



US00D950897S

(12) **United States Design Patent** (10) **Patent No.:** **US D950,897 S**
Blondeau (45) **Date of Patent:** **** May 10, 2022**

(54) **FOOTWEAR**
(71) Applicant: **Daniel R. Blondeau**, Kowloon (HK)
(72) Inventor: **Daniel R. Blondeau**, Kowloon (HK)
(**) Term: **15 Years**
(21) Appl. No.: **29/732,590**
(22) Filed: **Apr. 25, 2020**
(51) **LOC (13) Cl.** **02-04**
(52) **U.S. Cl.**
USPC **D2/917; D2/896**
(58) **Field of Classification Search**
USPC D2/896, 897, 901, 910-913, 916, 917,
D2/925, 946, 970, 971, 980, 989
CPC A41B 17/00; A43B 5/12; A43B 3/126;
A43B 5/08; A43B 7/14-145
See application file for complete search history.

D503,848 S * 4/2005 Le D2/969
D560,346 S * 1/2008 Belley D2/917
D569,081 S * 5/2008 Haft D2/919
D575,483 S * 8/2008 Taco D2/916
D661,875 S * 6/2012 Kelley D2/910
8,434,245 B2 5/2013 Bell et al.
8,438,756 B2* 5/2013 Kelley A43B 3/12
36/11.5
D803,543 S * 11/2017 Scott D2/980
10,383,401 B2 8/2019 Kilgore
2007/0199210 A1 8/2007 Vattes et al.
2018/0343956 A1 12/2018 Li et al.

FOREIGN PATENT DOCUMENTS

DE 8132143 1/1982
WO WO2012/140567 10/2012
WO WO2014/194395 12/2014

* cited by examiner

Primary Examiner — Rashida C. Walshon

(57) **CLAIM**

I claim the ornamental design for a footwear, as shown and described.

DESCRIPTION

FIG. 1 is a perspective side view showing my new design; FIG. 2 is a right elevation side view thereof; FIG. 3 is a left elevation side view thereof; FIG. 4 is a front elevation view thereof; FIG. 5 is a rear elevation view thereof; FIG. 6 is a top view thereof; and, FIG. 7 is bottom view thereof.
In the drawings, the broken lines are for the purpose of illustrating environment only and form no part of the claimed design.

1 Claim, 5 Drawing Sheets

(56) **References Cited**
U.S. PATENT DOCUMENTS

1,104,357 A 7/1914 Hassen
1,201,927 A 10/1916 Blum
2,457,630 A 12/1948 Beetson
2,679,117 A 5/1954 Reed
2,682,713 A 7/1954 Eiger
2,974,427 A 3/1961 Wolff
3,568,338 A 3/1971 Nadler
4,030,212 A 6/1977 Ito
4,194,308 A 3/1980 Karlsson
4,476,600 A 10/1984 Seidel et al.
5,604,997 A 2/1997 Dieter
D451,663 S * 12/2001 Haas D2/916
D465,906 S * 11/2002 Petrovski D2/916

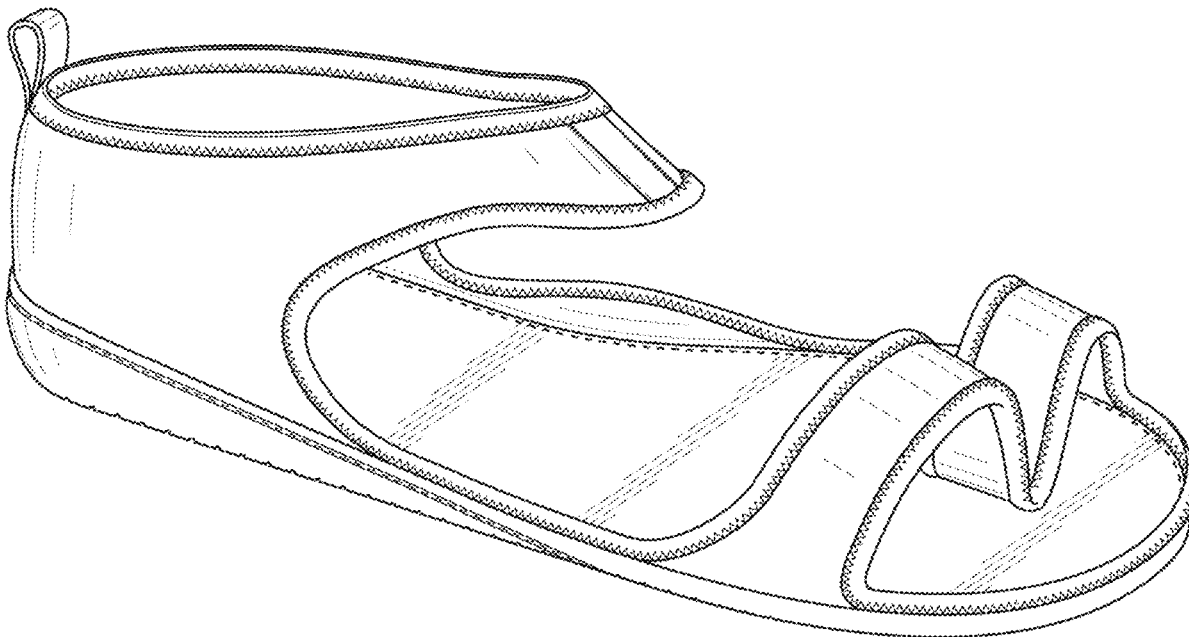

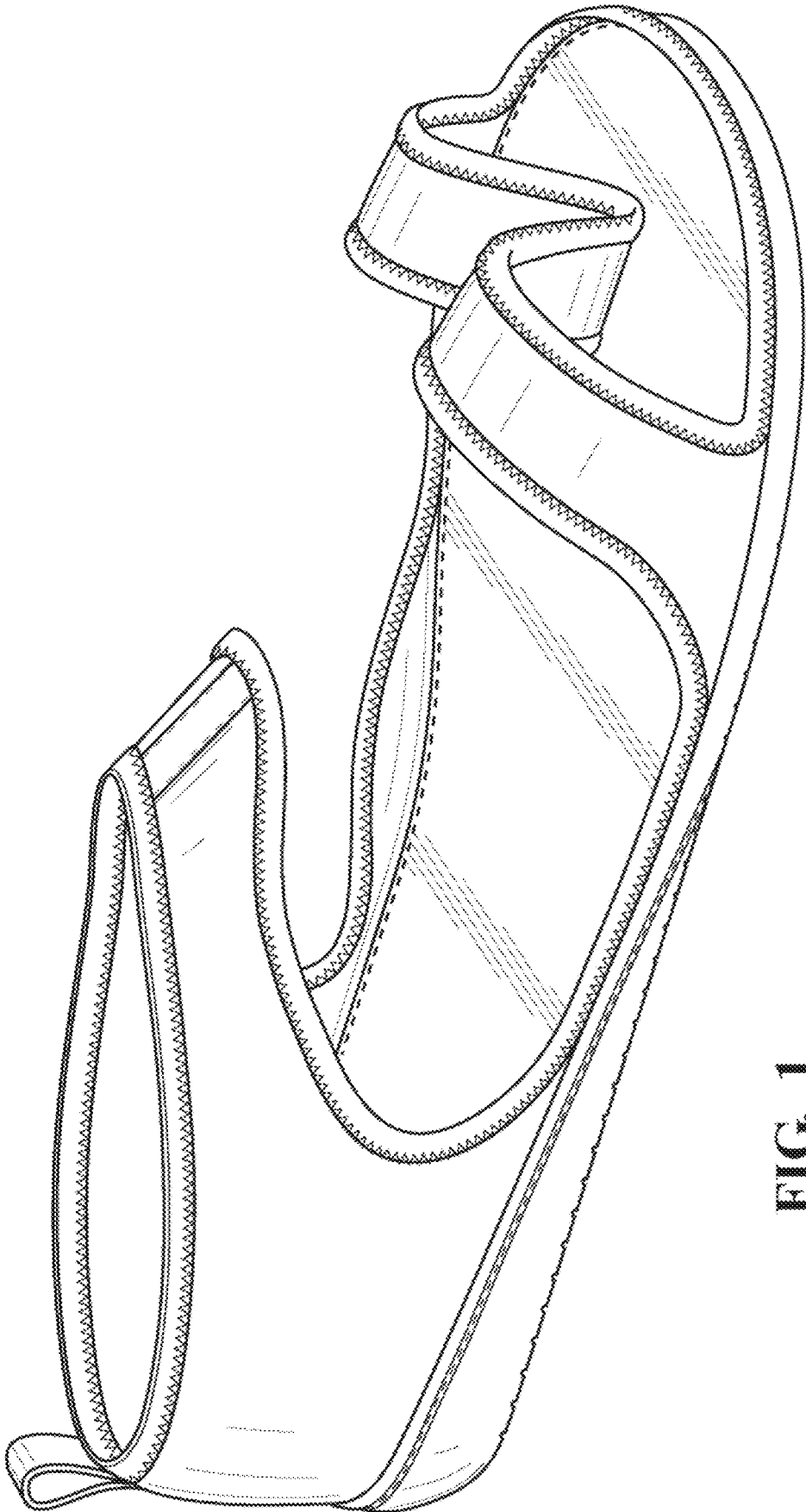

FIG. 1

FIG. 2

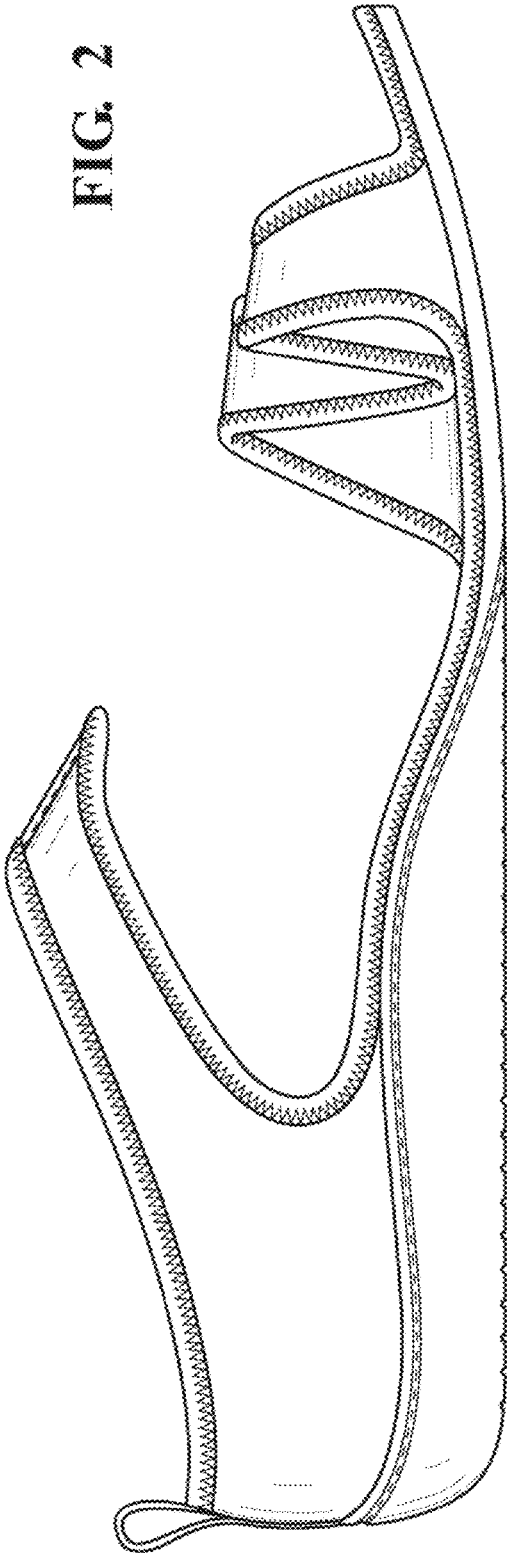
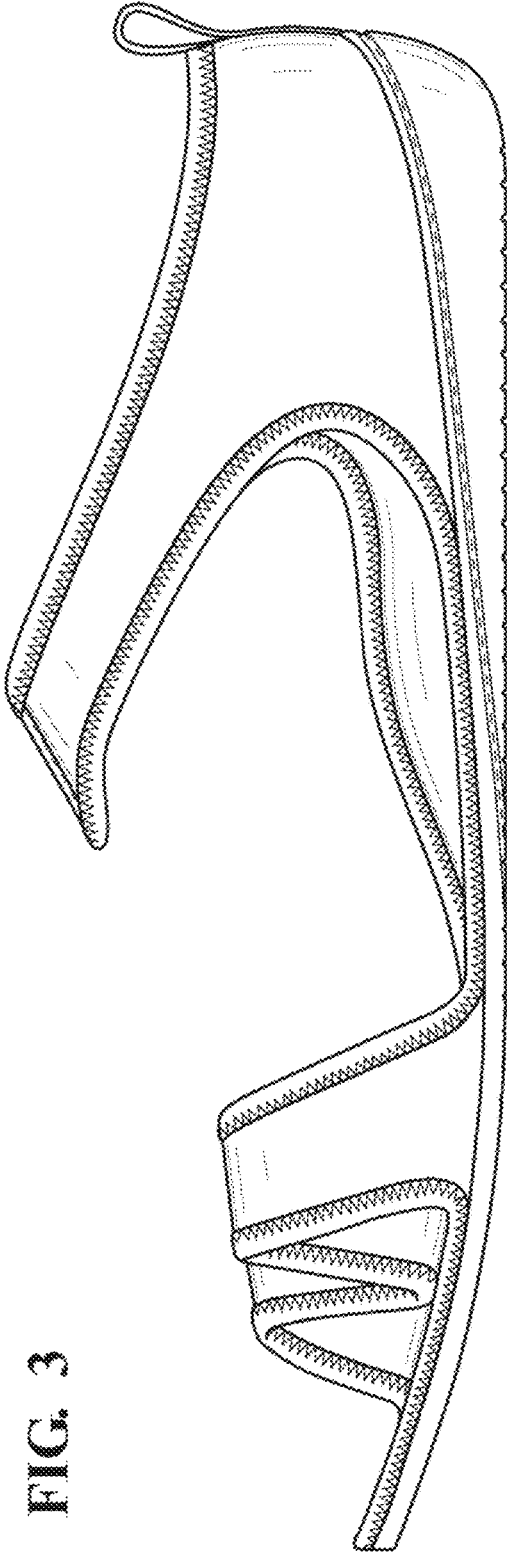

FIG. 3



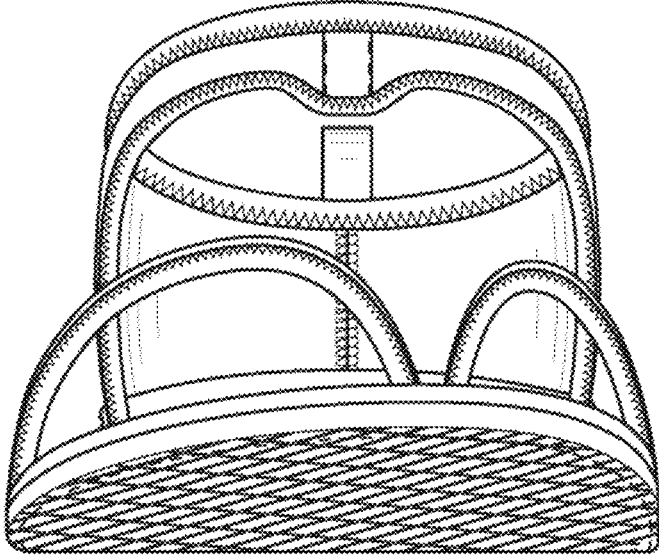

FIG. 4

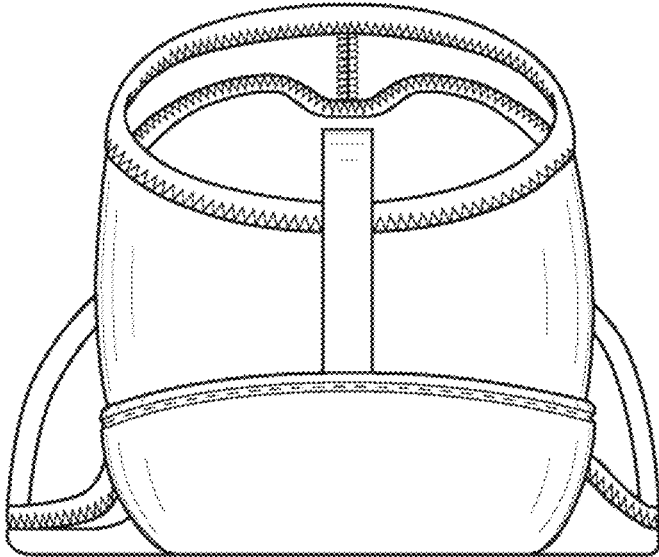

FIG. 5

FIG. 6

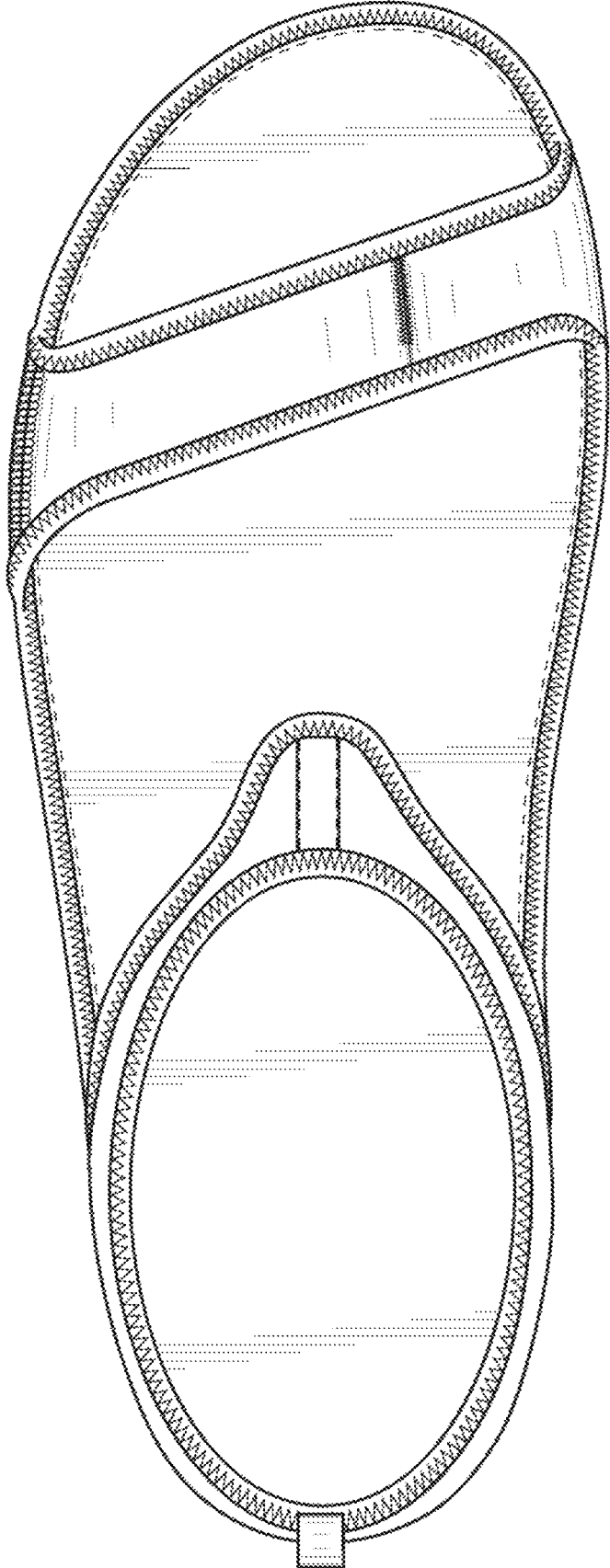

FIG. 7

