



US00D382108S

United States Patent [19]

Wheeler, Sr.

[11] Patent Number: Des. 382,108

[45] Date of Patent: **Aug. 12, 1997

[54] TACKLE BOX COVER

[76] Inventor: **Brian J. Wheeler, Sr.**, P.O. Box 2112, Waterville, Me. 04903-2112

[**] Term: 14 Years

[21] Appl. No.: 43,541

[22] Filed: Sep. 6, 1995

[51] LOC (6) Cl. 03-01

[52] U.S. Cl. D3/260; D3/905

[58] Field of Search D3/260, 273, 904, D3/905; 224/920; 43/25.2, 26, 54.1, 57.1; 383/106

[56] References Cited

U.S. PATENT DOCUMENTS

D. 257,906	1/1981	Weinreb	D3/283	X
D. 362,548	9/1995	King et al.	D3/902	X
1,869,071	7/1932	McLean	D3/904	X
4,506,769	3/1985	Franco et al.	190/110	X
4,657,135	4/1987	Kjose	190/18	X

4,671,008	6/1987	Lindemood	43/54.1
4,691,469	9/1987	Alsobrook et al.	43/54.1
4,782,873	11/1988	Messner et al.	312/249.11 X
4,852,293	8/1989	Levine et al.	43/54.1

Primary Examiner—Doris V. Coles
Assistant Examiner—Catherine R. Oliver

[57] CLAIM

The ornamental design for a tackle box cover, as shown and described.

DESCRIPTION

FIG. 1 is a front perspective view of a tackle box cover showing my new design;
 FIG. 2 is a top view of FIG. 1;
 FIG. 3 is a front elevation view of FIG. 1;
 FIG. 4 is a rear elevation view of FIG. 1;
 FIG. 5 is a side elevational view;
 FIG. 6 is a bottom view of FIG. 1; and
 FIG. 7 is an opposite side elevational view.

1 Claim, 4 Drawing Sheets

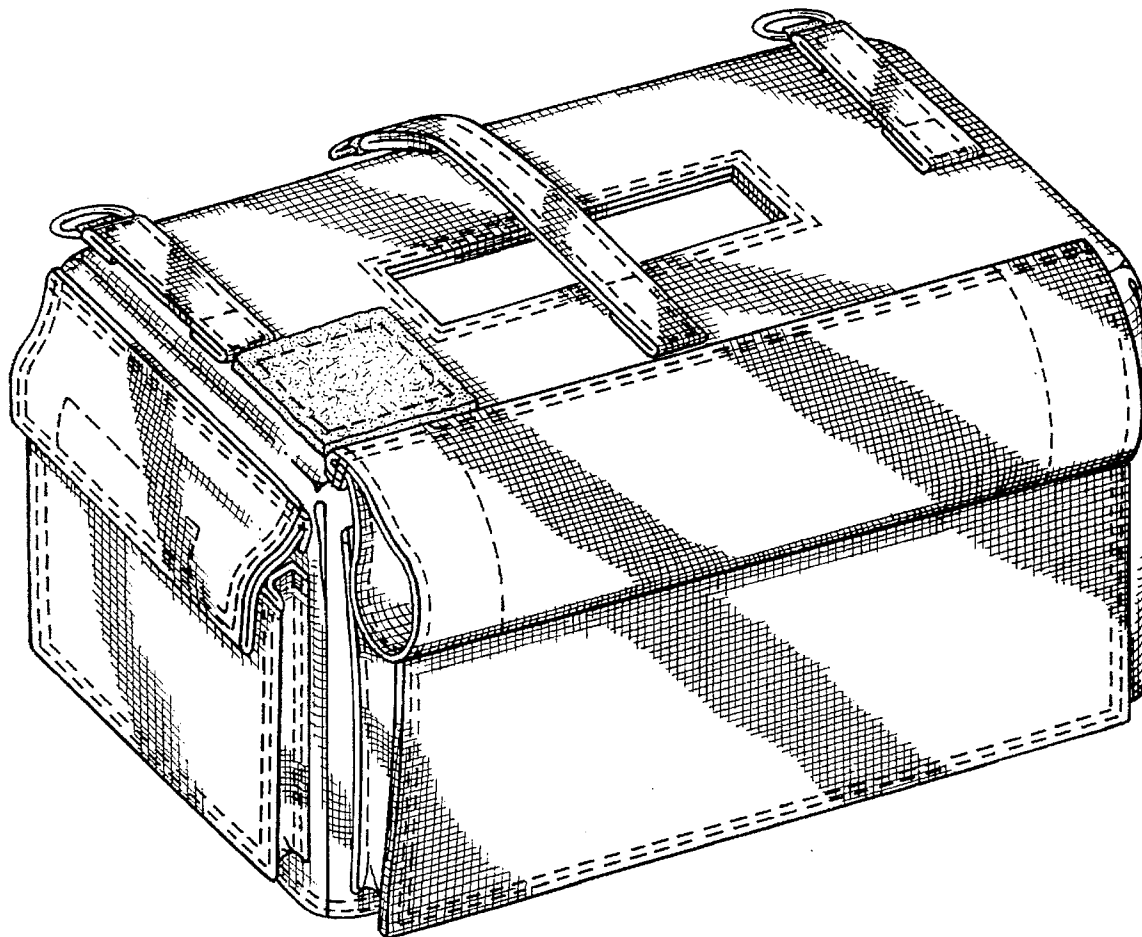

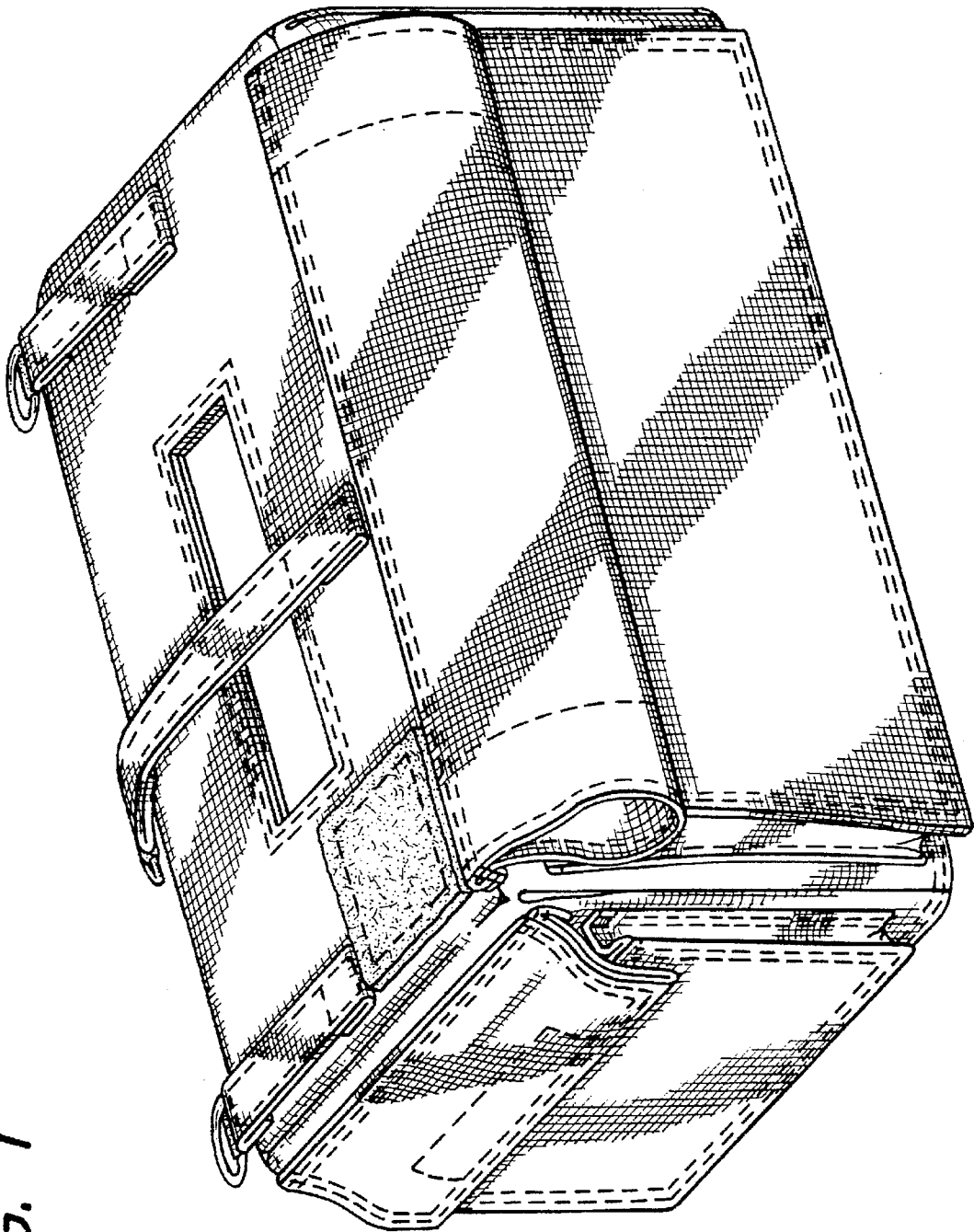

FIG. 1

FIG. 2

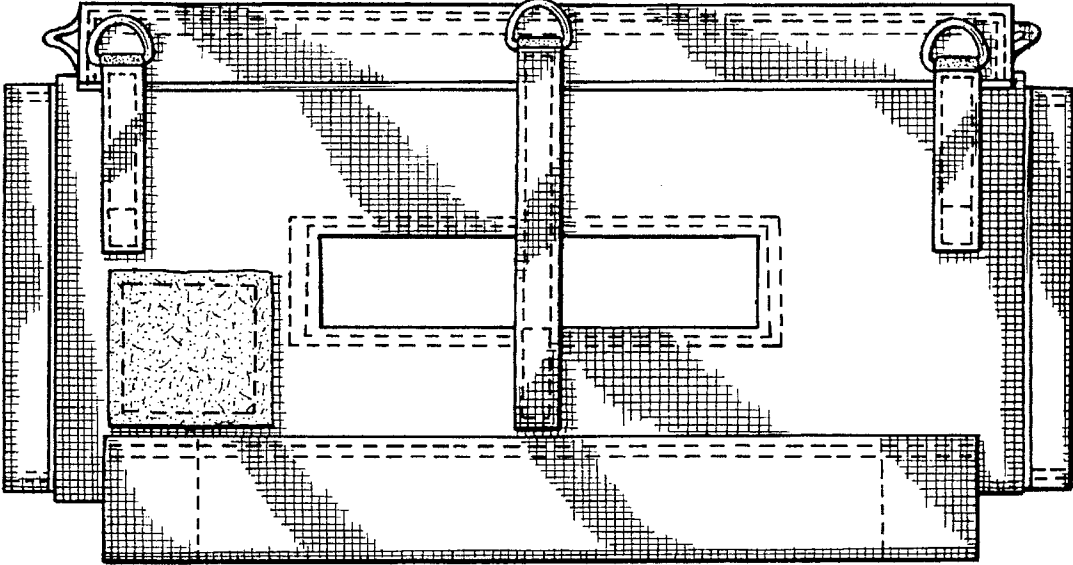

FIG. 3

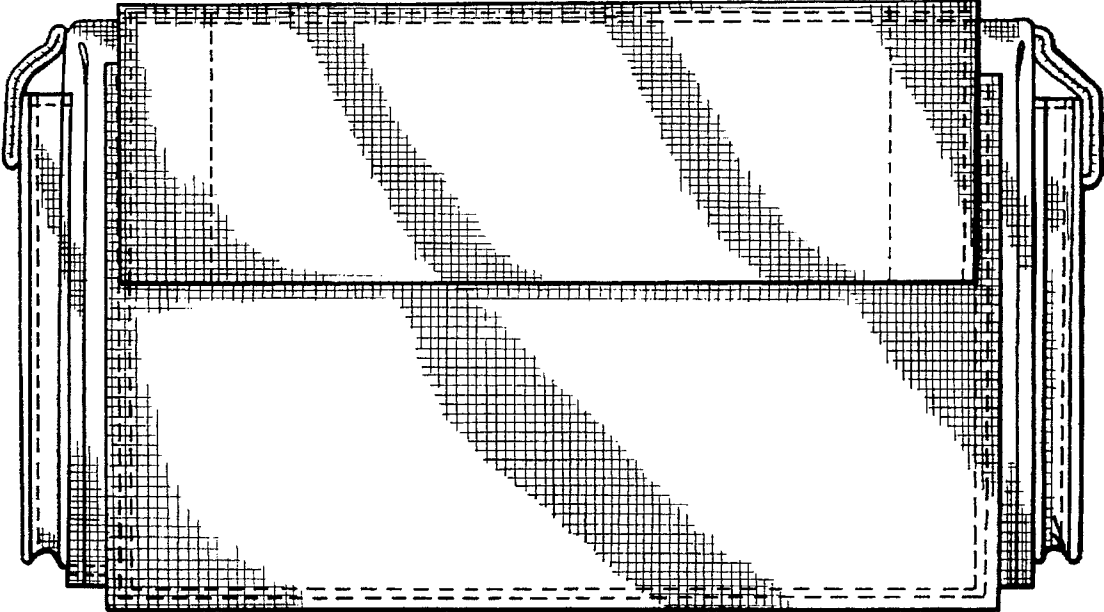

FIG. 4

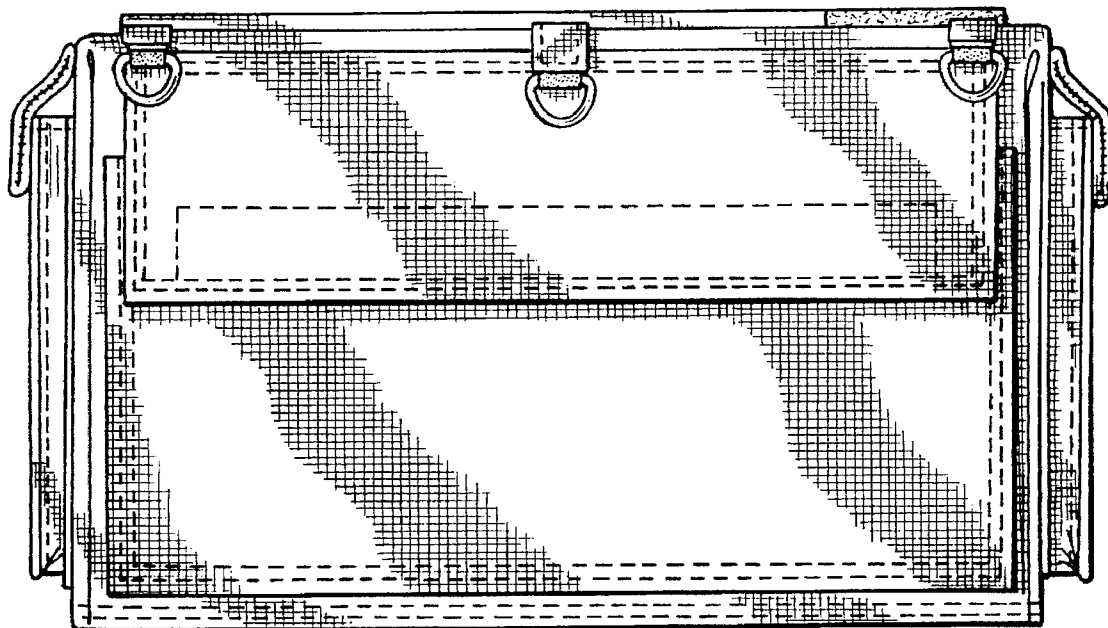

FIG. 5

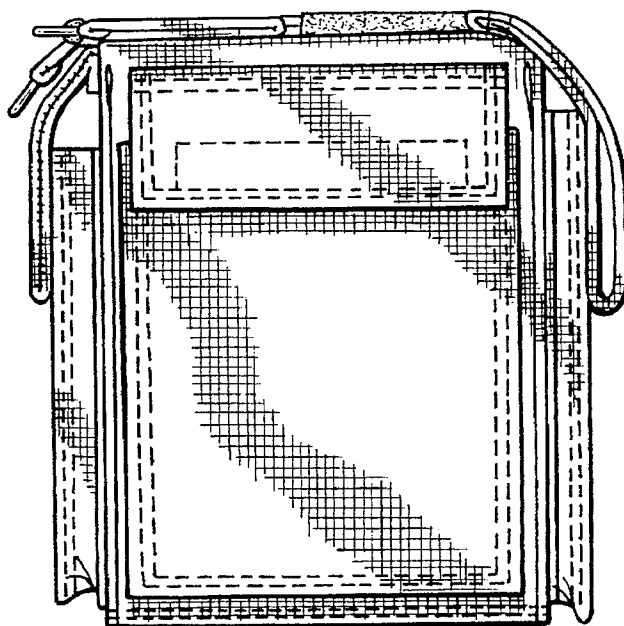

FIG. 6

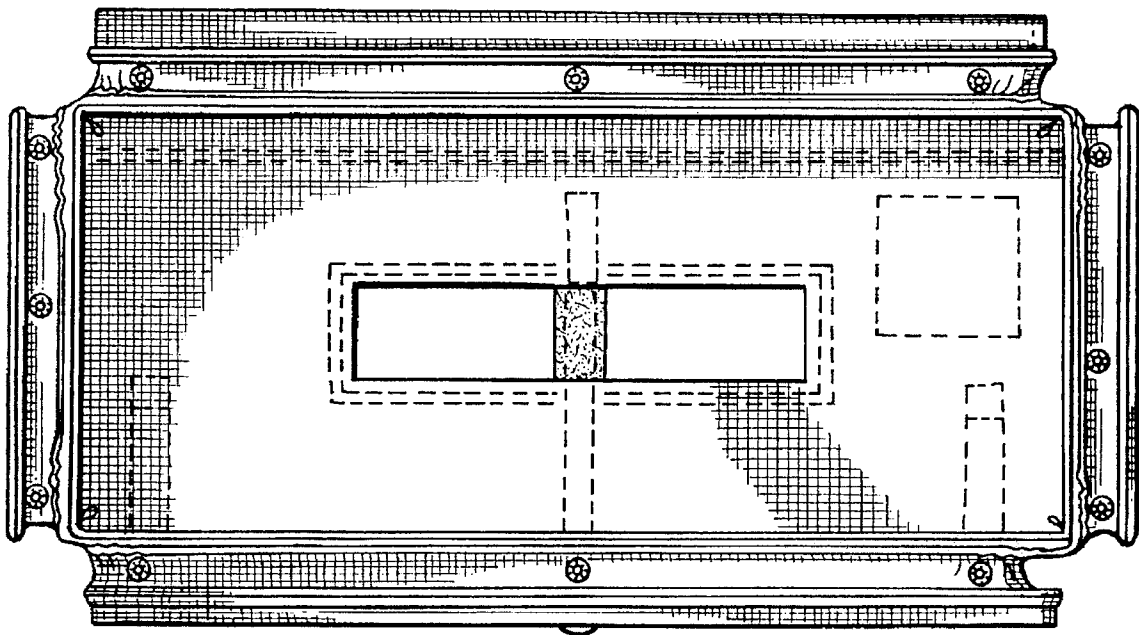

FIG. 7

