



US00D737490S

(12) **United States Design Patent**
Tompkin

(10) **Patent No.:** **US D737,490 S**

(45) **Date of Patent:** **** Aug. 25, 2015**

(54) **FLASHLIGHT HEAD**

(71) Applicant: **MerchSource, LLC**, Foothill Ranch, CA (US)

(72) Inventor: **Crispian Tompkin**, Los Angeles, CA (US)

(73) Assignee: **MerchSource, LLC**, Irvine, CA (US)

(**) Term: **14 Years**

(21) Appl. No.: **29/435,266**

(22) Filed: **Oct. 22, 2012**

(51) **LOC (10) Cl.** **26-02**

(52) **U.S. Cl.**

USPC **D26/46; D26/44**

(58) **Field of Classification Search**

USPC D26/37, 38, 40, 41, 44, 45, 46, 49;
362/157, 158, 183, 184, 171-174,
362/194-196, 200-208

CPC F21L 2/00; F21L 4/00; F21L 4/005;
F21L 17/00; F21L 13/08; F21Y 2101/00;
F21V 21/30; F21V 21/406; F21W 2131/406;
F21W 2131/407

See application file for complete search history.

(56) **References Cited**

U.S. PATENT DOCUMENTS

| | | | | |
|-----------|------|---------|--------------------|---------|
| 4,447,863 | A | 5/1984 | Fenne | |
| 5,142,467 | A | 8/1992 | Yuen | |
| 5,384,609 | A * | 1/1995 | Ogawa et al. | 396/419 |
| D505,218 | S * | 5/2005 | Van Deursen | D26/49 |
| D546,489 | S * | 7/2007 | Yuen | D26/42 |
| D554,788 | S * | 11/2007 | Chapman | D26/49 |
| 7,296,909 | B2 * | 11/2007 | Van Deursen et al. | 362/199 |
| D562,480 | S * | 2/2008 | Spartano et al. | D26/46 |
| D562,482 | S * | 2/2008 | Larkin | D26/49 |
| 7,342,360 | B2 | 3/2008 | Van Duersen et al. | |
| D574,529 | S * | 8/2008 | Squires et al. | D26/49 |
| D577,450 | S * | 9/2008 | Shiu | D26/49 |
| D593,240 | S * | 5/2009 | Caniparoli | D26/49 |
| D607,591 | S * | 1/2010 | Rivera et al. | D26/49 |

| | | | | |
|--------------|------|---------|------------------|---------|
| D610,728 | S * | 2/2010 | Baker et al. | D26/49 |
| D623,785 | S * | 9/2010 | Wessel | D26/49 |
| D623,786 | S * | 9/2010 | Wessel | D26/49 |
| D625,035 | S * | 10/2010 | Vanderbeek | D26/48 |
| D632,411 | S * | 2/2011 | Vanderbeek | D26/48 |
| 8,087,797 | B2 * | 1/2012 | Pelletier et al. | 362/205 |
| 8,262,248 | B2 * | 9/2012 | Wessel | 362/198 |
| D687,583 | S * | 8/2013 | von Waldthausen | D26/46 |
| D693,951 | S * | 11/2013 | Rugendyke et al. | D26/46 |
| 2003/0067771 | A1 | 4/2003 | Kung | |
| 2010/0182777 | A1 | 7/2010 | Van Duersen | |

* cited by examiner

Primary Examiner — Ian Simmons

Assistant Examiner — Carissa C Fitts

(74) *Attorney, Agent, or Firm* — Avyno Law P.C.

(57) **CLAIM**

I claim the ornamental design for a flashlight head, as shown and described.

DESCRIPTION

FIG. 1 is a perspective view of a flashlight head.
 FIG. 2 is a top view of the flashlight head as illustrated in FIG. 1.
 FIG. 3 is a left side elevation view of the flashlight head as illustrated in FIG. 1.
 FIG. 4 is a rear elevation view of the flashlight head as illustrated in FIG. 1.
 FIG. 5 is a right side elevation view of the flashlight head as illustrated in FIG. 1.
 FIG. 6 is a front view of the flashlight head as illustrated in FIG. 1.
 FIG. 7 is a rear view of the flashlight head as illustrated in FIG. 1.
 FIG. 8 is a perspective view of the flashlight head showing the legs of the tripod in an open position; and,
 FIG. 9 is another alternative perspective view of the flashlight head device showing the legs of the tripod in an open position. The dashed lines in various figures are for illustrative purposes only and form no part of the claimed design.

1 Claim, 5 Drawing Sheets

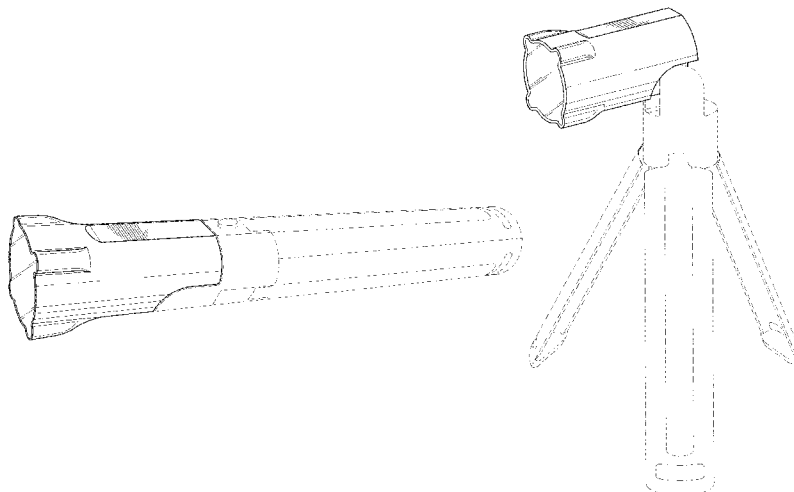
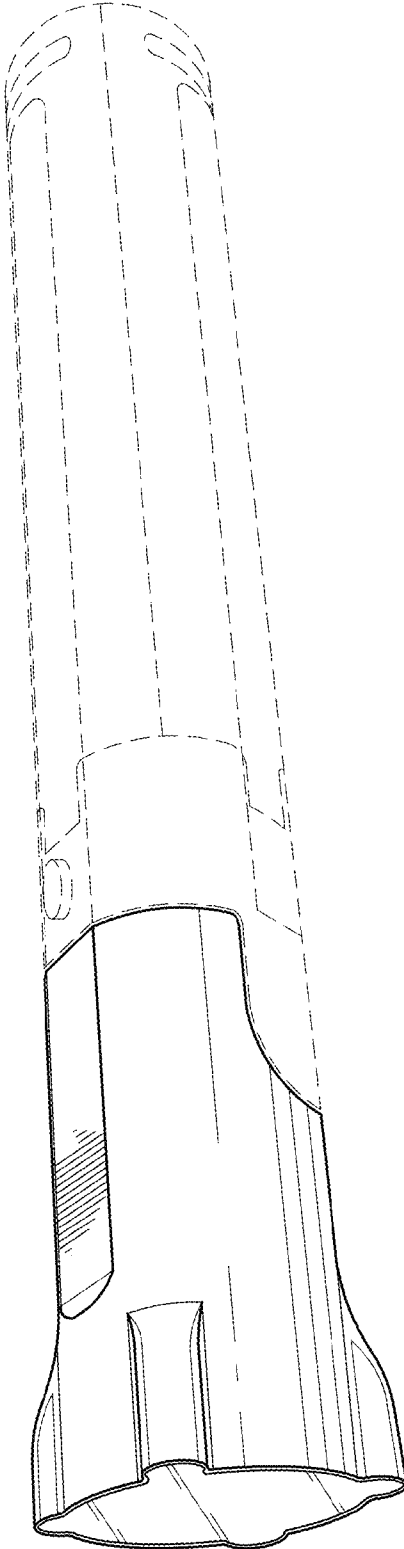

FIG. 1



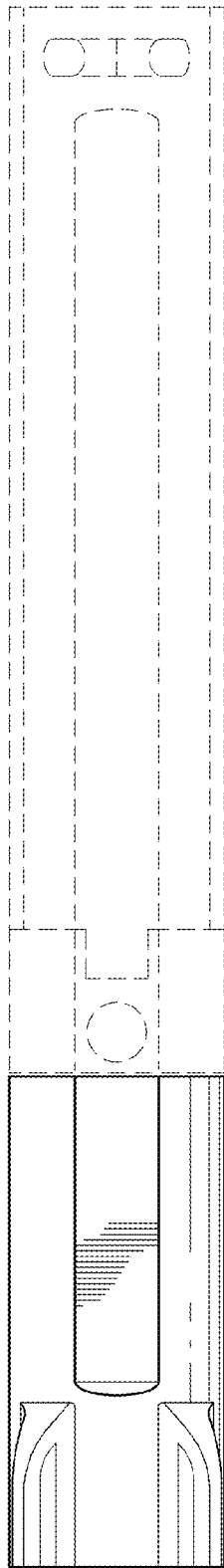

FIG. 2

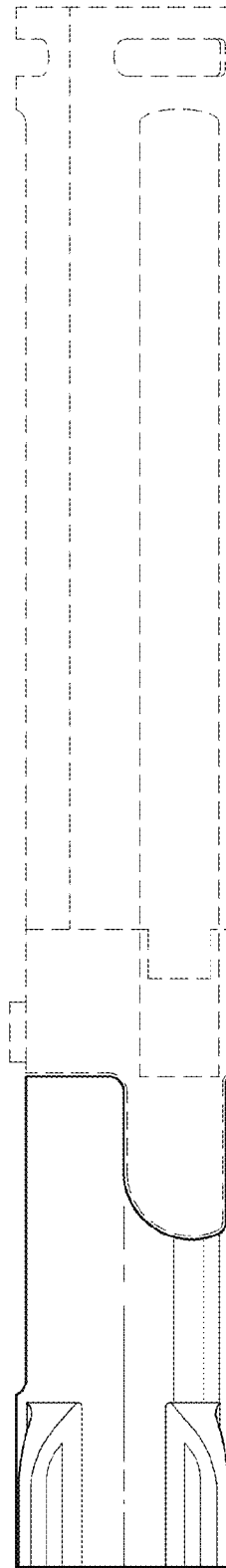

FIG. 3

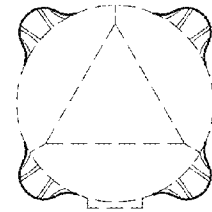
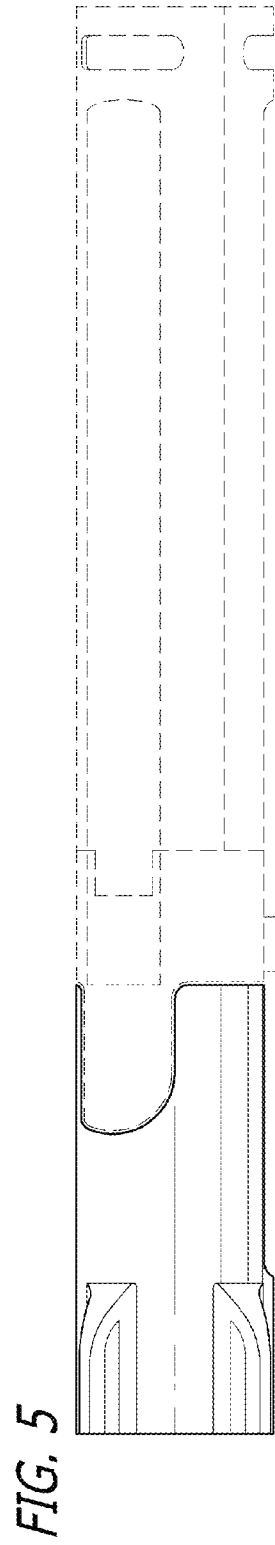
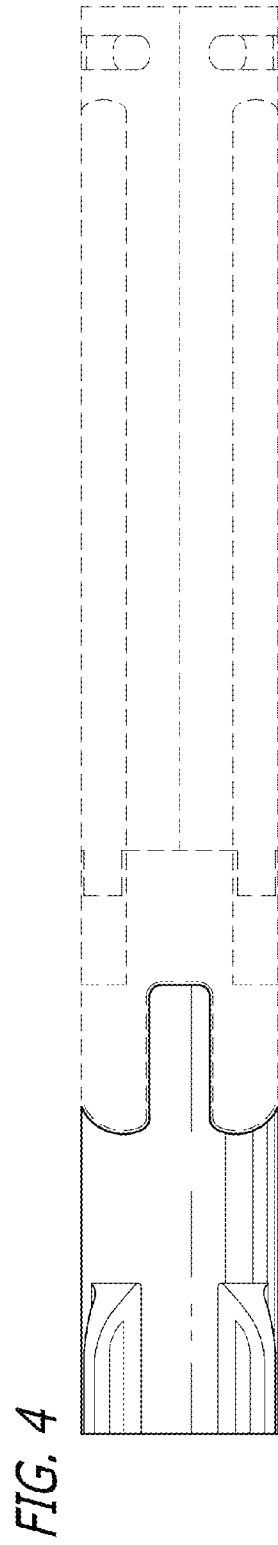

FIG. 7

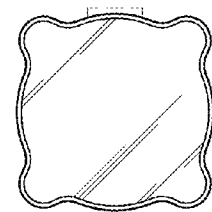

FIG. 6

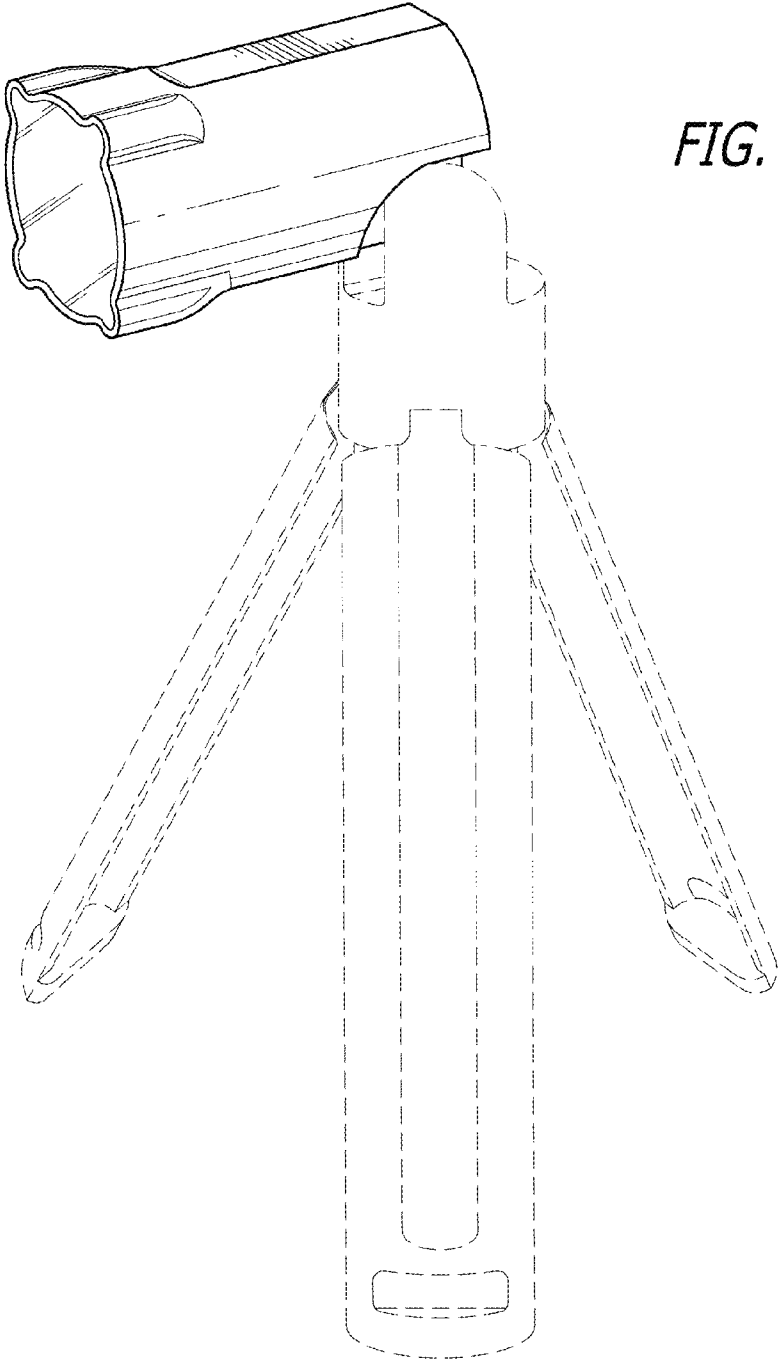

FIG. 8

FIG. 9

