



US00D843965S

(12) **United States Design Patent**  
Su et al.

(10) **Patent No.:** US D843,965 S  
(45) **Date of Patent:** \*\* Mar. 26, 2019

(54) **IP DESKTOP PHONE**  
(71) Applicant: **YEALINK (XIAMEN) NETWORK TECHNOLOGY CO., LTD.**, Xiamen (CN)  
(72) Inventors: **Jingfeng Su**, Xiamen (CN); **Jiancheng Zhang**, Xiamen (CN); **Weicen Xu**, Xiamen (CN)  
(73) Assignee: **YEALINK (XIAMEN) NETWORK TECHNOLOGY CO., LTD.**, Xiamen (CN)  
(\*\*) Term: **15 Years**  
(21) Appl. No.: **29/583,781**  
(22) Filed: **Nov. 9, 2016**

(30) **Foreign Application Priority Data**

Aug. 27, 2016 (CN) ..... 2016 3 0431930  
Aug. 27, 2016 (CN) ..... 2016 3 0432047

(51) **LOC (11) Cl.** ..... **14-03**  
(52) **U.S. Cl.**  
USPC ..... **D14/151**

(58) **Field of Classification Search**

USPC ... D14/140, 140.1, 140.7, 140.8, 141.2, 142, D14/144, 147, 148, 149, 150, 151, 158, D14/159, 188, 217, 240, 243, 247, 248, D14/251, 299, 329, 462, 467, 471, 130; D21/517  
CPC ..... H04M 1/00; H04M 1/003; H04M 1/006; H04M 1/02; H04M 1/0297; H04M 1/03; H04M 1/0214; H04M 1/6041; H04M 1/6066; H04M 1/23; H04M 1/253; H04M 1/2535; H04M 7/006  
See application file for complete search history.

(56) **References Cited**

U.S. PATENT DOCUMENTS

D271,972 S \* 12/1983 Genaro ..... D14/149  
D304,564 S \* 11/1989 Kido ..... D14/151

D306,444 S \* 3/1990 Fried ..... D14/151  
D312,459 S \* 11/1990 Oshima ..... D14/151  
D313,235 S \* 12/1990 Kido ..... D14/151  
D321,188 S \* 10/1991 Gordon ..... D14/142  
D332,263 S \* 1/1993 Taniguchi ..... D14/151  
5,412,417 A \* 5/1995 Tozuka ..... H04N 7/142  
348/14.01  
D381,981 S \* 8/1997 Johansson ..... D14/151  
D394,259 S \* 5/1998 Langlois ..... D14/151  
5,761,297 A \* 6/1998 Kingsbury ..... H04M 1/0295  
379/428.03  
D398,302 S \* 9/1998 Lio ..... D14/130  
D405,447 S \* 2/1999 Landry ..... D14/151  
D410,005 S \* 5/1999 Landry ..... D14/151  
D412,171 S \* 7/1999 Girardi ..... D14/151  
D427,985 S \* 7/2000 Takayama ..... D14/130  
D457,870 S \* 5/2002 Toyoshima ..... D14/130  
D470,830 S \* 2/2003 Weidinger ..... D14/151  
D472,540 S \* 4/2003 Katou ..... D14/151  
6,618,903 B2 \* 9/2003 Kim ..... H04M 1/02  
16/337  
D489,700 S \* 5/2004 Hillenmayer ..... D14/151  
D490,393 S \* 5/2004 Taniguchi ..... D14/151  
D490,394 S \* 5/2004 Taniguchi ..... D14/151  
D490,795 S \* 6/2004 Watanabe ..... D14/151  
D499,713 S \* 12/2004 Shibata ..... D14/151  
D500,482 S \* 1/2005 Shibata ..... D14/151  
D501,840 S \* 2/2005 Pelletier ..... D14/151  
D511,761 S \* 11/2005 Robinson ..... D14/151  
D512,705 S \* 12/2005 Bhavnani ..... D14/151  
D515,063 S \* 2/2006 Yanagisawa ..... D14/151  
D529,477 S \* 10/2006 Hsu ..... D14/151  
D530,303 S \* 10/2006 Tang ..... D14/151  
D537,065 S \* 2/2007 Chen ..... D14/151  
D550,195 S \* 9/2007 Ju ..... D14/151  
D551,203 S \* 9/2007 Abe ..... D14/151  
D552,588 S \* 10/2007 Park ..... D14/151  
D555,143 S \* 11/2007 Chou ..... D14/151  
D557,249 S \* 12/2007 Weidinger ..... D14/151  
D558,729 S \* 1/2008 Daly ..... D14/151  
D558,730 S \* 1/2008 Nakashima ..... D14/151  
D597,061 S \* 7/2009 Akatsu ..... D14/151  
D600,670 S \* 9/2009 Akatsu ..... D14/151  
D600,671 S \* 9/2009 Akatsu ..... D14/151  
D601,118 S \* 9/2009 Akatsu ..... D14/151  
D601,119 S \* 9/2009 Akatsu ..... D14/151  
D605,615 S \* 12/2009 Fuxen ..... D14/130  
D664,520 S \* 7/2012 Shadovitz ..... D14/150  
D739,373 S \* 9/2015 Hillenmayer ..... D14/144  
9,210,259 B2 \* 12/2015 Schaade ..... H04L 12/12  
D781,809 S \* 3/2017 Schwarz ..... D14/151

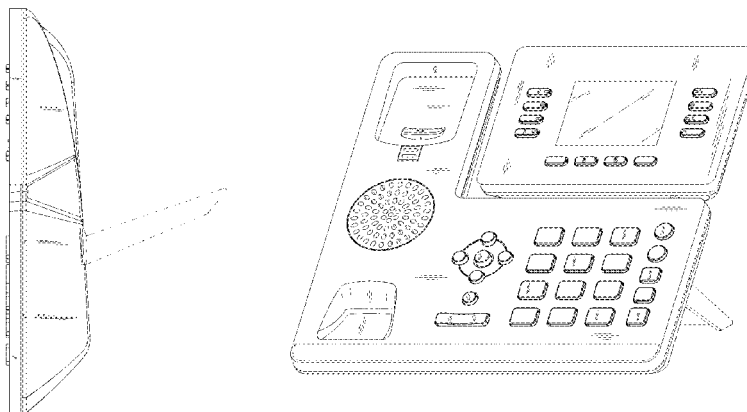

D782,994 S \* 4/2017 Schwarz ..... D14/151  
 D788,737 S \* 6/2017 Takei ..... D14/151  
 2004/0247113 A1\* 12/2004 Akatsu ..... H04M 1/02  
 379/419

## OTHER PUBLICATIONS

Desktop Telephones. (Design—©Questel) orbit.com.[online PDF]  
 164 pgs. Print Dates range Oct. 24, 2001 through Jun. 9, 2017.  
 [Retrieved on Feb. 14, 2018] <https://sobjprd.questel.fr/export/QPTUJ214/pdf2/35ea2805-a93d-4904-ab95-58ae76507bf0-232743.pdf>.\*

\* cited by examiner

*Primary Examiner* — Marie D. Fast Horse  
 (74) *Attorney, Agent, or Firm* — Gokalp Bayramoglu

## (57) CLAIM

The ornamental design for an IP desktop phone, as shown and described.

## DESCRIPTION

FIG. 1 is a front view of a first embodiment of an IP desktop phone showing my new design;  
 FIG. 2 is a back view thereof;  
 FIG. 3 is a left view thereof;  
 FIG. 4 is a right view thereof;  
 FIG. 5 is a top view thereof;  
 FIG. 6 is a bottom view thereof;  
 FIG. 7 is a perspective view thereof;  
 FIG. 8 is another perspective view thereof with a phone receiver illustrated in broken lines;  
 FIG. 9 is another front view of the first embodiment, with the display shown in an alternate position for use;  
 FIG. 10 is a back view thereof;  
 FIG. 11 is a left view thereof;  
 FIG. 12 is a right view thereof;  
 FIG. 13 is a top view thereof;  
 FIG. 14 is a bottom view thereof;  
 FIG. 15 is a perspective view thereof;  
 FIG. 16 is another perspective view thereof with the phone receiver illustrated in broken lines;  
 FIG. 17 is a front view of a second embodiment of the IP desktop phone;  
 FIG. 18 is a back view thereof;  
 FIG. 19 is a left view thereof;  
 FIG. 20 is a right view thereof;  
 FIG. 21 is a top view thereof;  
 FIG. 22 is a bottom view thereof;  
 FIG. 23 is a perspective view thereof;  
 FIG. 24 is another perspective view thereof with the phone receiver illustrated in broken lines;  
 FIG. 25 is another front view of the second embodiment, with the display shown in an alternate position for use;  
 FIG. 26 is a back view thereof;  
 FIG. 27 is a left view thereof;  
 FIG. 28 is a right view thereof;  
 FIG. 29 is a top view thereof;  
 FIG. 30 is a bottom view thereof;  
 FIG. 31 is a perspective view thereof;

FIG. 32 is another perspective view thereof with the phone receiver illustrated in broken lines;

FIG. 33 is a front view of a third embodiment of the IP desktop phone with the display shown in the same position for use as what is shown in FIGS. 25-32, the only deviation from the second embodiment is the shape of the number-pad buttons;

FIG. 34 is a back view thereof;

FIG. 35 is a left view thereof;

FIG. 36 is a right view thereof;

FIG. 37 is a top view thereof;

FIG. 38 is a bottom view thereof;

FIG. 39 is a perspective view thereof;

FIG. 40 is another perspective view thereof with the phone receiver illustrated in broken lines;

FIG. 41 is a front view of a fourth embodiment of the IP desktop phone;

FIG. 42 is a back view thereof;

FIG. 43 is a left view thereof;

FIG. 44 is a right view thereof;

FIG. 45 is a top view thereof;

FIG. 46 is a bottom view thereof;

FIG. 47 is a perspective view thereof;

FIG. 48 is another perspective view thereof with the phone receiver illustrated in broken lines;

FIG. 49 is another front view of the fourth embodiment, with the display shown in an alternate position for use;

FIG. 50 is a back view thereof;

FIG. 51 is a left view thereof;

FIG. 52 is a right view thereof;

FIG. 53 is a top view thereof;

FIG. 54 is a bottom view thereof;

FIG. 55 is a perspective view thereof;

FIG. 56 is another perspective view thereof with the phone receiver illustrated in broken lines;

FIG. 57 is a front view of a fifth embodiment of the IP desktop phone;

FIG. 58 is a back view thereof;

FIG. 59 is a left view thereof;

FIG. 60 is a right view thereof;

FIG. 61 is a top view thereof;

FIG. 62 is a bottom view thereof;

FIG. 63 is a perspective view thereof;

FIG. 64 is another perspective view thereof with the phone receiver illustrated in broken lines;

FIG. 65 is another front view of the fifth embodiment, with the display shown in an alternate position for use;

FIG. 66 is a back view thereof;

FIG. 67 is a left view thereof;

FIG. 68 is a right view thereof;

FIG. 69 is a top view thereof;

FIG. 70 is a bottom view thereof;

FIG. 71 is a perspective view thereof; and,

FIG. 72 is another perspective view thereof with the phone receiver illustrated in broken lines.

The broken lines showing the phone receiver depict environmental subject matter only and form no part of the claim, while all other broken lines in the drawings depict portions of the IP desktop phone that form no part of the claimed design.

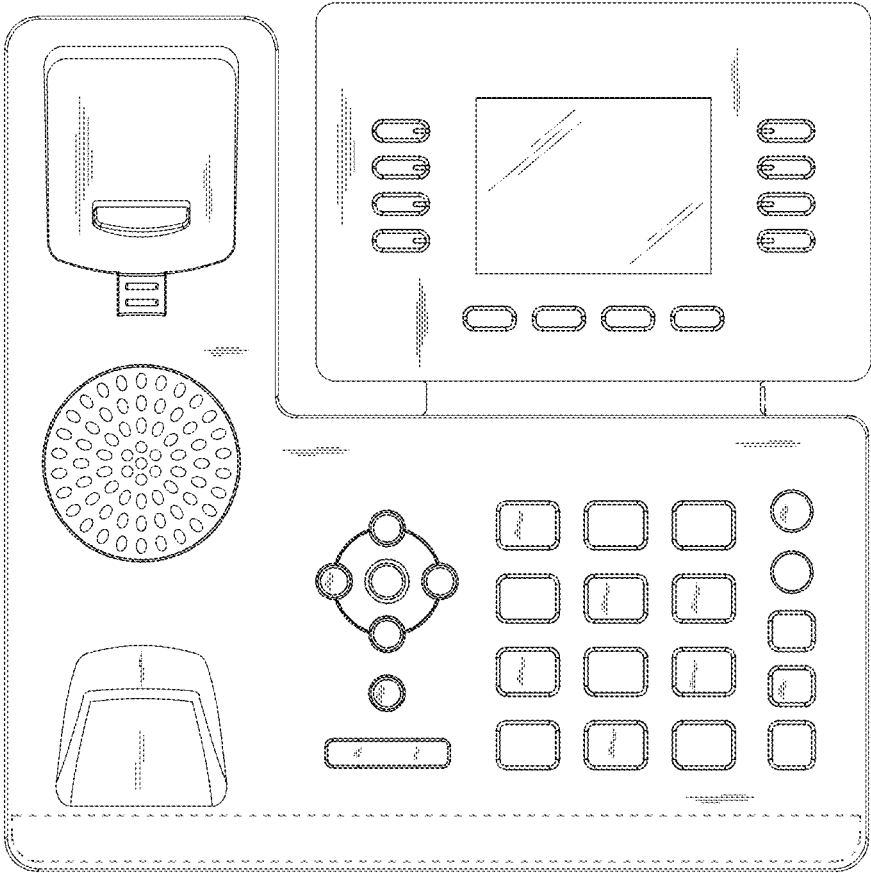

FIG. 1

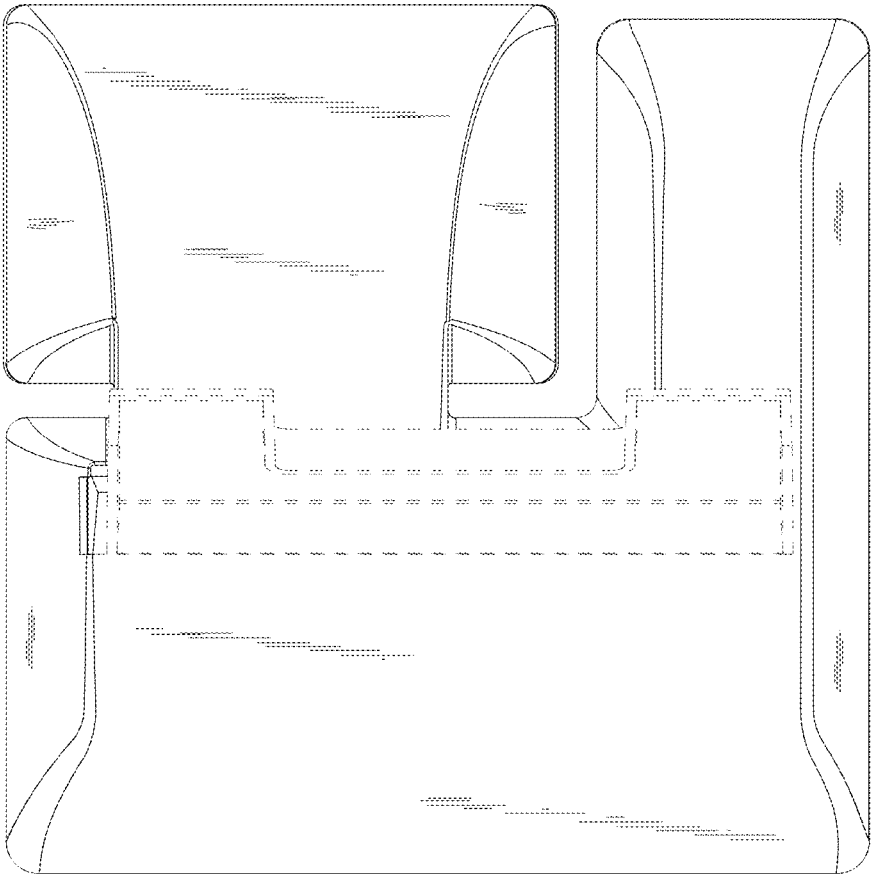

FIG. 2

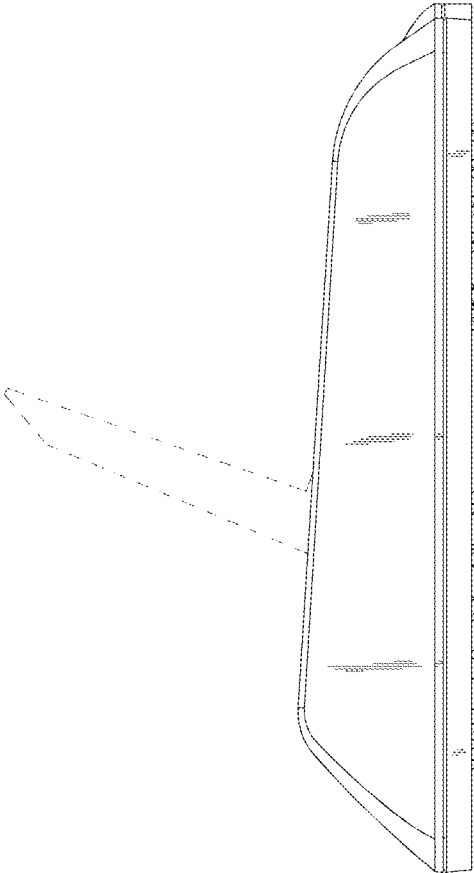

FIG. 3

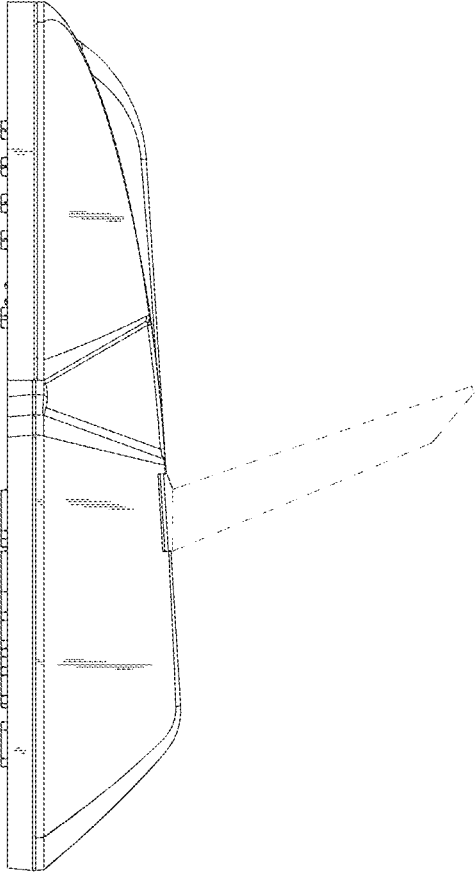

FIG. 4

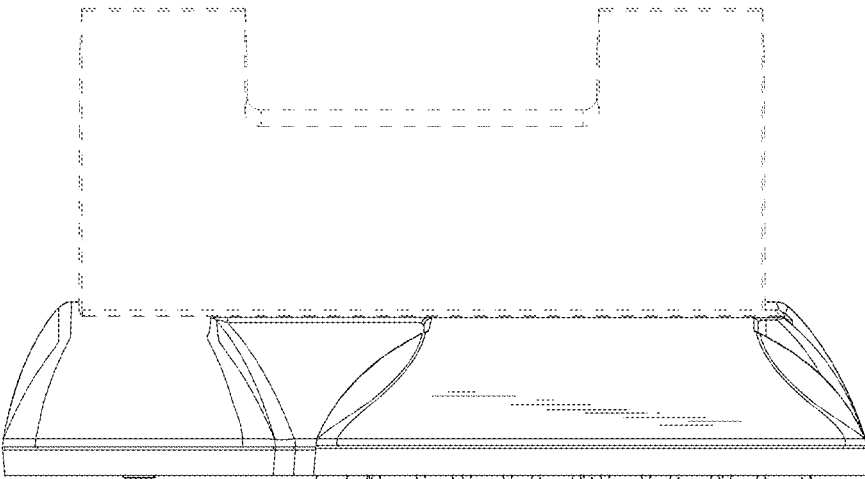

FIG. 5

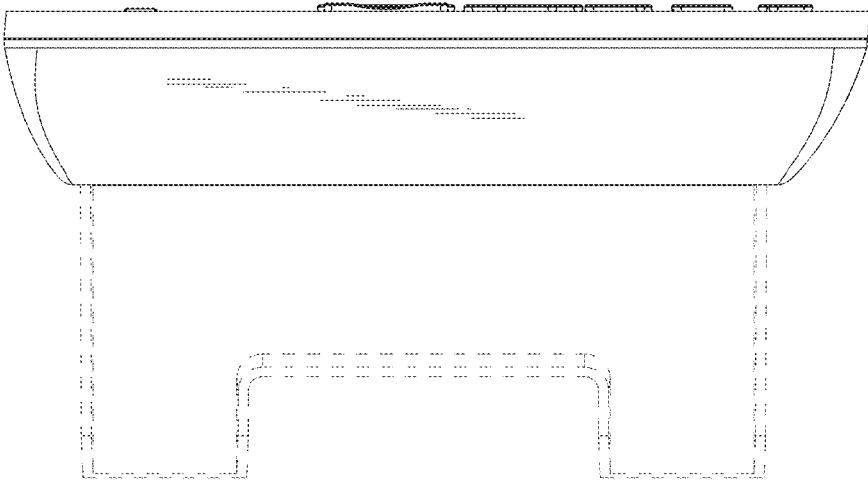

FIG. 6



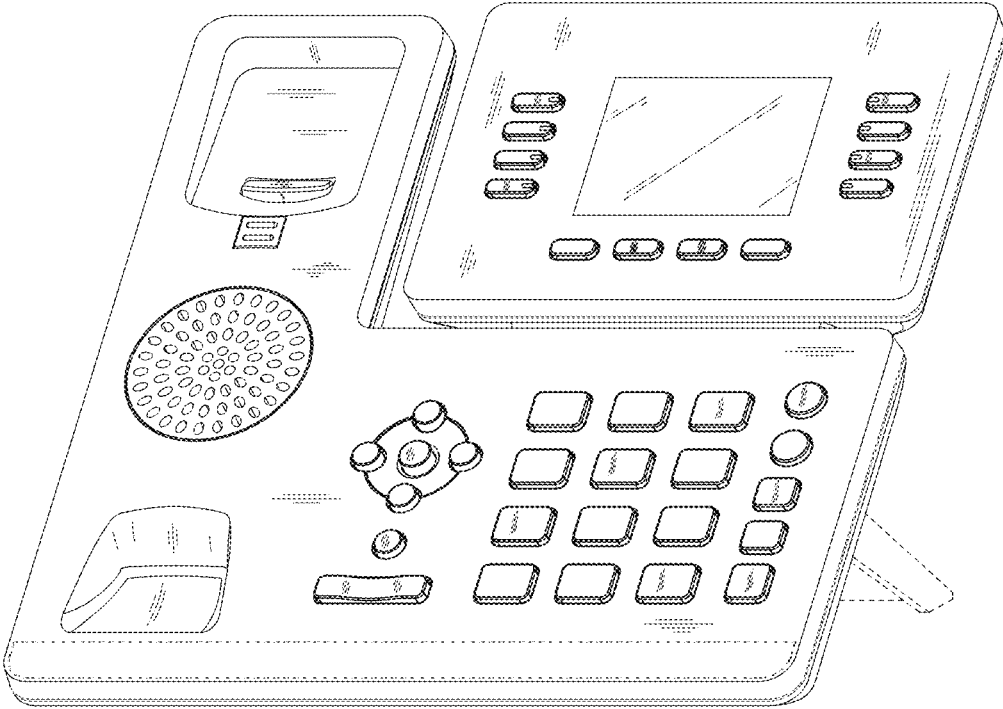

FIG. 7

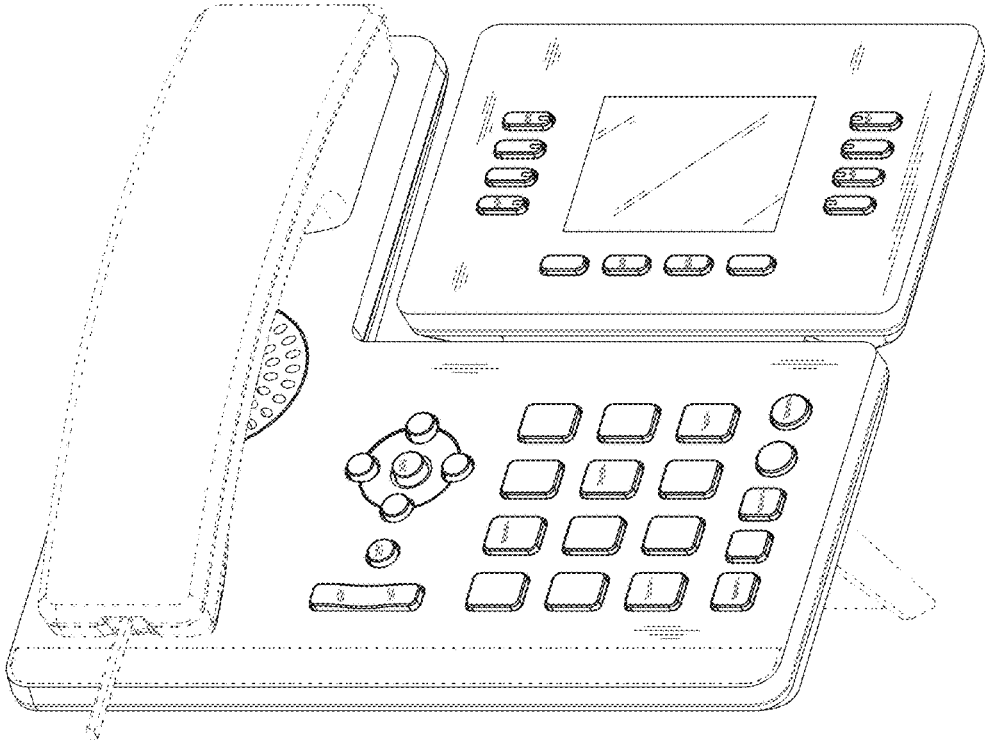

FIG. 8

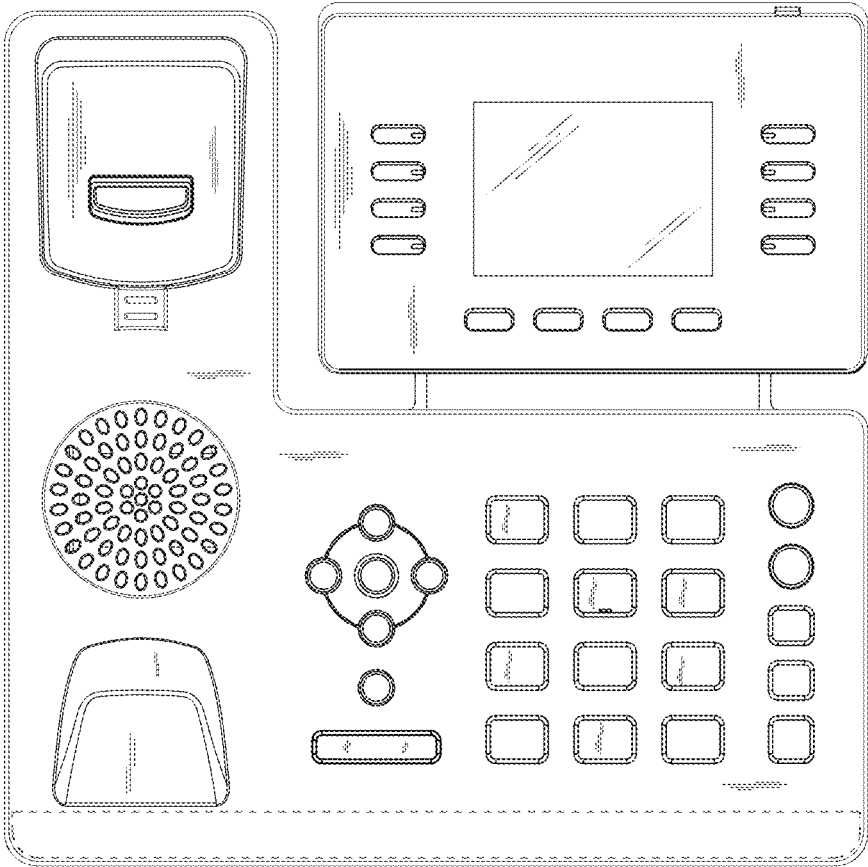

FIG. 9

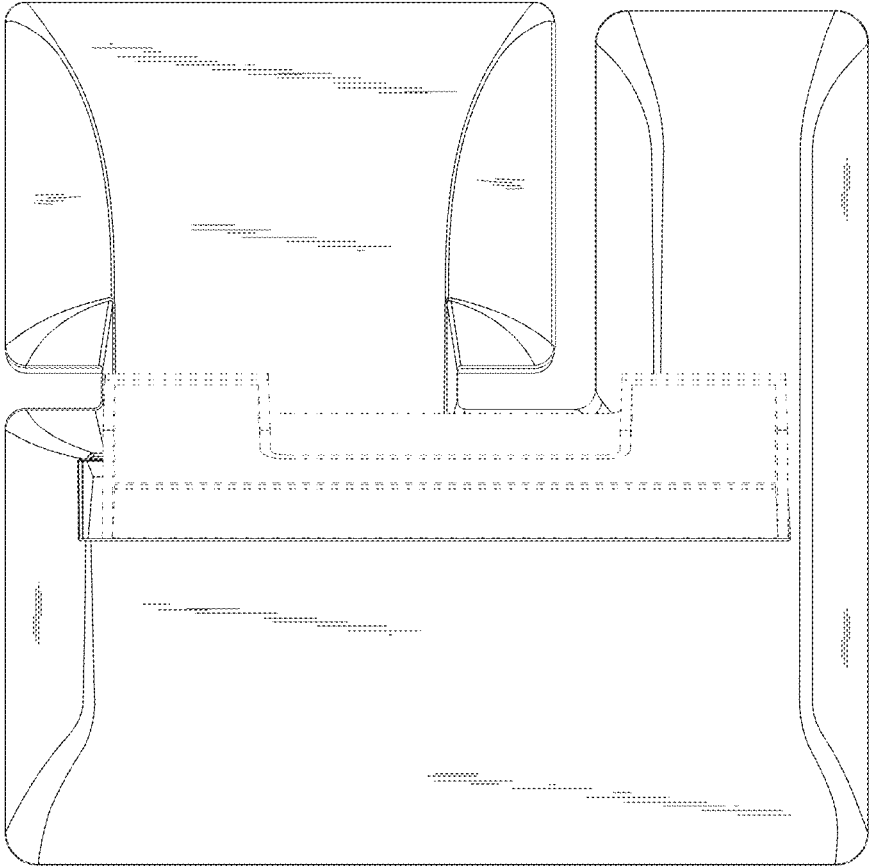

FIG. 10

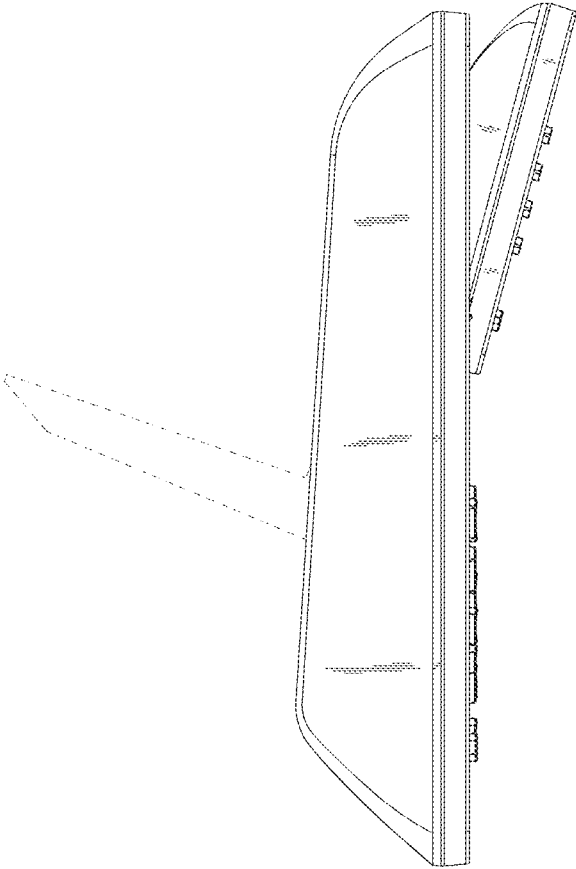

FIG. 11

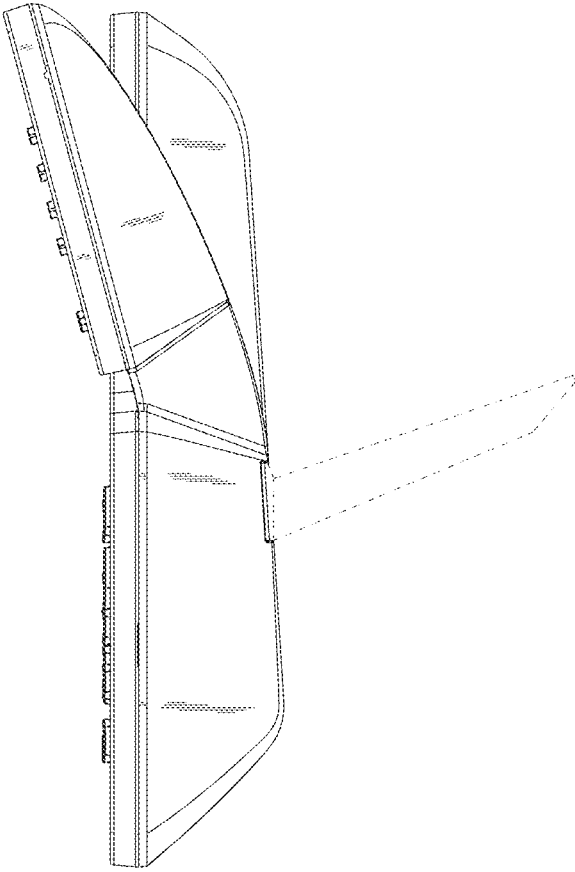

FIG. 12

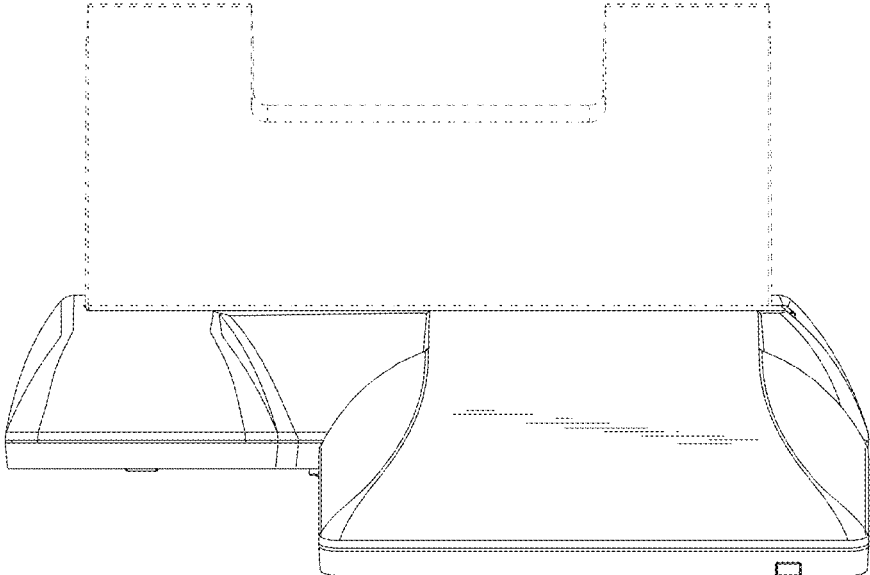

FIG. 13

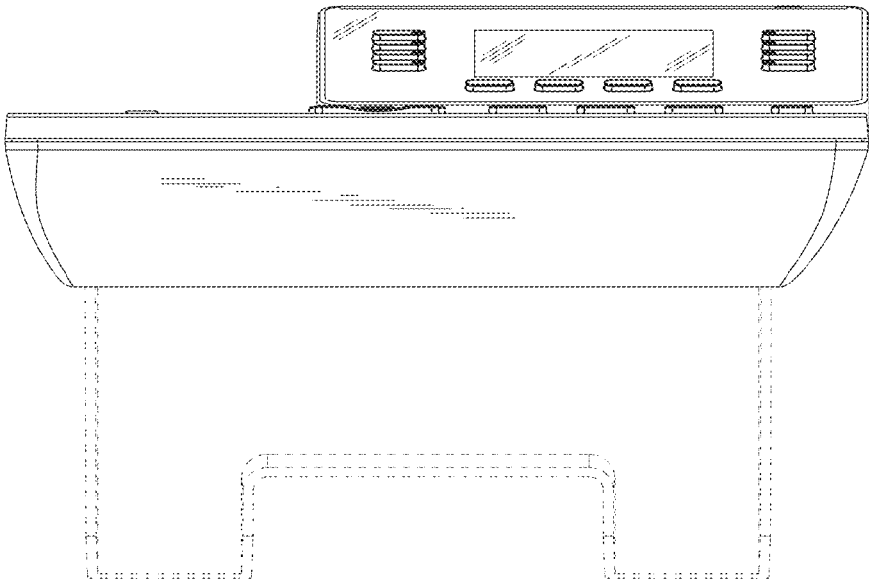

FIG. 14



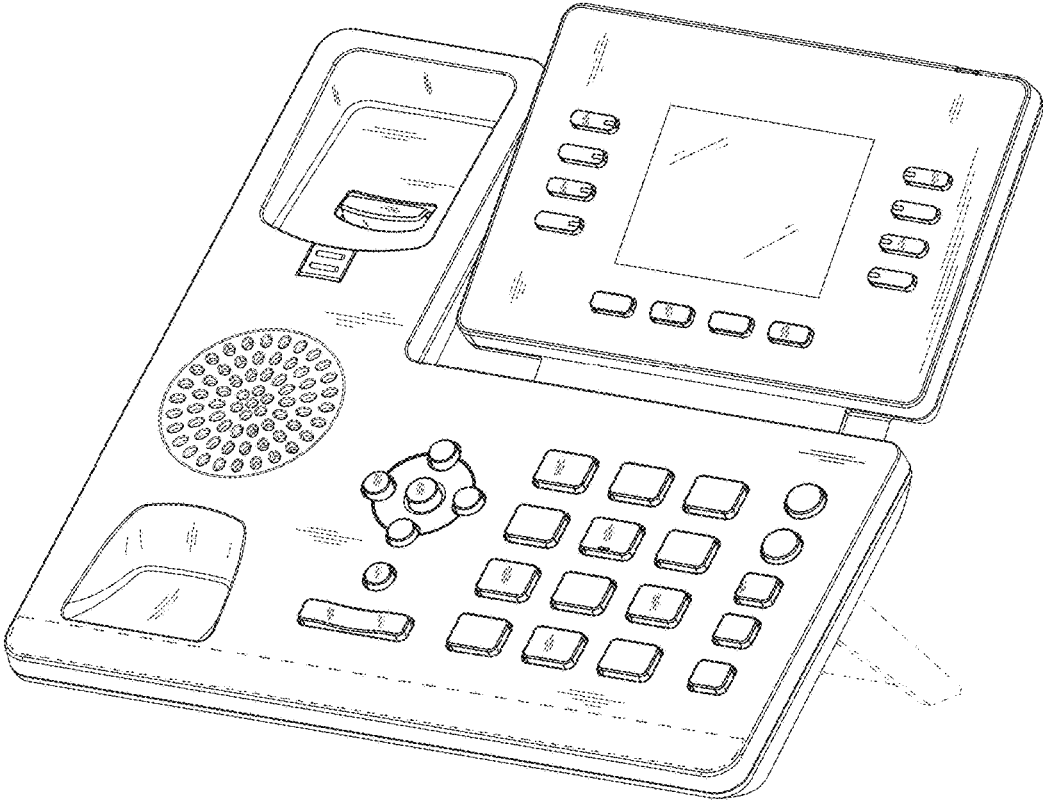

FIG. 15

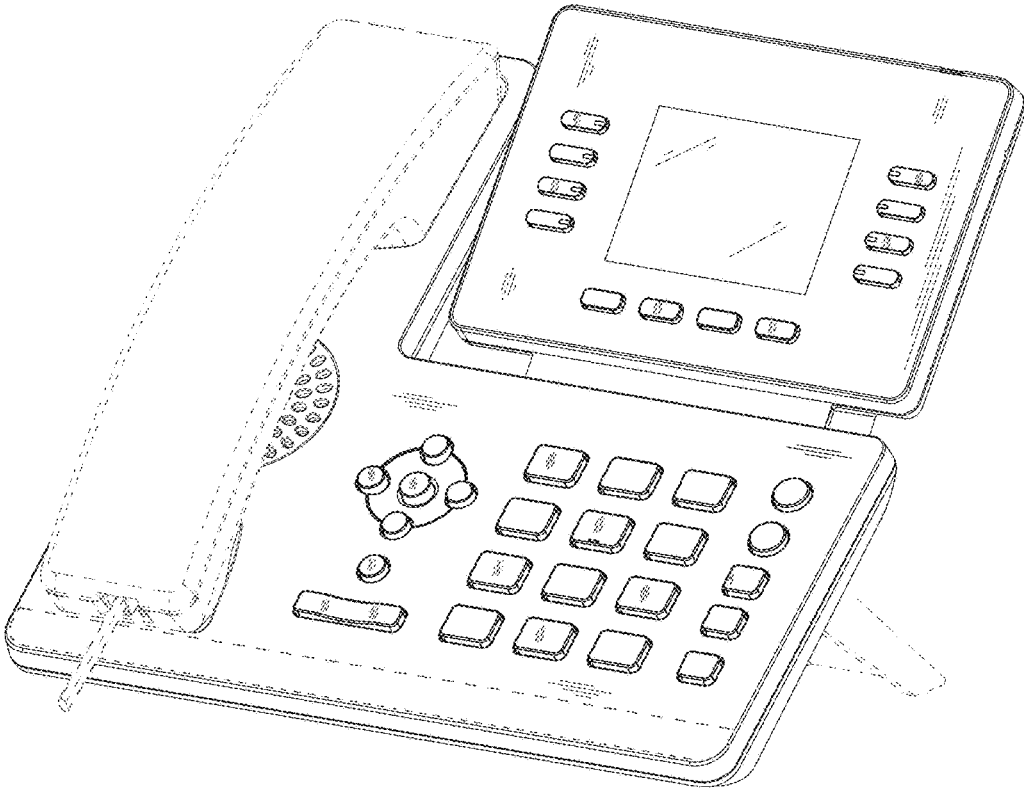

FIG. 16

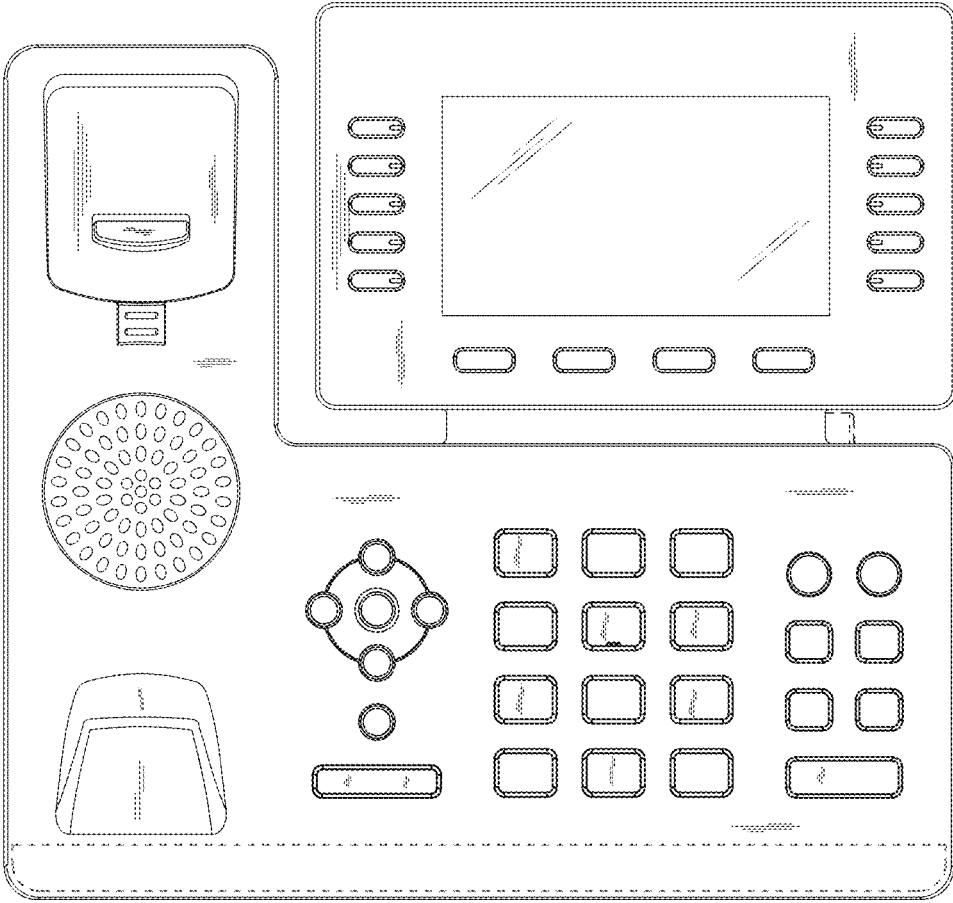

FIG. 17

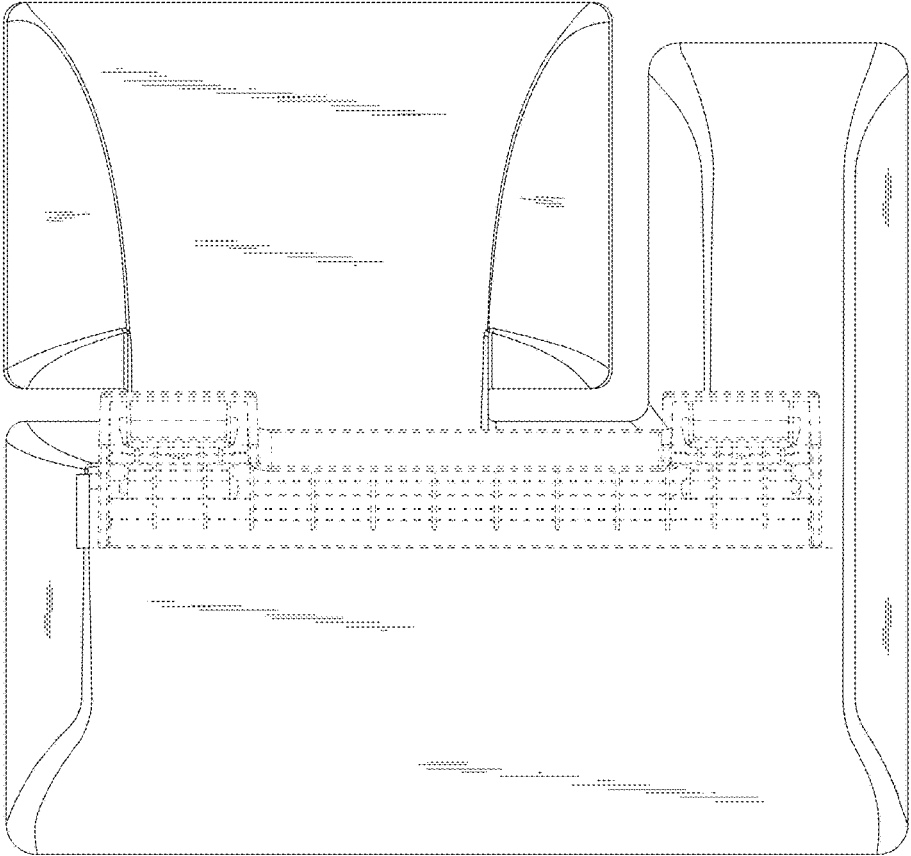

FIG. 18

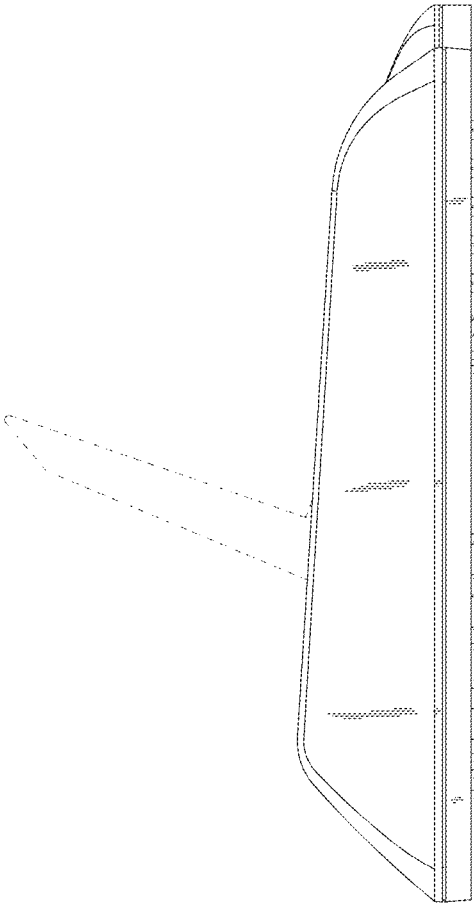

FIG. 19

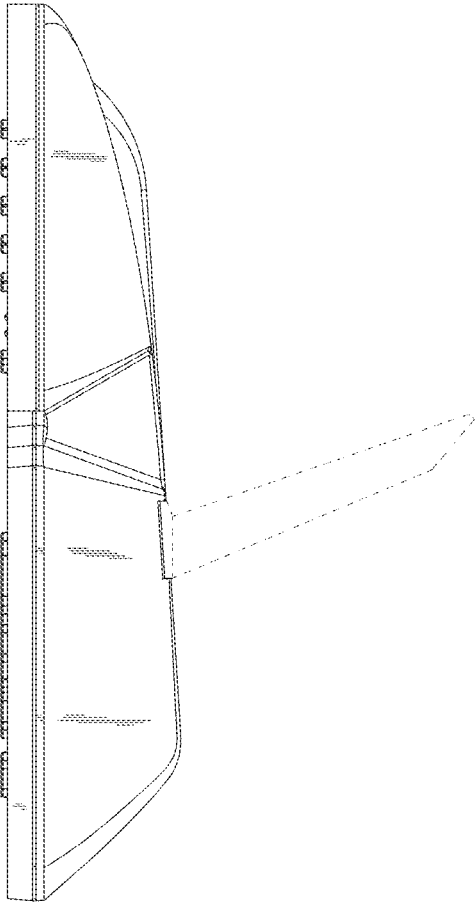

FIG. 20

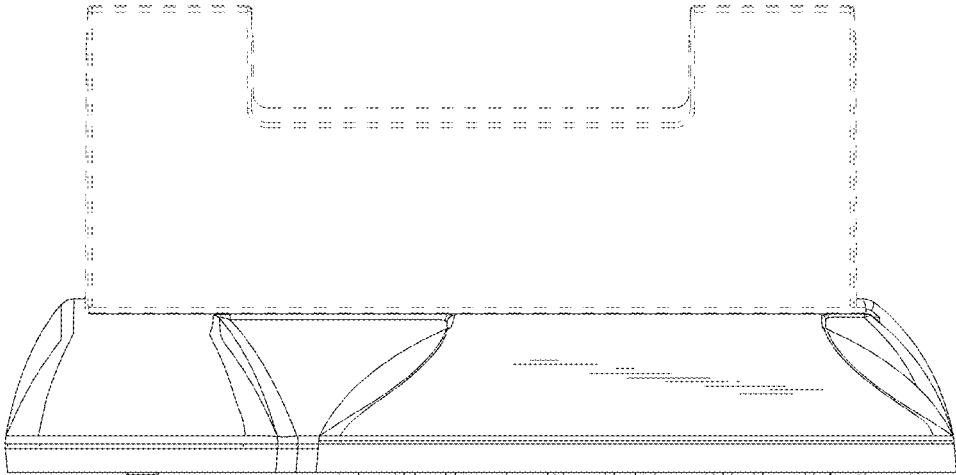

FIG. 21

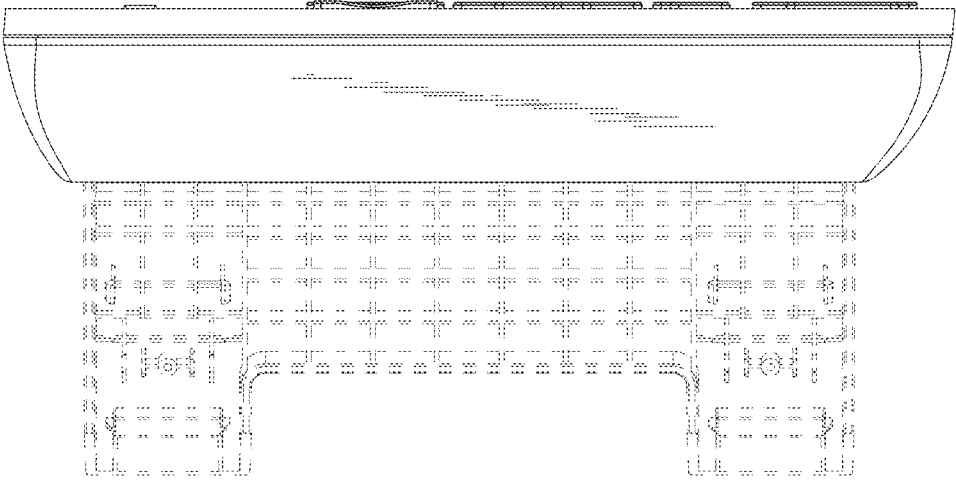

FIG. 22



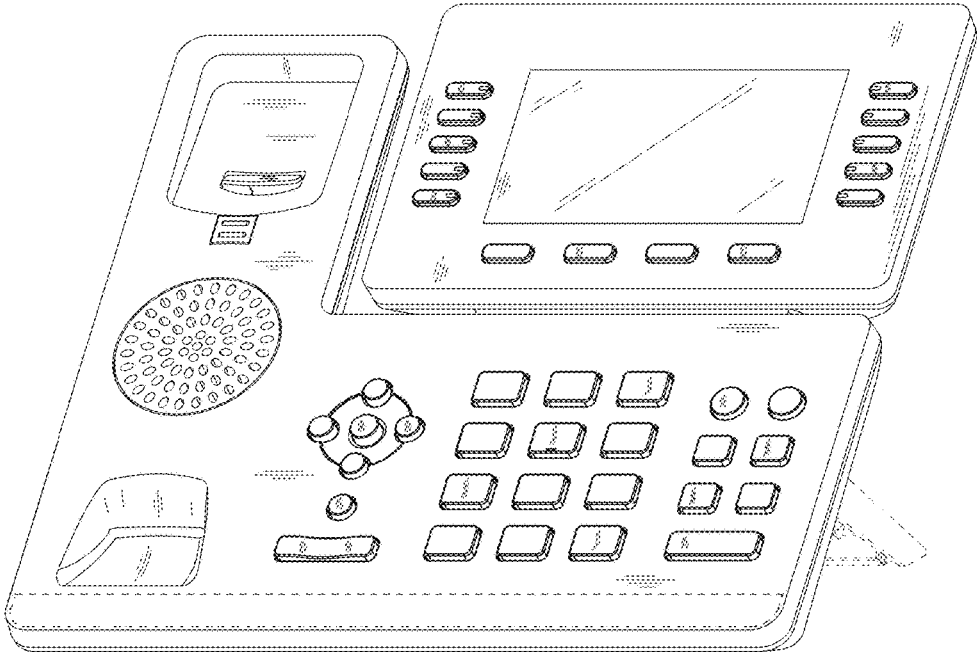

FIG. 23

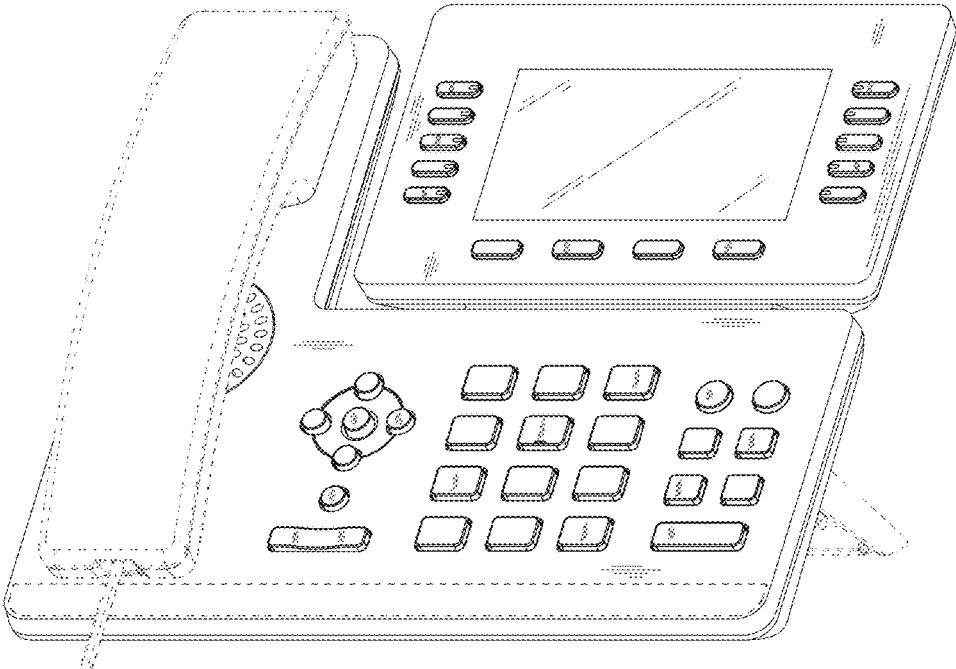

FIG. 24

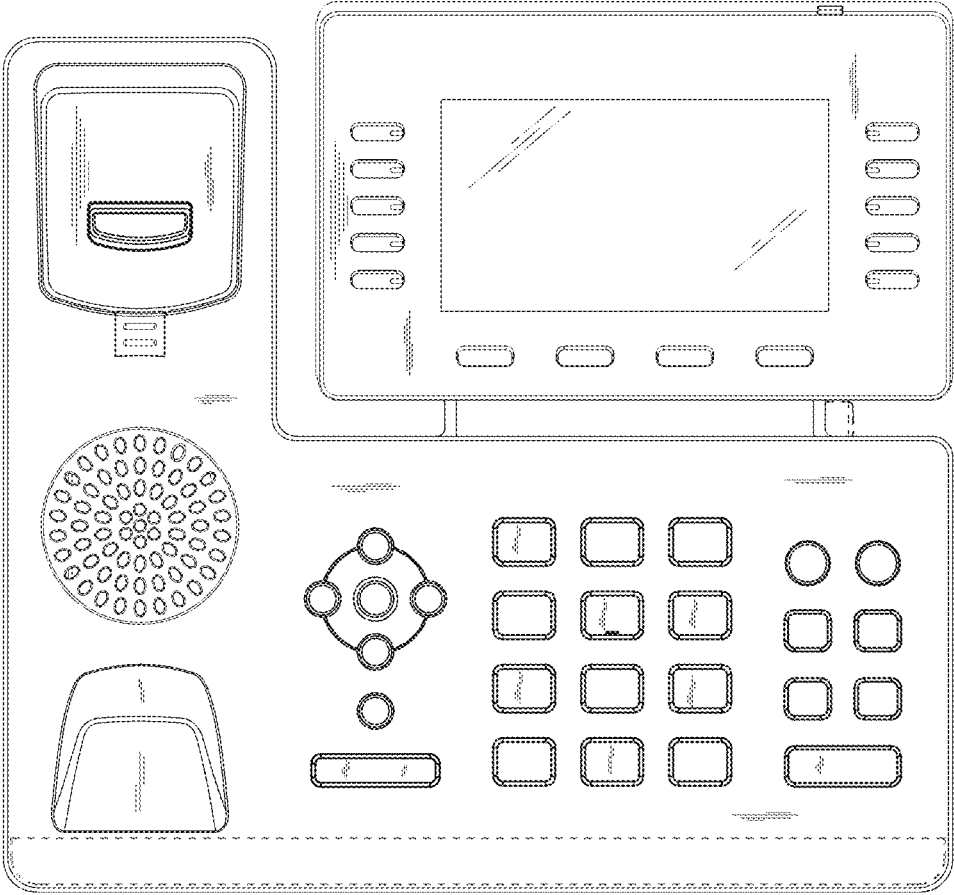

FIG. 25

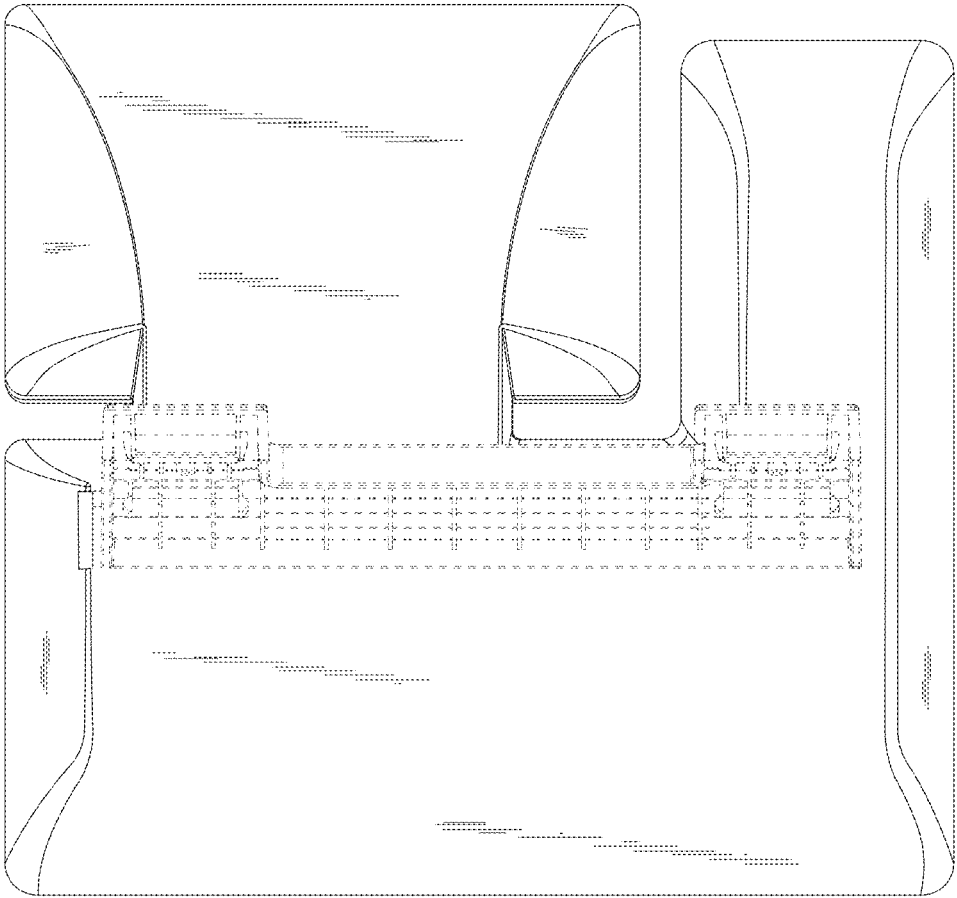

FIG. 26

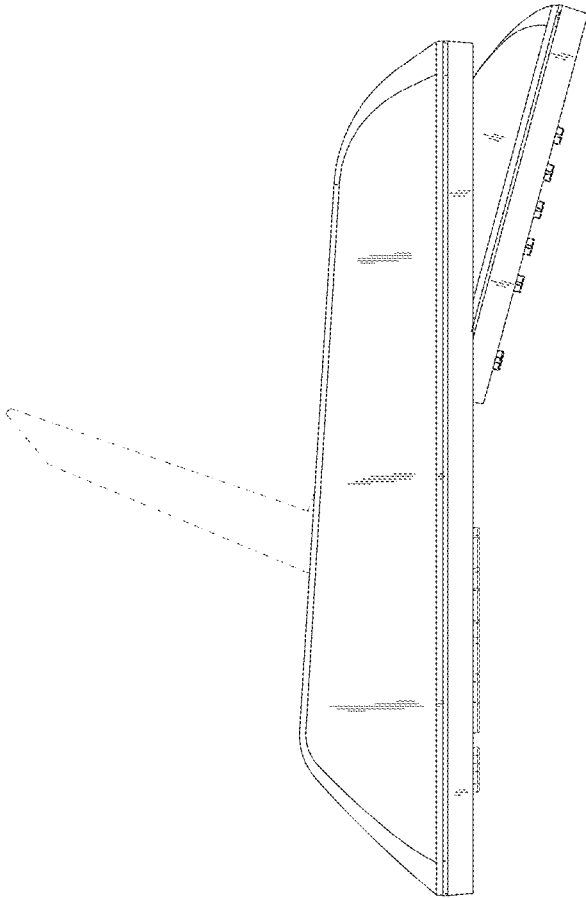

FIG. 27

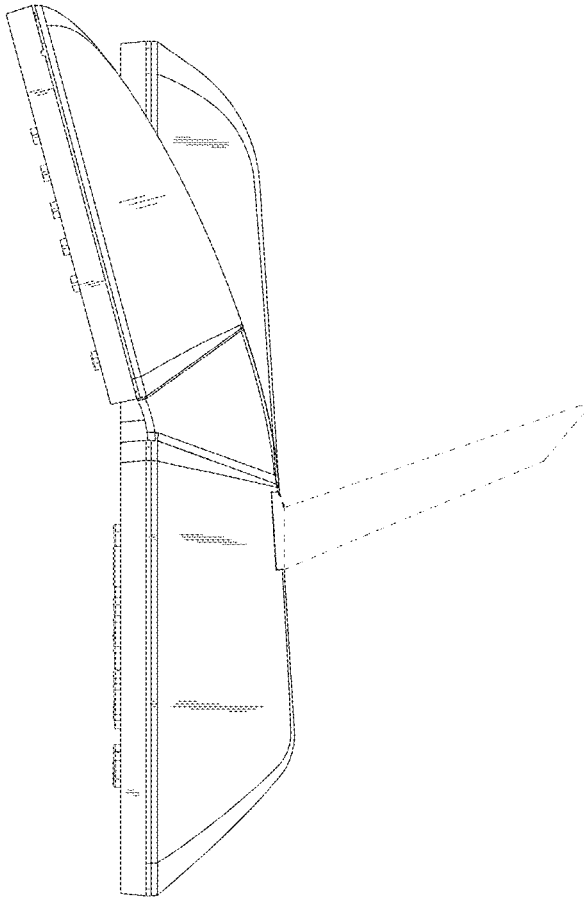

FIG. 28

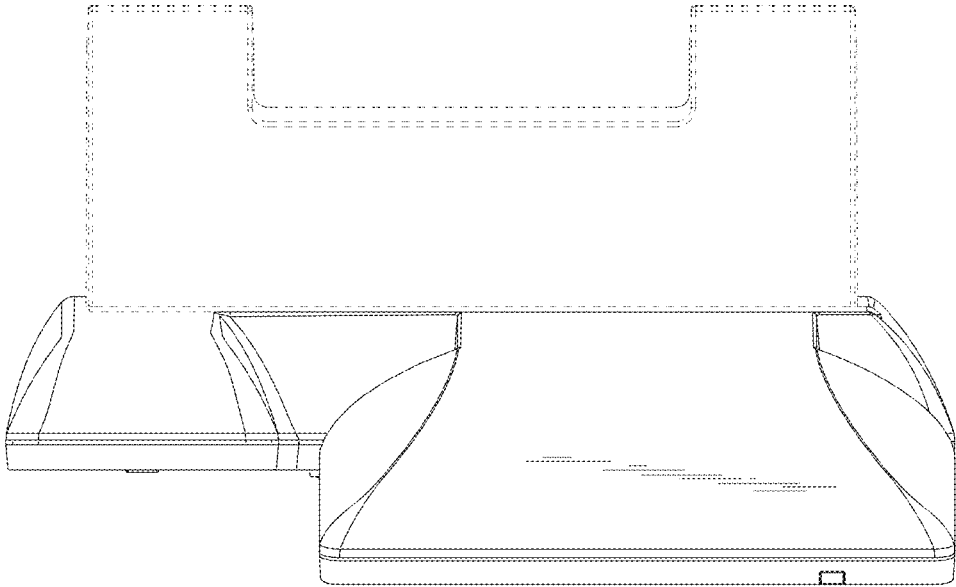

FIG. 29

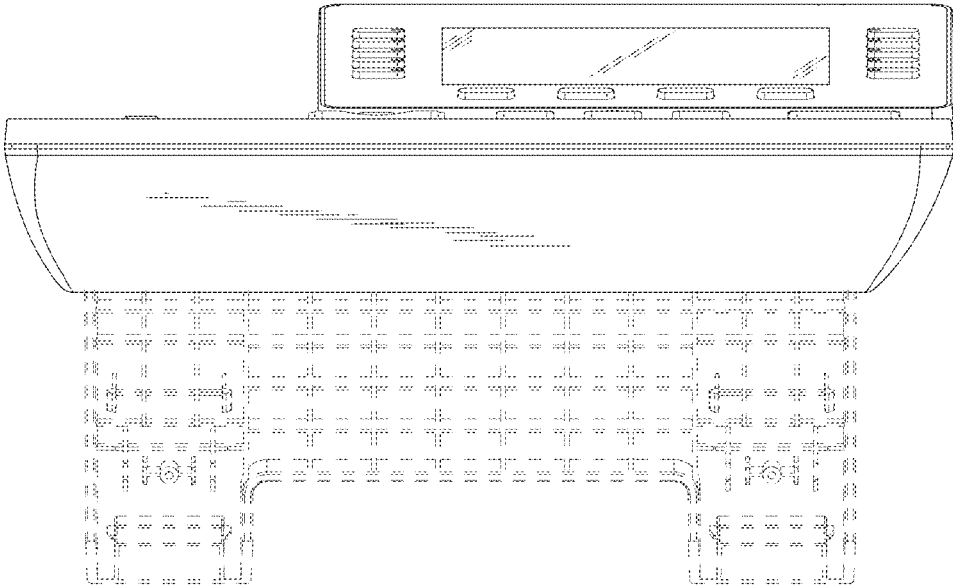

FIG. 30



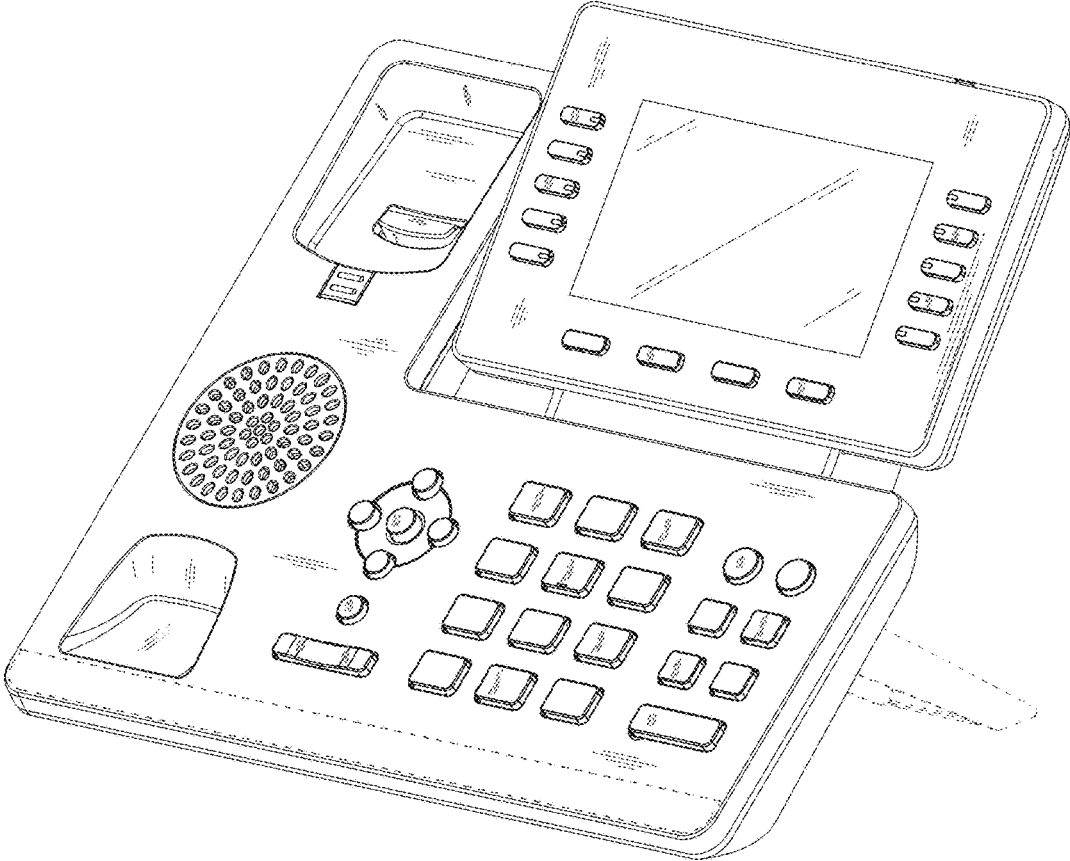

FIG. 31

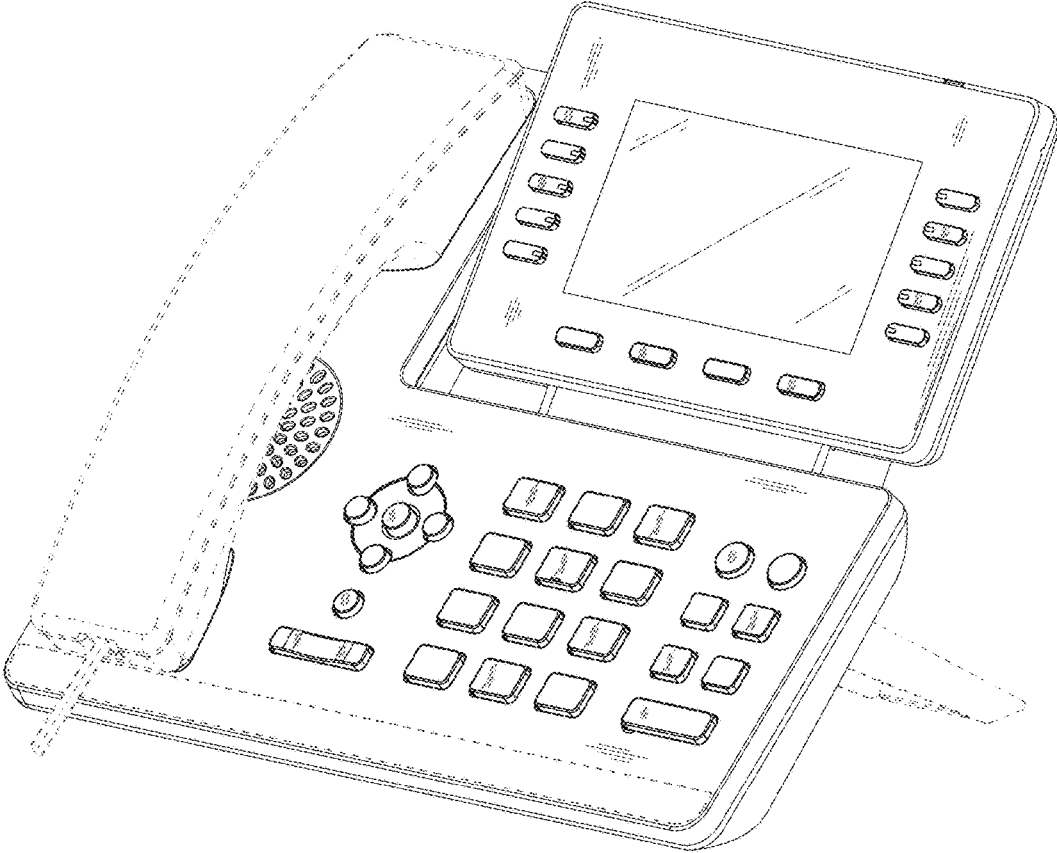

FIG. 32

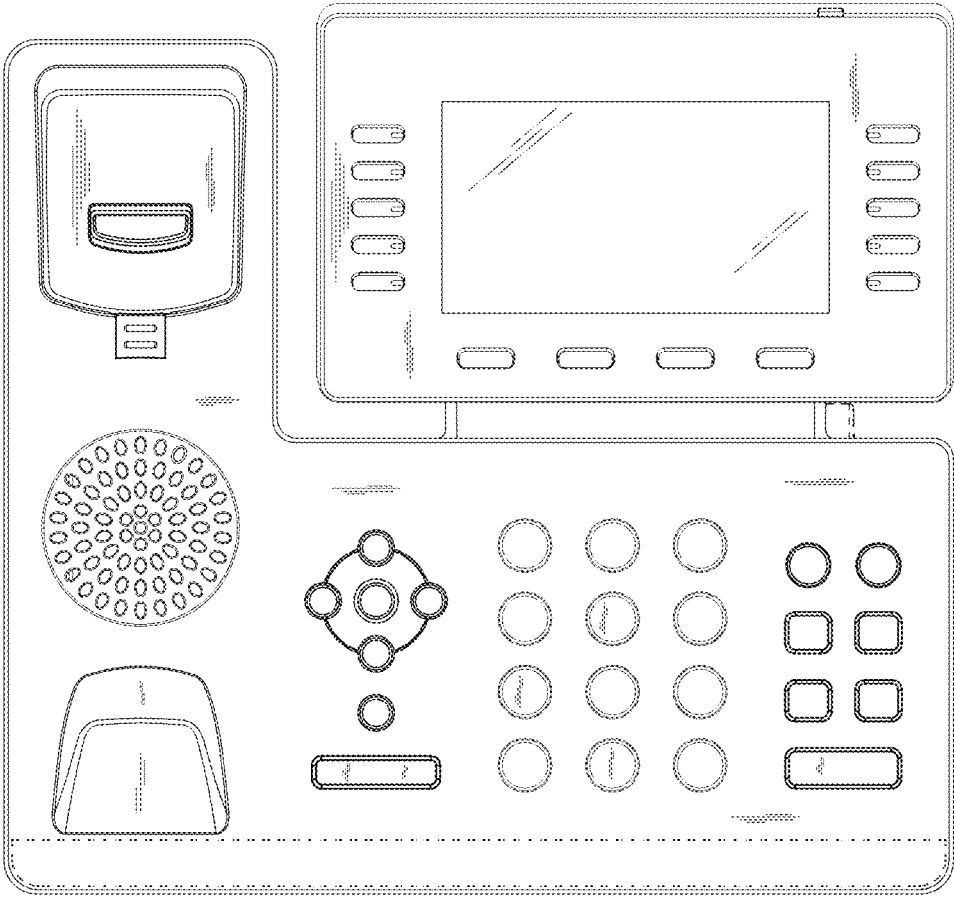

FIG. 33

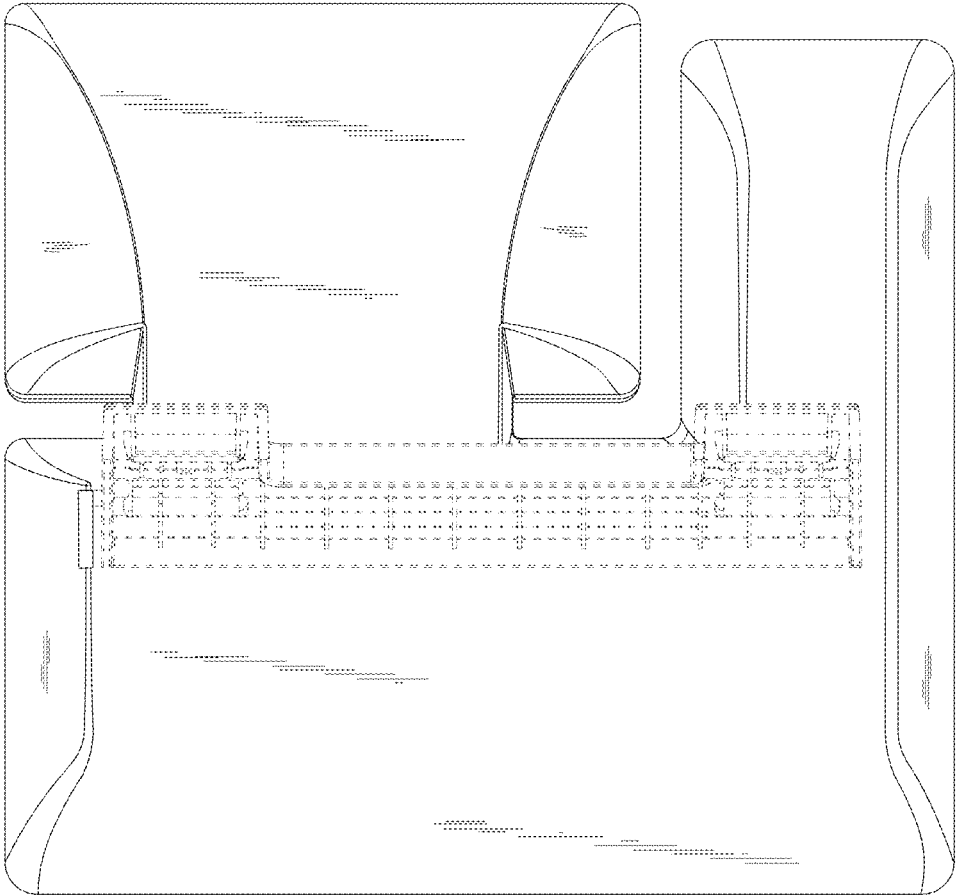

FIG. 34

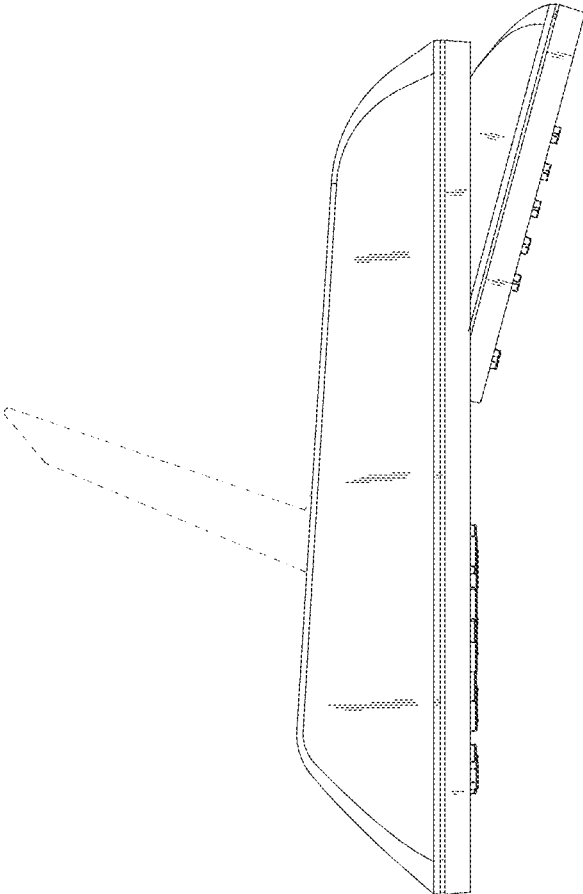

FIG. 35

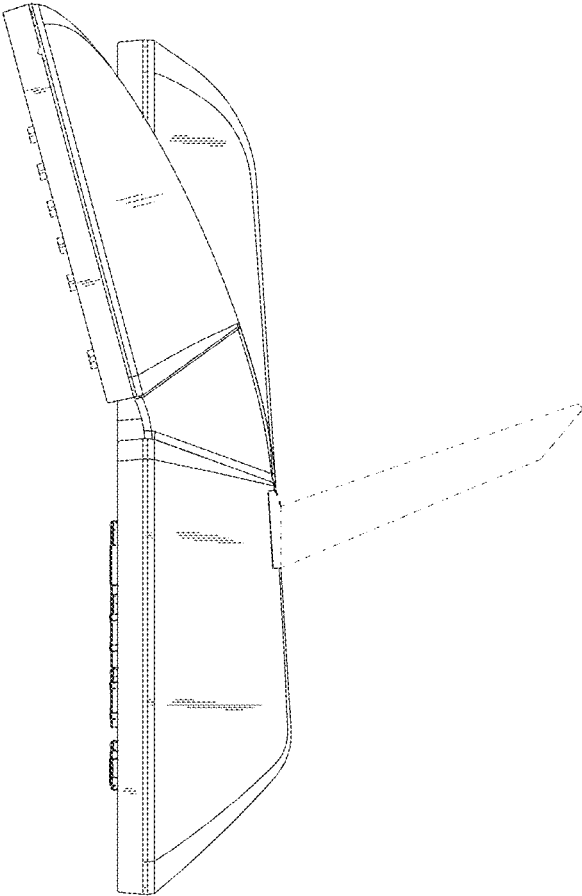

FIG. 36

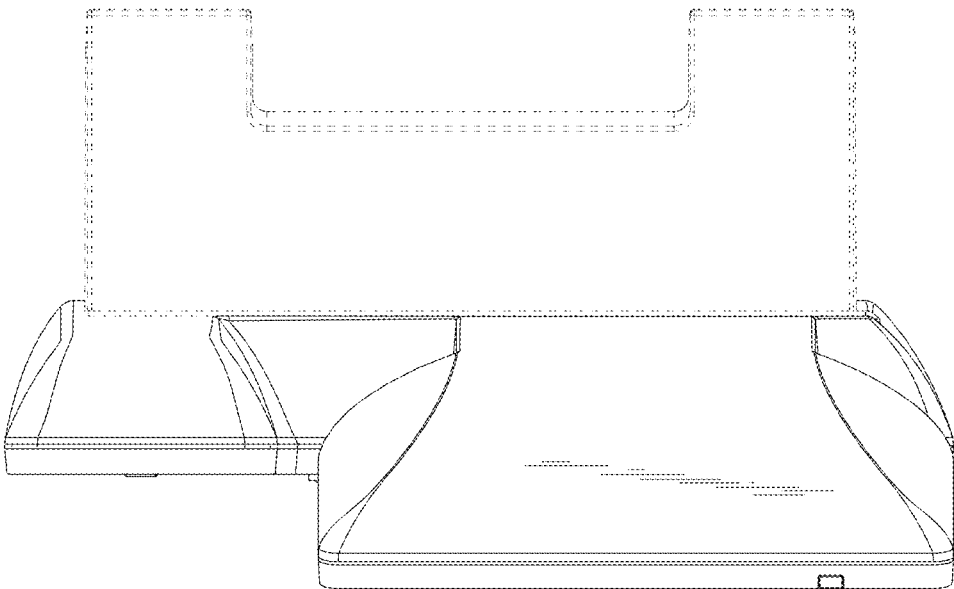

FIG. 37

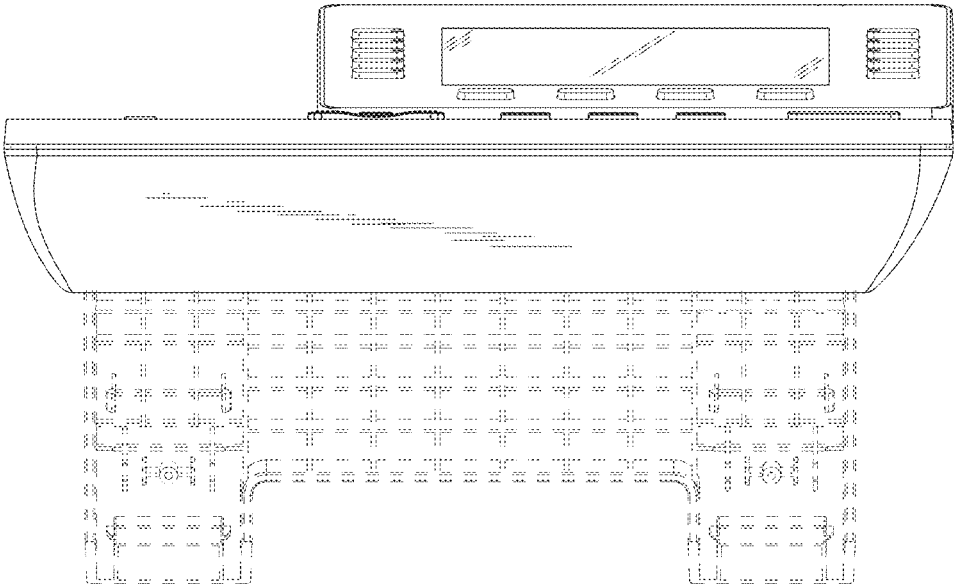

FIG. 38



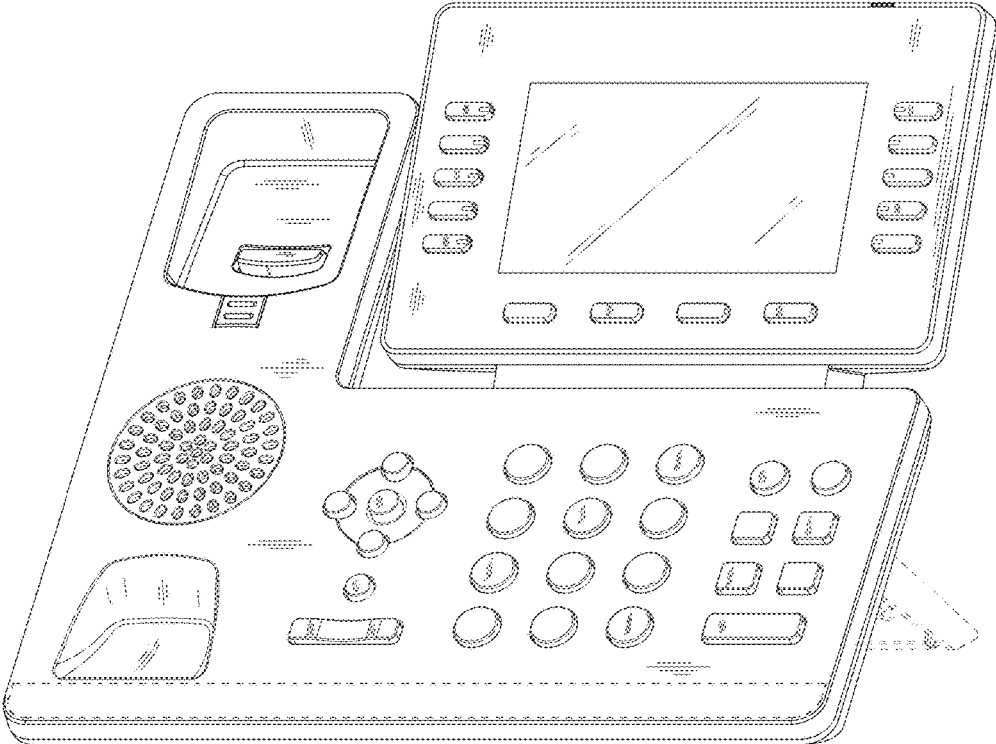

FIG. 39

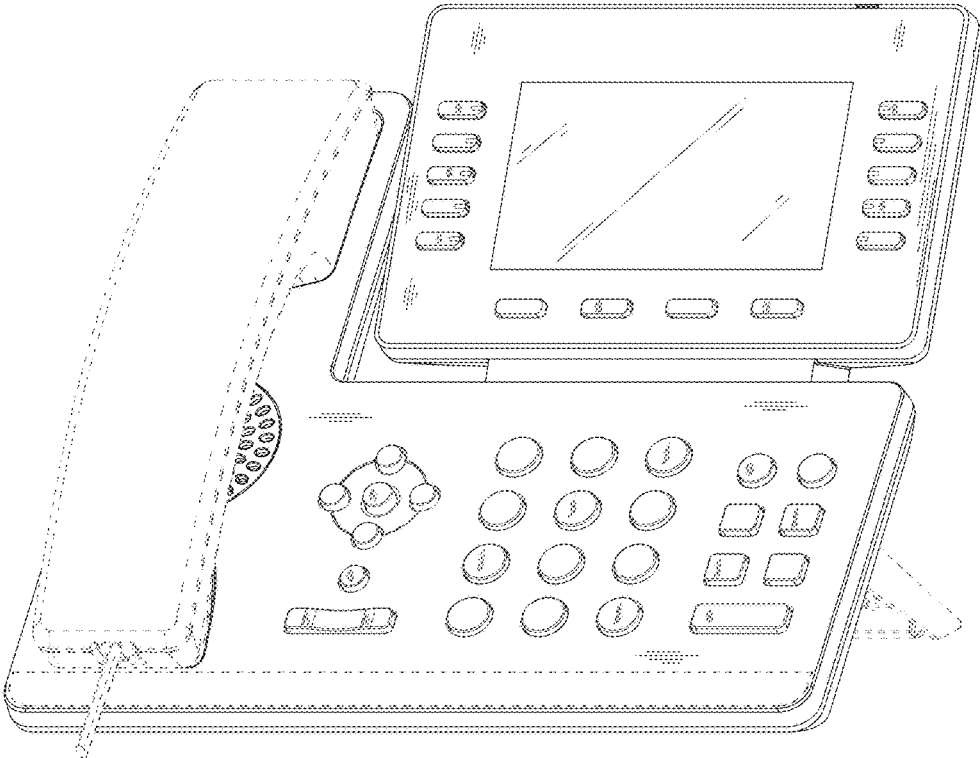

FIG. 40

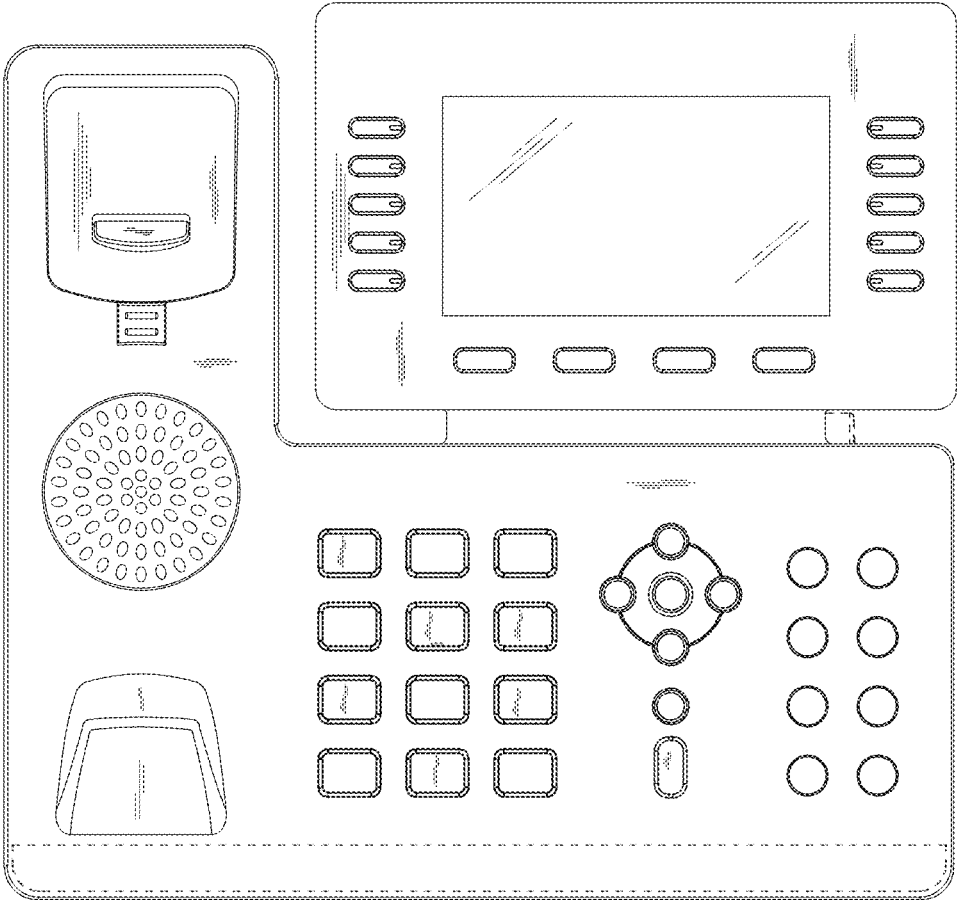

FIG. 41

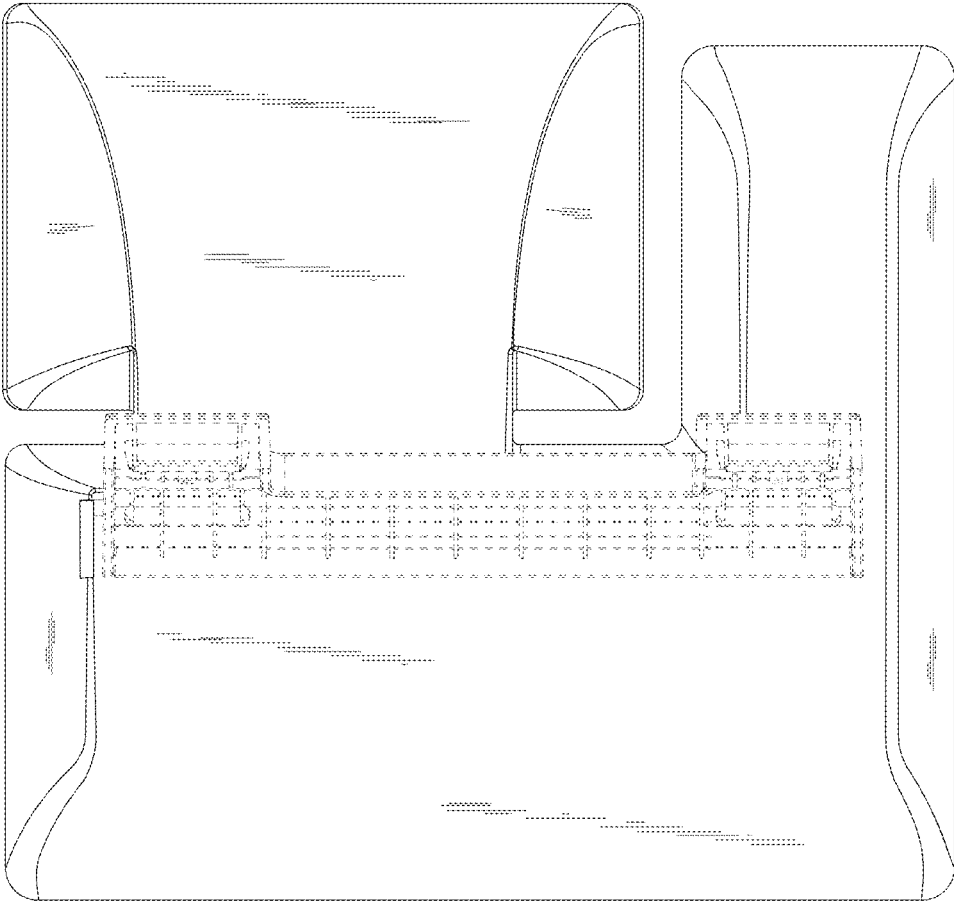

FIG. 42

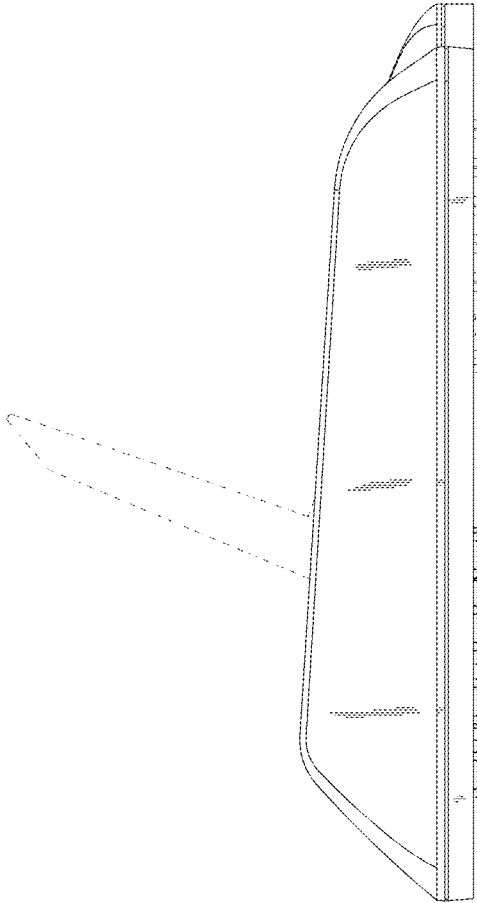

FIG. 43

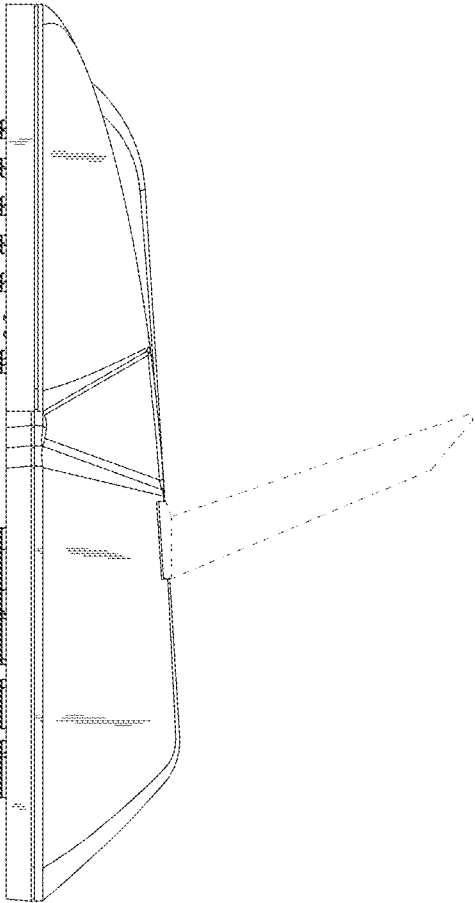

FIG. 44

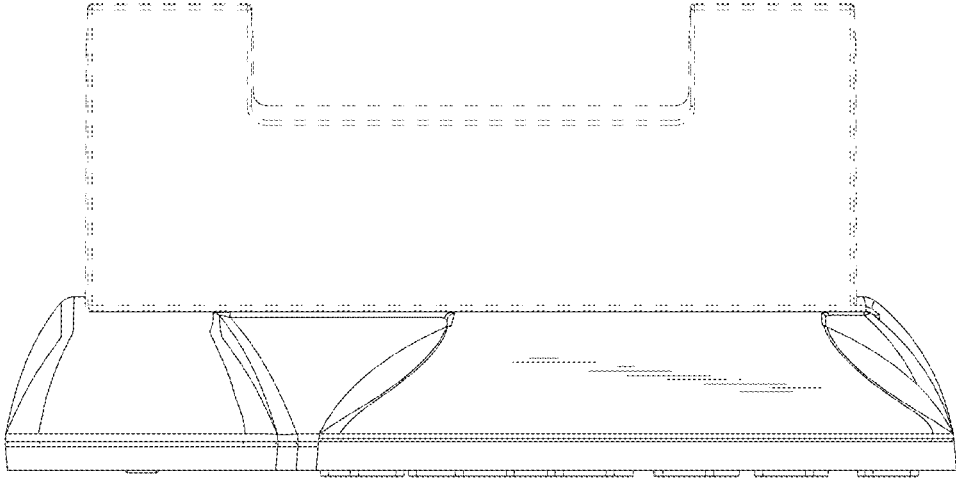

FIG. 45

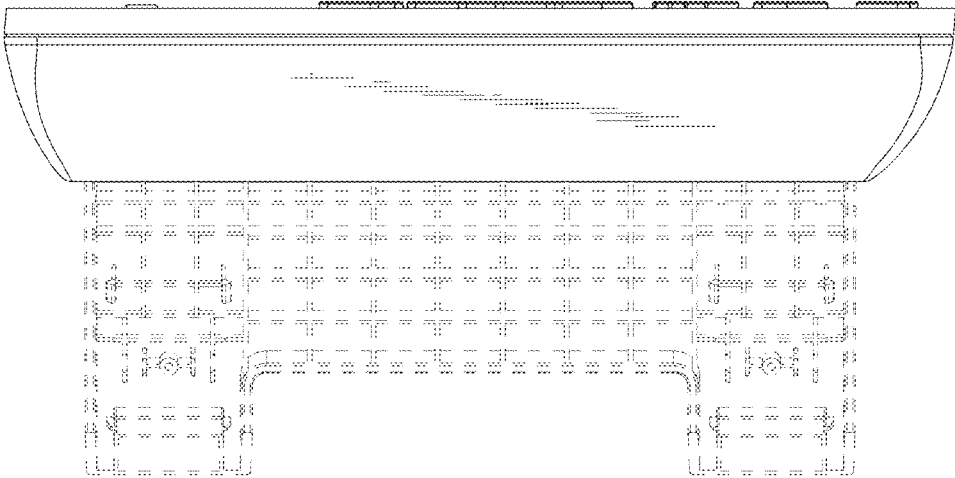

FIG. 46



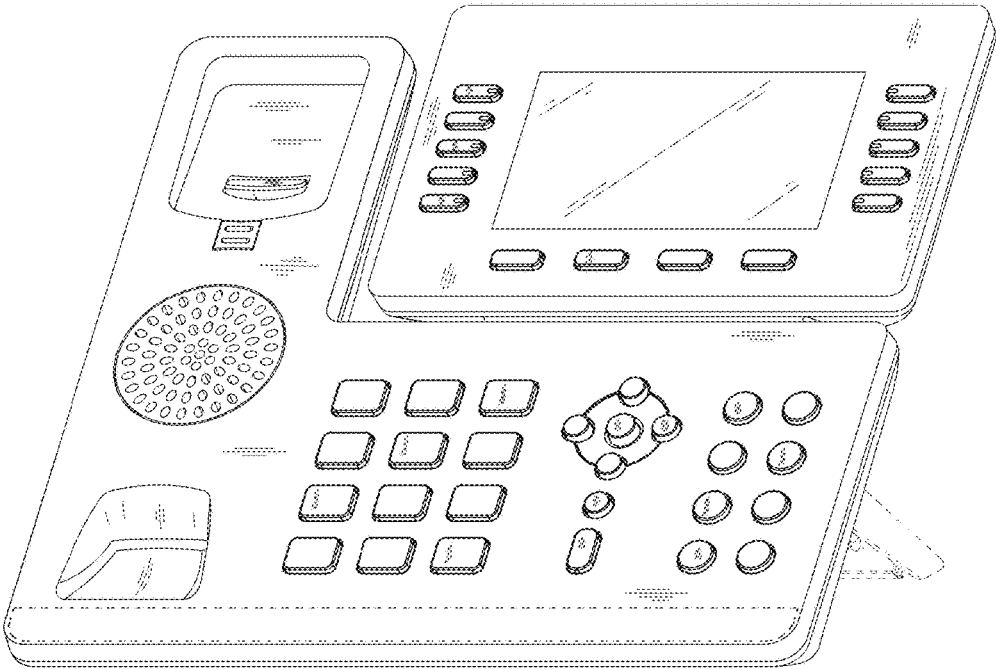

FIG. 47

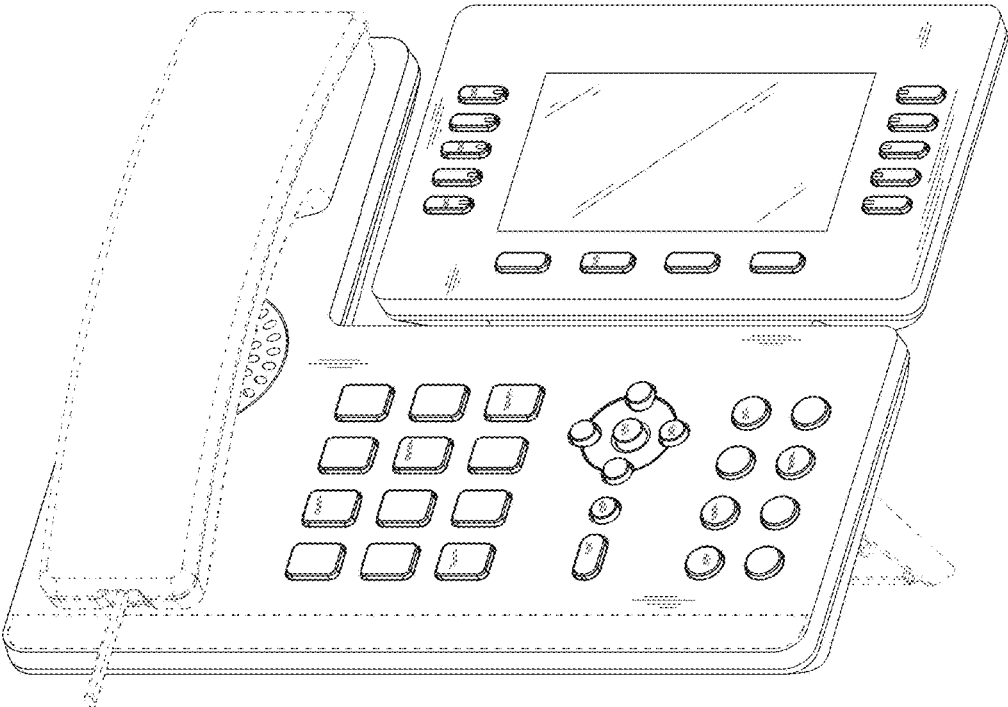

FIG. 48

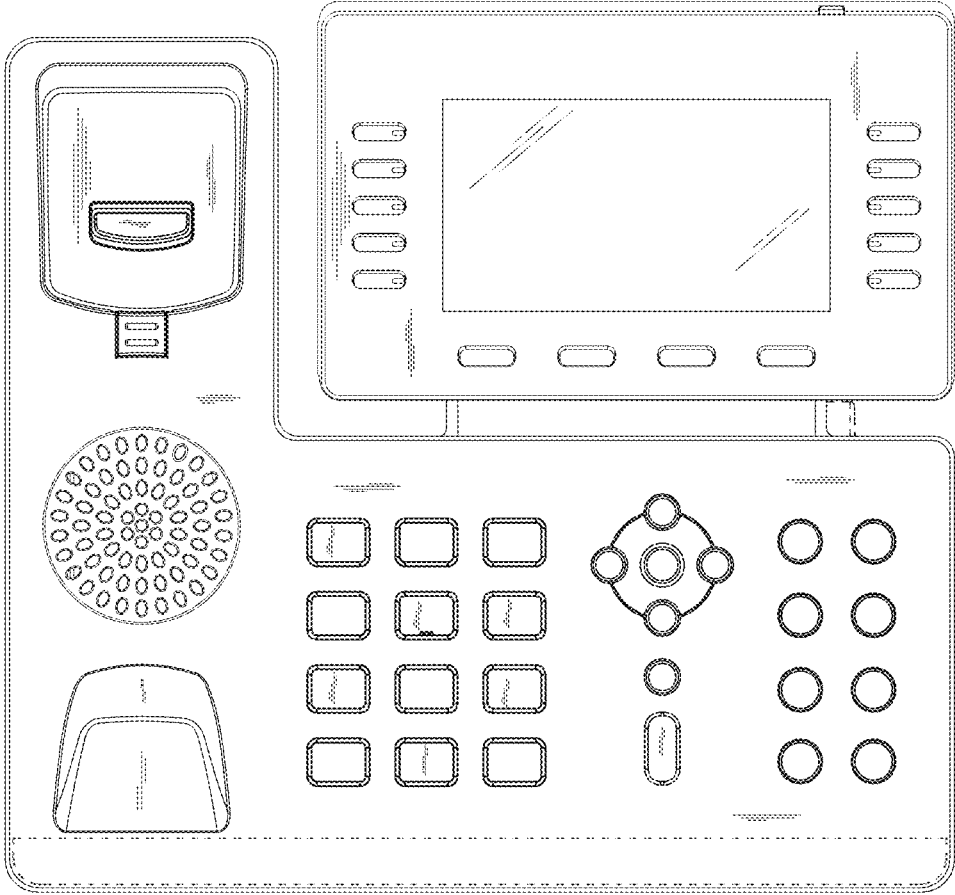

FIG. 49

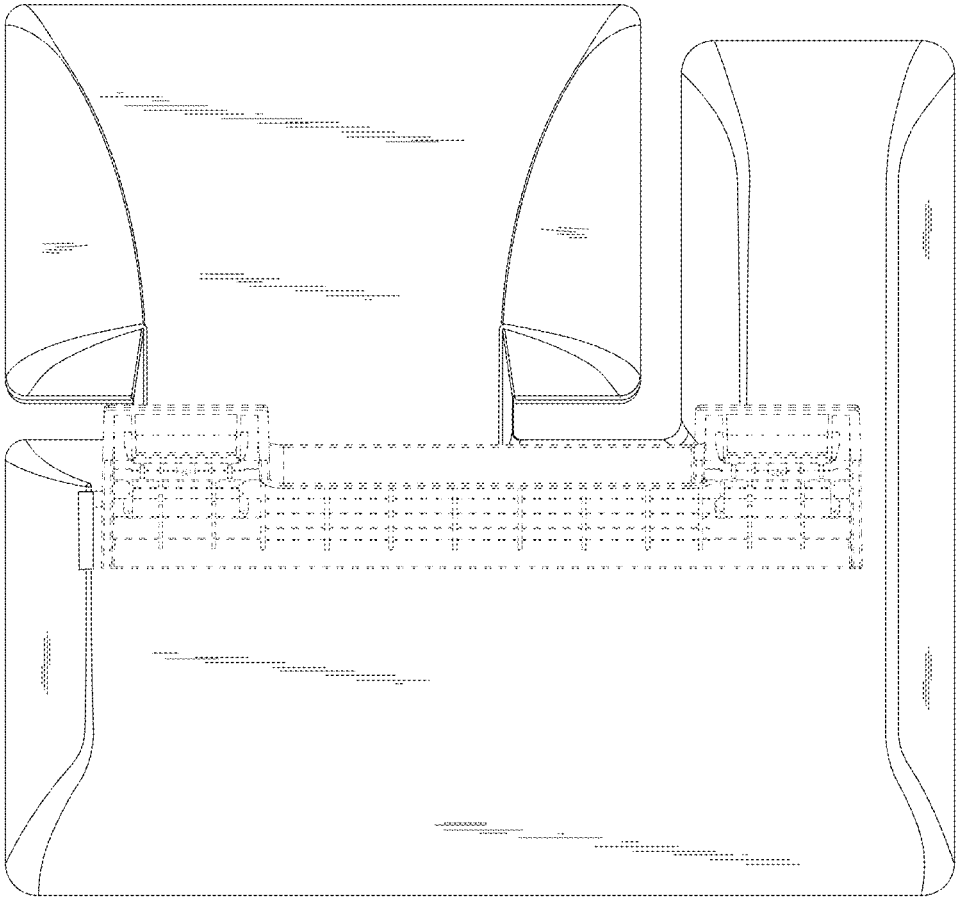

FIG. 50

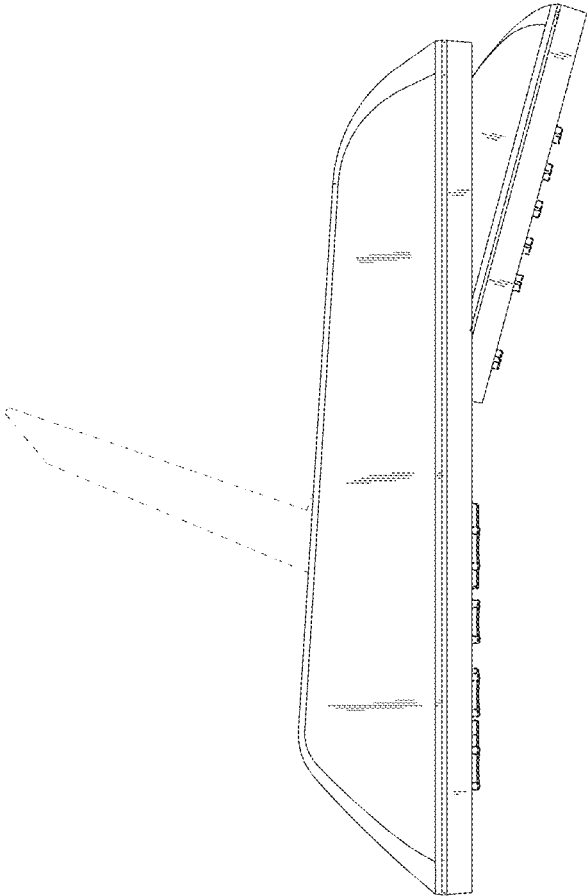

FIG. 51

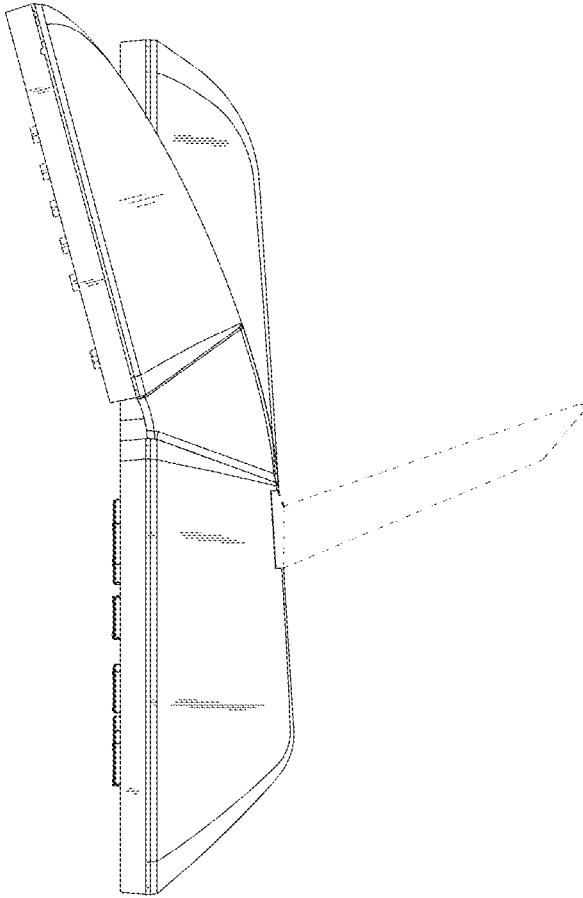

FIG. 52

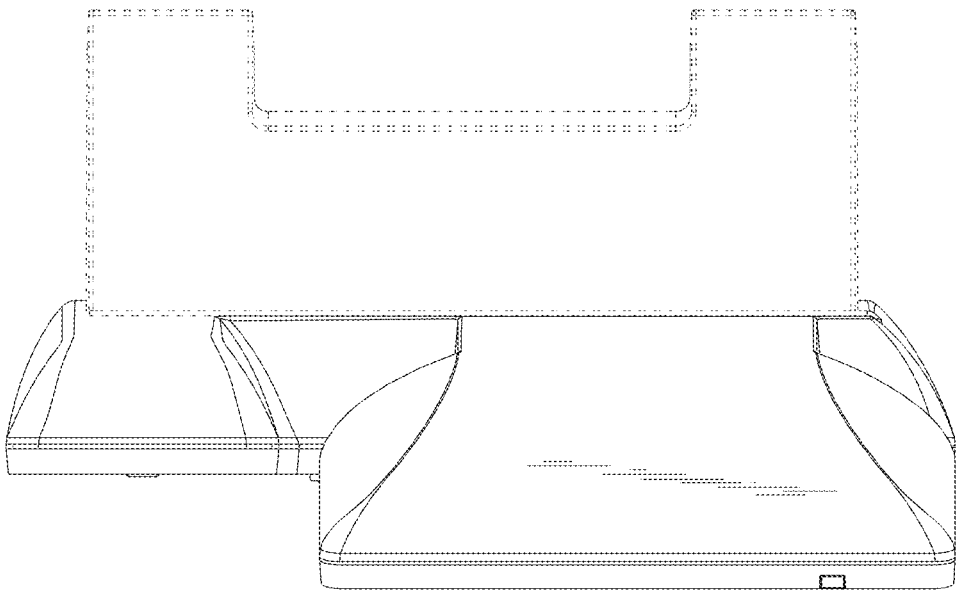

FIG. 53

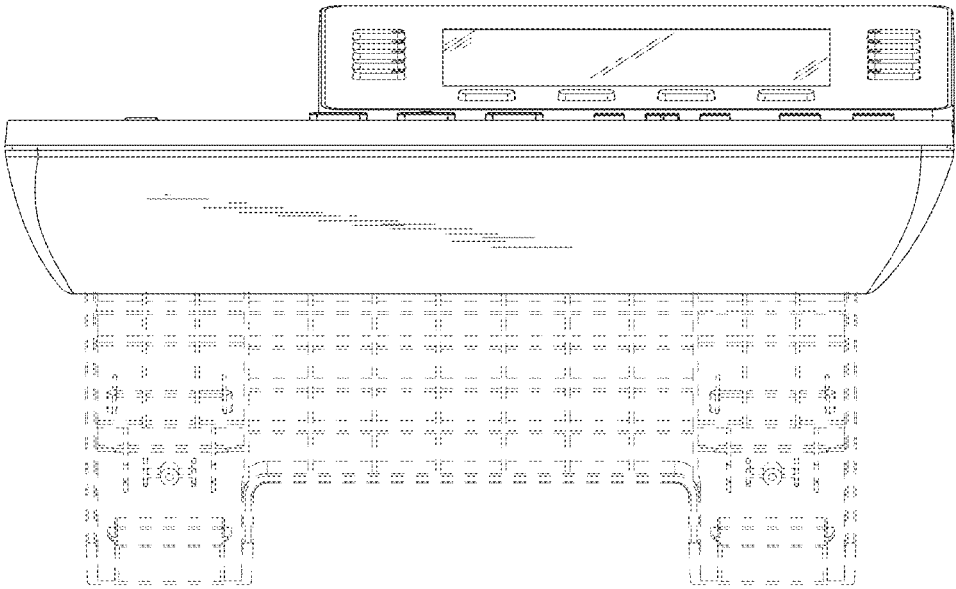

FIG. 54



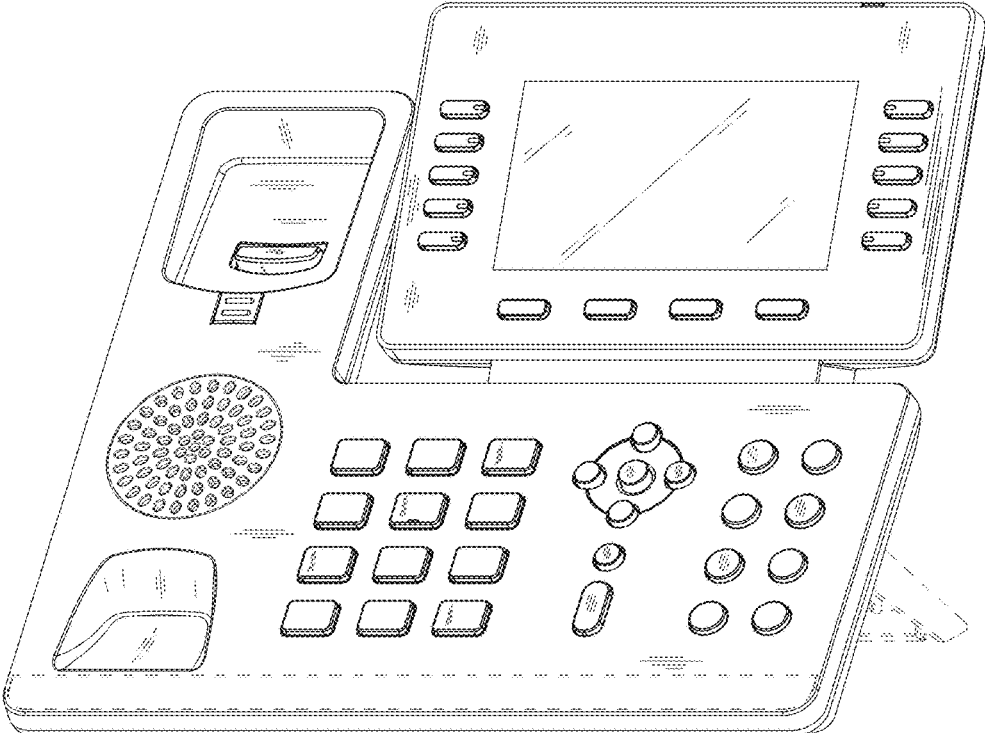

FIG. 55

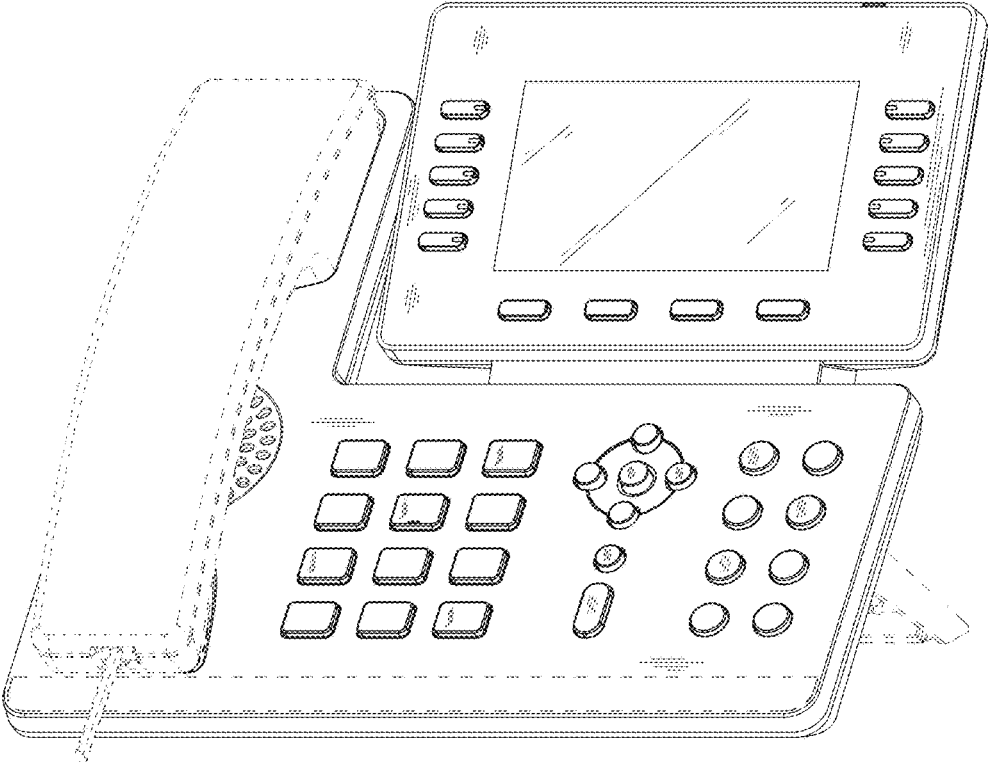

FIG. 56

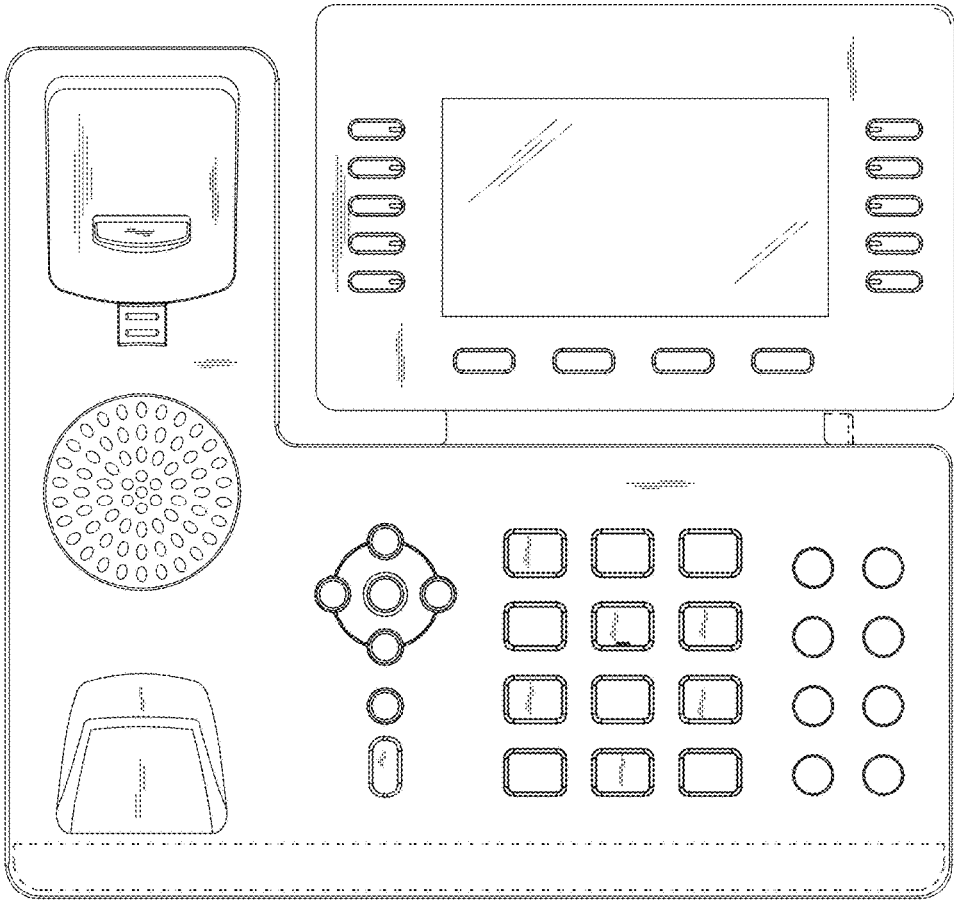

FIG. 57

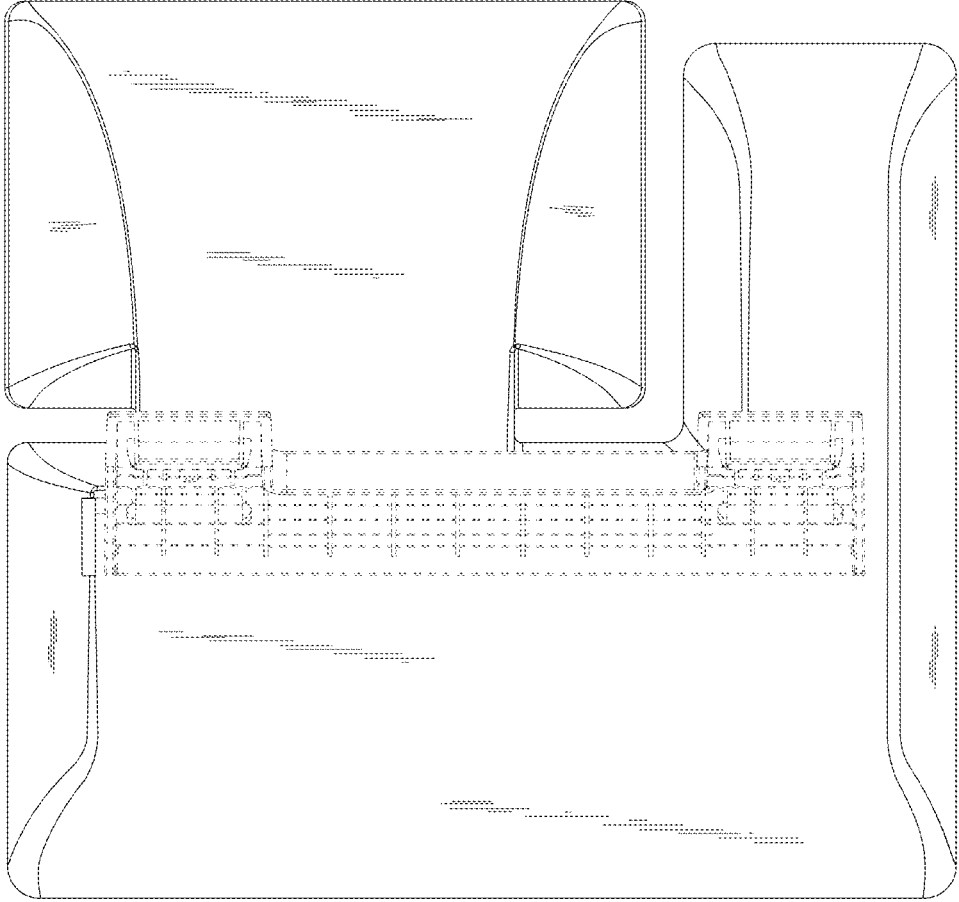

FIG. 58

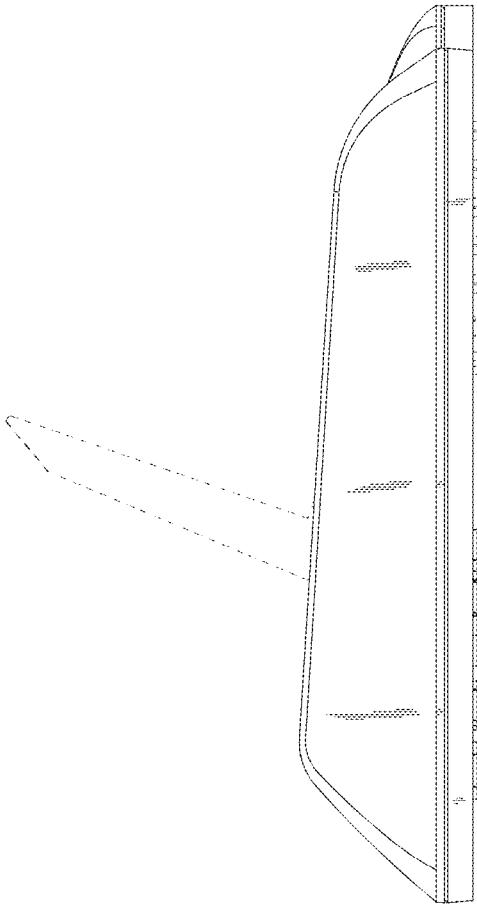

FIG. 59

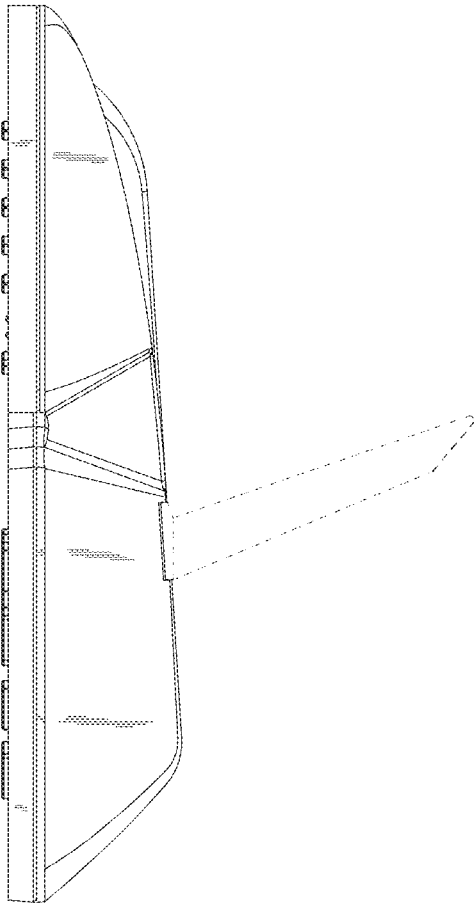

FIG. 60

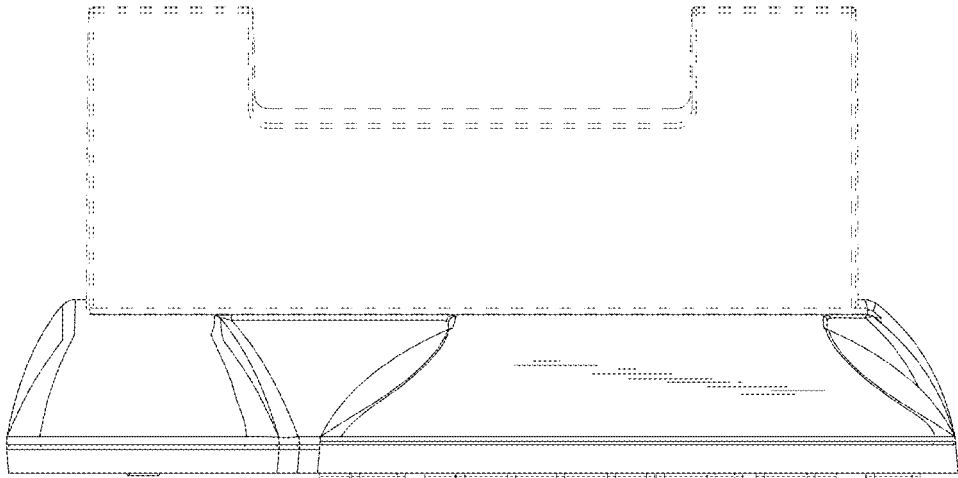

FIG. 61

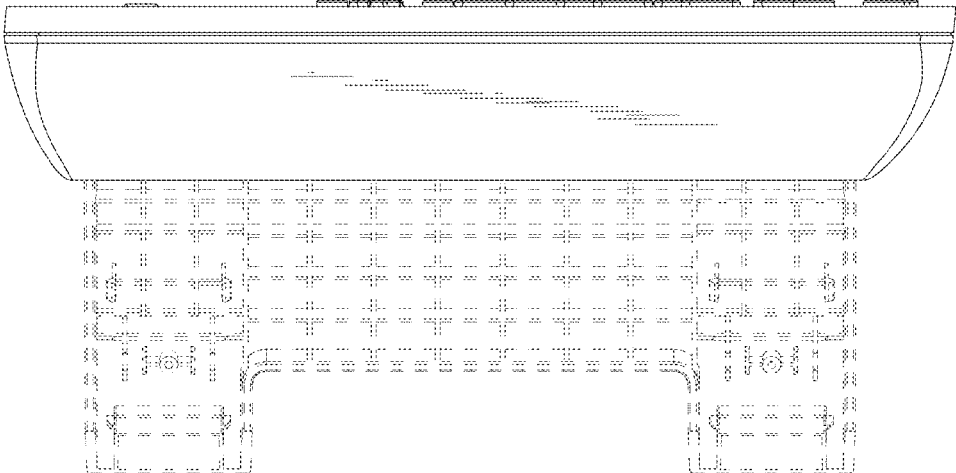

FIG. 62



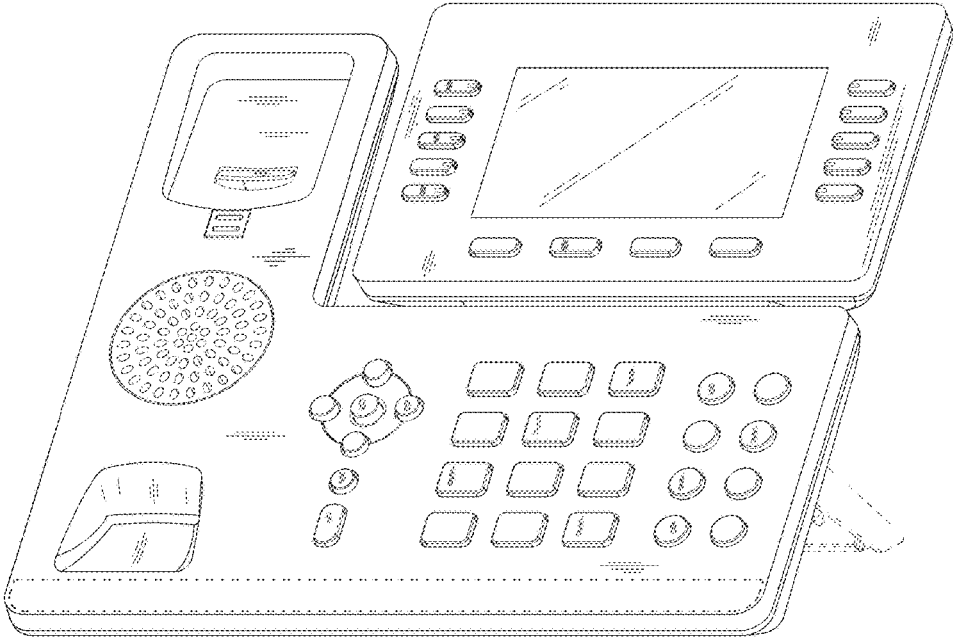

FIG. 63

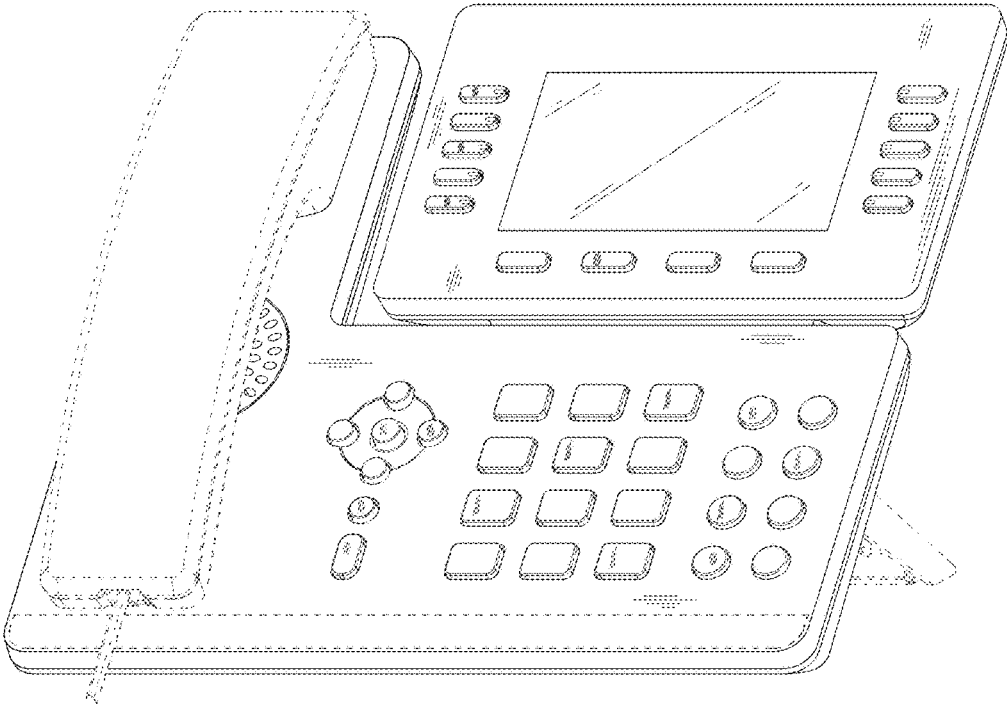

FIG. 64

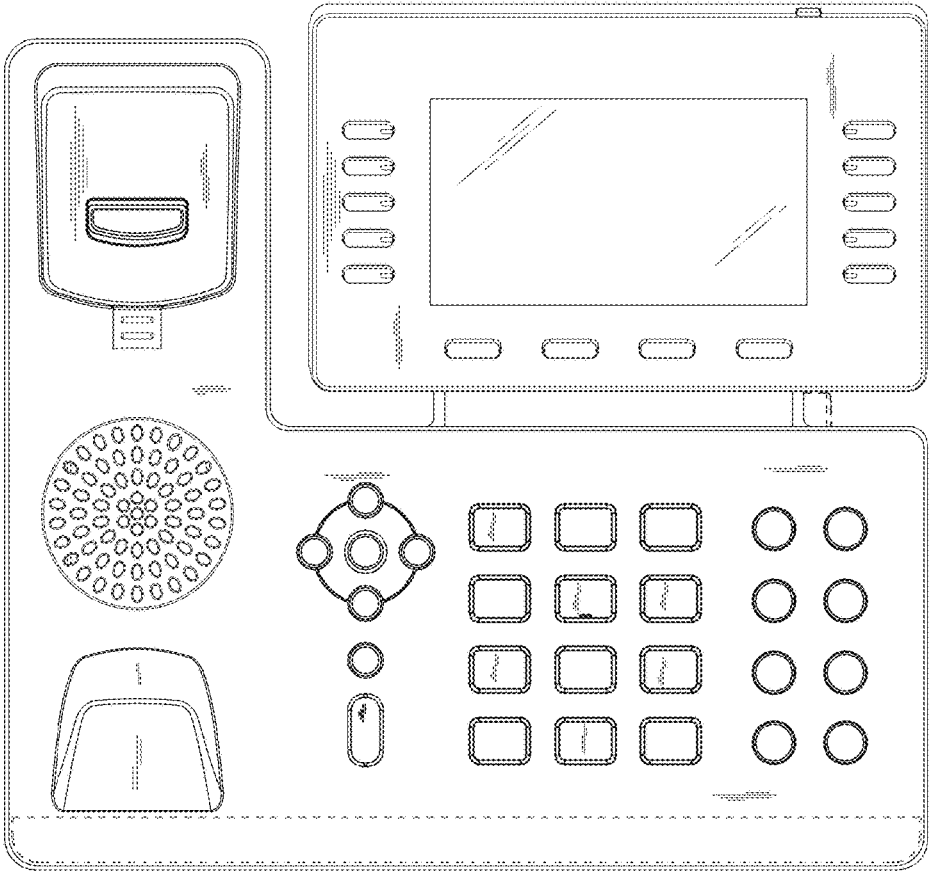

FIG. 65

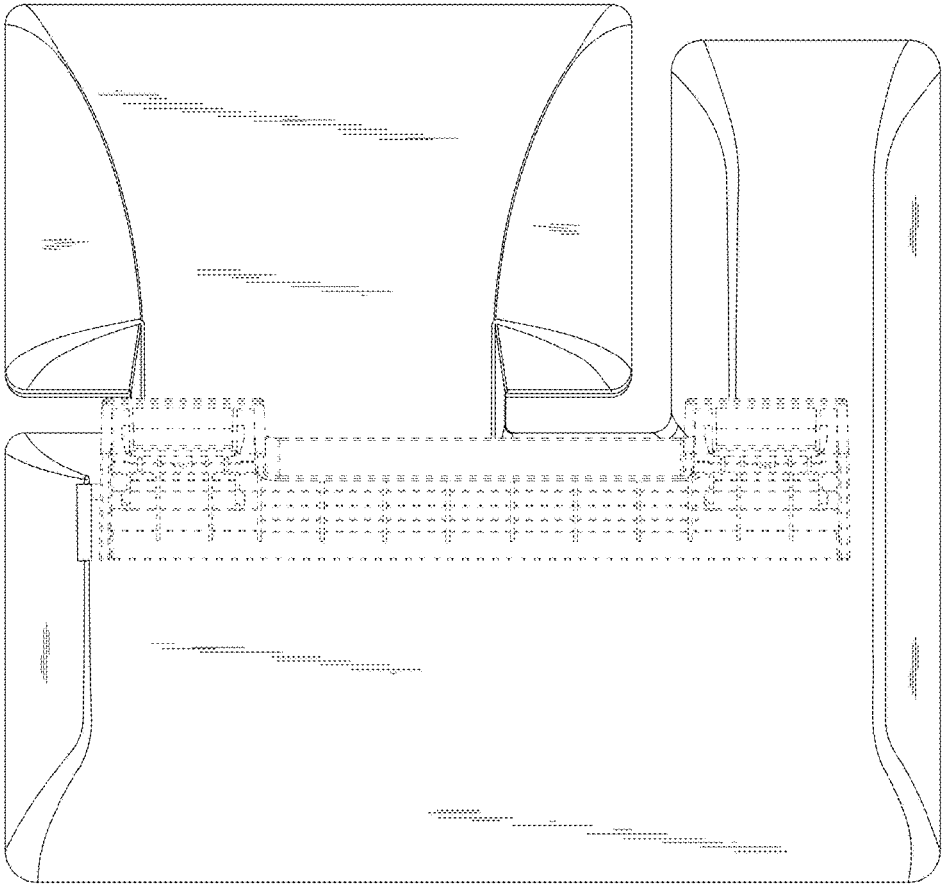

FIG. 66

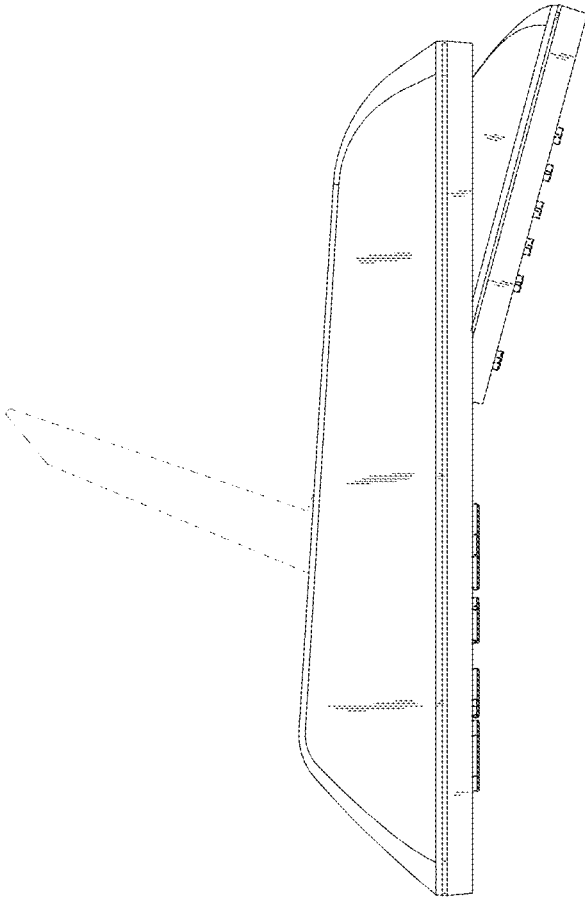

FIG. 67

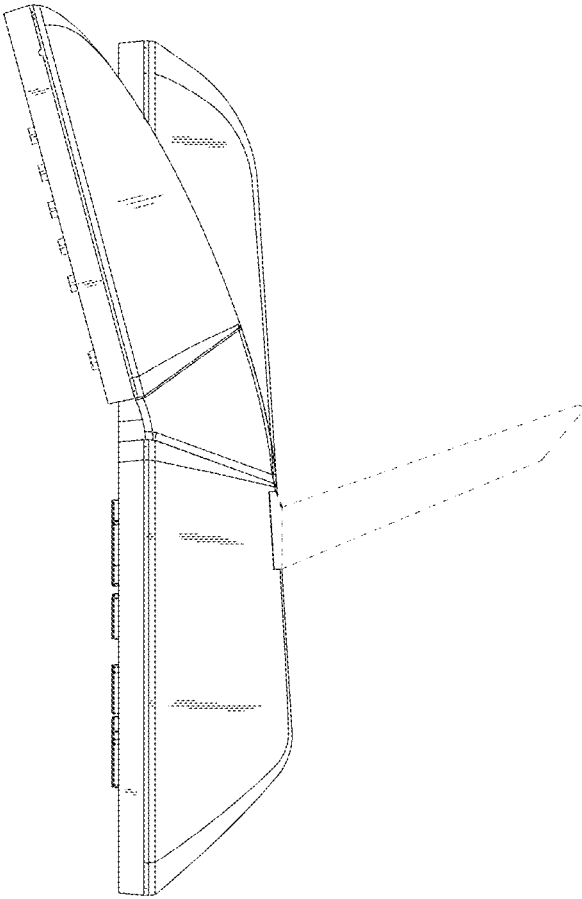

FIG. 68

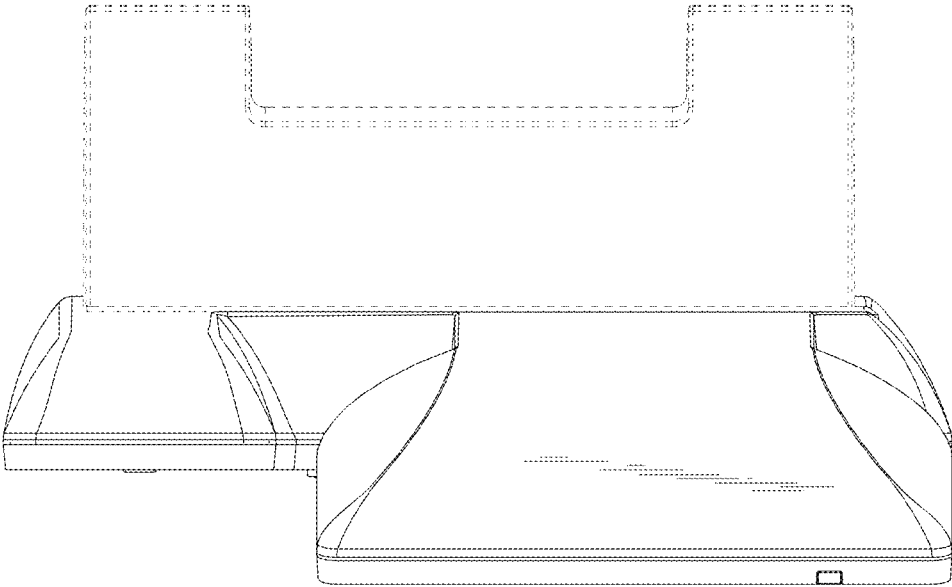

FIG. 69

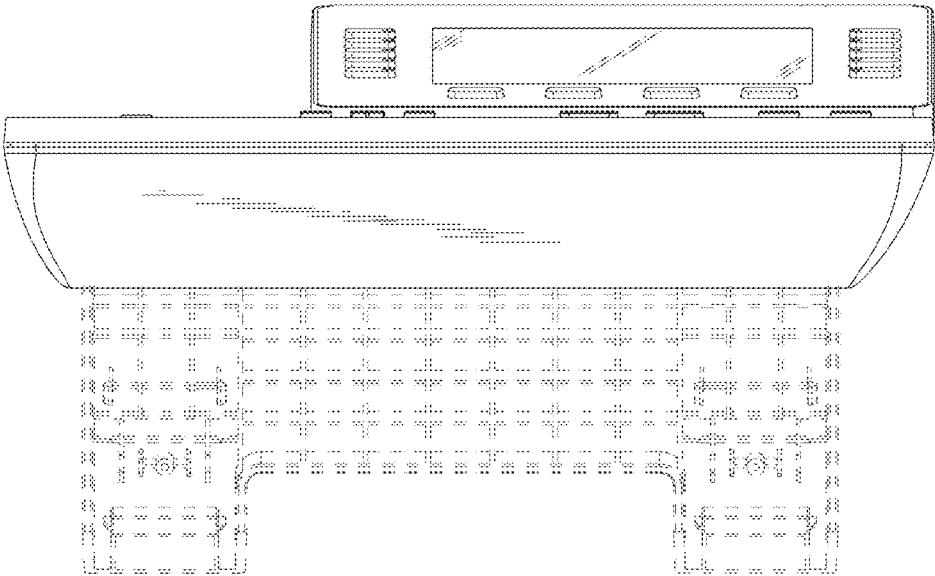

FIG. 70



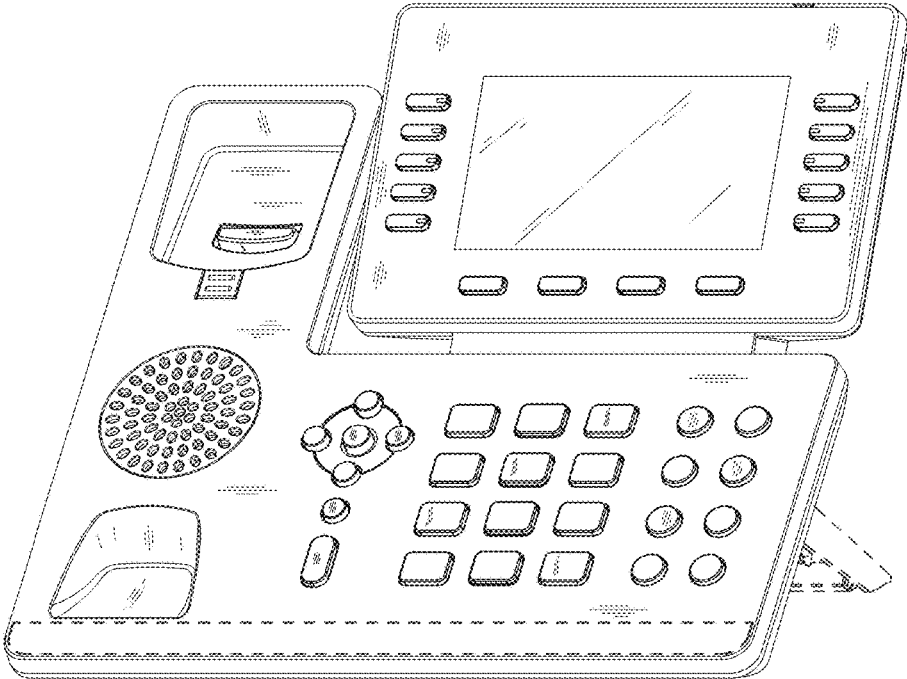

FIG. 71

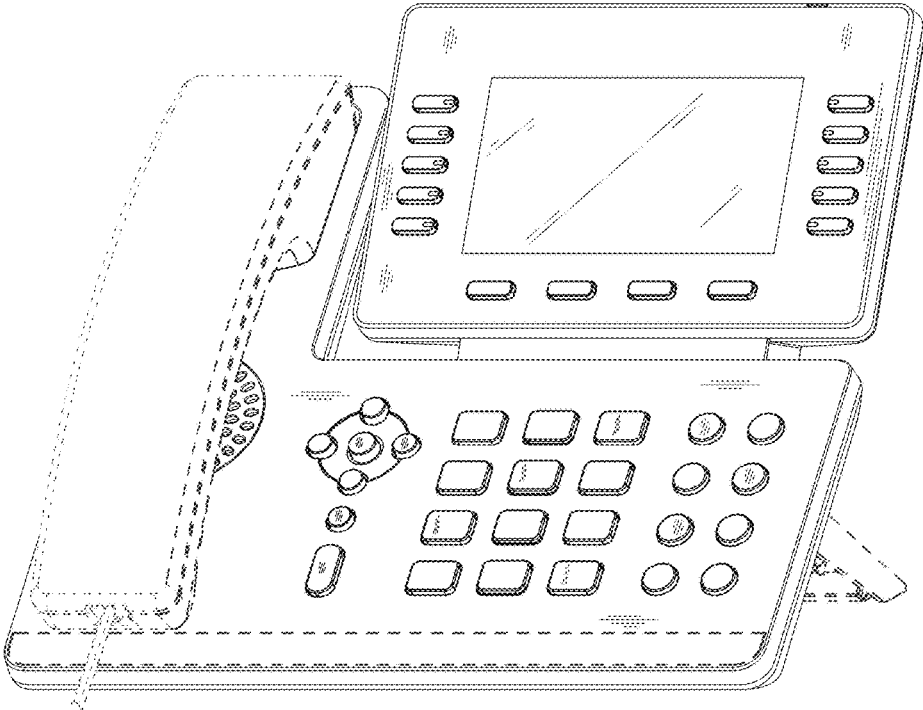

FIG. 72