



US00D368980S

United States Patent [19]
Ichikawa

[11] **Patent Number: Des. 368,980**
[45] **Date of Patent: **Apr. 16, 1996**

[54] **LIGHTER**
[75] Inventor: **Makoto Ichikawa**, Tokyo, Japan
[73] Assignee: **Modern Royal Co., Ltd.**, Tokyo, Japan
[**] Term: **14 Years**

2,529,094 11/1950 Miller 431/152
2,881,608 4/1959 Lockwood 431/152

Primary Examiner—A. Hugo Word
Assistant Examiner—Marcus Jackson
Attorney, Agent, or Firm—Oblon, Spivak, McClelland,
Maier & Neustadt

[21] Appl. No.: **35,888**
[22] Filed: **Mar. 8, 1995**
[52] **U.S. Cl.** **D27/141**
[58] **Field of Search** D27/101, 102,
D27/103, 139, 141, 142, 143, 144, 147,
154, 156, 157, 158, 159, 160; 131/173,
194, 270, 329, 336, 360, 361; 431/125,
129-152, 343

[57] **CLAIM**
The ornamental design for a lighter, as shown and described.

DESCRIPTION

FIG. 1 is a right front top perspective view of a lighter, showing my new design;
FIG. 2 is a front elevational view thereof;
FIG. 3 is a rear elevational view thereof;
FIG. 4 is a left side elevational view thereof;
FIG. 5 is a right side elevational view thereof;
FIG. 6 is a top plan view thereof;
FIG. 7 is a bottom plan view thereof; and,
FIG. 8 is a front elevational view thereof, with a lid in an open position.

[56] **References Cited**
U.S. PATENT DOCUMENTS
D. 75,135 5/1928 Rogers D27/141
D. 359,818 6/1995 Ichikawa D27/141
D. 360,052 7/1995 Ichikawa D27/141
D. 360,281 7/1995 Kim D27/141

1 Claim, 3 Drawing Sheets

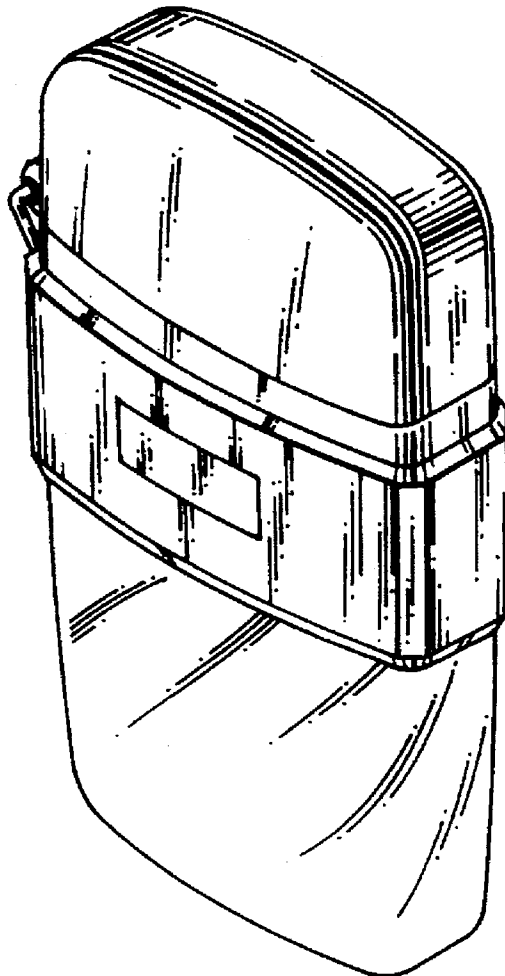

FIG. 1

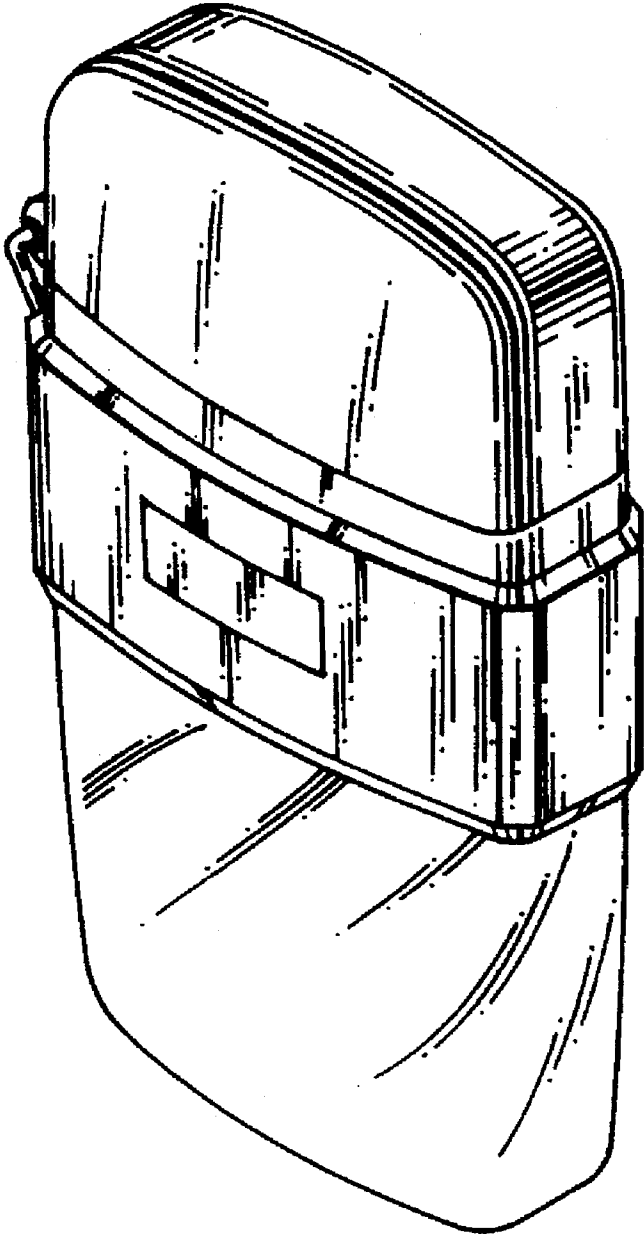

FIG. 2

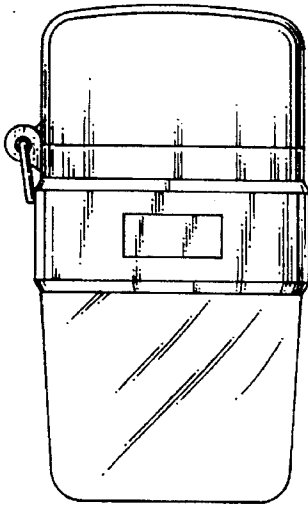

FIG. 3

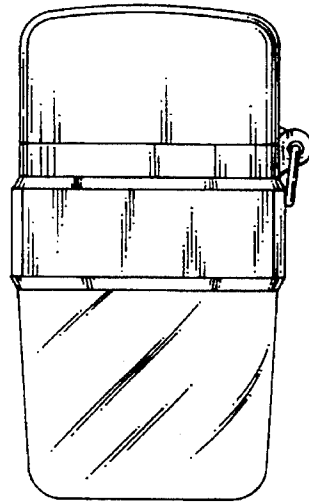

FIG. 4

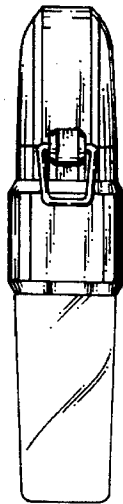

FIG. 5

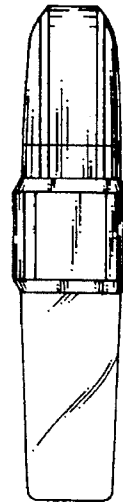

FIG. 6

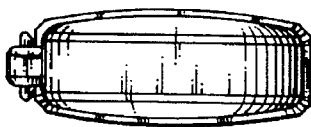

FIG. 7

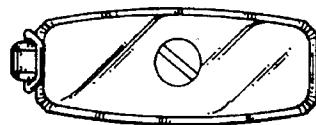

FIG. 8

