



US00D894536S

(12) **United States Design Patent**
Ngan

(10) **Patent No.:** **US D894,536 S**

(45) **Date of Patent:** **** Sep. 1, 2020**

(54) **PONCHO HOODIE** 3,381,306 A * 5/1968 Innes A47G 9/086
2/69

(71) Applicant: **Shun On John Ngan**, Carson, CA (US) D225,489 S 12/1972 Graham
3,797,043 A 3/1974 Brument

(72) Inventor: **Shun On John Ngan**, Carson, CA (US) (Continued)

(**) Term: **15 Years**

FOREIGN PATENT DOCUMENTS

(21) Appl. No.: **29/718,476** CA 2720578 11/2010
CA 144154 11/2013

(Continued)

(22) Filed: **Dec. 24, 2019**

(51) **LOC (12) Cl.** **02-02**

(52) **U.S. Cl.**
USPC **D2/825**

(58) **Field of Classification Search**
USPC D2/823, 825, 826, 828
See application file for complete search history.

OTHER PUBLICATIONS

Koretamp Poncho Liner posted to bushcraftoutfitters.com. Available date Jul. 17, 2019 [site visited Mar. 20, 2020]. Available: <<https://bushcraftoutfitters.com/koretamp-poncho-lined/>> (Year: 2019).*
(Continued)

(56) **References Cited**

U.S. PATENT DOCUMENTS

1,097,530 A 5/1914 Cabelinsky
1,243,206 A 10/1917 Norman
1,432,249 A * 10/1922 Robert A41D 7/008
2/69

1,643,440 A 9/1927 Baldwin
1,905,235 A 4/1933 Mandelert
D108,875 S 3/1938 Friedman
D113,194 S 1/1939 Storey et al.
2,143,931 A 1/1939 Aronson
2,260,427 A 10/1941 Bailey
2,292,347 A 8/1942 Bailey
2,372,110 A 3/1945 Noone
2,420,344 A 5/1947 Alexander
2,865,025 A 12/1958 Hennessey
2,873,449 A 2/1959 Herbert
2,967,306 A * 1/1961 Fabanich A41D 3/08
2/94

3,079,611 A 3/1963 Boryszewski
D196,096 S 8/1963 Griffith et al.
3,116,491 A * 1/1964 Previdi A41D 1/21
2/106

Primary Examiner — Kevin K Rudzinski

(74) *Attorney, Agent, or Firm* — Cislo & Thomas, LLP

(57) **CLAIM**

The ornamental design for a poncho hoodie, as shown and described.

DESCRIPTION

FIG. 1 is a perspective view of my poncho hoodie;
FIG. 2 is a front view thereof;
FIG. 3 is a right side view thereof;
FIG. 4 is a left side view thereof;
FIG. 5 is a rear view thereof;
FIG. 6 is a top view thereof; and,
FIG. 7 is a bottom view thereof.
The broken lines shown in the drawings illustrate portions of my poncho hoodie that form no part of the claimed design.

1 Claim, 5 Drawing Sheets

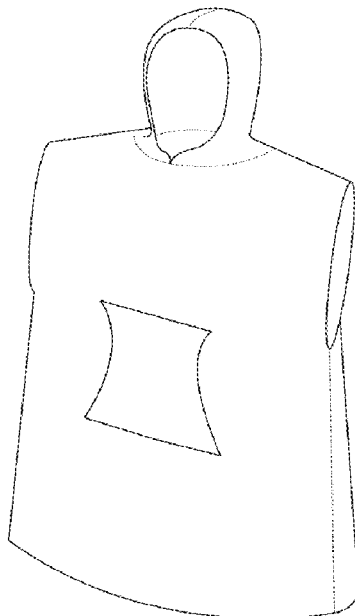

(56)

References Cited

U.S. PATENT DOCUMENTS

3,837,006	A	9/1974	Laseman		D638,612	S	5/2011	Benderradji	
4,055,853	A	11/1977	Argento et al.		D645,645	S *	9/2011	Dyer	D2/823
D247,331	S	2/1978	Nally		D653,836	S	2/2012	Woyshner et al.	
D247,526	S	3/1978	Nally		D663,105	S	7/2012	Selivon	
4,078,264	A *	3/1978	DeGennaro	A41D 3/08 2/88	D672,531	S	12/2012	Keifer	
4,227,264	A	10/1980	Spector et al.		D674,167	S	1/2013	Ehler	
4,370,755	A *	2/1983	Crumby	A41D 3/08 2/84	D677,859	S	3/2013	Andes	
4,404,687	A	9/1983	Hager		D677,860	S	3/2013	Kim	
4,502,155	A	3/1985	Itoi		D679,479	S	4/2013	Carrera et al.	
D294,535	S *	3/1988	Stricklin	D2/831	D679,484	S *	4/2013	Brown	D2/823
D296,605	S *	7/1988	Asher	2/69	8,424,113	B2 *	4/2013	Sprole	A47G 9/086 2/69
4,791,681	A	12/1988	Dean		8,424,114	B2	4/2013	Snyder et al.	
4,862,519	A	9/1989	Bull		D683,523	S	6/2013	Freedman	
4,928,321	A	5/1990	Dobson		D684,341	S *	6/2013	Freedman	D2/825
D312,721	S *	12/1990	Shea	D2/717	D684,409	S	6/2013	Juarez	
5,086,516	A	2/1992	Baxter et al.		D686,408	S	7/2013	Stemlight	
D325,459	S	4/1992	Keever		D687,210	S	8/2013	Krafnick	
5,119,510	A	6/1992	Schilling		D690,078	S	9/2013	Anderson	
5,206,957	A	5/1993	Gulick		D690,486	S	10/2013	Yan	
D351,712	S	10/1994	Jackson		D692,212	S	10/2013	Coward	
D365,193	S	12/1995	Dodd, Jr.		8,566,963	B2	10/2013	Ryan	
D385,088	S	10/1997	Handysides		D693,540	S	11/2013	Vanneste	
5,697,102	A	12/1997	Benjamin		D693,541	S	11/2013	Vanneste	
5,720,043	A	2/1998	White		8,578,515	B1	11/2013	Petersen	
5,787,504	A	8/1998	Wu		D701,677	S	4/2014	Tref	
5,850,634	A	12/1998	Toombs		D707,466	S	6/2014	Lancaster	
D414,013	S	9/1999	Group		D708,423	S *	7/2014	Adams	D2/744
5,996,121	A	12/1999	Harris		D714,021	S	9/2014	Bowen	
6,006,356	A	12/1999	Song		D714,524	S	10/2014	Borovicka	
6,014,772	A *	1/2000	Connelly	A41D 3/005 2/102	8,864,544	B2	10/2014	Anderman et al.	
D430,721	S	9/2000	Beauchan		D721,467	S	1/2015	Tref	
6,185,743	B1 *	2/2001	Mick	A41D 3/08 2/69	D728,900	S	5/2015	White	
D439,029	S	3/2001	Goldman		D732,800	S	6/2015	Brown	
6,219,847	B1	4/2001	Aikins		D736,496	S	8/2015	Gonzalez	
6,253,381	B1	7/2001	Kelley		D741,567	S	10/2015	Chang	
6,275,993	B1	8/2001	McCarley		D741,576	S	10/2015	Sakosits	
D453,607	S	2/2002	Tracy		D746,551	S	1/2016	Ingram	
6,405,377	B1	6/2002	Davis		D747,075	S	1/2016	Ingram	
D465,317	S	11/2002	Darling		D751,272	S	3/2016	Moehring	
D478,708	S *	8/2003	Miros	D2/831	9,295,292	B2	3/2016	Sachs	
D482,935	S	12/2003	Yamane		D754,947	S	5/2016	Borovicka	
6,760,921	B1	7/2004	Simmons		D758,046	S	6/2016	Grant	
D496,144	S	9/2004	Bourget		D758,700	S	6/2016	Borovicka	
6,839,911	B1	1/2005	Mathews		D762,345	S	8/2016	Adams et al.	
6,848,118	B2	2/2005	Barnes et al.		9,414,631	B2	8/2016	Schrimpf	
D507,693	S	7/2005	Walton		D765,349	S	9/2016	Hou	
6,922,848	B1	8/2005	Stanley		D765,351	S	9/2016	Shaw	
7,065,810	B2	6/2006	Robinson		D767,255	S	9/2016	Marino	
D541,011	S	4/2007	Day et al.		9,339,064	B2	9/2016	Shaw	
D551,429	S	9/2007	Wager		D769,580	S	10/2016	Conway et al.	
D553,329	S	10/2007	Wager		D770,136	S	11/2016	Darmour	
D553,330	S	10/2007	Wager		9,554,601	B2	1/2017	Arajakis	
D565,456	S	4/2008	Anderson et al.		D784,659	S	4/2017	Darmour	
7,418,740	B2	9/2008	Anderson et al.		D785,285	S	5/2017	Shamsid-Deen	
D584,482	S	1/2009	Marsh		D785,906	S	5/2017	Darmour	
D590,133	S	4/2009	Rogondino		D787,160	S	5/2017	Crowe et al.	
D591,028	S	4/2009	Rogondino		D790,809	S	7/2017	Lomax	
D594,633	S	6/2009	Floyd		D792,678	S	7/2017	Storlie et al.	
D600,884	S	9/2009	Patton		9,713,352	B2	7/2017	Demarest	
D601,327	S	10/2009	Anderson et al.		D801,005	S	10/2017	Perez	
D608,983	S	2/2010	Myers		9,775,387	B2	10/2017	Parr	
D609,432	S	2/2010	Jennings		D801,948	S	11/2017	Picunko	
D626,310	S	11/2010	Cruz		D802,884	S	11/2017	Bennett	
D626,720	S *	11/2010	Pinkhasov	D2/717	D802,886	S	11/2017	Salce, Jr. et al.	
D626,725	S	11/2010	Snyder et al.		D809,745	S	2/2018	Crowe et al.	
D627,540	S	11/2010	Claeys		D810,401	S	2/2018	Darmour	
D629,590	S	12/2010	Freedman et al.		D810,402	S	2/2018	Darmour	
D630,002	S	1/2011	Brown		D811,051	S	2/2018	Darmour et al.	
D630,003	S	1/2011	Brown		D815,801	S	4/2018	Torre	
D630,820	S	1/2011	Wilson		D820,560	S	6/2018	Reynolds et al.	
D636,973	S	5/2011	Smith et al.		D822,344	S *	7/2018	Karim	D2/728
					D827,247	S	9/2018	Genender	
					D827,248	S	9/2018	Genender	
					D827,249	S	9/2018	Darmour et al.	
					10,080,391	B2 *	9/2018	Rundle	A41D 3/08
					D830,735	S	10/2018	Johnson	
					D831,937	S	10/2018	James	
					10,130,126	B2	11/2018	Blauser	

(56)

References Cited

U.S. PATENT DOCUMENTS

D839,539	S	2/2019	Jones	
D839,546	S	2/2019	Noiberg	
D840,133	S	2/2019	Peck	
D841,289	S	2/2019	Frost et al.	
D842,589	S	3/2019	Johnson	
10,265,636	B2	4/2019	Anderman et al.	
D854,787	S	7/2019	Ngan	
D856,032	S	8/2019	Hindley	
D859,788	S	9/2019	Speciale et al.	
10,420,431	B1	9/2019	Speciale et al.	
D862,841	S	10/2019	Lomax	
D862,843	S	10/2019	Darmour	
D862,845	S	10/2019	Plant et al.	
10,485,278	B2	11/2019	Noll et al.	
D886,416	S	6/2020	Speciale	
2001/0032360	A1	10/2001	Bertrand	
2002/0142112	A1	10/2002	Tarrell	
2003/0061659	A1	4/2003	Dunlap	
2003/0182714	A1	10/2003	Mariland et al.	
2004/0181844	A1	9/2004	Kim	
2004/0237167	A1	12/2004	Curry	
2005/0144695	A1	7/2005	Aldridge et al.	
2006/0010555	A1*	1/2006	Hayes	A41D 13/0015 2/69
2007/0050882	A1	3/2007	Eisenhuth	
2007/0061940	A1	3/2007	Cazares	
2007/0083983	A1	4/2007	Barclay	
2007/0157359	A1*	7/2007	Reardon	A41D 13/1245 2/69
2007/0266473	A1	11/2007	Issel	
2008/0056508	A1	3/2008	Pierce et al.	
2008/0120774	A1	5/2008	Hite	
2008/0196140	A1	8/2008	Mayerson	
2008/0250560	A1	10/2008	Armstrong	
2009/0055991	A1	3/2009	Johnson et al.	
2009/0144874	A1	6/2009	Stein	
2009/0165206	A1	7/2009	Davis	
2009/0205117	A1	8/2009	Day et al.	
2009/0229034	A1	9/2009	Zmigrosky	
2009/0235426	A1	9/2009	Johnston et al.	
2010/0115684	A1	5/2010	Freedman et al.	
2010/0122395	A1*	5/2010	Wall	A41D 15/04 2/84
2010/0146680	A1	6/2010	Cuoco	
2010/0186166	A1	7/2010	Sulentie	
2011/0179559	A1	7/2011	Smoot	
2011/0185471	A1	8/2011	Buczekowski	
2011/0206299	A1	8/2011	Carmody	
2012/0005802	A1	1/2012	Claeys	
2012/0023635	A1	2/2012	Ehler	
2012/0060254	A1	3/2012	Blade	
2012/0144550	A1	6/2012	Nejad	
2013/0000010	A1	1/2013	Ryan	
2013/0019378	A1	1/2013	White	
2013/0042383	A1	2/2013	Ryan et al.	
2013/0130540	A1	5/2013	Oman et al.	
2013/0152269	A1	6/2013	Coward	
2013/0152270	A1	6/2013	Neal et al.	
2013/0219581	A1	8/2013	Schrumpf	
2013/0219616	A1	8/2013	Bozek	
2013/0269082	A1	10/2013	Bramblet	

2014/0068834	A1	3/2014	Skinner	
2014/0082818	A1	3/2014	Nysheva-Starr	
2014/0096305	A1	4/2014	Friesen	
2014/0215689	A1	8/2014	Perez	
2014/0237700	A1	9/2014	Albert	
2014/0259275	A1	9/2014	Walvius et al.	
2014/0310848	A1	10/2014	Ulriksen	
2014/0317824	A1	10/2014	Browning et al.	
2014/0331381	A1	11/2014	Arajakis	
2015/0121604	A1	5/2015	Lee et al.	
2015/0135397	A1	5/2015	Levine	
2015/0150319	A1	6/2015	Walmsley	
2015/0196061	A1	7/2015	Oliver	
2015/0250337	A1	9/2015	Gould	
2015/0296898	A1	10/2015	Bowen	
2015/0296909	A1	10/2015	Sachs	
2016/0157535	A1	6/2016	Tirro et al.	
2016/0174633	A1	6/2016	Macrae	
2016/0242474	A1	8/2016	Baschak	
2016/0309799	A1	10/2016	Nysheva-Starr	
2017/0020215	A1	1/2017	Merritt	
2017/0079350	A1	3/2017	Hourani	
2017/0164665	A1	6/2017	Johnson	
2017/0224030	A1	8/2017	Olivares	
2017/0224033	A1	8/2017	Latta, Jr.	
2017/0265545	A1	9/2017	Peng	
2017/0280793	A1	10/2017	Reyes	
2017/0311655	A1	11/2017	Gonzalez	
2018/0027889	A1	2/2018	Frost et al.	
2018/0049489	A1	2/2018	Noll	
2018/0092410	A1	4/2018	Rundle	
2018/0368496	A1	12/2018	Berberi	
2019/0142089	A1	5/2019	Emes	
2019/0216191	A1	7/2019	Botha et al.	
2019/0254410	A1	8/2019	DuVall	
2019/0269184	A1	9/2019	Gracie	
2020/0008500	A1	1/2020	Speciale	

FOREIGN PATENT DOCUMENTS

GB	2561262	12/2017
JP	1046408	2/1998
JP	2006207103	10/2006
NL	9302143	7/1995
WO	DM 091998	10/2016
WO	WO 2018222868	12/2018

OTHER PUBLICATIONS

Ho Stevie! Surf Poncho posted to amazon.com. Available date: Mar. 19, 2016 [site visited Mar. 20, 2020]. Available: <https://www.amazon.com/Ho-Stevie-Microfiber-Wetsuit-Changing/dp/B01CV1P9UG/ref=em_cr_arp_d_product_top?ie=UTF8> (Year: 2016).*

Open Road Goods Open Road Goods Surf Poncho/Adult Hooded Towel/Changing Towel/Wetsuit Changing Rebe/Swim Parka— Changing Poncho Charcoal Black/Indigo Blue; Saves a Sea Turtle's Life; https://www.amazon.com/Poncho-Adult-Hooded-Changing-Wetsuit/dp/B07BMR3KJ7/ref=sr_1_10?crd=2T0RU5Y9DSGSP&keywords=surf+poncho&qid=1576195319&prefix=surf+p%2Caps%2C195&sr=8-10, 8 pages.

* cited by examiner

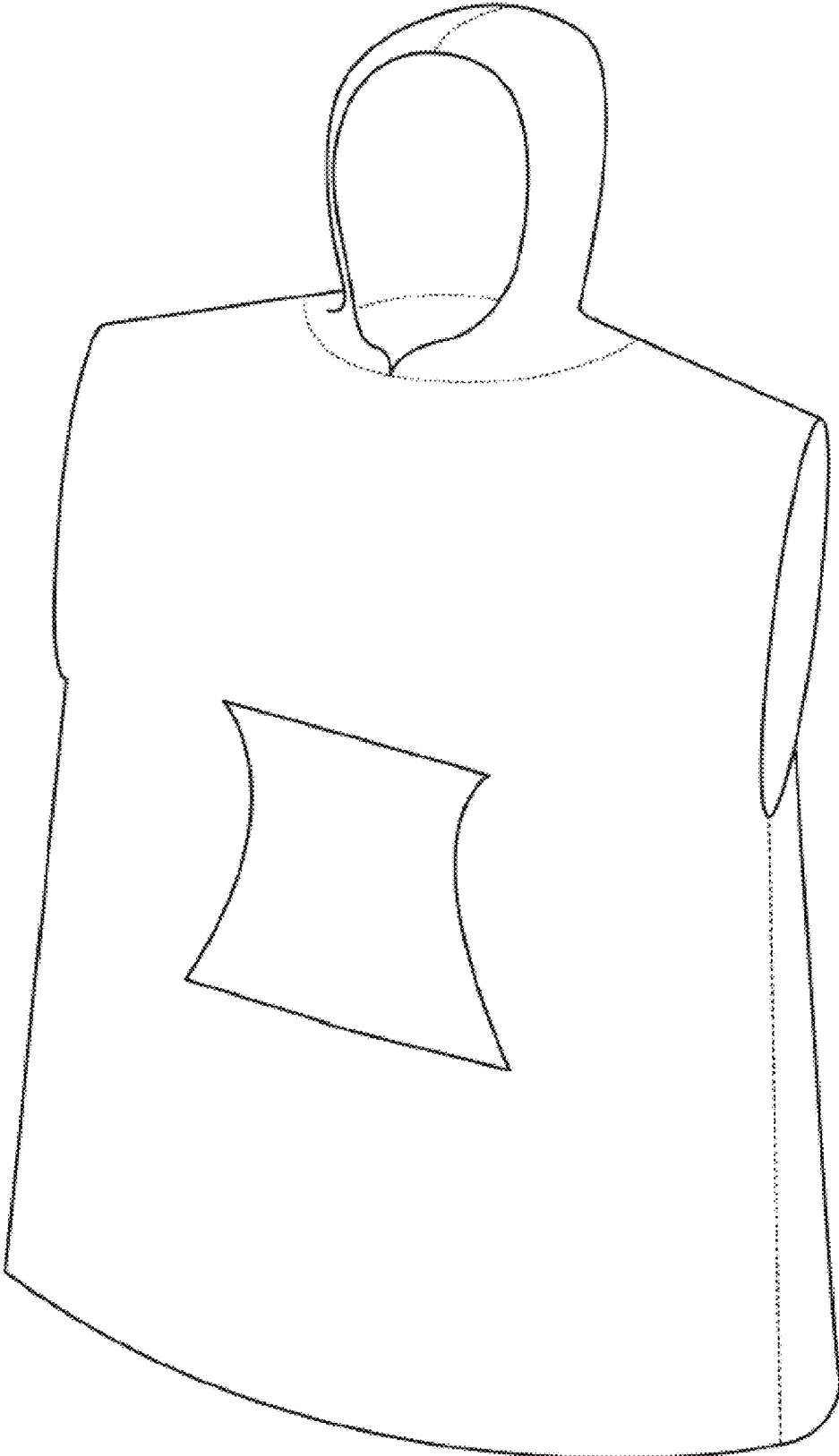

FIGURE 1

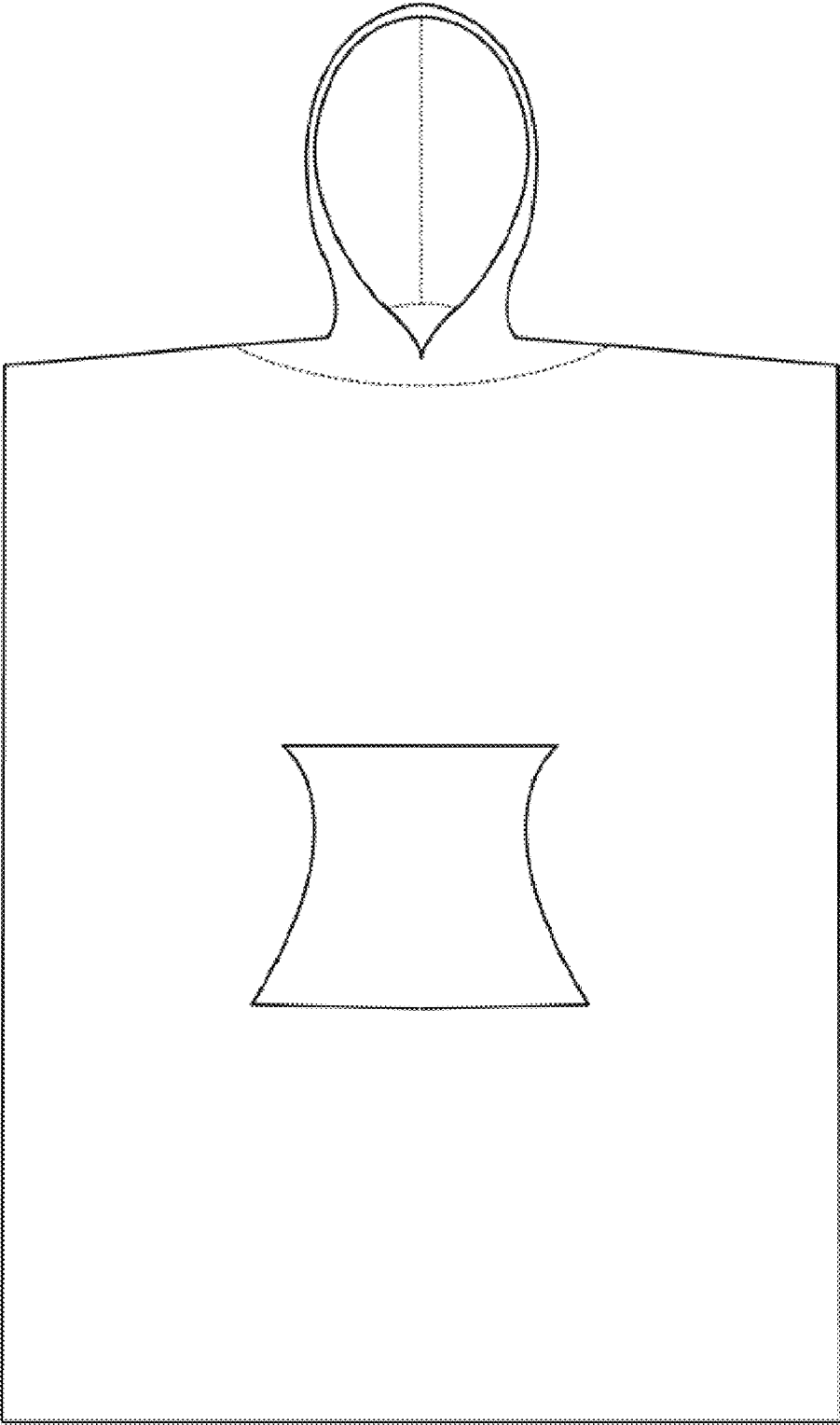

FIGURE 2

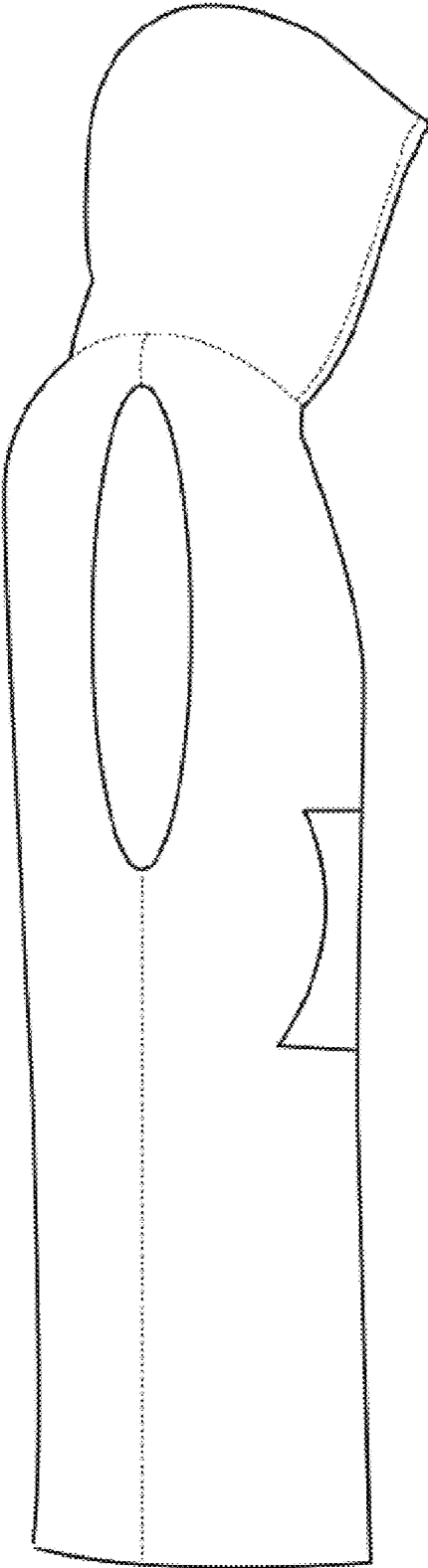

FIGURE 3

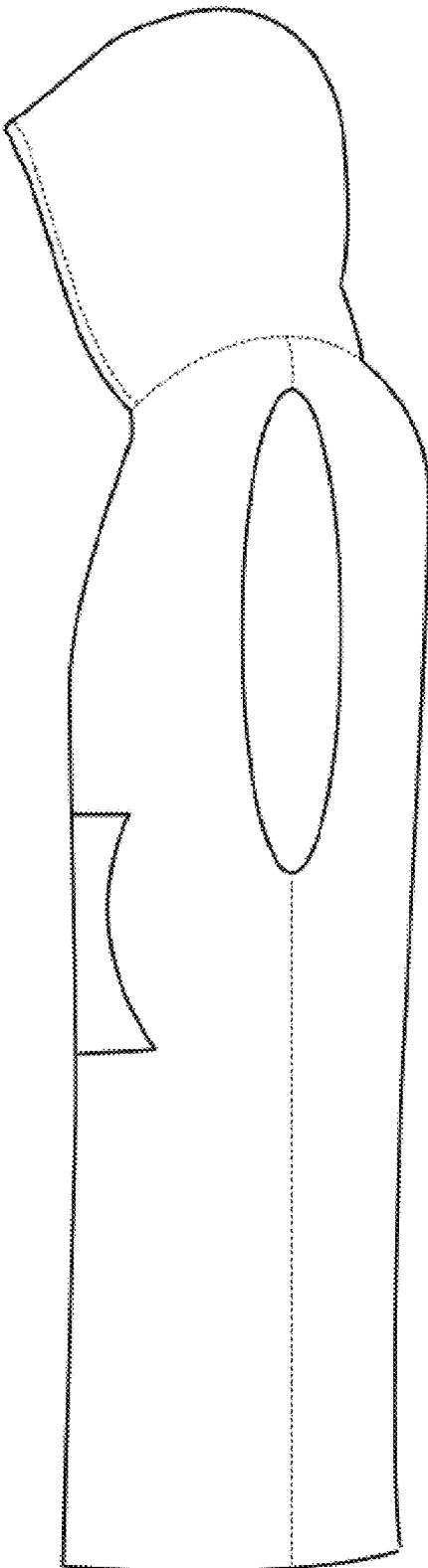

FIGURE 4

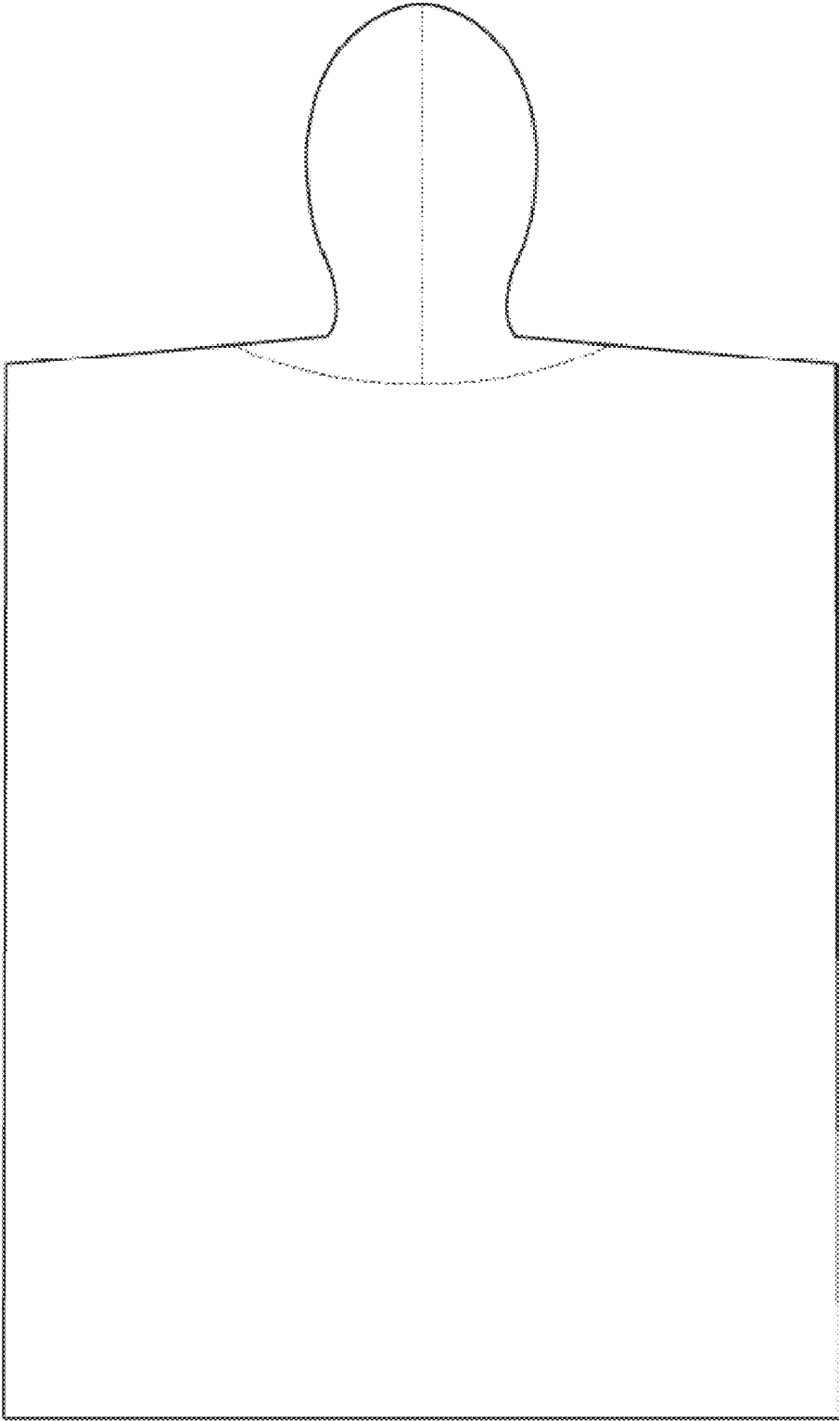

FIGURE 5

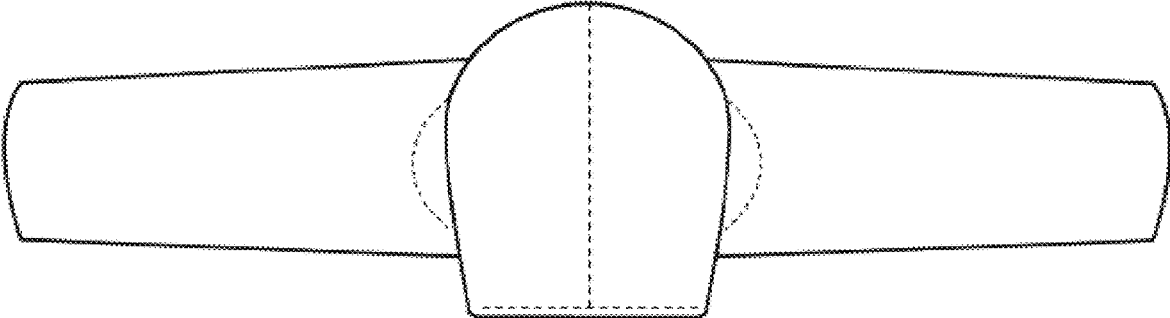

FIGURE 6

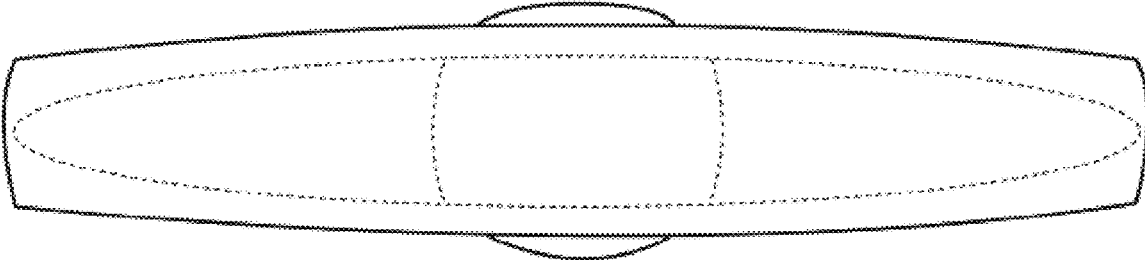

FIGURE 7