



*One Stop Solution Building Amenities*

+91 95379 02119, 99134 19644, 93134 67645

# ABOUT US

Established in the year 2015, **OM ENTERPRISE** is emerging as a consistent and developing business entity. We are engaged in supplying and wholesaling of extensive array of Garden Equipments, Play Ground Equipments, Outdoor Gym Equipments and Road Safety Products. We are one of the leading supplier and ensure that the end products match global quality standards using the best quality fiber, resin, mat and other safe and reliable materials.

Our ultimate motto is safety, security and comfort of toddlers, children and other users in general.

## CONTENTS

|   |   |
|---|---|
|  Bench 4 to 6                      |  Swings 14                    |
|  Road Safety Products 7-8          |  Merry Go Round 15            |
|  Dustbin (frp / Ss) 9             |  See-saw 16                  |
|  Frp Manhole Cover & Gratings 10 |  Climbers & Adventure 16-17 |
|  Artificial Grass 10             |  Spring Rides 18            |
|  Fancy Roto Planter 11           |  Multi Play Set 19 to 24    |
|  Rubber / E.p.d.m. Flooring 12   |  Indoor Game 34 to 36       |
|  Slides 13                       |  Gym Equipment 37-38        |



# WARRANTY FOR PLAYGROUND EQUIPMENT

Buyers agrees that products sold by "OM ENTERPRISE" carries the following warranty.

- Limited 5 years warranty on metallic parts like deck, ladder, railing, support climbers structural components.
- Limited 1 year warranty on swing bearings.
- Limited 1 year warranty on other metallic parts.
- Limited 1 year warranty for all FRP parts against manufacturing defect.
- Limited 6 months warranty on sewn fabric components, ropes and other other non-metallic parts.
- These limited warranties are against failure caused due to Material. It does not include normal / climatic wear & tear, overuse, abuse, mishandling, vandalism, negligence and cosmetic items (such as scratches, dents, marring, fading, discolouring, weathering).
- This warranty shall be valid only if equipments are installed & maintained as per our manual.
- This warranty cover's only repair & replacement of parts, which will be warranted only for the balance period.
- All warranties begin on the date of OM's invoice. The period of warranty will be considered from the date of invoice.

## CERTIFICATES



  
 Government of India  
 And  
 Government of Gujarat  
**Form GST REG-25**

**Certificate of Provisional Registration**

|  |                           |
|--|---------------------------|
| 1. GSTIN                                   | 24CAHP647231ZY            |
| 2. PAN                                     | CAHPB4723J                |
| 3. Legal Name                              | PRAYAG GOVINDBHAI BHIMANI |
| 4. Trade Name                              | OM ENTERPRISE             |
| 5. Registration Details under Existing Law |                           |
| Act  | Registration Number       |
| (a) TIN under Value Added Tax              | 24222501736               |
| Date                                       | 26/06/2017                |

This is a Certificate of Provisional Registration issued under the provisions of the Act.



# OUR CLIENTS





### FRP BENCH M-01



Bench Length : 4.5' ft.  
Bench Height : 3' ft.  
Bench Width : 2' - 4"  
Sitting Width : 1' - 5"

### FRP BENCH M-02



Bench Length : 4.5' ft.  
Sitting Width : 1' - 5"

### FRP BENCH M-03



Bench Length : 4.5' ft.  
Bench Height : 3' ft.  
Bench Width : 2' - 3"  
Sitting Width : 1' - 5"

### FRP BENCH M-04



Bench Length : 4.5' ft.  
Bench Height : 2' - 8"  
Bench Width : 2' - 2"  
Sitting Width : 1' - 5"

### FRP BENCH M-05



Bench Length : 4.5' ft.  
Bench Height : 2' - 8"  
Bench Width : 2' - 2"  
Sitting Width : 1' - 5"

### FRP BENCH M-06



Bench Length : 4.5' ft.  
Bench Height : 2' - 8"  
Bench Width : 2' - 2"  
Sitting Width : 1' - 5"

### FRP BENCH M-07



Bench Length : 4.5' ft.  
Bench Height : 2' - 8"  
Bench Width : 2' - 2"  
Sitting Width : 1' - 5"

### WOODEN BENCH M-08



Bench Length : 4.5' ft.  
Bench Height : 2' - 8"  
Bench Width : 2' - 2"  
Sitting Width : 1' - 5"

### FRP BENCH M-09



Bench Length : 4.5' ft.  
Bench Height : 3' ft.  
Bench Width : 2' - 2"  
Sitting Width : 1' - 5"

### FRP BENCH M-10



Bench Length : 4.5' ft.  
Bench Height : 3' ft.  
Bench Width : 2' - 2"  
Sitting Width : 1' - 5"

### FRP BENCH M-11



Bench Length : 4.5' ft.  
Bench Height : 2' - 8"  
Bench Width : 2' - 2"  
Sitting Width : 3' - 2"

### GI BENCH M-12



Bench Length : 5' ft.  
Bench Height : 3'  
Bench Width : 2' - 5"  
Sitting Width : 1' - 6"

### GI BENCH M-13



Bench Length : 4.5' ft.  
Bench Height : 2' - 8"  
Bench Width : 2' - 2"  
Sitting Width : 1' - 5"

### FRP BENCH M-14



Bench Length : 4.5' ft.  
Bench Height : 2' - 6"  
Bench Width : 2' - 3"  
Sitting Width : 1' - 6"

### FRP BENCH M-15



Bench Length : 4.5' ft.  
Bench Height : 2' - 6"  
Bench Width : 2'  
Sitting Width : 1' - 5"

### FRP STOOL M-16



Bench Length : 4.5' ft.  
Bench Height : 1' - 7"  
Sitting Width : 1' - 6"

### FRP STOOL M-17



Bench Length : 4.5' ft.  
Bench Height : 1' - 6"  
Sitting Width : 1' - 5"

### FRP STOOL M-18



Bench Length : 4.5' ft.  
Bench Height : 1' - 6"  
Sitting Width : 1' - 5"





**RSP (01)**  
PVC Speed Breaker  
L350 x W250 x H50(mm)



**RSP (02)**  
ABS Speed Breaker  
L350 x W250 x H50(mm)  
L350 x W250 x H65(mm)



**RSP (03)**  
ABS Speed Breaker  
L500 x W400 x H75(mm)



**RSP (04)**  
Long Speed Breaker  
L750 x W250 x H75(mm)



**RSP (05)**  
Rubber Speed Breaker  
L500 x W350 x H50(mm)



**RSP (06)**  
Rubber Speed Breaker  
L500 x W400 x H75(mm)



**RSP (07)**  
Rubber Speed Breaker  
L500 x W400 x H75(mm)



**RSP (08)**  
Rumbler Strip  
L500 x W130 x H25(mm)



**RSP (09)**  
Cable Protector  
L1000 x W300 x H45(mm)



**RSP (10)**  
Plastic & Rubber Corner Guard  
800, 1000 & 1200(mm)



**RSP (11)**  
Round Rubber Corner Guard  
800(mm)



**RSP (12)**  
3M Road Stud  
L100 x W90(mm)



**RSP (13)**

Aluminium Stud



**RSP (14)**

Solar Road Stud



**RSP (15)**

Card Stopper



**RSP (16)**

Red Barrier



**RSP (17)**

Traffic Cone  
Plastic Chain



**RSP (18)**

Spring Post



**RSP (19)**

Convex Mirror  
18", 24", 32", 40", 48"





Q Manager

RSP (20)



RSP (21)

Plastic Traffic Barrier



RSP (22)

Car Lock



RSP (23)

Traffic Button Light



RSP (24)

Reflective Tap



RSP (25)

LED Automatic Boom Barrier & RFID System



RSP (26)

Tripod Turnstile



RSP (27)

Tripod Turnstile With Face



RSP (28)

Flap Barrier



RSP (32)

Metal Detector Scan Gate



RSP (29)

Hand Metal Detector



RSP (30)

S.S. Bollards



RSP (31)

Under Car Mirror

THERMOPLASTIC ROAD MARKING

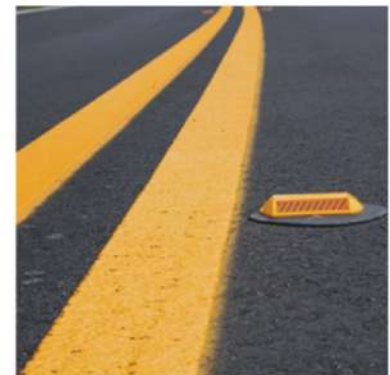

## DUSTBIN

PD-1



Capacity : 50 Ltr.  
Dia : 350 mm  
Height : 780 mm  
Color : Grey, Bridge



PD-2



Capacity : 100 Ltr.  
Dia : 650 mm  
Height : 1100 mm  
Color : Grey, Bridge

PD-3 (FRP)



Capacity : 12 Ltr.  
Dia : 500 mm  
Height : 740 mm  
Color : Multi Color



PD-4

- 1) 580 x 730 x 1000 mm  
Capacity : 240 Ltr.
- 2) 480 x 550 x 940 mm  
Capacity : 120 Ltr.



PD-5

- 1) 360 x 360 x 865 mm  
Capacity : 60 Ltr.
- 2) 410 x 410 x 915 mm  
Capacity : 80 Ltr.
- 3) 510 x 510 x 910 mm  
Capacity : 100 Ltr.



PD-6

Size : 450 x 450 mm

PD-7



775 x 1175 x 1325 mm  
Capacity : 660 Ltr.  
1073 x 1373 x 1354 mm  
Capacity : 1100 Ltr.

## SS DUSTBIN

SS-1



|        |    |    |    |
|--------|----|----|----|
| Dia    | 9  | 10 | 12 |
| Height | 12 | 14 | 24 |

SS-2



|        |    |    |    |
|--------|----|----|----|
| Dia    | 7  | 8  | 10 |
| Height | 11 | 13 | 15 |

SS-3



|        |    |    |    |
|--------|----|----|----|
| Dia    | 10 | 10 | 12 |
| Height | 24 | 32 | 24 |

SS-4



|        |    |    |    |
|--------|----|----|----|
| Dia    | 14 | 14 | 14 |
| Height | 18 | 24 | 28 |

SS-5



|        |    |    |    |
|--------|----|----|----|
| Dia    | 12 | 12 | 14 |
| Height | 24 | 28 | 28 |

SS-6



|        |    |    |    |
|--------|----|----|----|
| Dia    | 14 | 14 | 14 |
| Height | 18 | 24 | 28 |

SS-7



|        |    |    |    |
|--------|----|----|----|
| Dia    | 12 | 12 | 12 |
| Height | 18 | 24 | 28 |

SS-8



|        |    |    |    |
|--------|----|----|----|
| Dia    | 14 | 14 | 14 |
| Height | 18 | 24 | 28 |

SS-9



## PLANTER

P-1



|        |    |    |    |
|--------|----|----|----|
| Dia    | 12 | 14 | 15 |
| Height | 12 | 14 | 15 |



## FRP MANHOLE COVER & GRATINGS



Round

| Dia    | Inches |
|--------|--------|
| 560 MM | 22.5   |
| 600 MM | 24     |
| 690 MM | 27.5   |
| 720 MM | 28.5   |
| 900 MM | 36     |

Ton : 2.5, 5, 10, 25, 40



Square

| Dia            | Inches  |
|----------------|---------|
| 750 x 750 MM   | 30 x 30 |
| 900 x 900 MM   | 36 x 36 |
| 1000 x 1000 MM | 40 x 40 |
| 1200 x 1200 MM | 48 x 48 |

Ton : 2.5, 5, 10, 25, 40



Rectangle

| Dia           | Inches  |
|---------------|---------|
| 450 x 600 MM  | 18 x 24 |
| 450 x 900 MM  | 18 x 36 |
| 600 x 900 MM  | 24 x 36 |
| 900 x 1200 MM | 36 x 48 |

Ton : 2.5, 5, 10, 25, 40



Moulded Grating

1 sq.mtr. x 1 sq.mtr.



Pultruded Grating

1 sq.mtr. x 1 sq.mtr.



Recessed Cover

| Dia            | Inches  |
|----------------|---------|
| 300 x 300 MM   | 12 x 12 |
| 450 x 450 MM   | 18 x 18 |
| 600 x 600 MM   | 24 x 24 |
| 450 x 900 MM   | 18 x 36 |
| 600 x 900 MM   | 24 x 36 |
| 1000 x 1000 MM | 40 x 40 |

Ton : 2.5, 5, 10, 25, 40



Water Gully Cover

| Dia          | Inches  |
|--------------|---------|
| 450 x 450 MM | 18 x 18 |
| 500 x 600 MM | 20 x 24 |
| 600 x 600 MM | 24 x 24 |
| 600 x 900 MM | 24 x 36 |
| 750 x 750 MM | 30 x 30 |
| 900 x 900 MM | 36 x 36 |

Ton : 2.5, 5, 10, 25, 40

## ARTIFICIAL GRASS



PREMIUM QUALITY  
SIZE : 20 MM, 25 MM,  
35 MM, 40 MM



Sports Grass  
15 MM

Pile Height  
10 MM, 12 MM



# FANCY ROTO PLANTER



| FLORAL      |    |    |    |    |    |    |
|-------------|----|----|----|----|----|----|
| Dia (inch)  | 13 | 17 | 20 | 25 | 29 | 44 |
| Hgt. (inch) | 11 | 14 | 17 | 21 | 25 | 35 |



| CRYSTAL     |    |    |    |    |    |  |
|-------------|----|----|----|----|----|--|
| Dia (inch)  | 13 | 17 | 20 | 24 | 30 |  |
| Hgt. (inch) | 11 | 15 | 18 | 21 | 26 |  |



| PENTAS      |    |
|-------------|----|
| Dia (inch)  | 12 |
| Hgt. (inch) | 10 |



| ROMBUS      |    |    |    |    |
|-------------|----|----|----|----|
| Dia (inch)  | 12 | 14 | 16 | 18 |
| Hgt. (inch) | 11 | 12 | 14 | 16 |



| MARCO       |    |    |    |
|-------------|----|----|----|
| Dia (inch)  | 12 | 16 | 20 |
| Hgt. (inch) | 12 | 16 | 22 |



| JASPER      |    |    |    |
|-------------|----|----|----|
| Dia (inch)  | 20 | 25 | 30 |
| Hgt. (inch) | 8  | 10 | 12 |



| TULIP       |         |
|-------------|---------|
| Dia (inch)  | 15 x 15 |
| Hgt. (inch) | 19      |



| TULIP (BIG) |         |
|-------------|---------|
| Dia (inch)  | 16 x 16 |
| Hgt. (inch) | 30      |



| VISTA       |    |    |    |
|-------------|----|----|----|
| Dia (inch)  | 24 | 33 | 39 |
| Wgt. (inch) | 10 | 13 | 12 |
| Hgt. (inch) | 8  | 11 | 8  |



| RECH TECK   |    |    |
|-------------|----|----|
| Dia (inch)  | 36 | 40 |
| Wgt. (inch) | 13 | 20 |
| Hgt. (inch) | 15 | 20 |



## RUBBER FLOORING



Green



Blue



Terra Cotta Red



Gray



Gym

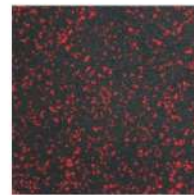

Black With Red



Bacik Black



Multi Color



Children Play

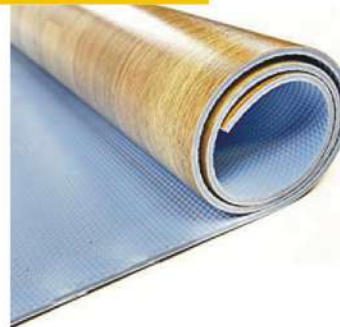

SIZE  
500 x 500 mm  
(2.78 sq.ft.)  
10mm, 15mm,  
20mm, 25mm

## E.P.D.M. FLOORING





# FRP PLAY GROUND EQUIPMENT

## SLIDES

### STRAIGHT SLIDE FRP

Length : 10' / 12' / 14'  
Width : 2' / 2' / 2'  
Height : 5' / 6' / 7'



### ROLLER SLIDE

Length : 10' / 12'  
Width : 2' / 2'  
Height : 5' / 6'



### TUBE SLIDE

Length : 10' / 12'  
Width : 2.5' / 2.5'  
Height : 5' / 6'



### CURVE SLIDE

Length : 10'  
Width : 2'  
Height : 5'



### SPIRAL SLIDE FRP (SMALL / BIG)

Length : 10' / 12'  
Width : 6' / 6'  
Height : 5' / 6'



### WIDE SLIDE M.S./S.S./FRP

Length : 12' / 14'  
Width : 4' / 4'  
Height : 6.5' / 6.5'



### SPIRAL BIG

Length : 14'  
Width : 7'  
Height : 7'



### FRP ROLLER SLIDE

Length : 10'  
Width : 2'  
Height : 5'



### TRIPAL WAVE SLIDE

Length : 10'  
Width : 2'  
Height : 5'



### DOUBLE CURVE SLIDE

Length : 10'  
Width : 4'  
Height : 5'

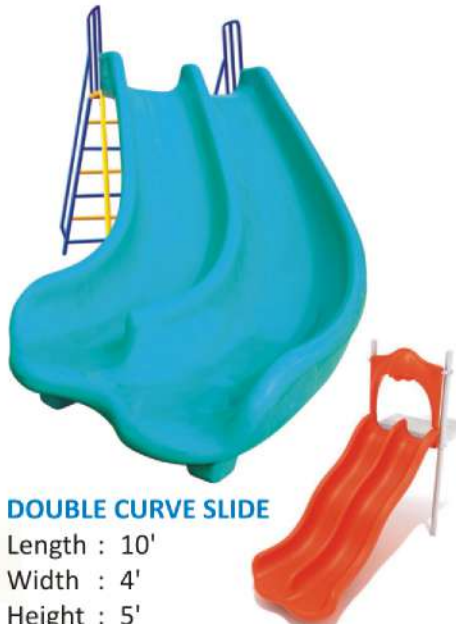



**SWINGS**



**DOUBLE ARCH SWING (BELT)**

Length : 8'  
Width : 4'  
Height : 8'



**SINGLE CIRCULAR SWING (SMALL)**

Length : 2.5'  
Width : 4'  
Height : 6'

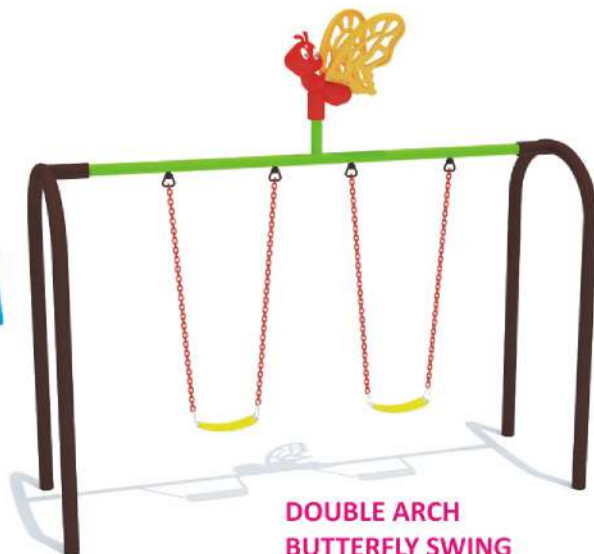

**DOUBLE ARCH BUTTERFLY SWING**

Length : 8'  
Width : 4'  
Height : 8'



**DOUBLE FISH SWING**

Length : 8'  
Width : 4'  
Height : 8'

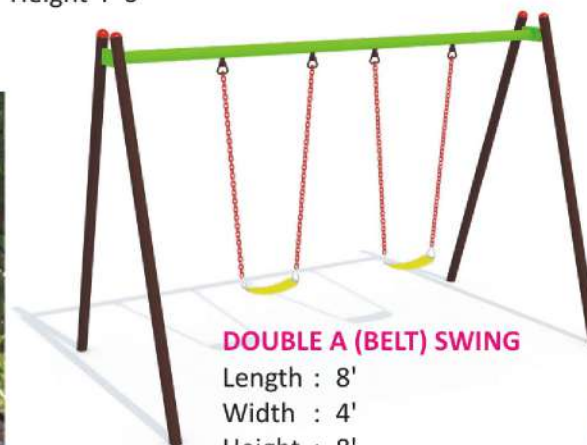

**DOUBLE A (BELT) SWING**

Length : 8'  
Width : 4'  
Height : 8'



**CIRCULAR SWING 4 SEAT (BIG)**

Length : 5'  
Width : 4'  
Height : 6'



**DOUBLE BUCKET SWING**

Length : 8'  
Width : 4'  
Height : 8'



**DOUBLE ARCH SWING (BUCKET)**

Length : 8'  
Width : 4'  
Height : 8'



**AMAZING ARCH COMBO SWING**

Length : 13'  
Width : 4'  
Height : 8'





**SITTING PLATFORM  
MERRY GO ROUND (FRP)**

Length : 5'  
Width : 5'  
Height : 3'



**PLAIN PLATFORM  
MERRY GO ROUND (FRP)**

Length : 5'  
Width : 5'  
Height : 3'



**6 SEAT PLATFORM  
MERRY GO ROUND**

Length : 5'  
Width : 5'  
Height : 3'

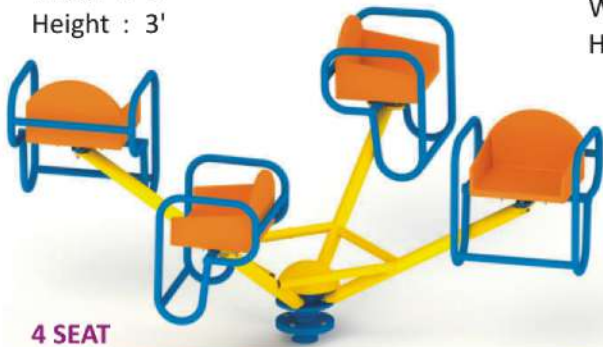

**4 SEAT  
MERRY GO ROUND**

Length : 5'  
Width : 5'  
Height : 2'



**DUCK & HORSE  
MERRY GO ROUND**

Length : 5'  
Width : 5'  
Height : 2.5'



**DUCK  
MERRY GO ROUND**

Length : 5'  
Width : 5'  
Height : 2.5'



**ELEPHANT  
MERRY GO ROUND**

Length : 4'  
Width : 4'  
Height : 2'



**HALF ROUND  
MERRY GO ROUND**

Length : 5'  
Width : 5'  
Height : 2'



**CYCLE  
MERRY GO  
ROUND**

Length : 4'  
Width : 4'  
Height : 2'



**DUCK & SEAT  
MERRY GO ROUND**

Length : 4'  
Width : 4'  
Height : 2'

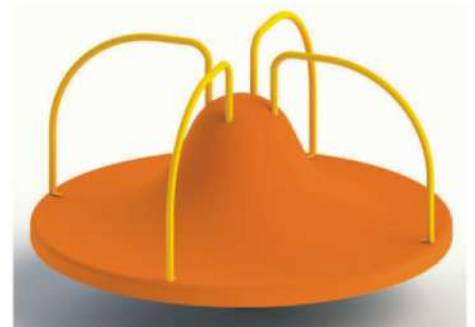

**VIP MERRY GO ROUND**

Length : 4'  
Width : 4'  
Height : 2'



## SEE-SAW



### SINGLE SEE-SAW

Length : 6'  
Width : 3'  
Height : 2'

### DOUBLE SEE-SAW

Length : 6'  
Width : 3'  
Height : 2'



### DOUBLE SEE-SAW (SMALL SEAT)

Length : 6'  
Width : 3'  
Height : 2'



### SINGLE HORSE SEE-SAW

Length : 8'  
Width : 2'  
Height : 2'



### MULTI SEE-SAW 4 SEAT

Length : 8'  
Width : 4'  
Height : 2'

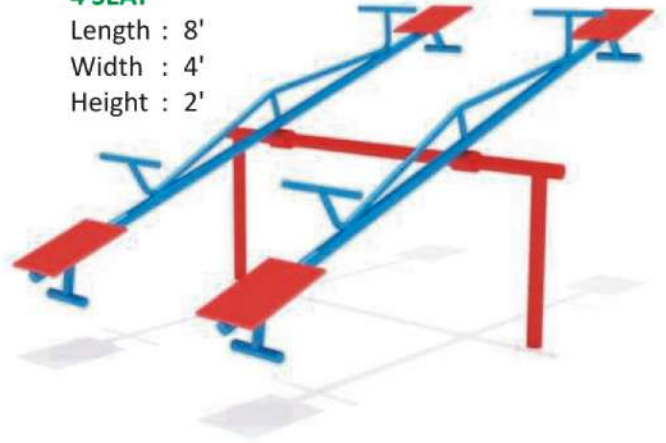

## CLIMBERS & ADVENTURE



### FRP + ROPE CLIMBER

Length : 10'  
Width : 5'  
Height : 8'



**MINI TRAMPOLINE**  
Diameter 5' Round



### TRAMPOLINE WITH SAFETY NET

Size  
08' Round  
10' Round  
12' Round  
14' Round  
16' Round





**CLIMBERS**



**C-1**  
Size : 7' x 3.6'



**C-2**  
Size : 8' x 3.75'

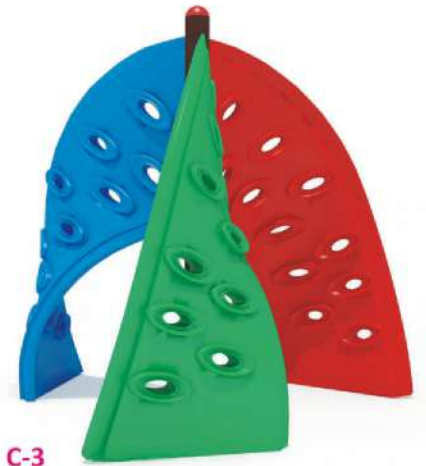

**C-3**  
Size : 8.2' x 8.2'



**C-4**  
Size : 8.85' x 3.6'

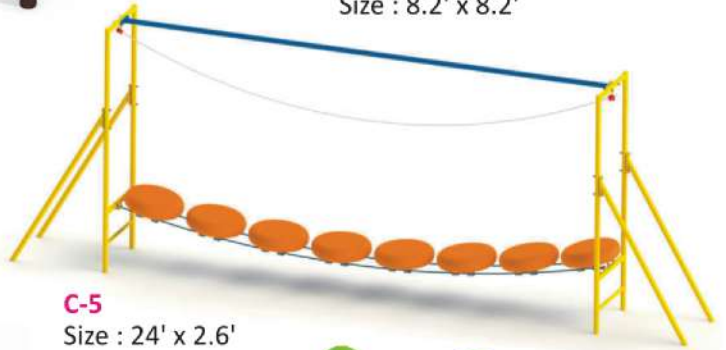

**C-5**  
Size : 24' x 2.6'

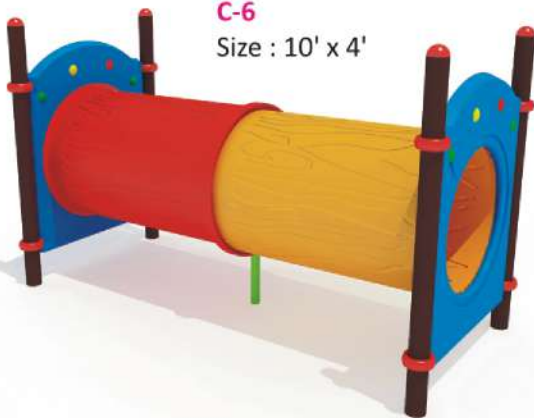

**C-6**  
Size : 10' x 4'

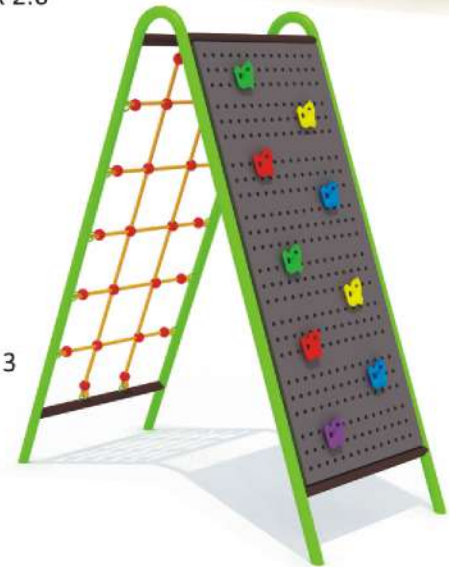

**C-7**  
Size : 6' x 3'



**C-8**  
Size : 20' x 20' x 6'

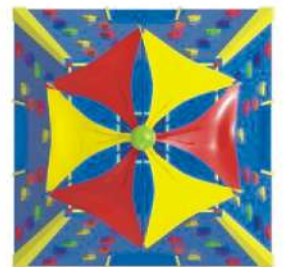

**C-9**  
Size : 5' x 5' x 10'



## SPRING RIDES



### DUCK SPRING RIDES

Length : 2'  
Width : 2'  
Height : 2.5'



### HORSE SPRING RIDES

Length : 2'  
Width : 2'  
Height : 2.5'



### ELEPHANT SPRING RIDES

Length : 2'  
Width : 2'  
Height : 2.5'



### BIKE SPRING RIDES

Length : 3'  
Width : 2'  
Height : 2.5'



### ANGRY BIRD SPRING RIDES (SMALL)

Length : 2'  
Width : 2'  
Height : 2.5'



### ANGRY BIRD SPRING RIDES (BIG)

Length : 2'  
Width : 2'  
Height : 2.5'

## FRP DUSTBIN



### TREE

Size : 4'



### DHINGLO

Size : 2.75'



### BABLO

Size : 3.5'



### MASHROOM

Size : 2.5'



### PENGUIN

Size : 4'



### MONKEY

Size : 4'



### HIPPO

Size : 3.75'



### RABBIT

Size : 3.75'



### BIG TREE

Size : 4'



### RABBIT FACE

Size : 3.25'



### ICE CREAM

Size : 3.75'



### DUCK

Size : 3.75'

**M.P.P.S. (01)**

Length : 7'

Width : 7'

Height : 5'



**M.P.P.S. (02)**

Length : 10'

Width : 7'

Height : 5'



**M.P.P.S. (03)**

Length : 11'

Width : 13'

Height : 8'



**M.P.P.S. (04)**

Length : 21'

Width : 10'

Height : 7'

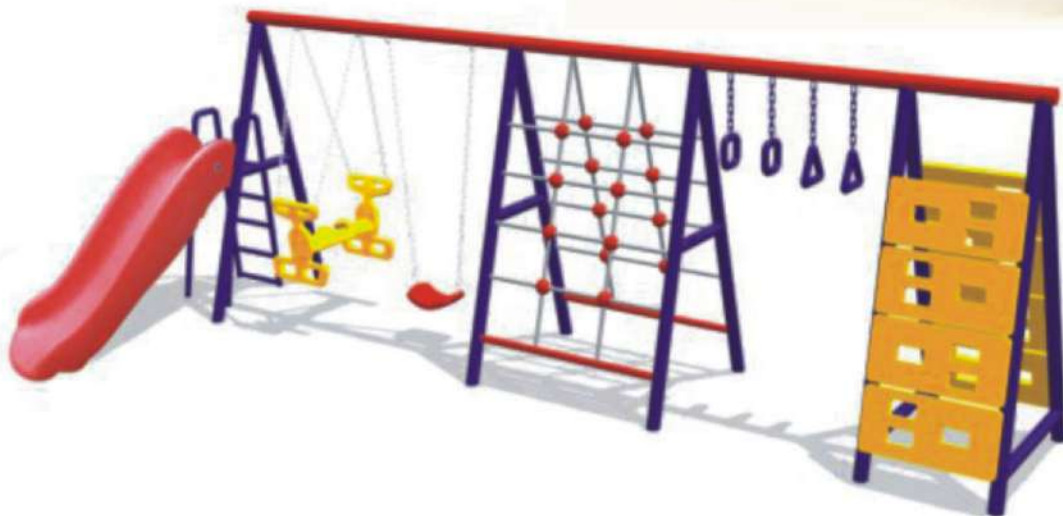



**M.P.P.S. (05)**

Length : 22'

Width : 22'

Height : 13'



**M.P.P.S. (07)**

Length : 14'

Width : 16'

Height : 13'



**M.P.P.S. (06)**

Length : 17'

Width : 17'

Height : 13'



**M.P.P.S. (08)**

Length : 23'

Width : 18'

Height : 11'



**M.P.P.S. (09)**

Length : 12'

Width : 18'

Height : 13'



**M.P.P.S. (10)**

Length : 18'

Width : 18'

Height : 13'



**M.P.P.S. (11)**

Length : 15'

Width : 18'

Height : 13'

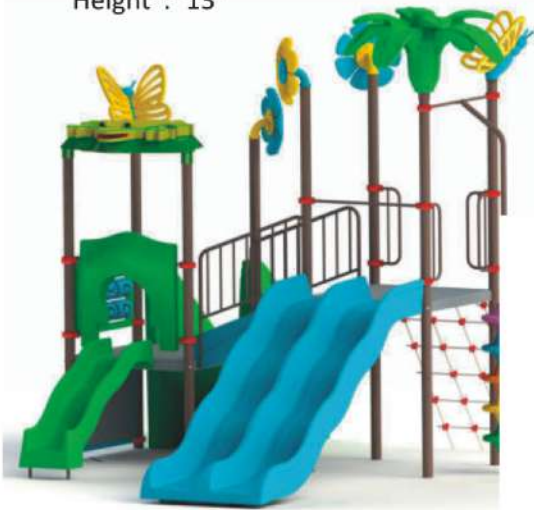

**M.P.P.S. (12)**

Length : 23'

Width : 34'

Height : 13'



**M.P.P.S. (13)**

Length : 27'

Width : 17'

Height : 13'



**M.P.P.S. (14)**

Length : 20'

Width : 16'

Height : 13'



**M.P.P.S. (15)**

Length : 28'

Width : 17'

Height : 13'







**M.P.P.S. (16)**

Length : 27'  
Width : 15'  
Height : 13'



**M.P.P.S. (17)**

Length : 27'  
Width : 16'  
Height : 13'

**M.P.P.S. (18)**

Length : 25'  
Width : 15'  
Height : 13'



**M.P.P.S. (19)**

Length : 29'  
Width : 16'  
Height : 13'





**M.P.P.S. (20)**

Length : 28'

Width : 31'

Height : 14'



**M.P.P.S. (21)**

Length : 20'

Width : 16'

Height : 13'



**M.P.P.S. (22)**

Length : 15'

Width : 18'

Height : 13'



Front Side

**M.P.P.S. (23)**

Length : 16'

Width : 16'

Height : 13'



Back Side



**M.P.P.S. (24)**

Length : 20'

Width : 18'

Height : 13'



**M.P.P.S. (25)**

Length : 15'

Width : 16'

Height : 8'



**M.P.P.S. (26)**

Length : 15'  
Width : 13'  
Height : 13'



**M.P.P.S. (27)**

Length : 8'  
Width : 15'  
Height : 13'



**M.P.P.S. (28)**

Length : 15'  
Width : 16'  
Height : 13'



**M.P.P.S. (29)**

Length : 16'  
Width : 16'  
Height : 13'



**M.P.P.S. (30)**

Length : 22'  
Width : 13'  
Height : 13'



**M.P.P.S. (31)**

Length : 55'  
Width : 16'  
Height : 13'





# ROTO PLAY GROUND EQUIPMENT

## SLIDES

### WAVE SLIDE

Length : 10'  
Width : 2'  
Height : 5'

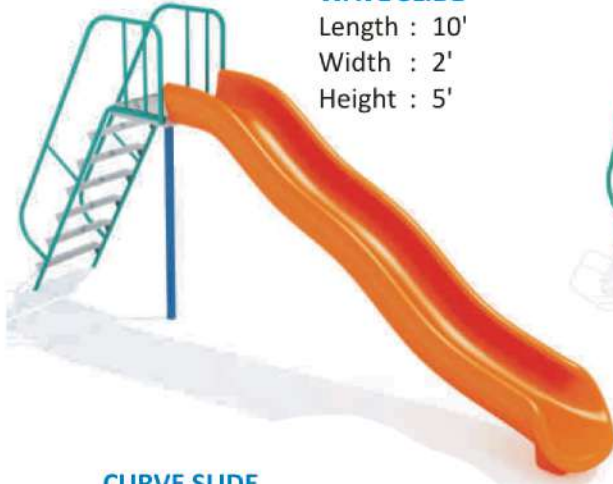

### HALF CURVE SLIDE

Length : 8' / 10'  
Width : 2' / 2'  
Height : 4' / 5'



### STRAIGHT SLIDE

Length : 8' / 10'  
Width : 2' / 2'  
Height : 4' / 5'



### CURVE SLIDE

Length : 10'  
Width : 2'  
Height : 5'



### SPIRAL SLIDE

Length : 10' / 12'  
Width : 6' / 6'  
Height : 5' / 6'



### DOUBLE CURVE SLIDE

Length : 10'  
Width : 2'  
Height : 5'



### DOUBLE SLIDE

Length : 10'  
Width : 4'  
Height : 5'

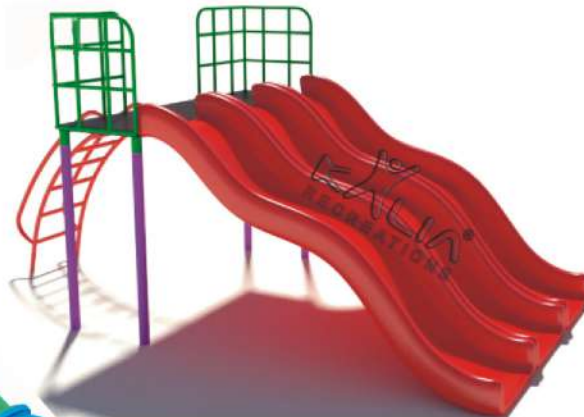

### TUBE SLIDE

Length : 10  
Width : 2'  
Height : 5'



### TRIPLE SLIDE

Length : 10'  
Width : 6'  
Height : 15'





**MERRY GO ROUND**



**SPRING MERRY GO ROUND (BIG)**  
Size : 4' x 4'

**MERRY GO ROUND (SMALL)**

Size : 4' x 4'



**HORSE PLATFORM MERRY GO ROUND**

Size : 4' x 4'



**HORSE MERRY GO ROUND**

Size : 5' x 5'



**ROUND PLANT SEAT MERRY GO ROUND**

Size : 4' x 4'

**DUCK MERRY GO ROUND**

Size : 5' x 5'



**SPRING RIDES**



**HORSE SPRING RIDES**

Size : 2.62' x 1.96' x 2.62'



**CAT SPRING RIDES**

Size : 2.62' x 1.47' x 2.95'



**DUCK SPRING RIDES**

Size : 3.11' x 1.31' x 3.21'



**PUPPY SPRING RIDES**

Size : 2.23' x 1.50' x 2.14'



**ELEPHANT SPRING RIDES**

Size : 3.11' x 1.31' x 3.21'



**SEA HORSE SPRING RIDES**

Size : 3.11' x 1.31' x 3.21'



**JURASSIC SPRING RIDES**

Size : 3.11' x 1.31' x 3.21'

## SEE-SAW

### DELUXE SINGLE SEE-SAW

Size : 6' x 2'



### DELUXE DOUBLE SEE-SAW

Size : 6' x 4'



### HORSE SEE-SAW

Size : 6.88' x 2'



### SEA HORSE SEE-SAW

Size : 6.88' x 2'

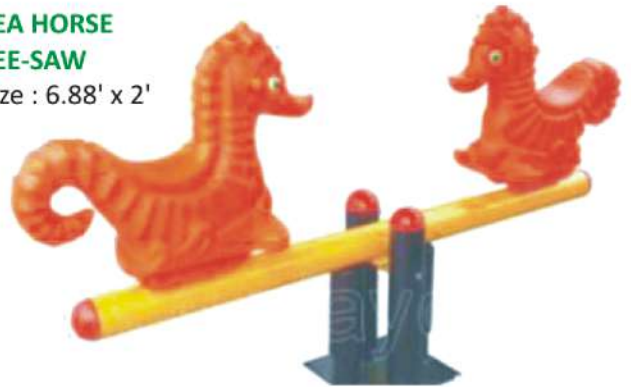

### SPRING SEE-SAW

Size : 6.88' x 2'

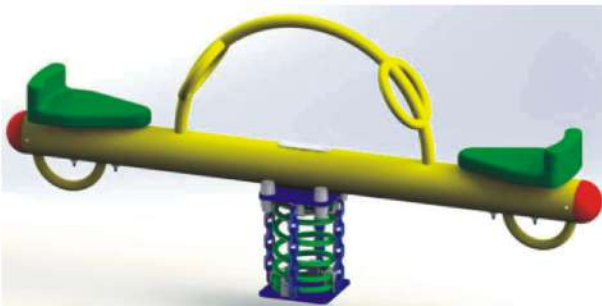

### U SEE-SAW

Size : 6.88' x 2'

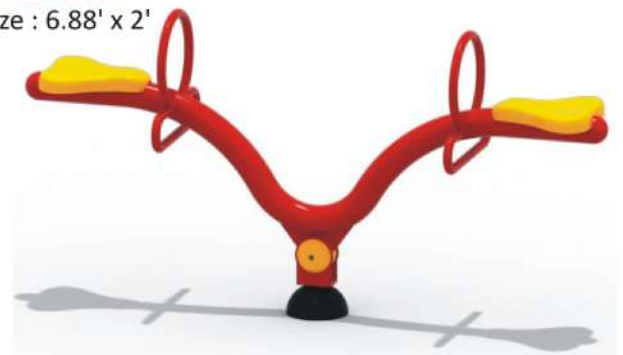

## MULTI PLAY STATION



### R.P.G.E. (01)

Length : 13'  
Width : 8'  
Height : 4'

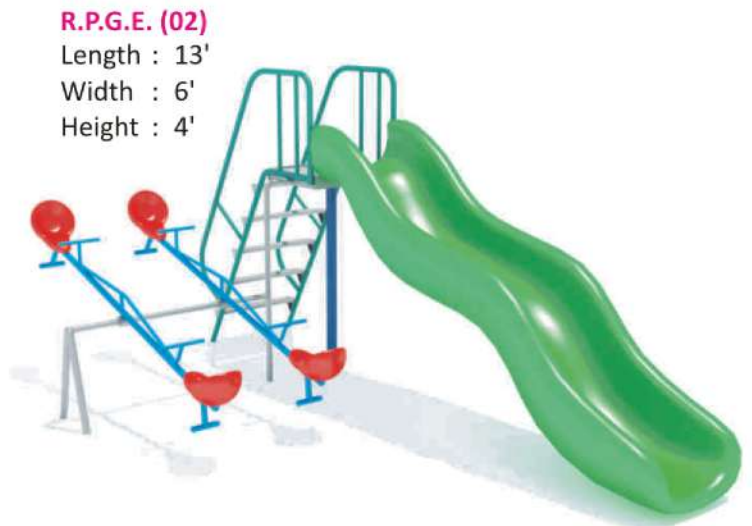

### R.P.G.E. (02)

Length : 13'  
Width : 6'  
Height : 4'





Top Side

**R.P.G.E. (03)**

Size : L 20' x W 13' x H 10'



Front Side



Top Side

**R.P.G.E. (04)**

Size : L 22' x W 15' x H 13'



Front Side

**R.P.G.E. (05)**

Size : L 50' x W 6' X H 11'



**R.P.G.E. (06)**

Size : L 20' x W 16' x H 9'



**R.P.G.E. (07)**

Size : L 12' x W 8.3' x H 7.3'



**R.P.G.E. (08)**

Size : L 14' x W 14' x H 13'



**R.P.G.E. (09)**

Size : L 20' x W 18' x H 13'

Back Side



Front Side



**R.P.G.E. (10)**

Size : L 20' x W 13' x H 13'

Back Side



Front Side



**R.P.G.E. (11)**

Size : L 21' x W 18' x H 13'

Back Side



Front Side

**R.P.G.E. (12)**

Size : L 24' x W 14' x H 15'



Back Side



Front Side



**R.P.G.E. (13)**

Size : L 24' x W 16' x H 13'

Back Side



Front Side



**R.P.G.E. (14)**

Size : L 24' x W 16' x H 13'

Back Side



Front Side





Back Side

**R.P.G.E. (15)**

Size : L 24' x W 16' x H 14'



Front Side



Back Side

**R.P.G.E. (16)**

Size : L 23' x W 18' x H 13'



Front Side



Back Side

**R.P.G.E. (17)**

Size : L 23' x W 21' x H 13'



Front Side

**R.P.G.E. (18)**

Size : L 18' x W 18' x H 13'



Back Side



Front Side



Back Side

**R.P.G.E. (19)**

Size : L 25' x W 25' x H 14'



Front Side



Back Side

**R.P.G.E. (20)**

Size : L 20' x W 14' x H 12'



Front Side





Back Side

**R.P.G.E. (22)**  
Size : L 26' x W 12' x H 13'



**R.P.G.E. (23)**  
Size : L 24' x W 15' x H 13'



Back Side

**R.P.G.E. (24)**  
Size : L 26' x W 17' x H 13'



Back Side



**R.P.G.E. (25)**  
Size : L 21' x W 12' x H 13'



Back Side

**R.P.G.E. (26)**  
Size : L 25' x W 17' x H 13'



Back Side





**R.P.G.E. (27)**

Size : L 24' x W 18' x H 13'



Back Side



Front Side

**R.P.G.E. (28)**

Size : L 37' x W 19' x H 13'



**R.P.G.E. (29)**

Size : L 50' x W 20' x H 18'



Back Side



Front Side

**R.P.G.E. (30)**

Size : L 20' x W 11' x H 13'



Back Side



Front Side

Front Side



Back Side



**R.P.G.E. (31)**

Size : L 45' x W 24' x H 20'





Front Side



Back Side

**R.P.G.E. (32)**

Size : L 50' x W 10' x H 13'



Front Side



Back Side

**R.P.G.E. (33)**

Size : L 50' x W 20' x H 17'



Front Side



Back Side

**R.P.G.E. (34)**

Size : L 41' x W 25' x H 18'



Front Side



Back Side

**R.P.G.E. (35)**

Size : L 45' x W 42' x H 18'



**INDOOR GAME**



**POOL TABLE**  
Size : 4.5' x 9'  
4' x 8'



**POOL TABLE**  
Size : 4.5' x 9'  
4' x 8'



**BADMINTON TABLE**  
Size : 4' x 8'



**TABLE TENNIS**  
Size : 9' x 5'



**SOCCER TABLE**  
Size : 4' x 2'



**AIR HOCKEY**  
Size : 4' x 8'



**CHESS QUARE**  
Size : 2' x 2'



**HEXAGON PLAYING CARD**  
Size : L 52' x W 48' x H 30'



**CAROM**  
Size : 35" x 35"



**SINGLE AIR WALKER**  
Size : L 3.25' x W 1.6'



**CROSS TRAINER**  
Size : L 3.9' x W 2.9'



**SURT BOARD**  
Size : L 3.9' x W 2.9'



**TWISTER TUB COMBO**  
Size : L 3.6' x W 2.9'



**CHEST PRESSURE**  
Size : L 3.9' x W 2.9'



**STANDING TWISTER**  
Size : L 3.9' x W 2.9'



**SHOULDER BUILDERS**  
Size : L 6.5' x W 2.9'

**CYCLE TAP**  
Size : L 3.25' x W 2.9'



**HORSE RIDER**  
Size : L 2.9' x W 3.25'

**SIT UP BOARD**  
Size : L 8.2' x W 5.25'







**DOUBLE  
LEG PRESS**

Size : L 6' x W 6'

**MANUAL WALKER**

Size : L 4.6' x W 2.3" x H 4.5'



**TAICHI DOUBLE**

Size : L 5' x W 4'



**SHOULDER  
TWIST SEAT COMBO**

Size : L 6' x W 6'



**CHEST PRESS  
BENCH**

Size : L 5' x W 2.3'



**ROWER**

Size : L 3' x W 5'

**HEXAGONAL GYM**

Size : L 16' x W 14'

Dia : 18'

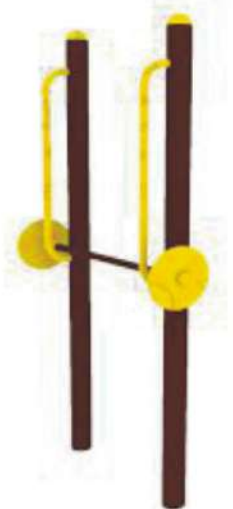

**SHOULDER BAR**

Size : L 4' x W 5'



COMMERCIAL  
TREADMILL (BIG)



AB CARE SEAT



HIGH CROSS  
TRAINER



HEAVY DUTY  
UP RIGHT BIKE



RECUMBENT BIKE



ORBIT RAC BIKE



DOUBLE  
TWISTER



SUPER BENCH





MULTI SET GYM



DUMBBELL STAND



COMMERCIAL PLATE



DUMBBELL

VENAL KETTLEBELL



ANTI BURST GYM BALL

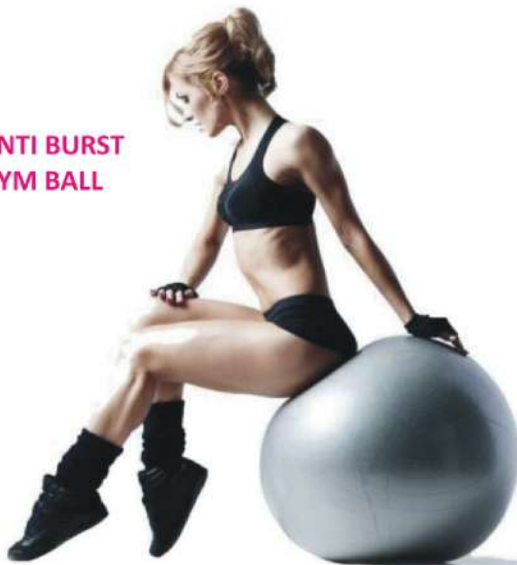

COMMERCIAL ROD



GYM YOGA MAT



Office : 1, 1st Floor, Turning Point,  
Opp. Omkar Row House,  
Nr. Uttran Railway Bridge,  
Uttran - 394105. Surat (Gujarat)

Mo.: +91 95379 02119, 99134 19644, 95101 86985, 93134 67645



info.om0001@gmail.com  
info.om77@gmail.com  
www.omprayag.com