

# **Peroxide Propulsion at The Turn of the Century**

William E. Anderson, NASA MSFC  
Kathy Butler, Boeing Rocketdyne Power & Propulsion  
Dave Crocket, Orbital Sciences Corp.  
Tim Lewis, Orbital Sciences Corporation  
Curtis McNeal, NASA MSFC

## **Introduction**

A resurgence of interest in peroxide propulsion has occurred in the last years of the 20<sup>th</sup> Century. This interest is driven by the need for lower cost propulsion systems and the need for storable reusable propulsion systems to meet future space transportation system architectures. NASA and the Air Force are jointly developing two propulsion systems for flight demonstration early in the 21<sup>st</sup> Century. One system will be a development of Boeing's AR2-3 engine, which was successfully fielded in the 1960s. The other is a new pressure-fed design by Orbital Sciences Corporation for expendable mission requirements. Concurrently NASA and industry are pursuing the key peroxide technologies needed to design, fabricate, and test advanced peroxide engines to meet the mission needs beyond 2005. This paper will present a description of the AR2-3, report the status of its current test program, and describe its intended flight demonstration. This paper will then describe the Orbital 10K engine, the status of its test program, and describe its planned flight demonstration. Finally the paper will present a plan, or technology roadmap, for the development of an advanced peroxide engine for the 21<sup>st</sup> Century.

## **AR2-3 Engine**

The AR2-3 rocket engine was developed by Rocketdyne in the 1950's, one of a family of aircraft rocket (AR) engines. The first AR engine was the AR-1, which operated at a fixed thrust of 5750 pounds. The engine was flight proven on the FJ-4 aircraft. The AR2 series of engines consist of the AR-2, AR2-1, AR2-2 and the AR2-3. The AR engine series are shown in Figure 1. All of the AR2 series engines provided a mainstage thrust of 6600 pounds and were variable down to 3300 pounds of thrust. The engines use 90% hydrogen peroxide and kerosene. These engines have been used on the FJ-4, F-86 and NF104A aircraft. The AR series rocket engines are integral, compact, liquid propellant, pump-fed engines designed to provide aircraft thrust augmentation.

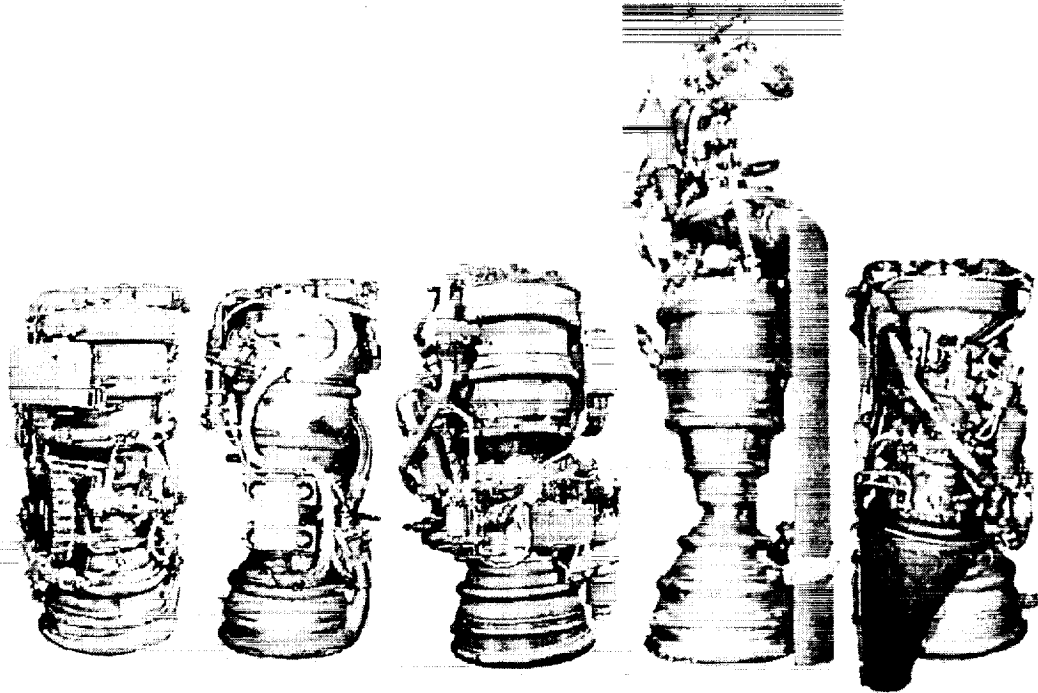

*Figure 1. AR-1, AR-2, AR2-1, AR2-2, AR2-3 Rocket Engines.*

The AR2-3 rocket engine supplies hydrogen peroxide and kerosene propellants to the thrust chamber by oxidizer and fuel centrifugal pumps, directly driven by a single turbine. Pumps and turbine are mounted on the same shaft. Oxidizer flows from the pump outlet through the pressure-actuated oxidizer valve, through the thrust chamber cooling jacket, and into the main thrust chamber, through the silver-plated catalytic screen pack, where it is decomposed into super-heated steam and oxygen. Fuel flows from the pump outlet through the chamber-pressure-actuated fuel valve, into the concentric annular-ring type fuel injector, and is injected into the hot, oxygen-rich gases, where it combusts and is exhausted through the 12:1 area ratio nozzle. Auto-ignition of the fuel eliminates the necessity for an ignition system. A small oxidizer flow, of about 3% from the oxidizer pump discharge, is delivered and metered through the thrust control valve into a catalytic gas generator, where it is decomposed into super-heated steam and oxygen to drive the turbine. An engine flow schematic is shown in Figure 2. Under emergency situations, the engine may be operated as a mono-propellant engine using the oxidizer. The engine operates at a moderate chamber pressure and provided 6600 pounds thrust at vacuum and 246 sec specific impulse. Additional performance parameters are shown in Figure 3.

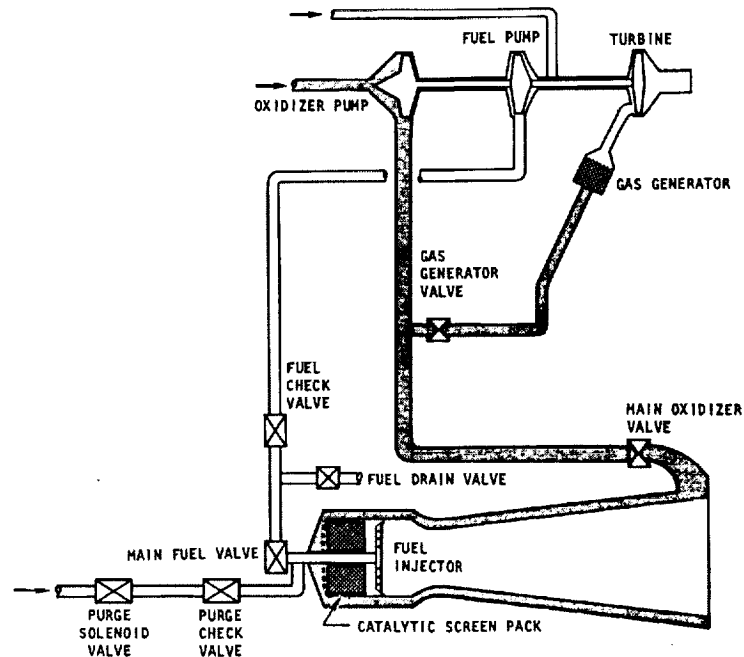
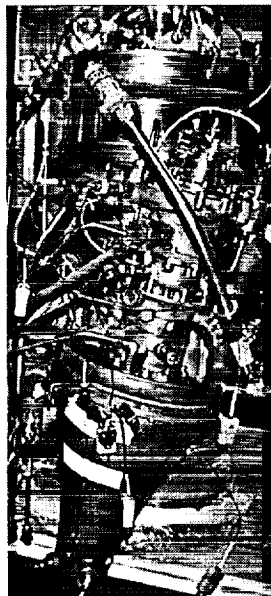

Figure 2. AR2-3 Engine Operating Schematic.



- Propellants 90% $H_2O_2$ /JP
- Thrust, vac (lbf) 6600
- Isp, vac (sec) 246
- Chamber pressure 560 (psia)
- Mixture ratio 6.5
- Area ratio 12:1
- Length (in) 32
- Engine diameter (in) 20
- Weight (lbm) 225
- Gimbal angle 0 (degrees)
- No. of restarts multiple
- Engine life >150 minutes

Figure 3. AR2-3 Engine Performance.

During the development testing, preliminary flight rating testing and qualification testing of the AR engine series, over 2200 tests have been conducted totaling more than 45 hours of engine operation. An AR engine has been operated continuously for up to 15 minutes. Up to 4 hours of operation have been accumulated on one engine. In addition to the long duration tests, many start-stop tests were performed to demonstrate the restart capability of the engine. Figure 4 shows an AR2-3 engine being hot fire tested in Rocketdyne's Santa Susana Test Facility.

The FJ-4 aircraft made 103 flights with a total of 3.5 hours of AR2-3 engine operation. It had a maximum altitude of 68,000 ft with up to 6 starts per flight. The F-86 aircraft made 31 flights with a total of 1.4 hours of AR2-3 engine operation up to an altitude of 72,000 ft. The NF-104A aircraft made 302 flights with a total of 8.6 hours of AR2-3 engine operation with a maximum altitude of over 120,000 ft. This aircraft was used as an astronaut trainer, allowing the trainee to experience a few seconds of weightlessness and permitting this aircraft to operate in the fringes of space. An NF-104F aircraft is shown in Figure 5, with the AR2-3 rocket engine firing over Edwards Air Force Base.

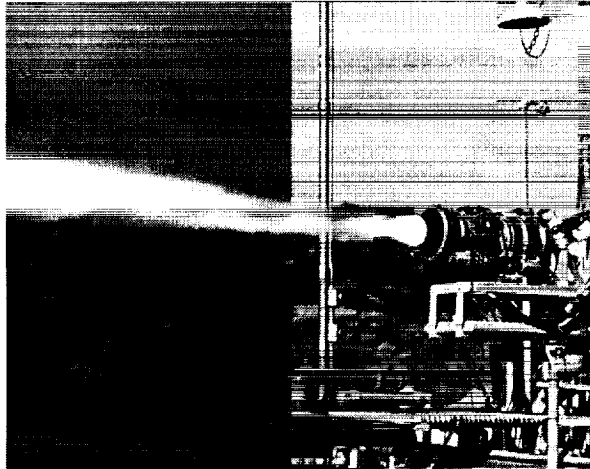

*Figure 4. AR2-3 Engine Hot Fire Testing.*

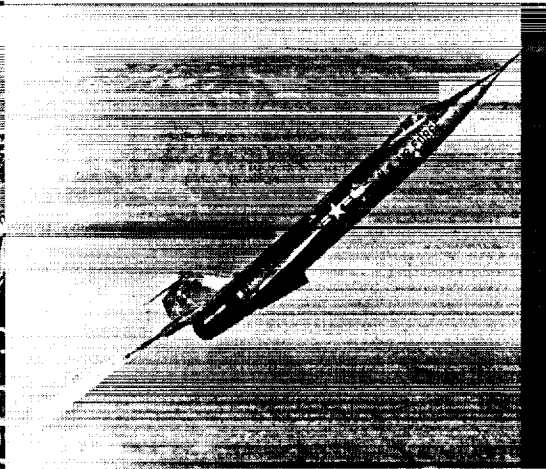

*Figure 5. NF-104A Aircraft With AR2-3 Firing*

### **AR2-3 Test Results**

AR2-3 engine assets were obtained for a hydrogen peroxide propulsion demonstration. The AR2-3 engine drawings and specifications were pulled from the Rocketdyne vault to guide the refurbishment effort. The engine components were disassembled and inspected for wear and damage. A few had never been hot fired. The individual parts were cleaned and reassembled into the components. The combustion chamber was flow tested with water. The turbopump was balanced and reassembled. The valves were actuated to determine the operating characteristics. The relay box was gutted and rewired. The fuel injector was brought into spec and was water flow tested.

The catalyst packs for the main chamber and the gas generator were disassembled. New screens were obtained and silver plated. The main chamber screens were packed into the main catalyst pack housing ready for engine assembly. Screens for two gas generator catalyst packs were packed, one for the engine and one for gas generator component testing at the Rocketdyne Santa Susanna Test Facility (SSFL). The gas generator testing took place over a period of 5 days. Twenty four tests were conducted with 3,192 seconds of operation and using 230 gallons of 85% hydrogen peroxide. All of the tests were successful and exhibited very stable operation over a range of operating conditions.

The newly refurbished components were assembled into an AR2-3 engine. Instrumentation was installed on many of the components in preparation for hot fire testing. The engine was leak tested and functionally tested before being boxed up and shipped to NASA-SSC for engine hot fire testing.

Engine tests were conducted between September and October of 1999 at NASA-SSC's E-3 facility under a Space Act Agreement with NASA-MSFC. The objectives of the testing included demonstration of both monopropellant and bipropellant startup, shutdown, and main stage performance. The first few tests were planned to be monopropellant operation only. Because the off design performance of the turbopump was unknown, a fuel bypass system was developed so that the pump performance could be fully understood prior to the addition of fuel into the main chamber. Fuel would enter the engine fuel pump and then be bypassed to a catch tank at the facility. This would allow for a more accurate attempt of judging the mixture ratio of the first bipropellant test and it would also allow the pump seals to break in properly. Photos of the engine installed in the test stand are shown in Figure 6.

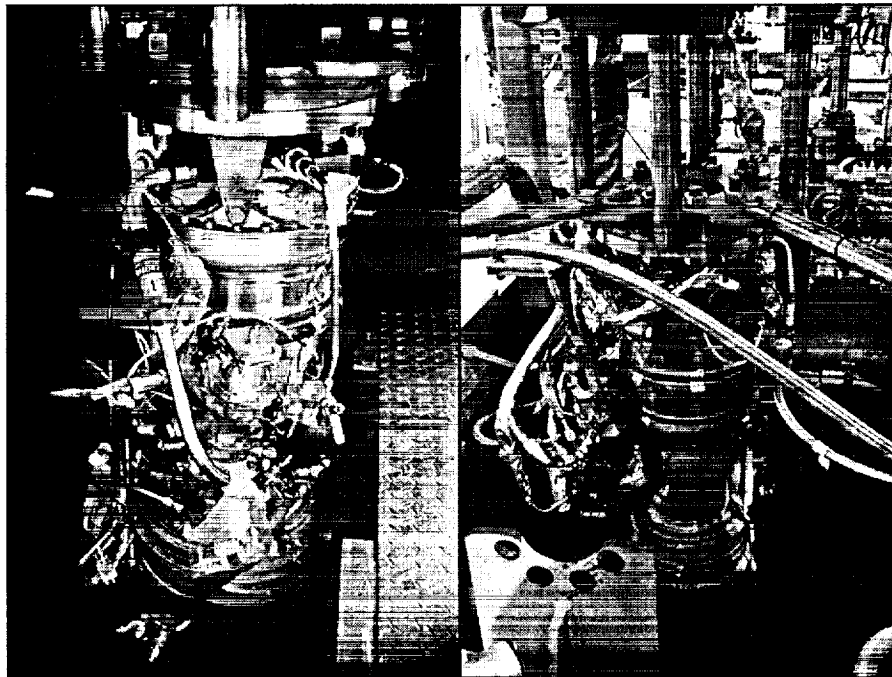

*Figure 6. AR2-3 Engine Installed in E-3 Test Stand (2 views).*

The objectives of the first few tests were to demonstrate the start and cutoff transient performance. The goal was to open the main oxidizer valve and generate main chamber pressure. The objectives of the later tests were to demonstrate steady state performance and to break-in the catalyst pack for consistent performance. After the first couple of tests, it was determined that residual water in the propellant system left over from water blowdown testing, lowered the hydrogen peroxide concentration to approximately 72%. This caused lower performance than expected and a slower engine start transient.

In many of the tests the engine exhaust was a cloudy vapor of steam and appeared to contain a lot of liquid, especially at startup. In some of the tests the exhaust would clear up and be almost undetectable, as super heated steam. Cloudy exhaust indicated poor hydrogen peroxide decomposition, with low main catalyst pack performance. High turbine exhaust temperatures indicated that the gas generator, on the other hand, performed very well with high efficiency. A comparison of the engine exhaust plumes from tests 5, 6, 8, and 10 can be seen in Figure 7. Tests 5 and 8 had clear plumes showing good hydrogen peroxide decomposition and tests 6 and 10 had cloudy plumes showing poor decomposition.

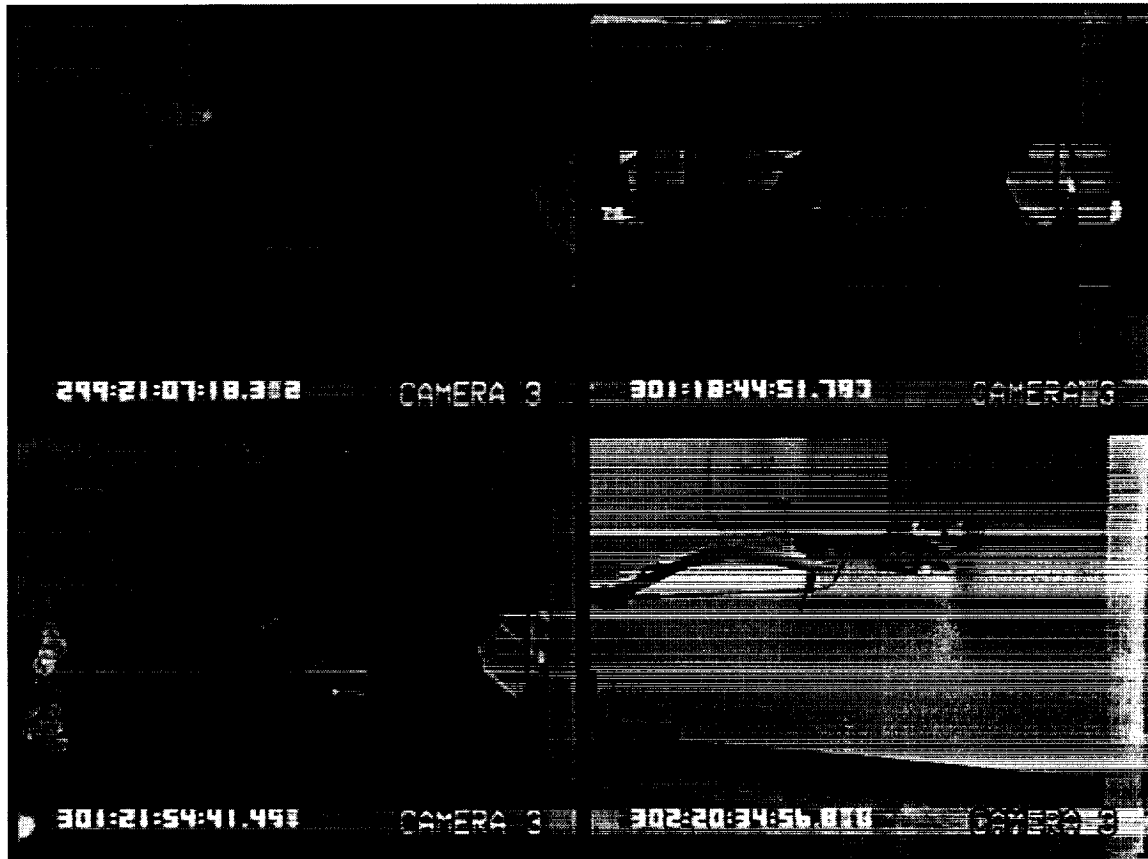

*Figure 7. Engine Exhaust Plumes During Tests 5, 6, 8 and 10.*

A difference was also noted in the transient and main stage performance between similar tests performed on different days. A faster startup and higher performance was often noted during the second test of the day versus the first test of the day. This was attributed to the difference in main catalyst pack temperature at startup, demonstrating that a warm catalyst pack has a faster startup transient. An example of this was the engine performance increase noted between tests 6, 7, and 8. It was attributed to the increase in temperature of the catalyst pack components with each successive test on the same day. The skin temperatures of chamber jacket head were steadily increasing prior to each test (Figure 8) which in all probability caused the engine performance increase because less energy was required to cause catalysis and thermal decomposition.

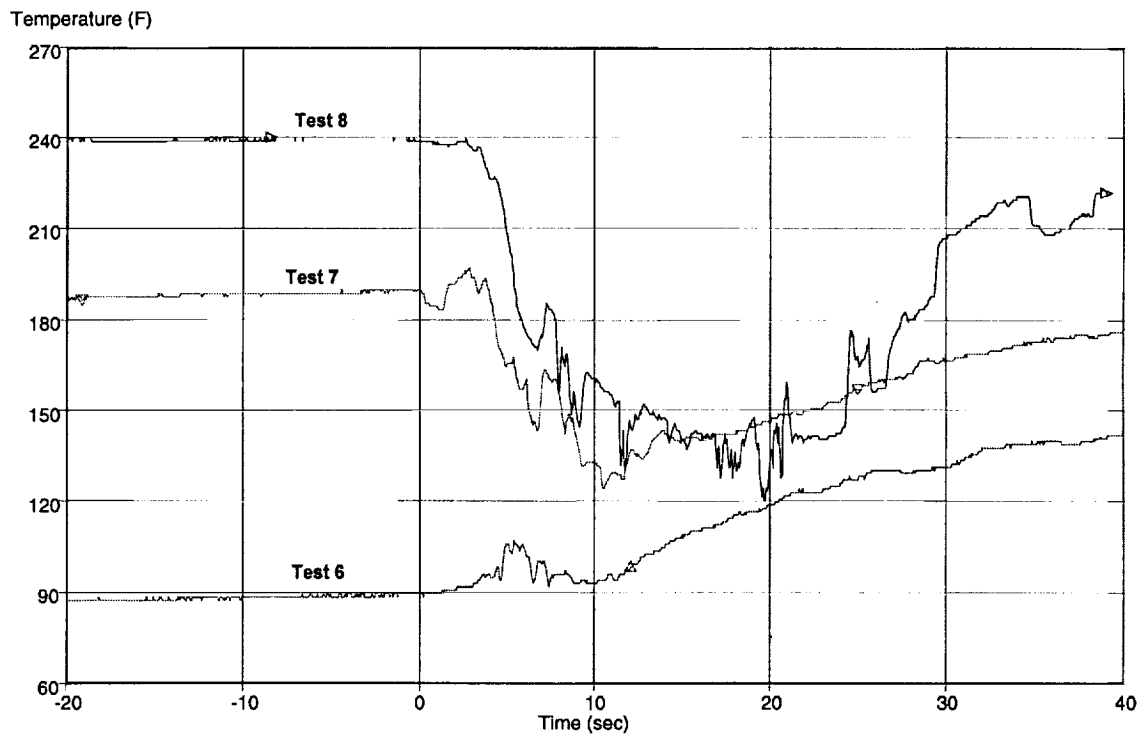

*Figure 8. Skin Temperatures of the Head End of the Chamber Jacket for Tests 6, 7 and 8.*

From September 30, 1999 to October 29, 1999, a total of 10 monopropellant tests were completed on the refurbished engine for an accumulated test time of 92.4 seconds. 84.3% concentration hydrogen peroxide from Solvay Interlox was used with JP-8 as the fuel for the first 8 tests. 89.2% concentration hydrogen peroxide from Degussa was used with JP-8 as the fuel for the last 2 tests, which should have increased the engine performance. Though a performance increase was seen, it was not as great as expected for the higher concentration peroxide. During the last test (test 10), the engine exhaust was dense, opaque atomized hydrogen peroxide and after shutoff liquid was seen dripping out of the nozzle.

Typical transient and steady state performance of the oxidizer system can be seen in the data from test 5 (Figure 9). The pressures and flowrate go up smoothly and level off at steady state. As comparison, the data from test 10 starts much the same way but takes an early dip and levels off at a lower pressure and flowrate, indicating there is a problem (Figure 10). This lower performance coincides with the previously noted cloudy engine exhaust plumes.

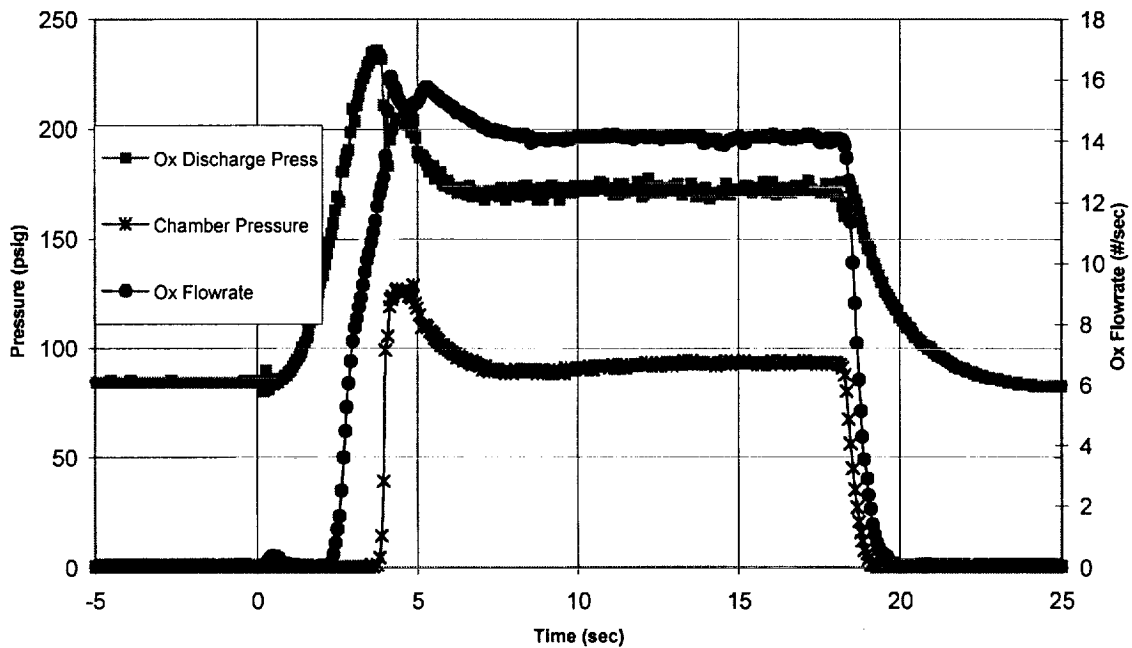
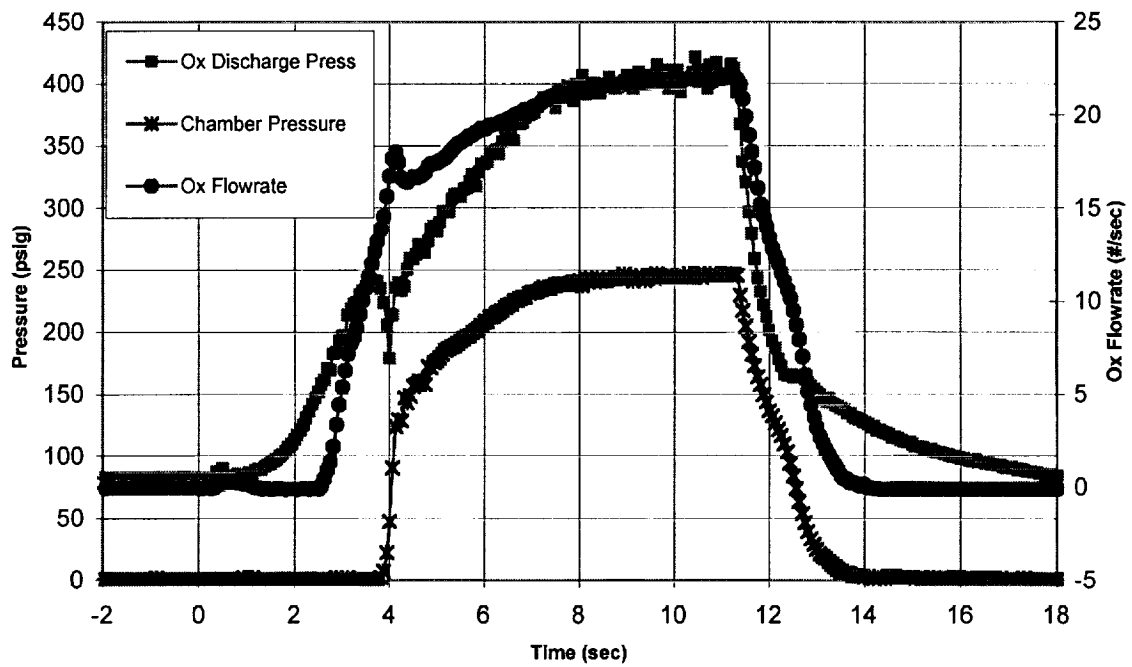

Figure 9. Oxidizer System Data Vs. Time During Test 5.  
 Figure 10. Oxidizer System Data Vs. Time During Test 10.

The C-star efficiencies of the main catalyst pack varied from test to test causing the main chamber pressure to be below what is required for proper engine bootstrap operation. Figure 11 shows the C-star from test to test as a function of time on the engine. The plot



includes test 2 and tests 4 through 10. Tests 1 and 3 were excluded from the chart because the chamber pressure did not reach a steady state value prior to the test cutoff. A definite improvement can be seen on tests that were completed on the same day with the exception of tests 9 and 10. If a straight line were to be placed across the peaks of tests 2, 5, 8, and 10, a general trendline of decreasing C-star can be seen, which indicates a steady degradation of the main catalyst pack activity and performance. Post test inspections did not indicate any abnormal operation with the remainder of the engine components.

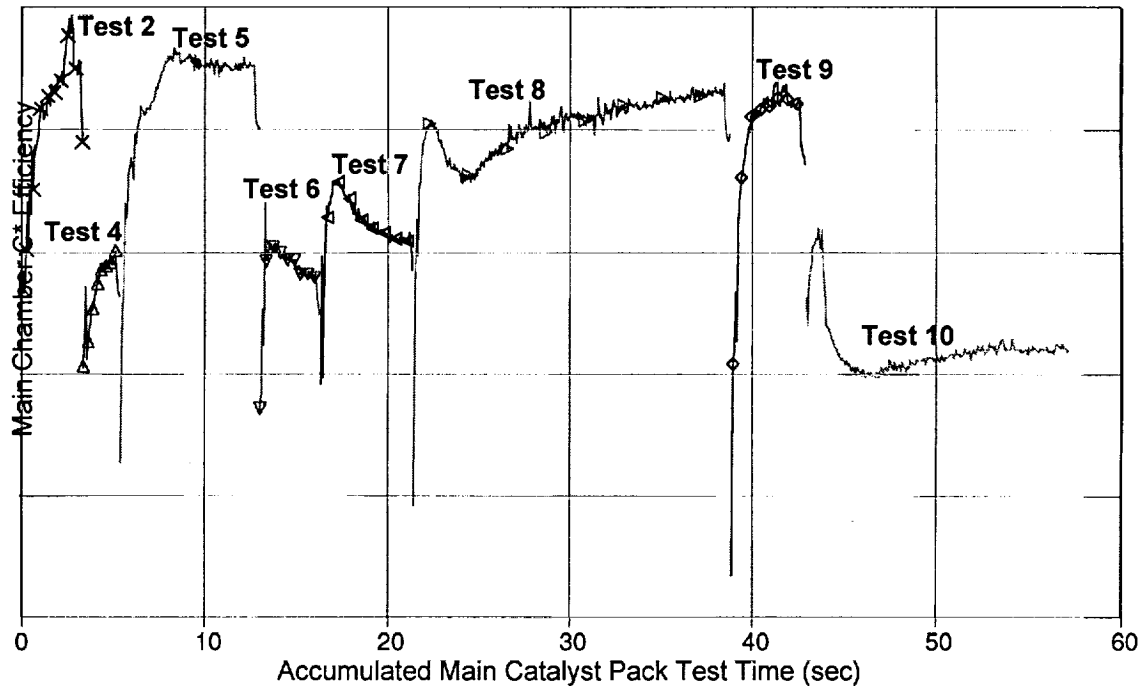

Figure 11. C\* Efficiency Vs. Engine Hot Fire Time.

Figure 12 summarizes the test data. A row of the data has been included which indicates the plume condition of the engine exhaust. Initial theories on the performance issues included coring, quenching at startup, inactivation by poisoning, and possible plating and activation process problems. Because of this, a decision was made to remove the engine from the test stand and inspect the main catalyst pack and gas generator catalyst pack. The investigations ultimately found that the catalyst bed was coring, flowing raw undecomposed hydrogen peroxide through the center of the catalyst pack due to insufficient silver along the screen surface. Only the outer "annulus of screen was active enough to decompose the propellant.

Test No.		1	2	3	4	5	6	7	8	9	10
Date		9/30/99	9/30/99	10/15/99	10/26/99	10/26/99	10/28/99	10/28/99	10/28/99	10/29/99	10/29/99
Test of Day		1	2	1	1	2	1	2	3	1	2
	Unit										
Duration	sec	4	6	3	6	11	6.4	8	20	8	18
Mono/Biprop		Mono	Mono	Mono	Mono	Mono	Mono	Mono	Mono	Mono	Mono
H2O2 Conc.	%	84.3	84.3	84.3	84.3	84.3	84.3	84.3	84.3	89.2	89.2
Operating Parameters											
Oxidizer Flowrate	lbm/sec	9.6	12.9	9.7	17.6	22.0	16.2	16.3	16.9	15.1	14.1
Thrust Chamber Pressure	psig	0.9	137.1	0.9	142.3	246.5	127.7	136.6	180.3	155.8	93.2
Turbine Inlet Temp	Deg F.	479.1	589.7	941.7	1124.6	1148.5	1114.5	1147.5	1144.5	1261.3	1302.2
Clear Exhaust Plume		no	some	no	no	yes	no	some	yes	some	no

Figure 12. Summary Data of Engine Hot Fire Testing.

## The X-37 Mission

NASA and Boeing have agreed to work together to build and fly a single X-37 reusable vehicle in orbit. The X-37 is one of several NASA Pathfinder vehicles planned to demonstrate reduced launch costs with advanced technology. The X-37 will be the first X-vehicle to demonstrate this technology in orbital flights.

The X-37 vehicle is 27.5 feet long - about half the length of the Shuttle payload bay - and weighs about 6 tons. Its wingspan is about 15 feet, and it contains an experiment bay 7 feet long and 4 feet in diameter that can accommodate a 500 lb package of experiments and equipment. It is designed to be modular to allow for rapid insertion of technologies and experiments. On-orbit propulsion will be provided by the AR2-3 engine using 90% hydrogen peroxide and JP-8. Hydrogen peroxide was selected over liquid oxygen because it is dense, storable, capable of tolerating months in orbit, and meets safety restrictions for being part of the payload in the Space Shuttle.

The missions will start with the X-37 vehicle traveling up into low earth orbit in the payload bay of the Space Shuttle sometime in late 2002. The different phases of the missions are shown in the series of images in Figure 13. The phases shown are: inside the payload bay of the Space Shuttle, being lifted out of the Shuttle with the remote arm, deployed from the Shuttle, some distance away from the Shuttle prior to main engine start, maneuvering around an orbiting object (2<sup>nd</sup> flight), reentry into the earth's atmosphere, gliding to the landing site, and landing on a runway. The first mission will last a few days before reentering and landing on earth. The X-37 vehicle will also be demonstrating operability in terms of vehicle turnaround. By using a hydrogen peroxide engine, the propulsion system turnaround is fairly quick. The second mission could last several weeks in orbit, demonstrating maneuvering around an orbiting object and evaluating long-duration mission systems and operations, before reentering and landing again on earth.

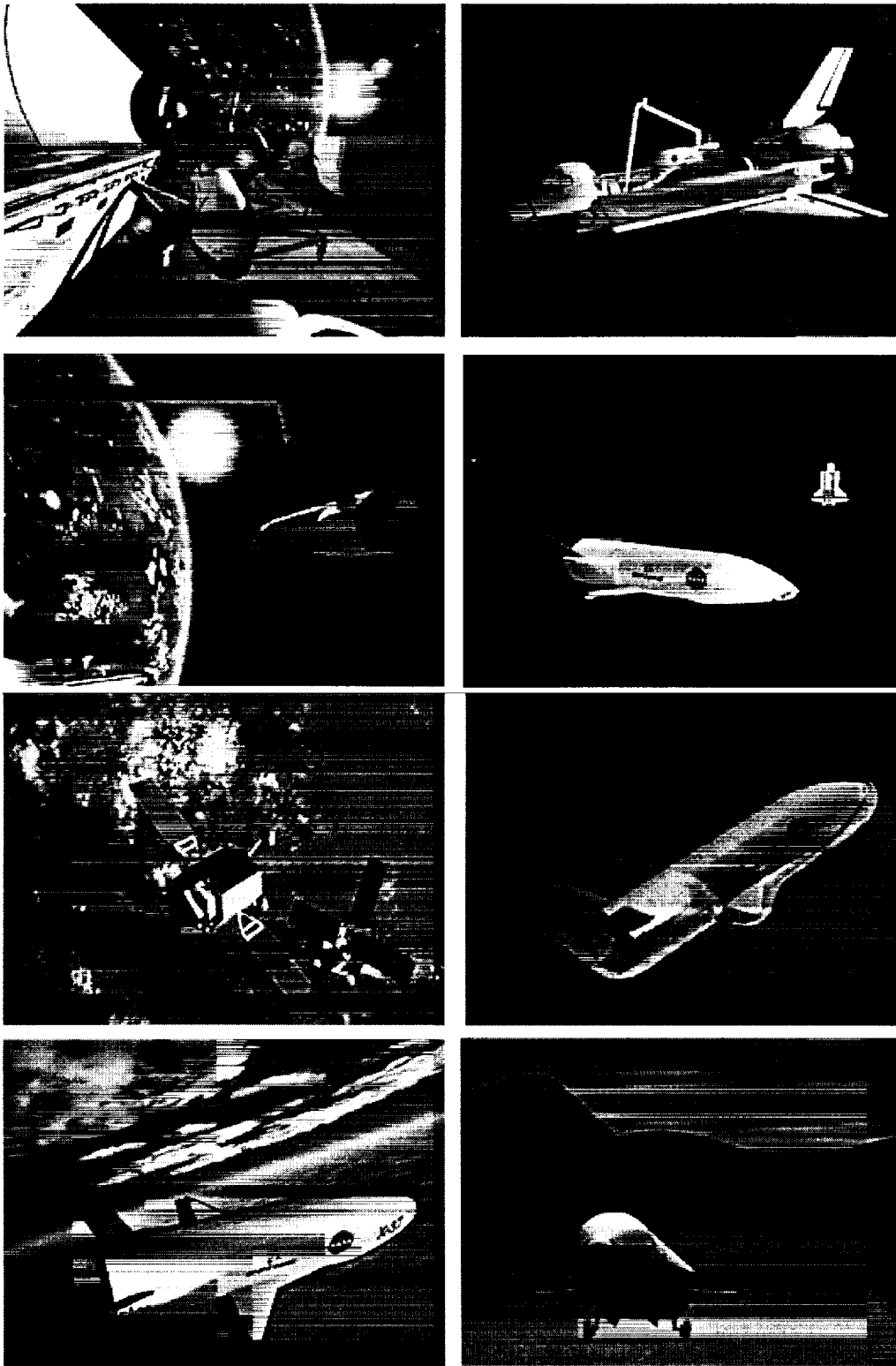

Figure 13. Different Phases of the X-37 Mission

## The USFE 10k Engine

The engine consists of pneumatically-actuated ball valves, propellant feed-lines, the oxidizer dome with a mount for gimbal attachments, a catalyst bed to convert the HTP into oxygen and superheated steam, a fuel injector, and an ablative chamber and nozzle. Low material and design costs coupled with robust margins were the guiding philosophy toward selecting a design.

The engine design and operating parameters are provided in Table 1. The engine develops 10,000 lbf of thrust at vacuum conditions with a 40:1 expansion ratio nozzle. Chamber pressure was chosen to be 500 psia, which spans the operating regimes of pressure-fed and pump-fed systems. Based on a component-level-demonstrated  $C^*$  efficiency of 0.97 and an estimated nozzle efficiency of 0.98, the delivered vacuum specific impulse is 290 s at a mixture ratio of 6.0.

Parameter	Value
Propellants	90% HTP/JP-8
Vacuum Thrust, lbf	10,000
Chamber Pressure, psia	500
Mixture Ratio	5.75
Nozzle Expansion Ratio	40 (five for ground tests)
Chamber Contraction Ratio	7.1
Delivered Specific Impulse, s	290
Flowrate, lb/s	34.5
Burn Time, s	200
Engine Envelope	60 in. long, 40 in. diameter

Table 1. Design and Operating Parameters of USFE Engine

The catalyst, injector, and ablative chamber designs are based on the results from two sets of subscale tests which used a 50 lbf monopropellant thruster for catalyst bed screening and a subscale bipropellant thrust chamber for injector development tests.<sup>1,2</sup> The subscale configuration captured key design features of the fullscale catalyst bed, the injector and the chamber.

Historical designs were used to size the thrust chamber (TCA, shown in Fig. 14).<sup>3</sup> To ensure autoignition of the fuel, a contraction ratio of about seven was chosen. The resulting chamber inner diameter was ten inches. Maintaining this inner diameter in the catalyst bed led to a bed mass flux, or  $G$ , the loading parameter, of about 0.4 lb/s-in<sup>2</sup>, which is also within the historical operating range of silver screen-based catalyst beds.

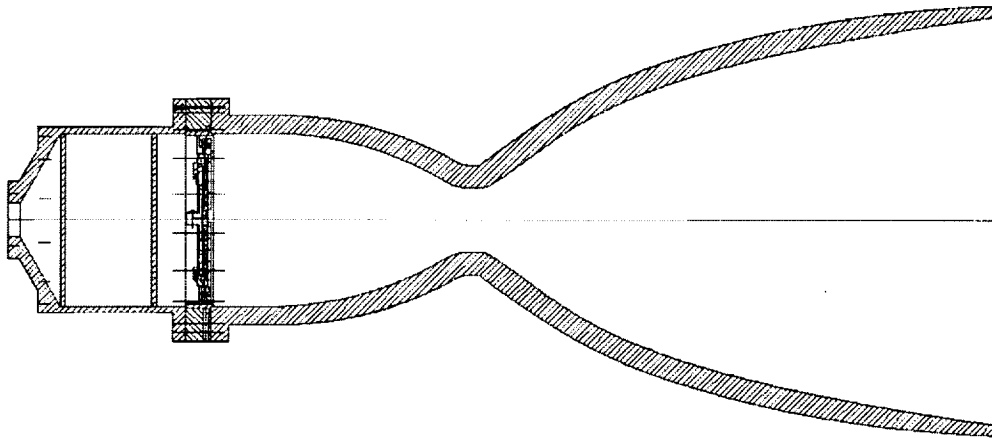

Fig. 14. USFE Thrust Chamber Assembly. TCA consists of oxidizer dome, catalyst bed assembly, fuel injector, and ablative chamber/nozzle. The chamber produces 10,000 lbf of thrust in space at a chamber pressure of 500 psia with an expansion ratio of 40.

## USFE 10k Engine Test Results

The full-scale tests consisted of five distinct test series:

- monopropellant tests to verify test operations and the performance of the catalyst bed
- start-up characterization tests to demonstrate reliable starting characteristics
- short duration tests in a copper heat-sink chamber to verify injector performance and to obtain chamber wall heat flux and high frequency combustion stability data
- longer duration tests (~ 30 s) with an ablative chamber to measure the erosion characteristics of the injector/chamber combination
- a long duration test (140 s) that simulates the total burn time of the actual mission to determine life.

Tests to date have used both 85% and 90% concentration (by weight) hydrogen peroxide. Prior to mid-1999, only 85% peroxide was available in bulk quantities for test. When 90% peroxide became available in mid-1999, it was used exclusively. Most of the discussion and data shown below is based on the tests using 85% peroxide. Data from the 90% peroxide tests are being reduced and analyzed at the present time; preliminary analysis has indicated that the results are as would be expected based on the 85% peroxide results.

Over 100 tests have been conducted, with the general objectives being to demonstrate the performance and life of the thrust chamber assembly, including catalyst bed, injector, and ablative chamber, and to demonstrate safe operations with hydrogen peroxide.

Component development success criteria were: 95% conversion efficiency in the catalyst bed (as determined from monopropellant  $C^*$  measurements); greater than 95% bipropellant  $C^*$  efficiency; and throat erosion rates less than 0.001 in/s. All these criteria were exceeded in the full scale tests. All operations were conducted safely. Some of the test highlights are:

- conducted over 125 tests
- accumulated nearly 30 minutes of test time
- accumulated over 300 seconds of bipropellant operation using ablative chambers, including one long-duration test of 140 s
- accumulated over 700 seconds of run time on a single cat bed without performance degradation
- demonstrated throat recession rates of less than 0.001 in/s
- demonstrated  $C^*$  efficiencies greater than 0.97 at nominal operating condition
- tested twelve different test article configurations
- tested both 85% and 90% peroxide from two different manufacturers
- demonstrated multiple restarts
- demonstrated throttling to 10% in monopropellant mode and to 20% in bipropellant mode
- maintained perfect safety record

The demonstration test TCA was designed in a bolted-together arrangement to allow for rapid component replacement. The TCA consisted of four distinct subcomponents: a workhorse oxidizer dome with a side inlet which served as a test facility interface; a catalyst bed assembly, including a structural housing and a slip-in catalyst bed to allow different cat bed designs to be tested; a fuel manifold (another test facility interface) and injector; and the chamber/nozzle.

Two basic chamber/nozzle configurations were tested – a copper heat sink chamber and an ablative chamber. The heat sink chamber was well-instrumented for making pressure and temperature measurements. Static pressure measurements were made in four axial locations – between the cat bed exit and the injector, downstream of the injector face, at the entrance to the converging part of the chamber, and in the chamber throat. A water-cooled high-speed pressure transducer was placed one inch downstream of the injector face. Linear array thermocouples were inserted into the chamber to measure heat flux at four different locations. The heat flux measurements in conjunction with the NAT<sup>4</sup> and CMA<sup>5</sup> codes were used to determine the near wall gas temperature. The near wall gas temperature was used to determine the operating O/F that would result in an acceptable amount of throat erosion in the ablative chamber.

The catalyst beds tested were essentially of the silver screen type. Both pure silver and silver-plated nickel screen catalysts were tested. Both uncoated and coated screens were tested. The best configuration tested was made of pure silver screens with a samarium nitrate coating. The bed length was two inches. The nominal bed loading was 0.4 lb/s-in<sup>2</sup>, and values up to 0.7 were tested with 85% peroxide. At this high value of  $G$ , high decomposition temperatures were measured, but the exhaust plume observed by remote cameras was not transparent like it was for the nominal case.

Catalyst bed performance was determined by comparing pressure and temperature measurements with pressures and decomposition gas temperatures predicted by a chemical equilibrium code. Pressure and temperature were measured at a location

between the cat bed exit and the injector entrance. Whenever the exhaust plume was clear, the measurements indicated essentially 100% decomposition.

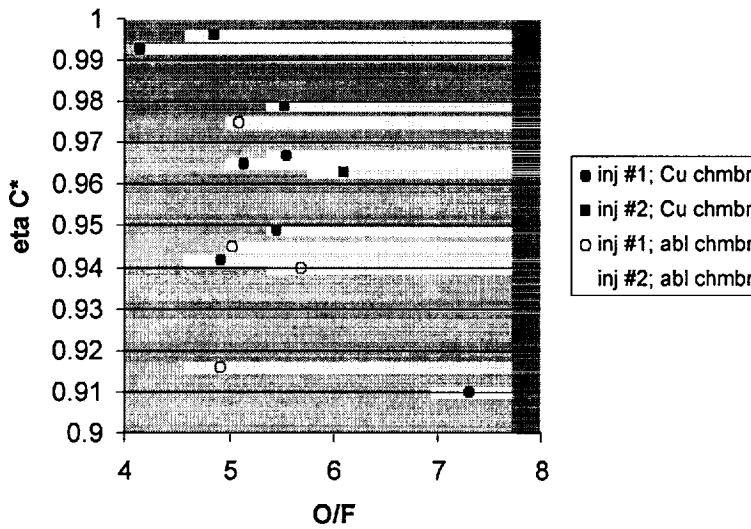

Fig. 15.  $C^*$  efficiency as function of O/F in heat sink (Cu) and ablative (abl) chambers. Injector # 1 is “steam port”

85% and 90% peroxide. Injector performance was determined from chamber pressure measurements and comparison with theoretical  $C^*$  values. The pressure loss across the injector was also measured. Both injectors achieved  $C^*$  efficiencies greater than 95% at their nominal operating conditions (Fig. 15). A higher operating O/F was possible with the ring injector because the fuel-rich periphery provided for minimal throat erosion.

The ablative chamber/nozzle consists of a silica phenolic liner and an epoxy-glass phenolic overwrap. For sea-level tests, the 40:1 nozzle is cut at a 5:1 ratio, providing a nearly ideal expansion to atmospheric conditions. The ablative chamber was instrumented with thermocouples and strain gages.

The throat erosion was measured after each test with calipers. The rate of erosion was determined to be a function of operating O/F and the injector that was used in the test. The gas temperature and chamber pressure are the primary parameters that determine the erosion rate of the silica phenolic. Silica is non-reactive with the combustion gas, thus there is no thermochemical erosion in this engine configuration. Mechanical (silica melt flow) erosion is the primary mechanism driving the material loss in the throat of the nozzle.

Two types of injectors were tested – a “steam port” design, similar to that used in the Gamma engines, and the other a ring-type injector. A third type of steam port injector has been fabricated and tested, with the data reduction ongoing at the present time. The ring injector used O/F biasing to provide a fuel-rich gas around the chamber periphery, and near stoichiometric conditions in the core. This injector has been tested with both

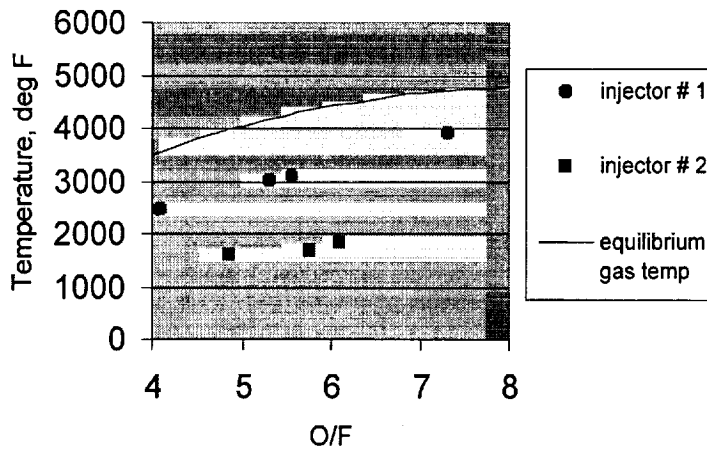

Fig. 16. Effective (near wall) gas temperature as function of O/F for each injector. Equilibrium bulk gas temperature is shown for comparison. Injector # 1 is "steam port" design and injector #2 is ring design.

The heat sink chamber provides an average heat transfer rate in the throat that can be used to infer the effective gas temperature. The effective near wall gas temperature provided by each injector was determined from the thermocouple measurements over a range of O/F conditions as shown in Fig. 16.

These results were then used to determine the viable operating conditions for ablation

testing with the composite nozzle. The agreement between the measured and predicted erosion rates were excellent. After the long duration (140 s) test, the chamber was cut into sections. A comparison of the measured and predicted char depth in the throat also indicated excellent agreement with less than 5% error. The low near wall gas temperatures indicated in Fig. 6, along with the low throat erosion rate ( $< 0.001$  in/s), prove the efficacy of the O/F biasing method to achieve minimal erosion while maintaining minimal performance loss.

## The USFE Mission

The purpose of the Upper Stage Flight Experiment (USFE) is to demonstrate key technologies necessary to the operation of an inherently simple propulsion system with an innovative, state-of-the-art structure. Two key low-cost vehicle elements will be demonstrated – a 10,000 lbf thrust pressure-fed engine and an integrated composite tank structure. These technologies will be demonstrated through numerous development tests culminating in an actual flight.



The Upper Stage Flight Experiment will fly as the third stage aboard an Orbital Suborbital Program (OSP) suborbital launch vehicle. Figure 17 shows an overview of the USFE mission. The USFE/OSP mission will fly out of the Alaska Spaceport on Kodiak Island in November 2001.

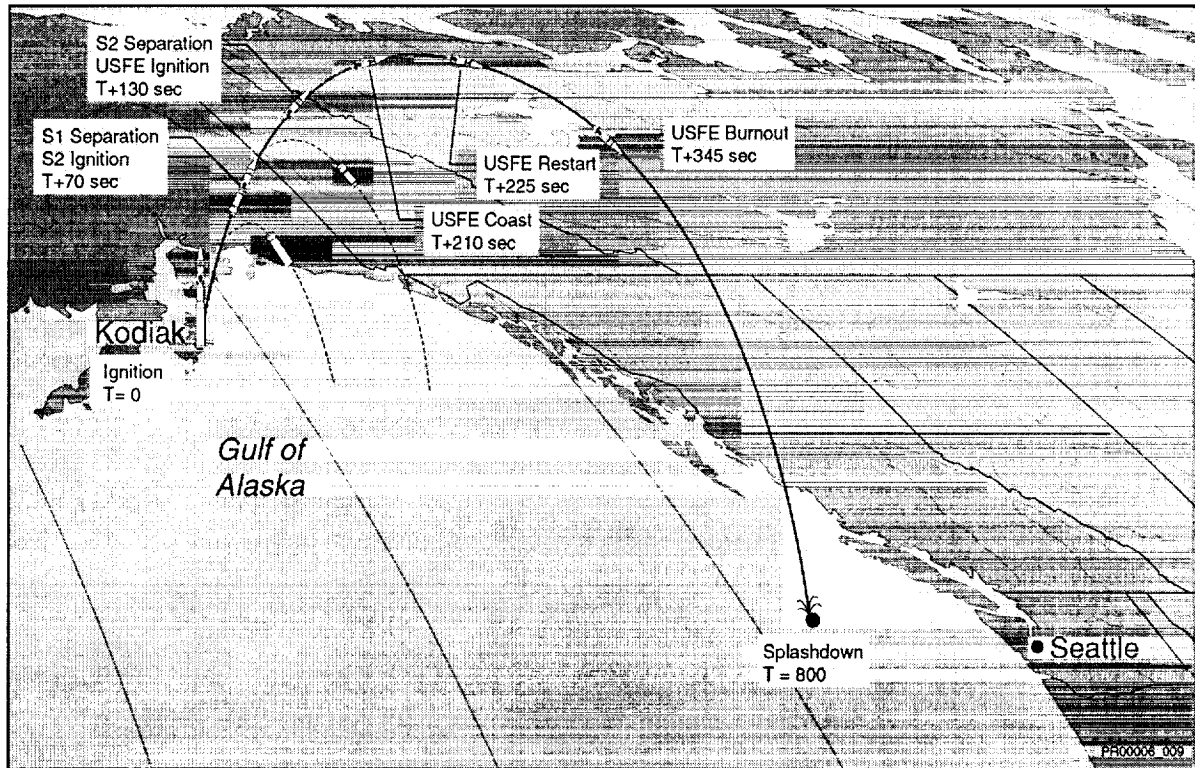

Fig. 17. The Upper Stage Flight Experiment.

Integration of the USFE and the OSP nosecone takes place at Orbital's facility in Arizona. The OSP vehicle avionics are located in the nosecone. After integration and test, including mission simulation testing, the USFE/nosecone assembly is shipped to the Alaska Spaceport for integration with the first and second stage of the OSP launch vehicle. After vehicle integration, checkout, and final mission simulation testing, USFE is loaded with propellants for launch. The propellant loading sequence consists of loading helium, nitrogen (for the attitude control system), JP-8, and hydrogen peroxide. Final checks are done and the count down to launch proceeds.

After stage 1 and 2 burn, USFE is separated from the 2<sup>nd</sup> stage by an ordnance separation event in the interstage. The vehicle is exo-atmospheric prior to stage 2 burn out. Immediately after Stage 2/USFE separation, USFE goes through its engine startup sequence. After engine start, USFE will burn for 80 seconds, shutdown, coast for 15 seconds, then restart and burn for 120 seconds. After shutdown USFE and the OSP nosecone reenter the atmosphere marking the end of the mission.

## An Advanced Peroxide/RP Engine

NASA's interest in peroxide propulsion is fostered by the need to achieve order of magnitude reductions in transportation costs to space. Two stage to orbit (TSTO) systems will need more operable, lower cost, reusable upper-stage propulsion systems than those presently available in the commercial marketplace. Even single stage to orbit (SSTO) systems will need orbital transfer stages with the same operating, cost, and performance characteristics as their TSTO competitors. An early decision by the designers of these advanced upper stages to utilize storable, non-cryogenic, environmental safe propellant systems, like peroxide/RP, can have significant impacts on operations costs for years to come. Storable propellants will enable off-line stage fueling, and storage of fueled stages to respond to short turn-around mission requirements. Non-cryogenic, non-toxic stages will allow off-line installation of payloads and eliminate the need for cryogenic/toxic safety procedures and special equipment. Environmentally safe stages will allow elimination of dangerous and potentially harmful propellant combinations, and their attendant costs, on which today's space transportation systems are dependent. But before tomorrow's advanced stage designers can begin their design they must have an engine system around which to design their airframe and its many subsystems. What might that

ideal peroxide/RP engine look like?

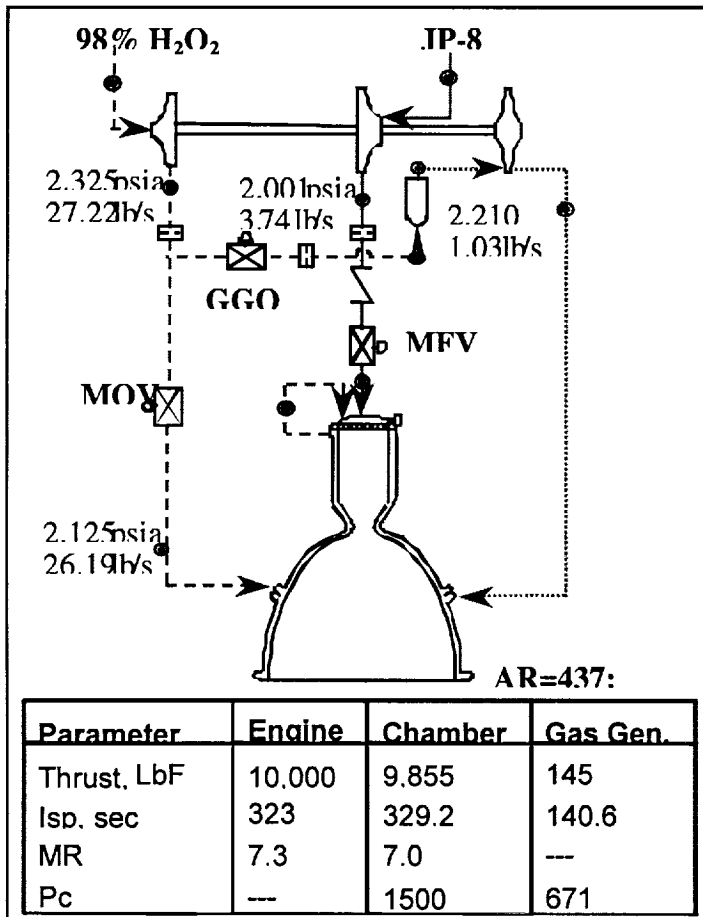

Figure 18: Representative Engine Power Balance

An ideal storable upper stage engine for the 21<sup>st</sup> Century would have the following characteristics:

- 1) It would utilize 98% peroxide as the oxidizer, and JP8 as the fuel. 98% peroxide because no advanced stage designer will be willing to carry any amount of water to orbit or the staging altitude. Peroxide/RP systems are only competitive with other traditional propellant systems on a density Isp basis when the water is minimized in the peroxide. It would utilize JP8 because it is the most readily available RP fuel and the lowest cost of the RP propellants.
- 2) It would include a turbopump. The use of a turbopump allows higher engine pressures, higher Isp,

lower stage structural weights, and more flexibility in stage design. The turbopump would be a minimal parts count, low cost, decomposed peroxide gas generator driven design. The turbopump would be robust, but have a recurring price below \$100,000. The turbopump would feature composite and ceramic materials, eliminating all metallic parts and their associated weights.

- 3) It would feature a liquid/liquid injector system. Decomposition of large amounts of peroxide by catalyst prior to JP8 injection is an unnecessary process step when thermal decomposition can be accomplished with proper injector and chamber design.
- 4) It would utilize an expansion deflection nozzle. Packaging the engine within the stage structure in order to maximize the available booster or advanced stage volume for payload will eliminate the use of today's large bell nozzles.
- 5) It will feature an integrated fluid/gas control module. Today's snake nest of discrete valves for each function, connecting plumbing, controllers and wiring represent as cost inefficient a design as can be generated.
- 6) It will be reusable, with a useful life exceeding 100 missions between out-of-airframe maintenance actions. It will be designed for ease of maintenance while installed in the airframe.

## **The Peroxide Pathway**

Developing this advanced peroxide engine will take years of careful development, sometimes stretching new technologies, and sometimes concentrating on integrating them. NASA has begun this development process under the auspices of the Advanced Space Transportation Program at the Marshall Space Flight Center. A technology roadmap (Figure 1) has been developed to guide this development. The development steps are as follows:

Step 1: Secure a reliable source of bulk quantities of high concentration peroxide. NASA, the Air Force, and industry will invest more than \$50million in the development of peroxide technology in the next decade in order to realize the potential of peroxide propulsion. That level of investment will be constantly at risk if the supply of 98% peroxide remains the product of a single specialty supplier. One of the proposals selected by NASA in response to the NASA Research Announcement (NRA) 8-21 Cycle 2 in 1999 was a proposal by Orbital Sciences to design, fabricate, and demonstrate a portable peroxide enrichment skid. A portable enrichment skid was selected because of the probable need of high concentration peroxide at multiple locations, including the Stennis Space Center in Mississippi, the Kennedy Space Center in Florida, the Kodiak Launch Center in Alaska, and at several industry facilities in California. Enriching peroxide means reducing the water content of the base product. In this case the enrichment skid is being designed to enrich commercially available 90% concentration material, available from Degussa Huls,

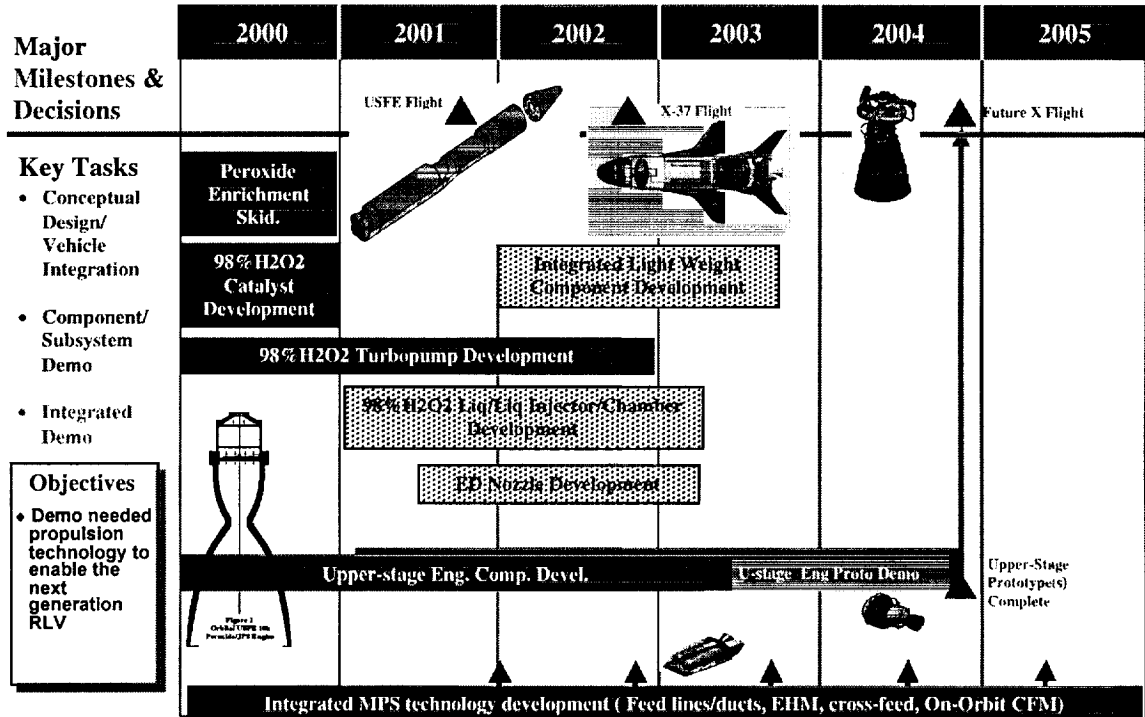

Figure 19-Peroxide Propulsion Technology Development Roadmap

FMC, and X-L Space Systems, to a 98% concentration material at a rate of 1000 pounds per day. The chosen enrichment process is crystall fractilization. The skid design and process controls are being engineered by Orbital's design partner Degussa Huls. The on-site enrichment process allows tighter control of product quality. It also allows concentrated product to be produced only as needed rather than stockpiled, thereby ensuring a safer operation. The enrichment skid also allows shipment of the less reactive 90% concentration product, and avoids exposure of the general public to the shipment of 98% material. The enrichment skid will be completed in 2000.

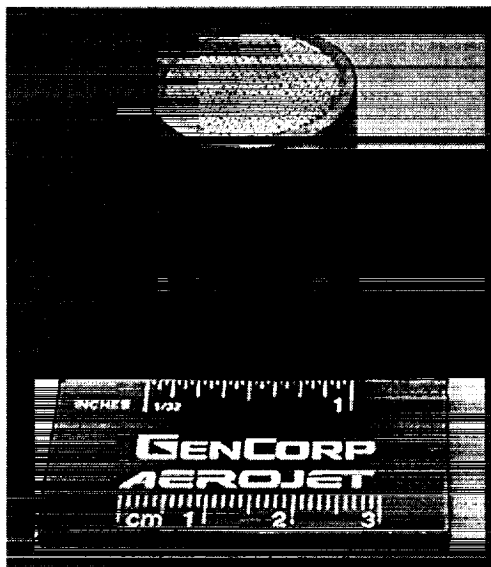

Figure 20: Monolithic Catalyst Bed

Step 2: Develop catalyst systems compatible with 98% peroxide. Catalyst systems are the key component in the integrated use of peroxide on future advanced upper stages. Catalyst will be used to generate gas to power the turbopump on the engine and to drive turbo generators for electrical power, to provide an ignition gas for thermal decomposition of peroxide in the engine, to decompose 98% peroxide for mono and bi-propellant attitude control thrusters, to generate warm gas heat for some systems, and to generate pressurization gas for tanks. A robust, long life, insensitive catalyst is the key to almost every liquid and gas system onboard future

advanced upper stages. Preliminary work on 98% peroxide catalyst was done in the 50s and 60s, but none of it resulted in definitive fielded systems. Aerojet, Boeing Rocketdyne, TRW, TRW partner General Kinetics, and TRW partner Purdue University were all selected by NASA in response to NRA8-21 cycle 2 to work on advanced catalyst for decomposition of 98% peroxide. In addition, Pratt & Whitney is performing research on 98% concentration catalyst systems on internal company funds. Competition is responsible for more technical innovation in industry than any other factor and this competition in the development of an advanced catalyst all but ensures success. All of the companies offer a different solution. And the costs to explore these potential solutions are moderate. The catalyst development work is planned for completion in 2000.

Step 3: Develop 98% compatible turbopumps. The next development step must be an advanced, low parts count, low recurring price, 98% peroxide compatible,

turbopump. This is the longest lead time component in the rocket engine and must be started as early as possible. Once developed it can be used to support pure rocket system development, as well as peroxide/RP Rocket Based Combined Cycle (RBCC) demonstrations and peroxide/hybrid development. Boeing Rocketdyne has teamed with NASA-MSFC to design, fabricate, and demonstrate a state-of-the-art low cost, low parts count, 98% peroxide compatible, gas generator driven turbopump. Boeing recently successfully designed, fabricated, and tested a 60K pound thrust Lox/RP

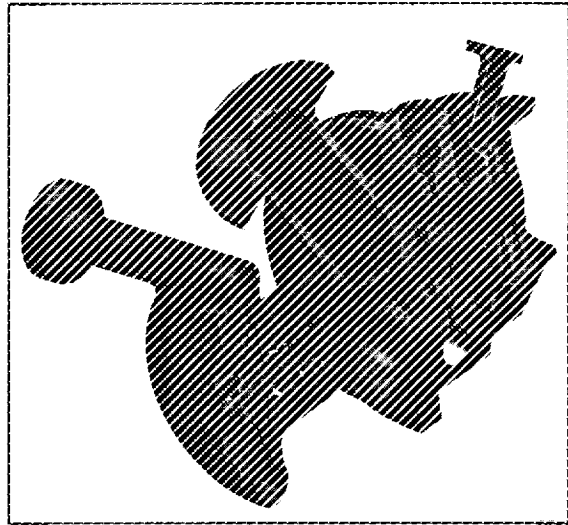

**Figure 21 : Peroxide Turbopump**

turbopump for the Low Cost Boost Technology project with a projected recurring cost approaching \$100,000. And Boeing designed, produced, and fielded a man rated turbopump in the AR2-3 several decades ago. With this success base to draw on, Rocketdyne will still be challenged to produce a modern pump with recurring costs approaching \$50,000 to support second generation X-37 and USFE mission plans. But it will still not be the non-metallic, light-weight, low parts count pump that is needed in the 21<sup>st</sup> Century. That will take an additional design and development cycle. The first peroxide pump iteration is expected to enter tests in 2002.

Step 4: Develop lightweight non-metallic reusable liquid/liquid injectors and combustion chambers. Elimination of the large catalyst packs will contribute significantly to lower engine weight and reduced engine maintenance. Liquid/liquid injection will eliminate energy losses occurring in the pre-chamber decomposition of the peroxide. And use of advanced non-metallic materials will substantially lower the weight of the engine. NASA expects to begin this development activity in FY2001.

Step 5: Develop a lightweight non-metallic reusable expansion deflection nozzle. Axial length to cross-sectional diameter ratios in excess of 1:3 will be necessary to meet future engine packaging requirements. Bell nozzles can not hang out the back of re-entering upper stage flight vehicles the way SSMEs do on the Shuttle.

Step 6: Develop a light-weight, non-metallic, fluid/gas control module. NASA and industry took a step in this direction by designing, fabricating, and flight testing a composite hydrogen control valve on the NASA/McDonnell Douglas DC-XA program in 1996. But more than fabrication of individual valves must be done. Consolidation of fluid and gas control functions, elimination of brackets and tubing, and relocation of components for ease of maintenance and test must dominate new designs.

Because safety is of paramount importance in dealing with such an energetic oxidizer, FMC Corporation was selected to perform hazardous materials testing of 98% concentration peroxide. Almost all of the data pertaining to safe handling and storage of 98% peroxide is three or more decades old. More current data will be required to satisfy today safety analyses and review boards. FMC, as a past American supplier of high concentration peroxide, is eminently qualified to perform these tests and establish the required safety data. This work is expected to be completed in 2000.

## **Conclusion**

Five years ago peroxide/RP propulsion figured in no-one's plans. Now at the turn of the century peroxide/RP propulsion is returning to flight status aboard joint Air Force/NASA research vehicles demonstrating it's capability to meet both expendable and reusable mission needs. And development of new peroxide/RP engines has begun to take advantage of the new materials and design processes available today to reach new performance levels. A successful development program will lead to long term commercial application of this technology to 21<sup>st</sup> century space transportation systems.

## **Acknowledgements**

The authors would like to acknowledge the help of Robert Ross, Doug Peters, Dave Mason, Scott Anderson, Jerry Golden, and Charles Cornelius of Orbital Sciences Corporation; Robert Bruce, Gary Taylor, Don Beckmeyer, Stan Warren and Scott Dracon of NASA Stennis Space Center; Fred Vaughn and Ray Nichols of Lockheed, Jim Guerrero and Dave Perkins of Air Force Phillips Lab; Ray Walsh of Schafer Corporation; Mark Ventura of General Kinetics; Ken and Norm Christensen of American Automated Engineering; and Abdi Nejad, P.-K. Wu, and Phil Morlan of Kaiser-Marquardt.

## **References**

1. "The AR2-3, AR-3 and AR-4 Rocket Engines Technical Information and Program Plan", BC72-29, 1972.
2. "Rocketdyne AR Engines", BC72-21, 1972.

3. "Air Force Evaluation of the F-86F with AR2 Rocket Augmentation", AFFTC-TR-60-39, October 1960.
4. "Final Report for the XLR46-NA-2 Aircraft Superperformance Rocket Engine", R-1726, October 30, 1959.
5. "AR2-3 IR&D Engine Testing At Stennis Space Center", internal Rocketdyne report, unreleased.
6. NASA-MSFC website on Pathfinder vehicles.  
"X-37: Taking the X-Planes to Orbit", Aviation Week, August 9, 1999.

**References**

<sup>1</sup>Wu, P.-K., Fuller, R.P., Morlan, P.W., Ruttle, D.W., Nejad, A.S., and Anderson, W.E., "Development of a Pressure-Fed Rocket Engine Using Hydrogen Peroxide and JP-8," AIAA Paper No. 99-2877, Los Angeles, CA, June 20-24, 1999.

<sup>2</sup>Morlan, P., Wu, P., Nejad, A., Ruttle, D., Fuller, R., and Anderson, W.E., "Catalyst Development For Hydrogen Peroxide Rocket Engines," AIAA Paper No. 99-2740, Los Angeles, CA, June 20-24, 1999.

<sup>3</sup>Anderson, W.E., Crockett, D., Hill, S., Lewis, T., Fuller, R., Morlan, P., Ruttle, D., Wu, P.-K., and McNeal, C., "Low Cost Propulsion Using a High-Density, Storable, and Clean Propellant Combination," AIAA Paper No. 98-3679, Cleveland, OH, July 13-15, 1998.

<sup>4</sup>Nozzle Aero Thermochemistry (NAT) Computer Code Version 2.0, February 1994, Aerotherm Corporation, Huntsville Operations, Huntsville, AL.

<sup>5</sup>CMA90S, December 1990, Acurex Corporation, Aerotherm Division, Huntsville Operations, Huntsville, AL.



# *Peroxide Propulsion at the Turn of the Century*

William E. Anderson, NASA MSFC

Kathy Butler, Boeing Rocketdyne Power & Propulsion

Dave Crocket, Orbital Sciences Corp.

Tim Lewis, Orbital Sciences Corporation

Curtis McNeal, NASA MSFC





- ◆ Introduction
- ◆ AR2-3 Engine Description
- ◆ AR2-3 Test Results
- ◆ The X-37 Mission
- ◆ USFE 10K Engine Description
- ◆ USFE 10K Engine Test Results
- ◆ The USFE Mission
- ◆ An Advanced Peroxide Propulsion Engine
- ◆ The Peroxide Pathway



Peroxide Propulsion at the Turn of the Century

# Peroxide/RP-The Best Packaged Power

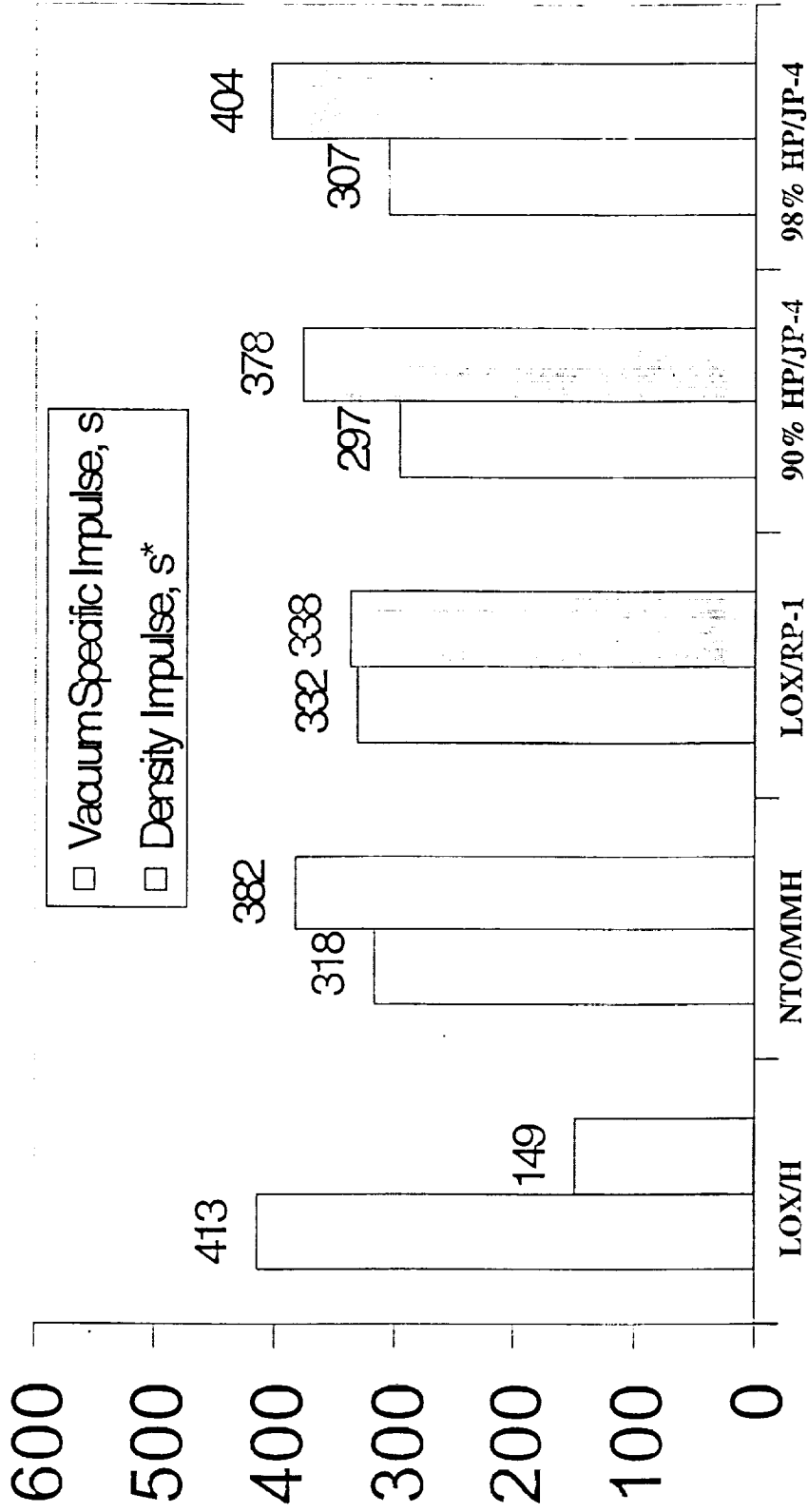



Peroxide Propulsion at the Turn of the Century

# AR Engine Series

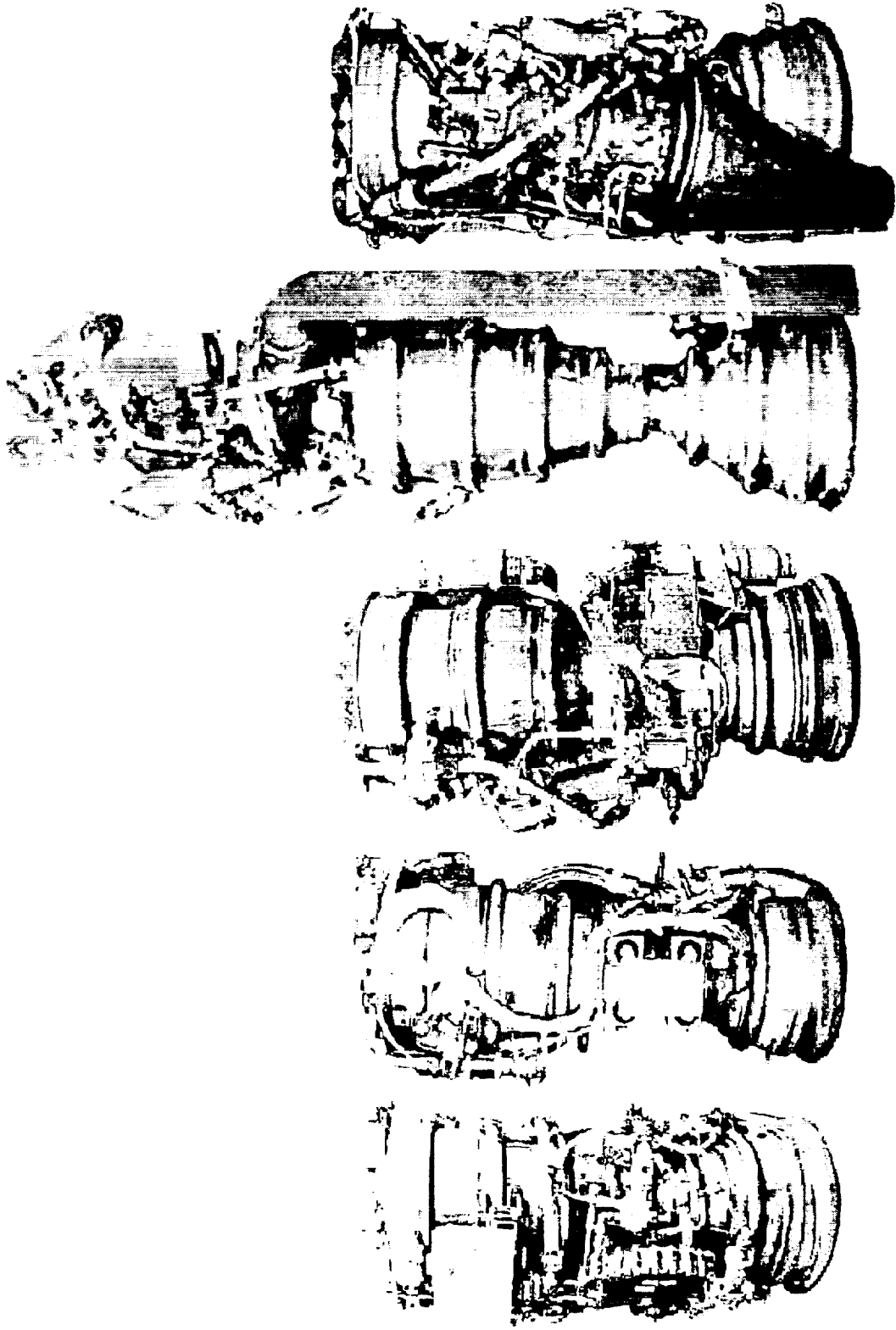



Peroxide Propulsion at the Turn of the Century

# AR2-3 Operating Schematic

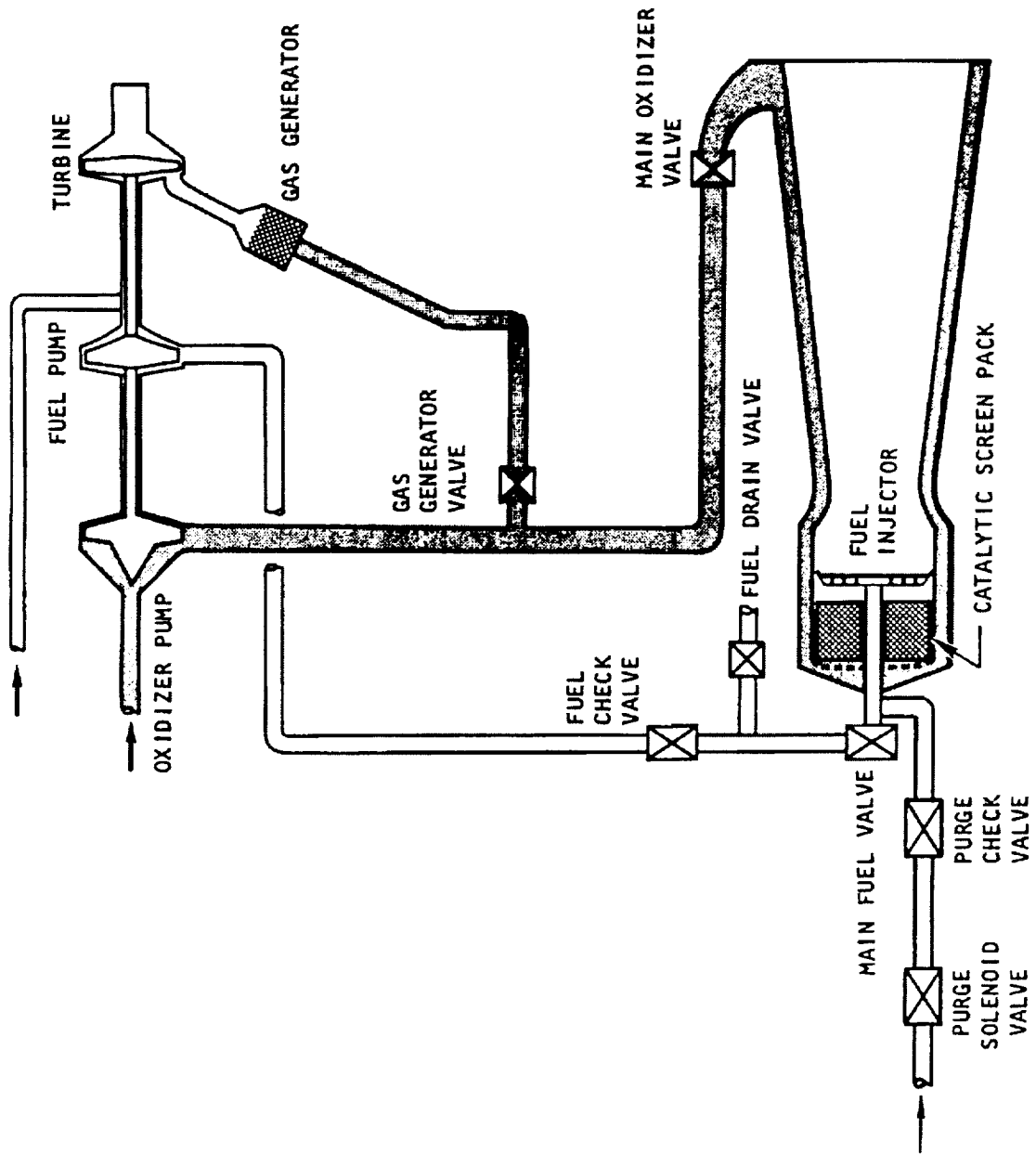



## AR2-3 Engine Performance.

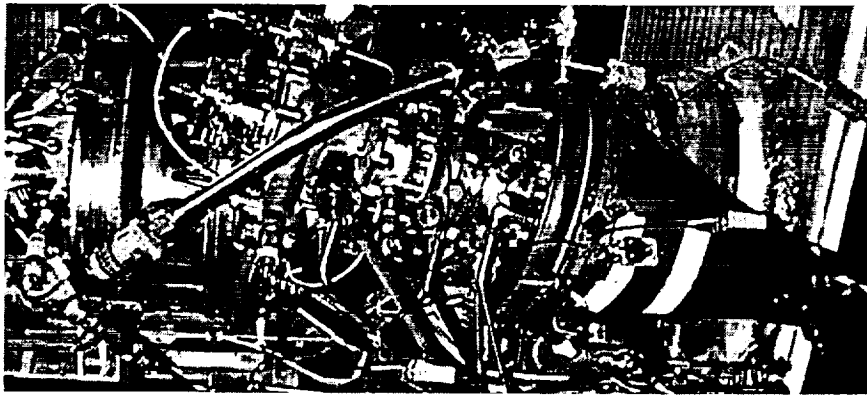

- Propellants 90%H<sub>2</sub>O<sub>2</sub>/JP
- Thrust, vac (lbf) 6600
- Isp, vac (sec) 246
- Chamber pressure (psia) 560
- Mixture ratio 6.5
- Area ratio 12:1
- Length (in) 32
- Engine diameter (in) 20
- Weight (lbm) 225
- Gimbal angle (degrees) 0
- No. or restarts multiple
- Engine life >150 minutes



*Peroxide Propulsion at the Turn of the Century*

# AR2-3 Test Firing

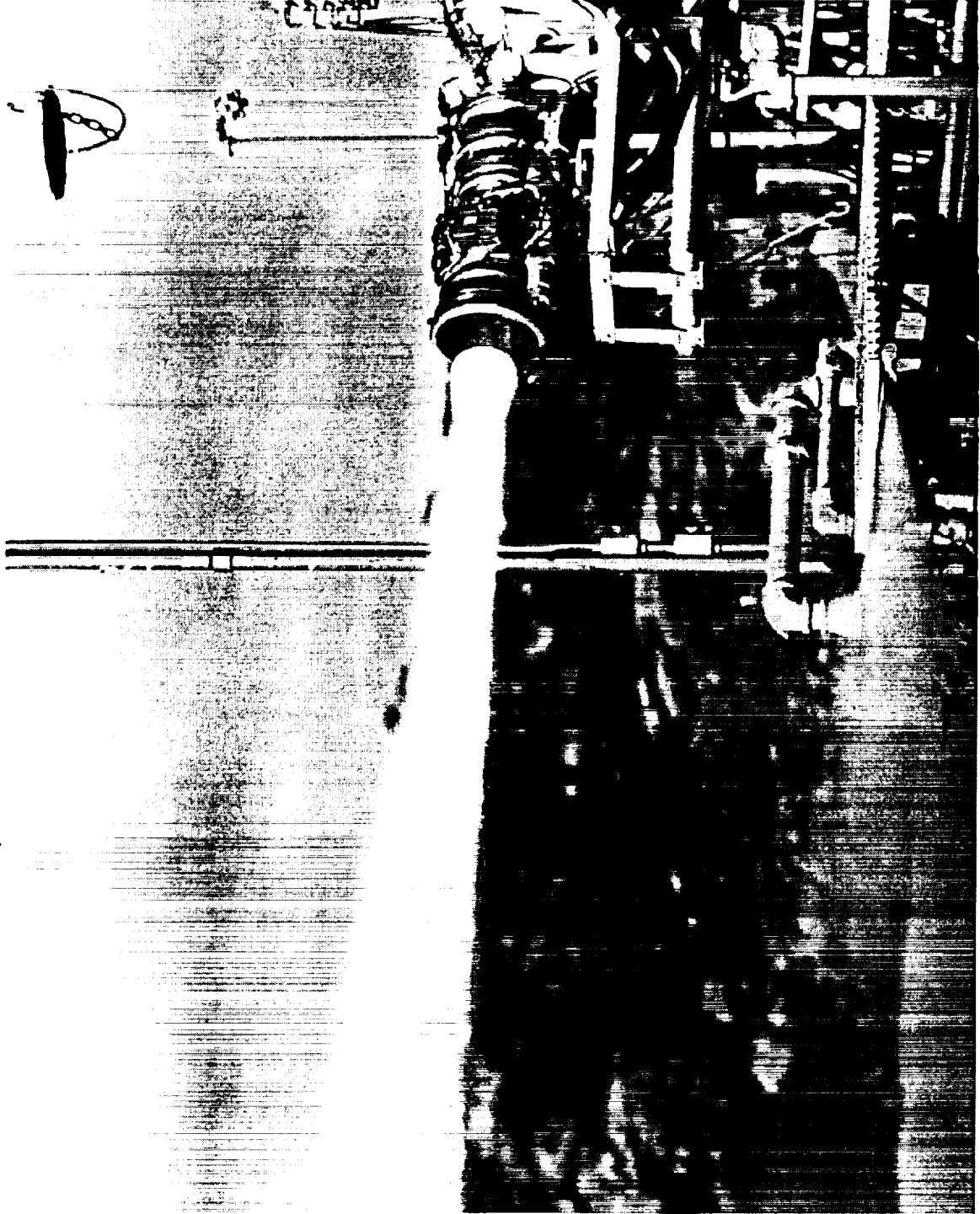



Peroxide Propulsion at the Turn of the Century

# F104 AR2-3 Operation





*Peroxide Propulsion at the Turn of the Century*

## AR2-3 in SSC Test Stand

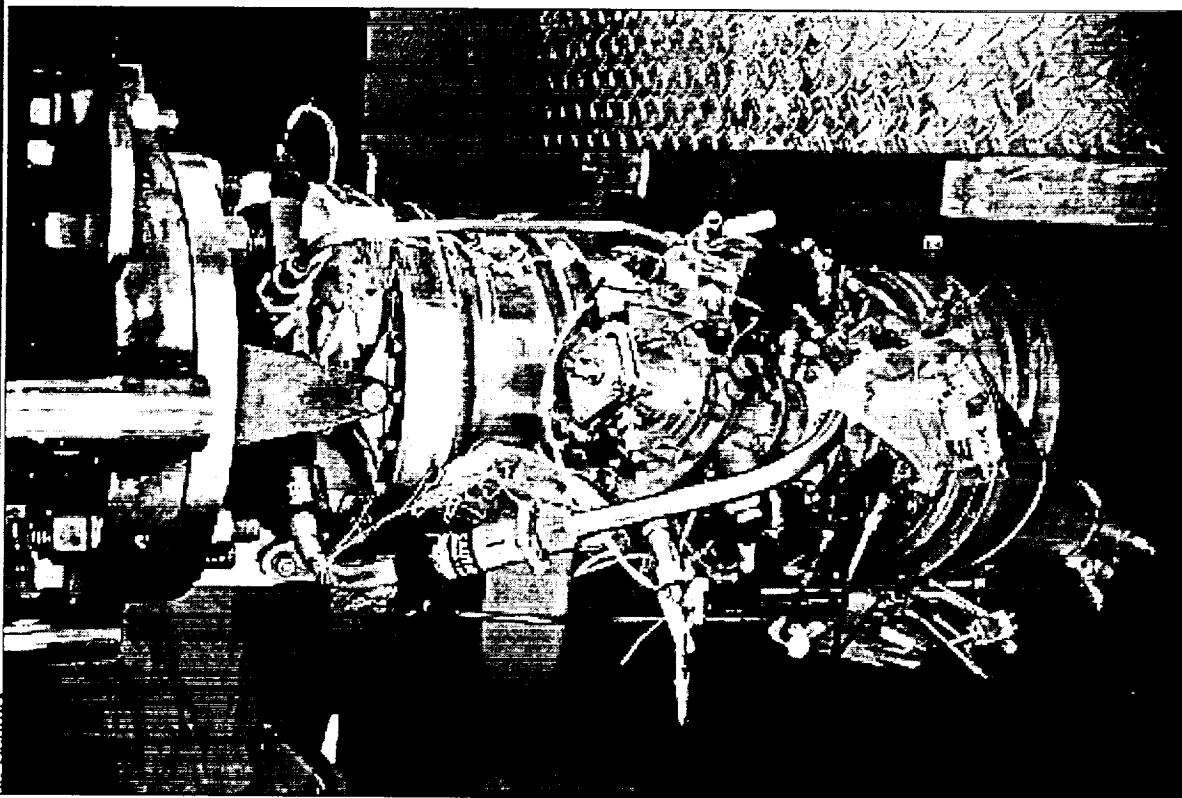





Peroxide Propulsion at the Turn of the Century

# Head End Skin Temps

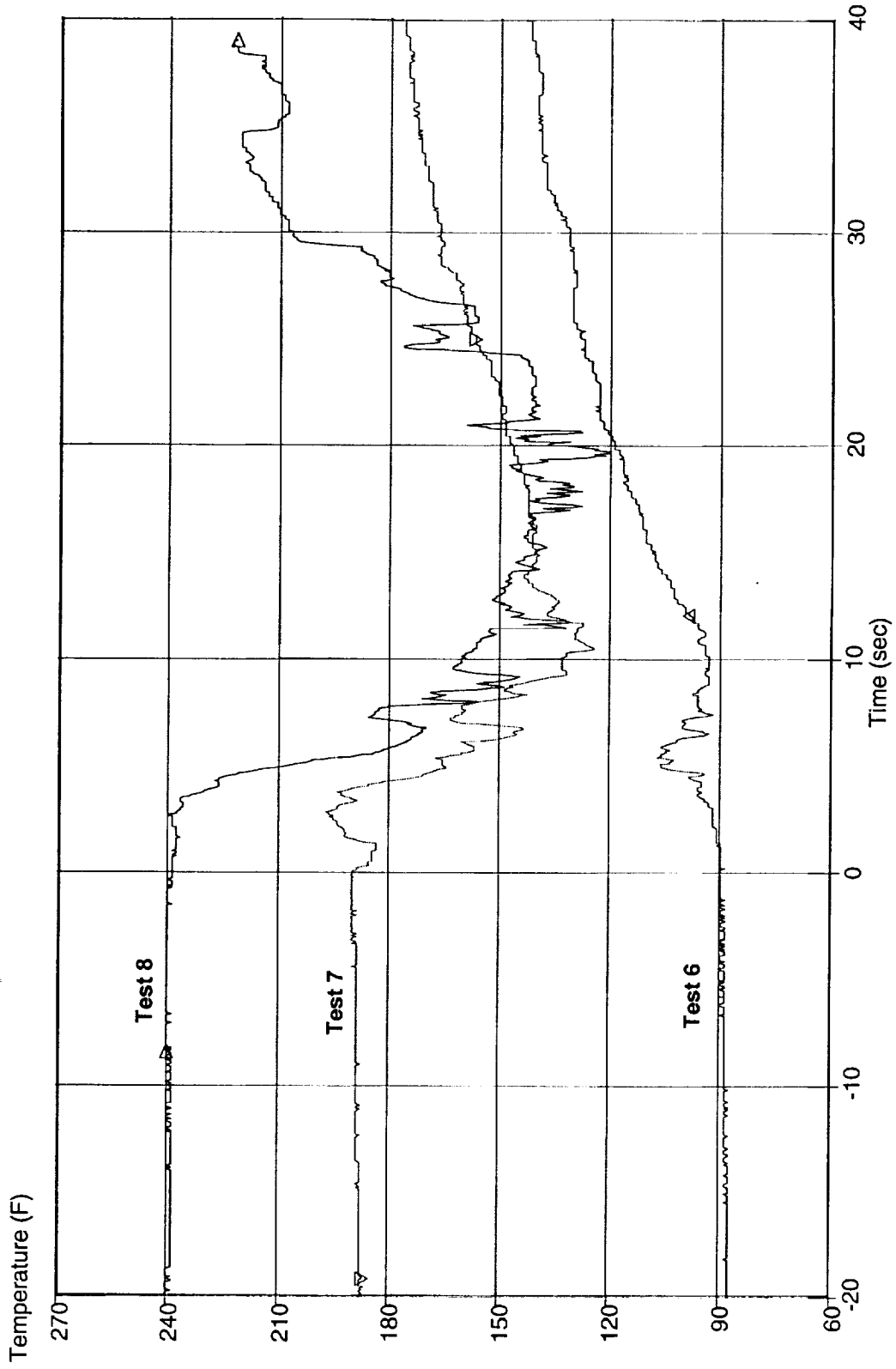



Peroxide Propulsion at the Turn of the Century

# Oxidizer System Data Vs. Time During Test 5

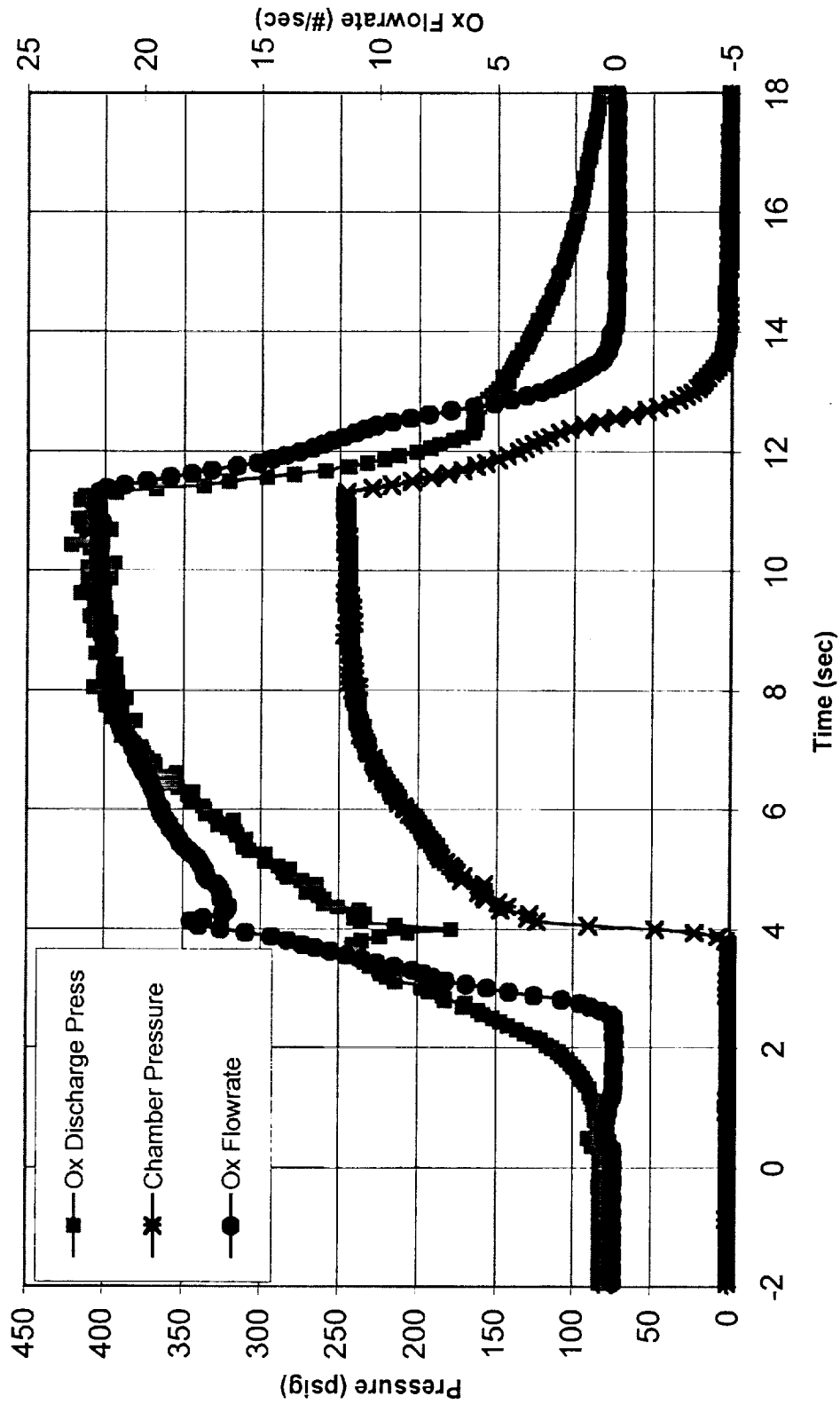



# Oxidizer System Data Vs. Time During Test 10

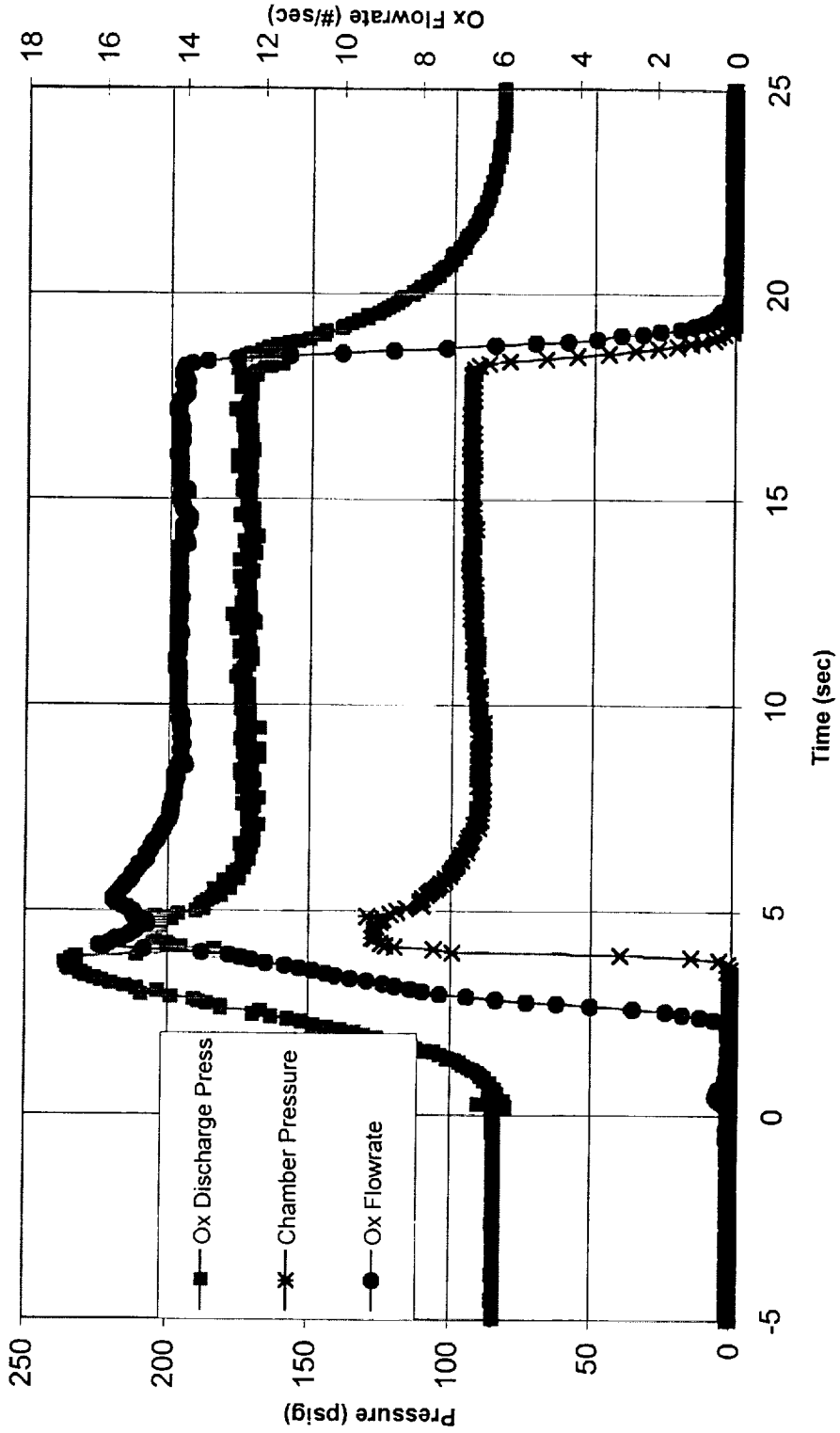



Peroxide Propulsion at the Turn of the Century

# C\* Efficiency Vs. Engine Hot Fire Time

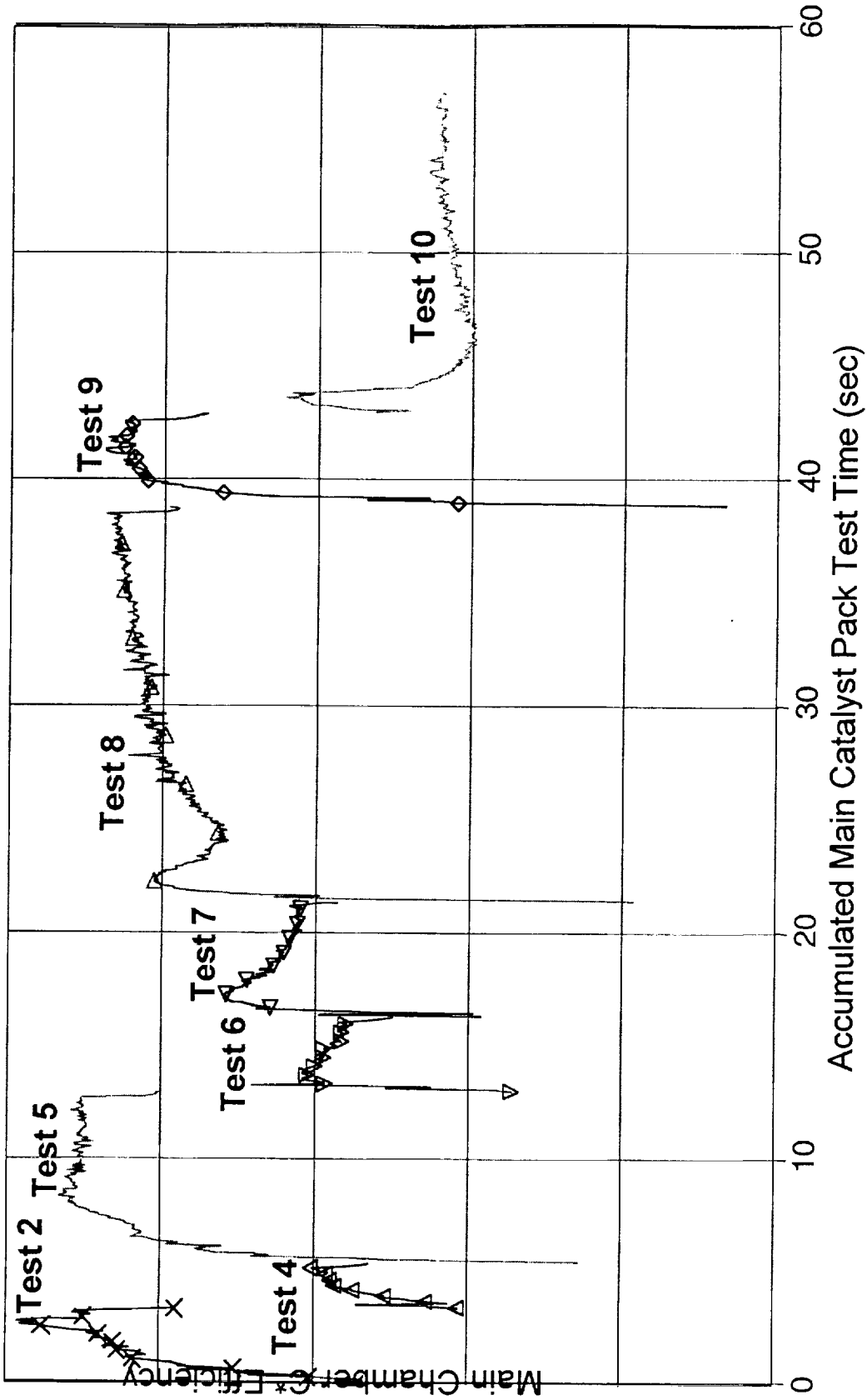



# Data Summary

Test No.	1	2	3	4	5	6	7	8	9	10
Date	9/30/99	9/30/99	10/15/99	10/26/99	10/26/99	10/28/99	10/28/99	10/28/99	10/29/99	10/29/99
Test of Day	1	2	1	1	2	1	2	3	1	2
Unit										
Duration	4	6	3	6	11	6.4	8	20	8	18
Mono/Biprop	Mono	Mono	Mono	Mono	Mono	Mono	Mono	Mono	Mono	Mono
H2O2 Conc.	84.3	84.3	84.3	84.3	84.3	84.3	84.3	84.3	89.2	89.2
Operating Parameters										
Oxidizer Flowrate	9.6	12.9	9.7	17.6	22.0	16.2	16.3	16.9	15.1	14.1
Thrust Chamber Pressure	0.9	137.1	0.9	142.3	246.5	127.7	136.6	180.3	155.8	93.2
Turbine Inlet Temp	479.1	589.7	941.7	1124.6	1148.5	1114.5	1147.5	1144.5	1261.3	1302.2
Clear Exhaust Plume	no	some	no	no	yes	no	some	yes	some	no



Peroxide Propulsion at the Turn of the Century

# X-37 Launch Sequence

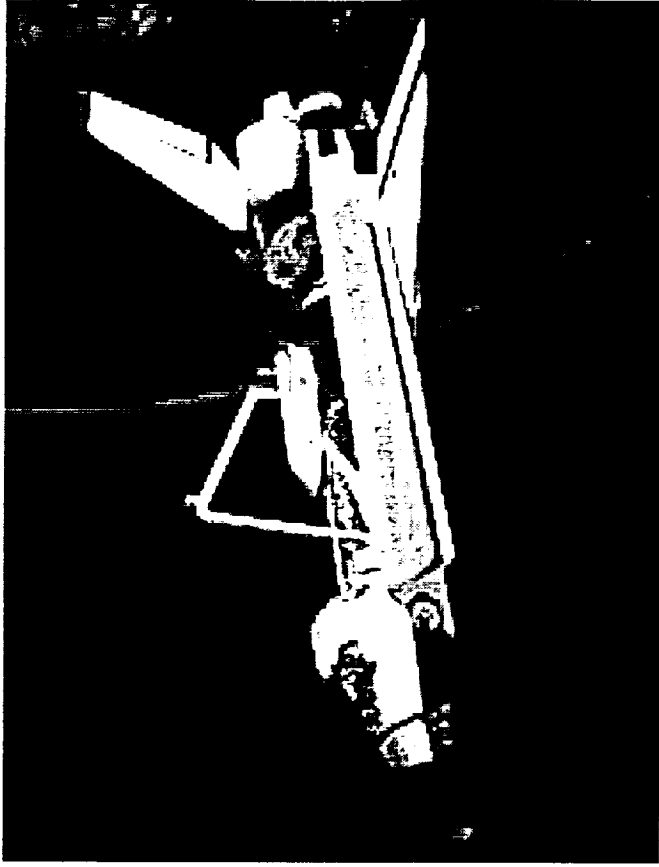



Peroxide Propulsion at the Turn of the Century

# X-37 Mission Sequence

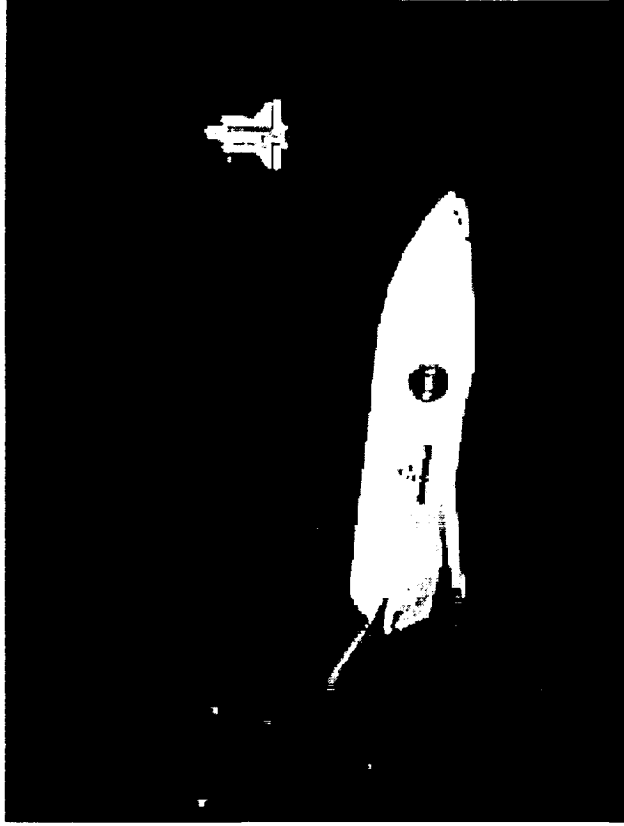



Peroxide Propulsion at the Turn of the Century

# X-37 Re-entry

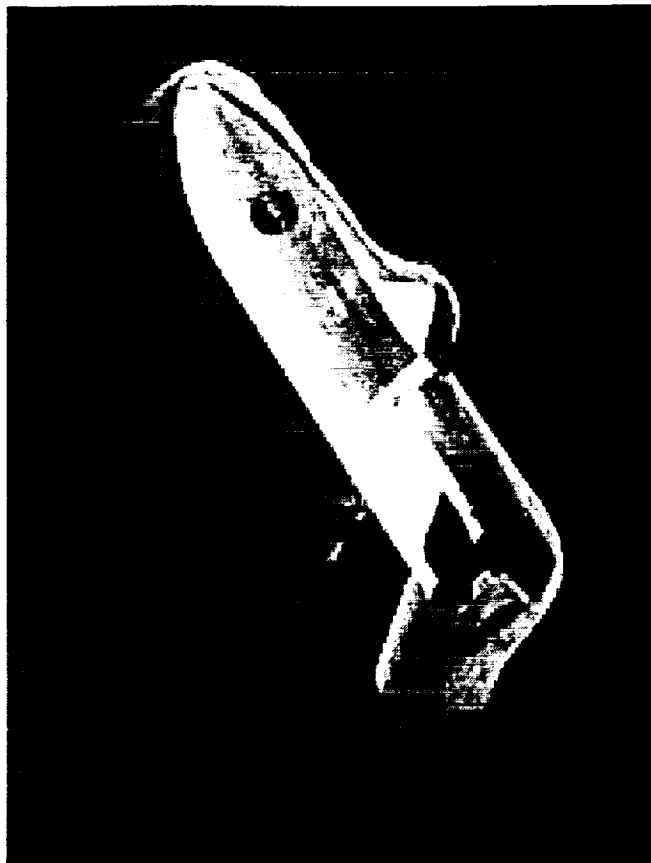





— Peroxide Propulsion at the Turn of the Century

# X-37 Landing

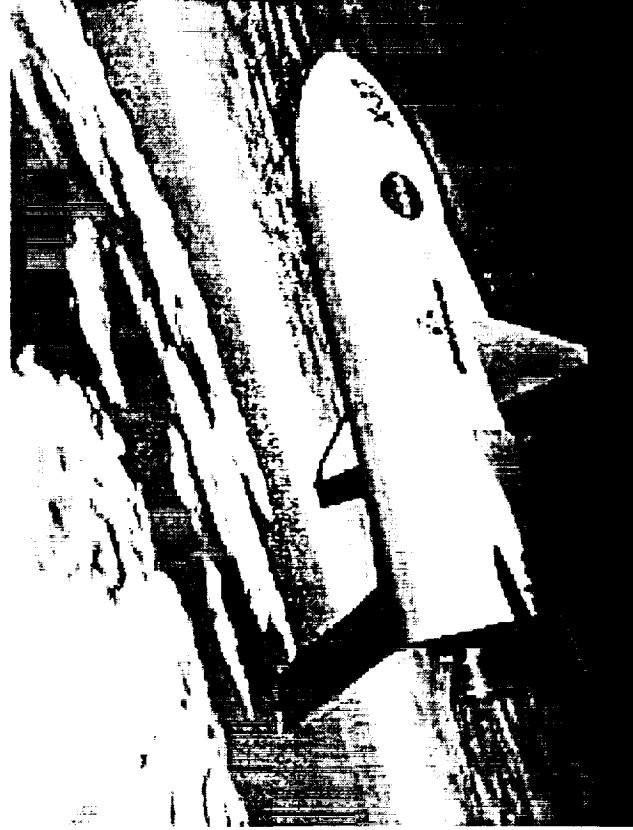

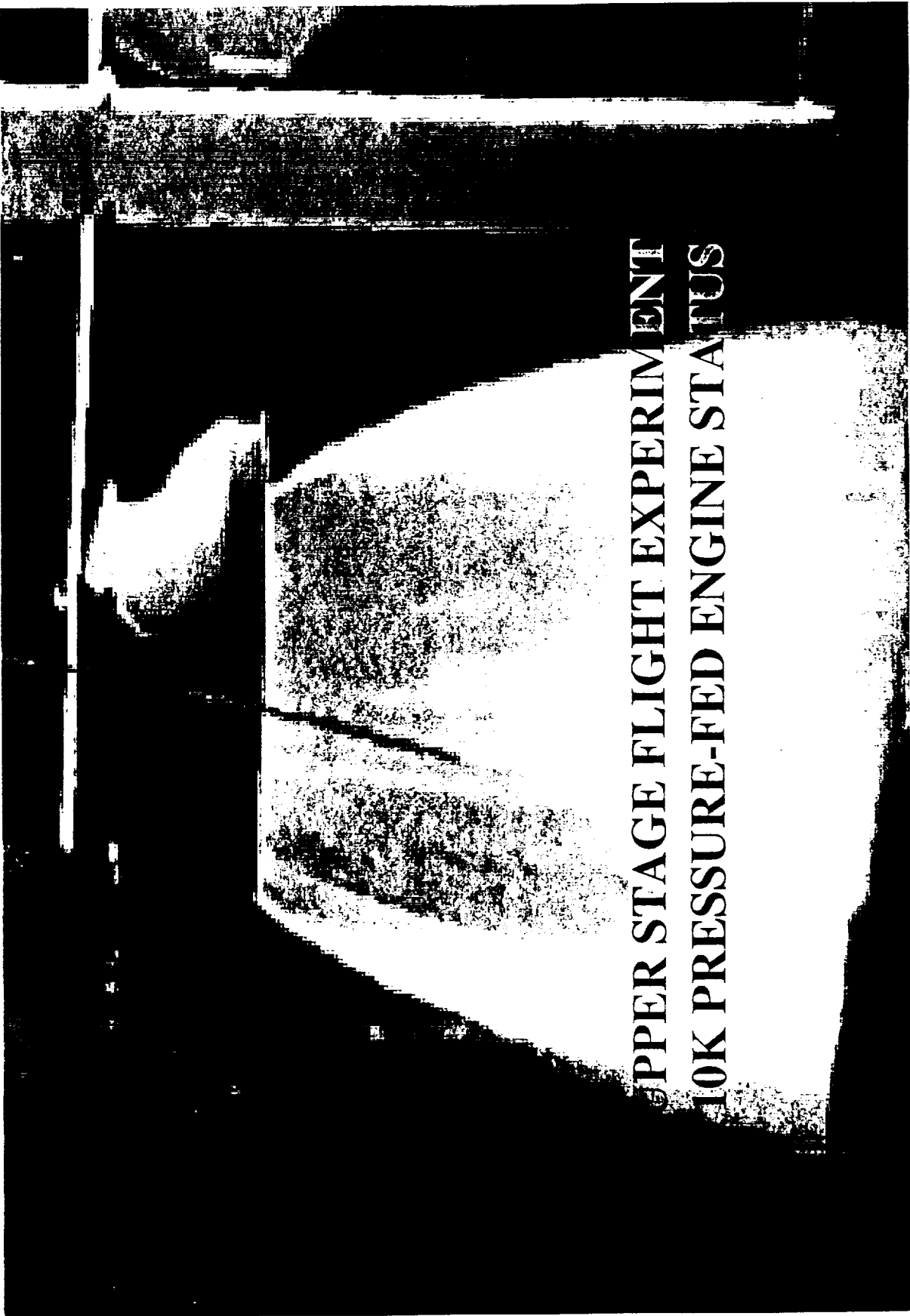

**UPPER STAGE FLIGHT EXPERIMENT  
10K PRESSURE-FED ENGINE STATUS**

## Acknowledgements

---

Robert Ross, Doug Peters, Dave Mason, Scott Anderson, Jerry Golden,  
and Charles Cornelius of Orbital Sciences Corporation

Robert Bruce, Gary Taylor, Don Beckmeyer, Stan Warren and Scott  
Dracon of NASA Stennis Space Center

Fred Vaughn and Ray Nichols of Lockheed

Jim Guerrero and Dave Perkins of Air Force Phillips Lab

Ray Walsh of Schafer Corporation

Mark Ventura and Eric Wernimont of General Kinetics

Ken and Norm Christensen of American Automated Engineering

Abdi Nejad, P.-K. Wu, and Phil Morlan of Kaiser-Marquardt

## Thrust Chamber Assembly

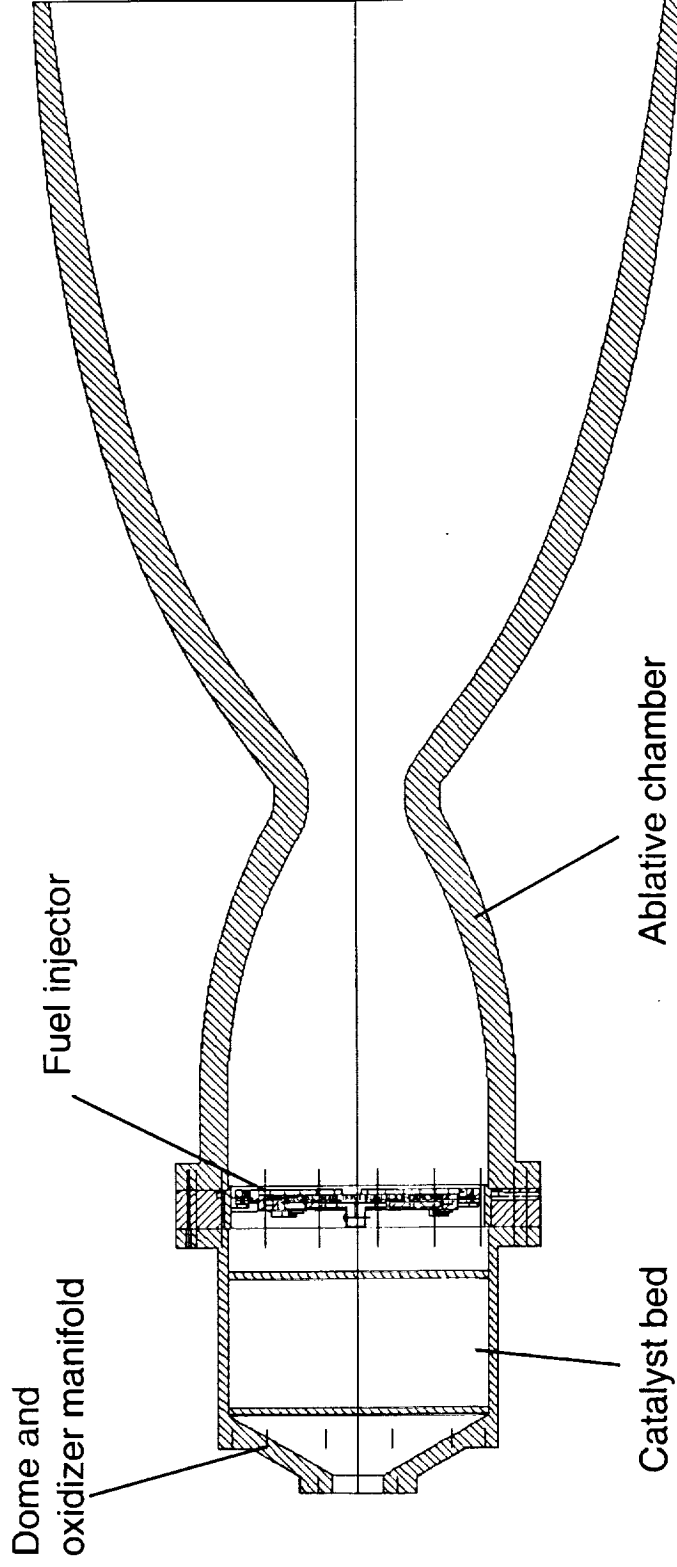

## Development Test Objectives

---

- Phase I w/85% peroxide
  - Monopropellant tests in instrumented heat sink chamber
    - verify test operations with hydrogen peroxide
    - characterize catalyst bed performance
  - Bipropellant tests in instrumented heat sink chamber
    - measure performance, wall heat flux, and combustion dynamics
  - Bipropellant tests in ablative chamber
    - measure throat erosion and char rate and compare with prediction
  - Long duration test (140 s) to verify life
- Phase II w/90% peroxide
  - Complete component development tests
    - Select catalyst bed and injector configurations
    - Finalize operating O/F
  - Start-up characterization - pulse starts vs bleed flow
    - Effects of 90% peroxide
      - Ignition, performance, face heating, throat erosion
  - Long duration test to verify life

## Development Test Hardware

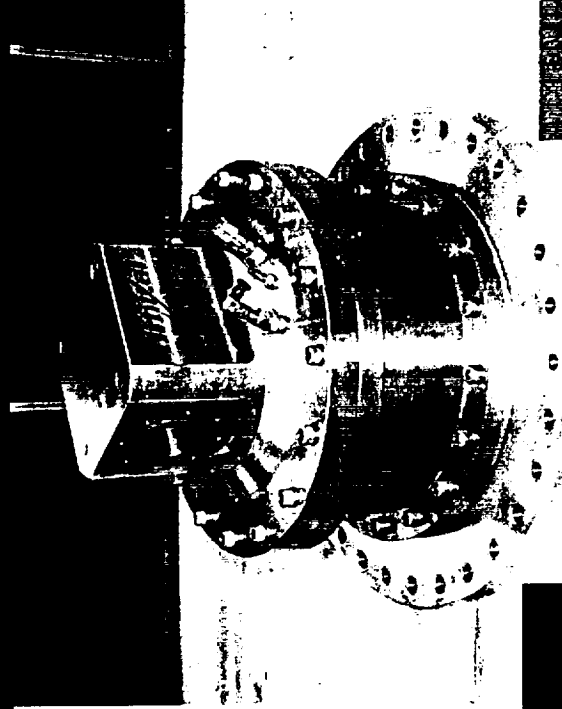

Ablative chamber

- silica phenolic
- 5:1 expansion

Heat sink chamber

- instrumented with pressure transducers and linear array TC's
- 5:1 expansion

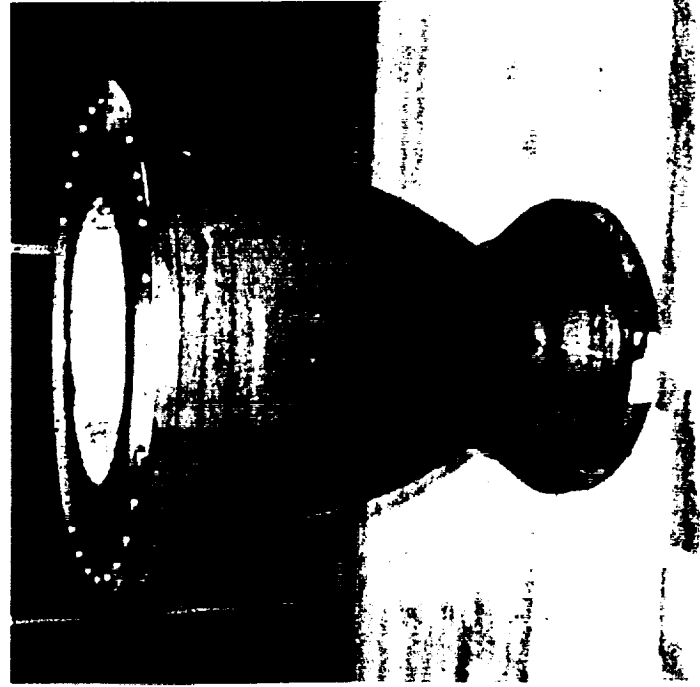

Dome and cat bed

- side inlet
- SS housing
- silver screen cat

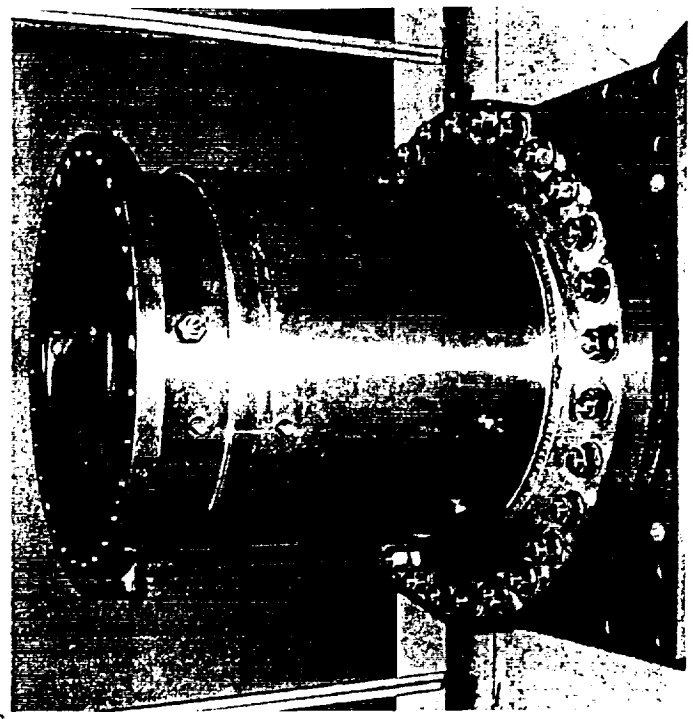

## Two Injectors Were Tested

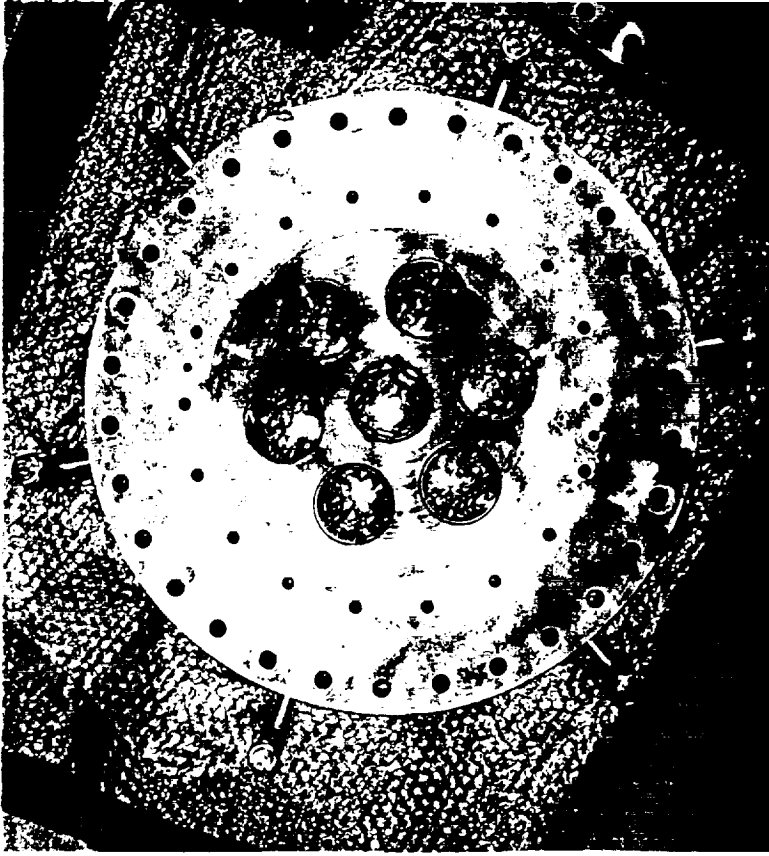

Steam port injector

- no film cooling
- inexpensive



Ring injector (shown modified)

- film cooling allows higher O/F, thus higher performance

## Injector Efficiency

98% efficiency achieved at O/F=6 with ring injector

### C\* Efficiency

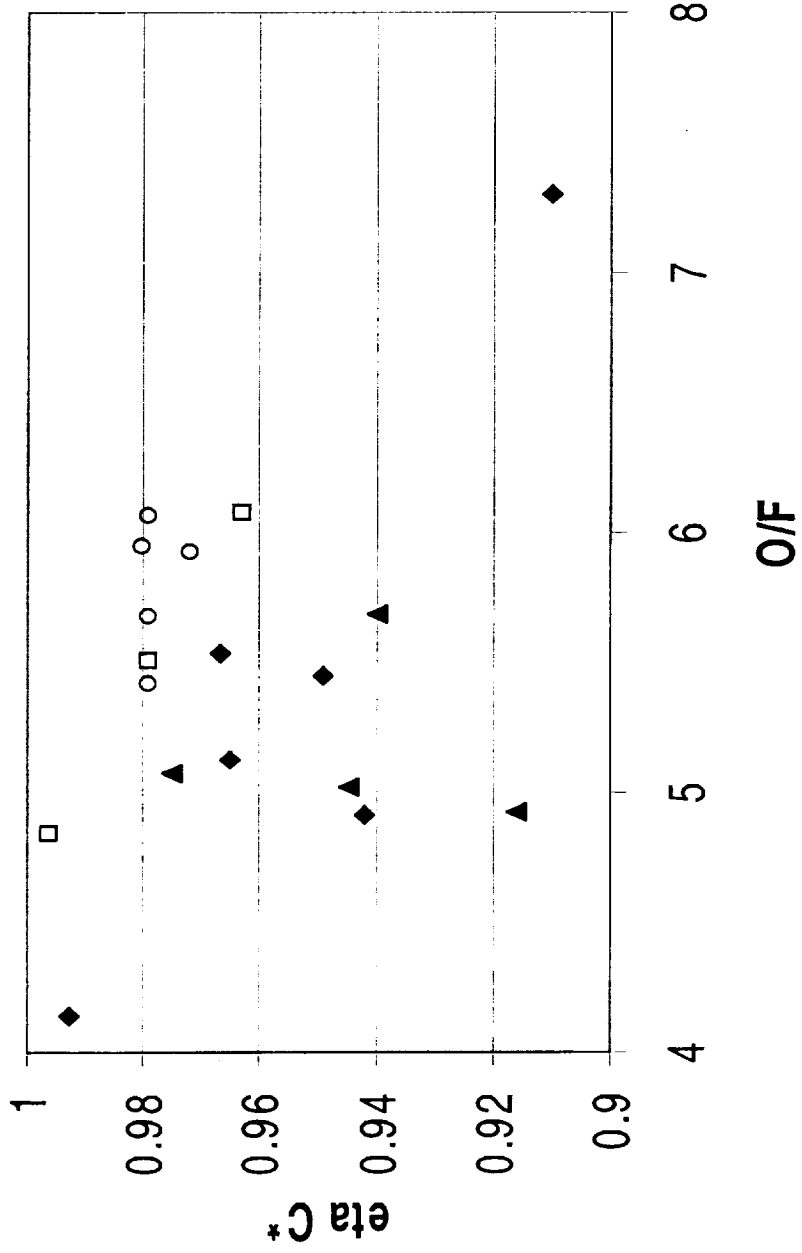

Solid symbols -  
steam port design

Open symbols -  
ring design



## Effective Near Wall Gas Temperature



Effect of film cooling measured by throat heat flux measurements in heat sink chamber

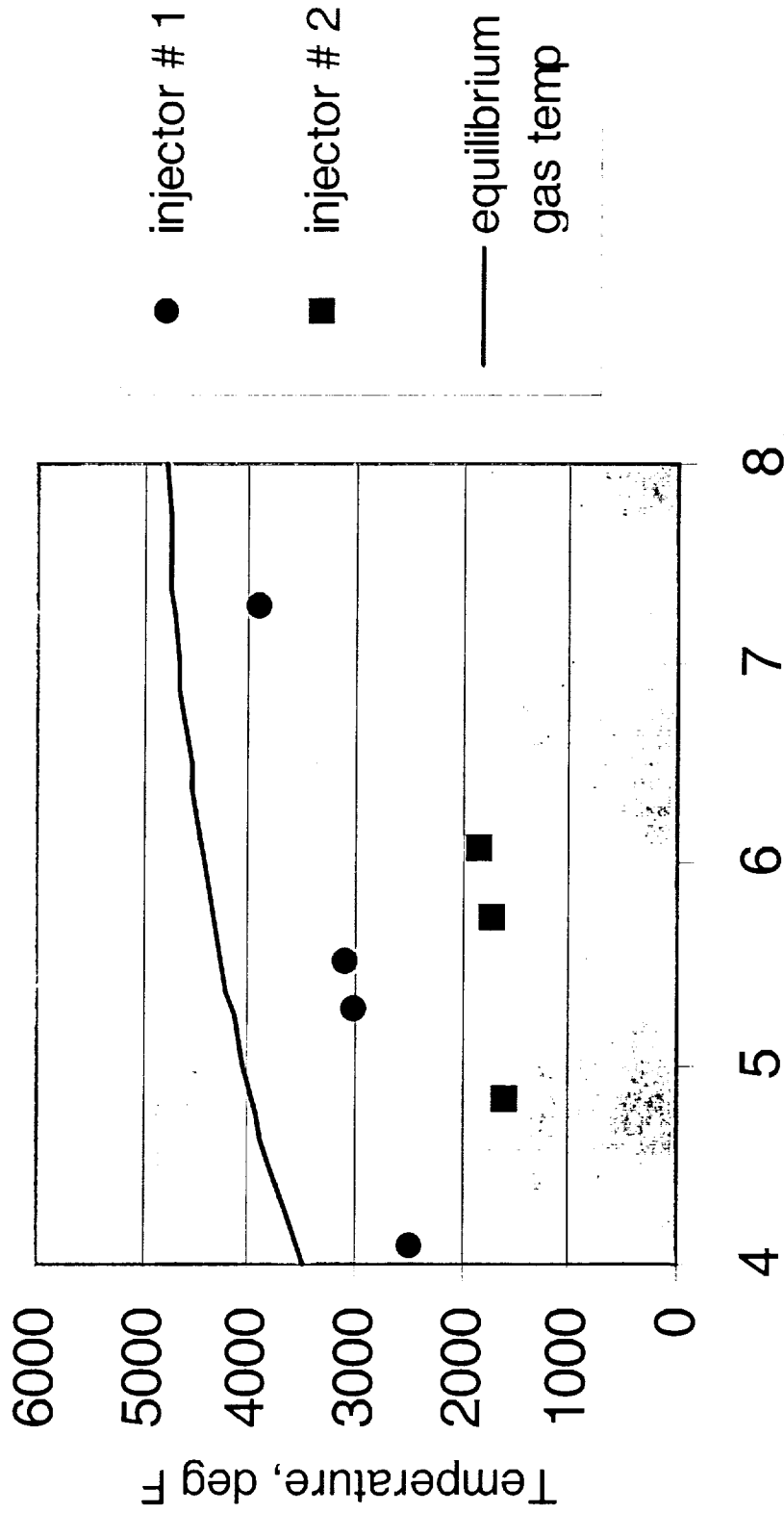

85% HTP/JP-8

Cu chamber heat flux measurements

## **Full-Scale Test Summary**

- conducted over 125 tests
- accumulated nearly 30 minutes of test time
- accumulated over 300 seconds of bipropellant operation using ablative chambers, including one long-duration test of 140 s
- accumulated over 700 seconds of run time on a single cat bed without performance degradation
- demonstrated throat recession rates of less than 0.001 in/s
- demonstrated  $C^*$  efficiencies greater than 0.97 at nominal operating condition
- tested twelve different test article configurations
- tested both 85% and 90% peroxide from two different manufacturers
- demonstrated multiple restarts
- demonstrated throttling to 10% in monopropellant mode and to 20% in bipropellant mode
- maintained perfect safety record

## Engine Parameters



Parameter	Value
Propellants	90% HTP/JP-8
Vacuum Thrust, lbf	10,000
Chamber Pressure, psia	500
Mixture Ratio	5.75
Nozzle Expansion Ratio	40 (five for ground tests)
Chamber Contraction Ratio	7.1
Delivered Specific Impulse, s	290
Flowrate, lb/s	34.5
Burn Time, s	200
Engine Envelope	60 in. long, 40 in. diameter



# Orbital

## OSP-USFE Vehicle Configuration

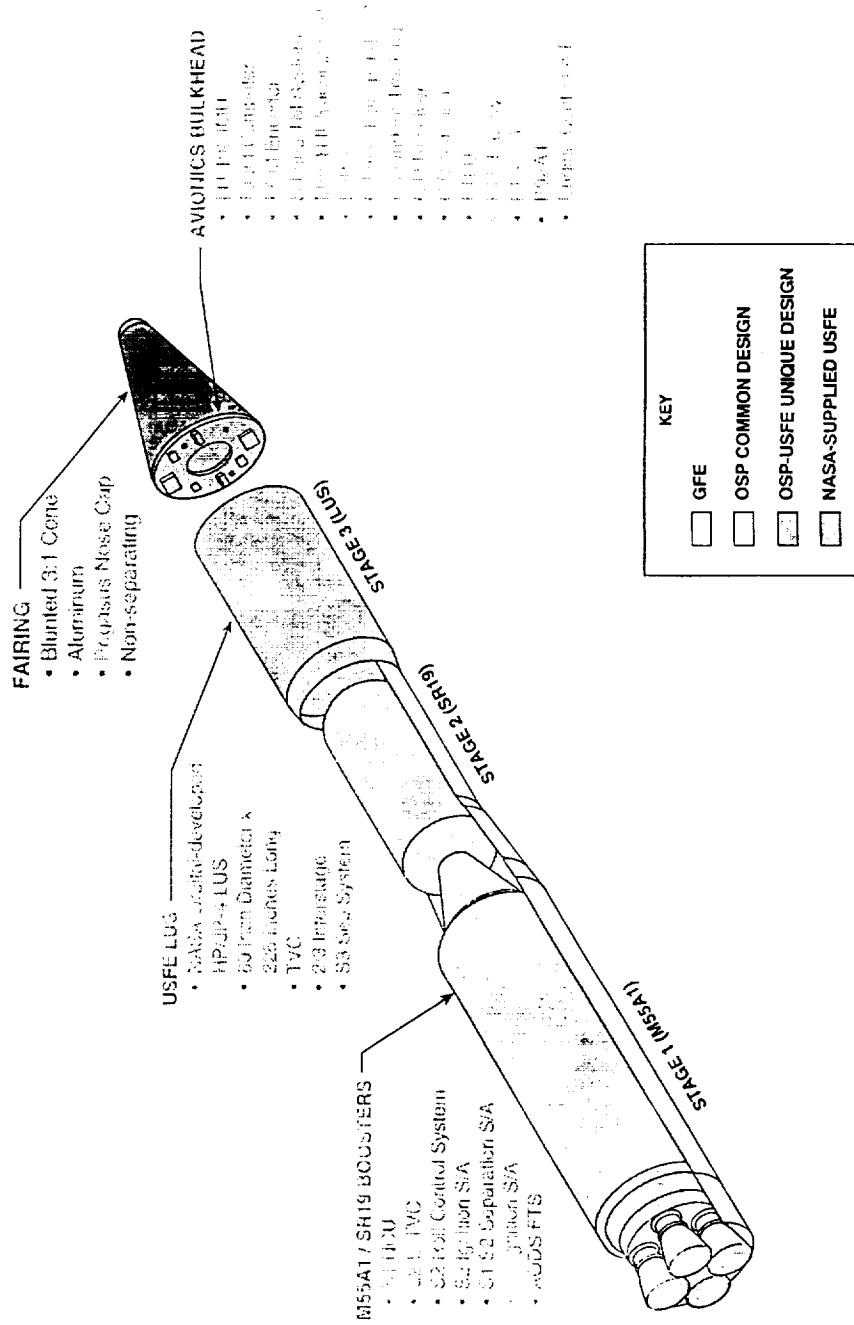

TM14008.004



# Upper Stage Flight Experiment Mission

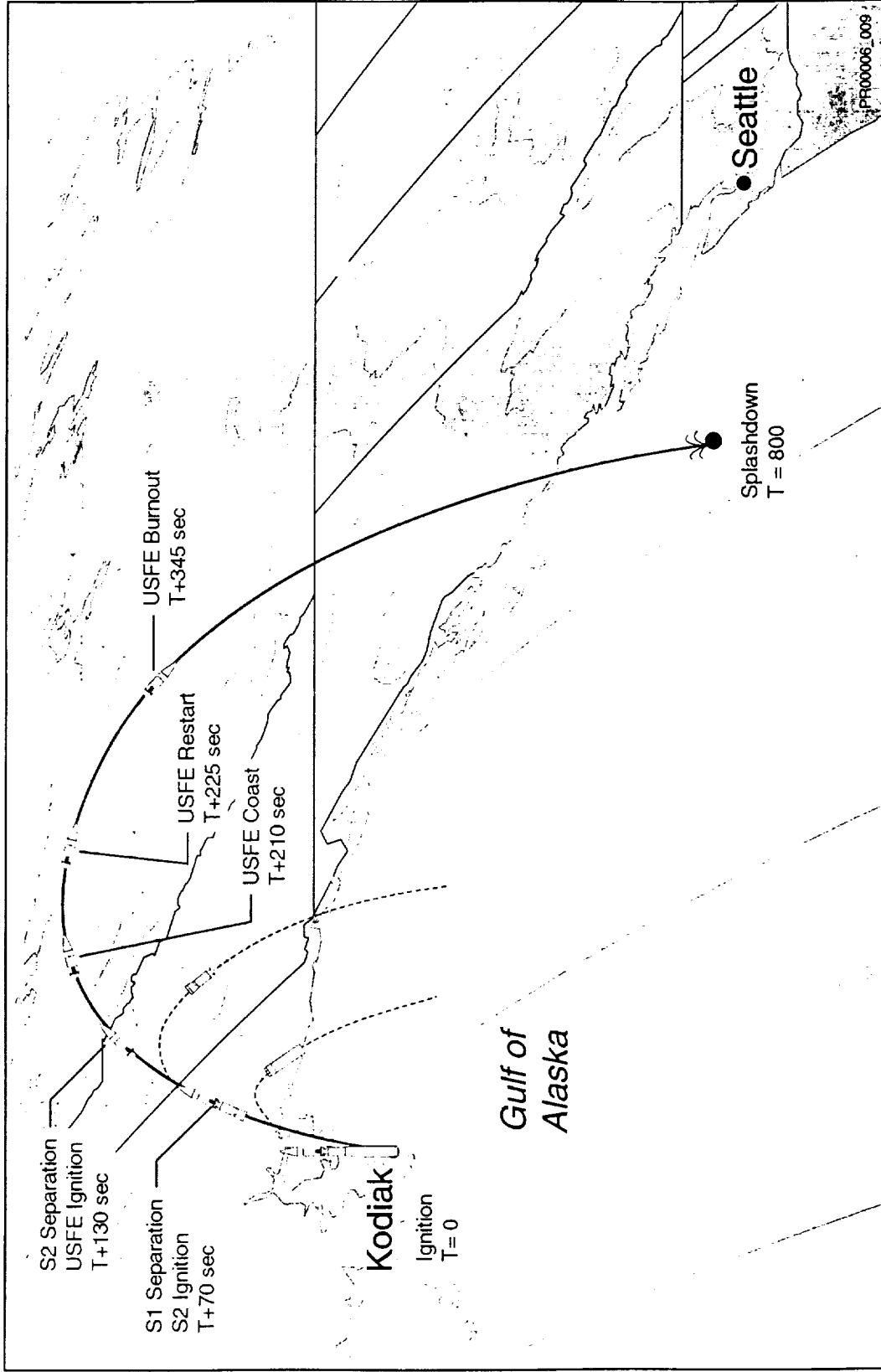



## **An Advanced Peroxide Propulsion Engine for the 21st Century**

*Peroxide Propulsion at the Turn of the Century*

---

- ◆ **The engine would utilize 98% peroxide as the oxidizer, and JP8 as the fuel.**
- ◆ **The engine would be turbopump driven.**
- ◆ **The engine would feature a liquid/liquid injector system.**
- ◆ **The engine would utilize an expansion deflection nozzle.**
- ◆ **The engine will utilize composites and ceramics throughout the design to lower engine weight and approach thrust to weight ratios of 100 without boosting engine thrust levels beyond robust design limits.**
- ◆ **The engine will be reusable, with a useful life exceeding 100 missions between out-of-airframe maintenance actions.**



Peroxide Propulsion at the Turn of the Century

# Representative Engine Power Balance

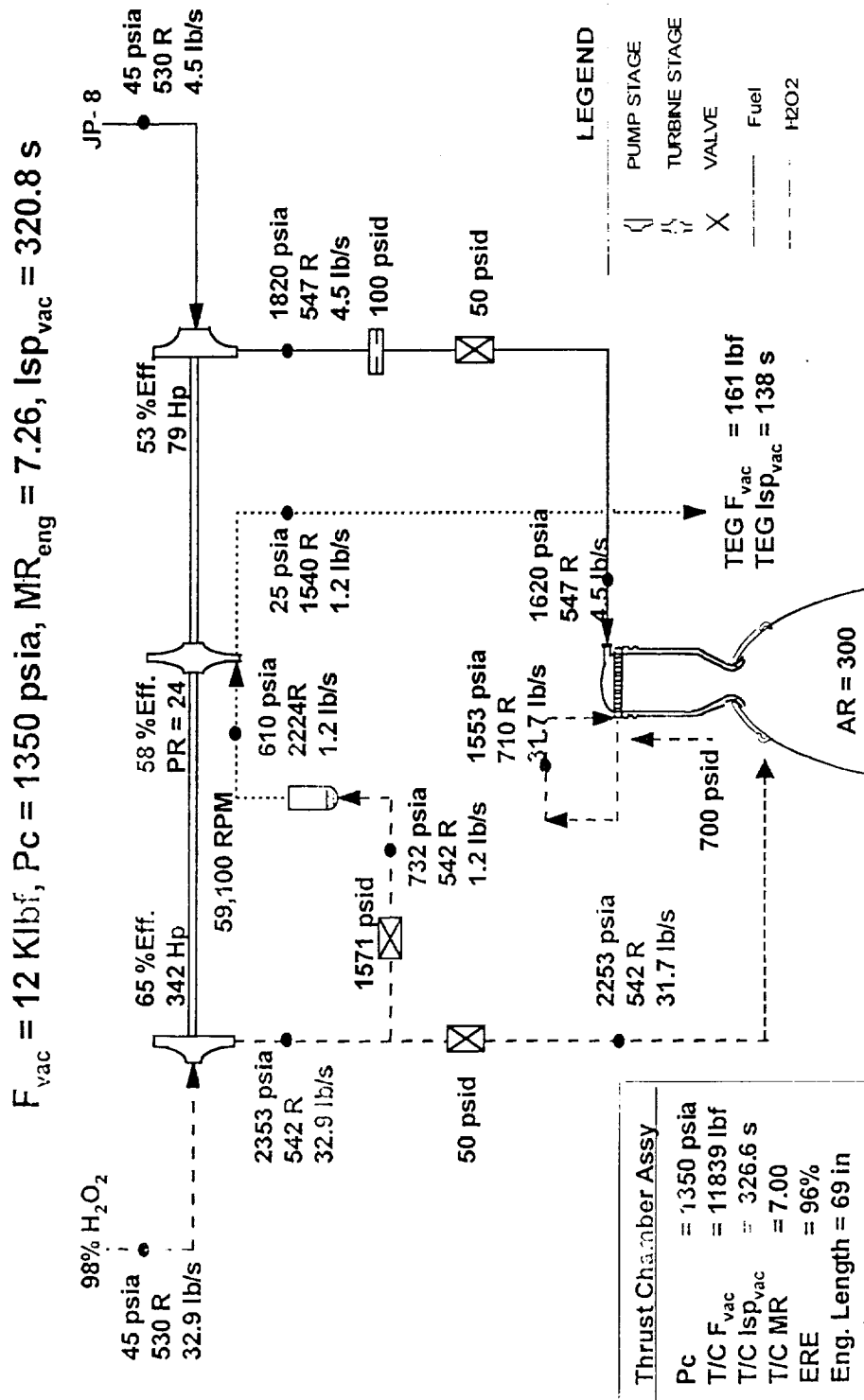

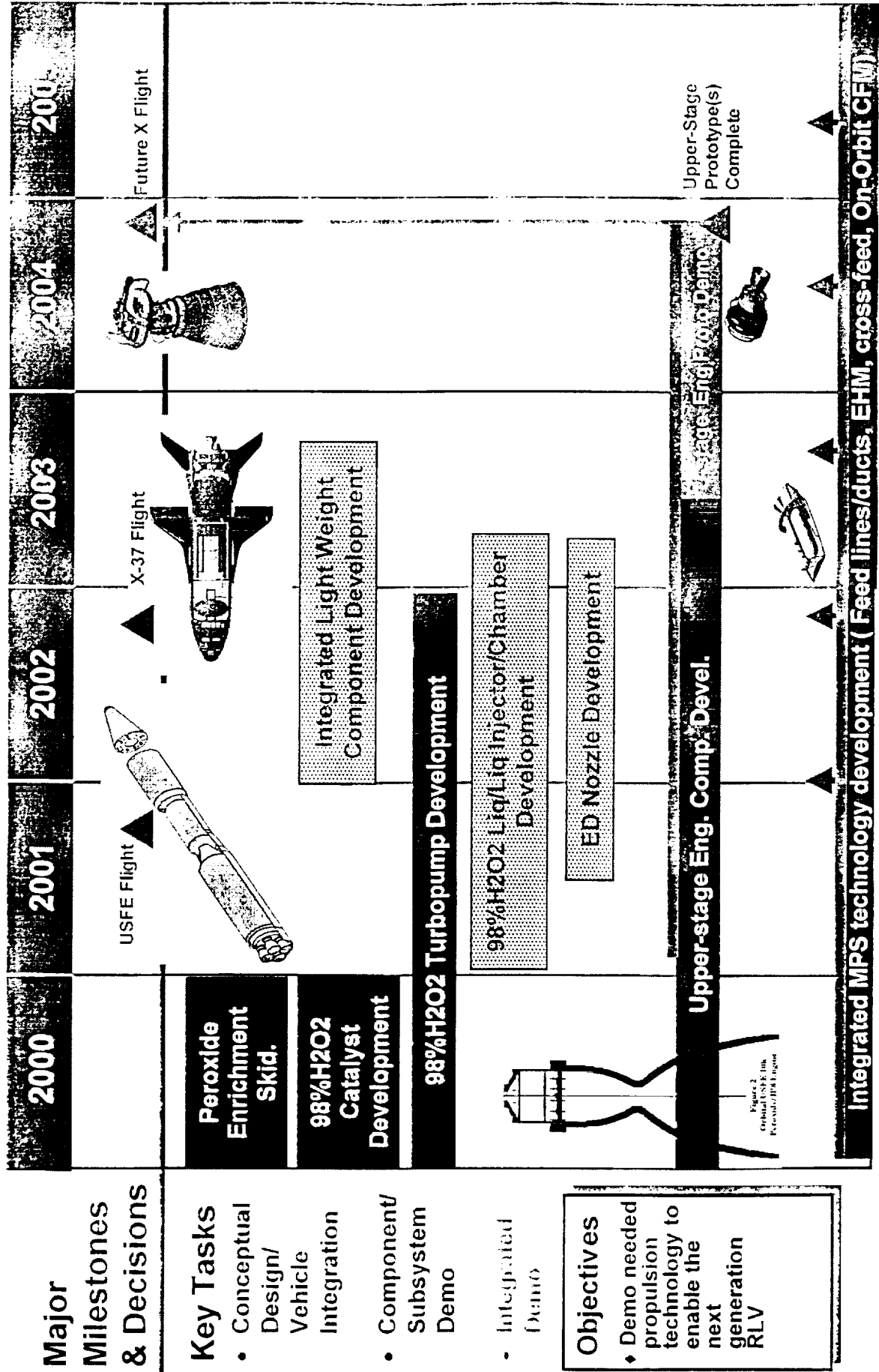

Figure 2  
Orbital USE Ink  
Perovskite/IR Engine





# Peroxide Enrichment Skid Ensures HCP Supply

Peroxide Propulsion at the Turn of the Century

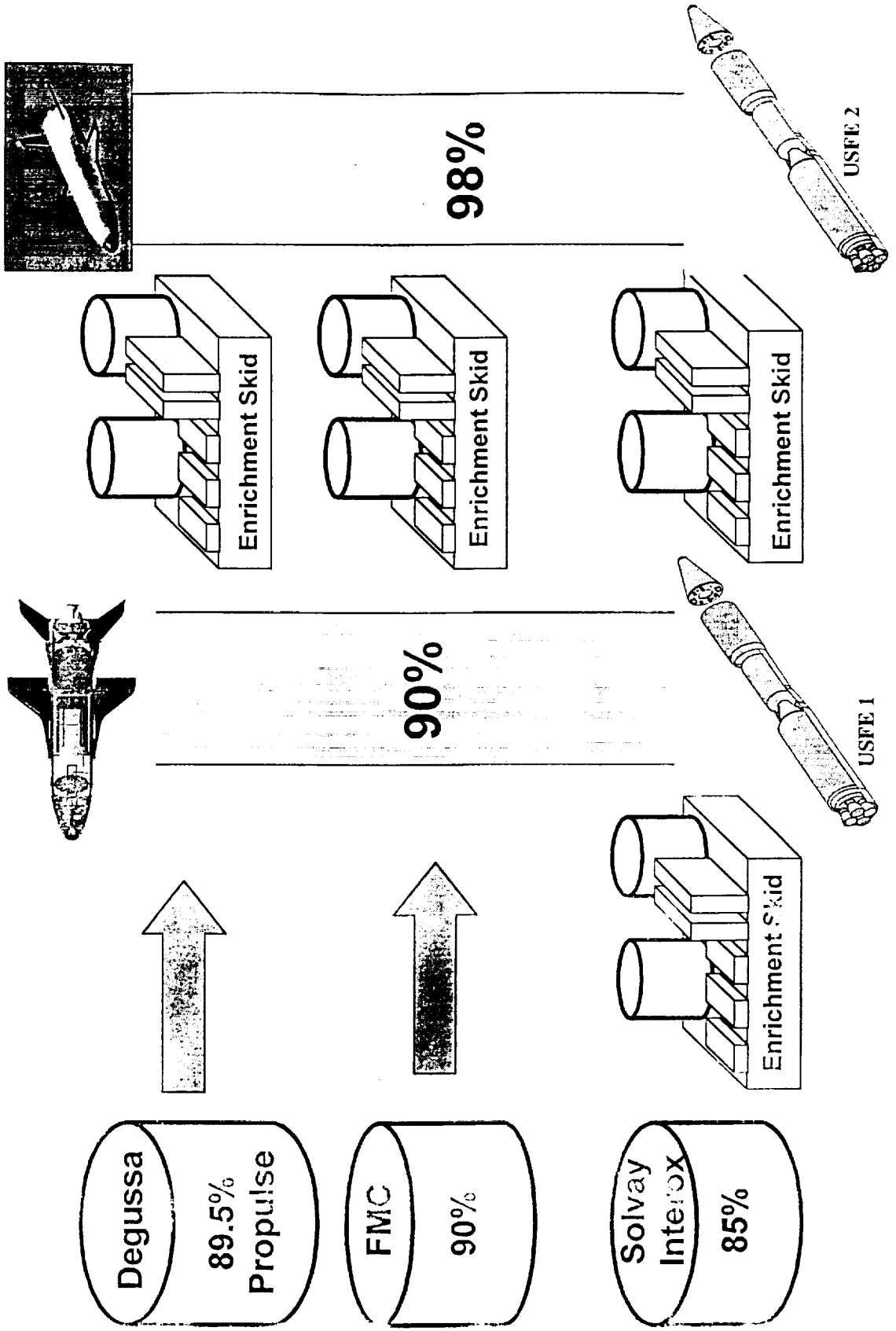



Peroxide Propulsion at the Turn of the Century

# Catalysts Are The Key

## NASA's Research Partners

GenCorp Aerojet

Boeing Rocketdyne

General Kinetics  
(TRW)

Purdue University  
(TRW)

TRW

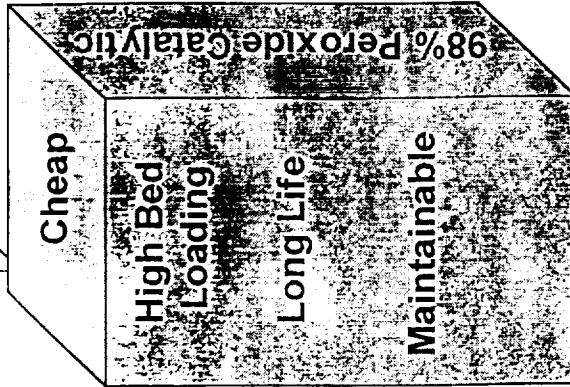
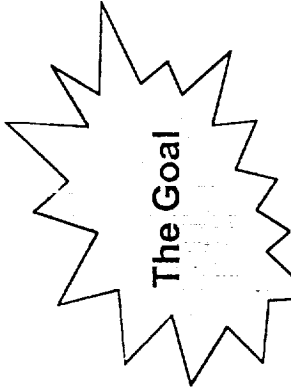

GG-Turbopump

GG-Turboalternator

GG-Ignitor

GG-Pressurization Systems

GG-Heat

GG-RCS Systems

GG-Water

GG-Oxygen generation



# Advanced Peroxide Turbopump

— Peroxide Propulsion at the Turn of the Century

