

# The DSLR Cinematography Guide

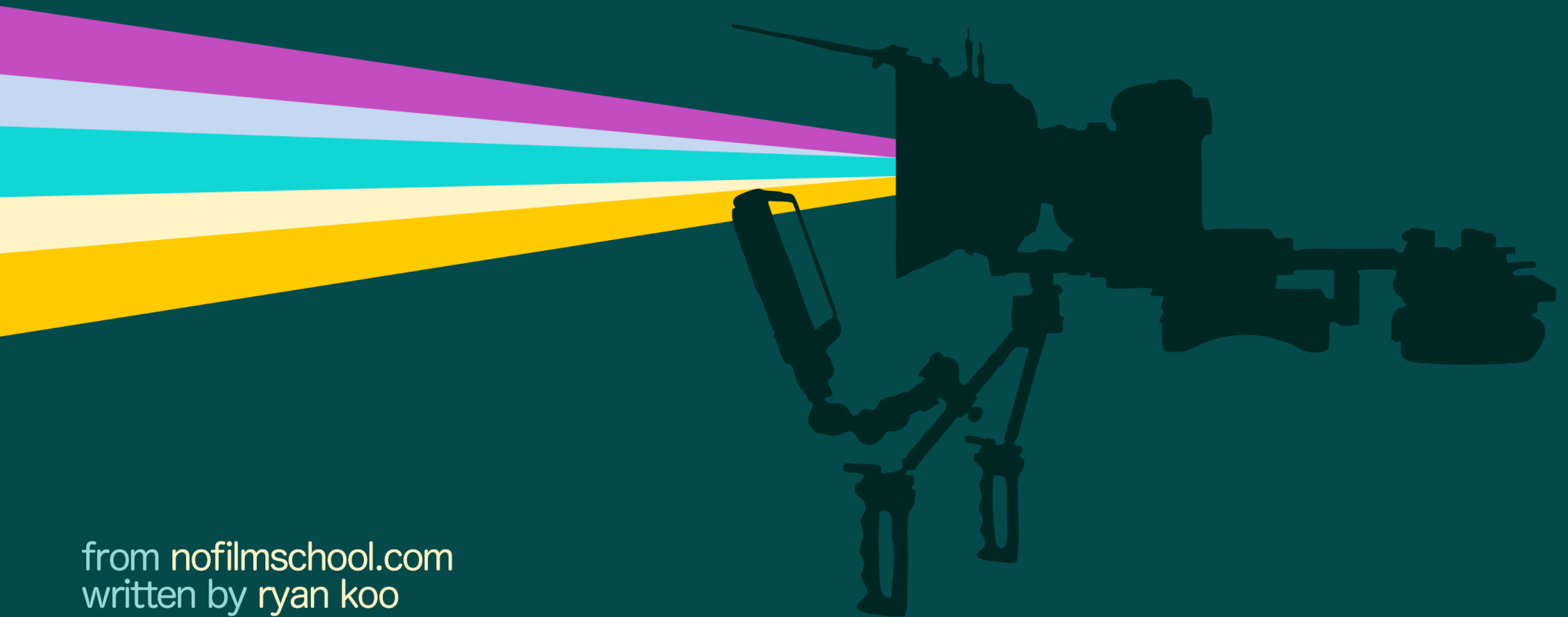

from [nofilmschool.com](http://nofilmschool.com)  
written by ryan koo

The latest version of this guide can always be found at  
<http://nofilmschool.com/dslr>

© 2010-2012 Ryan Koo

This document is licensed under Creative Commons, so the following freedoms apply. However, I would request you do not email this PDF to a friend; instead, please send them to <http://nofilmschool.com/dslr> where they can get their own copy of the guide for free. Thanks very much.

You are free:



**to Share** — to copy, distribute and transmit the work



**to Remix** — to adapt the work

Under the following conditions:



**Attribution** — You must attribute the work in the manner specified by the author or licensor (but not in any way that suggests that they endorse you or your use of the work).



**Noncommercial** — You may not use this work for commercial purposes.



**Share Alike** — If you alter, transform, or build upon this work, you may distribute the resulting work only under the same or similar license to this one.

You can find out more about this license at: <http://creativecommons.org/licenses/by-nc-sa/3.0/us/>

Most people would charge good money for this guide, but I'm giving it away free. In return, I ask that you please help support NoFilmSchool! You can do this via the following:

### Share the guide

If you have a blog or website, **please write a post telling others about NoFilmSchool** (and the DSLR Guide)! If you don't have a website, please share NoFilmSchool via Facebook, Twitter, or any other social network. Also, be **sure to friend us** on:

[Facebook](#)

[Twitter](#)

[Vimeo](#)

### Get your gear from the links in this guide

This guide includes a number of [affiliate links](#), which means I get a small percentage of anything you buy via those links. This percentage comes out of the store's cut, not yours — items won't cost you a penny more. In fact, if you want to support NoFilmSchool at no cost, one of the easiest ways to do so is to buy anything from either of the following stores (just click on the links below):



You can find out more about affiliate links — and more ways to support NoFilmSchool — by going to <http://nofilmschool.com/support>

On to the table of contents!

# TABLE OF CONTENTS

Chapter 01	Introduction .....	06
Chapter 02	Basic Cinematography Concepts .....	10
Chapter 03	Choosing A DSLR .....	22
Chapter 04	Saving Money .....	30
Chapter 05	Stuck Pixels .....	33
Chapter 06	Aliasing And Moiré .....	35
Chapter 07	Rolling Shutter .....	37
Chapter 08	Overheating .....	39
Chapter 09	Lenses: Using Primes, Choosing A Brand .....	41
Chapter 10	Lenses: Adapting, Purchasing .....	48
Chapter 11	Lenses: Focal Lengths, Depth Of Field .....	53
Chapter 12	Lenses: Renting, Converting .....	58
Chapter 13	Storage (For The Shoot) .....	62
Chapter 14	Support System .....	64

Chapter 15	Power .....	68
Chapter 16	Audio .....	71
Chapter 17	Magic Lantern Firmware .....	76
Chapter 18	GH1 Firmware .....	79
Chapter 19	Matte Box .....	81
Chapter 20	Filtration, Variable ND .....	83
Chapter 21	LCD Viewfinder .....	87
Chapter 22	Field Monitor .....	91
Chapter 23	Picture Style Editor .....	94
Chapter 24	Post-Production Overview .....	97
Chapter 25	Storage (For The Edit) .....	98
Chapter 26	Transferring, Viewing, Transcoding .....	101
Chapter 27	Audio Sync, Drift .....	104
Chapter 28	Noise Reduction .....	106
Chapter 29	Color Grading .....	109
Chapter 30	Thanks For Reading .....	111

# INTRODUCTION

Why are DSLRs so important?



That “movie mode” hidden in the menu system of your new DSLR? It’s not just a novelty feature. Together with the emergence of large CMOS imagers, HDSLRs are nothing short of a revolutionary, democratizing, disruptive moviemaking technology, as important as the invention of color film, 16mm, or HDTV. Not convinced? I’ve written more about how the DSLR is affecting the future of [not only cinematography but also photography](#), as well as how their low-light sensitivity [enables a whole new generation of international filmmakers to tell their story](#). However, the proof is in the pudding, so here are [ten examples of stunning DSLR cinematography](#). [Zacuto’s Great Camera Shootout 2010](#) is another great demonstration of what DSLRs are capable of when compared to (much more expensive) 35mm film cameras.

As for my own DSLR qualifications, I recently shot two episodes of the WBP Labs/ Babelgum show [RADAR](#) on a Nikon D90; [several behind-the-scenes videos](#) for Focus Features on a [Canon 5d Mark II](#); some other DSLR footage I can't yet talk about publicly; and I've lensed plenty of pre-DSLR projects (e.g. [The West Side](#), or [a music video I shot when I was 19](#)).

Digital cinematography is changing so rapidly these days that a printed book on the subject will likely be outdated by the time it reaches store shelves; this is especially true when it comes to the rapid release cycle of DSLRs. Up-to-date information can be found on online forums, but forums lack the organizing principles of a book, and as a result it

can take a ludicrously long time to piece together reliable information (I spent months forum-surfing to assemble my own camera package). Thus, this guide: I hope it saves readers money they would've otherwise spent on an out-of-date book, and I hope it saves forums from so many newbie — sorry, “n00b” — questions.

DSLRs (often called HDSLRs or VDSLRs now) are a great enabler on the “no film school” front, as they are priced to own and allow aspiring filmmakers to follow the “buy a



DSLRs are a great enabler on the “no film school” front.

camera and learn” lesson plan. But as with any creative tool, a DSLR is only as good as the person using it — because, while these cameras offer a world of advantages, they also come with a considerable set of drawbacks. However, these drawbacks are worth dealing with in order to get the kind of amazing images possible with an imaging sensor that has **twenty to thirty times more surface area** than that of a similarly priced, dedicated video camera. To emphasize: **these cameras are not designed to shoot movies**. Their primary function remains to shoot still photos, but **it just so happens that they shoot amazing video very inexpensively**, and for that they are worth tinkering with, hacking, and jumping through a number of hoops to use. And make no mistake: to modify these still cameras to behave like “real” movie cameras, there are a *lot* of hoops to jump through (thus the length of this guide), but you will be rewarded by using a camera that many of us could only dream of a few years ago, for cheaper than any of us imagined.



As with any creative tool, a DSLR is only as good as the person using it.

This guide assumes some basic knowledge of moving images, such as **exposure**, **shutter speed**, **focal length**, and **frame rate**. It focuses on the technical challenges unique to DSLR cinematography — it won’t teach you how to light scenes, stage camera movements, or cook a full English breakfast. It will, however, give you a huge jump start in figuring out how to make beautiful, inexpensive movies using a DSLR.

I can only take credit for a small percentage of the knowledge here. The vast majority of it comes from terrific user forums like **DV Info**, **Cinema5d**, **DVXuser**, **REDuser**, and **Creative COW**; news sites like **FreshDV** and **Pro Video Coalition**; and noted DSLR users like **Philip Bloom**, **Dan Chung**, **Vincent LaForet**, Jon Fairhurst, **Stu Maschwitz**, and **Shane Hurlbut** (not to mention firmware luminary **Tramm Hudson**). I’ve tried to credit and



link to others wherever possible, but ultimately **this is one person's opinion**. I've taken a lot of findings from the forums and aforementioned users, combined them with my own experiences, and distilled everything down into one time-saving guide. Plenty of people will disagree with some of what I say here, so please make the forums your first stop after reading this guide. Let me repeat: **if you have questions, take them to the forums** — you'll get a faster response and benefit from the wisdom of the crowd. Finally, take into account the crucial fact that **this guide is free!** It's saving a lot of people a lot of time, and it costs nothing, so with that in mind, please keep your comments and suggestions constructive.

The guide is organized in order of basic-to-advanced, meaning you can read it from start to finish if you're new to DSLR cinematography, or jump around using the table of contents if you're a seasoned vet. Without further ado, let's get started!

# BASIC CINEMATOGRAPHY CONCEPTS

What should I know about  
(digital) cinematography?



From reader emails, I realized that a basic introduction to some of the concepts referenced later in the guide might be helpful. Many of you are already familiar with these terms, so feel free to skip this chapter! However, if your background is in still photography or if you're new to digital imaging in general, this bonus chapter should help clarify some basic cinematography concepts that we'll be working with going forward. By no means is this an exhaustive glossary, but it is a good starting point. I'm going to explain things from a practical, crash-course standpoint rather than a scientific, 100% semantically-correct perspective, because I think it's handier to know *how* something works in practice than it is to know all of the details of *why* it works — if you're looking for knowledge of the latter, there are of course

thousands of good resources on the internet to bolster your knowledge. In alphabetical order, then, here are ten basic concepts you should be familiar with:

## 1. Aspect Ratios & Anamorphic Lenses

**Aspect Ratio** used to be a more prominent issue for digital cinematographers than it is today: before the advent of high-definition cameras, the standard 4:3 aspect ratio of standard-definition TV was generally seen as undesirable for anyone looking for a “cinematic” look, because 4:3 (or 1.33:1) content was associated with broadcast TV, while widescreen compositions were what people expected to see in the theater. When we say “4:3,” we mean the image is four units wide and three units high. When we say “1.33:1,” we mean... well, you get it — the same thing. Many times the “:1” is removed because it is implied — shooters will simply say “1.85” instead of “1.85:1.”

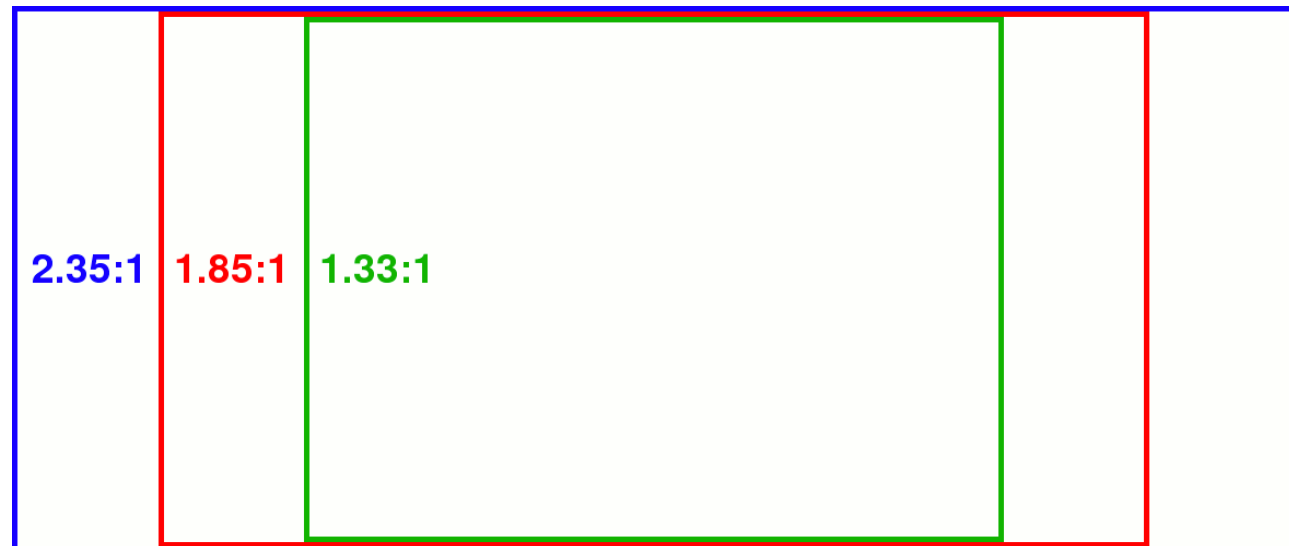

HDTV today is widescreen by default, with a 16:9 aspect ratio that works out to be 1.78:1 — very similar to the traditional 1.85:1 aspect ratio of many feature films. Other than these two virtually-indistinguishable aspect ratios, the most common widescreen aspect is the CinemaScope ratio of 2.35:1, which appears most often in the multiplex in big-budget films.

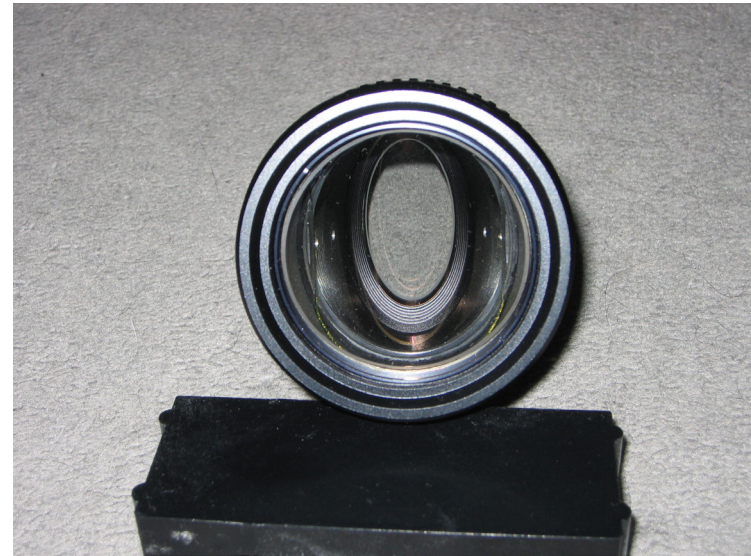

2.35:1 films are typically shot with anamorphic cine lenses. **Anamorphic lenses** are not spherical in the sense that they squeeze an image to fill the negative or sensor, with an additional step necessary during projection to re-stretch the image to the intended size. The odd-looking image here of a lens with an oval aperture demonstrates the non-spherical nature of an anamorphic lens (the aperture is perfectly round, but the lens is distorting our view of it). While it is possible to attach an anamorphic lens to a DSLR, most of us will simply shoot at the native widescreen aspect ratio of 16:9.

## 2. Bokeh

**Bokeh** (pronounced like “bo” from “boat” and “ke” from “Kentucky”) is one of the chief reasons many shooters have switched to DSLRs. Bokeh is a term derived from

the Japanese word “bokeh” which, roughly translated, means “blur quality.” Bokeh refers to the portions of an image that are defocused or blurry. In the filmmaker’s toolkit, bokeh is not only an aesthetically pleasing quality, but it also allows the filmmaker to focus the viewer’s eye on an object or area of interest in the frame. Bokeh is a function of shallow depth-of-field (see below).



Lossy codecs are the reason we can record hours of footage to inexpensive flash memory devices like CF and SD cards.

### 3. Compression & Bit Rate

**Compression** refers to a method for reducing the amount of data a DSLR produces; in the case of video-shooting DSLRs, all cameras currently employ some method of compression. If you’re used to shooting photos in **JPEG** format, you’re used to capturing compressed images; while RAW can also employ compression, it is generally thought of as “uncompressed.” This is because, as far as shooters are concerned, when we’re talking about compression we’re talking about lossy compression — meaning, a codec (compression algorithm) that throws out data in order to reduce file size. As you can imagine, tossing portions of an image has negative side effects, and while many codecs



DSLRs exploded in popularity almost singlehandedly because of their ability to render images with a shallow depth of field.

deal with images perceptually in order to minimize their perceived impact, the difference is there. For example, if you upload a video to YouTube, the service re-compresses your video in order to optimize it for internet delivery; you might not notice this compression, but check out this [video that's been recompressed a thousand times](#) and you can see that every compression step throws out data along the way. On the positive side, however, lossy codecs are also the reason we can record hours of footage to inexpensive flash memory devices like CF and SD cards.

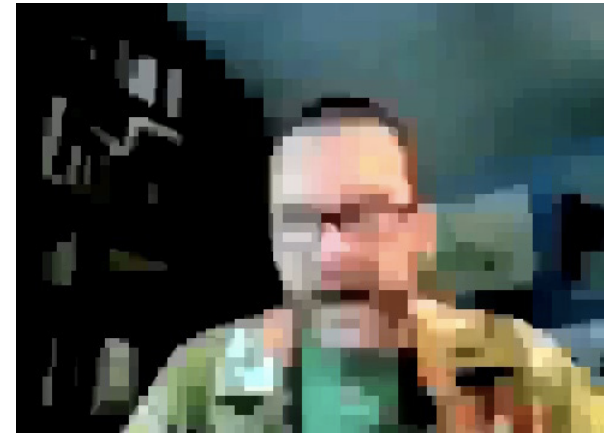

The most common compression formats in DSLRs are [h.264](#) and [MJPEG](#), and while both are lossy, h.264 is generally much more efficient (it introduces less artifacts at the same bit rate as MJPEG). **Bit rate** is the amount of data per time that a given codec adheres to; higher bit rates are almost always better because they use less compression. At press time there are no DSLRs that shoot uncompressed video.

## 4. Depth of Field

The amount to which objects in the foreground, mid-ground and background are all in focus at once is a function of **depth of field**. A shallow depth of field would mean that only one plane was in focus; a wide (or deep) depth of field would mean that all planes are in focus at once. Depth of field is determined by the focal distance and

aperture size (see below for more on Aperture). DSLRs exploded in popularity almost singlehandedly because of their ability to render images with a shallow depth of field. This is chiefly due to their massive sensor sizes (see the next chapter, “Choosing a DSLR,” for an examination of sensor sizes), which are exponentially larger than

previous video cameras. On a basic level, shallow depth of field (DOF) allows filmmakers to blur out areas of the image they deem to be unimportant or undesired.



## 5. Exposure & Aperture

**Exposure** refers to the amount of light allowed to enter the DSLR sensor (or any imaging surface). When shooting stills, DSLRs use a mechanical shutter to regulate exposure by opening for the desired amount of time (1/60th or 1/1000th of a second, for example) and then closing. DSLRs are generally rated to last for hundreds of thousands of shutter cycles, but at 24 frames per second, couldn't your DSLR reach that limit very quickly? No, because in video mode, DSLRs use an electronic shutter — the sensor basically turns on and off to regulate exposure, instead of relying on a physical barrier (i.e., the mechanical shutter) to regulate light. **Aperture** refers to the adjustable opening near the rear of

In video mode, DSLRs use an electronic shutter.

the lens that lets light through — the amount of light it transmits is generally referred to as the **F-stop** (T-stop is very similar, except it's *measured* instead of *calculated*).

We'll go more into depth on aperture in the "Lenses" section of the guide, but keep in mind that the size of the aperture does not only affect the *amount* of light, but also the angle of light rays hitting the sensor — a narrow aperture creates an image with a wide depth of field, whereas a large aperture creates an image with a shallower depth of field.

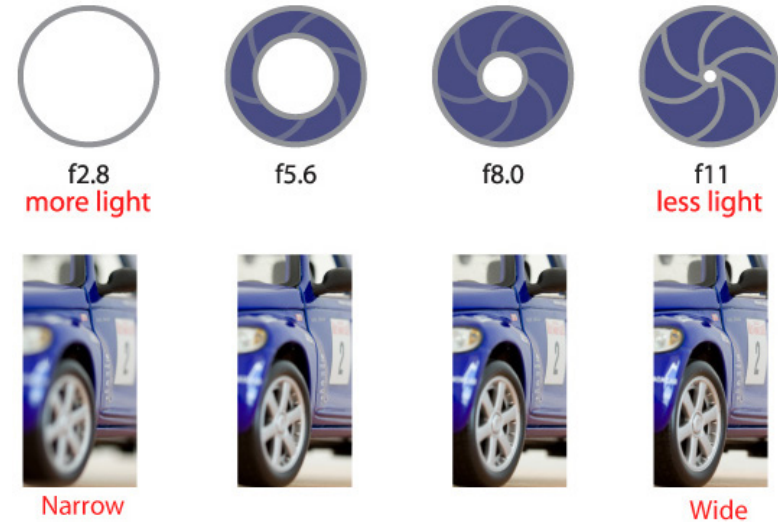

A narrow aperture creates an image with a wide depth of field, whereas a large aperture creates an image with a shallower depth of field.

## 6. Focal Length

Technically, **focal length** refers to the distance over which collimated rays are brought into focus. An easier way to think of it: focal length refers to image magnification. A longer focal length, e.g. 100mm, makes distant objects appear larger, whereas those same objects will appear smaller with a shorter focal length, e.g. 35mm. Focal length also refers to angle of view; longer focal lengths have a narrower angle of view, whereas shorter focal lengths have a broader angle of view. When it comes to focal length, a picture is worth a thousand words, so here are images taken with the camera in the same place, but with lenses of different focal lengths attached:





28mm



50mm



70mm



210mm



Being able to shoot in 24p is essential if you're planning on shooting narrative material.

## 7. Frame Rate

**Frame rate** is the frequency with which your DSLR captures consecutive images. This typically corresponds to the number right before a "P" in the case of progressive images,

so that 24p is 24 frames per second, 30p is 30 frames per second, and 60p is 6,000,000 frames per second. Just kidding. Different frame rates have very different motion rendering characteristics, which, combined with different shutter speeds, produce images that behave very differently. Motion pictures have had a standard frame rate of 24 frames per second since the 1920s, and audiences have come to associate this frame rate with cinematic content, so being able to shoot in 24p is essential if you're planning on shooting narrative material. However, you don't always have to shoot at the same frame rate at which you're planning on distributing your material. For example, if your DSLR can shoot 60p, this is a very effective way of acquiring slow-motion footage — anything shot at 60p can be played back at 40% speed in a 24p timeline for a flawless slow-motion effect, and can generally be slowed down further in your editing system.

## 8. ISO & Noise

ISO is actually the International Organization for Standardization, which is why you see it used in lots of places beyond photography — many businesses are certified [ISO:9001](#), for example. As cinematographers we're concerned with just one "standardization," however — the one that pertains to *measurement of noise in photography*. ISO as it relates to digital photography is based on analog standards of film speed — while we won't be shooting a frame of actual film with our DSLRs, our cameras are calibrated so that an ISO of 400 on our camera is somewhat equivalent to a film SLR's ISO 400. ISO is a logarithmic measurement, so ISO 400 is twice as sensitive to light as ISO 200, ISO 200 is twice as sensitive as ISO 100, and so on and so forth.

The relationships between sensitivity and **noise** is basically linear, however, so the



ISO is a logarithmic measurement, so ISO 800 is twice as sensitive to light as ISO 400, ISO 400 is twice as sensitive as ISO 200, and so on and so forth.

higher the ISO, the brighter the image — and the more noise contained in the image. However, thanks to sophisticated noise reduction and other processing tricks, DSLRs have managed to dramatically reduce noise at higher ISOs, and can often blow film stock out of the water (this depends on which camera you're shooting with, which we'll cover in the next chapter).

## 9. Progressive vs. Interlaced

**Interlacing** was a workaround invented for older-tech CRT monitors in the 1930s that has lived far too long. In the early days, video bandwidth was more limited than today, and so engineers found a way to divide a frame into two images and display it using alternating fields. As you can see in this image of a tire wheel, interlacing can cause motion artifacts (as well as a host of other problems). We're lucky to live in a predominantly progressive society today — in the imaging sense if not the political. **Progressive scanning** is a method that captures and displays the lines of an image in sequence, which is akin to motion picture film with regards to motion rendering. Compared to interlaced images, progressive images have a higher vertical resolution, lower incidence of artifacts, and scale better (both spatially and temporally). Friends don't let friends shoot interlaced! Luckily, while there are plenty of video cameras that shoot interlaced footage, every DSLR I can think of shoots progressive footage.



Interlacing can cause motion artifacts as well as a host of other problems.

## 10. Shutter Speed

**Shutter speed** refers to the length of time an image is exposed. For film SLRs, this would be measured by the amount of time the camera's mechanical shutter is open, but for shooting video on DSLRs, this is simulated electronically. Shutter speed affects the amount of light that reaches the camera and also affects the motion rendering of the moving

Shutter speed affects the amount of light that reaches the camera and also affects the motion rendering of the moving image.

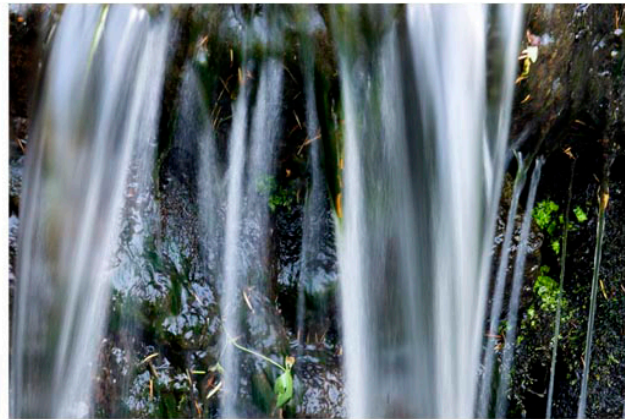

1/2

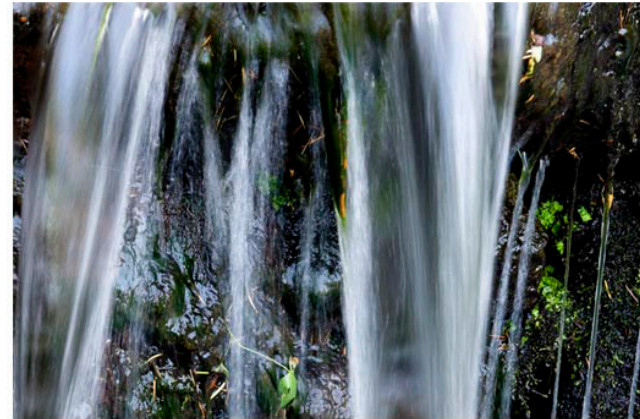

1/5

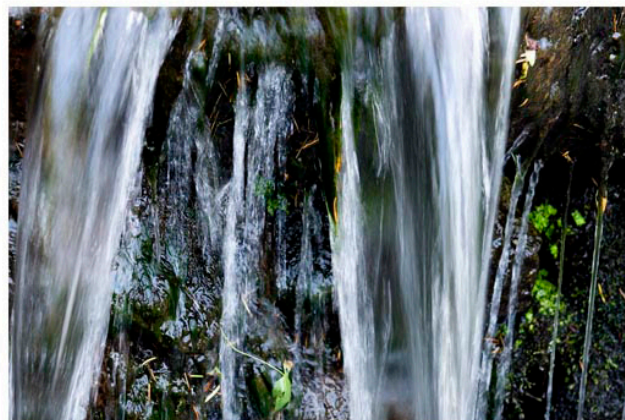

1/20

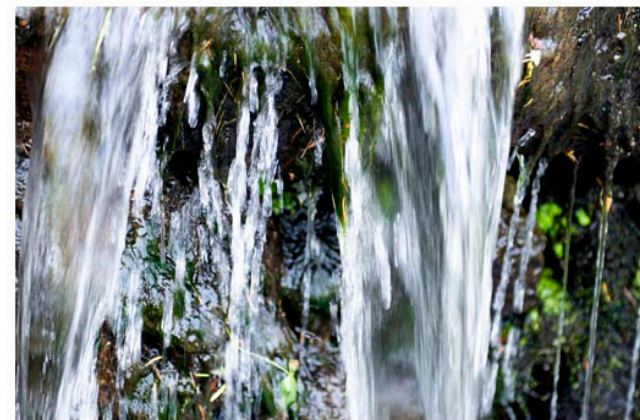

1/60

image. Lower shutter speeds yield a brighter and smoother image (up to and including water and light blurring tricks), whereas higher shutter speeds result in a darker and more stroboscopic image.

Motion picture film cameras typically shoot with a 180-degree shutter, which means that the shutter is open 50% of the time (180 out of 360 degrees). This means the amount of time your shutter is open is half of the shooting frame rate; thus, at 24 frames per second, a 180-degree shutter is best emulated on a DSLR by choosing a shutter speed of 1/48. This may not be possible depending on your DSLR, so the closest reading will do — 1/50 or 1/60, for example. This gives the most “filmic” rendering of motion, but can be varied greatly depending on your intention. Higher shutter speeds create “jerkier” images, as most famously seen in action films like [Saving Private Ryan](#) and [Gladiator](#). Conversely, lower shutter speeds create “smoother” images due to increased motion blur. There is no hard and fast rule when it comes to shutter speed, but if you’re not sure of what shutter speed to select, go with the setting that’s closest to half that of your current frame rate.

Okay! That was much longer chapter than I anticipated, despite blitzing through these concepts as quickly as possible. If you don’t understand something, don’t worry – you’ll figure it out as you go. Now let’s get started with DSLRs by checking out some cameras.

# CHOOSING A DSLR

Which camera is right for me?



This guide focuses on Canon’s EOS series of DSLRs ([1D Mark IV](#), [5D Mark II](#), [7D](#), [60D](#), [Rebel T1i](#), [Rebel T2i](#)), but also pertains to Nikon’s cameras ([D3100](#), [D90](#), [D300s](#), [D3s](#)), as well as other video-capable DSLRs like the [Panasonic Lumix GH1](#), [Pentax K-7 HD](#), and Sony’s [A55](#), [A33](#), and [NEX series](#). This chapter in particular is out-of-date, so check out the [top-selling DSLRs](#) list to find out what’s current. If you’re wondering why some DSLRs shoot video and others don’t — or why none of them did a couple years ago — check out [Gizmodo’s article](#). At this point in time I believe the Canon DSLRs offer the best quality and flexibility for filmmakers, due in part to their superior [h.264](#)-based codec (which is of higher quality than the [MJPEG](#) codecs of Nikon and the lower-bitrate [AVCHD](#) codec of Panasonic’s offering). However there are several top DSLRs contending for your hard-earned dollars (not all Canons); each camera has its

particular strengths and weaknesses, which should help you decide which DSLR is right for your particular needs.

The main thing to understand while reading the following comparison is how DSLR sensor size affects the images the camera produces. Larger sensors aren't *always* better, but for our purposes it's easiest to think of larger sensors as capturing images that have a shallower **depth of field**, greater **dynamic range**, and better **low-light sensitivity**. Here is a chart of DSLR sensor size: <sup>1</sup>

As you can see in the chart, Canon and Nikon's implementation of APS-C is *slightly* different, but not enough to make a practical difference. For comparison's sake, I've included the \$9,000 **Sony EX-3** professional video camera in the chart — you can see how much larger all of these DSLR sensors are, which is the chief reason why DSLRs are such a disruptive technology. With this in mind, let's take a look at the top DSLRs for filmmaking:

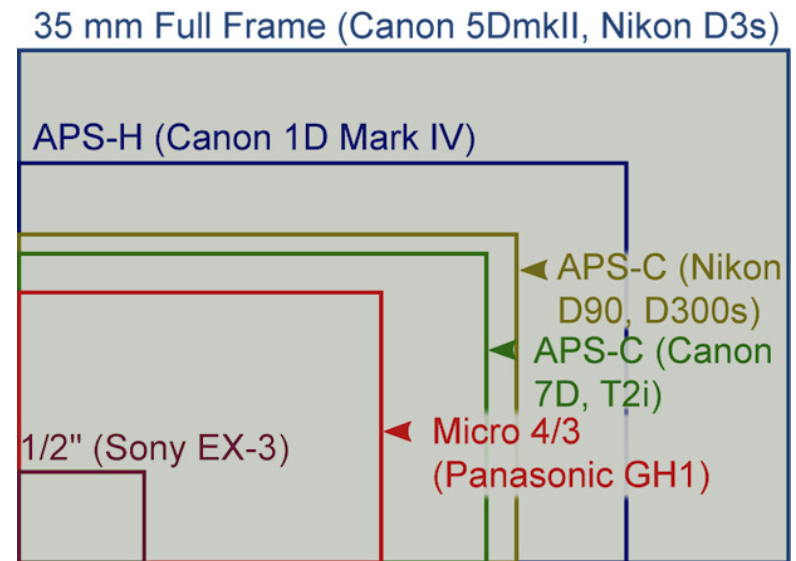

<sup>1</sup> Sensor size illustration modified from a Wikipedia image by Moxfyre and Autopilot.

## Canon 5D Mark II



**Strengths:** In my opinion, thanks to its full frame sensor the 5D produces the smoothest, most beautiful images of them all (this should be written out four times because this factor far outweighs the others... ) Also due to the sensor size, the 5D is the friendliest of the Canon DSLRs for using old SLR lenses (you don't have to deal with crop factors). Thanks to a firmware update, shoots at 1080p/24p as well as 30p. Also has manual 48KHz audio. Good build quality. Shoots terrific stills.



One important issue regarding your DSLR choice that you won't find in a manual or spec sheet is the camera's hackability.

**Weaknesses:** HDMI output drops to 480p the moment you hit record; this is terrible for using [field monitors](#) (not so much an issue if you're planning on using a LCD viewfinder). Footage starts to get noisy from heat without the camera telling you it's overheating. Full frame sensor can be an issue if you want to adapt cine lenses, which don't cover the almost [VistaVision](#)-sized sensor. No 50p or 60p which means you can't get great slow-motion footage from the camera. Full frame sensor means your depth of field is so shallow that it can be difficult to pull focus.

## Canon T2i (a.k.a 550D)

**Strengths:** A great deal — it's basically the same camera as the 7D (see below) for less





than half the price. Cinema-sized APS-C sensor size with lots of recording options: at 1080p, 24p/25p/30p; at 720p, 50p/60p (great for slow-mo work). Terrific LCD screen. Did I mention the T2i is a great deal? IMO it can't be beat as a "first DSLR."

**Weaknesses:** Not much weather coating, and not as good at shooting stills as some of the others (slower continuous shooting speed, no top LCD). HDMI-out drops to 480p during recording. Overheats easily. No manual audio control and no manual white balancing.

## Canon 7D



**Strengths:** Offers some advantages over its cheaper cousin T2i, chiefly that its HDMI-out stays at 1080i during recording. If you're planning on using a field monitor, this is huge. The 7D is also crazily weatherproofed — video camera users will not be used to being able to leave a camera recording in rain and snow, but the 7D can handle adverse conditions with aplomb; something to keep in mind if you're shooting in extreme conditions. Same sensor size and flexible video recording options as the T2i.

**Weaknesses:** More expensive than the [T2i](#) without offering a ton of upgraded features – it’s still priced very aggressively, and its price wouldn’t be considered a “weakness” if it weren’t for the cheapness of the T2i. Overheats easily. No manual audio control.

## Canon 1D Mark IV



**Strengths:** Canon engineers applied some magic to the sensor and got some extra low-light performance out of the sensor (most famously demonstrated by [Nocturne](#)). APS-H sensor size splits the difference between Full Frame and APS-C, which can offer some interesting advantages (zoom lenses get a bit more reach and your lens kit effectively doubles if you’re pairing the [1D](#) with a different camera because primes attain a different focal length on the 1D). Beefier batteries, beefier build quality.

**Weaknesses:** APS-H sensor splits the difference between Full Frame and APS-C, which can offer some interesting disadvantages (good luck finding good wide-angle lenses). No manual audio. More than twice as expensive as the [5D Mark II](#), yet has a smaller sensor.

## Nikon D3s

**Strengths:** Full frame sensor just like the [5DmkII](#); the best low-light performer of them



all thanks to A) the size of the sensor, B) larger pixels on the same size sensor (the D3s is 12MP instead of 21MP), and C) better noise reduction. If you've got a lot of Nikon lenses, you don't need to mess with adapters. Probably the best camera in this roundup for taking still photos.

**Weaknesses:** Maxes out at 720p! Crappy recording codec. 5-minute clip limit (Canons max out at 12 minute takes). Nikon engineers are still significantly behind Canon engineers when it comes to video and so the \$5k Nikon DSLR trails the \$800 Canon when it comes to resolution, codec, and frame rate options. No manual audio control.

## Panasonic GH1



**Strengths:** Inexpensive. Offers 1080p at 24p and 720p at 60p (for North America; 25p and 50p for PAL countries). Articulating LCD screen and actually viable auto focus give shooters greater flexibility than the other DSLRs here. The GH1 also doesn't line-skip like the Canons do which reduces or eliminates **aliasing** problems. I didn't consider the GH1 to be a particularly viable camera for filmmaking because of its codec, until it was significantly upgraded thanks to a brilliant **hacked firmware** that allows the codec bitrate to be raised from 17Mbit

to 50Mbit. For more on this firmware, see the chapter “GH1 Firmware.” At such a high datarate the efficiency of the codec is much less of an issue; this singlehandedly transforms the GH1 into a viable moviemaking tool. DVXUser has some [GH1/5D comparisons](#), from which users seem to favor the GH1’s image.

**Weaknesses:** Low-bitrate codec is crippling if you’re not into the idea of installing unsupported hacked firmware on your \$1k equipment. Not great in low light no matter what you do to the firmware. [Micro 4/3 sensor](#) won’t give you as shallow a DOF as the rest of the cameras here. No manual audio options.

To summarize, I still like the [Canon 5D Mark II](#) as an all-around great DSLR (for both movies and stills) despite its quirks; once Canon added 24p and manual 48KHz audio via firmware update, the 5D became a much more viable tool for shooting, say, feature films. On the lower end the [T2i](#) is so much camera for the money that I can’t see a downside to owning one (even as a B cam to, say, a [5D](#)). As the [GH1](#)’s hacked firmware matures, it will be interesting to see if it catches up to the Canons.

One could write an entire guide on choosing a DSLR, but that is a never-ending and ever-changing debate that I can’t resolve for anyone; each shooter’s DSLR choice comes down to availability, price point, and their own particular needs. Take into account the strengths and weaknesses mentioned above and also check out the forums for further info! Also, when budgeting for a camera package, assume the camera itself is going to make up a third (or less) of your overall expenses. This is just a rough rule of thumb, but if you have \$8k to spend, don’t target a camera that costs \$5k; consider a \$2-3k camera body and then budget for lenses, tripod, audio equipment, etc. and see where you end



When budgeting for a camera package, assume the camera itself is going to make up a third (or less) of your overall expenses.

up. While DSLRs are capable of capturing great moving images, they are by no means optimal for movie making in terms of features or ergonomics; thus a plethora of add-ons are necessary to make a DSLR behave like a “legitimate” movie camera. Unfortunately, much of the add-on market is targeted at accessorizing cameras that cost several times as much as a DSLR; when your camera costs \$300k, it makes sense to spend \$5k on a matte box; when your camera itself cost \$3k, it’s a bit harder to justify. This guide focuses on finding quality equipment on a reasonable budget.

# SAVING MONEY

How can I get the best deal on a DSLR?



Buying a gray market camera means you're ineligible for warranty coverage in the US.

**Once you've decided on a model, buy it from an authorized dealer.** If you're in the US, confirm on the manufacturer's website that the dealer is authorized (here are the dealer search pages for each manufacturer: [Canon](#), [Nikon](#), [Panasonic](#)). I recommend [B&H Photo](#), for two reasons: 1) I believe they have the best combination of price, selection, and service; and 2) I am a B&H partner, which means any items purchased through B&H links help support NoFilmSchool. It doesn't cost you anything to do so — B&H simply gives me a small percentage of their sale. Feel free to shop around, but digital cameras in particular are notorious for being sold through unauthorized channels, and while you'll see a number of seemingly great deals, many of these are [gray market](#) — they are new, sealed, genuine

products, but they're being imported directly from Taiwan or Hong Kong and are therefore bypassing the US division of the camera manufacturer. This is a sizable investment on your part and though the listing for "HUGE KIT!!! Camera, 7 lenses, 3 tripods, 48 batteries, and maid service" may be appealing — it's probably cheaper than the camera alone from an authorized dealer — buying a gray market camera means you're ineligible for warranty coverage in the US, which is not something to skip, especially if you plan on putting your camera to professional use.



If you know exactly what you want, however, you can often find the best deals by keeping an eye on eBay.

However, if you want to search [eBay](#) for deals on DSLRs, I've got a great way of doing so for USA-based shooters. To ensure we find reputable sellers, I've set up advanced eBay searches using Boolean logic in an attempt to eliminate gray market sellers. These links should only display USA-based authorized dealers (see below for a way to double-check). I've also eliminated used cameras and bid-only auctions, since authorized dealers generally sell new cameras as "Buy it Now." Here are the DSLRs for which I've set up customized searches, use whichever link corresponds to the camera you're interested in:

- [Canon EOS 5D Mark II](#)
- [Canon Rebel T2i](#)
- [Canon EOS 7D](#)

- [Canon EOS 1D Mark IV](#)
- [Nikon D3s](#)
- [Panasonic GH1](#)

I've arranged the search results by price (lowest to highest), but you'll want to scan the different listings to find the best deal (some will come with lenses, some will be body-only, and others will come in larger packages with multiple bundled items). Also make sure to note the shipping fee — some are non-existent and some are exorbitant. Once you've found your item, be sure to search the item's listing page for "USA Warranty," "Authorized Dealer," or something similar that affirms the seller is authorized to sell the particular brand of DSLR you're buying. I tried to customize the search as much as possible, but it's by no means infallible, so make sure they state somewhere in their listing that they're authorized.



Good used equipment is always better than cheap new equipment.

Finally, by buying used accessories on eBay, you can save hundreds; the end result is either significant money saved or more equipment purchased. A final tip: if you think you might freelance and charge an equipment fee, keep in mind your producer won't know if you bought your equipment used; good used equipment is always better than cheap new equipment.



# STUCK PIXELS

What are these tiny, persistent dots on my image?

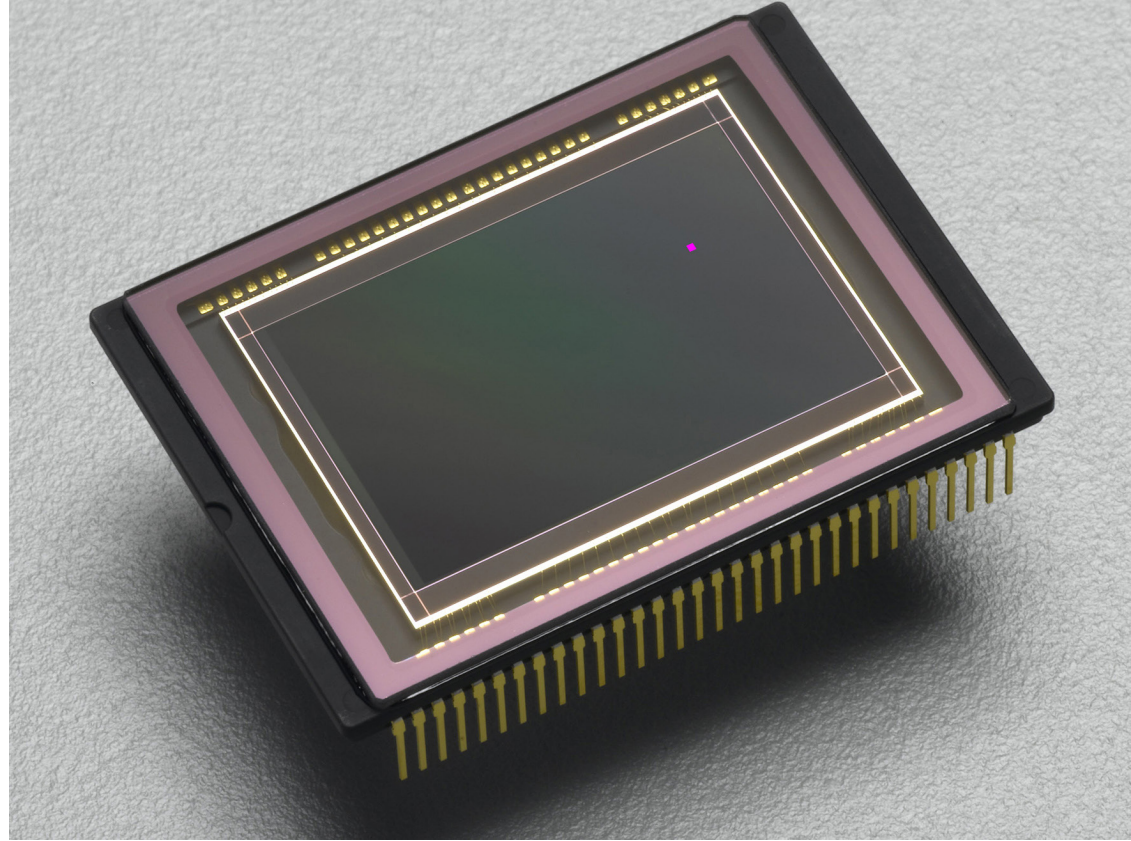

You will almost certainly get a camera that ships with a few hot pixels.

Another reason to buy your camera from an authorized dealer is the all-too-common issue of [stuck pixels](#) (also known as “hot” or “dead” pixels; see the purple dot on the next page for an example). With the extremely high pixel-count CMOS sensors (and massive sensor sizes) of current DSLRs, you will almost certainly get a camera that ships with a few hot pixels; video camera users accustomed to [CCD](#)-based imagers may not be ready for this. For pro DSLRs that ship with 20 million pixels, several stuck pixels are well within a manufacturer’s tolerated specs, and pro photo applications like [Lightroom](#) or [Aperture](#) often detect and fix stuck pixels automatically when you import still photos. However, there is no such fix for video, and while one stuck pixel out of 20 million unmoving pixels isn’t very noticeable on a still photo, one

stuck pixel out of two million moving pixels is often *very* noticeable (DSLRs record video in a reduced-resolution mode; 1080p is just shy of 2 million pixels). It's not entirely necessary to test for stuck pixels in still mode with your new camera — you'll drive yourself crazy thinking about your "defective" camera (if you really want to geek out, though, they have [programs](#) you can use to run tests).



The hot pixel issue alone is a good reason to buy from an authorized dealer with a decent return policy.

However, you *should* absolutely enter a low-light setting, crank up the ISO, and pan across a plain wall in movie mode to see if you have any persistent dots. My first 5D had 16 stuck pixels in still mode and 1 on video, so I exchanged it (my second fared better, with 7 stuck/hot pixels in still mode, but again a sole offender in video mode, for which I'm planning on having it serviced). The hot pixel issue alone is a good reason to buy from an authorized dealer with a decent return policy, as every DSLR is like a box of chocolates. Except these days a box of chocolates is not, in fact, like a box of chocolates: there are pictures on the outside of the box and you usually know exactly what you're going to get.

If you don't detect a dead pixel until you've already shot your footage, all is not lost. I wrote a post on the very subject of removing dead pixels using Final Cut, After Effects, or Vegas: [How to remove stuck pixels from video footage](#).

# ALIASING AND MOIRÉ

Why do jagged horizontal lines sometimes show up?



Another issue to be aware of before diving headfirst into the DSLR world is the problem of aliasing (moire is an offshoot of the same problem). Aliasing is a problem with DSLRs because the cameras were designed primarily to shoot still photos at much higher resolution than their video mode allows. So, in order to drop from 5616 x 3744 in still mode to 1920 x 1080 in video mode, the camera skips lines. Ideally the camera would sample all of the pixels and average them out, giving you a smooth image (think about resizing an image in Photoshop and choosing Bilinear or Bicubic); instead, because DSLRs lack the processing power required to do this in real time, they just toss every other line or so (think about resizing an image in Photoshop and choosing “Nearest Neighbor”). What you’re left with are unseemly jaggies.



The first thing you should do when switching your DSLR from still to movie mode is to make sure the Sharpness setting is turned all the way down.

The end result is most commonly seen on thin lines and patterns, and ranges from overt to invisible. For an example, watch the gray rooftop here:



*This video can be watched on the online version of this chapter, at: <http://nofilmschool.com/dslr/aliasing-and-moire/>*

The first thing you should do when switching your DSLR from still to movie mode is to **make sure the Sharpness setting is turned all the way down**. This won't come close to eliminating aliasing under all conditions but it should reduce your camera's problems. As the chips inside these cameras get more powerful, we might see a HDSLR that does some in-camera image sampling; but to eliminate aliasing problems, the best solution might be to actually lower the camera's resolution (this is one of the advantages of a 5-megapixel RED camera over a 21-megapixel DSLR).

For more on the technical reasons behind aliasing and moire, see [Barry Green's post at DVXuser](#) and [Stu Maschwitz's follow-up](#) (I commented on both as well).

# ROLLING SHUTTER

Why does the image appear unstable?



**Rolling shutter**, known informally as jello cam, is another drawback inherent to large CMOS sensors. Yes, CMOS technology allows you to put a big 'ole chip inside a relatively cheap camera (compared with a **3CCD** approach), but with the good (Shallow depth-of-field! Low-light sensitivity!) comes the bad (Stuck pixels! **Bayer filtering!**) and the ugly (Jello cam!). Because large CMOS sensors scan top-to-bottom instead of all at once like CCDs, fast movements and pans can cause the image to appear to wobble. I can show you better than I can tell you:



Don't expect to do any whip-pans with your DSLR, and don't expect to shoot Blair Witch-style.



*This video can be watched on the online version of this chapter, at: <http://nofilmschool.com/dslr/rolling-shutter/>*

Dealing with jello cam (same with aliasing) is all about knowing the enemy, and using the right tactics to avoid it. **Don't expect to do any whip-pans with your DSLR, and don't expect to shoot Blair Witch-style.** Treat your VDSLR like a larger motion picture camera — better yet, attach some accessories and a third point of contact (more on this later) to make you treat it like a larger motion picture camera — and do planned, slow camera movements. This instruction alone, more than any technical nugget contained in this guide, will help your productions tremendously! Also be aware of strobe lights, flash photography, or lightning — such rapid changes of illumination can cause partial exposures, where half of the frame is bright and half of it is dark.

# OVERHEATING

Why did the camera suddenly turn off?

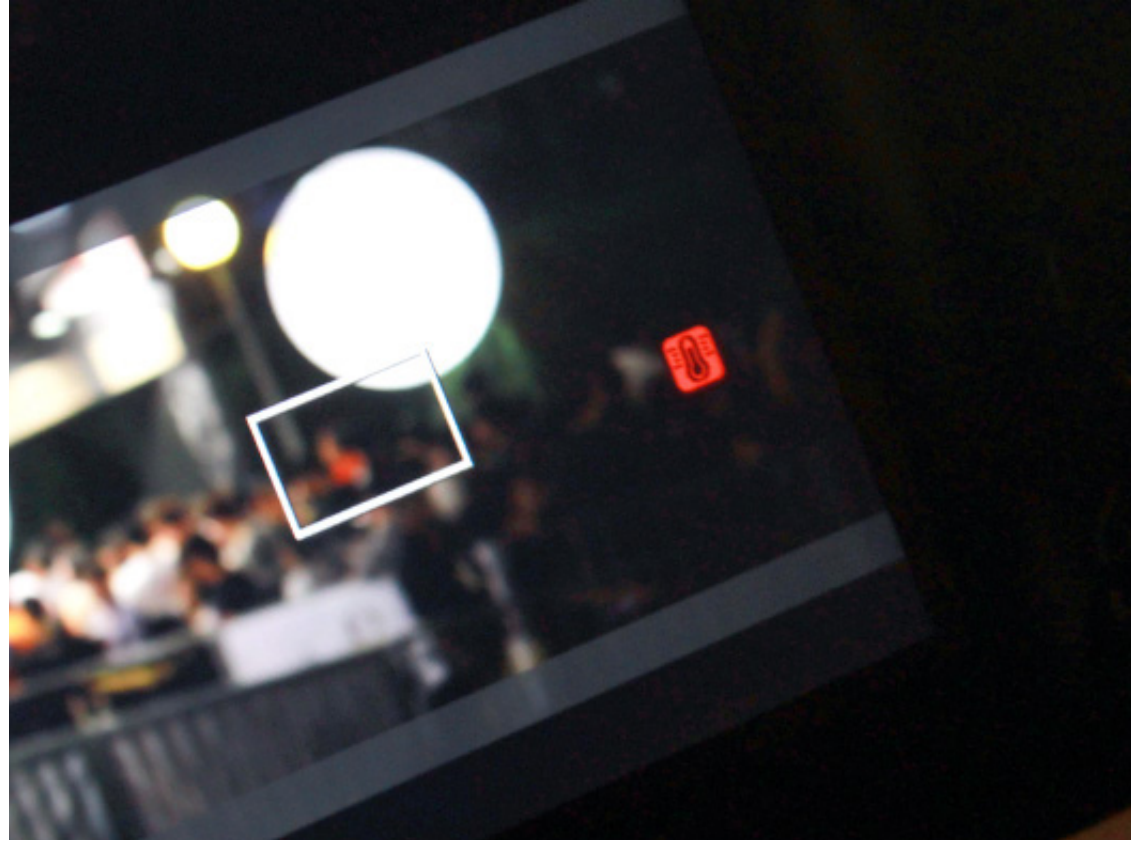

Overheating is an unfortunate side effect of getting a whole lot of camera for very little money.

DSLRs weren't designed to shoot video in a bona fide video production environment, so no matter which DSLR you buy, you're likely to have overheating problems. This is when the DSLR's operating temperature rises to the point where the camera either shuts down automatically, or the image becomes noisier due to the excess heat. This generally happens after several minutes of continuous shooting; in the case of the Nikon D90, the camera will just shut down and you'll be unable to enter Live View mode until it has sufficiently cooled; in the case of the 5D the camera will allow you to shoot as it overheats but your image will become noisier due to interference from the heat. Overheating is an unfortunate side effect of getting a whole lot of camera for very little money, and the best solution is actually to get two camera bodies so you can shoot with one while the other cools. Or, if you're on a

major production, get [13 bodies](#). Other than that, there's not a whole lot you can do to prevent it, except to take the camera out of Live View whenever possible, keep the shooting environment as cool as possible, and plan your production's breaks accordingly. On staged productions where it's a standard operating procedure to cut often, DSLR overheating is not a deal-breaker; however, **if you're considering a DSLR to shoot interviews this is a major consideration as your camera will inevitably run into issues in the middle of an interviewee's spiel.**

Here is a timelapse video of a [7D](#) in Live View; when the red flashing temperature icon appears, the camera will shut down.



*This video can be watched on the online version of this chapter, at:  
<http://nofilmschool.com/dslr/overheating/>*

Okay, enough about the drawbacks of shooting movies with HDSLRs! Remember you're getting a camera that has a shallower depth of field and is more sensitive to light than anything else south of \$20k! You've now been warned of the drawbacks, but as I said earlier: the hoops are worth jumping through.



# LENSES: USING PRIMES, CHOOSING A BRAND

Which lenses should I use?



One of the beauties of DSLR moviemaking is being able to change lenses. Up until this point in history, every video camera below \$5k has had one fixed lens that you shot everything through. <sup>2</sup> No longer!

But wait, what's the advantage of having interchangeable lenses, you ask? After all, many people buy their first DSLR and only use the all-purpose lens that came with it (sort of defeating the purpose of having a SLR in the first place). Well, there is no such thing as an

There is no such thing as an "all-purpose lens."

<sup>2</sup> There might be exceptions to this rule, but it's *basically* true.

“all-purpose lens.” It’d be like wearing an all-season outfit — you need winter clothes for when it’s cold out, summer clothes for when it’s hot out, and no clothes for when it’s nudist out.

With DSLR moviemaking, if you want your films to look like everyone else’s, use the stock lens. Fine. But the stock lens is not suited for narrative filmmaking. It’s cool for documentary, but for a shallow **depth of field** and better low-light sensitivity, you’re going to want **Prime lenses**. Wait, let me stress this a bit more:



## Primes!

Yes, for narrative filmmaking, primes are your BFF. Documentarians will probably want more zoom lenses in their kit for flexibility, but primes (meaning, lenses with a fixed focal length) are generally faster (in terms of light, I mean, not “how many shots you can get in an hour”) and less expensive. They also make you reposition the camera and put some thought into getting a shot rather than automatically reaching for the zoom, the latter of which is the hallmark of home movies.

Primes are less expensive than more mechanically complex zoom lenses, and because

For narrative filmmaking, primes are your BFF.



If you're on a tight budget and are mostly interested in shooting movies, you can skip the bundled lens, buy the body-only version, and spend the savings on used lenses.

they've been around for years, **“buy used” has seldom been more true than when it comes to DSLR lenses.** New DSLRs come with autofocus lenses, which work great for still images, but in video mode they're stuck using a contrast-detection method which is too slow to be viable; no one should be using autofocus on narrative films anyway. If you buy the camera with a bundled lens, you'll get a solid all-around lens for taking still photos; however, if you're on a tight budget and are mostly interested in shooting movies, you can skip the bundled lens, buy the body-only version, and spend the savings on used lenses. Here's where the great advantage of “obsolete” technology comes in: there are thousands of manual focus-only lenses out there with a deflated value because of their relative uselessness on modern DSLRs — except when it comes to video mode, where they're suddenly useful again.

While you can't beat good cine lenses, at this price point it's a blessing to have so many interchangeable lenses available at bargain prices. Many of these older manual lenses may not be up to the task of resolving 21 megapixels with aplomb, but they don't need to; in video mode, 1080p amounts to just shy of 2 megapixels, and any old halfway-decent SLR lens outstrips this resolution. For the web almost any SLR lens will be sharp enough, but if you're planning on going to the big screen (theatrical, a festival run, etc.) then you'll want to make sure you're getting a **sharp enough piece of glass.**

When it comes to assembling a kit of lenses, most filmmakers like to choose a brand and stick with it, so the visual characteristics of the lenses match up from shot-to-shot; with the same brand lenses in your kit, the lenses will also handle similarly (some have dampened focus rings and true aperture rings, whereas others rely on the camera for aperture selection electronically and have looser focus rings designed for autofocus).

Matching a lens brand to your camera — a common practice in the still world, and often a necessary one given the differences in lens mount electronics between manufacturers — is not nearly as important for video. <sup>3</sup> And thanks to the widespread availability of quality, low-cost lens adapters (pictured right) that allow one manufacturer's lenses to work with another's camera, you don't have to put Canon lenses on a Canon — you can generally interchange manual lenses at will with the right adapters. More on adapters in a bit, but first, let's take a look at the particular characteristics of each lens brand, for which I'll defer to DP [Shane Hurlbut](#) (*Into the Blue, Terminator Salvation*), who summarized them nicely on his [blog](#):



- **Canon lenses** “produce wonderful skin tones, have medium contrast and give you a wonderful gradation into the blacks.” The problem is, any recent Canon lens relies on the camera's electronics to control the aperture (not a good thing; most camera

<sup>3</sup> The newest version of the Magic Lantern firmware includes auto rack-focusing as a feature of software; it remains to be seen how practically important it is, but it does offer a compelling reason to stick with Canon autofocus lenses, if you like the idea of automated focus pulls. Personally, I'm not interested, but there may be some follow focus devices coming down the pipeline that use the Canon internal electronics.

operators, myself included, would rather have instant, tactile access to exposure controls), and older manual Canons are generally thought of as being slightly optically inferior to their Nikon counterparts. However, if you're buying a Canon EOS and going the hybrid route — you plan on shooting a lot of stills in addition to video — you will definitely want some quality, modern Canon glass.

- **Zeiss lenses** *“produce a colder, contrasty feel. They are incredibly sharp... Be sure to use more fill light when using these lenses and also control your highlights.”* Shane's absolutely right; one of the disadvantages to a DSLR movie when compared to, say, 35mm film is the DSLR has less **dynamic range** (and, to date, lacks some of the gamma knee options of a sophisticated video camera to control highlights). A very saturated, contrasty lens like the Zeiss would often be an advantage, and I do appreciate their aesthetic (I own a Zeiss set myself), but you have to be even more careful with **Zeiss** lenses to protect your highlights from blowing out harshly. Zeiss lenses are famous for having very large, all-metal focus rings with a lot of fluid drag, which many DPs like (I actually find the action a tad too heavy for handheld work), and they share many rendering qualities with Zeiss cine lenses, which is to say: they're beautiful.
- **Nikon lenses** *“are sharp with a little softer contrast than the **Zeiss** lenses.”* In my own experience, Nikon lenses are generally the most widely available and least expensive. They have manual apertures and a light touch to their focus rings (which I happen to like, but some don't), but they have one main problem: their focus rings turn in the opposite direction of every other lens (which can be confusing for operators or focus pullers). This means instead of turning the focus ring clockwise to focus nearer,

you turn Nikon lenses counterclockwise. I can't explain how infuriating this can be if you're used to the "standard" configuration; there are reversing gears for use on a follow focus, but it's a consideration regardless.

- **Panavisions**, of course, *"are the ultimate lenses."* But you can't afford them (in fact, you can't even buy them). If your production has a sizable budget and you're planning on renting equipment (and are shooting on a DSLR for some reason), by all means check them out, but know you'll need special adapters as well.
- **Leica lenses** *"delivered beautiful contrast and color throughout. They felt the closest to the Panavision Primo primes and had more of a cinema focus throw, even more than the Zeiss ZE primes. These lenses resolve so well on the big screen."* I haven't used Leica lenses myself, but shooters love them; there's some more on Leica lenses in the next section.

Finally, Zeiss has released a complete set of **Compact Prime CP.2 lenses** tailored for DSLR filmmaking. These





Of all of the gear covered in this guide, lenses just might be the best investment, because good optics will never be obsolete.

lenses are no joke, and as you can see, neither is their price. But compared to, say, their [complete set of DigiPrimes](#), the Compact Prime 2s are a bargain! Especially considering they are Zeiss's first set of cine lenses to offer full-frame coverage (this means you, [5D Mark II](#) owners, as well as future RED full-framers). So, what are some of the advantages of these Compact Primes? Geared focus *and* iris rings, smooth aperture adjustment (no mechanical stops), 14 aperture blades (which equals a smoother [bokeh](#) than their 9-bladed counterparts), and an interchangeable EOS/PL lens mount — it's enough to get a filmmaker like myself, who (present guide otherwise excepted) often wants to scream “enough about the minutiae of the technology, how good was the writing?!? And what does it *mean*?” excited about spending money I don't have. Here's the thing to keep in mind with lenses in general: of all of the gear covered in this guide, lenses just might be the best investment, because **good optics will never be obsolete**. So say you mortgage the house and drop \$20k on these Compact Primes? They'll work on your DSLR, a full-frame [RED](#), a 35mm film camera, and basically any cinema camera going forward (and they hold their value well if you one day decide to, or need to, sell). Just something to keep in mind as you budget for the various components listed here.

# LENSES: ADAPTING, PURCHASING

How can I use a different brand of lens on my DSLR?



To adapt a different brand of lens to your DSLR, you need a lens adapter. On the discount end, users report widespread [praise](#) for those sold by [eBay seller kawaphoto](#), and my experiences have bore this out (adapting both Olympus and Contax-mount lenses to Canon EOS). Considering some lens adapters run \$50+, being able to buy a \$10 adapter for every lens in your kit and keeping the adapters on them (preventing you from ever having to interchange them in the field) makes it feasible to base an entire lens kit around glass designed for a different camera, further saving you money. For example, Dan Chung has [recommended](#) buying Contax/Yashica-mount Zeiss lenses — less expensive than other Zeiss lenses due to their obsolete nature — and adapting them to Canon (advice that I followed, although I



recommend reading [this thread](#) to learn about potential mirror lock-up issues). Dan was one of the earliest adopters of DSLRs for professional video use, and he points out some [specific Zeiss/Contax bargains](#) (I have all of these in my own kit):

- [Zeiss 28mm f2.8](#)
- [Zeiss 50mm f1.4](#)
- [Zeiss 85mm f1.4](#)
- [Zeiss 135mm f2.8](#)

Note that availability and pricing of these lenses on [eBay](#) varies by the day — to get a good idea of what they're going for, click on "Completed Listings" in the left column. I can't say definitively that these lenses are the best deals around, as I need to get my hands on more lenses to A/B them — but I do like the Zeiss aesthetic and their lenses are built like trucks. Plus there is an [awesome Contax-to-Canon database](#) for figuring out which Contax lenses will fit which Canon DSLR. Shooters have also reported [great results](#) with Leica R series lenses, and there's [a database for that](#) too. In fact, if you're interested in Leica lenses — many people say their favorite DSLR video lenses are the Leica R series — here are some good focal lengths to look for on [eBay](#):



- [Leica R 28mm](#)
- [Leica R 35mm](#)
- [Leica R 50mm](#)
- [Leica R 60mm](#)
- [Leica R 90mm](#)
- [Leica R 135mm](#)

If you're wondering what the strange term appended to each Leica lens means, it signifies the speed of the lens: Noctilux are the fastest lenses at f1.2 (sometimes even f0.95!), followed by Summilux at f1.4, Summicron at f2, and Elmarit at f2.8.

As you'd expect, the fastest lenses are usually the most expensive (Leica R lens can run a bit more expensive than other brands, so I've created custom searches above that focus on Summilux, Summicron, and Elmarit glass). If you put together a kit based on Leica glass, you'll want to check out [Leitax adapters](#), generally thought of to be the best Leica R-to-Canon adapters.

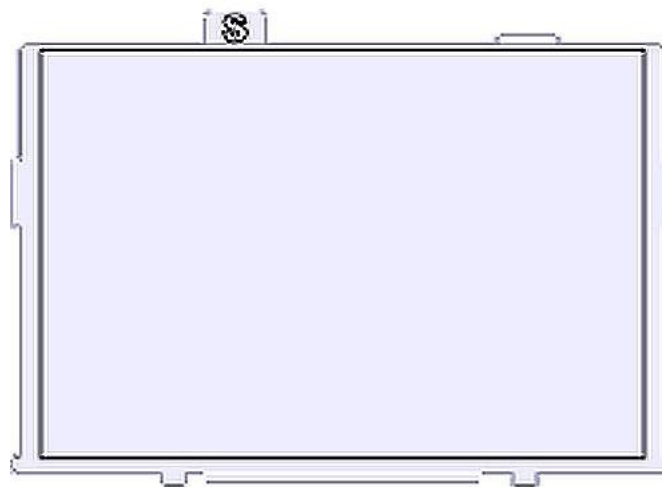

When adapting any brand (not just [Zeiss](#) or Leica) lenses to your DSLR, if you want to use them for still use as well as movie-shooting, there are more expensive adapters that offer an AF-confirm feature.

Such adapters contain electronics that allow the camera to confirm (depending on your settings, a red flash in the viewfinder and/or an audible beep) when sharp focus is obtained, even though the lens is of a different brand than the camera. Note that there is often some tweaking necessary with the settings, but if you're planning on taking stills with your manual lenses, the AF-confirm adapters from [eBay seller happypagehk](#) are well-liked (I have several "dumb" adapters and one such "smart" one in my kit). Additionally, if you're going to be shooting stills with fast primes on a 5D you're probably going to want to swap out the standard focus screen for the [Eg-S Super Precision Matte](#) model, which makes objects "pop" into focus a bit more (at the expense of viewfinder brightness — Canon recommends precision screens for lenses f/2.8 and faster).

As I said earlier, lenses hold their value. If you've got the money, buy new lenses that are made for your camera — you will avoid a lot of potential pitfalls. For example, Zeiss makes their [ZE series](#) of manual lenses specifically for Canon DSLRs; you may want to get these instead of used lenses if you can afford it (for more on why you might want to get [Nikon-mount ZF](#) Zeiss lenses instead, see "[Lenses: Renting, Converting](#)"). Here's why: while you can definitely get great results finding bargains and adapting older lenses to newer cameras, you will probably run into some problems along the way. Nothing is free, and if you're going to buy a used lens for \$300 and slap on a \$10 adapter, don't expect it to be every bit as great as its brand-new \$1,200 counterpart.

So — what are some of the potential pitfalls of using adapted lenses? There are two main issues to be aware of: infinity focus and mirror obstruction. I've had issues obtaining perfect infinity focus using adapted lenses — this is when your lens can focus "past" infinity, causing distant objects to be blurry when they should be sharp — and



If you're going to buy a used lens for \$300 and slap on a \$10 adapter, don't expect it to be every bit as great as its brand-new \$1,200 counterpart.

my 28mm Zeiss lens causes my 5D's mirror to sometimes get stuck when focused to infinity (more of an issue for shooting stills than movies, since the mirror is in lock-up position in movie mode). Adapting lenses is not for the faint of heart; we're talking about mechanical devices where millimeters matter, and in many cases [individual lenses behave differently with different adapters](#). For everything gained, something is lost — in this case, you're gaining a bunch of leftover dollars in your pocket, and losing some reliability and performance. For many shooters, myself included, it's not a choice: I had to go with adapted lenses as a matter of budget.

# LENSES: FOCAL LENGTHS, DEPTH OF FIELD

With which lenses should I  
build a kit?

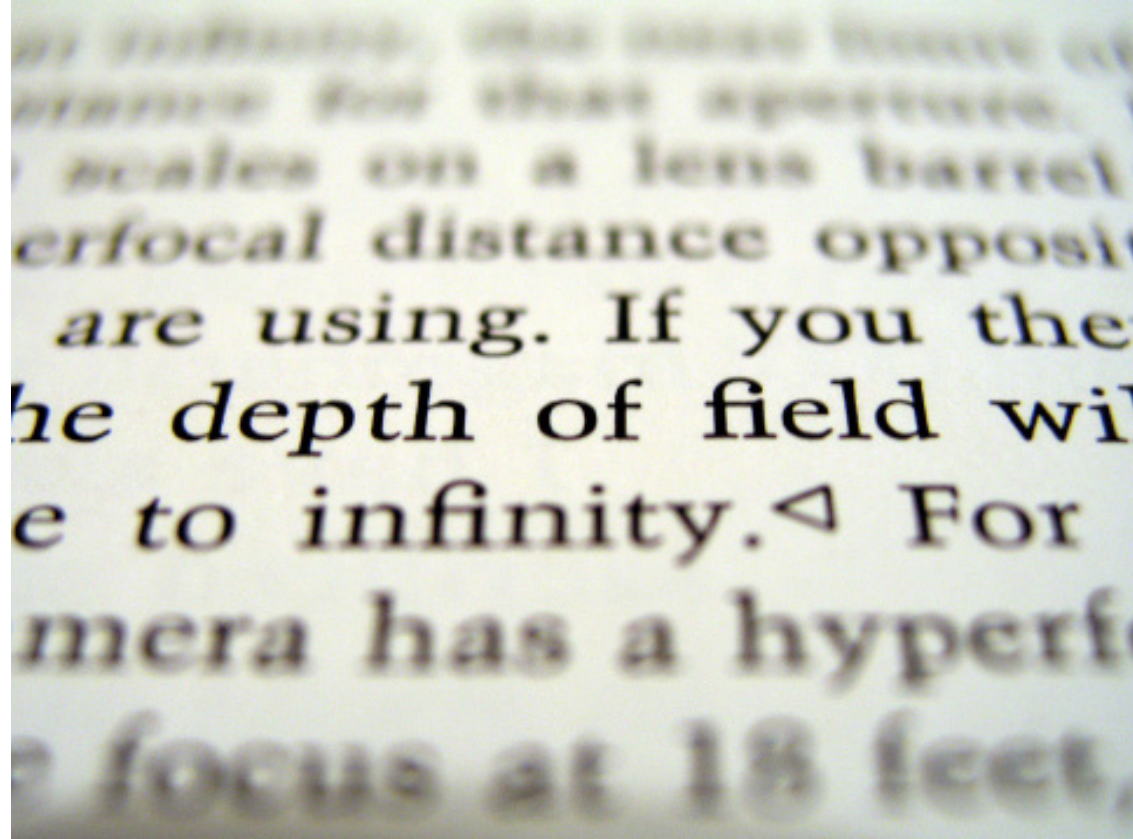

While older, manual SLR lenses are very inexpensive, there are disadvantages to using them for cinematography; these shortcomings are chiefly noticeable while pulling focus. For one, most still lenses *breathe*, meaning, they actually *change focal lengths slightly* while racking focus, which can be visually distracting for those used to cine lenses (which do not). As a related matter this breathing is accompanied by a physical lengthening (or shortening) of the lens while pulling focus, which can wreak havoc with the ability to use a matte box (see the matte box section). However, SLR lenses are exponentially cheaper than cine lenses — not to mention your DSLR probably doesn't have an *Arri PL* mount or any way of easily affixing cine lenses — so go with used SLR glass and be happy that you've got a video camera with

The first lens you should purchase is a 50mm prime.

interchangeable lenses for several times less \$\$\$ than any of us would've imagined a few years ago.

When it comes to choosing focal lengths, the first lens you should purchase is a 50mm prime, which is wide enough to get room coverage, yet not so wide that it introduces much **geometric**

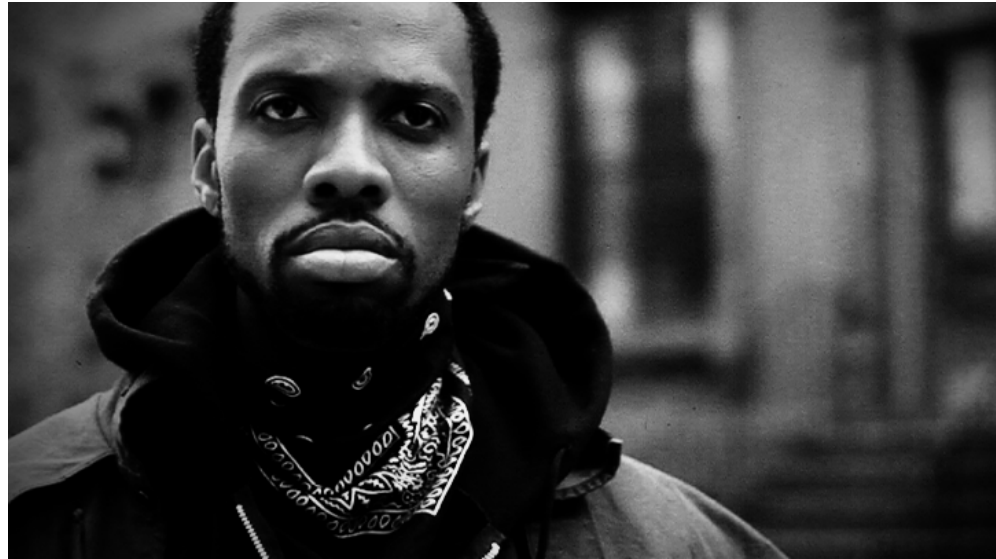

**distortion**. Hitchcock used it for the majority of his shots, and I shot 90% of **The West Side** with a 50 (pictured); they're workhorse lenses and are generally inexpensive. When buying lenses you will generally want faster glass for the best low-light performance and flexibility ( $f/1.4$  is basically as fast as it gets). To the layman, **f/stop** numbers seem undifferentiated, but the drop-off in light transmission from stop to stop is significant; exposure is logarithmic, so  $f/1.4$  transmits twice as much light as  $f/2$ ,  $f/2$  twice as much as  $f/2.8$ ,  $f/2.8$  twice as much as  $f/4$ , etc. After the 50mm one should expand in both directions, adding a 28mm or 35mm lens on the wider side as well as an 85mm and 135mm on the telephoto side (these numbers are approximate, given the varying lens lineup of different manufacturers). It's also a good idea to have a general zoom lens to



If you're just getting started and don't have a whole lot of money for lenses, ask friends and family if they have an old SLR they're not using, and if you can borrow/have their old lenses.

hit particular focal lengths, especially on the longer side, so something like a 70-200mm would serve you well.

If you're shooting on a full-frame camera like the [5D](#), the focal length listed on the barrel of a SLR lens will be accurate. However, if you're shooting on a DSLR with an APS-C or similar-sized sensor, you'll need to calculate the corresponding [crop factor](#) of your camera to get the accurate focal length. For example, if you're shooting with a [7D](#) or [T2i](#) you'll need to multiply by 1.6, so a 28mm lens becomes 45mm, a 50mm becomes 80mm, and so on and so forth. This makes crop-factor cameras better for telephoto work (they're a popular choice of wildlife and sports photographers) because your lenses automatically gain more "reach" — but it can often be harder to find good wide-angle lenses. The [1D Mark IV](#) has a crop factor of 1.3, which effectively splits the difference between full-frame and APS-C.

If you're just getting started and don't have a whole lot of money for lenses, ask friends and family if they have an old SLR they're not using, and if you can borrow/have their old lenses. Get an adapter for that brand and try them out (note that some manufacturers designed their lenses with rear tabs or flaps that may interfere with your camera's mirror, so you may have to file down such protrusions). If they perform well, then you've just saved yourself some money with the added bonus of clearing out your aunt's closet space. You'll probably want to upgrade eventually, but this can be a good way of shooting ASAP and learning on the fly.

Once you've got your lenses and start shooting, you'll notice that fast primes have a very narrow depth-of-field when wide open. This is mostly a blessing: for years, guerilla

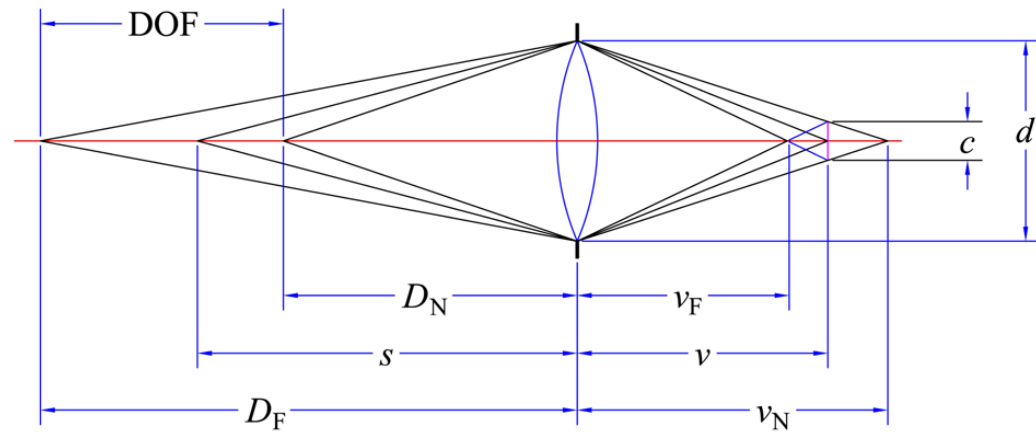

filmmakers have been after a narrow depth of field (previous video cameras in this price range had tiny imaging sensors, which yielded images with a very deep DOF), as most audiences associate shallow DOF with narrative filmmaking. A shallow DOF also allows you to defocus backgrounds that might not be production-designable and direct the viewer's attention to what you deem important in a scene. However, when working with full-frame sensors like that of the [5D](#), your DOF can become too narrow, so that it's nigh impossible to achieve sharp focus on a moving object (such as a person's face). Also [from Shane](#) (he's talking about a full-frame sensor): *"With a Canon 85mm lens, at a 1.4 T-stop you have a 1/32" of focus."* This means: your focus on a subject's face might be limited to the tip of their nose and not their eyes, or vice versa; this can be distracting to say the least, especially over the course of a shot. Even if your subject is stationary (say, in an interview), when they lean forward they might drop out of focus if you're using a wide-open aperture, and so you'll have to choose your f/stop wisely. Note that, at the same f/stop, perceived DOF is deeper on wider lenses and shallower on longer lenses (I say



perceived because technically this is not true; see [this article on DOF](#) for why). To further understand the relationship between sensor size, lens length, and f/stop, you can use a [calculator](#) to figure out the depth of field for a given lens (this is calculated based on “acceptable sharpness” a.k.a. the [circle of confusion](#)).

# LENSES: RENTING, CONVERTING

Can I upgrade my lenses — or rent better ones?



Is all this glass getting too expensive? Well, there's another thing to keep in mind: **you can rent lenses**. There's no better way to try different lenses than by... trying different lenses. If there's a local camera shop that has a well-stocked lens rental program, great. But if not, [BorrowLenses.com](https://www.borrowlenses.com) has a very wide selection of lenses (and other equipment, like audio accessories, memory cards, and underwater housings, not to mention DSLRs) available for rent by mail (you can rent for a period of 3 days all the way up to a month). Their prices are great — Canon's gorgeous 50mm f/1.2 prime goes for **\$1,500 new**, but at [BorrowLenses](https://www.borrowlenses.com) you can **rent it for a week for \$65** (plus shipping, which means it makes sense to rent several items at once). Another stunning lens, the [Zeiss ZE 50mm f/2 Makro](https://www.borrowlenses.com) retails for \$1,300 but **rents for**

a week for \$54. At these rates it doesn't make sense to not have the best glass available for an important shoot — even if you have a kit of lesser lenses for everyday shooting.

Renting, of course, is also a great way of trying out lenses instead of spending a bunch of money to add something site-unseen.

It doesn't make sense to not have the best glass available for an important shoot — even if you have a kit of lesser lenses for everyday shooting.



If you are buying lenses, however, earlier in the guide I mentioned buying Zeiss ZE lenses. The problem with Zeiss's ZE lenses, however, is that they don't have physical aperture rings, instead relying on Canon's internal electronics to control exposure. This means to change the aperture you have to turn a dial on the camera instead of a physical, tactile ring on the lens. This is far from ideal for video because A) you have less immediate tactile control over the aperture, and B) the motion of reaching for your camera's dial and turning it can ruin a shot (it's harder to keep steady in my experience than if you're "riding" the aperture manually). The best solution to this problem would

be to get the [Zeiss CP.2](#) lenses, which come with stopless physical aperture rings, but they're \$4,000 apiece. So: is there a way to get physical aperture controls on your Canon DSLR while buying new [Zeiss](#) lenses, without spending \$4k apiece? Yes! The solution is to buy [Zeiss ZF](#) lenses, which are made for Nikon's F-mount lens system, and then convert them.

This tip comes via [Philip Bloom](#), who recommends sending ZF lenses to [Duclos](#), who for \$250/lens (on average) will “cinemod” your ZF lens. What is the “cinemod?” Duclos de-clicks your iris ring (giving you stopless control over exposure), adds a physical gear for follow focus use, and adds a common-size front ring (for example, if you have a 77mm [Fader ND](#), you can have all of your lenses fit with 77mm front threads). Note that the problem with sending in Zeiss ZF lenses is that Nikon lenses pull focus in the opposite direction of all other brands, so for that reason alone I have a distaste for them (pulling focus on Nikon lenses and then switching to any other brand is a pain in the ass in terms of muscle memory). So while Bloom may recommend sending in ZF lenses — which is a great option (and I should note that some follow focuses (focusi?) allow you to reverse their gearing to correct this problem) — Duclos says they can cinemod many still lenses. I emailed the company asking which lenses they offer the service for, and got a prompt response from Matthew Duclos, their Optical Technician:



*“Our cine-mod is totally customizable per the customer and their needs. The back bone of the cine-mod consists of three parts: an 80mm front ring with 77mm screw in thread, a 32-pitch seamless focus gear, and lastly the iris de-clicking for smooth aperture manipulation. The front rings are made of aluminum and screw into the existing filter thread on the lens. We can also cut custom delrin front rings for lenses that don’t have a front thread. The focus gear can vary in size from 2” all the way to 4” depending on what is needed for the lens and/or setup. Each gear is cut to size individually and installed by a technician for a perfect fit. The aperture de-clicking is pretty self explanatory. As you can imagine, this makes the cine-mod very versatile in regards to your question about which brands we can modify. Just about anything that is well suited for motion picture use. Feel free to read some of my material on [MatthewDuclos.com](http://MatthewDuclos.com) as to what lenses work well for motion and why some lenses don’t.”*

I’m hoping to have my Contax-mount Zeiss lenses cinemodded by Duclos and will write a review here at NoFilmSchool when/if I do so.

# STORAGE (FOR THE SHOOT)

What memory cards should I use?



It's a good idea to buy reliable name-brand cards rather than save a few bucks on generic junk that might ruin a shot.

Buy name-brand, large-capacity memory cards (CF, SD, whatever your camera takes). In the case of the 5D, its 38Mbit video data rate works out to about 5 megabytes/sec,<sup>4</sup> and Canon recommends cards with a minimum sustained transfer rate of 8MB/sec. The 7D's data rate is slightly higher, but you still won't need UDMA cards (which promise 45 MB/s); however, you will still want plenty of data rate headroom and it's a good idea to buy reliable name-brand cards rather than save a few bucks on generic junk that might ruin a shot (you're

<sup>4</sup> To calculate megabytes/sec from a megabit specification, divide by 8 — there are 8 bits in a byte.

spending thousands of dollars on equipment, don't risk data loss in order to save \$30). I purchased Sandisk Extreme III 16GB cards based on the recommendations of others and haven't had any dropped frames, but I have gotten buffer warnings — so if going with SanDisk cards I would recommend others get the newer, faster, larger version, the [SanDisk Extreme 32GB 60MB/s CF cards](#). However on the forums the consensus top choice is currently the [Kingston Elite Pro 32 GB 133x cards](#), which offer a great price/performance ratio.



On the SD side of things, the [Kingston 32 GB Class 4 SDHC cards](#) are very well-reviewed (be sure a Class 4 card will be fast enough for your particular camera; if not, step up to [something faster](#)). As for how much storage space you'll need, it's a matter of how much shooting you'll be doing between chances to offload the cards; in the case of the [5D](#), my 16GB card holds roughly 45 minutes of footage, so calculate accordingly.

So far there are no external-storage recording options for DSLR users, but memory cards are fast and cheap; be glad tape is dead.

Memory cards are fast and cheap; be glad tape is dead.

# SUPPORT SYSTEM

How can I make a DSLR behave like a “real” movie camera?



DSLRs are so lightweight that they don't move like a film camera; when handheld, they jitter like a consumer camcorder, instantly marking your footage as amateur. And in many cases DSLRs are ergonomically worse than a camcorder, as they are designed to shoot stills, not video. There are two main steps in adapting your DSLR to handheld video work. One, **add weight in order to increase mass and minimize jitter**, which many of the add-ons discussed below will do. Two, **add a third point of contact to stabilize the camera against your body** (and relieve some of the burden from your arms). Because the mirror of your DSLR is raised during video shooting, you can't use the viewfinder to press the camera against your face for a third point of contact as you would while shooting stills. This leaves you with needing some



Extra mass and size will contribute further to your DSLR behaving like a “real” motion picture camera.

sort of attachment to adapt a fundamentally unergonomic chunk of metal to your fleshy human form.

Many of the accessory manufacturers in this space have a background in the film/video world, not photography, so at first glance their offerings may seem somewhat large and overbuilt.

However, this is usually not a bad thing as the extra mass and size will contribute further to your DSLR behaving like a “real” motion picture camera, which is not only something you perceive as the operator, but something audiences

perceive (perhaps subconsciously) in the camera movements. Manufacturers currently making suitable DSLR support systems include [Redrock Micro](#), [Zacuto](#), [Cavision](#), [Jag35](#), [Letus](#), [CPM Film Tools](#), [VariZoom](#), [indiSYSTEM](#), [Vocas](#), [Shoot35](#), and [Cinevate](#). [Zacuto's](#) kits range from \$550 to \$5,500 and are generally the most expensive, but if you've got the money they are widely thought of as well-built and reliable solutions. [Cinevate](#) offers a number of DSLR rigs at generally lower price points ranging from \$720 to \$2,600; [Redrock Micro](#) offers the widest range of options ranging from \$460 to \$2500. [Cavision's](#) DSLR products are inexpensive and are a good value, but in my experience they don't have the build quality of the more expensive rigs. This is less of an issue when dealing with a lightweight DSLR; I've shot several projects with my Cavision rig, but I wouldn't want to put a heavier camera on it.



If you're working with a DSLR in the sub-\$1,000 range and are on a very tight budget, the

above support systems might cost more than you're able or willing to spend. In this case, the place to go is [eBay](#). For whatever reason, a whole community of cheap DSLR support system manufacturers has sprung to life in India, and while I'm not endorsing any of their products (I have a knockoff Indian matte box which I would evaluate by saying "you get what you pay for"), if you're just getting started and funds are minimal, they're worth a look. Some [eBay](#) sellers proffering DSLR support gear include [DVcare](#), [Cine-City](#), [HDVshop](#), and the creatively named [Digital Video Product](#).



The industry standard rod system for camera support is based on 15mm rods spaced 60mm apart (there is also a larger standard based on 19mm rods which is overkill for DSLRs), so **you can mix and match most parts from different manufacturers to build your own frankensystem.** In my own experience it's a trial-and-error process to piece together the ideal kit for your particular shooting needs, so this is one area for which you should definitely spend some time on the forums. Also, these companies are

smaller than your average multinational corporation, and therefore will usually take the time to answer your questions. I hope to have more answers in this area when I've used a wider variety of gear.

Cinema5d has a [60-page DSLR rig review](#) covering a number of DSLR support systems, although there have been [rumblings](#) about the methodology and objectivity of their roundup; as with the info in this very guide, seek out as many experienced opinions on the forums as you can before you pull the trigger on a purchase, and then experiment to get the best results for your particular needs.

# POWER

What are the best options for powering my DSLR?



Shooting movies on your DSLR drains batteries rapidly, so you'll need plenty of spares. For the 5D and 7D, each genuine [Canon LP-E6 battery](#) runs \$100, which can add up quickly. Even the lower-priced T2i uses batteries that are equally expensive: the LP-E8. Nikons aren't any better on the [high end](#), although the D90 does have cheap batteries [available](#). However, generic imported batteries can be had on [eBay for \\$10](#). The difference? In Canon's case, the cheap imports lack the internal computer chip that their genuine counterparts have, which tells you how much battery life remains. The cheap ones, therefore, could potentially run out at the worst time during your shoot: mid-take. Then again, you can get 6 of them for the price of one "real" battery, so they're an attractive alternative for no-budget filmmakers. It's important to

note that the knockoff batteries won't work in Canon's charger; they require their own. The first time I plugged in the off-brand charger that came with my generic batteries, it fried itself in 5 minutes (the seller sent me another); YMMV. Finally, off-brand batteries do not work with the Magic Lantern firmware (as of version 0.1.6). More recently, [Series 7 SL-E6 batteries](#) have appeared at [B&H](#), which do contain the appropriate computer chip (they aren't significantly less expensive than the Canon originals, however).

You can also purchase a battery grip (for the [Canon 5D: BG-E6](#); for the [7D: BG-E7](#); for [Nikons](#)) for double the battery life, although many still photographers purchase a battery grip for the ergonomic aid it provides while shooting vertically in addition to the extra battery life (you can also use AA batteries with grips). For filmmaking shooting vertically is a moot issue, but considering most support systems require a riser to raise the low-sitting DSLR into a suitable position, the battery grip can also serve such a purpose. Generic battery grips are also available for 1/3 the price of their genuine Canon counterpart (for both Canons and Nikons users report [Zeikos](#) makes a quality alternative).



An alternative to using stock batteries is an external powering solution, where a cable can run from your battery compartment to a larger power source; one instance of this comes from battery specialist [Anton Bauer](#):



*This video can be watched on the online version of this chapter, at:  
<http://nofilmschool.com/dslr/power/>*

[Switronix](#) has also released an [external battery pack](#) for DSLRs, but I haven't seen any test results to date. Furthermore, [Hawk-Woods](#) has created power adapters for the 5D and 7D that offer connection to external batteries: the [DC-5D1](#) and the [DC-5D2](#) (they're the same unit with different battery connectors). Word on the street is they run around \$120.

# AUDIO

How can I record high-quality audio with my DSLR?



DSLRs aren't designed to record high-quality audio; they lack professional inputs for microphones and have an [auto-gain](#) (AGC) circuit that ruins any chance of manually setting your levels. This has changed with the recent introduction of Canon's [firmware upgrade for the 5d](#), which enables manual audio recording, so it's not to say you can't record theatrical-quality audio on your DSLR production; you just need the right equipment. Essentially, you have two options for audio recording: on-camera, or separate-system. On-camera is what any video camera user will be familiar with; you plug in your microphone(s), and the audio is recorded together with your video. Separate-system is what filmmakers accustomed to shooting celluloid will be familiar with; you record visuals to one medium and sounds to a

Separate-system affords you higher quality audio recording at the expense of convenience in the editing room; on-camera is the converse.

separate recorder, and then have to sync the two up during editing (thus the need for a [clapper](#) on shoots). Both approaches have their pros and cons (briefly: separate system affords you higher quality audio recording at the expense of convenience in the editing room; on camera is the converse), and which approach you go with will depend on your production needs and whether you even have the option of on-camera recording (your DSLR may not have a mic input, or you may be unable to disable the auto gain).



For a series of very helpful DSLR audio recording tests watch Jon Fairhurst's roundup of audio recorders (he also makes uncompressed audio samples available):

1. [Boom Mic](#)
2. [Camera Mounted Mic](#)
3. [Wireless Lavalier](#)
4. [Foley](#)
5. [Noise](#)
6. [Conclusions](#)

To record pro-level audio in-camera, you will need a device to connect your microphones (usually a XLR connector) to your camera (in the case of DSLRs, the audio input is a consumer-grade 1/8" stereo jack). The consensus on "best pre-amp/XLR adapter" is



the [Juicedlink CX231](#) (\$300). It offers pristine mic [pre-amps](#), good construction quality, very low noise, and [phantom power](#) for your mics (if you don't need phantom power, the [CX211](#) is cheaper). To use it, you screw the [Juicedlink](#) onto the bottom of your DSLR (or attach it elsewhere on your rig), plug in your balanced XLR audio cables into the Juicedlink, and run the included 1/8" stereo cable to your DSLR's mic input.

There are still a few issues — namely, headphone monitoring is in mono and the levels are quite low. To address these problems, [Jon Fairhurst](#) recommends a [Boostaroo headphone adapter](#) to achieve a usable monitoring volume (I've found the Boostaroo makes the audio approximately twice as loud, which is adequate for most situations).

If your DSLR doesn't offer manual audio settings, the [JuicedLink DN101](#) offers a solution to defeat DSLR auto-gain. But whereas the [5D's](#) new manual settings allow you to retain both channels of audio, the DN101's hardware solution gives you one channel instead of two (it defeats the AGC by blasting the unused channel with noise). This is fine if you're recording one microphone, but if you want two discreet channels of independently-adjustable audio and your camera doesn't offer manual audio input levels, you'll have to go separate-system. It's worth noting that Beachtek also offers a [DSLR solution](#), but its tone-based method of defeating AGC is, in my opinion and a lot of others', unusable for pro audio (this newer version I linked to is [reportedly improved](#), however). Additionally, [JuicedLink](#) is now offering the [DT454](#), which builds in the AGC defeating tone as well as level meters and a headphone monitor.



As with any XLR adapter of similar size, a Juicedlink or Beachtek can also double as a riser plate on your support system. Furthermore, the Juicedlink website offers a catalog of [very helpful audio recording tutorials](#) — indispensable if you find yourself trying to turn a friend into an audio crewmember.

If on-camera audio recording isn't an option for your DSLR — or if you have a need to untether your audio from your camera — there are a number of quality [flash memory recorders](#) available at very inexpensive price points. One of the most widely-used is the [Zoom H4n](#) ([review](#), [review](#)), which records at (up to) 24-bit/96kHz on SD or SDHC cards. It offers 2 XLR inputs, a built-in stereo mic, and offers 4 tracks of simultaneous recording, which enables the ability to simultaneously record its own stereo pickup in addition to audio from the 2 XLR inputs; for filmmaking where [foley](#) won't be possible, this can offer a nice mixing alternative, in that you can adjust separately-recorded ambient levels independently from your boom and lav levels. Having such a scratch track, assuming the H4n is protected by a [windscreen](#) and is well-positioned, can be a boon for post-production turnaround time on low-budget shows that have web, mobile, or low-end TV releases in mind. At \$350, the H4n is a great deal. One alternative: [The Tascam DR100](#), which others [review](#) well, but I witnessed the silver jog dial fall off repeatedly on a shoot (YMMV).



In addition to these two methods of recording, there's a third approach: purchase a CX231 to enable on-camera audio when you want it, and add a flash memory recorder for separate-system sound when the production calls for higher quality audio or needs the recordist to roam. A top choice for this purpose is the [Sony PCM-D50](#), which is similar to the H4n in size and functionality, but it only accepts a 1/8" stereo input. However, when connected to a CX231, the combination offers a great combination of mic pre-amps and recording medium — you could use this recording setup for a feature film, the self-noise is so low. Videographer/reporter Dan Chung has [reported](#) good results, and my own tests to date have confirmed this (however, your audio will travel over an unbalanced 1/8" cable for a short length, so you'll have to be vigilant for interference). An important feature of the PCM-D50 ([review](#), [review](#)) is its built-in limiter, which records each input at two levels simultaneously and automatically switches to the lower level if clipping results at the higher setting. For DSLR-based crews where the audio guy might not be a union man with decades of experience, this extra fault tolerance is crucial. Other advantages include 4GB of built-in flash memory (good for 6 hours of 48kHz audio), a 5-second pre-buffer (you can automatically start the recording 5 seconds before you pressed the button in case you weren't rolling for something), and a real, rideable input level knob (instead of the H4n's pushbuttons). Disadvantages to the PCM-D50 include its higher price, its 1/8" input, and its reliance on proprietary [Memory Stick](#) cards (honestly, Sony, still?).



# MAGIC LANTERN FIRMWARE

Is there unofficial firmware available for my Canon 5D?



**NOTE:** Since Canon released firmware 2.0.4 for the 5D, the utility of Magic Lantern firmware has been somewhat reduced.

The [Canon 5D](#) shipped with an amazing movie mode that was often infuriating because it lacked basic video camera functionality. Canon has done a nice job of adding some of the missing features — manual aperture and shutter speed and additional framerates — but

additional features have been added by Tramm Hudson, who hacked the camera's firmware and developed new features for the camera all on his own. I wondered about the 5D's hackability before the camera was even released, and I cannot overstate the value of what Tramm's managed with this free downloadable upgrade.



The [Magic Lantern firmware](#) adds the following features (taken from the ML wiki):

- On-screen audio meters
- Manual gain control with no AGC
- Zebra stripes (video peaking)
- Custom Cropmarks for 16:9, 2.35:1, 4:3 and any other format
- Control of focus and bracketing

These aren't "nice to have" features — they're must-haves. Here's Tramm with a demonstration of ML's capabilities (including some upcoming features):



*This video can be watched on the online version of this chapter, at: <http://nofilmschool.com/dslr/magic-lantern-firmware/>*

The Magic Lantern firmware is currently only available for the [5D](#) but is [coming soon to the 7D and T2i](#). However, it's currently incompatible with the 5D's latest firmware, so if you're a current 5D owner, be wary of upgrading (if you deem it necessary, you can [downgrade](#) in order to use Magic Lantern). The firmware is free, so please [donate to Tramm](#) to support ML's continued development and to thank him for his considerable contributions to DSLR cinematography.

# GH1 FIRMWARE

Is there unofficial firmware available for my Panasonic GH1?

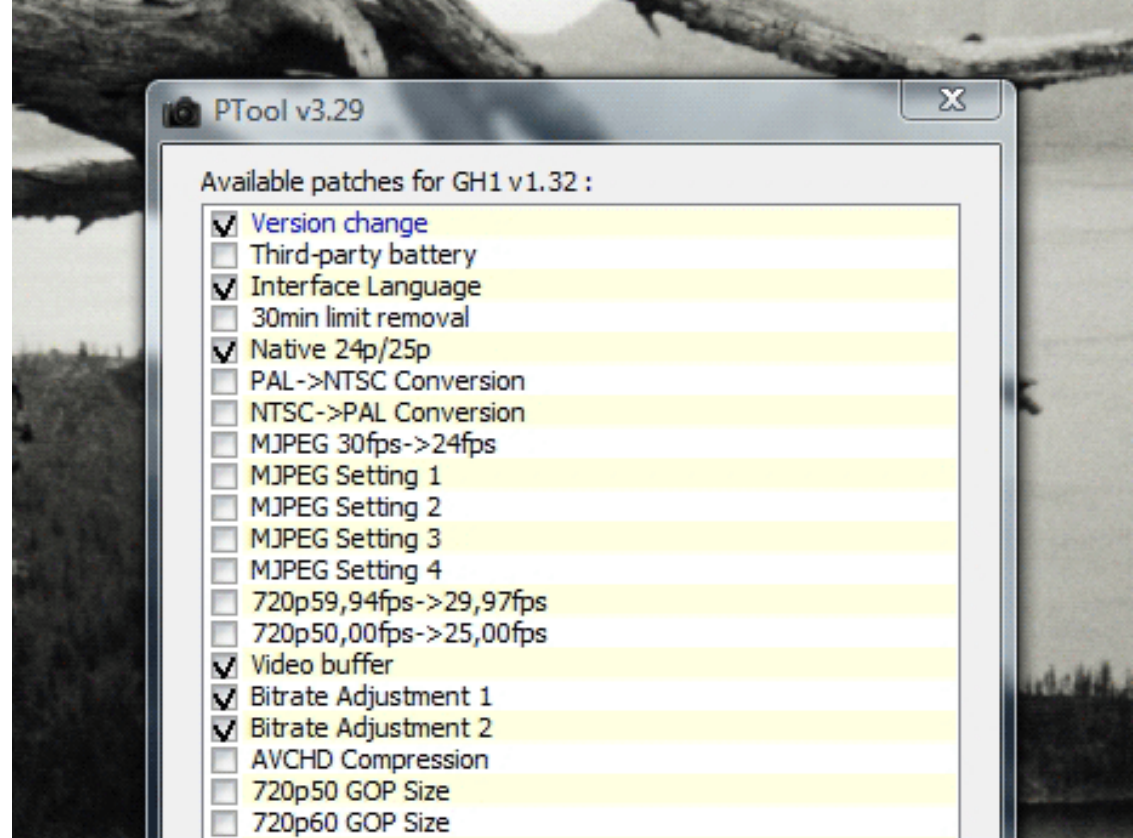

Thanks to the brilliance of [Vitaliy Keslev](#), the [Panasonic GH1](#) – a plastic, mirrorless, thousand-dollar camera – is now a real contender in the battle for DSLR supremacy. <sup>5</sup>

Unfortunately I'm only now getting my hands on a GH1, so at press time I'll have to reserve judgment as to how the camera compares to my 5D (I also have a Nikon D3100 and Canon

<sup>5</sup> Due to its lack of an optical viewfinder and mirror, the GH1 is technically not a DSLR – but given all DSLRs are in mirror lock-up position when shooting movies, for all intents and purposes this makes no difference for DSLR filmmakers. I'm going to call it a DSLR just for consistency's sake.

60D on the way, all courtesy [B&H Photo Video](#), so stay tuned to NoFilmSchool for future DSLR updates). However, in [some comparisons](#), shooters are claiming the GH1 is a better camera than the 5D. As with all claims and comparisons, your mileage may vary, and even with the higher bitrate there are some disadvantages to the GH1. Namely, that no matter what you do, the GH1 will never be a great low-light camera compared to the 5D (it has a smaller Micro 4/3 sensor that drinks in less light). Also, there is no way to set audio levels manually, so plan on shooting with separate system sound (upon unpacking the GH1, it may seem like there is no audio input, but in fact the camera has a combination remote/mic input).

Enough about the camera itself – if you already have it, you’re going to be interested in the hacked firmware, which drastically increases the AVCHD codec maximum bitrate to 44Mbit. This should singlehandedly vault the GH1 into viable filmmaking territory. The program is called PTool, and while it’s Windows-only, Mac users can run it using [Winebottler](#). Get the hacked firmware, and instructions for using it, [here at EOSHD](#).



# MATTE BOX

How can I make my camera look cooler? What are my options for reducing lens flares?



A matte box serves two purposes: one, to cut down on unwanted lens flares; two, to allow for easily changeable filters in front of your lens. You may not need one; it depends on how you feel about [lens flares](#), whether you're planning on using filtration, and how high-profile you can afford to be if you're on a guerrilla production (a matte box screams "real film" more than perhaps any other accessory, which I suspect is why a large portion of filmmakers run around with one attached: to look legit).

Because matte boxes have historically been used on "real" films (meaning, on productions using cameras that cost several times more than a DSLR), many manufacturers are accustomed to charging five figures for a device that essentially amounts to a box with

attachable metal flaps and a couple of slots. To be sure, it is important to get a quality matte box if you're adding one to your rig, but it doesn't make any sense in the world of relatively inexpensive DSLRs to spend as much on a box that sits in front of your camera as you did on the camera itself.

In the sub-\$1000 category, shooters laud the [Redrock Micro microMatteboxes](#) as good values if you're looking for something large for narrative filmmaking, or the more compact [Genus](#) for run-and-gun and documentary work. Other low-cost options include those from [Cavision](#) and [GearDear](#). Because I am a poor independent filmmaker I went the route of purchasing a matte box from an [Indian eBay seller](#) (the matte box seems to me like a good area to save money in order to divert funds towards other equipment, e.g. another lens), but I plan on replacing it with something more professional as soon as I can afford it. [FreshDV](#) has a good roundup review of [a number of matte boxes](#) on the higher end (the [Genus](#) is the least expensive in the review).

The issue to be aware of with any matte box is getting its rear opening to fit your lenses; generally a matte box's rear opening is 105mm or larger, and your lenses likely have various front thread sizes ranging from 49-82mm. Some matte boxes come with a set of "donuts" for stepping down to a variety lens sizes, whereas others come with a single ring. I prefer a universal donut like those from [Zacuto](#) or [Genus](#), which can save you a lot of time when it comes to changing lenses. Without a universal donut, you'll need a variety of step down and step up rings (good source: [camerafilters.com](#)), and every time you change a lens you'll have to fiddle with step up rings, which rarely align perfectly. A universal donut is a time-saving advantage and also gives you some leeway with your lenses displacing as they focus (extending or retracting).



The issue to be aware of with any matte box is getting its rear opening to fit your lenses.

# FILTRATION, VARIABLE ND

How can I better control the light entering my camera?



For motion pictures the standard shutter speed is the equivalent of a 180-degree shutter: on 24p cameras, 1/48th of a second, and on 30p cameras, 1/60th.

If you're coming from a background in still photography, one of the first things you'll notice while shooting video is this: once you lock in the shutter speed, you don't have nearly the amount of control over exposure that you did back when shooting at 1/1000th of a second was viable. Motion in video will look stroboscopic at higher shutter speeds (see: the action scenes in either [Saving Private Ryan](#) or [Gladiator](#)). For motion pictures the standard shutter speed is the equivalent of a **180-degree shutter**: on 24p cameras, 1/48th of a second, and on 30p cameras, 1/60th. In daylight, if you want to maintain a relatively open aperture (for shallow depth-of-field) at either shutter speed, you're going to need neutral density (ND) filters. If you're coming from a background in video, you're likely used to video cameras having

built-in, switchable ND filters; welcome to the world of still cameras, where this is no longer the case. Therefore [ND filters](#) are the first thing to add to your filter kit; they come in a variety of strengths, with the most common denominations being 0.3, 0.6, and 0.9 (respectively, 1, 2, and 3 stops of light reduction). You can stack them in a mattebox for greater light attenuation in order to maintain your desired shutter speed and aperture in bright settings.

The above method is the traditional “movie” way of doing things — using drop-in glass filters in a matte box — but in our new era of hybridized imaging, another option is to use a variable ND solution. In this situation, rather than using a drop-in filter or combination of filters in hopes of getting your ideal exposure, you can continuously adjust a rotating filter to darken the scene faster and more precisely. [6](#) A variable ND setup offers as little as 2 stops and as many as 8 stops of attenuation; the [Singh-Ray](#) is the original variable ND filter but the [Fader ND](#) series of filters on eBay are just as good and a lot cheaper. Note that newer versions of the [Fader ND](#), known as the [Fader ND Mark II \(review\)](#), alleviate [reported image softness problems](#). What were these problems? Essentially, at longer focal lengths (100mm +), the original Fader ND caused the image to soften — note that this was mostly an issue on still images, where resolutions are several times that of 1080p video. I haven’t experienced any such issues

[6](#) This is achieved by using two polarizers (a circular and a linear) in conjunction with each other; because a polarizer filter only allows light to pass through in one direction (which makes it most commonly useful for eliminating reflections off of windows or water), when stacked with a second polarizer, the two can be oriented so each only allows light through in the opposite direction of the other; therefore, no light is transmitted.

while shooting video with my Fader ND, but I haven't put it to use as much as I'd like, and I haven't used it to shoot stills. Note that there are a lot of bootleg Fader NDs on [eBay](#), which are rife with color cast and softness issues — be sure to buy from [Light Craft Workshop](#), the only “authorized” dealer on [eBay](#).

Here is a clip of a variable ND filter in action:



*This video can be watched on the online version of this chapter, at: <http://nofilmschool.com/dslr/filtration/>*

Once you have your ND filters, there is a whole world of creative uses for filters beyond simple exposure correction.

In practice, you wouldn't do this during a shot; to use a variable ND, you lock in your desired shutter speed and aperture, and if the scene is overexposed (often in daylight), you use the ND filter to bring down the exposure to the correct level. Note that with a screw-in variable ND filter, you will want to buy the size that fits your largest lens (e.g. 72mm) and then use step-up rings on the front of your smaller lenses. A word of caution with using variable ND filters, however: their response to light is not entirely linear, i.e. at higher levels of light attenuation they may let more green light through than other wavelengths. You can see one slight example of this at the end of the embedded video; I would not worry about the Fader for web video and television work as it's been tested by a lot of shooters (myself included), but if you're going to the big screen and are very color-critical (and have a sizable shoot budget and the schedule to match), you may want to think about going with the traditional stackable ND approach.

Once you have your ND filters, there is a whole world of creative uses for filters beyond simple exposure correction. This could be its own guide, so for now here is an overview of some different [types of lens filters](#). Note that filters are going in front of your lens, so they are one area where bargain-hunting can be risky; whereas a cheap shoulder support could give you a sore shoulder, a cheap filter could outright ruin your image; [beware the reaper of cheap glass](#).

# LCD VIEWFINDER

Which viewfinders can I attach to my DSLR?



A video camera has an electronic viewfinder that you can adjust vertically to accommodate typical videocamera shooting positions (handheld, on the shoulder, low angle, etc). A SLR film camera, on the other hand, has a fixed optical viewfinder requiring you to press the (much smaller) camera to your face. When shooting movies with a DSLR, however, the camera's mirror is in its **locked-up** position, so if you look into the camera's optical viewfinder all you'll see is black. Today's DSLRs offer an electronic solution similar to video cameras: the **Live View** LCD was one of the first steps in enabling DSLRs to shoot movies, and as a result, the LCD screen is what you'll use to frame and focus shots.

However, there are a plethora of issues with shooting movies on a small, fixed LCD screen; an add-on viewfinder is one way to address (some of ) these issues. A viewfinder usually provides magnification and allows you to isolate the LCD screen from sunlight; additionally, it provides a crucial third point of contact for stabilizing all-too jittery DSLR shots. An LCD viewfinder is basically just a [loupe](#) that you attach to your DSLR's screen (via straps, adhesive, a fixed mount, or magnets). Models vary in their magnification, optic quality, and attachment method; I'll spotlight two popular models and provide my own review of a third option.



At the top of the heap is the [Zacuto Z-Finder](#). Here's a [review](#) by a self-professed "Zacuto fanboy," but everyone else seems to love it too; for \$395, it better be the best. For that price, one has to question whether they would rather have an external monitor, but if you're planning on shooting primarily handheld and on-the-go, a good viewfinder is a worthwhile investment, and the Z-Finder is the one to beat. The Zacuto provides 3X magnification, attaches via an adhesive frame, and offers a [diopter](#) for shooters who wear glasses. There's also a cheaper Z-Finder, the \$265 [Z-Finder JR](#), which leaves out the diopter and mounting frame in favor of a less expensive bracket.





At half the price of the Z-Finder is the very popular [LCDVF](#), which was bootstrapped in Estonia by Cinema5d user [Tonis](#). Originally sold direct and now distributed by a network of dealers, the LCDVF is available for [\\$180](#), offers 2X magnification, and attaches via a magnetic frame. There are some user opinions [here](#), and even Philip Bloom (the aforementioned [Zacuto](#) fanboy) [seems to like it](#); dozens more reviews can be found via search. Tonis might just have hit the sweet spot for price/performance, but the LCD omits an adjustable diopter: if you wear glasses, you may or may not be able to focus through the viewfinder.



Because I had some old [Cavision](#) parts lying around from my previous camera rig, I went with the Canadian manufacturer's [LCD model](#) because I liked the idea of having a viewfinder that could swing-away. However, while the direct sales staff were very helpful, I can't say the same about the viewfinder itself. Cavision parts are modestly priced, but many of them are also modestly manufactured, and I've found that the viewfinder has too narrow a field of focus, so that the edges of the screen appear blurry. With a magnification factor of 6X, the Cavision offers the largest image size of the bunch, but I've also found this to be a disadvantage for two reasons: one, the resolution of DSLR LCD screens isn't high enough to support a 6X magnification, so you become too aware of the distracting gridlines between pixels; two, the image is large enough that

it takes up too much of your field of view and it's not easy to "take it all in" for composing shots. I found my eye frequently panning across the magnified image, and I'd rather have something that doesn't force me to shift my focal point so often. It'd be like trying to compose a shot with an IMAX screen in front of you; as a cinemagoer, the huge screen size offers an immersive experience, but as a cinematographer you'd want to back up for framing purposes. Some of these issues have been [corroborated by others](#), so I'd have to recommend one of the other two options.



Smaller rig  
for low profile  
shooting?  
Viewfinder.  
Larger rig  
for narrative  
projects? Field  
monitor.

The chief drawback when shooting with a viewfinder attached is: you don't have the vertical adjustability of a real videocamera, where the eyepiece swivels up and down. This allows you to get low and high angles; with a DSLR viewfinder, you're locked in to shooting straight ahead from head-level. This is why DSLR viewfinders have some sort of release mechanism, but even without a viewfinder it can be hard to get low and high shots since the LCD screen itself does not articulate. When you're thinking about monitor versus viewfinder, a lot of it comes down to what size rig you're planning on using. Smaller rig for low profile shooting? Viewfinder. Larger rig for narrative projects? Field monitor.

# FIELD MONITOR

Which LCD monitors can I attach to my DSLR?



First off, I don't currently own a field monitor. This is primarily because they cost money, but I've also been waiting for Tramm to get 1080i HDMI-out enabled during recording on the **5D** (which **may or may not** make it into the next release). Currently, as soon as recording starts on the **5D**, the output resolution drops to 480p, which makes an external monitor much less useful for focusing. This change in resolutions also introduces a number of issues with monitor switching; every monitor is different, but many monitors take a few seconds to switch modes, and repeated hundreds of times a day, this can be an exercise in frustration. The **7D** has its **own issues** as well, and presumably the **T2i** introduces a host of new (but different!) problems. Despite these issues, however, I'm currently planning on buying the **SmallHD**

[DP-SLR](#), which at 5.6" is a bit smaller than many monitors but large enough to provide for more precise focus monitoring while still being able to mount it to a handheld rig (with an articulating arm, which will allow for more angles). It's very high resolution, has upgradeable firmware, and should work great on whatever camera I shoot with next (a RED, for example).



Until then, to digest what's currently being said on the forums:

For \$230 the [Lilliput 669](#) is a great cheap option. A monitor at this price point isn't going to have a lot of adjustment options and won't offer the most accurate color reproduction, but again, if you spent \$800 on a DSLR then you probably don't want to spend \$1,000 or more on a field monitor (some would [disagree](#)). The Lilliput has a 7" screen and is 800×480 native resolution; there's a lot of good info in [this thread](#) at Cinema5d. Note for the Lilliput you will need a few accessories (miniHDMI to HDMI adapter, batteries, etc.) to get properly connect and mount the monitor; I haven't tested it myself but there are some forum tips in [here](#) as well as more details on [battery options](#).



For \$800 the [SmallHD DP1](#) is a very popular choice; it has a higher 1024×768 resolution for what approximates to 720p resolution. Similarly to the LCDVF, the guys at the North Carolina-based SmallHD bootstrapped their own 10" LCD monitor and are now selling them

at volume, and the general consensus on the [forums](#) is the SmallHD can't be beat at the \$800 price point. I look forward to shooting with their smaller model; after all I have to help my fellow Carolinians [raise up](#).

There are plenty of more expensive monitors on the market from manufacturers like [Marshall](#), [Ikan](#), [Manhattan](#), and [Panasonic](#), but for DSLR use I'll move on; if you're spending \$2,000 on a field monitor, you'll probably want to do your own research rather than take my word for it. If I do come across any of these other monitors, I'll add my thoughts. In the meantime, Cinema5D has published a [four monitor review](#), comparing the [smallHD DP-1](#), [ikan V8000HDMI](#), [Marshall V-LCD70P-HDMI](#), and [ikan V5600](#). There were also some new monitors [demonstrated at NAB](#).



# PICTURE STYLE EDITOR

How can I gain finer control  
over my image?

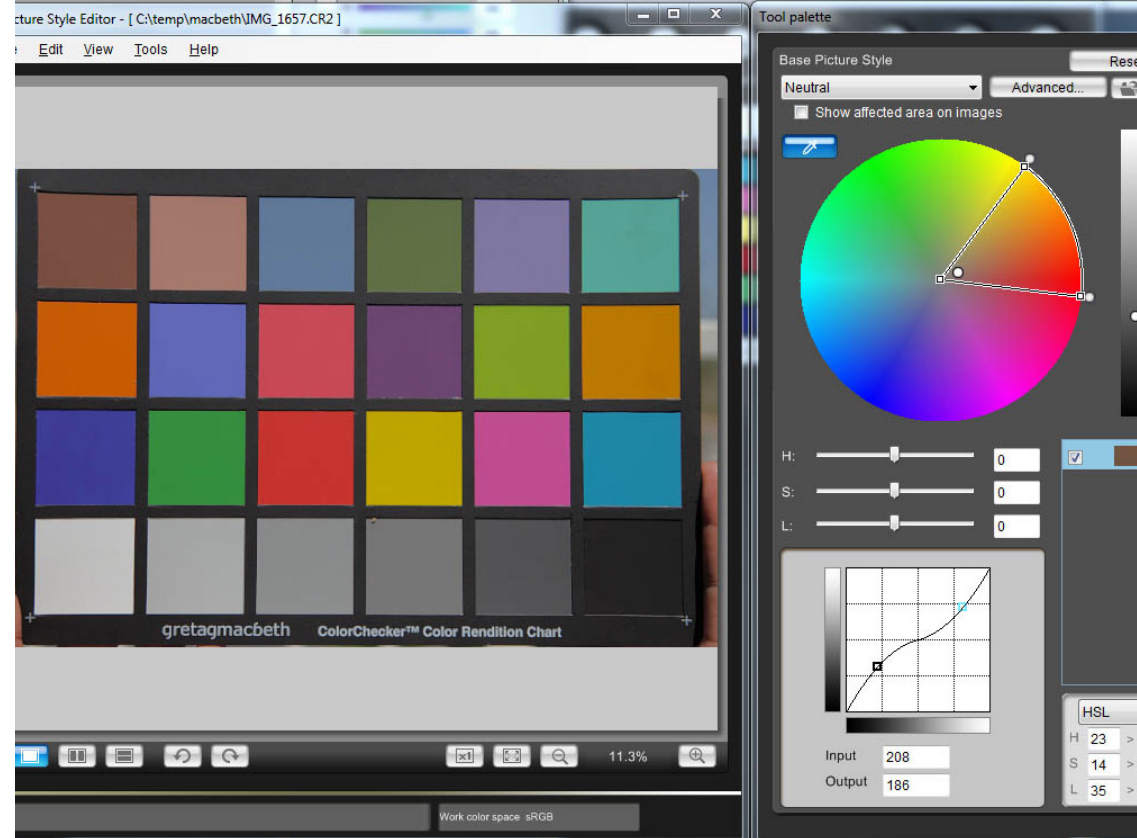

When shooting with a Canon DSLR one of the first things you should do is to switch the in-camera Picture Style from “Standard” to “Neutral” and dial down the contrast all the way; this will give you a flatter image that gives you more flexibility with the image in post.

Shooting with the factory-supplied Neutral setting is just the beginning of optimizing your camera for filmmaking. The next step is to put to use the [Picture Style Editor](#) software, which is one of the most important features for Canon DSLR cinematographers (Nikon users have a similar software, the [Picture Control Utility](#)). The software allows you to make a wide range of adjustments to your camera’s “look” — color response, gamma curve, etc. — sort of like

giving you a choice of film stocks. It's a bit user-unfriendly, but it affords you the ability to implement a pseudo-RAW workflow (it's not a true RAW image ala the RED camera, wherein one can losslessly manipulate the camera's white balance, brightness, contrast, etc. after the fact), and used wisely, you can get a nice, flat, gradable image out of a camera that ships with woefully pumped contrast and crushed blacks. The fact is, many guerilla cinematographers were happy to have Cinegamma and other custom knee settings when they made their low-end debut on the venerable DVX-100 in 2002, but most of us wouldn't have guessed that gamma curves and color matrices would ever be user-editable on a \$2,000, mass-market camera. But it just so happens that Canon's software for customizing photo styles also works in movie mode, and thus another feature from six-figure cameras has made its way down to four-figure DSLRs.

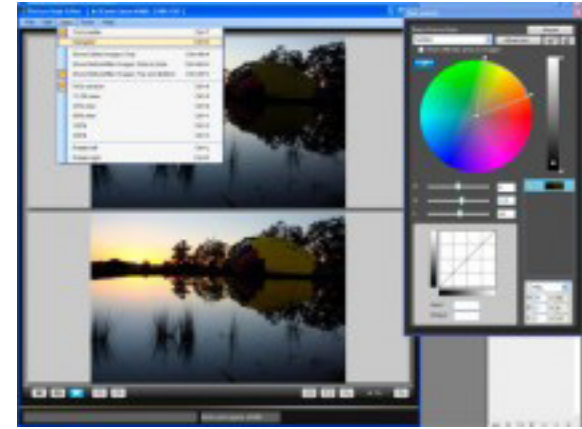

Here's a great video tutorial, with example shots, of the benefits of using the Picture Style Editor:



*This video can be watched on the online version of this chapter, at:  
<http://nofilmschool.com/dslr/picture-style-editor/>*



If you're willing to put in the work, it's definitely worth it to create your own Picture Style.

Many users would just download the freely available [Marvels](#), [Superflat](#), or [Extraflat](#) picture styles; across the board, they give you a flatter image than the default shipping preset. However, every individual camera is different, and one user designing an optimized setting for their own camera does not mean that same setting will be optimal for yours. Using preset custom picture styles is becoming more controversial, with many [shooters](#) (myself included) noticing some [drawbacks](#) to using over-flattened picture styles. While you often gain perceived latitude and shadow detail by using custom styles, you can also lose detail and introduce more noise and banding thanks to the h.264 compression algorithm. I've noticed these artifacts in post-production with footage shot with the Marvels and Superflat styles, and am currently creating my own subtle flat look tailored for the unique characteristics of my particular 5D. [Shane has a great tutorial](#) on setting up your own Picture Style, by optimizing the white balance and tonal curve of your particular camera (also handy for matching multiple DSLRs to each other). Users have also created Picture Styles emulating specific film stocks, as posted by [sumitagarwal](#), but most of these are probably too extreme for shooting under normal conditions (the h.264 compression algorithm breaks down pretty easily when pushed). If you're willing to put in the work, it's definitely worth it to create your own Picture Style; don't assume that someone else's testing with their camera will yield the same results for yours. If you're just looking to shoot out of the box as quickly as possible, I'd use Neutral and turn down the Contrast all the way, and worry about custom Picture Styles later.



# POST-PRODUCTION OVERVIEW

I shot beautiful footage with my DSLR. Now what?



The chief issue with DSLR post-production is transcoding your camera's files to an editable format.

This is “The DSLR Cinematography Guide,” not “The DSLR Post-Production Guide,” so these sections will be a bit shorter (if I expand them, maybe I’ll move them to their own separate guide one day). The chief issue with DSLR post-production is transcoding your camera’s files to an editable format (their natives files aren’t optimal for editing) and syncing audio (if you recorded it separately). Thankfully Canon has released their own [plugin](#) for Final Cut-based editors that takes care of the transcoding, but read on for my suggested workflow, storage solutions, transcoding recommendations, and other workarounds. If you want someone else’s (longer) take, check out [Oliver Peters’ post](#).

# STORAGE (FOR THE EDIT)

How can I ensure I avoid data loss?



Never edit video on the same hard drive that you're running your operating system on.

This applies to video editing in general, not just DSLR-originated footage, but because of my [past experiences with data loss](#), I hope I can help others avoid the same fate. Some of this will be obvious advice for those of you with video editing experience, so feel free to skip to the next section if you're a seasoned editor...

First off, never edit video on the same hard drive that you're running your operating system on. While you can save your *program* files on your internal drive, for the video files themselves you're going to want a separate drive (usually an external drive).

If you can afford it, get a good 4-drive enclosure and set it to RAID 5.

Some tips when buying an external drive:

- If possible, buy a drive enclosure that has a fan. Heat is a killer.
- Buy the fastest interface your computer has (obviously). USB 2 is a minimum; if you have a Firewire port, get a **Firewire drive**; even if it's FW400, it will be faster than USB 2.0 **eSATA** is a good deal faster than both but **FW800** is also quick. If you notice those different links return a lot of the same results, it's because many drives have multiple interfaces; this is a good thing for portability between machines.
- Don't buy LaCie. I'm sure they make *some* decent products, but I've known too many people who've had LaCie drives fail on them (myself included) to be able to recommend their drives. Maybe this is because their drives are very popular and therefore there are more of them out there, but still. I don't trust 'em.
- If you're going with a multi-drive **RAID** enclosure, don't use RAID 0 unless you're going to be doing daily backups — "RAID 0" should actually be "AID 0," because there is nothing Redundant about it. If you can afford it, get a good **4-drive enclosure** and set it to RAID 5.
- Look for drives that run at 7200RPM instead of 5400RPM. They're a good deal faster.



However, I would not recommend 10000RPM drives unless you have cash to burn, as they're significantly more expensive than 7200RPM drives — without being a proportionately faster (for the best bang-for-buck, build a multi-drive RAID array out of 7200RPM drives).

If you're shooting in 1080p you're going to need a lot of space; [1TB is a good place to start](#) these days. You can also build your own enclosure if you have a spare hard drive sitting around; I've built four cheap ones using this ugly [Rosewill enclosure](#), because it has a big-ass fan and is USB2 and eSATA. Suffice to say this ugly drive has never failed on me, which is not to say that "this is a a great drive enclosure," but I take it as evidence that a cooling fan should be a necessary feature for external drives — in the same time period I've been using this Rosewill, I've had three fanless LaCie drives brick themselves in my possession.

# TRANSFERRING, VIEWING, TRANSCODING

How can I prepare my  
footage for editing?



First things first: if your computer has a firewire port, buy a [firewire CF reader](#) (assuming your camera shoots on CF cards). Firewire-based readers are far faster than their USB counterparts, and this simple purchase will save you a lot of time in offloading the sizable movie files. Once you've copied the files over to your external drive, you might discover that your computer can't play back the files smoothly. These are high-resolution, highly compressed files — and while the compression does a good job of keeping file size down, it also means you need a [sizable computer](#) to decode them. While you may be able to playback the native files without any stuttering if you have a recent and/or expensive desktop — or if your camera uses an inferior MotionJPEG codec (as do all Nikon DSLRs to date) — if the files play more smoothly

on your camera's LCD than they do on your desktop, try downloading the latest version of [VLC](#) (PC and Mac), and follow [these instructions](#) to configure it for playback.

The h.264 files that Canon DSLRs shoot aren't well suited for editing, what with their 4:2:0 [chroma subsampling](#) and processor-intensive, [interframe codec](#) (the same goes for the files spawned by Panasonic and Nikon DSLRs). You'll want to [transcode](#) the clips into a format that will play smoothly and maintain quality during color correction. The lone exception to this rule is if you're editing in [Premiere Pro CS5](#) (or later), which can sometimes handle DSLR footage natively. If you're going to be editing in [Final Cut Pro](#), download [Canon's EOS Movie Plugin-E1 for Final Cut Pro](#). The E1 plugin adds timecode to your footage, transcodes footage as quickly as possible, and brings the clips in using FCP's native Log & Transfer function. On most reasonable Macs, the ProRes clips are laptop editable in real-time (with the [FCP](#) viewer zoomed to 50% or less at Medium quality, my four year-old



laptop can edit the 1080p transcodes from an external USB 2.0 hard drive in real-time).

If you're not editing in FCP, you can use [MPEG Streamclip](#), a cross-platform freeware utility, to transcode footage. Note that [Premiere Pro CS4](#) on a Mac, in my experience, is unable to adequately handle any flavor of Canon DSLR footage, so for Mac users I recommend Final Cut; on the PC, users report good experiences with [Vegas](#), and the Windows version of [Premiere Pro CS4](#) will also edit Cineform files. If you're going with a PC-based NLE, [Cineform Neo Scene](#) is a good transcoding/editing plugin (note the software costs \$129 (or \$99 at B&H)). Here are some [Neo Scene workflow tips](#).

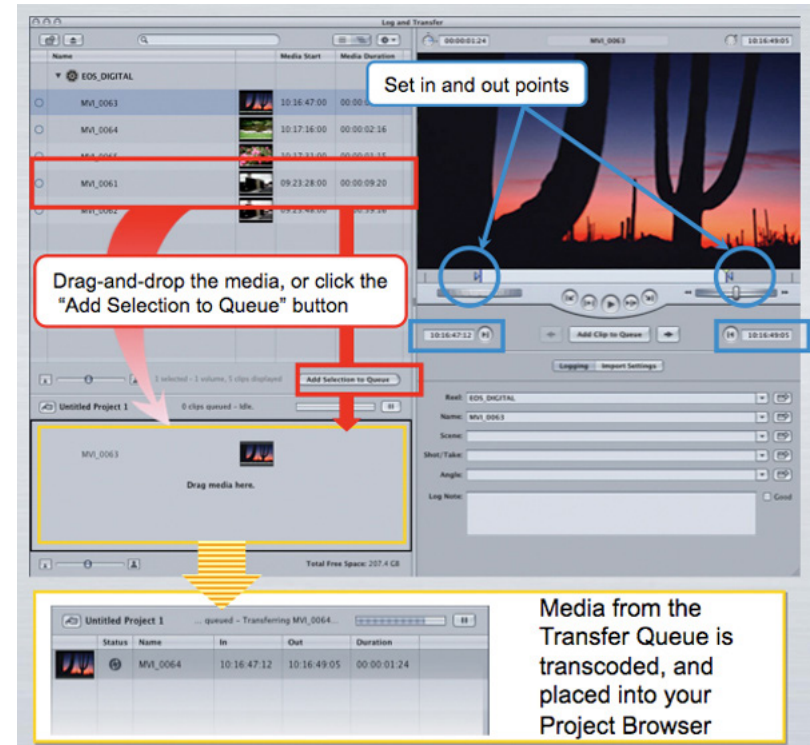

# AUDIO SYNC, DRIFT

How do I ensure my audio perfectly matches my video?



Pluraleyes will take your high-quality audio files and automatically sync them to your “dummy” track.

If you’re shooting separate-system sound, you’ll have separate audio clips on a recorder or memory card and will need to sync them to your video files. However, unlike the old method of using sticks (aka a clapper) and visually matching up the audio waveform to the video by hand, you can use an automated plugin called [Pluraleyes](#). This plugin will take your high-quality audio files and automatically sync them to your “dummy” track (the inferior audio recorded on-camera), as illustrated in [Philip Bloom’s tutorial](#).

Pluraleyes is currently available for [FCP](#), [Vegas](#), and [Premiere Pro CS5](#). If you don’t want to spend \$99 to save a lot of time, or if you’re not syncing all that much material, you can do it by hand. Here’s a video tutorial on the basics of syncing audio manually in FCP, including sub-



frame audio editing to make sure sync is exact:



*This video can be watched on the online version of this chapter, at: <http://nofilmschool.com/dslr/audio-sync-drift/>*

Depending on your DSLR, you might experience audio drift when working with longer sequences. Audio drift is when a shot's audio and video are in sync at the beginning of the shot but not at the end. This is most common with **Canon 5D** footage shot at 30 frames per second, which doesn't conform to the industry-standard 29.97fps. **7** Most NLEs are configured to interpret imported audio at 29.97, not a "true" 30p, and this discrepancy can cause audio sync problems. Many users have reported that slowing audio clips to 99.99% in the editing timeline fixes the problem, but a better solution is to start with the correct setup in **FCP**, which keeps both video and audio at native settings without any drift.

**Bruce Sharpe illustrates this** and even offers the correct FCP setup file for download. If you're using Cineform Neo Scene for transcoding, it should automatically correct this problem, and if you're shooting at 24p, you shouldn't have to worry about drift as long as your sequence presets are correct.

**7** 29.976 frames per second is an industry standard as a result of the legacy NTSC field rate of 59.94 Hz.

# NOISE REDUCTION

What's the best way to get rid of noise in post?

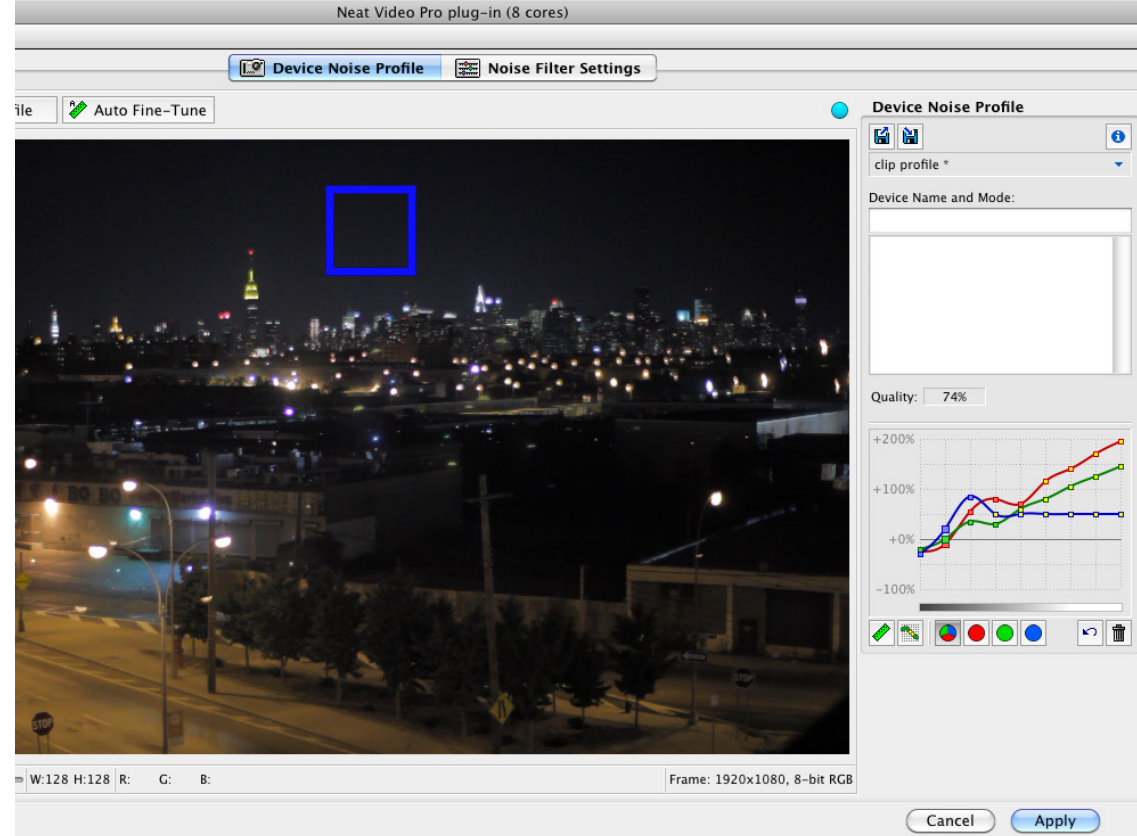

Thanks to the increased sensitivity of large CMOS sensors found in DSLRs, many shooters are now accustomed to shooting in available light, nighttime settings, and other conditions that would've been previously impossible to film under. This is a blessing and a curse; thanks to some [highly publicized demos](#), many DSLR shooters now think their cameras can see in the dark. And while DSLRs are much more sensitive than film stock thanks to sophisticated noise reduction algorithms, high ISO settings are still accompanied by noise.

In an ideal world, you'd still bring in enough light for every scene. But the reality of independent and guerilla filmmaking is such that this is not always possible. You should

Shooting in the dark and applying noise reduction later is not a substitute for lighting – but noise reduction can get you out of a jam.

always try to shoot with enough light to keep the ISO further down on the scale, because in addition to bringing with them more noise, higher ISO settings are also less sharp. Shooting in the dark and applying noise reduction later is not a substitute for lighting – but noise reduction can get you out of a jam.

My favorite noise reduction application is [Neat Video](#). It's an amazingly flexible, customizable plugin for Final Cut, After Effects, Premiere Pro, Vegas, and other host programs as well. The Pro version (which is what you'll want – the Home plugin is restricted to SD resolutions) costs \$99 and pays for itself the first time you use it. Note that you should know your workflow in advance, as each different host program requires a different purchase; I use the After Effects version because I almost always finish using AE, but I won't lie: I wish Neat's license was more liberal (along the lines of, say, Red Giant's Magic Bullet set of plugins, which work in any host program with one purchase). Regardless, tasteful use of Neat Video can save many shots, and it also offers some sharpness controls to regain perceptual sharpness that might've been lost due to high ISO settings.

This image, of the Manhattan skyline as seen from Brooklyn at night, was a noisy shot as a camera original. As



it should've been – the only lights were the ambient lights of the city. As a still image, it looked fine – but in motion, the skyline shimmered with noisy artifacts, which I was able to remove completely using Neat Video. The finished image is rock-solid, sharp, and usable – a perfect example of a situation where we couldn't bring any lights, and thus had to rely on noise reduction in post.



Too much noise reduction can result in an image that appears plasticky.

The effectiveness of Neat Video can be more readily seen in motion than it can in any still I can show you, so take a look at [this video by Photoframd](#) for an example of Neat Video in action. Neat's [examples page](#) also contains some good examples; I can state from experience that Neat can salvage many shots with amazing results.

Just be careful not to overdo it, as too much noise reduction can result in an image that appears plasticky. One further caution: Neat Video is able to use multiple processor cores, but it doesn't (at press time) use your GPU to accelerate its rendering, which means it's slow. Render times can add up quickly, so I recommend applying Neat as a last step and running noise reduction overnight if you must. But when it comes to getting the absolute best image out of your DSLR, using Neat Video is worth the wait.

# COLOR GRADING

How can I modify my image in post to suit my tastes?

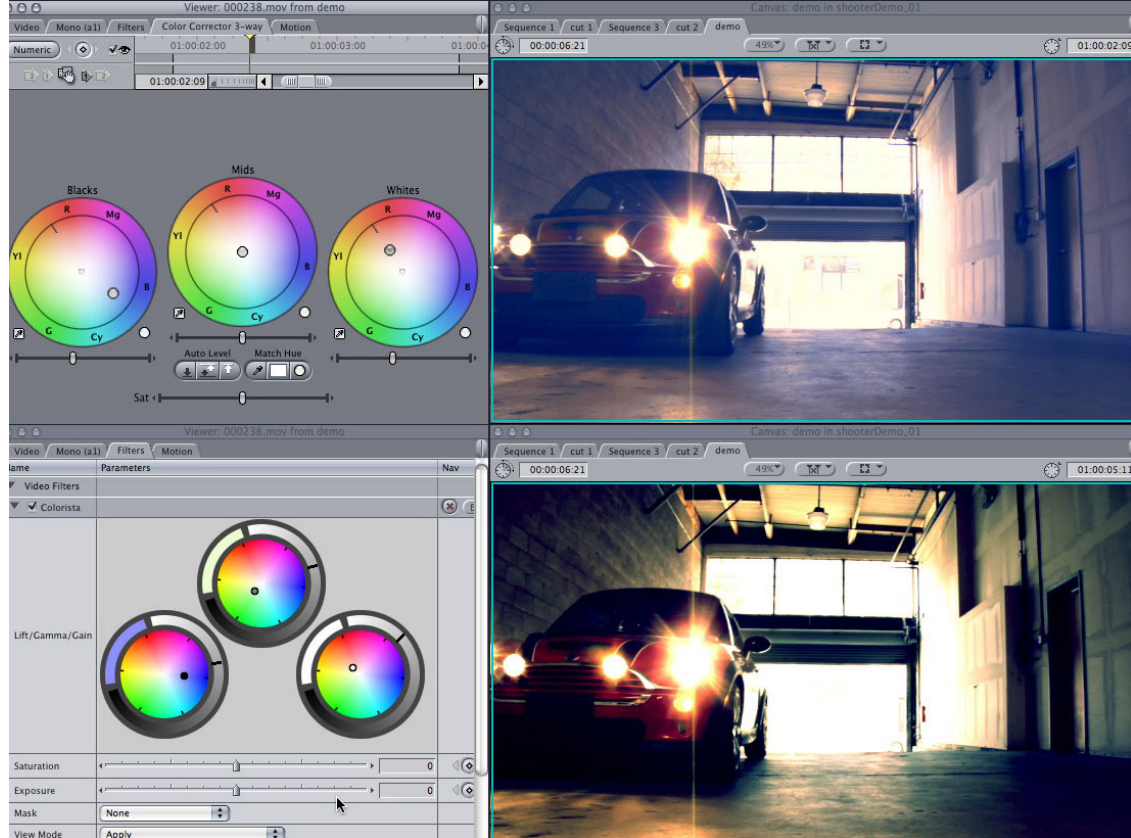

The line between cinematographer and colorist is increasingly blurring.

Color grading is commonly known as “color correction,” but I prefer the more British term “grading” since “correction” implies a colorist’s job is to fix mistakes, when it’s really much more creative than that. In fact, the line between cinematographer and colorist is increasingly blurring, and today you can’t be great at one job if you don’t have a good understanding of the other.

Since this is a “cinematography” guide, I won’t go too deep into grading other than to say that you should absolutely have a project-specific aesthetic in mind before you shoot, as

opposed to figuring it out once the footage is already in your NLE. As for how to grade, [Stu Maschwitz](#) has made a terrific tutorial demystifying color correction using his own software [Magic Bullet Looks](#) and [Colorista](#), collectively part of the [Magic Bullet Suite](#) (of which I'm a user). The techniques presented in the tutorial apply to any three-way color correction tool (such as those included in Final Cut and [Premiere Pro](#), the incredibly deep but frustrating Apple Color, or the oft-overlooked Color Finesse plugin that ships with [After Effects](#)). Here's the tutorial, which focuses on "summer blockbuster" looks:



*This video can be watched on the online version of this chapter, at: <http://nofilmschool.com/dslr/color-grading/>*

Deft use of digital color grading, in conjunction with a DSLR's shallow depth-of-field images, can make for amazing images at incredibly low prices points.

# THANKS FOR READING

## How can I help support NoFilmSchool?

I hope you found a lot of valuable information in these hundred-odd pages! It took me a long time to write, and I hope it helps people shoot better films and save some money too.

One way to support NoFilmSchool is to buy your DSLR gear via the [Amazon](#) and [B&H Photo](#) links in the guide — it doesn't cost you anything, but it might help me get my hands on some more gear, and get some film projects off the ground too. In fact, whatever it is you're looking for, if you click on these links to start your search, you'll be supporting NoFilmSchool at no cost! These merchants give a small percentage to NoFilmSchool, which comes out of their margin (it doesn't cost you a penny). Click on the links on the next page to help out:



A final way to support the site is to share NoFilmSchool around. Post it to your blog, share it via Facebook and Twitter... whatever you can do to spread the word!

Also, be sure to follow us on:

[Facebook](#)

[Twitter](#)

[Vimeo](#)

**We're all in this together.** I believe the opportunity exists for all of us to forge independent, self-sustaining, creatively fulfilling careers — as long as we actively support each other and share what we learn. See you on the site and thanks for reading!



# IMAGE CREDITS

Images in this guide appear courtesy the following sources: Ryan Koo; publicly available product photos; Public Domain or [Creative Commons](#)-licensed images. Page numbers and attributions for Creative Commons images (or images otherwise approved by the source) are as follows:

- 12 – [Scope Aperture](#) by I B Wright
- 13 – [Josefina with Bokeh](#) by Che
- 17 – [Angle of Views](#) by Koyaanis Qatsi
- 19 – [Interlaced video frame \(car wheel\)](#) by Mikus
- 37 – [Rolling Shutter Artefact, again](#) by henry...
- 39 – [Overheating](#) by WolfFang Digital
- 53 – [DOF-ShallowDepthofField](#) by Ligar
- 62 – [139GB, batteries](#) by SoulRider.222