

COMPREHENSIVE HISTORY OF THE MULTI-AGENT SYSTEMS LAB AT THE UNIVERSITY OF MASSACHUSETTS AMHERST 1978 – 2014

Victor Lesser and Daniel Corkill

In the Beginning

The research area now known as multi-agent systems (MAS) was initially called “distributed AI” (DAI). DAI research in the Department of Computer Science at the University of Massachusetts Amherst began shortly after Victor Lesser’s arrival in 1977. This work was inspired by two sources. The first was Lesser’s experiences on the Hearsay-II speech understanding system project at CMU. The second was a suggestion made by Dr. Robert Kahn of DARPA’s Information Processing Technology (IPTO) office at a meeting at CMU in 1976. Dr. Kahn was exploring a new technology called packet radio (now called WiFi), and he suggested that combining packet radio with inexpensive microprocessors to perform distributed interpretation of sensory data was a promising research direction. Processor nodes (agents) would be spatially distributed and interact using low-bandwidth packet-radio communication. Lesser’s experiences with a parallel version of the Hearsay-II speech understanding system [53] caused him to wonder whether the error-resolution techniques in Hearsay-II [54] could also handle the uncertainty in distributed interpretation caused by bandwidth limitations among agents. Lesser’s idea was to use a distributed search among agents, similar in character to the search in Hearsay-II, but in this case using only exchanged high-level abstract hypotheses. This intuition led to the development of one of the first multi-agent systems. That system was called Distributed Hearsay-II and used multi-agent concepts in a simulated distributed sensing application. Distributed Hearsay-II used a problem-solving architecture that was advanced for the time, and it opened up a number of exciting research issues. The Distributed Hearsay-II work was performed jointly by Lesser and CMU professor Lee Erman, and was supported by CMU professor Raj Reddy. This work was reported at the First International Conference of Distributed Processing in 1979 [83], where it was a finalist in the Outstanding Paper Award Competition. A follow-on journal article was published in *IEEE Transactions on Computers* [84].

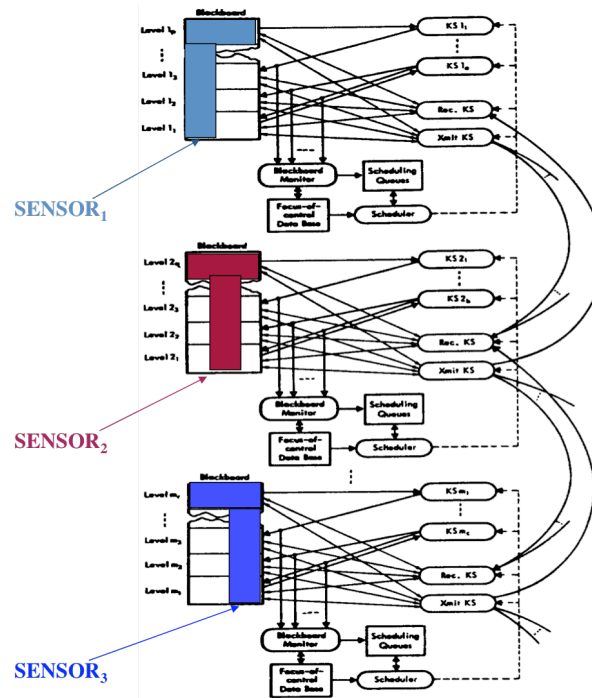

Distributed Hearsay II [84]

The beginnings of what would later become the MAS Lab¹ (originally called the DAI group) can be traced to the summer of 1978 when Lesser first received NSF support. This allowed him to hire his first two graduate students, Richard Brooks and Daniel Corkill. The first paper published by the lab [82] appeared in December 1978 at the first workshop devoted to MAS issues—the DARPA Workshop on Distributed Sensor Nets held at CMU. The MAS Lab also did early work on distributed traffic light control [19] and on distributed planning [28]. The lab’s early MAS research was funded by NSF and DARPA grants² and set a tone for research in the lab. The emphasis was on building complex single-agent and multi-agent testbeds that permit the empirical demonstration of the effectiveness of concepts. In fact one of the last papers published by the lab in 2014 was a re-examination of many of the interesting empirical phenomena that were observed over the years [97]. These research testbeds and application systems were valuable in forcing the lab to address real problems and led to a deep understanding of our research ideas.

The lab’s first MAS testbed was developed in 1978. It was a competitive agent-teaming environment called the Distributed Processing Game that is described succinctly by Filman and Friedman [55, pages 318–319]. The research objective behind the game was direct competitive comparison of two agent teams’ ability to assess the environment, develop strategies, and execute them effectively. Team developers quickly learned that creating an effective team for the game required individual agent and collaboration

¹ The UMass Laboratory for Multi-Agent Systems came into existence as an official entity in 1992 with Lesser as its director.

² Over the years, the MAS Lab has also received considerable funding from the AFOSR through Rome Labs and ONR, and generous donations from Honeywell Research Labs, GTE, Network General Corporation, and Raytheon.

capabilities beyond the techniques available at the time. Nevertheless, the experience provided valuable intuitions about how to design a testbed to be an effective research tool.



Early members of the lab, circa 1981. (Front, from left: Peter Bates, Sherryl Franklin, Richard Brooks, Daniel Corkill. Back, from left: Jasmina Pavlin, Eva Hudlickà, Victor Lesser, Larry Lefkowitz.

The application domains for successor MAS Lab testbeds have included adaptive sensor networks for vehicle tracking and weather monitoring [36, 61, 74, 86], sound understanding [90], information gathering on the internet [94], peer-to-peer information retrieval [141], intelligent user interfaces [39, 68], intelligent home automation [93], distributed traffic light control [19], distributed fire-fighting [101], distributed airport scheduling [108], distributed network diagnosis [124], distributed task allocation [3], multi-agent concurrent manufacturing design [79], circuit-switched and packet network routing [27, 132], and virtual agent enterprises [148]. Associated with these testbeds has also been an emphasis on developing tools for debugging and understanding the functioning of these testbeds [13, 52, 111] and for building them [32, 62, 125].

Single-Agent Research

The lab recognized from the start the important ties between the capabilities of an agent and the capabilities of the multi-agent system. For this reason, research on single-agent systems has gone hand in hand with research on multi-agent systems. The early work on single-agent systems focused on the use of a blackboard architecture as the underlying agent problem-solving architecture, and the lab was at the forefront of blackboard architecture development during the 1980s through the mid-1990s. The lab's contributions to blackboard problem solving include the integrated goal and data blackboard architecture [29], self-aware control through diagnosis of problem solving [67], goal relationships [88], opportunistic planning for blackboard control [20, 48], learning of control strategies [105], and sharing of meta-information [77]. Additionally,

there was the development of the UMass Generic Blackboard System (UMass GBB) [32, 33], an advanced tool for building complex and efficient blackboard applications.³ During this period, there was also initial work on addressing real-time considerations into AI problem solving [44, 48, 87] through structured approximate processing and planning.

From the late 1980s into the 1990s, the lab worked with Professor Hamid Nawab of Boston University to develop an advanced architecture for signal understanding. This research introduced a number of novel ideas on signal reprocessing. This architecture, called IPUS, was used to develop the most advanced sound-understanding application of the time. In IPUS, inconsistencies in higher-level results were used to direct the reprocessing of the raw input data with new parameters [90] and was built on RESUN framework that allowed opportunistic control planning based on the sources of uncertainty in the current interpretation of the data [20]. IPUS included a component that learned a symbolic representation for new sounds based on detected inconsistencies with existing sound models [17].

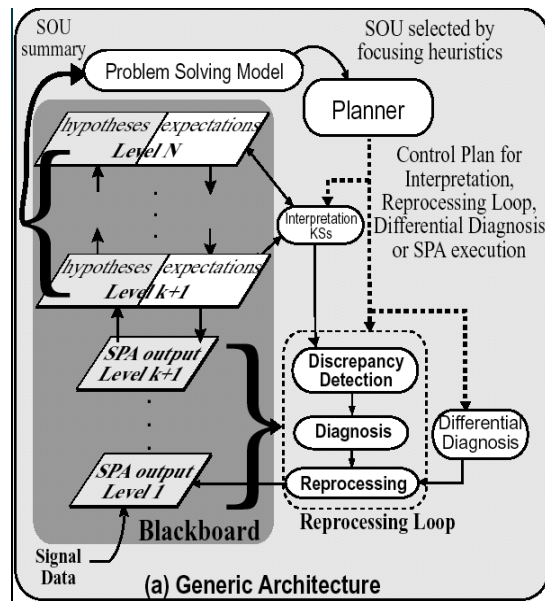

IPUS Architecture [90]

In the 1990s, the lab formalized blackboard problem solving through the development of the IDP/UPC framework based on the use of stochastic attribute grammars [129]. During this period, there was also work on a more principled view of parallelism in blackboard problem solving [43] and production systems [107]. In the late 1980s, the lab did some of the first work in the area of software process modeling based on AI planning and plan recognition techniques. This work was used as part of intelligent user interfaces [67, 78]; in later work on this area it was expanded into a multi-agent context [45]. More recently, the lab worked on a decision support tool for managing dynamic business processes [34].

In the mid-1990s, the lab began to focus agent and multi-agent problem solving on

³ UMass GBB was distributed to over 300 sites worldwide.

the TAEMS hierarchical task network structure [42, 59].⁴ Using TAEMS, work was done on real-time issues under the title of Design-to-Time and Design-to-Criteria planning and scheduling [57, 126, 128]. The lab built several tools based on this representation, which are downloadable from the MAS website.

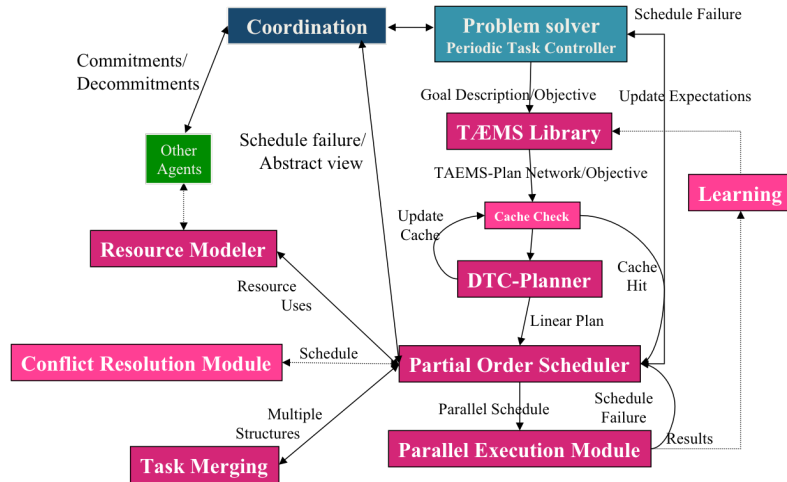

SRTA: *Soft Real-time Agent Architecture* [65]

A major use of the TAEMS tool set occurred in 2004 when the lab built a fully functioning adaptive real-time distributed sensor network running on actual hardware [61]. This application included a soft real-time agent architecture, called SRTA [65]. In the late 1990s, the TAEMS tool set was used to build an advanced real-time information-gathering agent on the internet, called BIG [94]. Finally, we worked on an agent architecture with meta-level control that uses a learned MDP with states representing abstractions of the underlying system state to make meta-level decisions about how to dynamically balance the amount of computational resources allocated for control versus domain problem-solving activities [112].

Multi-Agent Research

The lab has made a number of important contributions to the field of multi-agent systems. These contributions can be grouped in terms of research performed during three eras (DVMT, GPGP/TAEMS, ORG), each lasting over a decade. Within each era, the contributions are arranged in terms of five major research areas of multi-agent systems: Cooperative Distributed Problem Solving, Coordination, Organizational Control, Negotiation, and Multi-Agent Learning.⁵

- **Cooperative Distributed Problem Solving (CDPS)** research represents paradigms and algorithms for how cooperative agents work together to solve a problem. It also addresses the techniques for local problem solving in agents in the face of uncertainty and how results of one agent's local problem solving are used in other agents' local

⁴ A modified version of TAEMS [18] was used by the COORDINATORS program funded by DARPA's IPTO [95].

⁵ Three survey articles provide additional background on what has been perceived by the lab as important multi-agent systems research topics [50, 91, 92].

problem solving.

- **Coordination** research involves multi-agent control techniques for introducing coherency into the computational and communication activities of agents who work together. It uses short-term agreements among agents to perform specific activities for certain periods of time. This type of control can be considered as operational or tactical, and is dynamic and short-term in character.
- **Organizational Control** investigates approaches for scaling multi-agent systems to large numbers of agents. Organizational control is a multi-level approach in which long-term organizational goals and roles including communication patterns are used as guidelines for agents' detailed operational decisions. It represents more strategic, long-term control decisions than the tactical, short-term control decisions used in coordination.
- **Negotiation** involves protocols and reasoning necessary for agents to come to agreement over a set of issues where they have different perspectives based on their local knowledge and objectives.⁶
- **Multi-Agent Learning** uses techniques for long-term adaptation of agent activities based on agents' experiences resulting from interacting with other agents and the environment.

Even though these research areas are tightly intertwined and it is sometimes difficult to decide which category specific work fits into, classifying research into these areas clarifies how research efforts are interrelated across eras.

The DVMT Era

The first era, called the DVMT era, spanned the 1980s and early 1990s. It is called the DVMT era because the DVMT (Distributed Vehicle Monitoring Testbed) was the distributed sensor network application in which the lab conducted most of its research during this period. This was one of the first large-scale and well-instrumented testbed developed for AI research. This era focused mainly on generalizing the Distributed Hearsay-II effort; however, there were many efforts to broaden the lab's research focus beyond distributed interpretation. An overview of the research in this era is described in a retrospective article [89]. The major contributions of this era include:

- **Cooperative Distributed Problem Solving**
 - The Functionally Accurate Cooperative paradigm (FA/C) was developed as a way of structuring a cooperative distributed problem-solving system where inconsistency among different agent views can be tolerated. Through a high-level agent dialogue that implements a distributed search, most inconsistencies can be resolved without synchronization or significant transfer of information among agents [85, 89]. This was the first work to enunciate the idea that it is

⁶ Negotiation techniques can be used for coordination and, in many cases, the research described here has that character. However, it is also broader in scope, and for that reason negotiation research is a separate category from coordination.

more appropriate in a multi-agent system to focus on managing uncertainty rather than eliminating it, and on “satisficing” rather than optimizing.

- The Distributed Vehicle Monitoring Testbed (DVMT) was created as a testbed (based on a distributed sensor network application) in which issues in cooperative distributed problem solving could be studied empirically [86]. This testbed received a lot of attention from the AI community as a framework for doing empirical experimentation.
- A model for CDPS that integrated task- and result-sharing computational models was developed [75].
- Work on distributed constraint satisfaction was performed at the end of this era. This research involved a circuit-switched network routing application with complex constraints. This work resulted in an early and influential work on a distributed constraint-satisfaction algorithm that was guaranteed either to find a complete solution or to indicate that there was no complete solution possible; in the latter case, the algorithm would find a solution that solved the largest number of high-level constraints (goals) [27].

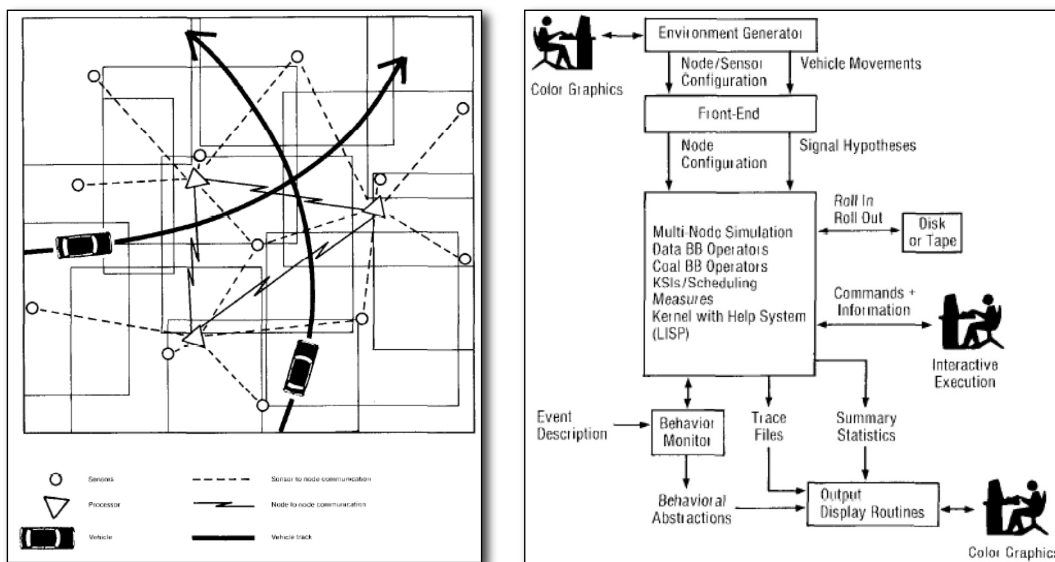

The Distributed Vehicle Monitoring Testbed [86]

- **Coordination**

- During this era an increasingly sophisticated set of coordination techniques were developed for the DVMT (many using meta-level information and more advanced local problem-solving architectures) culminating in the creation of the Partial Global Planning (PGP) coordination framework.⁷ PGP was the first to show how multi-agent planning could be used to solve complex agent

⁷ A comprehensive overview of the development of coordination mechanisms based on the DVMT during the 1980s is provided in a 1991 journal article [89].

coordination issues in computationally realistic times [51]. It also explored such meta-level control issues as the trade-off between responsiveness (and the associated coordination overhead) and predictability in coordination mechanisms [47]. The PGP work was a co-winner of the Influential Paper Award at the 2008 AAMAS conference.

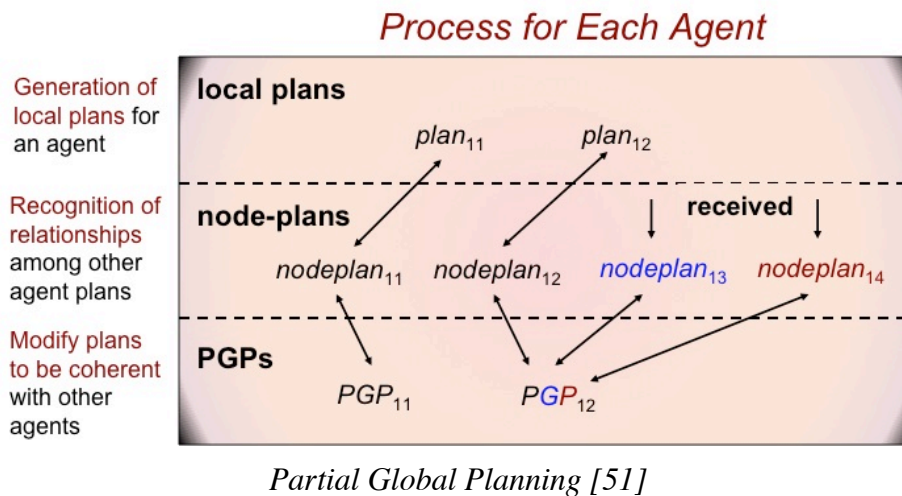

- **Organizational Control**

- The first framework for organizational control in a multi-agent system was developed and its utility was demonstrated experimentally [30, 31]. Interest area specifications were used to represent organizational guidelines. An advanced local control structure that was guided by these interest area specifications was also developed [29]. This work further introduced the benefit of an organization composed of skeptical agents.
- Experimental work based on the PGP coordination framework showed the advantages of hybrid organizational control; in this case, having different organizational control regimes for control and domain problem solving [51].
- EFFIGY, the first automated system for creating an organization design was developed for a distributed sensor network application [110].

- **Negotiation**

- Three separate investigations explored the use of negotiation in multi-agent systems. The first involved the development of a multi-attributed, multi-step negotiation protocol for a multi-agent planning application involved in distributed fire-fighting teams [101]. The second investigation used a negotiated-search protocol for concurrent design where the agents used a centralized blackboard to interact by posting not only partial designs, but also meta-level characterization of their local design spaces [76, 77]. The third investigation involved integrating a multi-step negotiation protocol into the PGP coordination framework for performing task decomposition and allocation [49].

The GPGP/TAEMS Era

The second, GPGP/TAEMS era lasted through the late 1990s and early 2000s. A major focus of this era was generalizing the experiences from the DVMT era; in particular, understanding how the experiences in developing coordination techniques for distributed sensor interpretation application domains could be applied to other types of multi-agent application domains. This generalization process began with seeing coordination in terms of a distributed search on a hierarchical goal tree that was distributed among the agents; there were also relationships among goal within and across agents; these relationships were based on resources and data needed to solved goals, how the solution to specific goals related to each other, precedence relationship, etc. [68,70]. This era also included the lab's continuing effort to broaden its research focus by initiating research into self-interested agents and application domains that involved distributed scheduling. The contributions of this era include:

- **Cooperative Distributed Problem Solving**
 - The DRESUN framework for distributed interpretation applications was developed based on our earlier work on the RESUN opportunistic planner [20]. This work showed how a sophisticated approach to uncertainty management in the local agent problem solving, in conjunction with a simple communication protocol based on uncertainty resolution, could be used to generate complex, multi-step dialogues among agents [21].
 - A concept called domain monotonicity was introduced [22, 23] to explain why, for many application domains, once a certain level of belief was reached by an agent about its best hypothesized local solution to its part of the problem (in the context of limited information received from other agents about their best local solutions) it was likely to be part of the correct overall solution to the problem. This work provided an explanation for why FA/C systems created the correct solution a high percentage of the time without significant communication of local state among agents.
- **Coordination**
 - The first generic, quantitative and deadline-based framework for complex agent coordination was created, called Generic Partial Global Planning (GPGP) [40, 46, 96]. The generic aspects of the framework were accomplished through the specification of agent activities in the TAEMS hierarchical task network model, which included quantitative information about task performance and coordination relationships among tasks [42]. This body of work included a new approach to coordination based on reasoning about uncertainty in commitments that received a Best Paper Award [130].⁸ The GPGP work received a special recognition award in 2006 for foundational research in generalized coordination technologies from the Information Processing Technology Office at DARPA.

⁸ A comprehensive overview of the development of GPGP during this era is provided in a 2004 journal article [96].

- A variety of new coordination techniques were developed for a complex distributed scheduling application [26, 108]. This work showed the need for an approach to coordination of distributed schedulers that at times required a centralization of scheduling when there were very complex interdependencies among the schedules of different agents [109].

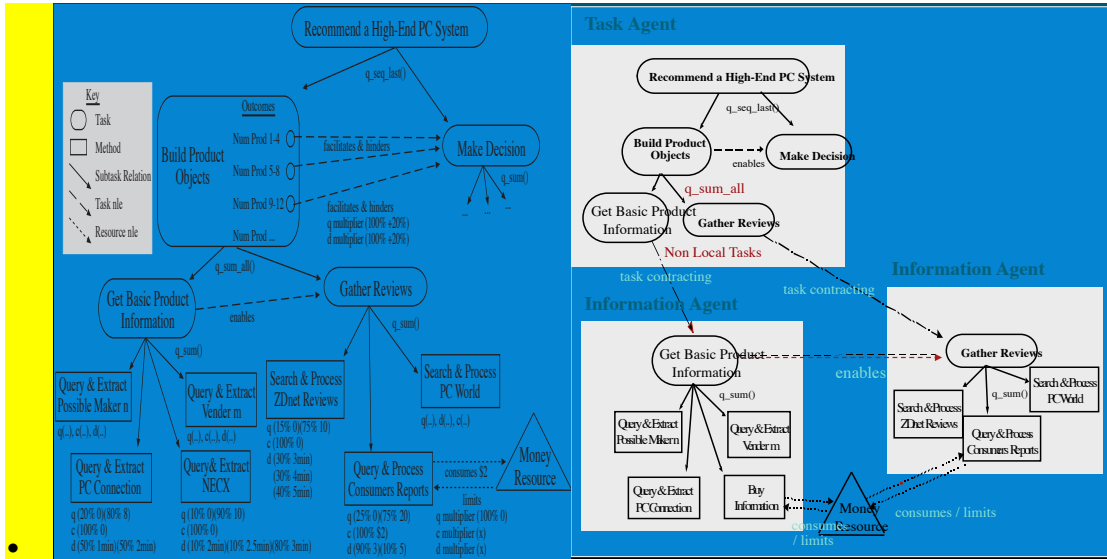

• *TAEMS Hierarchical Task Network [42,96]*

- An analytical model for a simple coordination protocol (in an abstract task allocation problem) was developed that showed the utility of meta-level information when there is uncertainty about agent activities [41].

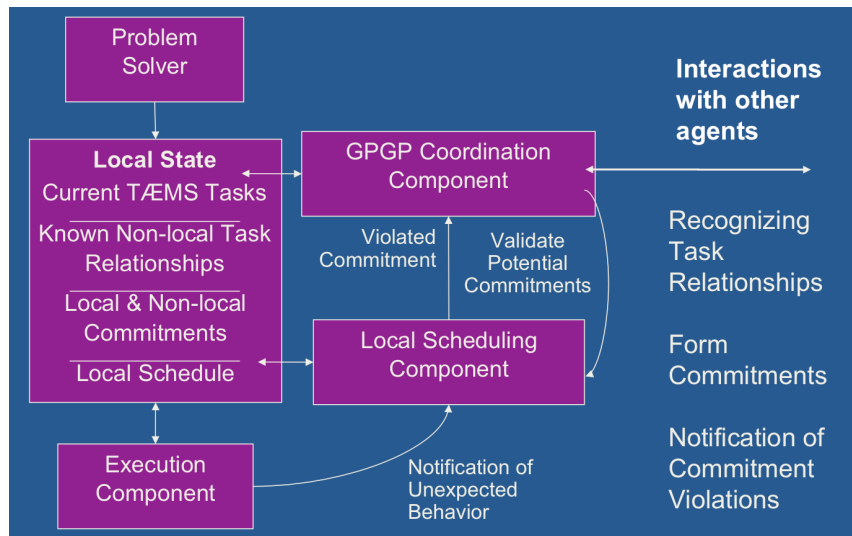

GPGP Agent Architecture [96]

- **Organizational Control**

- The MQ agent control architecture for use by organizationally situated agents

was developed. This work recognized the need for a more complex view of an agent's local utility calculations in an organizational setting [127].

- **Negotiation**
 - This work articulated and provided solutions for many of the issues in negotiation [114]⁹ and coalition formation [115] when there were realistic limitations on computation and communication capabilities. It also created a backtracking instrument for negotiation, called leveled-commitment contracts, to accommodate future events that are uncertain due to incomplete information or computational limits [116]. This latter work was a finalist for the Influential Paper Award at the 2008 AAMAS Conference.
- **Multi-Agent Learning**
 - This research showed that a variety of single-agent learning technologies (reinforcement learning, instance-based learning, and case-based learning) could be applied to long-term adaptation of multi-agent control in complex applications with positive results [105, 106, 124].

The ORG Era

The third era, called the ORG era, started in the early 2000s and lasted until the lab's closure. Its name signifies a major theme of the lab's efforts during this period of developing techniques for scaling multi-agent systems based on organizational control. In part, this emphasis came out of a project that consumed a tremendous amount of the lab's effort early in the era. This project involved building a distributed sensor network for real-time vehicle tracking, containing potentially hundreds to thousands of adaptive sensor/processor nodes [61, 95]. As in other eras, there has been a diversity of research efforts, though in the ORG era it seems that the efforts are more diverse than in the past. However, most efforts can be easily allied with research directions started in the previous eras.

⁹ Although the important research on negotiation represented by the TRACONET system [113] was not conducted at this lab, the write-up for the work was completed here.



Real-time Distributed Sensor Network for Vehicle Tracking [61,95]

The major contributions during the early part of this era (2001–2008) included:

- **Cooperative Distributed Problem Solving**
 - A new approach, called Asynchronous Partial Overlay (APO), for solving distributed constraint satisfaction and optimization problems was developed. APO was based on the powerful idea of dynamic partial centralization [98, 99, 100].
- **Coordination**
 - In collaboration with Professor Shlomo Zilberstein, the lab was at the forefront of a recent movement in the MAS community to use Decentralized Markov Decision Process (DEC-MDPs) [14, 15, 16, 58, 130, 131] as a formal basis for understanding and implementing multi-agent coordination. The lab won two best paper awards in this area [15,16]. In addition, there was formal work on defining the complexity of solving DEC-MDPs in terms of the amount of information that needs to be communicated among agents either implicitly or explicitly in order to find a solution [121].
 - A formal framework was developed for trading off communication for reduced utility by representing the problem as DEC-MDP [117]. This work was done in the context of distributed Bayesian Networks, and included the first work to automate the generation of abstractions for use in reducing communication bandwidth in a multi-agent context [120].
 - An approach for meta-level reasoning in a multi-agent context was created based on learning an MDP controller. The MDP controller made decisions for an agent about how much effort to spend on local planning, scheduling and negotiation with other agents, in contrast to doing local domain problem solving [112].

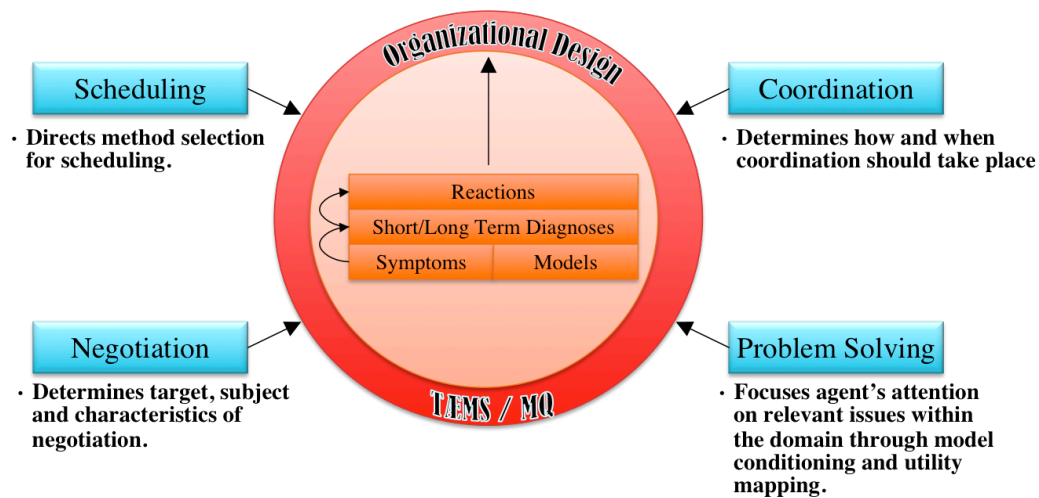

Organizational Adaptation [60]

- **Organizational Control**

- Work in organizational control resulted in new techniques for organizational design, analytic modeling of organizations, and organizational evolution in diverse applications: distributed sensor networks [61, 64, 66, 123], distributed task allocation [1, 2, 3] and peer-to-peer information retrieval [140, 141, 142, 143, 144]. The highlights of this work include:
 - The development of a fully functioning agent-based distributed, adaptive real-time sensor application that showed the utility of using organization control [61].
 - The creation of analytic models that predicted the performance of a number of multi-agent applications with organizational control [64, 66].
 - The building of two different search frameworks, ODML and KB-ORG, for automated organizational design based on a quantitative perspective on organizational performance [66, 123].
 - The demonstration of organizational adaptation and self-design [3, 60, 122, 141, 143].
 - A comprehensive survey of different approaches to organizational control in multi-agent systems [63].

- **Negotiation**

- Techniques were developed for controlling multi-linked negotiation involving concurrent negotiations within and spread across multiple agents, and negotiation among semi-cooperative agents where the agents are neither fully cooperative nor totally self-interested [74, 118, 119, 146, 147, 148, 150]. There was also work on techniques for multi-level negotiation in which negotiation at an abstract level is first completed, and then refined, based on more detailed

negotiation [145].

- **Multi-Agent Learning**

- A new multi-agent reinforcement learning algorithm called the Weighted Policy Learner (WPL) was created, which allows agents to reach a Nash Equilibrium (NE) with minimum knowledge [2, 4]; it was applied to the problem of distributed task allocation with larger numbers of agents. This work also includes organizational self-design where, as part of the learning process, agents can change the overlay network that indicates which agents are their neighbors so as to minimize communication delays [3].

From 2005 through 2011, the lab was involved in a major project based in the NSF Engineering Research Center at UMass, called CASA (Collaborative Adaptive Sensing of the Atmosphere), working with the center on developing distributed control and optimization algorithms for control of adaptive radars for forecasting severe weather conditions for a system called DCAS [74].¹⁰ It was exciting to see Agent and MAS technology applied to a real and successful system that was field tested in Oklahoma. It was also surprising to come full circle on this project, in that a blackboard-like architecture was at the heart of the NETRAD (now called DCAS) agent architecture. Additionally, the lab more directly continued to do research on blackboard architectures with the work on GBBopen [35].

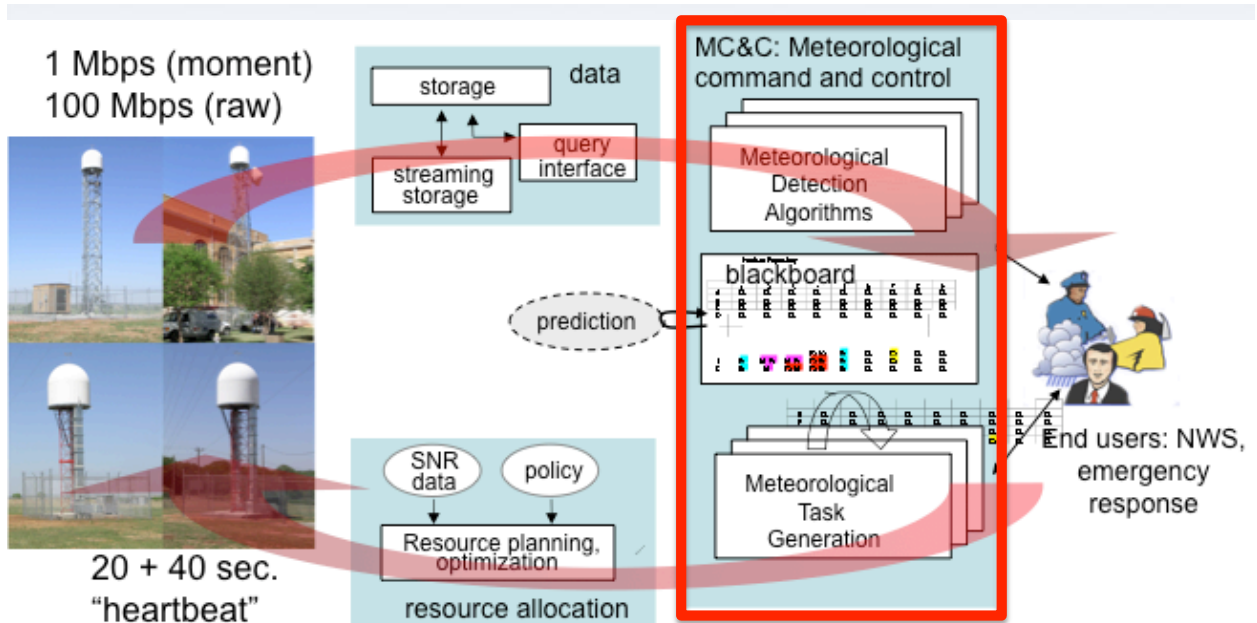

The DCAS Severe Weather Radar Detection and Tracking System [152]

¹⁰ Mike Krainin, a former undergraduate research assistant in the lab, won a Goldwater Fellowship and an honorable mention in the CRA undergraduate research competition based on his CASA research work [74].

Research Directions from 2008–2014

The three major research efforts during this last period involved multi-agent learning in an organizational context, the development of organizational adept agents, and learning using only a few examples based on the integration of diverse learning components [149]. Other projects during this period focused on bargaining for multiple resources in a market setting, development of improved algorithms for distributed constrained optimization algorithms, and power aware sensor network architectures [36].

The major contributions during the last part of the lab’s history (2008–2014) included:

- **Cooperative Distributed Problem Solving**
 - A more efficient version of the Max-Sum approximate Decentralized Constraint Optimization (DCOP) algorithm was developed based on a two-level hierarchical message-passing scheme. This scheme exploits many variables to one agent mapping given by the underlying domain hardware structure [71].
 - An algorithm was developed that lowers computational difficulty in solving m-ary DCOP with general constraint functions [72].
 - A new approach for solving DCOPs, called DJAO, was created based on combining two well-known DCOP algorithms, ADOPT and Action-GDL. It is based on AND/OR junction graph for efficient distributed search. This algorithm significantly reduces communication overhead without losing accuracy [73].

- **Coordination**
 - A domain-independent approach was developed, using a new interaction measure, that allows agents to dynamically identify their beneficial coordination set (i.e., whom to coordinate with) in different situations and to trade off its performance and communication cost. By limiting their coordination set, agents dynamically decompose the coordination network in a distributed way, resulting in dramatically reduced communication without significantly affecting overall performance. This was applied to a multi-agent learning problem [139].
 - A new formal framework, EDI-CR, was created for specifying both Partially Ordered Stochastic Games (POSG) and DEC-MDP problems that allows for the development of more efficient algorithms for approximately solving these problems when communication is permitted. This new framework integrates the work on both transition-independent and event-driven interaction DEC-MDPs and provides representational efficiency when agents are loosely coupled [103, 104].
 - In collaboration with Professor Anita Raja, we developed distributed techniques for learning multi-agent meta-level control; a local agent-based

reinforcement learning algorithm was combined with a local agent neighborhood optimization algorithm to learn multiagent meta-level control agent policies in a decentralized fashion. We then augment the agent with a heuristic rule-based algorithm that uses information provided by the reinforcement learning algorithm in order to resolve conflicts among agent policies from a local perspective at both learning and execution stages. [25].

- **Organizational Control**

- A formal model for agent interaction was defined and used to dynamically evolve an appropriate supervisory control organization as part of the ongoing agent learning; this dual-learning approach showed better performance than a static approach—an unexpected result [136]!
- An organizationally adept software agent (OAA) was built that can reorient its local activities based on its interpretation of organizational intent, allowing emergent and adaptive organizational behavior within designed organizations. One of the novel ideas explored in this work is the use of annotated organizational guidelines that provide performance expectations that can be used by an OAA to improve its local decision-making and to help it detect when its organizational guidelines are no longer appropriate for the current environment [37].
- It was empirically demonstrated that “the sweet spot” organizational hypothesis, which posits that only as the overall workload approaches the limit of agents’ capabilities is effective organization control crucial to success. As part of this work, measures were created that can be used to assess the potential benefit of organization in a specific setting and whether the organization design must be highly effective [38].

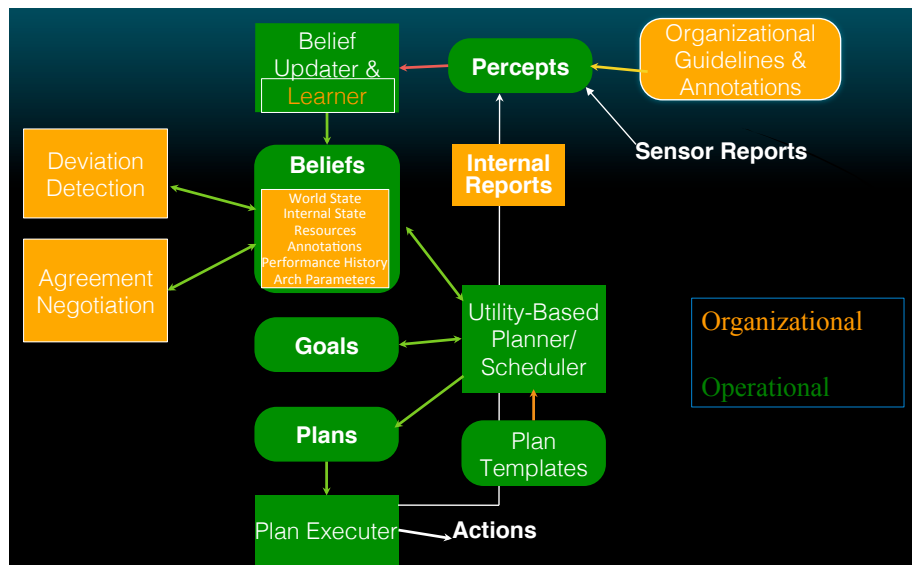

An Organizationally Adept Agent based on a BDI Architecture [37]

- **Negotiation**

- The first algorithm for finding pure strategy equilibria in bilateral bargaining with uncertainty was developed; Additionally, the first formal analysis of concurrent negotiation was conducted [6]. As part of this work, an algorithm based on backward induction to compute the subgame perfect equilibrium of concurrent one-to-many negotiation and many-to-many negotiation was constructed [12].
- New heuristics were created for applying complex negotiation mechanisms to realistic applications where multiple resources from separate buyers need to be acquired in order for a task to be successfully completed; this work showed the importance of both decommitment mechanisms that allowed for multiple tentative resource contracts and dynamically adjusting the reserve price associated with a specific resource based on the on-going overall negotiation process [5, 10, 11]. This approach was evaluated in a realistic real-time cloud computing application based on Amazon's cloud, and showed superior performance to that of other known approaches, including a centralized combinatorial auction. This is a surprising and important result [7].
- The lead author of this body of work on negotiation, Bo An, won the 2010 IFAAMAS (International Foundation for Autonomous Agents and Multiagent Systems) Victor Lesser Distinguished Dissertation Award.

- **Multi-Agent Learning**

- The first practical approach to scaling reinforcement learning to thousands of cooperating agents was created, based on the idea of low-overhead organizational-based supervisory control based on domain-dependent knowledge. This novel approach exploits non-local information to dynamically coordinate and shape learning processes of individual learning agents while still allowing agents to react autonomously to local feedback [135, 151].
- Supervisory control was also exploited to adaptively identify opportunities to periodically transfer experiences among cooperating reinforcement learning agents, based on dynamically identify agents operating under approximately similar dynamics [56].
- A domain-independent supervisory control was developed for learning Networked Distributed POMDPs [138, 139].
- In collaboration with Professor Anita Raja, a new approach to multi-agent reinforcement learning was created where the agent's learning state space is gradually increased as the need for a more non-local view of neighboring agents is recognized because of conflicts among its actions and those of its neighbors [24].
- A new multi-agent reinforcement learning algorithm was created based on the idea of policy prediction; this algorithm had better convergence

properties than existing approaches [137].

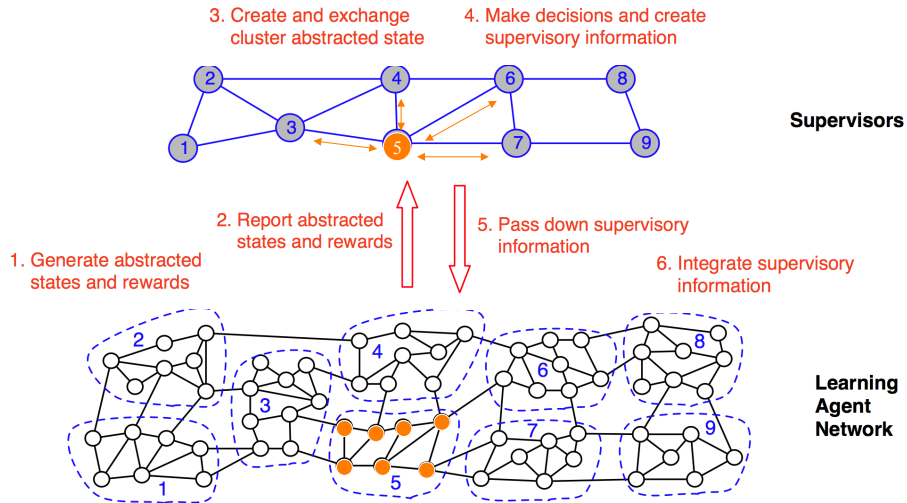

Supervisory Control of Multi-Agent Learning [135]

MAS Lab Closure

It was with a tinge of sadness but also with great pride that, after 36 years, we closed the Multi-Agent Systems Lab in December 2014. In November 2014, the lab's last PhD student graduated and our sponsored research efforts were completed. It felt like the appropriate time.

Since its inception the lab has been pursuing a distributed model of computation involving a network of cooperating, intelligent agents—potentially encompassing both people and computers. Our work has been strongly motivated by practical applications but hopefully never losing sight of the more general domain-independent implications of our solutions and wherever possible trying to construct formal models and analysis. The goal of this work is to create a modular and scalable frameworks for building complex distributed problem-solving applications that operate in open environments where there is limited communication and a wide range of task and environmental uncertainties. Implicit in this work has been the desire to understand deeply the nature of coordination and cooperation, both from an empirical and theoretical perspective.

This has led us to explore a number of larger research issues, many of which have been in one way or another an implicit motivator of the lab's research since the beginning:

- How to create computationally practical models/theories for cooperation/coordination that exploit the characteristics of the underlying domain to make them more useable in realistic distributed applications?
- How does the nature of local problem-solving need to change when it is done in the context of other agents?

- How to scale up multi-agent systems to hundreds or thousands of agents? this includes issues involved in creation of agent organizations and the associated issue of how they are assembled in the marketplace of agents; how their structure is determined and evolves; how designed and emergent organizations can be integrated; and how to construct organizationally situated agents.
- How to formally characterize the interdependencies among agent activities and relate that characterization to the appropriate satisficing multi-agent coordination protocol, given specific resource constraints and utility criteria? More generally is there a theory of distributed search that can explain and encompass all the different mechanisms that can be used to coordinate agent activities?
- How can agents adapt their activities from both a short- and long-term perspective—what are appropriate learning mechanisms in a multi-agent context? This also includes the question of how emergent behavior arises?
- How to develop an integrated view of “satisficing” (a formal perspective) that takes into account approximate problem solving, partial and abstract communication of problem-solving results, and approximate coordination?
- How is coordination of cooperative versus self-interested agents different. Is there a unifying theme that will bridge what are now perceived as very different subfields of MAS? What are mechanisms for agents to coordinate when balancing local (self-interested) and non-local concerns (social welfare – cooperative)?
- How can different representations of agent activities — for instance, at the network transport level and at the organization level — interact in order to adapt their local policies/strategies to the needs of other levels?

One of the key approaches that has been pursued by the lab is the development of self-aware agents that reason about their own local state as well as the goals, plans, intentions, and knowledge of other agents in deciding how to interact with them. This reasoning can be more complex potentially than that required for domain problem solving. Agents, and the system as a whole, operate in a “satisficing” mode—doing the best they can with the current resource constraints. In such systems, managing uncertainty is as an integral part of network problem solving. Agents of necessity are highly adaptive and function in a way that leads to highly reliable systems. They are able to adapt their problem-solving structure to respond to changing task and environmental situations in both short- and long-term ways. These systems can involve tens to hundreds (and more) of agents, requiring complex organizational relationships among agents. There is much work left for the full potential of this model to be realized. The challenges of this realization are as exciting and interesting as in the first days of the lab’s existence but we now must leave it to other researchers to do continue this work.

When the lab was formed, the MAS community consisted of only a handful of researchers, and there were no conferences or workshops focused on this area. It is very rewarding that the MAS community now consists of thousands of researchers, and there are a large number of workshops, conferences, and journals featuring autonomous agents and multi-agent research. We are pleased to have played a role in the creation and success of this community. In total, the lab published over 400 papers (many highly cited),

graduated 35 PhD students (a number of whom are now leading researchers in the community) with 94 PhD descendants, and hosted a large number of extended visits by international researchers (see Appendix A of detail listing of lab personnel).

In the final analysis, the longevity and success of the MAS Lab as an exciting and innovative place to investigate issues in autonomous agents and multi-agent systems stemmed from all the wonderful graduate students, colleagues, and visitors who worked with us over the years. We thank all of you for making our lives so rich. We also must extend a special thanks to the lab's business manager/grant administrator for a large part of its history, Michele Roberts, whose hard work, intelligence, and foresight kept thing functioning smoothly.

Victor R. Lesser, Director
Distinguished Professor Emeritus

Daniel Corkill, Associate Director
Senior Research Fellow



Computer Science Building

References

1. Abdallah, Sherief; Lesser, Victor (2005). "Modeling Task Allocation Using a Decision Theoretic Model." *Proceedings of Fourth International Joint Conference on Autonomous Agents and Multiagent Systems*, ACM Press, pp. 719–726.
2. Abdallah, Sherief; Lesser, Victor (2006). "Learning the Task Allocation Game." *Proceedings of the Fifth International Joint Conference on Autonomous Agents and Multi-Agent Systems*, ACM Press, pp. 850–857.
3. Abdallah, S.; Lesser, V. (2007). "Multiagent Reinforcement Learning and Self-organization in a Network of Agents." *Proceedings of the Sixth International Joint Conference on Autonomous Agents and Multi-Agent Systems*, Honolulu. IFAAMAS, pp. 172–179. Best Paper Award finalist.

4. Abdallah, Sherief; Lesser, Victor (2008). "A Multiagent Reinforcement Learning Algorithm with Non-linear Dynamics." *Journal of Artificial Intelligence Research*. Volume 33, pp. 521–549.
5. An, Bo; Gatti, Nicola; Lesser, Victor (2009). "Bilateral Bargaining with One-Sided Two-Type Uncertainty." Proceedings of 2009 IEEE/WIC/ACM International Conference on Web Intelligence and Intelligent Agent Technology, Milan: IEEE Computer Society, Vol. 2, pp. 403–410.
6. An, Bo; Lesser, Victor; Irwin, David; Zink, Michael (2010). "Automated Negotiation with Decommitment for Dynamic Resource Allocation in Cloud Computing." Proceedings of the 9th International Conference on Autonomous Agents and Multiagent Systems, Toronto. IFAAMAS, pp. 981–988.
7. An, Bo; Lesser, Victor (2010). "Characterizing Contract-based Multi-agent Resource Allocation in Networks." *IEEE Transactions on Systems, Man and Cybernetics: Part B*, Vol. 40 (3): 575–586.
8. An, Bo; Lesser, Victor (2011) "Negotiation over Decommitment Penalty" Umass Department of Computer Science; Technical Report 2011-009.
9. An, Bo (2011). Automated Negotiation for Complex Multi-Agent Resource Allocation. Ph.D. Thesis.
10. An, Bo; Lesser, Victor; Westbrook, David; Zink, Michael (2011). "Agent-mediated Multi-step Optimization for Resource Allocation in Distributed Sensor Networks." Proceedings of the 10th International Conference on Autonomous Agents and Multiagent Systems–Innovative Applications Track. Tumer, Yolum, Sonenberg and Stone (eds.), Vol. 2, pp. 609–616.
11. An, Bo; Lesser, Victor; Sim, Kwang Mong (2011). "Strategic Agents for Multi-Resource Negotiation." *Autonomous Agents and Multi-Agent Systems*. Springer Netherlands. Vol. 23 (1): 114–153.
12. An, Bo; Gatti, Nicola; Lesser, Victor (2013). "Bilateral Bargaining with One-Sided Uncertain Reserve Prices." *Autonomous Agents and Multi-Agent Systems*, Springer, 26 (3): 420–455.
13. Bates, P.C.; Wileden, J.C.; Lesser, V.R. (1983). "A Debugging Tool for Distributed Systems." *Proceedings of the Second Annual Phoenix Conference on Computers and Communications*, pp. 311–315.
14. Becker, Raphen; Zilberstein, Shlomo; Lesser, Victor; Goldman, Claudia (2004). "Solving Transition Independent Decentralized Markov Decision Processes." *Journal of Artificial Intelligence Research*, Vol. 22, pp. 423–455.
15. Becker, Raphen; Lesser, Victor; Zilberstein, Shlomo (2005). "Analyzing Myopic Approaches for Multi-Agent Communication." *Proceedings of the 2005 IEEE/WIC/ACM International Conference on Intelligent Agent Technology*, IEEE Computer Society, pp. 550–557. Winner of the Best Paper Award.
16. Becker, Raphen; Carlin, Alan; Lesser, Victor; Zilberstein, Shlomo (2009). "Analyzing Myopic Approaches for Multi-Agent Communication." *Computational Intelligence*. Volume 25, Number 1, Blackwell Publishers, pp. 31–50. (An earlier version of this paper was the winner of a best paper award; Becker, Raphen; Lesser, Victor; Zilberstein, Shlomo (2005). "Analyzing Myopic Approaches for Multi-Agent

- Communication.” *Proceedings of the 2005 IEEE/WIC/ACM International Conference on Intelligent Agent Technology*, IEEE Computer Society, pp. 550–557.)
17. Bhandaru, M.; Lesser, V. (1998). “Discrepancy Directed Model Acquisition for Adaptive Perceptual Systems.” *Computational Auditory Scene Analysis*, Rosenthal and Okuno (eds.), NJ: Lawrence Erlbaum Associates, pp. 215–232.
 18. Boddy, M., Horling, B., Phelps, J., Golman, R., Vincent, R., Long, A., Kohout, B. (2005). C-TAEMS language specification v. 1.06.
 19. Brooks, R.S.; Lesser, V.R. (1979). “Distributed Problem Solving Using Iterative Refinement.” *University of Massachusetts-Amherst Computer and Information Science Department Technical Report 79-14*.
 20. Carver, N.; Lesser, V.R. (1993). “A Planner for the Control of Problem-Solving Systems.” *IEEE Transactions on Systems, Man, and Cybernetics – Special Issue on Planning, Scheduling and Control*. Vol. 23 (6): 1519–1536.
 21. Carver, N.; Lesser, V. (1995). “The DRESUN Testbed for Research in FA/C Distributed Situation Assessment: Extensions to the Model of External Evidence.” *Proceedings of the First International Conference on Multi-Agent Systems*, AAAI Press, pp. 33–40.
 22. Carver, N., Lesser, V.; Whitehair, R. (1996). “Nearly Monotonic Problems: A Key to Effective FA/C Distributed Sensor Interpretation?” In *Proceedings of Thirteenth National Conference on Artificial Intelligence*, Vol. 1. Portland, Oregon: AAAI Press/MIT Press, pp. 88–95.
 23. Carver, N.; Lesser, V.R. (2003). “Domain Monotonicity and the Performance of Local Solution Strategies for CDPS-based Distributed Sensor Interpretation and Distributed Diagnosis.” *Autonomous Agents and Multi-Agent Systems*, Kluwer Academic Publishers, 6(1): 35–76.
 24. Cheng, Shanjun; Raja, Anita; Lesser Victor (2013). “Using Conflict Resolution to Inform Decentralized Learning.” *Proceedings of 12th International Conference on Autonomous Agents and Multiagent Systems (AAMAS)*. Ito, Jonker, Gini, and Shehory (eds.), IFAAMAS, St. Paul, MN, pp. 893–900.
 25. Cheng, Shanjun; Raja, Anita; Lesser Victor (2013). “Multiagent Meta-level Control for Radar Coordination.” *Web Intelligence and Agent Systems: An International Journal*, IOS Press, Netherlands, Vol. 11, No.2: pp. 81–105.
 26. Chia, M.H., Neiman, D.E.; Lesser, V.R. (1998). “Poaching and Distraction in Asynchronous Agent Activities.” *Proceedings of the Third International Conference on Multi-Agent Systems*, pp. 88–95.
 27. Conry, S.E.; Kuwabara, K.; Lesser, V.R.; Meyer, R.A. (1991). “Multistage Negotiation for Distributed Constraint Satisfaction.” *IEEE Transactions on Systems, Man and Cybernetics*, 21(6): 1462–1477.
 28. Corkill, Daniel (1979). “Hierarchical Planning in a Distributed Problem-Solving Environment.” *Proc. 6th International Joint Conference on AI*, Tokyo, pp. 168–175.
 29. Corkill, D.D.; Lesser, V.R.; Hudlickà, E. (1982). “Unifying Data-Directed and Goal-Directed Control: An Example and Experiments.” *Proceedings of the 1982 National Conference on Artificial Intelligence*, pp. 143–147.

30. Corkill, Daniel D. (1983). "A Framework for Organizational Self-Design in Distributed Problem-Solving Networks." Ph.D. thesis, University of Massachusetts Amherst, February 1983. (Also available as Department of Computer and Information Science Technical Report 82-33, University of Massachusetts, 1982.)
31. Corkill, D.D.; Lesser, V.R. (1983). "The Use of Meta-Level Control for Coordination in a Distributed Problem Solving Network." *Proceedings of the Eighth International Joint Conference on Artificial Intelligence*, Karlsruhe, FRG, pp. 748–756.
32. Corkill, D.D., Gallagher, K. Q.; Murray, K. E. (1986). "GBB: A generic blackboard development system." *Proceedings of the National Conference on Artificial Intelligence*, Philadelphia, pp. 1008–1014.
33. Corkill, Daniel; Gallagher, Kevin Q.; Johnson, Philip M. (1987). "Achieving flexibility, efficiency, and generality in blackboard architectures." *Proceedings of the National Conference on Artificial Intelligence*, Seattle, pp. 18–23.
34. Corkill, Daniel D.; Rubinstein, Zachary B.; Lander, Susan E.; Lesser Victor R. (2003). "Live-representation Process Management." *Proceedings of Fifth International Conference on Enterprise Information Systems*, Angers, France, Vol. 8, pp. 202–208.
35. Corkill, Daniel D. *GBBopen Reference Manual*. The GBBopen Project, 2004–ongoing.
36. Corkill, D.D. (2008). "Reporting down under: A CNAS (Collaborative Network for Atmospheric Sensing) update." *Proceedings of the Second International Workshop on Agent Technology for Sensor Networks (ATSN-08)*, Estoril, Portugal, pp. 25–32.
37. Corkill, Daniel; Zhang, Chongjie; da Silva, Bruno; Kim, Yoonheui; Garant, Daniel; Lesser, Victor; Zhang, Xiaoqin (2013). "Biasing the Behavior of Organizationally Adept Agents (Extended Abstract)." *Proceedings of the 12th International Conference on Autonomous Agents and Multiagent Systems*, Ito, Jonker, Gini, and Shehory, ed., IFAAMAS, pp. 1309-1310. See also: Corkill, Daniel, et. al., (2013). "Biasing the behavior of organizationally adept agents." Technical Report UM-CS-2013-005, School of Computer Science, University of Massachusetts Amherst, Feb. 2013.
38. Corkill, Daniel; Garant, Daniel; Lesser, Victor (2015); "Exploring the Effectiveness of Agent Organizations." Technical Report UM-CS-2015-005, School of Computer Science, University of Massachusetts Amherst, Jan. 2015.
39. Croft, W.B.; Lefkowitz, L.S.; Lesser, V.R.; Huff, K.E. (1983). "POISE: An Intelligent Interface for Profession-Based Systems." *Proceedings of the Conference on Artificial Intelligence*, Oakland University, Rochester, Michigan.
40. Decker, K.; Lesser, V. (1993). "A One-Shot Dynamic Coordination Algorithm for Distributed Sensor Networks." *Proceedings of the Eleventh National Conference on Artificial Intelligence*, AAAI, pp. 210–216.
41. Decker, K.; Lesser, V. (1993). "An Approach to Analyzing the Need for Meta-Level Communication." *Proceedings of the 13th International Joint Conference on Artificial Intelligence*, Vol. 1, pp. 360–366.

42. Decker, K.; Lesser, V.R. (1993). "Quantitative Modeling of Complex Environments." *International Journal of Intelligent Systems in Accounting, Finance and Management, special issue on Mathematical and Computational Models of Organizations: Models and Characteristics of Agent Behavior*, Vol. 2: 215–234.
43. Decker, K.; Garvey, A.; Humphrey, M.; Lesser, V. (1993). "Control Heuristics for Scheduling in a Parallel Blackboard System." *International Journal of Pattern Recognition and Artificial Intelligence*, Vol. 7, No. 2, pp. 243–264.
44. Decker, K.; Garvey, A.; Humphrey, M.; Lesser, V. (1993). "Real-Time Control Architecture for an Approximate Processing Blackboard System." *International Journal of Pattern Recognition and Artificial Intelligence*, 7 (2): 265–284.
45. Decker, K.; Lesser, V. (1995). "Coordination Assistance for Mixed Human and Computational Agents." *Proceedings of the Second International Conference on Concurrent Engineering Research and Applications*, McLean VA, pp. 337–348.
46. Decker, K.; Lesser, V. (1995). "Designing a Family of Coordination Algorithms." *Proceedings of the First International Conference on Multi-Agent Systems (ICMAS-95)*, San Francisco: AAAI Press, pp. 73–80.
47. Durfee, E.; Lesser, V. (1988). "Predictability Versus Responsiveness: Coordinating Problem Solvers in Dynamic." *Proceedings of the Seventh National Conference on Artificial Intelligence*, pp. 66–71.
48. Durfee, E.H.; Lesser, V.R. (1988). "Incremental Planning to Control a Time-Constrained, Blackboard-Based Problem Solver." *IEEE Transactions on Aerospace and Electronic Systems—Special Issue on Space Telerobotics*, Vol. 24, No. 5, pp. 647–662.
49. Durfee, E.H.; Lesser, V.R. (1989). "Negotiating Task Decomposition and Allocation Using Partial Global Planning." *Distributed Artificial Intelligence*, M. Huhns and L. Gasser (eds.), Pitman Publishing Ltd., London, England, Vol. 2, pp. 229–244.
50. Durfee, E.H.; Lesser, V.R.; Corkill, D.D. (1989). "Trends in Cooperative Distributed Problem Solving." *IEEE Transactions on Knowledge and Data Engineering*, 1(1), pp. 63–83.
51. Durfee, E.H.; Lesser, V.R. (1991). "Partial Global Planning: A Coordination Framework for Distributed Hypothesis Formation." *IEEE Transactions on Systems, Man, and Cybernetics*, 21(5): 1167–1183.
52. Egyed, Alexander; Horling, Bryan; Becker, Raphen; Balzer, Robert (2003). "Visualization and Debugging Tools." *Distributed Sensor Networks: A multiagent perspective*, Lesser, Victor; Ortiz, Charles; and Tambe, Milind (eds.), Kluwer Academic Publishers, pp. 33–41.
53. Erman, L.D.; Hayes-Roth, F.; Lesser, V.R.; Reddy, D.R. (1980). "The HEARSAY-II Speech Understanding System: Integrating Knowledge to Resolve Uncertainty." *Computing Surveys* 12, (2), pp. 213–253.
54. Fennell, R.D.; Lesser, V.R. (1977). "Parallelism in AI Problem Solving: A Case Study of HEARSAY-II." *IEEE Transactions on Computers - Special Issue on Multiprocessors*, C-26, 2, pp. 98–111.
55. Filman, R.; Friedman, D. (1984). *Coordinated Computing: Tools and Techniques for Distributed Software*, McGraw-Hill Book Company.

56. Garant, Daniel; da Silva, Bruno; Zhang, Chongjie; Lesser, Victor (2015) "Accelerating Multi-agent Reinforcement Learning with Dynamic Co-learning." Technical Report UM-CS-2015-004, School of Computer Science, University of Massachusetts Amherst, Jan. 2015.
57. Garvey, A.; Lesser, V. (1993). "Design-to-time Real-Time Scheduling." *IEEE Transactions on Systems, Man and Cybernetics – Special Issue on Planning, Scheduling and Control*. Vol. 23 (6): 1491–1502.
58. Guo, AnYuan; Lesser Victor (2006). "Stochastic Planning for Weakly-Coupled Distributed Agents." *Proceedings of the Fifth Joint Conference on Autonomous Agents and Multiagent Systems*, ACM, pp. 326–328.
59. Horling, Bryan; Lesser, Victor; Vincent, Regis; Wagner, Tom; Raja, Anita; Zhang, Shelley; Decker, Keith; and Garvey, Alan (1999). "The TAEMS White Paper," Internal MAS Lab memo.
60. Horling, B.; Benyo, B.; Lesser, V. (2001). "Using Self-Diagnosis to Adapt Organizational Structures." *Proceedings of the Fifth International Conference on Autonomous Agents*, ACM Press, pp. 529–536.
61. Horling, B.; Mailler, R.; Shen, J.; Vincent, R.; Lesser, V. (2003). "Using Autonomy, Organizational Design and Negotiation in a Distributed Sensor Network." *Distributed Sensor Networks: A Multiagent Perspective*. Lesser, V.; Ortiz, C.; Tambe, M. (Eds.), Kluwer, pp. 139–183.
62. Horling, Bryan; Mailler, Roger; Lesser, Victor (2004). "Farm: A Scalable Environment for Multi-Agent Development and Evaluation." *Lecture Notes in Computer Science: Software Engineering for Multi-Agent Systems II—Research Issues and Practical Applications*. Lucena, Garcia, Romanovsky, Castro and Alencar (Eds.), Berlin: Springer-Verlag, Vol. 2940, pp. 225–242.
63. Horling, Bryan; Lesser, Victor (2005). "A Survey of Multi-Agent Organizational Paradigms." *The Knowledge Engineering Review*, Volume 19, Number 4, Cambridge University Press, pp. 281–316.
64. Horling, Bryan; Lesser, Victor (2005). "Analyzing, Modeling and Predicting Organizational Effects in a Distributed Sensor Network." *Journal of the Brazilian Computer Society, Special Issue on Agents Organizations*, pp. 9–30.
65. Horling, Bryan; Lesser, Victor; Vincent, Regis; Wagner, Thomas (2006). "The Soft Real-Time Agent Control Architecture." *Autonomous Agents and Multi-Agent Systems*, Volume 12, Number 1, Springer, pp. 35–92.
66. Horling, Bryan; Lesser, Victor (2008). "Using Quantitative Models to Search for Appropriate Organizational Designs." *Autonomous Agents and Multi-Agent Systems*. Springer-Netherlands, Vol. 16 (2): 95–149.
67. Hudlickà, E.; Lesser, V. (1987). "Modeling and Diagnosing Problem-Solving System Behavior." *IEEE Transactions on Systems, Man, and Cybernetics*, Vol. 17, No. 3, pp. 407–419.
68. Huff, K.E.; Lesser, V.R. (1989). "A Plan-Based Intelligent Assistant that Supports the Software Development Process." *Proceedings of the 3rd ACM SIGSOFT/SIGPLAN Software Engineering Symposium on Practical Software Development Environments*, Boston, MA, pp. 97–106.

69. Kim, Y.; Lesser, V. (2008). "Finding Minimum Data Requirements Using Pseudo-Independence." *Proceedings of the 2008 IEEE/WIC/ACM International Conference on Intelligent Agent Technology (IAT'08)*, Sydney, Australia, Vol. 2, pp. 57–64.
70. Kim, Yoonheui; Lesser, Victor; Ganesan, Deepak; Sitaraman, Ramesh (2009). "Cluster-Swap: A Distributed K-median Algorithm for Sensor Networks." *Proceedings of IEEE/WIC/ACM International Conference on Web Intelligence and Intelligent Agent Technology*, Milan: IEEE Computer Society, Vol. 2, pp. 363–370.
71. Kim, Yoonheui; Krainin, Michael; Lesser, Victor (2011). "Effective Variants of the Max-Sum Algorithm for Radar Coordination and Scheduling." *Proceedings of 2011 IEEE/WIC/ACM International Conference on Web Intelligence and Intelligent Agent Technology*, Lyon, France, pp. 357–364.
72. Kim, Yoonheui; Lesser, Victor (2013). "Improved Max-Sum Algorithm For DCOP with n-ary Constraints." *Proceedings of the 12th International Conference on Autonomous Agents and Multiagent Systems (AAMAS)*. Ito, Jonker, Gini, and Shehory (eds.), IFAAMAS, St. Paul, MN, pp. 191–198.
73. Kim, Yoonheui; Lesser, Victor (2014). "DJAO: A Communication-Constrained DCOP Algorithm that Combines Features of ADOPT and Action-GDL." *Proceedings of the 28th AAAI Conference on Artificial Intelligence*, AAAI Press, pp. 2680–2687.
74. Krainin, Michael; An, Bo; Lesser, Victor (2007). "An Application of Automated Negotiation to Distributed Task Allocation." *2007 IEEE/WIC/ACM International Conference on Intelligent Agent Technology*, IEEE Computer Society Press, pp. 138–145.
75. Lâasri, B., Lâasri, H., Lander, S.; Lesser, V. (1992). "A Generic Model for Intelligent Negotiating Agents." *International Journal on Intelligent Cooperative Information Systems*, Volume 1, Number 2, pp. 291–317.
76. Lander, S.; Lesser, V. (1992). "Customizing Distributed Search Among Agents with Heterogeneous Knowledge." *Proceedings of the First International Conference on Information and Knowledge Management*, pp. 335–344.
77. Lander, S.; Lesser, V. (1997). "Sharing Meta-Information to Guide Cooperative Search Among Heterogeneous Reusable Agents." *IEEE Transactions on Knowledge and Data Engineering*, 9 (2), pp. 193–208.
78. Lefkowitz, L.S.; Lesser, V.R. (1988). "Knowledge Acquisition as Knowledge Assimilation." *International Journal of Man-Machine Studies*, 29 (2): pp. 215–226.
79. Lesser, Victor (1973). "A Dynamically Reconfigurable Multiple Micro-Processor." *International Conference on Computer Architecture*.
80. Lesser, Victor (1974). "The Design of an Emulator for a Parallel Machine Language." *Proceedings of the meeting on SIGPLAN/SIGMICRO Interface*, ACM Press, pp. 23–36.
81. Lesser, V.R.; Fennell, R.D.; Erman, L.D.; Reddy, D.R. (1975). "Organization of the Hearsay-II Speech Understanding System." *IEEE Transactions on Acoustics, Speech, and Signal Processing*, ASSP-23, 1, pp. 11–23.
82. Lesser, V.R.; Corkill, D.D. (1978). "Functionally-Accurate Distributed Problem-Solving Systems." *Proceedings of the DARPA Distributed Sensor Nets Workshop*, Carnegie-Mellon University, pp. 21–26.

83. Lesser, V.R.; Erman, L.D. (1980). "An Experiment in Distributed Interpretation." *Proceedings of 1st International Conference on Distributed Computing Systems*, Huntsville, Alabama, pp. 553–557.
84. Lesser, V.R.; Erman, L.D. (1980). "Distributed Interpretation: A Model; an Experiment." *IEEE Transactions on Computers - Special Issue on Distributed Processing*, Vol. C-29, 12, pp. 1144–1163.
85. Lesser, V.R.; Corkill, D.D. (1981). "Functionally-Accurate Cooperative Distributed Systems." *IEEE Transactions on Systems, Man, and Cybernetics - Special Issue on Distributed Problem Solving*, Vol. SMC-11, No.1, pp. 81–96.
86. Lesser, V.R.; Corkill, D.D. (1983). "The Distributed Vehicle Monitoring Testbed: A Tool for Investigating Distributed Problem Solving Networks." *AI Magazine*, 4(3), pp. 15–33.
87. Lesser, V.R.; Pavlin, J.; Durfee, E.H. (1988). "Approximate Processing in Real-Time Problem Solving." *AI Magazine*, Vol. 9, No. 1, pp. 49–61.
88. Lesser, V.R.; Corkill, D.D.; Hernandez, J.; Whitehair, R.C. (1989). "Focus of Control through Goal Relationships." *Proceedings of the Eleventh International Joint Conference on Artificial Intelligence*, Vol. 1, Detroit, pp. 497–503.
89. Lesser, V.R. (1991). "A Retrospective View of FA/C Distributed Problem Solving." *IEEE Transactions on Systems, Man, and Cybernetics*, 21(6): 1347–1362.
90. Lesser, V.; Nawab, H.; Klassner, F. (1995). "IPUS: An Architecture for the Integrated Processing and Understanding of Signals." *Artificial Intelligence*, 77, pp. 129–171.
91. Lesser, V.R. (1998). "Reflections on the Nature of Multi-Agent Coordination and Its Implications for an Agent Architecture." *Autonomous Agents and Multi-Agent Systems*, Kluwer Academic Publishers, Vol. 1, pp. 89–111.
92. Lesser, V. (1999). "Cooperative Multiagent Systems: A Personal View of the State of the Art." *IEEE Trans. Knowledge and Data Engineering*, Vol. 11, No. 1, pp. 133–142.
93. Lesser, V.; Atighetchi, M.; Benyo, B.; Horling, B.; Raja, A.; Vincent, R.; Wagner, T.; Xuan, P.; Zhang, S.X.Q. (1999). "The UMASS Intelligent Home Project." *Proceedings of the Third International Conference on Autonomous Agents*, Seattle, pp. 291–298.
94. Lesser, V.; Horling, B.; Klassner, F.; Raja, A.; Wagner, T.; Zhang, S.X.Q. (2000). "BIG: An Agent for Resource-Bounded Information Gathering and Decision Making." *Artificial Intelligence, Special Issue on Internet Information Agents*, 118 (1-2), Elsevier Science, pp. 197–244.
95. Lesser, V.; Ortiz, C.; Tambe, M. (Eds.). (2003). *Distributed Sensor Networks: A Multiagent Perspective*, (2003). Kluwer Academic Publishers.
96. Lesser, V.; Decker, K.; Wagner, T.; Carver, N.; Garvey, A.; Horling, B.; Neiman, D.; Podorozhny, R.; NagendraPrasad, M.; Raja, A.; Vincent, R.; Xuan, P.; Zhang, X.Q. (2004). "Evolution of the GPGP/TAEMS Domain-Independent Coordination Framework." *Autonomous Agents and Multi-Agent Systems*. Kluwer Academic Publishers, 9 (1-2): 87–143.

97. Lesser, Victor; Corkill, Daniel (2014). "Challenges for Multi-Agent Coordination Theory Based on Empirical Observations." *Proceedings of 13th International Conference on Autonomous Agents and Multiagent Systems*. Special track on Challenges and Visions. Lomuscia, A.; Scerri, P.; Bazzan, A.; Huhns, M. (eds.), Paris, France. IFAAMAS, pp. 1157–1160.
98. Mailler, Roger; Lesser, Victor (2004). "Solving Distributed Constraint Optimization Problems Using Cooperative Mediation." *Proceedings of Third International Joint Conference on Autonomous Agents and Multi-Agent Systems*, IEEE Computer Society, Vol. 1, pp. 438–445.
99. Mailler, Roger; Lesser, Victor (2006). "A Cooperative Mediation-Based Protocol for Dynamic, Distributed Resource Allocation." *IEEE Transactions on Systems, Man, and Cybernetics, Part C: Applications and Reviews – Special Issue on Game-theoretic Analysis and Stochastic Simulation of Negotiation Agents*. IEEE Press. Vol. 36 (1): 80–91.
100. Mailler, Roger; Lesser, Victor (2006). "Asynchronous Partial Overlay: A New Algorithm for Solving Distributed Constraint Satisfaction Problems." *Journal of Artificial Intelligence Research*, Volume 25, pp. 529–576.
101. Moehlman, T., Lesser, V.; Buteau, B. (1992). "Decentralized Negotiation: An Approach to the Distributed Planning Problem." *Group Decision and Negotiation*, Volume 1, Number 2, K. Sycara (ed.), Norwell, MA: Kluwer Academic Publishers, pp. 161–192.
102. Mostafa, H.; Lesser, V.; Miklau, G. (2008). "Self-interested Database Managers Playing the View Maintenance Game." *Proceedings of the Seventh International Conference on Autonomous Agents and Multi-Agent Systems*. Padgham, Parkes, Müller and Parsons (eds.), IFAAMAS, pp. 871–878.
103. Mostafa, Hala; Lesser, Victor (2009). "Offline Planning for Communication by Exploiting Structured Interactions in Decentralized MDPs." *Proceedings of 2009 IEEE/WIC/ACM International Conference on Web Intelligence and Intelligent Agent Technology*, Milan: IEEE Computer Society, Vol. 2, pp. 193–200.
104. Mostafa, Hala; Lesser, Victor (2011). "Compact Mathematical Programs For DEC-MDPs With Structured Agent Interactions." *Proceedings of the 27th Conference on Uncertainty in Artificial Intelligence (UAI 2011)*, Barcelona, pp. 523–530.
105. Nagendra Prasad, M.V.; Lesser, V.R.; Lander, S. (1998). "Learning Organizational Roles for Negotiated Search in a Multiagent System." *International Journal of Human-Computer Studies*, Vol. 48, pp. 51–67.
106. Nagendra Prasad, M.V.; Lesser, V. (1999). "Learning Situation Specific Coordination in Cooperative Multi-Agent Systems." *Autonomous Agents and Multi-Agent Systems*, Kluwer Academic Publishers, Vol. 2, pp. 173–207.
107. Neiman, Daniel (1994). "Issues in the Design and Control of Parallel Rule-Firing Production Systems." *Journal of Parallel and Distributed Computing*, Vol. 23, No. 3, pp. 338–363.
108. Neiman, D.; Hildum, D.; Lesser, V.; Sandholm, T. (1994). "Exploiting Meta-level Information in a Distributed Scheduling System." *Proceedings of Twelfth National Conference on Artificial Intelligence*, pp. 394–400.

109. Neiman, D.; Lesser, V. (1996). "A Cooperative Repair Method for a Distributed Scheduling System." *Proceedings of the Third International Conference on Artificial Intelligence Planning Systems*, Edinburgh, Scotland, pp. 166–173.
110. Pattison, H.E.; Corkill, D.D.; Lesser, V.R. (1986). "Instantiating Descriptions of Organizational Structures." *Distributed Artificial Intelligence*, Michael N. Huhns (ed.), Pitman Publishing Ltd., London, pp. 59–95.
111. Pavlin, J.; Corkill, D. D. (1984). "Selective Abstraction of AI System Activity." *Proceedings of the National Conference on Artificial Intelligence*, Austin, Texas, pp. 264–268.
112. Raja, Anita; Lesser, Victor (2007). "A Framework for Meta-level Control in Multi-Agent Systems." *Autonomous Agents and Multi-Agent Systems*, Springer, Vol. 15 (2): pp. 147–196.
113. Sandholm, T. (1993). "An Implementation of the Contract Net Protocol Based on Marginal Cost Calculations." *Proceedings of the Eleventh National Conference on Artificial Intelligence (AAAI)*, pp. 256–262. (An earlier version appeared in *Proceedings of the Twelfth International Workshop on Distributed Artificial Intelligence*, pp. 295–308.)
114. Sandholm, T.; Lesser, V. (1995). "Issues in Automated Negotiation and Electronic Commerce: Extending the Contract Net Framework." *Proceedings of First International Conference on Multi-Agent Systems*, San Francisco: AAAI Press, pp. 328–335.
115. Sandholm, T.W.; Lesser, V. (1997). "Coalitions Among Computationally Bounded Agents." *Artificial Intelligence, Special issue on Economic Principles of Multi-Agent Systems*, 94 (1), pp. 99–137.
116. Sandholm, T.; Lesser, V. (2001). "Leveled Commitment Contracts and Strategic Breach." *Games and Economic Behavior*, Special Issue on Economics and AI. Academic Press, Vol. 35, pp. 212–270.
117. Shen, J.; Lesser, V.; Carver, N. (2003). "Minimizing Communication Costs in Distributed Bayesian Networks Using a Decentralized MDP." *Proceedings of the Second International Joint Conference on Autonomous Agents and Multi-Agent Systems*, Melbourne, Australia, pp. 678–685.
118. Shen, Jiaying; Zhang, Xiaoqin; Lesser, Victor (2004). "Degree of Local Cooperation and its Implication on Global Utility." *Proceedings of Third International Joint Conference on Autonomous Agents and MultiAgent Systems*, IEEE Computer Society, Volume 2, pp. 546–553.
119. Shen, Jiaying; Weber, Ingo; Lesser, Victor (2005). "OAR: A Formal Framework for Multi-Agent Negotiation." *Proceedings of the Twentieth National Conference on Artificial Intelligence*, pp. 176–183. (see also Lesser, Victor; Shen, Jiaying; Weber, Ingo; Zhang, Xiaoqin "Shelley" (2012). "Formal Analysis of Negotiation Protocols for Task Allocation." In *Negotiation and Argumentation in Multi-Agent Systems*, Lopes, F.; H. Coelho (eds.), Bentham Science Publishers. Chapter 6, 42 pages.)
120. Shen, Jiaying; Lesser, Victor (2006). "Communication Management Using Abstraction in Distributed Bayesian Networks." *Proceedings of the Fifth*

- International Joint Conference on Autonomous Agents and Multi-Agent Systems*, ACM Press, pp. 622–629.
121. Shen, Jiaying; Becker, Raphen; Lesser, Victor (2006). “Agent Interaction in Distributed MDPs and its Implications on Complexity.” *Proceedings of the Fifth International Joint Conference on Autonomous Agents and Multi-Agent Systems*, ACM, pp. 529–536.
 122. Sims, M.; Goldman, C.; Lesser, V. (2003). “Self-Organization through Bottom Coalition Formation.” *Proceedings of the Second International Joint Conference on Autonomous Agents and Multi-Agent Systems (AAMAS)*, Melbourne, Australia, pp. 867–874.
 123. Sims, Mark; Corkill, Daniel; Lesser, Victor (2008). “Automated Organization Design for Multi-agent Systems.” *Autonomous Agents and Multi-Agent Systems*. Springer Netherlands, Vol. 16 (2): 151–185.
 124. Sugawara, T.; Lesser, V.R. (1998). “Learning to Improve Coordinated Actions in Cooperative Distributed Problem-Solving Environments.” *Machine Learning*, Kluwer, Vol. 33, Nos. 2-3, pp. 129–153.
 125. Vincent, R.; Horling, B.; Lesser, V. (2001). “An Agent Infrastructure to Evaluate Multi-Agent Systems: The Java Agent Framework and Multi-Agent System Simulator.” *Lecture Notes in Artificial Intelligence 1887: Infrastructure for Agents, Multi-Agent Systems, and Scalable Multi-Agent Systems*. Wagner & Rana (eds.), Springer, pp. 102–127.
 126. Wagner, T.; Garvey, A.; Lesser, V. (1998). “Criteria-Directed Task Scheduling.” *International Journal of Approximate Reasoning*, Elsevier Science Inc., Vol. 19 (1-2), pp. 91–118.
 127. Wagner, Thomas; Lesser, Victor (1999). “Relating Quantified Motivations for Organizationally Situated Agents.” *Proceedings Sixth International Workshop on Agent Theories, Architectures, and Languages*, pp. 334–348.
 128. Wagner, Thomas; Raja, Anita; Lesser, Victor (2006). “Modeling Uncertainty and Its Implications to Sophisticated Control in TÆMS Agents.” *Autonomous Agents and Multi-Agent Systems*. Vol. 13 (3), pp. 235–292.
 129. Whitehair, R.; Lesser, V. (1995). “IDP: A Formalism for Modeling and Analyzing Complex Interpretation Problem Domains.” *University of Massachusetts-Amherst Computer Science Technical Report 95–39*.
 130. Xuan, Ping; Lesser, Victor (1999). “Incorporating Uncertainty in Agent Commitments.” *Proceedings of the Sixth International Workshop on Agent Theories, Architectures, and Languages (ATAL’99)*, pp. 57–70. Winner of Best Student Paper Award.
 131. Xuan, Ping; Lesser, Victor; Zilberstein, Shlomo (2001). “Communication Decisions in Multi-Agent Cooperation: Model and Experiments.” *Proceedings of the Fifth International Conference on Autonomous Agents*, pp. 616–623.
 132. Xuan, Ping; Lesser, Victor (2002). “Multi-Agent Policies: From Centralized One to Decentralized Ones.” *Proceedings of the 1st International Joint Conference on Autonomous Agents and Multiagent Systems*, Volume Part 3, ACM Press, pp. 1098–1105. (also see Xuan, P.; Lesser, V. (2007). “Decomposing Centralized Multiagent

- Policies.” *University of Massachusetts Amherst, Computer Science Technical Report.*)
133. Zafar, H.; Lesser, V.; Corkill, D.; Ganesan, D. (2008). “Using Organization Knowledge to Improve Routing Performance in Wireless Multi-Agent Networks.” *Proceedings of the Seventh International Conference on Autonomous Agents and Multi-Agent Systems*. Padgham, Parkes, Müller and Parsons (eds.), IFAAMAS, pp. 821–828.
 134. Zhang, Chongjie; Lesser, Victor; Shenoy, Prashant (2009). “A Multi-Agent Learning Approach to Online Distributed Resource Allocation.” *Proceedings of the 21st International Joint Conference on Artificial Intelligence (IJCAI)*, pp. 361–366.
 135. Zhang, Chongjie; Abdallah, Sherief; Lesser, Victor (2009). “Integrating Organizational Control into Multi-Agent Learning.” *Proceedings of the 8th International Conference on Autonomous Agents and Multiagent Systems, Budapest, Vol. 2*, pp. 757–764.
 136. Zhang, Chongjie; Lesser, Victor; Abdallah, Sherief (2010). “Self-Organization for Coordinating Decentralized Reinforcement Learning.” *Proceedings of 9th International Conference on Autonomous Agents and Multiagent Systems, Toronto: IFAAMAS*, pp. 739–746.
 137. Zhang, Chongjie; Lesser, Victor (2010). “Multi-Agent Learning with Policy Prediction.” *Proceedings of the 24th AAI Conference on Artificial Intelligence, Atlanta: AAI*, pp. 927–934
 138. Zhang, Chongjie; Lesser, Victor (2011). “Coordinated Multi-Agent Reinforcement Learning in Networked Distributed POMDPs.” *Proceedings of 25th AAI Conference on Artificial Intelligence San Francisco*, pp. 764–770.
 139. Zhang, Chongjie; Lesser, Victor (2013). “Coordinating Multi-Agent Reinforcement Learning with Limited Communication.” *Proceedings of the 12th International Conference on Autonomous Agents and Multiagent Systems (AAMAS)*. Ito, Jonker, Gini, & Shehory (eds.), IFAAMAS, St. Paul, MN, pp. 1101–1108.
 140. Zhang, Haizheng; Lesser, Victor (2005). “A Queuing Theory Based Analysis on Agent Control Mechanisms in Peer-to-Peer based Information Retrieval Systems.” *International Conference on Information and Knowledge Management 2005 Workshop on Peer-to-Peer-based Information Retrieval*.
 141. Zhang, Haizheng; Lesser, Victor (2006). “Forming and Searching Content-Based Hierarchical Agent Clusters in Distributed Information Retrieval Systems.” *Web Intelligence and Agent Systems*, IOS Press, Vol. 4 (4), pp. 353–370.
 142. Zhang, Haizheng; Lesser, Victor (2006). “Multi-Agent Based Peer-to-Peer Information Retrieval Systems with Concurrent Search Sessions.” *Proceedings of the Fifth International Joint Conference on Autonomous Agents and Multiagent Systems*, ACM, pp. 305–312.
 143. Zhang, Haizheng; Lesser, Victor (2007). “A Reinforcement-Learning-based Distributed Search Algorithm for Hierarchical Peer-to-Peer Information.” *Proceedings of the Sixth International Joint Conference on Autonomous Agents and Multi-Agent Systems*, IFAAMAS, pp. 219–226.

144. Zhang, Haizheng; Lesser, Victor (2008). *Toward Peer-to-Peer Based Semantic Search Engines – An Organizational Approach*. VDM Verlag.
145. Zhang, Xiaoqin; Lesser, Victor; Wagner, Tom (2004). “A Layered Approach to Complex Negotiations.” *Web Intelligence and Agent Systems: An International Journal*. IOS Press, Netherlands, Vol. 2(2), pp. 91–104.
146. Zhang, Xiaoqin; Lesser, Victor; Abdallah, Sherief (2005). “Efficient Management of Multi-Linked Negotiation Based on a Formalized Model.” *Autonomous Agents and Multi-Agent Systems*, Volume 10, Number 2, pp. 165–205.
147. Zhang, Xiaoqin; Lesser, Victor; Podorozhny, Rodion (2005). “Multi-Dimensional, MultiStep Negotiation for Task Allocation in a Cooperative System.” *Autonomous Agents and MultiAgent Systems*, Volume 10, Number 1, pp. 5–40.
148. Zhang, Xiaoqin; Lesser, V.; Wagner, T (2006). “Integrative Negotiation Among Agents Situated in Organizations.” *IEEE Transactions on Systems, Man, and Cybernetics*, Part C: Applications and Reviews — Special Issue on Game-theoretic Analysis and Stochastic Simulation of Negotiation Agents. IEEE Press, Vol. 36 (1): 19–30.
149. Zhang, Xiaoqin (Shelley); et al. (2012). “An Ensemble Architecture for Learning Complex Problem-Solving Techniques from Demonstration.” *ACM Transactions on Intelligent Systems and Technology*, ACM: New York, Vol. 3, No. 4, Article 75: 38 pages.
150. Zhang, Xiaoqin (Shelley); Lesser, Victor (2013). “Meta-Level Coordination for Solving Distributed Negotiation Chains in Semi-Cooperative Multi-Agent Systems.” *Group Decision and Negotiation*, Springer Netherlands, Vol. 22, Issue 4, pp. 681–713.
151. Zhu, Xiangbin; Zhang, Chongjie; Lesser, Victor (2013). "Combining Dynamic Reward Shaping and Action Shaping for Coordinating Multi-agent Learning," Proc. of IEEE/WIC/ACM International Joint Conferences on Web Intelligence (WI) and Intelligent Agent Technologies (IAT), pp. 321-328.
152. Zink, M.; Westbrook, D.; Abdallah, S.; Horling, B.; Lyons, E.; Lakamraju, V.; Manfredi, V.; Kurose, J.; Hondl, K. (2005). “Meteorological Command and Control: An End-to-end Architecture for a Hazardous Weather Detection Sensor Network.” *Proceedings of the ACM Workshop on End-to-End, Sense-and-Respond Systems, Applications, and Services (EESR 05)*, pp. 37–42.

APPENDIX

LAB PERSONNEL THROUGH THE YEARS

The lab, over its 36 years of existence, has graduated 35 Ph.D. students.¹¹ Their names, thesis titles, current positions and notable achievements are listed below:

- Richard Brooks**, 1983 “*Experiments in Distributed Problem Solving.*”
- Daniel Corkill**, 1983 “*A Framework for Organizational Self-Design in Distributed Problem-Solving Networks.*”
- Jasmina Pavlin**, 1985 “*A Model for Prediction and Description of Knowledge-Based System Behavior.*”
- Eva Hudlickà**, 1986 “*Diagnosing Problem Solving System Behavior.*”
- Edmund Durfee**,* 1987 “*A Unified Approach to Dynamic Coordination: Planning Actions and Interactions in a Distributed Problem Solving Network.*” (NSF presidential young investigator award; AAAI Fellow; IEEE Fellow)
- Lawrence Lefkowitz**, 1987 “*Knowledge Acquisition through Anticipation of Modifications.*”
- Karen Huff**, 1989 “*Plan-Based Intelligent Assistance: An Approach to Supporting the Software Development Process.*” (Deceased)
- Norman Carver**,* 1990 “*Sophisticated Control for Interpretation: Planning to Resolve Sources of Uncertainty.*”
- Philip Johnson**,¹² 1990 “*Type Flow Analysis for Exploratory Software Development.*”
- Daniel Neiman**,* 1992 “*Design and Control of Parallel Rule-Firing Production Systems.*”
- Susan Lander**,* 1994 “*Distributed Search and Conflict Management Among Reusable Heterogeneous Agents.*”
- David Hildum**,¹³ 1994 “*Flexibility in a Knowledge-Based System for Solving Dynamic Resource-Constrained Scheduling Problems.*”
- Keith Decker**, 1995 “*Environment Centered Analysis and Design of Coordination Mechanisms.*” (NSF CAREER award)
- Alan Garvey**, 1996 “*Design-to-time Real-time Scheduling.*”
- Robert Whitehair**, 1996 “*A Framework for the Analysis of Sophisticated Control.*”
- Tuomas W. Sandholm**, 1996 “*Negotiation Among Self-Interested Computationally Limited Agents.*” (NSF CAREER award; IJCAI’03 Computer & Thought Award; ACM/SIGART 2001 Autonomous Agents Research Award; AAAI Fellow)
- Frank Klassner**, 1996 “*Data Reprocessing in Signal Understanding Systems.*”

¹¹ Unless otherwise noted, Victor Lesser was the primary Ph.D. supervisor of these students.

¹² Co-chaired with Jack Wileden.

¹³ Chaired by Daniel Corkill.

- M. V. Nagendra Prasad**, 1997 “*Learning Situation-Specific Control in Multi-Agent Systems.*”
- Malini K. Bhandaru**, 1998 “*Learning Object Models for Adaptive Perceptual Systems.*”
- Thomas Wagner**, 1999 “*Towards Quantified Control for Organizationally Situated Agents.*”
- Ping Xuan**, 2002 “*Uncertainty Handling and Decision Making in Multi-Agent Cooperation.*”
- XiaoQin “Shelley” Zhang**, 2002 “*Sophisticated Negotiation in Multi-Agent Systems.*”
- Zachary Rubinstein**, 2002 “*Efficient Scheduling of Evolving, Nondeterministic Process Plans in Dynamic Environments.*”
- Anita Raja**, 2003 “*Meta-Level Control in Multi-Agent Systems.*”
- Roger Mailler**,* 2004 “*A Mediation-Based Approach to Cooperative, Distributed Problem Solving.*”
- Bryan Horling**, 2005 “*Quantitative Organizational Modeling and Design for Multi-Agent Systems.*”
- Sherief Abdallah**, 2006 “*Scalable Cooperative Multiagent Reinforcement Learning in the Context of an Organization.*”
- Raphen Becker**,¹⁴ 2006 “*Exploiting Structure in Decentralized Markov Decision Processes.*”
- AnYuan Guo**, 2006 “*Planning and Learning for Weakly-Coupled Distributed Agents.*”
- Haizheng Zhang**, 2006 “*Learning Based Organizational Approaches for Peer-to-Peer Based Information Retrieval Systems.*”
- Jiaying Shen**, 2007 “*Communication Management in Distributed Sensor Interpretation.*”
- Bo An**, 2011 “*Automated Negotiation for Complex Multi-Agent Resource Allocation.*” (Winner of the 2010 IFAAMAS Victor Lesser Distinguished Dissertation Award and a 2012 Recipient of ‘China’s 1,000 Young Talents Program’ Award);
- Hala Mostafa**, 2011 “*Exploiting Structure in Coordinating Multiple Decision Makers.*”
- Chongjie Zhang**, 2011 “*Scaling Multi-Agent Learning in Complex Environments.*”
- Yoonheui Kim**, 2015 “*Application of Techniques for Map Estimation to Distributed Constraint Optimization Problem.*”

In addition to the above Ph.D. graduates of the lab, the following people have also made important contributions to the lab during their tenure as professional or student members. They include (chronologically by commencement of their collaboration): Dr. Scott Reed, Dr. Jeff Bonar, Dr. Peter Bates, Sherryl (Franklin) Radbil, Joseph Hernandez, Daniel McCue, Edward Pattison, Anil Rewari, David Westbrook, Zarko Cvetanovic, Prabhat Gupta, Margie Connell, Izaskun Gallastegi, Dr. Marty Humphrey, Dr. Hassan Lâasri, Dr. Brigitte Maitre-Lâasri, Dorothy Mammen, Quin Long, Mike Chia, Dr. Ana Bazzan, Dr. Regis Vincent, Mike Atighetchi, Brett Benyo, Dr. Claudia Goldman-

¹⁴ Co-chaired with Shlomo Zilberstein

Shenhar, Dr. Rodion Podorozhny, Dr. Kyle Rawlins, John Ostwald, Gerhard Schroff, Dr. Ingo Weber, Dr. Ning Zhang, Huzaifa Zafar, Mark Sims, Michael Krainin, Eric O'Connor, Kirby Seitz, Dr. Bruno Castor da Silva and Daniel Garant.

The lab has also benefited from hosting numerous long-term visitors and collaborating with several UMass faculty. The long-term visitors include, in the order of their arrival: Professors Pang Yung-Jie, Susan Conry, Robert Meyer, Jiwen Guan, Kazuhiro Kuwabara, Toshiharu Sugawara, Chengji Zhang, Sergei Nirenburg, Satoru Fujita, Hitoshi Ogawa, Yang Xiang, Young-Im Cho, He Luo, and Zhiqi Shen. The UMass faculty include: Professors Bruce Croft, Deepak Ganesan, David Jensen, Jim Kurose, Gerome Miklau, Lee Osterweil, Paul Utgoff, Jack Wileden, Beverly Woolf, Shlomo Zilberstein, and Michael Zink (Electrical and Computer Engineering), and Professors Abhi Deshmukh and Ian Grosse (Mechanical and Industrial Engineering). There have also been long-term external collaborations with Professors Hamid Nawab of Boston University, Chunyan Maio of Nanyang Technological University (Singapore), Catholijn Jonkers and Birna van Riemsdijk of Delft University of Technology (Delft, Netherlands), and collaborating with former members of the lab: Professors Bo An, Sherief Abdallah, Ana Bazzan, Edmund Durfee, Norman Carver, Anita Raja, and Xiaoqin "Shelley" Zhang. We also collaborated with Dr. Douglas Holzhaeur and Dale Richards (Rome Labs) and Dennis Rock (Boeing).

Finally, it is with great appreciation that the lab acknowledges the contributions of Michele Roberts, who for over 25 years was the business manager/grant administrator for the lab.