

THE HANCOCK ACIDITY FUNCTION FOR POLYFLUORIC
ACID AND SOME RELATED SUPERACID SYSTEMS

THE HAMMETT ACIDITY FUNCTION FOR HYDROFLUORIC
ACID AND SOME RELATED SUPERACID SYSTEMS

BY

JACK JOAN-NAN LIANG, B. Sc., M. Sc.

A Thesis

Submitted to the School of Graduate Studies
in Partial Fulfilment of the Requirements
for the Degree
Doctor of Philosophy

McMaster University

September 1976

© JACK JOAN-NAN LIANG · 1976

DOCTOR OF PHILOSOPHY (1976)
(CHEMISTRY)

McMASTER UNIVERSITY
Hamilton, Ontario

TITLE: The Hammett Acidity Function for Hydrofluoric Acid and
some related Superacid Systems

AUTHOR: Jack Joan-Nan Liang, B. Sc. (National Taiwan Normal University)
M. Sc. (Kent State University)

SUPERVISOR: Professor. R. J. Gillespie

NUMBER OF PAGES: xiv, 182



ABSTRACT

The Hammett acidity function, H_0 , has been measured for some superacid systems. These systems include HSO_3F , $\text{CF}_3\text{SO}_3\text{H}$ and HF and their mixtures with some Lewis acids such as NbF_5 , TaF_5 , AsF_5 and SbF_5 . Some base-HF mixtures were also studied for the HF system.

The acidities of these systems were determined by measuring their ability to protonate the very weakly basic nitro aromatic indicators. The protonation behaviour was studied by means of UV-Visible spectrophotometry as well as NMR spectrometry.

The H_0 value for 100 % HF was found to be greater than that of 100 % H_2SO_4 and was close to that of 100 % HSO_3F . The acidities for the acid systems MF_5 -HF were found to be in the order $\text{SbF}_5 > \text{AsF}_5 > \text{TaF}_5 > \text{NbF}_5$. The H_0 values obtained in the present measurements indicated that the SbF_5 -HF system is much more acidic than the previously known most highly acidic system, HSO_3F - SbF_5 - 3SO_3 .

The application of the superacid media in synthetic chemistry has become more important in recent years, for example they have been used as solvents in the preparation of carbonium ions and other highly electrophilic cations.

ACKNOWLEDGEMENT

The author wishes to express his gratitude for the advice and direction given throughout this work by Professor R. J. Gillespie. He would also like to thank his colleagues for their kind assistance.

The encouragement of my wife, Katy, is greatly appreciated. Thanks are also due to Katy for typing some of the manuscript.

TABLE OF CONTENTS

	Page
CHAPTER I: INTRODUCTION	1
A. SUPERACIDS AND THEIR ACIDITIES	1
B. ACIDITY FUNCTION MEASUREMENTS	6
C. PURPOSE OF THE PRESENT WORK	19
CHAPTER II: EXPERIMENTAL PROCEDURES	20
A. ACIDS	20
B. FLUORIDE ACCEPTORS	22
C. ACID-PENTAFLUORIDE MIXTURES	23
D. NITRO AROMATIC INDICATORS	23
E. MANIPULATION OF MATERIALS	24
F. PREPARATIONS OF SAMPLES	24
F-1. SOLUTIONS OF $\text{MF}_5\text{-HSO}_3\text{F}$ AND $\text{MF}_5\text{-CF}_3\text{SO}_3\text{H}$	24
F-2. SOLUTIONS OF $\text{MF}_5\text{-HF}$	25
G. UV-VISIBLE AND NMR SPECTRA	27
CHAPTER III: THE FLUOROSULFURIC ACID SOLVENT SYSTEM	28
A. INTRODUCTION	28
B. ACIDITY FUNCTION MEASUREMENTS BY THE ABSORPTION METHOD	28
C. ACIDITY FUNCTION MEASUREMENTS BY THE NMR METHOD	30
D. DISCUSSION	31
CHAPTER IV: THE TRIFLUOROMETHANESULFONIC ACID SOLVENT SYSTEM	56
A. INTRODUCTION	56
B. ACIDITY FUNCTION MEASUREMENTS	59
C. DISCUSSION	60

TABLE OF CONTENTS (cont.)

	Page
CHAPTER V: THE HYDROFLUORIC ACID SOLVENT SYSTEM	72
A. INTRODUCTION	72
B. HAMMETT ACIDITY FUNCTION MEASUREMENTS	81
B-1. DILUTE SOLUTIONS OF H ₂ O IN HF AND HF IN HF	81
B-2. FLUOROSULFURIC ACID IN HF	84
B-3. PHOSPHORUS PENTAFLUORIDE IN HF	84
B-4. NIOBIUM PENTAFLUORIDE IN HF	85
B-5. ARSENIC PENTAFLUORIDE IN HF	85
B-6. TANTALUM PENTAFLUORIDE IN HF	89
B-7. ANTIMONY PENTAFLUORIDE IN HF	90
C. DISCUSSION	92
C-1. NITRO AROMATIC INDICATORS	92
C-2. H ₀ FOR 100 % HF	94
C-3. THE VERY WEAK ACIDS HSO ₃ F, PF ₅ AND NbF ₅	94
C-4. COMPARISON OF THE STRENGTHS OF ACIDS OF THE HF SYSTEM	95
C-5. THE THEORETICAL H ₀ VALUES FOR THE STRONG ACID AND STRONG BASE	95
C-6. IONIZATION CONSTANTS OF WEAK ACIDS IN HF	97
CHAPTER VI: DISCUSSION	170
A. THE HAMMETT ACIDITY FUNCTIONS IN SUPERACID SYSTEMS ..	170
B. ACIDITY FUNCTIONS OTHER THAN H ₀	171
C. THE SIGNIFICANCE OF ACIDITY MEASUREMENTS	177
REFERENCES	179
APPENDIX	183

LIST OF TABLES

TABLE		Page
I	Extinction coefficients of 2,4,6-trinitrotoluene in the $\text{NbF}_5\text{-HSO}_3\text{F}$ system	33
II	Extinction coefficients of 1,3,5-trinitrobenzene in the $\text{NbF}_5\text{-HSO}_3\text{F}$ system	34
III	Ionization ratios of 2,4,6-trinitrotoluene in the $\text{NbF}_5\text{-HSO}_3\text{F}$ system	36
IV	Ionization ratios of 1,3,5-trinitrobenzene in the $\text{NbF}_5\text{-HSO}_3\text{F}$ system	37
V	$-H_0$ values for the $\text{NbF}_5\text{-HSO}_3\text{F}$ system	39
VI	Extinction coefficients of 2,4,6-trinitrotoluene in the $\text{TaF}_5\text{-HSO}_3\text{F}$ system	41
VII	Extinction coefficients of 1,3,5-trinitrobenzene in the $\text{TaF}_5\text{-HSO}_3\text{F}$ system	42
VIII	Ionization ratios of 2,4,6-trinitrotoluene in the $\text{TaF}_5\text{-HSO}_3\text{F}$ system	44
IX	Ionization ratios of 1,3,5-trinitrobenzene in the $\text{TaF}_5\text{-HSO}_3\text{F}$ system	45
X	$-H_0$ values for the $\text{TaF}_5\text{-HSO}_3\text{F}$ system	47
XI	^{19}F chemical shifts of 2,4-dinitrofluorobenzene in the $\text{SbF}_5\text{-HSO}_3\text{F}$ system	48
XII	^1H chemical shifts of 2,4,6-trinitrotoluene in the $\text{SbF}_5\text{-HSO}_3\text{F}$ system	50
XIII	^{19}F chemical shifts of 2,4-dinitrofluorobenzene in the $\text{SbF}_5\text{-HSO}_3\text{F}$ system with known $-H_0$ values	52
XIV	Ionization ratios of 2,4-dinitrofluorobenzene in the $\text{SbF}_5\text{-HSO}_3\text{F}$ system and the $-H_0$ values	55
XV	The titration of $\text{CF}_3\text{SO}_2\text{H}$ by the anhydride $(\text{CF}_3\text{SO}_2)_2\text{O}$	62
XVI	Extinction coefficients of 2,4,6-trinitrotoluene and 1,3,5-trinitrobenzene in the $\text{SbF}_5\text{-CF}_3\text{SO}_2\text{H}$ system	64
XVII	Ionization ratios of 2,4,6-trinitrotoluene in the $\text{SbF}_5\text{-CF}_3\text{SO}_2\text{H}$ system	66

LIST OF TABLES (cont.)

TABLE		Page
XXVIII	Ionization ratios of 1,3,5-trinitrobenzene in the $\text{SbF}_5\text{-CF}_3\text{SO}_3\text{H}$ system	67
XIX	$-H_0$ values for the $\text{SbF}_5\text{-CF}_3\text{SO}_3\text{H}$ system	69
XX	Extinction coefficients of 2,4-dinitrotoluene in the $\text{PF}_5\text{-CF}_3\text{SO}_3\text{H}$ system	70
XXI	Ionization ratios of 2,4-dinitrotoluene in the $\text{SbF}_5\text{-CF}_3\text{SO}_3\text{H}$ system	70
XXII	Extinction coefficients of 2,4,6-trinitroaniline in the $\text{H}_2\text{O-HF}$ system	100
XXIII	Ionization ratios of 2,4,6-trinitroaniline in the $\text{H}_2\text{O-HF}$ system and the resulting $-H_0$ values	102
XXIV	Extinction coefficients of 2,4,6-trinitroaniline in very dilute solutions of H_2O in HF	104
XXV	Extinction coefficients of p-nitrotoluene in very dilute solutions of H_2O in HF	105
XXVI	Ionization ratios of 2,4,6-trinitroaniline in very dilute solutions of H_2O in HF	107
XXVII	Ionization ratios of p-nitrotoluene in very dilute solutions of H_2O in HF	108
XXVIII	Extinction coefficients of 2,4,6-trinitroaniline in the KF-HF system	110
XXIX	Ionization ratios of 2,4,6-trinitroaniline in the KF-HF system and the H_0 values	112
XXX	Extinction coefficients of p-nitrotoluene in the $\text{HSO}_3\text{F-HF}$ system	114
XXXI	Ionization ratios of p-nitrotoluene in the $\text{HSO}_3\text{F-HF}$ system and the $-H_0$ values	116
XXXII	Extinction coefficients of p-nitrotoluene in the $\text{PF}_5\text{-HF}$ system	117
XXXIII	Ionization ratios of p-nitrotoluene in the $\text{PF}_5\text{-HF}$ system and the $-H_0$ values	117

LIST OF TABLES (cont.)

TABLE	Page
XXXIV	Extinction coefficients of p-nitrotoluene in the NbF_5 -HF system 119
XXXV	Extinction coefficients of p-nitrochlorobenzene in the NbF_5 -HF system 119
XXXVI	Extinction coefficients of 2,4-dinitrotoluene in the NbF_5 -HF system 120
XXXVII	Extinction coefficients of 2,4,6-trinitrotoluene in the NbF_5 -HF system 120
XXXVIII	Extinction coefficients of 1,3,5-trinitrobenzene in the NbF_5 -HF system 121
XXXIX	Ionization ratios of 2,4,6-trinitrotoluene in the NbF_5 -HF system 124
XL	Ionization ratios of 1,3,5-trinitrobenzene in the NbF_5 -HF system 124
XLI	$-H_0$ values for the NbF_5 -HF system 126
XLII	Extinction coefficients of 2,4,6-trinitrotoluene in the AsF_5 -HF system 128
XLIII	Extinction coefficients of 1,3,5-trinitrobenzene in the AsF_5 -HF system 129
XLIV	Adjusted extinction coefficients of 2,4,6-trinitrotoluene in the AsF_5 -HF system 134
XLV	Adjusted extinction coefficients of 1,3,5-trinitrobenzene in the AsF_5 -HF system 136
XLVI	Ionization ratios for the diprotonation of 2,4,6-trinitrotoluene in the AsF_5 -HF system 138
XLVII	Ionization ratios for the diprotonation of 1,3,5-trinitrobenzene in the AsF_5 -HF system 139
XLVIII	$-H_0$ values for the AsF_5 -HF system 141
XLIX	Observed and adjusted extinction coefficients of 2,4,6-trinitrotoluene in the TaF_5 -HF system 142
L	Observed and adjusted extinction coefficients of 1,3,5-trinitrobenzene in the TaF_5 -HF system 143

LIST OF TABLES (cont.)

TABLE	Page
LI Observed and adjusted extinction coefficients of 2,4,6-trinitrochlorobenzene in the TaF_5 -HF system	144
LII Ionization ratios for the diprotonation of 2,4,6-trinitrotoluene in the TaF_5 -HF system	147
LIII Ionization ratios for the diprotonation of 1,3,5-trinitrobenzene in the TaF_5 -HF system	148
LIV Ionization ratios for the diprotonation of 2,4,6-trinitrochlorobenzene in the TaF_5 -HF system	149
LV $-H_0$ values for the TaF_5 -HF system	151
LVI Observed and adjusted extinction coefficients of 2,4,6-trinitrotoluene in the SbF_5 -HF system	152
LVII Observed and adjusted extinction coefficients of 1,3,5-trinitrobenzene in the SbF_5 -HF system	152
LVIII Observed and adjusted extinction coefficients of 2,4,6-trinitrochlorobenzene in the SbF_5 -HF system	153
LIX Observed and adjusted extinction coefficients of 1,3-dichloro-2,4,6-trinitrobenzene in the SbF_5 -HF system	154
LX Adjusted extinction coefficients for the diprotonation of 2,4,6-trinitrochlorobenzene in the SbF_5 -HF system ...	155
LXI Adjusted extinction coefficients for the diprotonation of 1,3-dichloro-2,4,6-trinitrobenzene in the SbF_5 -HF system	156
LXII Ionization ratios for the diprotonation of 2,4,5-trinitrochlorobenzene in the SbF_5 -HF system	163
LXIII Ionization ratios for the diprotonation of 1,3-dichloro-2,4,6-trinitrobenzene in the SbF_5 -HF system	164
LXIV $-H_0$ values for the SbF_5 -HF system	166
LXV ϵ_B , ϵ_{BH^+} and pK_{BH^+} values for the nitro aromatic indicators in the MF_5 -HF system	167
LXVI Evaluation of overlap of nitro aromatic indicators in the HF solvent system	167
LXVII Ionization constants of weak acids in HF	169
LXVIII Ionization constant of water in HF	169

LIST OF FIGURES

FIGURE		page
1	$-H_0$ values for the acids of the H_2SO_4 solvent system	9
2	$-H_0$ values for the acids of the HSO_3F solvent system	20
3	$-H_0$ values for the HSO_3F-3SO_2 and HSO_3F-KCO_2F systems	11
4	$-H_0$ values for the H_2O-HF system	13
5	Wonei vacuum line and HF distillation apparatus	21
6	Apparatus for mixing the acid solution with indicator sample	26
7	Extinction coefficients of 2,4,6-trinitrotoluene and 1,3,5-trinitrobenzene in the NbF_5-HSO_3F system	35
8	Ionization ratios of 2,4,6-trinitrotoluene and 1,3,5-trinitrobenzene in the NbF_5-HSO_3F system	38
9	$-H_0$ functions for the acids of the HSO_3F solvent system	40
10	Extinction coefficients of 2,4,6-trinitrotoluene and 1,3,5-trinitrobenzene in the TaF_5-HSO_3F system	43
11	Ionization ratios of 2,4,6-trinitrotoluene and 1,3,5-trinitrobenzene in the TaF_5-HSO_3F system	46
12	^{19}F chemical shifts of 2,4-dinitrofluorobenzene in the SbF_5-HSO_3F system	49
13	1H chemical shifts of 2,4,6-trinitrotoluene in the SbF_5-HSO_3F system	51
14	^{19}F chemical shifts vs. $-H_0$ for 2,4-dinitrofluorobenzene in the SbF_5-HSO_3F system	53
15	Plot of $b-b' / H_0-H_0'$ vs. $-H_0$ for 2,4-dinitrofluorobenzene in the SbF_5-HSO_3F system	54
16	^{19}F nmr spectra of $SbF_5-CF_3SO_3H$ with 2.2 m of SbF_5 at $-50^\circ C$ and SbF_5-HSO_3F with 1.7 m SbF_5	58

LIST OF FIGURES (cont.)

FIGURE		Page
17	Conductometric titration of freshly distilled CF_3CO_2H by the same base at $25^\circ C$	67
18	Extinction coefficient of 2,4,6-trinitroaniline and 1,3,5-trinitrobenzene in the $SbF_5-CF_3CO_2H$ system	68
19	Ionization ratios of 2,4,6-trinitroaniline and 1,3,5-trinitrobenzene in the $SbF_5-CF_3CO_2H$ system	69
20	$-H_0$ values for acids of the CF_3CO_2H solvent system	71
21	The electrical conductivity of bases in HF	75
22	The conductivity of solutions of SbF_5 in HF at $0^\circ C$...	79
23	Extinction coefficients of 2,4,6-trinitroaniline in the H_2O-HF system	101
24	$-H_0$ values for the H_2O-HF system in $29^\circ-100^\circ$ HF region	103
25	Extinction coefficients of 2,4,6-trinitroaniline and p-nitrotoluene in dilute solutions of H_2O in HF	106
26	Ionization ratios of 2,4,6-trinitroaniline and p-nitrotoluene in dilute solutions of H_2O in HF	109
27	Extinction coefficients of 2,4,6-trinitroaniline in the $KF-HF$ system	111
28	$-H_0$ values for strong base KF , base water and weak acids, PF_5 and HSO_3F , in the HF system	113
29	Extinction coefficients of p-nitrotoluene in the HSO_3F-HF system	115
30	Extinction coefficients of p-nitrotoluene in the PF_5-HF system	118
31	Extinction coefficients of nitro aromatic indicators in NbF_5-HF system	122
32	Extinction coefficients of 2,4,6-trinitroaniline and 1,3,5-trinitrobenzene in the NbF_5-HF system	123
33	Ionization ratios of 2,4,6-trinitroaniline and 1,3,5-trinitrobenzene in the NbF_5-HF system	125

LIST OF FIGURES (cont.)

FIGURE	Page
34	The $-H_0$ activity function in the VF_5-HF system 127
35	Extinction coefficients of 2,4,6-trinitrotoluene and 1,3,5-trinitrobenzene in the AsF_5-HF system 130
36	Extinction coefficients of 2,4,6-trinitrotoluene in the AsF_5-HF system 131
37	Extinction coefficients of 1,3,5-trinitrobenzene in the AsF_5-HF system 132
38	Absorption spectra of 2,4,6-trinitrotoluene in the AsF_5-HF system 133
39	Absorption spectra of 1,3,5-trinitrobenzene in the AsF_5-HF system 137
40	Adjusted extinction coefficients of 2,4,6-trinitrotoluene and 1,3,5-trinitrobenzene in the AsF_5-HF system 137
41	Ionization ratios of 2,4,6-trinitrotoluene and 1,3,5-trinitrobenzene in the AsF_5-HF system 140
42	Observed extinction coefficients of some nitro aromatic indicators in the TaF_5-HF system 145
43	Adjusted extinction coefficients of some nitro aromatic indicators in the TaF_5-HF system 146
44	Ionization ratios of some nitro aromatic indicators in the TaF_5-HF system 150
45	Observed extinction coefficients of 2,4,6-trinitrochlorobenzene in the SbF_5-HF system 157
46	Observed extinction coefficients of 1,3-dichloro-2,4,6-trinitrobenzene in the SbF_5-HF system 158
47	Adjusted extinction coefficients of 2,4,6-trinitrochlorobenzene in the SbF_5-HF system 159
48	Adjusted extinction coefficients of 1,3-dichloro-2,4,6-trinitrobenzene in the SbF_5-HF system 160
49	Absorption spectra of 2,4,6-trinitrochlorobenzene in the SbF_5-HF system 161

LIST OF FIGURES (cont.)

FIGURE		Page
10	Absorption curve of 2,4-dichloro-2,4,6-trinitrobenzene in the $\text{H}_2\text{O}-\text{HF}$ system	162
11	Indicator ratio vs pH representation of 2,4,6-trinitrophenol and 2,4-dinitrophenol alone in the $\text{H}_2\text{O}-\text{HF}$ system	167
12	$-\text{H}_0$ values of $\text{HF}-\text{HF}$ and CO_2-HF , calculated H_0 values and $-\text{H}_0$ values from the conductivity data	169
13	Acidity functions for the $\text{H}_2\text{O}-\text{H}_2\text{CO}_3$ system	175
14	$-\text{R}_0(\text{H})$ and $-\text{H}_0$ functions for the $\text{H}_2\text{O}-\text{HF}$ system	176

CHAPTER I
INTRODUCTION

A. SUPERACIDS AND THEIR ACIDITIES

A superacid may be defined as an acidic medium having a greater acidity, that is a higher proton-donating ability, than concentrated aqueous solutions of the common strong inorganic acids such as H_2SO_4 and HClO_4 ^{1,2}. Some well-known superacid systems are H_2SO_4 and HSO_3F in the anhydrous state and mixtures of these acids with various Lewis acids e.g. $\text{HSO}_3\text{F}-\text{AsF}_5$, $\text{HSO}_3\text{F}-\text{SbF}_5$ and $\text{HSO}_3\text{F}-\text{SbF}_5-3\text{SO}_3$ ³.

Superacids belong to the general class of proton or Bronsted acids. A proton acid is defined as any species which has the ability to donate a proton to a suitable base as in equation (I-1)



The relative strengths of acids may be measured by their tendency to protonate a suitable base. Water has usually been chosen as the most convenient and suitable base. The extent of ionization of an acid in dilute solution in water



is conveniently measured by determining the pH of the solution,
 $\text{pH} = -\log [\text{H}_3^+\text{O}]$.

However in more concentrated solutions this method is no longer valid. The pH can no longer be defined as $-\log [\text{H}_3^+\text{O}]$ and moreover the acidity is no longer given by the concentration of

H_3O^+ . It is evident that in sufficiently concentrated solutions the concentration of water becomes relatively small and therefore the concentration of H_3O^+ decreases although the acidity of the solution as measured by the tendency of the solution to protonate another weak base continues to increase to 100% acid.

Hammett and Deyrup⁴ proposed a method for measuring the acidities of such concentrated aqueous acid solutions by using a series of suitable weakly basic indicators; they defined an acidity function, H_0 by the following equation,

$$H_0 = pK_{BH^+} - \log \frac{[BH^+]}{[B]} \quad (I-3)$$

where $[BH^+] / [B]$ is the ionization ratio of a suitable basic indicator B which is ionized according to the equation (I-4).



and K_{BH^+} is the equilibrium constant for the dissociation of the conjugate acid BH^+ , i.e. the ionization constant of BH^+ ,

$$K_{BH^+} = \frac{a_{H^+} a_B}{a_{BH^+}} = \frac{f_{H^+} f_B [B]}{f_{BH^+} [BH^+]} \quad (I-5)$$

where a_{H^+} , a_B and a_{BH^+} are the activities of the hydrated hydrogen ion, the base and the conjugate acid respectively and f 's are their corresponding activity coefficients.

Since the activity coefficients in concentrated acid solutions are unknown, the acidity function is defined as

$$h_0 = a_{H^+} \frac{f_B}{f_{BH^+}} = K_{BH^+} \frac{[BH^+]}{[B]} \quad (I-6)$$

Defining $H_0 = -\log h_0$ gives equation (I-3).

At infinitely dilute aqueous solution f_B and f_{BH^+} approach unity and a_{H^+} becomes equal to $[H^+]$, therefore the acidity function H_0 is the same as pH, that is $H_0 = -\log [H^+]$.

The procedure to find the ionization ratio is to determine the absorption spectrum of the indicator in acid mixtures of suitable concentration such that the indicator is present essentially entirely as the protonated or the unprotonated form. Then for any given wavelength at intermediate acid concentrations the extinction coefficient is given by equation (I-7),

$$\epsilon = \frac{c_B [B] + c_{BH^+} [BH^+]}{[B] + [BH^+]}$$
 (I-7)

where c_B and c_{BH^+} are extinction coefficients for the neutral and fully protonated forms of indicator respectively. When this is solved for the ionization ratio the following relationship is obtained, (in the following chapters I is given as $[B] / [BH^+]$),

$$\frac{[BH^+]}{[B]} = \frac{c - c_B}{c_{BH^+} - c}$$
 (I-8)

For solutions of a suitable indicator in very dilute solutions of an acid in H_2O , the pK_{BH^+} of the indicator can be determined directly from the equation

$$pK_{BH^+} = \lim_{C_A \rightarrow 0} \left(\log \frac{[BH^+]}{[B]} - \log [H^+] \right)$$
 (I-9)

where C_A is molar acid concentration. For a strong acid $[H^+]$ may be taken to be equal to the stoichiometric concentration of the acid. The extrapolation to infinite dilution of a plot of $(\log [BH^+] / [B] - \log [H^+])$ against acid concentration leads to a value

of pK_{BH^+} .

The pK_{BH^+} of a weaker indicator C can be determined by overlap by making measurements of the ionization ratios of B and C over the same suitable acid concentration range.

$$pK_{BH^+} - pK_{CH^+} = \log \frac{[BH^+]}{[B]} - \log \frac{[CH^+]}{[C]} \quad (I-10)$$

A third base D ($pK_{CH^+} < pK_{DH^+}$) for which protonation occurs at acid concentrations overlapping with those for CH^+ may now be evaluated. This may be continued for a series of bases of decreasing strength provided that in the overlapping range the plot of $\log I$ against acid concentrations for pairs of indicators are parallel. For this to be true the assumption (I-11) must be valid.

$$\frac{f_{BH^+}}{f_B} = \frac{f_{CH^+}}{f_C} = \frac{f_{DH^+}}{f_D} = \text{etc.} \quad (I-11)$$

The determination of acidity in superacid media is by no means limited to the use of absorption spectra. Any property of an indicator which can be related to change of the ionization ratio of the indicator can be used to evaluate the acidity of the media. The accuracy of the resulting acidity scale will be dependent upon the sensitivity of the property being measured to change in the ratio of protonated to unprotonated forms of bases; and the concentration of the basic indicator required to run the spectra. The absorption method is most widely used because, for suitable bases, the ionization ratio can be accurately measured and the required concentration of basic indicator is so small that in most cases it does not alter the acidity of the medium appreciably.

NMR spectroscopy is one of the methods other than absorption that is frequently used. This technique uses changes in the chemical shift of a suitable atom in the indicator as a measure of the degree of protonation of the indicator. The ionization ratio is given by equation (I-12),

$$\frac{[BH^+]}{[B]} = \frac{\delta_B - \delta}{\delta - \delta_{BH^+}} \quad (I-12)$$

where δ_B and δ_{BH^+} are the chemical shifts of unprotonated and fully protonated forms of indicator at suitable acid concentrations. δ is the average chemical shift of the indicator in a solution containing both forms at intermediate acid concentrations. This implies a rapid exchange between the protonated and unprotonated forms.

The nmr technique has the advantage that it may be used to determine acidities in systems which are highly colored. Its main disadvantage is that relatively high concentrations of the basic indicators are required in order to obtain reliable spectra. This will certainly alter the acidity of the medium and therefore result in an inaccurate acidity. This disadvantage may be overcome by the use of a Fourier transform spectrometer which would allow the study of very dilute solutions. In principle it is possible to determine the acidity of any acid system by selecting a suitable indicator whose chemical shift on protonation is sufficiently large to allow an accurate evaluation of the ionization ratio.

Both the absorption and nmr technique along with some other methods to evaluate medium acidity have been reviewed in detail in books of "Acidity Functions" by C. H. Rochester⁵ and "Reaction Mechanisms in H₂SO₄ and other Strong Acid Solutions" by M. Liler.⁶

B. Acidity Function Measurements

Aqueous solutions of H₂SO₄ have been extensively reinvestigated since the pioneering work of Hammett and Deyrup⁴. It has been pointed out that the series of indicators used by Hammett and Deyrup included bases of various different types such as ketones and anilines and that the assumption that the activity coefficient ratio is the same for two indicators over a given acid concentration range is less likely to be true for two indicators of different type than for two indicators of the same type. Therefore several workers⁷⁻⁹ have remeasured the acidity functions of H₂SO₄-H₂O system using a series of indicators which included only primary anilines. The new values differ appreciably in the region of very high acid concentrations. The results have been summarized by Rochester⁵ who gives detailed references to the original workers.

Acidity measurements were first extended into completely non-aqueous system by Brand et al.¹⁰ who extended Hammett's measurements up to 100% H₂SO₄ and into oleum systems (mixtures of H₂SO₄ and SO₃). As no suitably weak primary aniline bases were available Brand used a set of aromatic nitro compounds as indicators.

The necessity of using a different set of indicators represents a difficulty in the determination of H₀ values for superacid systems. Gillespie and Peel¹¹ have shown that the two indi-

7

catōrs 2,4,6-trinitroaniline and p-nitrotoluene have a satisfactory overlap in the acid range of 98-99 % H₂SO₄. In any case the acidity function values for acidities greater than that of 100 % H₂SO₄ are determined using a set of indicators which are all nitro aromatic compounds and it is reasonable to suppose that they give a consistent set of acidity values relative to 100 % H₂SO₄.

Acidities greater than that of 100 % H₂SO₄ may be obtained in systems containing acids of the sulfuric acid system; that is substances capable of protonating sulfuric acid

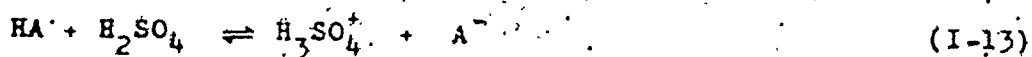

Several such systems have been studied by Gillespie et al.¹¹

Their results for H₂SO₄-SO₃ (H₂S₂O₇), H₂SO₄-HB(HSO₄)₄, H₂SO₄-HSO₃F and H₂SO₄-HSO₃Cl are shown in Figure. 1.

Both HSO₃F-H₂SO₄ and HSO₃Cl-H₂SO₄ have been studied over the whole concentration range. HSO₃F behaves as a rather weak acid of the H₂SO₄ solvent system ionizing to a small extent according to the equation (I-14)



In the region of 100 % HSO₃F, H₀ increases very rapidly, and this is presumably to be associated with the self-ionization of HSO₃F

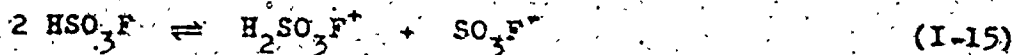

As the concentration of the very weakly basic H₂SO₄ decreases to a very low value and the concentration of SO₃F⁻ decreases accordingly, so the concentration of highly acidic H₂SO₃F⁺ ion increases rapidly up to the value that it has in 100 % HSO₃F.

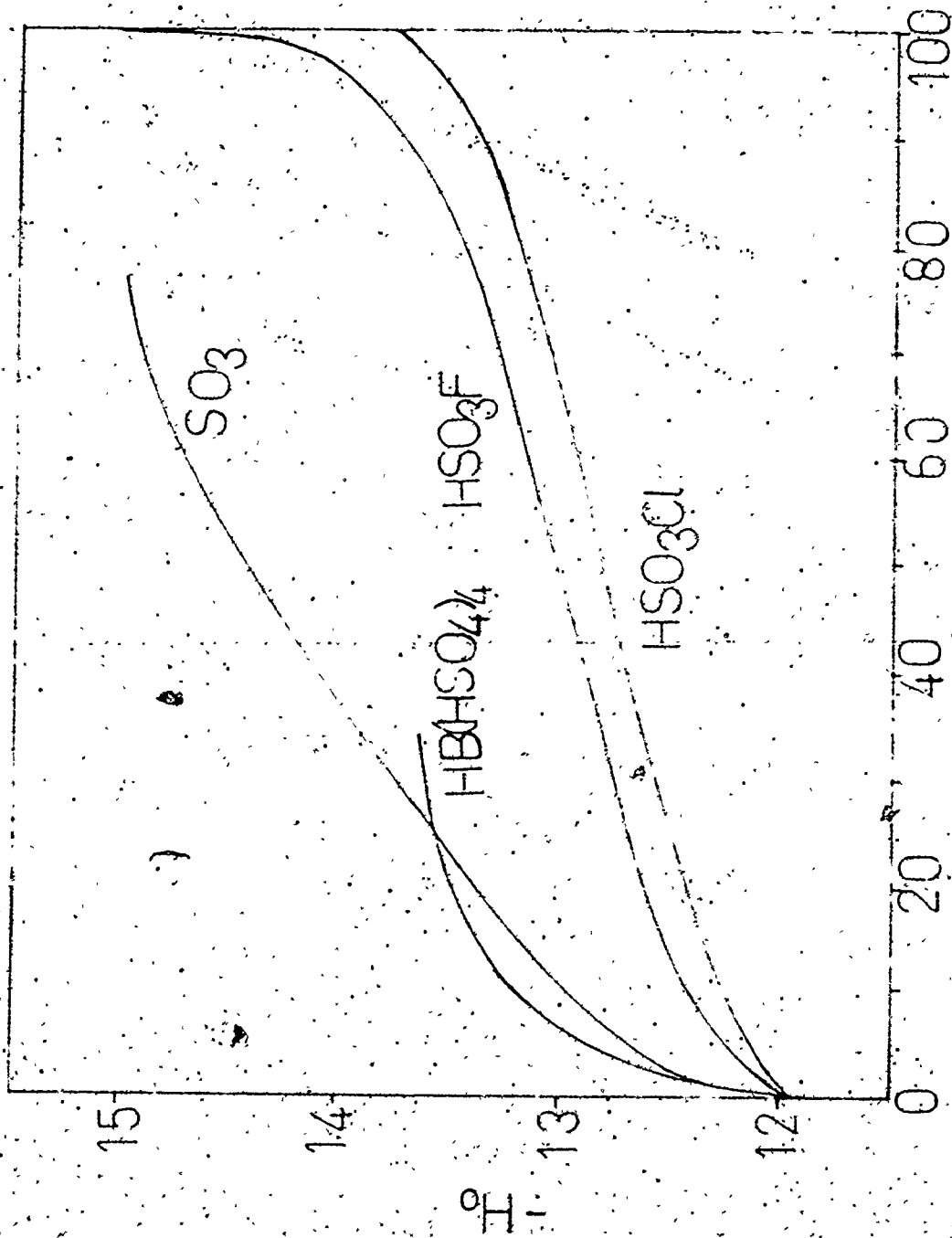

Figure 1. H_0 values for the acids of the H_2SO_4 solvent systems.

Systems of still higher acidity were measured by Gillespie and Peel³ by adding Lewis acids such as SbF_5 , $\text{SbF}_5 \cdot 3\text{SO}_3$ and AsF_5 to HSO_3F . H_0 measurements were made in these systems using very weakly basic indicators such as 2,4-dinitrofluorobenzene, 2,4,6-trinitrotoluene, 1,3,5-trinitrobenzene and 2,4,6-trinitrochlorobenzene. Their results for $\text{HSO}_3\text{F} \cdot \text{SO}_3$, $\text{HSO}_3\text{F} \cdot \text{AsF}_5$, $\text{HSO}_3\text{F} \cdot \text{SbF}_5$ and $\text{HSO}_3\text{F} \cdot \text{SbF}_5 \cdot 3\text{SO}_3$ are shown in Figure 2. The ability of these solutes to increase the acidity increases in the order $\text{SO}_3 < \text{AsF}_5 < \text{SbF}_5 < \text{SbF}_5 \cdot 3\text{SO}_3$. This is consistent with conductivity studies^{12,13}, which have shown that $\text{SbF}_5 \cdot 3\text{SO}_3$ is a strong acid, fully ionized in HSO_3F , that SbF_5 is a weak acid with $K_a = 3.7 \times 10^{-3} \text{ m Kg}^{-1}$, that AsF_5 is weaker still, and that SO_3 causes no measurable increase in the conductivity of HSO_3F solutions.

The dilute solutions (0 - 7 % mole) of $\text{SbF}_5 \cdot 3\text{SO}_3$ in HSO_3F are the most highly acidic HSO_3F systems which have so far been measured. A study of more concentrated and presumably more acidic HSO_3F systems will only be possible if suitably very weakly basic indicators can be found.

The acidity of solutions in HSO_3F systems may be attributed primarily to the concentration of $\text{H}_2\text{SO}_3\text{F}^+$. From the concentration of $\text{H}_2\text{SO}_3\text{F}^+$ in 100 % HSO_3F and the measured $-H_0$ of 100 % HSO_3F , the following relation was obtained

$$H_0 = -\log [\text{H}_2\text{SO}_3\text{F}^+] - 18.79 \quad (I-16)$$

Theoretical H_0 values can then be calculated for a strong acid or a strong base. These values for dilute solutions are shown in Figure 3 along with the observed values of H_0 for $\text{SbF}_5 \cdot \text{HSO}_3\text{F}$ and $\text{KSO}_3\text{F} \cdot \text{HSO}_3\text{F}$ systems measured by Gillespie and Peel³. Since they did not

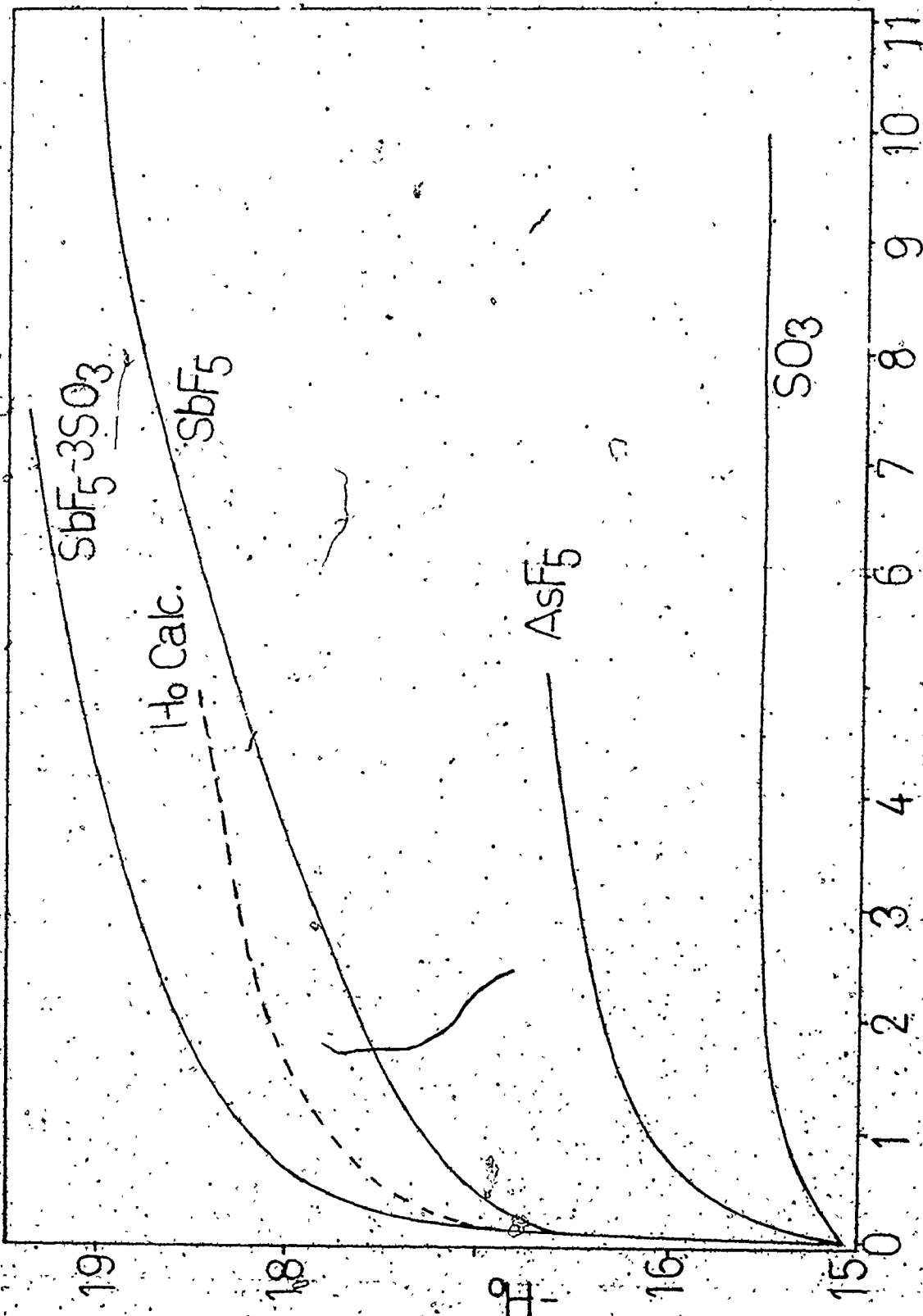

Figure 2. -H₀ values for the acids of the HSO₃F solvent systems

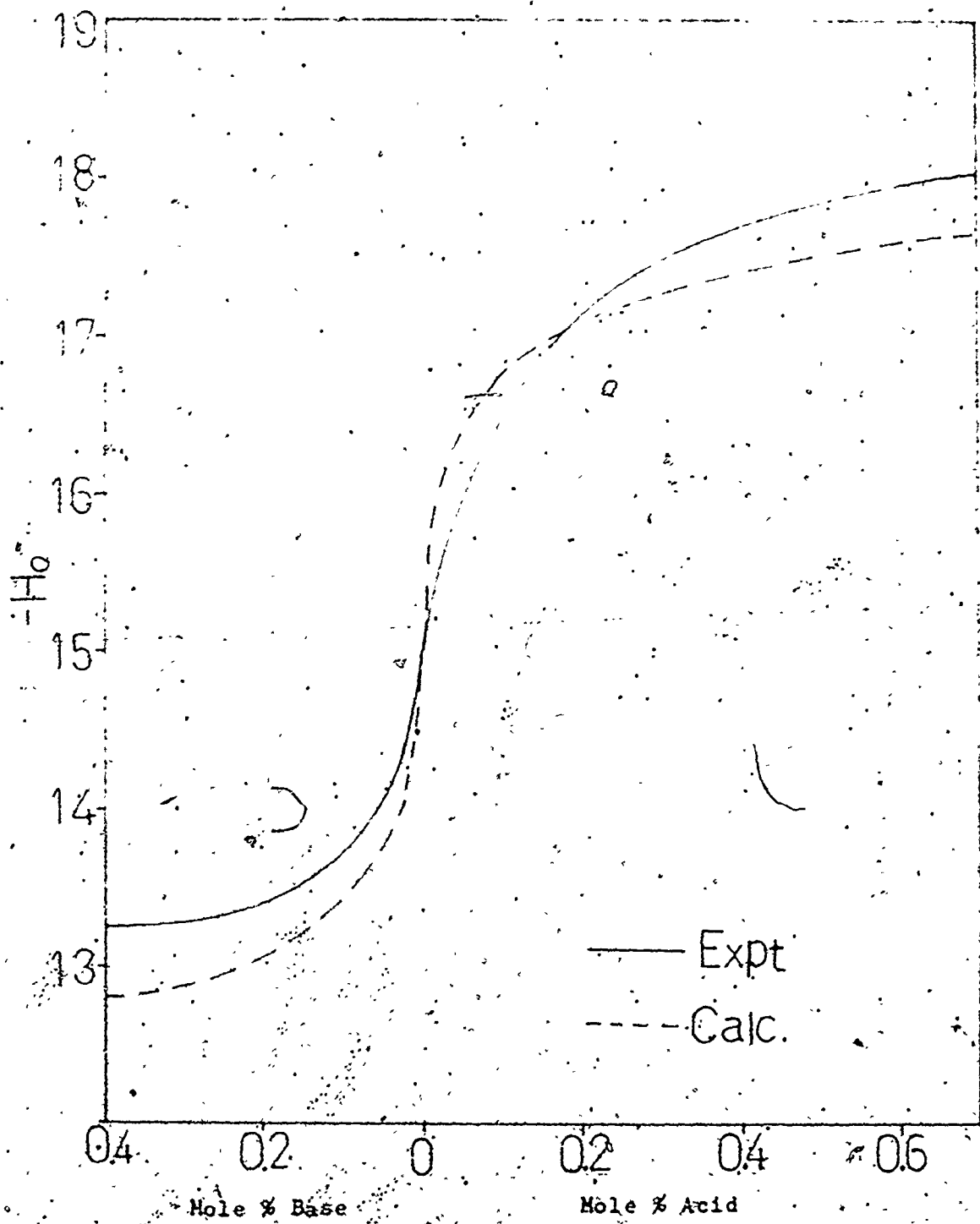

Figure 3. $-H_0$ values for $\text{HSO}_3\text{F}-\text{SbF}_5-3\text{SO}_3$ and $\text{HSO}_3\text{F}-\text{KSO}_3\text{F}$

measure the $\text{SbF}_5\text{-SO}_3$ system below 0.2% mole concentrations those H_0 values were taken from $\text{SbF}_5\text{-HSO}_3\text{F}$ system. The actual H_0 values for $\text{SbF}_5\text{-SO}_3$ in this range should be slightly greater. It can be seen from Figure 3 that the calculated H_0 and experimental H_0 are in reasonable agreement in dilute regions. The large difference at higher concentrations as shown in Figure 2 may presumably be attributed to activity effects.

The equation (I-16) may be used to calculate the ionization constants for weak acids such as AsF_5 , SbF_5 etc.,



From the measured H_0 the concentration of $\text{H}_2\text{SO}_3\text{F}^+$ can be calculated, and assuming the concentrations of $\text{H}_2\text{SO}_3\text{F}^+$ and $\text{MF}_5\text{SO}_3\text{F}^-$ are equal in equation (I-17), K_a may be calculated.

$$K_a = \frac{[\text{H}_2\text{SO}_3\text{F}^+][\text{MF}_5\text{SO}_3\text{F}^-]}{[\text{MF}_5]} \quad (\text{I-18})$$

A value of 2.2×10^{-3} mole Kg^{-1} was found for SbF_5 which is close to the value of 3.7×10^{-3} mole Kg^{-1} found by a conductometric method¹².

The Hammett acidity function H_0 for aqueous hydrogen fluoride was first investigated by Bell et al.¹⁴ up to 43% HF and later by Hyman et al.¹⁵ up to 100% HF. Dallinga et al.¹⁶ recently remeasured H_0 values in the range of 38-100% HF. Their results are reproduced in Figure 4. The pK values for the three indicators used by Bell and 2,4,6-trinitroaniline used by Hyman and Dallinga were based on the "best value" given by Paul and Long⁷. These pK values have

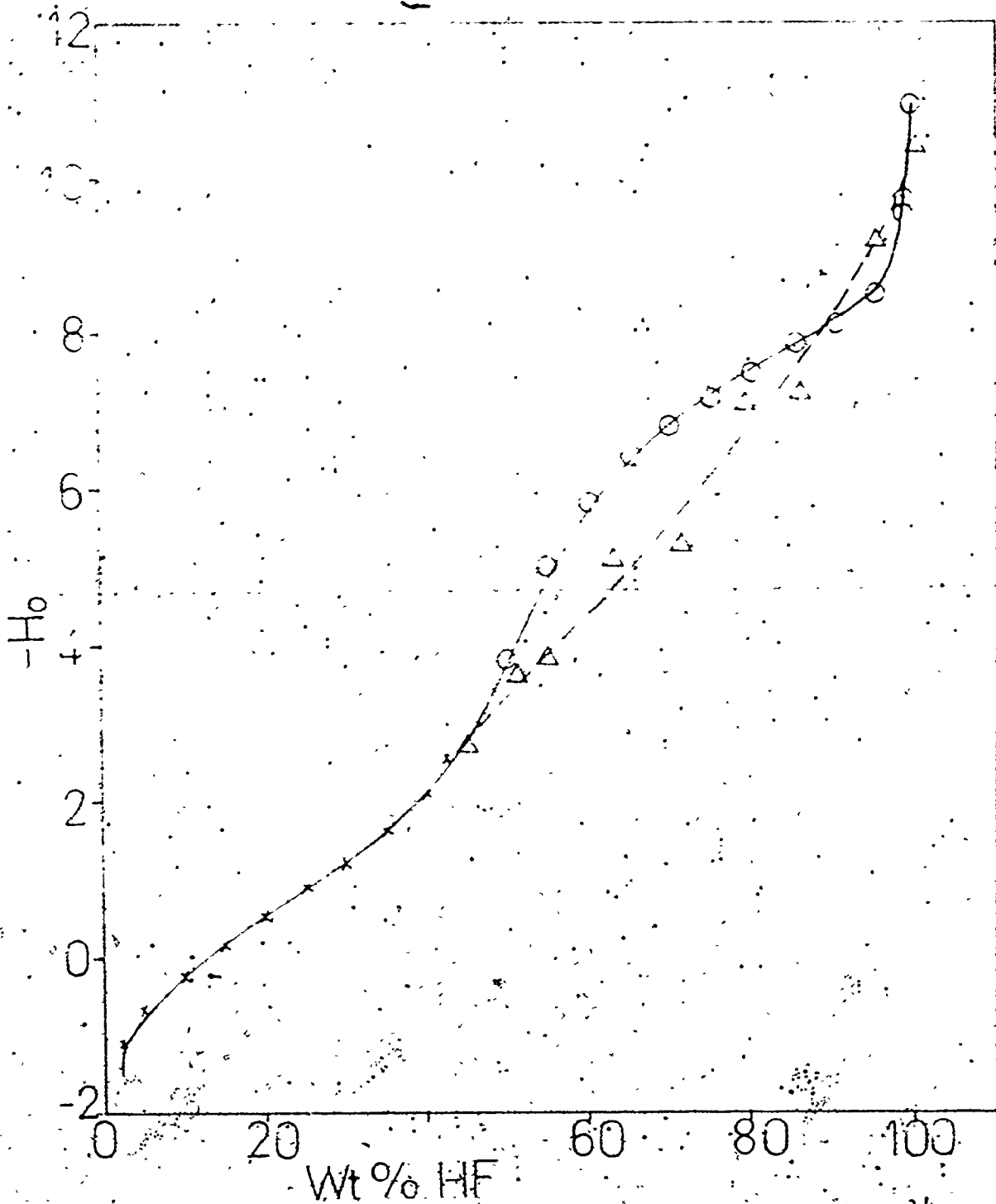
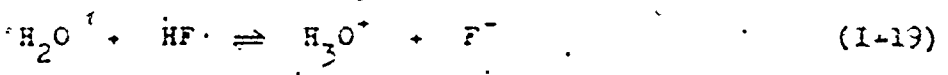

Figure 4. H_o values for HF- H_2O system. (X) Bell et al.¹⁴
 (o) Hyman et al.¹⁵, (Δ) Dallinga et al.¹⁶

been reevaluated by Jorgenson and Hartter⁹ and the H_0 values shown in Figure 4 have been adjusted accordingly.

It has been shown that HF is a weak acid in dilute aqueous solution but the acidity increases rapidly as the water content of the solution becomes small.^{14,15} In dilute solutions the actual acidic species present is H_3O^+ ion according to the equation (I-19)



with $K_{HF} = 3.53 \times 10^{-4}$ at 25°C.²³ The acidity of the dilute solution is given by the concentration of H_3O^+ . In sufficiently dilute solution the H_3O^+ ion is hydrated by water molecules, but as the concentration of HF is increased the number of water molecules available to hydrate the H_3O^+ ion decreases accordingly. As the extent of hydration of H_3O^+ decreases the hydrated complex becomes smaller in size, its positive charge becomes more concentrated, and its acidity is expected to increase. At still higher HF concentrations the polymeric species H_2F_2 , and in general H_nF_n , are present which are stronger proton donors than HF and are completely ionized to give the more acidic $H_3F_2^+$ etc.

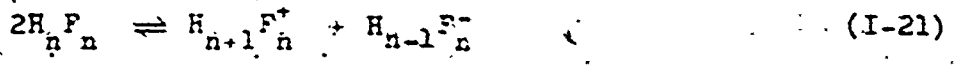

In 100 % HF a sharp increase in acidity is observed which is the consequence of the above two reactions, and since all acidic species in 100 % HF, H_2F^+ , $H_3F_2^+$ etc. are much more acidic than H_3O^+ in H_2O -HF the acidity of 100 % HF should increase sharply.

The exact value of μ_0 for 100 % HF has been uncertain as it depends strongly on the presence of small amounts of impurities which are very difficult to remove; the most important of these is water which exhibits basic behaviour. A value of -13.90 was given by Hyman et al.¹⁵ for an acid that had a conductivity of $10^{-5} \text{ ohm}^{-1} \text{ cm}^{-1}$ at 25°C.

Substances such as SbF_5 , AsF_5 and PF_5 which exhibit acid behaviour in the HSO_3F solvent system have been studied in HF by conductivity^{17,18} and cryoscopic measurements^{19,20}. In dilute solutions SbF_5 is a strong acid ionizing according to the equation



At higher concentrations the formation of polymeric species may occur

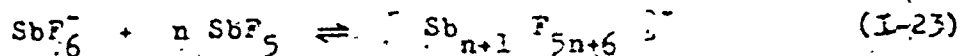

Arsenic pentafluoride has been found to be less ionized in HF according to the equation



Phosphorus pentafluoride behaves as a non-electrolyte and is too weak a fluoride ion acceptor to enhance the acidity of HF. The strong proton acid HSO_3F exhibits no appreciable acidic property in HF.

Conductivity and cryoscopic measurements only give

the dissociation constant of an acid in HF, which is not very useful if one wishes to compare the acidity between two different systems. Although some H_0 values for HF systems have been reported they are either inaccurate or too few in number to properly describe the whole system. For example Hyman et al.¹⁷ gave a value of -14.3 for 0.36 M SbF_5 and -15.2 for 3.0 M SbF_5 based on conductivity measurements in which they made assumptions about the ionization process and the relationship between H_0 value and the concentration of H_2F^+ . These values are highly unreliable because the calculation involved the H_0 value for 100% HF and the autoprotolysis constant whose values have been since reevaluated.

Evidence that the SbF_5 -HF system is even more highly acidic than the SbF_5 - HSO_3F system was first studied by Olah et al.²¹ as a result of their studies on the hydrogen-deuterium exchange of H_2 and D_2 in superacid systems. The exchange reactions take place in the mixtures of H_2 (D_2) with a deuterium acid (or proton acid) - SbF_5 mixture as shown by the formation of HD by mass spectroscopy

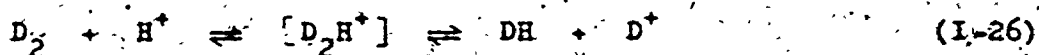
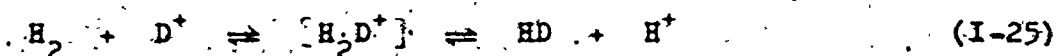

The rate of hydrogen-deuterium exchange was found to be in the order $HF-SbF_5(1:1) > HSO_3F-SbF_5(1:1) > H_2SO_4-SbF_5(1:1)$. Since the exchange reaction involves the protonation (deuteronation) of D_2 (H_2), it was concluded that the acidities of these systems are in the same order.

From their studies of the reactions of hydroxy-carbonium ions in superacids Brouwer et al.²² also have determined relative acidic strengths for the following acid systems for which they gave the relative values ; HF-SbF₅ (1:1) : HF-SbF₅ (9:1) : HSO₃F-SbF₅ (1:1) : HSO₃F-SbF₅ (5:1) => 500: 1: 10⁻¹: 10⁻⁵. This result was based on the measurements of the rates of monocation-dication equilibria of some ketones or the rearrangement of protonated ketones in superacid systems. For example, the 1,3-diketones are protonated to form dications in highly acidic systems and monocations in less acidic systems. Equilibration of dication and monocation can be studied by proton nmr spectroscopy. The position of monocation and dication equilibrium, which can be determined by the proton nmr spectra, provides a direct measure of H₂F⁺ or HF₂⁻ concentrations.

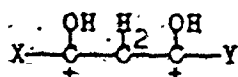

Dication (D)

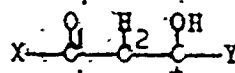

Monocation (M)



$$K_b = \frac{[\text{D}][\text{HF}_2^-]}{[\text{M}]} \quad (\text{I-26})$$

where K_b is an equilibrium constant. From the previously estimated value of H_0 by Gillespie and Peel³ for "magic acid", i. e. 1:1 HSO₃F-SbF₅, -19.5, a value of -21 for 9:1 HF-SbF₅ and -24 for 1:1 HF-SbF₅ were found by correlation.

More recently Kramer²³ has attempted to rank strong acids using a selectivity parameter $1/S$ which is defined as the ratio of

the isomerization and exchange rate constants k_{iso}/k_{ex} of some acid catalyzed reactions. A hydrocarbon labelled with tritium was mixed with an unlabelled hydrocarbon over an acid catalyst. A "perfect" acid would allow only isomerization to occur without hydrogen exchange while a "poor" acid, which is unable to stabilize the ion, would tend to induce faster exchange than isomerization. All three acid systems, MF_5-HF , MF_5-HSO_3F and $MF_5-CF_3SO_3H$ show a tendency to increase the ratio k_{iso}/k_{ex} in the order $NbF_5-HA < TaF_5-HA < SbF_5-HA$. For SbF_5-HA systems the ordering is $SbF_5-CF_3SO_3H > SbF_5-HF > SbF_5-HSO_3F$ which indicates again that SbF_5-HF system is more acidic than the SbF_5-HSO_3F system.

In the light of kinetic studies it seems that the SbF_5-HF system has a higher acidity than the SbF_5-HSO_3F system. Until the present time no detailed and accurate study of this highly acidic SbF_5-HF system has been made, though some H_0 values have been obtained very recently from kinetic studies, for example by Brouwer et al.'s studies and by Siskin and Kosci²⁴ who made a similar study to that of Olah et al. of the hydrogen-deuterium exchange in superacid systems. Siskin and Kosci made measurements of exchange rates in various acid systems whose H_0 values had been measured and they attempted to find H_0 values for the unmeasured acid systems by assuming that there was a linear correlation between H_0 and the exchange rate. A value of -24.3 was obtained for $HF-SbF_5(10:1)$ and -18.5 for $HF-TaF_5(10:1)$. Kramer's finding that $SbF_5-CF_3SO_3H$ was more acidic than SbF_5-HSO_3F or SbF_5-HF has been proved

to be incorrect in the present measurements (Chapter IV).

C. Purpose of present work

The investigation of the acidities for some superacid systems which either have not been studied extensively or have never been studied is the main interest in the present work. For example, both aqueous and non-aqueous HF systems, because of the difficulty in handling, have been very little studied and there is lack of agreement between the results that have been obtained. The quantitative H_0 values for the non-aqueous HF- MF_5 systems, which are known to be highly acidic, have never been established. In the present work acidities of these systems have been measured in terms of the acidity function H_0 for the first time. Also the H_0 value for 100 % HF has been reevaluated.

The HSO_3F solvent system has been studied quite extensively. In addition to the acids AsF_5 , SbF_5 and SbF_5-3SO_3 for which H_0 values of their HSO_3F solutions have been measured, other Lewis acids such as NbF_5 and TaF_5 have been reported to exhibit acidic properties in HSO_3F . Their H_0 values have been measured in the present work and compared with the previously investigated systems.

The present acidity measurements have been made mostly by the UV-visible absorption method. Some measurements have also been made by the nmr method for the SbF_5-HSO_3F system, primarily to test the applicability of this method for the determination of the H_0 acidity function.

CHAPTER II

EXPERIMENTAL

A. Acids

Technical grade fluorosulfuric acid (Allied Chemical Corp.) was purified by fractional distillation through a reflux column packed with small glass rings. The apparatus and procedure are discussed elsewhere in greater detail.^{25,26} The fraction boiling between 161.5° and 163.5° C was collected. The resulting acid was found to contain a 5×10^{-2} molal excess of SO_3 by cryoscopic titration. The composition of the acid was adjusted to exactly 100 % by adding a known amount of HF dissolved in HSO_3F .

Anhydrous hydrogen fluoride (Harshaw Chemical Co.) was purified by fractional distillation. A Kel-F distillation column suitable for the fractionation of commercial grade HF has been described by Shamir and Netzer.²⁷ A vacuum line equipped with a distillation apparatus is shown in Figure 5. Hydrogen fluoride was first distilled from the commercial cylinder into a Kel-F storage vessel (S) and then transferred into the Monel still pot (R). The pot was kept under total reflux by keeping it at 35°C and cold water was kept running through the condenser. After refluxing for 12 hours the distillate was collected in the receiver at P or the forerun container (B), depending on its conductivity. Acid which had a conductivity of 10^{-5} to 10^{-6} ohms⁻¹ cm⁻¹ was considered to be good material.

Trifluoromethylsulfuric acid (3M Co.) was purified by fractional distillation as described for HSO_3F . The fraction of boiling

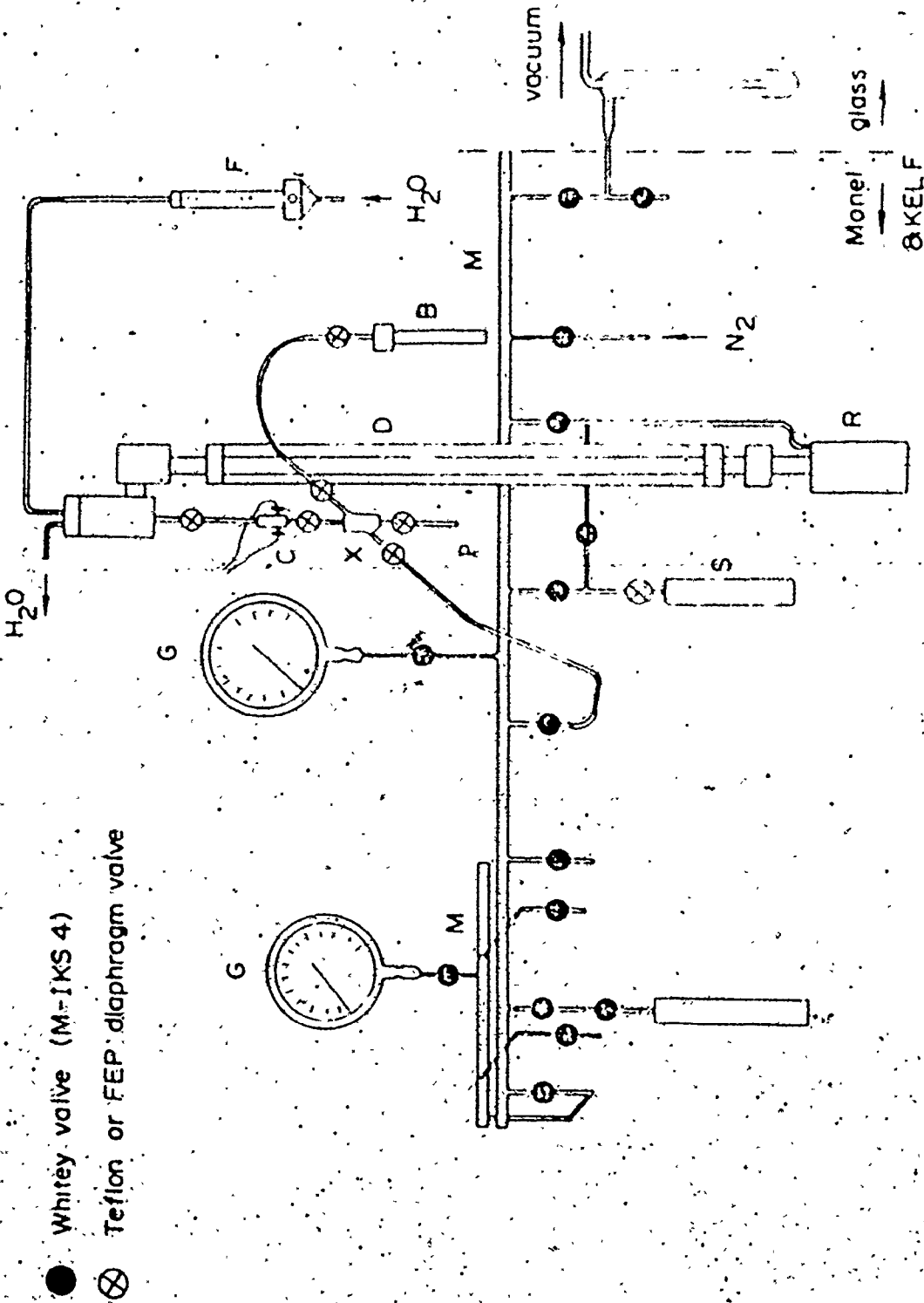

- Whitey valve (M-IKS 4)
- ⊗ Teflon or FEP diaphragm valve

Figure 5. Monel vacuum line and HF distillation apparatus; (M) Monel manifold, (G) Monel Bourdon gauge, (D) Distillation column, (C) Conductivity cell, (S) Kel-F storage vessel, (V) Copper HF disposal can, (F) Flow meter, (X) Kel-F connector, (B) Forerun collecting tube, (P) Take-off point for conductivity grade HF.

point between 161.5° and 162.5°C was collected. The resulting acid was reported and also found in the present work to contain 2% mole of water by conductimetric titration using freshly prepared trifluoromethylsulfuric anhydride to titrate the acid.²³ The calculated amount of anhydride was added to adjust the freshly distilled acid to 100 % $\text{CF}_3\text{SO}_3\text{H}$.

Trifluoromethylsulfuric anhydride was prepared by mixing the acid $\text{CF}_3\text{SO}_3\text{H}$ with phosphorus anhydride P_2O_5 , the mixture was then heated in vacuo and the volatile material was transferred to a trap cooled to -183°C . Redistillation from P_2O_5 gave the anhydride $(\text{CF}_3\text{SO}_2)_2\text{O}$.

B. Fluoride acceptors

Antimony pentafluoride (Ozark-Mahoning Co.) was purified by double distillation in a Pyrex glass still in an atmosphere of dry nitrogen. The apparatus and procedure are described by Barr.²⁵ The fraction boiling between 142° and 143°C was collected. The distillate was placed in a Kel-F vessel and pumped at 60°C until bubbling ceased.

Arsenic pentafluoride (Ozark-Mahoning Co.) was found to be free of impurities as shown by its gas-phase infrared spectrum and was distilled from the cylinder.

Tantalum pentafluoride (Ozark-Mahoning Company) and niobium pentafluoride (Ozark-Mahoning Company) were purified by vacuum sublimation in a Vycor apparatus.

Phosphorus pentafluoride (Ozark-Mahoning Co.) was distilled from the cylinder and used without further purification.

C. Acid-pentafluoride mixtures

Stock solutions of $\text{SbF}_5\text{-HSO}_3\text{F}$ were prepared by weight in a grease-free Pyrex and Teflon vacuum line, by distillation of SbF_5 onto frozen 100 % HSO_3F . The stock solutions were then diluted in a dry box by mixing the desired concentration of SbF_5 .

The solutions of HF-MF_5 (M = Sb, As, and F) were prepared by weight in the Teflon vacuum line, by distillation of MF_5 onto frozen HF in the Kel-F trap equipped with teflon valves.

The solutions of HF-NbF_5 and HF-TaF_5 were prepared by weight in teflon vacuum line, by distillation of a weighed quantity of HF onto a weighed quantity of NbF_5 and TaF_5 in Kel-F traps.

The solutions of $\text{SbF}_5\text{-CF}_3\text{SO}_3\text{H}$ were prepared in the same way as for $\text{SbF}_5\text{-HSO}_3\text{F}$.

D. Aromatic nitro compounds

The nitro indicators p-nitrotoluene (m.p. 51.0° ; lit.²⁹ 51.7°C), m-chloronitrobenzene (m.p. 43.5° ; lit.²⁹ 44°C), 2,4-dinitrotoluene (m.p. 70° ; lit.²⁹ $70\text{-}1^\circ\text{C}$), 2,4,6-trinitrotoluene (m.p. 81.5° ; lit.²⁹ 82°C), 1,3,5-trinitrobenzene (m.p. 122° ; lit.²⁹ $121\text{-}2^\circ\text{C}$), 2,4,6-trinitrochlorobenzene (m.p. 82° ; lit.²⁹ 83°C), obtained from Eastman Organic Chemicals were recrystallized from anhydrous methanol. The indicators were air-dried and stored in standard desiccators over P_2O_5 for one week before being sealed in air tight containers.

The indicators p-fluoronitrobenzene (m.p. 26.9° ; lit.²⁹ 26°C), 2,4-dinitrofluorobenzene (m.p. 25.4° ; lit.²⁹ 26°C) obtained from Eastman Organic Chemicals were purified by repeated fractional

freezing and stored in dry dark containers.

The indicator 2,4,6-trinitroaniline (m.p. 192° ; lit.²⁹ $190-1^{\circ}\text{C}$) obtained from Eastman Organic Chemicals was purified from glacial acetic acid.

E. Manipulation of Materials

Most of the compounds used in the course of this work were moisture sensitive, and they could be handled only in a vacuum line or, if non-volatile, in the inert atmosphere of a dry box.

The dry box (S. Blickman Inc.) had an evacuable port in which the hot glassware was placed immediately prior to use. Evacuation of the port was continued for half an hour before being refilled with extra dry nitrogen. The nitrogen was circulated through an external circuit in which any moisture or acid vapor was removed in liquid nitrogen traps.

The vacuum line used to handle HF was constructed of Monel metal and equipped with Whitey valves (M-IKS4).

F. Preparations of Samples

F-1. Solutions of $\text{HSO}_3\text{F-MF}_5$ and $\text{CF}_3\text{SO}_3\text{H-MF}_5$: Solutions for study by UV-visible absorption were prepared by the following method. A 0.02 g sample of indicator was weighed into 10 g of acetone outside the dry box. A 0.02 g aliquot of the resulting solution was weighed into a 10 ml volumetric flask after which the solvent was evaporated. The flask was then brought into the dry box and filled to the mark with the acid solution under study. Solutions of indicators were then transferred into 1.0 cm Suprasil UV cells (Hellma Ltd.) fitted with standard taper 7.5 ground glass tops and

Teflon stoppers. A reference sample of the exact composition of the acid mixture under study was transferred into a matching 1.0 cm UV cell. Spectra were recorded as soon as possible making use of a Cary 14 Spectrophotometer (Applied Physics Corp.).

Solutions for study by nmr were prepared in the dry box. The concentration of the indicator was ca. 0.15M. Solutions were transferred into 5 mm O.D. ("pyrex" nmr tubes and later sealed off under vacuum.

F-2, Solutions of HF-MF₅: Samples of indicators were prepared in the same manner as in F-1 except for replacing the 10 ml volumetric flask by a Kel-F trap fitted with teflon valve. The acid solution under study was poured into the indicator trap in a closed-system consisting of a Y-connector and Teflon valves (Figure 6). The concentration of indicator was estimated by measuring the height of solution in the trap and later on replacing the solution by the same amount of distilled water. The volume of this amount of water was then calculated by means of the relationship $v = wt./d$ where d is the density of water at 22°C. After the sample was well mixed, it was transferred to the UV cell by pouring in the closed-system. The UV cells had a teflon body and sapphire windows. The sapphire windows (Harshaw Chemical Co.) of 1" diameter and 1 mm thickness were fitted into the body with teflon gaskets and brass nuts. The path length of the cells was 1 cm. The cells could be sealed by fitting with a Teflon valve. The cells were easily cleaned without dismantling the windows by placing them in an Ultrasonic Cleaner (Cole-Parmer Co.) with solvent acetone

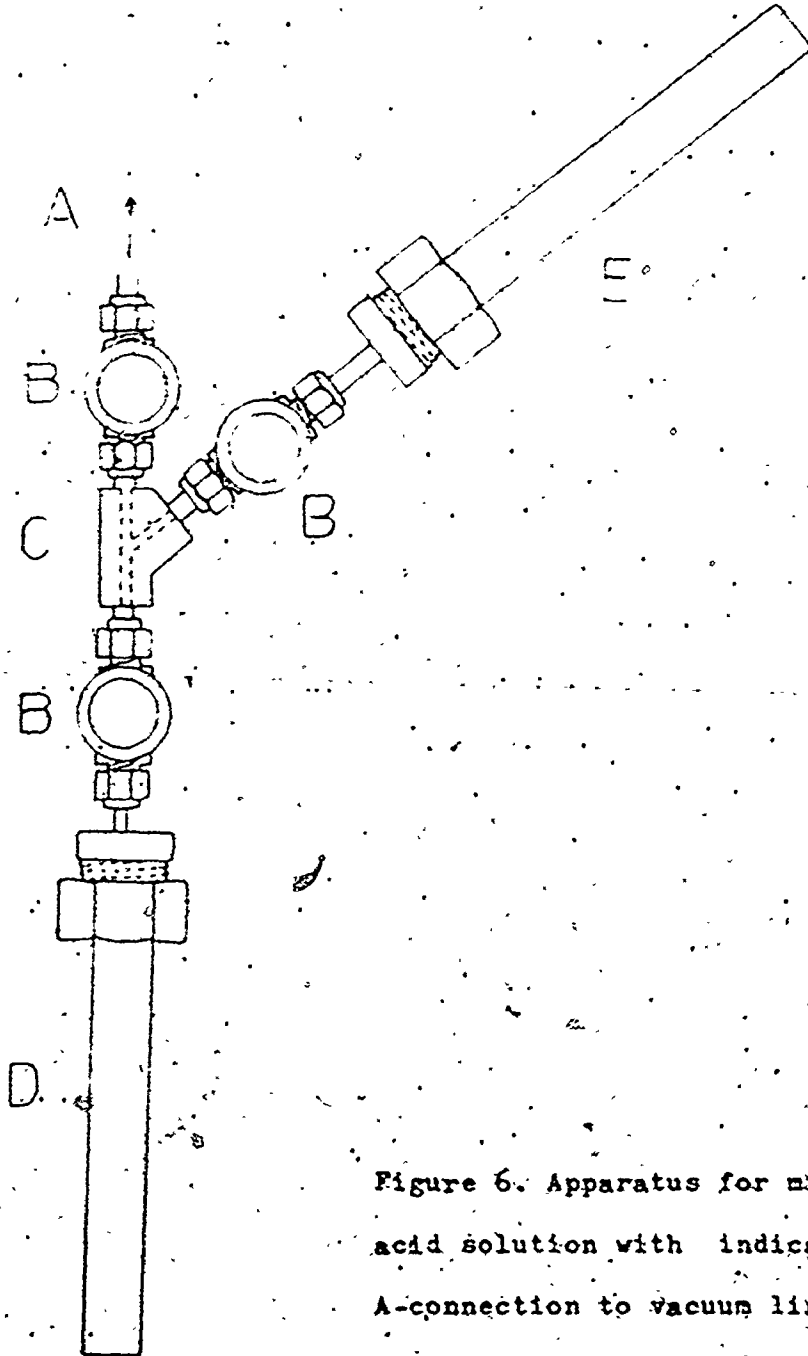

Figure 6. Apparatus for mixing the acid solution with indicator sample

A-connection to vacuum line

B-Teflon valves

C-Y connector

D-indicator sample trap

E-acid solution trap

or water after which they were flushed with solvent in a spectrophotometer cell washer, Vacuwasher (Bal-Art Co.). The cells were dried in an oven (ca. 70°C) and evacuated on the vacuum line prior to use.

G. UV-visible and nmr spectra

A Cary 14 spectrophotometer was used in the absorption study. Extinction coefficients (ϵ) were calculated from the observed absorbance (A) values according to

$$\epsilon = \frac{A}{Cl}$$

where C is the concentration of the indicator in molar units and l is the path length of the cell used (1cm). Absorption spectra were recorded at room temperature (22 ± 1°C).

^1H nmr spectra were recorded with a T 60 or HA 100 (Varian Corp.) spectrometer. The resonance of the reference material, tetramethylsilane (TMS) was determined by exchange of sample tubes in the probe of the spectrometer.

^{19}F nmr spectra were recorded with a DP 60 spectrometer (Varian Corp.) operating at 56.4 MHz and equipped with a variable temperature control unit. Chemical shifts were reported with reference to fluorotrichloromethane whose resonance was determined by the exchange of sample tubes in the probe of the spectrometer.

CHAPTER III

THE FLUROSULFURIC ACID SOLVENT SYSTEM

A. Introduction

The physical and chemical properties of fluorosulfuric acid have been described in detail.³⁰ Its application as a solvent in synthetic chemistry has become increasingly important in recent years. This wide application is attributed to its high acidity, particularly as a mixture with some Lewis acids such as AsF_5 and SbF_5 . These acids function as SO_3F^- anion acceptors

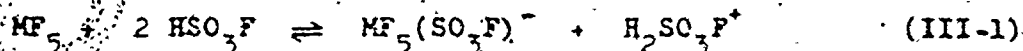

and hence increase the concentration of the highly acidic species, $\text{H}_2\text{SO}_3\text{F}^+$:

The acidity of several HSO_3F -Lewis acid systems has been measured by Gillespie and Peel³¹. In addition to these Lewis acids (Fig. 2) NbF_5 and TaF_5 are capable of increasing the acidity of HSO_3F .^{31,32} The reaction between NbF_5 or TaF_5 and HSO_3F is presumed to be analogous to that of SbF_5 in HSO_3F as given by equation (III-1).

B. Acidity measurements by the absorption method

Acidity measurements were made using the two indicators, 2,4,6-trinitrotoluene and 1,3,5-trinitrobenzene. Tables I and II list the observed extinction coefficients in NbF_5 - HSO_3F up to the composition of 7 mole % of NbF_5 . These values are plotted as a function of the NbF_5 concentration in Figure 7. The ionization

ratios were calculated at regularly spaced concentrations of NbF_5 and are listed in Tables III and IV and plotted in Figure 8. The c_B , c_{BH^+} and $\text{p}K_{\text{BH}^+}$ values for the two indicators were determined previously by Gillespie and Peel³. The c_B 's were found in 100 % H_2SO_4 solutions in which the indicators are not protonated. The c_{BH^+} 's were found in dilute solutions of SbF_5 in HSO_3F in which the indicators are fully mono-protonated³. The $\text{p}K_{\text{BH}^+}$ values were obtained by overlap with stronger bases in the region of 100 % HSO_3F . The $-\text{H}_0$ values are listed in Table V and plotted in Figure 9.

The same two indicators were used for the TaF_5 - HSO_3F system. Their observed extinction coefficients are listed in Tables VI and VII and are plotted in Figure 10. Tables VIII and IX list the ionization ratios at regularly spaced concentrations of TaF_5 and they are plotted in Figure 9.

The ($\text{p}K_{\text{BH}^+} + \log I$) values for 2,4,6-trinitrotoluene and 1,3,5-trinitrobenzene along with the average $-\text{H}_0$ values in the TaF_5 - HSO_3F system are listed in Table X. The $-\text{H}_0$ values are plotted in Figure 9 together with the values for the systems measured previously by Gillespie and Peel³; HSO_3F - SO_3 , HSO_3F - AsF_5 and HSO_3F - SbF_5 for comparison. It is apparent that NbF_5 is a very weak acid, only slightly stronger than SO_3 which agrees with the conductivity results³² in which NbF_5 solutions in HSO_3F were found to have a very low conductivity. The ionization constant K_a of NbF_5 in HSO_3F can be calculated using equation (I-16) and equation (I-18). A value of 3.0×10^{-6} was obtained. This may be compared with the value of 4.6×10^{-7} obtained previously for SO_3 .

TaF_5 is a stronger acid than NbF_5 but is much weaker than SbF_5 . The ionization constant K_a for TaF_5 in HSO_3F is calculated to be 4.0×10^{-5} .

C. ACIDITY MEASUREMENTS BY THE NMR METHOD

Some measurements for the SbF_5 - HSO_3F system were made by the nmr method using 2,4-dinitrofluorobenzene for ^{19}F nmr and 2,4,6-trinitrotoluene for proton nmr. Tables XI and XII list their chemical shifts which are plotted in Figures 12 and 13. A greater change in chemical shift with increasing acid concentration was observed for ^{19}F nmr than for 1H nmr. Protons of the methyl group in protonated 2,4,6-trinitrotoluene are deshielded by only about 0.5 ppm relative to the same protons in the unprotonated indicator. This small change is not practically useful in the acidity evaluation since it is difficult to determine whether this change is due to protonation or to solvent effects. Therefore the 1H nmr results were not treated further.

Using the present observed chemical shifts of 2,4-dinitrofluorobenzene in the SbF_5 - HSO_3F system and the known H_0 values for this acid system measured by Gillespie and Peel³, which are shown in Table XIII, a plot of chemical shift δ vs. H_0 was made and is shown in Figure 14. Two useful data were obtained from this protonation curve. One is the pK value of the indicator which is equal to the medium acidity corresponding to half-protonation and is obtained by finding the maximum slope in a plot of $(\delta - \delta') / (H_0 - H_0')$ vs. H_0 , as shown in Figure 15. A value of -17.40 for pK_{BH_2} of 2,4-dinitrofluorobenzene was found which was very close

to the value of -17.35 obtained by the absorption method. Other data are the values for δ_B and δ_{BH^+} (or δ_{BH^+} and $\delta_{BH_2^{+2}}$ for the diprotonation) of the indicator. A value of 100 for δ_{BH^+} was obtained from the lower level portion of the curve in Figure 14 for 2,4-dinitrofluorobenzene and a value of 77 for $\delta_{BH_2^{+2}}$ was estimated from the upper level portion.

The values of δ were taken at regularly spaced concentrations of SbF_5 from Figure 12 and the ionization ratios were calculated. They are listed in Table XIV together with $-H_0$ values. These $-H_0$ values are also plotted in Figure 9 with the previously measured values using the absorption method for comparison.

D. DISCUSSION

The acidities of the solutions of Lewis acids in the HSO_3F solvent system may thus be arranged in the order $SO_3 < NbF_5 < AsF_5 < TaF_5 < SbF_5 < SbF_5 \cdot 3SO_3$. The acidities of TaF_5 and AsF_5 are very close with TaF_5 being slightly higher.

The ^{19}F nmr method has been found to be very satisfactory for the H_0 measurements and for the pK evaluation of very weak bases. The H_0 values obtained by ^{19}F nmr are almost identical to those observed by the absorption method except in dilute solutions. It has been pointed out that in very dilute solutions of acids in HSO_3F the acidity is very sensitive to the addition of very small amounts of base. The amount of indicator added in the nmr measurements undoubtedly has the effect of appreciably reducing the acidity of such dilute acid solutions.

The basicity determination of weak bases by the nmr method has been made by many workers.³³⁻³⁵ Taft and Levine³³ determined the pK values for fluorene derivatives in H_2SO_4 by ^{19}F nmr. Lee³⁴ evaluated the pK values for some aliphatic ketones in H_2SO_4 by proton nmr and Levy et al.³⁵ studied the ionization behavior of a number of halogen substituted ketones by proton nmr in acid systems such as H_2SO_4 and superacid SbF_5-HSO_3F .

The two indicators, 2,4,6-trinitrotoluene and 1,3,5-trinitrobenzene behave quite uniformly in NbF_5-HSO_3F and TaF_5-HSO_3F as shown by their plots of $\log I$ vs. acid concentration. The indicator 2,4,6-trinitrotoluene was diprotonated beyond the concentration around 3 mole % TaF_5 as shown by the shift of λ_{max} to shorter wavelength and the marked increase in ϵ values.

TABLE I
 EXTINCTION COEFFICIENTS OF 2,4,6-TRI-
 NITROTOLUENE IN THE NbF_5 - HClO_4 SYSTEM

Mole % NbF_5	λ_{max} (nm)	c	Mole % NbF_5	λ_{max} (nm)	c
0.2812	315	3900	2.6000	318	5100
0.3336	320	4900	2.6940	319	7300
0.5312	316	4000	2.8000	318	5300
0.5936	317	4600	2.8106	319	5700
0.7179	317	4800	3.1652	319	6700
0.8746	320	4700	3.7055	316	8000
1.3662	318	6300	4.0654	320	8300
1.4513	318	5200	4.5109	320	8100
1.4640	319	5700	5.4535	320	7800
1.5590	320	5500	5.8000	319	8000
1.8550	320	5400	6.8547	319	8400
2.0541	319	5800	6.9537	320	8100

TABLE II
EXTINCTION COEFFICIENTS OF 1,3,5-TRI-
NITROBENZENE IN THE NbF_5-HSO_3F SYSTEM

Mole % NbF_5	λ_{max} (nm)	ϵ
0.3466	295	2500
0.3788	294	3300
0.5391	295	2600
0.6610	295	2900
1.1464	297	4100
1.7070	296	3400
1.8550	308	2700
2.4257	297	3600
3.0754	297	3700
3.2228	296	3500
3.7055	295	3100
4.0486	296	3500
4.8525	299	4300
6.1195	300	5300
6.6857	299	4100
6.8000	300	4100
7.7616	300	4500

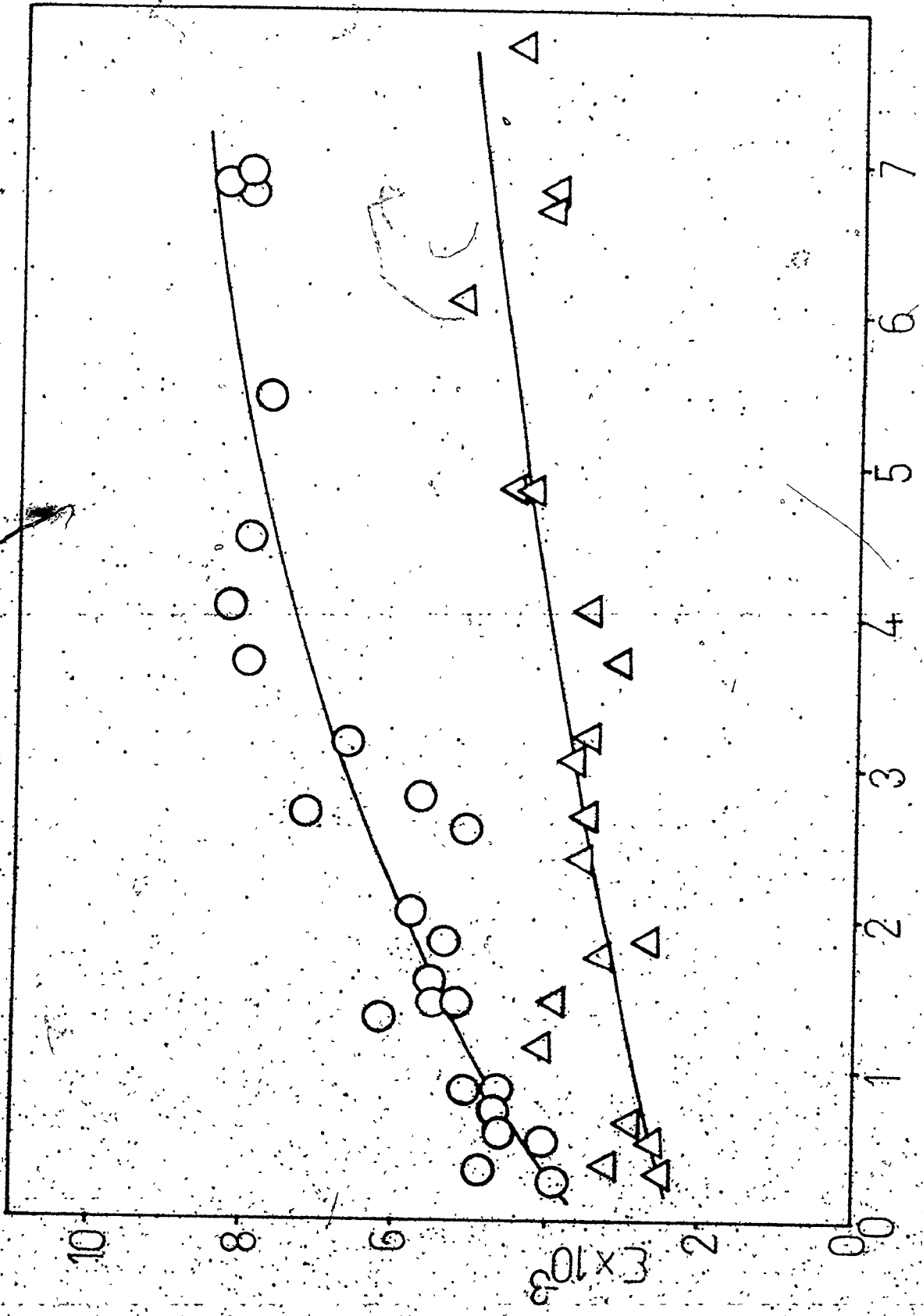

Figure 7. Extinction coefficients for 2,4,6-trinitrotoluene (O) and 1,3,5-trinitrobenzene (Δ) in the $\text{NbF}_5\text{-H}_2\text{SO}_3\text{F}$ system.

TABLE III
IONIZATION RATIOS OF 2,4,6-TRINITROTOLUENE IN
THE NbF_5 - HSO_3F SYSTEM

$$c_B = 960$$

$$c_{\text{BH}^+} = 10600$$

$$pK_{\text{BH}^+} = -15.60$$

Mole % NbF_5	c	$\log I$
0.25	3900	0.36
0.50	4200	0.29
1.00	4900	0.16
1.50	5400	0.07
2.00	5900	-0.02
2.50	6300	-0.09
3.00	6700	-0.17
4.00	7400	-0.30
5.00	7900	-0.41
6.00	8300	-0.50
7.00	8600	-0.58

TABLE IV
IONIZATION RATIOS OF 1,3,5-TRINITROBENZENE IN
THE $\text{NbF}_5\text{-HSO}_3\text{F}$ SYSTEM

$c_B = 800$	$c_{\text{BH}^+} = 10700$	$pK_{\text{BH}^+} = -16.04$
mole % NbF_5	c	$\log I$
0.25	2500	0.68
0.50	2600	0.65
1.00	2900	0.57
1.50	3100	0.52
2.00	3300	0.47
2.50	3400	0.45
3.00	3600	0.40
4.00	4100	0.30
5.00	4400	0.24
6.00	4600	0.21
7.00	4900	0.15

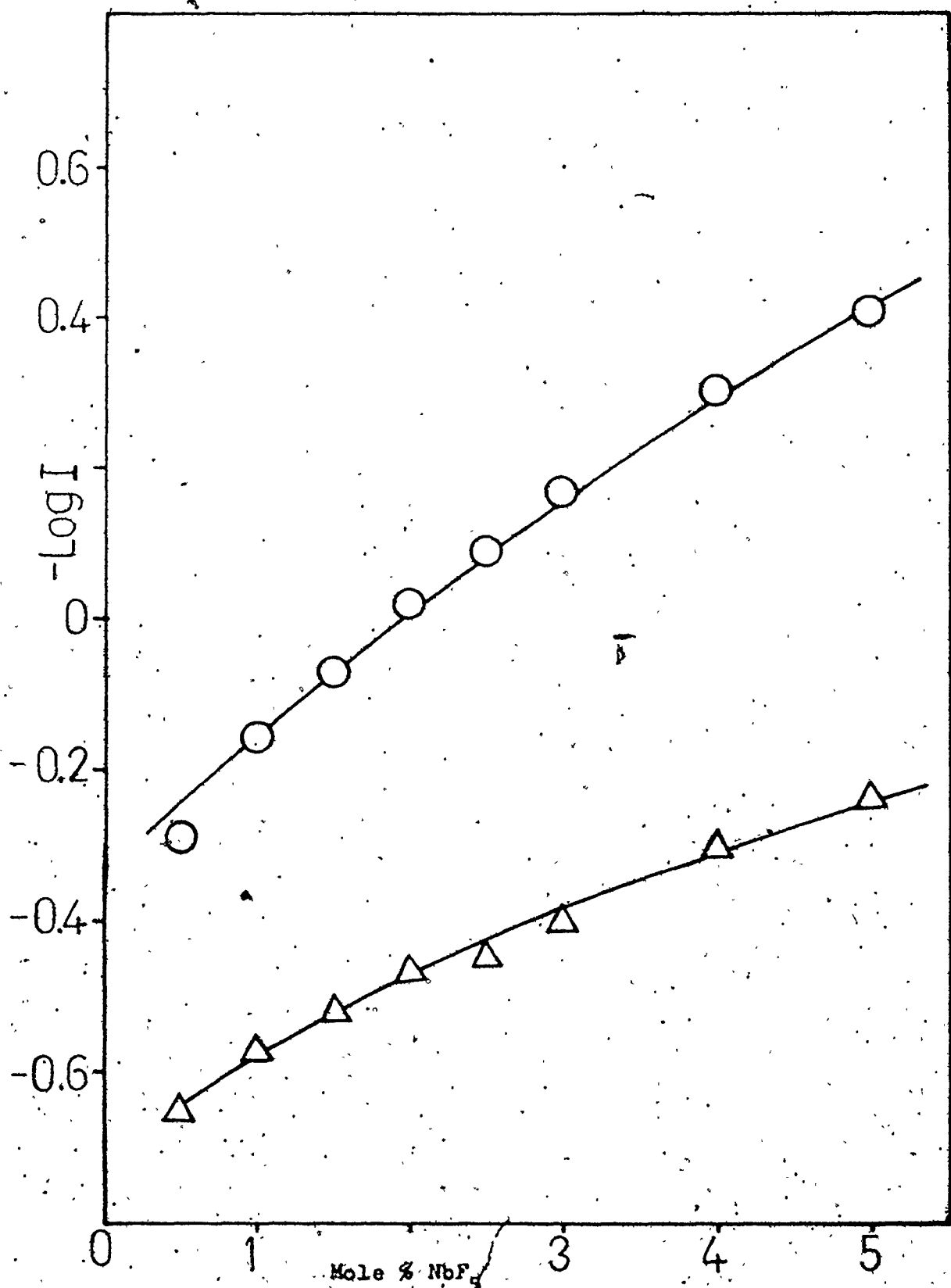

Figure 8. Ionization ratios of 2,4,6-trinitrotoluene (O) and 1,3,5-trinitrobenzene(Δ) in the NbF_5 - H_2SO_4 system.

TABLE V
 - H_0 VALUES FOR THE NbF_5 - H_2SO_4 SYSTEM

Mole % NbF_5	2,4,6-trinitro- toluene	1,3,5-trinitro- benzene	Average
0.25	15.24	15.36	15.30
0.50	15.31	15.39	15.35
1.00	15.44	15.47	15.46
1.50	15.53	15.52	15.53
2.00	15.62	15.57	15.60
2.50	15.69	15.59	15.64
3.00	15.77	15.64	15.71
4.00		15.74	15.74
5.00		15.80	15.80
6.00		15.83	15.83
7.00		15.89	15.89

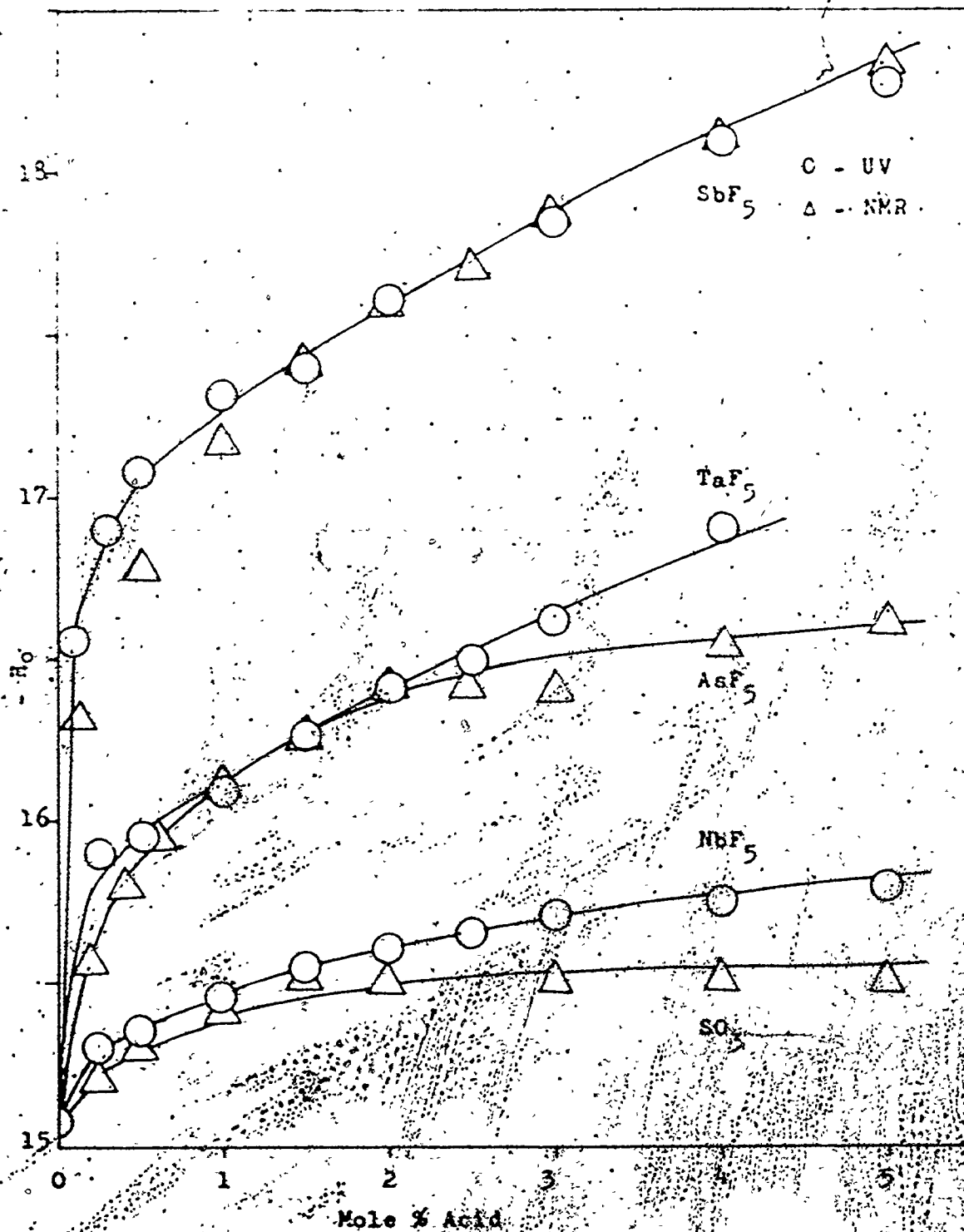

Figure 9. $-H_0$ functions for the HSO_3F solvent system.
 NbF_5 , TaF_5 and SbF_5 (NMR) --- present work
 SO_3 , AsF_5 and SbF_5 (UV) ---- Gillespie and Peal

TABLE VI
EXTINCTION COEFFICIENTS OF 2,4,6-TRINITRO-
TOLUENE IN THE TaF_5 - HSC_2F SYSTEM

Mole % TaF_5	λ_{max} (nm)	ϵ
0.4130	326	8,900
0.5290	325	8,300
0.5430	323	8,400
0.5845	325	7,900
0.8645	322	7,800
1.0430	325	8,200
1.0694	322	8,000
1.5480	322	8,000
1.5691	322	8,300
1.8210	326	8,700
2.0840	323	9,000
2.2800	320	10,400
2.3970	320	9,500
2.6930	323	10,400
2.7690	319	11,700
3.1790	320	10,800
3.4540	321	10,200
3.7890	319	12,500
3.9260	321	10,500
4.6800	318	13,100
7.0800	315	14,100

TABLE VII
EXTINCTION COEFFICIENTS OF 1,3,5-TRINITRO-
BENZENE IN THE TaF₅-HSO₃F SYSTEM

Mole % TaF ₅	λ_{max} (nm)	ϵ
0.4130	304	5,200
0.5290	301	5,400
0.5430	304	4,800
1.0430	304	5,600
1.8210	304	7,200
2.3970	304	7,300
2.6931	302	8,300
3.1792	301	8,400
3.7891	301	8,500
4.6803	301	9,500
7.0884	297	10,500

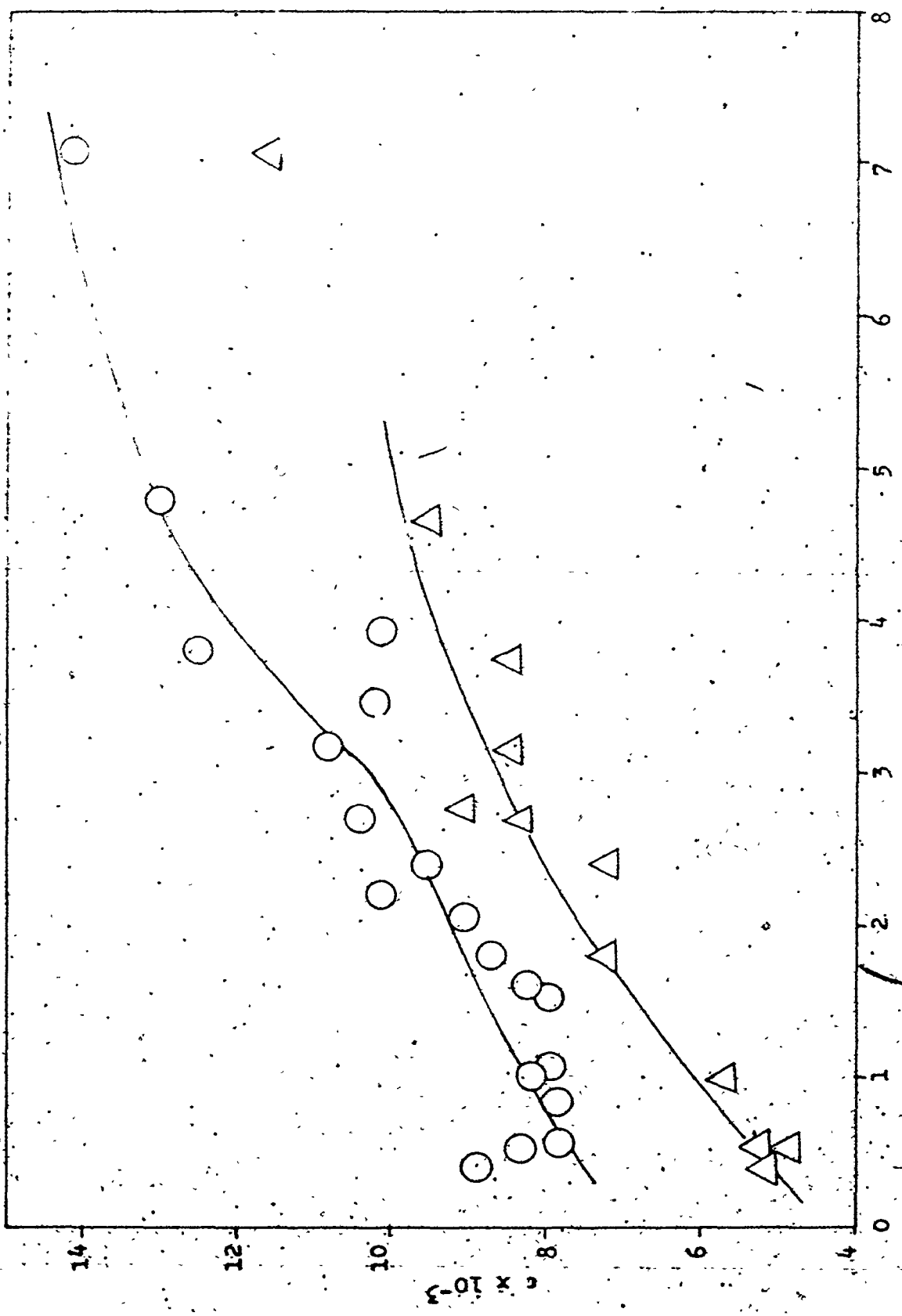

Figure 10. Extinction coefficients of 2,4,6-trinitrotoluene (O) and 1,3,5-trinitrobenzene (Δ) in the $TaF_5-H_2SO_3F$ system.

TABLE VIII
 IONIZATION RATIOS OF 2,4,6-TRINITROCLUENE
 IN THE $\text{TaF}_5\text{-HSO}_3\text{F}$ SYSTEM

Mole % TaF_5	$c_{\text{B}} = 960$	$c_{\text{BH}^+} = 10,600$	$\text{pK}_{\text{BH}^+} = -15.60$
		c	$\log I$
0.25		7,200	-0.28
0.50		7,500	-0.32
0.75		7,900	-0.41
1.00		8,200	-0.48
1.25		8,600	-0.58
1.50		8,900	-0.67
2.00		9,300	-0.81
2.50		9,600	-0.94

TABLE IX
IONIZATION RATIOS OF 1,3,5-TRINITROBENZENS
IN THE TaF₅-HSO₃F SYSTEM

$c_B = 800$ $c_{BH^+} = 10,700$ $pK_{BH^+} = -16.04$

Mole % TaF ₅	ϵ	log I
0.25	5,100	0.12
0.50	5,500	0.04
0.75	5,800	-0.01
1.00	6,100	-0.06
1.25	6,500	-0.13
1.50	6,800	-0.19
2.00	7,400	-0.30
2.50	8,000	-0.43
3.00	8,600	-0.57
4.00	9,500	-0.86

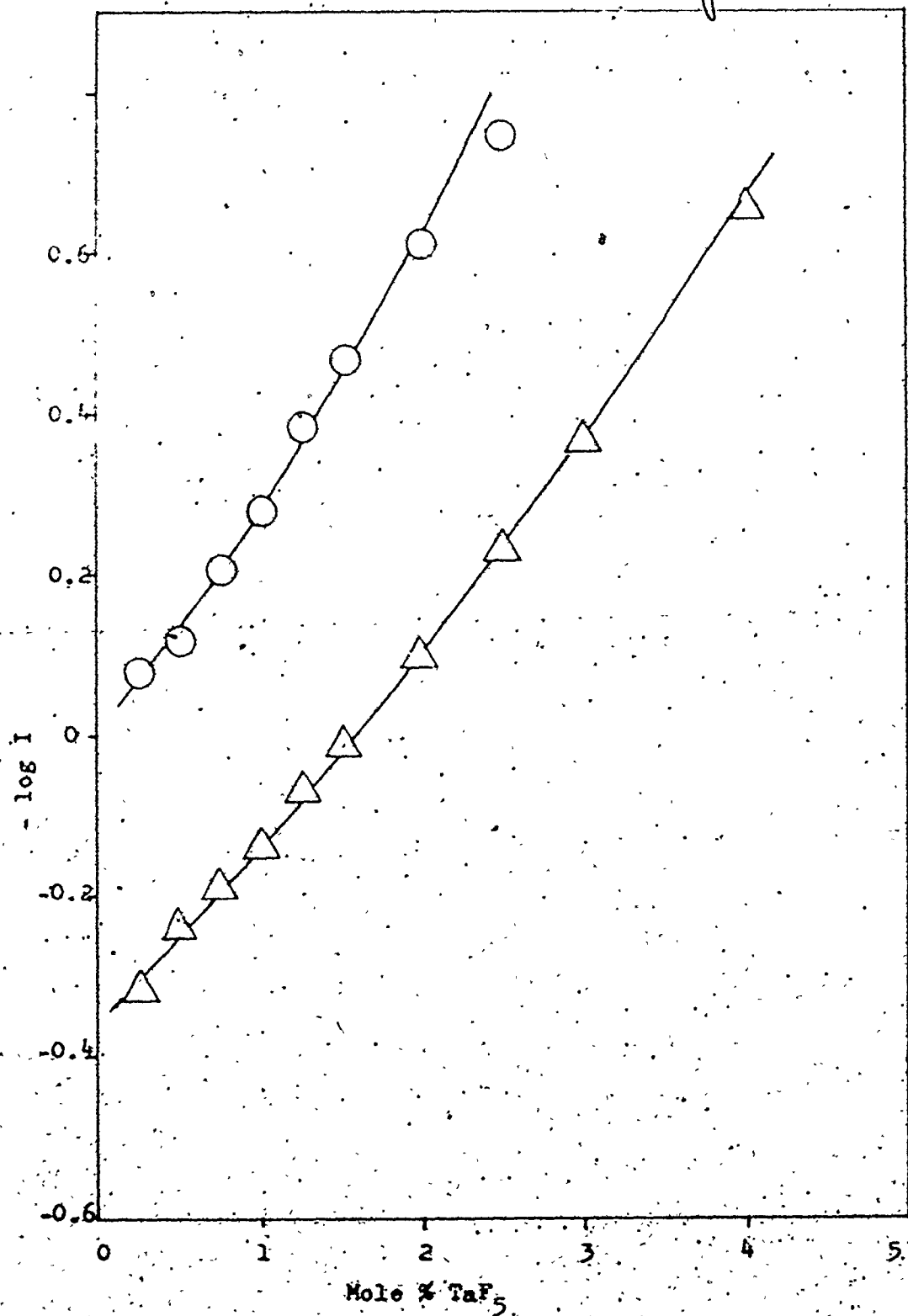

Figure 11. Ionization ratios of 2,4,6-trinitrotoluene (O) and 1,3,5-trinitrobenzene (Δ) in the TaF₅-HSO₃F system.

TABLE X

 μ_{H_0} VALUES FOR THE TaF_5 - HSO_3F SYSTEM

Mole % TaF_5	2,4,6-trinitro- toluene	1,3,5-trinitro- benzene	Average
0.25	15.88	15.92	15.90
0.50	15.92	16.00	15.94
0.75	16.01	16.05	16.03
1.00	16.08	16.10	16.09
1.25	16.18	16.17	16.18
1.50	16.27	16.25	16.26
2.00	16.41	16.34	16.38
2.50	16.49	16.47	16.48
3.00		16.61	16.61
4.00		16.90	16.90

TABLE XI

¹⁹F CHEMICAL SHIFTS OF 2,4-DINITROFLUOROBENZENE IN THESbF₅-HSO₃F SYSTEM

Mole % SbF ₅	δ (ppm)	Mole % SbF ₅	δ (ppm)
0.0000	100.08	4.9107	80.09
0.0829	99.99	5.3989	80.47
0.1152	98.04	10.6673	78.73
0.1633	99.40	14.2528	76.90
0.1909	98.30	15.5627	76.33
0.2603	98.04		
0.2719	97.20		
0.7717	93.92		
0.7984	93.06		
0.9657	90.28		
1.1479	90.88		
1.2416	90.32		
1.4277	87.37		
1.9236	85.75		
2.4890	85.29		
2.8089	83.66		
3.9878	80.91		

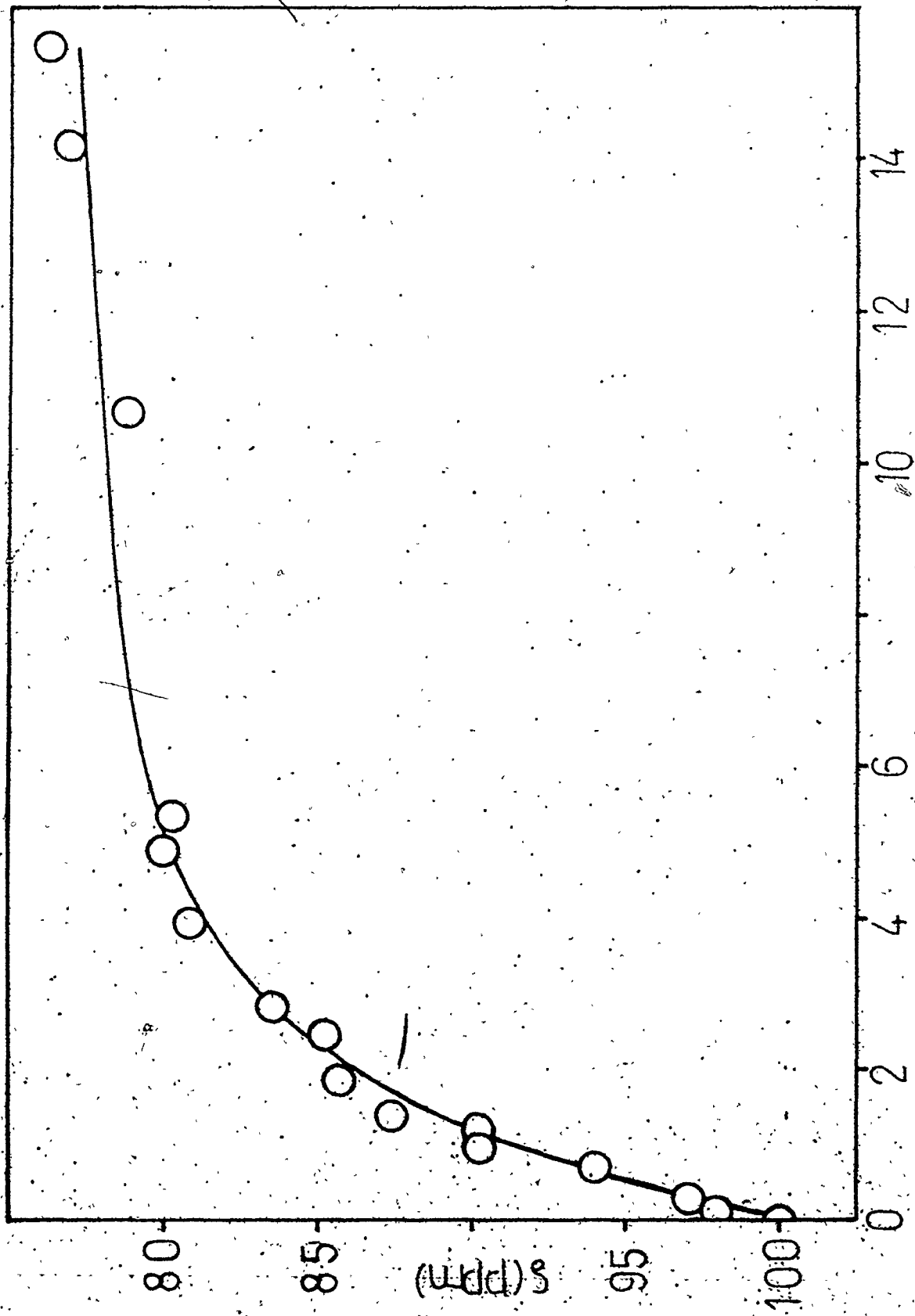

Figure 12. ^{19}F chemical shifts of 2,4-dinitrofluorobenzene in the $\text{SbF}_5\text{-MSO}_3\text{F}$ system.

Mole % SbF_5

TABLE XII
 THE ^1H CHEMICAL SHIFTS OF 2,4,6-TRINITROTOLUENE IN
 THE $\text{KSO}_3\text{-HSO}_3\text{F}$ AND $\text{SbF}_5\text{-HSO}_3\text{F}$ SYSTEMS

Mole % KSO_3F	δ (ppm)	Mole % SbF_5	δ (ppm)
0.0000	2.57	0.5542	2.67
0.0763	2.55	0.9817	2.68
0.3422	2.56	2.3597	2.72
1.0771	2.55	3.8377	2.73
1.9366	2.55	5.5714	2.77
2.7581	2.57	6.9856	2.81
		10.2033	2.87
		13.1251	2.86
		15.4614	2.89
		22.9468	2.99
		27.2223	2.98
		29.0800	3.08
		29.1672	3.01

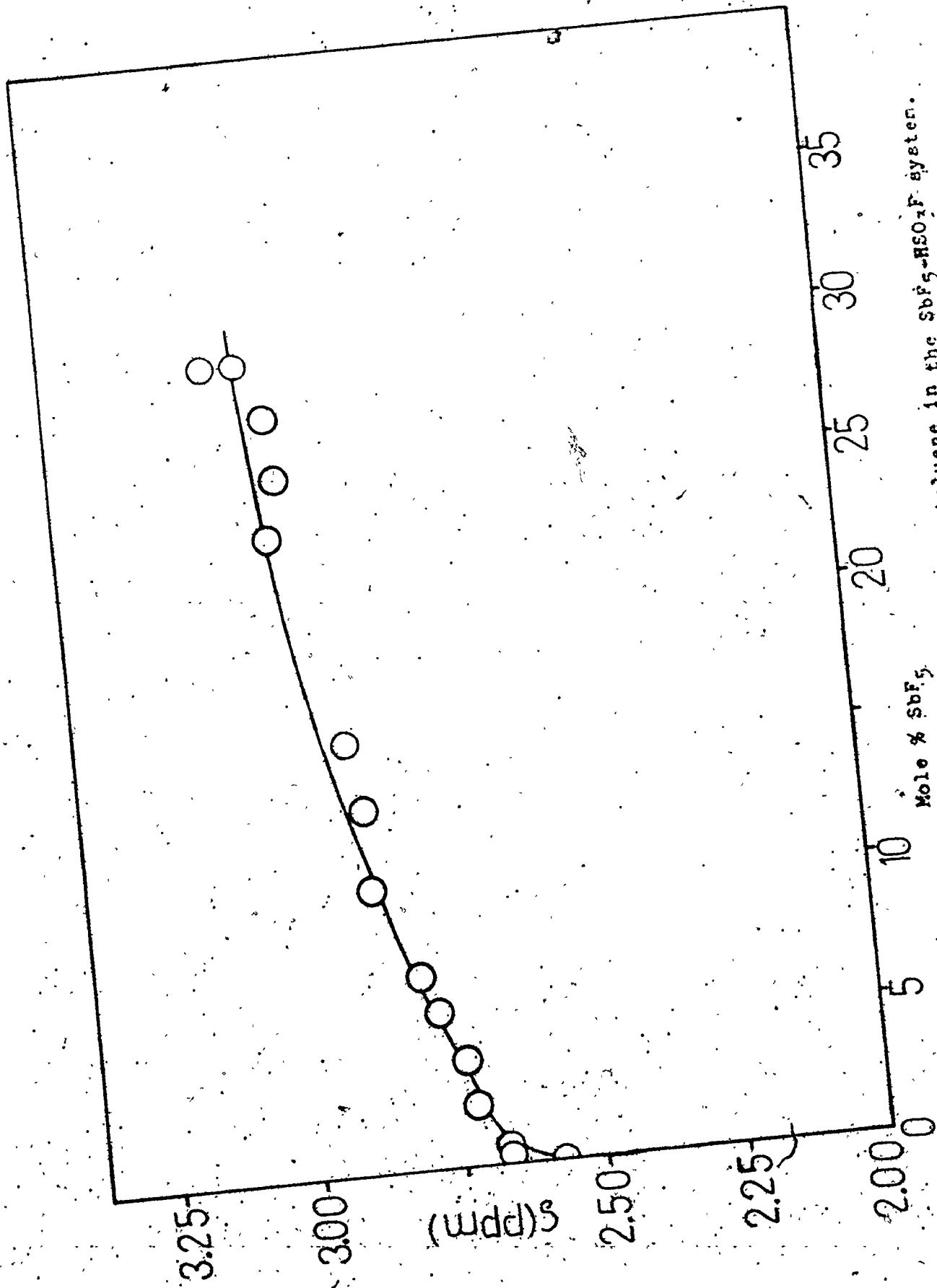

Figure 13. ¹H chemical shifts of 2,4,6-trinitrotoluene in the SbF₅-HSO₃F system.

TABLE XIII

^{19}F CHEMICAL SHIFTS OF 2,4-DINITROFLUOROBENZENE
IN THE $\text{SbF}_5\text{-HSO}_3\text{F}$ SYSTEM WITH KNOWN $-H_0$ VALUES

Mole % SbF_5	δ (ppm)	$-H_0$
0.00	100.08	15.07
0.01	100.02	15.29
0.02	100.00	15.49
0.04	999.90	15.61
0.06	99.30	16.13
0.08	99.10	16.37
0.10	98.90	16.55
0.14	98.80	16.73
0.30	98.00	16.92
0.50	98.00	17.08
0.75	94.90	17.22
1.00	91.50	17.32
1.50	88.40	17.49
2.00	85.90	17.61
3.00	82.70	17.84
4.00	81.00	18.08
5.00	80.05	18.28
6.00	79.70	18.48
7.00	79.30	18.66
8.00	78.90	18.79
9.00	78.70	18.88
10.00	78.20	18.94

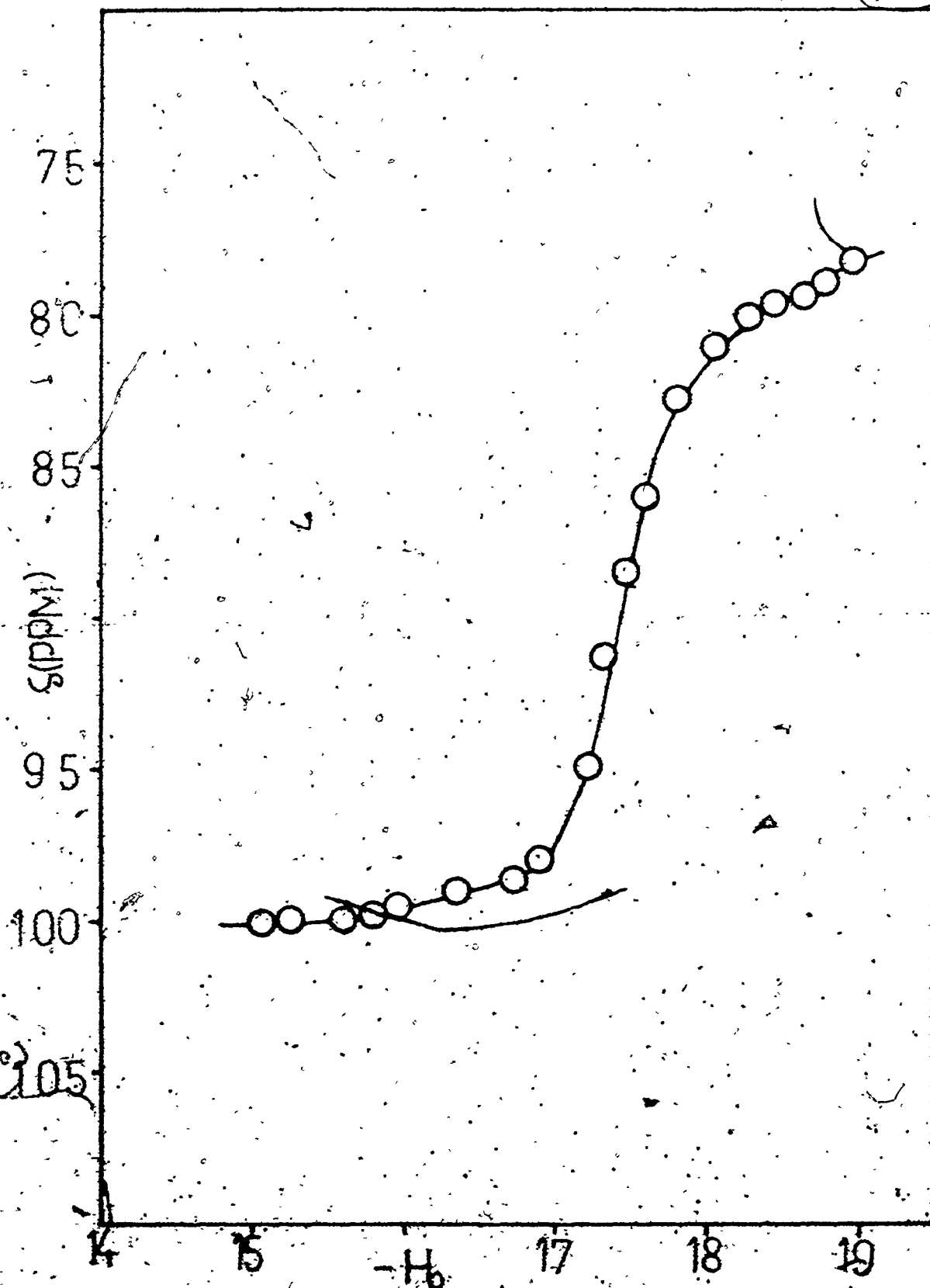

Figure 14. ^{19}F chemical shifts vs. H_0 for 2,4-dinitrofluorobenzene in the $\text{SF}_6\text{-HSO}_3\text{F}$ system.

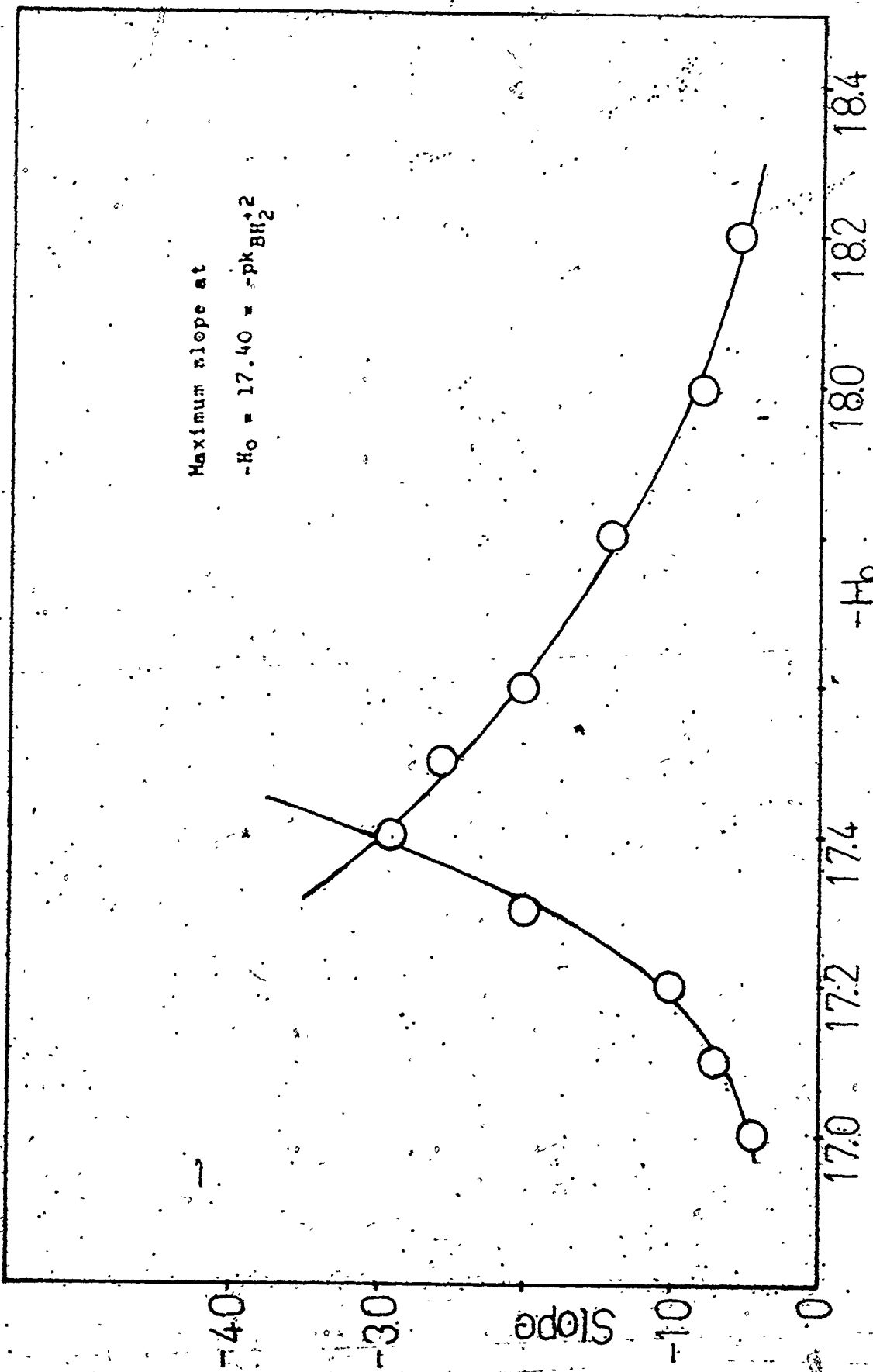

Figure 15. Plot of $\delta\delta / H_0 - H_0$ vs. H_0 for 2,4-dinitrochlorobenzene in the SbF_5-MSO_4F system.

TABLE XIV
 IONIZATION RATIOS OF 2,4-DINITROFLUORO-
 BENZENE IN THE SbF_5 - HSC_3F SYSTEM

$\delta_{\text{B}^+} = 100$ $\delta_{\text{BH}_2^+} = 77$ $\text{pK}_{\text{BH}_2^+} = -17.35$

Mole % SbF_5	δ	$\log I$	$-\text{H}_0$
0.20	98.0	1.02	16.33
0.50	95.0	0.56	16.79
1.00	91.3	0.18	17.17
1.50	88.3	-0.06	17.41
2.00	86.2	-0.23	17.58
2.50	84.5	-0.38	17.73
3.00	83.2	-0.51	17.86
4.00	81.5	-0.72	18.08
5.00	80.2	-0.95	18.30
6.00	79.5	-1.13	18.48

CHAPTER IV

THE TRIFLUOROMETHANESULFONIC ACID SOLVENT SYSTEM

A. INTRODUCTION

Trifluoromethanesulfonic acid was first prepared by oxidation of bis(trifluoromethylthio)mercury by aqueous hydrogen peroxide.³⁶ A more convenient method is the electrolysis of a solution of methylsulphonyl chloride in anhydrous HF.³⁷

Trifluoromethanesulfonic acid is a stable, colorless liquid with a boiling point of 162°C. It fumes copiously on exposure to moisture and must be handled in a completely dry environment.

By means of conductivity measurements in acetic acid,³⁸ it was found that $\text{CF}_3\text{SO}_3\text{H}$ had a dissociation constant 14 times greater than that of H_2SO_4 . Presumably $\text{CF}_3\text{SO}_3\text{H}$ is dissociated according to the equation (IV-1) in this solvent

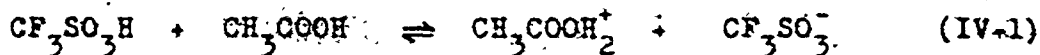

Therefore it is expected that in the anhydrous state $\text{CF}_3\text{SO}_3\text{H}$ might be a stronger acid than 100% H_2SO_4 . In the anhydrous state the autoprotolysis presumably occurs in the same manner as for fluorosulfuric acid

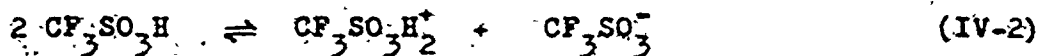

The $\text{CF}_3\text{SO}_3\text{H}_2^+$ ion, like $\text{H}_2\text{SO}_3\text{F}^+$ ion in HSO_3F , is a more acidic species than the acid itself. The autoprotolysis constant has not been determined previously, and there has been very few investigations of this solvent system. Kraser²³ has made some kinetic studies using this acid and the mixtures with some Lewis acids such as SbF_5 .

TaF₅ and NbF₅ as solvents. It was found that all these systems are highly acidic and the selectivity parameter (see Chapt I) for SbF₅-CF₃SO₃H is the highest among the SbF₅-HA systems. However Kramer has pointed out that there is some uncertainty about the stability of CF₃SO₃H and the solutions containing Lewis acids in the prolonged period of kinetic study and the results on these systems are only tentative.

An acid of the CF₃SO₃H solvent system may be conveniently treated as a solute which ionizes according to the equation (IV-3)

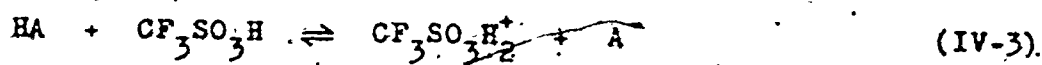

and a base according to the equation (IV-4)

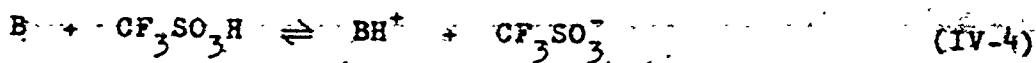

The CF₃SO₃H₂⁺ ion and CF₃SO₃⁻ ion are the characteristic ions of the autoprotolysis of the solvent.

The enhancement of the acidity of the HA-CF₃SO₃H systems is essentially due to the increasing concentration of the CF₃SO₃H₂⁺ ion. The role of Lewis acids such as SbF₅ in CF₃SO₃H is to act as an acceptor of the anion CF₃SO₃⁻.

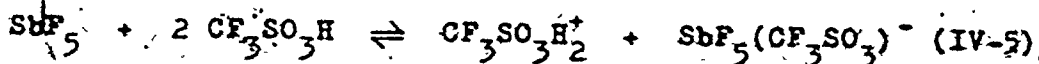

In concentrated solutions the formation of the "dimeric" species, (SbF₅)₂SO₃CF₃⁻ is possible. The ¹⁹F NMR spectrum of a solution of 2.2 m SbF₅ in CF₃SO₃H at -50°C is essentially the same as in HSO₃F in the F-on-Sb region.^{12,39} The spectra for both systems are shown in Figure 16. The two high-field peaks D and E constitute two AX₂ spectra which arise from fluorines bonded to anti-

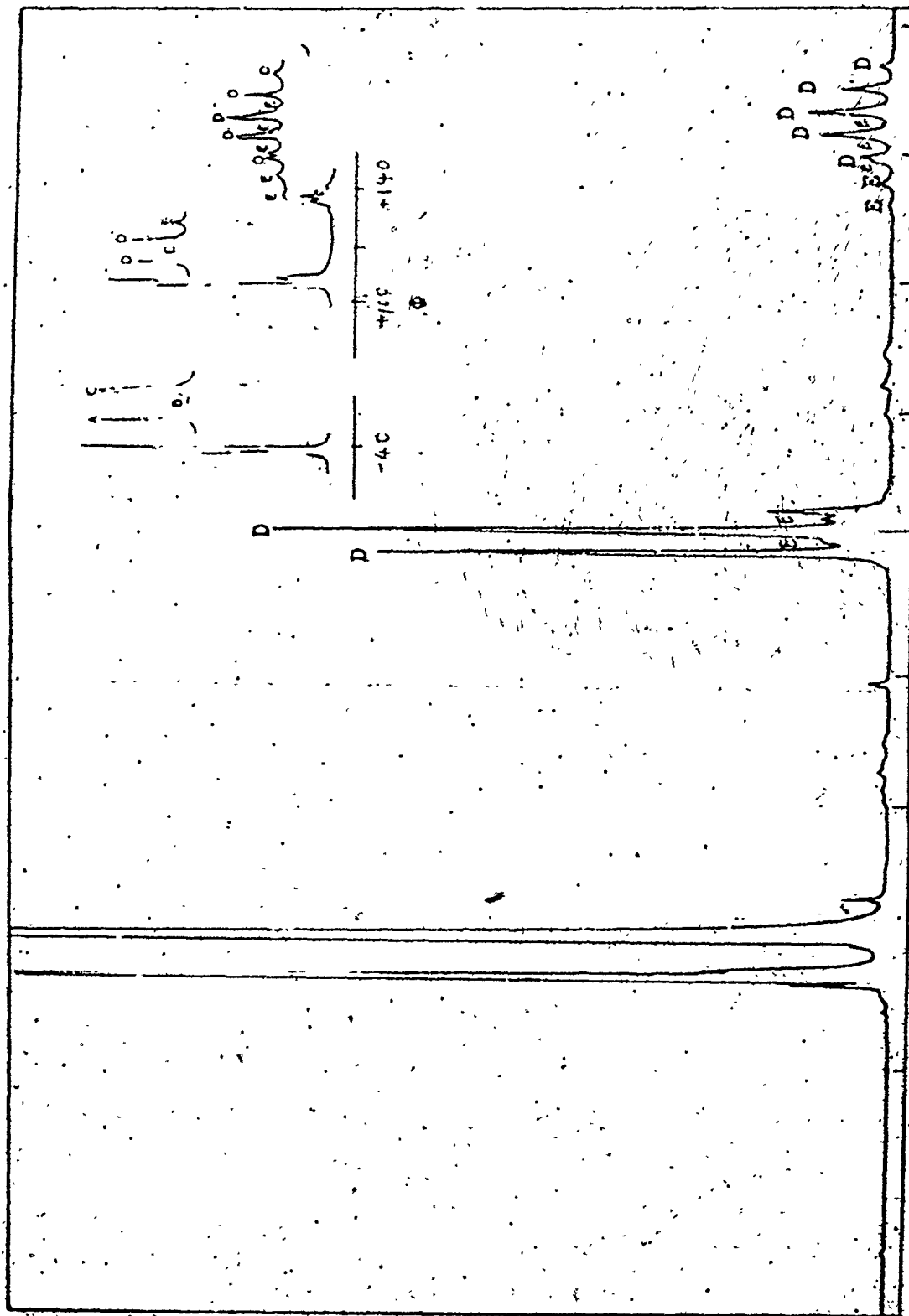
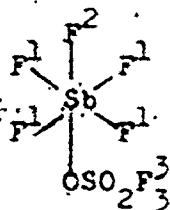
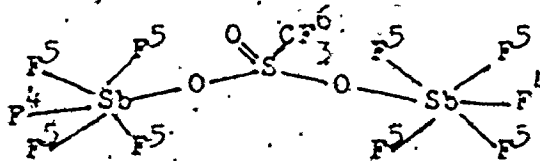

Figure 16. ^{19}F nmr spectrum of $\text{SbF}_5\text{-CF}_3\text{SO}_3\text{H}$ with 2.2 m of SbF_5 at -50°C .
 Upper right is for $\text{SbF}_5\text{-HSO}_3\text{F}$ with 1.7 m of SbF_5 , reference 12.

mony in $\text{SbF}_5\text{SO}_3\text{CF}_3^-$ (I) and $(\text{SbF}_5)_2\text{SO}_3\text{CF}_3^-$ (II)



(I)



(II)

B. ACIDITY FUNCTION MEASUREMENTS

Freshly distilled $\text{CF}_3\text{SO}_3\text{H}$ was reported to contain 2 mole % water from conductivity measurements.²³ A conductivity study of the freshly distilled $\text{CF}_3\text{SO}_3\text{H}$ used in the present work confirmed this earlier result. Table XV and Figure 17 show the present conductivity results. The conductivity decreases with the addition of the anhydride $(\text{CF}_3\text{SO}_2)_2\text{O}$ down to the value, $1.08 \times 10^{-4} \text{ ohm}^{-1} \text{ cm}^{-1}$ at 1.8 mole % anhydride after which the conductivity remains constant. This may be taken as the electrical conductivity of the pure acid and is almost the same as for HSO_3F ($k = 1.085 \times 10^{-4} \text{ ohm}^{-1} \text{ cm}^{-1}$).³⁰ The sample of $\text{CF}_3\text{SO}_3\text{H}$ used in the present work was adjusted to 100 % $\text{CF}_3\text{SO}_3\text{H}$ by adding a calculated amount of the anhydride.

The acidity of the $\text{SbF}_5\text{-CF}_3\text{SO}_3\text{H}$ system was measured using nitro aromatic compounds as indicators. Table XVI lists the extinction coefficients of 2,4,6-trinitrotoluene and 1,3,5-trinitrobenzene in the $\text{SbF}_5\text{-CF}_3\text{SO}_3\text{H}$ system. These are plotted in Figure 18. The ϵ values at regularly spaced concentrations of SbF_5 were taken and the ionization ratios were calculated and are given in Tables

XVII and XVIII and are plotted in Figure 19. The values of ϵ_B , ϵ_{BH^+} and pK_{BH^+} were assumed to be the same as those found in the HSO_3F system. In the range of SbF_5 concentrations presently studied the two indicators 2,4,6-trinitrotoluene and 1,3,5-trinitrobenzene are not fully protonated. Since no other Lewis acid- CF_3SO_3H systems having a higher acidity than $SbF_5-CF_3SO_3H$ have been investigated, it is not possible to check the ϵ_{BH^+} values.

The ($pK_{BH^+} + \log I$) values and the average H_0 are listed in Table XIX. For 100 % CF_3SO_3H the above two indicators are too weak to be protonated to an appreciable extent. Therefore a stronger indicator, 2,4-dinitrotoluene was used. It was protonated appreciably in 100 % CF_3SO_3H . Addition of PF_5 to CF_3SO_3H does not very much increase the extent of protonation (Tables XX and XXI). This rather weak acid, PF_5 was thus used in extrapolating to obtain the H_0 value for 100 % CF_3SO_3H . The $-H_0$ values for both $SbF_5-CF_3SO_3H$ and $PF_5-CF_3SO_3H$ are plotted in Figure 20 along with the previously determined SbF_5-HSO_3F system for comparison.

C. DISCUSSION

It is concluded that the trifluoromethanesulfonic acid and the solutions of SbF_5 in CF_3SO_3H are superacid systems. The H_0 value indicates that 100 % CF_3SO_3H is a stronger acid than 100 % H_2SO_4 but weaker than 100 % HSO_3F . The difference in the acidity of these acids may be explained in terms of their structures. The only structural difference between FSO_3H and CF_3SO_3H is the replacement of fluorine by the CF_3 group. Since the CF_3 group has a lower electronegativity (3.3) than fluorine (4.0),⁴⁰ the

electron-withdrawing ability is less for CF_3 and the hydrogen is less easily lost from $\text{CF}_3\text{SO}_3\text{H}$ than from FSO_3H .

The addition of SbF_5 to $\text{CF}_3\text{SO}_3\text{H}$ increases the acidity rapidly. The initial increase in the H_0 curve for $\text{SbF}_5\text{-CF}_3\text{SO}_3\text{H}$ is as steep as for $\text{SbF}_5\text{-HSO}_3\text{F}$ which may suggest that $\text{CF}_3\text{SO}_3\text{H}$ has an autoprotolysis constant of the same magnitude. Since it is still unknown whether SbF_5 is a strong acid in $\text{CF}_3\text{SO}_3\text{H}$, the exact K_{ap} value cannot be deduced from the H_0 curve of the $\text{SbF}_5\text{-CF}_3\text{SO}_3\text{H}$ system.

The H_0 curve shows that, after a rapid initial increase, the acidity does not increase very much with acid concentration. This is because of the formation of "dimeric" species, $(\text{SbF}_5)_2\text{SO}_3\text{CF}_3^-$, which has been detected in the ^{19}F nmr spectrum.

The H_0 value for 100% $\text{CF}_3\text{SO}_3\text{H}$ was determined in the $\text{PF}_5\text{-CF}_3\text{SO}_3\text{H}$ system. PF_5 is a very weak acid in $\text{CF}_3\text{SO}_3\text{H}$ and the H_0 curve for $\text{PF}_5\text{-CF}_3\text{SO}_3\text{H}$ can be extrapolated to 100% $\text{CF}_3\text{SO}_3\text{H}$ just as in the HSO_3F system in which the H_0 curve for $\text{SO}_3\text{-HSO}_3\text{F}$ was extrapolated to 100% HSO_3F .³ Because of a relatively large K_{ap} value for HSO_3F , 3.8×10^{-8} , compared with 9.8×10^{-13} mole² Kg⁻² for HF (Chapt V - A), the effect of the small amount of impurity or indicator is not so great as in the HF system.

TABLE XV

THE TITRATION OF $\text{CF}_3\text{SO}_3\text{H}$ BY THE ANHYDRIDE $(\text{CF}_3\text{SO}_2)_2\text{O}$

Mole % Anhydride added	$k \times 10^4, \text{ohm}^{-1} \text{cm}^{-1}$
0.000	6.79
0.451	5.84
0.848	5.52
1.124	3.86
1.271	3.18
1.489	1.60
1.774	1.09
1.985	1.08
2.199	1.08
2.514	1.09
3.609	1.09
5.243	1.11

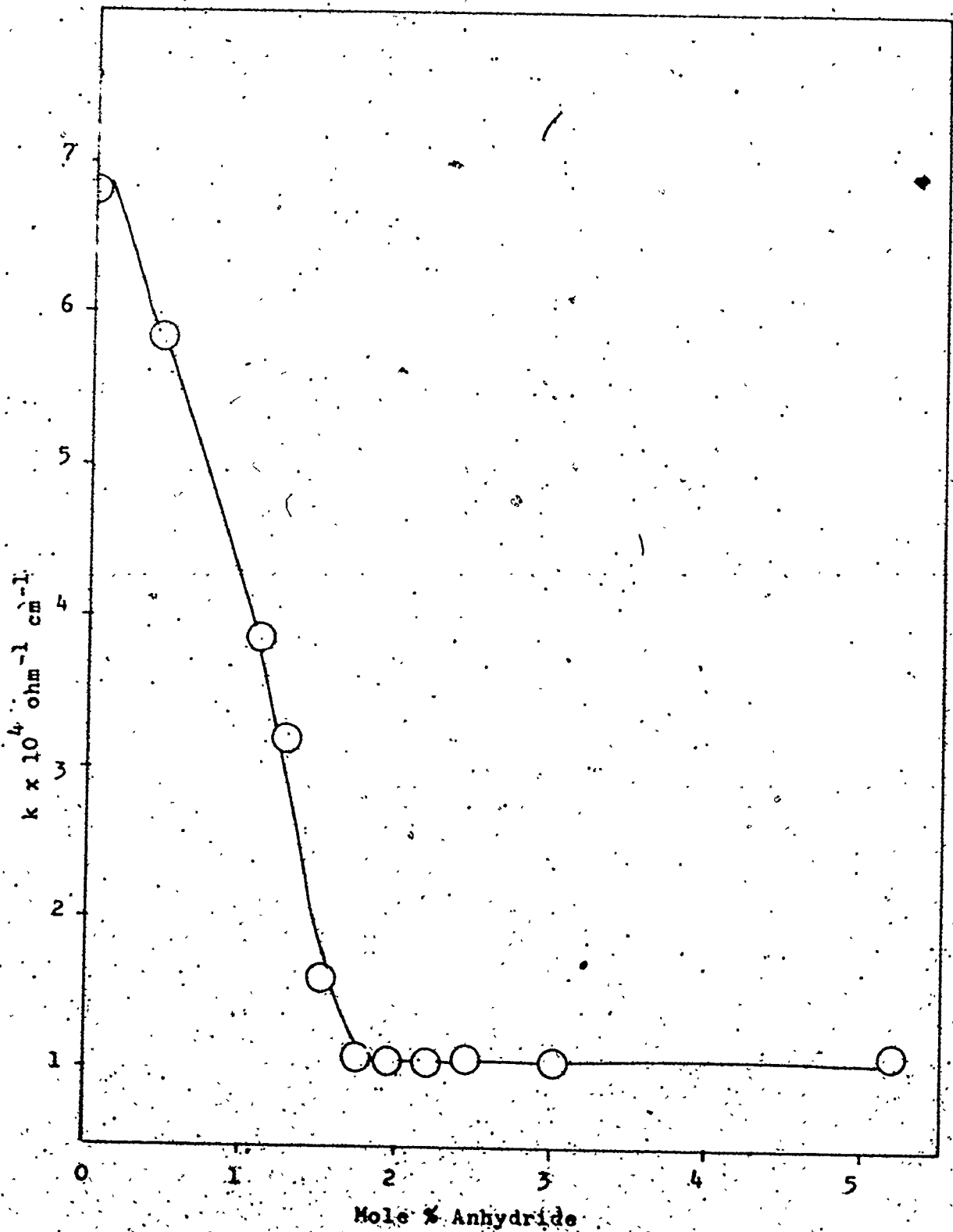

Figure 17. Conductimetric titration of freshly distilled $\text{CF}_3\text{SO}_3\text{H}$ by the anhydride at 25°C .

TABLE XVI
 EXTINCTION COEFFICIENTS OF 2,4,6-TRINITROTOLUENE
 AND 1,3,5-TRINITROBENZENE IN THE $\text{SbF}_5\text{-CF}_3\text{SO}_3\text{H}$ SYSTEM

Mole % SbF_5	2,4,6-trinitrotoluene		1,3,5-trinitrobenzene	
	λ_{max} (nm)	ϵ	λ_{max} (nm)	ϵ
0.0000	327	1300	329	1100
0.0446	327	4200	325	1800
0.0890	327	5800	325	2200
0.1381	327	8400	321	3300
0.2492	327	7700	319	4000
0.3514	325	8300	317	4900
0.5217	327	8300	320	6300
0.9228	327	9600	316	5600
0.9825			314	7300
1.4713	327	9100	318	7100

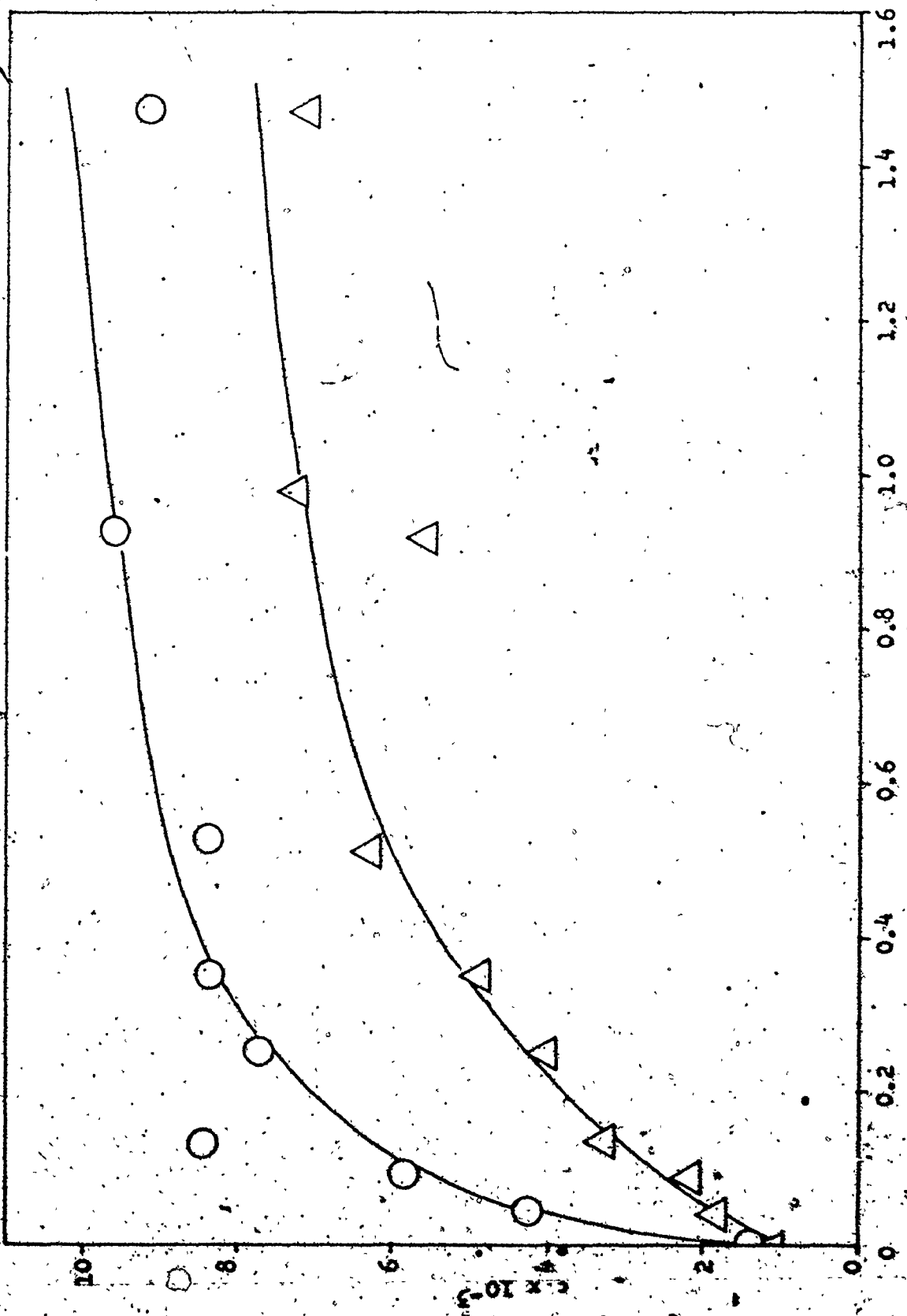

Figure 18. Extinction coefficients of 2,4,6-trinitrotoluene (O) and 1,3,5-trinitrobenzene (Δ) in the SbF₅-CF₃SO₃H system.

TABLE XVII
 IONIZATION RATIOS OF 2,4,6-TRINITRO-
 TOLUENE IN THE $\text{SbF}_5\text{-CF}_3\text{SO}_3\text{H}$ SYSTEM

$$\epsilon_B = 960 \quad c_{\text{BH}^+} = 10,600 \quad pK_{\text{BH}^+} = -15.60$$

Mole % SbF_5	c	$\log I$
0.02	3,200	0.52
0.05	4,600	0.21
0.10	5,800	0.00
0.15	6,600	-0.35
0.20	7,000	-0.24
0.25	7,600	-0.35
0.30	7,800	-0.39
0.40	8,400	-0.53
0.50	8,800	-0.64
0.70	9,200	-0.77
1.00	9,600	-0.94
1.50	10,000	-1.18

TABLE XVIII
IONIZATION RATIOS OF 1,3,5-TRINITROBENZENE
IN THE $SbF_5-CF_3SO_2H$ SYSTEM

$c_B = 800$ $c_{BH^+} = 10,700$ $pK_{BH^+} = -16.04$

Mole % SbF_5	c	log I
0.05	2000	0.86
0.10	2600	0.65
0.15	3200	0.49
0.20	3700	0.38
0.25	4100	0.30
0.30	4500	0.22
0.40	5100	0.11
0.50	5600	0.03
0.70	6300	-0.10
1.00	6900	-0.21
1.50	7400	-0.30

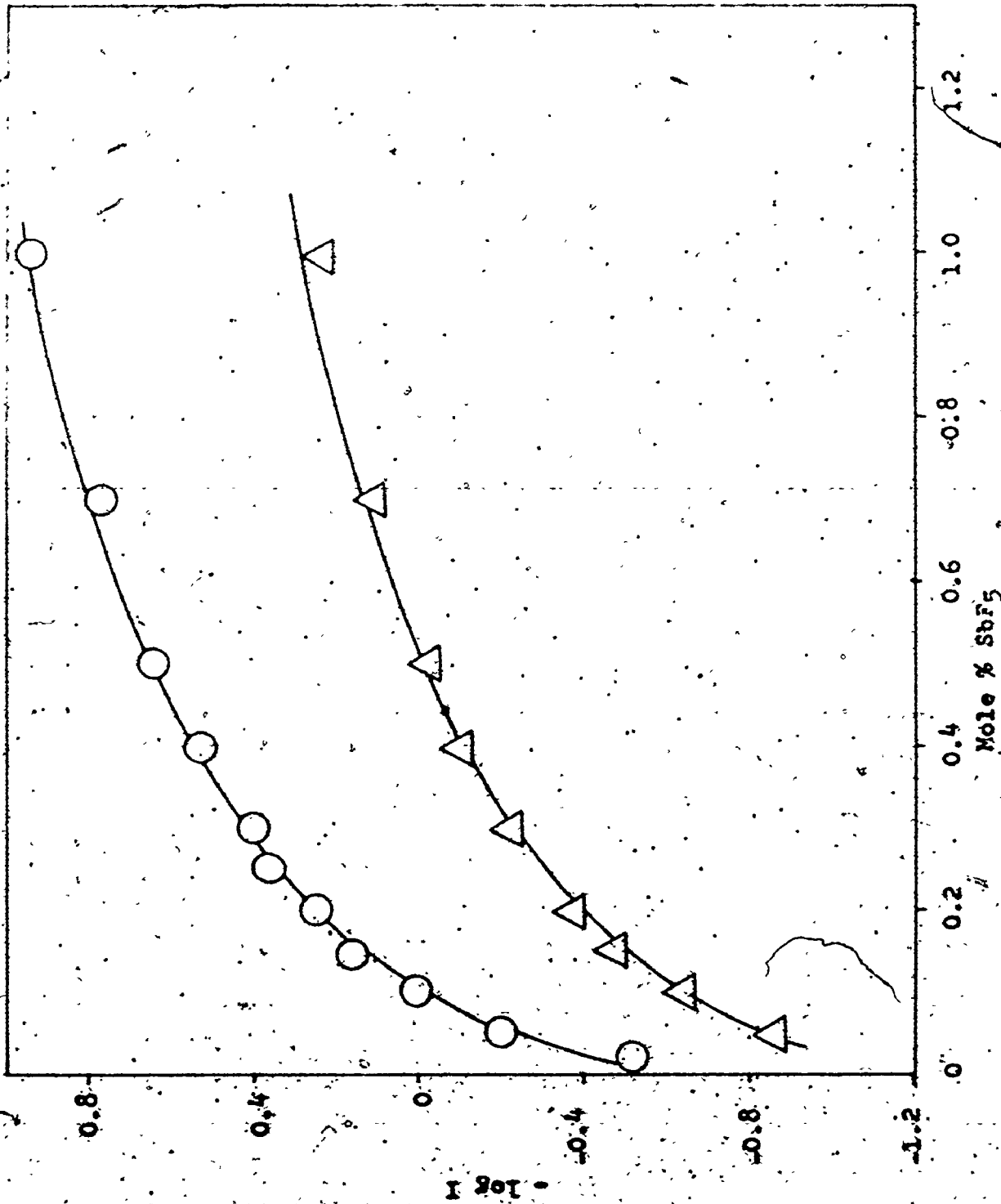

Figure 19. Ionization ratios of 2,4,6-trinitrotoluene (O) and 1,3,5-trinitrobenzene (Δ) in the SbF₅-CF₃SO₃H system.

TABLE XIX

 H_2O VALUES FOR THE $\text{SbF}_5\text{-CF}_3\text{SO}_3\text{H}$ SYSTEM

Mole % SbF_5	2,4,6-trinitro- toluene	1,3,5-trinitro- benzene	Average
0.02	15.08		15.08
0.05	15.39	15.18	15.29
0.10	15.60	15.39	15.50
0.15	15.75	15.55	15.65
0.20	15.84	15.66	15.75
0.25	15.95	15.74	15.85
0.30	15.99	15.82	15.91
0.40	16.13	15.93	16.03
0.50	16.24	16.01	16.13
0.70	16.37	16.14	16.26
1.00	16.54	16.25	16.40
1.50		16.34	16.34
2.00		16.42	16.42

TABLE XX
EXTINCTION COEFFICIENTS OF 2,4-DINITROTOLUENE
IN THE $\text{PF}_5\text{-CF}_3\text{SO}_3\text{H}$ SYSTEM

Mole % PF_5	λ_{max} (nm)	ϵ
0.0000	339	8,400
0.0184	335	8,600
0.0748	339	8,500
0.1295	339	9,900
0.2080	339	9,500
0.4137	339	9,500

TABLE XXI
IONIZATION RATIOS OF 2,4-DINITROTOLUENE
IN THE $\text{PF}_5\text{-CF}_3\text{SO}_3\text{H}$ SYSTEM

Mole % PF_5	ϵ	$\log I$	$\text{pK}_{\text{BH}^+} = -\text{H}_0$
0.00	8400	-0.09	13.84
0.05	8700	-0.13	13.88
0.10	8900	-0.16	13.91
0.20	9300	-0.22	13.97
0.30	9600	-0.26	14.01
0.40	9700	-0.28	14.03

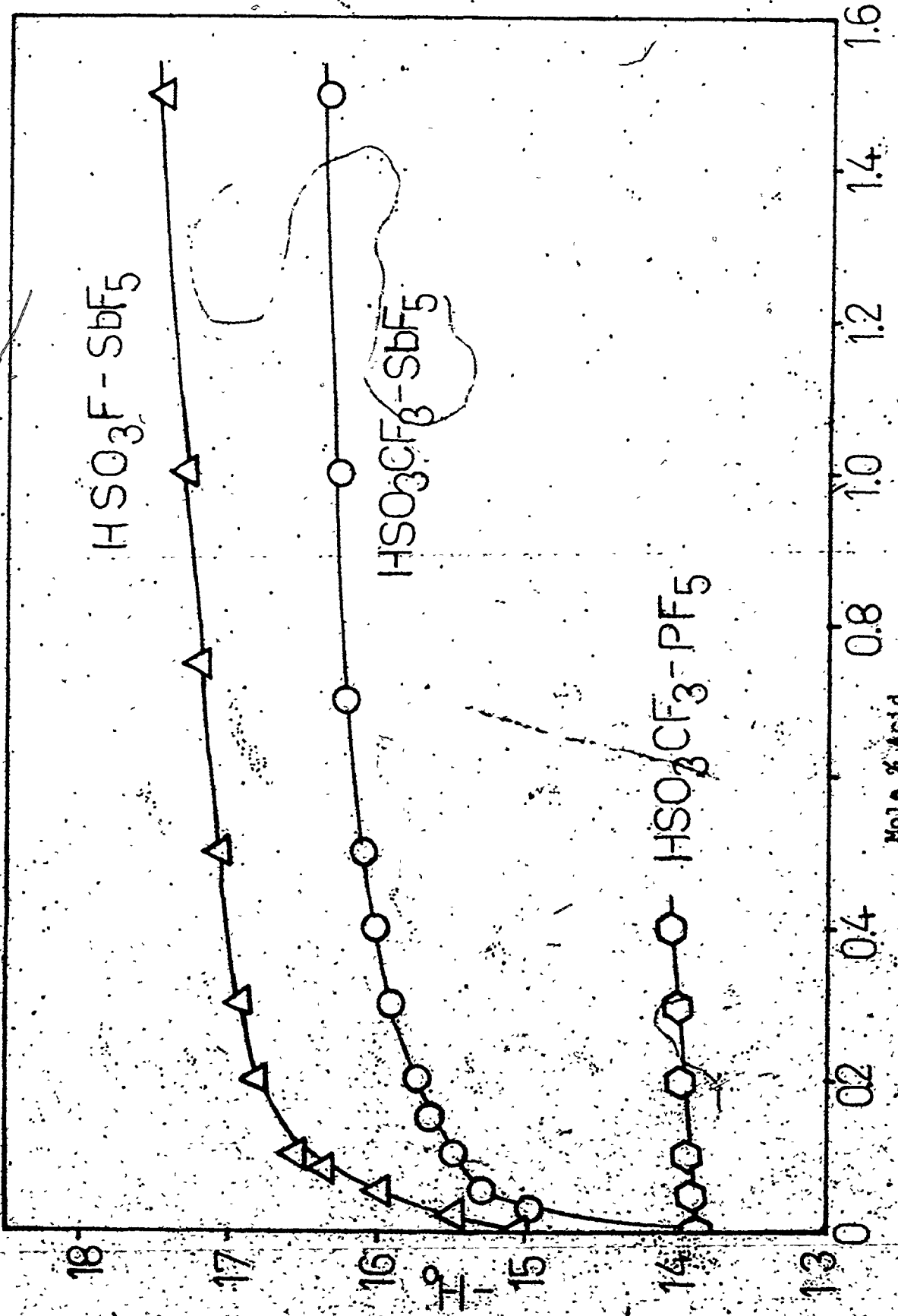

Figure 20. H_0 values for acids of the CF_3SO_3H solvent systems.

CHAPTER V

THE HYDROFLUORIC ACID SOLVENT SYSTEM

AC INTRODUCTION

Anhydrous hydrogen fluoride is made industrially from fluorspar (CaF_2) and concentrated H_2SO_4 . It is supplied in steel cylinders with a purity of 99.5%. Most of impurities can be removed by column distillation as described in the experimental section. From the specific conductivity of $10^{-5} \text{ ohm}^{-1} \text{ cm}^{-1}$ at 20°C the water content is estimated to be ca. 10^{-4} m .

Since the development of fluorine-containing plastics, such as Teflon, Kel-F etc., the studies of anhydrous HF solutions have been expanded tremendously. The chemistry of HF has been reviewed by many workers.⁴¹⁻⁴⁶ Reviews of the properties of HF and the chemistry of the HF solvent system have been given by Hyman and Katz⁴⁷ and Kilpatrick and Jones.⁴⁸

Anhydrous HF is a colorless liquid with a low boiling point (19.5°C). It has a low viscosity⁴⁹, 0.207 centipoise at 20°C ; a high dielectric constant⁵⁰, 80 at 0°C and a wide liquid range, 102.9°C , making it a good solvent. These properties suggest that, like water, hydrogen fluoride is an associated liquid. Hydrogen bonding plays an important role in HF solutions just as in water. Unlike in water, a three-dimensional network is unlikely in HF and this is presumably why it has a much lower viscosity than water.

Besides association, self-ionization or autoprotolysis is

another important type of molecular interaction in liquid HF. It has a simple form as in the equation (V-1)



The autoprotolysis constant K_{ap} can be estimated from the electrical conductivity data. A value of $2 \times 10^{-10} \text{ mole}^2 \text{ Kg}^{-2}$ at 20°C has been given by Kilpatrick and Luborsky⁵¹ from their conductance measurements of solutions of BF_3 in HF. Since many approximations have been made in this estimation, their K_{ap} value can be considered only as approximate. Since only the simple ionic self-dissociation (V-1) is present in the pure HF, a more accurate K_{ap} value may be calculated from the conductance of pure HF, which has been determined as $2.1 \times 10^{-6} \text{ ohm}^{-1} \text{ cm}^{-1}$ at 0°C ¹⁸ or $8 \times 10^{-7} \text{ ohm}^{-1} \text{ cm}^{-1}$ at 20°C ⁵², and the equivalent ionic conductance at infinite dilution $\lambda_{\text{H}_2\text{F}^+}^0$ and $\lambda_{\text{F}^-}^0$ for H_2F^+ and F^- ion, 350 and 270 $\text{ohm}^{-1} \text{ cm}^2 \text{ equiv}^{-1}$ at 0°C or 455 and 350 $\text{ohm}^{-1} \text{ cm}^2 \text{ equiv}^{-1}$ at 20°C ^{18,53} by using the equations $(\lambda_{\text{H}_2\text{F}^+}^0 + \lambda_{\text{F}^-}^0) = k \times 1000 / C$ and $K_{ap} = C^2$, where k is the specific conductivity of pure HF and C is the molarity of the H_2F^+ or F^- ion. A value of $1.15 \times 10^{-11} \text{ mole}^2 \text{ Kg}^{-2}$ at 0°C or $9.84 \times 10^{-13} \text{ mole}^2 \text{ Kg}^{-2}$ at 20°C was obtained, which is considerably smaller than the corresponding constant in HSO_3F , $3.8 \times 10^{-8} \text{ mole}^2 \text{ Kg}^{-2}$ at 25°C .³ It has been suggested⁴⁷ that the true equilibrium constant might be even lower and may approach that of water in the rigorous absence of all impurities.

The high mobility for both H_2F^+ and F^- indicates that they conduct by a proton-transfer or chain conduction mechanism.^{18,53}

The conduction mechanism may be represented in simple form by the

following equations

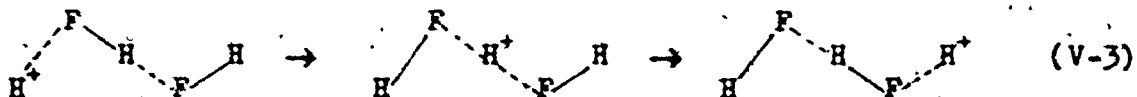

An acid or a base of the HF solvent system may be defined as a solute which ionizes to give the H_2F^+ ion or the F^- ion, just as in the HSO_3F solvent system in which an acid gives the $\text{H}_2\text{SO}_3\text{F}^+$ ion and a base gives the SO_3F^- ion.

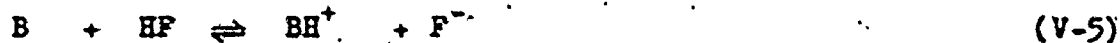

The ions H_2F^+ and F^- are the characteristic autoprotolysis ions of the solvent. Both H_2F^+ and F^- are extensively solvated but they are represented as H_2F^+ and F^- for simplicity.

Potassium fluoride and other alkali metal fluorides are the simplest solutes acting as bases in the HF solvent system. Cryoscopic measurements²⁰ showed that in dilute solutions they are strong electrolytes and are completely ionized

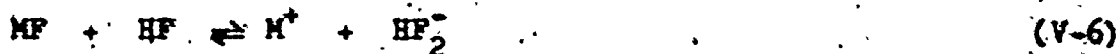

Electrical conductivity measurements^{52,53} of solutions of NaF and KF in HF at 0°C showed that the F^- ion has a high mobility. Their conductivities are shown in Figure 21 along with those of H_2O -HF.

It is seen that the conductivity curves for NaF and KF in HF are indistinguishable within experimental error. A value of 390 for the equiva-

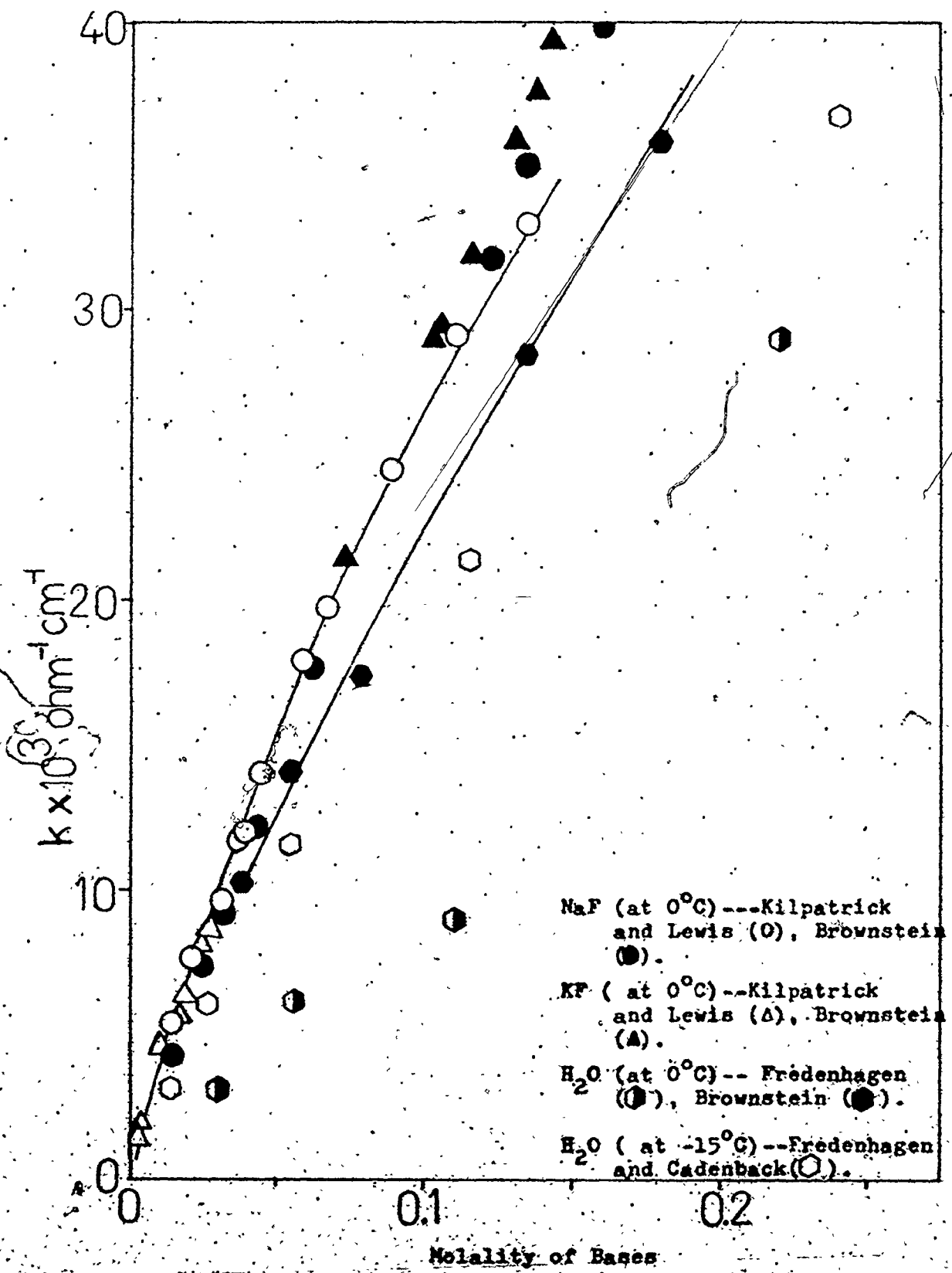

Figure 21. The electrical conductivities of bases in HF.

lent conductance at infinite dilution Λ_0 was obtained from a plot of $\sqrt{\Lambda}$ vs. equivalent conductance. The transference numbers of t_{Na^+} and t_{K^+} were found to be 0.30. From these data the mobilities of F^- and Na^+ or K^+ were found to be 270 and 120 respectively. The high mobility for the F^- ion has been explained in terms of the proton-transfer process.

Of all the bases the most interesting is water. Conductivity measurements for solutions of H_2O in HF have been made by Fredenhagen^{54,55} at $0^\circ C$ and $-15^\circ C$ and later by Brownstein⁵² at $0^\circ C$. These conductances are shown in Figure 21. There is considerable difference between the results of these two workers but the data of Brownstein seem much more reliable. The conductances of KF or NaF-HF are higher than those of H_2O -HF at $0^\circ C$.

The acidity functions H_0 for H_2O -HF have been measured by Bell et al.¹⁴ up to the concentration of H_2O at 43% by weight and by Hyman et al.¹⁵ up to almost 100% HF. Their results already have been shown in Figure 4. No H_0 acidity function measurements have been found in the literature for alkali metal fluoride-HF system except two H_0 values given by Hyman et al.¹⁵ for NaF solutions in HF; -10.30 for 0.45% NaF and -9.10 for 4.3% NaF.

Because of the low basicity of the solvent HF only a few solutes are expected to act as acids in the HF system. The only proton acids reported to act as acids are perchloric and fluorosulfuric acid.⁴⁷ Cryoscopic measurements²⁰ appeared to show that H_2SO_4 was a non-electrolyte in HF, but conductivity measurements²⁵ showed that H_2SO_4 was ionized slightly according to the equation

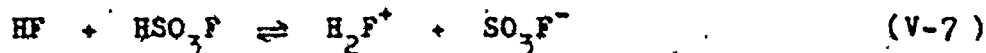

i.e. it behaves as a very weak acid in HF.

The most important class of acids in the HF solvent system is the Lewis acids of which the majority are Group V fluorides. They all act as fluoride ion acceptors. The net result of the addition of a fluoride ion acceptor in HF is an increase in the concentration of the solvated proton, H_2F^+

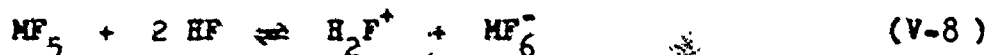

From a study of the chemical reactions of a large number of fluorides MF_5 in HF, Clifford et al.⁵⁶⁻⁵⁸ concluded that some of them exhibited acid behaviour. They examined the ability of various fluorides to give typical acid reactions. For example, the ability of HF solutions of the fluorides MF_5 to dissolve cobalt trifluoride and the metals chromium, magnesium and manganese. Based on this study relative acidic strengths were found to be in the order $\text{SbF}_5 > \text{AsF}_5 > \text{PF}_5$.

Kilpatrick and Lewis⁵³ made the first quantitative study of antimony pentafluoride in HF; they studied the electrical conductivity of dilute solutions of SbF_5 and NaSbF_6 . They concluded that antimony pentafluoride is a strong acid and ionizes in HF according to the equation

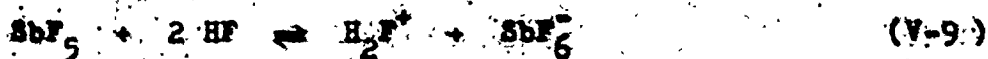

Later Ryan et al.¹⁷ reinvestigated the SbF_5 -HF system by means of electrical conductivity and molecular spectroscopy. They found that the conductivity increased by adding SbF_5 in HF and reached a maximum

at 10 % SbF_5 (Figure 22), and from the infrared and Raman spectra of SbF_5 in HF they obtained evidence for the formation of the SbF_6^- ion. Since the conductivity of the solutions rose to a maximum at a rather low SbF_5 concentrations and decreased rather rapidly with further increase the concentration of SbF_5 , they postulated an equilibrium involving an undissociated ion-pair species. At higher concentrations the amount of ionization drops off rapidly and the complex becomes the predominant species,

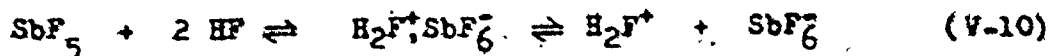

Another demonstration that SbF_5 acts as an acid in HF is the conductimetric titration of SbF_5 by water in liquid HF performed by Hyman et al.⁵⁹ On addition of water, the conductivity decreased, passed through a minimum, and then increased again, presumably because of the following neutralization reaction

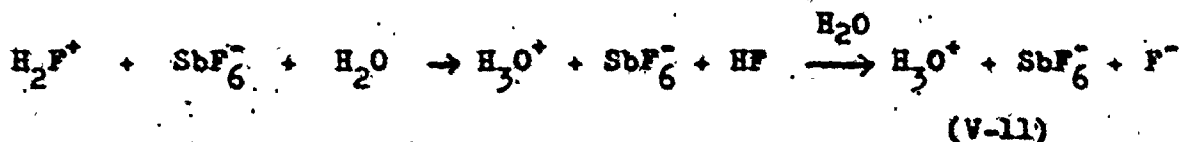

This also showed that H_2F^+ and F^- ions had higher mobilities than the H_3O^+ ion.

In contrast to Hyman et al.'s postulated formation of the ion-pair species, Gillespie and Moss's investigation¹⁸ gave no evidence for this species. They studied the ^{19}F nmr spectra of SbF_5 -HF solutions and found that apart from SbF_6^- at least one other anionic species is present, i.e. $\text{Sb}_2\text{F}_{11}^-$. They found at

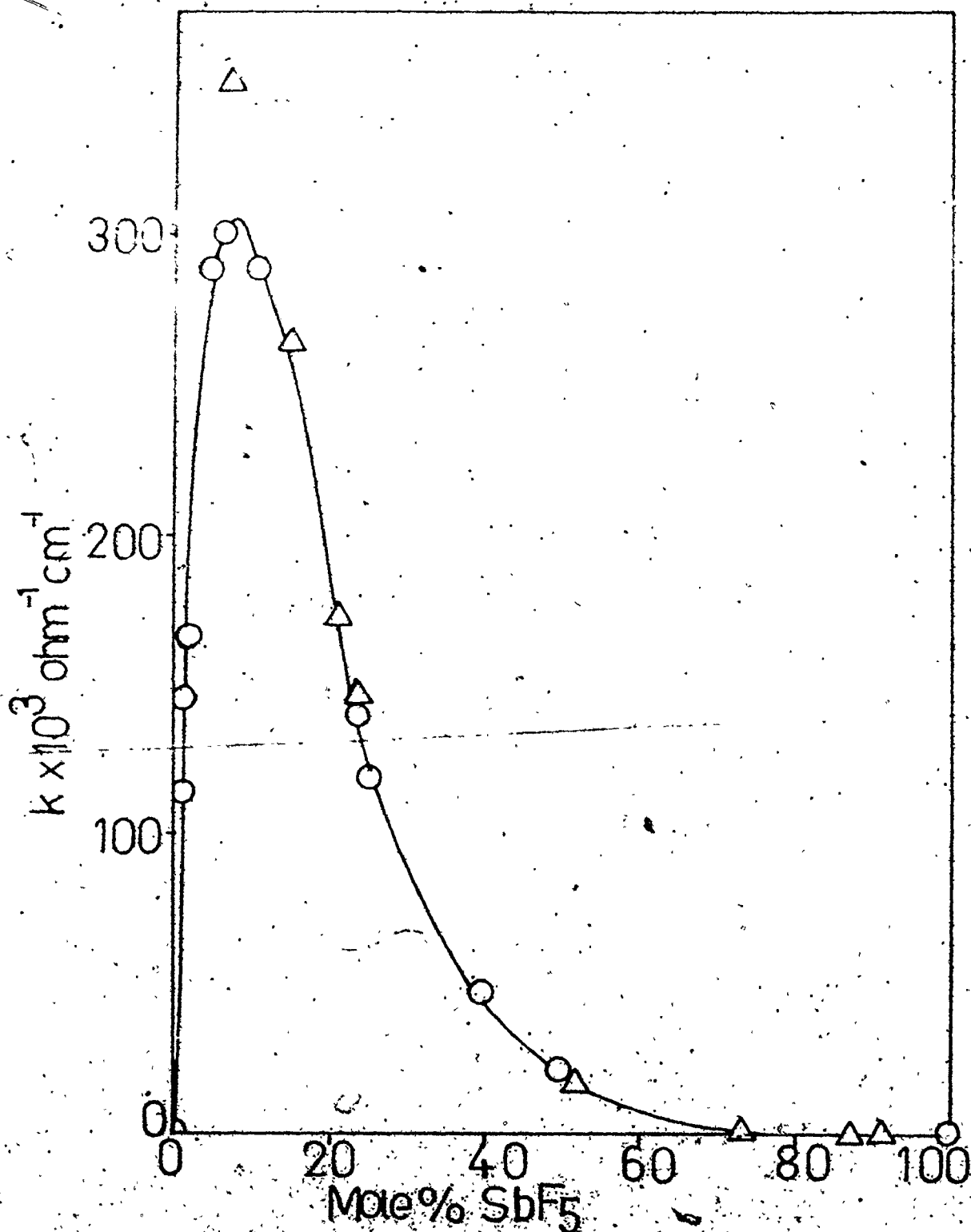
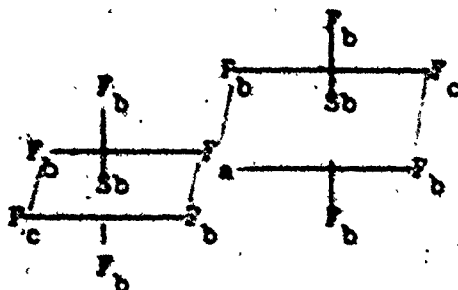

Figure 22. Conductivity of solutions of SbF_5 in HF at 0°C .
(Δ) Ryan et al., (\circ) Gillespie and Moss.

room temperature all solutions of SbF_5 in HF gave only two ^{19}F resonances, the high field resonance due to the solvent and a broad low field resonance due to the anionic species. At low temperature and in more concentrated solutions, three new resonances with relative areas 1:8:2 appeared showing some fine structure. They have interpreted these as arising from the three different fluorines F_a , F_b and F_c in the $\text{Sb}_2\text{F}_{11}^-$ ion



The concentration of this dimeric species increases with increasing SbF_5 concentration by reaction of SbF_6^- with SbF_5



In more concentrated solutions, $\text{Sb}_3\text{F}_{16}^-$ is probably present. Gillespie and Moss also remeasured the electrical conductivity of SbF_5 -HF solutions (Figure 22) and from which they obtained the $\lambda_{\text{H}_2\text{F}^+}^0$ value, $350 \text{ ohm}^{-1} \text{ cm}^2 \text{ equiv}^{-1}$ at 0° C .

The rapid decrease in conductivity in concentrated solutions may be due to the solvation of SbF_6^- and probably other polynuclear species such as $\text{Sb}_2\text{F}_{11}^-$. As more HF participating the solvations the less HF will be able to take part in the proton-transfer process. Viscosity changes may also be important. Therefore the combination of the conductivity and nmr measurements show that SbF_5 is indeed a strong acid in dilute solution.

Arsenic pentafluoride is less acidic than SbF_5 as shown

by conductivity measurements and PF_5 is weaker still.¹⁹

The acidic properties of TaF_5 , NbF_5 and PF_5 in HF have been demonstrated by McCaulay et al.⁶⁰ by measuring the ability of these fluorides to extract m- and p-xylene from an n-heptane solution into an excess of HF. The effectiveness of the extraction is in the order $\text{TaF}_5 > \text{NbF}_5 > \text{PF}_5$. Clifford et al.⁵⁶⁻⁵⁸ have reported the weakly acidic behaviour of NbF_5 in HF. Hatton et al.⁶¹ studied the nuclear magnetic resonances of ^{93}Nb , ^{121}Sb and ^{181}Ta in solutions of pentafluorides in 48 % aqueous HF. All these solutions yield the hexafluoride ion MF_6^- . If these fluorides ionize to give MF_6^- in aqueous HF solutions, they probably ionize to a greater extent in anhydrous HF.

B. HAMMETT ACIDITY FUNCTION MEASUREMENTS

The objective of the present work was to extend the early measurements of Bell et al.¹⁴ and Hyman et al.¹⁵ on the H_2O -HF system up to 100 % HF and into the still more acidic SbF_5 -HF system.

B-1. Dilute solutions of H_2O in HF and KF in HF

The acidity of dilute solutions of H_2O in HF was reinvestigated. The indicator 2,4,6-trinitroaniline used by Hyman et al. is the weakest primary aniline base that has been used for the H_0 measurements. The best value of pK_{BH^+} for 2,4,6-trinitroaniline is -10.10 determined by Jorgenson and Hartter⁹ in the H_2SO_4 solvent system. It was assumed that this value also applied to the HF solvent system. The extinction coefficients for this indicator in H_2O -HF are listed in Table XXII and plotted in Figure 23. The ionization

ratios were calculated and are listed in Table XXIII.

The ($pK_{BH^+} + \log I$) or H_0 values are plotted in Figure 24 together with previous values determined by Hyman et al.¹⁵ and Dallinga et al.¹⁶ Values of -10.89 and -10.39 were obtained by Hyman and Dallinga respectively for 100 % HF. The present data may be extrapolated to give an apparent value $H_0 = -10.96$. However none of these three values represent the true H_0 value for 100 % HF. Considering the extremely small value of the autoprotolysis constant for $2 HF \rightleftharpoons H_2F^+ + F^-$, a small amount of impurity such as water will displace the equilibrium to the left thus diminishing the acidity. The addition of the basic indicator will also affect the autoprotolysis. It is for this reason that it is not possible to obtain the H_0 for 100 % HF directly. The same situation was encountered in the previous measurements³ for 100 % HSO_3F . The best method to estimate the H_0 for 100 % HF would be to find the inflection point in a plot of H_0 for strong acid and strong base vs. acid or base concentrations. The extrapolation method used to obtain H_0 for 100 % HSO_3F is not feasible for 100 % HF. This will be further discussed in later section (see section C-2).

Since 2,4,6-trinitroaniline is the weakest of the primary aniline bases, a new set of indicators has to be used for H_2O -HF in 100 % HF region. Following Gillespie and Peel's work³ in extending the H_2SO_4 system to $H_2SO_4-SO_3$ and to HSO_3F by using nitro aromatic compounds as indicators, p-nitrotoluene was used in the present work. Since the theory requires the behaviour of good Hammett bases to be independent of the composition of the acid solvents, it should be

expected that 2,4,6-trinitroaniline and p-nitrotoluene would give a satisfactory overlap in the 100 % HF region just as in the $\text{H}_2\text{SO}_4\text{-SO}_3$ system.

$\text{H}_2\text{O-HF}$ solutions were prepared with concentrations so dilute that their concentrations were not measurable by weight but were determined by the electrical conductivity. Since water in HF is converted to $\text{H}_3\text{O}^+\text{F}^-$, and its equivalent conductance at infinite dilution Λ_0 was estimated to be $360 \text{ ohm}^{-1} \text{ cm}^2 \text{ equiv}^{-1}$ from the conductivity data⁵², the content of water could be estimated from the observed conductance of the solutions.

Tables XXIV and XXV list the extinction coefficients of 2,4,6-trinitroaniline and p-nitrotoluene. These are plotted in Figure 25. The concentrations of water as measured by the electrical conductivity range from 0.1 to 10^{-4} molality and are listed in Tables XXIV and XXV along with the conductivities. The calculated ionization ratios are listed in Tables XXVI and XXVII and are plotted in Figure 26. The values of ϵ_B and ϵ_{BH^+} , 8,500 and 200 for 2,4,6-trinitroaniline were found in $\text{H}_2\text{O-HF}$ solutions from the level portion in Figure 23 and in dilute solutions of AsF_5 in HF in which the indicator was fully protonated while the values, 200 and 19,200 for p-nitrotoluene were found in solutions of $\text{H}_2\text{O-HF}$ with concentrations 0.5 to 2 mole % H_2O and in $\text{NbF}_5\text{-HF}$ solutions where the indicator was completely protonated. A value of -11.49 for pK_{BH^+} of p-nitrotoluene was obtained by overlap with 2,4,6-trinitroaniline. This value may be compared with -11.35 determined in the H_2SO_4 system.

Table XXVIII and Figure 27 give the extinction coefficients of 2,4,6-trinitroaniline in solutions of the strong base KF in HF.

The ionization ratios and the $(pK_{BH^+} + \log I)$ values are listed in Table XX IX. The H_o values are plotted in Figure 28. It is seen that KF is a stronger base than H_2O and KF is completely ionized²⁰ in HF while the ionization constant of H_2O in HF has been estimated to be 0.55 at $0^\circ C$ by Kongpricha and Clifford⁶² from the influence of water on the solubility of CaF_2 in HF and 0.35 at $0^\circ C$ by Brownstein⁵² from conductivity results for H_2O -HF and KF-HF.

B-2. FLUOROSULFURIC ACID IN HF

Some measurements were made for HSO_3F in HF using p-nitrotoluene as indicator. The extinction coefficients are listed in Table XXX and are plotted in Figure 29. The ionization ratios were calculated and are listed in Table XXXI. The $(pK_{BH^+} + \log I)$ values are plotted in Figure 28. It seems that HSO_3F is a very weak acid in HF.

B-3. PHOSPHORUS PENTAFLUORIDE IN HF

A limited number of measurements for PF_5 in HF were made using p-nitrotoluene. In their freezing-point measurements, Dean et al.¹⁹ found a relatively high PF_5 vapor pressure in the solutions of PF_5 in HF even at $-83.6^\circ C$. The actual concentration of PF_5 in the present measurements must be less than the amount of PF_5 added as some PF_5 remains in the vapor.

The extinction coefficients of p-nitrotoluene in PF_5 -HF are shown in Table XXXII and Figure 30. The ionization ratios and the $(pK_{BH^+} + \log I)$ values are listed in Table XXXIII. The H_o values which are plotted in Figure 28 show that PF_5 is indeed acting as an acid in HF.

B-4. NIOBIUM PENTAFLUORIDE IN HF

The solubility of NbF_5 in HF is 6.8 g/100 g HF (0.72 mole % NbF_5) at 25°C according to Jache and Cady.⁶³

In a search for indicators with a suitable basicity for the determination of H_0 acidity functions for NbF_5 -HF, the following indicators were tried; p-nitrotoluene ($pK_{\text{BH}^+} = -11.35$), p-chloronitrobenzene (-12.70), 2,4-dinitrotoluene (-13.75), 2,4,6-trinitrotoluene (-15.60) and 1,3,5-trinitrobenzene (-16.04). The values of pK_{BH^+} for these indicators were determined previously in the H_2SO_4 or HSO_3F system.^{3,11} It was found that all the indicators except the last two were fully protonated even in very dilute solutions of NbF_5 in HF as shown by their extinction coefficients which are listed in Tables XXXIV to XXXVI and plotted in Figure 31.

Tables XXXVII and XXXVIII and Figure 32 show extinction coefficients of 2,4,6-trinitrotoluene and 1,3,5-trinitrobenzene in NbF_5 -HF up to its solubility limit. The ionization ratios are listed in Tables XXXIX and XL and are plotted in Figure 33. The values of ϵ_B for these two indicators were found in H_2O -HF and ϵ_{BH^+} from the level portions of the plot of ϵ vs. mole% NbF_5 at high NbF_5 concentrations. The ($pK_{\text{BH}^+} + \log I$) values and their average $-H_0$ values are listed in Table XLI and plotted in Figure 34.

From the H_0 values it is seen that the acidity of NbF_5 solutions in HF is greater than that of PF_5 in HF which agrees with the relative acid strengths reported by McCaulay et al.⁶⁰ but not with the finding by Clifford et al.⁵⁶⁻⁵⁸ that PF_5 was a stronger acid than NbF_5 . The H_0 value of -13.40 for 0.02 M solution

of NbF_5 in HF given by Hyman et al.¹⁷ is too low. The present measurements show that it is no less than -15.

B-5. ARSENIC PENTAFLUORIDE IN HF

The solubility of AsF_5 in HF has not been studied in detail. Cryoscopic study¹⁹ showed that AsF_5 was moderately soluble in HF.

The observed extinction coefficients of 2,4,6-trinitrotoluene and 1,3,5-trinitrobenzene in the AsF_5 -HF system are listed in Tables XLII and XLIII and are plotted in Figure 35. It is seen that both these two indicators are diprotonated in the solutions of AsF_5 in HF, since the positions of absorption peaks have shifted to shorter wavelength than λ_{max} for the monoprotinated forms and the observed extinction coefficients are greater than the assigned c_{BH^+} values in the HSO_3F system. More convincing evidence is the shape of the absorption peak which appears to be unsymmetric at the maximum absorption and must be composed of two peaks arising from the mono- and di-protonation. Figures 36 and 37 show some of these absorption curves which indicate an increase in intensity of the peak from the diprotonation.

The observed absorption arising from mono- and di-protonation may be broken down into two components by using a curve resolver. For this purpose a Dupont 310 Curve Resolver accompanied by a Dupont Curve Plotter was used. Standard gaussian shaped curves were generated by the instrument and then electronically added together in order to produce the observed absorption curves.

In the case of 2,4,6-trinitrotoluene, the absorption spectra may be resolved into the peaks resulting from the first protonated

nitro group (325 nm), the second protonated nitro group (300 nm) and the unprotonated nitro group (below 230 nm), In order to find the extinction coefficients for the second protonated nitro group it is necessary to subtract the absorption of the first nitro group from the observed absorption curve. Figure 38 shows two examples of how the composite absorption curves may be broken down into two components. The adjusted extinction coefficients are listed in Table XLIV. The absorption curves of 1,3,5-trinitrobenzene was treated in the same way. In this case the first protonation gave an absorption at 300 and the second at 280 nm. Figure 39 shows two examples of the analysis of the composite absorption peaks. Table XLV lists the adjusted extinction coefficients. The adjusted extinction coefficients for both 2,4,6-trinitrotoluene and 1,3,5-trinitrobenzene are plotted in Figure 40 which show the typical behaviour of the extinction coefficients for the protonation of an aromatic nitro group. A rapid rise in ϵ values is followed by a gradual decrease in the slope of the curves as AsF_5 concentration is increased.

The ionization ratios were calculated using the relationship

$$I = \frac{\epsilon_{\text{BH}^+} - \epsilon}{\epsilon - \epsilon_{\text{BH}_2^+}} \quad (\text{V-13})$$

where $\epsilon_{\text{BH}_2^+}$ is the adjusted extinction coefficient of the fully diprotonated indicator at the maximum wavelength λ_{max} , ϵ is the observed adjusted extinction coefficient at the wavelength of the diprotonated indicator and ϵ_{BH^+} is the adjusted extinction coeffi-

cient of the fully monoprotonated indicator at the wavelength of the second nitro group's absorption. The values of $\epsilon_{\text{BH}_2^{+2}}$ for 2,4,6-trinitrotoluene and 1,3,5-trinitrobenzene were found to be 15,400 and 16,000 respectively in the $\text{SbF}_5\text{-HF}$ system. Their corresponding values for ϵ_{BH^+} were found to be 2,000 and 2,500 at the same wavelength of $\epsilon_{\text{BH}_2^{+2}}$.

ϵ values were taken at regularly spaced AsF_5 concentrations from Figure 40. The ionization ratios were calculated and are tabulated in Tables XLVI and XLVII and are plotted in Figure 41. It is seen that the two indicators behave quite uniformly. Using the overlap technique and the $\text{pK}_{\text{BH}_2^{+2}}$ of 2,4,6-trinitrotoluene (-18.35) as found in the $\text{SbF}_5\text{-HSO}_3\text{F}$ system, the ionization constant $\text{pK}_{\text{BH}_2^{+2}}$ for protonated 1,3,5-trinitrobenzene was found to be -18.93.

The ($\text{pK}_{\text{BH}_2^{+2}} + \log L$) values for the indicators studied in $\text{AsF}_5\text{-HF}$ are listed in Table XLVIII together the average -H_0 values. The acidity functions obtained from the protonation of the positively charged base BH^+ is defined as H_+

$$\text{H}_+ = \text{pK}_{\text{BH}_2^{+2}} - \log \frac{[\text{BH}_2^{+2}]}{[\text{BH}^+]} \quad (\text{V-14})$$

In the measurements of the second protonation of a series of nitro aromatic compounds in oleum by Brand et al.¹⁰ and in the HSO_3F system by Gillespie and Peel,³ it was assumed that the H_+ acidity function followed closely the corresponding H_0 scale. This appears to be justified and can perhaps be attributed to the fact that the nitro groups behave independently in the polynitro indicators. For this reason the acidity function values obtained from

the second protonation of the indicators are expressed as H_0 values. The resulting H_0 functions for the AsF_5 -HF system are plotted in Figure 34.

B-6. TANTALUM PENTAFLUORIDE IN HF

The solubility of TaF_5 in HF is 15.2 g / 100 g HF (1.1 mole % TaF_5) at 25°C according to Jache and Cady.⁶³

The observed and adjusted extinction coefficients of 2,4,6-trinitrotoluene, 1,3,5-trinitrobenzene and 2,4,6-trinitrochlorobenzene are listed in Tables XLIX to LI and are plotted in Figures 42 and 43. As in the AsF_5 -HF system, the adjusted extinction coefficients were obtained by resolving the observed extinction coefficients into their two components resulting from the mono- and di-protonation. The ionization ratios were calculated at regularly spaced TaF_5 concentrations and are listed in Tables LII to LIV. These are plotted in Figure 44. The $(pk_{BH_2^{+2}} + \log I)$ values are listed in Table LV along with the average $-H_0$ values which are plotted in Figure 34. The ϵ_{BH^+} and $\epsilon_{BH_2^{+2}}$ for all these three indicators are found in the SbF_5 -HF system. The $pk_{BH_2^{+2}}$ values were again determined by overlap based on $pk_{BH_2^{+2}} = -18.36$ for 2,4,6-trinitrotoluene. A value of -18.89 for 1,3,5-trinitrobenzene and -19.77 for 2,4,6-trinitrochlorobenzene were found. The evaluation of $pk_{BH_2^{+2}}$ values is based on the equation (I-10)

$$pk_{BH_2^{+2}} - pk_{CH_2^{+2}} = \log \frac{[BH_2^{+2}]}{[BH^+]} - \log \frac{[CH_2^{+2}]}{[CH^+]} \quad (I-10)$$

where BH^+ is a known indicator and CH^+ is a weaker base whose protonation occurs at acid concentrations overlapping with those for BH^+ .

In the present case, 2,4,6-trinitrotoluene is the indicator with the known $pK_{BH_2^{+2}}$ value, -18.36, and 1,3,5-trinitrobenzene and 2,4,6-trinitrochlorobenzene are indicators whose $pK_{CH_2^{+2}}$ values are to be determined. This was made simply by finding the difference of ionization ratios at acid concentrations in which the two indicators have protonation overlapping each other. The two indicators, 2,4,6-trinitrotoluene and 1,3,5-trinitrobenzene overlap well between acid concentrations of 0.20 and 0.70 mole % TaF_5 . The difference of their ionization ratios at the regularly spaced concentrations of mole % TaF_5 ; 0.20, 0.25, 0.30, 0.40, 0.50, 0.60 and 0.70 are -0.64, -0.57, -0.52, -0.49, -0.48, -0.51 and -0.52. The average value is -0.53 which added to $pK_{BH_2^{+2}}$ value, -18.36, for 2,4,6-trinitrotoluene gave the $pK_{CH_2^{+2}}$ value, -18.89, for 1,3,5-trinitrobenzene. The ionization ratios difference between 1,3,5-trinitrobenzene and 2,4,6-trinitrochlorobenzene at acid concentrations of mole % TaF_5 ; 0.40, 0.50, 0.60, 0.70 and 0.80 are -0.82, -0.83, -0.88, -0.91 and -0.99. The average value is -0.88 which added to the $pK_{BH_2^{+2}}$ value, -18.89 for 1,3,5-trinitrobenzene gave the $pK_{CH_2^{+2}}$ value, -19.77 for 2,4,6-trinitrochlorobenzene. The accuracy for these $pK_{BH_2^{+2}}$ values is ± 0.10 . The $pK_{BH_2^{+2}}$ value of 1,3,5-trinitrobenzene determined in the AsF_5 -HF system is -18.93 which is essentially the same as the value determined in the TaF_5 -HF system.

B-7. ANTIMONY PENTAFLUORIDE IN HF

As expected the strong acid SbF_5 in HF is so acidic that two indicators, 2,4,6-trinitrotoluene and 1,3,5-trinitrobenzene are fully diprotonated in this acid solvents. The observed and

adjusted extinction coefficients are listed in Tables LVI and LVII. These adjusted extinction coefficients are used as $\epsilon_{\text{BH}_2^{+2}}$ in calculating the ionization ratios in previous sections for the AsF_5 -HF and TaF_5 -HF systems. The ϵ_{BH^+} values at the same wavelength of $\epsilon_{\text{BH}_2^{+2}}$ are obtained from the monoprotonation absorption curves which are separated from diprotonation by resolving the observed absorptions.

Two weaker indicators, 2,4,6-trinitrochlorobenzene and 1,3-dichloro-2,4,6-trinitrobenzene were tried in the SbF_5 -HF system. Their observed and adjusted extinction coefficients are listed in Tables LVIII to LXI and Figures 45 to 48. The absorption for the first nitro group occurs at $\lambda = 340$ nm and $\lambda = 300$ nm for the second nitro group for 2,4,6-trinitrochlorobenzene. The corresponding λ values for 1,3-dichloro-2,4,6-trinitrobenzene are 340 nm and 310 nm. Figures 49 and 50 show some examples of absorption curves for these two indicators. Tables LXII and LXIII list the ionization ratios which are plotted in Figure 51. The $\epsilon_{\text{BH}_2^{+2}}$ values, 16,000 for 2,4,6-trinitrochlorobenzene and 20,000 for 1,3-dichloro-2,4,6-trinitrobenzene were obtained from the level portions of the adjusted absorption curves (Figures 47 and 48). The ϵ_{BH^+} values, 16,00 and 4,400 were obtained from the absorption curves of the monoprotonated indicators at the wavelength of λ_{max} for $\epsilon_{\text{BH}_2^{+2}}$. The $\text{pK}_{\text{BH}_2^{+2}}$ value for 1,3-dichloro-2,4,6-trinitrobenzene was obtained by overlap with 2,4,6-trinitrochlorobenzene. A value of -20.27 ± 0.05 was obtained by taking the ionization ratio difference in the overlapping range. The $(\text{pK}_{\text{BH}_2^{+2}} + \log I)$ values together with the average $-\text{H}_0$ values for the SbF_5 -HF system are listed in Table LXIV and plotted

in Figure 34.

C. DISCUSSION

C-1. Nitro aromatic indicators

It has been demonstrated that the Hammett acidity function, H_0 can be extended into the superacid region by the use of a self-consistent set of aromatic nitro indicators.³ The protonation behaviour of these indicators was found to be similar to that of the aniline and by the use of these two sets of indicators the H_0 scale has been extended from dilute solutions of acid in H_2O to the highly acidic SbF_5-HSO_3F system^{3,11} and to the still more highly acidic SbF_5-HF system in the present work.

The reference point for the present measurements was chosen to be pK_{BH^+} of 2,4,6-trinitroaniline, -10.10. The nitro aromatic indicator, p-nitrotoluene has been proved to behave very similarly to the aniline indicator, 2,4,6-trinitroaniline in the previous measurements in H_2SO_4 and in the present measurements in HF, although the pK_{BH^+} value obtained by overlap to 2,4,6-trinitroaniline differs a little in these two solvents. A value of -11.35 was found in the H_2SO_4 system and -11.49 in the HF system for pK_{BH^+} of p-nitrotoluene. This difference is small but not negligible and may be due to solvent effects. From the H_0 functions for the acids in HF it can be seen that an overlap determination of the pK_{BH^+} values for the weaker bases with respect to p-nitrotoluene is not possible since no acid systems with suitable acidity range have been found between the PF_5-HF and NbF_5-HF systems. Therefore the pK_{BH^+} values for the nitro aromatic indicators used presently are those deter-

mined by Gillespie and Peel.^{3,11} The $pK_{BH_2^{+2}}$ values for the diprotonation of 1,3,5-trinitrobenzene, 2,4,6-trinitrochlorobenzene and 1,3-dichloro-2,4,6-trinitrobenzene were determined by overlap in the SbF_5 -HF system based on -18.35 for $pK_{BH_2^{+2}}$ of 2,4,6-trinitrotoluene.

The ϵ_B and ϵ_{BH^+} (or ϵ_{BH^+} and $\epsilon_{BH_2^{+2}}$ for the diprotonation) values for the nitro aromatic indicators used in the present work were determined in the HF system in the present work or in the HSO_3F system in the previous measurements.³ They are listed in Table LXV along with the pK values.

The degree of parallelism of the indicators can be tested by the method of Johnson et al.⁶⁴ who showed that in general one may write $\log I_2 = a_{2,1} \log I_1 + a_{2,1} pK_1 - pK_2$ and $H_2 = a_{2,1} H_1$ where $a_{2,1}$ is the constant that measures the degree of parallelism of indicator 1 and 2 and should be unity for a pair of well-behaved indicators. H_1 and H_2 are acidity functions defined by indicators 1 and 2 respectively. The product $\prod a_{i,i-1}$ indicates how the i th indicator behaves with respect to the acidity functions defined by the first indicator. Individual $a_{i,i-1}$ values were obtained from plots of $\log I_i$ vs. $\log I_{i-1}$. The values for the protonated 2,4,6-trinitrotoluene were determined in the HSO_3F system, since a systematic evaluation from the aniline 2,4,6-trinitroaniline is not possible. The values for $a_{i,i-1}$ and $\prod a_{i,i-1}$ are listed in Table LXVI. The values of $a_{i,i-1}$ are comparable to those previously reported³.

C-2. H₀ value for 100 % HF

The value of H₀ for 100 % HF cannot be determined directly because of its very small autoprotolysis constant (9.84×10^{-13} mole² Kg⁻² at 20°C). A very small amount of an acidic or a basic impurity such as water or the very small concentrations of basic indicator used in the determination of H₀ very considerably repress the autoprotolysis and hence have a drastic effect on the value of H₀: The only way that H₀ can be determined with any reliability is by interpolation from values for more acidic and more basic solutions where the effects of traces of impurities or the indicator itself are much smaller. Figure 52 shows H₀ values for solutions of KF and SbF₅ in HF and thus represents the titration curve of the strong base KF by the strong acid SbF₅. The point of inflection of this curve then gives the H₀ value for 100 % HF; this was found by taking the mean of the H₀ value for a curve of acid and that for the curve of base and the average of several such values from different low concentrations of acid and base was taken. The average was found to be -15.10 ± 0.05 which is much higher than the values obtained by direct measurements in HF, -10.90 by Hyman et al.¹⁵ and -10.40 by Dallinga et al.¹⁶ or by extrapolation of the data for the H₂O-HF system, -11.0 in the present measurements. It is concluded that neither of these methods is satisfactory.

C-3. The very weak acids HSO₃F and PF₅ and weak acid NbF₅

The same difficulties, i.e. the effect of the basic indicator and possible traces of water on the autoprotolysis of the

solvent also very considerably affect the determination of H_0 values for very weak acids such as HSO_3F and PF_5 ; The apparent values obtained for these two acids never reach the value obtained for 100 % HF. The reason for this is that they are not sufficiently ionized to neutralize the very small concentration of F^- arising from the ionization of the indicator and possible traces of water. Niobium pentafluoride on the other hand, although a very weak acid is apparently strong enough to neutralize the F^- from the indicator and from traces of water and the H_0 values are greater than that for 100 % HF.

C-4. Comparison of the strengths of acids of the HF system

AsF_5 and TaF_5 are relatively strong acids in HF and SbF_5 is the strongest acid based on the present measurements. It is concluded that the order of the acidity in the HF system is $\text{SbF}_5 > \text{AsF}_5 > \text{TaF}_5 > \text{NbF}_5 > \text{PF}_5 > \text{HSO}_3\text{F}$. This is consistent with the order $\text{SbF}_5 > \text{AsF}_5 > \text{PF}_5 > \text{HSO}_3\text{F}$ from cryoscopic and conductivity measurements,^{19,20} and also the order $\text{TaF}_5 > \text{NbF}_5 > \text{PF}_5$ from the extraction study.⁶⁰

C-5. The theoretical H_0 values for the strong acid and base

It is reasonable to assume that the acidity of solutions in HF is determined primarily by the concentration of H_2F^+ just as the acidity of dilute aqueous solutions is determined by the concentration of H_3O^+ . Hence an assumption is made; $H_0 \propto [\text{H}_2\text{F}^+]$ or

$$H_0 = -\log [\text{H}_2\text{F}^+] + \text{constant} \quad (\text{V-15})$$

An acid such as SbF_5 increases the concentration of H_2F^+ according to the equation (V-9)

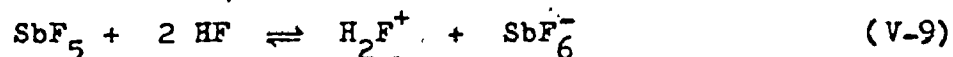

and a base KF decreases the concentration of H_2F^+ according to the equation (V-16)



The constant in the equation (V-15) may be determined from the concentration of H_2F^+ and the H_0 value for 100 % HF. The concentration of H_2F^+ in 100 % HF has been found to be 9.92×10^{-7} mole Kg^{-1} from the conductivity measurements⁵² and the H_0 value, -15.10, in the present measurements. Substituting these data into the equation (V-15) the following relationship was obtained

$$H_0 = -\log [H_2F^+] - 21.10 \quad (V-17)$$

Using this equation theoretical H_0 values for a strong acid and a strong base may be calculated ; they are shown in Figure 52. They were found to be very close to the measured values. The difference may be attributed to activity effects. From the definition of H_0 given by the equation (V-18)

$$H_0 = -\log h_0 = -\log \left(\frac{a_{H^+} f_B}{f_{BH^+}} \right) \quad (V-18)$$

it is seen that the difference between H_0 and a_{H^+} ($= a_{H_2F^+}$, in strong acid $a_{H_2F^+}$ is equal to the stoichiometric acid concentration) results from variations of the activity coefficients of the species in the protonation equation with changing acid concentrations



The constant 21.10 in the equation (V-17), was obtained in 100 % HF. The addition of strong acid to HF will affect the activity and with increasing concentrations of strong acid SbF_5 the equation

(V-17) will become less valid.

C-6. Ionization constants of weak acids and H₂O in HF

The ionization constants of the weak acids, AsF₅, TaF₅ and NbF₅ in HF may be calculated by the use of the equation (V-17) and the equation (V-20)

$$K_a = \frac{[MF_6^-][H_2F^+]}{[MF_5]} \quad (V-20)$$

The concentration of H₂F⁺ may be obtained from the measured H₀ values by using the equation (V-17) and the concentration of MF₆⁻ is assumed to be equal to that of H₂F⁺. It was found that the apparent K_a decreases with decreasing MF₅ concentrations and on extrapolation to infinite dilution the values of 3 x 10⁻⁵, 8 x 10⁻⁶ and 2 x 10⁻¹¹ mole.Kg⁻¹ were obtained for AsF₅, TaF₅ and NbF₅ respectively. The calculated K_a values are listed in Table LXVII.

The ionization constant of water in HF may be calculated in the same way by using the following equations



$$K_b = \frac{[H_3O^+][F^-]}{[H_2O]} \quad (V-22)$$

A value of 4 x 10⁻² mole Kg⁻¹ was found for K_b of H₂O in HF at 22°C. This K_b value may be compared with those calculated from the conductivity data by using the equation

$$\lambda_{H_3O^+}^{\circ} + \lambda_{F^-}^{\circ} = \frac{k \times 1000}{[H_3O^+]} \quad (V-23)$$

where k is the specific conductivity and λ^o's are the ionic

mobility. Using Brownstein's conductivity data⁵² and the ionic mobility,⁵³ $\lambda_{\text{H}_3\text{O}^+}^{\circ} = 120$ and $\lambda_{\text{F}^-}^{\circ} = 270 \text{ ohm}^{-1} \text{ cm}^2 \text{ equiv}^{-1}$, a value of $7 \times 10^{-2} \text{ mole Kg}^{-1}$ was obtained for K_b of water in HF. The $\lambda_{\text{H}_3\text{O}^+}^{\circ}$ value⁵³ was assumed to be the same as the $\lambda_{\text{K}^+}^{\circ}$ because of the radius of H_3O^+ is close to that of K^+ . The calculated K_b values are shown in Table LXVIII. It is seen that the K_b value obtained from the measured H_0 values is of the same magnitude to that from conductivity data. They are, however, smaller than the values, 0.55 obtained by Kongpricha and Clifford⁶² and 0.35 by Brownstein.⁵² Kongpricha and Clifford's value was obtained by extrapolation from data obtained on solutions with ionic strengths in the range 0.64 to 0.41 and so could be inaccurate. Brownstein's value was obtained by comparison with electrolytes and could not be of great accuracy.

TABLE XXII
EXTINCTION COEFFICIENTS OF 2,4,6-TRINITROANILINE
IN THE H₂O-HF SYSTEM

Mole% H ₂ O	λ_{max} (nm)	ϵ
0.0174	415	1,300
0.1197	415	2,600
0.4919	415	3,700
0.6703	415	4,700
1.0645	415	6,000
1.5415	415	7,100
1.9717	415	6,500
2.1333	415	7,300
2.4676	415	7,900
4.4057	415	8,500
6.9517	415	8,400

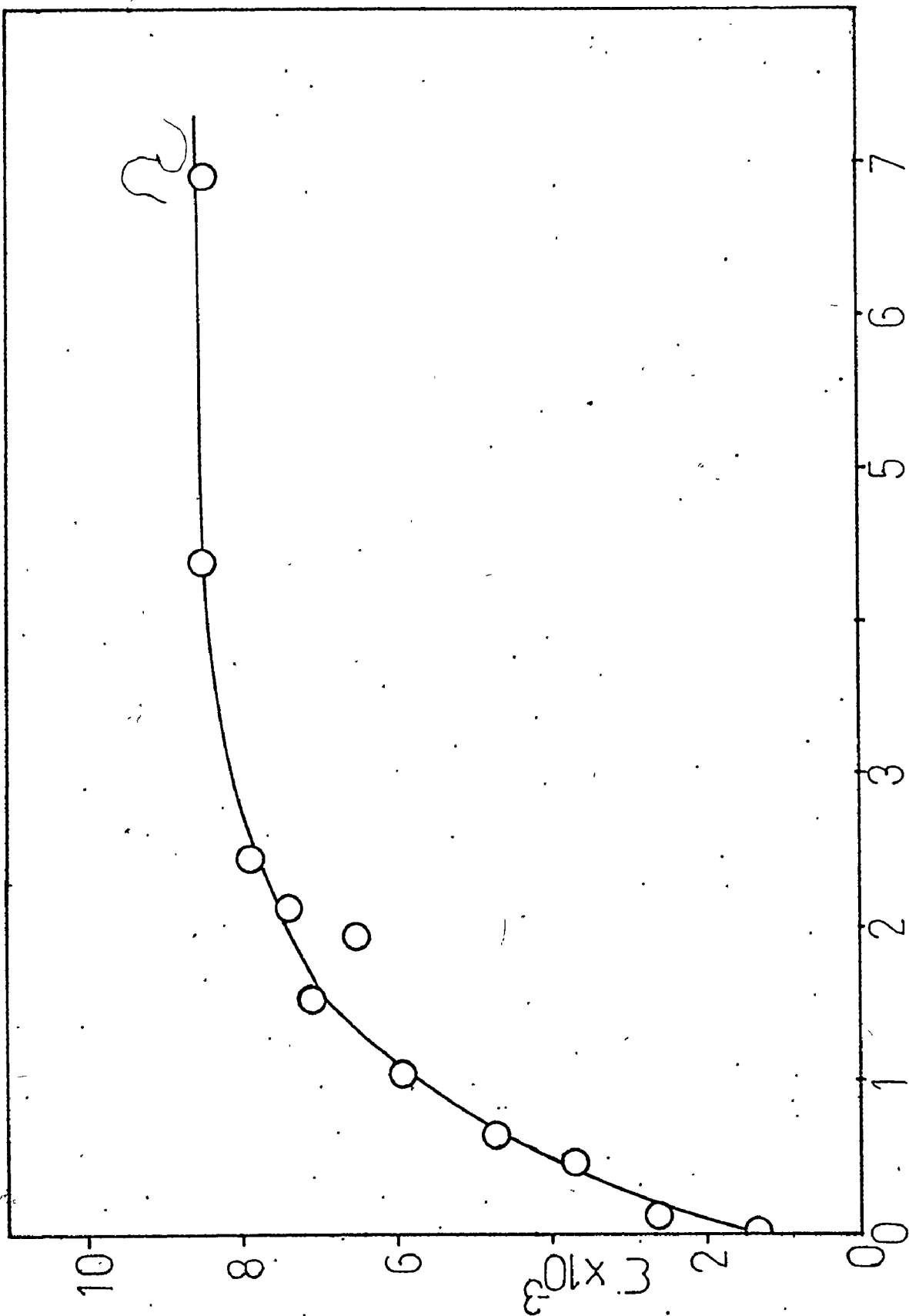

Figure 23. Extinction coefficients of 2,4,6-trinitroaniline in the H₂O-HF system.

TABLE XXIII

IONIZATION RATIOS OF 2,4,6-TRINITROANILINE IN THE
H₂O-HF SYSTEM AND THE RESULTING -H₀ VALUES

$$c_B = 8500$$

$$c_{BH^+} = 200$$

$$pK_{BH^+} = -10.10$$

Mole% H ₂ O	ϵ	log I	-H ₀
0.02	1400	-0.77	10.87
0.05	1800	-0.62	10.72
0.10	2300	-0.47	10.57
0.20	3000	-0.29	10.39
0.30	3600	-0.16	10.26
0.40	4000	-0.07	10.17
0.50	4300	-0.01	10.11
0.60	4600	0.05	10.05
0.80	5200	0.18	9.92
1.00	5700	0.30	9.80
1.50	6800	0.54	9.56
2.00	7400	0.82	9.28

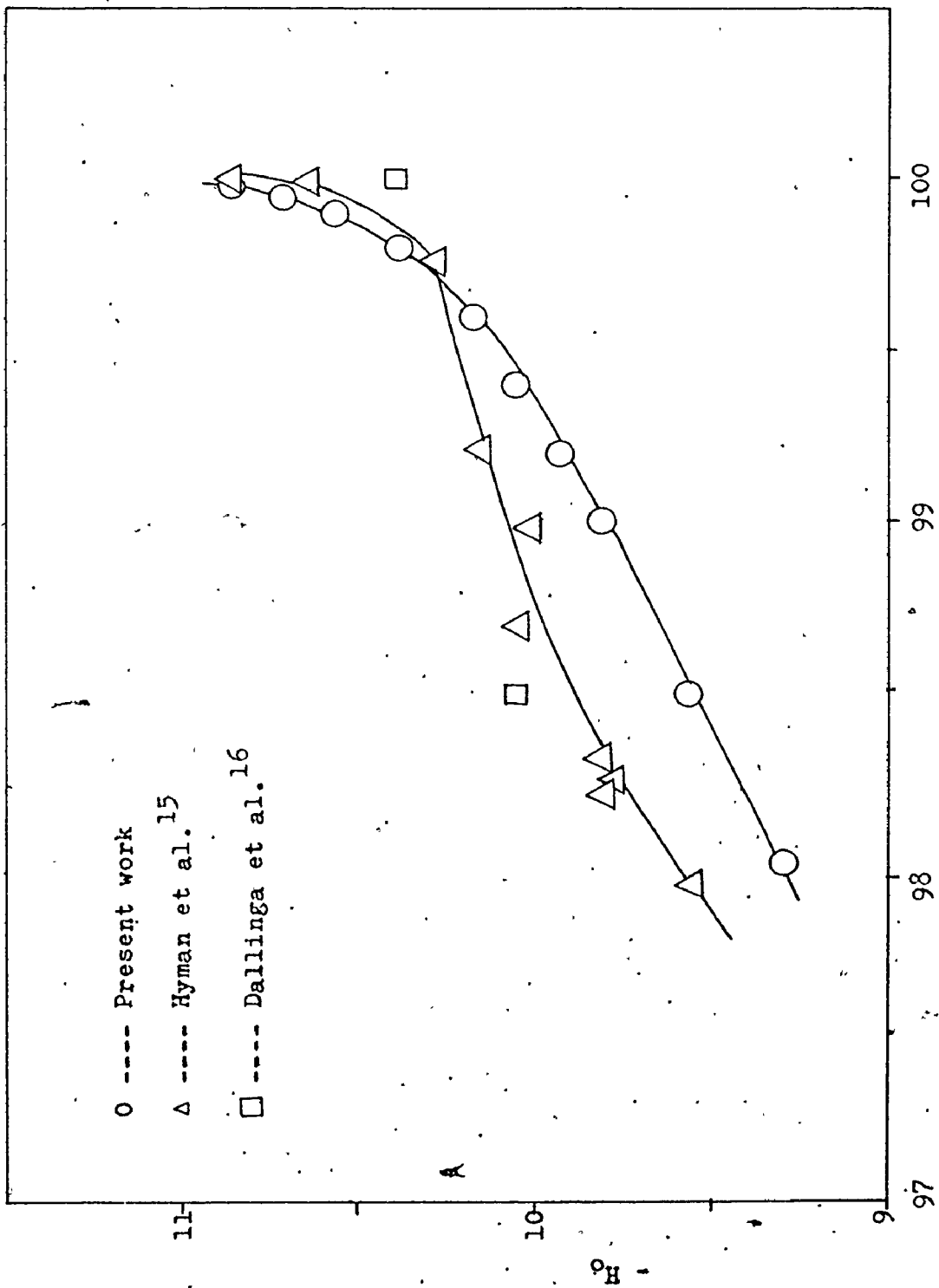

Figure 24. $-H_0$ values for the H_2O-HF system in 98-100 % HF region.

TABLE XXIV

EXTINCTION COEFFICIENTS OF 2,4,6-TRINITROANILINE
IN VERY DILUTE SOLUTIONS OF H₂O IN HF

$k \times 10^4$ (ohm ⁻¹ cm ⁻¹)	$m \times 10^2$	λ_{\max} (nm)	ϵ
212.685	5.91	415	4,500
141.146	3.92	415	3,600
104.925	2.91	415	2,700
56.716	1.58	415	1,100
33.772	0.93	415	700
30.163	0.84	415	700
8.507	0.24	415	600
7.670	0.21	415	500
6.742	0.19	415	600
4.976	0.14	415	300

TABLE XXV

EXTINCTION COEFFICIENTS OF p-NITROTOLUENE

IN VERY DILUTE SOLUTIONS OF H₂O IN HF

$k \times 10^4$ (ohm ⁻¹ cm ⁻¹)	$m \times 10^2$	λ_{\max} (nm)	ϵ
201.084	5.59	360	1,000
132.767	3.69	360	1,200
87.652	2.44	360	1,200
56.716	1.58	360	1,800
35.448	0.99	360	2,100
30.163	0.84	360	2,500
10.132	0.28	360	2,400
9.410	0.26	360	2,600
6.716	0.19	360	3,100
4.589	0.13	360	4,800
1.714	0.05	360	4,800
1.354	0.04	360	5,100
0.812	0.02	360	5,100

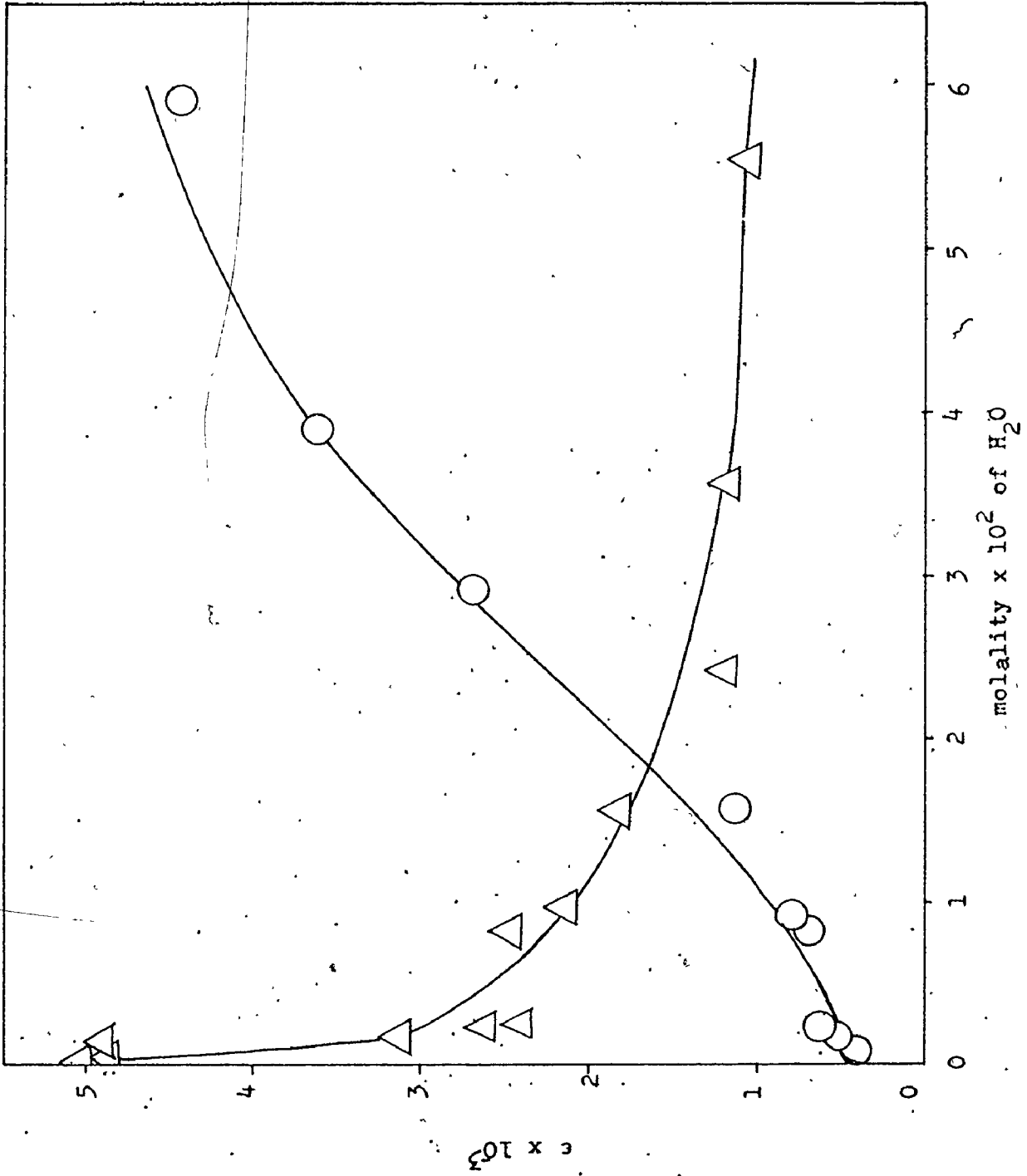

Figure 25. Extinction coefficients of 2,4,6-trinitroaniline (O) and p-nitrotoluene (Δ) in dilute solutions of H_2O in HF.

TABLE XXVI.
 IONIZATION RATIOS OF 2,4,6-TRINITROANILINE IN DILUTE
 SOLUTIONS OF H₂O IN HF

$c_B = 8,500$ $c_{BH^+} = 200$ $pK_{BH^+} = -10.10$

$m \times 10^2$	ϵ	$\log I$	$-H_0$
0.25	550	-1.36	11.46
0.50	600	-1.30	11.40
0.75	700	-1.19	11.29
1.00	950	-1.00	11.10
1.50	1,450	-0.75	10.85
2.00	1,900	-0.59	10.69
2.50	2,400	-0.44	10.54
3.00	2,800	-0.34	10.44
4.00	3,600	-0.16	10.26
5.00	4,250	-0.02	10.12
6.00	4,550	-0.04	10.06

TABLE XXVII
 IONIZATION RATIOS OF p-NITROTOLUENE IN DILUTE

$m \times 10^2$	SOLUTIONS OF H ₂ O IN HF		
	$\epsilon_B = 200$ ϵ	$\epsilon_{BH^+} = 19,200$ $\log I$	$pK_{BH^+} = -11.35$ $-H_0$
0.05	4,500	0.53	10.82
0.10	3,700	0.65	10.70
0.25	2,950	0.77	10.58
0.50	2,500	0.86	10.49
0.75	2,200	0.93	10.42
1.00	2,000	0.98	10.37
1.50	1,700	1.07	10.28
2.00	1,500	1.13	10.22
2.50	1,350	1.19	10.16
3.00	1,200	1.26	10.09
3.50	1,150	1.28	10.07
4.00	1,100	1.30	10.05
5.00	1,050	1.33	10.02
6.00	1,000	1.36	9.99

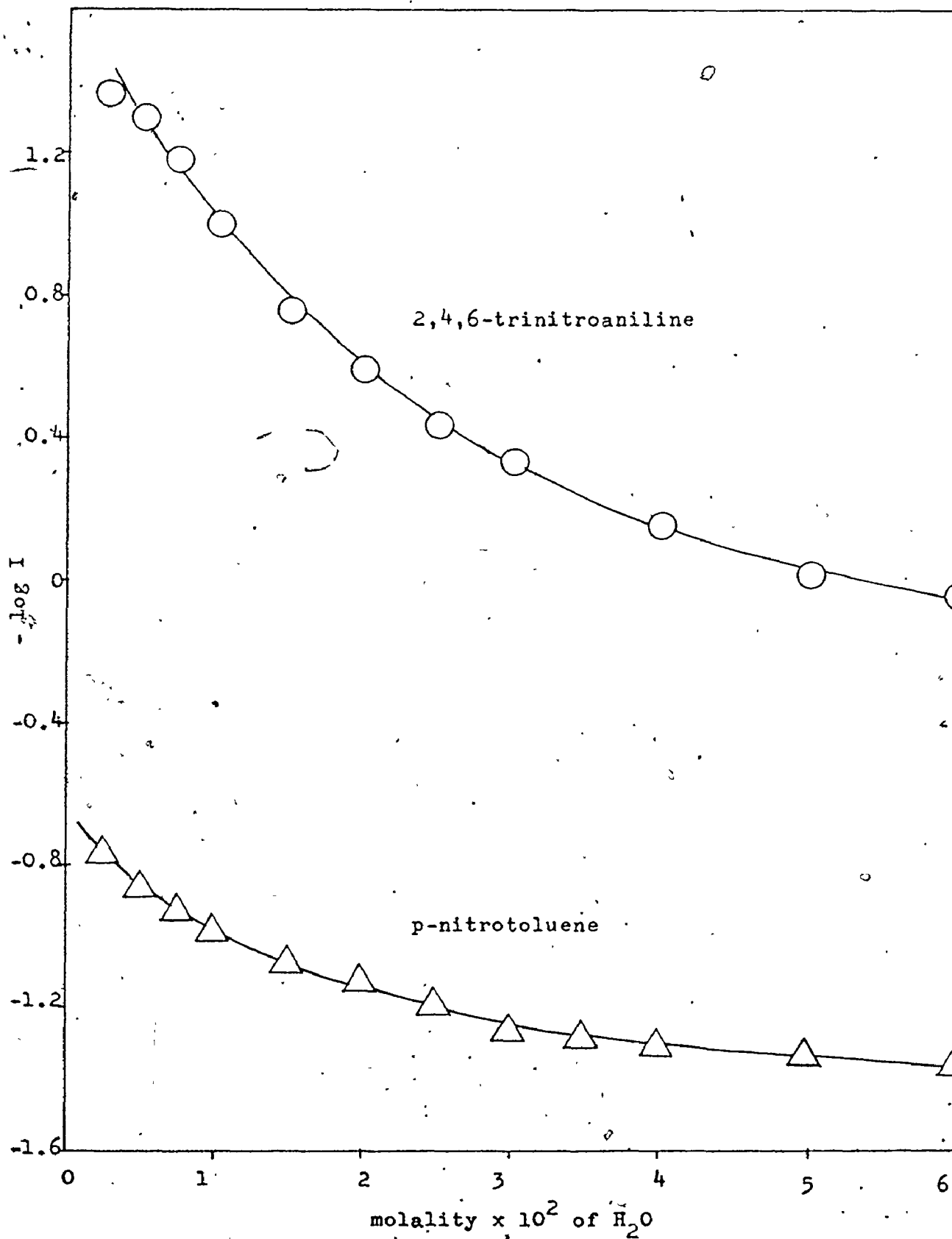

Figure 26. Ionization ratios of indicators in dilute solutions of H_2O in HF.

TABLE XXVIII
EXTINCTION COEFFICIENTS OF 2,4,6-TRINITROANILINE
IN THE KF-HF SYSTEM

Mole% KF	λ_{\max} (nm)	ϵ
0.0253	415	1,400
0.1435	415	5,000
0.3922	415	5,400
0.4294	415	5,900
0.4315	415	7,700
0.8455	415	8,100
0.8535	415	8,200
1.2118	415	8,100
1.6847	415	8,500
1.8306	415	9,000
2.7950	415	8,300

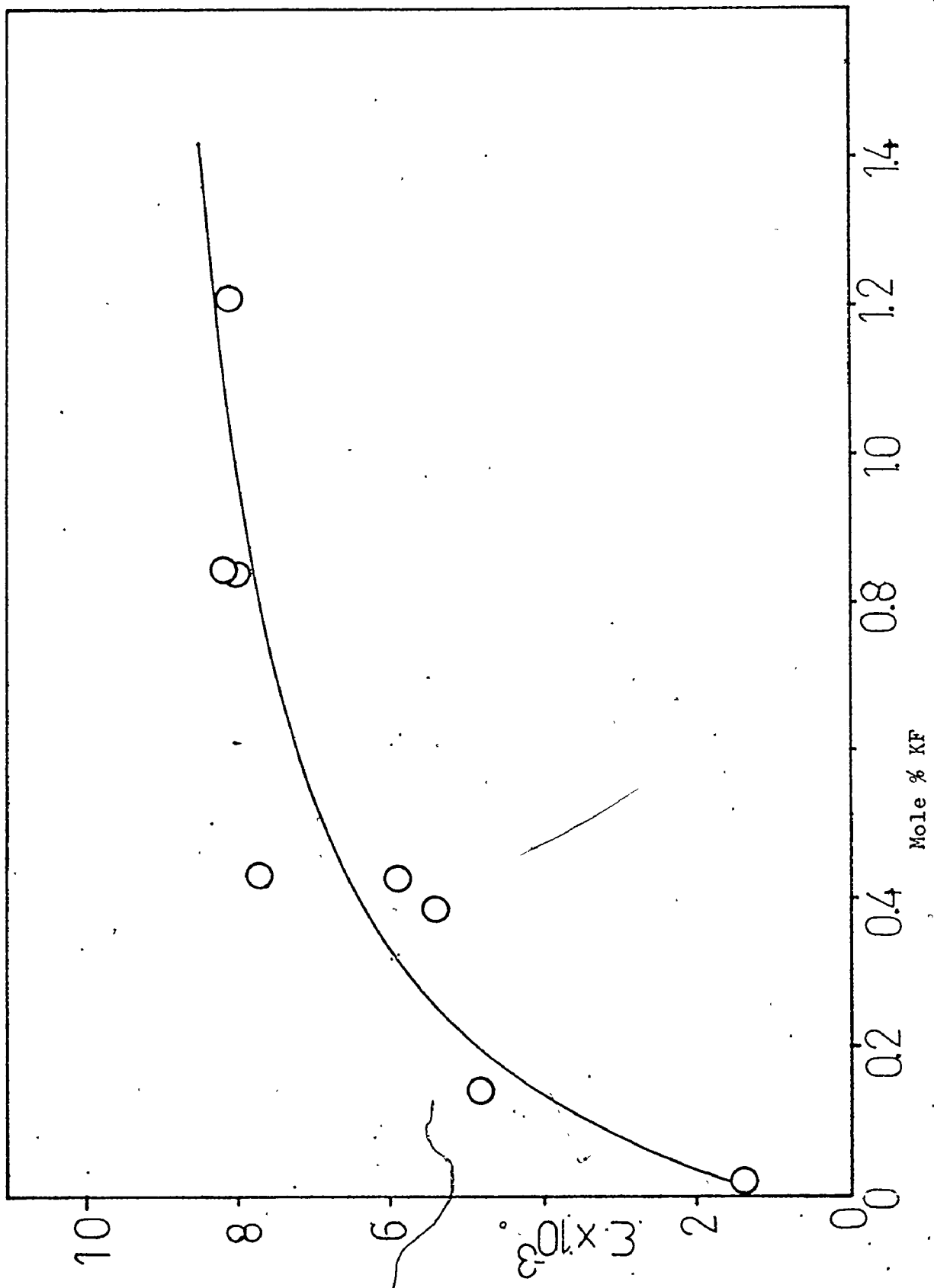

Figure 27. Extinction coefficients of 2,4,6-trinitroaniline in the KF-HF system.

TABLE XXIX
 IONIZATION RATIOS OF 2,4,6-TRINITROANILINE
 AND $-H_0$ VALUES IN THE KF-HF SYSTEM

Mole% KF	c	$\log I$	$-H_0$
0.02	1600	-0.69	10.79
0.04	2100	-0.53	10.63
0.06	2600	-0.43	10.53
0.08	3000	-0.29	10.39
0.10	3400	-0.20	10.30
0.15	4200	-0.03	10.13
0.20	4900	0.11	9.99
0.30	5800	0.32	9.78
0.40	6400	0.47	9.63
0.60	7200	0.66	9.37
0.70	7 00	0.82	9.28
0.80	7600	0.91	9.19
0.90	7800	1.04	9.06

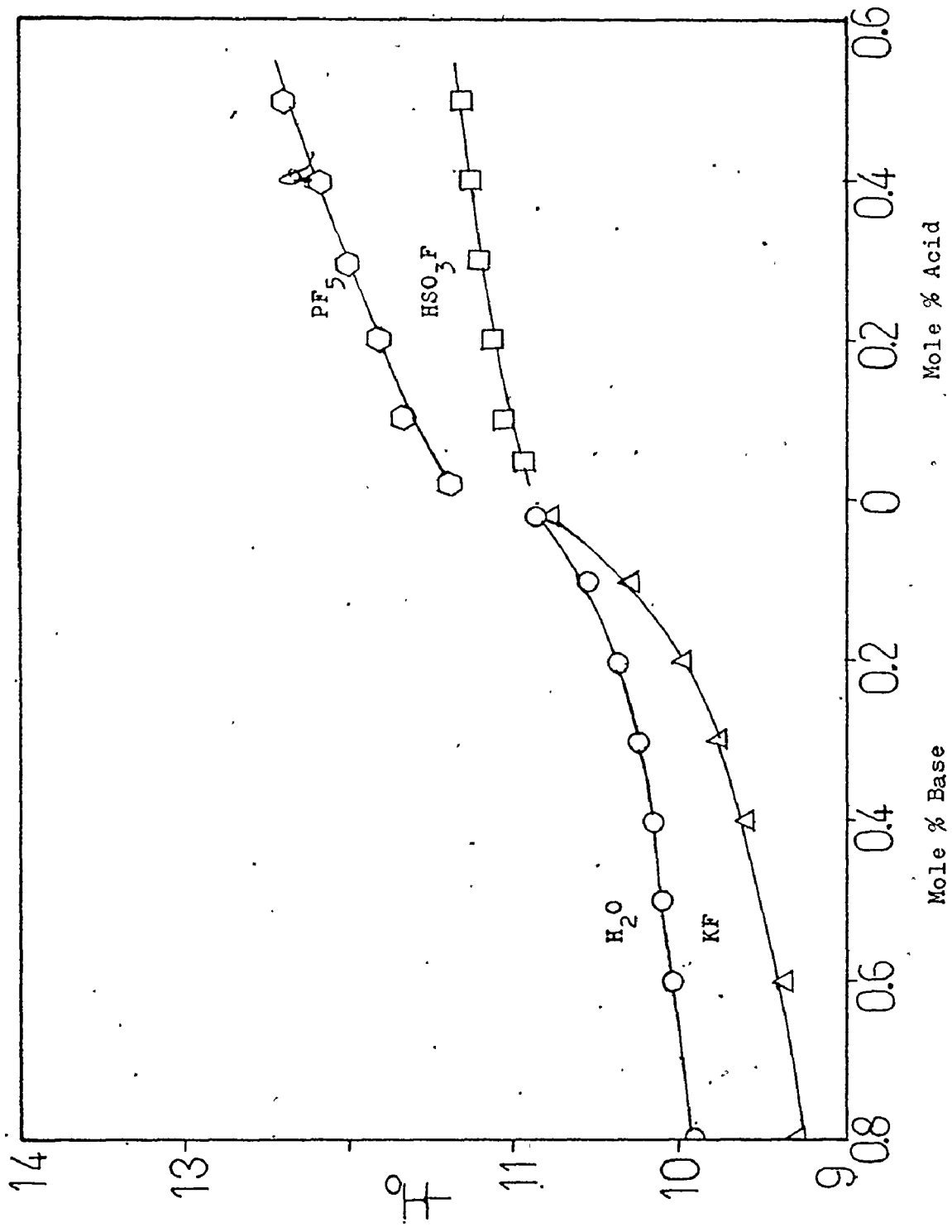

Figure 28. $-H_0$ functions for strong bases and weak acids in the HF system.

TABLE XXX
EXTINCTION COEFFICIENTS OF p-NITROTOLUENE
IN THE HSO₃F-HF SYSTEM

Mole % HSO ₃ F	λ_{\max} (nm)	ϵ
0.1287	368	6,800
0.3203	369	8,600
0.6142	370	9,000
0.8678	370	10,400
1.1502	370	11,000
1.7578	370	11,700
2.2732	371	14,100
4.1235	371	19,000

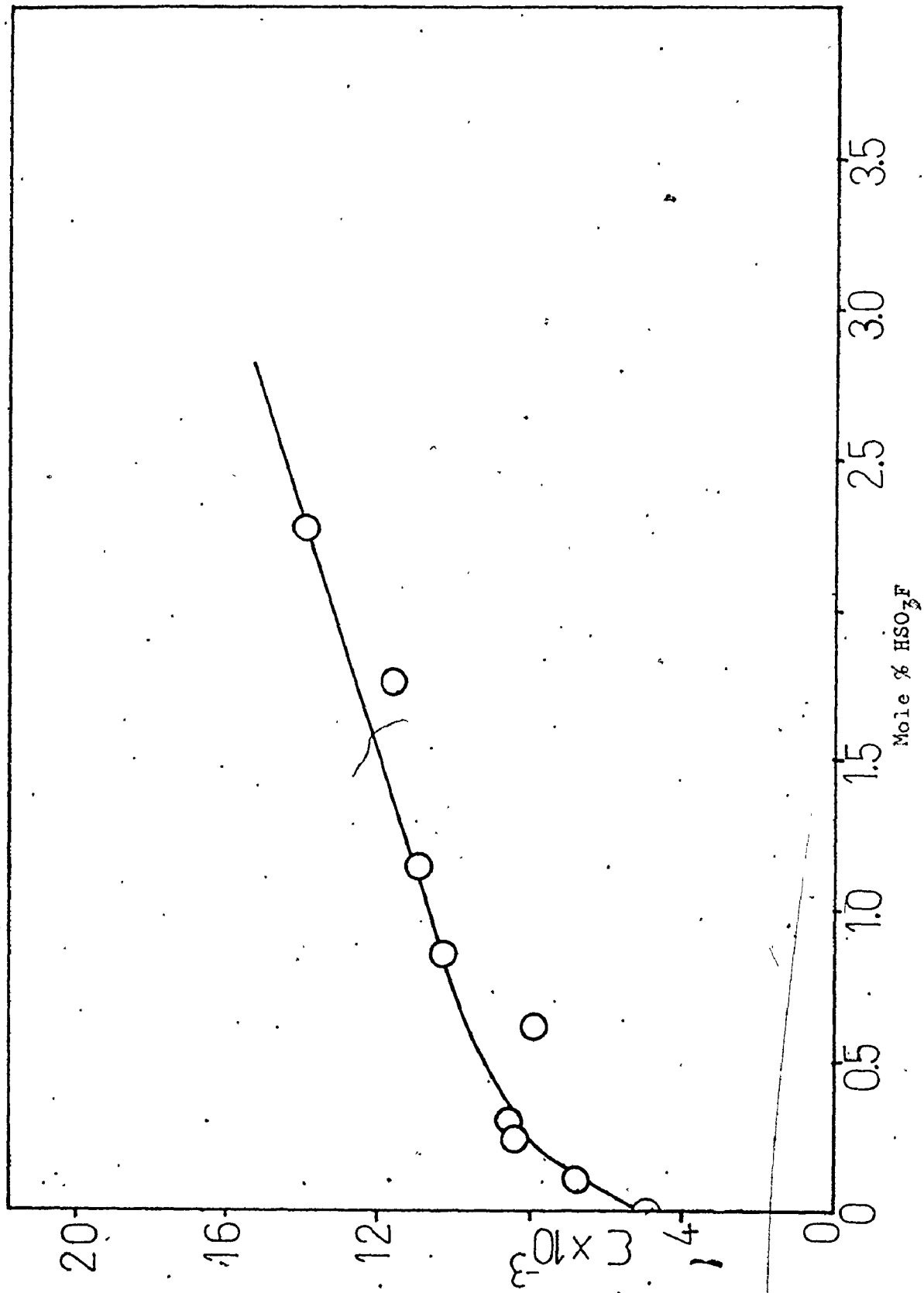

Figure 29. Extinction coefficients of p-nitrotoluene in the HSO_3F -HF system.

TABLE XXXI
 IONIZATION RATIOS OF p-NITROTOLUENE
 IN THE HSO₃F-HF SYSTEM

Mole% HSO ₃ F	ϵ	log I	-H ₀
0.05	5400	0.42	10.93
0.10	6300	0.32	11.03
0.15	6800	0.27	11.08
0.20	7300	0.22	11.13
0.25	7800	0.18	11.17
0.30	8100	0.15	11.20
0.40	8700	0.09	11.26
0.50	9100	0.05	11.30
0.60	9600	0.01	11.34
1.00	10800	-0.10	11.45
1.50	12000	-0.22	11.57
2.00	13000	-0.32	11.67
2.50	14500	-0.50	11.85

 $\epsilon_B = 200$ $\epsilon_{BH^+} = 19,200$ $pK_{BH^+} = -11.49$

TABLE XXXII
 EXTINCTION COEFFICIENTS OF p-NITROTOLUENE
 IN THE PF₅-HF SYSTEM

Mole% PF ₅	λ_{\max} (nm)	ϵ
0.0345	370	11,800
0.1604	370	13,400
0.5521	370	16,300
0.8459	370	20,100

TABLE XXXIII
 IONIZATION RATIOS OF p-NITROTOLUENE
 IN THE PF₅-HF SYSTEM

Mole% PF ₅	$\epsilon_B = 200$	$\epsilon_{BH^+} = 19,200$	$\text{pk}_{BH^+} = -11.35$
	ϵ	$\log I^-$	$-H_0$
0.02	10500	-0.03	11.38
0.06	11800	-0.25	11.53
0.10	12900	-0.31	11.66
0.20	14400	-0.47	11.82
0.30	15600	-0.63	11.98
0.40	16000	-0.69	12.04
0.50	16200	-0.90	12.25

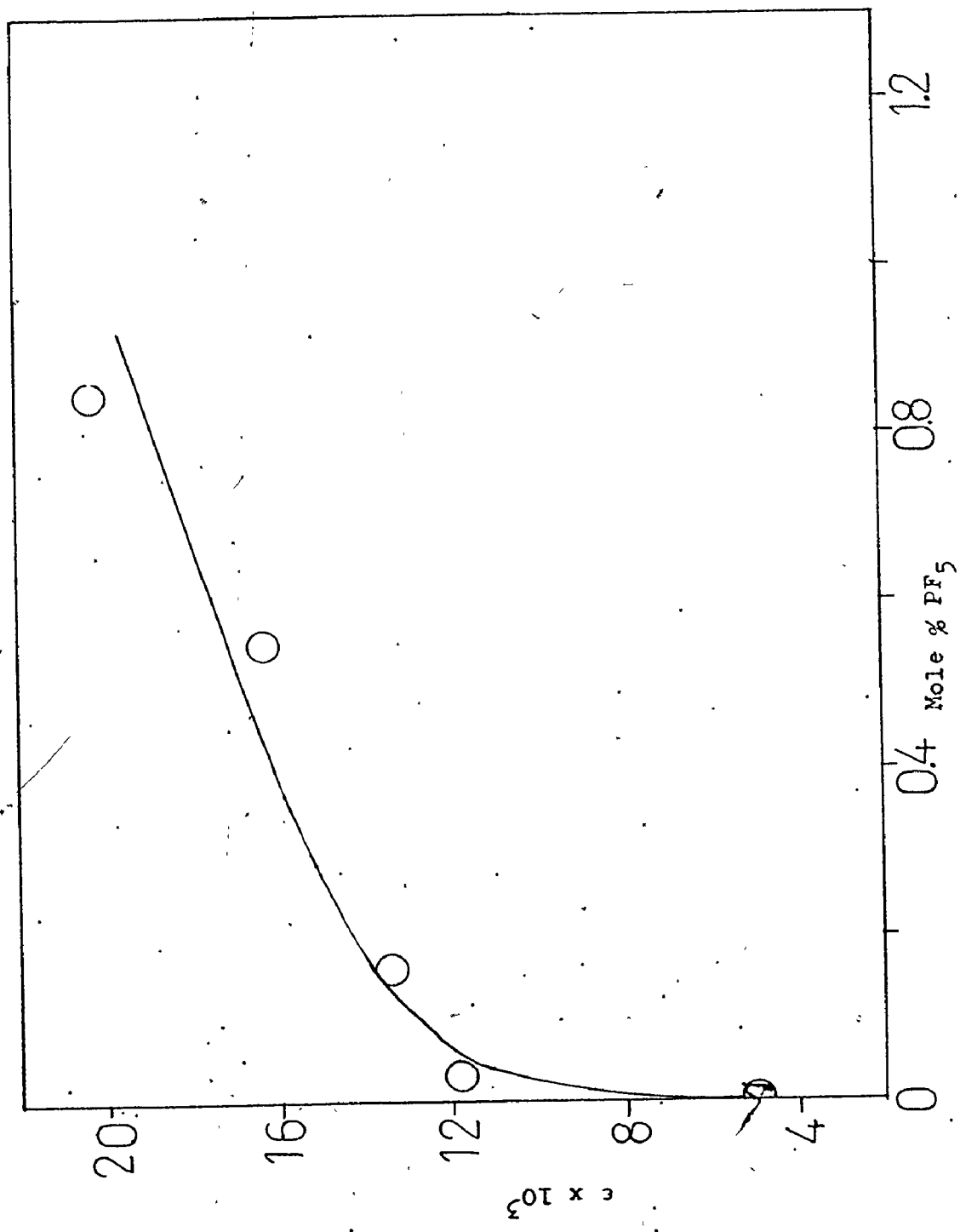

Figure 30. Extinction coefficients of p-nitrotoluene in the PF_5 -HF system.

TABLE XXXIV

EXTINCTION COEFFICIENTS OF p-NITROTOLUENE IN NbF₅-HF

Mole % NbF ₅	λ_{\max} (nm)	ϵ
0.0096	369	16,200
0.0975	369	20,900
0.1381	369	18,900
0.2022	369	18,700
0.3056	369	18,100
0.3516	369	20,700
0.5389	369	19,600
0.6146	369	20,100

TABLE XXXV

EXTINCTION COEFFICIENTS OF p-NITROCHLOROBENZENE IN

THE NbF₅-HF SYSTEM

Mole % NbF ₅	λ_{\max} (nm)	ϵ
0.0252	378	19,000
0.0928	378	19,400
0.1834	378	18,500
0.3378	378	20,500
0.4919	378	20,100
0.5127	378	20,700

TABLE XXXVI
EXTINCTION COEFFICIENTS OF 2,4-DINITROTOLUENE IN
THE NbF₅-HF SYSTEM

Mole % NbF ₅	λ_{\max} (nm)	ϵ
0.0873	315	13,200
0.1757	305	17,600
0.2903	305	21,600
0.4152	305	20,700

TABLE XXXVII
EXTINCTION COEFFICIENTS OF 2,4,6-TRINITROTOLUENE IN
THE NbF₅-HF SYSTEM

Mole % NbF ₅	λ_{\max} (nm)	ϵ
0.0227	317	2,800
0.0747	316	6,600
0.1117	317	7,300
0.1497	317	10,100
0.1839	315	9,600
0.2241	316	9,900
0.3097	315	9,800
0.3484	315	10,300
0.5181	315	12,200
0.6479	315	11,900

TABLE XXXVIII
EXTINCTION COEFFICIENTS OF 1,3,5-TRINITROBENZENE IN
THE NbF_5 -HF SYSTEM

Mole % NbF_5	λ_{max} (nm)	ϵ
0.0242	310	2,500
0.1095	306	4,400
0.1512	305	5,900
0.2274	303	8,800
0.3082	299	8,400
0.3434	300	9,700
0.5205	294	9,900
0.5619	297	11,100

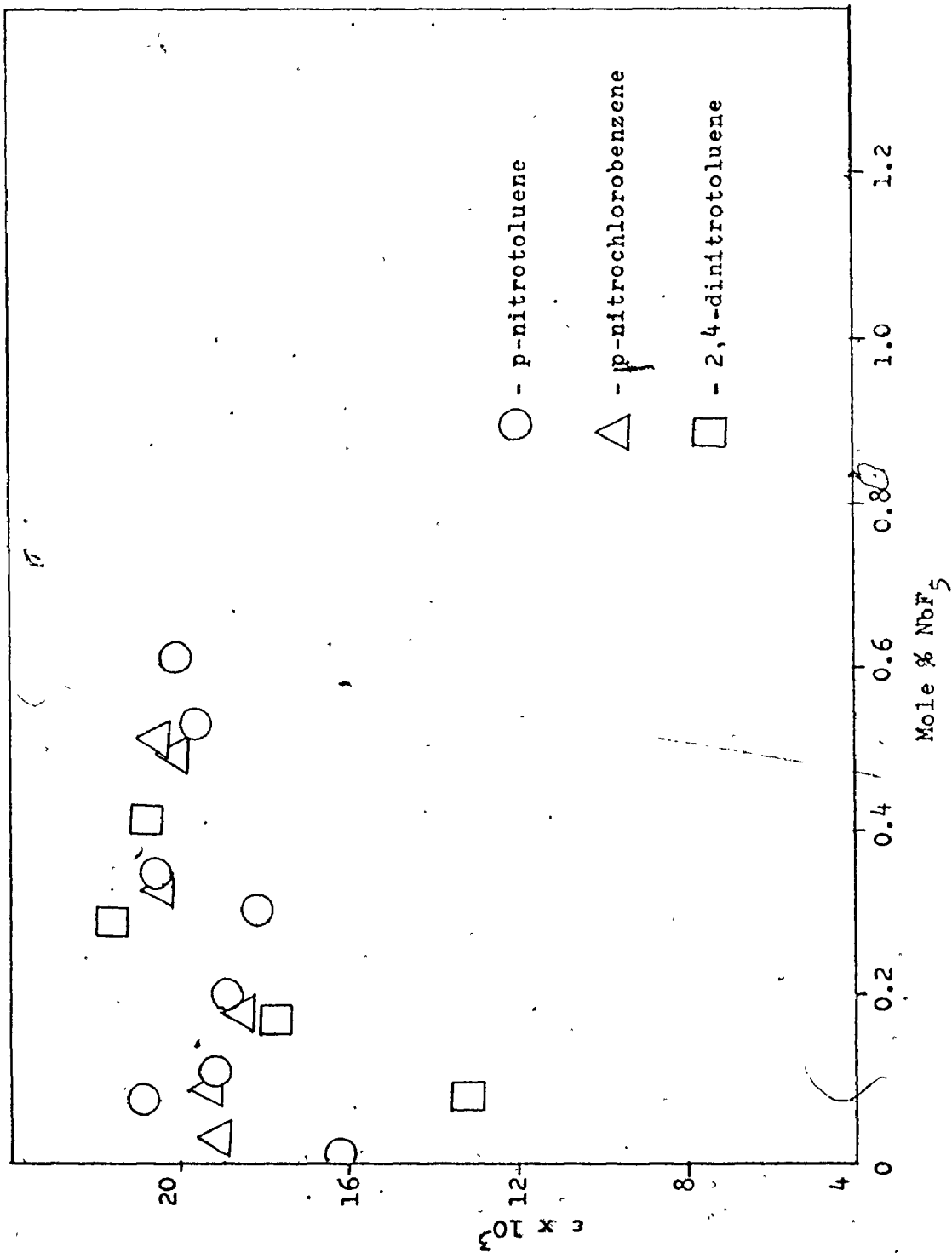

Figure 31 . Extinction coefficients of nitro aromatic indicators in the NbF₅-HF system.

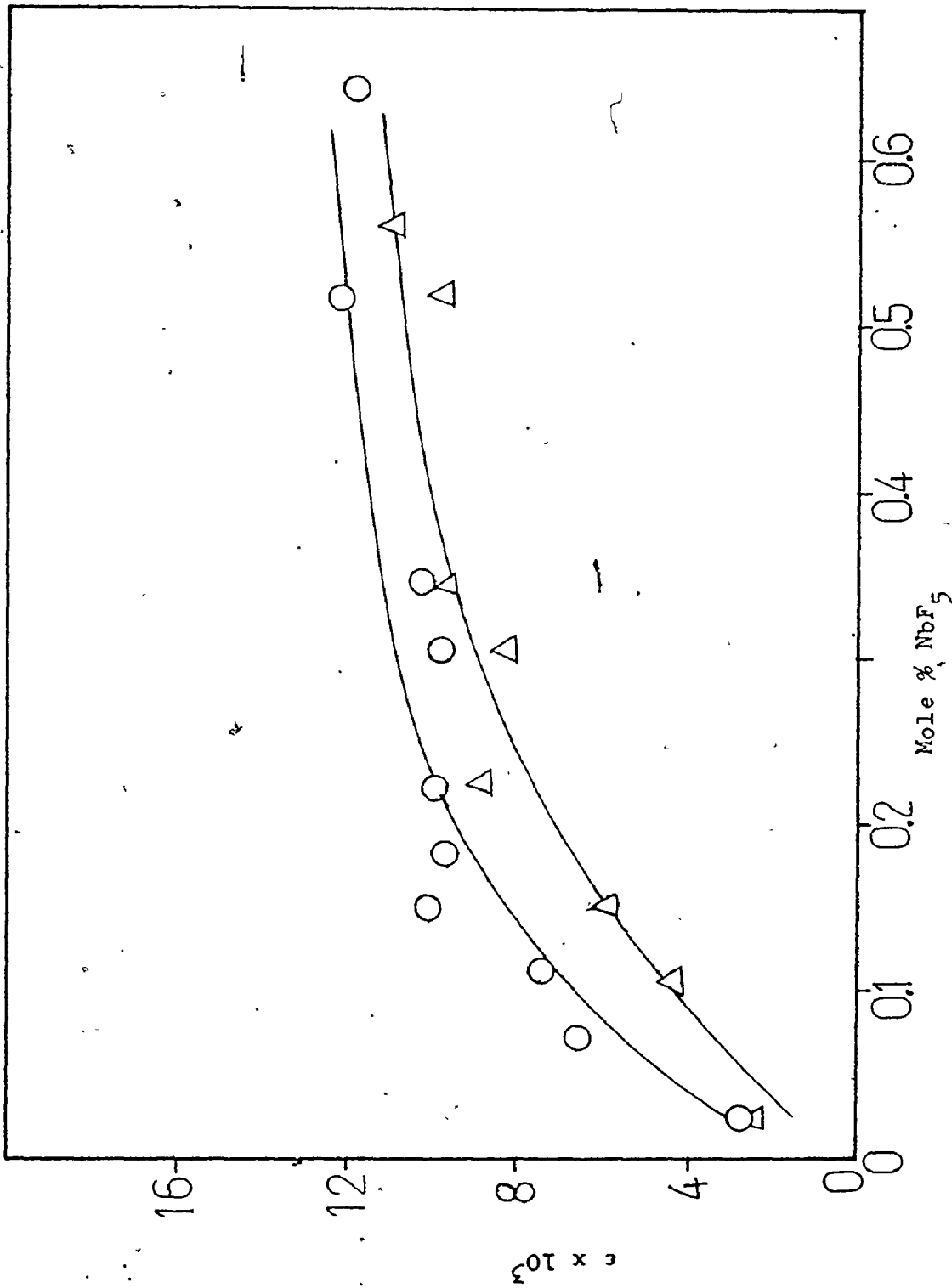

Figure 32. Extinction coefficients of 2,4,6-trinitrotoluene (O) and 1,3,5-trinitrobenzene in the NbF_5 -HF system.

TABLE XXXIX
 IONIZATION RATIOS OF 2,4,6-TRINITROTOLUENE IN
 THE NbF_5 -HF SYSTEM

Mole % NbF_5	ϵ	$\log I$
0.05	4,400	0.43
0.10	6,600	-0.05
0.15	8,400	-0.46
0.20	9,400	-0.78
0.25	10,200	-1.31

$\epsilon_B = 2100$ $\epsilon_{\text{BH}^+} = 10,600$ $pK_{\text{BH}^+} = -15.60$

TABLE XL
 IONIZATION RATIOS OF 1,3,5-TRINITROBENZENE IN
 THE NbF_5 -HF SYSTEM

Mole % NbF_5	ϵ	$\log I$
0.05	2,700	1.06
0.10	4,400	0.42
0.15	6,000	0.07
0.20	7,200	-0.17
0.25	8,200	-0.40
0.30	9,000	-0.61
0.40	9,800	-0.94

$\epsilon_B = 2000$ $\epsilon_{\text{BH}^+} = 10,700$ $pK_{\text{BH}^+} = -16.04$

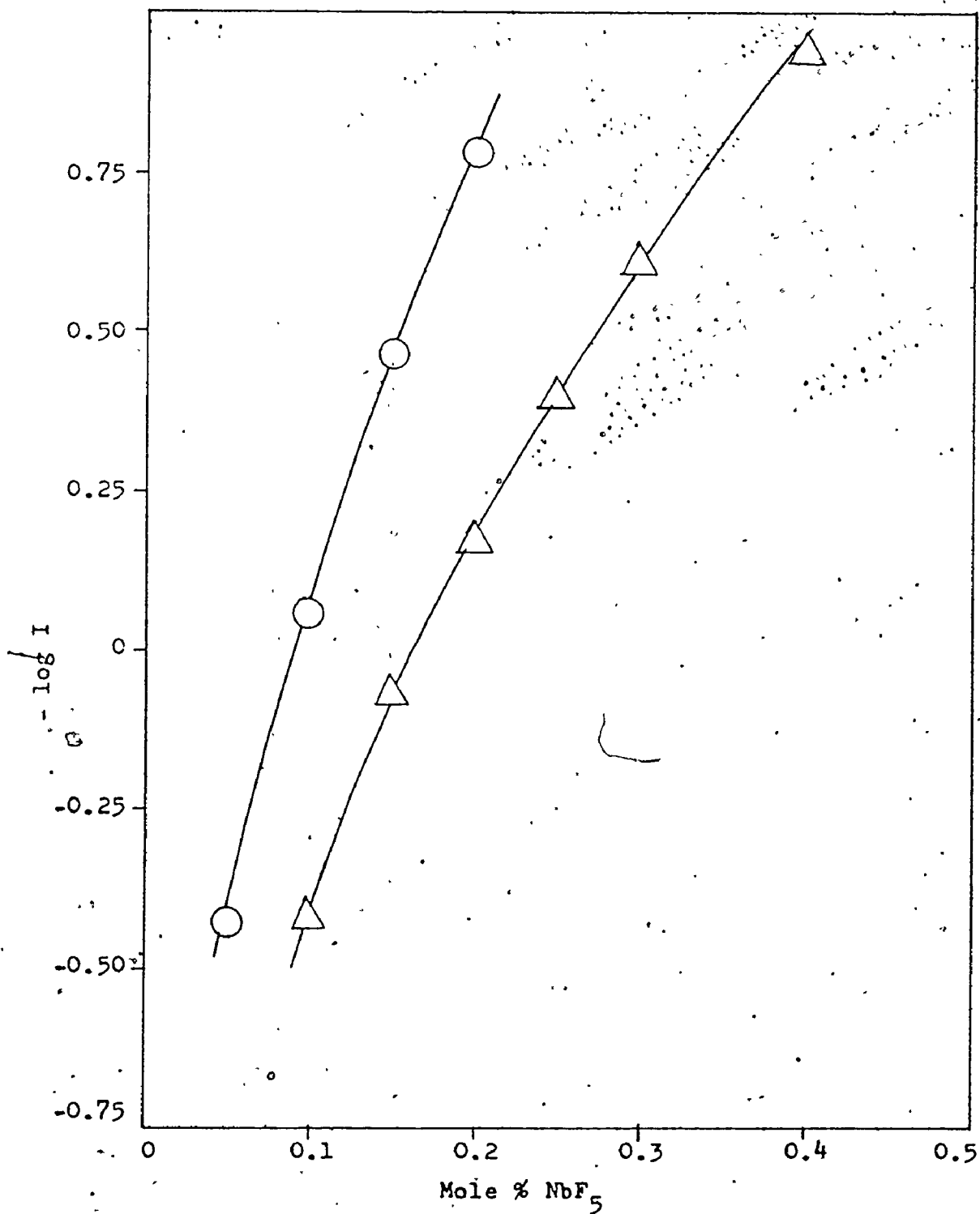

Figure 33 . Ionization ratios of 2,4,6-trinitrotoluene (O) and 1,3,5-trinitrobenzene (Δ) in the $\text{NbF}_5\text{-HF}$ system.

TABLE XLI
-H₀ VALUES FOR THE NbF₅-HF SYSTEM

Mole % NbF ₅	2,4,6-trinitro- toluene	1,3,5-trinitro- benzene	Average
0.05	15.17		15.17
0.10	15.65	15.62	15.64
0.15	16.06	15.97	16.02
0.20	16.38	16.21	16.30
0.25		16.44	16.44
0.30		16.65	16.65
0.40		16.98	16.98

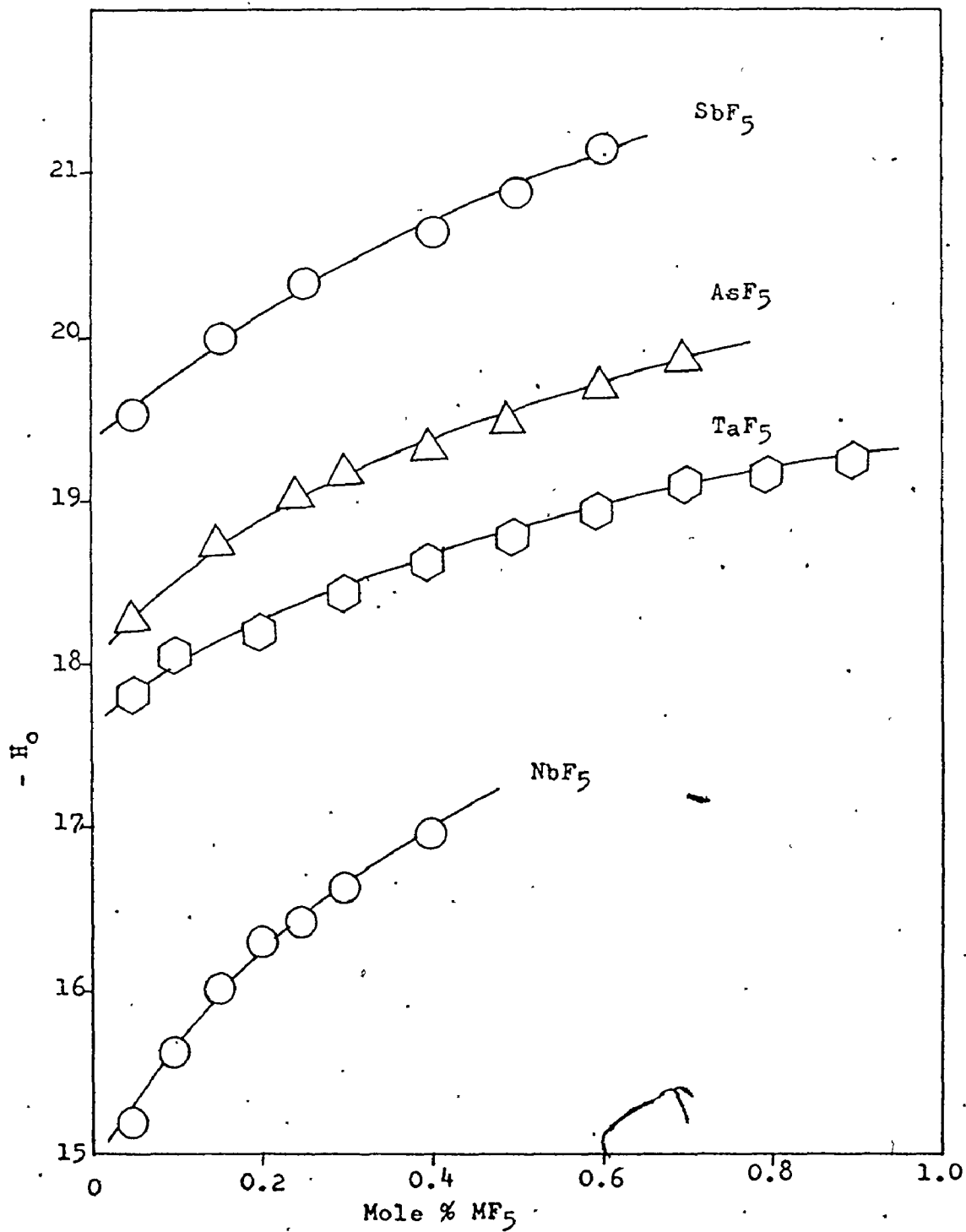

Figure 34. The $-H_0$ acidity functions in the MF_5 -HF system.

TABLE XLII
EXTINCTION COEFFICIENTS OF 2,4,6-TRI-
NITROTOLUENE IN THE AsF_5 -HF SYSTEM

Mole % AsF_5	λ_{max} (nm)	ϵ
0.0418	308	12,400
0.1023	294	14,600
0.1532	295	15,000
0.2673	294	16,000
0.3117	294	17,300
0.3671	292	19,700
0.5215	295	19,100
0.7343	293	19,100
0.9909	293	18,400

TABLE XLIII
EXTINCTION COEFFICIENTS OF 1,3,5-TRINITRO-
BENZENE IN THE NbF_5 -HF SYSTEM

Mole % AsF_5	λ_{max} (nm)	ϵ
0.1039	288	12,000
0.1625	280	15,000
0.2482	280	14,200
0.2513	280	17,400
0.4016	280	16,100
0.5205	280	17,700
0.7925	280	19,200

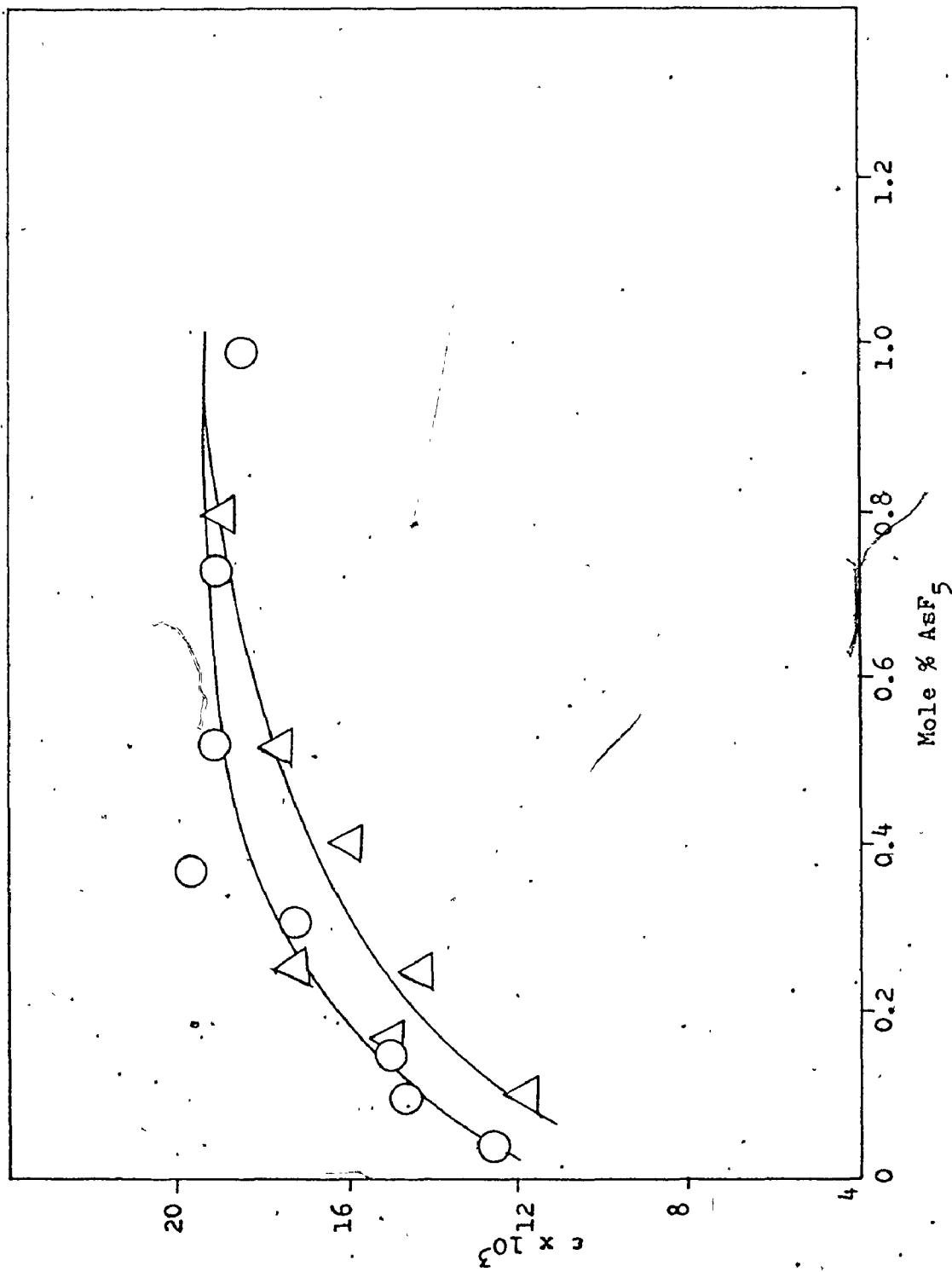

Figure 35. Extinction coefficients of 2,4,6-trinitrotoluene (O) and 1,3,5-trinitrobenzene(Δ) in the ASF_5 -HF system.

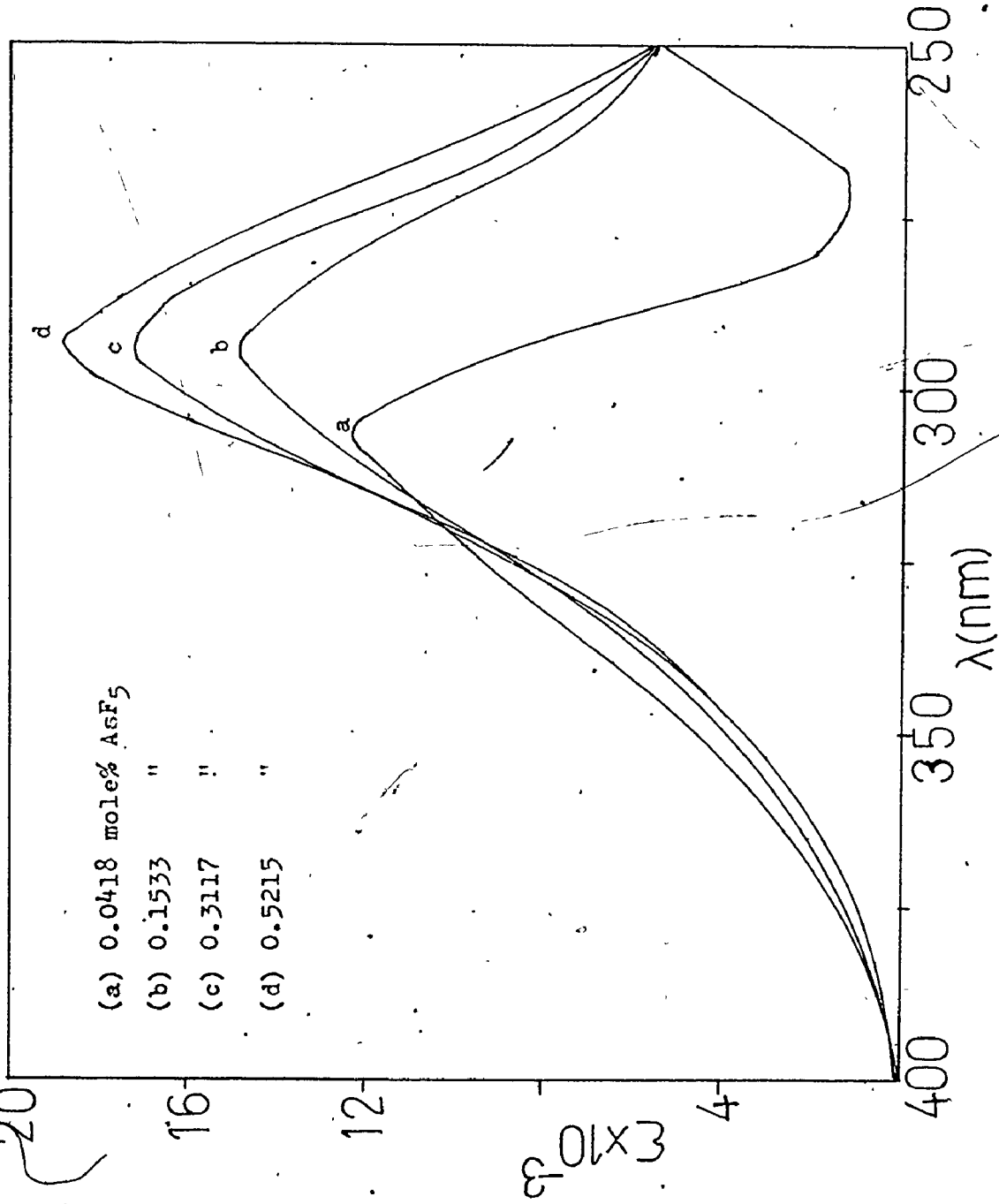

Figure 36. Extinction coefficients of 2,4,6-trinitrotoluene in the AsF₅-HF system.

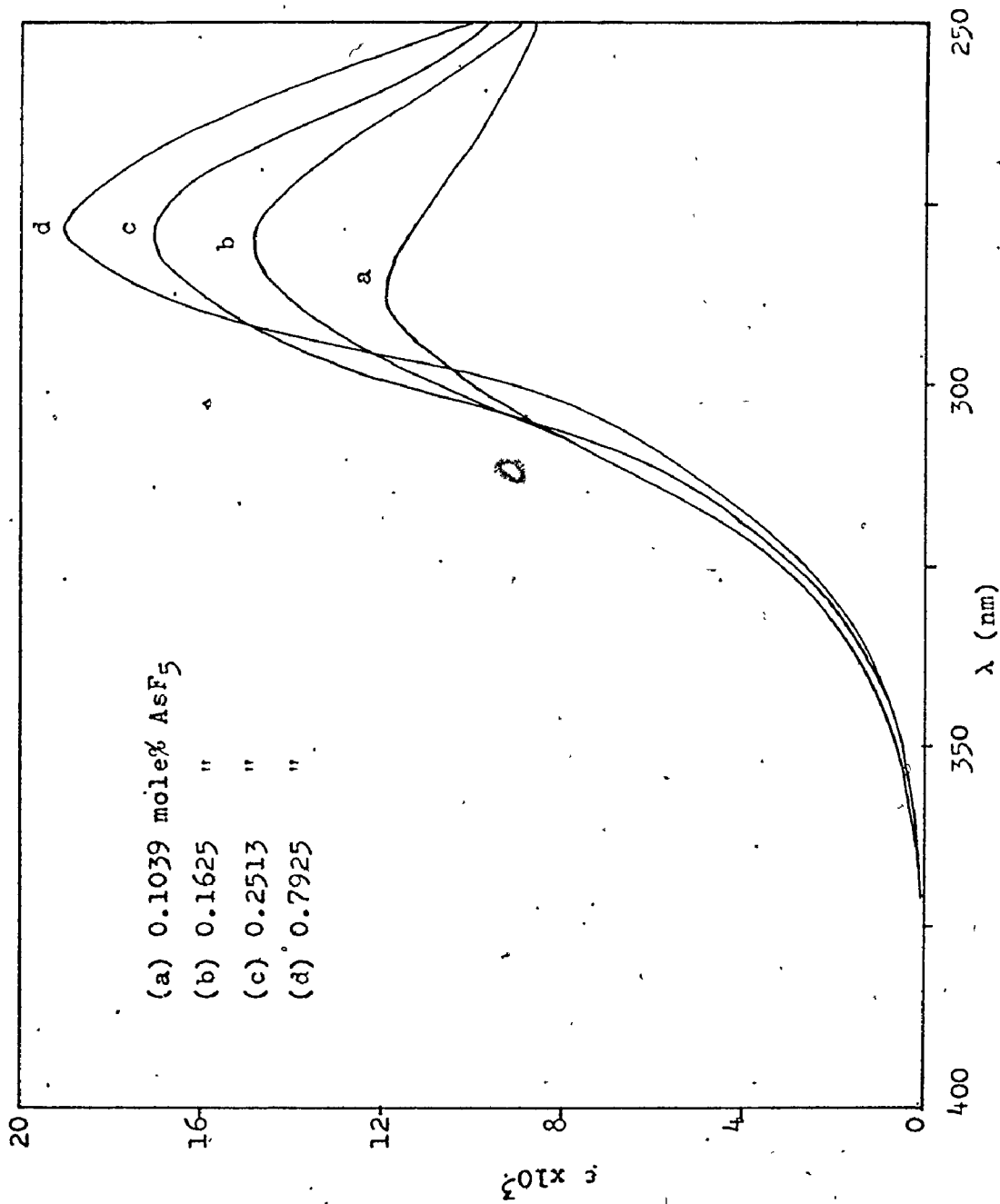

Figure 37. Extinction coefficients of 1,3,5-trinitrobenzene in the AsF₅-HF system.

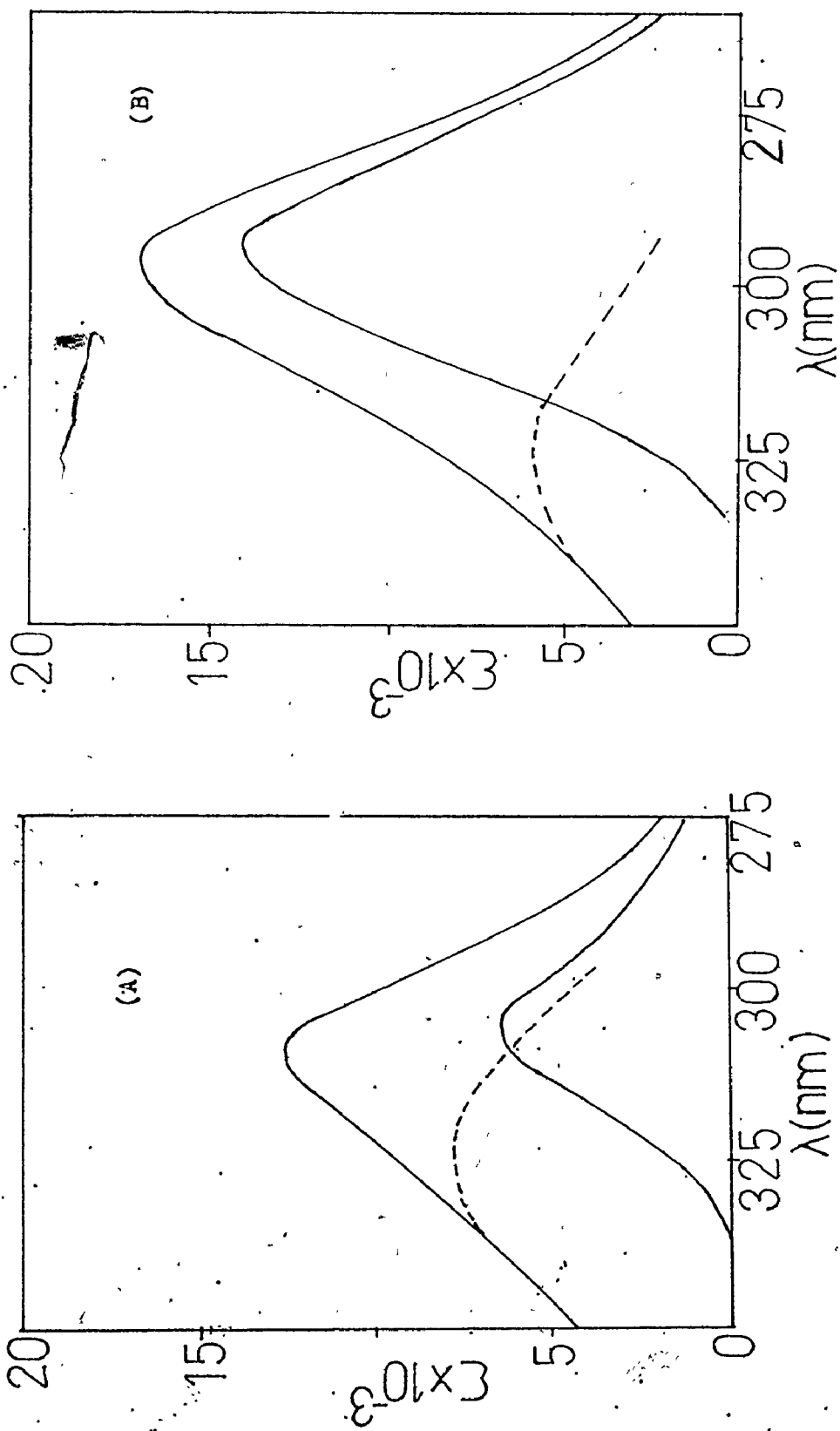

Figure 38. Absorption spectra of 2,4,6-trinitrotoluene in the AsF_5 -HF system.

(A) 0.0418 mole% AsF_5 (B) 0.3117 mole% AsF_5 .

TABLE XLIV
ADJUSTED EXTINCTION COEFFICIENTS OF 2,4,6-
TRINITROTOLUENE IN THE AsF_5 -HF SYSTEM

Mole % AsF_5	λ_{max} (nm)	ϵ
0.0418	302	6,800
0.1023	290	10,400
0.1532	293	10,600
0.2673	290	12,400
0.3117	290	14,000
0.3671	290	15,800
0.5215	290	15,400
0.7343	290	15,400
0.9909	290	15,000

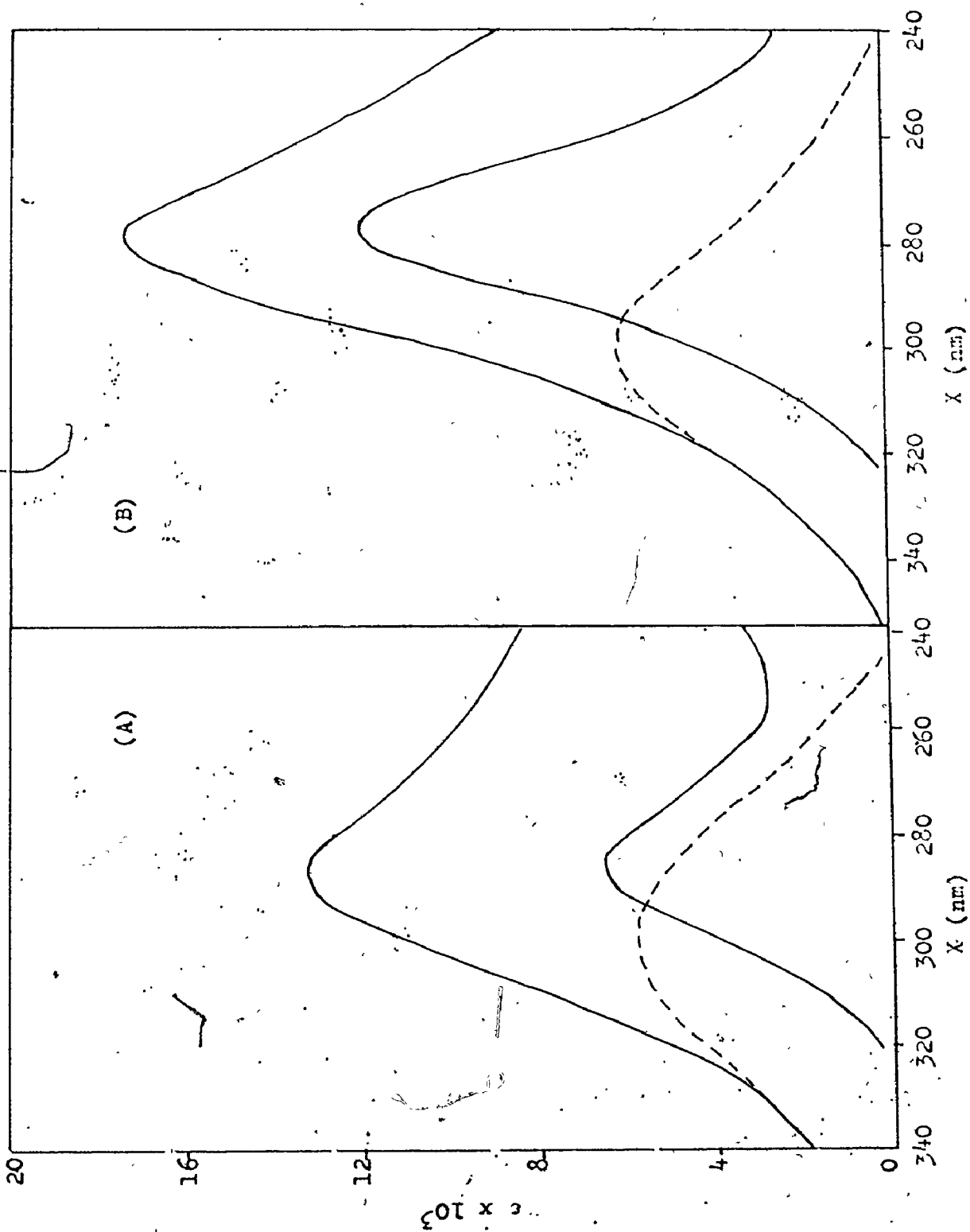

Figure 39. Absorption spectra of 1,3,5-trinitrobenzene in the AsF_5 -HF system. (A) 0.1079 mole % AsF_5 (B) 0.4016 mole % AsF_5 .

TABLE XLV
ADJUSTED EXTINCTION COEFFICIENTS OF 1,3,5-
TRINITROBENZENE IN THE AsF_5 -HF SYSTEM

Mole % AsF_5	λ_{max} (nm)	ϵ
0.1039	285	6,100
0.1625	280	9,100
0.2482	278	9,000
0.2513	278	11,400
0.4016	278	11,600
0.5205	278	13,000
0.7925	278	16,000

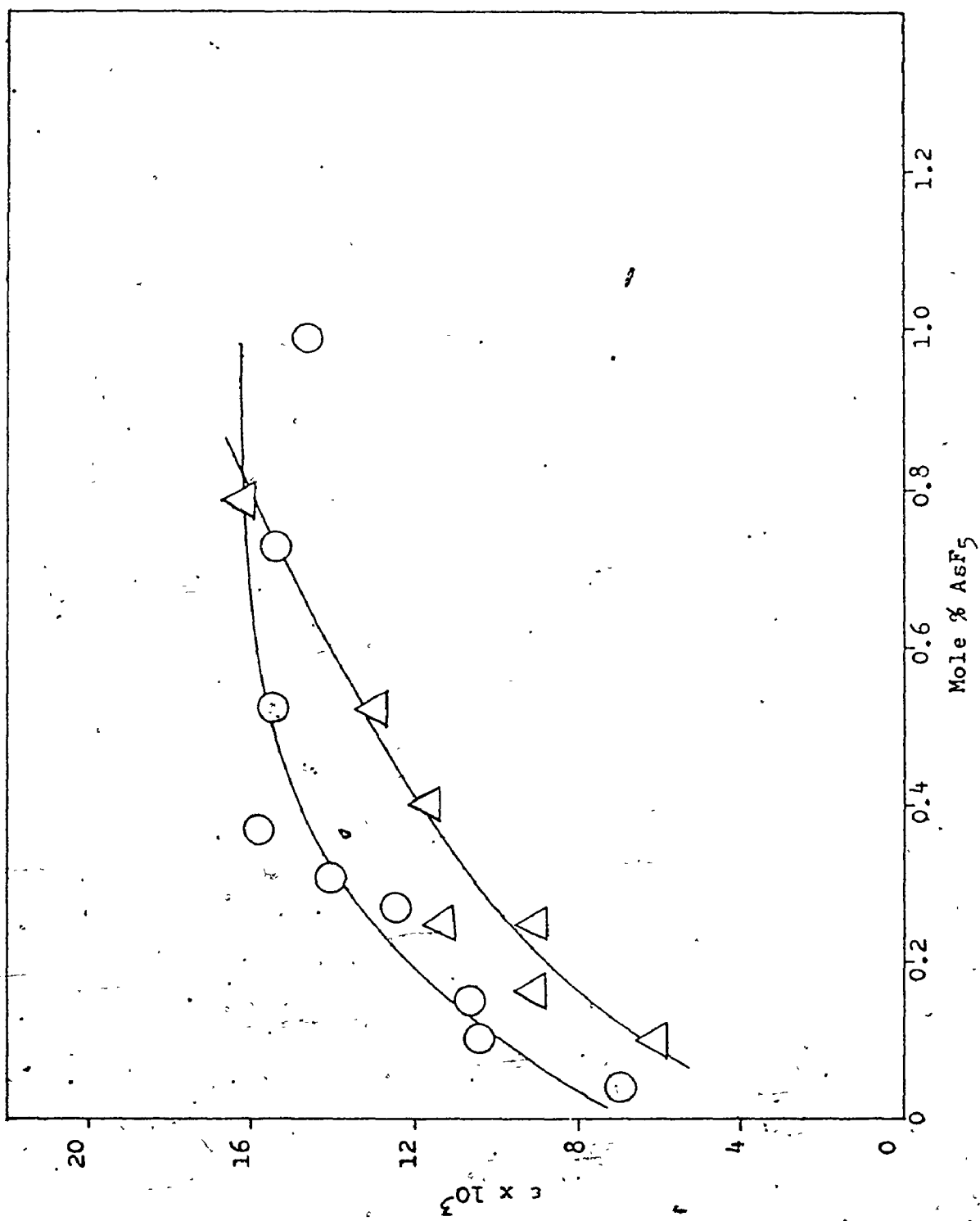

Figure 40. Adjusted extinction coefficients of 2,4,6-trinitrotoluene(O) and 1,3,5-trinitrobenzene (Δ) in the AsF_5 -HF system.

TABLE XLVI
 IONIZATION RATIOS FOR THE DIPROTONATION OF
 2,4,6-TRINITROTOLUENE IN THE AsF_5 -HF SYSTEM

$c_{\text{BH}^+} = 2,000$	$c_{\text{BH}_2^+} = 15,400$	$pK_{\text{BH}_2^+} = -18.36$
Mole % AsF_5	ϵ	$\log I$
0.05	8,000	0.09
0.10	10,000	-0.17
0.15	11,300	-0.36
0.20	12,100	-0.49
0.25	13,000	-0.66
0.30	13,600	-0.81
0.35	14,400	-1.09
0.40	14,800	-1.33

TABLE XLVII
 IONIZATION RATIOS FOR THE DIPROTONATION OF
 1,3,5-TRINITROBENZENE IN THE AsF_5 -HF SYSTEM

$\epsilon_{\text{BH}^+} = 2,500$	$\epsilon_{\text{BH}_2^+} = 16,000$	$\text{pK}_{\text{BH}_2^+} = -18.93$
Mole % AsF_5	ϵ	log I
0.05	5,000	0.64
0.10	6,400	0.39
0.15	7,600	0.22
0.20	8,900	0.05
0.25	9,800	-0.07
0.30	10,600	-0.18
0.40	12,000	-0.38
0.50	13,100	-0.56
0.60	14,100	-0.79
0.70	14,900	-1.05

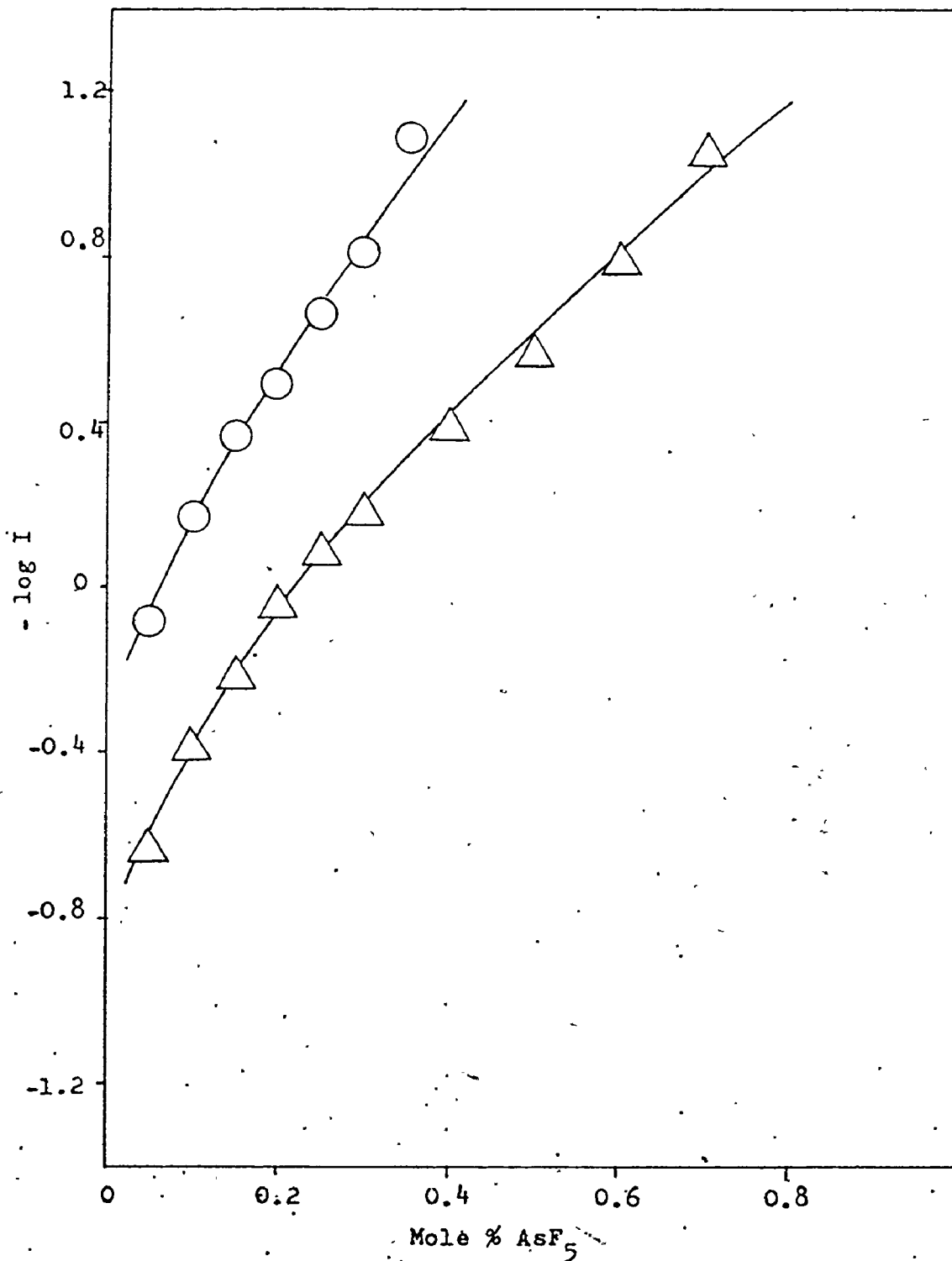

Figure 41. Ionization ratios of 2,4,6-trinitrotoluene(O) and 1,3,5-trinitrobenzene(Δ) in AsF_5 -HF.

TABLE XLVIII

-H_o VALUES FOR THE AsF₅-HF SYSTEM

Mole% AsF ₅	2,4,6-trinitro- toluene	1,3,5-trinitro- benzene	Average
0.05	18.27	18.29	18.28
0.10	18.53	18.54	18.54
0.15	18.72	18.71	18.72
0.20	18.85	18.88	18.87
0.25	19.02	19.00	19.01
0.30	19.17	19.11	19.14
0.40		19.31	19.31
0.50		19.49	19.49
0.60		19.72	19.72
0.70		19.89	19.89

TABLE XLIX
 OBSERVED AND ADJUSTED EXTINCTION COEFFICIENTS
 OF 2,4,6-TRINITROTOLUENE IN THE TaF₅-HF SYSTEM

Mole% TaF ₅	Observed		Adjusted	
	λ_{\max} (nm)	ϵ	λ_{\max} (nm)	ϵ
0.0562	315	11,200	307	5,400
0.1989	308	12,500	300	7,000
0.2712	297	15,300	293	10,100
0.6284	294	15,500	290	11,600
0.7332	296	16,700	290	13,600
0.8515	293	17,700	290	14,600
1.1682	293	20,000	288	15,500

TABLE L
OBSERVED AND ADJUSTED EXTINCTION COEFFICIENTS
OF 1,3,5-TRINITROBENZENE IN THE TaF₅-HF SYSTEM

Mole% TaF ₅	Observed		Adjusted	
	λ_{\max} (nm)	ϵ	λ_{\max} (nm)	ϵ
0.0785	294	9,300	285	4,800
0.1533	294	9,200	285	4,800
0.2657	287	11,500	282	5,200
0.3050	287	14,600	280	7,200
0.4932	285	13,900	280	8,400
0.5789	285	15,600	280	9,300
0.8072	283	18,100	280	12,000
0.9157	284	18,700	280	12,800

TABLE LI
OBSERVED AND ADJUSTED EXTINCTION COEFFICIENTS
OF 2,4,6-TRINITROCHLOROBENZENE IN THE TaF₅-HF SYSTEM

Mole% TaF ₅	Observed λ_{\max} (nm)	ϵ	Adjusted λ_{\max} (nm)	ϵ
0.1191	328	6,800		
0.2217	325	9,600		
0.3871	323	10,300	313	2,600
0.5282	321	10,200	310	3,000
0.6392	320	12,700	307	3,600
0.7974	320	16,200	305	4,200
1.1241	315	15,300	305	5,600

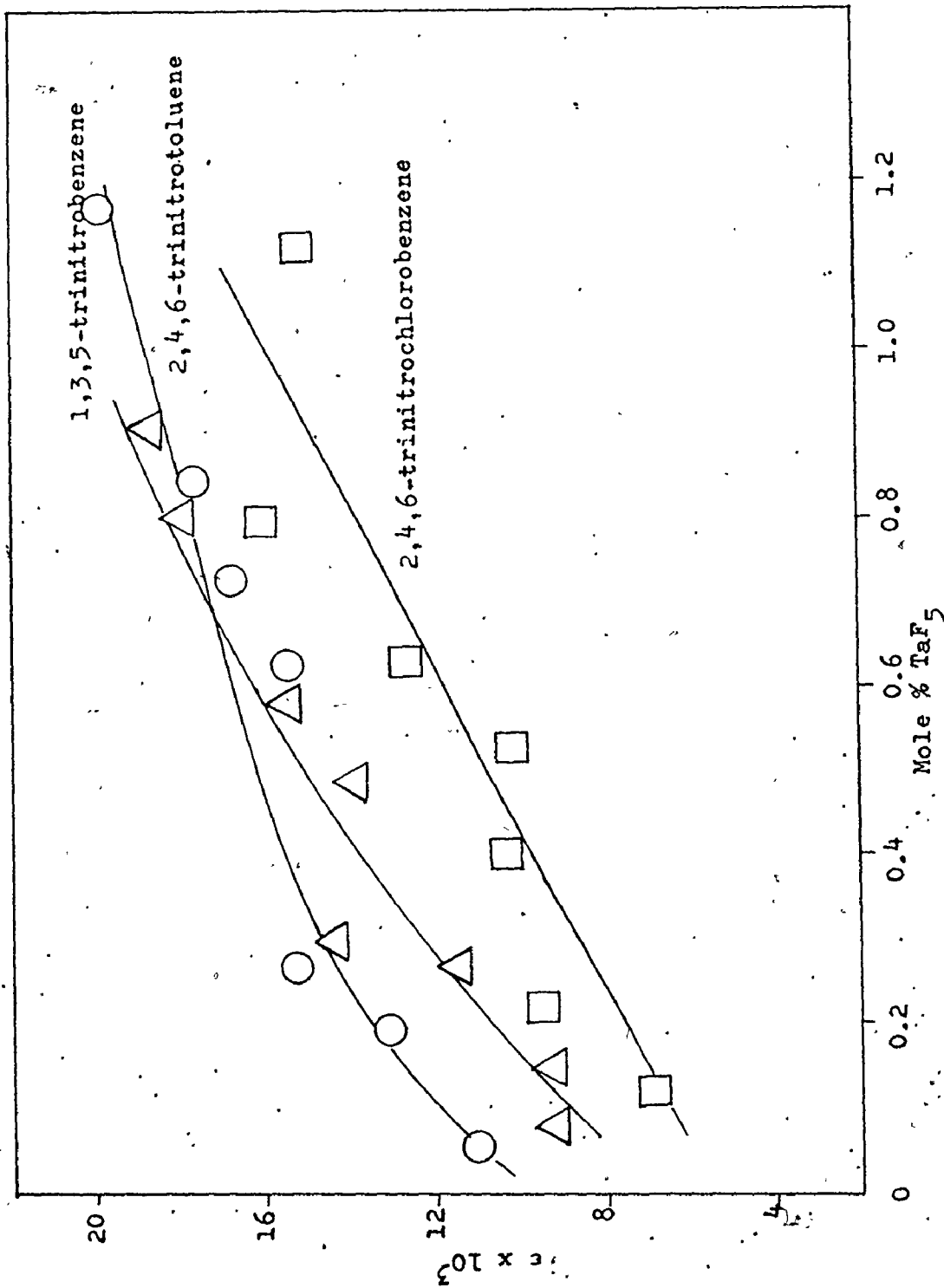

Figure 42. Observed extinction coefficients of nitro aromatic indicators in the TaF₅-HF system.

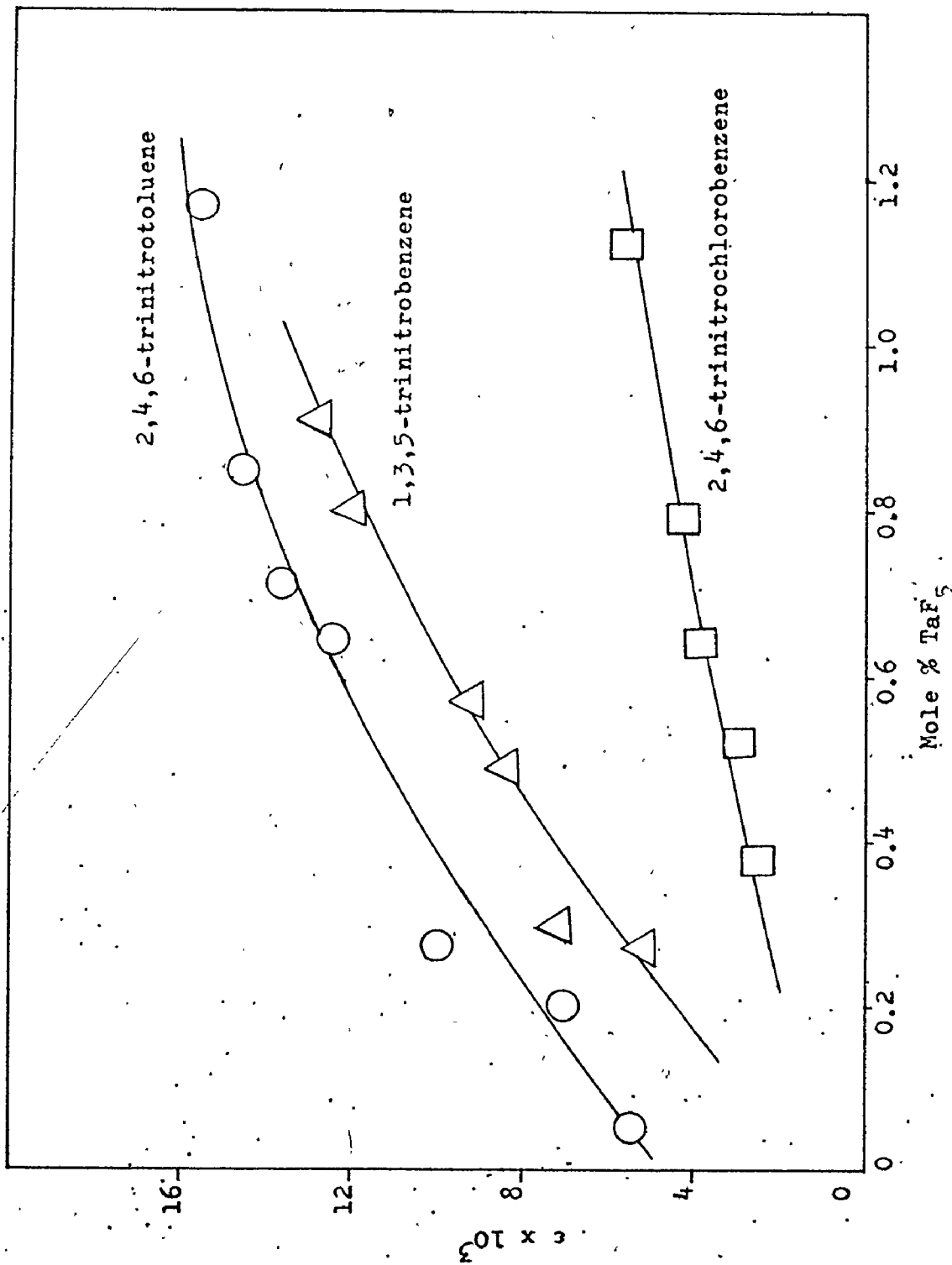

Figure 43. Adjusted extinction coefficients of nitro aromatic indicators in the TaF₅-HF system.

TABLE LII

IONIZATION RATIOS FOR THE DIPROTONATION OF
2,4,6-TRINITROTOLUENE IN THE TaF₅-HF SYSTEM

	$c_{\text{BH}^+} = 2000$	$c_{\text{BH}_2^{+2}} = 15,400$	$pK_{\text{BH}_2^{+2}} = -18.36$
Mole % TaF ₅	ϵ		log I
0.05	5,500		0.52
0.10	6,300		0.32
0.15	7,000		0.23
0.20	7,600		0.15
0.25	8,300		0.05
0.30	8,900		-0.03
0.40	10,100		-0.18
0.50	11,200		-0.34
0.60	12,400		-0.54
0.70	13,200		-0.71

TABLE LIII
IONIZATION RATIOS FOR THE DIPROTONATION OF
1,3,5-TRINITROBENZENE IN THE TaF₅-HF SYSTEM

$\epsilon_{\text{BH}^+} = 2,500$	$\epsilon_{\text{BH}_2^{+2}} = 16,000$	$\text{pK}_{\text{BH}_2^{+2}} = -18.93$
Mole % TaF ₅	ϵ	log I
0.10	2,800	1.65
0.15	3,600	1.05
0.20	4,400	0.79
0.25	5,100	0.62
0.30	5,800	0.49
0.40	6,900	0.31
0.50	8,200	0.14
0.60	9,500	-0.03
0.70	10,700	-0.19
0.80	11,800	-0.35
0.90	12,700	-0.49

TABLE LIV

IONIZATION RATIOS FOR THE DIPROTONATION OF
2,4,6-TRINITROCHLOROBENZENE IN TaF₅-HF

	$\epsilon_{\text{BH}^+} = 1,600$	$\epsilon_{\text{BH}_2^{+2}} = 16,000$	$\text{pK}_{\text{BH}_2^{+2}} = -19.76$
Mole % TaF ₅	ϵ	$\log I$	
0.20	1,800	1.86	
0.25	2,000	1.54	
0.30	2,200	1.36	
0.40	2,600	1.13	
0.50	3,000	0.97	
0.60	3,600	0.85	
0.70	3,900	0.72	
0.80	4,300	0.64	
0.90	4,700	0.56	
1.00	5,100	0.49	

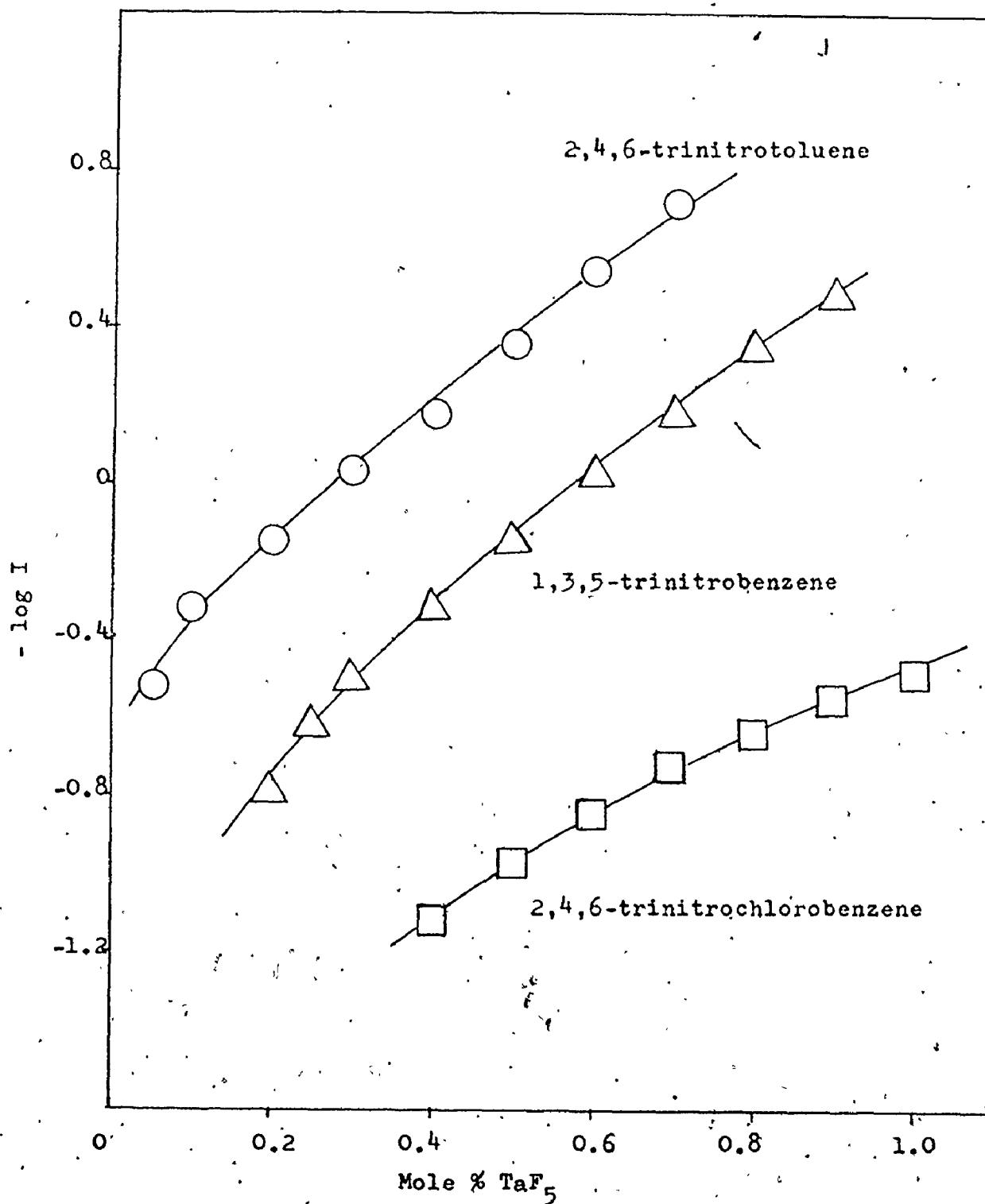

Figure 44. Ionization ratios of nitro aromatic indicators in the TaF_5 -HF system.

TABLE IV
-H_o VALUES FOR THE TaF₅-HF SYSTEM

Mole % TaF ₅	2,4,6-trinitro- toluene	1,3,5-trinitro- benzene	2,4,6-trinitro- chlorobenzene	Average
0.05	17.83			17.83
0.10	18.04			18.04
0.15	18.13			18.13
0.20	18.21	18.14		18.18
0.25	18.31	18.31		18.31
0.30	18.39	18.44		18.42
0.40	18.54	18.62	18.63	18.60
0.50	18.70	18.79	18.79	18.76
0.60	18.90	18.96	18.91	18.92
0.70	19.07	19.12	19.04	19.08
0.80			19.12	19.12
0.90			19.20	19.20
1.00			19.27	19.27

TABLE LVI

OBSERVED AND ADJUSTED EXTINCTION COEFFICIENTS
OF 2,4,6-TRINITROTOLUENE IN THE SbF_5 -HF SYSTEM

Mole % SbF_5	Observed		Adjusted	
	λ_{max}	ϵ	λ_{max}	ϵ
0.0573	294	18,800	290	15,000
0.0783	292	20,800	290	15,400
0.2079	292	20,400	290	15,300
0.2967	289	20,000	288	15,400
0.6052	286	20,900	285	15,600

TABLE LVII

OBSERVED AND ADJUSTED EXTINCTION COEFFICIENTS
OF 1,3,5-TRINITROBENZENE IN THE SbF_5 -HF SYSTEM

Mole % SbF_5	Observed		Adjusted	
	λ_{max}	ϵ	λ_{max}	ϵ
0.0465	283	19,800	280	16,000
0.1889	279	18,400	278	15,800
0.4983	275	18,300	273	16,100
1.1206	274	19,900	273	16,300

TABLE LVIII
OBSERVED EXTINCTION COEFFICIENTS OF 2,4,6-
TRINITROCHLOROBENZENE IN THE SbF_5 -HF SYSTEM

Mole % SbF_5	λ_{max} (nm)	ϵ
0.0345	320	13,700
0.1288	301	13,100
0.1513	310	13,800
0.3769	298	18,600
0.4361	286	15,700
0.5517	297	17,700
0.5906	301	17,400
0.8503	284	19,900
1.1403	291	19,300
1.2411	290	18,100

TABLE LIX

OBSERVED EXTINCTION COEFFICIENTS OF 1,3-DICHLORO-
2,4,6-TRINITROBENZENE IN THE SbF_5 -HF SYSTEM

Mole % SbF_5	λ_{max} (nm)	ϵ
0.1066	327	13,500
0.1621	324	18,800
0.1706	322	16,600
0.2748	318	16,700
0.3293	317	19,100
0.4250	316	18,000
0.4780	316	22,900
0.7196	315	25,300
0.9259	315	19,800
1.1856	315	25,600
1.7186	315	25,600

TABLE LX

ADJUSTED EXTINCTION COEFFICIENTS FOR THE DIPROTONATION OF
2,4,6-TRINITROCHLOROBENZENE IN THE SbF_5 -HF SYSTEM

Mole % SbF_5	λ_{max} (nm)	ϵ
0.0345	315	6,700
0.1288	300	9,900
0.1513	305	11,000
0.3769	295	16,400
0.4361	285	12,200
0.4578	295	14,800
0.5517	295	17,000
0.5906	297	16,000
0.8503	290	16,400
1.1403	290	16,400
1.2411	290	16,000

TABLE LXI

ADJUSTED EXTINCTION COEFFICIENTS FOR THE DIPROTONATION
OF 1,3-DICHLORO-2,4,6-TRINITROBENZENE IN THE SbF_5 -HF SYSTEM

Mole % SbF_5	λ_{max} (nm)	ϵ
0.1066	320	8,000
0.1621	315	11,200
0.1706	315	10,400
0.2748	315	12,400
0.3293	313	15,000
0.4250	313	14,000
0.4780	313	17,600
0.7196	310	20,200
0.9259	310	15,600
1.1856	310	20,400
1.7186	310	20,400

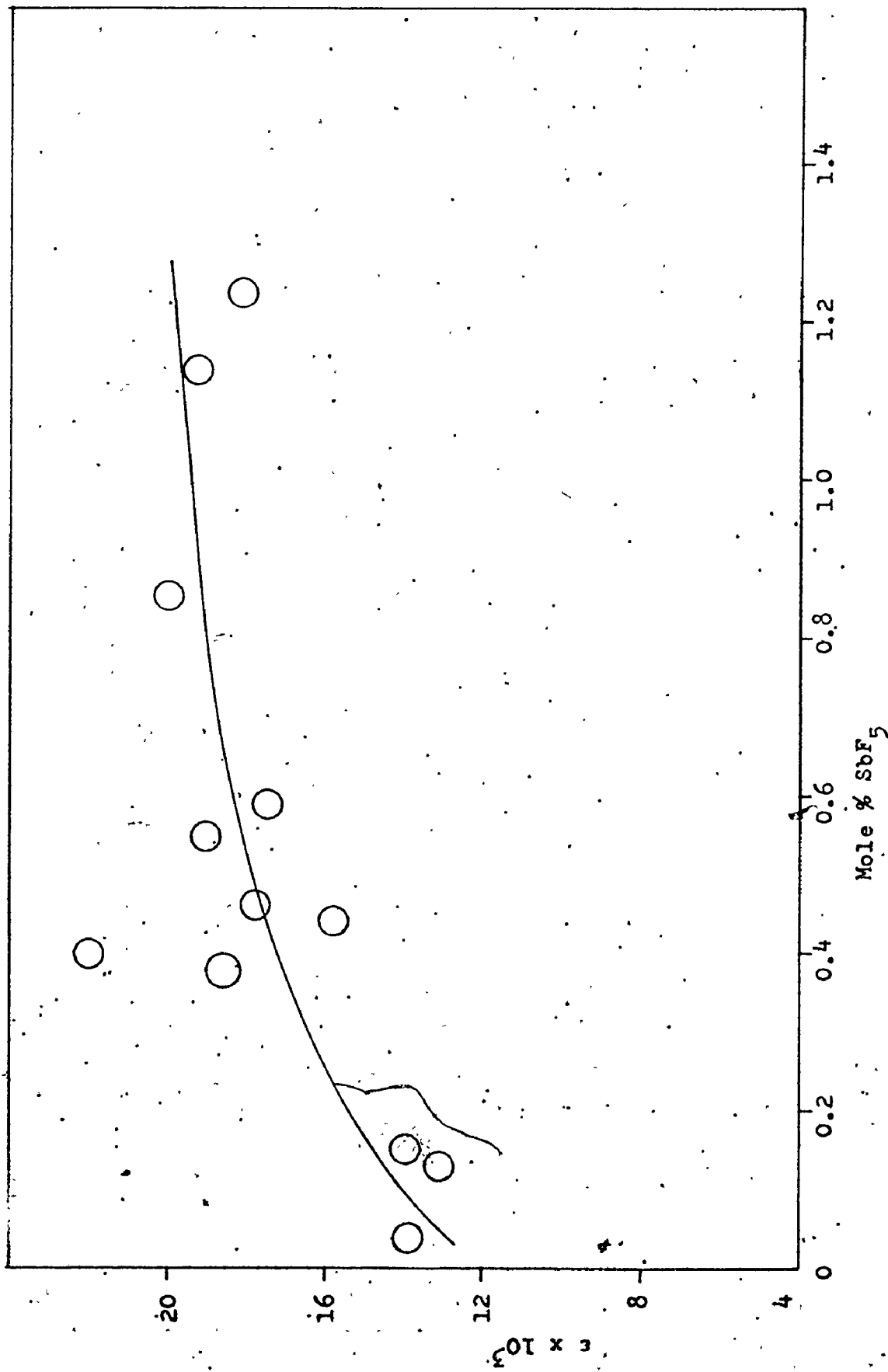

Figure 45. Observed extinction coefficients of 2,4,6-trinitrochlorobenzene in SbF₅-HF.

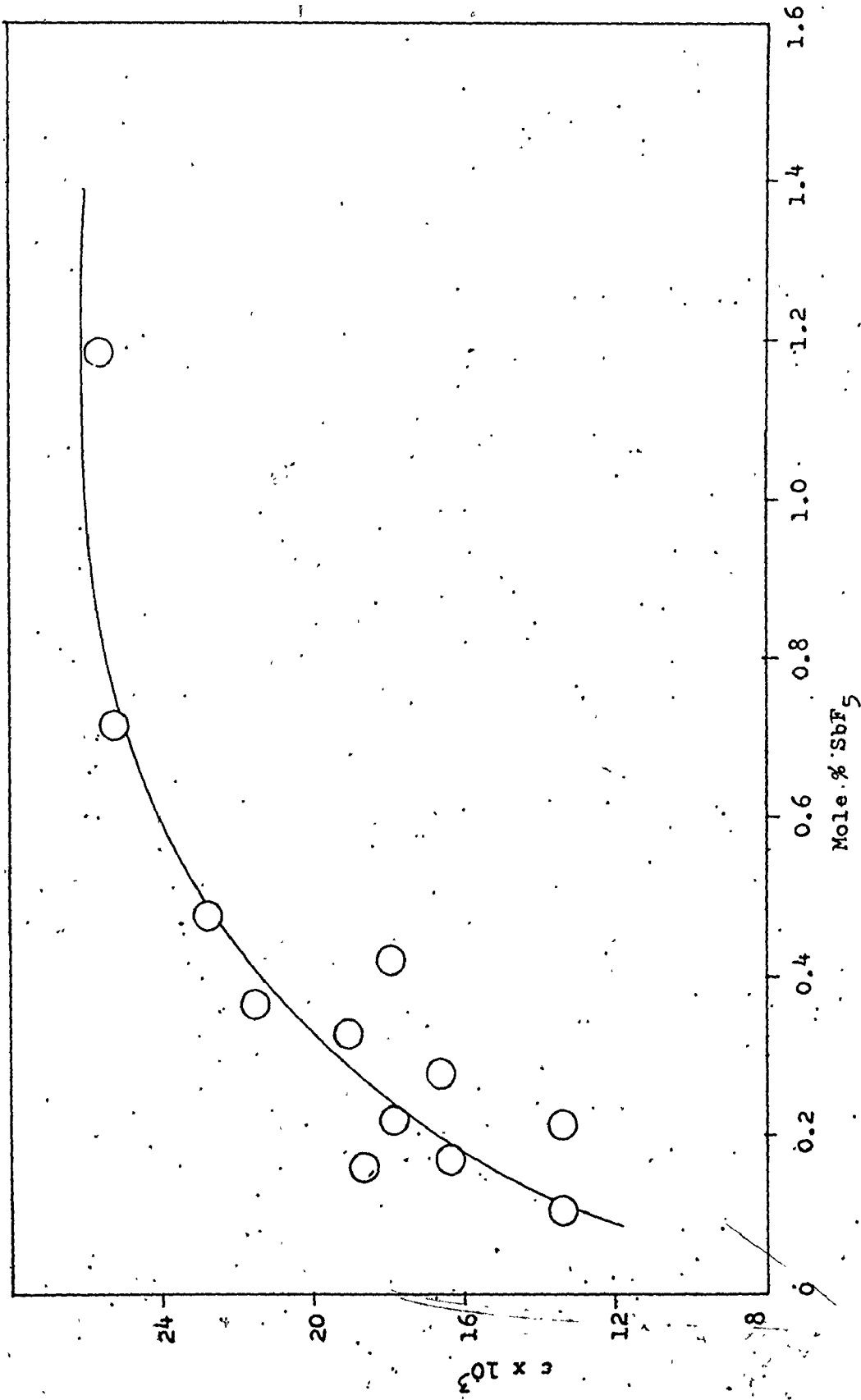

Figure 46: Observed extinction coefficients of 1,3-dichloro-2,4,6-trinitrobenzene in the SbF₅-HF system.

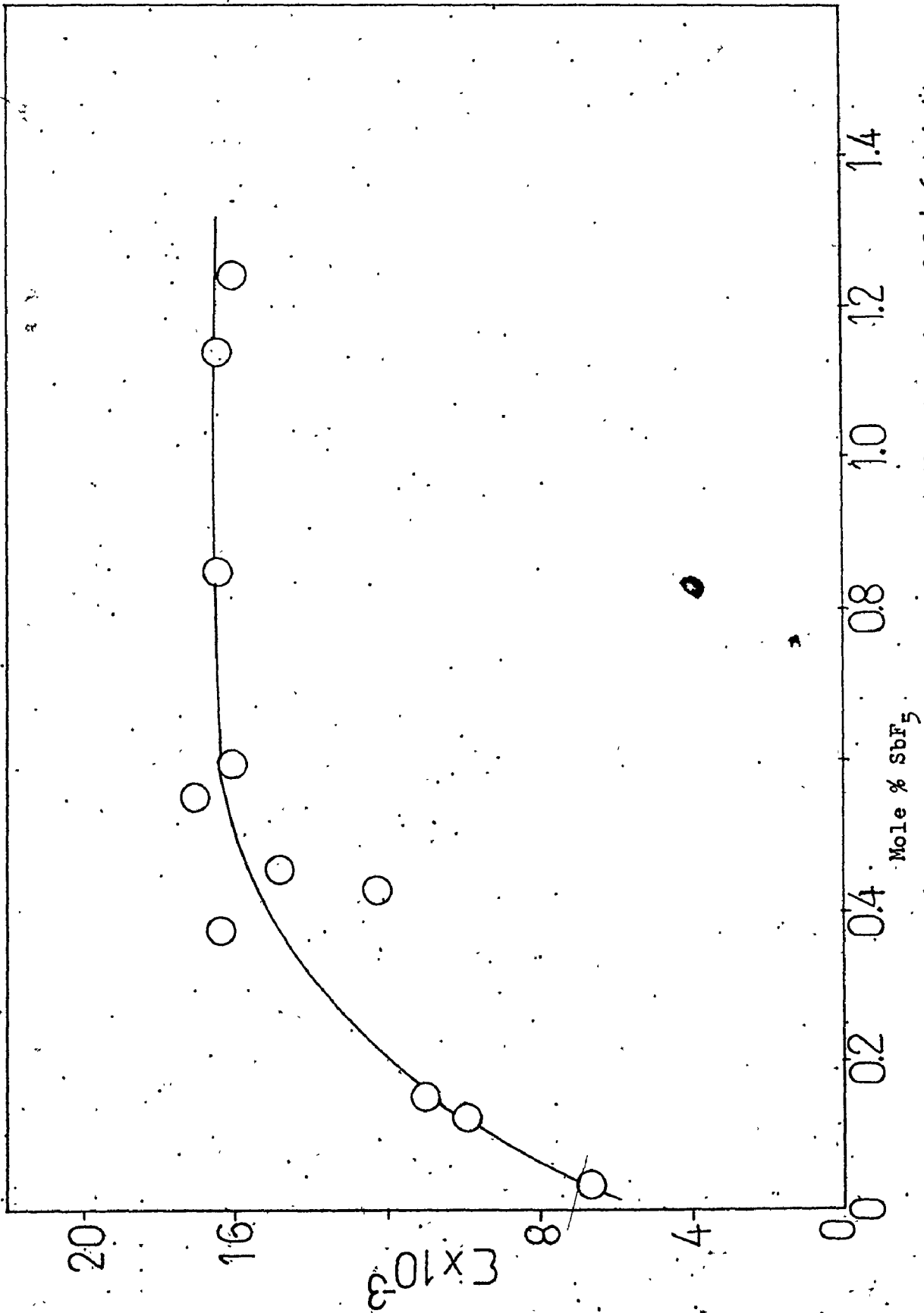

Figure 47. Adjusted extinction coefficients for the diprotonation of 2,4,6-trinitrochlorobenzene in the SbF_5 -HF system.

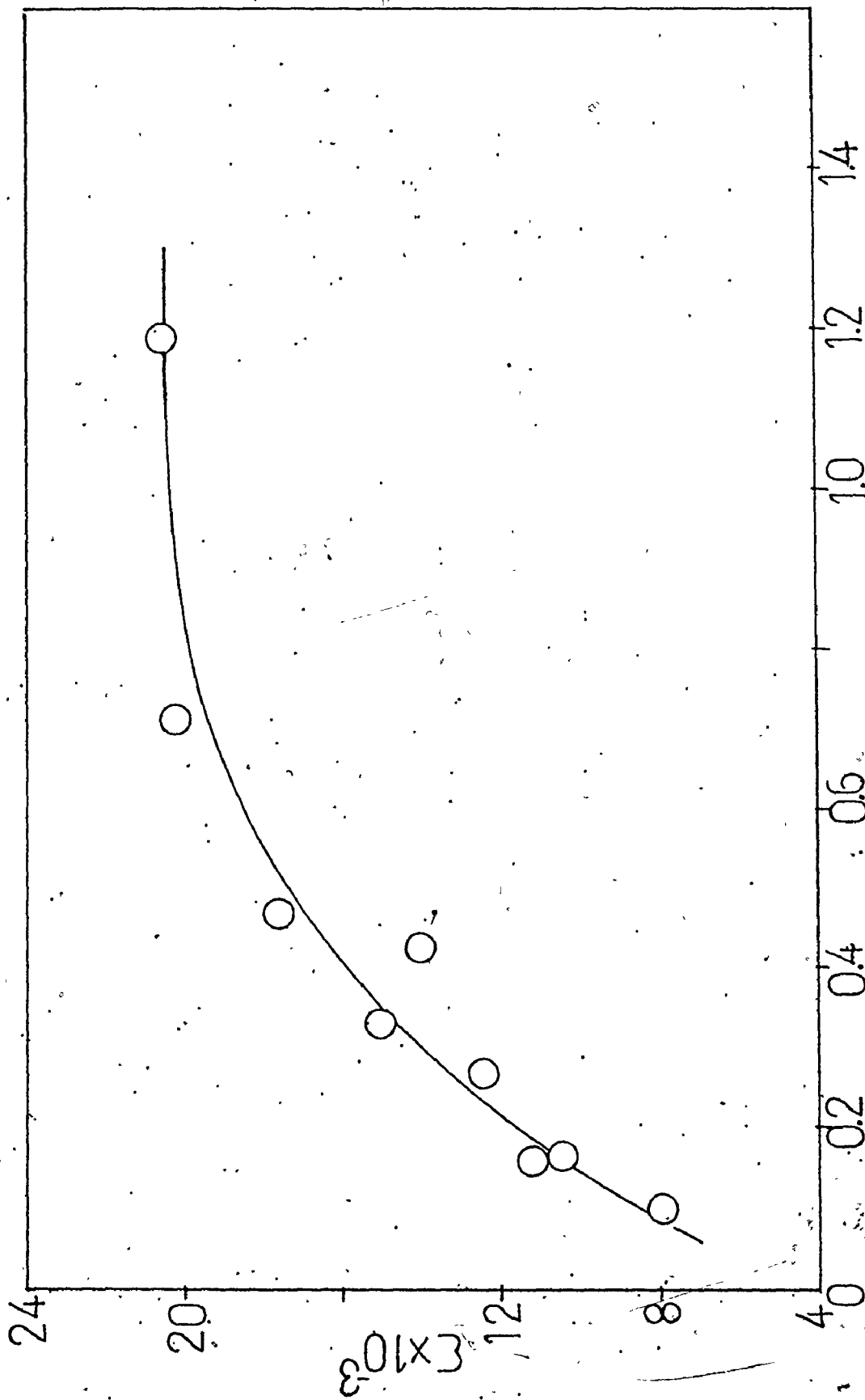

Figure 48. Adjusted extinction coefficients of 1,3-dichloro-2,4,6-trinitrobenzene in the SbF_5 -HF system.

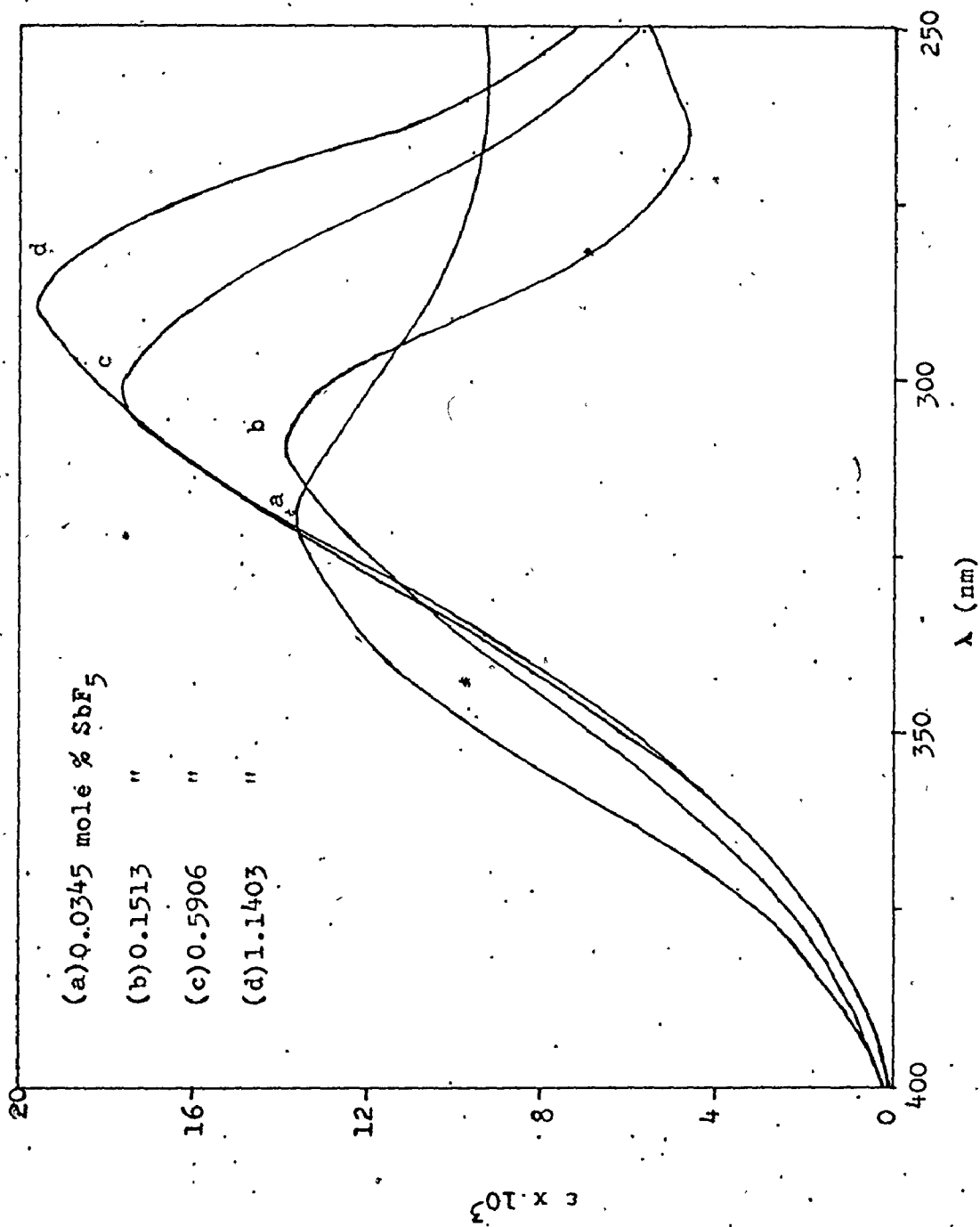

Figure 49. Absorption curves of 2,4,6-trinitrochlorobenzene in the SbF_5 -HF system.

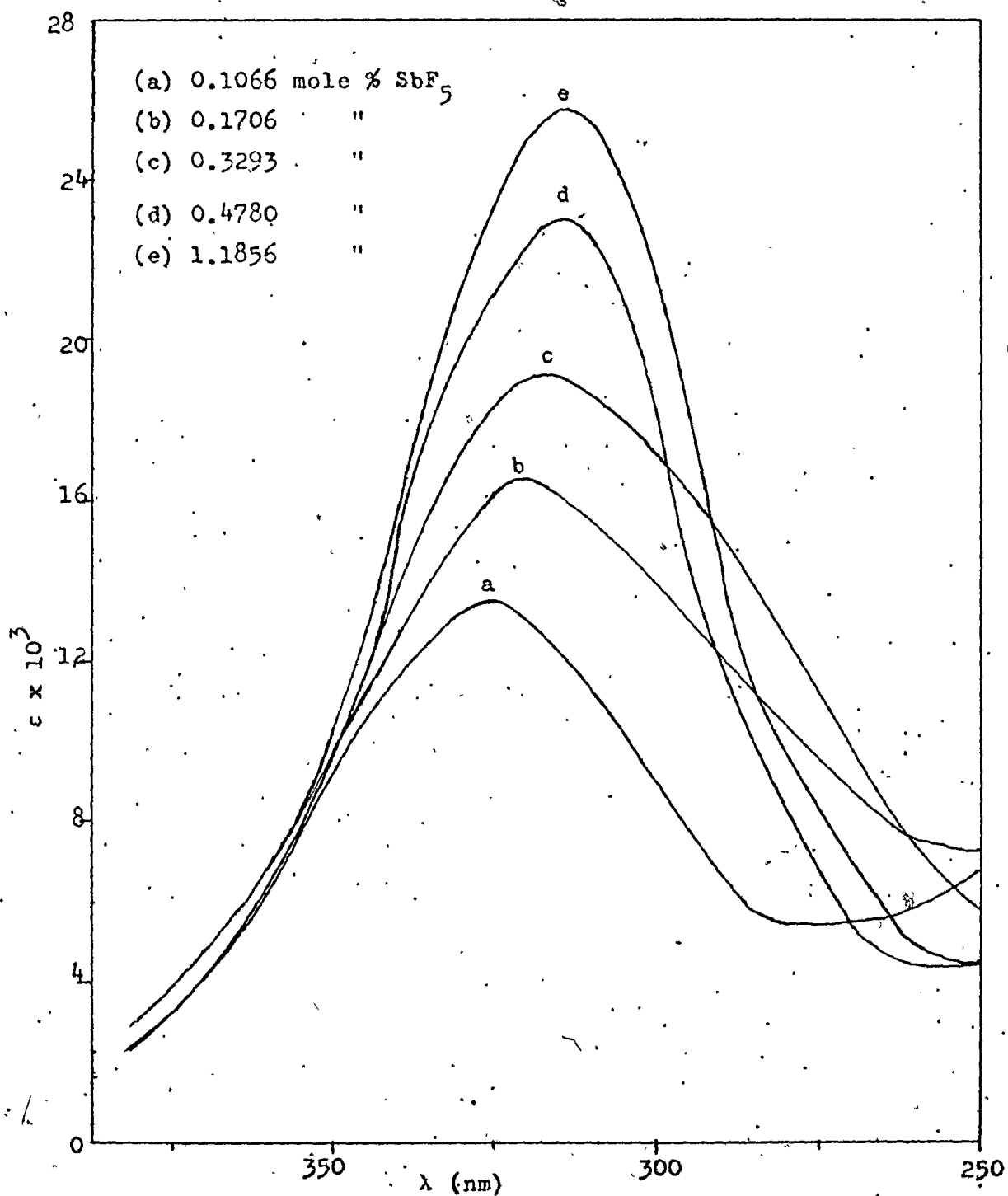

Figure 50. Absorption spectra of 1,3-dichloro-2,4,6-trinitrobenzene in the SbF_5 -HF system.

TABLE LXII

IONIZATION RATIOS FOR THE DIPROTONATION OF 2,4,6-
TRINITROCHLOROBENZENE IN THE SbF_5 -HF SYSTEM

$$c_{\text{BH}^+} = 1,600 \quad c_{\text{BH}_2^{+2}} = 16,000 \quad pK_{\text{BH}_2^{+2}} = -19.76$$

Mole % SbF_5	c	$\log I$
0.05	7,000	0.22
0.10	9,000	-0.02
0.15	10,600	-0.22
0.20	11,900	-0.40
0.25	13,000	-0.58
0.30	13,600	-0.69
0.40	15,200	-1.23

TABLE LXIII

IONIZATION RATIOS FOR THE DIPROTONATION OF 1,3-DICHLORO-
2,4,6-TRINITROBENZENE IN THE SbF_5 -HF SYSTEM

	$\epsilon_{\text{BH}^+} = 4,400$	$\epsilon_{\text{BH}_2^{+2}} = 20,400$	$\text{pK}_{\text{BH}_2^{+2}} = -20,23$
Mole % SbF_5	ϵ		$\log I$
0.05	7,000		0.71
0.10	8,200		0.51
0.15	10,200		0.25
0.20	11,600		0.09
0.25	13,000		-0.07
0.30	14,000		-0.18
0.40	15,900		-0.41
0.50	17,400		-0.64
0.60	18,600		-0.90

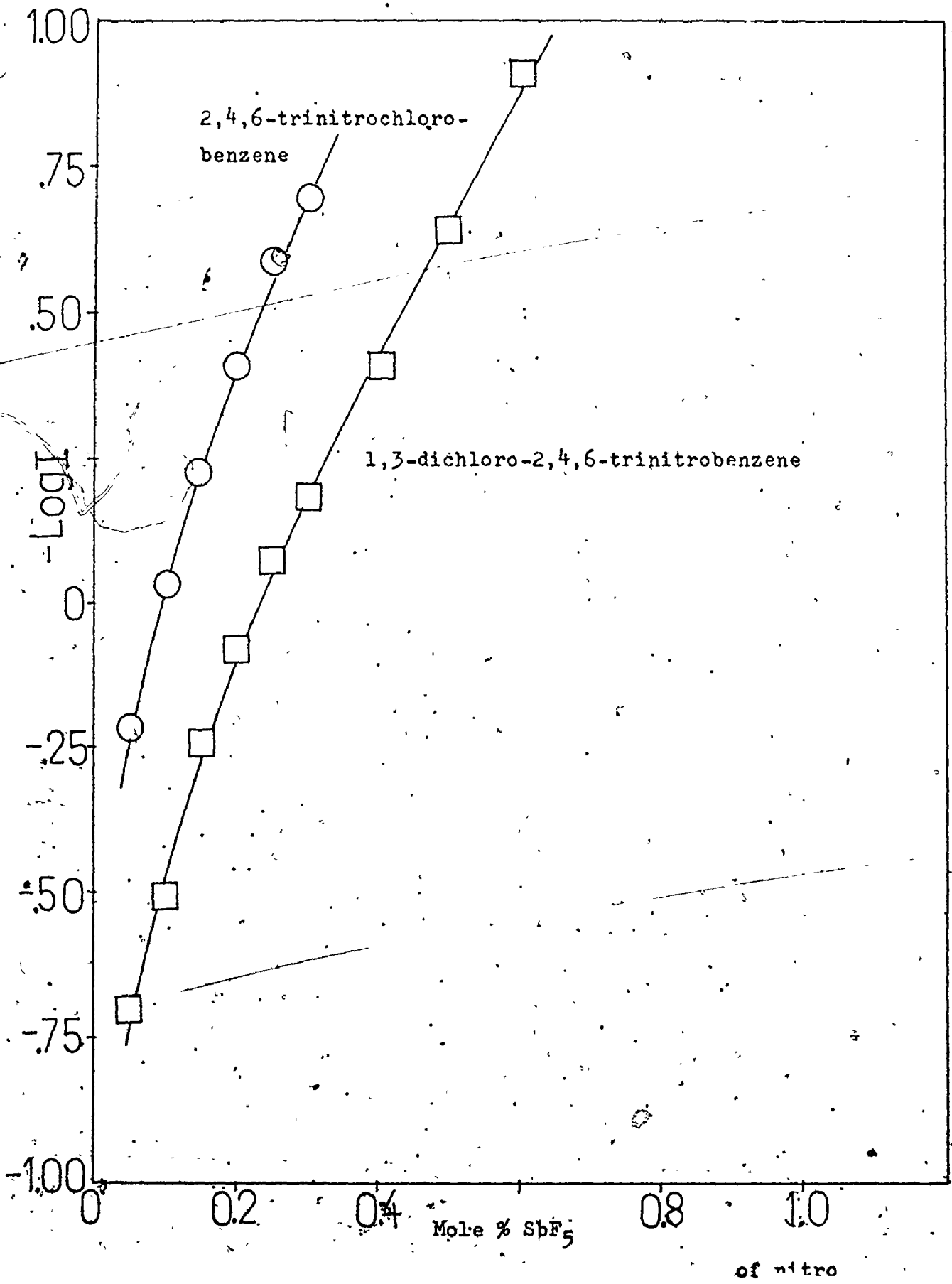

TABLE LXIV
-H₀ VALUES FOR THE SbF₅-HF SYSTEM

Mole % SbF ₅	2,4,6-trinitro- chlorobenzene	1,3-dichloro- 2,4,6-trinitro- benzene	Average
0.05	19.54	19.52	19.53
0.10	19.78	19.72	19.75
0.15	19.98	19.98	19.98
0.20	20.16	20.14	20.15
0.25	20.34	20.30	20.32
0.30	20.45	20.41	20.43
0.40		20.64	20.64
0.50		20.87	20.87
0.60		21.13	21.13

TABLE LXV

ϵ_B , ϵ_{BH^+} AND pK_{BH^+} VALUES FOR THE NITRO AROMATIC INDICATORS IN THE MF_5 -HF SYSTEM

Indicator	ϵ_B	ϵ_{BH^+}	$-pK_{BH^+}$
(2,4,6-trinitrotoluene)H ⁺	2,000	15,400	18.36
(1,3,5-trinitrobenzene)H ⁺	2,500	16,000	18.93
(2,4,6-trinitrochlorobenzene)H ⁺	1,600	16,000	19.76
(1,3-dichloro-2,4,6-trinitrobenzene)H ⁺	4,400	20,400	20.23

TABLE LXVI

EVALUATION OF OVERLAP OF NITRO AROMATIC INDICATOR IN THE HF SOLVENT SYSTEM.

INDICATOR	$a_{i,i-1}$	II $a_{i,i-1}$
(2,4,6-trinitrotoluene)H ⁺	0.97	0.97
(1,3,5-trinitrobenzene)H ⁺	0.88	0.85
(2,4,6-trinitrochlorobenzene)H ⁺	0.92	0.78
(1,3-dichloro-2,4,6-trinitrobenzene)H ⁺	0.99	0.77

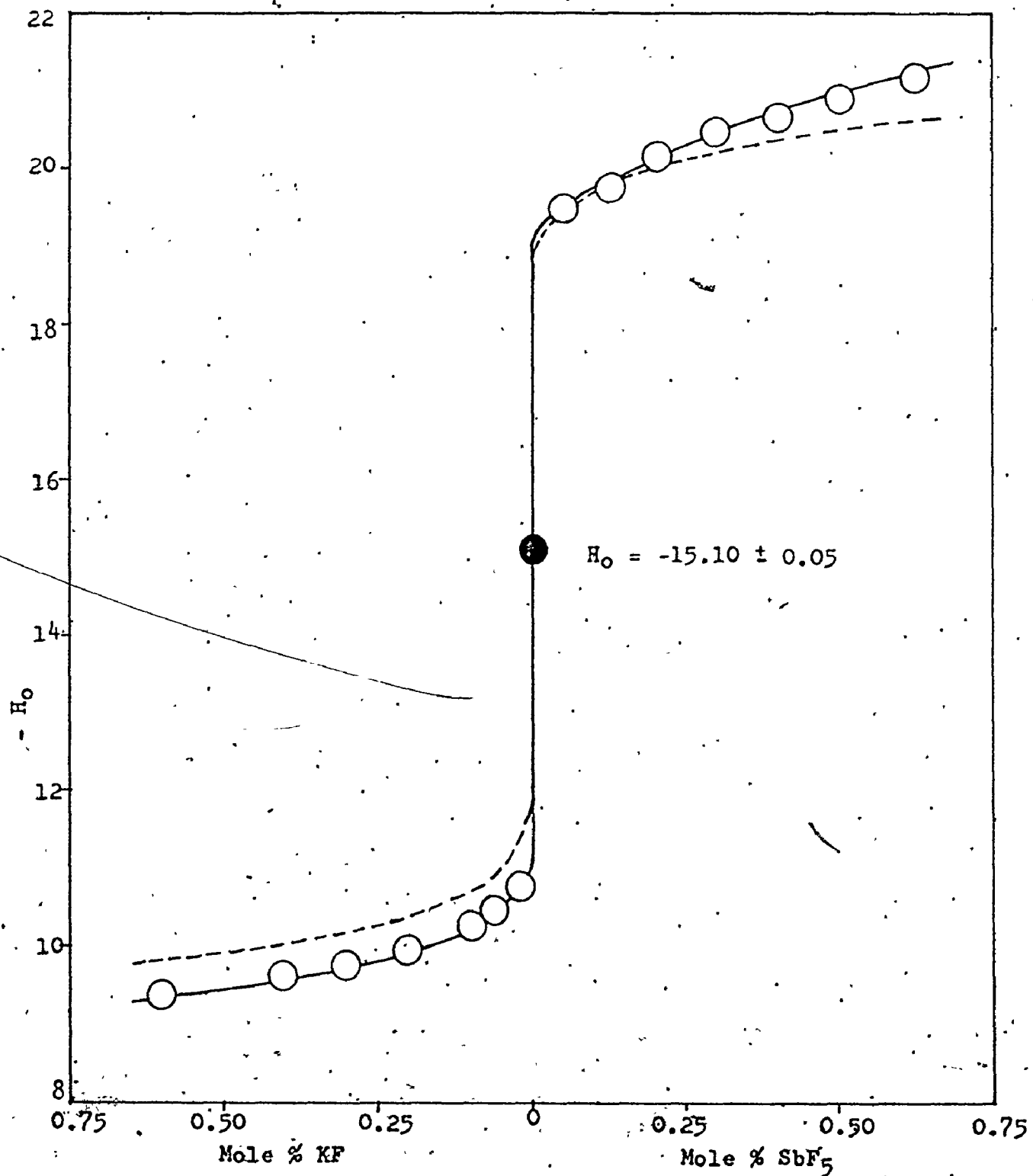

Figure 52. $-H_0$ values of $KF-HF$ and SbF_5-HF . (O) - experimental
(----) - calculated.

TABLE LXVII

IONIZATION CONSTANTS OF WEAK ACIDS IN HF

Molality of MF_5	K_a		
	AsF_5	TaF_5	NbF_5
0.025	9.12×10^{-5}	1.15×10^{-5}	0.4×10^{-10}
0.05	15.13×10^{-5}	1.52×10^{-5}	1.80×10^{-10}
0.075	33.47×10^{-5}	1.53×10^{-5}	8.53×10^{-10}
0.10	34.69×10^{-5}	1.45×10^{-5}	25.6×10^{-10}
0.125	52.88×10^{-5}	2.11×10^{-5}	38.7×10^{-10}
0.15	80.23×10^{-5}	2.91×10^{-5}	81.7×10^{-10}
Extrapolated to $m = 0$ of MF_5	3×10^{-5}	8×10^{-6}	2×10^{-11}

TABLE LXVIII

IONIZATION CONSTANT OF WATER IN HF

m of H_2O	K_b^1	m of H_2O	K_b^2
0.025	0.036	0.036	0.068
0.05	0.064	0.053	0.076
0.10	0.050	0.079	0.054
0.15	0.056	0.34	0.087
0.20	0.059	0.182	0.094
		0.232	0.097
At $m = 0$	0.038		0.068

1. from the present measurements, 2. from conductivity data. ⁵²

CHAPTER VI

DISCUSSION

A. THE HAMMETT ACIDITY FUNCTIONS IN SUPERACID MEDIA

The measurements of the Hammett acidity function H_0 have been extended to MF_5 -HF systems. Due to the lack of sufficiently weakly basic indicators, the most highly acidic system which has been studied in the present work is 0.60 mole % SbF_5 in HF with $H_0 = -21.13$ which is more acidic than the most highly acidic system, 7 mole % SbF_5-3SO_3 in HSO_3F , measured previously.³ The previous qualitative suggestion that the SbF_5 -HF system has very high acidity has thus been confirmed. The $-H_0$ values given by Siskin et al.²⁴ from the study of the rate of protonation of deuterium seem not entirely unjustified; they gave a value of 24.3 for 10 mole % SbF_5 and 18.5 for TaF_5 solution which they stated to be 10 mole % TaF_5 but must in fact have been a 1.1 mole % TaF_5 saturated solution. The $-H_0$ value, 15.1 for 100 % HF indicates that its acidity is very close to that of 100 % HSO_3F , 15.07 and is rather greater than the value for 100 % H_2SO_4 , 11.93. Moreover the increase in acidity on adding strong Lewis acids is much more rapid for the HF system than for the HSO_3F system. This is essentially a consequence of the smaller K_{ap} value for HF. The $-H_0$ curve increases rapidly as the concentration of strong base, KF in HF or KSO_3F in HSO_3F , decreases and passes through an inflection point at 100 % HA and continues to go up with increasing concentration of strong acid, SbF_5 in HF or SbF_5-3SO_3 in HSO_3F . The rate of increase near the pure solvent is dependent upon the magnitude of

the K_{ap} value of the solvent. HF, having a smaller K_{ap} than HSO_3F , has a sharper increase in acidity as the concentration of the strong base decreases. This is due to the small concentration of H_2F^+ or F^- in HF. The addition of strong acid or strong base will drastically increase H_2F^+ or F^- concentration. In the H_2SO_4 or HSO_3F system, the relatively extensive self-dissociation makes these systems highly buffered and the change in H_0 in the vicinity of 100 % acid is much smaller than in HF.

Measurements could not be made on more concentrated solutions of SbF_5 in HF or more highly acidic systems because of the lack of weaker nitro aromatic indicators than the weakest presently used.

B. ACIDITY FUNCTIONS OTHER THAN H_0

The limited availability of suitably weak nitro aromatic indicators necessitates the exploration of other sets of indicators. The acidity functions defined by different indicators are not identical to the H_0 function. Most acidity function measurements have been made with aniline indicators; however, there is no reason to assume that H_0 scale is better than any other similarly determined acidity scales. As a result of the large accumulation of data on the H_0 function for various acid mixtures this scale is often used as a reference system for comparison with other acidity functions.

The H_0'' acidity function,⁶⁵ based on the ionization of a group of 15 N,N-dialkylnitroanilines and N-alkylnitrodiphenylamines in the $\text{H}_2\text{O}-\text{H}_2\text{SO}_4$ system changes much more rapidly with increasing acid concentration than does the H_0 function. The behaviour of this aniline and the weakest indi-

cator, N-methyl-2,2',4,4'-tetranitrodiphenylamine has pK_{BH^+} value of -10.56.

The H_I acidity function, as developed by Hinman and Lang,⁶⁶ is based upon the protonation behaviour of a series of alkylated indoles whose pK_{BH^+} values range from 0.30 for 1,2-dimethylindole to -6.31 for tryptamine. The behaviour of H_I acidity function is very similar to that of the H_0''' scale.

The H_A acidity function proposed by Yates et al.^{67,68} is based on the behaviour of a group of amides. This acidity function changes less rapidly with increasing acid concentration than H_0 scale does. The pK_{BH^+} values range from -1.23 for 2-pyrrolicarboxamide to -4.08 for 2,4,6-trinitrobenzamide.

The H_B acidity function is based on the protonation behaviour of ketones,⁶⁹ a series of benzophenones, ranging from $pK_{BH^+} = -3.34$ for 2,2',4,4'-tetramethoxybenzophenone to $pK_{BH^+} = -6.88$ for 4-nitrobenzophenone. The behaviour of H_B is similar to that of H_0 below 60 % H_2SO_4 .

The second oldest acidity function H_R , developed by Deno et al.⁷⁰ is based on an overlapping series of triarylcarbinols whose pK_{BH^+} values range from 0.82 for 4,4',4''-trimethoxytriphenylcarbinol to -16.27 for 4,4',4''-trinitrotriphenylcarbinol. It differs from those previously discussed in that the reaction is not the addition of a proton to neutral base, it is rather a loss of water

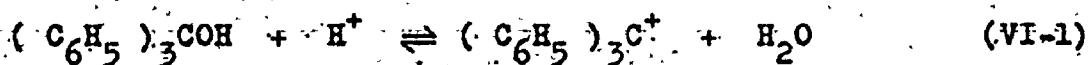

The progress of the reaction being observed is the conversion of

water to oxonium ion which depends on the acid concentration. The H_R function is defined as

$$H_R = pK_{R^+} - \log \frac{[R^+]}{[ROH]} \quad (\text{VI-2})$$

which can be rewritten in the form

$$H_R = -\log a_{H^+} \frac{f_{ROH}}{f_{R^+}} + \log a_{H_2O} \quad (\text{VI-3})$$

where R is an arylcarbinol and a_{H_2O} is the activity of water. If one defines a function H'_R

$$H'_R = pK_{R^+} - \log \frac{[R^+]}{[ROH]} - \log a_{H_2O} \quad (\text{VI-4})$$

then

$$H'_R = -\log a_{H^+} \frac{f_{ROH}}{f_{R^+}} \quad (\text{VI-5})$$

which is of similar form to the H_0 acidity function or any other acidity functions previously mentioned. It was found that the arylcarbinol based function H'_R increased more rapidly with increasing acid concentration than all other acidity functions.

The redox acidity function $R_0(H)$ which is obtained from E.M.F. measurements was first measured in H_2SO_4 system by Michaelis and Granick⁷¹ and later by Strehlow and Wendt.⁷² The measurements were made in a cell with a ferrocene / ferricinium redox electrode

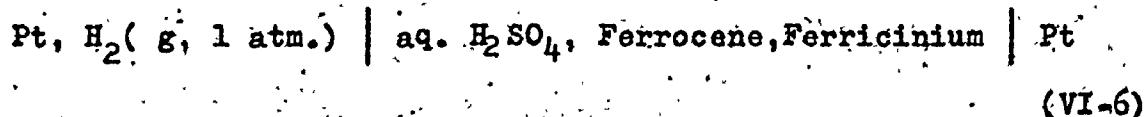

The redox acidity function $R_0(H)$ is defined as

$$R_0(H) = \frac{F}{2.303} \left[\frac{E_0}{X} - E_0 \right]$$

where E_X^0 is the potential in a given medium and E_W^0 is the standard potential of H_2 electrode.

Various acidity functions for the aqueous H_2SO_4 system are shown in Figure 53. Many other aqueous acid solutions also have been studied; for example, H_0 for solutions of HCl , H_3PO_4 and toluene-sulfonic acid,⁷³ H_I for aqueous solutions of $HClO_4$,⁶⁶ H_A for HCl solutions,⁷⁴ H_R or H_R^I for $HClO_4$ and HNO_3 ,⁷⁵ D_0 for D_2O - D_2SO_4 using a series of aniline indicators used for the H_0 measurements,⁷⁶ $R_0(H)$ for the aqueous HF system^{77,78} and anhydrous HF ,⁷⁹ and H_B for the H_2SeO_4 - H_2O system.⁸⁰

To extend the present measurements of H_0 functions to higher concentrations of SbF_5 in HF , it might be possible to use another type of base such as a ketone. The series of ketones used by Levy et al.³⁵ might be worthwhile trying. They determined the basicity constants of a series of halogen substituted acetones by the nmr method. These constants range from $pK_{BH^+} = -7.5$ for acetone to $pK_{BH^+} = -17$ for 1,1,3,3-tetrafluoroacetone. Less basic ketones are available such as 1,3-dichloro-1,1,3,3-tetrafluoroacetone, pentachloroacetone, hexafluoroacetone and hexachloroacetone.

The application of the $R_0(H)$ scale to the aqueous HF system was first made by Vaillant et al.^{77,78} and to anhydrous HF by Menard et al.⁷⁹ Their results for aqueous HF are plotted in Figure 54 together with the corresponding H_0 values for comparison. The $R_0(H)$ for anhydrous HF obtained by Menard et al.⁷⁹ was not in fact for 100 % HF but a solution of 0.1 M KF , and in Figure 54 values for $R_0(H)$ and H_0 for anhydrous are not given. The extension of

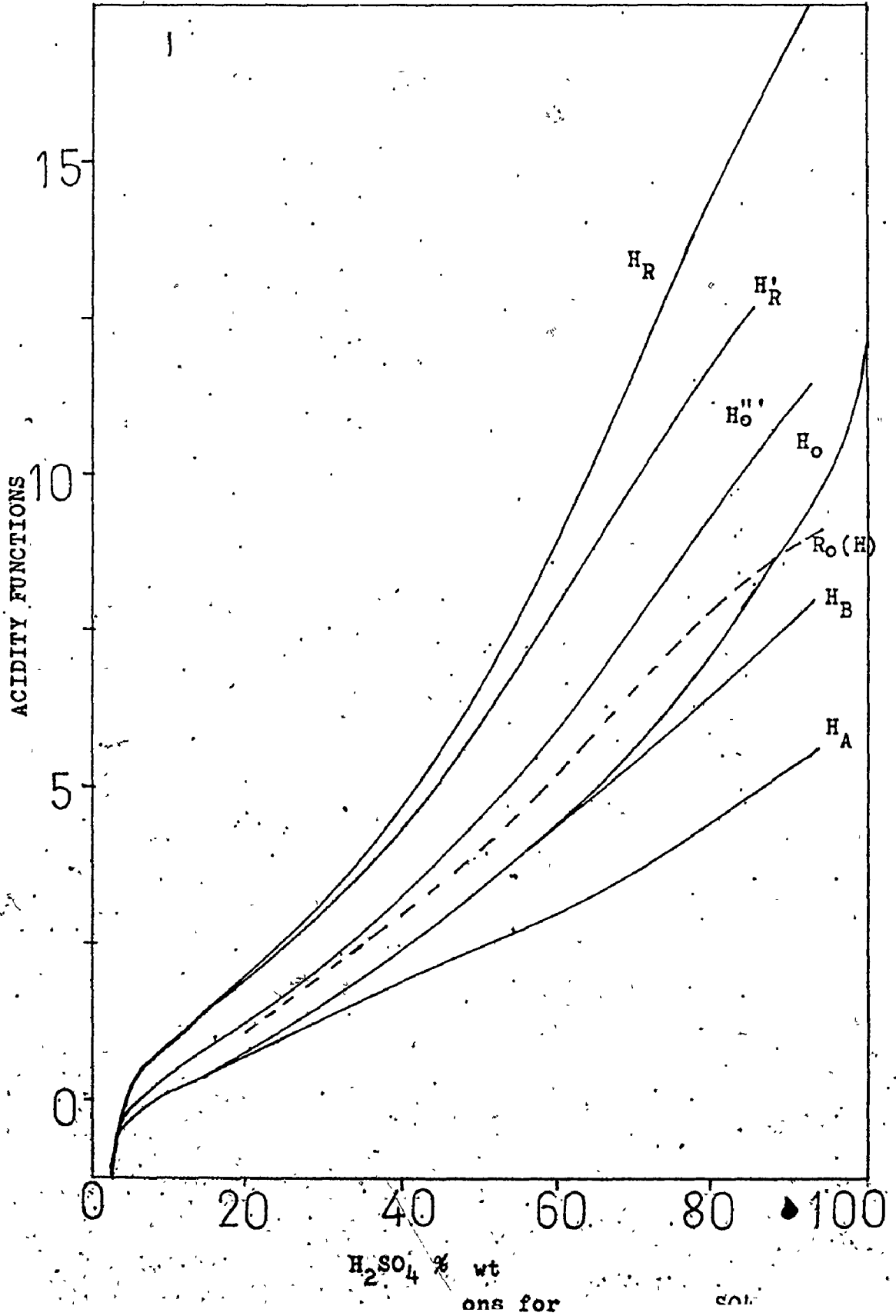

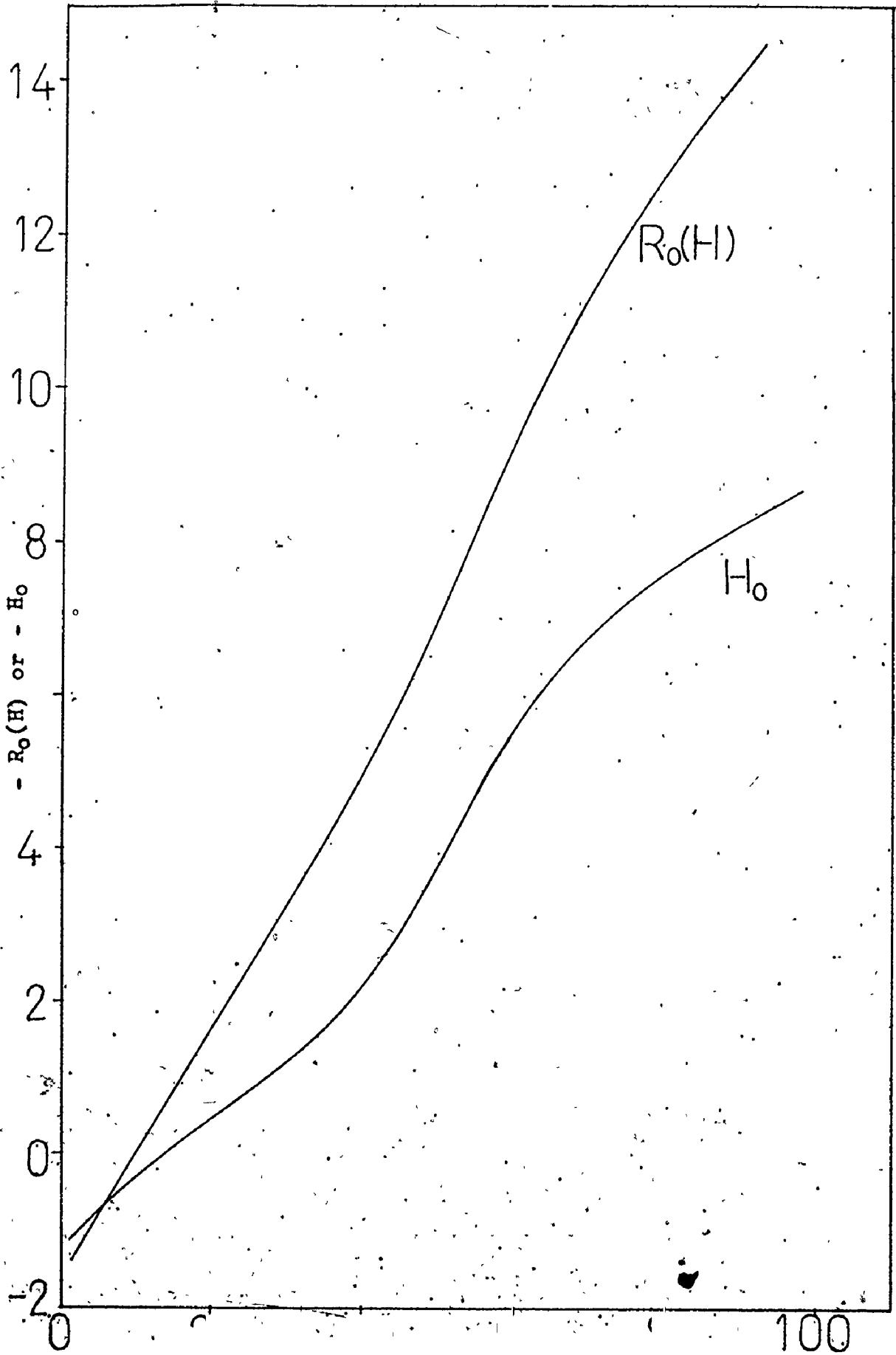

the $R_0(H)$ measurements to the highly acidic SbF_5 -HF system has not been made. However Masson et al.⁸¹ have performed a potentiometric acid-base titration in anhydrous HF by using quinones as indicators. Their results were expressed in terms of basicity constant pK_b or acidity constant pK_a (with $pK_b + pK_a = pK_i$, K_i is the ionic constant for $H^+ + F^- = HF$) for bases or acids in HF based on $pK_b = 0$ for 1 M KF solution in HF. They found that HSO_3F was a very weak acid in HF ($pK_b = 2.54$), that TaF_5 was a weak acid ($pK_b = 6.28$) and that SbF_5 was a moderately strong acid ($pK_b = 9.63$). The result for SbF_5 is in contrast to the present measurements and conductivity or cryoscopic studies in which SbF_5 was found to be a strong acid in HF.

C. THE SIGNIFICANCE OF ACIDITY MEASUREMENTS

The results of the exploration of superacids have been extensively applied in both organic and inorganic chemistry. One of the earliest applications is the protonation studies in SbF_5 - HSO_3F medium. For example, the observation of the proton nmr spectra of conjugate acids of some carboxylic acids at low temperature led to the identification of two isomers, (I)⁸² and (II)^{83,84} for conjugate acid of acetic acid.

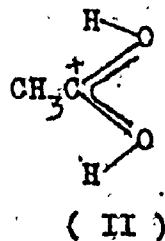
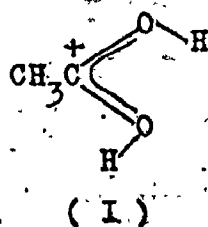

A still more important application of superacids is

as solvents in the preparations of new cations such as carbonium ions or polycations. These cations are highly electrophilic species and can only be obtained as stable species in solvents of very low basicity and in the presence of anions of very low basicity, that is, the anions of very strong acids such as SO_3F^- , SbF_6^- or $\text{Sb}_2\text{F}_{11}^-$. For example t-butanol is completely converted to the trimethyl carbonium ion in $\text{HSO}_3\text{F}-\text{SbF}_5-\text{SO}_2$ at -60°C

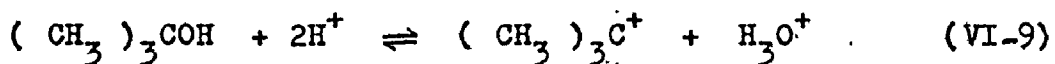

Other examples are halogen cations, such as I_2^+ , I_3^+ , ClF_2^+ , BrF_2^+ etc., cations of sulfur, selenium and tellurium such as S_4^{+2} , Se_4^{+2} , Te_4^{+2} etc., and cations of rare gas fluoride, such as KrF^+ , XeF_3^+ , XeF_5^+ etc.,

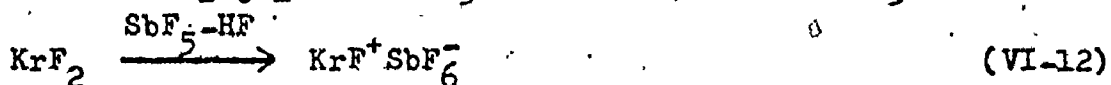
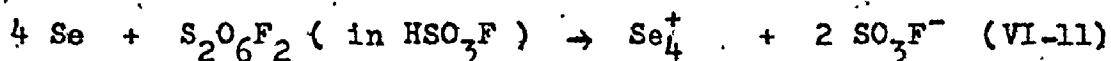
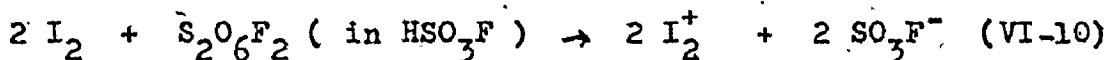

The chemistry of superacids has been extensively investigated. In the future more new reactions and species may be discovered by further studies using superacid systems as reaction media. The search for still more acidic media continues, and this could for example, lead to the production of stable solutions of such interesting species as H_3^+ , CH_3^+ , CH_5^+ and C_2H_5^+ which — although they are in principle possible — have not yet been observed, except possibly as unstable intermediates,²¹ because all presently available media are too basic.

REFERENCES

1. R. J. Gillespie and T. E. Peel, "Superacid Systems" in Advances in Physical Org. Chem., 9, V. Gold, ed., Academic Press, London, 1971.
2. R. J. Gillespie, Endeavor, 32, 3(1973).
3. R. J. Gillespie and T. E. Peel, J. Amer. Chem. Soc., 95, 5173 (1973).
4. L. P. Hammett and A. J. Deyrup, J. Amer. Chem. Soc., 54, 2721 (1932).
5. C. H. Rochester, "Acidity Functions", Academic Press, New York, 1970.
6. M. Liler, "Reaction mechanisms in H_2SO_4 and other strong acid solutions", Academic Press, 1971.
7. M. A. Paul and F. A. Long, Chem. Revs., 57, 1(1957).
8. K. N. Bascombe and R. P. Bell, J. Chem. Soc., 1096(1959).
9. M. J. Jorgenson and D. R. Hartter, J. Amer. Chem. Soc., 85, 878(1963).
10. J. C. D. Brand, W. E. Horing, and M. B. Thornley, J. Chem. Soc., 1374(1952).
11. R. J. Gillespie, T. E. Peel and E. A. Robinson, J. Amer. Chem. Soc., 93, 5083(1971).
12. R. C. Thompson, J. Barr, R. J. Gillespie, J. B. Milne and R. A. Rothenbury, Inorg. Chem., 4, 1641(1965).
13. R. J. Gillespie, K. Quchi and G. P. Pez, Inorg. Chem., 8, 63(1969).
14. R. P. Bell, K. N. Bascombe and J. C. McCoubrey, J. Chem. Soc., 1286(1956).
15. H. H. Hyman, M. Kilpatrick and J. J. Katz, J. Amer. Chem. Soc., 79, 3668(1957).
16. G. Dallinga, J. Gaef and E. L. Mackor, Rec. Trav. Chim., 89, 1068(1970).

17. H. H. Hyman, M. Kilpatrick and J. J. Katz, *J. Phys. Chem.*, 65, 123(1961).
18. R. J. Gillespie and K. C. Moss, *J. Chem. Soc.*, 1170(1966).
19. P. A. W. Dean, R. J. Gillespie, R. Hulme and D. A. Humphreys, *J. Chem. Soc.*, (A), 341(1971).
20. R. J. Gillespie and D. A. Humphreys, *J. Chem. Soc.*, (A), 2311(1970).
21. G. A. Olah, J. Shen and R. H. Schläsbery, *J. Amer. Chem. Soc.*, 92, 3831(1970).
22. D. M. Brouwer and J. A. Van Docern, *Rec. Trav. Chim.*, 91, 895(1972).
23. G. M. Kramer, *J. Org. Chem.*, 40, No. 3, 298(1975).
24. M. Siskin and W. P. Kocsi, private communication.
25. J. Barr, R. J. Gillespie and R. C. Thompson, *Inorg. Chem.*, 3, 1149(1964).
26. T. E. Peel, Ph. D. Thesis, McMaster University, Hamilton, 1970.
27. J. Shamir and A. Netzer, *J. Sci. Instru.*, 1, 770(1968).
28. T. Gramstad and R. N. Haszeldine, *J. Chem. Soc.*, 4069(1957).
29. Handbook of Chemistry and Physics, R. C. West ed., The Chemical Rubber Co., 49th edition, 1968-69.
30. R. J. Gillespie, *Accts. Chem. Res.*, 1, 202(1968).
31. A. A. Wolf, *J. Chem. Soc.*, 433(1955).
32. R. J. Gillespie, K. Quchi and G. P. Pez, *Inorg. Chem.*; 8, 63(1969).
33. R. W. Taft and P. L. Levines, *Analy. Chem.*, 34, 436(1962).
34. D. G. Lee, *Canad. J. Chem.*, 48, 1919(1970).
35. G. C. Levy, J. D. Cargioli and W. Racela, *J. Amer. Chem. Soc.*, 92, 6238(1970).
36. R. N. Haszeldine and J. M. Kidd, *J. Chem. Soc.*, 4228(1954).
37. R. N. Haszeldine and J. M. Kidd, *J. Chem. Soc.*, 173(1956).

38. Trimesylate acid FC-24, 3M Co. Technical information (1971).
39. A. Commeyras and G. A. Olah, J. Amer. Chem. Soc., 91, 2929(1969).
40. J. March, "Advanced Organic Chemistry", Ref. 17, p 18, McGraw-Hill Inc., New York, 1968.
41. J. H. Simons, Chem. Revs., 8, 213(1931).
42. J. H. Simons in "Fluorine Chemistry", J. H. Simons, ed., Vol. 1, pp225, Academic Press, New York, 1951.
43. A. G. Sharpe, Advan. Fluorine Chem., 1, 29(1960).
44. R. D. Peacock, Progr. Inorg. Chem., 2, 193(1960).
45. M. Hudlicky, "Organic fluorine Chemistry", Pergamon Press, New York, 1962.
46. J. Burdon and J. C. Tatlow, Advan. Fluorine Chem., 1, 129(1960).
47. H. H. Hyman and J. J. Katz in "Non-aqueous Solvent Systems", T. C. Waddington, ed., Academic Press, 1965.
48. M. Kilpatrick and J. G. Jones in "The Chemistry of Non-aqueous Solvents", J. J. Lagowski, ed., Academic Press, New York, 1967.
49. J. H. Simons and R. D. Dresdener, J. Amer. Chem. Soc., 66, 1070(1944).
50. K. Fredenhagen and J. Dahmlos, Z. Inorg. Chem., 178, 272(1929).
51. M. Kilpatrick, and F. E. Luborsky, J. Amer. Chem. Soc., 76, 5865(1954).
52. S. M. Brownstein, Ph. D. Thesis, McMaster University, Hamilton, Ontario, 1970.
53. M. Kilpatrick and T. J. Lewis, J. Amer. Chem. Soc., 78, 5186(1956).
54. K. Fredenhagen, Z. Phys. Chem., 128, 1(1927).
55. K. Fredenhagen and G. Cadenbach, Z. Phys. Chem., A146, 245(1932).
56. A. F. Clifford, H. C. Beachell and W. M. Jack, J. Inorg. and Nuclear Chem., 5, 57(1957).
57. A. F. Clifford and A. G. Morris, J. Inorg. and Nuclear Chem., 5, 71(1957).

58. A. F. Clifford and S. Kongpricha, J. Inorg. and Nuclear Chem., 5, 76(1957).
59. H. H. Hyman, T. J. Lane and J. A. O'Donnell, 145th meeting, Amer. Chem. Soc., Abstracts, p.63T.
60. D. A. McCaulay, W. S. Higley and A. P. Lien, J. Amer. Chem. Soc., 78, 3009(1956).
61. J. V. Hatton, Y. Saito and W. G. Schneider, Canad. J. Chem., 43, 47(1965).
62. S. Kongpricha and A. F. Clifford, J. Inorg. and Nuclear Chem., 18, 270(1961).
63. A. W. Jache and G. H. Cady, J. Phys. Chem., 56, 1106(1952).
64. C. D. Johnson, A. R. Katritzky and S. A. Shapiro, J. Amer. Chem. Soc., 91, 6654(1969).
65. E. M. Arnett and G. W. Mach, J. Amer. Chem. Soc., 86, 2671(1964).
66. R. L. Hinman and J. Lang, J. Amer. Chem. Soc., 86, 3796(1964).
67. K. Yates, J. B. Stevens and A. R. Katritzky, Canad. J. Chem., 42, 1957(1964).
68. K. Yates and J. B. Stevens, Canad. J. Chem., 43, 529(1965).
69. T. G. Brown and J. Phillips, J. Chem. Soc., B, 650(1966).
70. N. C. Deno, J. J. Jaruzelski and A. Schriesheim, J. Amer. Chem. Soc., 77, 3044(1955).
71. L. Michaelis and S. Granick, J. Amer. Chem. Soc., 64, 1861(1942).
72. H. Strehlow and H. Wendt, Z. Phys. Chem., 30, 141(1961).
73. E. M. Arnett and G. W. Mach, J. Amer. Chem. Soc., 88, 1177(1966).
74. K. Yates and J. C. Riordan, Canad. J. Chem., 43, 2328(1965).
75. N. C. Deno, H. E. Berkheimer, W. L. Evans and H. J. Peterson, J. Amer. Chem. Soc., 81, 2344(1959).
76. J. Sierra, M. Ojeda and P. A. H. Wyatt, J. Chem. Soc., B, 1570(1970).

77. A. Vaillant, J. Devynck and B. Tremillon, Analytical Letters, 6(12), 1095(1973).
78. A. Vaillant, J. Devynck and B. Tremillon, Electroanaly. Chem. and Interfacial Electrochem., 57, 219(1974).
79. H. Menard, J. P. Masson, J. Devynck and B. Tremillon, J. Electroanal. Chem.; 63, 163(1975).
80. J. P. Masson, J. Devynck and B. Tremillon, J. Electroanal. Chem., 64, 193(1975).
81. S. Wasif, J. Chem. Soc., A, 142(1967).
82. T. Birchall and R. J. Gillespie, Canad. J. Chem., 43, 1045(1965).
83. M. Brookhart, G. C. Levy and S. Winstein, J. Amer. Chem. Soc., 89, 1735(1967).
84. G. A. Olah and A. M. White, J. Amer. Chem. Soc., 89, 3591(1967).

APPENDIX

A. INTRODUCTION

The experimental data obtained by the absorption method of determining H_o can be treated in several different ways. The method used in this thesis was to plot the observed extinction coefficients and then to read off from a smooth curve drawn through these points values of the extinction coefficients at selected concentrations. Values of H_o were then calculated at these concentrations using equation (I-8). An alternative method is to calculate an H_o value from each of the observed extinction coefficients and then to obtain smoothed H_o values from a curve fitted to the H_o values by a least square method. The purpose of this appendix is to present the results of some calculations of H_o values using this alternative method and to compare these with those given in the main body of the thesis.

B. THE LEAST SQUARES METHOD

The relationship between the Hammett acidity function H_o (y) and the concentration of acid or base x is assumed to have the form of a second order parabola.

$$y = a_0 + a_1x + a_2x^2 \quad (1)$$

In order to find the coefficients a_0 , a_1 and a_2 , the method of the least squares was used and the equation (1) was rewritten as

$$y = c_0\phi_0(x) + c_1\phi_1(x) + c_2\phi_2(x) \quad (2)$$

The $\phi_i(x)$'s are the orthogonal functions and are given by

$$\phi_0(x) = 1 \quad (3)$$

$$\phi_1(x) = x - \frac{[x]}{N} \quad (4)$$

$$\phi_2(x) = x^2 - \frac{[x^3]}{[x^2]} - \frac{[x][x^2]}{N} \left(x - \frac{[x]}{N} \right) - \frac{[x^2]}{N} \quad (5)$$

where the bracket [] is the sum $\sum_{i=1}^N$ and N is the number of data points.

The coefficients c_i were calculated from the formula

$$c_0 = \frac{[\phi_0(x) y]}{[\phi_0(x) \phi_0(x)]} = \frac{\sum_{i=1}^N y_i}{\sum_{i=1}^N \phi_0^2(x_i)} \quad (6)$$

$$c_1 = \frac{[\phi_1(x) y]}{[\phi_1(x) \phi_1(x)]} = \frac{\sum_{i=1}^N \phi_1(x_i) y_i}{\sum_{i=1}^N \phi_1^2(x_i)} \quad (7)$$

$$c_2 = \frac{[\phi_2(x) y]}{[\phi_2(x) \phi_2(x)]} = \frac{\sum_{i=1}^N \phi_2(x_i) y_i}{\sum_{i=1}^N \phi_2^2(x_i)} \quad (8)$$

The sample standard deviation is given by

$$s^2 = \frac{1}{N-3} \sum_{i=1}^N (y_i - y'_i)^2 \quad (9)$$

where $(y_i - y'_i)$ is the deviation between the observed values and the values fitted by the best curves.

C. RESULTS AND DISCUSSION

Several systems were selected for treatment by this method. The calculations are shown in Table (VII-1) to (VII-4). The first step is to find the orthogonal functions $\phi_i(x)$ using the equations (3) to (5).

The numerical values of $\phi_1(x_1)$ were then calculated and were used to find the coefficients c_1 using the equations (6) to (8). The next step is to substitute the ϕ_1 and c_1 into the least squares fitted equation (2) from which the fitted values y' (H_0) were calculated. These H_0 values are plotted in Figures 55 to 58 together with the values given in this thesis.

The sample standard deviation calculated by equation (9) were found to be 0.04, 0.09, 0.03 and 0.04 respectively for the H_2O -HF, KF-HF, AsF_5 -HF and SbF_5 -HF systems. Another quantity, $|\Delta y|$, the absolute magnitude of the greatest deviation between the observed values and the fitted values, is more indicative of the error in H_0 and was found to be 0.25, 0.36, 0.16 and 0.24 respectively for the above four systems.

It will be seen from Figures 55 to 58 that the H_0 values obtained by the method described in the appendix do not differ significantly from those obtained by the method used in the main body of the thesis. It was therefore not considered worthwhile to apply this alternative method to all experimental data in the thesis.

TABLE (VII-1) THE CALCULATION OF THE LEAST SQUARES METHOD FOR THE H₂O-HF SYSTEM

x	y	x ²	x ³	φ ₁ (x)	φ ₁ ² (x)	φ ₂ (x)	φ ₂ ² (x)	y'	Δy	Δy ²	
0.02	-10.92	0.0004	0.000008	-0.9825	0.9653	.5372	.2885838	-10.67	-.25	.0625	
0.12	-10.49	0.0144	0.001728	-0.8825	0.7788	.3352	.112359	-10.58	.09	.0081	
0.50	-10.24	0.2500	0.125000	-0.5025	0.2525	-.25	.0625	-10.26	.02	.0004	
0.67	-10.03	0.4489	0.300763	-0.3325	0.1106	-.4183	.1749748	-10.13	.10	.01	
1.07	-9.73	1.1449	1.225043	0.0675	0.0046	-.5863	.3437476	-9.85	.12	.0144	
1.54	-9.41	2.3716	3.652264	0.5375	0.2889	-.3748	.140475	-9.58	.17	.0289	
1.97	-9.61	3.8809	7.645373	0.9675	0.9361	.2057	.0423124	-9.38	-.23	.0529	
2.13	-9.33	4.5369	9.663597	1.1275	1.2713	.5161	.2663592	-9.32	.01	.0001	
Sum	8.02	-79.76	12.6480	22.613776	0	4.6081	-0.0352	1.4313118	-79.77	.03	.1773

φ₀(x) = 1

φ₁(x) = x - $\frac{8.02}{8}$ = x - 1.0025

φ₂(x) = x² - $\frac{22.6138}{8}$ - $\frac{(8.02)(12.648)}{8}$ (x - $\frac{8.02}{8}$) - $\frac{12.648}{8}$

φ x² - 2.16 x + 0.58

c₀ = $\frac{-79.76}{8}$ = -9.97

c₁ = $\frac{2.9350}{4.6081}$ = 0.637

c₂ = $\frac{-1.8735}{1.431312}$ = -0.131

y = -9.97 + 0.64(x-1.0025) - 0.13(x² - 2.16x + 0.58)

= -0.13 x² + 0.92 x - 10.69

TABLE (VII-2) THE CALCULATION OF THE LEAST SQUARES METHOD FOR THE KF-HF SYSTEM

x	y	x ²	x ³	$\phi_1(x)$	$\phi_1^2(x)$	$\phi_2(x)$	$\phi_2^2(x)$	y'	Δy	Δy^2
.0253	-10.87	.00064	.000016	-0.76667	0.58778	0.94821	.8991	-10.52	-.35	.1225
.1435	- 9.96	.02059	.002955	-0.64847	0.42051	0.62903	.39567	-10.23	.27	.0729
.3922	- 9.87	.15382	.060329	-0.39977	0.15981	0.04868	.00237	- 9.68	-.20	.04
.4294	- 9.76	.18438	.079175	-0.36257	0.13146	-0.02748	.00076	- 9.60	-.16	.0256
.4315	- 9.13	.18619	.080342	-0.36047	0.12993	-0.03170	.00101	- 9.48	.35	.1225
.8455	- 8.80	.71487	.604423	-0.05353	0.00287	-0.69087	.47773	- 8.89	.09	.0081
.8535	- 8.67	.742846	.621742	0.06153	0.00379	-0.70024	.49033	- 8.87	.20	.04
1.2118	- 8.80	1.46845	1.779479	0.41983	0.17626	-0.98827	.97669	- 8.44	-.36	.1296
2.7950	- 8.49	7.81203	21.83461	2.00303	4.01214	0.81277	.66060	- 8.53	.04	.0016
Sum	7.1277	-84.35	11.2695	25.0631	5.62455	3.90384	-84.24	-.12	.5628	

$$\phi_1(x) = x - 0.792$$

$$\phi_2(x) = x^2 - 2.87x + 1.02$$

$$c_0 = -9.37$$

$$c_1 = 0.69$$

$$c_2 = -.65$$

$$y = -0.65x^2 + 2.56x - 10.58$$

TABLE (VII-4). THE CALCULATION OF THE LEAST SQUARES METHOD FOR THE SBF₅-HF SYSTEM

x	y	x ²	x ³	$\phi_1(x)$	$\phi_1^2(x)$	$\phi_2(x)$	$\phi_2^2(x)$	y'	Δy	Δy^2	
0.11	-19.52	.0121	.00133	-.17	.0289	.0168	.000282	-19.69	.17	.029	
0.16	-20.10	.0256	.00410	-.12	.0144	.0008	.000006	-19.90	-.20	.04	
0.17	-20.01	.0289	.00491	-.11	.0121	-.0018	.000032	-19.94	-.07	.0049	
0.28	-20.23	.0784	.02195	0	0	-.0172	.000296	-20.34	.08	.0064	
0.33	-20.52	.1089	.03594	.05	.0025	-.0162	.0002624	-20.45	-.07	.0049	
0.43	-20.41	.1849	.07951	.15	.0225	.0008	.000006	-20.65	.24	.0576	
0.48	-20.90	.2304	.11059	.20	.0400	.0168	.0002822	-20.72	.18	.0324	
Sum	1.96	-141.69	.6692	.25833	0	.1204	0	.00113	-141.66	.33	.1752

$\phi_1(x) = x - 0.28$

$\phi_2(x) = x^2 - 0.59x + 0.0696$

$c_0 = -20.24$

$c_1 = -2.79$

$c_2 = 4.38$

$y = 4.38x^2 - 5.37x - 19.15$

LEAF 189 OMITTED IN PAGE NUMBERING.

TABLE (VII-3) THE CALCULATION OF THE LEAST SQUARES METHOD FOR THE ASF₅-HF SYSTEM

x	y	x ²	x ³	$\phi_1(x)$	$\phi_1^2(x)$	$\phi_2(x)$	$\phi_2^2(x)$	y'	Δy	Δy^2	
0.1039	-18.49	.01079	.00112	-.1774	.0315	0.02362	.00056	-18.56	0.07	.0049	
0.1625	-18.91	.02641	.00429	-.1188	.0141	0.00229	.000005	-18.78	-0.13	.0169	
0.2482	-18.90	.06160	.01529	-.0331	.0011	-0.01655	.000274	-19.05	0.15	.0225	
0.2513	-19.22	.06315	.01587	-.0300	.0009	-0.01696	.000287	-19.06	-0.16	.0256	
0.4016	-19.25	.16128	.06477	.1203	.0144	-0.01359	.000185	-19.39	0.14	.0196	
0.5205	-19.58	.27092	.14101	.2392	.0572	0.02108	.000044	-19.51	-0.07	.0049	
Sum	1.6880	-114.35	.59416	.24236	.0002	.11926	-.000098	.001753	-114.35	0	.0944

$\phi_1(x) = x - 0.2813$

$\phi_2(x) = x^2 - 0.63x + 0.08$

$c_0 = -19.06$

$c_1 = -2.27$

$c_2 = 4.20$

$y = 4.20x^2 - 4.92x - 18.09$

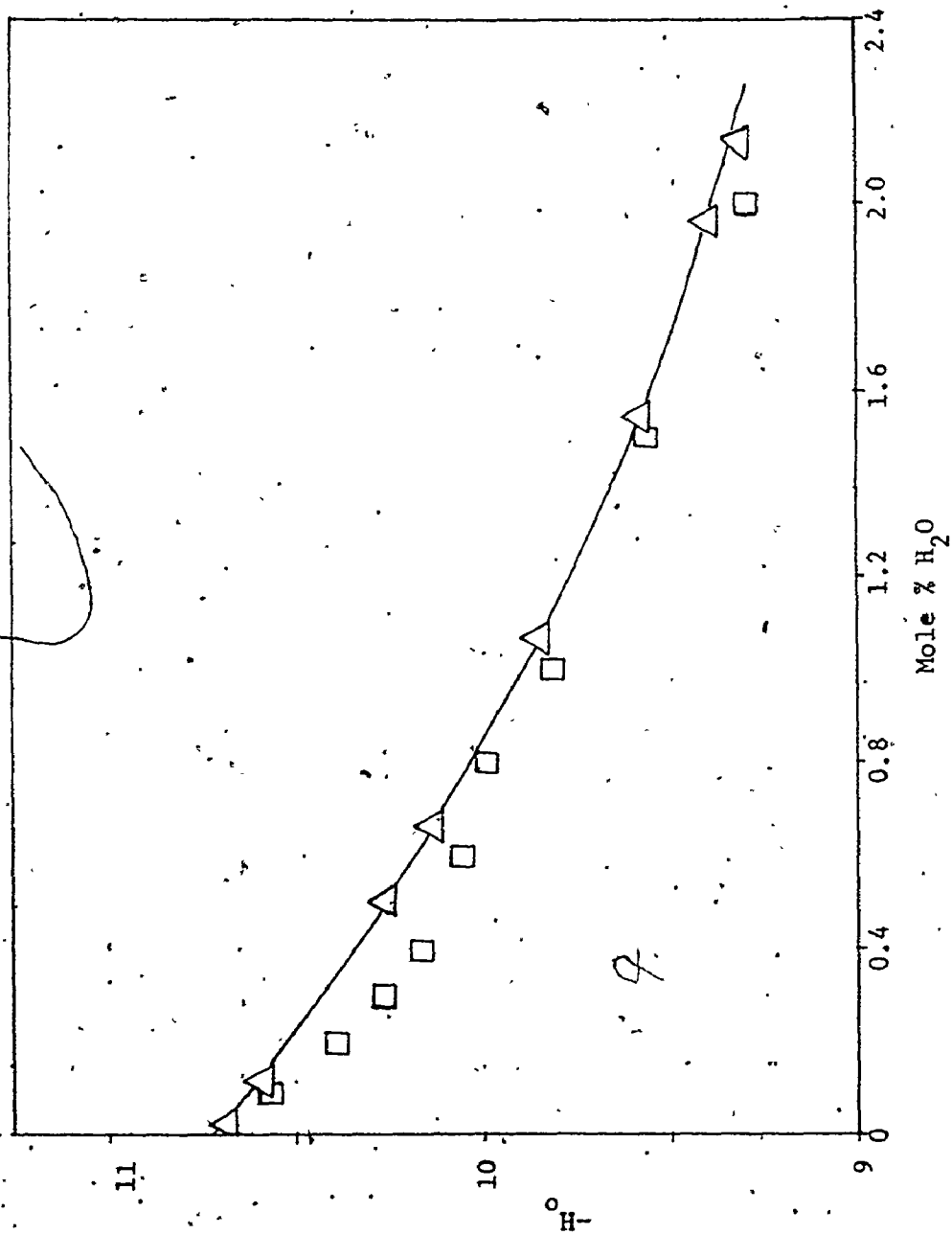

Figure 55. The H_o values for the H₂O-HF system. Δ -- values obtained by the least squares method, \square -- given in the thesis.

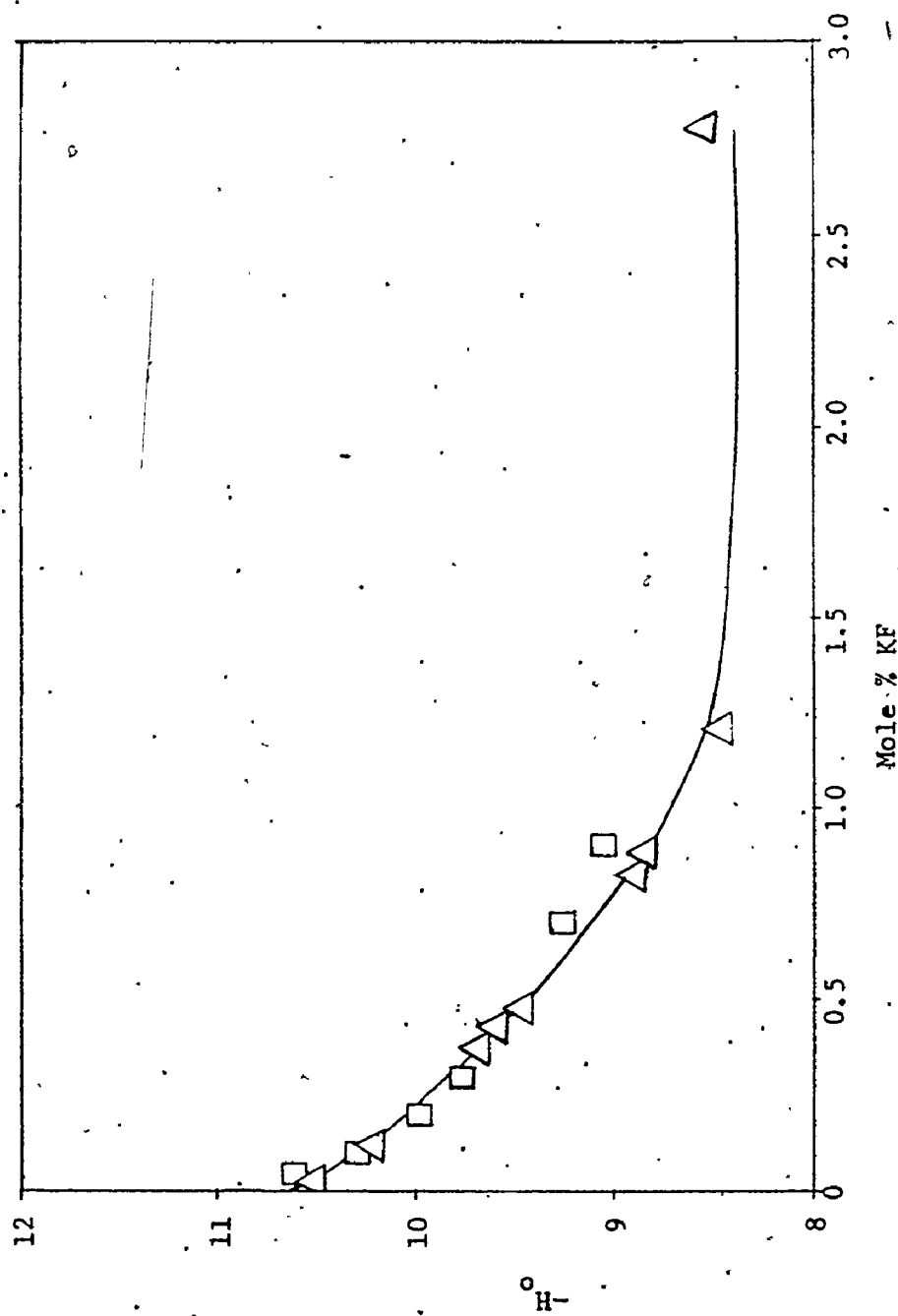

Figure 56. The H_o values for the KF-HF system. \triangle -- values obtained the least squares method, \square -- given in the thesis.

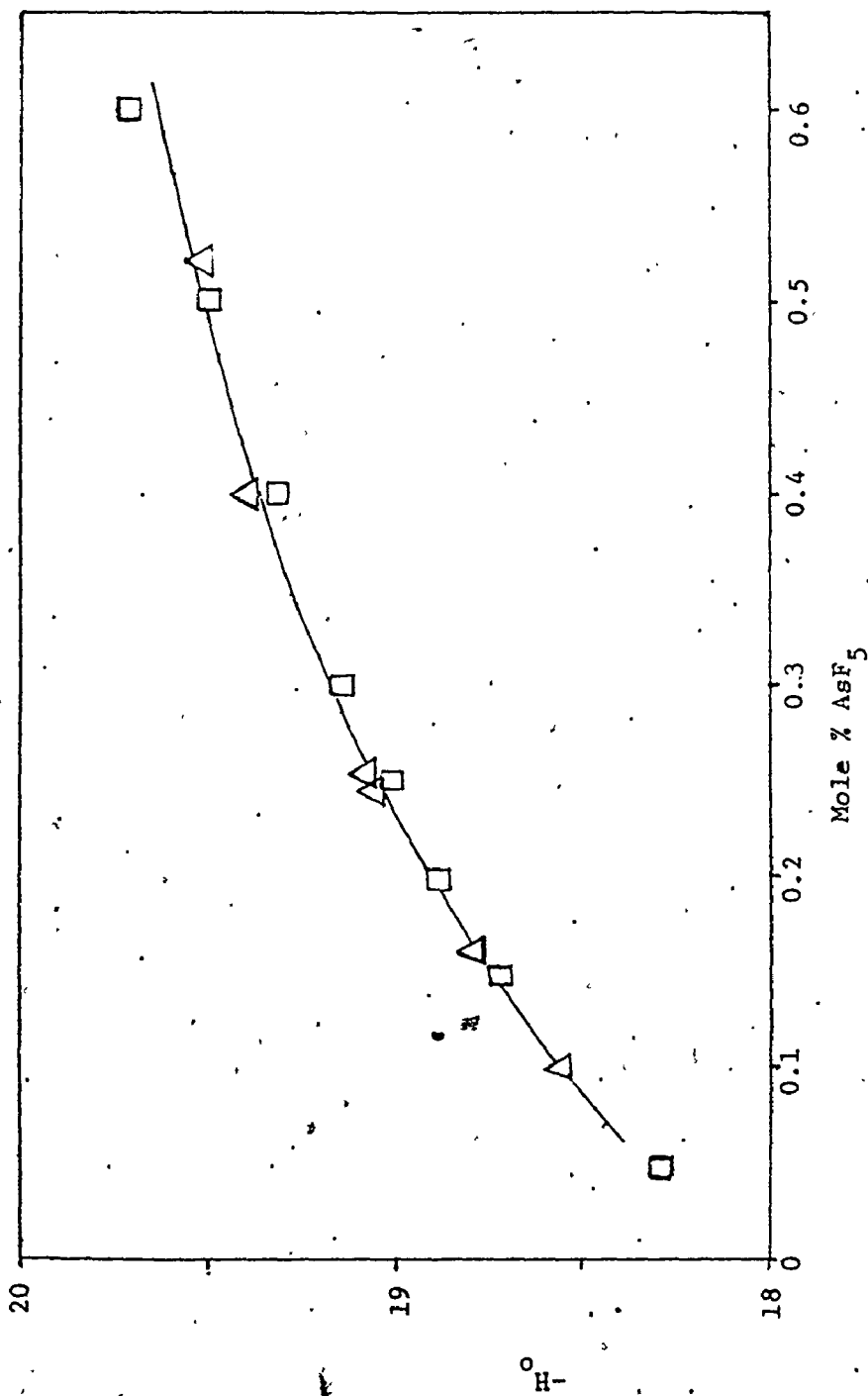

Figure 57. The H_0 values for the AsF_5 -HF system. Δ --- values obtained by the least squares method, \square -- given in the thesis.

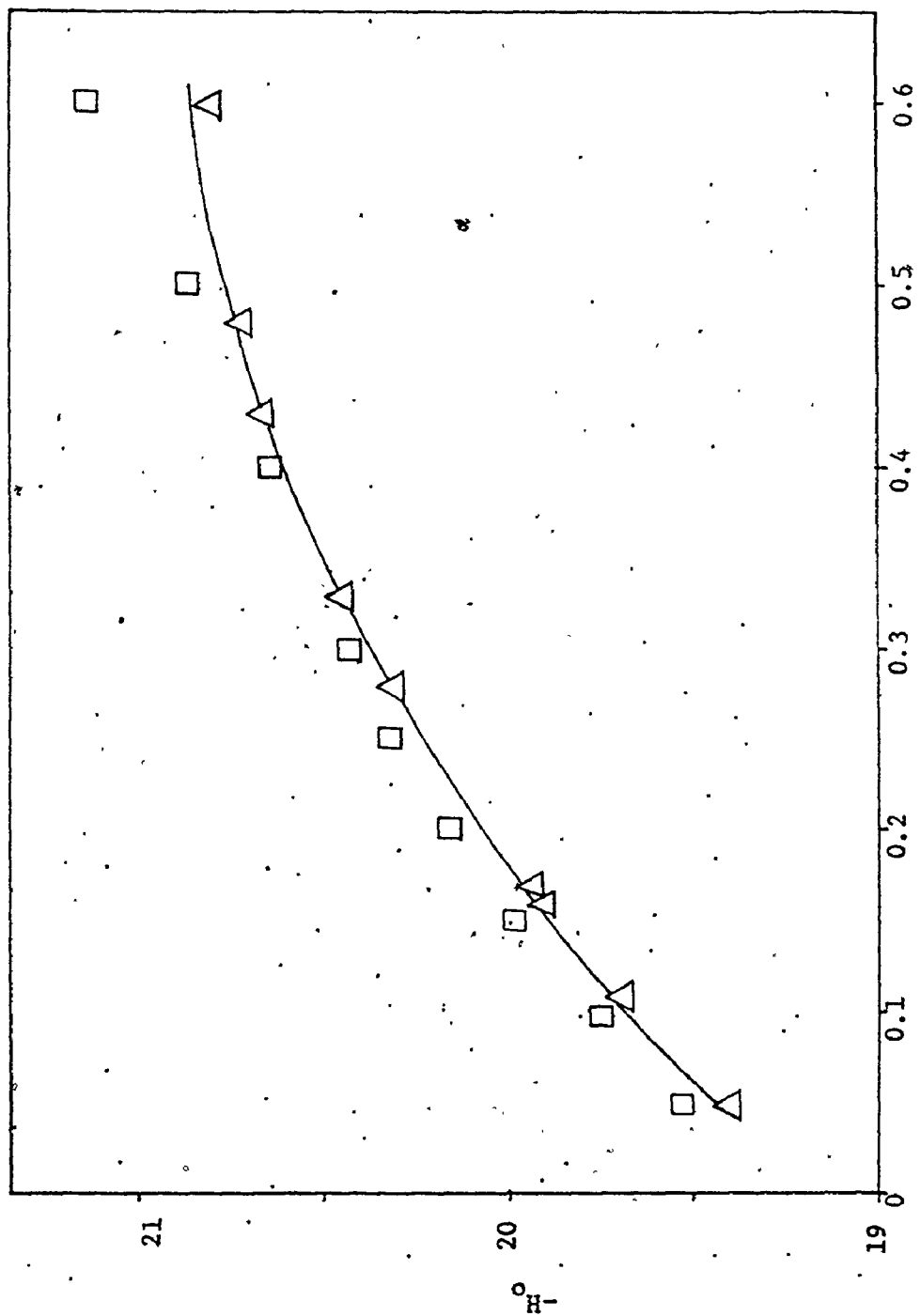

Figure 58. The H_0 values for the SbF_5 -HF system. \triangle --- values obtained by the least squares method, \square --- given in the thesis.