



Opentrons Flex

Instruction Manual



Opentrons Labworks Inc.

December 2023

© OPENTRONS 2023

Opentrons Flex™ (Opentrons Labworks, Inc.)

Registered names, trademarks, etc. used in this document, even when not specifically marked as such, are not to be considered unprotected by law.

Table of Contents

Preface	9
Structure of this manual	9
Notes and warnings	10
Chapter 1: Introduction	11
1.1 Welcome to Opentrons Flex	11
What's new in Flex	11
Flex workstations	12
1.2 Safety information	16
Safety symbols	16
Electrical safety warnings	17
Additional safety warnings	18
Safety cautions	18
Biological safety	19
Toxic fumes	19
Flammable liquids	19
1.3 Regulatory compliance	20
Safety	20
Electromagnetic compatibility	20
FCC warnings and notes	20
Canada ISED compliance	21
Environmental warning	21
Wi-Fi precertification	21
Chapter 2: Installation and Relocation	22
2.1 Safety and operating requirements	22
Where to place Opentrons Flex	22
Power consumption	24
Environmental conditions	24
2.2 Unboxing	25
Effort and time required	25
Crate and packing material	25
Product elements	26
Part 1: Remove the crate	27
Part 2: Release the Flex	29
Part 3: Final assembly and power on	32

2.3 First run	35
Power on	35
Connect to a network or computer	36
Install software updates	37
Attach Emergency Stop Pendant	38
Give your robot a name	38
2.4 Instrument installation and calibration	38
Pipette installation	39
Gripper installation	40
2.5 Relocation	40
Short moves	41
Long-distance moves	41
General moving advice	42
Final thoughts about moving	44
Chapter 3: System Description	45
3.1 Physical components	45
Frame and enclosure	46
Deck and working area	46
Staging area	47
Deck fixtures	48
Waste chute	49
Staging area slots	49
Movement system	51
Touchscreen and LED displays	51
3.2 Pipettes	53
Pipette specifications	54
Pipette calibration	55
Pipette tip rack adapter	55
Partial tip pickup	56
Pipette sensors	56
Pipette firmware updates	57
3.3 Gripper	57
Gripper specifications	58
Gripper calibration	58
Gripper firmware updates	58
3.4 Emergency Stop Pendant	59
When to use the E-stop	59
Engaging and releasing the E-stop	60

3.5 Connections	61
Power connection	61
USB and auxiliary connections	62
Network connections	62
3.6 System specifications	63
General specifications	63
Environmental specifications	64
Certifications	64
Serial number	64
Chapter 4: Modules	66
4.1 Supported modules	66
4.2 Module caddy system	67
4.3 Module calibration	68
When to calibrate modules	69
How to calibrate modules	69
4.4 Heater-Shaker Module GEN1	70
Heater-Shaker features	70
Heater-Shaker specifications	72
4.5 Magnetic Block GEN1	73
Magnetic Block features	73
Magnetic Block specifications	74
4.6 Temperature Module GEN2	75
Temperature Module features	75
Temperature Module specifications	77
4.7 Thermocycler Module GEN2	77
Thermocycler features	78
Thermocycler specifications	79
Chapter 5: Labware	80
5.1 Labware concepts	80
Labware as hardware	80
Labware as data	80
Custom labware	81
5.2 Reservoirs	82
Single-well reservoirs	82
Multi-well reservoirs	82
Reservoirs and API definitions	83
Custom reservoir labware	83
5.3 Well plates	83

6-well plates	84
12-well plates	84
24-well plates.....	84
48-well plates.....	84
96-well plates.....	85
384-well plates	86
Well plate adapters.....	86
Well plates and API definitions.....	87
Custom well plate labware.....	87
5.4 Tips and tip racks	88
Tip racks	88
Tip-pipette compatibility	89
Tip rack adapter.....	89
5.5 Tubes and tube racks	90
Tube and rack combinations	91
6-tube racks	91
10-tube racks.....	91
15-tube racks	92
24-tube racks	92
Tube rack API definitions	92
Custom tube rack labware.....	93
5.6 Aluminum blocks	93
Flat bottom plate	93
24-well aluminum block	94
96-well aluminum block	94
Standalone adapters	94
Aluminum block labware combinations	94
24-well aluminum block labware combinations.....	95
96-well aluminum block labware combinations.....	95
5.7 Labware and the Opentrons Flex Gripper	96
5.8 Custom labware definitions	96
Creating custom labware definitions	97
JSON labware schema.....	99
JSON labware definitions	104
Chapter 6: Protocol Development	105
6.1 Pre-made protocols	105
Protocol Library	105
Custom Protocol Development service	107

6.2 Protocol Designer	109
Protocol Designer requirements	109
Designing a protocol	110
Modifying existing protocols.....	114
6.3 Python Protocol API	115
Writing and running scripts.....	115
Python-exclusive features	116
6.4 OT-2 protocols.....	117
OT-2 Python protocols.....	118
OT-2 JSON protocols	120
Magnetic Module protocols.....	120
Chapter 7: Software and Operation.....	121
7.1 Touchscreen operation.....	121
Robot dashboard	121
Protocol management	122
Protocol details	124
Run setup	127
Labware Position Check	128
Run progress.....	130
Run completion	131
Instrument management.....	132
Robot settings.....	133
Deck configuration	136
7.2 Opentrons App.....	139
App installation	139
Transferring protocols to Flex.....	140
Module status and controls	142
Recent protocol runs	143
7.3 Advanced operation.....	144
Jupyter Notebook	144
Command-line operation over SSH.....	145
Chapter 8: Maintenance and Service	147
8.1 Cleaning your Flex	147
Before you begin	147
What you can clean.....	147
Cleaning solutions.....	148
Frame and window panel cleaning	148
Deck cleaning	148

Gantry cleaning	149
Waste chute cleaning	149
8.2 Cleaning pipettes and tips	149
Pipette decontamination.....	150
Cleaning pipette tips	151
8.3 Cleaning the gripper.....	152
8.4 Cleaning modules.....	153
General module cleaning	153
Thermocycler seals.....	154
8.5 Autoclave-safe labware.....	154
8.6 Servicing Flex	155
Opentrons services.....	155
Installation qualification and operation qualification ...	155
Preventative maintenance	156
Warranty.....	157
Appendix A: Glossary	158
Appendix B: Additional Documentation.....	170
B.1 Opentrons Knowledge Hub	170
B.2 Python Protocol API documentation.....	170
B.3 Opentrons HTTP API reference.....	171
B.4 Developer documentation.....	171
Appendix C: Open-Source Software	172
C.1 Opentrons on GitHub.....	172
C.2 Opentrons monorepo	173
C.3 Other repositories	175
Appendix D: Support and Contact Information	176
D.1 Sales	176
D.2 Support	176
D.3 Business information	177

Preface

Welcome to the instruction manual for the Opentrons Flex liquid handling robot. This manual guides you through just about everything you need to know to set up and use Flex, focusing on topics that are most relevant to everyday users of Flex in a lab environment.

Structure of this manual

Opentrons Flex is a complex system, so there are many different paths to learning everything it can do. Feel free to jump straight to the chapter that addresses whatever topic you're curious about! For example, if you already have a Flex set up in your lab, you can skip past the Installation and Relocation chapter.

If you prefer a guided approach, this manual is structured so you can follow it from beginning to end.

- **Learn about Flex.** The distinguishing features of Flex are listed in [Chapter 1: Introduction](#). The introduction also includes important safety and regulatory information.
- **Get started with Flex.** If you need to set up your Flex, follow the detailed instructions in [Chapter 2: Installation and Relocation](#). Then familiarize yourself with the components of Flex in [Chapter 3: System Description](#).
- **Set up your deck.** Configuring the deck enables different scientific applications on Flex. [Chapter 4: Modules](#) describes Opentrons peripherals that you can install into or on top of the deck to perform specific scientific tasks. [Chapter 5: Labware](#) explains how to work with equipment for holding liquids.
- **Run a protocol.** The core use of Flex is running standardized scientific procedures, known as protocols. [Chapter 6: Protocol Development](#) offers several ways to get ready-made protocols or design them yourself. To run your protocol, follow the instructions in [Chapter 7: Software and Operation](#), which also has instructions for performing other tasks and customizing your robot's settings.
- **Keep Flex running.** Follow the advice in [Chapter 8: Maintenance and Service](#) to keep your Flex clean and running optimally. Or sign up for one of the Opentrons services listed there and let us take care of Flex for you.
- **Learn even more.** Still need something else? Consult the appendices.
 - [Appendix A: Glossary](#) defines Flex-related terms.
 - [Appendix B: Additional Documentation](#) points you to even more resources for Opentrons products and writing code to control Flex.

■ PREFACE

- [Appendix C: Open-Source Software](#) explains how Opentrons software is hosted on GitHub as a resource for both developers and non-developers.
- [Appendix D: Support and Contact Information](#) lists how to get in touch with Opentrons if you need assistance beyond what our documentation provides.

Notes and warnings

Throughout this manual, you'll find specially formatted note and warning blocks. Notes provide helpful information that may not be obvious in the ordinary course of using Flex. Pay special attention to warnings — they are only used in situations where you run the risk of personal injury, damage to equipment, loss or spoilage of samples or reagents, data loss, or other harm.

Notes and warnings look like this:



Sample Note: This is something you ought to know, but it doesn't pose any danger.



Sample Warning: This is something you need to know because there is risk associated with it.

Introduction

This chapter introduces you to the Opentrons Flex ecosystem, including the overall system design and available workstation configurations. It also includes important compliance and safety information, which you should review before setting up your Opentrons Flex robot. For more details on the features of Opentrons Flex, see the [System Description chapter](#).

1.1 Welcome to Opentrons Flex

Opentrons Flex is a liquid-handling robot designed for high throughput and complex workflows. The Flex robot is the base of a modular system that includes pipettes, a labware gripper, deck fixtures, on-deck modules, and labware — all of which you can swap out yourself. Flex is designed with a touchscreen so you can work with it directly at the lab bench, or you can control it from across your lab with the Opentrons App or our open-source APIs.

Flex workstations come with all of the equipment — robot, hardware, and labware — that you need to get started automating common lab tasks. For other applications, Opentrons Flex runs on fully open-source software and firmware, and is reagent- and labware-agnostic, giving you control over how you design and run your protocols.

What's new in Flex

Opentrons Flex is part of the Opentrons liquid handler series of robots. Users of Opentrons Flex may be familiar with the Opentrons OT-2, our personal pipetting robot. Flex goes beyond the capabilities of OT-2 in several key areas, delivering higher throughput and walkaway time.

Feature	Description
Pipette throughput	Flex pipettes have 1, 8, or 96 channels. The 96-channel pipette operates on 12 times as many wells at once as the largest OT-2 pipette.
Pipette and tip capacities	Flex pipettes have larger volume ranges (1–50 μL , 5–1000 μL) and can all work with any volume of Opentrons Flex tips. This is an improvement over OT-2 pipettes, which have smaller ranges and must use tips with a matching volume range.

Gripper	The Opentrons Flex Gripper picks up and moves labware around the deck automatically, without user intervention. The gripper enables more complex workflows within a single protocol run.
Automated calibration	Positional calibration of Flex pipettes and the gripper is fully automated. Press one button, and the instrument will move to precision-machined points on the deck to determine its exact position, saving that data for use in your protocols.
Touchscreen	Flex has its own touchscreen interface that lets you control it directly, in addition to using the Opentrons App. Use the touchscreen to start protocol runs, check job status, and change settings right on the robot.
Module caddies	Flex modules fit into caddies that occupy space below the deck. Caddies place your labware closer to the deck surface and allow for below-deck cable routing. Caddies enable even more module and labware configurations on the deck.
Deck slot coordinates	Deck slots on Flex are numbered with a coordinate system (A1–D4) which is similar to how wells are numbered on labware.
Movable trash	The trash bin can go in multiple deck locations on Flex. The default location (slot A3) is the recommended position. You can also use the gripper to dispose of trash in the optional waste chute.
Size and weight	Flex is a bit bigger and much heavier than OT-2. Installation tasks on Flex require the assistance of a lab partner.

A detailed [comparison of robot technical specifications](#) is available on the Opentrons website.

Both Flex and OT-2 robots run on our open-source software, and the Opentrons App can control both types of robots at once. While OT-2 protocols can't be run directly on Flex, it's straightforward to adapt them (see the [OT-2 Protocols section](#) of the Protocol Development chapter for details).

Flex workstations

Opentrons Flex workstations include the Flex robot, accessories, pipettes and gripper, on-deck modules, and labware needed to automate a particular application. All workstation components are modular. If you need to change applications, you can add or swap in other Flex hardware and compatible consumables.

■ CHAPTER 1: INTRODUCTION

NGS WORKSTATION

The Opentrons Flex NGS Workstation automates NGS library prep. It can automate pre-sequencing workflows using any leading reagent system, including fragmentation- and tagmentation-based library prep.

In addition to the Flex robot, the NGS Workstation includes:

- Gripper
- Choice of pipette configuration
 - Two 8-Channel Pipettes (1–50 μ L and 5–1000 μ L)
 - 96-Channel Pipette (5–1000 μ L)
- Waste Chute
- Magnetic Block
- Temperature Module
- Thermocycler Module
- Labware kit with filter tips, microcentrifuge tubes, reservoirs, and PCR plates

PCR WORKSTATION

The Opentrons Flex PCR Workstation automates PCR setup and thermocycling workflows for up to 96 samples. It can aliquot chilled reagents and samples into a 96-well PCR plate. With the addition of the automated Thermocycler Module, use the gripper to load the plate into the Thermocycler, and then run your chosen PCR program.

In addition to the Flex robot, the PCR Workstation includes:

- Gripper
- Choice of pipette configuration
 - 1-Channel Pipette (1–50 μ L) and 8-Channel Pipette (1–50 μ L)
 - 96-Channel Pipette (5–1000 μ L)
- Waste Chute
- Temperature Module
- Labware kit with filter tips, microcentrifuge tubes, reservoirs, and PCR plates

■ CHAPTER 1: INTRODUCTION

NUCLEIC ACID EXTRACTION WORKSTATION

The Opentrons Flex Nucleic Acid Extraction Workstation automates DNA/RNA isolation and purification. It uses the Magnetic Block for separation of magnetic beads, and the Heater-Shaker for sample lysis and resuspension of magnetic beads.

In addition to the Flex robot, the Nucleic Acid Extraction Workstation includes:

- Gripper
- Choice of pipette configuration
 - 1-Channel Pipette (5–1000 µL) and 8-Channel Pipette (5–1000 µL)
 - 96-Channel Pipette (5–1000 µL)
- Waste Chute
- Magnetic Block
- Heater-Shaker Module
- Labware kit with filter tips, reservoirs, PCR plates, and deep well plates

MAGNETIC BEAD PROTEIN PURIFICATION WORKSTATION

The Opentrons Flex Magnetic Bead Protein Purification Workstation automates small-scale protein purification and proteomics sample prep for up to 96 samples. It is compatible with many popular magnetic-bead-based reagents.

In addition to the Flex robot, the Protein Purification Workstation includes:

- Gripper
- Choice of pipette configuration
 - 1-Channel Pipette (5–1000 µL) and 8-Channel Pipette (5–1000 µL)
 - 96-Channel Pipette (5–1000 µL)
- Waste Chute
- Magnetic Block
- Heater-Shaker Module
- Labware kit with filter tips, reservoirs, PCR plates, and deep well plates

FLEX PREP WORKSTATION

The Opentrons Flex Prep Workstation automates simple pipetting workflows. Configure the workstation with 1-Channel and 8-Channel Pipettes to perform tasks such as sample transfer, sample duplication, and

■ CHAPTER 1: INTRODUCTION

reagent aliquoting. Configure the workstation with the 96-Channel Pipette to perform high-throughput reagent aliquoting and plate stamping.

In addition to the Flex robot, the Flex Prep Workstation includes:

- Choice of pipette configuration:
 - 1-Channel Pipette (5–1000 μL) and 8-Channel Pipette (5–1000 μL)
 - 96-Channel Pipette (5–1000 μL)
- Labware kit with filter tips, microcentrifuge tubes, and reservoirs

PLASMID PREP WORKSTATION

The Opentrons Flex Plasmid Prep Workstation automates magnetic-bead-based plasmid extraction and purification workflows. This workstation is equipped with high-volume pipettes, a Heater-Shaker Module, and a Magnetic Block to accommodate most bead-based chemistry.

In addition to the Flex robot, the Plasmid Prep Workstation includes:

- Gripper
- 1-Channel Pipette (5–1000 μL) and 8-Channel Pipette (5–1000 μL)
- Waste Chute
- Magnetic Block
- Heater-Shaker Module
- Labware kit with filter tips, microcentrifuge tubes, reservoirs, PCR plates, and deep well plates

SYNBIO WORKSTATION

The Opentrons Flex SynBio Workstation automates a variety of synthetic biology workflows such as DNA synthesis and cloning. It uses the Magnetic Block and Temperature Module to support most bead-based chemistry. Add the Thermocycler Module to perform heated lid incubations and amplifications.

In addition to the Flex robot, the SynBio Workstation includes:

- Gripper
- 1-Channel Pipette (5–1000 μL) and 8-Channel Pipette (5–1000 μL)
- Magnetic Block
- Temperature Module





- Labware kit with regular and filter tips, microcentrifuge tubes, reservoirs, PCR plates, and deep well plates

1.2 Safety information

The Opentrons Flex liquid handling robot has been designed for safe operation. Refer to the specifications and compliance guidelines in this section to ensure safe usage of your Flex. These guidelines cover safe use of input and output connections for the product, including the power and data connections, as well as warning labels found on the Flex robot and related hardware. Using the device in a manner other than those specified in this manual may put the user and equipment at risk.

Safety symbols

Various labels on the Flex and in this manual warn you about sources of potential injury or harm.

Symbol	Description
	<p>Warning: Alerts users to</p> <ul style="list-style-type: none"> ▪ Potentially hazardous conditions. ▪ Actions that may result in personal injury or death.
	<p>Caution: Cautions users against</p> <ul style="list-style-type: none"> ▪ Damage to the equipment. ▪ Lost or corrupted data. ▪ Unrecoverable interruption of the operation being performed.
	<p>Electrical shock: Identifies instrument components that might pose a risk of electrical shock if the instrument is handled improperly.</p>
	<p>Hot surface: Identifies instrument components that pose a risk of personal injury due to high heat/temperatures if the instrument is handled improperly.</p>
	<p>Pinch point: Identifies instrument components that can pose a risk of personal injury when in motion.</p>



CHAPTER 1: INTRODUCTION

You will find the following labels on the Flex:

- Intellectual property labels
- Regulatory compliance labels (e.g., [ETL](#))
- Electrical hazard labels
- General warning labels
- Product labels
- Pinch point labels
- High voltage labels
- Power rating labels

Electrical safety warnings





Always observe the following electrical safety warnings:

Symbol	Description
	Plug the robot into a grounded, Class 1 circuit. See the Power Connection section in the System Description chapter.
	Do not connect (plug in), disconnect (unplug), or use AC power cables if: <ul style="list-style-type: none">▪ The cable is frayed or damaged.▪ Other attached cables, cords, or receptacles are frayed or damaged. Using damaged power cords can cause an electric shock hazard resulting in serious injury or damage to the robot.
	Do not replace the AC power cable unless at the direction of Opentrons Support.

For more information on electrical requirements, see the [Power Consumption section](#) of the Installation and Relocation chapter.



Additional safety warnings

Always observe the following additional safety warnings:

Symbol	Description
	Opentrons Flex has not been certified for use with explosive or flammable liquids. Do not load plates, tubes, or vials containing explosive or flammable liquids into the robot or otherwise operate the instrument with explosive or flammable liquids in the enclosure.
	Use good laboratory practices and follow the manufacturer's precautions when working with chemicals. Opentrons is not responsible or liable for any damages because of, or as a result of, the use of hazardous chemicals.
	The Flex weighs 88.5 kg (195 lbs). As a result, it requires two people to lift and move it safely. See the Relocation section in the Installation and Relocation chapter.
	The Flex should be placed on a surface capable of supporting its weight of 88.5 kg (195 lbs) with sufficient surface area to accommodate the robot plus its minimum clearance distance (20 cm/8 in). See the Safety and Operating Requirements section in the Installation and Relocation chapter.
	The Flex can emit vibrations while in operation. Place the robot on a surface that is sturdy, level, and water-resistant with cross-bracing or welded joints. See the Safety and Operating Requirements section in the Installation and Relocation chapter.

Safety cautions

To help protect the Flex from damage, follow these precautions:

Symbol	Description
	Use labware that is ANSI/SLAS-compliant or approved by Opentrons. See the Labware chapter .
	Keep corrosive materials, agents, or otherwise damaging materials away from the robot.

Biological safety

Treat specimens and reagents containing materials taken from humans as potentially infectious agents. Opentrons recommends using safe laboratory procedures as explained in [Biosafety in Microbiological and Biomedical Laboratories \(BMBL\) 6th Edition](#).

Under normal circumstances, the Flex does not create detectable aerosols from source liquids. However, under certain conditions, it is possible to generate aerosols from source liquids. When operating with biosafety level 2 or greater source liquids, consider taking precautions against aerosol exposure, in accordance with your local regulatory bodies. To minimize the potential risk of aerosol exposure from the robot, ensure that you:

- Perform maintenance as described in the [Maintenance and Service chapter](#).
- Properly install and secure all instrument covers, pipettes, modules, and labware.
- Use proper pipetting technique to aid in the mitigation of aerosols.

Toxic fumes

If you're working with volatile solvents or toxic substances, use an efficient laboratory ventilation system to remove any vapors that may be produced.

Flammable liquids

The Flex has not been evaluated for use with flammable liquids and should not be used with flammable liquids.

1.3 Regulatory compliance

Opentrons Flex complies with all applicable requirements of the following safety and electromagnetic standards.

Safety

Rule ID	Title
IEC/UL/CSA 61010-1	Safety Requirements for Electrical Equipment for Measurement, Control, and Laboratory Use – Part 1: General Requirements
IEC/UL/CSA 61010-2-051	Particular requirements for laboratory equipment for mixing and stirring

Electromagnetic compatibility

Rule ID	Title
EN/BSI 61326-1	Electrical Equipment for Measurement, Control, and Laboratory Use – EMC Requirements – Part 1: General Requirements
FCC 47 CFR Part 15 Subpart B Class A	Unintentional Radiators
IC ICES-003	Spectrum Management and Telecommunications – Interference-Causing Equipment Standard – Information Technology Equipment (Including Digital Apparatus)

FCC warnings and notes

Warning: Changes or modifications to this unit not expressly approved by Opentrons could void the user's authority to operate the equipment.

This device complies with Part 15 of the FCC rules. Operation is subject to the following:

■ CHAPTER 1: INTRODUCTION

- This device may not cause harmful interference.
- This device must accept any interference received, including interference that may cause undesired operation.

Note: This equipment has been tested and found to comply with the limits for a Class A digital device, pursuant to Part 15 of the FCC rules. These limits are designed to provide reasonable protection against harmful interference when the equipment is operated in a commercial environment. This equipment generates, uses, and can radiate radio frequency energy and, if not installed and used in accordance with the instruction manual, may cause harmful interference to radio communications. Operation of this equipment in a residential area is likely to cause harmful interference in which case the user will be required to correct the interference at their own expense.

Canada ISED compliance

Canada ICES-003(A) / NMB-003(A)

This product meets the applicable Innovation, Science and Economic Development Canada technical specifications.

Le présent produit est conforme aux spécifications techniques applicables d'Innovation, Sciences et Développement économique Canada.

Environmental warning

Warning: Cancer and Reproductive Harm – www.P65Warnings.ca.gov

Wi-Fi precertification

The Wi-Fi module is precertified for use in many regions:

- United States (FCC): FCC Identifier UAY-W8997-M1216
- European Economic Area (CE): No public identifier (self-declaration)
- Canada (IC): Hardware Version Identification Number W8997-M1216
- Japan (TELEC): Certified number 020-170034
- India (WPC): Registration number ETA-SD-20191005525 (self-declaration)

Installation and Relocation

This chapter describes how to prepare your lab for Opentrons Flex, how to set up the robot, and how to move it if necessary. Before taking delivery of your Flex, make sure that your lab or facility meets all the criteria in the Safety and Operating Requirements section. When it's time to get your Flex up and running, follow the detailed instructions in the Unboxing, First Run, and Instrument Installation and Calibration sections, or use the Opentrons [Onsite Support Set Up service](#). And if you ever need to move your Flex to a new location, near or far, follow the steps in the Relocation section.

2.1 Safety and operating requirements

Where to place Opentrons Flex

Space is a valuable commodity in almost every lab. Your Flex is going to need some — but not too much, as it's designed to fit on half of a standard lab bench. Make sure that you have a space that meets the following criteria.

- **Bench surface:** Stationary, sturdy, level, water-resistant surface. Tables or benches with wheels (even locking wheels) are not recommended. Flex moves quickly and has a lot of mass, which can shake or imbalance lightweight or movable tables.
- **Weight bearing:** The robot alone weighs 88.5 kg (195 lb) and should only be lifted by two people working together. Place the robot on a surface that can readily support its weight plus the weight of any modules, labware, liquids, or other lab equipment to be used in your applications.
- **Operating space:** The robot's base dimensions are 87 cm W x 69 cm D x 84 cm H (about 34" x 27" x 33"). Flex needs 20 cm (8") of side and back clearance for cables, USB connections, and to dissipate exhaust from modules that heat and cool.



Warning: *Do not* position the sides or back of the Flex flush against a wall.

CHAPTER 2: INSTALLATION AND RELOCATION

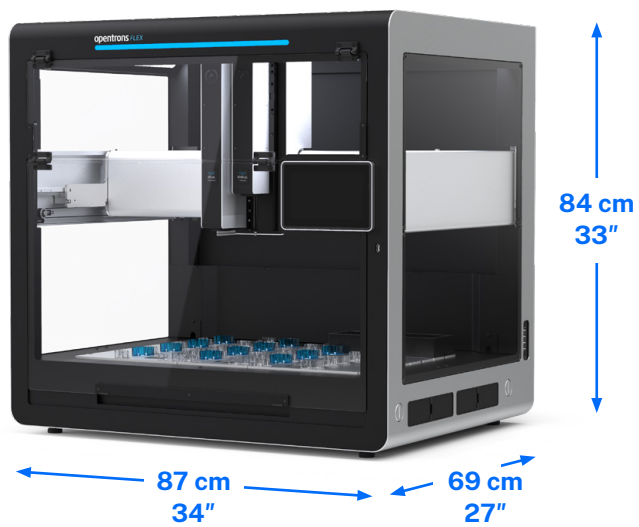

Opentrons Flex base dimensions.

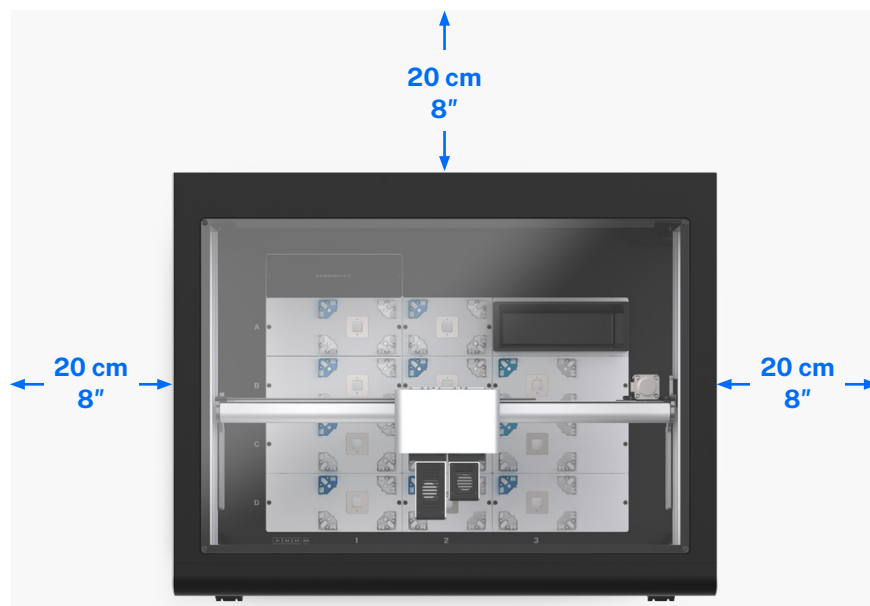

Top view of Opentrons Flex, showing minimum side and back clearance.

Power consumption

Opentrons Flex should be connected to a wall outlet at or near the bench location where you install it. Only connect Flex to circuits that can accommodate its maximum power draw:

- **Input power:** 36 VDC, 6.1 A
- **Idle consumption:** 30–40 W
- **Typical consumption:** 50–100 W (during protocol run)
- **Maximum consumption:** Approximately 120 W

Exact power consumption depends on:

- The amount and type of movement executed during a protocol.
- The amount of time the robot spends idle.
- The status of the lights on the robot.
- How many instruments are attached.

Remember to account for other electronics that consume power on the same circuit, including Flex modules with their own power supplies. For example, the Thermocycler Module has a maximum power consumption (630 W) that is much greater than the Flex robot itself. If necessary, consult the manager of your facility to make sure it meets your equipment’s power requirements.

Environmental conditions

Environmental conditions for recommended use, acceptable use, and storage vary:

	Recommended for system operation	Acceptable for system operation	Storage and transportation
Ambient temperature	+20 to +25 °C	+2 to +40 °C	-10 to +60 °C
Relative humidity	40–60%, non-condensing	30–80%, non-condensing (below 30 °C)	10–85%, non-condensing (below 30 °C)
Altitude	Approximately 500 m above sea level	Up to 2000 m above sea level	Up to 2000 m above sea level

■ CHAPTER 2: INSTALLATION AND RELOCATION

Opentrons has validated the performance of Opentrons Flex in the conditions recommended for system operation, and operation in those conditions should provide optimal results. Flex is safe to use in conditions acceptable for system operation, but results may vary. Do not power on or use Flex in conditions outside of those bounds. The storage and transportation conditions only apply when the robot is completely disconnected from power and other equipment.

2.2 Unboxing

Congratulations! Your Opentrons Flex has arrived and you've prepared a space for it in your lab. Let's open that monster crate, remove the robot, and prepare it for operation. The information in this section provides a parts list and instructions that walk you through the steps required to get the Flex unboxed, set up, and ready for use. We've divided the setup procedure into three parts:

- Part 1 covers disassembling the crate.
- Part 2 covers detaching the Flex from the crate and moving it to a final assembly location.
- Part 3 covers final assembly and powering on the robot for the first time.

Effort and time required

You'll want to ask a lab partner to assist with the unboxing, lifting, moving, and assembly process. You'll need to budget about 30 minutes to an hour for this effort.



Note: The Flex requires two people to lift it properly. Also, lifting and carrying the Flex by its handles is the best way to move the robot.

Crate and packing material

Unpacking a Flex gives you an awesome robot, but you're also left with several large crate panels along with assorted shipping components and padding. While you could discard this material, we encourage you to keep these items if storage space is available. The packaging is reusable, which helps prepare your Flex for shipping if you ever need to send it somewhere else (e.g., to a conference or a new facility) in the future.

Product elements

The Flex ships with the components listed below. Pipettes, the gripper, and modules come in separate packaging from the main Flex crate, even if you purchased them together as a workstation.

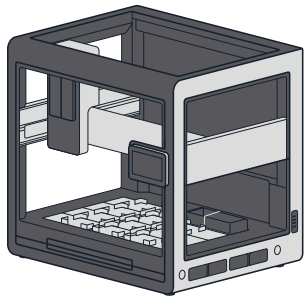

(1) Opentrons Flex robot

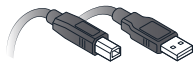

(1) USB cable



(1) Power cable



(1) Ethernet cable



(5) L-keys
(12 mm hex, 1.5 mm hex,
2.5 mm hex, 3 mm hex,
T10 Torx)

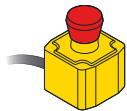

(1) Emergency Stop Pendant

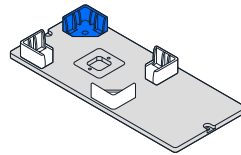

(1) Deck slot with labware clips

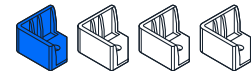

(4) Spare labware clips



(1) Pipette calibration probe

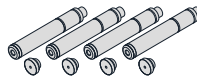

(4) Carrying handles and caps

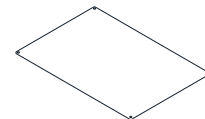

(1) Top window panel

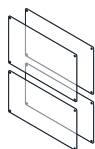

(4) Side window panels

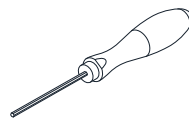

(1) 2.5 mm hex screwdriver

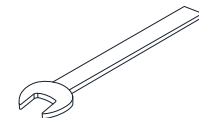

(1) 19 mm wrench



(16 + spares) Window screws
(M4x8 mm flat head)



(10) Spare deck slot screws
(M4x10 mm socket head)



(12) Spare deck clip screws
(M3x6 mm socket head)

Part 1: Remove the crate

Opentrons ships your Flex in a sturdy plywood crate. The shipping crate uses hook and latch clamps to secure the top, side, and bottom panels together. Using latches, instead of nails or screws, means you won't need a crowbar (or a lot of force) to disassemble the crate, and you can reassemble it later, if needed.



Note: Crate edges can get roughed up during shipping. You may want to use work gloves to protect your hands from wood splinters.

To release the latches, flip the latch tab up and turn it to the left (counterclockwise). This action moves the clamp arm out of its corresponding retaining bracket. You can then flip the latch arm away from the crate.

- 1 Unlock the eight latches holding the top to the sides.

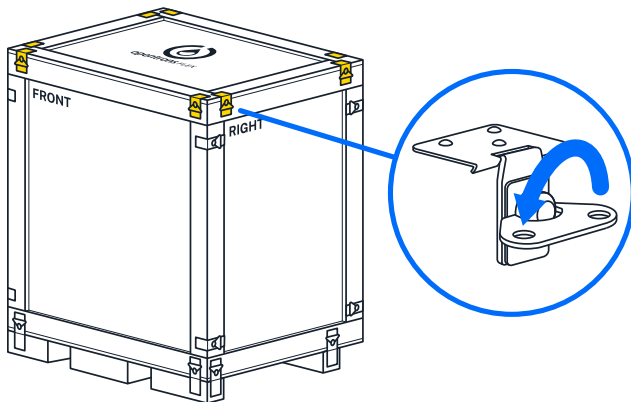

- 2 Remove the top panel after releasing the latches.

CHAPTER 2: INSTALLATION AND RELOCATION

- 3 Cut open the blue shipping bag, remove these items from the padding, and set them aside:
 - User Kit
 - Power, Ethernet, and USB cables
 - Emergency Stop Pendant

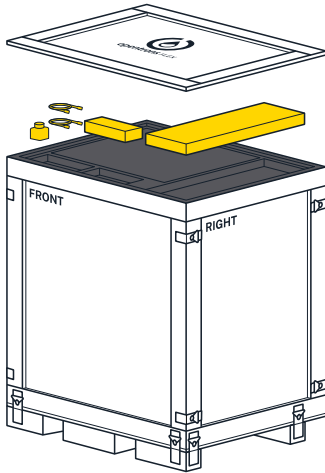

- 4 Remove the top piece of foam padding to expose the window panels. The padding protects the side and top panels.
- 5 Remove the window panels and set them aside. You'll attach these later.

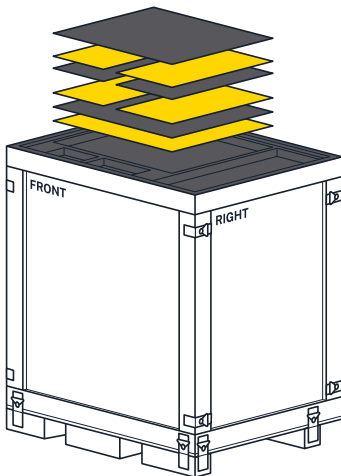

CHAPTER 2: INSTALLATION AND RELOCATION

- 6 Unlock the remaining 16 latches holding the side panels to each other and the base of the crate.
- 7 Remove the side panels and set them aside.

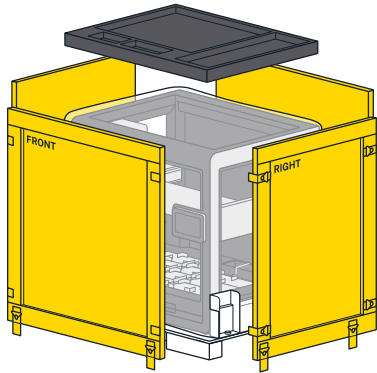

Part 2: Release the Flex

After completing the steps in Part 1, you should now see a robot that's in a protective bag and attached to orange steel mounting components. The bag encloses the robot and protects it from the outside environment. Steel brackets secure the robot to the bottom of the crate. Two shipping frames support the robot, distributing its weight evenly, and keeping it rigid so it doesn't warp during shipping.

Continue to unpack the Flex and get it off the crate base.

- 8 Using the 19 mm wrench from the User Kit, unbolt the brackets from the crate bottom. You can discard the brackets, or save them for future use.

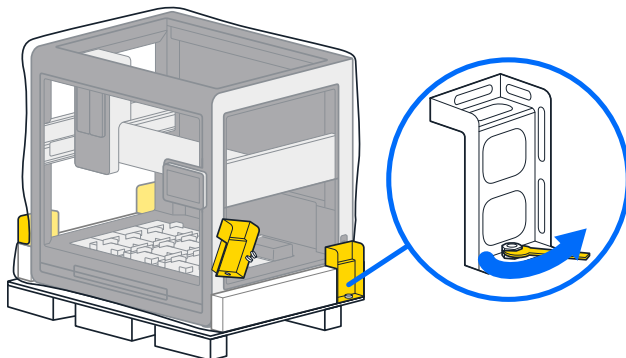

CHAPTER 2: INSTALLATION AND RELOCATION

- 9 Pull or roll the shipping bag all the way down to expose the entire robot.

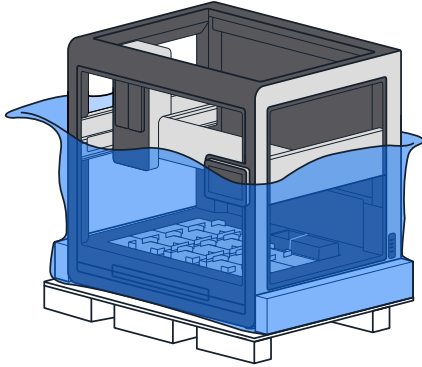

- 10 With help from your lab partner, grab the handholds in the orange shipping frames on either side of the robot's base, lift the Flex off the crate base, and set it down on the floor. Save or discard the crate base and shipping frame.

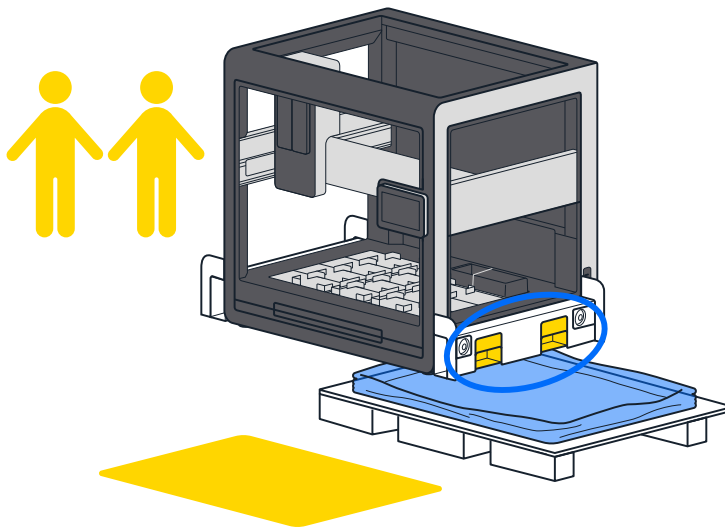

CHAPTER 2: INSTALLATION AND RELOCATION

- 11 Using the 12 mm hex L-key from the User Kit, remove the four bolts holding the shipping frames to the Flex. Save or discard the frames and bolts.

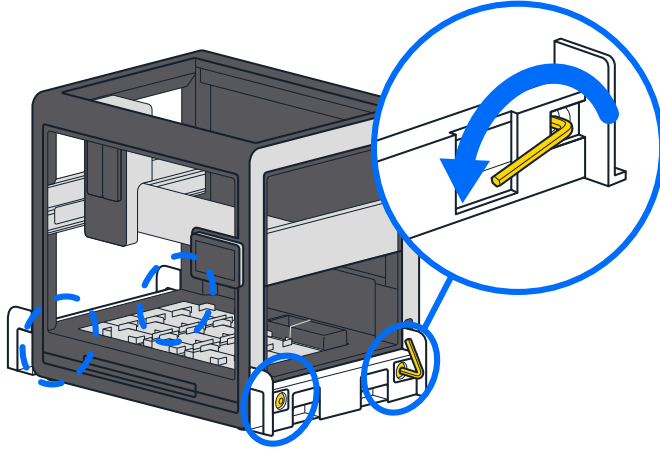

- 12 Remove the four aluminum handles from the User Kit. Screw the handles into the same locations that held the 12 mm shipping frame bolts.

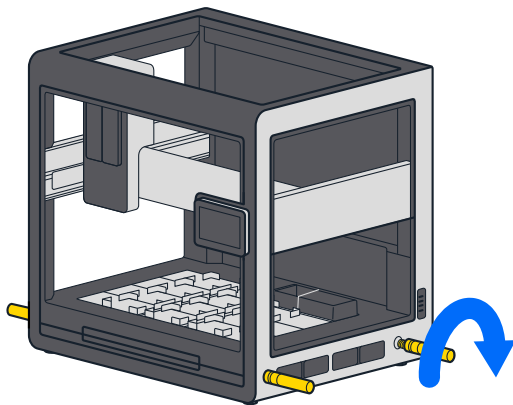

CHAPTER 2: INSTALLATION AND RELOCATION

- 13 With help from your lab partner, lift the Flex by its carrying handles and move it to a workbench for final assembly.

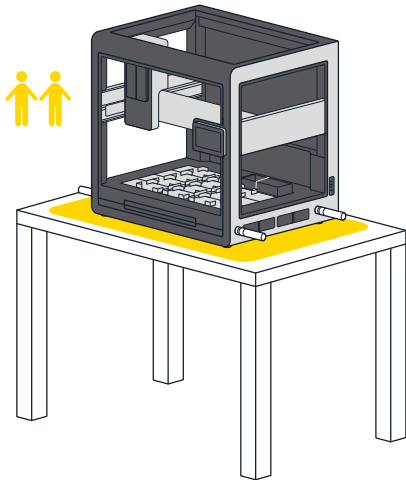

Part 3: Final assembly and power on

After moving the Flex to a temporary work area, or its permanent home, it's time to put the finishing touches on your new robot.

- 14 If you have moved the robot to its final, working location, remove the carrying handles and replace them with the finishing caps. The caps close the handle openings in the frame and give the robot a clean appearance. Return the handles to the User Kit for storage.

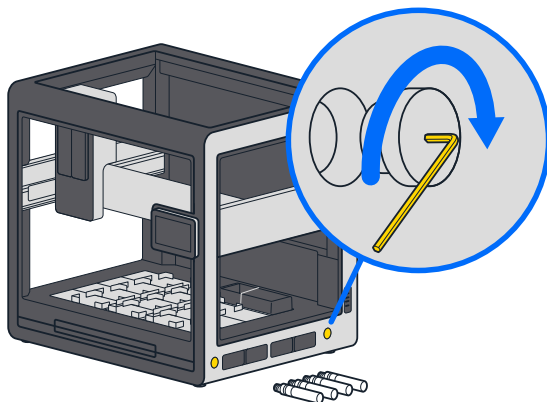

CHAPTER 2: INSTALLATION AND RELOCATION

- 15 Retrieve the top and side panels from the packing foam you set aside after removing the crate top.
- 16 Fit the window panels to the Flex by following the labeling information on the front protective film. Then remove the protective film.
- 17 Using the beveled window screws and the 2.5 mm screwdriver from the User Kit, attach the window panels to the Flex. Make sure the beveled (V-shaped) holes in the window panels are facing out (towards you). This allows the screws to fit flush with the surface of the window.

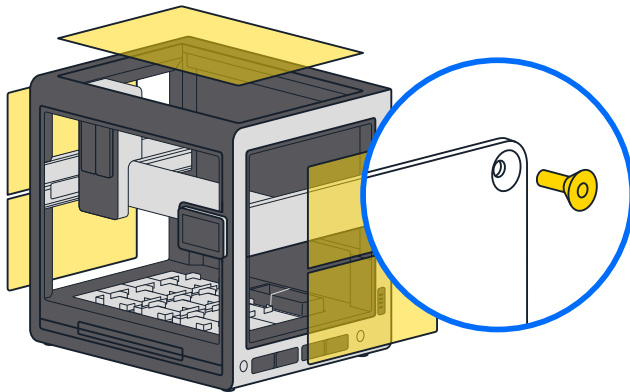

Warning: Incorrectly orienting the panels can lead to damage. Excessive screw torque can crack the panels. Hand tighten the screws until the window panels are reasonably secure. This is not a trial of strength.

CHAPTER 2: INSTALLATION AND RELOCATION

- 18 Using the 2.5 mm screwdriver from the User Kit, remove the locking screws from the gantry. These screws prevent the gantry from moving while in transit. The gantry locking screws are located:
- On the left side rail near the front of the robot.
 - Underneath the vertical gantry arm.
 - On the right side rail near the front of the robot in an orange bracket. There are two screws here.

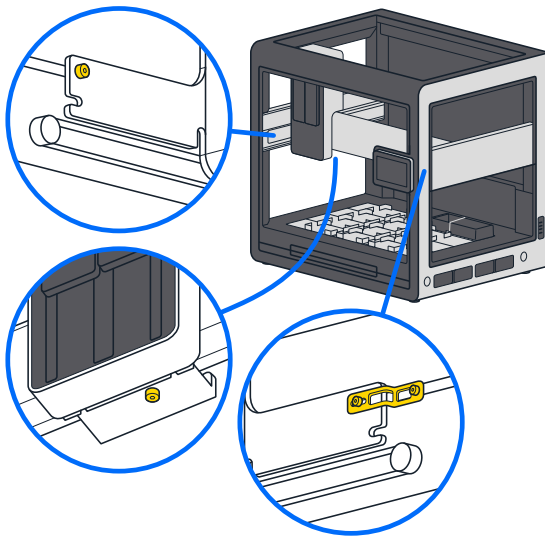

The gantry moves easily by hand after removing all the shipping screws.

- 19 Cut and remove the two rubber bands that hold the trash bin in place during shipping.

CHAPTER 2: INSTALLATION AND RELOCATION

- 20 Attach the power cord to Flex and plug it into the wall outlet. Make sure the deck area is free of obstructions. Flip the power switch on the back left of the robot. Once powered on, the gantry moves to its home location and the touchscreen displays additional configuration instructions.

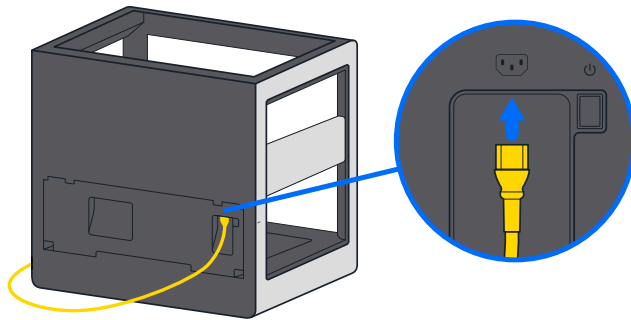

Now that your Flex is out of the box and ready to go, continue to the First Run section below.

2.3 First run

Perform basic setup on the touchscreen before connecting any other hardware to your Flex. The robot will guide you through connecting to your lab network, updating to the latest software, and personalizing Flex by giving it a name.

Power on

When you power on Flex, the Opentrons logo will appear on the touchscreen. After a few moments, it will show the “Welcome to your Opentrons Flex” screen.

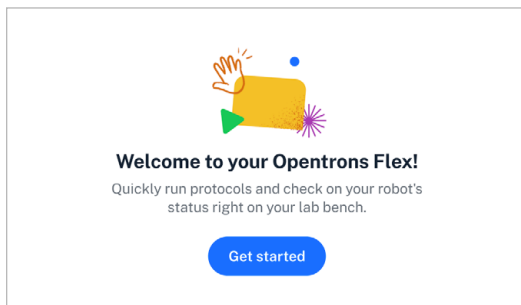

The Opentrons Flex welcome screen. You should only see this screen when you start your Flex for the first time.

Connect to a network or computer

Follow the prompts on the touchscreen to get your robot connected so it can check for software updates and receive protocol files. There are three connection methods: Wi-Fi, Ethernet, and USB.

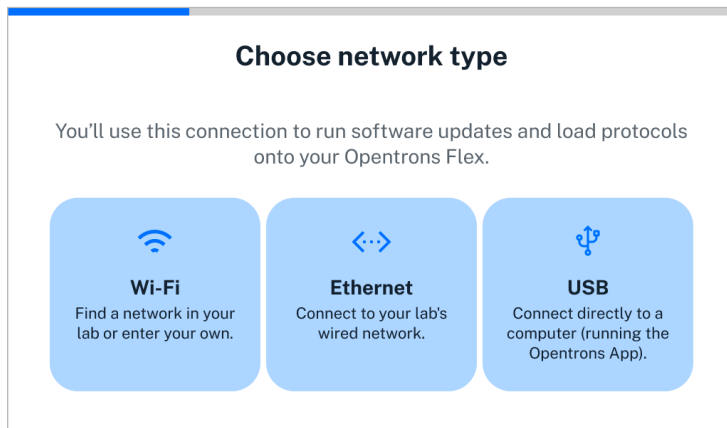

Network connection options. You need to have internet connectivity to set up Flex.

Wi-Fi: Use the touchscreen to connect to Wi-Fi networks that are secured with WPA2 Personal authentication (most networks that only require a password to join fall under this category).



Note: Flex does not support captive portals (networks that don't have a password but load a webpage to authenticate users after connecting).

You can also connect to an open Wi-Fi network, but this is not recommended.



Warning: Connecting to an open Wi-Fi network will allow anyone in range of the network signal to control your Opentrons Flex robot without authentication.

If you need to connect to a Wi-Fi network that uses enterprise authentication (including “eduroam” and similar academic networks that require a username and password), first connect to the Opentrons App by Ethernet or USB to complete initial setup. Then connect to the enterprise Wi-Fi network in the networking settings for your Flex. To access the networking settings:

■ CHAPTER 2: INSTALLATION AND RELOCATION

1. Click **Devices** in the left sidebar of the Opentrons App.
2. Click the three-dot menu (:) for your Flex and choose **Robot Settings**.
3. Click the **Networking** tab.

Select your network from the dropdown menu or choose “Join other network...” and enter its SSID. Choose the enterprise authentication method that your network uses. The supported methods are:

- EAP-TTLS with TLS
- EAP-TTLS with MS-CHAP v2
- EAP-TTLS with MD5
- EAP-PEAP with MS-CHAP v2
- EAP-TLS

Each of these methods requires a username and password, and depending on your exact network configuration may require certificate files or other options. Consult your facility’s IT documentation or contact your IT manager for details of your network setup.

Ethernet: Connect your robot to a network switch or hub with an Ethernet cable. You can also connect directly to the Ethernet port on your computer, starting in robot system version 7.1.0.

USB: Connect the provided USB A-to-B cable to the robot’s USB-B port and an open port on your computer. Use a USB B-to-C cable or a USB A-to-C adapter if your computer does not have a USB-A port.

To proceed with setup, the connected computer must have the Opentrons App installed *and running*. For details on installing the Opentrons App, see the [App Installation section](#) of the Software and Operation chapter.

Install software updates

Now that you’ve connected to a network or computer, the robot can check for software and firmware updates and download them if needed. If there is an update, it may take a few minutes to install. Once the update is complete, the robot will restart.

Attach Emergency Stop Pendant

Connect the included Emergency Stop Pendant (E-stop) to an auxiliary port (AUX-1 or AUX-2) on the back of the robot.

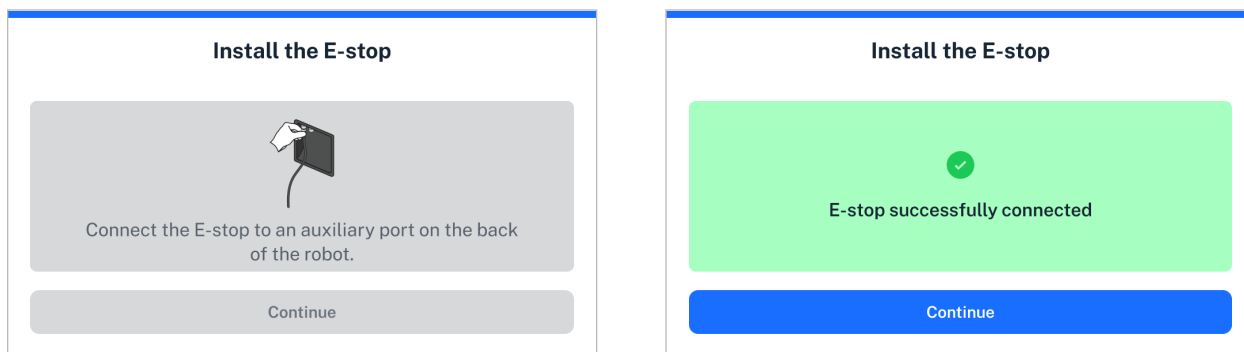

Before and after connecting the Emergency Stop Pendant.

Attaching and enabling the E-stop is *mandatory* for attaching instruments and running protocols on Flex. For more information on using the E-stop during robot operation, see the [Emergency Stop Pendant section](#) of the System Description chapter.

Give your robot a name

Naming your robot lets you easily identify it in your lab environment. If you have multiple Opentrons robots on your network, make sure to give them unique names. Once you've confirmed your robot's name, you'll be taken to your Opentrons Flex Dashboard. Likely the next step you'll want to take is attaching instruments, which is covered in the next section.

2.4 Instrument installation and calibration

After initial robot setup, the next step is to attach instruments to the robot and calibrate them.

To install an instrument, first tap on **Instruments** on the touchscreen or go to the **Pipettes and Modules** section of the device detail screen in the Opentrons App. Choose an empty mount and select either **Attach Pipette** or **Attach Gripper**. If the mount you want to use is already occupied, you need to detach the pipette or gripper first.



Note: The overall installation process is the same regardless of whether you use the touchscreen or the Opentrons App. Whatever device you begin on will control the installation process until you complete or cancel it.

If you begin on the touchscreen, the app will show the robot as being “busy”. If you begin in the app, the touchscreen will show a modal indicating that instrument installation is in progress.

The exact installation process varies depending on the instrument you are attaching, as covered in the sections below. All instruments have an automated calibration procedure, which you should perform immediately after installation.

Pipette installation

When you install a pipette, you will be guided through the following steps on the touchscreen or in the Opentrons App.

1. CHOOSE PIPETTE TYPE

Choose between **1- or 8-Channel Pipette** and **96-Channel Pipette**. Attaching the 96-Channel Pipette requires a few additional steps because it attaches to a special mounting plate that spans both pipette mounts.

2. PREPARE FOR INSTALLATION

Remove labware from the deck and clean up the working area to make attachment and calibration easier. Also gather the needed equipment, such as the calibration probe, hex screwdriver, and mounting plate (for the 96-Channel Pipette).

3. CONNECT AND SECURE THE PIPETTE

The gantry will move to the front of the robot so you can attach the pipette.

1- and 8-Channel Pipettes connect directly to a pipette mount. The 96-Channel Pipette requires a mounting plate. In order to attach the mounting plate, you must first disconnect the z-axis carriage for the right pipette mount.

■ CHAPTER 2: INSTALLATION AND RELOCATION

Connect the pipette to the chosen pipette mount and secure its screws.

4. RUN AUTOMATED CALIBRATION

To calibrate the pipette, attach the calibration probe to the appropriate pipette nozzle. The pipette will automatically move to touch certain points on the deck and save these calibration values for future use. Once calibration is complete and you've removed the probe, the pipette will be ready for use in protocols.

Gripper installation

When you install the gripper, you will be guided through the following steps on the touchscreen or in the Opentrons App.

1. PREPARE FOR INSTALLATION

Remove labware from the deck and clean up the working area to make attachment and calibration easier. Also gather the required hex screwdriver and make sure that the calibration pin is in its storage area on the gripper.

2. CONNECT AND SECURE THE GRIPPER

The gantry will move to the front of the robot so you can attach the gripper. Connect the gripper to the extension mount and secure its screws.

3. RUN AUTOMATED CALIBRATION

To calibrate the gripper, insert the calibration pin in the front jaw. The gripper will automatically move to touch certain points on the deck and save these calibration values for future use. Then repeat the same process with the calibration pin in the back jaw. Once calibration is complete and you've put the pin back in its storage location, the gripper will be ready for use in protocols.

2.5 Relocation

This section provides advice and instructions about how to move your Opentrons Flex robot over short and long distances.

Short moves

A short move spans a range of distances from “let’s just move it over a little bit” to across the lab, down the hall, or another floor in your building. In these cases, you can move your Flex by hand. Transporting it on a hand cart is also a good option.



Warning: The Flex weighs 88.5 kg. As a result, it requires two people to lift and move it safely.

Reattach the lift handles to move your Flex to a new, nearby location. Lifting and carrying the Flex by its handles is the right way to move the robot short distances. Remove the handles and store them in the User Kit after the move is complete. To prevent damaging the robot, always use the lift handles to pick it up and move it. Do not grab the frame to lift or move your robot.

Long-distance moves

A long-distance move transports your Flex off the grounds of your university, facility, or institution. Across town, to a new city, state, province, or country are all examples of a long-distance move. In this case, you’ll need to pack the Flex to protect it from the elements, shocks, and rough movements that may occur while in transit.

If you’ve kept the shipping crate and internal supports that came with your Flex, you can repackage it in these materials for a long-distance move. Follow the [unboxing steps](#) in reverse order to prepare your Flex for a long-distance move. Basically, you should:

- Disconnect the power and network cable, if attached.
- Remove all attached hardware and labware.
- Reattach the deck plates.
- Lock the gantry (see the [General Moving Advice section](#) below).
- Remove and store the window panels.

If you kept the original crate:

- Reattach the shipping frame to the Flex and secure it to the pallet base using the L-brackets.
- Add padding and reassemble the shipping crate.

■ CHAPTER 2: INSTALLATION AND RELOCATION

If you don't have the original crate and related material, contact a reputable shipping company. They can manage the packing, transportation, and delivery process for you.

General moving advice

DISCONNECT POWER AND NETWORK CABLES

Before moving your Flex, don't forget to:

- Turn off the power and unplug it from the power supply.
- Disconnect the Ethernet or USB cable, if used.

LOCK THE GANTRY

Before moving your Flex, reinsert the locking screws to hold the gantry in place. The gantry locking points are located:

- On the left side rail near the front of the robot.
- Underneath the vertical gantry arm.
- On the right side rail near the front of the robot. Locking this part of the gantry requires the small orange bracket and two locking screws.

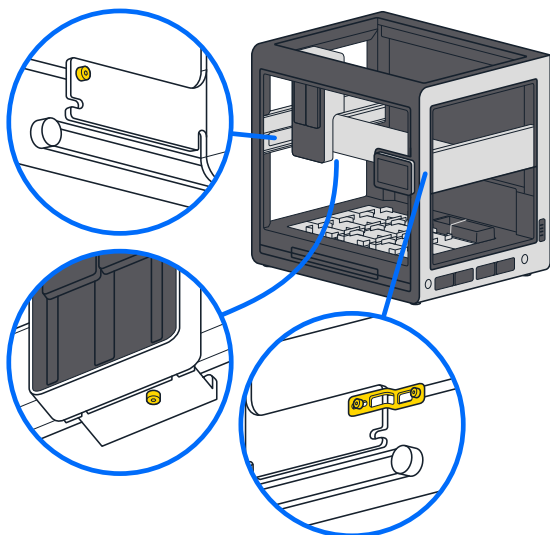

■ CHAPTER 2: INSTALLATION AND RELOCATION

HOME THE GANTRY

You may not want to lock the gantry if you're only moving the robot to a nearby location. If you decide not to lock it, at least use the touchscreen or the Opentrons App to send the gantry to its home position before powering it down.

To home the gantry via the touchscreen, tap the three-dot menu (:) and then tap **Home gantry**.

To home the gantry via the Opentrons App:

- Click **Devices**.
- Click on your Flex in the device list.
- Click the three-dot menu (:) and then click **Home gantry**.

REMOVE MODULES

In-deck modules and other attachments add extra weight to your Flex. They also affect the robot's center of gravity, which can make it feel "tippy" when lifting it. To help lighten and balance the robot, remove any attached instruments and labware before you pick it up.

REINSTALL DECK SLOTS

We recommend reattaching the deck slots for a long-distance move. Securing the slots in their original locations helps prevent accidental loss.

Reattaching the deck slots for short moves around the lab is optional.

POST-MOVE RECALIBRATION

You should recalibrate any instruments and modules after reinstalling them. For more details on [module calibration](#), see the Modules chapter.

Final thoughts about moving

Your Flex is a sturdy and well-built machine, but it is also a precise scientific instrument designed to exacting tolerances. As a result, you should treat it with care when relocating it within your local work area or sending it across the country. This means following the guidance provided here *and* using your own common sense about how to transport an expensive piece of laboratory equipment. Bottom line: when moving your Flex, err on the side of caution and extra padding.

If you have questions or concerns about relocating your Flex, contact us at support@opentrons.com.

System Description

This chapter describes the hardware systems of Opentrons Flex, which underlie its core lab automation features. The deck, gantry, and instrument mounts of Opentrons Flex enable the use of precision liquid- and labware-handling components. The on-device touchscreen enables running protocols and checking on the robot's status without needing to bring your computer to the lab bench. Wired and wireless connectivity enables additional control from the Opentrons App (see the [Software and Operation chapter](#) for more details) and extending the system's features by attaching peripherals (see the [Modules chapter](#)).

3.1 Physical components

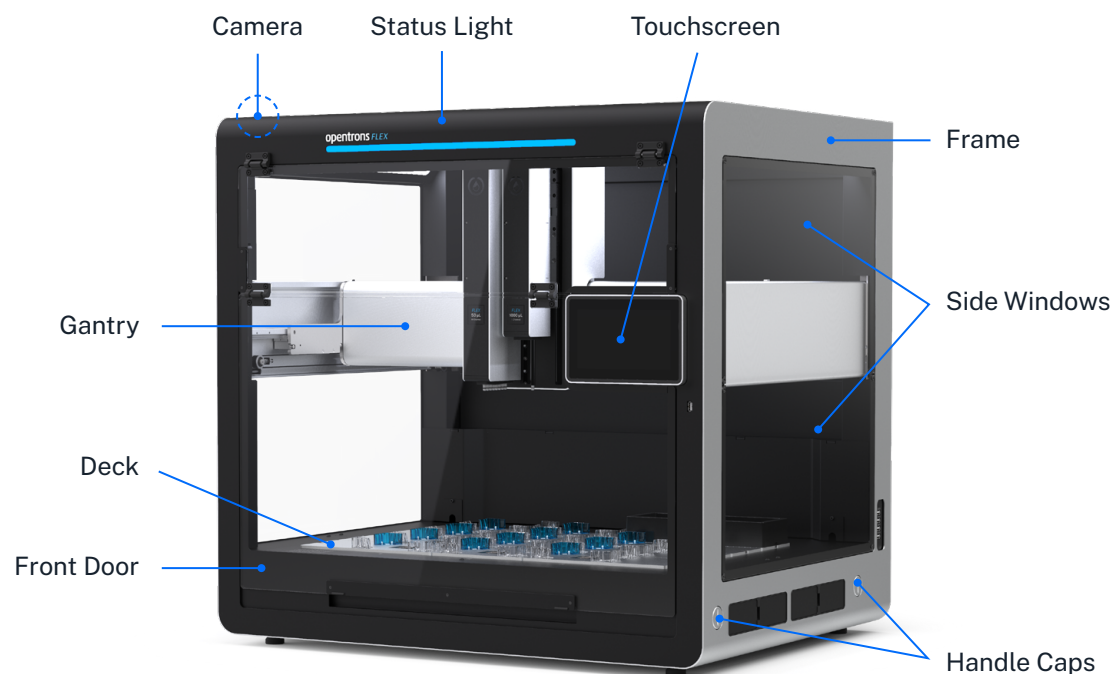

Locations of the physical components of Opentrons Flex.

Frame and enclosure

The *frame* of the Opentrons Flex robot provides rigidity and structural support for its deck and gantry. All of the mechanical subsystems are situated on and mounted to the main frame. The frame is constructed primarily of sheet metal and aluminum extrusions.

The metal frame has openings for *side windows* and a *front door* made of transparent polycarbonate that let you see what's going on inside Flex. The front door hinges open for access to the interior of the system. With the front door open, you can attach instruments, modules, and deck fixtures; prepare the deck before a protocol; or manipulate the state of the deck during a protocol.

White LED strips on the inside top edges of the frame provide software-controllable ambient lighting. A 2-megapixel camera can photograph the deck and working area for recording and tracking protocol execution.

Deck and working area

The deck is the machined aluminum surface on which automated science protocols are executed. The deck has 12 main ANSI/SLAS-format slots that can be reconfigured to hold labware, modules, and consumables. The deck slots are identified by a coordinate system, with slot A1 at the back left and slot D3 at the front right.

Expansion Slot (for Thermocycler)

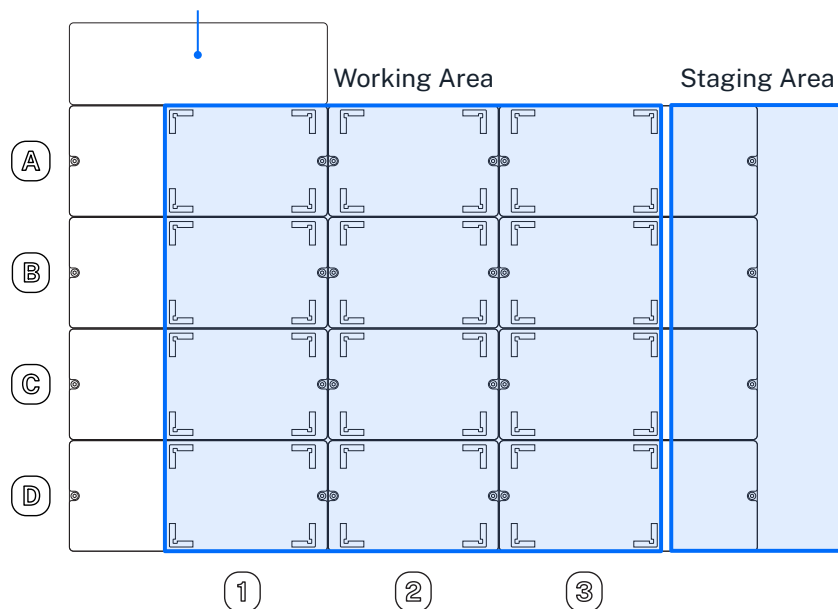

Areas of the deck within Flex.

■ CHAPTER 3: SYSTEM DESCRIPTION

The *working area* is the physical space above the deck that is accessible for pipetting. Labware placed in slots A1 through D3 are in the working area.

Opentrons Flex comes with *removable deck slots* for all 12 positions in the working area. Each deck slot has corner *labware clips* for securely placing labware on the deck.

You can reconfigure the deck by replacing slots with other *deck fixtures*, including the *movable trash*, *waste chute*, and *module caddies*. The *expansion slot* behind A1 is only used to make additional room for the Thermocycler Module, which occupies slots A1 and B1.



Note: Deck slots are interchangeable within a column (1, 2, or 3) but not across columns; column 1 and column 3 slots are distinct pieces despite their similar size. You can tell which column a slot goes in by orienting the blue labware clip to the back left.

You should leave deck slots installed in locations where you want to place standalone labware. The deck and items placed on it remain static, unless moved by the gripper or manual intervention.

Staging area

The *staging area* is additional space along the right side of the deck. You can store labware in this location after installing *staging area slots*. Labware placed in slots A4 through D4 are in the staging area. Flex pipettes cannot reach into the staging area, but the gripper can pick up and move labware to and from this location. Adding extra slots helps keep the working area available for the equipment used in your automated protocols.

Staging area slots are included in certain workstation configurations and are also available for purchase from <https://shop.opentrons.com>.

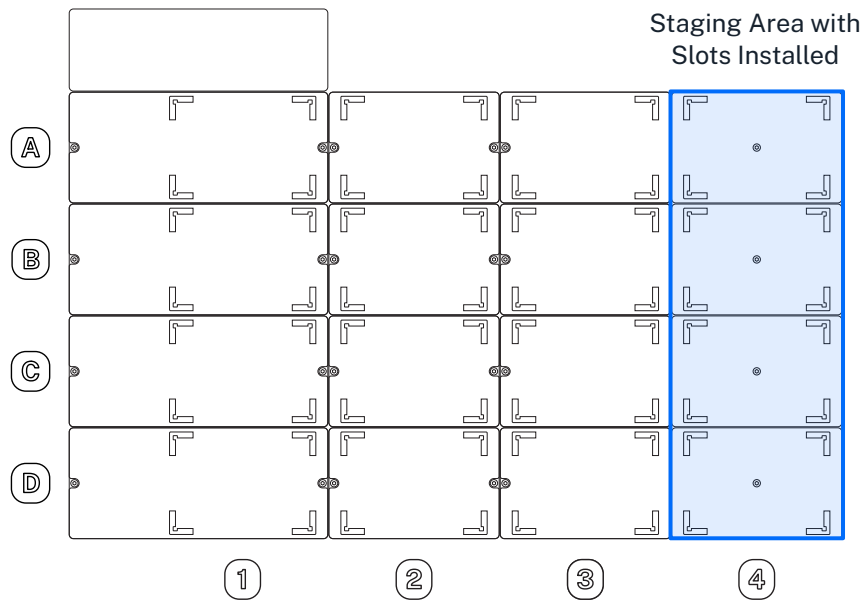

Deck fixtures

Fixtures are hardware items that replace standard deck slots. They let you customize the deck layout and add functionality to your Flex. Currently, deck fixtures include the staging area slots, the internal trash bin, and the external waste chute. You can only install fixtures in a few specific deck slots. The following table lists the deck locations for each fixture.

Fixture	Slots
Staging area slots	A3-D3
Trash bin	A1-D1 and A3-D3
Waste chute	D3 only
Waste chute with staging area slot	D3 only

Fixtures are unpowered. They do not contain electronic or mechanical components that communicate their current state and deck location to the robot. This means you have to use the deck configuration feature to let the Flex know what fixtures are attached to the deck and where they're located.

You can access the deck configuration settings from the touchscreen via the three-dot (⋮) menu and from the Opentrons App. See the [Deck Configuration section](#) of the Software and Operation chapter for information on how to configure the deck from the touchscreen.

Waste chute

The Opentrons Flex Waste Chute transfers liquids, tips, tip racks, and well plates from the Flex enclosure to a trash receptacle placed below its external opening. The waste chute attaches to a deck plate adapter that fits in slot D3. It also comes with a special window half panel that lets the chute extend out of the front of the robot.

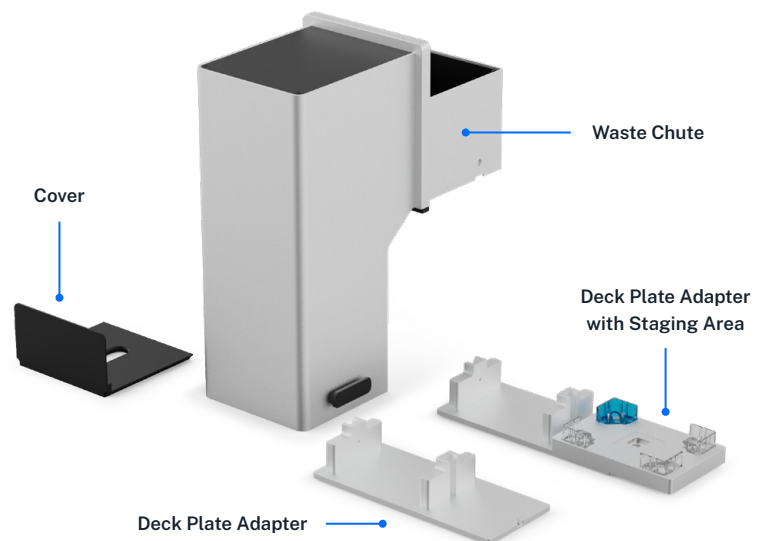

Components of the waste chute.

Staging area slots

Staging area slots are ANSI/SLAS compatible deck pieces that replace standard slots in column 3 and add new slots to the staging area — all without losing space in the working area. You can install a single slot or a maximum of four slots to create a new column (A4 to D4) along the right side of the deck. Note, however, that replacing deck slot A3 requires moving the trash bin. By adding staging area slots to the deck, your Flex robot can store more labware and operate more efficiently.

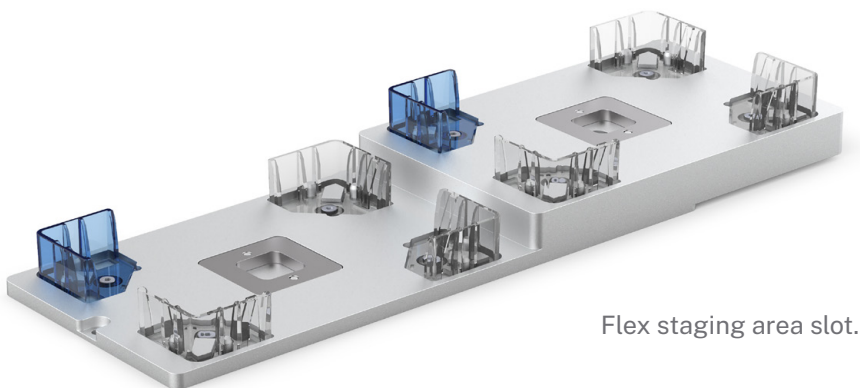

SLOT INSTALLATION

To install, remove the screws that attach a standard slot to the deck and replace it with the staging area slot. After installation, use the touchscreen or Opentrons App to tell the robot you've added a staging area slot to the deck.

Installing a staging area slot.

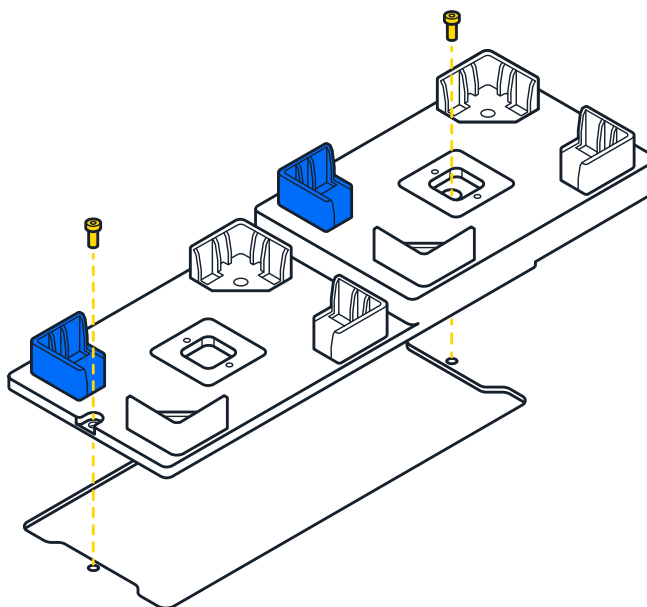

SLOT COMPATIBILITY

Staging area slots are compatible with the Flex instruments, modules, and labware listed below.

Flex component	Staging area compatibility
Gripper	The Flex Gripper can move labware to or from staging area slots.
Pipettes	Flex pipettes cannot reach the staging area. Use the gripper to move tip racks and labware from the staging area to the working area before pipetting.
Modules	<p>The Magnetic Block GEN1 can be placed in column 3 on top of a staging area slot. Modules are not supported in column 4.</p> <p>Powered modules such as the Heater-Shaker and Temperature Module fit into caddies that can be placed in column 3. You can't add a staging area slot to a position occupied by a module caddy.</p>
Labware	Staging area slots have the same ANSI/SLAS dimensions as standard deck slots. Use gripper-compatible labware in the staging area, or manually add and remove labware from this location.

Movement system

Attached to the frame is the *gantry*, which is the robot's movement and positioning system.

The gantry moves separately along the x- and y-axis to position the pipettes and gripper at precise locations for protocol execution. Movement along these axes is precise to the nearest 0.1 mm. The gantry is controlled by 36 VDC hybrid bipolar stepper motors.

In turn, attached to the gantry are the *pipette mounts* and the *extension mount*. These move along the z-axis to position the pipettes and gripper at precise locations for protocol execution. Movement along this axis is controlled by 36 VDC hybrid bipolar stepper motors.

The electronics contained in the gantry provide 36 VDC power and communications to the pipettes and gripper, when attached.

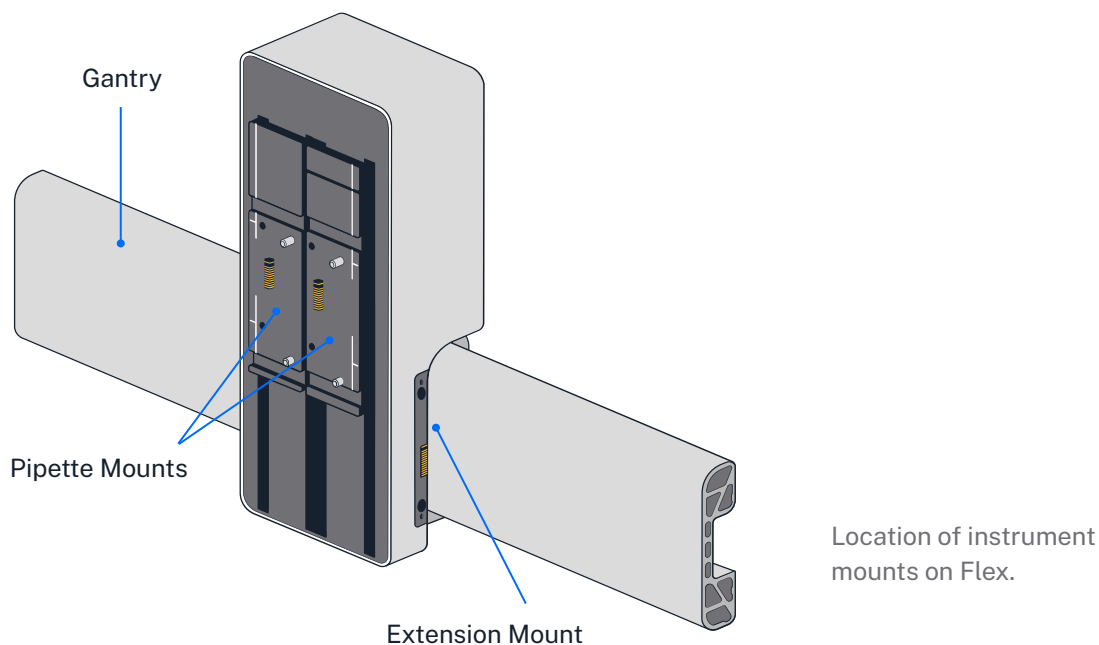

Touchscreen and LED displays

The primary user interface is the 7-inch LCD *touchscreen*, located on the front right of the robot. The touchscreen is covered with Gorilla Glass 3 for scratch and damage resistance. Access many features of Flex right on the touchscreen, including:

CHAPTER 3: SYSTEM DESCRIPTION

- Protocol management
- Protocol setup, execution, and monitoring
- Labware management
- Robot settings
- System software and firmware updates
- Operation logs and error notifications

For more information on using Flex via the touchscreen, see the [Touchscreen Operation section](#) of the Software and Operation chapter.

The *status light* is a strip of LEDs along the top front of the robot that provides at-a-glance information about the robot. Different colors and patterns of illumination can communicate various success, failure, or idle states:

LED color	LED pattern	Robot status
○ White Neutral states	Solid	Powered on and not running a protocol
	Pulsing	Robot is busy (e.g., updating software or firmware, setting up protocol run, canceling protocol run)
● Green Normal states	Blinks twice	Action is complete (e.g., protocol stored, software updated, instrument attached or detached)
	Solid	Protocol is running
	Pulsing	Protocol is complete
● Blue Mandatory states	Pulsing	Protocol is paused
● Yellow Abnormal states	Solid	Software error
● Red Emergency states	Blinks three times, repeatedly	Physical error (e.g., instrument crash)

The status light can also be disabled in the robot settings.

3.2 Pipettes

Opentrons *pipettes* are configurable devices used to move liquids throughout the working area during the execution of protocols. There are several Opentrons Flex pipettes, which can handle volumes from 1 μL to 1000 μL in 1, 8, or 96 channels:

- Opentrons Flex 1-Channel Pipette (1–50 μL)
- Opentrons Flex 1-Channel Pipette (5–1000 μL)
- Opentrons Flex 8-Channel Pipette (1–50 μL)
- Opentrons Flex 8-Channel Pipette (5–1000 μL)
- Opentrons Flex 96-Channel Pipette (5–1000 μL)

Pipettes attach to the gantry using captive screws on the front of the pipette. 1-channel and 8-channel pipettes each occupy one *pipette mount* (left or right); the 96-channel pipette occupies both mounts. For details on installing pipettes, see [Instrument Installation and Calibration](#).

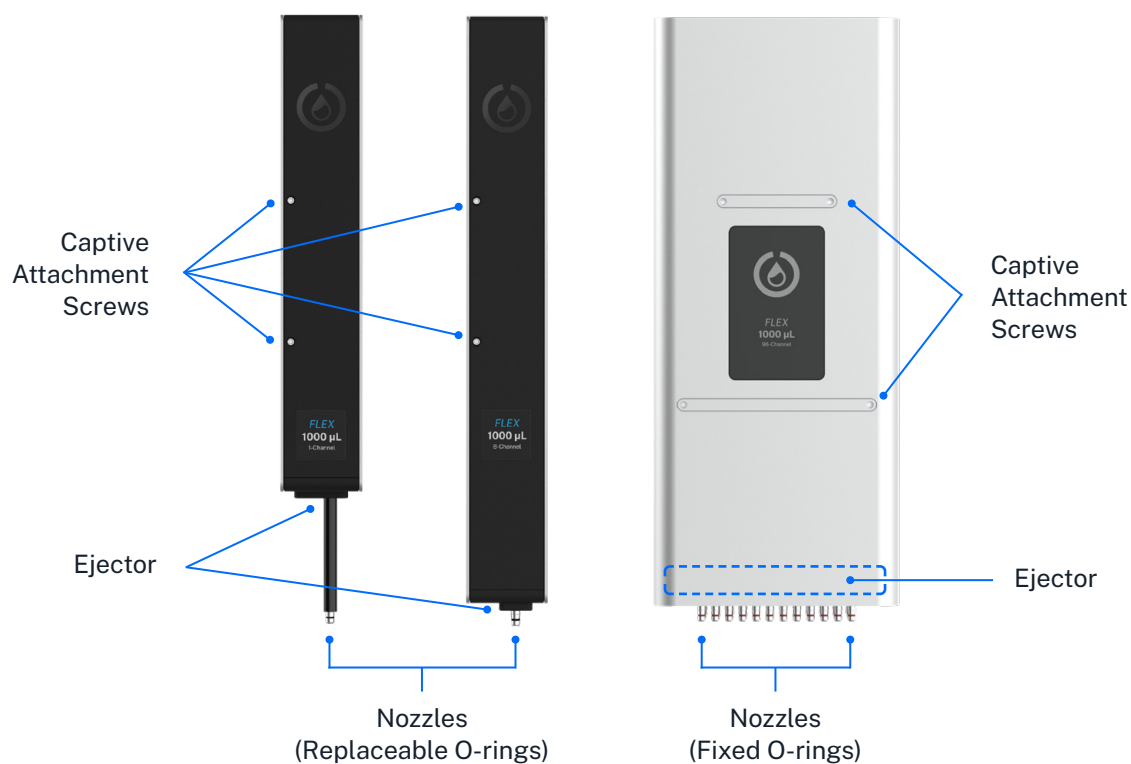

Locations of components of the 1-, 8-, and 96-channel pipettes.

CHAPTER 3: SYSTEM DESCRIPTION

The pipettes pick up disposable plastic *tips* by pressing them onto the pipette *nozzles*, and then use the tips to aspirate and dispense liquids. The amount of total force required for pickup increases as more tips get picked up simultaneously. For smaller numbers of tips, the pipette attaches tips by pushing each pipette nozzle down into a tip. To achieve the necessary force to pick up a full rack of tips, the 96-channel pipette also pulls the tips upward onto the nozzles. This pulling action requires placing tip racks into a *tip rack adapter*, rather than directly in a deck slot. To discard tips (or return them to their rack), the pipette *ejector* mechanism pushes the tips off of the nozzles.

Pipette specifications

Opentrons Flex pipettes are designed to handle a wide range of volumes. Because of their wide overall range, they can use multiple sizes of tips, which affect their liquid-handling characteristics. Opentrons has tested Flex pipettes for accuracy and precision in a number of tip and liquid volume combinations:

Pipette	Tip Capacity	Tested Volume	Accuracy %D	Precision %CV
Flex 1-Channel 50 µL	50 µL	1 µL	8.00%	7.00%
	50 µL	10 µL	1.50%	0.50%
	50 µL	50 µL	1.25%	0.40%
Flex 1-Channel 1000 µL	50 µL	5 µL	5.00%	2.50%
	50 µL	50 µL	0.50%	0.30%
	200 µL	200 µL	0.50%	0.15%
	1000 µL	1000 µL	0.50%	0.15%
Flex 8-Channel 50 µL	50 µL	1 µL	10.00%	8.00%
	50 µL	10 µL	2.50%	1.00%
	50 µL	50 µL	1.25%	0.60%
Flex 8-Channel 1000 µL	50 µL	5 µL	8.00%	4.00%
	50 µL	50 µL	2.50%	0.60%
	200 µL	200 µL	1.00%	0.25%
	1000 µL	1000 µL	0.70%	0.15%

	50 μ L	5 μ L	10.00%	5.00%
Flex 96-Channel 1000 μ L	50 μ L	50 μ L	2.50%	1.25%
	200 μ L	200 μ L	1.50%	1.25%
	1000 μ L	1000 μ L	1.50%	1.50%

Keep this accuracy information in mind when choosing tips for your pipette. In general, for best results you should use the smallest tips that meet the needs of your protocol.



Note: Opentrons performs volumetric testing of Flex pipettes to ensure that they meet the accuracy and precision specifications listed above. You *do not* have to calibrate the volume that your pipettes dispense before use. You only have to perform positional calibration. See the next section, as well as the [Pipette Installation section](#) of the Installation and Relocation chapter, for details.

The Opentrons Care and Opentrons Care Plus services include yearly pipette replacement and certificates of calibration. See the [Servicing Flex section](#) of the Maintenance and Service chapter for details.

Pipette calibration

The User Kit includes a metal pipette calibration probe, which you use during positional calibration. During protocol runs, safely store the probe on the magnetic holder on the front pillar of the robot. During the calibration process, attach the probe to the appropriate nozzle and lock it in place. The robot moves the probe to calibration points on the deck to measure the pipette's exact position.

Pipette tip rack adapter

The Opentrons Flex 96-channel pipette ships with four tip rack adapters. These are precision formed aluminum brackets that you place on the deck. The adapters hold Flex 50 μ L, 200 μ L, and 1000 μ L tip racks.



■ CHAPTER 3: SYSTEM DESCRIPTION

Because of the force involved, the 96-channel pipette requires an adapter to attach a full tip rack properly. During the attachment procedure, the pipette moves over the adapter, lowers itself onto the mounting pins, and pulls tips onto the pipettes by lifting the adapter and tip rack. Pulling the tips, rather than pushing, provides the leverage needed to secure tips to the pipettes and prevents warping the deck surface. When finished, the 96-channel pipette lowers the adapter and empty tip rack onto the deck. See the [Tips and tip racks](#) section of the Labware chapter for more information.

Partial tip pickup

The 96-channel pipette can pick up a full rack of tips or a smaller number of tips. This increases the number of applications you can perform with the 96-channel pipette, since it occupies both pipette mounts.

Currently, the 96-channel pipette supports partial tip pickup for 8 tips in a column layout. In this configuration, the pipette either uses its leftmost nozzles to pick up tips right-to-left from a tip rack, or its rightmost nozzles to pick up tips left-to-right from a tip rack.

When picking up fewer than 96 tips from a tip rack, the rack must be placed directly on the deck, *not* in the tip rack adapter.

Pipette sensors

Opentrons Flex pipettes have a number of sensors that detect and record data about the status of the pipette and any tips it has picked up.

CAPACITANCE SENSORS

In combination with a metal probe or conductive tip, the capacitance sensors detect when the pipette makes contact with something. Detection of contact between the metal probe and the deck is used in the automated [pipette calibration](#) and [module calibration](#) processes.

1-channel pipettes have one capacitance sensor, while multi-channel pipettes have two: on channels 1 and 8 of 8-channel pipettes, and on channels 1 and 96 (positions A1 and H12) of the 96-channel pipette.

OPTICAL TIP PRESENCE SENSORS

A photointerruptor switch detects the position of the pipette's tip ejector mechanism, confirming whether tips were successfully picked up or dropped. 1-channel, 8-channel, and 96-channel pipettes all have a single optical sensor that monitors tip attachment across all channels.

Pipette firmware updates

Opentrons Flex automatically updates pipette firmware to keep it in sync with the robot software version. Pipette firmware updates are typically quick, and occur whenever:

- You attach a pipette.
- The robot restarts.

If, for any reason, your pipette firmware and robot software versions get out of sync, you can manually update the firmware in the Opentrons App.

1. Click **Devices**.
2. Click on your Flex in the device list.
3. Under Instruments and Modules, the out-of-sync pipette will show a warning banner reading "Firmware update available." Click **Update now** to begin the update.

You can view the currently installed firmware version of any attached pipette. On the touchscreen, go to **Instruments** and tap the pipette name. In the Opentrons App, find the pipette card under Instruments and Modules, click the three-dot menu (⋮), and then click **About pipette**.

3.3 Gripper

The *grripper* moves labware throughout the working area and staging area during the execution of protocols. The gripper attaches to the *extension mount*, which is separate from the pipette mounts; the gripper can be used with any pipette configuration. For details on installing the gripper, see [Instrument Installation and Calibration](#).

The gripper can move labware across the deck and onto or off of modules. The gripper can manipulate certain fully skirted well plates, deep well plates, and tip racks. For more details on what labware the gripper can move, see the [Labware and the Opentrons Flex Gripper section](#) of the Labware chapter, or consult the [Opentrons Labware Library](#).

Gripper specifications

The *jaws* perform the primary motion of the gripper, which is to open or close two parallel *paddles* to apply or release force on the sides of labware. Movement of the jaws is controlled by a 36 VDC brushed motor connected to a rack-and-pinion gear system.

To move a piece of labware that has been gripped by the jaws, the gantry lifts the gripper along the z-axis, moves it laterally, and then lowers it into the labware's new position.

Locations of components of the gripper.

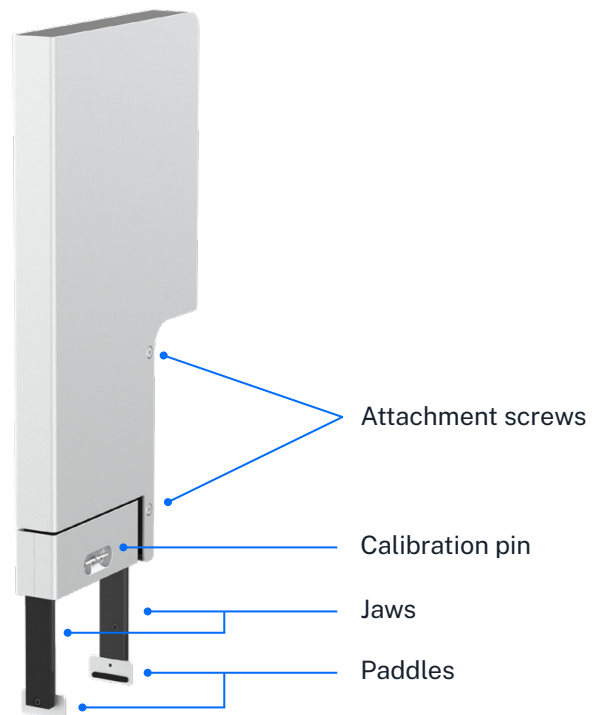

Gripper calibration

The gripper includes a metal *calibration pin*. The calibration pin is located in a recessed storage area on the lower part of the gripper. A magnet holds the pin in place. To remove the calibration pin, grasp it with your fingers and pull gently. To replace the pin, put it back in the storage slot. You'll know it's secure when it snaps into place.

When calibrating the gripper, attach the pin to each jaw in turn. The robot moves the pin to calibration points on the deck to measure the gripper's exact position.

During protocol runs, place the pin in its storage area for safekeeping. Contact us at support@opentrons.com if you lose the calibration pin.

Gripper firmware updates

Opentrons Flex automatically updates the gripper firmware to keep it in sync with the robot software version. Gripper firmware updates are typically quick, and occur whenever:

■ CHAPTER 3: SYSTEM DESCRIPTION

- You attach the gripper.
- The robot restarts.

If, for any reason, your gripper firmware and robot software versions get out of sync, you can manually update the firmware in the Opentrons App.

1. Click **Devices**.
2. Click on your Flex in the device list.
3. Under Instruments and Modules, the out-of-sync gripper will show a warning banner reading “Firmware update available.” Click **Update now** to begin the update.

You can view the currently installed firmware version of the gripper. On the touchscreen, go to **Instruments** and tap the gripper. In the Opentrons App, find the gripper card under Instruments and Modules, click the three-dot menu (⋮), and then click **About gripper**.

3.4 Emergency Stop Pendant

The *Emergency Stop Pendant (E-stop)* is a dedicated hardware button for quickly stopping robot motion. Opentrons Flex requires a functional, disengaged E-stop to be attached at all times. When you press the stop button, Flex cancels any running protocol or setup workflow as quickly as possible and prevents most robot motion.

When to use the E-stop

You may need to press the E-stop:

- When there is imminent risk of injury or harm to a user.
- When there is imminent risk of damage to the robot or other hardware.
- When samples or reagents are in imminent danger of contamination.
- After a hardware collision.

Ideally you should never have to press the E-stop (except during infrequent hardware quality testing).

Do not use the E-stop to cancel normal, expected operations. Instead, use the software button on the touchscreen or in the Opentrons App. Pausing via software will let you resume or cancel your protocol, whereas pressing the E-stop always cancels the protocol immediately.

Engaging and releasing the E-stop

The E-stop has a press-to-engage, twist-to-release mechanism.

- **Engage:** Push down firmly on the red button. Flex will enter the stopped state.
- **Resolve:** Once stopped, safely address any problems in the working area, such as clearing spills, removing labware, or moving the gantry (it should move freely and easily by hand).
- **Release:** Twist the button clockwise. It will pop up to its disengaged position.
- **Reset:** On the touchscreen or in the Opentrons App, confirm that you are ready for Flex to resume motion. The gantry will return to its home position and module activity will resume.

In the stopped state, Flex and connected hardware will behave as follows:

Hardware	Behavior
Gantry	<ul style="list-style-type: none"> ▪ Automated horizontal motion is halted. ▪ Manual horizontal motion is allowed.
Pipettes	<ul style="list-style-type: none"> ▪ Vertical motion of pipettes is halted. ▪ The motor brakes on vertical axes are engaged to prevent pipettes from falling. ▪ Plunger motion and tip pickup is halted.
Gripper	<ul style="list-style-type: none"> ▪ Vertical motion of the gripper is halted. ▪ The motor brake on the vertical axis is engaged to prevent the gripper from falling. ▪ The jaw motors that exert gripping force remain enabled, so the gripper will not drop labware it may be carrying.
Heater-Shaker Module	<ul style="list-style-type: none"> ▪ The shaker stops and homes. ▪ The labware latch opens. ▪ Heating is disabled.
Temperature Module	<ul style="list-style-type: none"> ▪ Heating or cooling is disabled.
Thermocycler Module	<ul style="list-style-type: none"> ▪ Heating or cooling is disabled.
Status light	<ul style="list-style-type: none"> ▪ The light turns red.
Touchscreen	<ul style="list-style-type: none"> ▪ A cancellation message takes over the screen. ▪ An on-screen indicator shows when you have successfully disengaged the stop button.

3.5 Connections

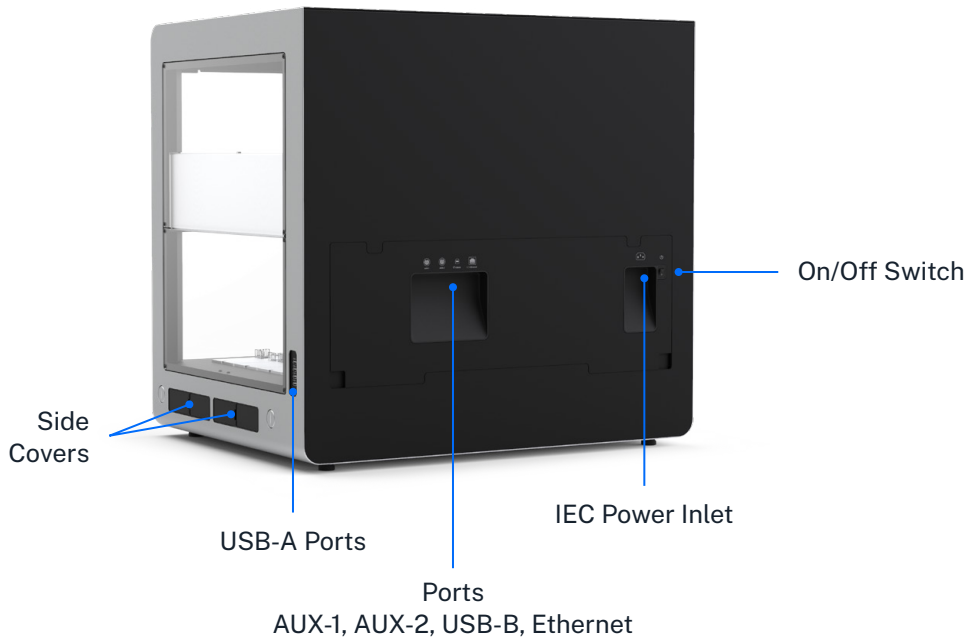

Power connection

Opentrons Flex connects to a power source via a standard IEC-C14 inlet. The robot contains an internal full-range AC/DC power supply, accepting 100–240 VAC, 50/60 Hz input and converting it to 36 VDC. All other internal electronics are powered by the 36 VDC supply.



Warning: Only use the power cord provided with the robot. Do not use a power cord with inadequate current or voltage ratings.

Keep the power cord free of obstructions so you can remove it if necessary.

There is also a CR1220 coin cell battery to power the robot's real-time clock when not connected to mains power. The battery is located inside the touchscreen enclosure. Contact Opentrons Support for more information if you think you need to replace the battery.

USB and auxiliary connections

Opentrons Flex has 10 total USB ports located in different areas of the robot, which serve different purposes.

The 8 rear USB-A ports (numbered USB-1 through USB-8) and 2 auxiliary ports (M12 connectors numbered AUX-1 and AUX-2) are for connecting Opentrons modules and accessories. See the [Modules chapter](#) for more information on connecting these devices and using them in your protocols.

The rear USB-B port is for connecting the robot to a laptop or desktop computer, to establish communication with the Opentrons App running on the connected computer. The front USB-A port (USB-9), located below the touchscreen display, has the same functionality as the rear USB-A ports.



Note: The USB ports are power-limited to protect the robot and connected devices. Power delivery is split internally into three port groups: the left rear USB-A ports (USB-1 through USB-4), the right rear USB-A ports (USB-5 through USB-8), and the front USB-A port. Each of these groups will deliver a maximum of 500 mA to connected USB 2.0-compatible devices.

Network connections

Opentrons Flex can connect to a local area network through a wired (Ethernet) or wireless (Wi-Fi) connection.

The Ethernet port is located on the rear of the robot. Connect it to an Ethernet hub or switch on your network. Or, starting in robot system version 7.1.0, connect it directly to an Ethernet port on your computer.

The internal Wi-Fi module supports 802.11 ac/a/b/g/n networks with a dual-band 2.4/5 GHz antenna.

3.6 System specifications

General specifications

Dimensions	87 × 69 × 84 cm / 34.25 × 27 × 33 in (W, D, H)
Weight	88.5 kg / 195 lb
Deck slots	<ul style="list-style-type: none"> ▪ 12 ANSI/SLAS-compatible slots in working area (accessible to pipettes) ▪ 4 additional slots for staging tips and labware (accessible only to gripper)
Touchscreen	7-inch LCD touchscreen with scratch- and damage-resistant Gorilla Glass 3
Wi-Fi	802.11 ac/a/b/g/n dual-band (2.4/5 GHz)
Ethernet	100 Mbps
USB	<ul style="list-style-type: none"> ▪ 9 USB-A ports ▪ 1 USB-B port ▪ USB 2.0 speed
Camera	2MP, photo and video
Robot power input	<ul style="list-style-type: none"> ▪ 100–240 VAC, 50–60 Hz, 1φ ▪ 4.0 A/115 VAC, 2.0 A/230 VAC
Mains supply voltage fluctuation	±10%
Mains supply frequency fluctuation	±5%
Distribution system	TN-S
Short-circuit supply current	6.3 A
Frame composition	Rigid steel and CNC aluminum design
Window composition	Removable polycarbonate side windows and front door
Ventilation requirements	At least 20 cm / 8 in between the unit and a wall

Connected PC requirements	The Opentrons App runs on: <ul style="list-style-type: none">▪ Windows 10 or later▪ macOS 10.10 or later▪ Ubuntu 12.04 or later
----------------------------------	---

Environmental specifications

Environmental conditions	Indoor use only
Ambient temperature	+20 to +25 °C (recommended)
Relative humidity	40–60%, non-condensing (recommended)
Pollution degree	2 (non-conductive pollution only)

For additional information on acceptable environmental conditions for use and transport, see the [Environmental Conditions section](#) of the Installation and Relocation chapter.

Certifications

Certifications complete	CE, ETL, FCC, ISO 9001
Not certified/validated	IVD, GMP

A summary of certification information is printed on a sticker on the back of Flex, near the on/off switch. For detailed certification and compliance information, see the [Regulatory Compliance section](#) in the Introduction.

Serial number

Every Flex has a unique serial number. The format of the serial number provides additional information, including the robot's date of production. For example, the serial number FLXA1020231007001 would indicate:

CHAPTER 3: SYSTEM DESCRIPTION

Characters	Category	Meaning
FLX	Model	The robot is an Opentrons Flex.
A10	Version	A code for the production version of the robot.
2023	Year	The robot was made in 2023.
10	Month	The robot was made in October.
07	Day	The robot was made on the 7th day of the month.
001	Unit	A unique number for robots made on a certain day.

You can find the serial number for your Flex:

- On the certification sticker on the back of Flex, near the on/off switch.
- On the reverse side of the touchscreen (towards the working area).
- In the Opentrons App under **Devices** > your Flex > **Robot settings** > **Advanced**.

Modules

Opentrons Flex integrates with a number of Opentrons hardware modules. All modules are peripherals that occupy deck slots, and most are controlled by the robot over a USB connection.

This chapter describes the functions and physical specifications of modules that are compatible with the Opentrons Flex system, as well as how to attach and calibrate them. For further details on module setup and use, consult the manuals for the individual modules. For details on integrating modules into your protocols, see the [Protocol Designer section](#) of the Protocol Development chapter or the online [Python Protocol API documentation](#).

4.1 Supported modules

Opentrons Flex is compatible with four types of on-deck Opentrons modules:

- The **Heater-Shaker Module** provides on-deck heating and orbital shaking. The module can be heated to 95 °C, and can shake samples from 200 to 3000 rpm.
- The **Magnetic Block** is a passive device that holds labware close to its high-strength neodymium magnets. The OT-2 Magnetic Module GEN1 and GEN2, which actively move their magnets up and down relative to labware, are not supported on Opentrons Flex.
- The **Temperature Module** is a hot and cold plate module that is able to maintain steady state temperatures between 4 and 95 °C.
- The **Thermocycler Module** provides on-deck, fully automated thermocycling, enabling automation of upstream and downstream workflow steps. Thermocycler GEN2 is fully compatible with the gripper. Thermocycler GEN1 cannot be used with the gripper, and is therefore not supported on Opentrons Flex.

Some modules originally designed for the OT-2 are compatible with Flex, as summarized in the table below. A checkmark indicates compatibility, and an X indicates incompatibility.

Device type and generation	OT-2	Flex
Heater-Shaker Module GEN1	✓	✓
Magnetic Module GEN1	✓	×
Magnetic Module GEN2	✓	×
Magnetic Block GEN1	×	✓
Temperature Module GEN1	✓	×
Temperature Module GEN2	✓	✓
Thermocycler Module GEN1	✓	×
Thermocycler Module GEN2	✓	✓
HEPA Module	✓	×

4.2 Module caddy system

Compatible modules are designed to fit into caddies that occupy space below the deck. This system allows labware on top of modules to remain closer to the deck surface, and it also allows for below-deck cable routing so the deck stays tidy during your protocol runs.

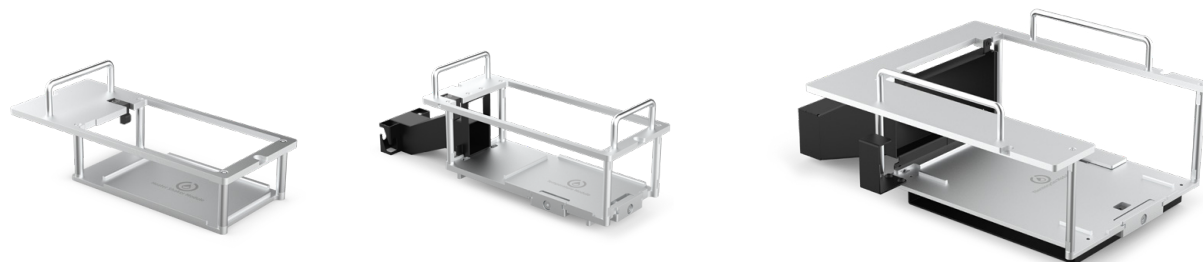

Caddies for the Heater-Shaker, Temperature, and Thermocycler Modules.

To fit a module into the deck surface, it must first be placed into the corresponding module caddy. Each type of compatible module has its own caddy design that aligns the module and labware precisely with the surrounding deck. (The exception is the Magnetic Block, which does not require power or USB cable routing and thus sits directly on the deck surface.) Caddies for modules that occupy a single slot can be placed anywhere in column 1 or 3; the Thermocycler can only be placed in slots A1 and B1 simultaneously.

In general, to install a module caddy:

1. Remove any deck slots from the location where the module will go.
2. Seat the module into its caddy and tighten its anchors.
3. Route the module power and USB cables through the side covers, up through the empty deck slot, and attach them to the module.
4. Seat the module caddy into the slot and screw it into place.

For exact installation instructions, consult the Quickstart Guide or Instruction Manual for the specific module. Cable connections and method of attachment to the caddy vary by module.

4.3 Module calibration

When you first install a module on Flex, you need to run automated positional calibration. This process is similar to positional calibration for instruments, and ensures that Flex moves to the exact correct locations for optimal protocol performance. During calibration, Flex will move to locations on a module calibration adapter, which looks similar to the calibration squares that are part of removable deck slots.

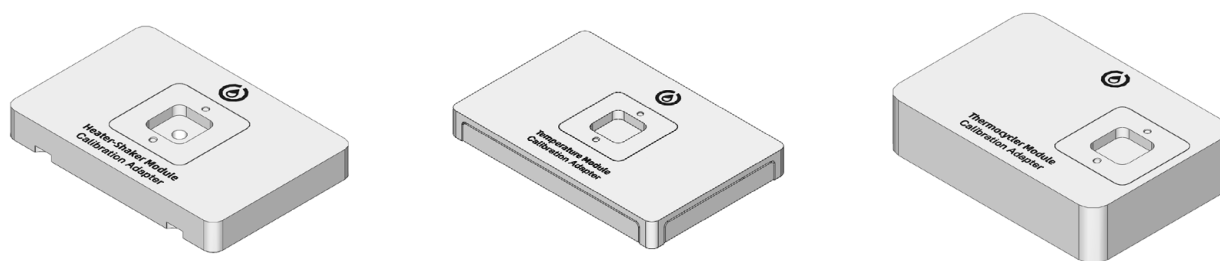

Calibration adapters for the Heater-Shaker, Temperature, and Thermocycler Modules.

Module calibration is required for all modules that install via a caddy: the Heater-Shaker, Temperature, and Thermocycler Modules. The Magnetic Block doesn't require calibration, and is ready for use as soon as you place it on the deck.

When to calibrate modules

Flex automatically prompts you to perform calibration when you connect and power on a module that doesn't have any stored calibration data. (You can dismiss this prompt, but you won't be able to run protocols with the module until you calibrate it.)

Once you've completed calibration, Flex stores the calibration data and module serial number for future use. Flex won't prompt you to recalibrate unless you delete the calibration data for that module in the robot settings. You can freely power your module on and off, or even move it to another deck slot, without needing to recalibrate. If you want to recalibrate, you can begin the process at any time from the module card in the Opentrons App. (Recalibration is not available from the touchscreen.)

How to calibrate modules

Instructions on the touchscreen or in the Opentrons App will guide you through the calibration procedure. In general the steps are:

1. Gather the required equipment, including the module calibration adapter and pipette calibration probe.
2. Place the calibration adapter on the module surface and ensure that it is completely level.
Some modules may require you to fasten the adapter to the module.
3. Attach the calibration probe to a pipette.
4. Flex will automatically move to touch certain points on the calibration adapter and save these calibration values for future use.

Once calibration is complete and you've removed the adapter and probe, the module will be ready for use in protocols.

At any time, you can view and manage your module calibration data in the Opentrons App. Go to **Robot Settings** for your Flex and click on the **Calibration** tab.

4.4 Heater-Shaker Module GEN1



Heater-Shaker features

HEATING AND SHAKING

The Heater-Shaker provides on-deck heating and orbital shaking. The module can be heated to 95 °C, with the following temperature profile:

- Temperature range: 37–95 °C
- Temperature accuracy: ± 0.5 °C at 55 °C
- Temperature uniformity: ± 0.5 °C at 55 °C
- Ramp rate: 10 °C/min

The module can shake samples from 200 to 3000 rpm, with the following shaking profile:

- Orbital diameter: 2.0 mm
- Orbital direction: Clockwise
- Speed range: 200–3000 rpm
- Speed accuracy: ± 25 rpm

The module has a powered labware latch for securing plates to the module prior to shaking.

CHAPTER 4: MODULES

THERMAL ADAPTERS

A compatible thermal adapter is required for adding labware to the Heater-Shaker. Adapters can be purchased directly from Opentrons at <https://shop.opentrons.com>. Currently available Thermal Adapters include:

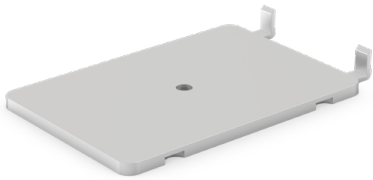

Universal Flat Adapter



PCR Adapter

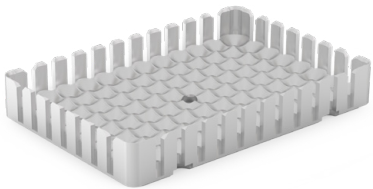

Deep Well Adapter



96 Flat Bottom Adapter

SOFTWARE CONTROL

The Heater-Shaker is fully programmable in Protocol Designer and the Python Protocol API. The Python API additionally allows for other protocol steps to be performed in parallel while the Heater-Shaker is active. See [Non-blocking commands](#) in the API documentation for details on adding parallel steps to your protocols.

Outside of protocols, the Opentrons App can display the current status of the Heater-Shaker and can directly control the heater, shaker, and labware latch.

Heater-Shaker specifications

Dimensions	152 × 90 × 82 mm (L/W/H)
Weight	1.34 kg
Module power input	36 VDC, 6.1 A
Power adapter input	100–240 VAC, 50/60 Hz
Mains supply voltage fluctuation	±10%
Overvoltage	Category II
Power consumption	<p>Idle: 3 W</p> <p>Typical:</p> <ul style="list-style-type: none"> ▪ Shaking: 4–11 W ▪ Heating: 10–30 W ▪ Heating and shaking: 10–40 W <p>Maximum: 125–130 W</p>
Environmental conditions	Indoor use only
Ambient temperature	20–25 °C
Relative humidity	Up to 80%, non-condensing
Altitude	Up to 2,000 m above sea level
Pollution degree	2

4.5 Magnetic Block GEN1



Magnetic Block features

The Opentrons Magnetic Block GEN1 is a magnetic 96-well plate holder. Magnetic blocks are used in protocols that rely on magnetism to pull particles out of suspension and retain them in well plates during wash, rinse, or other elution procedures. For example, automated NGS preparation; purifying genomic and mitochondrial DNA, RNA, or proteins; and other extraction procedures are all use cases that can involve magnetic blocks.

MAGNETIC COMPONENTS

The Magnetic Block is unpowered, does not contain any electronic components, and does not move magnetic beads up or down in solution. The wells consist of 96 high-strength neodymium ring magnets fixed to a spring-loaded bed, which helps maintain tolerances between the block and pipettes while running automated protocols.

SOFTWARE CONTROL

The Magnetic Block GEN1 is fully programmable in Protocol Designer and the Python Protocol API.

Outside of protocols, however, the touchscreen and the Opentrons App *are not* aware of and *cannot* display the current status of the Magnetic Block GEN1. This is an unpowered module. It does not contain electronic or mechanical components that can communicate with the Flex robot. You “control” the Magnetic Block via protocols that use the Opentrons Flex Gripper to add and remove labware from this module.

Magnetic Block specifications

Dimensions	136 × 94 × 45 mm (L/W/H)
Weight	1.13 kg
Module power	None, module is unpowered
Magnet grade	N52 neodymium
Environmental conditions	Indoor use only
Ambient temperature	20–25 °C
Relative humidity	30–80%, non-condensing
Altitude	Up to 2000 m above sea level
Pollution degree	2

4.6 Temperature Module GEN2



Temperature Module features

HEATING AND COOLING

The Opentrons Temperature Module GEN2 is a hot and cold plate module. It is often used in protocols that require heating, cooling, or temperature changes. The module can reach and maintain temperatures ranging from 4 °C to 95 °C within minutes, depending on the module's configuration and contents.

THERMAL BLOCKS

To hold labware at temperature, the module uses aluminum thermal blocks. The module comes with 24-well and 96-well thermal blocks. The Temperature Module caddy comes with a deep well block and a flat bottom block designed for use with the Flex Gripper. The blocks hold 1.5 mL and 2.0 mL tubes, 96-well PCR plates, PCR strips, deep well plates, and flat bottom plates.



Note: The module also ships with a flat bottom block for the OT-2. Do not use the OT-2 block with Flex. The flat bottom block for Flex has the words “Opentrons Flex” on its top surface. The one for OT-2 does not.

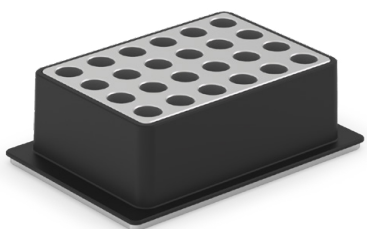

24-well thermal block

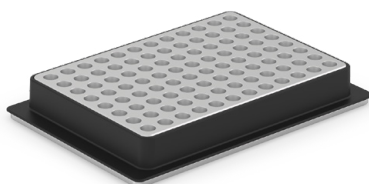

96-well thermal block

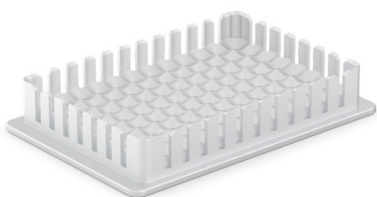

Deep well thermal block



Flat bottom thermal block for Flex

WATER BATHS AND HEATING

Because air is a good thermal insulator, gaps between labware and a thermal block can affect the time-to-temperature performance of the Temperature Module. Placing a little water in the 24- or 96-well thermal blocks eliminates air gaps and improves heating efficiency. The ideal amount of water depends on the thermal block and labware. See the [Temperature Module White Paper](#) for further recommendations.

SOFTWARE CONTROL

The Temperature Module is fully programmable in Protocol Designer and the Python Protocol API.

Outside of protocols, the Opentrons App can display the current status of the Temperature Module and can directly control the temperature of the surface plate.

Temperature Module specifications

Dimensions	194 × 90 × 84 mm (L/W/H)
Weight	1.5 kg
Module power	<ul style="list-style-type: none">▪ Input: 100–240 VAC, 50/60 Hz, 4.0 A▪ Output: 36 VDC, 6.1 A, 219.6 W max
Environmental conditions	Indoor use only
Ambient temperature	<22 °C (recommended for optimal cooling)
Relative humidity	Up to 60%, non-condensing
Altitude	Up to 2000 m above sea level
Pollution degree	2

4.7 Thermocycler Module GEN2



Thermocycler features

The Opentrons Thermocycler Module GEN2 is a fully automated on-deck thermocycler, providing hands-free PCR in a 96-well plate format. Its heated lid and disposable seal fit tightly over the plate, ensuring efficient sample heating and minimal evaporation.

HEATING AND COOLING

The Thermocycler's block can heat and cool, and its lid can heat, with the following temperature profile:

- Thermal block temperature range: 4–99 °C
- Thermal block maximum heating ramp rate: 4.25 °C/s from GEN2 ambient to 95 °C
- Thermal block maximum cooling ramp rate: 2.0 °C/s from 95 °C to ambient
- Lid temperature range: 37–110 °C
- Lid temperature accuracy: ±1 °C

The automated lid can be opened or closed as needed during protocol execution.

THERMOCYCLER PROFILES

The Thermocycler can execute *profiles*: automatically cycling through a sequence of block temperatures to perform heat-sensitive reactions.

RUBBER AUTOMATION SEALS

The Thermocycler comes with rubber automation seals to help reduce evaporation. Each seal must be sterilized before use and can be used for several runs. Additional seals can be purchased directly from Opentrons at <https://shop.opentrons.com>.

SOFTWARE CONTROL

The Thermocycler is fully programmable in Protocol Designer and the Python Protocol API.

Outside of protocols, the Opentrons App can display the current status of the Thermocycler and can directly control the block temperature, lid temperature, and lid position.

Thermocycler specifications

Dimensions (lid open)	244.95 × 172 × 310.1 mm (L/W/H)
Dimensions (lid closed)	244.95 × 172 × 170.35 mm (L/W/H)
Weight (including rear duct)	8.4 kg
Power adapter voltage	100–240 V at 50/60 Hz
Power adapter current	8.5–5 A
Overvoltage	Category II
Environmental conditions	Indoor use only
Ambient temperature	20–25 °C (ideal); 2–40 °C (acceptable)
Relative humidity	30–80%, non-condensing
Altitude	Up to 2000 m above sea level
Ventilation requirements	At least 20 cm / 8 in between the unit and a wall

Labware

This chapter covers items in the [Opentrons Labware Library](#) you can use with Opentrons Flex and the Opentrons Flex Gripper. It also covers custom labware and, for our power users, links labware components to their corresponding JSON file definitions.

You can purchase labware from the original equipment manufacturers or from the Opentrons shop at <https://shop.opentrons.com>. And, Opentrons is always working to verify new labware definitions. See the Labware Library (linked above) for the latest listings.

5.1 Labware concepts

Labware encompasses more than just the objects placed on the deck and used in a protocol. To help you understand Opentrons labware, let's examine this topic from three different perspectives. For the Opentrons Flex, labware includes items in our Labware Library, data that defines each piece of labware, and custom labware.

Labware as hardware

The Labware Library includes everything you can use by default with Opentrons Flex. These are durable components and consumable items that you work with, reuse, or discard while running a protocol. You don't need to take any special steps to work with the items in the Labware Library. The Flex robot knows how to work with everything in the library automatically.

Labware as data

Labware information is stored in Javascript object notation (JSON) files with `.json` file extensions. A JSON file includes spatial dimensions (length, width, height), volumetric capacity (μL , mL), and other metrics that define surface features, their shapes, and locations. When running a protocol, the Flex reads these `.json` files to know what labware is on the deck and how to work with it.

Custom labware

Custom labware is labware that *is not* included in the Labware Library or is labware created by the [Custom Labware Creator](#). However, sometimes the idea of custom labware comes burdened by notions of complexity, expense, or difficulty. But, custom labware shouldn't be hard to understand or create. Let's take a moment to unpack the concept of custom labware.

As an example, the Opentrons Labware Library includes 96-well plates (200 μ L) from Corning and Bio-Rad, but other manufacturers make these well plates too. And, thanks to commonly accepted industry standards, the differences among these ubiquitous lab items are minor. However, an ordinary 200 μ L, 96-well plate from Stellar Scientific, Oxford Lab, or Krackeler Scientific (or any other supplier for that matter) is "custom labware" for the Flex because it isn't pre-defined in our Labware Library. Additionally, minor differences in labware dimensions can have a drastic impact on the success of your protocol run. For this reason, it's important to have an accurate labware definition for each labware you want to use in your protocol.

Also, while custom labware could be an esoteric, one-off piece of kit, most of the time it's just the tips, plates, tubes, and racks used every day in labs all over the world. Again, the only difference between Opentrons labware and custom labware is the new item is not predefined in the software that powers the robot. The Flex can, and does, work with other basic labware items or something unique, but you need to record that item's characteristics in a labware definition JSON file and import that data into the Opentrons App. See the [Custom Labware Definitions section](#) below for more information.

To sum up, labware includes:

- Everything in the Opentrons Labware Library.
- Labware definitions: data in a JSON file that defines shapes, sizes, and capabilities of individual items like well plates, tips, reservoirs, etc.
- Custom labware, which are items that aren't included in the Labware Library.

After reviewing these important concepts, let's examine the categories and items in the Opentrons Labware Library. After that, we'll finish the chapter with an overview of the data components of a labware file and summarize the Opentrons features and services that help you create custom labware.

5.2 Reservoirs

The Opentrons Flex works by default with the single- and multi-well reservoirs listed below. Using these reservoirs helps reduce your prep work burden because they're automation-ready right out of the box. Reservoir information is also available in the [Opentrons Labware Library](#).

Single-well reservoirs

Manufacturer	Specifications	API load name
Agilent	<ul style="list-style-type: none"> 290 mL V bottom 	agilent_1_reservoir_290ml
Axygen	<ul style="list-style-type: none"> 90 mL Flat bottom 	axygen_1_reservoir_90ml
NEST	<ul style="list-style-type: none"> 195 mL Flat bottom 	nest_1_reservoir_195ml
	<ul style="list-style-type: none"> 290 mL V bottom 	nest_1_reservoir_290ml



Multi-well reservoirs

Manufacturer	Specifications	API load name
NEST	<ul style="list-style-type: none"> 12 wells 15 mL/well V bottom 	nest_12_reservoir_15ml
USA Scientific	<ul style="list-style-type: none"> 12 wells 22 mL/well V bottom 	usascientific_12_reservoir_22ml



Reservoirs and API definitions

The [Opentrons Labware Library](#) defines the characteristics of the reservoirs listed above in separate JSON files. The robot and the [Opentrons Python API](#) rely on these JSON definitions to work with labware used by your protocols. For example, when working with the API, the `ProtocolContext.load_labware` function accepts these labware names as valid parameters in your code. Linked API load names connect to the reservoir labware definitions in the [Opentrons GitHub repository](#).

Custom reservoir labware

Try creating a custom labware definition with the [Opentrons Labware Creator](#) if a reservoir you'd like to use isn't listed here. A custom definition combines all the dimensions, metadata, shapes, volumetric capacity, and other information in a JSON file. The Opentrons Flex needs this information to understand how to work with your custom labware. See the [Custom Labware Definitions section](#) section for more information.

5.3 Well plates

The Opentrons Flex works by default with well plates listed below. Using these well plates helps reduce your prep work burden because they're automation-ready right out of the box. Well plate information is also available in the [Opentrons Labware Library](#).

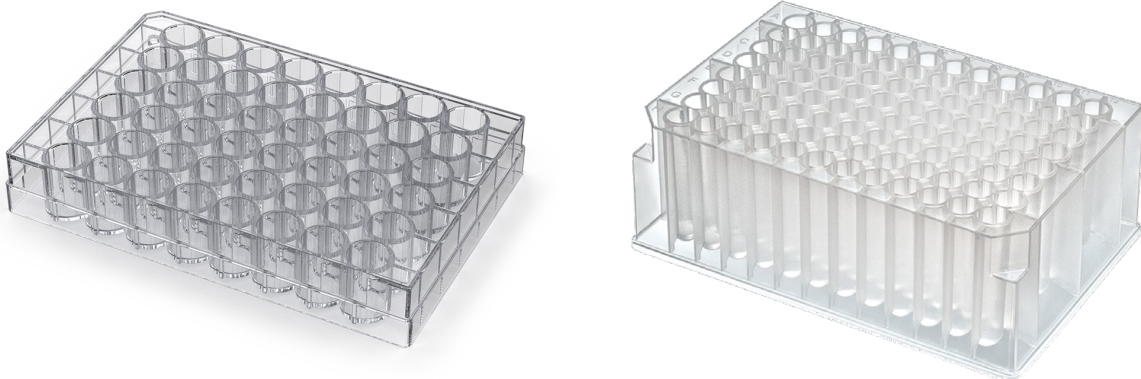

6-well plates

Manufacturer	Specifications	API load name
Corning	<ul style="list-style-type: none"> 6 wells 16.8 mL/well Circular wells, flat bottom 	corning_6_wellplate_16.8ml_flat

12-well plates

Manufacturer	Specifications	API load name
Corning	<ul style="list-style-type: none"> 12 wells 6.9 mL/well Circular wells, flat bottom 	corning_12_wellplate_6.9ml_flat

24-well plates

Manufacturer	Specifications	API load name
Corning	<ul style="list-style-type: none"> 24 wells 3.4 mL/well Circular wells, flat bottom 	corning_24_wellplate_3.4ml_flat

48-well plates

Manufacturer	Specifications	API load name
Corning	<ul style="list-style-type: none"> 48 wells 1.6 mL/well Circular wells, flat bottom 	corning_48_wellplate_1.6ml_flat

96-well plates

Manufacturer	Specifications	API load name
Bio-Rad	<ul style="list-style-type: none"> 96 wells 200 µL/well Circular wells, V bottom 	biorad_96_wellplate_200ul_pcr
Corning	<ul style="list-style-type: none"> 96 wells 360 µL/well Circular wells, flat bottom 	corning_96_wellplate_360ul_flat
NEST	<ul style="list-style-type: none"> 96 wells 100 µL/well Circular wells, V bottom PCR full skirt 	nest_96_wellplate_100ul_pcr_full_skirt
	<ul style="list-style-type: none"> 96 wells 200 µL/well Circular wells, flat bottom 	nest_96_wellplate_200ul_flat
	<ul style="list-style-type: none"> 96 deep wells 2000 µL/well Square wells, V bottom 	nest_96_wellplate_2ml_deep
Opentrons	<ul style="list-style-type: none"> Tough 96 wells 200 µL/well Circular wells, V bottom PCR full skirt 	opentrons_96_wellplate_200ul_pcr_full_skirt
Thermo Scientific	<ul style="list-style-type: none"> Nunc 96 deep wells 1300 µL/well Circular wells, U bottom 	thermoscientificnunc_96_wellplate_1300ul
	<ul style="list-style-type: none"> Nunc 96 deep wells 2000 µL/well Circular wells, U bottom 	thermoscientificnunc_96_wellplate_2000ul
USA Scientific	<ul style="list-style-type: none"> 96 deep wells 2.4 mL/well Square wells, U bottom 	usascientific_96_wellplate_2.4ml_deep

384-well plates

Manufacturer	Specifications	API load name
Applied Biosystems	<ul style="list-style-type: none"> 384 wells 40 µL/well Circular wells, V bottom 	appliedbiosystemsmicroamp_384_wellplate_40ul
Bio-Rad	<ul style="list-style-type: none"> 384 wells 50 µL/well Circular wells, V bottom 	biorad_384_wellplate_50ul
Corning	<ul style="list-style-type: none"> 384 wells 112 µL/well Square wells, flat bottom 	corning_384_wellplate_112ul_flat

Well plate adapters

The aluminum plates listed below are [thermal adapters](#) for the Opentrons Heater-Shaker GEN1 module. You can use these standalone adapter definitions to load Opentrons verified or custom labware on top of the Heater-Shaker.

Adapter type	API load name
Opentrons Universal Flat Heater-Shaker Adapter	opentrons_universal_flat_adapter
Opentrons 96 PCR Heater-Shaker Adapter	opentrons_96_pcr_adapter
Opentrons 96 Deep Well Heater-Shaker Adapter	opentrons_96_deep_well_adapter
Opentrons 96 Flat Bottom Heater-Shaker Adapter	opentrons_96_flat_bottom_adapter

You can also load both the adapter and labware with a single definition. Our Labware Library includes several pre-configured thermal adapter and labware combinations that make the Heater-Shaker ready to use right out of the box.



Note: Don't use a combined definition if you need to move labware onto or off of the Heater-Shaker during your protocol, either with the gripper or manually. Use a standalone adapter definition instead.

Adapter/labware combination	API load name
Opentrons 96 Deep Well Heater-Shaker Adapter with NEST Deep Well Plate 2 mL	opentrons_96_deep_well_adapter_nest_wellplate_2ml_deep
Opentrons 96 Flat Bottom Heater-Shaker Adapter with NEST 96 Well Plate 200 µL Flat	opentrons_96_flat_bottom_adapter_nest_wellplate_200ul_flat
Opentrons 96 PCR Heater-Shaker Adapter with NEST Well Plate 100 µL	opentrons_96_pcr_adapter_nest_wellplate_100ul_pcr_full_skirt
Opentrons Universal Flat Heater-Shaker Adapter with Corning 384 Well Plate 112 µL Flat	opentrons_universal_flat_adapter_corning_384_wellplate_112ul_flat

Adapters can be purchased directly from Opentrons at <https://shop.opentrons.com>.

Well plates and API definitions

The [Opentrons Labware Library](#) defines the characteristics of the well plates listed above in separate JSON files. The Flex robot and the [Opentrons Python API](#) rely on these JSON definitions to work with labware used by your protocols. For example, when working with the API, the `ProtocolContext.load_labware` function accepts these labware names as valid parameters in your code. Linked API load names connect to the well plate labware definitions in the [Opentrons GitHub repository](#).

Custom well plate labware

Try using the Opentrons Labware Creator to make a custom labware definition if a well plate you'd like to use isn't listed here. A custom definition combines all the dimensions, metadata, shapes, volumetric capacity, and other information in a JSON file. The Opentrons Flex reads this information to understand how to work with your custom labware. See the [Custom Labware Definitions section](#) for more information.

5.4 Tips and tip racks

Opentrons Flex tips come in 50 μL , 200 μL , and 1000 μL sizes. These are clear, non-conducting polypropylene tips that are available with or without filters. They're packaged sterile in racks that hold 96 tips and are free of DNase, RNase, protease, pyrogens, human DNA, endotoxins, and PCR inhibitors. Racks also include lot numbers and expiration dates.

Flex pipette tips work with the Opentrons Flex 50 μL and 1000 μL pipettes in the 1-, 8-, and 96-channel configurations. While you can put any of the Flex tips on the 50 μL and 1000 μL pipettes, try to match the tip to the pipette's rated capacity. For example, it might be odd to put a 1000 μL tip on the 50 μL pipette. For the 1000 μL pipette, you could certainly use a 50 μL , 200 μL , or 1000 μL tip.

Tip racks

Unfiltered and filtered tips are bundled into a rack that consists of a reusable base plate, a mid-plate that holds 96 tips, and a lid.

Tip rack by volume	API load name
50 μL	<ul style="list-style-type: none"> Unfiltered: opentrons_flex_96_tiprack_50ul Filtered: opentrons_flex_96_filtertiprack_50ul
200 μL	<ul style="list-style-type: none"> Unfiltered: opentrons_flex_96_tiprack_200ul Filtered: opentrons_flex_96_filtertiprack_200ul
1000 μL	<ul style="list-style-type: none"> Unfiltered: opentrons_flex_96_tiprack_1000ul Filtered: opentrons_flex_96_filtertiprack_1000ul

To help with identification, the tip rack mid-plates are color coded based on tip size:

- 50 μL : magenta
- 200 μL : yellow
- 1000 μL : blue

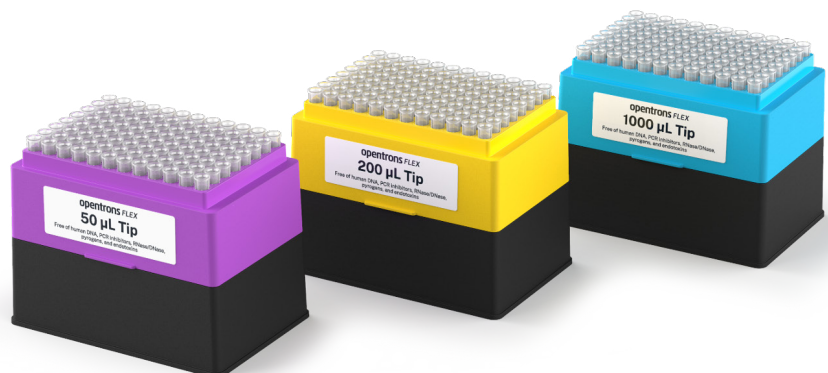

When ordering or reordering, tips and racks come in two different packaged configurations:

- **Racks:** Consist of separately shrink-wrapped tip racks (base plate, mid-plate with tips, and lid). Racked configurations are best when cleanliness is paramount, to avoid cross-contamination, or when your protocols don't allow for base plate or component reuse.
- **Refills:** Consist of one complete tip rack (base plate, mid plate with tips, and lid) and individual tip containers. Refill configurations are best when your protocols allow for base plate or component reuse.

Tip-pipette compatibility

Flex pipette tips are designed for the Opentrons Flex pipettes. Flex tips are not backwards compatible with Opentrons OT-2 pipettes, nor can you use OT-2 tips on Flex pipettes.

Other industry-standard tips may work with Flex pipettes, but this is not recommended. To ensure optimum performance, you should only use Opentrons Flex tips with Flex pipettes.

Tip rack adapter

The 96-channel pipette requires an adapter to attach a full rack of tips properly. During the attachment procedure, the pipette moves over the adapter, lowers itself onto the mounting pins, and pulls tips onto the pipettes by lifting the adapter and tip rack.





Note: Only use the tip rack adapter when picking up a full rack of tips at once. Place tip racks directly on the deck when picking up fewer tips.



Warning: Pinch point hazard. Keep hands away from the tip rack adapter while the pipette is attaching pipette tips.

Adapter type	API load name
Opentrons Flex 96 Tip Rack Adapter	opentrons_flex_96_tiprack_adapter

The tip rack adapter is compatible with the Opentrons Flex Gripper. You can use the gripper to place fresh tip racks on the adapter or to pick up and move used tip racks into the waste chute.

5.5 Tubes and tube racks



The [Opentrons 4-in-1 Tube Rack system](#) works with the Opentrons Flex by default. Using the 4-in-1 tube rack helps reduce your prep work burden because the combinations it provides are automation-ready right out of the box. More information is also available in the [Opentrons Labware Library](#).

Tube and rack combinations

The Opentrons 4-in-1 tube rack supports a wide variety of tube sizes, singly or in different size (volume) combinations. These include a:

- 6-tube rack for 50 mL tubes (6 x 50 mL).
- 10-tube combination rack for four 50 mL tubes and six 15 mL tubes (4 x 50 mL, 6 x 15 mL).
- 15-tube rack for 15 mL tubes (15 x 15 mL).
- 24-tube rack for 0.5 mL, 1.5 mL, or 2 mL tubes (24 x 0.5 mL, 1.5 mL, 2 mL).



Note: All tubes are cylindrical with V-shaped (conical) bottoms unless otherwise indicated.

6-tube racks

Tube type	API load name
6 Falcon 50 mL	opentrons_6_tuberack_falcon_50ml_conical
6 NEST 50 mL	opentrons_6_tuberack_nest_50ml_conical

10-tube racks

Tube type	API load name
<ul style="list-style-type: none"> ▪ 4 Falcon 50 mL ▪ 6 Falcon 15 mL 	opentrons_10_tuberack_falcon_4x50ml_6x15ml_conical
<ul style="list-style-type: none"> ▪ 4 NEST 50 mL ▪ 6 NEST 15 mL 	opentrons_10_tuberack_nest_4x50ml_6x15ml_conical

15-tube racks

Tube type	API load name
15 Falcon 15 mL	opentrons_15_tuberack_falcon_15ml_conical
15 NEST 15 mL	opentrons_15_tuberack_nest_15ml_conical

24-tube racks

Tube type	API load name
24 Eppendorf Safe-Lock 1.5 mL	opentrons_24_tuberack_eppendorf_1.5ml_safelock_snapcap
24 Eppendorf Safe-Lock 2 mL, U-shaped bottom	opentrons_24_tuberack_eppendorf_2ml_safelock_snapcap
24 generic 2 mL screw cap	opentrons_24_tuberack_generic_2ml_screwcap
24 NEST 0.5 mL screw cap	opentrons_24_tuberack_nest_0.5ml_screwcap
24 NEST 1.5 mL screw cap	opentrons_24_tuberack_nest_1.5ml_screwcap
24 NEST 1.5 mL snap cap	opentrons_24_tuberack_nest_1.5ml_snapcap
24 NEST 2 mL screw cap	opentrons_24_tuberack_nest_2ml_screwcap
24 NEST 2 mL snap cap, U-shaped bottom	opentrons_24_tuberack_nest_2ml_snapcap

Tube rack API definitions

The [Opentrons Labware Library](#) defines the characteristics of the tube racks listed above in separate JSON files. The Flex robot and the [Opentrons Python API](#) rely on these JSON definitions to work with labware used by your protocols. For example, when working with the API, the `ProtocolContext.load_labware` function accepts these labware names as valid parameters in your code. Linked API load names connect to the tube rack labware definitions in the [Opentrons GitHub repository](#).

Custom tube rack labware

Try creating a custom labware definition using the [Opentrons Labware Creator](#) if a tube and rack combination you'd like to use isn't listed here. A custom definition combines all the dimensions, metadata, shapes, volumetric capacity, and other information in a JSON file. The Opentrons Flex reads this information to understand how to work with your custom labware. See the [Custom Labware Definitions section](#) section for more information.

5.6 Aluminum blocks

Aluminum blocks ship with the Temperature Module GEN2 and can be purchased separately as a [three-piece set](#). The set includes a flat bottom plate, a 24-well block, and a 96-well block.

The Opentrons Flex uses aluminum blocks to hold sample tubes and well plates on the Temperature Module or directly on the deck. When used with the Temperature Module, the aluminum blocks can keep your sample tubes, PCR strips, or plates at a constant temperature between 4 °C and 95 °C.

Flat bottom plate

The flat bottom plate for Flex ships with the Temperature Module's caddy and is compatible with various ANSI/SLAS standard well plates. This flat plate differs from the plate that ships with the Temperature Module itself or the separate three-piece set. It features a wider working surface and chamfered corner clips. These features help improve the performance of the Opentrons Flex Gripper when moving labware onto or off of the plate.

You can tell which flat bottom plate you have because the one for Flex has the words "Opentrons Flex" on its top surface. The one for OT-2 does not.



24-well aluminum block

The 24-well block is used with individual sample vials. For example, it accepts sample vials that:

- Have V-shaped or U-shaped bottoms.
- Secure contents with snap cap or screw cap closures.
- Hold liquid in capacities of 0.5 mL, 1.5 mL, and 2 mL.



96-well aluminum block

The 96-well block supports a wide variety of well plate types. For example, it accepts well plates that are:

- From major well-plate manufacturers like Bio-Rad and NEST.
- Designed with V-shaped bottoms, U-shaped bottoms, or flat bottoms.
- Designed with 100 μ L or 200 μ L wells.



It is also compatible with generic PCR strips.

Standalone adapters

Thermal block	API load name
Flex flat bottom plate	opentrons_aluminum_flat_bottom_plate
24-well aluminum block	See <i>labware combinations below</i> .
96-well aluminum block	opentrons_96_well_aluminum_block

Aluminum block labware combinations

The [Opentrons Labware Library](#) supports the following block, vial, and well plate combinations, which are also defined in separate JSON labware definition files. The Flex robot and the [Opentrons Python API](#)

rely on these JSON definitions to work with labware used by your protocols. For example, when working with the API, the `ProtocolContext.load_labware` function accepts these labware names as valid parameters in your code. The tables below list the default block/container combinations and related API load names. Links connect to corresponding JSON definitions in the [Opentrons GitHub repository](#).



Note: All tubes have V-shaped bottoms unless otherwise indicated.

24-well aluminum block labware combinations

24-well block contents	API load name
Generic 2 mL screw cap	opentrons_24_aluminumblock_generic_2ml_screwcap
NEST 0.5 mL screw cap	opentrons_24_aluminumblock_nest_0.5ml_screwcap
NEST 1.5 mL screw cap	opentrons_24_aluminumblock_nest_1.5ml_screwcap
NEST 1.5 mL snap cap	opentrons_24_aluminumblock_nest_1.5ml_snapcap
NEST 2 mL screw cap	opentrons_24_aluminumblock_nest_2ml_screwcap
NEST 2 mL snap cap, U-shaped bottom	opentrons_24_aluminumblock_nest_2ml_snapcap

96-well aluminum block labware combinations

96-well block contents	API load name
Bio-Rad well plate 200 µL	opentrons_96_aluminumblock_biorad_wellplate_200uL
Generic PCR strip 200 µL	opentrons_96_aluminumblock_generic_pcr_strip_200uL
NEST well plate 100 µL	opentrons_96_aluminumblock_nest_wellplate_100uL

5.7 Labware and the Opentrons Flex Gripper

Although the Opentrons Flex works with all the inventory in the Labware Library, the Opentrons Flex Gripper is compatible with specific labware items only. Currently, the Gripper is optimized for use with the following labware items.

Labware category	Brands
Deep Well Plates	<ul style="list-style-type: none"> NEST 96 Deep Well Plate 2 mL
Fully Skirted 96 Well Plates	<ul style="list-style-type: none"> Opentrons Tough 96 Well Plate 200 μL PCR Full Skirt NEST 96 Well Plate 200 μL Flat
Tip Racks (unfiltered and filtered tips)	<ul style="list-style-type: none"> Opentrons Flex 96 Tip Rack 50 μL Opentrons Flex 96 Tip Rack 200 μL Opentrons Flex 96 Tip Rack 1000 μL



Note: For best results, use the Flex Gripper only with the labware listed above. The Flex Gripper may work with other ANSI/SLAS automation compliant labware, but this is not recommended.

5.8 Custom labware definitions

As discussed at the beginning of this chapter, custom labware is labware that's not listed in the Opentrons Labware Library. You can use other common or unique labware items with the Flex by accurately measuring and recording the characteristics of that object and saving that data in a JSON file. When imported into the app, the Flex and the API uses that JSON data to interact with your labware. Opentrons provides tools and services, which we'll examine below, to help you use the Flex with custom labware.

Creating custom labware definitions

Opentrons tools and services help put custom labware within your reach. These features accommodate different skill levels and ways of working. Creating your own labware, and using it with the Opentrons Flex, helps make the robot a versatile and powerful addition to your lab.

CUSTOM LABWARE CREATOR

The [Custom Labware Creator](#) is a no-code, web-based tool that uses a graphical interface to help you create a labware definition file. Labware Creator produces a JSON labware definition file that you import into the Opentrons App. After that, your custom labware is available to the Flex robot and the Python API.

CUSTOM LABWARE SERVICE

Get in touch with us if the labware you'd like to use isn't available in the library, if you can't create your own definitions, or because a custom item includes different shapes, sizes, or other irregularities described below.

Labware you can define in Labware Creator	Labware Opentrons needs to define
<input checked="" type="checkbox"/> Wells and tubes are uniform and identical.	<input checked="" type="checkbox"/> Wells and tube shapes vary.
<input checked="" type="checkbox"/> All rows are evenly spaced (the space between rows is equal).	<input checked="" type="checkbox"/> Rows are not evenly spaced.
<input checked="" type="checkbox"/> All columns are evenly spaced (the space between columns is equal).	<input checked="" type="checkbox"/> Columns are not evenly spaced.
<input checked="" type="checkbox"/> Fits perfectly in one deck slot.	<input checked="" type="checkbox"/> Smaller than one deck slot (requires adapter) or spans multiple deck slots.

Here are some diagrams that help you visualize the examples described above.

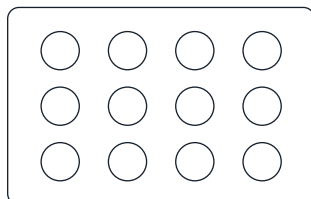

✓ **Regular**

All columns are evenly spaced and all rows are evenly spaced.
Columns do not need to have the same spacing as rows.

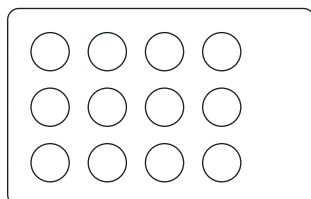

✓ **Regular**

The grid does not have to be in the center of labware.

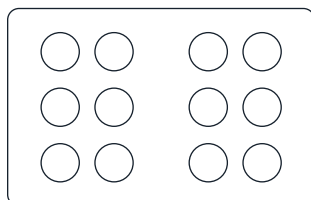

✗ **Irregular**

Rows are evenly spaced but **columns are not evenly spaced.**

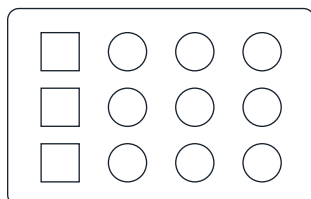

✗ **Irregular**

Columns/rows are evenly spaced but **wells are not identical.**

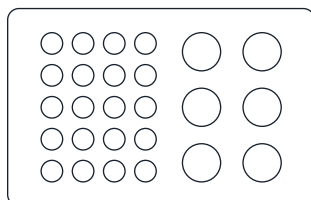

✗ **Irregular**

There is **more than one grid.**

Our labware team will work to understand your needs and design custom labware definitions for you. See the support articles [Requesting a Custom Labware Definition](#) and the [Custom Labware Request](#) form for more information. This is a fee-based service.

PYTHON API

While you cannot create custom labware with our API, you can use custom labware with the available API methods. However, you need to define your custom labware first and import it into the Opentrons App. Once you have added your labware to the Opentrons App, it's available to the Python API and the robot. See the [Custom Labware Definitions section](#) of the Python API documentation for more information. For information about writing protocol scripts with the API, see the [Python Protocol API section](#) in the Protocol Development chapter.

JSON labware schema

A JSON file is the blueprint for Opentrons standard and custom labware. This file contains and organizes labware data according to the design specifications set by the default schema.

A schema is a framework for organizing data. It sets the rules about what information is required or optional and how it's organized in the JSON file. If you're interested, take a moment to review [our labware schema](#). For an actual example, see the schema for the [Opentrons 96 PCR Adapter](#). The following table lists and defines the items in the Opentrons labware schema.

Property	Data type	Definition
schemaVersion	Number	Schema version used by a labware. The current version is 2.
version	Integer	An incrementing integer that identifies the labware version. Minimum version is 1.
namespace	String	See <code>safeString</code> in the JSON definitions section below.
metadata	Object	Properties used for search and display. Accepts only: <ul style="list-style-type: none"> ▪ <code>displayName</code> (String): An easy-to-remember labware name. ▪ <code>displayCategory</code>: Labels used in the UI to categorize labware. See <code>displayCategory</code> in the JSON definitions section below. ▪ <code>displayVolumeUnits</code> (String): Labels used in the UI to indicate volume. Must be either μL, mL, or L.
brand	Object	Information about the labware manufacturer or those products the labware is compatible with.

parameters	Object	<p>Internal parameters that describe labware characteristics. Accepts only:</p> <ul style="list-style-type: none"> ▪ <code>format</code> (String): Determines labware compatibility with multichannel pipettes. Must be one of <code>96Standard</code>, <code>384Standard</code>, <code>trough</code>, <code>irregular</code>, or <code>trash</code>. ▪ <code>quirks</code> (Array): Strings describing labware behavior. See the Opentrons 96 Deep Well Adapter definition. ▪ <code>isTiprack</code> (Boolean): Indicates if labware is a tip rack (<code>true</code>) or not (<code>false</code>). ▪ <code>tipLength</code> (Number): Required if labware is a tip rack. Specifies tip length (in mm), from top to bottom, as indicated in technical drawings or as measured with calipers. ▪ <code>tipOverlap</code> (Number): Required if labware is a tip rack. Specifies how far tips on a tip rack are expected to overlap with the pipette's nozzle. Defined as tip length minus the distance between the bottom of the pipette and the bottom of the tip. The robot's calibration process may fine-tune this estimate. ▪ <code>loadName</code>: Name used to reference a labware definition (e.g., <code>opentrons_flex_96_tiprack_50_u1</code>). ▪ <code>isMagneticModuleCompatible</code> (Boolean): Indicates if labware is compatible with the Magnetic Module. ▪ <code>magneticModuleEngageHeight</code>: How far the Magnetic Module will move its magnets when used with this labware. See <code>positiveNumber</code> in the JSON definitions section below.
ordering	Array	<p>An array that tracks how wells should be ordered on a piece of labware. See the Opentrons 96 PCR Adapter example.</p>
cornerOffsetFromSlot	Object	<p>Used for labware that spans multiple deck slots. Offset is the distance from the left-front-bottom corner of the slot to the left-front-bottom corner of the labware bounding box. Accepts only:</p> <ul style="list-style-type: none"> ▪ <code>x</code> (number) ▪ <code>y</code> (number) ▪ <code>z</code> (number) <p>For labware that does not span multiple slots, these values should be zero. See <code>positiveNumber</code> in the JSON definitions section below.</p>

dimensions	Object	<p>Outer dimensions (in mm) of a piece of labware. Accepts only:</p> <ul style="list-style-type: none"> ▪ xDimension (length) ▪ yDimension (width) ▪ zDimension (height) <p>See the Opentrons 96 PCR Adapter example.</p>
wells	Object	<p>An unordered object of well objects, including position and dimensions.</p> <p>Each well object's key is the well's coordinates, which must be an uppercase letter followed by a number, e.g., A1, B1, H12.</p> <p>Each well object accepts the following properties:</p> <ul style="list-style-type: none"> ▪ depth (Number): The distance (in mm) between the top and bottom of the well. For tip racks, depth is ignored in favor of tipLength, but the values should match. ▪ x (Number): Location of the center-bottom of a well in reference to the left of the labware. ▪ y (Number): Location of the center-bottom of a well in reference to the front of the labware. ▪ z (Number): Location of the center-bottom of a well in reference to the bottom of the labware. ▪ totalLiquidVolume (Number): Total well, tube, or tip volume in μL. ▪ xDimension (Number): Length of a rectangular well. ▪ yDimension (Number): Width of a rectangular well. ▪ diameter (Number): Diameter of a circular well. ▪ shape (String): Either rectangular or circular. If rectangular, specify xDimension and yDimension. If circular, specify diameter. <p>For a circular well example, see the Opentrons 96 PCR Adapter. For a rectangular well example, see the NEST 96 Deep Well Plate 2mL.</p> <p>For dimension, depth, and volume, see positiveNumber in the JSON definitions section below.</p>

groups	Array	<p>Logical well groupings for metadata and display purposes. Changes in groups do not affect protocol execution. Each item in the array accepts:</p> <ul style="list-style-type: none"> ▪ wells (Array): An array of wells (e.g., ["A1", "B1", "C1"]) that share the same metadata. Array elements are strings. ▪ metadata (Object): Metadata specific to a grid of wells. Accepts only: <ul style="list-style-type: none"> ▪ displayName (String): Human-readable name for the well group. ▪ displayCategory: Labels used to categorize well groups. See displayCategory in the JSON definitions section below. ▪ wellBottomShape (String): Bottom shape of a well. Available shapes are flat, u, or v only. ▪ brand: Brand information for the well group. See brandData in the JSON definitions section below.
allowedRoles	Array	<p>Defines an item's role or purpose. If the allowedRoles field is missing from a definition, an item is treated as labware. Possible array items are only the following strings:</p> <ul style="list-style-type: none"> ▪ labware (standard labware items) ▪ adapter (items designed to hold labware) ▪ fixture (items that are affixed to the deck) ▪ maintenance (items not used in normal protocol runs)
stackingOffset WithLabware	Object	<p>For labware that can stack on top of another piece of labware. Used to determine z-height (labware z height + adapter z height - overlap). See coordinates in the JSON definitions section below.</p>
stackingOffset WithModule	Object	<p>For labware that can stack on top of a module. Used to determine z-height (module labware offset z + labware z - overlap). See coordinates in the JSON definitions section below.</p>

gripperOffsets	Object	<p>Offsets added when calculating the coordinates the gripper should go to when picking up or dropping other labware on this labware. Includes a default object that includes two properties:</p> <ul style="list-style-type: none">▪ <code>pickUpOffset</code>: Offset added to calculate the pick-up coordinates of labware placed on this labware.▪ <code>dropOffset</code>: Offset added to calculate the drop-off coordinates of labware placed on this labware. <p>See coordinates in the JSON definitions section below.</p>
gripForce	Number	<p>Measured in newtons, this is the force which the gripper uses to grasp labware. Recommended values are between 5 and 16.</p>
gripHeight FromLabware Bottom	Number	<p>Recommended z-axis height, from the labware bottom to the center of the gripper pads.</p>

JSON labware definitions

Property	Data type	Definition
positiveNumber	Number	Minimum: 0.
brandData	Object	Information about branded items. Accepts only: <ul style="list-style-type: none"> brand (String): Brand/manufacturer's name. brandId (Array): OEM part numbers or IDs. links (Array): Manufacturer URLs. Array items are strings.
displayCategory	String	Must be one of: <ul style="list-style-type: none"> tipRack tubeRack reservoir trash wellPlate aluminumBlock adapter other
safeString	String	A string safe to use for load names and namespaces. Lowercase letters, numerals, periods, and underscores only.
coordinates	Object	Coordinates that specify a distance or position along the x-, y-, and z-axes. Accepts only: <ul style="list-style-type: none"> x (number) y (number) z (number)

Protocol Development

The Opentrons Flex system can run a wide variety of automated protocols, for tasks such as PCR, NGS, ELISA, and many more. You can run fully built and verified protocols, edit community protocols to suit your needs, or design protocols from scratch – with or without writing code.

This chapter provides an overview of each of these protocol development methods, as well as giving guidance on how to adapt protocols written for the Opentrons OT-2 to run on Opentrons Flex.

6.1 Pre-made protocols

Protocol Library

The Opentrons Protocol Library hosts protocols authored either by Opentrons itself or by members of the Opentrons community. To find a protocol that fits your target application, use the search field at the top of the [Protocol Library homepage](#).

You can also browse protocols by categories, like DNA/RNA, cell biology, cell and tissue culture, proteins, commercial assay kits, or molecular biology. There's even a category for protocols that create art by pipetting! Take some time to check out the protocols in our library. Understanding what's available – and making some cool pixel art – is a great way to learn about the features and capabilities of your robot before moving on to using real samples and reagents.

SEARCHING FOR PROTOCOLS

The Protocol Library search returns results as you type. You can select a result from the search list or click **View All Results** to go to the full results page, which shows more details about each protocol and lets you filter them based on several criteria.

Each protocol card will show:

CHAPTER 6: PROTOCOL DEVELOPMENT

Item	Description
Protocol name	The name of the protocol.
Verification	Badges indicate if the protocol is verified by OpenTrons, a third-party manufacturer, or members of the community.
Time estimate	Approximately how long the protocol takes to run.
Description	A short summary of what the protocol does.
Robot model	Which OpenTrons robots the protocol is compatible with.
Protocol editability	JSON protocols are editable in Protocol Designer, with no coding required. Python protocols are editable in any text editor, using the Python Protocol API.
Modules	Any hardware modules that are required.

In addition to these categories, in the sidebar you can filter results by:

- **Pipettes:** Which pipettes the protocol uses (you can usually change a protocol's pipettes, but it may affect the run time and the number of tips consumed).
- **Categories:** Target applications, like DNA/RNA, cell biology, proteins, etc.
- **Protocol version:** Show or hide older versions of protocols.

PROTOCOL DETAILS

Click on a protocol to go to its detail page, which provides even more information. In addition to what is shown in search, here you can see:

- **Supporting data:** Additional data, explanations, or links to outside sources provided by the protocol author.
- **What you'll need:** A complete list of all equipment needed for the protocol, including the robot, modules, labware, pipettes, and third-party kits.
- **Protocol steps:** A list of steps written by the protocol author, as well as a visual deck map and list of liquids specified in the protocol file.

■ CHAPTER 6: PROTOCOL DEVELOPMENT

The details page also provides basic instructions for downloading and running the protocol. For more information on importing a protocol to the Opentrons App and setting up a run, see the [Transferring Protocols to Flex section](#) in the Software and Operation chapter.

Custom Protocol Development service

Opentrons provides a [Remote Custom Protocol Development service](#) for applications not already included in the Protocol Library. Our comprehensive authoring and validation service has a turnaround time of two weeks. As part of the service, Opentrons field applications scientists will:

- Develop the Python protocol.
- Validate the code.
- Install the protocol remotely.
- Create deck and reagent setup instructions.
- Optimize your protocol as much as needed within one week of initial delivery.

By default, Opentrons adds all custom protocols to the Protocol Library so the community can benefit from them. However, if your application requires privacy, you can opt out of inclusion in the Protocol Library.



Note: The Custom Protocol Development service only writes Python protocols that control Opentrons hardware. It does not cover controlling the robot with code in other languages, nor does it cover controlling third-party hardware.

PROTOCOL REQUEST GUIDELINES

Describing your protocol in detail enables Opentrons field applications scientists to accurately code the automation that you need. Consider your protocol's requirements, including:

- Hardware (pipettes, gripper, modules, fixtures).
- Labware (Opentrons verified, other standard, or custom).

Also consider special cases that apply to your protocol, like:

- Liquids that are volatile, viscous, or otherwise behave differently than water.
- Conservation of expensive reagents.

CHAPTER 6: PROTOCOL DEVELOPMENT

- Sterility and cross-contamination.
- Advanced pipetting techniques like air-gapping, high or low flow rate, or pipetting at specific locations within wells.

To explain the movements the robot will make in executing the protocol, start with your initial deck state. Where should modules, labware, and trash containers be located? Which liquids will be in which labware, and in what quantities? Use the coordinate systems printed on the Opentrons Flex deck and on standard labware to describe these locations.

Next, give step-by-step instructions on how Opentrons Flex should handle liquids, specifying quantities in microliters (μL) and giving exact source and destination locations (rows, columns, or individual wells of labware).

In general, following the style of the methods section of an academic paper will help the Opentrons team understand your instructions. And always err on the side of providing extra information — it may be exactly the detail we need to write code for your protocol.

CUSTOM PROTOCOL PRICING

The Custom Protocol Development service is open to all owners of Opentrons Flex systems. Pricing is based on complexity of your workflow.

Complexity	Price	Description
Complex	\$2,250	Protocols that require complex Python code and a longer time for protocol optimization. Example applications include NGS, nucleic acid purification, nucleic acid extraction, protein expression, and purification.
Moderately Complex	\$1,750	Protocols that require moderately complex Python code and time for protocol optimization. Example applications include ELISA, protein crystallization, Bradford Assays or BCA assays, transfection or transformation assays, drug discovery, MALDI spotting, microarray prep, flow cytometry, complex serial dilutions, workflows with multiple variables, and workflows with highly unique plate maps.

■ CHAPTER 6: PROTOCOL DEVELOPMENT

Simple	\$1,250	Protocols that require basic Python code and minimal optimization. Example applications include PCR setup, sample aliquoting, normalization, cherrypicking, CSV file handling, media exchange, and mass spectrometry sample preparation.
Amendments	\$750	Amendments to existing protocols in the Protocol Library only.

You can purchase protocol development [from the Opentrons shop](#), or you can contact Opentrons Sales for more information.

6.2 Protocol Designer

[Protocol Designer](#) is a web-based, no-code tool for developing protocols that run on Opentrons robots, including Opentrons Flex. You can use Protocol Designer to create protocols that:

- Aspirate, dispense, transfer, and mix liquids.
- Move labware around the deck with the gripper.
- Operate Opentrons Flex modules.
- Pause to let you verify progress or access samples.

All work on your protocol takes place within your web browser. When you're done creating or editing your protocol, you need to export it to a JSON file. Then upload that file to a robot and run it, as you would with any protocol.



Protocol Designer requirements

Currently, Protocol Designer is only supported for use in Google Chrome and requires an internet connection. Uploading and running JSON protocols on Opentrons Flex requires version 7.0.0 or later of the Opentrons App.

You can't create or modify Python protocol files with Protocol Designer.

Designing a protocol

Protocols are all about informing the robot what hardware it will use to take specific actions. This process is broken down into three tabs in Protocol Designer:

Icon	Tab
	The File tab is where you manage protocol files and specify hardware for use in your protocol.
	The Liquids tab lets you define samples, reagents, and any other liquids that your robot will handle.
	The Design tab is where you specify the initial state of the deck, add steps that the robot will perform, and view the projected outcomes of those steps.

To create a protocol from scratch, you'll start on the File tab, work with the Liquids and Design tabs, and then return to the File tab to export your work. The remainder of this section goes through the protocol creation process in detail.

PART 1: CREATE A PROTOCOL

When you launch Protocol Designer, you'll begin on the **File** tab. In the left sidebar, click **Create New** to open the Create New Protocol dialog. Click on the image of Opentrons Flex and then click **Next**.

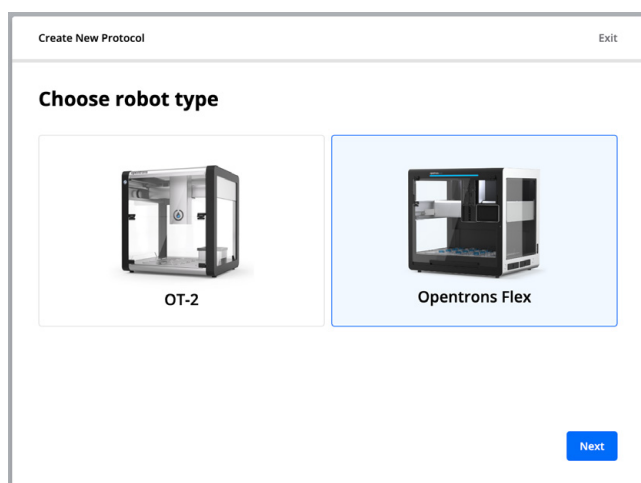

Choosing to create a protocol for Opentrons Flex in Protocol Designer.

CHAPTER 6: PROTOCOL DEVELOPMENT

Enter a name for your protocol, which is how it will appear in the Opentrons App and on the touchscreen. You'll also see your protocol name in the Protocol Designer header while you're working on it. Optionally add a description and author information for your protocol.

Next, Protocol Designer guides you through choosing the hardware used in your protocol:

1. Pipettes and what type of tip racks you'll use with them. Every protocol requires at least one pipette.
2. Staging area slots in column 3 (optional).
3. Additional hardware used in your protocol, such as modules, the gripper, or the waste chute. Only [modules that are compatible with Flex](#) are shown.



Note: There are currently some limitations on what hardware you can add to a JSON protocol.

- You can't use multiple types of tips with a single pipette (e.g., using filter tips for certain pipetting actions and unfiltered tips for other actions).
- You can't use multiple modules of the same type.

If your application requires these features, you'll need to use a Python protocol.

See the [Python-exclusive features section](#) below.

At any time, you can return to the File tab to rename your protocol, add an author name or description, or change your hardware configuration.

PART 2: DEFINE LIQUIDS

Move on to the **Liquids** tab to set up samples and reagents. This tab is only for *defining* types of liquids. You'll indicate the starting positions and amounts of liquids in Part 3, on the Design tab.

Click **New Liquid** and then enter the name of your liquid and an optional description. You can also choose whether to *serialize* the liquid, so each well containing that liquid will be numbered on the deck map and in action steps. For example, if your protocol has blood samples, serialization can help you keep them separate in your workflow, while still labeling them all as "blood" and color-coding them the same.

Each type of liquid appears in a different color on the deck map in Protocol Designer, in the Opentrons App, and on the touchscreen. You can use the default color, pick another preset color, or enter an RGB hex code to set a custom color.

PART 3: LAY OUT THE DECK

Go to the Design tab to do the final setup step, which is placing labware and liquids on the deck. The main view on this tab is the deck map, which shows everything on the deck down to individual wells — even on 384-well plates.

The deck map starts with the tip racks and modules you chose for your protocol in their default locations. Hover over any open slot and click **Add Labware or Adapter** to add more tip racks, other types of labware, or adapters. Drag and drop labware to an open slot to move it there, or to an occupied slot to swap the two pieces of labware.



Note: You can't move modules or adapters around the deck map by drag and drop.

This is to make it easier to move *labware* onto or off of a module.

- To change a module's position, return to the **File** tab and click **Edit** next to the module name.
- To change an adapter's position, add a new adapter. Then move the labware from the old adapter to the new adapter. Finally, delete the old adapter.

Hover over any labware and click **Add Liquids** to specify which wells contain which liquid. Clicking on a single well or dragging across a range of wells will reveal a form at the top of the screen. Choose one of the liquids you defined and the volume *each* well should start with, in μL . For example, if you select the first column on a 96-well plate and specify 100 μL , that will be 800 μL of liquid total (100 μL \times 8 wells).

PART 4: ADD STEPS

At last, it's time to tell your robot how to move liquid around the deck. Click **Add Step** and choose the type of step.

- Pipetting steps
 - **Transfer:** Move liquid from one well or group of wells to another. Specify the source, where liquid will be aspirated from, on the left. Specify the destination, where liquid will be dispensed, on the right. Click either gear icon to change behaviors such as flow rate, tip height, knocking droplets off (touch tip), air gapping, blowout, and more. In the Sterility & Motion section, choose the correct tip-use strategy for your application.

CHAPTER 6: PROTOCOL DEVELOPMENT

- **Mix:** Repeatedly aspirate and dispense liquid within the same well. Choose how much liquid to mix with, the number of mixing repetitions, and which wells will be mixed. Like with transfer steps, click either gear to change mixing behavior. You can also choose a tip-use strategy for mixing. These options are more limited than for transfers, since all liquid returns to its starting location when mixing.
- Gripper steps
 - **Move Labware:** Control the Flex Gripper or move labware around the deck manually. Choose which labware you want to move and its new location. Check the **Use Gripper** box to have the gripper move the labware automatically, or leave it unchecked to have the protocol pause so you can move the labware manually. You need to use the gripper to dispose labware by moving it into the waste chute. You need to move labware manually to move it off the deck (without disposing it).
- Module steps
 - **Heater-Shaker:** Control the temperature, shake speed, and labware latch of the Heater-Shaker Module. You can set an optional timer that will pause the protocol for a set period of time *after* the other actions are completed (heating to high temperatures or waiting for the module to passively cool to a temperature can take a long time).
 - **Temperature:** Set a target temperature or deactivate the Temperature Module.
 - **Thermocycler:** This action has two mutually exclusive sets of options.
 - Change Thermocycler state: Set a block temperature, set a lid temperature, or move the lid.
 - Program a Thermocycler profile: Define a *profile*, a timed heating and cooling routine that can be automatically repeated. Each step of the profile holds the block at a certain temperature for a certain time. Profiles do not change the temperature of the lid.
 - **Pause:** Prevent the protocol from continuing until one of three criteria is met. Pauses can require user intervention (pressing a button on the touchscreen or in the app), wait for a fixed time, or wait until a module reaches a target temperature. Timed pauses are useful for incubation or letting the Magnetic Block work.

PART 5: EDIT STEPS

Once you've created a step, preview its effects by hovering over it in the Protocol Timeline. Affected tips and wells will be highlighted, as will the entire labware containing those wells.

Show or hide the details of a step by clicking the disclosure triangle to the right of its name. For liquid handling steps, this will show every discrete aspirate and dispense pair comprising the step. For module steps, this will show the features of the module that the step controls.

■ CHAPTER 6: PROTOCOL DEVELOPMENT

Click on the name of a step in the Protocol Timeline to edit it. Shift-click to select a range of steps and enter batch editing mode. If you select only transfer or mix steps, you can change their behavior as a batch. Reorder steps by dragging and dropping them up or down in the Protocol Timeline.

When editing any step, click **Notes** to change the step name or add a description of what the step does. Custom step names replace their default action descriptions (like “Transfer” and “Temperature”) in the Protocol Timeline, making it easier to navigate around your protocol.

PART 6: EXPORT YOUR PROTOCOL

When your protocol is complete, click **Final Deck State** to preview how the deck should appear at the end of your protocol. In this view (or when viewing a particular step), you can click on labware and examine the expected quantity of liquid in each well.

To save your work, return to the File tab and click **Export** to download your protocol as a JSON file. The file will have the name you chose in the Protocol Name field and will have a .json extension. You can find exported protocols in the default download location of your web browser.

To run your protocol, import it into the Opentrons App. (See the [Software and Operation chapter](#) for details on installing and using the Opentrons App.) Then either run it from the app or send it to your Flex to run from the touchscreen.

Modifying existing protocols

Click **Import** in the File tab to load an existing protocol. Choose any JSON protocol file from the standard system file picker. Once loaded, you can edit any aspect of the protocol, including its name, description, hardware configuration, and steps.



Warning: Importing a protocol will replace any other protocol that you’ve been working on in Protocol Designer. Be sure to export your work before importing another file, or open Protocol Designer in a second browser tab to work on multiple files at once.

6.3 Python Protocol API

Writing protocol scripts in Python gives you the most fine-grained control of Opentrons Flex. Version 2 of the Python Protocol API is a single Python package that exposes a wide range of liquid handling features on Opentrons robots. For an idea of the breadth of the API, check out the [full online documentation](#), which includes topic-based articles as well as a [comprehensive reference](#) of all methods and functions contained in the package. If you've never written an Opentrons protocol before and want to build one from scratch, follow the [Tutorial](#).

Writing and running scripts

Python protocols generally follow the same basic structure:

1. Importing the `opentrons` package.
2. Declaring the requirements and metadata in their respective dictionaries.
3. Defining a `run()` function that contains all of the instructions to the robot, including:
 - [Pipettes](#) the protocol will use.
 - Locations of [modules](#), [labware](#), and [deck fixtures](#).
 - [Liquid](#) types and locations (optional).
 - Commands the system will physically execute (e.g., [simple](#) or [complex](#) liquid handling commands, [module](#) commands, or [movement](#) commands).

Python

```
from opentrons import protocol_api
requirements = {'robotType': 'Flex', 'apiLevel': '2.15'}

def run(protocol):

    # labware
    plate = protocol.load_labware('corning_96_wellplate_360ul_flat', location='D1')
    tiprack = protocol.load_labware(
        'opentrons_flex_96_tiprack_200ul', location='D2')

    # pipettes
    left_pipette = protocol.load_instrument(
        'flex_1channel_1000', mount='left', tip_racks=[tiprack])

    # commands
    left_pipette.pick_up_tip()
    left_pipette.aspirate(100, plate['A1'])
    left_pipette.dispense(100, plate['B2'])
    left_pipette.drop_tip()
```

If you're running a protocol via the Opentrons App or the touchscreen, you don't need to call the `run()` function, because the robot software does it for you.

However, one of the advanced features of the Python API is to control a robot outside of the usual flow for setting up and running a protocol. Opentrons Flex runs a Jupyter Notebook server, which can execute discrete blocks of code (called *cells*), rather than a complete protocol file. When organizing your code into cells, you can define a `run()` function (and then call it) or run commands without one. It's also possible to execute complete protocols in a Jupyter terminal session or when connected to Flex via SSH. For more information, see the [Advanced Operation section](#) of the Software and Operation chapter.

Python-exclusive features

Certain features are only available in Python protocols, either because they are part of the API or because of the inherent flexibility of Python code.

■ CHAPTER 6: PROTOCOL DEVELOPMENT

NON-BLOCKING COMMANDS

Some module commands that take a long time to complete (such as heating from ambient temperature to a high temperature) can be run in a *non-blocking* manner. This lets your protocol save time by continuing on to other pipetting tasks instead of waiting for the command to complete. Non-blocking commands are currently supported on the [Heater-Shaker Module](#).

MULTIPLE MODULES OF THE SAME TYPE

While Protocol Designer limits you to having one of each type of module on the deck, the Python API only restricts module placement based on physical limitations. [ProtocolContext.load_module\(\)](#) allows placing any module anywhere in column 1 or 3 (except the Thermocycler Module, which only fits in slots A1 and B1).

PYTHON PACKAGES

Not only does the Python API support some features not included in Protocol Designer, but every Python protocol *is a Python script*, which means that it can perform any computation that relies on the Python standard libraries or the suite of libraries included in the Flex system software.

You can even install additional Python packages on Flex. [Connect to your flex via SSH](#) and install the package with `pip`. To avoid analysis errors in the Opentrons App, install the packages on your computer as well. In the Opentrons App settings, go to **Advanced** and click **Add override path** in the Override Path to Python section. Choose the copy of python on your system that has access to the packages.

6.4 OT-2 protocols

There are hundreds of OT-2 protocols in the Protocol Library, and you may have created your own OT-2 protocols for your lab. Opentrons Flex can perform all the basic actions that the OT-2 can, but OT-2 protocols aren't directly compatible with Flex. However, with a little effort, you can adapt an OT-2 protocol so it will run on Flex. This lets you have parity across different Opentrons robots in your lab, or you can extend older protocols to take advantage of new features only offered on Flex.

OT-2 Python protocols

Using the Python Protocol API, you only have to change a few aspects of an OT-2 protocol for it to run on Flex.

METADATA AND REQUIREMENTS

The API requires you to declare that a protocol is designed to run on Flex. Use the `robotType` key in the new requirements dictionary. You should also specify an `apiLevel` of 2.15 or higher. You can specify `apiLevel` either in the metadata dictionary or the requirements dictionary.

Python

```
from opentrons import protocol_api
requirements = {'robotType': 'Flex', 'apiLevel': '2.15'}
```

PIPETTES AND TIP RACKS

Flex uses different types of pipettes and tip racks than OT-2, which have their own load names in the API. Choose pipettes of the same capacity or larger (or whatever you've outfitted your Flex with).

For example, you could convert an OT-2 protocol that uses a P300 Single-Channel GEN2 pipette and 300 μ L tips to a Flex protocol that uses a Flex 1-Channel 1000 μ L pipette and 1000 μ L tips:

Python

```
# Original OT-2 code
def run(protocol: protocol_api.ProtocolContext):
    tips = protocol.load_labware("opentrons_96_tiprack_300ul", 1)
    left_pipette = protocol.load_instrument(
        "p300_single_gen2", "left", tip_racks=[tips]
    )
```

CHAPTER 6: PROTOCOL DEVELOPMENT

Python

```
# Modified Flex code
def run(protocol: protocol_api.ProtocolContext):
    tips = protocol.load_labware("opentrons_flex_96_tiprack_1000ul", "D1")
    left_pipette = protocol.load_instrument(
        "flex_1channel_1000", "left", tip_racks[tips]
    )
```

The only necessary changes are the new arguments of `load_labware()` and `load_instrument()`. Keep in mind that if you use smaller capacity tips than the original protocol, you may need to make further adjustments to avoid running out of tips, and the protocol may take longer to execute.

DECK SLOTS

The API accepts OT-2 and Flex deck slot names interchangeably. It's good practice to use the coordinate deck slot format in Flex protocols (as in the example in the previous subsection), but it's not required. The correspondence between deck slot numbers is as follows:

Flex	A1	A2	A3	B1	B2	B3	C1	C2	C3	D1	D2	D3
OT-2	10	11	Trash	7	8	9	4	5	6	1	2	3

A protocol that calls `protocol.load_labware("opentrons_flex_96_tiprack_200ul", "1")` would require you to place that tip rack in slot D1 on Flex.

MODULES

Update module load names for the Temperature Module and Thermocycler Module to ones that are compatible with Flex, if necessary. Flex supports:

- `temperature module gen2`
- `thermocycler module gen2` or `thermocyclerModuleV2`

The Heater-Shaker Module only has one generation, which is compatible with Flex and OT-2. For protocols that load `magnetic module`, `magdeck`, or `magnetic module gen2`, see Magnetic Module Protocols below.

OT-2 JSON protocols

Currently, Protocol Designer can't convert an OT-2 protocol to a Flex protocol. You have to choose which robot the protocol will run on when you create it.

Since Flex protocols support nearly all the features of OT-2 protocols, you can create a new protocol that performs all the same steps, but is designed to run on Flex. The simplest way to do this is:

1. Launch Protocol Designer and import your OT-2 protocol.
2. Open a second browser window and launch Protocol Designer there.
3. Create a new Flex protocol in the second browser window.
4. Set up the Flex hardware as similarly as possible as the OT-2 hardware. For example, choose pipettes of the same capacity or larger, and choose modules of the same type.
5. Replicate the liquid setup and steps from the OT-2 protocol.
6. Export your Flex protocol. Import it into the Opentrons App and check the run preview to see that it performs the same steps as your OT-2 protocol.

You can make bigger changes if your Flex configuration differs significantly from your OT-2 configuration, but you may need to re-verify your protocol.

Magnetic Module protocols

Note that there is no direct analogue of the Magnetic Module on Flex. You'll have to use the Magnetic Block and Flex Gripper instead. This will require reworking some of your protocol steps, and you should verify that your new protocol design achieves similar results.

Software and Operation

There are multiple ways to control Opentrons Flex, depending on the needs of your lab. You can perform most functions either from the touchscreen or from a computer running the Opentrons App. This chapter will focus primarily on touchscreen operation, and will only cover features of the Opentrons App that are not possible on the touchscreen. It will also outline advanced control features, such as running Python code using the Jupyter Notebook server or from the command line of Flex.

One major difference between touchscreen and app operation is the software's relationship to the robot. The touchscreen is integrated, and therefore only controls the Flex robot that it's physically a part of. In contrast, the Opentrons App can control any number of Opentrons robots connected to the computer that's running the app. Using both pieces of software is required to set up Flex and run your first protocol, but it's up to you to decide the balance of how you will control Flex in your daily workflow.

7.1 Touchscreen operation

You can use the touchscreen to control Flex whenever the robot is on. If your robot is on and the touchscreen is off, tap it once to wake the screen.

Robot dashboard

The dashboard is the main screen for the robot, accessible by tapping the robot's name in the top left corner of the touchscreen.

The dashboard provides quick access to recently run protocols. It displays protocols as large cards in a horizontal carousel. Green cards show protocols that are ready to run. Orange cards show protocols that require hardware setup or have a deck configuration conflict. The dashboard can display up to eight previously run protocols.

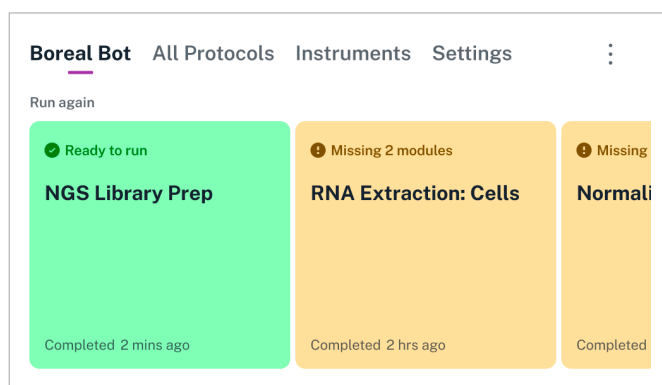

CHAPTER 7: SOFTWARE AND OPERATION

From the dashboard you can also perform actions that apply to the robot as a whole, rather than a particular protocol. Access these actions by tapping the three-dot (:) menu:

- **Home gantry:** Move the gantry to its home position at the back right of the working area.
- **Restart robot:** Perform a soft restart of the robot.
- **Deck configuration:** Manage deck fixture locations.
- **Lights on/off:** Toggle the LED lights that illuminate the working area.

The top navigation on the dashboard provides access to the other main screens: All Protocols, Instruments, and Settings. Next we'll look at how to manage protocols on the All Protocols screen.

Protocol management

The All Protocols screen is an interactive list of all protocols that you've stored on Opentrons Flex. (Sending a protocol to Flex requires the Opentrons App. See the [Transferring Protocols to Flex section](#) below for details on that process.)

There are two sections of the All Protocols screen:

- Pinned protocols: Large cards in a horizontal carousel at the top of the screen.
- Other protocols: A vertical list at the bottom of the screen.

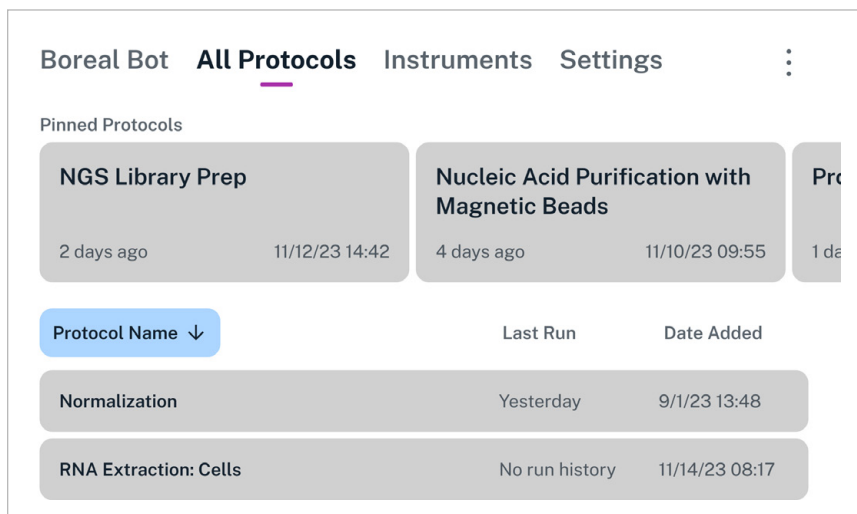

Regardless of which section a protocol is in, its card or list entry includes information about when it was last run and when it was added to this robot.

CHAPTER 7: SOFTWARE AND OPERATION



Note: Flex can store a maximum of 20 unique protocols. It automatically deletes older protocols to maintain this limit. Use the Opentrons App if you need to manage a larger number of protocols.

PIN A PROTOCOL

Long press on a protocol and tap **Pin protocol** to move it to the pinned protocols section. Conversely, long press a pinned protocol and tap **Unpin protocol** to remove it from the section.

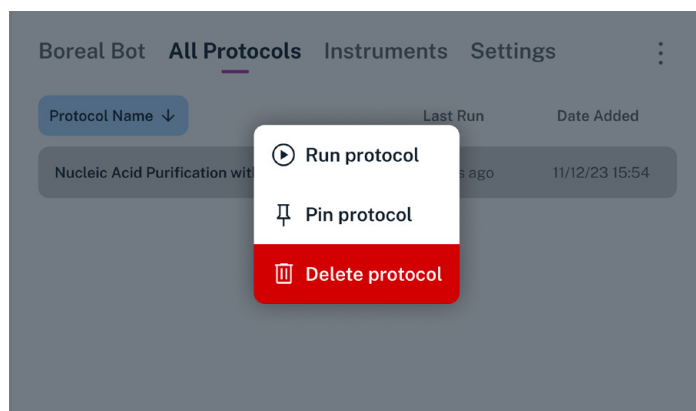

You can pin up to eight protocols. When you hit the maximum, you'll need to unpin a protocol before pinning another one.

SORT PROTOCOLS

Tap any of the three headers — Protocol Name, Last Run, or Date Added — to sort the All Protocols section. Tap once to sort protocols in ascending order (A to Z for names, oldest to newest for dates). Tap again to reverse the sort order. The current sort criterion is highlighted in blue and the current sort order is indicated by an upward or downward arrow.

DELETE A PROTOCOL

Long press on a protocol and tap **Delete protocol** to delete it directly from the All Protocols screen. Flex will prompt you for confirmation that you want to delete the protocol file and all of its run history.

CHAPTER 7: SOFTWARE AND OPERATION

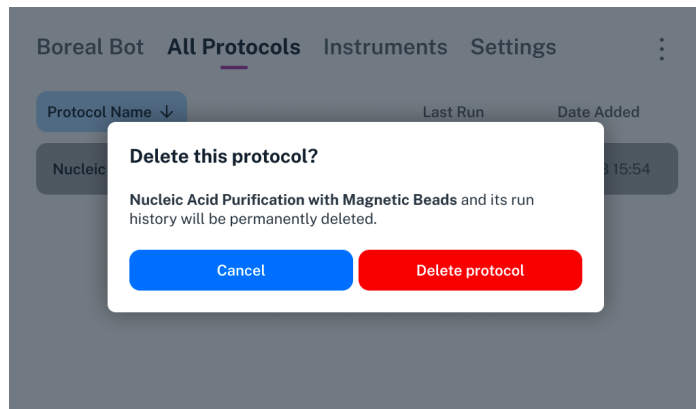

Warning: Run history is *not recoverable* after you delete a protocol on Flex. The protocol file itself is also not recoverable, although you may be able to resend the protocol to Flex if you've kept a copy of it on a computer.

Protocol details

Tap on any protocol to view its detail screen. This screen displays all of the types of information included in the protocol file, as well as common protocol actions. An indicator at the top left of the screen shows whether the protocol is ready to run, or whether you need to perform additional setup.

SUMMARY TAB

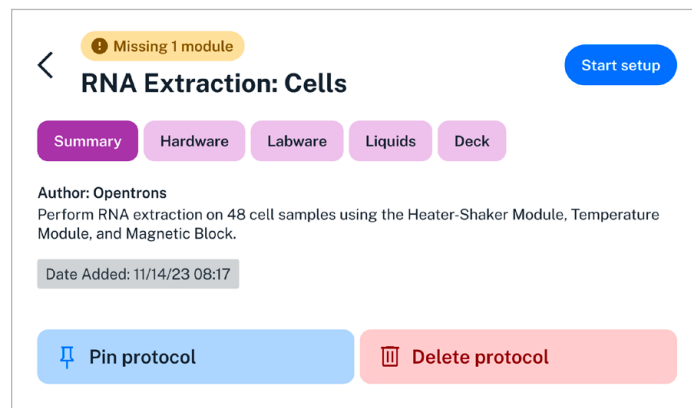

CHAPTER 7: SOFTWARE AND OPERATION

The Summary tab shows:

- **Protocol name:** For protocols with very long names, tap to toggle between the full and truncated name.
- **Author:** Who created the protocol.
- **Description:** For protocols with long descriptions, scroll to read the full text.
- **Date added:** Timestamp when Flex received the protocol file.

HARDWARE TAB

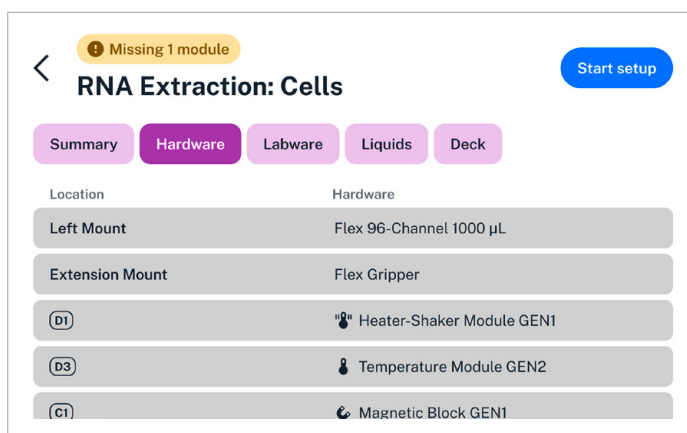

The Hardware tab is a list of all instruments, modules, and fixtures used in the protocol. The Location column tells you where the hardware needs to be attached to Flex. For instruments, location can be the left pipette mount, right pipette mount, both mounts (for the 96-channel pipette), or the extension mount (for the gripper). For modules and fixtures, the location is the deck slot or slots that the item occupies.

LABWARE TAB

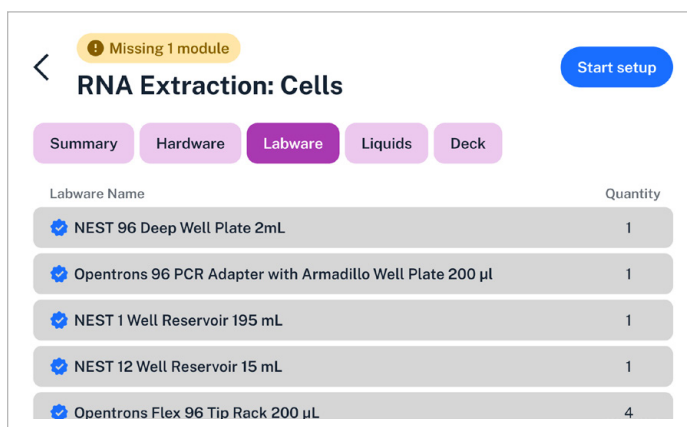

CHAPTER 7: SOFTWARE AND OPERATION

The Labware tab is a list of all labware used in the protocol. It shows the names and quantities of labware. It does not show their locations, since labware can be moved, added, or removed from the deck during the course of a protocol. Use the Deck tab to see initial positions of labware.

Opentrons-verified labware is indicated with a blue checkmark.

LIQUIDS TAB

The screenshot shows the 'Liquids' tab selected in the 'RNA Extraction: Cells' protocol. At the top, there is a 'Missing 1 module' warning and a 'Start setup' button. Below the title, there are five tabs: Summary, Hardware, Labware, Liquids (selected), and Deck. The main area displays a table of liquids:

Liquid Name	Total Volume
Lysis buffer	8400 μL
Stop buffer	6500 μL
Wash buffer	44500 μL

The Liquids tab lists all liquids to be loaded into labware at the start of the protocol. It shows the color code of the liquid (as assigned by the protocol author), the liquid name, and the total volume of liquid used across all wells. Use the Deck tab to see well-by-well initial positions of liquids.

DECK TAB

The screenshot shows the 'Deck' tab selected in the 'RNA Extraction: Cells' protocol. At the top, there is a 'Missing 1 module' warning and a 'Start setup' button. Below the title, there are five tabs: Summary, Hardware, Labware, Liquids, and Deck (selected). The main area displays a visual map of the deck, showing a 4x4 grid of wells. The rows are labeled A, B, C, and D. The columns are labeled 1, 2, 3, and 4. The map shows the initial positions of liquids, with color-coded wells corresponding to the liquids in the Liquids tab. Well A4 is empty, while other wells contain liquids of various colors (purple, yellow, green, red, blue, etc.).

The Deck tab shows a visual map of the deck at the beginning of the protocol.

CHAPTER 7: SOFTWARE AND OPERATION

For an interactive view that provides more information about the contents of each deck slot, tap **Start setup**, then tap **Labware**, and then tap **Map View**. There you can tap on any labware to see its type and custom label (if set by the protocol).

ACTION BUTTONS

On any of the protocol detail tabs, three action buttons are available:

- **Start setup** (top right)
- **Pin protocol** (bottom left)
- **Delete protocol** (bottom right)

Next we'll look at the steps for setting up and performing a protocol run.

Run setup

When you start setup for a protocol, you'll see the "Prepare to run" screen, which summarizes all of the requirements for the protocol.

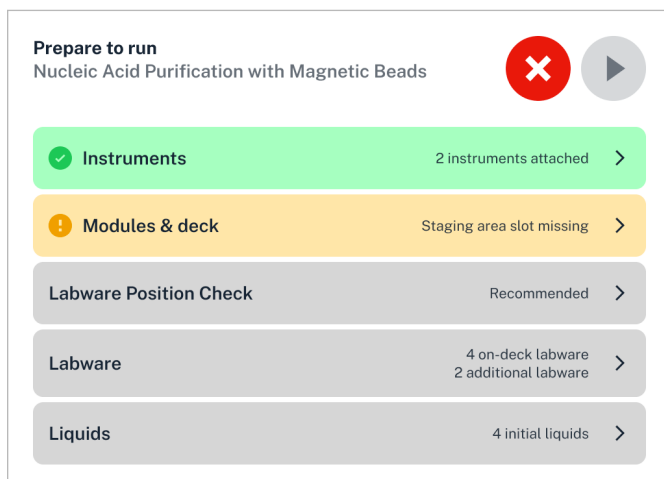

All sections of the "Prepare to run" screen. On the touchscreen, scroll the list to see all sections.

If hardware is not connected or calibrated, you will see a warning icon (exclamation point) and the row will be highlighted in orange. If all requirements are met, you will see a checkmark and the row will be highlighted in green. The rows for labware and liquids are always grey, since you have to verify their positions manually before starting the run.

Tap any row with a right arrow to show more information for that category. (The one exception is tapping Labware Position Check, which begins that process. See the next subsection for more details.)

Category	Description
Instruments	See if all instruments are attached to the correct mounts and calibrated. Tap Attach or Calibrate to set up any that aren't.
Modules & deck	See the locations and connection statuses of hardware on the deck. <ul style="list-style-type: none">Tap ⓘ Setup Instructions to get detailed module instructions from the Opentrons Help Center.Tap Map View to switch to a visual layout of hardware positions.
Labware	See the locations of labware. Each labware lists its initial deck location, and icons indicate labware that are on top of modules. Tap Map View to switch to a visual layout of labware positions.
Liquids	See the types and total volumes of liquids. Tap any liquid name to expand a list of well-by-well volumes. In turn, tap an individual volume row to show a visual layout of its location within labware.

On any category screen, return to the “Prepare to run” screen by tapping the back arrow in the top left.

Labware Position Check

Opentrons recommends performing Labware Position Check before your protocol run. This process fine-tunes the positioning of instruments, relative to specific types of labware in specific slots on the deck. The results of Labware Position Check are saved as labware offsets, which are measured to the nearest 0.1 mm. You can apply saved labware offsets to future runs of the same protocol (or other protocols that use the same labware in the same positions) to save time.

Labware Position Check guides you through these steps:

1. Attach the calibration probe to the pipette.
2. Clear the deck of labware, but leave modules in place.
3. Place a specific type of labware in a specific deck slot.
4. Align the probe to the labware using the on-screen jog controls. Then confirm the position.

CHAPTER 7: SOFTWARE AND OPERATION

- Repeat steps 3 and 4 for each labware–slot combination used in your protocol.
- Review and save your new labware offset data.
- Remove the calibration probe from the pipette.

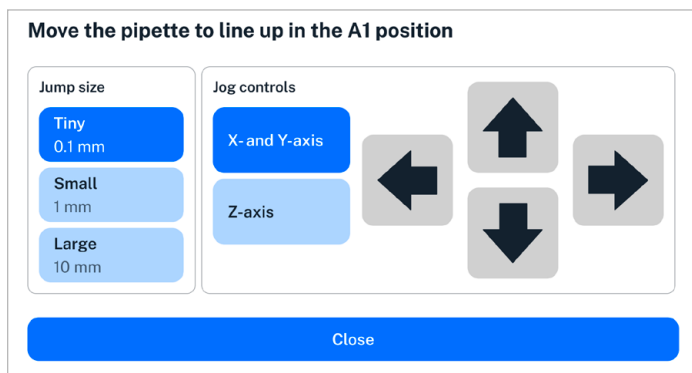

Jog controls used in Labware Position Check. Use larger jump sizes to move the pipette quickly, but beware of crashing the pipette into labware.

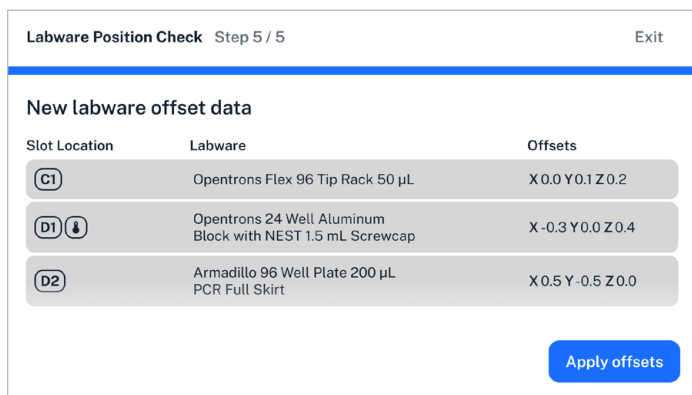

Summary of new labware offsets ready to be applied to a protocol.

When you run Labware Position Check for the first time, the pipette will start at its default position for all labware (X 0.0 Y 0.0 Z 0.0). On subsequent runs, the pipette will start at the previously saved offset locations. This lets you quickly confirm offset data before every protocol run.



Note: The pipette will always start at the default position if you turn off Apply Labware Offsets in the robot settings.

Run progress

Once everything is set up, begin your run by tapping the play button  on the “Prepare to run” screen. Flex will begin the protocol and you’ll see the Running screen.

The Running screen gives you quick access to stop and play/pause controls, in case you need to intervene in your protocol. On the default view, these controls are large and only the current step of the protocol is shown.

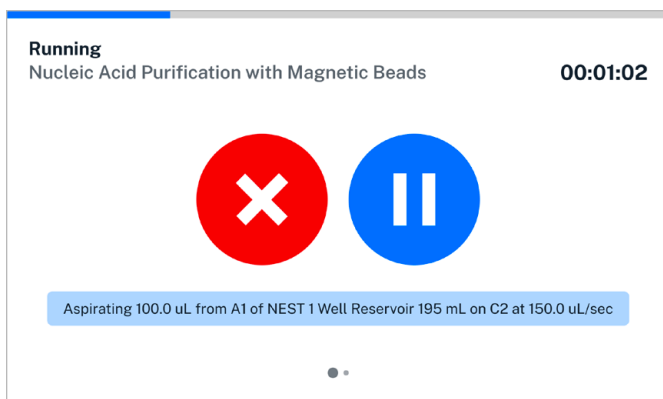

Swipe from right to left to see an alternative view with smaller controls and more protocol steps. The current step will always be at the top of the list.

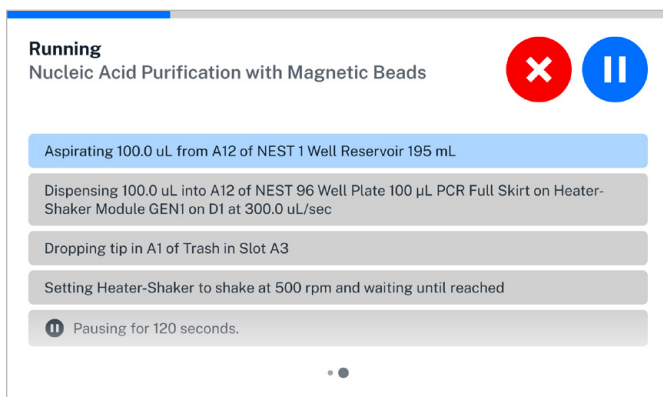

Run completion

At the end of your protocol, a large “Run completed” or “Run failed” message will take over the touchscreen. These color-coded messages match the LED status bar at the top of the robot and are visible at a distance.

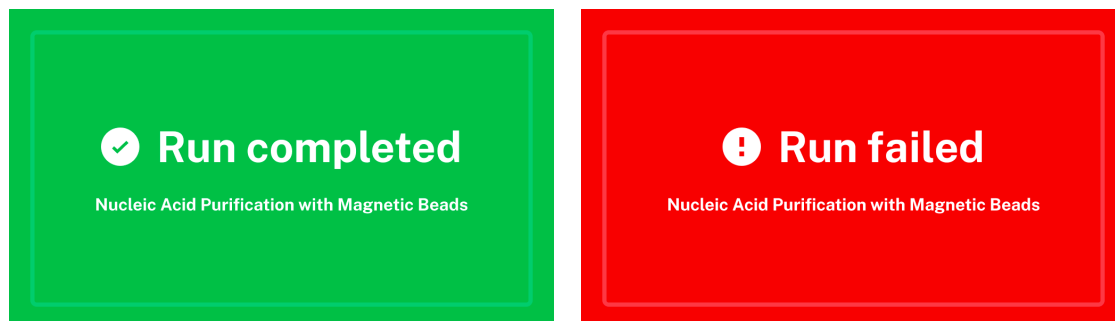

Tap anywhere on either of these screens to go to the run summary screen, which shows information about the protocol run time and next steps. The summary screen always gives you the options to **Return to dashboard** or have the protocol **Run again**. If the run failed, you can also **View error details** and begin the troubleshooting process.

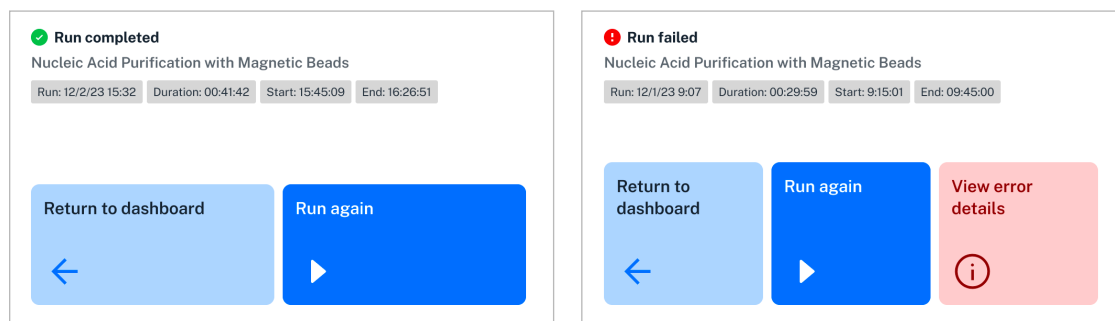

Instrument management

The Instruments screen is an interactive list of all instruments that you've connected to your Flex. The list is organized by mount: left pipette mount, right pipette mount, and extension mount.

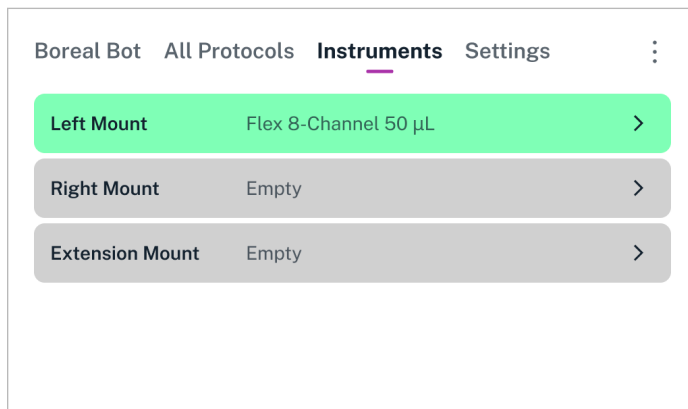

For an empty mount, tap anywhere on the row to begin the process of attaching an instrument.

For an occupied mount, the row lists its current contents. Tap anywhere on the row to get more details about the instrument, detach it, or recalibrate it.

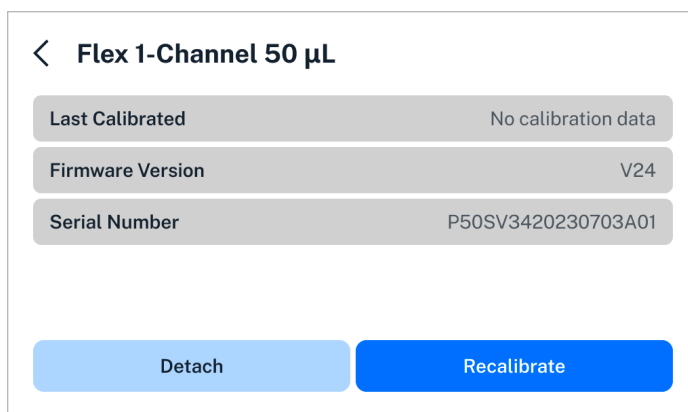

- **Last Calibrated:** The date and time of the instrument's most recent calibration.
- **Firmware Version:** The version of the firmware running on the instrument. Flex automatically updates instrument firmware whenever the instrument is attached, depending on the robot system version.
- **Serial Number:** A unique identifier for the instrument. If you are having problems with an instrument, Opentrons Support will want to know the serial number.

■ CHAPTER 7: SOFTWARE AND OPERATION

ATTACH AN INSTRUMENT

Choose an empty mount and then choose the type of instrument to install. Then connect and secure the instrument using its captive mounting screws. For more details, follow the instructions on the touchscreen or see the [Instrument Installation and Calibration section](#) of the Installation and Relocation chapter.

Exact installation steps depend on the instrument you choose and the current setup of your robot. For example, if you have an 8-channel pipette already attached and you attempt to install the 96-channel pipette on the other mount, the touchscreen will give you instructions for detaching the 8-channel so the 96-channel can occupy both mounts.

DETACH AN INSTRUMENT

Choose an attached instrument that you want to detach. Then loosen the instrument's captive mounting screws and remove it from the gantry. For more details, follow the instructions on the touchscreen. Exact removal steps depend on the instrument you choose and the current setup of your robot.

RECALIBRATE AN INSTRUMENT

Choose an attached instrument that you want to recalibrate. Then connect the instrument's calibration probe or pin and begin the automated calibration process. For more details, follow the instructions on the touchscreen or see the [Instrument Installation and Calibration section](#) of the Installation and Relocation chapter.



Note: The new calibration data will overwrite any previous calibration data for that instrument.

Robot settings

The Settings screen lists all the ways you can customize the behavior of your Flex.

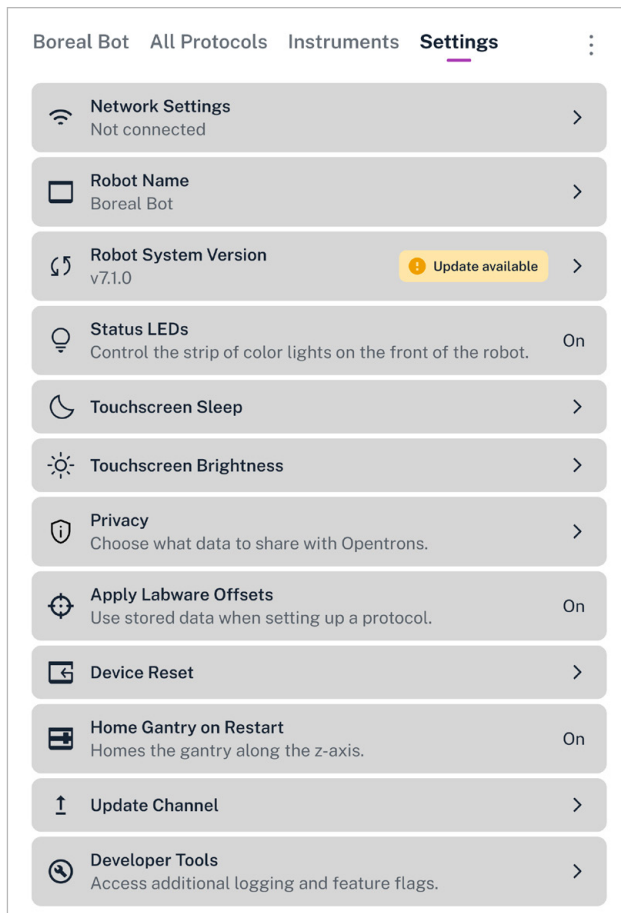

All settings available on Flex. On the touchscreen, scroll the list to see all the settings.

Although they are presented in a single list, they roughly break down into four categories.

SETUP

All of these settings are covered when you [first set up your Flex](#). However, you can change them at any time.

- **Network Settings:** View the status of or set up a Wi-Fi, Ethernet, or USB connection. Multiple connections can be active simultaneously.
- **Robot Name:** Change the name of your Flex. The robot name appears on the touchscreen dashboard and in the Opentrons App.
- **Robot System Version:** See the current version of the robot software or check for updates. If Flex has already automatically checked for updates and found one, this item will have an “Update available” badge in the settings list.

■ CHAPTER 7: SOFTWARE AND OPERATION

DISPLAY

Control how Flex displays information to meet the needs of your lab and users.

- **Status Light:** Turn on or off the strip of color lights on the front of the robot.
- **Touchscreen Sleep:** Set how long the touchscreen should remain on when idle. The default is for the display to never go to sleep. When the screen is asleep, tap it once to wake it.
- **Touchscreen Brightness:** Set the screen's brightness to one of six levels by tapping – or +.

PRIVACY

Choose what data you want Flex to share with Opentrons. This information is always anonymized and we only use it to improve our products.

Flex records what it's doing in several log files that are stored on the robot. These logs are grouped into two categories for privacy opt-in purposes:

- **Robot Logs:** Data about robot server activities, executed API commands, and interactions with attached modules.
- **Display Usage:** Data about how the touchscreen draws its graphics.

If you opt out of automatic data sharing, you can still [download your Flex log files](#) for your own use or to manually send them to Opentrons Support for troubleshooting.



Note: There are separate privacy controls in the Opentrons App. Turning sharing on or off from the touchscreen only affects data collected and sent by the robot. Your laptop or desktop computer will still automatically share data if this feature is enabled in the Opentrons App.

ADVANCED

You shouldn't need these settings for everyday operation, but they may be useful for troubleshooting or testing pre-release features.

■ CHAPTER 7: SOFTWARE AND OPERATION

- **Apply Labware Offsets:** Choose whether to use saved offset data from Labware Position Check in subsequent protocol runs. This setting is on by default. Opentrons recommends running Labware Position Check before every run, and applying previous labware offsets at the beginning of Labware Position Check can make the process quicker.
- **Device Reset:** Batch delete certain types of information from the robot, such as calibrations, run history, or protocols.
- **Home Gantry on Restart:** By default, the gantry moves to its home position any time you turn on Flex. Only disable this behavior if you have a reason that the gantry must remain stationary after powering on.
- **Update Channel:** Choose whether to receive stable or beta software updates.
- **Developer Tools:** Enable additional tools and features designed for developers. Not recommended unless instructed by Opentrons Support.

Deck configuration

Deck configuration tells your Flex what fixtures are attached to the deck, in what locations. You need to inform the robot about installed fixtures because they're unpowered attachments. They do not contain electronic or mechanical components that communicate with the robot. Flex won't know what's attached and where it is until you configure deck fixtures via the touchscreen or Opentrons App.

Mapping fixtures to deck slots allows the robot to find discrepancies between the hardware used in a protocol and what it thinks is attached to the deck. Flex detects potential conflicts between the hardware setup of a protocol and the robot's current deck configuration (see [Resolving Deck Conflicts](#) below). Running protocols with proper deck configuration helps avoid collisions among the various components installed on the robot.

For more information on which fixtures you can configure in which slots, see the [Deck Fixtures section](#) in the System Description chapter.

ADDING AND REMOVING FIXTURES

To add deck fixtures via the touchscreen:

1. Tap the three-dot (:) menu and then tap **Deck configuration**. This opens the interactive deck map.
2. Tap a blue deck slot that you want to configure. This opens the fixture menu.
3. From the fixture menu, select the item you want to add.

CHAPTER 7: SOFTWARE AND OPERATION

4. Tap a fixture to add it to the deck.
5. Tap **Confirm**.

Click the **X** on a fixture on the deck map to remove it from the deck configuration.

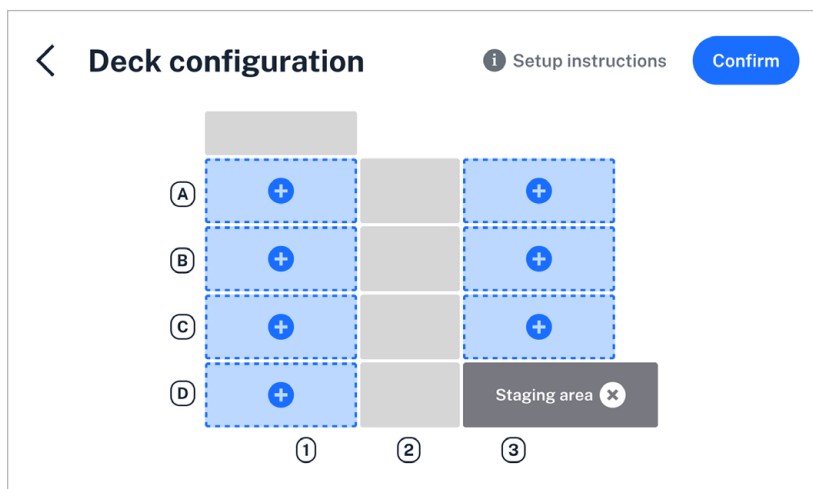

A Flex configured with a staging area slot in D3, and no other fixtures.

You can also configure the deck in the Opentrons App, on the robot details page for your Flex.

RESOLVING DECK CONFLICTS

Flex displays orange warning prompts when setting up a protocol run that conflicts with the current deck configuration. To resolve the conflict:

1. Tap the prompt for more information on what the protocol specifies, compared to the current deck configuration.
2. Inspect the hardware configuration of your Flex and attach, move, or remove the deck fixtures or modules as needed.
3. Tap **Update deck** to clear the conflict warning.

Alternatively, you can modify your protocol to fit your current deck configuration, and then resend it to your Flex.

Your Flex won't run a protocol until you resolve all deck conflict warnings.

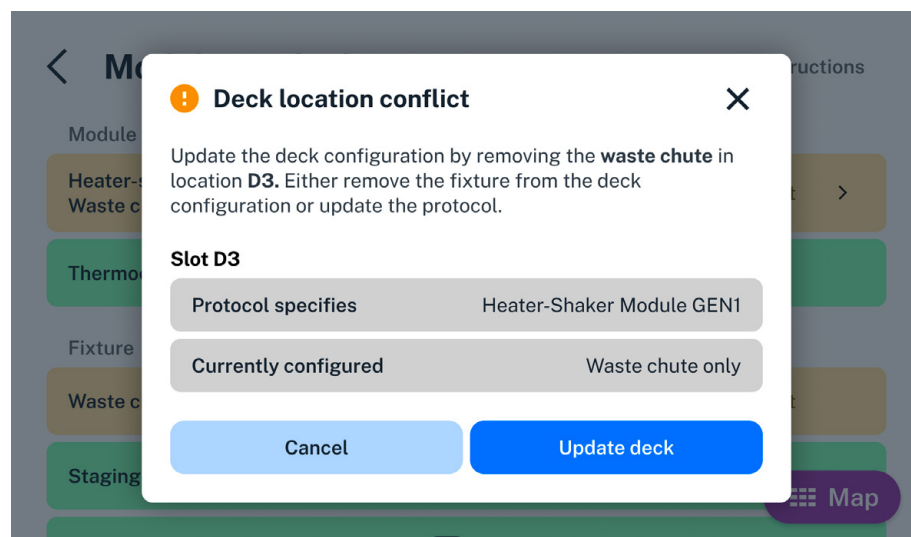

This protocol requires a Heater-Shaker in slot D3, but the deck configuration indicates that the waste chute is in that location.

FIXTURE STATUSES

The following table defines the statuses the robot generates when it compares its configured deck fixtures to your protocol.

Status	Description
Configured	A fixture is specified in the correct location. Always verify that the fixture is physically attached before running the protocol.
Location conflict	A deck slot is configured with a fixture different from the fixture specified in your protocol (e.g., the protocol specifies a waste chute, but deck slot D3 is occupied by a staging area slot).
Not configured	A fixture required by your protocol is missing from the deck configuration (e.g., the protocol requires a staging area slot but that fixture is not configured in the specified location).

The following table defines the deck configuration statuses the robot generates when it compares its attached instruments and attached modules to its deck configuration and your protocol.

Status	Description
Attach pipette	A required pipette is not attached.
Calibrate	A module needs calibration. It is in the right location and connected to the robot.
Calibrate pipette	An attached pipette requires calibration.
Connected	Modules are connected, calibrated, and in the right locations. Configuration status is good.
Location conflict	A module location conflicts with a deck fixture.
Not connected	The module is not connected to the robot or is powered off. Once connected, there will be no location conflict.

7.2 Opentrons App

App installation

Download the Opentrons App at <https://opentrons.com/ot-app/>. The app requires Windows 10, macOS 10.10, or Ubuntu 12.04 or later. The app may run on other Linux distributions, but Opentrons does not officially support them.

WINDOWS

The Windows version of the Opentrons App is packaged as an installer. To use it:

- Open the .exe file you downloaded from opentrons.com.
- Follow the instructions in the installer. You can install the app for a single user or all users of the computer.

The app opens automatically once installed. Grant the app security or firewall permissions, if prompted, to make sure it can launch and communicate with Flex over your network.

MACOS

The macOS version of the Opentrons App is packaged as a disk image. To use it:

1. Open the .dmg file you downloaded from opentrons.com. A window for the disk image will open in Finder.
2. Drag the Opentrons icon onto the Applications icon in the window.
3. Double-click on the Applications icon.
4. Double-click on the Opentrons icon in the Applications folder.

Grant the app security or firewall permissions, if prompted, to make sure it can launch and communicate with Flex over your network.

UBUNTU

The Ubuntu version of the Opentrons App is packaged as an Appliance. To use it:

1. Move the .Appliance file you downloaded from opentrons.com to your Desktop or Applications folder.
2. Right-click the .Appliance file and choose **Properties**.
3. Click the **Permissions** tab. Then check **Allow executing file as a program**. Close the Properties window.
4. Double-click the .Appliance file.



Note: Do not use third-party Appliance launchers with the Opentrons App. They may interfere with app updates. Opentrons does not support using third-party launchers to control Opentrons robots.

Transferring protocols to Flex

Every protocol will begin as a file on your computer, regardless of what method of [Protocol Development](#) you use. You need to import the protocol into the Opentrons App and then transfer it to your Flex. When transferring a protocol, you can choose to begin run setup immediately or later.

CHAPTER 7: SOFTWARE AND OPERATION

IMPORT A PROTOCOL

When you first launch the Opentrons App, you will see the Protocols screen. (Click **Protocols** in the left sidebar to access it at any other time.) Click **Import** in the top right corner to reveal the Import a Protocol pane. Then click **Choose File** and find your protocol in the system file picker, or drag and drop your protocol file into the well.

The Opentrons App will analyze your protocol as soon as you import it. *Protocol analysis* is the process of taking the JSON object or Python code contained in the protocol file and turning it into a series of commands that the robot can execute in order. If there are any errors in your protocol file, or if you're missing custom labware definitions, a warning banner will appear on the protocol's card. Correct the errors and re-import the protocol. If there are no errors, your protocol is ready to transfer to Flex.



Actions available in the three-dot menu (:) for imported protocols.



Note: In-app protocol analysis is only a preliminary check of the validity of your protocol. Protocol analysis will run again on the robot once you transfer the protocol to it. It's possible for analysis to fail in the app and succeed on the robot, or vice versa. Analysis mismatches may occur when your app and robot software versions are out of sync, or if you have customized the Python environment on your Flex.

RUN IMMEDIATELY

Click the three-dot menu (:) on your protocol and choose **Start setup**. Choose a connected and available Flex from the list to transfer the protocol and begin run setup immediately. The run setup screen will appear both in the app and on the touchscreen, and you can continue from either place.

CHAPTER 7: SOFTWARE AND OPERATION

If you stay in the app, expand the sections under the Setup tab and follow the instructions in each one: Robot Calibration, Module Setup (if your protocol uses modules), Labware Position Check (recommended), and Labware Setup. Then click  **Start run** to begin the protocol.

If you move to the touchscreen, follow the steps in the [Run Setup section](#) above.

RUN LATER

Click the three-dot menu () on your protocol and choose **Send to Opentrons Flex**. Choose a connected and available Flex from the list to transfer the protocol. A message indicating a successful transfer will pop up both in the app and on the touchscreen. To set up your protocol, you need to move to the touchscreen and follow the steps in the [Run Setup section](#) above.

Module status and controls

Use the Opentrons App to view the status of modules connected to your Flex and control them outside of protocols. Click **Devices** and then click on your Flex to view its robot details page. Under Instruments and Modules, there is a card for each attached module. The card shows the type of module, what USB port it is connected to, and its current status.

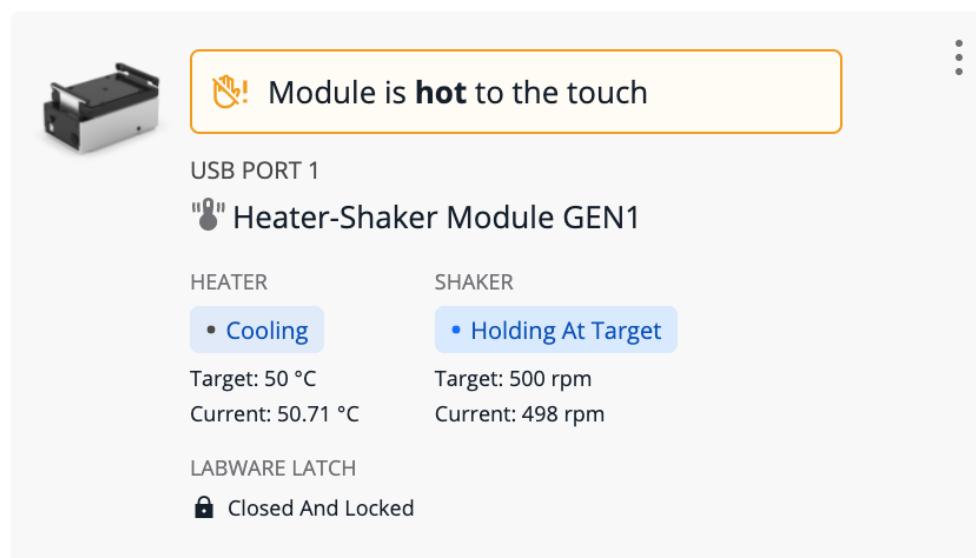

The screenshot displays a module status card for a Heater-Shaker Module GEN1. At the top left is an image of the module. To its right is a yellow warning box with a hand icon and the text "Module is hot to the touch". Below this, the text "USB PORT 1" is shown. The module name "Heater-Shaker Module GEN1" is displayed with a robot icon. The card is divided into two columns: "HEATER" and "SHAKER". Under "HEATER", there is a blue pill-shaped button with a dot and the text "Cooling". Below it, the target temperature is "50 °C" and the current temperature is "50.71 °C". Under "SHAKER", there is a blue pill-shaped button with a dot and the text "Holding At Target". Below it, the target speed is "500 rpm" and the current speed is "498 rpm". At the bottom, the "LABWARE LATCH" is shown as "Closed And Locked" with a lock icon. A three-dot menu icon is visible in the top right corner of the card.

Module card for the Heater-Shaker Module.



Note: The Magnetic Block does not have a card in Instruments and Modules, since it is unpowered and does not connect to Flex via USB.

Click the three-dot menu (:) on the module card to choose from available commands. You can always choose **About module** to see the firmware version and serial number of the module. (This information is very useful when contacting Opentrons Support!) The other commands depend on the type of the module and its current status:

Module type	Commands
Heater-Shaker	Set module temperature/Deactivate heater
	Open labware latch/Close labware latch
	Test shake/Deactivate shaker
Temperature	Set module temperature/Deactivate module
Thermocycler	Set lid temperature/Deactivate lid
	Open lid/Close lid
	Set block temperature/Deactivate block

Recent protocol runs

The robot details page lists up to 20 recent protocol runs. This provides additional information compared to the touchscreen, which only shows the most recent run for each unique protocol.

Each entry in the recent protocol runs list includes the protocol name, its timestamp, whether the run was canceled or completed, and the duration of the run. Click the disclosure triangle next to any run to show its associated labware offset data. Click the three-dot menu (:) for related actions:

- **View protocol run record:** Show the protocol run screen as it appeared when the protocol ended (succeeded, failed, or was canceled), including all performed steps.
- **Rerun protocol now:** The same as choosing **Start setup** on the corresponding protocol.

CHAPTER 7: SOFTWARE AND OPERATION

- **Download run log:** Save to your computer a JSON file containing information about the protocol run, including all performed steps.
- **Delete protocol run record:** Delete all information about this protocol run from Flex, including labware offset data. When you choose this option, it's as though the protocol run never happened.



Note: If you need to maintain a comprehensive record of all runs performed on your Flex, you must use the **Download run log** feature to save this information to your computer. Flex *will not* retain information about more than 20 runs on the robot. Proceeding to the Run Setup screen generates an entry in the list and counts towards the maximum of 20 runs, even if you never begin the protocol.

7.3 Advanced operation

Jupyter Notebook

Flex runs a [Jupyter Notebook](#) server on port 48888, which you can connect to with your web browser. Use Jupyter to individually run discrete chunks of Python code, called *cells*. This is a convenient environment for writing and debugging protocols, since you can define different parts of your protocol in different notebook cells, and run a single cell at a time.

Access your robot's Jupyter Notebook either:

- In the Opentrons App. Go to **Devices** > your robot > **Robot Settings** > **Advanced** and then click **Launch Jupyter Notebook**.
- In your web browser. Navigate directly to `http://<robot-ip>:48888`, replacing `<robot-ip>` with the local IP address of your Flex.

For more details on using Jupyter, including preparing executable cells of code and running them on a robot, see the [Jupyter Notebook section](#) of the Python Protocol API documentation.

Command-line operation over SSH

Connect to your Flex over SSH to [run protocols directly from the command line](#) or to perform advanced tasks, such as [customizing the Python environment on the robot](#). Protocols that reference external files on disk (apart from custom labware definition files) must be run from the command line.

You need to set up SSH access before you can connect. Setup requires a bash or zsh shell with openssh installed. In your shell, generate private and public key files by running:

```
ssh-keygen -f robot_key
```

Enter a passphrase when prompted. You can leave it empty, but Opentrons does not recommend this.

Next, use a USB-A flash drive to copy the public key file to your robot. Connect the drive to your computer and copy `robot_key.pub` to the root of the drive. Then eject the drive and connect it to an open USB-A port on your Flex.



Note: The flash drive must be formatted with a standard filesystem readable by the embedded Linux system on Flex. HFS- and APFS-formatted drives are not supported.

On your computer, post an HTTP request to read the public key file from the drive. Replace `ROBOT_IP` with the local IP address of your Flex:

```
curl \
  --location --request POST \
  'http://ROBOT_IP:31950/server/ssh_keys/from_local'
```

The transfer is successful if you get a 201 response with a message indicating how many keys were added. If the transfer fails, you will get a 404 response.

■ CHAPTER 7: SOFTWARE AND OPERATION

Once the transfer is complete, connect to your robot, again replacing `ROBOT_IP` with the local IP address of your Flex:

```
ssh -i robot_key root@ROBOT_IP
```

You'll know the connection worked if you see an ASCII art version of the Openrons logo.

Maintenance and Service

This chapter covers how to perform routine maintenance on your Opentrons Flex, and what to do if you require service for a problem. You should be able to perform cleaning tasks yourself, whereas service and repairs should be handled by Opentrons Support.

8.1 Cleaning your Flex

Routine cleaning helps keep Flex free of contaminants that can affect your protocols. Cleaning also gives you a chance to inspect the robot for wear and damage. You should review this section for information, instructions, and resources about how to clean your Flex, pipettes, gripper, modules, and other hardware.

If you have any questions about cleaning your Flex and its related components, contact the support team at support@opentrons.com.

Before you begin

Flex is an electrically powered mechanical device. As a good practice, turn off the power before you start cleaning it and before reaching inside the enclosure. You may even want to unplug the robot as well. These are simple safety steps you can take to make the robot inoperable until you're finished.

Along with turning the power off, remove any instruments, modules, and labware before cleaning the robot. Removing attached items gives you more room to work and provides better access to the deck, gantry, and other spaces.

What you can clean

You can wipe off all the visible and easily accessible surfaces of your Flex. This includes the exterior and interior frame, touchscreen, windows, gantry, and deck. The Flex does not have any internal parts that you need to open or disassemble for this level of maintenance. If you can see it, you can clean it. If you can't see it, don't clean it.

Cleaning solutions

The following table lists the chemicals you can use to clean your Flex. Diluted alcohol and distilled water are our recommended cleaning solutions, but you can refer to this list for other cleaning options. You can also use these chemicals to clean modules, pipettes, and other attached hardware.



Warning: *Do not use acetone.* The robot, pipettes, and modules are made from materials that acetone can damage or dissolve.

Solution	Recommendations
Alcohol	Includes ethyl/ethanol, isopropyl, and methanol. Dilute to 70% for cleaning. Do not use 100% alcohol.
Bleach	Dilute to 10% (1:10 bleach/water ratio) for cleaning. Do not use 100% bleach.
Distilled water	You can use distilled water to clean or rinse your robot.

Frame and window panel cleaning

To clean the exterior and interior frame and window panels of your Flex:

1. Dampen a soft, clean cloth or paper towel with a cleaning solution.
2. Gently wipe off the exposed and easily accessible surface areas.
3. Use a cloth dampened with distilled water for a rinse wipedown.
4. Let the robot air dry.

Deck cleaning

To clean the deck, deck slots, and trash bin:

1. Dampen a soft, clean cloth or paper towel with a cleaning solution.
2. Gently wipe off the deck, deck slots, and trash bin. You can remove the deck slots and trash bin for easier access.

3. Use a cloth dampened with distilled water for a rinse wipedown.
4. Let the deck pieces air dry. Replace any pieces that you removed for cleaning.

Gantry cleaning

To clean the gantry:

1. Dampen a soft, clean cloth or paper towel with a cleaning solution.
2. Gently wipe off the horizontal and vertical gantry surfaces, and side rails.
3. Use a cloth dampened with distilled water for a rinse wipedown.
4. Let the gantry air dry.

Waste chute cleaning

To clean the waste chute:

1. Remove the waste chute from its deck plate adapter.
2. Dampen a soft, clean cloth or paper towel with a cleaning solution.
3. Gently wipe down the exterior of the chute. The interior is powder-coated steel, so you can clean it with mild detergents or surfactants.
4. Use a cloth dampened with distilled water for a rinse wipedown.
5. Let the waste chute air dry and reattach it to the deck.

8.2 Cleaning pipettes and tips

To clean a 1-, 8-, or 96-channel pipette:

1. Remove the pipette from the gantry.
2. Dampen a soft, clean cloth or paper towel with a cleaning solution.
3. Gently wipe down the following parts:
 - Body
 - Ejector
 - Nozzles
4. Use a cloth dampened with distilled water for a rinse wipedown.
5. Let the pipette air dry and reattach.

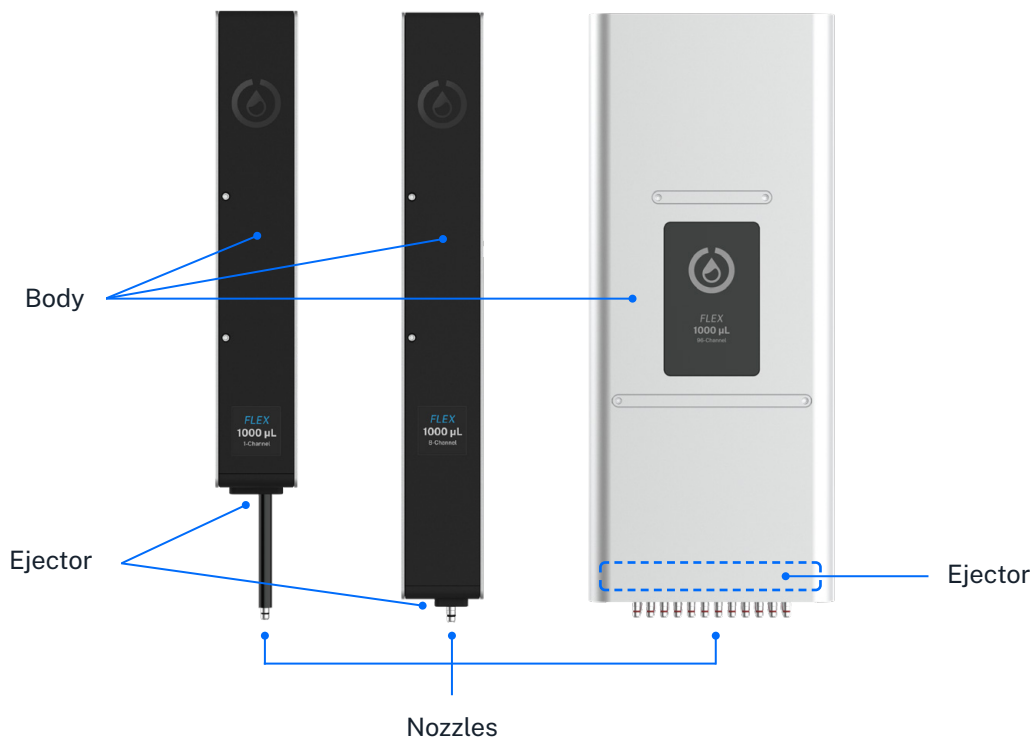

Warning:

- Do not disassemble Flex pipettes for cleaning or attempt to clean their internal electronic components.
- Do not put Flex pipettes in an autoclave. The high temperatures, pressures, and steam used inside an autoclave can damage the electronics, circuit boards, small electric motors, and other sensitive components.

Pipette decontamination

The routine cleaning steps described above may not clean your pipette if it becomes contaminated with substances like nucleic acids, proteins, or radioactive material. When a pipette becomes contaminated, try the decontamination steps described in this section. You can also contact support if your pipette gets contaminated and these cleaning procedures do not work.

OUTSIDE OF THE PIPETTE

Refer to the following table for recommended cleaning methods, by contamination type.

Contaminant	Cleaning recommendation
Aqueous solutions	Rinse the contaminated parts with distilled water or 70% ethanol and air dry at 15.5 °C (60 °F).
Nucleic acids	Clean the contaminated parts in a glycine/HCl buffer (pH 2) for 10 minutes, rinse with distilled water, and air dry.
Organic solvents	Allow the solvent to evaporate on its own or immerse the pipette <i>nozzle only</i> in a detergent, rinse with distilled water, and air dry.
Proteins	Clean the contaminated parts with a detergent, rinse with distilled water, and air dry. <i>Do not</i> use alcohol. That will set the proteins.
Radioactive materials	Place the pipette nozzle in a solution like Decon 90, rinse with distilled water, and air dry.

INSIDE THE PIPETTE

Filtered pipette tips help prevent contaminating the barrel or inside of the pipette. But, you cannot disassemble the barrel if it becomes contaminated. If the inside of your pipette gets contaminated, the following steps may help remove the contamination:

1. Inject a small amount of cleaning solution into the barrel using a manual pipette or syringe.
2. Gently shake the pipette to swirl the cleaning solution.
3. Rinse with distilled water.
4. Let the pipette air dry and reattach.

Cleaning pipette tips

Flex pipette tips are disposable items. While you can reuse attached tips if your protocol allows it, they're not designed to be removed, cleaned, and then reattached. Also, cleaning Flex pipette tips in a parts washer or an autoclave can cause them to warp. Discard pipette tips after you no longer need them. You can always buy more at <https://shop.opentrons.com/tips-and-labware/>.

8.3 Cleaning the gripper

To clean the gripper:

1. Remove the gripper from the gantry.
2. Dampen a soft, clean cloth or paper towel with a cleaning solution.
3. Gently wipe down the following parts:
 - Gripper body
 - Jaws
 - Paddles
4. Use a cloth dampened with distilled water for a rinse wipedown.
5. Let the gripper air dry and reattach.



Warning:

- Do not disassemble the gripper for cleaning or attempt to clean its internal electronic components.
- Do not put the gripper in an autoclave. The high temperatures, pressures, and steam used inside an autoclave can damage the electronics, circuit boards, small electric motors, and other sensitive components.

GRIPPER PADDLES

The gripper paddles are wear items that require periodic replacement. When cleaning the gripper, inspect the rubber pads for tears, nicks, or other wear. Replace the paddles as needed with the two spares (included with the gripper). If you need additional gripper paddles, contact Opentrons Support at support@opentrons.com.



Note: Aggressive cleaning chemicals may reduce the lifetime of the rubber pads on the gripper paddles.

8.4 Cleaning modules

You can clean the surfaces of any of your Flex modules. The general procedure is the same for all supported modules: Heater-Shaker, Magnetic Block, Temperature, and Thermocycler.

Be sure to turn the module's power off before cleaning it. You can clean the top surfaces of modules while they're installed in a deck slot. However, for better access, you may want to:

- Remove the caddy and module from the deck slot.
- Remove the module from the caddy.
- Disconnect any USB or power cables (if you're cleaning a powered module).



Warning:

- *Do not* disassemble modules for cleaning or attempt to clean their internal electronic components.
- *Do not* put Flex modules in an autoclave. The high temperatures, pressures, and steam used inside an autoclave can damage the electronics, circuit boards, small electric motors, and other sensitive components.

General module cleaning

Once you've prepared the module for cleaning:

1. Dampen a soft, clean cloth or paper towel with a cleaning solution.
2. Gently wipe off the module's surfaces.
3. Use a cloth dampened with distilled water as a rinse wipedown.
4. Let the module air dry.

Thermocycler seals

To set up the Thermocycler with a clean seal:

1. Affix a seal to the Thermocycler lid (if one isn't attached already).
2. Wipe the seal with a 1:10 diluted bleach solution.
3. Rinse the seal with molecular biology grade water.
4. Let the seal air dry.

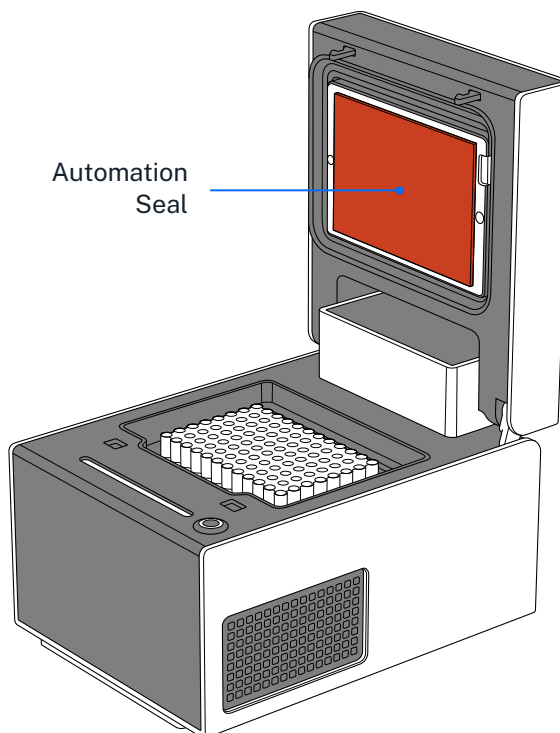

8.5 Autoclave-safe labware

The following table lists labware sold by Opentrons that we have verified as autoclave-safe. If you're using labware from a manufacturer that's not listed here, refer to their website to see whether those items can be autoclaved.

Labware type	Autoclave-safe items
Reservoirs	All NEST reservoirs
Well plates	<ul style="list-style-type: none"> ▪ Thermo Scientific Nunc 96-Well Plate, 1300 μL ▪ Thermo Scientific Nunc 96-Well Plate, 2000 μL ▪ USA Scientific 96 Deep Well Plate, 2.4 mL
Sample vials	Eppendorf Safe-Lock 1.5 mL and 2.0 mL vials (when left open at 121 °C, 20 min)

In general, plastic labware is designed to be consumable. If you aren't sure whether a piece of labware is autoclave-safe, it's best to discard it and replace it with new, clean labware.

8.6 Servicing Flex

Opentrons Flex is designed for years of full-time operation. Unlike cleaning, you should not attempt to service or repair Flex yourself. Opentrons offers multiple levels of service for Flex and related Opentrons hardware, some of which include maintenance and repairs. All Opentrons hardware also has a 1-year warranty, which you can extend to 2 years.

Opentrons services

Opentrons offers two levels of service, Opentrons Care and Opentrons Care Plus, both of which include benefits for onboarding, maintenance, repair, and more. Both services are available in the continental United States; Opentrons Care is also available internationally. Both services include:

- Onboarding with an Opentrons field applications scientist.
- Parts for yearly preventive maintenance.
- Access to a dedicated support engineer.
- Extension of the Opentrons warranty from 1 to 2 years.

In addition, Opentrons Care Plus includes on-site visits for:

- Installation.
- Preventive maintenance, yearly.
- Repairs, as needed.

You can also purchase services a la carte, including installation, protocol development (remote or on-site), repair, relocation, and preventive maintenance. Visit the [Services category](#) of the Opentrons Shop, or contact Opentrons Sales for more information.

Installation qualification and operation qualification

Opentrons recommends performing installation qualification and operation qualification (IQ/OQ) after you first set up Flex, after you attach hardware, and after having service performed. IQ/OQ generally verifies:

- The serial numbers of your hardware, including the Flex robot, pipettes, gripper, and modules.
- Software and firmware versions.
- Proper connection of attached hardware.
- Pipette and module calibrations.

Consult the [Flex IQ/OQ form](#) for a complete checklist of IQ/OQ activities to perform.

Preventative maintenance

Opentrons recommends performing basic maintenance tasks — above and beyond cleaning, but not repairs or service — on a regular schedule. These recommendations assume that Flex is in operation 20 hours per week, 50 weeks per year. Adjust the schedule to meet your needs if you use your Flex more or less.

Frequency	Task	Description
Daily	Empty trash	Take the movable trash out of its deck slot, safely discard its contents, and replace it into the deck.
	Inspect working area	Clear the deck of any debris, liquid, or no-longer-needed labware. Check that the plastic labware clips are not damaged.
Weekly	Clean surfaces	Clean the exterior surfaces of the deck, gantry, windows, instruments, and other hardware, as described above.
Monthly	Power cycle	Turn off Flex and all connected modules. Then turn them back on.
Every six months	Inspect pipettes	Inspect the O-rings on the pipette nozzles for signs of wear (notches, deformation). Replace the O-rings with the provided spares, if needed.
	Inspect gripper	Inspect the rubber pads on the gripper paddles. Replace the paddles with the provided spares, if needed.
	Recalibrate instruments	Run recalibration for the pipettes and gripper.
Yearly	Evaluate pipette performance	Evaluate the overall performance of your Flex pipettes. Replace any pipette that is not performing according to the published accuracy and precision standards .

The annual on-site preventative maintenance visit that is part of Opentrons Care Plus includes performance of all of the tasks listed above, as well as replacement parts.

Warranty

All hardware purchased from Opentrons is covered under a [1-year standard warranty](#). Opentrons warrants to the end-user of the products that they will be free of manufacturing defects due to part quality issues or poor workmanship and also warrants that the products will materially conform to Opentrons' published specifications. See also the [General Terms and Conditions of Sale](#).

The Opentrons Protect Extended Warranty (1 additional year; 2 years total) is available for purchase from the Opentrons Shop.

Contact us at support@opentrons.com if you have any questions about our warranty.

Glossary

This appendix defines terms related to Opentrons Flex. It omits industry-standard terms like “labware” unless the term has a special meaning in relation to Flex. For example, the definition for *pipette* describes the narrower meaning that the term has when using Flex, as opposed to any pipette you might find elsewhere in a lab.

The glossary is formatted to help you navigate within it and to other places in this manual. Words in italics indicate terms that are also defined in the glossary. Extremely common terms like “deck”, “module”, “pipette”, and “protocol” aren’t italicized, to improve readability. Links within definitions take you to the most relevant section that includes additional discussion of the term. And you can always use your PDF reader to search for every occurrence of a term to find even more information.

ABOVE DECK

Space that is on or above the level of the robot’s deck area.

ALUMINUM BLOCK

See *thermal block*.

AMBIENT LIGHTING

LEDs that illuminate the interior of Flex, which you can toggle on and off from the *touchscreen* or the *Opentrons App*.

AUXILIARY PORTS

Ports on the back of the Flex labeled AUX-1 and AUX-2. The port connection type is an [IEC M12 metric screw connector](#). See the [Connections section](#) in the System Description chapter.

A1 EXPANSION SLOT

The area of the deck behind slot A1. When its cover is removed, the A1 expansion slot provides enough space to install the Thermocycler Module. See the [Deck and Working Area section](#) of the System Description chapter.

■ APPENDIX A: GLOSSARY

BELOW DECK

The empty area below the robot's *deck slots*. This space provides clearance for module caddies that sit below the deck and allows for below-deck cable routing.

CADDY

See *module caddy*.

CALIBRATION PIN

A metal pin you attach to the *gripper's jaws* during gripper calibration. See the [Gripper Calibration section](#) in the System Description chapter.

CALIBRATION PROBE

A metal collar you attach to the *nozzle* of a pipette during pipette calibration, module calibration, and *Labware Position Check*. See the [Pipette Calibration section](#) in the System Description chapter and the [Module Calibration section](#) in the Modules chapter. See also the [Labware Position Check section](#) of the Software and Operation chapter.

CALIBRATION SQUARE

The central part of a *removable deck slot* or *module calibration adapter*. The square is made of steel to reduce the chance of surface damage during calibration.

CAMERA

A built-in camera that provides an above-deck view inside the Flex enclosure.

CARRYING HANDLE

One of four aluminum handles that screw into the bottom corners of the robot. The handles help make Flex easier to lift. Lifting the robot requires two people. Using the handles is the best way to pick up Flex and move it.

■ APPENDIX A: GLOSSARY

CARRYING HANDLE CAP

A flat metal cover that goes over the attachment point for a *carrying handle*. The caps close the handle openings in the *frame* and give the robot a clean appearance. See the [Physical Components section](#) in the System Description chapter.

DASHBOARD

The main screen for the robot, accessible by tapping the robot's name in the top left corner of the *touchscreen*. The dashboard gives you quick access to recently run protocols. See the [Touchscreen Operation section](#) in the Software and Operation chapter.

DECK

The machined aluminum surface on which automated science protocols are executed. It includes the *working area*, *staging area*, and *A1 expansion slot*. See the [Deck and Working Area section](#) in the System Description chapter.

DECK BORDER

The fixed portion of the deck around the four edges of the robot (outside of the area where *deck slot* panels fit). It contains the removable accessory covers.

DECK FIXTURE

Hardware items that replace standard *deck slots*. They let you customize the deck layout and add functionality to your Flex. Deck fixtures include the *staging area slots*, *trash bin*, and *waste chute*.

DECK SLOT

A detachable panel on the deck area. Remove deck slots to install modules and for access to the space below the deck.

EJECTOR

The mechanism that automatically pushes tips off the *nozzle* of a pipette. See the [Pipettes section](#) in the System Description chapter.

■ APPENDIX A: GLOSSARY

EMERGENCY STOP PENDANT

An external accessory that you press to stop the robot immediately. Also referred to as the E-stop. See the [Emergency Stop Pendant section](#) in the System Description chapter.

EXPANSION SLOT

See *A1 expansion slot*.

EXTENSION MOUNT

The attachment point on the *gantry* for the Flex Gripper. See the [Movement System section](#) in the System Description chapter.

FINISHING CAP

See *carrying handle cap*.

FIRMWARE

The low-level software that controls the Flex robot and all of its peripheral systems. The Flex robot will automatically update the firmware on connected instruments and modules to stay in sync with the robot software version.

FIXTURE

See *deck fixture*.

FRAME

The outer metal structure of the robot.

FRONT DOOR

The hinged clear panel on the front of the robot.

■ APPENDIX A: GLOSSARY

GANTRY

The robot's positioning system that moves attached *instruments* horizontally (on the x- and y-axis). See the [Movement System section](#) in the System Description chapter.

GRIPPER

The Opentrons Flex Gripper, an *instrument* that picks up labware and moves it around the deck automatically.

HOME GANTRY

The act of moving the *gantry* to a defined position at the back right of the *working area*.

INSTRUMENT

Any component that attaches to the *gantry* and manipulates liquids or labware on the deck. Examples include the 1- , 8- , and 96-channel pipettes, and the gripper.

INSTRUMENT MOUNT

Attachment point for an *instrument*. Examples include the *pipette mounts* and the *extension mount* for the *gripper*. See the [Movement System section](#) in the System Description chapter.

JAWS

The moving pincers of the *gripper*. See the [Gripper Specifications section](#) in the System Description chapter.

JSON PROTOCOL

A standardized scientific procedure written as a [JavaScript object notation](#) file. The Opentrons *Protocol Designer* outputs JSON protocols.

■ APPENDIX A: GLOSSARY

JSON SCHEMA

A set of requirements for the structure and contents of a [JavaScript object notation](#) file. For example, all of the [Opentrons labware definitions](#) are formatted according to a particular JSON schema, while *JSON protocols* follow another schema.

LABWARE CLIPS

The plastic pieces at the corners of *deck slots*. Labware clips hold labware in place.

LABWARE CREATOR

The [Opentrons Labware Creator](#) is a no-code, web-based tool that uses a graphical interface to help you create a labware definition file to import into the *Opentrons App*. After importing it, your custom labware is available to the Flex robot and the *Python Protocol API*.

LABWARE LIBRARY

The [Opentrons Labware Library](#) lists the durable and consumable items you can use with the Flex by default, without customization. It includes things like well plates, reservoirs, tips, tip racks, and tubes.

LABWARE OFFSET

Positional data that is created and stored by running *Labware Position Check*. Flex takes these offsets into account when moving to a particular type of labware in a particular *deck slot*.

LABWARE POSITION CHECK

A guided process to visually check and adjust pipette movement relative to a piece of labware, with a resolution of 0.1 mm. See the [Labware Position Check section](#) in the Software and Operation chapter.

LIFT HANDLES

See *carrying handles*.

■ APPENDIX A: GLOSSARY

LIGHTS

See *ambient lighting* or *status light*.

MAINTENANCE POSITION

A specific *gantry* position at the front left side of the *working area*. The gantry moves to this position to facilitate adding or removing *instruments*.

MODULE

A peripheral that occupies a *deck slot*. Most modules are controlled by the robot via a USB connection. The Heater-Shaker, Temperature Module, and Thermocycler are all powered modules. The Magnetic Block is an unpowered module. See the [Modules chapter](#).

MODULE CADDY

A container that holds a module. It is used to attach modules to the deck area and help with module removal. Caddies place your labware closer to the deck surface and allow for below-deck cable routing.

MODULE CALIBRATION ADAPTER

An adapter that sits on top of a module and is used to automatically calibrate module position.

MOUNTING PLATE

See *96-channel mounting plate*.

NOZZLE

The working end of a pipette. Flex pipettes pick up disposable tips by pressing the nozzles down into them. See the [Pipettes section](#) in the System Description chapter.

■ APPENDIX A: GLOSSARY

OPENTRONS APP

Software used to control a Flex (or other OpenTrons robots) from a laptop or desktop computer. The OpenTrons App is available for Mac, Windows, and Linux. See the [OpenTrons App section](#) of the Software and Operation chapter.

PADDLE

Part of the *gripper* that grasps and holds labware. Paddles are replaceable wear items. See the [Gripper Specifications section](#) in the System Description chapter.

PINNED PROTOCOL

Protocols you have saved for easy access at the top of the All Protocols tab on the *touchscreen*. See the [Protocol Management section](#) in the Software and Operation chapter.

PIPETTE

[OpenTrons Flex Pipettes](#) are configurable devices used to move liquids throughout the *working area* during the execution of protocols. There are several Flex pipettes, which can handle volumes from 1 μL to 1000 μL in 1, 8, or 96 channels. See the [Pipettes section](#) in the System Description chapter.

PIPETTE MOUNT

The attachment point on the *gantry* for a pipette. See the [Movement System section](#) in the System Description chapter.

PROFILE

See *Thermocycler profile*.

PROTOCOL

An automated task or procedure you program to run on OpenTrons robots, including OpenTrons Flex. You can also search for, download, and use ready-made protocols from the OpenTrons *Protocol Library*.

■ APPENDIX A: GLOSSARY

PROTOCOL DESIGNER

A web-based, no-code tool for developing *JSON protocols* that run on Opentrons robots, including Opentrons Flex. See the [Protocol Designer section](#) in the Protocol Development chapter and <https://designer.opentrons.com>.

PROTOCOL LIBRARY

A public, searchable library that hosts protocols authored by Opentrons or by members of the Opentrons community. See the [Protocol Library section](#) of the Protocol Development chapter and <https://protocols.opentrons.com>.

PROTOCOL RUN

A particular instance of Flex performing the actions specified in a protocol file. Only a single protocol run can be active at any given time. Flex stores historical data on the time and outcome of the 20 most recent protocol runs.

PYTHON PROTOCOL

A protocol script written using the Opentrons *Python Protocol API*. See the [Writing and Running Scripts section](#) in the Protocol Development chapter.

PYTHON PROTOCOL API

A Python package that exposes a wide range of liquid handling features on Opentrons robots. See the [Python Protocol API section](#) in the Protocol Development chapter and the online [Opentrons Python Protocol API documentation](#).

REMOVABLE DECK SLOT

See *deck slot*.

RUN

See *protocol run*.

■ APPENDIX A: GLOSSARY

SIDE COVERS

Detachable panels on the side of the robot, used for module exhaust and external cable routing. See the [Connections Section](#) in the System Description chapter.

SIDE WINDOWS

Fixed clear panels on the right and left sides of the robot.

STAGING AREA

The right-hand side of the *deck* (column 4), which is only accessible by the *gripper*. This area requires special *staging area slots* for use. See the [Staging Area section](#) in the System Description chapter.

STAGING AREA SLOT

Staging area slots are ANSI/SLAS compatible deck pieces that replace the standard slots in column 3 (A3 to D3) and extend a new slot into the *staging area*. You can install a single slot or a maximum of four slots to create a new column (A4 to D4) along the right side of the *deck*. See the [Staging Area section](#) in the System Description chapter.

STATUS LIGHT

A strip of color LEDs along the top front of the robot. This light provides at-a-glance information about the robot. Different colors and patterns of illumination can communicate various success, failure, or idle states. See the [Touchscreen and LED Displays section](#) in the System Description chapter.

THERMAL ADAPTER

Aluminum blocks that attach to the Heater-Shaker and hold labware. See the [Thermal Adapters section](#) in the Modules chapter.

THERMAL BLOCK

Aluminum blocks that attach to the Temperature Module and hold labware to facilitate heating, cooling, and maintaining temperature. See the [Thermal Blocks section](#) in the Modules chapter.

■ APPENDIX A: GLOSSARY

THERMOCYCLER PROFILE

A sequence of temperature changes used by the Thermocycler to perform heat-sensitive reactions. See the [Thermocycler Profiles section](#) in the Modules chapter.

TIP RACK ADAPTER

An aluminum bracket used by the 96-channel pipette to attach a full rack of pipette tips. See the [Pipettes section](#) in the System Description chapter.

TOUCHSCREEN

The interactive LCD screen mounted to the front of the robot. See the [Touchscreen and LED Displays section](#) in the System Description chapter.

TRASH BIN

A removable trash container. By default, it occupies slot A3 on the deck.

USB PORTS

Connections for Flex accessories, modules, and computers. See the [USB and Auxiliary Connections section](#) in the System Description chapter.

USER KIT

A box that contains tools, fasteners, and spare parts. Every Flex robot ships with a User Kit.

WASTE CHUTE

A *deck fixture* that transfers liquids, tips, tip racks, and well plates from the Flex enclosure to a trash receptacle placed below its external opening.

WORKING AREA

The physical space above the deck that is accessible for pipetting. See the [Deck and Working Area section](#) in the System Description chapter.

■ APPENDIX A: GLOSSARY

WORKSTATION

Opentrons Flex workstations include the Flex robot, instruments, modules, accessories, and labware needed to automate a particular application. See the [Flex Workstations section](#) in the Introduction.

Z-AXIS CARRIAGE

The *gantry* component that includes the *pipette mounts* and the *extension mount* for the *gripper*. It moves these *instruments* along the z-axis (up and down) to locate them precisely during protocol execution. See the [Movement System section](#) in the System Description chapter.

96-CHANNEL MOUNTING PLATE

A metal frame that mounts to the *z-axis carriage*. It holds the 96-channel pipette to the *gantry*.

Additional Documentation

Opentrons maintains additional online documentation for our hardware and software products. You may find these resources valuable as you use Opentrons Flex.

B.1 Opentrons Knowledge Hub

The [Opentrons Knowledge Hub](#) hosts publications about Opentrons products and related scientific applications. Some of the publication categories are:

- **Application Notes:** Scientific papers on performing particular applications with Opentrons hardware. Topics range from nucleic acid extraction and NGS quantification to handling volatile or viscous liquids.
- **Certificates:** Official regulatory and compliance documents for Opentrons hardware.
- **Documentation & Manuals:** Product instruction manuals (including this one) for Opentrons robots and modules. Also includes digital versions of the Quickstart Guides that ship in Opentrons product packages.
- **White Papers:** Documents that detail how Opentrons products are constructed and validated. White papers include dimensional drawings of Opentrons hardware.

B.2 Python Protocol API documentation

The [online documentation for the Opentrons Python Protocol API](#) describes how to write automated biology lab protocols for Opentrons robots and hardware modules. The documentation includes a [Tutorial](#) for users writing their first Python protocol.

The Python API documentation covers writing Python code to:

- Load and work with labware.
- Load and work with Opentrons modules.
- Load and work with pipettes and the gripper.
- Perform discrete liquid-handling actions, such as aspirating and dispensing.
- Perform complex liquid-handling actions, such as transfers between wells.
- Move instruments to exact locations in the working area.

■ APPENDIX B: ADDITIONAL DOCUMENTATION

There is also a [Python API reference](#) with information about all of the classes and methods that comprise the API.

B.3 Opentrons HTTP API reference

The [Opentrons HTTP API reference](#) describes all of the endpoints of the API used to directly control Opentrons robots. The API has many endpoint categories, including:

- Querying the state of the robot.
- Performing calibration tasks.
- Managing and running protocols.
- Moving the gantry and instruments.
- Controlling discrete systems like the ambient lighting and camera.

The API reference is defined by and generated from an [OpenAPI](#) specification.

B.4 Developer documentation

Documentation for working directly with Opentrons source code is available alongside the corresponding code on GitHub. Notable documentation pages include:

- [Development Environment Setup](#): Opinionated instructions for setting up your computer to work on the software in the Opentrons/opentrons repository. These setup steps are required for running the Opentrons App or a simulated robot server from source.
- [Opentrons Emulation Wiki](#): Explanation and instructions for using our software that emulates Opentrons robots at the firmware or hardware level.

Open-Source Software

Opentrons believes that open-source software and hardware make science better. That's why we make our code available on GitHub and welcome contributions from the open-source community.

This appendix covers various ways to use Opentrons open-source resources and describes the structure of our repositories.

C.1 Opentrons on GitHub

The Opentrons GitHub organization can be found at <https://github.com/Opentrons>. All of our publicly hosted code resides there, including the Flex robot software, the Opentrons App, and our Python and HTTP APIs.

Our GitHub site has several useful resources for Flex users, and you can participate in our community even if you're not a coder.



Note: As you browse our GitHub repositories, you will encounter references to `ot3`, which is a model identifier for Opentrons Flex. If you're having trouble finding something when searching for "Flex", try searching for "ot3" or "OT-3" instead.

Releases

Whenever we create a new version of the robot software and Opentrons App, we publish it on GitHub as a release. Past releases of Opentrons software are kept at <https://github.com/Opentrons/opentrons/releases>.

Opentrons recommends running the latest version of our software. However, we recognize that some users need access to previous versions (e.g., for validation or compliance purposes). Download previous versions of the Opentrons App or robot software under the **Assets** section of each release entry on GitHub.

Opening issues

Contact Opentrons Support first if you're having a problem with your robot. Before opening an issue, search through [existing issues](#) to prevent creating a duplicate.

We accept two types of issue reports: bugs and feature requests. Each has its own issue template. Fill out all parts of the template with as much detail as possible to help us address your issue completely and quickly.

Contributing code

Get started working with Opentrons code by following the [development environment setup instructions](#). Work on your code in your own fork and then create a pull request to contribute to our codebase. For additional details on creating pull requests, including testing requirements, see the [contributing guide](#).

Open-source licenses

Most Opentrons repositories are licensed under the Apache License 2.0, but some use other licenses. Consult the license on each repository before using or modifying the code it contains. Keep in mind that any code you contribute will be governed by the license in place on the corresponding repository.

C.2 Opentrons monorepo

Most of our software is in the [Opentrons/opentrons](#) *monorepo*: a single repository that contains multiple software projects, each in its own directory. The README.md file in each directory describes the project and gives advice on working with the code. The default branch in the monorepo is called `edge`.

The following (non-exhaustive) list of directories, subdirectories, and files can help you navigate the monorepo and find code relevant to using Flex.

APPENDIX C: OPEN-SOURCE SOFTWARE

Path	Description
/api/	Source for the Python Protocol API, written in Python and distributed as the <code>opentrons PyPI</code> package.
/api/docs/	Documentation for the Python Protocol API, written in ReStructuredText.
/api/release-notes.md	Release notes for the robot system software (as a whole, including changes outside of the <code>/api/</code> directory).
/app-shell-odd/	Electron application wrapper for the touchscreen software — “odd” stands for <i>on-device display</i> .
/app-shell/	Electron application wrapper for the Opentrons App.
/app-shell/build/release-notes.md	Release notes for the Opentrons App (as a whole, including changes outside of the <code>/app-shell/</code> directory).
/app/	Source for the Opentrons App. Use <code>make</code> commands in this directory to run the app from source.
/labware-library/	Source for the Labware Library website.
/protocol-designer/	Source for Protocol Designer, our no-code web application for creating JSON protocol files.
/robot-server/	The web service that runs the Opentrons HTTP API. The Opentrons App and touchscreen use HTTP API calls to control the robot. You can also write your own software that makes HTTP API calls or use software like <code>curl</code> or Postman to make individual calls to a robot.
/shared-data/	Special directory for data that needs to be shared between projects.
/shared-data/labware/	Schema and labware definitions for Opentrons-verified labware. The Python Protocol API and Labware Library both use the definition files stored here.
/shared-data/python/	Source for the <code>opentrons-shared-data</code> Python package, which is a dependency of the main <code>opentrons</code> package.

C.3 Other repositories

Opentrons also maintains software outside of the monorepo. A few key repositories include:

Repository	Description
buildroot	The Opentrons fork of Buildroot , the embedded Linux system builder, which we use to configure and build our robots' operating systems.
oe-core	The heart of Opentrons' openembedded system definitions.
opentrons-emulation	Emulation of Opentrons robots and modules at either the hardware or firmware level. Uses Docker , configuration files, and a simple command-line interface.
opentrons-modules	Firmware for all Opentrons modules.
ot3-firmware	Firmware for Opentrons Flex and all of its peripheral systems.
Protocols	All protocols hosted publicly on the Opentrons Protocol Library. If you just need to find a protocol, use the Protocol Library website rather than this repository.

Support and Contact Information

Contact us if you have any questions about the Opentrons Flex liquid handling robot. Opentrons teams are here to help you with:

- Sales
- Technical support
- Applications support
- Warranty service
- Supplies and accessories

D.1 Sales

Contact Sales if you'd like to talk with a representative about the Flex and schedule a demo.

- Phone: +1 (908) 869-8907
- Email: sales@opentrons.com
- For online chat, go to [Opentrons Sales Assistance](#) and click **Chat With Us**.

Sales business hours are Monday through Friday, 9:00 AM–6:00 PM Eastern Time (UTC–5 in autumn/winter, UTC–4 in spring/summer).

D.2 Support

Answers to many common questions are available on the Opentrons Help Center at <https://support.opentrons.com/>. Contact Opentrons Support directly if you can't find an answer to your question. We can also help you with warranty issues, parts, repairs, supplies, and other support-related problems or concerns.

- Email: support@opentrons.com
- For online chat, go to the [Opentrons website](#) and click on the live chat popup on the lower right corner of the page.

■ APPENDIX D: SUPPORT AND CONTACT INFORMATION

Support business hours are Monday through Friday, 9:00 AM–6:00 PM Eastern Time (UTC–5 in autumn/winter, UTC–4 in spring/summer).

For after-hours contact and communication, we will do our best to address your issues, but may not be able to provide a proper response until the next business day.

D.3 Business information

Opentrons Labworks Inc
45-18 Ct Square W
Long Island City, NY 11101, USA
<https://opentrons.com/>

Our general office hours are Monday through Friday, 9:00 AM–6:00 PM Eastern Time (UTC–5 in autumn/winter, UTC–4 in spring/summer).

Opentrons is closed for the following US holidays:

- New Year's Day
- Martin Luther King Jr. Day
- President's Day
- Memorial Day
- Juneteenth
- Independence Day
- Labor Day
- Veteran's Day
- Thanksgiving Day (Thursday and Friday)
- Christmas Day through New Year's Eve

