

इंटरनेट

मानक

Disclosure to Promote the Right To Information

Whereas the Parliament of India has set out to provide a practical regime of right to information for citizens to secure access to information under the control of public authorities, in order to promote transparency and accountability in the working of every public authority, and whereas the attached publication of the Bureau of Indian Standards is of particular interest to the public, particularly disadvantaged communities and those engaged in the pursuit of education and knowledge, the attached public safety standard is made available to promote the timely dissemination of this information in an accurate manner to the public.

“जानने का अधिकार, जीने का अधिकार”

Mazdoor Kisan Shakti Sangathan

“The Right to Information, The Right to Live”

“पुराने को छोड़ नये के तरफ”

Jawaharlal Nehru

“Step Out From the Old to the New”

IS/IEC 60958-3 (2003): Digital audio interface, Part 3: Consumer applications [LITD 7: Audio, Video and Multimedia Systems and Equipment]



“ज्ञान से एक नये भारत का निर्माण”

Satyanarayan Gangaram Pitroda

“Invent a New India Using Knowledge”



“ज्ञान एक ऐसा खजाना है जो कभी चुराया नहीं जा सकता है”

Bhartrhari—Nitiśatakam

“Knowledge is such a treasure which cannot be stolen”

BLANK PAGE



भारतीय मानक
अंकीय श्रव्य अन्तर्पुष्ट
भाग 3 उपभोक्ता अनुप्रयोग

Indian Standard
DIGITAL AUDIO INTERFACE
PART 3 CONSUMER APPLICATIONS

ICS 33.160.01

© BIS 2007

BUREAU OF INDIAN STANDARDS
MANAK BHAVAN, 9 BAHADUR SHAH ZAFAR MARG
NEW DELHI 110002

NATIONAL FOREWORD

This Indian Standard (Part 3) which is identical with IEC 60958-3 (2003) 'Digital audio interface — Part 3: Consumer applications' issued by the International Electrotechnical Commission (IEC) was adopted by Bureau of Indian Standards on the recommendation of the Radio Communication Sectional Committee and approval of the Electronics and Information Technology Division Council.

The text of IEC Standard has been approved as suitable for publication as an Indian Standard without deviations. Certain conventions are, however, not identical to those used in Indian Standards. Attention is particularly drawn to the following:

- a) Wherever the words 'International Standard' appear referring to this standard, they should be read as 'Indian Standard'.
- b) Comma (,) has been used as a decimal marker, while in Indian Standards, the current practice is to use a point (.) as the decimal marker.

In this adopted standard, reference appears to certain International Standards for which Indian Standards also exist. The corresponding Indian Standards which are to be substituted in their places are listed below along with their degree of equivalence for the editions indicated:

<i>International Standard</i>	<i>Corresponding Indian Standard</i>	<i>Degree of Equivalence</i>
IEC 60958-1 (2004) Digital audio interface — Part 1: General	IS/IEC 60958-1 : 2004 Digital audio interface: Part 1 General	Identical
IEC 60958-4 (2003) Digital audio Interface — Part 4: Professional applications	IS/IEC 60958-4 : 2003 Digital audio interface: Part 4 Professional applications (TA4)	do

The technical committee has reviewed the provisions of the following International Standards referred in this adopted standard and has decided that they are acceptable for use in conjunction with this standard:

<i>International Standard</i>	<i>Title</i>
IEC 60268-11 (1987)	Sound system equipment — Part 11: Application of connectors for the interconnection of sound system components
IEC 60841 (1988)	Audio recording — PCM encoder/decoder system
IEC 60908 (1999)	Audio recording—compact disc digital audio system
IEC 61119-1 (1992)	Digital audio tape cassette system (DAT) — Part 1: Dimensions and characteristics
IEC 61119-6 (1992)	Digital audio tape cassette system (DAT) — Part 6: Serial copy management system

The technical committee decided to provide Table IV of IEC 60268-11 : 1987 in this standard for details on connectors for both outputs and inputs as mentioned in clause 7.3.4 of this standard and is therefore given at the end of this Standard as National Annex A.

For the purpose of deciding whether a particular requirement of this standard is complied with, the final value, observed or calculated, expressing the result of a test or analysis, shall be rounded off in accordance with IS 2 : 1960 'Rules for rounding off numerical values (*revised*)'. The number of significant places retained in the rounded off value should be same as that of the specified value in this standard.

Indian Standard

DIGITAL AUDIO INTERFACE

PART 3 CONSUMER APPLICATIONS

1 Scope

This part of IEC 60958 specifies the consumer application of the interface for the interconnection of digital audio equipment defined in IEC 60958-1.

NOTE When used in a consumer digital processing environment, the interface is primarily intended to carry stereophonic programmes, with a resolution of up to 20 bits per sample, an extension to 24 bits per sample being possible.

2 Normative references

The following referenced documents are indispensable for the application of this document. For dated references, only the edition cited applies. For undated references, the latest edition of the referenced document (including any amendments) applies.

IEC 60268-11:1987, *Sound system equipment – Part 11: Application of connectors for the interconnection of sound system components*

IEC 60841:1988, *Audio recording – PCM encoder/decoder system*

IEC 60908:1999, *Audio recording – Compact disc digital audio system*

IEC 60958-1, *Digital audio interface – Part 1: General*

IEC 60958-4, *Digital audio interface – Part 4: Professional applications*

IEC 61119-1:1992, *Digital audio tape cassette system (DAT) – Part 1: Dimensions and characteristics*

IEC 61119-6:1992, *Digital audio tape cassette system (DAT) – Part 6: Serial copy management system*

3 Terms and definitions

The terms and definitions given in IEC 60958-1 apply to this part of IEC 60958.

4 Interface format

The interface format as defined in IEC 60958-1 shall be used.

Unless otherwise specified in the annexes, the following specification is applicable:

- An audio sample word has a length of 20 bits/sample. The auxiliary sample bits are an optional expansion of the audio sample, if not used = "0".
- User data is not used, all bits = "0".
- Channel status is identical for both sub-frames of the interface, with the exception of the channel number, if that is not equal to zero.

5 Channel status

5.1 General

For every sub-frame, the channel status bit provides information related to the audio channel that is carried in that same sub-frame.

Channel status information is organized in a 192-bit block, subdivided into 24 bytes, numbered 0 to 23 (see Table 1). The first bit of each channel status block is carried in the frame with preamble "B".

The individual bits of a channel status block are numbered 0 to 191.

The primary application is indicated by channel status bit 0.

As stated in IEC 60958-1, for the consumer digital audio applications described in this standard, this first channel status bit equals "0".

NOTE As stated in IEC 60958-1, for professional application this first channel status bit equals "1".

Secondary applications may be defined within the framework of these primary applications.

5.2 Application

5.2.1 Channel status general format

For each channel, the channel status block provides the information described in this clause and summarized in Table 1.

Table 1 – Channel status general format for consumer use

Byte

0	a = "0"	b	c	d			Mode	
bit	0	1	2	3	4	5	6	7
1								
bit	8	9	10	11	12	13	14	15
2								
bit	16	17	18	19	20	21	22	23
3								
bit	24	25	26	27	28	29	30	31
4								
bit	32	33	34	35	36	37	38	39
5								
bit	40	41	42	43	44	45	46	47
6								
bit	48	49	50	51	52	53	54	55
7								
bit	56	57	58	59	60	61	62	63
8								
bit	64	65	66	67	68	69	70	71
9								
bit	72	73	74	75	76	77	78	79
10								
bit	80	81	82	83	84	85	86	87
11								
bit	88	89	90	91	92	93	94	95
12								
bit	96	97	98	99	100	101	102	103
13								
bit	104	105	106	107	108	109	110	111
14								
bit	112	113	114	115	116	117	118	119
15								
bit	120	121	122	123	124	125	126	127
16								
bit	128	129	130	131	132	133	134	135
17								
bit	136	137	138	139	140	141	142	143
18								
bit	144	145	146	147	148	149	150	151
19								
bit	152	153	154	155	156	157	158	159
20								
bit	160	161	162	163	164	165	166	167
21								
Bit	168	169	170	171	172	173	174	175
22								
Bit	176	177	178	179	180	181	182	183
23								
Bit	184	185	186	187	188	189	190	191

a: use of channel status block.
b: linear PCM identification.

c: copyright information.
d: additional format information.

Byte 0: General control and mode information

Control:

Bit 0 "0" Consumer use of channel status block. (see notes 1 and 2)

NOTE 1 The significance of byte 0, bit 0 is such that transmission from an interface conforming to IEC 60958-4 can be identified.

Bit 1 "0" Audio sample word represents linear PCM samples. (see note 2)
 "1" Audio sample word used for other purposes.

NOTE 2 The functions of channel status bits 0 and 1 are defined in IEC 60958-1.

Bit 2 "0" Software for which copyright is asserted. (see note 3)
 "1" Software for which no copyright is asserted.

NOTE 3 Bit 2 is referred to as the "Cp-bit". It should indicate whether copyright protection has been asserted.

The copyright status may be unknown for certain applications. The above interpretation is therefore not valid in combination with some category codes (as indicated in the annex associated with the category code). The Cp-bit can alternate between 0 and 1 at a rate between 4 Hz and 10 Hz (see Annex A).

Bits 3 Additional format information, meaning depends on bit 1.
to 5

When bit 1 = "0", linear PCM audio mode:

Bit 3 4 5
State "0 0 0" 2 audio channels without pre-emphasis.
 "1 0 0" 2 audio channels with 50 μ s /15 μ s pre-emphasis.
 "0 1 0" Reserved (for 2 audio channels with pre-emphasis).
 "1 1 0" Reserved (for 2 audio channels with pre-emphasis).
All other states of bits 3 to 5 are reserved and shall not be used until further defined.

NOTE 4 The single and dual channel operating modes are defined with the frame format in IEC 60958-1.

When bit 1 = "1", other than linear PCM applications:

Bit 3 4 5
State "0 0 0" Default state for applications other than linear PCM.
All other states of bits 3 to 5 are reserved and shall not be used until further defined.

Bits 6 and 7 Channel status mode, indicates one of four possible channel status formats (bytes 1 to 23). There are four possible modes for each of the states of bit 1.

Bit 6 7
State "0 0" Mode 0, refer to 5.2.2.
All other states of bits 6 and 7 are reserved and shall not be used until further defined.

The contents of bits 8 to 191 depend on the mode as indicated by bits 6 and 7. If not defined otherwise, the default value is "0".

5.2.2 Mode 0 channel status format for digital audio equipment for consumer use

When the audio sample word represents linear PCM and the channel status mode is mode 0, the channel status format shown in Table 2 should be applied.

Table 2 – Mode 0 channel status format for consumer use

Byte	a = "0"	b = "0"	c	d			Mode = "0 0"	
0	0	1	2	3	4	5	6	7
1	Category code							
2	Source number				Channel number			
3	Sampling frequency				Clock accuracy			
4	Word length				Original sampling frequency			
5								
6								
7								
8								
9								
10								
11								
12								
13								
14								
15								
16								
17								
18								
19								
20								
21								
22								
23								
	184	185	186	187	188	189	190	191
	a: use of channel status block. b: linear PCM identification.				c: copyright information. d: additional format information.			

Byte 0 as defined in 5.2.1, with:

Bit 1	"0"	Audio sample word represents linear PCM samples.
Bits 6 to 7	"0 0"	Mode 0.

Byte 1: Category code

The category code indicates the kind of equipment that generates the digital audio interface signal. See the relevant annexes for the assignments. Bit 8 = LSB, bit 15 = MSB.

Byte 2: Source and channel number

Bits 16 to 19 Source number, bit 16 = LSB, bit 19 = MSB.

Bit	16	17	18	19	
State	"0 0 0 0"				Do not take into account.
	"1 0 0 0"				1
	"0 1 0 0"				2
	"1 1 0 0"				3
				
	"1 1 1 1"				15

Bits 20 to 23 Channel number (audio channel), bit 20 = LSB, bit 23 = MSB.

Bit	20	21	22	23	
State	"0 0 0 0"				Do not take into account.
	"1 0 0 0"				(left channel for stereo channel format).
	"0 1 0 0"				(right channel for stereo channel format).
	"1 1 0 0"				
				
	"1 1 1 1"				

NOTE 1 The single and dual channel operating modes are defined with the frame format in IEC 60958-1.

Byte 3: Sampling frequency and clock accuracy

Bits 24 to 27 Sampling frequency

Bit	24	25	26	27	
State	"0 0 1 0"				22,05 kHz
	"0 0 0 0"				44,1 kHz
	"0 0 0 1"				88,2 kHz
	"0 0 1 1"				176,4 kHz
				
	"0 1 1 0"				24 kHz
	"0 1 0 0"				48 kHz
	"0 1 0 1"				96 kHz
	"0 1 1 1"				192 kHz
				
	"1 1 0 0"				32 kHz
	"1 0 0 0"				Sampling frequency not indicated

All other combinations are reserved and shall not be used until further defined.

Bits 28 to 29	Clock accuracy.	
Bit	28	29
State	"0 0"	Level II
	"1 0"	Level I
	"0 1"	Level III
	"1 1"	Interface frame rate not matched to sampling frequency.

Byte 4: Word length and original sampling frequency

Bit 32	"0"	Maximum audio sample word length is 20 bits.
	"1"	Maximum audio sample word length is 24 bits.

Bits 33 to 35	Sample word length		
Bit	33	34	35
State	"0 0 0"	Word length not indicated (default)	Word length not indicated (default)
	"1 0 0"	20 bits	16 bits
	"0 1 0"	22 bits	18 bits
	"0 0 1"	23 bits	19 bits
	"1 0 1"	24 bits	20 bits
	"0 1 1"	21 bits	17 bits

All other combinations are reserved and shall not be used until further defined.

NOTE 2 The first edition of IEC 60958 had bits 32 to 35 reserved and set to zero. Therefore, the all zero state for these bits on a received signal may be an indicator that the word length indication has not been implemented.

Bits 36 to 39	Original sampling frequency	
Bit	36	37 38 39
State	"1 1 1 1"	44,1 kHz
	"1 1 1 0"	88,2 kHz
	"1 1 0 1"	22,05 kHz
	"1 1 0 0"	176,4 kHz
	"1 0 1 1"	48 kHz
	"1 0 1 0"	96 kHz
	"1 0 0 1"	24 kHz
	"1 0 0 0"	192 kHz
	"0 1 1 1"	Reserved
	"0 1 1 0"	8 kHz
	"0 1 0 1"	11,025 kHz
	"0 1 0 0"	12 kHz
	"0 0 1 1"	32 kHz
	"0 0 1 0"	Reserved
	"0 0 0 1"	16 kHz
	"0 0 0 0"	Original sampling frequency not indicated (default)

NOTE 3 The original sampling frequency field may be used to indicate the sampling frequency of a signal prior to sampling frequency conversion in a consumer playback system.

NOTE 4 Many of the values indicated for a frequency in the original sampling frequency field in byte 4 are the ones complement of the values used for that frequency in the sampling frequency field in byte 3.

5.3 Copyright management guidelines for consumer application of the digital audio interface

5.3.1 General

Category codes are defined for all consumer products that are capable of supplying a digital signal to consumer digital audio recorders, except for products that are fully transparent from input to output.

Category codes for products have been grouped by general function of the product. This makes it possible to take into account future digital recording products not yet defined in detail. Such a product then deals with the group code under a general rule. These rules define whether a digital recorder is enabled to record a copyright protected digital signal.

Unless otherwise specified, any consumer equipment capable of transferring digital audio information from an input terminal to an output terminal, if not fully transparent and regardless of the delay or type of transformation of the audio content of the signal, shall copy channel status bits 0, 1, 3, 4, 5, 6 and 7 from the source. Bit 2 shall be copied from the source, unless otherwise specified in the annexes.

Bit 15 is referred to as the "L-bit". It indicates the "generation status" of the digital audio signal.

"Generation status" means:

- whether the signal emanates from a source that has been produced or published or authorized by the rights owner of the material, such as commercially released pre-recorded compact discs or DAT tapes or a digital broadcast (referred to herein as "original") and for which copyright has been asserted; or
- whether the signal emanates from a recording made from such "original" material (i.e. "a home-copy of generation 1 or higher").

Generally the L-bit is specified as:

Bit 15	"0"	No indication.
	"1"	Commercially released pre-recorded software.

For historical reasons, the reverse situation is valid for the signals originating from:

- laser optical products (category code "100 XXXXL");
- broadcast reception (category codes "001 XXXXL" and "011 1XXXL").

For these category codes, the L-bit indicates:

Bit 15	"0"	Commercially released pre-recorded software.
	"1"	No indication.

The generation status may be unknown for certain applications. The above interpretation is therefore not valid in combination with some category codes such as:

- general (category code "000 00000");
- analogue/digital converters for analogue signals without copyright information (category code "011 00XXL").

5.3.2 Category code groups

5.3.2.1 The category code groups are defined in Table 3.

Table 3 – Category code groups

Bits 8 to 15	Category
"000 00000"	General. Used temporarily
"100 XXXXL"	Laser optical products
"010 XXXXL"	Digital/digital converters and signal processing products
"110 XXXXL"	Magnetic tape or disc based products
"001 XXXXL" and "011 1XXXXL"	Broadcast reception of digitally encoded audio signals with or without video signals
"101 XXXXL"	Musical instruments, microphones and other sources without copyright information
"011 00XXL"	Analogue/digital converters for analogue signals without copyright information
"011 01XXL"	Analogue/digital converters for analogue signals which include copyright information in the form of "Cp-bit and L-bit status"
"000 1XXXXL"	Solid state memory based products
"000 0001L"	Experimental products not for commercial sale
"111 XXXXL"	Not defined. Reserved
"000 0XXXXL"	Not defined. Reserved, except "000 00000" and "000 0001L"

5.3.2.2 Within a group, a further indication of the type of source is given.

5.3.2.2.1 For the general category code ("000 00000") the following applies:

- used temporarily;
- applied specifically for digital audio broadcast reception with or without a video signal, for example digital satellite reception in Japan in the case where no copyright information is transmitted. (See also Annex H.)

5.3.2.2.2 For the group of laser optical products (category code = "100 XXXXL") the category codes are defined in Table 4.

Table 4 – Category code groups for laser optical products

Bits 8 to 15	Category
"100 00000"	Compact disc digital audio signal compatible with IEC 60908 (see Annex A)
"100 1000L"	Laser optical digital audio systems for which no other category code is defined (see Annex D)
"100 1001L"	Mini disc system (see Annex N)
"100 1100L"	Digital versatile disc (DVD) (see Annex P)
"100 others"	Reserved

5.3.2.2.3 For the group of digital/digital converters and signal processing products (category code = "010 XXXXL"), the category codes are defined in Table 5.

Table 5 – Category code groups for digital/digital converter and signal processing products

Bits 8 to 15	Category
"010 0000L"	PCM encoder/decoder (see Annex B)
"010 0100L"	Digital signal mixer (see Annex E)
"010 1100L"	Sampling rate converter (see Annex F)
"010 0010L"	Digital sound sampler (see Annex G)
"010 1010L"	Digital sound processor (see Annex O)
"010 others"	Reserved

5.3.2.2.4 For the group of magnetic tape or magnetic disc based products (category code = "110 XXXXL"), the category codes are defined in Table 6.

Table 6 – Category code groups for magnetic tape or magnetic disc based products

Bits 8 to 15	Category
"110 0000L"	DAT (see Annex C)
"110 1000L"	Video tape recorder with digital sound
"110 0001L"	Digital compact cassette (see Annex M)
"110 others"	Reserved

5.3.2.2.5 For the group of broadcast reception of digitally encoded audio with/without video signals (category code = "001 XXXXL" or "011 1XXXL"), the category codes are defined in Table 7.

Table 7 – Category code groups for broadcast reception of digitally encoded audio with/without video signals

Bits 8 to 15	Category
"001 0000L"	Digital audio broadcast signal with or without a video signal (Japan) (see Annex H)
"001 1000L"	Digital audio broadcast signal with or without a video signal (Europe) (see Annex J)
"001 0011L"	Digital audio broadcast signal with or without a video signal (USA) (see Annex K)
"001 0001L"	Electronic software delivery (see Annex L)
"001 0010L"	Used by another standard (see note)
"001 others"	Reserved
"011 1XXXL"	Reserved

NOTE The code "001 0010L" is under consideration for use in connection with IEC 62105.

- 5.3.2.2.6 For the group of musical instruments, microphones and other sources that create original sound (category code = "101 XXXL"), the category codes are defined in Table 8.

Table 8 – Category code groups for musical instruments, microphones and other sources that create original sound

Bits 8 to 15	Category
"101 0000L"	Synthesizer
"101 1000L"	Microphone
"101 others"	Reserved

- 5.3.2.2.7 For the group of analogue/digital converters for analogue signals without copyright information (category code = "011 00XXL"), the category codes are defined in Table 9.

Table 9 – Category code groups for A/D converters for analogue signals without copyright information

Bits 8 to 15	Category
"011 0000L"	A/D converter
"011 00 others"	Reserved

- 5.3.2.2.8 For the group of analogue/digital converters for analogue signals which include copyright information in the form of "Cp-bit and L-bit status" (category code = "011 01XXL"), the category codes are defined in Table 10.

Table 10 – Category code groups for A/D converters for analogue signals with copyright information

Bits 8 to 15	Category
"011 0100L"	A/D converter
"011 01 others"	Reserved

- 5.3.2.2.9 For the group of solid state memory based products (category code = "000 1XXXL"), the category codes are defined in Table 11.

Table 11 – Category code groups for solid state memory based products

Bits 8 to 15	Category
"000 1000L"	Digital audio recorder and player using solid state memory
"000 1 others"	Reserved

- 5.3.2.2.10 For experimental products not for commercial sale (category code = "000 0001L"), the following definition applies.

New products for which a category code is not yet defined, or for which circuitry to signal the appropriate category code is not yet available.

6 User data

6.1 General

The default value of the user bits is logical "0".

For interchangeability of equipment it is strongly recommended to use the general user data format described below for consumer applications of the user data.

6.2 Application

6.2.1 User data bit stream

The user data bits from every sub-frame in a frame combine so that there is just one user data bit stream for each interface.

6.2.2 User data message structure

A message consists of information units (IUs). An IU consists of one start bit (logical value "1") followed by seven information bits.

The eight bits of an IU are also referred to as the P, Q, R, S, T, U, V and W bits. IUs in a message are separated by up to and including eight bits with a logical value "0". The nominal number of bits with logical value "0" between IUs is four. Messages are separated by more than eight bits with a logical value "0". An example of this structure is shown in Figure 1.

Bit	0	1	2	3	4	5	6	7	8	9	10	11	
0	0	0	1	Q	R	S	T	U	V	W	0	0	A)
+12	0	0	1	Q	R	S	T	U	V	W	0	0	
+24	1	Q	R	S	T	U	V	W	0	0	0	0	B)
+36	0	0	0	0	1	Q	R	S	T	U	V	W	C)
+48	1	Q	R	S	T	U	V	W	0	0	0	0	
+60	1	Q	R	S	T	U	V	W	0	0	0	0	D)
+72	0	0	0	0	0	0	0	1	Q	R	S	T	
+84	U	V	W	0	0	0	0	1	Q	R	S	T	E)
+96	U	V	W	0	0	0	0	0	1	Q	R	S	

Key

0 Bit between IUs with logical value "0".

1 Start bit P, first bit of IU with logical value "1".

Q, R, S, T, U, V, W Information bits.

A) Example of an IU: start bit plus seven information bits.

B) Maximum distance between two IUs of the same message is two bits.

C) Minimum distance between two IUs of the same message is zero bits.

D) Distance of more than eight bits between IUs indicates start of a new message.

E) Nominal distance between two IUs of the same message is four bits.

Figure 1 – Example of message structure using information units

6.2.3 Equipment classification

Equipment is divided into three classes, according to the category code of the channel status. See also the relevant annexes.

Future equipment, for which there is no relevant annex, shall be classified as belonging to one of the three classes defined below.

6.2.3.1 Class I: original user data generating equipment

Original user data generating equipment will generate user data bits according to a format that is defined in the standard for that equipment. See the relevant annex.

Any new equipment in this class will carry the general user data format as defined in 6.2.4.1.

6.2.3.2 Class II: user data transparent equipment

The user data transparent equipment shall either provide all "0" user data bits, or transfer the user data bits it receives from its input unchanged to its output. If the processing of the audio information causes considerable delay, it is recommended that the user data bits should be equally delayed.

6.2.3.3 Class III: mixed mode user data equipment

This class of equipment shall either operate as class II (user data transparent) equipment or originate a new user data stream according to the general user data format.

The possible user data formats for this class are:

- all "0" bits;
- the complete user data information of the input, or one of the inputs in the case of multiple inputs;
- the general user data format. The information carried in this case may originate from within the equipment itself, or be transcoded from the input source(s).

6.2.4 User data message length and contents

The possible length and contents of the user data messages depends on the category code of the equipment. See the relevant annexes.

For new equipment that is capable of generating original user data contents, the general user data format shall be used.

6.2.4.1 General user data format

According to the general user data format, a message consists of a minimum of 3 and a maximum of 129 information units, except for a length of 96 information units. A total message length of 96 information units is reserved for some specific laser optical products (see 6.2.4.2).

The contents of the first IU are shown in Figure 2.

1 (Start)	1 (Q)	Mode R	Mode S	Mode T	Item U	Item V	Item W
-----------	-------	--------	--------	--------	--------	--------	--------

Figure 2 – First UI contents

The bits R, S, T, U, V, W have the following meaning:

Mode	RST	
	000	Not used, reserved for digital compact cassette (DCC).
	1XX	} May be used for new messages.
	X1X	
	XX1	

The mode bits indicate a class of messages, for example text, preset information, etc., and the item bits give a further definition of the type of message.

It is recommended that any new application should conform as much as possible to messages coded according to the general user data format that have been defined for other applications.

The second IU contains a number indicating the following number of IUs as shown in Figure 3.

1 (Start)	IU Count6	IU Count5	IU Count4	IU Count3	IU Count2	IU Count1	IU Count0
-----------	-----------	-----------	-----------	-----------	-----------	-----------	-----------

Figure 3 – Second UI contents

IU count6 is the most significant bit; IU count0 is the least significant bit. The number is coded as a binary number in the range 1 to 127 (000 0001b to 111 1111b) except that the value 94 is not possible.

The third IU contains the originating category code, without the L-bit, of the equipment that generates the general user data format messages as shown in Figure 4.

1 (Start)	C-Ch bit 8	C-Ch bit 9	C-Ch bit 10	C-Ch bit 11	C-Ch bit 12	C-Ch bit 13	C-Ch bit 14
-----------	------------	------------	-------------	-------------	-------------	-------------	-------------

Figure 4 – Third UI contents

The L-bit (C-channel bit 15) is not carried in this message, as it is not relevant for the decoding of the user data messages. Therefore, any decisions on the copyright status of the audio information shall be based on the category code and Cp-bit as carried in the channel status.

The IUs that follow the third IU contain user information.

User information that originally was organized as bytes is carried as in Figure 5: four successive IUs carry a maximum of three successive bytes (X, Y and Z, 7 = MSB, 0 = LSB) in bits R, S, T, U, V, W of the IUs:

1 (Start)	Q	X7	X6	X5	X4	X3	X2
1 (Start)	Q	X1	X0	Y7	Y6	Y5	Y4
1 (Start)	Q	Y3	Y2	Y1	Y0	Z7	Z6
1 (Start)	Q	Z5	Z4	Z3	Z2	Z1	Z0

Figure 5 – User information

The Q bits can optionally indicate that the remaining six bits of the IU contain an error:

- "0" no error detected.
- "1" error in bits R, S, T, U, V, W.

If not used, the error flag should be set to a logical "0" value.

If the number of bytes to transfer does not fill a complete quadruplet (i.e. just one or two bytes, not three bytes), the remaining byte(s) shall be coded as "0 0 0 0 0 0 0".

6.2.4.2 General user data format for some specific laser optical products

For historical reasons the laser optical products with category codes "100 0000" (compact disc digital audio, see IEC 60908) and "100 1001L" (mini disc) employ a user data format that differs from the one defined above. In this format, no message length specifier is applied. Instead the length is fixed to 96 IUs. The information in the Q bits of the IUs is considered to be in a separate channel (the Q channel).

Each group of six bits R, S, T, U, V, W of an information unit is called a SYMBOL.

The SYMBOL numbering follows the numbering of the bits in Table A.1.

A group of 24 SYMBOLS is called a PACK:

- PACK 1 is formed by symbols 1 to 24;
- PACK 2 is formed by symbols 25 to 48;
- PACK 3 is formed by symbols 49 to 72;
- PACK 4 is formed by symbols 73 to 96.

Information will be carried in the PACKS according to specific formats.

7 Electrical and optical requirements

7.1 General

Two types of transmission lines are defined: unbalanced and optical fibre.

7.2 Timing accuracy

7.2.1 Accuracy of sampling frequency (clock accuracy)

Three levels of sampling frequency accuracy are defined to meet various requirements of the frequency accuracy. These levels shall be indicated in the channel status data.

7.2.1.1 Level I: high accuracy mode

The transmitted sampling frequency shall be within a tolerance of $\pm 50 \times 10^{-6}$.

7.2.1.2 Level II: normal accuracy mode

The transmitted sampling frequency shall be within a tolerance of $\pm 1\,000 \times 10^{-6}$.

7.2.1.3 Level III: variable pitch shifted clock mode

The signal in this mode can be received by specially designed receivers.

NOTE The frequency range is under consideration. A range of $\pm 12,5\%$ is envisaged.

7.2.1.4 Interface frame rate not matched to sampling frequency

This state is used to indicate high speed and other transfers where the interface does not carry an embedded sampling frequency clock.

7.2.2 Receiver locking range

By default, receivers should be able to lock to signals of level II accuracy with respect to the supported standard sampling frequencies.

If a receiver is only capable of normal operation with a narrower locking range, then this range should exceed the sample frequency tolerance of level I and it shall be specified as a level I receiver.

If a receiver is capable of normal operation at sample rate variations corresponding to level III, then this shall be specified as a level III receiver.

NOTE Until the range for level III has been defined, the frequency range supported by a level III receiver should be at least $\pm 12,5\%$. For clarity, the actual value should be specified.

7.2.3 Receiver sampling frequency support

The product specification or application standard may define the sampling frequencies that shall be supported by a receiver. In the absence of such a definition, the receiver shall support 32 kHz, 44,1 kHz and 48 kHz operation.

7.3 Unbalanced line

7.3.1 General characteristics

The interconnecting cable shall be unbalanced and screened (shielded) with a nominal characteristic impedance of $(75 \pm 26,25) \Omega$ at frequencies from 0,1 MHz to 128 times the maximum frame rate.

The transmission circuit configuration shown in Figure 6 may be used.

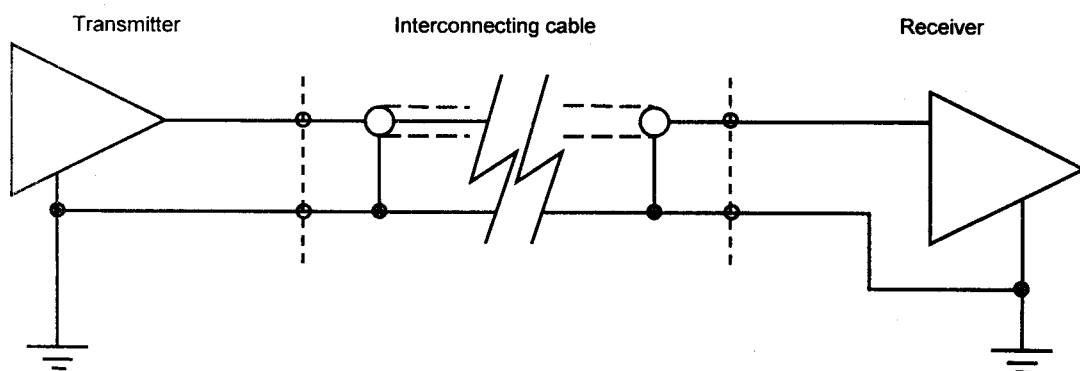

Figure 6 – Simplified example of the configuration of the circuit (unbalanced)

NOTE Additional components may be needed for implementation. A transformer in the transmitter with a floating (non-earthed) secondary can be used to avoid any potential earth loops and provide a useful bandwidth limitation to reduce high-frequency radiation.

7.3.2 Line driver characteristics

7.3.2.1 Output impedance

The line driver shall have an unbalanced output with an internal impedance of $(75 \pm 15) \Omega$, when measured at the terminals to which the line is connected, at frequencies from 0,1 MHz to 128 times the maximum frame rate.

7.3.2.2 Signal amplitude

The signal amplitude shall be $(0,5 \pm 0,1)$ V peak-to-peak, when measured across a $(75 \pm 0,75)$ Ω resistor connected to the output terminals, without any interconnecting cable present.

7.3.2.3 DC output voltage

The d.c. voltage shall be less than 0,05 V, when measured across a $(75 \pm 0,75)$ Ω resistor connected to the output terminals, without any interconnecting cable present.

7.3.2.4 Rise and fall times

The time difference between the 10 % and 90 % points of any transition shall be less than 0,4 UI (see Figure 7).

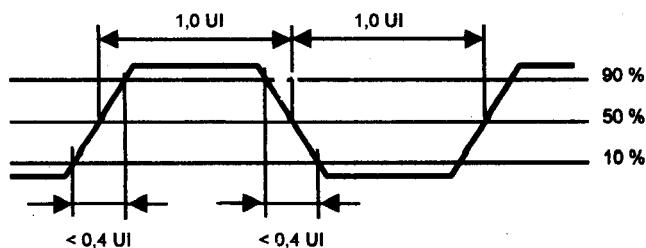

Figure 7 – Rise and fall times

7.3.2.5 Intrinsic jitter

The peak intrinsic output jitter measured at all the data transition zero crossings shall be less than 0,05 UI when measured with the intrinsic jitter measurement filter.

NOTE This applies both when the equipment is locked to an effectively jitter-free timing reference (which may be a modulated digital audio signal) and when the equipment is free-running.

The jitter weighting filter is shown in Figure 8. It is a minimum-phase high pass filter with a 3 dB frequency of 700 Hz, a first order roll-off to 70 Hz and with a passband gain of unity.

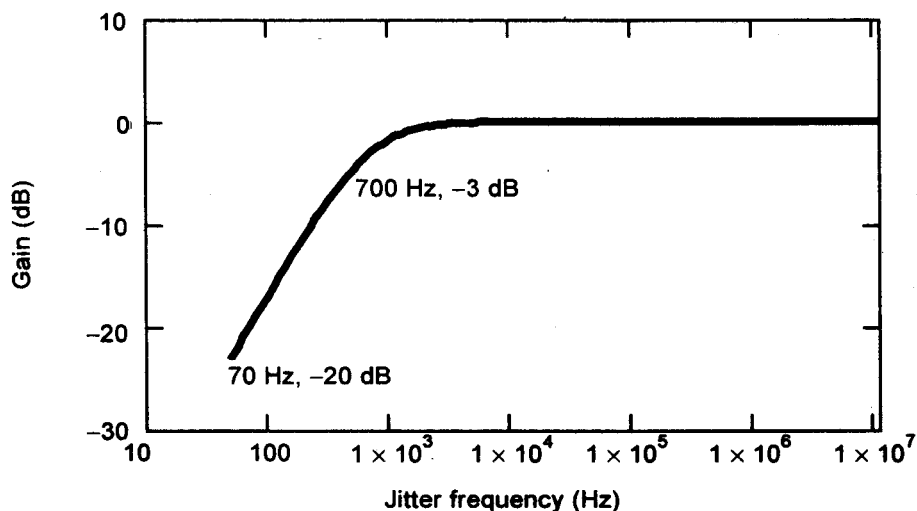

Figure 8 – Intrinsic jitter measurement filter

7.3.2.6 Jitter gain or peaking

The sinusoidal jitter gain from any timing reference input to the signal output shall be less than 3 dB at all frequencies.

7.3.3 Line receiver characteristics

7.3.3.1 Terminating impedance

The receiver shall present a substantially resistive impedance of $(75 \pm 3,75) \Omega$ to the interconnecting cable over the frequency band 0,1 MHz to 128 times the maximum frame rate.

7.3.3.2 Maximum input signals

The receiver shall correctly interpret the data when presented with a signal, the peak-to-peak voltage of which, measured in accordance with 7.3.2.2, is 0,6 V.

7.3.3.3 Minimum input signals

The receiver shall correctly sense the data when a random input signal produces the eye diagram characterized by a V_{\min} of 200 mV and T_{\min} of 0,5 UI (see Figure 9).

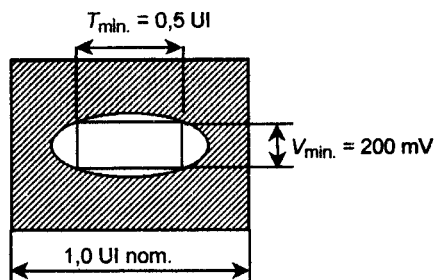

Figure 9 – Eye diagram

NOTE This diagram does not define the tolerance to deviation in the zero crossings. These are defined by the jitter tolerance template in 7.3.3.4, which requires that the minimum pulse width is not smaller than 0,8 UI.

7.3.3.4 Receiver jitter tolerance

An interface data receiver should correctly decode an incoming data stream with any sinusoidal jitter defined by the jitter tolerance template of Figure 10.

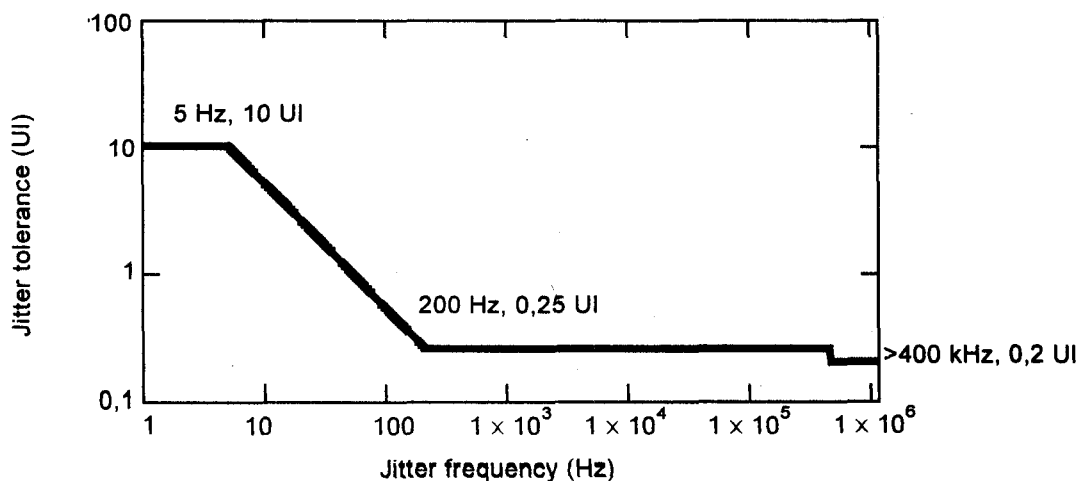

Figure 10 – Receiver jitter tolerance template

NOTE The template requires a jitter tolerance of 0,2 UI peak-to-peak at frequencies above 400 kHz, 0,25 UI between 400 kHz and 200 Hz, increasing with the inverse of frequency below 200 Hz to level off at 10 UI peak-to-peak below 5 Hz.

7.3.4 Connectors

The standard connector for both outputs and inputs shall be the free pin connector and fixed socket connector described in 8.6 of Table IV of IEC 60268-11:1987.

A male plug shall be used at both ends of the cable.

Equipment manufacturers shall clearly label digital audio inputs and outputs.

7.4 Optical connection

Under consideration.

Annex A
(normative)

**Application of the digital audio interface
in the compact disc digital audio system**

(See IEC 60908)

This annex applies to equipment having category code "100 00000".

A.1 General: application specific details

The audio sample word length is 16 bits.

The auxiliary sample bits are = "0".

A.2 Channel status: application specific details

The four CONTROL bits of the Q-channel (subcode) shall be copied to the channel status bits 0 to 3 (part of the CONTROL in the channel status).

Bit 2, the Cp-bit, shall mean:

Bit 2	"0"	Software for which copyright is asserted.
	"1"	Software for which no copyright is asserted.

The Cp-bit may alternate between 0 and 1 at a rate between 4 Hz and 10 Hz.

The Cp-bit indicates in the alternating mode that the signal does not emanate from commercially released pre-recorded software, but from a recording made from "original" material, that is, a home-copy of generation 1 or higher.

A.3 User data: application specific details

Equipment specified in this annex is classified as class I (see 6.2.3).

The user data carries the subcode (see Table A.1).

The U-bits form one subcode block of 1 176 bits (average) multiplexed over the left and the right channel. One compact disc frame consists of one subcoding symbol with 12 audio samples. 98 subcoding symbols constitute one subcoding block, resulting in 12 times 98 = 1 176 U-bits.

The subcode synchronization word is minimum 16 "0" bits.

Table A.1 – Example of 2-channel compact disc format

No.	Preamble SYNC	AUX	Audio samples				MSB	V	U	C	P
1	B	0000	0000	XXXX	XXXX	XXXX	XXXX	0	0	C1L	P
2	W	0000	0000	XXXX	XXXX	XXXX	XXXX	0	0	C1R	P
3	M	0000	0000	XXXX	XXXX	XXXX	XXXX	0	0	C2L	P
4	W	0000	0000	XXXX	XXXX	XXXX	XXXX	0	0	C2R	P
5	M	0000	0000	XXXX	XXXX	XXXX	XXXX	0	0	C3L	P
6	W	0000	0000	XXXX	XXXX	XXXX	XXXX	0	0	C3R	P
7	M	0000	0000	XXXX	XXXX	XXXX	XXXX	0	0	C4L	P
8	W	0000	0000	XXXX	XXXX	XXXX	XXXX	0	0	C4R	P
9	M	0000	0000	XXXX	XXXX	XXXX	XXXX	0	0	C5L	P
10	W	0000	0000	XXXX	XXXX	XXXX	XXXX	0	0	C5R	P
11	M	0000	0000	XXXX	XXXX	XXXX	XXXX	0	0	C6L	P
12	W	0000	0000	XXXX	XXXX	XXXX	XXXX	0	0	C6R	P
13	M	0000	0000	XXXX	XXXX	XXXX	XXXX	0	0	C7L	P
14	W	0000	0000	XXXX	XXXX	XXXX	XXXX	0	0	C7R	P
15	M	0000	0000	XXXX	XXXX	XXXX	XXXX	0	0	C8L	P
16	W	0000	0000	XXXX	XXXX	XXXX	XXXX	0	0	C8R	P
17	M	0000	0000	XXXX	XXXX	XXXX	XXXX	0	0	C9L	P
18	W	0000	0000	XXXX	XXXX	XXXX	XXXX	0	0	C9R	P
19	M	0000	0000	XXXX	XXXX	XXXX	XXXX	0	0	C10L	P
20	W	0000	0000	XXXX	XXXX	XXXX	XXXX	0	0	C10R	P
21	M	0000	0000	XXXX	XXXX	XXXX	XXXX	0	0	C11L	P
22	W	0000	0000	XXXX	XXXX	XXXX	XXXX	0	0	C11R	P
23	M	0000	0000	XXXX	XXXX	XXXX	XXXX	0	0	C12L	P
24	W	0000	0000	XXXX	XXXX	XXXX	XXXX	0	0	C12R	P
25	M	0000	0000	XXXX	XXXX	XXXX	XXXX	0	1	C13L	P
26	W	0000	0000	XXXX	XXXX	XXXX	XXXX	0	Q1	C13R	P
27	M	0000	0000	XXXX	XXXX	XXXX	XXXX	0	R1	C14L	P
28	W	0000	0000	XXXX	XXXX	XXXX	XXXX	0	S1	C14R	P
29	M	0000	0000	XXXX	XXXX	XXXX	XXXX	0	T1	C15L	P
30	W	0000	0000	XXXX	XXXX	XXXX	XXXX	0	U1	C15R	P
31	M	0000	0000	XXXX	XXXX	XXXX	XXXX	0	V1	C16L	P
32	W	0000	0000	XXXX	XXXX	XXXX	XXXX	0	W1	C16R	P
33	M	0000	0000	XXXX	XXXX	XXXX	XXXX	0	0	C17L	P
34	W	0000	0000	XXXX	XXXX	XXXX	XXXX	0	0	C17R	P
35	M	0000	0000	XXXX	XXXX	XXXX	XXXX	0	0	C18L	P
36	W	0000	0000	XXXX	XXXX	XXXX	XXXX	0	0	C18R	P
37	M	0000	0000	XXXX	XXXX	XXXX	XXXX	0	1	C19L	P
38	W	0000	0000	XXXX	XXXX	XXXX	XXXX	0	Q2	C19R	P
39	M	0000	0000	XXXX	XXXX	XXXX	XXXX	0	R2	C20L	P
40	W	0000	0000	XXXX	XXXX	XXXX	XXXX	0	S2	C20R	P
41	M	0000	0000	XXXX	XXXX	XXXX	XXXX	0	T2	C21L	P
42	W	0000	0000	XXXX	XXXX	XXXX	XXXX	0	U2	C21R	P
43	M	0000	0000	XXXX	XXXX	XXXX	XXXX	0	V2	C22L	P
44	W	0000	0000	XXXX	XXXX	XXXX	XXXX	0	W2	C22R	P
45	M	0000	0000	XXXX	XXXX	XXXX	XXXX	0	0	C23L	P
46	W	0000	0000	XXXX	XXXX	XXXX	XXXX	0	0	C23R	P
47	M	0000	0000	XXXX	XXXX	XXXX	XXXX	0	0	C24L	P
48	W	0000	0000	XXXX	XXXX	XXXX	XXXX	0	0	C24R	P

Annex B
(normative)

**Application of the digital interface in the 2-channel
PCM encoder/decoder**

(See IEC 60841)

This annex applies to equipment having category code "010 0000L".

B.1 General: application specific details

The audio sample word length is 14 or 16 bits.

The auxiliary sample bits are "0".

B.2 Channel status: application specific details

Copy and emphasis bits of the CONTROL bits should be copied from the source (the polarity should be inverted).

B.3 User data: application specific details

Equipment specified in this annex is classified as class I (see 6.2.3).

All user data bits are "0".

Annex C (normative)

Application of the digital interface in the 2-channel digital audio tape recorder in the consumer mode

(See IEC 61119-1 and IEC 61119-6)

This annex applies to equipment having category code "110 0000L".

C.1 General: application specific details

The audio sample word length is 16 bits. The auxiliary sample bits are "0".

C.2 Channel status: application specific details

Bits 0 to 4 ("CONTROL") and bits 24 to 27 ("Fs") should be copied from the source.

Table C.1 illustrates the use of the Cp-bit, L-bit and category code for DAT.

Table C.1 – Use of Cp-bit, L-bit and category code for DAT

Application or source signal	Input signal to DAT-recorder for consumer audio use of C-channel			On DAT tape	Effect on DAT output
	Cp-bit bit 2	Category code Bits 8 to 14	L-bit Bit 15	ID 6	Cp-bit / L-bit bit 2 / bit 15
	No copyright "1"		Home copy "0"		Recordable
General	"1"	"0000000"	"0"	"11"	Set bit 2 to "0"
Laser optical product	"1"	"100XXXX"	"1"	"00"	
D/D converter	"1"	"010XXXX"	"0"	"00"	
Magnetic product	"1"	"110XXXX"	"0"	"00"	
Broadcast reception	"1"	"001XXXX" and "0111XXX"	"1"	"00"	
Musical instrument	"1"	"101XXXX"	"0"	"00"	
Present A/D converter	"1"	"01100XX"	"0"	"11"	
Future A/D converter	"1"	"01101XX"	"0"	"00"	
Solid state memory	"1"	"0001XXX"	"0"	"00"	
Experimental	"1"	"0000001"	"0"	"00"	
	No copyright "1"		Pre-recorded "1"		Recordable
General	"1"	"0000000"	"1"	"11"	Set bit 2 to "0"
Laser optical product	"1"	"100XXXX"	"0"	"00"	
D/D converter	"1"	"010XXXX"	"1"	"00"	
Magnetic product	"1"	"110XXXX"	"1"	"00"	
Broadcast reception	"1"	"001XXXX" and "0111XXX"	"0"	"00"	
Musical instrument	"1"	"101XXXX"	"1"	"00"	
Present A/D converter	"1"	"01100XX"	"1"	"11"	
Future A/D converter	"1"	"01101XX"	"1"	"00"	
Solid state memory	"1"	"0001XXX"	"1"	"00"	
Experimental	"1"	"0000001"	"1"	"00"	

Table C.1 (continued)

Application or source signal	Input signal to DAT-recorder for consumer audio use of C-channel			On DAT tape	Effect on DAT output
	Cp-bit bit 2	Category code Bits 8 to 14	L-bit Bit 15	ID 6	Cp-bit / L-bit bit 2 / bit 15
	With copyright "0"		Home copy "0"		Not recordable
D/D converter	"0"	"010XXXX"	"0"	-	Not recordable
Magnetic product	"0"	"110XXXX"	"0"	-	Not recordable
Musical instrument	"0"	"101XXXX"	"0"	-	Not recordable
Future A/D converter	"0"	"01101XX"	"0"	-	Not recordable
Solid state memory	"0"	"0001XXX"	"0"	-	Not recordable
Experimental	"0"	"0000001"	"0"	-	Not recordable
Laser-optical product	"0"	"100XXXX"	"1"	-	Not recordable
Broadcast reception	"0"	"0111XXX"	"1"	-	Not recordable
Broadcast reception	"0"	"001XXXX"	"1"	-	Not recordable
CD recordable	"Alternating at 4 Hz to 10 Hz"	"1000000"	"0"	-	Not recordable
	With copyright "0"		Pre-recorded "1"		Recordable set bit 15 to "0"
D/D converter	"0"	"010XXXX"	"1"	"10"	Set bit 15 to "0"
Magnetic product	"0"	"110XXXX"	"1"	"10"	Set bit 15 to "0"
Musical instrument	"0"	"101XXXX"	"1"	"10"	Set bit 15 to "0"
Future A/D converter	"0"	"01101XX"	"1"	"10"	Set bit 15 to "0"
Solid state memory	"0"	"0001XXX"	"1"	"10"	Set bit 15 to "0"
Experimental	"0"	"0000001"	"1"	"10"	Set bit 15 to "0"
Laser optical product	"0"	"100XXXX"	"0"	"10"	Set bit 15 to "0"
Broadcast reception	"0"	"0111XXX"	"0"	"10"	Set bit 15 to "0"
Broadcast reception	"0"	"001XXXX"	"0"	"10"	Set bit 15 to "0"

C.3 User data: application specific details

Equipment specified in this annex is classified as class I (see 6.2.3.1).

The user data carries a message of a single information unit. The Q and R bits will reflect the state of the start-ID and shortening-ID, respectively. This is shown in Table C.2.

The start bit of the information unit is carried in the sub-frame of the first sampling word (L_0), the Q bit ("start-ID") in the sub-frame of the second sampling word (R_0) and the R-bit ("shortening-ID") in the sub-frame of the third sampling word (L_1), of one DAT frame. Other bits are logical zero "0". When the DAT player replays normally, start-ID and shortening-ID should be transmitted whenever it detects them, that is, start-ID: (300 ± 30) frames and shortening-ID: (33 ± 3) frames.

When the player shortens playback, shortening-ID should be transmitted once for the first frame.

Transmission of start-ID and shortening-ID is illustrated by an example in Figure C.1.

Audio sample word/DAT frame:

$F_s = 48 \text{ kHz}$: L_0 R_0 L_1 R_1 L_2 L_{1439} R_{1439} 2 880 words
 $F_s = 44,1 \text{ kHz}$ L_0 R_0 L_1 R_1 L_2 L_{1322} R_{1322} 2 646 words
 $F_s = 32 \text{ kHz}$ L_0 R_0 L_1 R_1 L_2 L_{959} R_{959} 1 920 words (32K, 32K 4-channel mode)
 $F_s = 32 \text{ kHz}$ L_0 R_0 L_1 R_1 L_2 L_{1919} R_{1919} 3 840 words (32K LP mode)

Table C.2 – User data application in the DAT system

Word	User data
L_0	Sync
R_0	S-ID
L_1	Sh-ID
R_1	0
L_2	0
R_2	0
.....
.....
.....
.....
.....
L_0	Sync
R_0	S-ID
L_1	Sh-ID
R_1	0

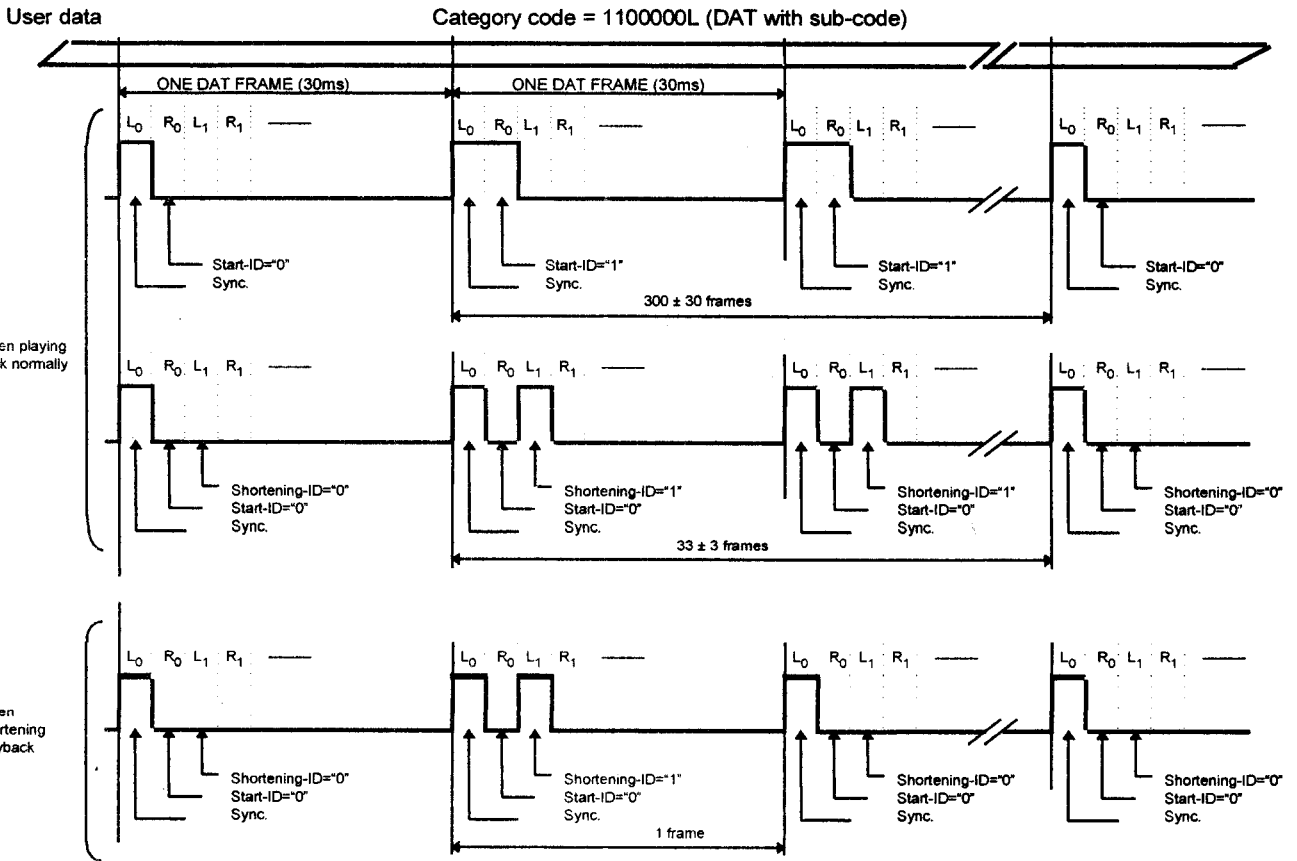

Figure C.1 – Example of different combinations of start-ID and shortening-ID

Annex D

(normative)

Application of the digital interface in laser optical digital audio systems for which no other category code is defined

This annex applies to equipment having category code "100 1000L".

D.1 General: application specific details

This category code is for signals from laser optical read-out of discs not compatible with IEC 60908, for example, the magnetic-optical type.

The code "100 10000" shall be used for read-out from pre-recorded discs.

The code "100 10001" shall be used for read-out from home-recorded discs.

The audio sample word length is maximum 16 bits.

The auxiliary sample bits are "0".

D.2 Channel status: application specific details

Not applicable.

D.3 User data: application specific details

Equipment specified in this annex is classified as class I (see 6.2.3).

Annex E
(normative)

**Application of the digital interface in a digital audio mixer
in the consumer mode**

This annex applies to equipment having category code "010 0100L".

E.1 General: application specific details

This category code is for signals from products that mix various digital input channels into one or more digital output signals.

E.2 Channel status: application specific details

This category code shall be used only for products that correctly flag in the output signal the copyright status and the generation status of the input signal(s). Where more than one digital audio input signal is combined into one digital audio output signal, and at least one of the input signals is a first generation or higher copy over which copyright protection has been asserted, then the equipment shall reflect in the L-bit of the digital output signal the generation status for a first generation or higher copy, and in the Cp-bit that copyright protection is asserted.

The product shall always apply category code 010 0100L, even when the equipment is adjusted so as not to alter the input signal, i.e. the output signal is identical to the input signal. However, when all input signals originate from an A/D converter and carry category code 011 00XXL, the output signal can also carry category code A/D converter (011 00XXL).

Input signals, of which the copyright status is ambiguous such as with category code "general", shall result in an output signal with bit 2 = "0" and bit 15 = "1" (copyright protection asserted, original).

E.3 User data: application specific details

Equipment specified in this annex is classified as class III (see 6.2.3).

Annex F

(normative)

Application of the digital interface with a sampling rate converter in the consumer mode

This annex applies to equipment having category code "010 1100L".

F.1 General: application specific details

This category code is for signals from products that modify or change the sampling frequency of digital signals.

F.2 Channel status: application specific details

This category code shall be used only for products that correctly flag in the output signal the copyright status and the generation status of the input signal. Input signals for which copyright protection has been asserted, and which are not "original" shall result in an output signal with bit 2 = "0" and bit 15 = "0".

The product shall always apply category code 010 1100L, whether the equipment is adjusted so as not to alter the signal (so that the input signal is identical to the output signal), or is adjusted differently. However, when the input signal originates from an A/D converter and carries category code 011 00XXL, the output signal can also carry category code A/D converter (011 00XXL).

Input signals, of which the copyright status is ambiguous such as with category code "general", shall result in an output signal with bit 2 = "0" and bit 15 = "1" (copyright protection asserted, original).

F.3 User data: application specific details

Equipment specified in this annex is classified as class III (see 6.2.3).

Annex G
(normative)

**Application of the digital interface with a digital sound sampler
in the consumer mode**

This annex applies to equipment having category code "010 0010L".

G.1 General: application specific details

This category code is for signals from products that sample and reassemble digital input signal(s) into one or more digital output signals.

G.2 Channel status: application specific details

This category code shall only be used for products that correctly flag in the output signal the copyright status and the generation status of the input signal. Input signals for which copyright protection has been asserted, and which are not "original", and which are used for sampling for more than 1 s, shall result in an output signal with bit 2 = "0" and bit 15 = "0".

When the input signal originates from an A/D converter and carries category code 011 00XXL, the output signal can also carry category code A/D converter (011 00XXL).

Input signals, of which the copyright status is ambiguous such as with category code "general", shall result in an output signal with bit 2 = "0" and bit 15 = "1" (copyright protection asserted, original).

G.3 User data: application specific details

Equipment specified in this annex is classified as class III (see 6.2.3).

Annex H
(normative)

Application of the digital interface in a digital broadcast receiver (Japan)
in the consumer mode

This annex applies to equipment having category code "001 0000L".

H.1 General: application specific details

This category code shall be used for digital audio broadcast reception with or without a video signal (for example digital satellite reception) in Japan.

The audio sample word length is 14 or 16 bits.

The auxiliary sample bits are "0".

H.2 Channel status: application specific details

Bits 0 to 5 (CONTROL) should be copied from the source.

Cp-bit = "0" in the case where copyright information has been transmitted and copyright protection asserted, or no copyright information is transmitted.

Cp-bit = "1" in the case where copyright information has been transmitted and no copyright protection asserted.

H.3 User data: application specific details

Equipment specified in this annex is classified as class I (see 6.2.3).

User data bits = "0" (reserved).

Annex J
(normative)

**Application of the digital interface in a digital broadcast receiver (Europe)
in the consumer mode**

This annex applies to equipment having category code "001 1000L".

J.1 General: application specific details

This category code shall be used for digital audio broadcast reception with or without a video signal (for example digital satellite reception) in Europe.

The audio sample word length is 14 or more bits.

J.2 Channel status: application specific details

Cp-bit = "0" in the case where copyright information has been transmitted and copyright protection asserted, or no copyright information is transmitted.

Cp-bit = "1" in the case where copyright information has been transmitted and no copyright protection asserted.

J.3 User data: application specific details

Equipment specified in this annex is classified as class I (see 6.2.3).

User data bits = "0" (reserved).

Annex K

(normative)

Application of the digital interface in a digital broadcast receiver (USA) in the consumer mode

This annex applies to equipment having category code "001 0011L".

K.1 General: application specific details

This category code shall be used for digital audio broadcast reception with or without a video signal (for example digital satellite reception) in the USA.

The audio sample word length is 14 bits or more.

K.2 Channel status: application specific details

Cp-bit = "0" in the case where copyright information has been transmitted and copyright protection asserted, or no copyright information is transmitted.

Cp-bit = "1" in the case where copyright information has been transmitted and no copyright protection asserted.

K.3 User data: application specific details

Equipment specified in this annex is classified as class I (see 6.2.3).

User data bits = "0" (reserved).

Annex L
(normative)

**Application of the digital interface for electronic software delivery
in the consumer mode**

This annex applies to equipment having category code "001 0001L".

L.1 General: application specific details

This category code shall be used for digital audio signals from receivers for which a fee may be charged for the reception of certain software.

L.2 Channel status: application specific details

Cp-bit = "0" in the case where copyright information has been transmitted and copyright protection asserted, or no copyright information is transmitted.

Cp-bit = "1" in the case where copyright information has been transmitted and no copyright protection asserted.

L.3 User data: application specific details

Equipment specified in this annex is classified as class I (see 6.2.3).

Annex M (normative)

Application of the digital interface in the digital compact cassette system in the consumer mode

This annex applies to equipment having category code "110 0001L".

M.1 General: application specific details

This category code shall be used for equipment specified according to the digital compact cassette (DCC) system.

M.2 Channel status: application specific details

Not applicable.

M.3 User data: application specific details

Equipment specified in this annex is classified as class I (see 6.2.3).

Two modes are available, marker mode and extended mode. Both use the same definition of messages. Marker mode is required, extended mode is optional.

M.3.1 Marker mode

This mode allows just one message that contains the most important information. This message consists of one information unit, which is shown in Figure M.1.

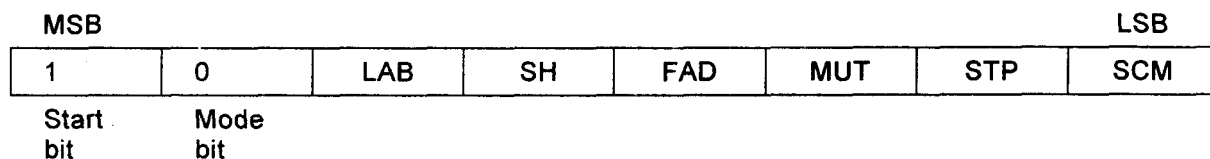

Figure M.1

The bits have the following definition:

- The first bit is the start bit and is equal to "1".
- The second bit is "0" to identify that it is a marker mode message.
- LAB (LABEL): gives an indication of the position of the start of a track. The following rules apply:

During playback the equipment should:

- 1) set the LAB-bit to "1" for 16 frames at the start of a new track;

NOTE The "0" to "1" transition coincides with the track start (a track start is indicated on pre-recorded tapes by the "1" to "0" transition of the L-ID, and on consumer recorded tapes by the "0" to "1" transition of the same bit);

- 2) set the LAB-bit to "0" if the SCM-ID (and SCM-bit in the marker mode) is "1".

during recording the equipment should:

- 3) record an L-ID = "1" for 16 frames if it detects an SCM bit "1" to "0" transition;
- 4) record an L-ID = "1" for 16 frames if it detects a LAB-bit "0" to "1" transition.

- SH (SHORTENING ID): if this bit is set to "1", play starts.
- FAD (FADE): if this bit is set to "1", a gradual reduction of playback level occurs from start of mute, and a gradual increase of playback level occurs from reset of mute. If this bit is set to "0", start and reset of mute occur in one step.
- MUT (MUTE): if this bit is set to "1", mute starts, and will continue until the bit is reset to "0".
- STP (STOP): this bit is set to "1" if no audio signal is available due to search actions or when playback is stopped. Otherwise, it is set to "0".
- SCM (SECTOR MARKER): this bit is set to "1" during detection of a sector marker.

This marker mode message shall be sent at least once for every DCC tape frame.

It is recommended that the information be sent simultaneously with the audio information.

NOTE L-ID and sector markers are signals recorded in the auxiliary information track of the DCC player, indicating specific portions of the tape.

M.3.2 Extended mode

In this mode, several messages are defined. The first IU of a message is as shown in Figure M.2.

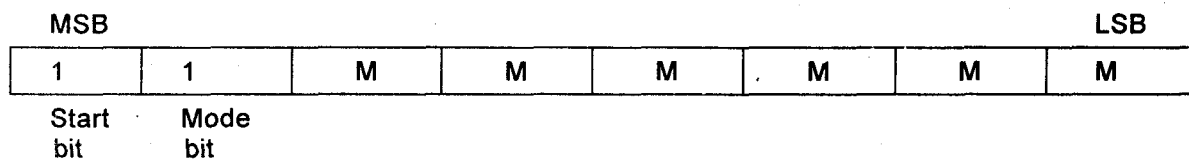

Figure M.2

- The first bit is the start bit and is equal to "1".
- The second bit is "1" to identify the extended mode.
- The remaining bits indicate the message number.

M.3.2.1 Message number "000000": current status

Implementation of this message is optional. If implemented, a message shall be sent at least once in every tape frame.

This message contains information on the current status of the deck. Three bytes of information shall be made available: deck status, track number and index number. The three bytes are carried in four IUs. The layout of the whole message shall be as Table M.1.

Table M.1 – Layout of message number “000000”

1 (Start)	1 (Extended mode)	0	0	0	0	0	0
1 (Start)	Error flag	State 7	State 6	State 5	State 4	State 3	State 2
1 (Start)	Error flag	State 1	State 0	Track 7	Track 6	Track 5	Track 4
1 (Start)	Error flag	Track 3	Track 2	Track 1	Track 0	Index 7	Index 6
1 (Start)	Error flag	Index 5	Index 4	Index 3	Index 2	Index 1	Index 0

The error flag is optional and can be used to indicate whether the information in the IU is possibly in error: “0” = no error, “1” = possible error in the remaining six bits.

The deck status is carried with the MSB first. It is a BCD-coded two-digit message. The codes given in Table M.2 apply:

Table M.2 – Deck status codes

Code	Meaning	Explanation
00	STOP	Deck stopped, no information read from tape
01	PAUSE	Deck in pause mode, no information read from tape
02	EJECT	Cassette ejected, no ITTS and auxiliary information available from tape
11	PLAY-A	Playback of sector A, information read from tape
12	PLAY-B	Playback of sector B, information read from tape
13	PLAY-C	Playback of sector C, information read from tape
14	PLAY-D	Playback of sector D, information read from tape
18	CC-PLAY	A compact cassette is played back, no information from tape
21	WIND	Wind (forward in time), no information read from tape
22	REWIND	Rewind (backwards in time), no information read from tape
23	SEARCH-F	Forward search, track number estimated from markers
24	SEARCH-B	Backward search, track number estimated from markers
30	REC-PAU	Recording + pause mode, no ITTS and auxiliary information available from tape
31	REC	Recording, no ITTS and auxiliary information available from tape

Mode indications 30 and 31 of Table M.2 shall be available only during recording from analogue sources. Recording from digital sources implies that the information from the digital source will be copied on the digital output.

The track and index information is copied from the auxiliary data, or may be estimated during search or playback of tapes with track numbering. During playback of tapes without track numbering or compact cassettes, the track and index number is unknown (“00”). Both bytes are BCD-coded with MSB first.

M.3.2.2 Message numbers “000001”, “000010”, “000011”: ITTS packet message

Text information in the form of “ITTS packets” from the DCC tape can optionally be transferred on the digital output. If implemented, the message number “000000” (current status) shall also be implemented. All ITTS packets shall be sent in the same sequence as recorded on the DCC tape.

The message number indicates whether the message contains the start of an ITTS packet, a continuation or the end of a packet:

Message number	Contents
----------------	----------

"000001"	ITTS packet start or complete packet
"000010"	ITTS packet continuation
"000011"	ITTS packet continuation and end

The 48 bytes of an ITTS packet shall be coded in a similar way to the method used for coding the three bytes of the current status message, using four IUs for every three bytes, bytes coded with the MSB first. If a message does not contain a multiple of three ITTS bytes, the remaining bits in the IU that contains the last bits of the final ITTS byte shall be padded with "0" bits (for example for a message of two ITTS bytes, three information units are used, in which the two final bits of the third information unit contain "0"). It is not permitted to add an IU that is fully padded with "0" bits, as this would make the detection of an ITTS byte with all zeros impossible.

In total, the extended message consists of a maximum of 66 IUs: one IU to indicate extended message, one IU containing message contents identification, and a maximum of 64 IUs for the ITTS packet data, including error flags and start bits.

An example of a complete ITTS packet extended message is shown in Table M.3.

Table M.3 – ITTS packet extended message example

1 (Start)	1 (Extended mode)	0	0	0	0	0	1
1(Start)	IU count ₆	IU count ₅	IU count ₄	IU count ₃	IU count ₂	IU count ₁	IU count ₀
1(Start)	Error flag	Byte 1 ₆	Byte 1 ₆	Byte 1 ₅	Byte 1 ₄	Byte 1 ₃	Byte 1 ₂
1(Start)	Error flag	Byte 1 ₁	Byte 1 ₀	Byte 2 ₇	Byte 2 ₆	Byte 2 ₅	Byte 2 ₄
1(Start)	Error flag	Byte 2 ₃	Byte 2 ₂	Byte 2 ₁	Byte 2 ₀	Byte 3 ₇	Byte 3 ₆
1(Start)	Error flag	Byte 3 ₅	Byte 3 ₄	Byte 3 ₃	Byte 3 ₂	Byte 3 ₁	Byte 3 ₀
...
1(Start)	Error flag	Byte 46 ₇	Byte 46 ₆	Byte 46 ₅	Byte 46 ₄	Byte 46 ₃	Byte 46 ₂
1(Start)	Error flag	Byte 46 ₁	Byte 46 ₀	Byte 47 ₇	Byte 47 ₆	Byte 47 ₅	Byte 47 ₄
1(Start)	Error flag	Byte 47 ₃	Byte 47 ₂	Byte 47 ₁	Byte 47 ₀	Byte 48 ₇	Byte 48 ₆
1(Start)	Error flag	Byte 48 ₅	Byte 48 ₄	Byte 48 ₃	Byte 48 ₂	Byte 48 ₁	Byte 48 ₀

The information unit count (IU count_{6...0}) indicates how many information units will follow and can range from 0 (no ITTS information available) to 64 (complete ITTS packet).

IU count₆ = MSB, IU count₀ = LSB, binary coded.

The error flag is optional and can be used to indicate whether the information in the IU is in error: "0" = no error detected, "1" = error in the remaining six bits.

Bytes 46 to 48 represent here the three last character codes in an ITTS packet.

Partial ITTS packets may be sent in similar fashion. The message number may need to be changed according to the contents: start, continuation or end. Several combinations are possible, as shown in M.3.2.3. a), b) and c).

It is also allowed to mix ITTS messages with marker mode and other extended mode messages, as long as the ITTS packet sequence is maintained, as shown in clause M.3.2.3 d).

M.3.2.3 Examples of ITTS packet transfer**a) Complete ITTS packet transfer:**

Message number	IU count	Total message length	ITTS bytes
000001 start	64	66	48

b) One ITTS packet in the form of two combined messages:

Message number	IU count	Total message length	ITTS bytes
000001 start	32	34	24
000011 end	32	34	24

c) Two examples of one ITTS packet in the form of three combined messages:**Example 1**

Message number	IU count	Total message length	ITTS bytes
000001 start	11	13	8
000010 continue	43	45	32
000011 end	11	13	8

NOTE The number of ITTS bytes transferred in a message in the examples above may be changed, as long as the total number of ITTS bytes remains below 48 and the IU count is adjusted accordingly.

Example 2

Message number	IU count	Total message length	ITTS bytes
000001 start	12	14	9
000010 continue	40	42	30
000011 end	12	14	9

d) One ITTS packet in the form of eight messages with marker mode and current status:

First byte	IU count	Total message length	ITTS bytes
11000001 start	8	10	6
11000010 continue	8	10	6
11000010 continue	8	10	6
11000010 continue	8	10	6
10xxxxxx marker	–	1	–
11000000 current status	–	5	–
11000010 continue	8	10	6
11000010 continue	8	10	6
11000010 continue	8	10	6
11000011 end	8	10	6

Other message numbers are reserved for future use.

Annex N
(normative)

**Application of the digital interface in the mini disc system
in the consumer mode**

This annex applies to equipment having category code "100 1001L".

N.1 General: application specific details

This category code is for signals from products according to the mini disc system.

N.2 Channel status: application specific details

Not applicable.

N.3 User data: application specific details

Equipment specified in this annex is classified as class I (see 6.2.3).

The format of user data is in accordance with A.3.

Annex O
(normative)

**Application of the digital interface in a digital sound processor
in the consumer mode**

This annex applies to equipment having category code "010 1010L".

O.1 General: application specific details

This category code is for signals from products that transform the audio information, such as equalization, echo, delay, surround sound, etc.

O.2 Channel status: application specific details

Not applicable.

O.3 User data: application specific details

Equipment specified in this annex is classified as class II (see 6.2.3).

Annex P
(normative)

**Application of the digital interface in the digital versatile disc system
(DVD) in the consumer mode**

This annex applies to equipment having category code "100 1100L"

P.1 General: application specific details

This category code is for signals from products according to the DVD system.

P.2 Channel status: application specific details

Not applicable.

P.3 User data: application specific details

Equipment specified in this annex is classified as class I (see 6.2.3).

Annex Q (informative)

The use of original sampling frequency, sampling frequency and clock accuracy

The bit states in the channel status fields for “original sampling frequency”, “sampling frequency” and “clock accuracy” can identify the process being executed in a player and interface unit of a transmitter.

For explanation, terms are defined in Table Q.1.

Table Q.1 – Term definition

Term	Meaning	Explanation
OSF	Original sampling frequency	Sampling frequency recorded on disc, etc. This can be identified by bits 36-39
TSF	Transmitted sampling frequency	The sampling frequency required to present the transmitted audio data at the intended reproduction speed. This can be identified by bits 24-27
IFR	Interface frame rate	Frame rate on interface
N	Up or down sampling ratio	By re-sampling, etc.
M	High-speed transmission ratio	By high-speed revolution of disc, etc.

Player and interface model is described in Figure Q.1.

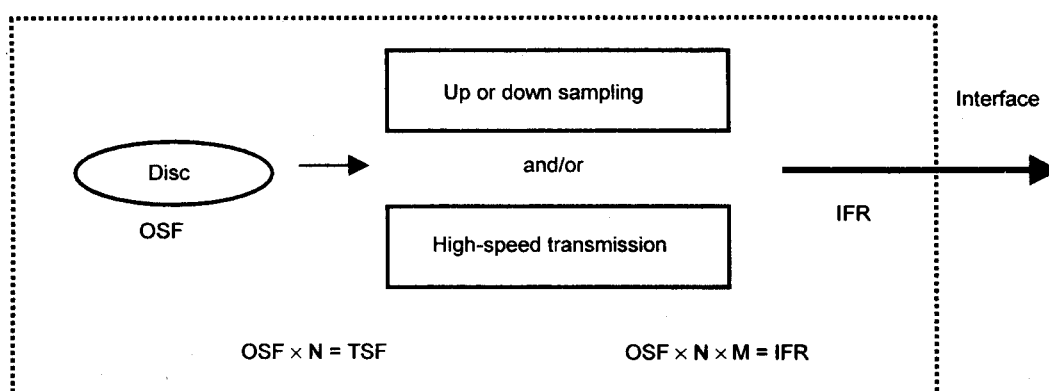

Figure Q.1 – Player and interface model

In this model, cases depend on the state of channel status bits 28 and 29, as described in Table Q.2. With the state “11”, “interface frame rate not matched to sampling frequency”, high-speed transmission is used and the interface frame rate (IFR) is scaled up from the transmitted sampling frequency (TSF) by the high-speed transmission ratio (M). For other states of bits 28 and 29, IFR is equal to TSF.

TSF is equal to the original sampling frequency (OSF) except when up or down sampling (sample rate conversion) is used. In that case, the TSF is scaled from the OSF by the up or down sampling ratio (N).

Table Q.2 – Cases

Bits 28,29	TSF	IFR	Case
11	$TSF = N \times OSF$	$IFR = TSF \times M$	High-speed transmission and up or down sampling
11	$TSF = OSF$	$IFR = TSF \times M$	High-speed transmission
00, 01, 10	$TSF = N \times OSF$	$IFR = TSF$	Up or down sampling
00, 01, 10	$TSF = OSF$	$IFR = TSF$	Original

In Table Q.3, some examples of cases are described.

Table Q.3 – Example

	Player conditions					Interface coding		
	Sampling frequency recorded in disc	Up or down sampling ratio	Transmitted sampling frequency	High-speed transmission ratio	Interface frame rate	"Clock accuracy"	"Original sampling frequency" (OSF)	"Sampling frequency" (TSF)
	OSF	N	TSF	M	IFR	Bit 28,29	Bits 36-39	Bits 24-27
Formula			$OSF \times N$		$OSF \times N \times M$			
Example	44.1 kHz	2	88.2 kHz	1	88.2 kHz	00,01,10	1111	0001
		1	44.1 kHz	1	44.1 kHz	00,01,10		0000
				2	88.2 kHz	11		
				4	176.4 kHz	11		
	96 kHz	1	96 kHz	1	96 kHz	00,01,10	1010	0101
				2	192 kHz	11		
		1/2	48 kHz	1	48 kHz	00,01,10		0100
				2	96 kHz*	11		
	192 kHz	1	192 kHz	1	192 kHz	00,01,10	1000	0111
				1	96 kHz	00,01,10		
		1/2	96 kHz	2	192 kHz*	11		0101
				1	48 kHz	00,01,10		
1/4	48 kHz	2	96 kHz	11	0100			
		4	192 kHz*	11				





NOTE Even if OSF is equal to IFR, there may be down sampling and high speed transmission process if TSF is not also equal. See marked (*) portion.

NATIONAL ANNEX A

(National Foreword)

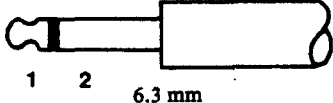
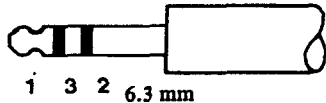
Types of connectors and their application

TABLE IV

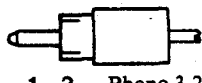
Contact numbers and IEC type designation	Connector designation		Application
8.1 130-8 IEC-xx  1 2 6.3 mm	Pin connector (plug)	Free	Loudspeaker; headphone; microphone; extension cord
	Socket connector (jack)	Fixed	On equipment: output for loudspeaker; output for headphone; input for microphone
	Socket connector	Free	Extension cord
8.2 130-8 IEC-yy  1 3 2 6.3 mm	Pin connector (plug)	Free	Headphone; extension cord
	Socket connector (jack)	Fixed	On equipment: output for headphone
	Socket connector	Free	Extension cord
8.3 130-8 IEC-01  1 2 Miniature 3.5 mm	Pin connector (plug)	Free	Loudspeaker; earphone; headphone; microphone; audio signals for tape recorder (see Note 1 to Table V)
	Socket connector (jack)	Fixed	On equipment: output for loudspeaker; output for earphone; output for headphone; input for microphone; input or output of audio signals for tape recorders (see Note 1 to Table V)
8.4 130-8 IEC-pp  1 3 2 Miniature 3.5 mm	Pin connector (plug)	Free	Headphone
	Socket connector (jack)	Fixed	On equipment: output for headphone
8.5 130-8 IEC-02  1 2 Sub-miniature 2.5 mm	Pin connector (plug)	Free	Earphone; on/off switch on microphone for remote control (in combination with miniature 3.5 mm connector)
	Socket connector (jack)	Fixed	On equipment: output for earphone; input for remote control of microphone (in combination with miniature 3.5 mm connector)
8.6 130-8 IEC-zz  1 2 Phono 3.2 mm	Pin connector	Free	Input or output for audio signal
	Socket connector	Fixed	On equipment: input or output for audio signal

Bureau of Indian Standards

BIS is a statutory institution established under the *Bureau of Indian Standards Act, 1986* to promote harmonious development of the activities of standardization, marking and quality certification of goods and attending to connected matters in the country.

Copyright

BIS has the copyright of all its publications. No part of these publications may be reproduced in any form without the prior permission in writing of BIS. This does not preclude the free use, in course of implementing the standard, of necessary details, such as symbols and sizes, type or grade designations. Enquiries relating to copyright be addressed to the Director (Publications), BIS.

Review of Indian Standards

Amendments are issued to standards as the need arises on the basis of comments. Standards are also reviewed periodically; a standard along with amendments is reaffirmed when such review indicates that no changes are needed; if the review indicates that changes are needed, it is taken up for revision. Users of Indian Standards should ascertain that they are in possession of the latest amendments or edition by referring to the latest issue of 'BIS Catalogue' and 'Standards: Monthly Additions'.

This Indian Standard has been developed from Doc: No. LTD 20 (2036).

Amendments Issued Since Publication

Amendment No.	Date of Issue	Text Affected

BUREAU OF INDIAN STANDARDS

Headquarters:

Manak Bhavan, 9 Bahadur Shah Zafar Marg, New Delhi 110 002

Telephones: 2323 0131, 2323 3375, 2323 9402

Website: www.bis.org.in

Regional Offices:

	Telephones
Central : Manak Bhavan, 9 Bahadur Shah Zafar Marg NEW DELHI 110 002	{ 2323 7617 2323 3841
Eastern : 1/14, C.I.T. Scheme VII M, V.I.P. Road, Kankurgachi KOLKATA 700 054	{ 2337 8499, 2337 8561 2337 8626, 2337 9120
Northern : SCO 335-336, Sector 34-A, CHANDIGARH 160 022	{ 260 3843 260 9285
Southern : C.I.T. Campus, IV Cross Road, CHENNAI 600 113	{ 2254 1216, 2254 1442 2254 2519, 2254 2315
Western : Manakalaya, E9 MIDC, Marol, Andheri (East) MUMBAI 400 093	{ 2832 9295, 2832 7858 2832 7891, 2832 7892

Branches: AHMEDABAD. BANGALORE. BHOPAL. BHUBANESHWAR. COIMBATORE. FARIDABAD. GHAZIABAD. GUWAHATI. HYDERABAD. JAIPUR. KANPUR. LUCKNOW. NAGPUR. PARWANOO. PATNA. PUNE. RAJKOT. THIRUVANANTHAPURAM. VISAKHAPATNAM.