

GRNLED
GOLUMEN® EuroLight
PRODUCT ALBUM



2024
BROCHURE
By Greenriy Technology Co., Limited



📍 6FL, Block 9, FuDing Street, Tiebian Village
528478, Henglan Town, Zhongshan, China

☎ +8613570825764

✉ info@grnled.com

🌐 <https://grnled.com>

✉ grnled01@gmail.com

Greenriy Technology Co.,Limited/Shenzhen Gelvmei Technology Co.,Ltd with brand GRNLED, GOLUMEN, and EuroLight which is especially for Nigeria Market is a professional manufacturer, factory, supplier of Led lights. Established in 2014 at Shenzhen city in China, has grown from its humble origins into an lighting industry leader and the best manufacturer and supplier. By focusing on advanced led technologies and outstanding talent, GRNLED offers professionals and users the solutions and support their need for a wide variety of applications. Our production capacity up to 10000pcs/days for common standard lighting. We pursue the following company culture to create the greatest value for customers

WHY US

- **Certification:** ISO9001:2015 listed. And all products are are CE Certified, RoHS Compliant.
- **One-stop supply:** Mostly all types led lights we can produce.
- **Better price:** Our led lamps are 10%-30% cheaper than other suppliers on the market.
- **OEM ODM Service:** Accept OEM ODM for different items.
- **Faster delivery:** Delivery time is fastest, some items is only 1-3days.
- **Quality Control:** Each lights will be 8-12hours age test before sent out.

WARRANTY

- The basic warranty periods for our led lights is 2-3years, and 5years .
- During guarantee periods, GRNLED provide following supports
- We can send **FREELY** new products or spares to you if there is any quality issues caused by us within guarantee periods.
- Out of warranty period, It is ok for us to provide extra spares, but all expense for repair and shipping cost should be paid by customers.

PARTNERS



CONTENT

Page 1	Led Panel Light	Page 10-30	LED Downlight	Page 34-37	LED High Bay Light	Page 47-49	LED Wall Light	Page 52	Outdoor Spotlight
Page 2-4	Magnetic track light System	Page 31	Led Linear Light	Page 38-40	LED Floodlight	Page 50	LED Bollard Light	Page 53	Underwater light
Page 5-9	Normal LED Track Light	Page 32-33	LED Batten Lighting	Page 42-46	LED Street Light	Page 51	Inground LED LIGHT		



- Osram/Bridgelux SMD Chips, 100-130lm/W output, 2700K-6500K
- 110/220-240VAC LiFud/Eagleries/Philips/Osram/TRIDONIC driver, 3/5 Years warranty.
- Emergency kits/ Surface/ Suspension/ Clips/ Recessed installation options.

GR-PL-D Series

Backlit type

IP22 / IP65

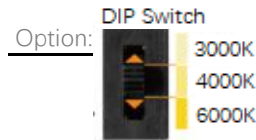

3 CCT in 1 light

Options



Surface with frame



Clips install with springs



Suspended with ropes

Order Model	Power Watt	Dimension mm	CRI	PF	IP Grade
GR-PL3030-18WD	18W	295*295	>80/90	>0.9	IP22 /IP65
GR-PL6030-24WD	24W	595*295	>80/90	>0.95	IP22 /IP65
GR-PL6060-40WD	36-40W	595*595	>80/90	>0.95	IP22 /IP65
GR-PL6060-40WD	30-40W	603*603	>80/90	>0.95	IP22 /IP65
GR-PL12030-40WD	36-40W	1195*295	>80/90	>0.95	IP22 /IP65
GR-PL12060-72WD	50-72W	1195*595	>80/90	>0.95	IP22 /IP65
GR-PL12015-30WD	30W	1195*145	>80/90	>0.95	IP22 /IP65
GR-PL12020-30WD	30-36W	1195*195	>80/90	>0.95	IP22 /IP65

GR-PL-H Series

Grille Panel Light

Surface/ Recessed

DIP Switch

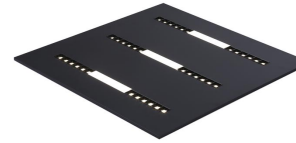

Order Model	Power Watt	Dimension mm	CRI	PF	IP Grade
GR-PL6060-40WH-A	40W	595*595	>80/90	>0.9	IP22
GR-PL6060-40WH-B	40W	595*595	>80/90	>0.95	IP22
GR-PL6060-40WH-C	40W	595*595	>80/90	>0.95	IP22

GR-PL Series

Edge-lit Slim type

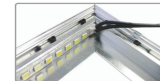

Order Model	Power Watt	Dimension mm	CRI	PF	IP Grade
GR-PL3030-18W	18W	295*295	>80	>0.9	IP22/IP65
GR-PL6060-40W	40W	595*595	>80	>0.95	IP22/IP65
GR-PL12030-40W	40W	1195*295	>80	>0.95	IP22/IP65
GR-PL12060-50W	50W	1195*595	>80	>0.95	IP22/IP65
GR-PL12060-60W	60W	1195*595	>80	>0.95	IP22/IP65

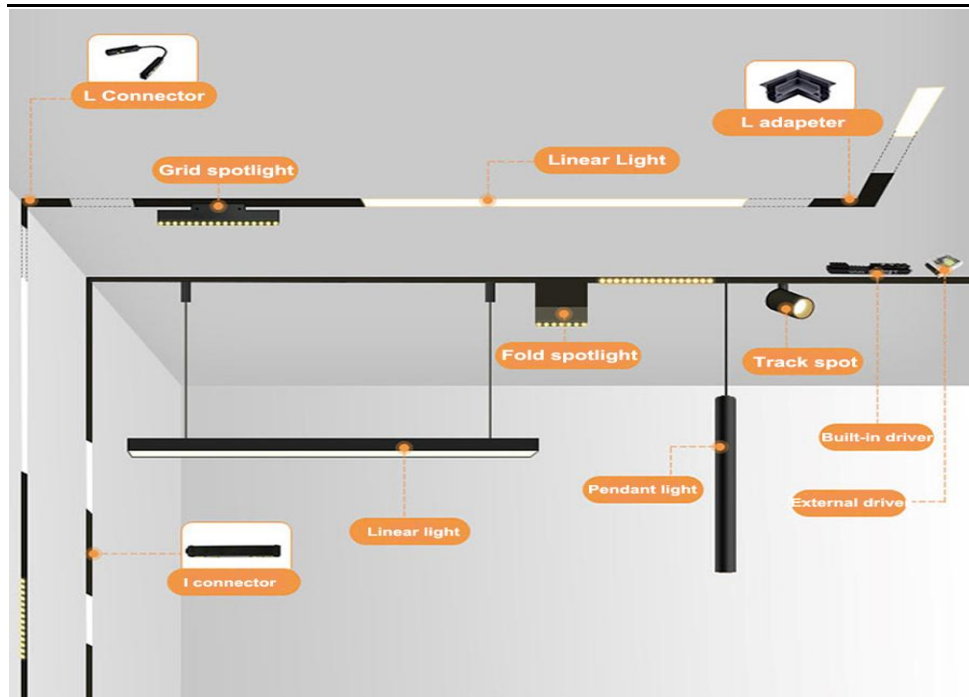

- DC48V Input
- 20MM/35MM Width Track optional. White/Black optional
- DALI Dimmable/ Remote control, Zigbee 3CCT+Dim solution Working with Google Home, Amazon Alexa smart speaker and TUYA APP.



Magnetic Grille Spotlights



Order Model	Power Watt	Dimension mm
GR-ML-6WGS	6W	L112*W22/35
GR-ML-12WGS	12W	L220*W22/35
GR-ML-18WGS	18W	L328*W22/35
GR-ML-24WGS	24W	L435*W22/35
GR-ML-30WGS	30W	L543*W22/35

Magnetic linear profile light



Order Model	Power Watt	Dimension mm
GR-ML-10WML	10W	L300*W22/35
GR-ML-20WML	20W	L600*W22/35
GR-ML-30WML	30W	L900*W22/35

Magnetic Fold Spotlights



Order Model	Power Watt	Dimension mm
GR-ML-6WFS	6W	L118*W22/35
GR-ML-12WFS	12W	L230*W22/35
GR-ML-18WFS	18W	L338*W20

Magnetic track spotlights



Order Model	Power Watt	Dimension mm
GR-ML-10WTL	10W	D50*100
GR-ML-15WTL	15W	D55*130
GR-ML-20WTL	20W	D60*135





MAGNETIC TRACK AND ACCESORIES

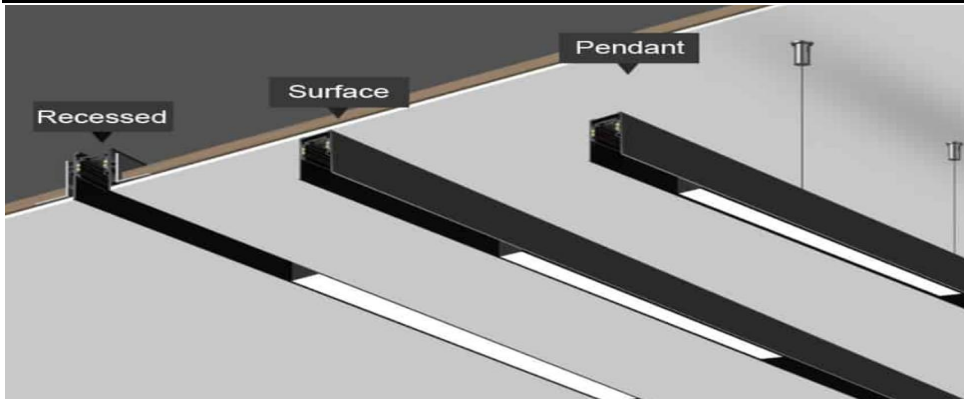

Recessed Track

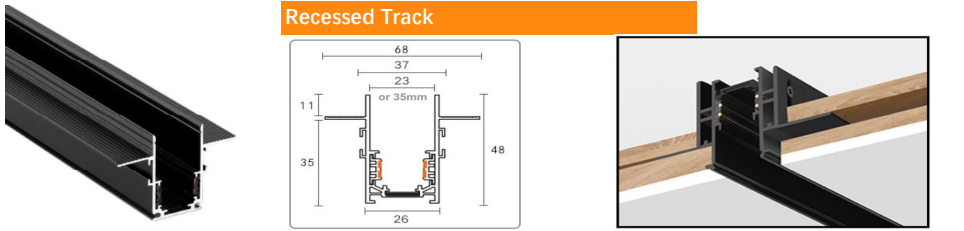

Surface/Suspension Track

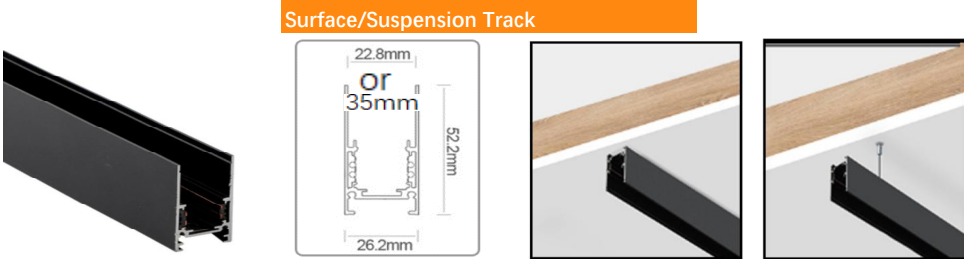

Trimless Track

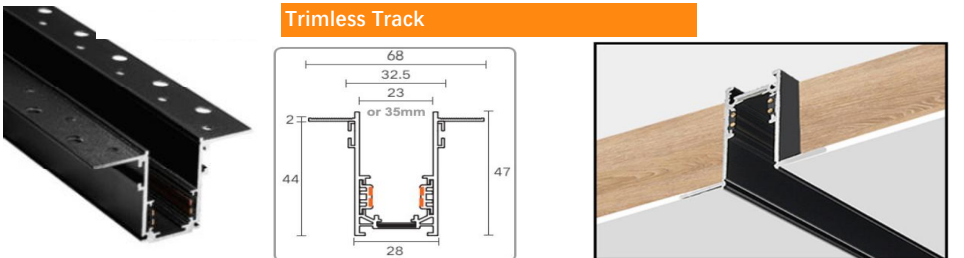

4 in 1 Magnetic track

One track can be compatible with surface, recessed, trimless, pendant installation

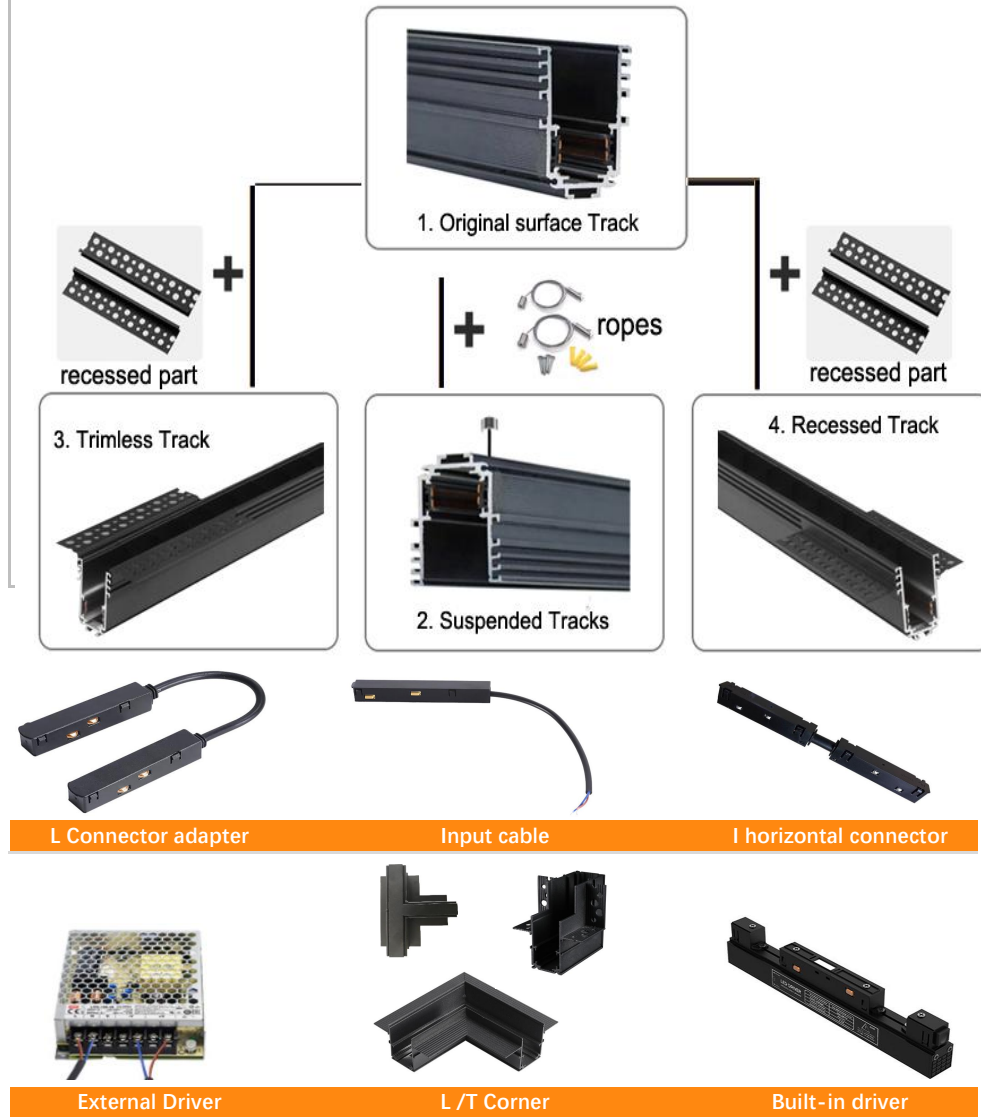



Order Model	Power Watt	CRI	Voltage
GR-ML-10WTL-03	10W	>90	48VDC
GR-ML-15WTL-03	15W	>90	48VDC
GR-ML-20WTL-03	20W	>90	48VDC
GR-ML-30WTL-03	30W	>90	48VDC

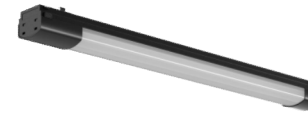

Surface Magnetic linear Light

Order Model	Power Watt	Dimension (mm)	Voltage
GR-ML-12WML-03	12W	L370*34	48VDC
GR-ML-24WML-03	24W	L675*34	48VDC
GR-ML-30WML-03	30W	L975*34	48VDC



Surface magnetic grille light

Order Model	Power Watt	Dimension (mm)	Voltage
GR-ML-10WGS-033	10W	L304*34	48VDC
GR-ML-20WGS-03	20W	L605*34	48VDC
GR-ML-30WGS-03	30W	L856*34	48VDC



Surface magnetic fold grill light

Order Model	Power Watt	Dimension (mm)	Voltage
GR-ML-6WFS-033	6W	L128*34	48VDC
GR-ML-12WFS-03	12W	L237*34	48VDC
GR-ML-18WFS-03	18W	L344*34	48VDC
GR-ML-24WFS-03	24W	L452*34	48VDC

ACCESSORIES



- Low glare, commercial application
- Osram/Bridgelux COB/SMD Chips, CRI92, 2700K-6500K
- 110/220-240VAC LiFud/Eagleries/Philips/Osram/TRIDONIC driver,3/5 Years warranty.
- Matt black/White housing optional.



Options

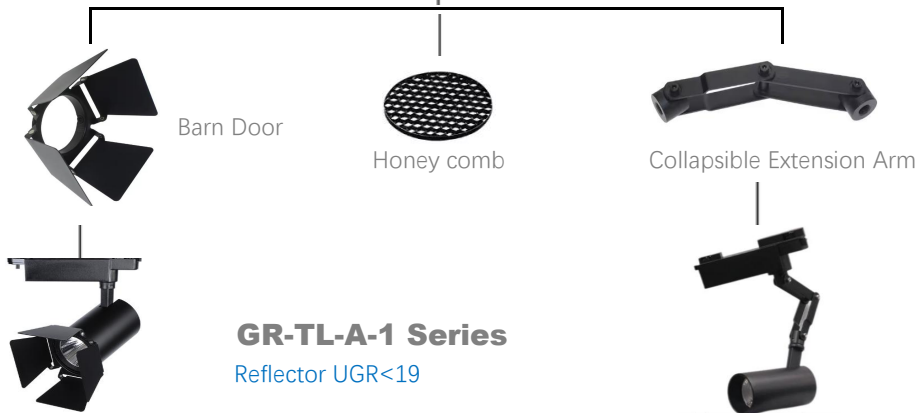

GR-TL-A-1 Series
Reflector UGR<19

Order Model	Power Watt	Dimension mm	Circuit	Lumens	Beam angle
GR-TL-10WA-1	10W	Φ50x100mm	1 circuit	1100lm	15/24/36°
GR-TL-15WA-1	15W	Φ60*135mm	1 circuit	1500lm	15/24/36°
GR-TL-20WA-1	20W	Φ60*135mm	1 circuit	2000lm	15/24/36°
GR-TL-25WA-1	25W	Φ80x145mm	1 circuit	2500lm	15/24/36°
GR-TL-30WA-1	30W	Φ80x150mm	1 circuit	3000lm	15/24/36°
GR-TL-35WA-1	35W	Φ90x160mm	1 circuit	2500lm	15/24/36°

GR-TL-A Series
Reflector UGR<19



Order Model	Power Watt	Dimension mm	Circuit	Lumens	Beam angle
GR-TL-10WA	10W	Φ50x100mm	1 circuit	1100lm	15/24/36/60°
GR-TL-15WA	15W	Φ60*135mm	1 circuit	1500lm	15/24/36/60°
GR-TL-20WA	20W	Φ70*145mm	1 circuit	2000lm	15/24/36/60°
GR-TL-30WA	30W	Φ80x150mm	1 circuit	3000lm	15/24/36/60°
GR-TL-35WA	35W	Φ90x160mm	1 circuit	3500lm	15/24/36/60°
GR-TL-40WA	40W	Φ90x160mm	1 circuit	4000lm	15/24/36/60°
GR-TL-45WA	45W	Φ90x160mm	1 circuit	4500lm	15/24/36/60°

GR-TL-B Series

1/ 3 Phases
0-10V/ DALI Dimmable options



Order Model	Power Watt	Dimension mm	Phase	Lumens	Beam angle
GR-TL-20WB	20W	Φ100*150mm	1 / 3 Phases	2000lm	15/24/36°
GR-TL-25WB	25W	Φ100*150mm	1 / 3 Phases	2500lm	15/24/36°
GR-TL-30WB	30W	Φ100*150mm	1 / 3 Phases	3000lm	15/24/36°
GR-TL-35WB	35W	Φ100*150mm	1 / 3 Phases	3500lm	15/24/36°



GR-TL-F-1 Series

1/ 3 Phases

Order Model	Power Watt	Dimension mm	Phase	Lumens	Beam angle
GR-TL-10WF-1	10W	Φ91*110mm	1 / 3 Phases	2500lm	15/24/36°
GR-TL-20WF-1	20W	Φ91*110mm	1 / 3 Phases	3000lm	15/24/36°
GR-TL-30WF-1	30W	Φ91*110mm	1 / 3 Phases	3500lm	15/24/36°

- Integrated driver in track
- Osram/Bridgelux COB/SMD Chips, CRI92, 2700K-6500K
- 110/220-240VAC Eagleries/ Osram/ Philips/ LiFud/ ALLOOKING driver,3/5 Years warranty.
- Matt black/White housing optional.
- 1phase / 3 phases / DALI /0-10V dimmable options



GR-TL-F-2 Series

1/ 3 Phases

DIP Switch CCT option

3 Color temperature in 1 light



Order Model	Power Watt	Dimension mm	Phase	Lumens	Beam angle
GR-TL-25WF-2	25W	Φ91*110mm	1 / 3 Phases	2500lm	15/24/36°
GR-TL-30WF-2	30W	Φ91*110mm	1 / 3 Phases	3000lm	15/24/36°
GR-TL-35WF-2	35W	Φ91*110mm	1 / 3 Phases	3500lm	15/24/36°
GR-TL-40WF-2	40W	Φ105*130mm	1 / 3 Phases	4000lm	15/24/36°

GR-TL-F Series

phase/ 3 Phases(3 Circuit):
15/24/36/60°



Order Model	Power Watt	Dimension mm	Phase	Lumens	Beam angle
GR-TL-15WF	15W	Φ90*90mm	1 / 3 Phases	1500lm	15/24/36/60°
GR-TL-20WF	20W	Φ90*90mm	1 / 3 Phases	2000lm	15/24/36/60°
GR-TL-25WF	25W	Φ90*90mm	1 / 3 Phases	2500lm	15/24/36/60°
GR-TL-30WF	30W	Φ100*100mm	1 / 3 Phases	3000lm	15/24/36/60°
GR-TL-35WF	35W	Φ100*100mm	1 / 3 Phases	3500lm	15/24/36/60°
GR-TL-40WF	40W	Φ100*106mm	1 / 3 Phases	4000lm	15/24/36/60°

LED TRACK LIGHT



GR-TL-T Series

Shapeable & Zoomable
Surface/Track install

Order Model	Power Watt	Dimension mm	Installation	Lumens Lm	CRI
GR-TL-7WT	7W	φ55*190mm	Surface/Track	700lm	>90
GR-TL-10WT	10W	φ55*190mm	Surface/Track	1000lm	>90
GR-TL-15WT	15W	φ55*190mm	Surface/Track	1500lm	>90

GR-TL-D Series

Beam angle adjust from 15-60°



Order Model	Power Watt	Dimension mm	Track head	Lumens Lm	CRI
GR-TL-10WD	10W	φ55*135mm	1/ 2 circuits	1000lm	>90
GR-TL-15WD	15W	φ65*165mm	1/ 2 circuits	1500lm	>90
GR-TL-20WD	20W	φ75*170mm	1/ 2 circuits	2000lm	>90
GR-TL-25WD	25W	φ75*170mm	1/ 2 circuits	2500lm	>90
GR-TL-30WD	30W	φ80*200mm	1/ 2 circuits	3000lm	>90



Order Model	Power Watt	Remark
GR-TL-30WH	30W-35W	1/3 phases



Order Model	Power Watt	Dimension mm
GR-TL-30WR	30W	10W

GR-TL-C Series
Round/Square



Order Model	Power Watt	Dimension mm	Installation	CRI	Beam angle
GR-TL-10WC	10W	Φ80*50mm	Surface/Track	>90	15/24/36/60°
GR-TL-20WC	20W	Φ100*55mm	Surface/Track	>90	15/24/36/60°
GR-TL-30WC	30W	Φ120*65mm	Surface/Track	>90	15/24/36/60°

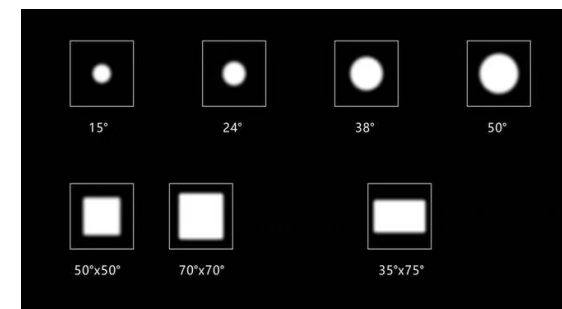

Order Model	Power Watt	Dimension mm	Installation	CRI	Beam angle
GR-TL-10WP	10W	65*65*45	2/3/4 Wires	>90	15/24/36/60°
GR-TL-15WP	15W	82*82*63	2/3/4 Wires	>90	15/24/36/60°
GR-TL-20WP	20W	95*95*63	2/3/4 Wires	>90	15/24/36/60°
GR-TL-30WP	30W	120*120*63	2/3/4 Wires	>90	15/24/36/60°

GR-TL-L Series
Linear grille spotlight/ profile



Order Model	Power Watt	Dimension mm	Installation	CRI	Beam angle
GR-TL-10WL	10W	214*33*57	2/3/4 Wires	>90	24/36/120°
GR-TL-18WL	18W	346*33*57	2/3/4 Wires	>90	24/36/120°
GR-TL-28WL	28-30W	478*33*57	2/3/4 Wires	>90	24/36/120°
GR-TL-35WL	35W	611*33*57	2/3/4 Wires	>90	24/36/120°



Order Model	Power Watt	Remark
GR-TL-30WQ	30W	1/3 phases

Order Model	Power Watt	Remark
GR-TL-30WY	30W	1/3 phases



Order Model	Material	Conductor	Length	Color	Beam angle
2Wire Track	PVC	Copper	1m/2m/3m	White/Black	24/36/120°
2 Wire Track	Aluminum	Copper	1m/2m/3m	White/Black	24/36/120°
3Wirs Track	Aluminum	Copper	1m/2m/3m	White/Black	24/36/120°
4Wires Track	Aluminum	Copper	1m/2m/3m	White/Black	24/36/120°



GR-TL-G Series
Adjustable beam angle
From 15° to 60°

Order Model	Power Watt	CRI	Remark
GR-TL-25WG	25W	>92	1/3phases
GR-TL-35WG	35W	>92	1/3phases

GR-TL-U Series
Recessed/Surface options



Order Model	Power Watt	Input Voltage	Installation	CRI	Beam angle
GR-TL-10WU	10W	100-240VAC	Surface/recessed	>90	15/24/36°
GR-TL-20WU	20W	100-240VAC	Surface/recessed	>90	15/24/36°
GR-TL-30WU	30W	100-240VAC	Surface/recessed	>90	15/24/36°



Order Model	Material	Conductor
I connector	PVC	Copper
L connector	PVC	Copper
T Connector	PVC	Copper
Cross connector	PVC	Copper

- Osram/Bridgelux COB Chips, CRI90.2700K-6500K
- 110/220-240VAC LiFud/Eagleries/Philips/Osram/TRIDONIC driver,3/5 Years warranty.
- Optional: Triac /0-10V /DALI dimmable, Emergency kits .
- White/black body finished optional.

GR-DL-S-01 Series

TOP Commercial



Order Model	Power Watt	Dimension mm	CRI	IP Grade	Beam anlge
GR-DL-15WS-01	15W	Ø95*75	Φ80mm	IP22	15/30/45°
GR-DL-20WS-01	20W	Ø120*95	Φ95-100mm	IP22	15/30/45°
GR-DL-30WS-01	30W	Ø140*105	Φ120-125mm	IP22	15/30/45°
GR-DL-40WS-01	40W	Ø167*120	Φ150mm	IP22	15/30/45°
GR-DL-50WS-01	50W	Ø197*140	Φ180-185mm	IP22	15/30/45°
GR-DL-60WS-01	60W	Ø236*165	Φ220mm	IP22	15/30/45°
GR-DL-80WS-01	80W	Ø236*165	Φ220mm	IP22	15/30/45°

GR-DL-S Series

TOP IP20/IP44



Order Model	Power Watt	Dimension mm	Cut out mm	Lumens Lm	Beam angle
GR-DL-10WS	10W	Ø85*H55	Ø75	1100lm	15/24/36/60°
GR-DL-15WS	15W	Ø110*H65	Ø95	1500lm	15/24/36/60°
GR-DL-25WS	25W	Ø140*H70	Ø120	2000lm	15/24/36/60°
GR-DL-30WS	30W	Ø160*H85	Ø145	3000lm	15/24/36/60°
GR-DL-35WS	35W	Ø185*H95	Ø165	3500lm	15/24/36/60°
GR-DL-40WS	40W	Ø185*H95	Ø165	4000lm	15/24/36/60°
GR-DL-50WS	50W	Ø215*H95	Ø195	5000lm	15/24/36/60°

- available to **adjust CCT range from 3000K to 6000K**
- Osram/Bridgelux COB/SMD Chips, CRI80/90, 110-150LM/W
- 110/220-240VAC LiFud/Eagleries/Philips/Osram/TRIDONIC driver, 3/5 Years warranty.
- Optional: Triac /0-10V /DALI dimmable, Emergency kits .

GR-DL-B Series

Tunable white downlight
110°



Options



Control by Phone APP/Google Home



Order Model	Power Watt	Dimension mm	Cut out mm	Lumens Lm	Color temp
GR-DL-9WB	9W	ø110×H50	ø85-95	900lm	3CCT
GR-DL-10WB	10W	ø120×H50	ø95-105	1200lm	3CCT
GR-DL-15WB	15W	ø145×H57	ø115-130	1500lm	3CCT
GR-DL-18WB	18W	ø180×H57	ø150-170	1800lm	3CCT
GR-DL-24WB	24W	ø191×H57	ø160-180	2400lm	3CCT

GR-DL-A-07 Series

TOP downlight- IP44

Black White Gun Black



Options



Control by Phone APP/Google Home



Order Model	Power Watt	Dimension mm	Cut out mm	Lumens Lm	Beam angle
GR-DL-7WA-07	7W	Ø62×H45	Ø50-55	700lm	36/60°
GR-DL-10WA-07	10W	Ø82×H55	Ø70-75	1000lm	36/60°
GR-DL-12WA-07	12W	Ø82×H55	Ø70-75	1200lm	36/60°
GR-DL-15WA-07	15W	Ø102×H62	Ø90-95	1500lm	36/60°
GR-DL-20WA-07	20W	Ø130×H70	Ø115-120	1800lm	36/60°
GR-DL-24WA-07	24W	Ø130×H70	Ø115-120	2400lm	36/60°

GR-DL-A Series

Commercial downlight- IP54

Hot sales



Order Model	Power Watt	Dimension mm	Cut out mm	Lumens Lm	Beam angle
GR-DL-9WA	9W	Ø93*H45	Ø75-80	900lm	60°
GR-DL-12WA	12W	Ø112*H52	Ø95	1200lm	60°
GR-DL-15WA	15W	Ø135*H60	Ø115	1500lm	60°
GR-DL-18WA	18-20W	Ø162*H72	Ø140-145	1800lm	60°
GR-DL-24WA	24W-30W	Ø192*H83	Ø170-175	2400lm	60°
GR-DL-30WA	30W-35W	Ø225*H97	Ø205	3000lm	60°
GR-DL-36WA	36W-40W	Ø225*H97	Ø205	3500lm	60°

- Commercial project application
- Osram/Bridgelux Chips, CRI90.2700K-6500K
- 110/220-240VAC LiFud/Eagleries/Philips/Osram/TRIDONIC driver, 3/5 Years warranty.
- Optional: Triac /0-10V /DALI dimmable, Emergency kits .

GR-DL-E

Competitive project item

HOT Sale IP20



Order Model	Power Watt	Dimension mm	Cut out mm	CRI	IP Grade
GR-DL-7WE	7W	Ø108*H50	Ø90mm	>80 >90	IP20
GR-DL-9WE	9W	Ø115*H50	Ø95-100mm	>80 >90	IP20
GR-DL-12WE	12W	Ø145*H50	Ø120-125mm	>80 >90	IP20
GR-DL-15WE	15W	Ø180*H55	Ø160mm	>80 >90	IP20
GR-DL-18WE	18W	Ø180*H55	Ø160mm	>80 >90	IP20
GR-DL-24WE	24W	Ø190*H55	Ø170mm	>80 >90	IP20

- Low glare, commercial application
- Osram/Bridgelux COB/SMD Chips, CRI80/90, 2700K-6500K
- 110/220-240VAC LiFud/Eagleries/Philips/Osram/TRIDONIC driver,3/5 Years warranty.
- Optional: Triac /0-10V /DALI dimmable, Emergency kits .

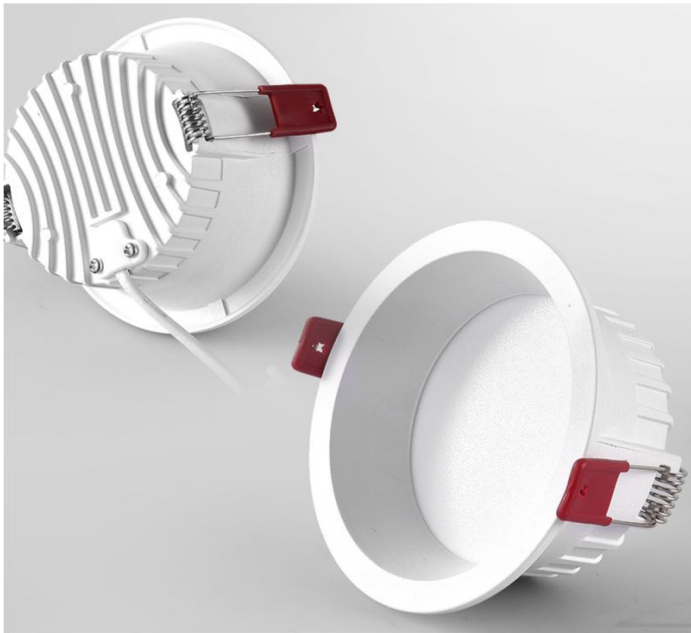

GR-DL-A-1
Deep downlight- IP44
↓ IP54

Option:

Order Model	Power Watt	Dimension mm	Cut out mm	Lumens Lm	Beam anlge
GR-DL-7WA-1	7W	Ø95*H45	Ø75	700lm	110°
GR-DL-10WA-1	10W	Ø115*H48	Ø95	1000lm	110°
GR-DL-12WA-1	12W	Ø115*H48	Ø95	1200lm	110°
GR-DL-15WA-1	15W	Ø138*H56	Ø120	1500lm	110°
GR-DL-18WA-1	18W	Ø170*H62	Ø150	1800lm	110°
GR-DL-24WA-1	24W	Ø170*H62	Ø150	2400lm	110°

GR-DL-A-3

Deep downlight- IP20

Top Commercial item, UGR<1

HOT Sale



Order Model	Power Watt	Dimension mm	Cut out mm	Lumens Lm	Beam anlge
GR-DL-9WA-3	9W	9W	Ø100*H60	Ø80-85mm	90°
GR-DL-12WA-3	12W	12W	Ø120*H70	Ø95-100mm	90°
GR-DL-15WA-3	15W	15w	Ø145*H80	Ø120-125mm	90°
GR-DL-20WA-3	20W	20W	Ø170*H90	Ø140-150mm	90°
GR-DL-25WA-3	25W	25W	Ø190*H100	Ø160-170mm	90°
GR-DL-30WA-3	30W	30W	Ø220*H110	Ø200-205mm	90°
GR-DL-35WA-3	35W	35W	Ø220*H110	Ø200-205mm	90°
GR-DL-40WA-3	40W	40W	Ø220*H110	Ø200-205mm	90°



Order Model	Power Watt	Dimension mm	Cut out mm	CRI	Beam angle
GR-DL-7WA-08	7W	Ø65*H55	Ø55mm	>90	15/24/38°
GR-DL-10WA-08	10W	Ø85*H80	Ø75mm	>90	15/24/38°
GR-DL-15WA-08	15W	Ø101*H95	Ø90mm	>90	15/24/38°
GR-DL-18WA-08	18W	Ø101*H95	Ø90mm	>90	15/24/38°
GR-DL-25WA-08	25W	Ø118*H120	Ø105mm	>90	15/24/38°

GR-DL-A-04
IP44 UGR<17



Order Model	Power Watt	Dimension mm	Cut out mm	CRI	Beam angle
GR-DL-7WA-4	7W	Ø85*H46	Ø75mm	>80 >90	90°
GR-DL-15WA-4	15W	Ø138*H64	Ø120mm	>80 >90	90°
GR-DL-18WA-4	18W	Ø138*H64	Ø120mm	>80 >90	90°
GR-DL-24WA-4	24W	Ø185*H79	Ø160mm	>80 >90	90°

GR-DL-B-01 Series

Ultra thin downlight IP44

Backlit



Order Model	Power Watt	Dimension mm	Cut out mm	CRI	IP Grade
GR-DL-7WB-1	7W	ø100×H32	ø75-80	>80 >90	IP44
GR-DL-9WB-1	9W	ø120×H32	ø90-100	>80 >90	IP44
GR-DL-12WB-1	12W	ø145×H34	ø115-120	>80 >90	IP44
GR-DL-15WB-1	15W	ø165×H34	ø140-150	>80 >90	IP44
GR-DL-18WB-1	18W/24W	ø180×H35	ø165	>80 >90	IP44
GR-DL-24W/30WB-1	24W/30W	ø230×H35	ø195-205	>80 >90	IP44

GR-DL-MI
Mini downlight

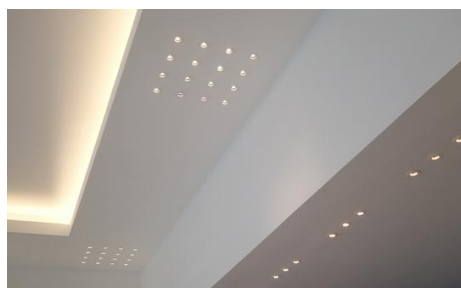

Order Model	Power Watt	Dimension mm	Cut out mm	Input	IP Grade
GR-DL-3WMIA	3W	Ø38*H28mm	Ø30	100-240VAC	IP20

- Osram/Bridgelux Chips, CRI80-90,2700K-6500K
- 110/220-240VAC isolated driver ,3/5 Years warranty.
- Optional: Triac /0-10V /DALI dimmable,

GR-DL-L-1 Series

Fixed Linear downlight



Order Model	Power Watt	Dimension mm	Cut out mm	CRI	Beam angle
GR-DL-10WL-1	10W±5%	L145*45*H35	L140*W36	>80 >90	15/24/36°
GR-DL-20WL-1	20W±5%	L282*45*H35	L275*W35	>80 >90	15/24/36°
GR-DL-30WL-1	30W±5%	L415*45*H35	L410*W35	>80 >90	15/24/36°

GR-DL-L-3 Series

Trimless

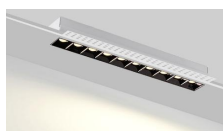

Order Model	Power Watt	Dimension mm	Cut out mm	CRI	Beam angle
GR-DL-5WL-3	5W	L140*105*H42	L140*W50	>80 >90	15/30/45°
GR-DL-10WL-3	10W	L273*105*H42	L275*W50	>80 >90	15/30/45°
GR-DL-20WL-3	20W	L540*105*H42	L540*W50	>80 >90	15/30/45°
GR-DL-40WL-3	40W	L1203*W105	L1205*W50	>80 >90	15/30/45°

GR-DL-L-2 Series

Adjustable 30°



Order Model	Power Watt	Dimension mm	Cut out mm	CRI	Beam angle
GR-DL-10WL-2	10W±5%	L165*62*H35	L158*W51	>80 >90	15/24/36°
GR-DL-20WL-2	20W±5%	L298*62*H35	L290*W51	>80 >90	15/24/36°
GR-DL-30WL-2	30W±5%	L430*62*H35	L420*W52	>80 >90	15/24/36°

GR-DL-L-4 Series

Surface mounted



Order Model	Power Watt	Dimension mm	IP Rate	CRI	Beam angle
GR-DL-5WL-4	5W	L138*33*H60	IP22	>80 >90	15/30/45°
GR-DL-10WL-4	10W	L270*33*H60	IP22	>80 >90	15/30/45°
GR-DL-15WL-4	15W	L403*33*H60	IP22	>80 >90	15/30/45°
GR-DL-20WL-4	20W	L535*33*H60	IP22	>80 >90	15/30/45°

- Competitive housing for projects.
- Osram/Bridgelux SMD Chips, CRI80,2700K-6500K
- 110/220-240VAC LiFud/Eagleries/Philips/Osram/TRIDONIC driver,3/5 Years warranty.
- Optional: Triac /0-10V /DALI dimmable, Emergency kits .

GR-DL-D Series

4inch- 10inch



Order Model	Power Watt	Dimension mm	Cut out mm	CRI	IP Grade
GR-DL-7WD	7W/9W	Ø106*H46	Ø90	>80 >90	IP20
GR-DL-12WD	12W	Ø115*H46	Ø95	>80 >90	IP20
GR-DL-15WD	15W	Ø160*H55	Ø140	>80 >90	IP20
GR-DL-18WD	18W	Ø180*H60	Ø160	>80 >90	IP20
GR-DL-24WD	24W	Ø190*H60	Ø170	>80 >90	IP20
GR-DL-30WD	30W	Ø220*H62	Ø205	>80 >90	IP20
GR-DL-30WD-9in	30W	Ø250*H62	Ø230-240	>80 >90	IP20
GR-DL-30WD-10in	30W	Ø300*H62	Ø250-280	>80 >90	IP20

GR-DL-N Series
Commercial 2.5-10INCH



120°



Order Model	Power Watt	Dimension mm	Cut out mm	Light source	IP Grade
GR-DL-12WN	12W	Ø145*H65	Ø130	SMD/COB	IP20
GR-DL-15WN	15W	Ø145*H65	Ø130	SMD/COB	IP20
GR-DL-20WN	20W	Ø165*H65	Ø145	SMD/COB	IP20
GR-DL-24WN	24W	Ø190*H75	Ø170	SMD/COB	IP20
GR-DL-30WN	30W	Ø190*H75	Ø170	SMD/COB	IP20
GR-DL-40WN	40W	Ø225*H75	Ø205	SMD/COB	IP20
GR-DL-42WN-9in	42W	Ø250*H75	Ø200-240	SMD/COB	IP20
GR-DL-40WN-10in	40W	Ø300*H75	Ø250-280	SMD/COB	IP20

- IP65 waterproof. THD:<15%
- Osram/Bridgelux SMD/COB Chips, CRI80-90. 2700K-6500K
- 110/220-240VAC LiFud/Eagleries/Philips/Osram/TRIDONIC driver,3/5 Years warranty.
- Optional: Triac /0-10V /DALI dimmable, Emergency kits .

GR-DL-W-03 Series

IP65 Waterproof
UGR<17



Order Model	Power Watt	Dimension mm	Cut out mm	IP Grade	Beam anlg
GR-DL-9WW-03	7/9W	ø94*64mm	ø75mm	IP65	60°
GR-DL-12WW-03	12W	ø115*68mm	ø95mm	IP65	60°
GR-DL-18WW-03	18W	ø140*74mm	ø120mm	IP65	60°
GR-DL-20WW-03	20W	ø140*74mm	ø120mm	IP65	60°
GR-DL-24WW-03	24W	ø185*80mm	ø160mm	IP65	60°
GR-DL-30WW-03	30W	ø185*80mm	ø160mm	IP65	60°



GR-DL-W Series

IP65 Waterproof
SMD/COB Options
110° beam angle

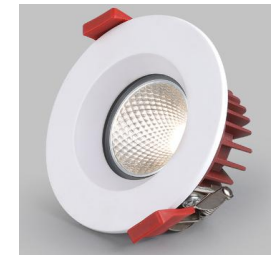

Order Model	Power Watt	Dimension mm	Cut out mm	Light source	IP Grade
GR-DL-7WW	7W	ø95×H45	75-80mm	SMD/COB	IP65
GR-DL-12WW	12W	ø115×H50	95-100mm	SMD/COB	IP65
GR-DL-15WW	15W	ø145×H60	120-125mm	SMD/COB	IP65
GR-DL-20WW	20W	ø160×H60	145-150mm	SMD/COB	IP65
GR-DL-30WW	30W	ø190×H60	170mm	SMD/COB	IP65
GR-DL-40WW	40W	ø230×H75	205mm	SMD/COB	IP65

- IP65 waterproof. THD:<15%
- Osram/Bridgelux SMD Chips, CRI80-90. 2700K-6500K
- 110/220-240VAC LiFud/Eagleries/Philips/Osram/TRIDONIC driver,3/5 Years warranty.
- Optional: Triac /0-10V /DALI dimmable, Emergency kits .

GR-DL-W-01 Series

IP65 Waterproof

UGR<17



Order Model	Power Watt	Dimension mm	Cut out mm	IP Grade	Beam anlge
GR-DL-10WW-1	10W	ø87*72mm	ø75mm	IP65	55°
GR-DL-12WW-1	12W	ø87*72mm	ø75mm	IP65	55°
GR-DL-15WW-1	15W	ø110*82mm	ø95mm	IP65	55°
GR-DL-24WW-1	24W	ø138*100mm	ø120mm	IP65	55°
GR-DL-30WW-1	30W	ø157*110mm	ø140mm	IP65	55°
GR-DL-35WW-1	35W	ø183*125mm	ø160mm	IP65	55°

GR-DL-W-04 Series

IP65 Waterproof



Order Model	Power Watt	Dimension mm	Cut out mm	Light source	IP Grade
GR-DL-9WW-04	9W	ø95×H45	75-80mm	COB	IP65
GR-DL-15WW-04	15W	ø115×H50	95-100mm	COB	IP65

GR-DL-W-02 Series

IP65 Waterproof

Adjustable



Order Model	Power Watt	Dimension mm	Cut out mm	CRI	IP Grade
GR-DL-5WW-02	5W	φ63*H69mm	φ55mm	>90	IP65
GR-DL-7WW-02	7W	φ85*H64mm	φ75mm	>90	IP65
GR-DL-10WW-02	10W	φ85*H74mm	φ75mm	>90	IP65
GR-DL-12WW-02	12W	φ85*H89mm	φ95mm	>90	IP65
GR-DL-15WW-02	15W	φ110*H83mm	φ95mm	>90	IP65
GR-DL-20WW-02	20W	φ110*H83mm	φ95mm	>90	IP65



GR-DL-G Series

Adjustable 30°



Black /White /Silver /Gun / gold / rose

Order Model	Power Watt	Dimension mm	Cut out mm	IP Grade	Beam anlge
GR-DL-7WG	5W/7W	φ63*H68	φ55mm	IP22	15/24/36°
GR-DL-10WG	7W/10W	φ85*H80	φ75mm	IP22	15/24/36°
GR-DL-15WG	15W	φ110*H88	φ95mm	IP22	15/24/36°
GR-DL-20WG	20W	φ110*H88	φ95mm	IP22	15/24/36°
GR-DL-25WG	25W	φ130*H120	φ120mm	IP22	15/24/36°
GR-DL-30WG	30W	φ130*H120	φ120mm	IP22	15/24/36°



GR-DL-G-4 Series

Adjustable 30°



Order Model	Power Watt	Dimension mm	Cut out mm	IP Grade	Beam anlge
GR-DL-7WG-4	7W	ø85*H90mm	ø75mm	IP22	15/24/36°
GR-DL-10WG-4	10W	ø85*H90mm	ø75mm	IP22	15/24/36°
GR-DL-12WG-4	12W	ø85*H90mm	ø75mm	IP22	15/24/36°
GR-DL-15WG-4	15W	ø105*H107mm	ø95mm	IP22	15/24/36°
GR-DL-20WG-4	20W	ø105*H107mm	ø95mm	IP22	15/24/36°
GR-DL-30WG-4	30W	ø130*H125mm	ø115mm	IP22	15/24/36°

- Adjustable 30°, UGR<15
- Osram/Bridgelux COB Chips, >CRI90. 2700K-6500K
- 110/220-240VAC LiFud/Eagleries/Philips/Osram/TRIDONIC driver,3/5 Years warranty.
- Optional: Triac /0-10V /DALI dimmable, Emergency kits .

GR-DL-G-05 Series

Adjustable 30°



Order Model	Power Watt	Dimension mm	Cut out mm	IP Grade	Beam anlge
GR-DL-7WG-05	7W	90*70mm	70-75	IP22	15/24/36°
GR-DL-10WG-05	10W	108*70mm	90-95	IP22	15/24/36°
GR-DL-15WG-05	15W	108*82mm	90-95	IP22	15/24/36°
GR-DL-20WG-05	20W	138*85mm	120mm	IP22	15/24/36°
GR-DL-30WG-05	30W	160*125mm	140-145mm	IP22	15/24/36°
GR-DL-40WG-05	40W	180*150mm	160-165mm	IP22	15/24/36°
GR-DL-50WG-05	50W	180*150mm	160-165mm	IP22	15/24/36°

GR-DL-G-01 Series

Adjustable 30°

Trimless



Order Model	Power Watt	Dimension mm	Cut out mm	IP Grade	Beam angle
GR-DL-7WG-01	7W	91*53*80mm	φ55mm	IP22	15/24/36°
GR-DL-10WG-01	10W	116*71*85	φ75mm	IP22	15/24/36°
GR-DL-12WG-01	12W	116*71*100	φ75mm	IP22	15/24/36°
GR-DL-15WG-01	15W	142*92*118	φ95mm	IP22	15/24/36°
GR-DL-20WG-01	20W	142*92*118	φ95mm	IP22	15/24/36°

• Low glare, UGR<17

• Osram/Bridgelux COBChips, CRI90.2700K-6500K

• 110/220-240VAC LiFud/Eagleries/Philips/Osram/TRIDONIC driver,3/5 Years warranty.

• Optional: Triac /0-10V /DALI dimmable, Emergency kits .

GR-DL-G-02 Series

Gimbal 350°+ 70° adjustable



Order Model	Power Watt	Dimension mm	Cut out mm	IP Grade	Beam angle
GR-DL-10WG-02	10W	ø90*H100	ø75mm	IP20	15/24/36°
GR-DL-15WG-02	15W	ø110*H135	ø95mm	IP20	15/24/36°
GR-DL-20WG-02	20W	ø130*H135	ø115mm	IP20	15/24/36°
GR-DL-25WG-02	25W	ø130*H135	ø115mm	IP20	15/24/36°
GR-DL-30WG-02	30W	ø165*H170	ø145mm	IP20	15/24/36°
GR-DL-35WG-02	35W	ø165*H170	ø145mm	IP20	15/24/36°

- Osram/Bridgelux COB Chips, CRI80.2700K-6500K
- 110/220-240VAC LiFud/Eagleries/Philips/Osram/TRIDONIC driver,3/5 Years warranty.
- Optional: Triac /0-10V /DALI dimmable, Emergency kits .

GR-DL-G-03 Series

30° adjustable UGR<12

Hotel project

Order Model	Power Watt	Dimension mm	Cut out mm	IP Grade	Beam anlge
GR-DL-30WG-03	30W	Φ140*120mm	Φ120mm	IP22	15/24/36°
GR-DL-35WG-03	35W	Φ140*120mm	Φ120mm	IP22	15/24/36°
GR-DL-40WG-03	40W	Φ160*140mm	Φ145mm	IP22	15/24/36°
GR-DL-50WG-03	50W	Φ160*150mm	Φ145mm	IP22	15/24/36°

GR-DL-G-07 Series

30° adjustable CRI90

Black/White/Silver/Gun/ gold/rose gold

Order Model	Power Watt	Dimension mm	Cut out mm	IP Grade	Beam anlge
GR-DL-10WG-07	10W	Φ85*60mm	Φ75mm	IP22 / IP44	15/24/36°
GR-DL-15WG-07	15W	Φ110*80mm	Φ95mm	IP22/ IP44	15/24/36°
GR-DL-20WG-07	20W	Φ140*90mm	Φ120mm	IP22 / IP44	15/24/36°

GR-DL-G-08

30° adjustable +350°

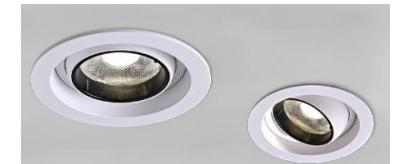

Order Model	Power Watt	Dimension mm	Cut out mm	IP Grade	Beam anlge
GR-DL-10WG-08	10W/12W	Φ90*98mm	Φ75mm	IP22	15/24/36°
GR-DL-15WG-08	15W	Φ109*107mm	Φ95mm	IP22	15/24/36°
GR-DL-20WG-08	20W	Φ109*107mm	Φ95mm	IP22	15/24/36°
GR-DL-30WG-08	30W	Φ134*130mm	Φ120mm	IP22	15/24/36°

GR-DL-G-09 Series

90° adjustable+360° rotation
 Recessed/surface/Track

- Osram/Bridgelux COB Chips, CRI90.2700K-6500K
- 110/220-240VAC LiFud/Eagleries/Philips/Osram/TRIDONIC driver,3/5 Years warranty.
- Optional: Triac /0-10V /DALI dimmable, Emergency kits .
- White/black body finished optional.



Order Model	Power Watt	Dimension mm	Cut out mm	IP Grade	Beam anlge
GR-DL-10WG-09	10W	Φ83mm	Φ75mm	IP22	15/24/36°
GR-DL-20WG-09	15W-20W	Φ100mm	Φ90mm	IP22	15/24/36°

Order Model	Power Watt	Dimension mm	CRI	IP Grade	Beam anlge
GR-DL-9WI	9W	Φ70*100mm	>90	IP22	15/24/36°
GR-DL-15WI	15W/20W	Φ90*110mm	>90	IP22	15/24/36°
GR-DL-25WI	25W	Φ110*115mm	>90	IP22	15/24/36°
GR-DL-30WI	30W	Φ110*150mm	>90	IP22	15/24/36°

- Osram/Bridgelux COB Chips, CRI90.2700K-6500K
- 110/220-240VAC LiFud/Eagleries/Philips/Osram/TRIDONIC driver,3/5 Years warranty.
- Optional: Triac /0-10V /DALI dimmable, Emergency kits .
- White/black body finished optional.

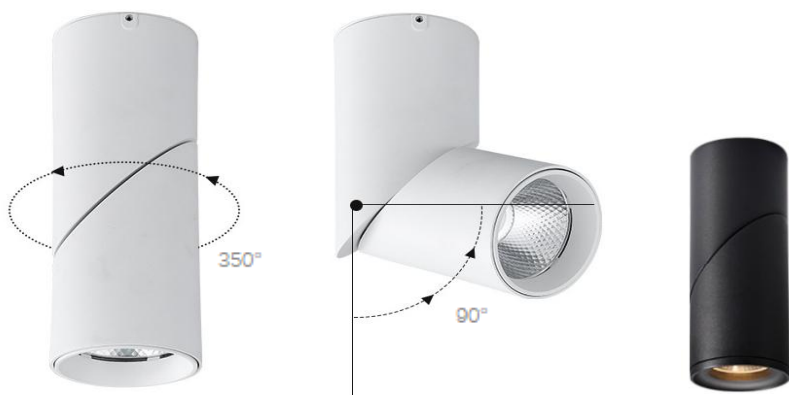
GR-DL-Z-02 Series

90° adjustable+350° rotation

Order Model	Power Watt	Dimension mm	CRI	IP Grade	Beam anlge
GR-DL-10WZ-02	10W	Ø60*H180	>90	IP22	15/24/36°
GR-DL-15WZ-02	15W	Ø60*H180	>90	IP22	15/24/36°
GR-DL-20WZ-02	20W	Ø75*L200	>90	IP22	15/24/36°

GR-DL-Z-01 Series

90° adjustable+360° rotation



Order Model	Power Watt	Dimension mm	CRI	IP Grade	Beam anlge
GR-DL-10WZ-01	10W	Ø60*H162	>90	IP22	15/24/36°
GR-DL-15WZ-01	15W	Ø76*H172	>90	IP22	15/24/36°
GR-DL-20WZ-01	20W	Ø82*H182	>90	IP22	15/24/36°
GR-DL-25WZ-01	25W	Ø82*H182	>90	IP22	15/24/36°

GR-DL-5WC Series

90° adjustable+360° rotation

Order Model	Power Watt	Dimension mm	Output mm	IP Grade	Beam anlge
GR-DL-5WC100	5W	Ø65*L100	Ø50-55	IP22	15/24/36°
GR-DL-5WC200	5W	Ø65*L200	Ø50-55	IP22	15/24/36°
GR-DL-5WC300	5W	Ø65*L300	Ø50-55	IP22	15/24/36°



SQUARE LED DOWNLIGHT



- Osram/Bridgelux COB Chips, CRI90.2700K-6500K
- 110/220-240VAC LiFud/Eagleries/Philips/Osram/TRIDONIC driver,3/5 Years warranty.
- Optional: Triac /0-10V /DALI dimmable, Emergency kits .
- White/black body finished optional.



GR-DL-V-01 Series

30° adjustable

Trimless



Order Model	Power Watt	Dimension mm	Outcut mm	IP Grade	Beam anlge
GR-DL-7WV-01	7W	Ø65*55*H85	58*55mm	IP Grade	15/24/36/55°
GR-DL-10WV-01	10W	Ø85*85*H85	78*75mm	IP22	15/24/36/55°
GR-DL-12WV-01	12W	Ø85*85*H106	78*75mm	IP22	15/24/36/55°
GR-DL-15WV-01	15W	Ø85*85*H111	78*75mm	IP22	15/24/36/55°
GR-DL-20WV-01	20W	Ø105*H124	98*95mm	IP22	15/24/36/55°
GR-DL-2x7WV-01	2x7W	L115*65*H85	105*55mm	IP22	15/24/36/55°
GR-DL-2x10WV-01	2x10W	L155*85*H85	145*75mm	IP22	15/24/36/55°
GR-DL-2x12WV-01	2x12W	L155*85*H106	145*75mm	IP22	15/24/36/55°
GR-DL-2x15WV-01	2x15W	L155*85*H111	145*75mm	IP22	15/24/36/55°
GR-DL-2x20WV-01	2x20W	L195*105*H124	185*95mm	IP22	15/24/36/55°



Twin



GR-DL-V Series

30° adjustable



Order Model	Power Watt	Dimension mm	Outcut mm	IP Grade	Beam anlge
GR-DL-5WV	5W	Ø68*H70	55*55	IP22	15/24/36°
GR-DL-7WV	7W	Ø90*H92	75*75	IP22	15/24/36°
GR-DL-10WV	10W	Ø90*H92	75*75	IP22	15/24/36°
GR-DL-15WV	15W	Ø107*H107	95*95	IP22	15/24/36°

GR-DL-W-07 Series

IP65 Waterproof



Order Model	Power Watt	Dimension mm	Outcut mm	IP Grade	Beam anlge
GR-DL-10WW-07	10W	LW110*H59	95*95	IP65	60°
GR-DL-15WW-07	15W	LW130*H70	115*115	IP65	60°
GR-DL-20WW-07	20W	LW130*H70	115*115	IP65	60°
GR-DL-30WW-07	30W	LW165*H80	150*150	IP65	60°
GR-DL-40WW-07	40W	LW225*H90	205*205	IP65	90°

- Osram/Bridgelux COB Chips, CRI90.2700K-6500K
- 110/220-240VAC LiFud/Eagleries/Philips/Osram/TRIDONIC driver,3/5 Years warranty.
- Optional: Triac /0-10V /DALI dimmable, Emergency kits .
- White/black body finished optional.

GR-DLG-N Series

TOP Commercial



Order Model	Power Watt	Dimension mm	CRI	IP Grade	Beam anlge
GR-DLG-7WN	7W	Ø115*105	95mm	IP22	15/24/36°
GR-DLG-12WN	12W	Ø135*125	120mm	IP22	15/24/36°
GR-DLG-7WN*2	7W*2	Ø165*125	145-150mm	IP22	15/24/36°
GR-DLG-12WN*2	12W*2	Ø90*80	75mm	IP22	15/24/36°
GR-DLG-7WN*3	7W*3	Ø115*105	95mm	IP22	15/24/36°
GR-DLG-12WN*3	12W*2	Ø135*125	120mm	IP22	15/24/36°

GR-DLG-F Series

Pull out type

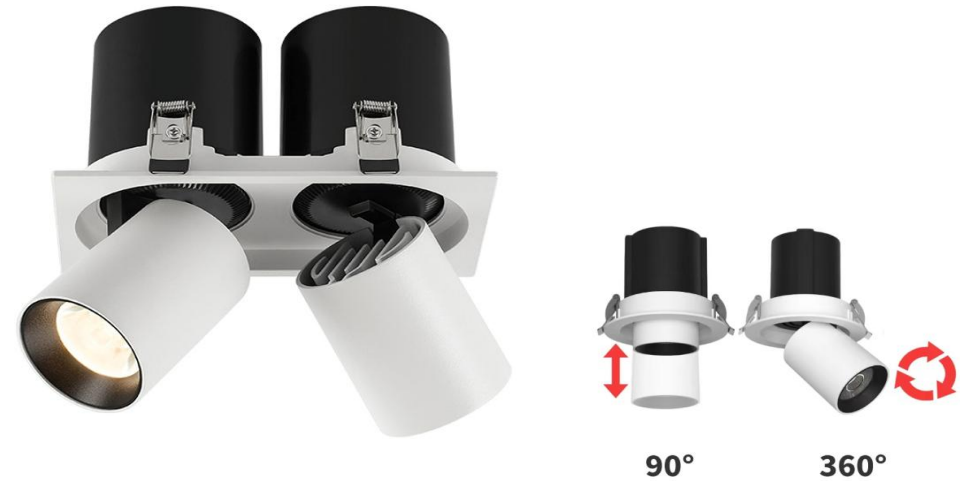

Order Model	Power Watt	Dimension mm	CRI	IP Grade	Beam anlge
GR-DLG-7WF	7W	Ø90*80	75mm	IP22	15/24/36°
GR-DLG-10WF	15W	Ø115*105	95mm	IP22	15/24/36°
GR-DLG-20WF	20W	Ø135*125	120mm	IP22	15/24/36°
GR-DLG-25WF	25W	Ø165*125	145-150mm	IP22	15/24/36°
GR-DLG-7WF*2	7W*2	Ø90*80	75mm	IP22	15/24/36°
GR-DLG-10WF*2	15W*2	Ø115*105	95mm	IP22	15/24/36°
GR-DLG-20WF*2	20W*2	Ø135*125	120mm	IP22	15/24/36°
GR-DLG-25WF*2	25W*2	Ø165*125	145-150mm	IP22	15/24/36°

- Osram/Bridgelux COB Chips, CRI90.2700K-6500K
- 110/220-240VAC LiFud/Eagleries/Philips/Osram/TRIDONIC driver,3/5 Years warranty.
- Optional: Triac /0-10V /DALI dimmable, Emergency kits .
- White/black body finished optional.

GR-DLG-E Series

30° adjustable



Order Model	Power Watt	Dimension mm	Outcut mm	IP Grade	Beam anlge
GR-DLG-10WE	10W	L130*W130	L110*W110	IP22	15/24/36°
GR-DLG-15WE	15W	L145*W145	L125*W125	IP22	15/24/36°
GR-DLG-20WE	20W/25W	L185*W185	L160*W160	IP22	15/24/36°
GR-DLG-10WE*2	10W*2	W130*L225	L205*W110	IP22	15/24/36°
GR-DLG-15WE*2	15W*2	L255*W145	L240*W125	IP22	15/24/36°
GR-DLG-20WE*2	20W*2	L365*W145	L345*W125	IP22	15/24/36°
GR-DLG-10WE*3	10W*3	W130*L325	L305*W110	IP22	15/24/36°
GR-DLG-15WE*3	15W*3	L365*W145	L345*W125	IP22	15/24/36°
GR-DLG-20WE*3	20W*3	L485*W185	L460*W160	IP22	15/24/36°

GR-DLG-A Series

Fixed / UGR<19



Order Model	Power Watt	Dimension mm	Outcut mm	IP Grade	Beam anlge
GR-DLG-10WA	10W	L85*W85*68	L75*W75	IP22	15/24/36°
GR-DLG-10WA*2	10W*2	L168*W85	L160*75	IP22	15/24/36°
GR-DLG-10WA*3	10W*3	L256*W85	L245*W75	IP22	15/24/36°
GR-DLG-10WA*4	10W*4	L165*W165	L155*W155	IP22	15/24/36°

GR-DLG-B Series

30° adjustable



Order Model	Power Watt	Dimension mm	Outcut mm	IP Grade	Beam anlge
GR-DLG-10WB	10W-15W	L88*W88	L75*75	IP22	15/24/36°
GR-DLG-10WB*2	10W-15W*2	L168*W88	L160*75	IP22	15/24/36°
GR-DLG-10WB*3	10W-15W*3	L247*W88	L238*W75	IP22	15/24/36°
GR-DLG-10WB*4	10W-15W*4	L168*W168	L160*W160	IP22	15/24/36°



GR-DLG-L Series

Ultra thin



Order Model	Power Watt	Dimension mm	CRI	IP Grade	Beam anlge
GR-DLG-10WL	10W	115*115*55	>90	IP22	15/24/36°
GR-DLG-10WL*2	10W*2	223*115*55	>90	IP22	15/24/36°
GR-DLG-10WL*3	10W*3	328*115*55	>90	IP22	15/24/36°
GR-DLG-10WL*4	10W*4	225*225*55	>90	IP22	15/24/36°

GR-DLG-H Series



Order Model	Power Watt	Dimension mm	CRI	IP Grade	Beam anlge
GR-DLG-10WH	10W	100*100	>90	IP22	15/24/36°
GR-DLG-10WH*2	10W*2	200*100	>90	IP22	15/24/36°
GR-DLG-10WH*4	10W*4	200*200	>90	IP22	15/24/36°

- Osram/Bridgelux COB Chips, CRI90.2700K-6500K
- 110/220-240VAC LiFud/Eagleries/Philips/Osram/TRIDONIC driver,3/5 Years warranty.
- Optional: Triac /0-10V /DALI dimmable, Emergency kits .
- White/black body finished optional.

GR-DLG-K Series

30° adjustable



Order Model	Power Watt	Dimension mm	CRI	IP Grade	Beam anlge
GR-DLG-10WK	10W	L168*W90	>90	IP22	15/24/36°
GR-DLG-15WK	15W	L250*W140	>90	IP22	15/24/36°
GR-DLG-20WK	20W-25W	L250*W140	>90	IP22	15/24/36°
GR-DLG-10WK*2	10W*2	L210*W115	>90	IP22	15/24/36°
GR-DLG-15WK*2	15W*2	L300*W160	>90	IP22	15/24/36°
GR-DLG-20WK*2	20W-25W*2	L300*W160	>90	IP22	15/24/36°

- Osram/Bridgelux COB Chips, CRI90.2700K-6500K
- 110/220-240VAC LiFud/Eagleries/Philips/Osram/TRIDONIC driver,3/5 Years warranty.
- Optional: Triac /0-10V /DALI dimmable, Emergency kits .
- White/black body finished optional.

GR-FM-F Series

IP65 Waterproof



Black/White/Silver/Gun/ gold/rose gold

Order Model	Power Watt	Dimension mm	CRI k	IP Grade	Beam anlge
GR-FM-10WF	10-12W	Ø75*118mm	>90	IP65	50°
GR-FM-15WF	15W	Ø95*128mm	>90	IP65	50°
GR-FM-20WF	20W	Ø95*128mm	>90	IP65	50°
GR-FM-25WF	25W	Ø120*150mm	>90	IP65	50°
GR-FM-30WF	30W	Ø120*150mm	>90	IP65	50°
GR-FM-40WF	35-40W	Ø148*180mm	>90	IP65	50°
GR-FM-50WF	50W	Ø171*200mm	>90	IP65	50°

GR-FM-A Series



Order Model	Power Watt	Dimension mm	CRI	IP Grade	Beam anlge
GR-FM-10WA	10-12W	Ø75*118mm	>90	IP20	15/24/36°
GR-FM-15WA	15W	Ø95*128mm	>90	IP20	15/24/36°
GR-FM-20WA	20W	Ø95*128mm	>90	IP20	15/24/36°
GR-FM-25WA	25W	Ø120*120mm	>90	IP20	24/36/60°
GR-FM-30WA	30W	Ø140*140mm	>90	IP20	24/36/60°
GR-FM-35WA	35W	Ø160*160mm	>90	IP20	24/36/60°
GR-FM-45WA	45W	Ø160*160mm	>90	IP20	24/36/60°
GR-FM-60WA	60W	Ø190*100mm	>90	IP20	24/36/60°

GR-FM-D Series

Square



Order Model	Power Watt	Dimension mm	CRI	IP Grade	Beam anlge
GR-FM-7WD	7W	Ø55*55*80	>90	IP22	15/24/36°
GR-FM-10WD	10W	Ø75*75*95	>90	IP22	15/24/36°
GR-FM-12WD	12W	Ø75*75*130	>90	IP22	15/24/36°
GR-FM-15WD	15W	Ø95*95*110	>90	IP22	15/24/36°
GR-FM-20WD	20W	Ø115*115*110	>90	IP22	15/24/36°
GR-FM-25WD	25W	Ø115*115*160	>90	IP22	15/24/36°

- Osram/Bridgelux COB/SMD Chips, CRI90.2700K-6500K
- 110/220-240VAC LiFud/Eagleries/Philips/Osram/TRIDONIC driver,3/5 Years warranty.
- Optional: Triac /0-10V /DALI dimmable, Emergency kits .
- White/black body finished optional.



Pendant

GR-FM-Q Series

Competitive items

Order Model	Power Watt	Dimension mm	CRI	IP Grade	Beam anlge
GR-FM-5WQ	5W	φ88*72	>80	IP20	110°
GR-FM-7WQ	7W	φ105*75	>80	IP20	110°
GR-FM-9WQ	9W	φ138*75	>80	IP20	110°
GR-FM-12WQ	12W	φ160*75	>80	IP20	110°
GR-FM-18WQ	18W	φ178*75	>80	IP20	110°
GR-FM-24WQ	24W	φ230*100	>80	IP20	110°

GR-FM-S Series

Adjustable beam angle



Order Model	Power Watt	Dimension mm	CRI k	IP Grade	Beam anlge
GR-FM-10WS	10W	φ75*150	>90	IP22	15/24/36°
GR-FM-15WS	15W	φ95*150	>90	IP22	15/24/36°
GR-FM-20WS	20W	φ115*160	>90	IP22	15/24/36°



GR-FM-E Series

Order Model	Power Watt	Dimension mm	CRI	IP Grade	Beam anlge
GR-FM-10WE	10W	φ105*95mm	>90	IP22	110°
GR-FM-15WE	15W	φ138*95mm	>90	IP22	110°
GR-FM-20WE	20W	φ160*105mm	>90	IP22	110°
GR-FM-24WE	24W	φ180*110mm	>90	IP22	110°
GR-FM-30WE	30W	φ220*120mm	>90	IP22	110°



GR-CD-A Series

Ultra-thin **IP20**

Order Model	Power Watt	Dimension mm	CRI	IP Grade	Beam angle
GR-CD-12WA	12W	Ø280*50mm	>80	IP20	110°
GR-CD-18WA	18W	Ø320*50mm	>80	IP20	110°
GR-CD-24WA	24W	Ø380*50mm	>80	IP20	110°
GR-CD-36WA	36W	Ø430*50mm	>80	IP20	110°

GR-CD-E Series

Ultra-thin **IP65**



Order Model	Power Watt	Dimension mm	CRI	IP Grade	Beam angle
GR-CD-12WE	12W	Ø240*50	>80	IP20	110°
GR-CD-18WE	18W	Ø300*50	>80	IP20	110°
GR-CD-24WE	24W	Ø400*50	>80	IP20	110°
GR-CD-30WE	30W	Ø400*50	>80	IP20	110°

- Epistar/Bridgelux SMD Chips, CRI80.2700K-6500K
- 110/220-240VAC Constant current driver,2/3Years warranty.
- Chips+ Lens+ PC Cover .



GR-CD-H Series

Emergency kits available

Motion Sensor available

IP65 Waterproof

Order Model	Power Watt	Dimension mm	CRI	IP Grade	Beam angle
GR-CD-12WH	12W	Ø275*H80	>80	IP65	110°
GR-CD-15WH	15W	Ø275*H80	>80	IP65	110°
GR-CD-18WH	18W	Ø275*H80	>80	IP65	110°
GR-CD-24WH	24W	Ø325*H90	>80	IP65	110°
GR-CD-30WH	30W	Ø325*H90	>80	IP65	110°

- Epistar/Bridgelux SMD Chips, CRI80/90, 2700K-6500K
- 110/220-240VAC Constant current driver, 2/3/5Years warranty.
- .Each lamp with LED driver and work independently, but they can seamlessly connection

GR-LS5070 Series

Pendant/ Surface Linear lights

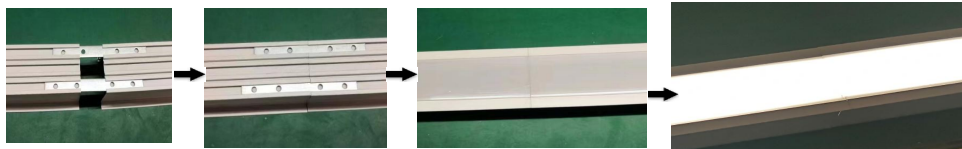
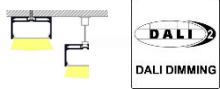

.Each lamp with LED driver and work independently, but they can seamlessly connection

Order Model	Power Watt	Dimension mm	CRI	IP Grade
GR-LS5070-120	36W-40W	L1185*W50*H70	>80/90	IP22
GR-LS5070-150	45W-50W	L1485*W50*H70	>80/90	IP22
GR-LS5070-240	72W-80W	L2390*W50*H50	>80/90	IP22

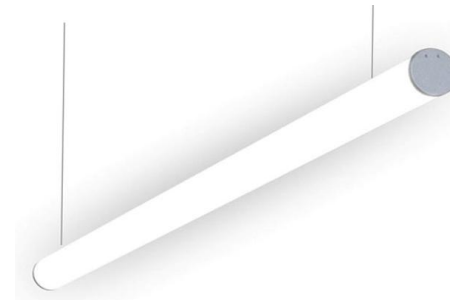

Order Model	Power Watt
GR-LS60-120CM	36W
GR-LS60-150CM	45W

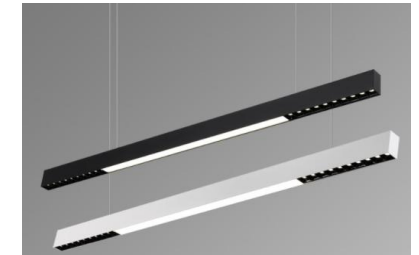

Combined pendant lamp
Model:GR-LS6633-36W
Size:L1065*W33*H66mm

GR-LS5035/6535 Series

Recessed Linear Light

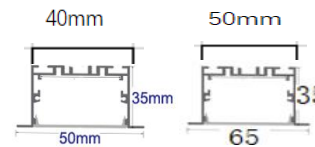

Order Model	Power Watt	Length mm	Outcut mm	CRI	IP Grade
GR-LS5035-120	36W	1200	W40*H65	>80/90	IP22
GR-LS5035-150	48W	1500	W40*H65	>80/90	IP22
GR-LS5035-240	60W	2400	W40*H65	>80/90	IP22
GR-LS6535-120	36W	1200	W52*H65	>80/90	IP22
GR-LS6535-150	48W	1500	W52*H65	>80/90	IP22
GR-LS6535-240	72W	2400	W52*H65	>80/90	IP22

- Osram/Bridgelux SMD Chips, 100-130lm/W output, 2700K-6500K
- AC/DC12V/ 24V/36V 48V or 110/220-240VAC,3/5 Years warranty.
- Emergency kits/ Surface/ Suspension installation options.

GR-TP-A Series

PC Bottom+PC Cover
Steel clips



Options



Onekey set the Watt. of the drive



Onekey set the Emergency



Onekey set the Microwave Sensor

Order Model	Power Watt	Dimension mm	CRI	PF	IP Grade
GR-TP-2F1A	10W	600*82*72	>80/90	>0.9	IP65
GR-TP-2F2A	18-20W	600*82*72	>80/90	>0.95	IP65
GR-TP-4F1A	18W	1200*82*72	>80/90	>0.95	IP65
GR-TP-4F2A	36-40W	1200*82*72	>80/90	>0.95	IP65
GR-TP-5F1A	30W	1500*82*72	>80/90	>0.95	IP65
GR-TP-5F2A	50-60W	1500*82*72	>80/90	>0.95	IP65
GR-TP-6F2A	50-60W	1800*82*72	>80/90	>0.95	IP65

GR-TP-B Series

ABS Bottom+PC Cover
Including T8 LED Tube

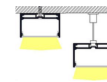

Order Model	Power Watt	Dimension mm	CRI	Source	IP Grade
GR-TP-2F1B	9W	655*75*86	>80/90	1pcs*2ft T8	IP65
GR-TP-2F2B	2*9W	655*113*86	>80/90	2pcs*2ft T8	IP65
GR-TP-4F1B	18W	1265*75*86	>80/90	1pcs*4ft T8	IP65
GR-TP-4F2B	2*18W	1265*113*86	>80/90	2pcs*4ft T8	IP65
GR-TP-5F1B	22W	1565*75*86	>80/90	1pcs*5ft T8	IP65
GR-TP-5F2B	2*22W	1565*113*86	>80/90	2pcs*5ft T8	IP65

GR-TP-D Series

Whole plastic body+Al heat

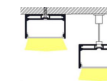

Order Model	Power Watt	Dimension mm	CRI	Source	IP Grade
GR-TP-2F2D	20-24W	622*73*51	>80/90	1pcs*2ft T8	IP65
GR-TP-4F2D	40-48W	1223*73*51	>80/90	2pcs*2ft T8	IP65
GR-TP-5F2D	60W	1525*73*52	>80/90	1pcs*4ft T8	IP65

- Osram/Bridgelux SMD Chips, 100-130lm/W output, 2700K-6500K
- AC/DC12V/ 24V/36V 48V or 110/220-240VAC, 2/3 Years warranty.



T5 LED Batten		
Model	Length	Wattage
GR-T5-60	600mm	9W
GR-T5-120	1200mm	18W
GR-T5-150	1500mm	22W



Dust-proof LED Batten IP44		
Model	Length	Wattage
GR-TP-2F2L	600mm	18W
GR-TP-4F2L	1200mm	36W
GR-TP-5F2L	1500mm	45W

GR-TP-G Series

Series connection
Surface mounted



Order Model	Power Watt	Dimension mm	CRI	PF	IP Grade
GR-TP-2F2G	18W	622*50*40	>80/90	>0.9	IP20
GR-TP-4F2G	36W	1223*50*40	>80/90	>0.9	IP20
GR-TP-5F2G	40W	1525*50*40	>80/90	>0.9	IP20



IP65 Waterproof T8 LED Tube		
Model	Length	Wattage
GR-T8-60A	600mm	9W
GR-T8-120A	1200mm	18W
GR-T8-150A	1500mm	22W



T8 LED Tube Light		
Model	Length	Wattage
GR-T860-9W	600mm	9W
GR-T8120-18W	1200mm	18W
GR-T8150-22W	1500mm	22W

GR-TP-N Series

MOQ200PCS/Model
Surfac/pendant



Order Model	Power Watt	Dimension mm	CRI	PF	IP Grade
GR-TP-2F2N	20-30W	622*135*68	>80/90	>0.9	IP20
GR-TP-4F2N	40-60W	1226*135*68	>80/90	>0.9	IP20
GR-TP-5F2N	60-80W	1525*135*68	>80/90	>0.9	IP20

- Lumileds/Bridgelux SMD Chips, 130-190lm/W output, 2700K-6500K
- Moso/Philips/Meanwell/SUNCOM Driver 110/220^o-277VAC, 3/5 Years warranty.
- Available to be cord with AU UK Plug

GR-HB-A Series
Classic



Order Model	Power Watt	LED QTY PCS	CRI	Beam angle	IP Grade
GR-HB-100WA	100W	133pcs	>80	60/90/120°	IP65
GR-HB-150WA	150W	192pcs	>80	60/90/120°	IP65
GR-HB-200WA	200W	280pcs	>80	60/90/120°	IP65
GR-HB-240WA	240W	280pcs	>80	60/90/120°	IP65

GR-HB-B Series
Highest lumen 150-200lm/W



Bracket

Options



Emergency kits



DALI DIMMING





Power

60%
80%
100%

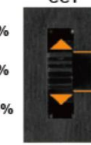

CCT

3000K
4000K
5000K



Selectable Power



CCT

DIP Selectable Wattages+ 3 Color temp in 1 light

Order Model	Power Watt	Lumens lm	Beam angle	Input	IP Grade
GR-HB-100WB	100W	>16000lm	60/90/120°	100-277V	IP65
GR-HB-150WB	150W	>24000lm	60/90/120°	100-277V	IP65
GR-HB-200WB	200W	>32000lm	60/90/120°	100-277V	IP65

- Lumileds/Bridgelux SMD Chips, 130-190lm/W output, 2700K-6500K
- Moso/Philips/Meanwell/SUNCOM Driver 110/220-277VAC, 3/5 Years warranty.

GR-HB-E Series

100-265VAC or AC/DC12V 24V 36V 48V 60V optional

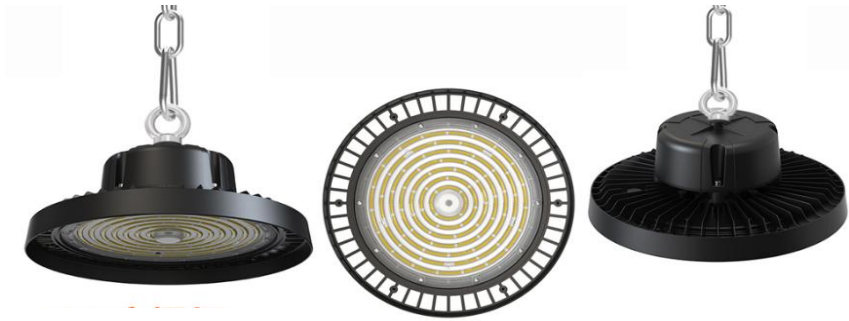

100W-300W

GR-HB-B-1 Series

Top level

150lm-200lm/W



400W 480W



100-265VAC Type



AC/DC12V 24V 36V 48V 60V Input with bracket



Order Model	Power Watt	Lumens	Diameter	Beam angle	IP Grade
GR-HB-100WB-1	100W	15000lm	Ø250	60/90/120°	IP65
GR-HB-150WB-1	150W	22500lm	Ø300	60/90/120°	IP65
GR-HB-200WB-1	200W	30000lm	Ø345	60/90/120°	IP65
GR-HB-300WB-1	300W	60000lm	Ø385	60/90/120°	IP65
GR-HB-400WB-1	400W	80000lm	Ø490	60/90/120°	IP54
GR-HB-480WB-1	480W	80000lm	Ø490	60/90/120°	IP54

Order Model	Power Watt	Lumens Im	IP Grade	Beam angle	Input voltage
GR-HB-100WE	100W	13000lm	IP65	90°	110/220VAC
GR-HB-150WE	150W	195000lm	IP65	90°	/
GR-HB-200WE	200W	26000lm	IP65	90°	DC12V/24V/36V/48V/60V
GR-HB-240WE	240W	32000lm	IP65	90°	

GR-HB-F Series

Square High Bay Light

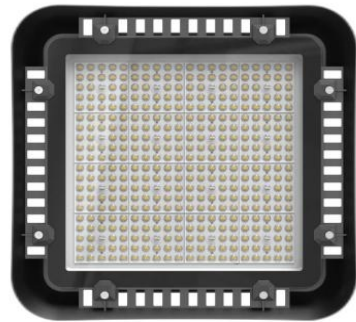
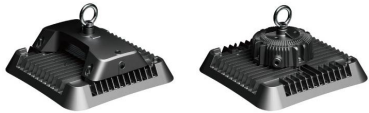

Wire install



Surface



Adjustable Joint



Bracket



Wall mount

Order Model	Power Watt	Lumens lm	Beam angle	Input	IP Grade
GR-HB-100WF	100W	16000lm	60/90/120°	100-277V	IP65
GR-HB-150WF	150W	24000lm	60/90/120°	100-277V	IP65
GR-HB-200WF	200W	32000lm	60/90/120°	100-277V	IP65

GR-HB-02 Series

Sensor High Bay Light

Microwave-sensing high-bay lights: can achieve full brightness when people come, 20%, 30%, 50% lighting effect when people walk away, sensing distance 12-15 meters



Order Model	Power Watt	Lumens lm	Beam angle	Input	IP Grade
GR-HB-100WB-02	100W	16000lm	60/90/120°	100-277V	IP65
GR-HB-150WB-02	150W	24000lm	60/90/120°	100-277V	IP65
GR-HB-200WB-02	200W	32000lm	60/90/120°	100-277V	IP65

GR-HB-L Series

Surface/Pendant



Order Model	Power Watt	Lumens PCS	Length mm	Beam angle	IP Grade
GR-SL-50WL	50W	6000lm	353mm	90°	IP65
GR-SL-100WL	100W	12000lm	557mm	90°	IP65
GR-SL-150WL	150W	18000lm	823mm	90°	IP65
GR-SL-200WL	200W	24000lm	1089mm	90°	IP65
GR-SL-250WL	250W	30000lm	1355mm	90°	IP65

GR-HB-M Series

Copper heat Channel



Feature

- Three different driver installation.
- Philips SMD LED Chips, 110-120lm/W output,60/90°/120° beam angle.
- Meanwell/Philips/Isolated constant current led driver CE approval, 2/3/5Years warranty,

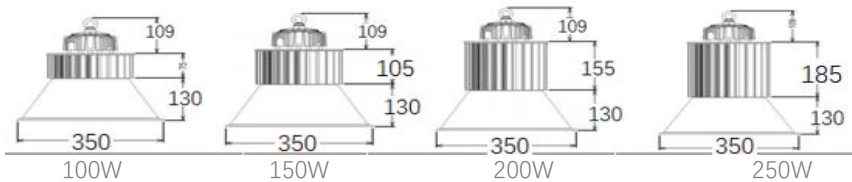

Order Model	Power Watt	LED QTY PCS	CRI	PF	IP Grade
GR-HB-100WM	100W	105pcs	>80	>0.95	IP65
GR-HB-150WM	150W	154pcs	>80	>0.95	IP65
GR-HB-200WM	200W	203pcs	>80	>0.95	IP65
GR-HB-250WM	250W	252pcs	>80	>0.95	IP65

GR-HB-N Series

Economy High Bay Lights

60/90/120° aluminum cover options



Order Model	Power Watt	Lumens lm	Beam angle °	PF	IP Grade
GR-HB-50WN	50W	5500lm	60/90/120°	>0.95	IP54
GR-HB-100WN	100W	11000lm	60/90/120°	>0.95	IP54
GR-HB-150WN	150W	16500lm	60/90/120°	>0.95	IP54
GR-HB-200WN	200W	22000lm	60/90/120°	>0.95	IP54
GR-HB-300WN	300W	33000lm	60/90/120°	>0.95	IP54

- Aluminum body+ Toughed glass cover
- Lumileds/Bridgelux SMD Chips, 110-140lm/W output, 2700K-6500K
- Photocell / 0-10V/Triac /DALI Dimmable / SPD(10-20KV) optional
- DONE /Meanwell/ PHILIPS Driver, 3/5Years warranty, 100-277VAC 50/60Hz

GR-FL-A Series

60/90/120° - 130lm/W

Top level



GR-FL-A-01 Series

100-265VAC/ DC12V 24V 36V 48V Option



Options



AC/DC12V 24V 36V 48V 60V Input options



Photocell (dusk to dawn)

Order Model	Power Watt	Lumens lm	Beam angle	IP Grade	Voltage
GR-FL-50WA	50W	6500lm	60/90/120°	IP66	100-265V
GR-FL-100WA	100W	13000lm	60/90/120°	IP66	100-265V
GR-FL-150WA	150W	21000lm	60/90/120°	IP66	100-265V
GR-FL-200WA	200W	26000lm	60/90/120°	IP66	100-265V
GR-FL-300WA	300W	39000lm	60/90/120°	IP66	100-265V
GR-FL-400WA	300W	42000lm	60/90/120°	IP66	100-265V

Order Model	Power Watt	Lumens lm	Beam angle	IP Grade	Voltage
GR-FL-20WA-01	20W	2000lm	120°	IP66	220V or AC/DC12V/24V/36V/48V/60V optional
GR-FL-30WA-01	30W	3000lm	120°	IP66	
GR-FL-50WA-01	50W	5000lm	120°	IP66	
GR-FL-100WA-01	100W	10000lm	120°	IP66	
GR-FL-150WA-01	150W	15000lm	120°	IP66	
GR-FL-200WA-01	200W	20000lm	120°	IP66	

GR-FL-M Series

50W/Modular. 130-160lm/W



Options



Emergency kits



AC/DC12V/24V/36V/48V optional

Order Model	Power Watt	Dimension mm	Input voltage	IP Grade	Beam angle
GR-FL-50WM	50W	75*315*140	100-277VAC	IP66	60/90/75*150°
GR-FL-100WM	100W	156*315*140	100-277VAC	IP66	60/90/75*150°
GR-FL-150WM	150W	237*315*140	100-277VAC	IP66	60/90/75*150°
GR-FL-200WM	200W	324*315*140	100-277VAC	IP66	60/90/75*150°
GR-FL-250WM	250W	399*315*140	100-277VAC	IP66	60/90/75*150°
GR-FL-300WM	300W	474*304*145	100-277VAC	IP66	60/90/75*150°
GR-FL-400WM	400W	324*610*140	100-277VAC	IP66	60/90/75*150°
GR-FL-500WM	500W	399*610*140	100-277VAC	IP66	60/90/75*150°

GR-FL-G Series

250W/Module 130-160lm/w



Options



with Shading cover

Order Model	Power Watt	LED QTY PCS	Beam angle	IP Grade	Voltage
GR-FL-250WG	250W±5%	343pcs	25°/60°/90°	IP66	100-265V
GR-FL-500WG	500W±5%	686pcs	25°/60°/90°	IP66	100-265V
GR-FL-750WG	750W±5%	1029pcs	25°/60°/90°	IP66	100-265V
GR-FL-1000WG	1000W±5%	1372pcs	25°/60°/90°	IP66	100-265V
GR-FL-1500WG	1500W±5%	2178pcs	25°/60°/90°	IP66	100-265V
GR-FL-2000WG	2000W±5%	2744pcs	25°/60°/90°	IP66	100-265V

GR-FL-E Series

100W/Module 130-160lm/w



Order Model	Power Watt	Dimension mm	Beam angle	IP Grade	Voltage
GR-FL-100WE	100W±5%	120*335*125	25°/60°/90°	IP66	100-265V
GR-FL-200WE	200W±5%	246*335*125	25°/60°/90°	IP66	100-265V
GR-FL-300WE	300W±5%	372*335*125	25°/60°/90°	IP66	100-265V
GR-FL-400WE	400W±5%	500*335*125	25°/60°/90°	IP66	100-265V
GR-FL-600WE	600W±5%	372*626*125	25°/60°/90°	IP66	100-265V

GR-FL-SL Series

Solar Flood light



Feature

- High quality Solar Panel, high efficiency
- LiFepo4 Li-battery, very stable and long duration.
- Remote controller included, easy to do adjust the brightness and working time.
- The glass cover and the battery are fixed with screws, which can be removed and replaced

Order Model	Power Watt	LiFepo4 Battery	Solar Panel	IP Grade	Duration
GR-FL-40WSL	40W	3.2V 5AH	6V 8W	IP65	2raining day
GR-FL-60WSL	60W	3.2V 10AH	6V 12W	IP65	2raining day
GR-FL-120WSL	120W	3.2V 15AH	6V 15W	IP65	2raining day
GR-FL-200WSL	200W	3.2V 20AH	6V 25W	IP65	2raining day
GR-FL-300WSL	300W	3.2V 25AH	6V 30W	IP65	2raining day
GR-FL-400WSL	400W	3.2V 30AH	6V 35W	IP65	2raining day
GR-FL-500WSL	500W	3.2V 40AH	6V 40W	IP65	2raining day

GR-SL-H-01 Series

TOP Garden street light



Type Y



Adjustable joint type



Type 7

Order Model	Power Watt	Lumens lm	Input	IP Grade	Install Diameter
GR-SL-20WH-01	20W	3000lm	100-265V	IP65	Φ60/75mm
GR-SL-30WH-01	30W	4500lm	100-265V	IP65	Φ60/75mm
GR-SL-50WH-01	50W	7500lm	100-265V	IP65	Φ60/75mm
GR-SL-70WH-01	70W	8400lm	100-265V	IP65	Φ60/75mm
GR-SL-100WH-01	100W	13000lm	100-265V	IP65	Φ60/75mm
GR-SL-150WH-01	150W	20000lm	100-265V	IP65	Φ60/75mm

GR-SL-R Series

Adjustable garden street light



Order Model	Power Watt	Dimension mm	Install diameter
GR-SL-50WR	50W	390*125*62	D50
GR-SL-100WR	100W	465*145*73	D60
GR-SL-150WR	150W	535*160*73	D60
GR-SL-200WR	200W	605*200*73	D60

GR-TY Series

Garden street light



Order Model	Power Watt	Lumens lm	Input	IP Grade	Install Diameter
GR-TY-20W	20W	3000lm	100-265V	IP65	Φ60/75mm
GR-TY-30W	30W	4500lm	100-265V	IP65	Φ60/75mm
GR-TY-50W	50W	7500lm	100-265V	IP65	Φ60/75mm
GR-TY-70W	70W	8400lm	100-265V	IP65	Φ60/75mm
GR-TY-100W	100W	13000lm	100-265V	IP65	Φ60/75mm
GR-TY-150W	150W	20000lm	100-265V	IP65	Φ60/75mm

GR-SL-K Series

Economy



Order Model	Power Watt	Dimension mm	Install diameter
GR-SL-50WK	50W	390*125*62	D50
GR-SL-100WK	100W	465*145*73	D60
GR-SL-150WK	150W	535*160*73	D60
GR-SL-200WK	200W	605*200*73	D60

GR-SL-B-01 Series

Long linear street light
50W/Modular



Order Model	Power Watt	Dimension mm	Lumens	IP Grade	Install Diameter
GR-SL-50WB-01	50W	265*103*77	6500lm	IP65	Φ60mm
GR-SL-100WB-01	100W	520*103*77	13000lm	IP65	Φ60mm
GR-SL-150WB-01	150W	775*103*77	19000lm	IP65	Φ60mm
GR-SL-200WB-01	200W	1030*103*77	25000lm	IP65	Φ60mm

GR-SL-C Series



Feature

- Grey/black finished
- Philips SMD3030 or COB, 100-110lm/W Output
- Photocell / 0-10V/Triac /DALI Dimmable options
- Isolated waterproof driver. 100-240VAC as standard, AC/DC12V 24V 48V available



Order Model	Power Watt	LED QTY PCS	PF	IP Grade	Install Diameter
GR-SL-50WC	50W	1pcs	>0.95	IP65	Φ50mm
GR-SL-100WC	100W	2pcs	>0.95	IP65	Φ60mm
GR-SL-150WC	150W	3pcs	>0.95	IP65	Φ60mm
GR-SL-200WC	200W	4pcs	>0.95	IP65	Φ60mm
GR-SL-250WC	250W	5pcs	>0.95	IP65	Φ60mm

- Integrated module heat sink., good for projects
- Philips SMD3030, 110-150lm/W Output
- DONE/PHILIPS/MEANWELL Driver,100-277VAC 50/60Hz or 12V/24V/36V/48VDC 2/3/5Years warranty
- Photocell / 0-10V/Triac Dimmable options. 70*140° beam angle

GR-SL-B Series
Popular modular type
50W/Modular

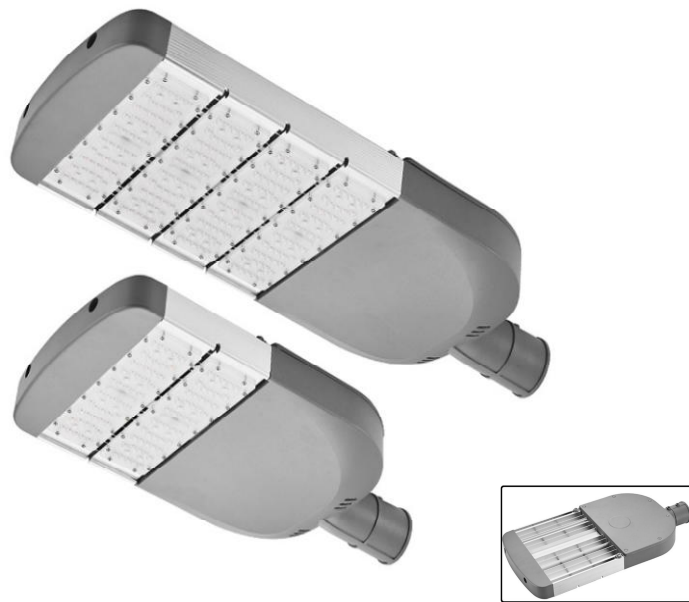

Order Model	Power Watt	Lumens lm	Input	IP Grade	Install Diameter
GR-SL-100WB	100W	13000lm	100-265V	IP65	Φ60mm
GR-SL-150WB	150W	19000lm	100-265V	IP65	Φ60mm
GR-SL-200WB	200W	26000lm	100-265V	IP65	Φ60mm
GR-SL-250WB	250W	31000lm	100-265V	IP65	Φ60mm
GR-SL-300WB	300W	38000lm	100-265V	IP65	Φ60mm
GR-SL-400WB	400W	50000lm	100-265V	IP65	Φ60mm

GR-SL-B-02 Series

Competitive Modular
110V-240VAC OR DC12V/24V/36V/48V optional

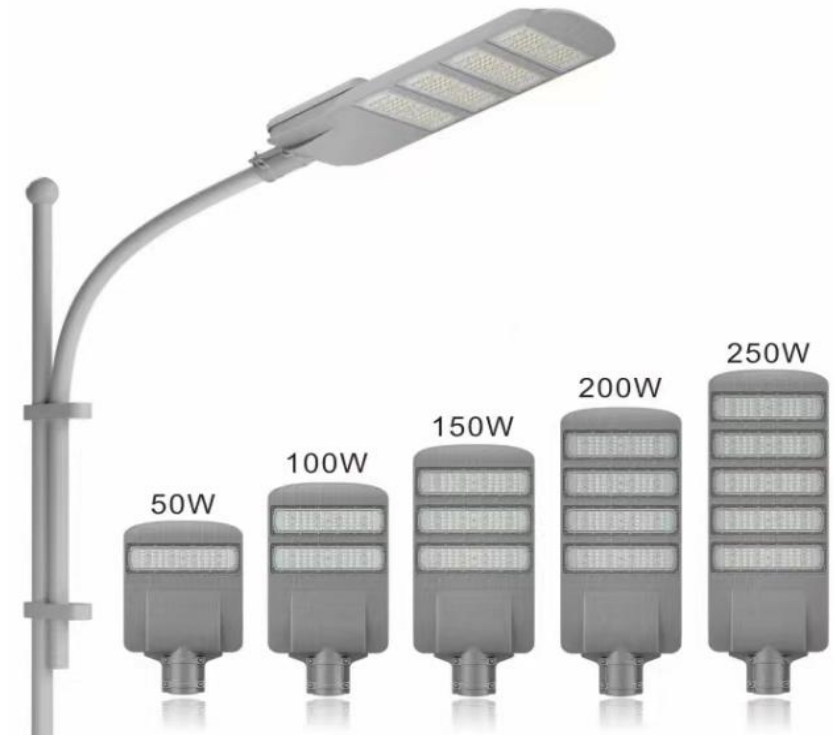

Order Model	Power Watt	Lumens lm	Input	IP Grade	Install Diameter
GR-SL-100WB-02	100W	11000lm	110-220V or 12V 24V 36V 48VDC	IP66	Φ60mm
GR-SL-150WB-02	150W	18000lm		IP66	Φ60mm
GR-SL-200WB-02	200W	24000lm		IP66	Φ60mm
GR-SL-250WB-02	250W	29000lm		IP66	Φ60mm

- Adjustable 90°
- Lumileds/Bridgelux SMD Chips, 110-140lm/W output, 2700K-6500K
- Photocell / 0-10V/Triac /DALI Dimmable / SPD(10-20KV) optional
- DONE /Meanwell/ PHILIPS Driver, 3/5Years warranty, 100-277VAC 50/60Hz



GR-SL-D Series

90° adjustable
50W/Modular

Order Model	Power Watt	Lumens lm	PF	IP Grade	Install Diameter
GR-SL-100WD	100W	12000lm	>0.95	IP65	Φ60mm
GR-SL-150WD	150W	18000lm	>0.95	IP65	Φ60mm
GR-SL-200WD	200W	26000lm	>0.95	IP65	Φ60mm
GR-SL-250WD	250W	32000lm	>0.95	IP65	Φ60mm
GR-SL-300WD	300W	38000lm	>0.95	IP65	Φ60mm
GR-SL-400WD	400W	50000lm	>0.95	IP65	Φ60mm

GR-SL-D-02 Series

Removable modular
50W/modular



Order Model	Power Watt	LED QTY PCS	PF	IP Grade	Install Diameter
GR-SL-50WD-02	50W	64pcs	>0.95	IP66	Φ60mm
GR-SL-100WD-02	100W	128pcs	>0.95	IP66	Φ60mm
GR-SL-150WD-02	150W	192pcs	>0.95	IP66	Φ60mm
GR-SL-200WD-02	200W	256pcs	>0.95	IP66	Φ60mm
GR-SL-250WD-02	250W	320pcs	>0.95	IP66	Φ60mm

GR-SL-H Series

Top level-Tool free



Feature

- Clip parts, free-tool design
- Adjustable installation joint, 130-160lm/W output
- Meanwell/ Philips/ DONE driver top quality types, 3/5 Years warranty
- Photocell/ 0-10V dimmable/ Cut-off switch available, 60°/90°/120°/T2M/T3M/T4M beam angle



Order Model	Power Watt	Lumens lm	PF	IP Grade	Install Diameter
GR-SL-50WH	50-60W	7500lm	>0.95	IP66	Φ60mm
GR-SL-100WH	100W	14000lm	>0.95	IP66	Φ60mm
GR-SL-150WH	150-180W	22000lm	>0.95	IP66	Φ60mm
GR-SL-200WH	200W	28000lm	>0.95	IP66	Φ60mm
GR-SL-250WH	250W	33000lm	>0.95	IP66	Φ60mm
GR-SL-300WH	300W	42000lm	>0.95	IP66	Φ60mm

GR-SL-H-02 Series

Competitive item



Feature

- Lens cover+Toughed glass cover.
- Philips/osram SMD LED Chips, 110-150lm/W output. 70°*140° beam angle
- Isolated driver /Meanwell/ Philips/ DONE, 2/3/5 Years warranty. 6-20KV Surge protection

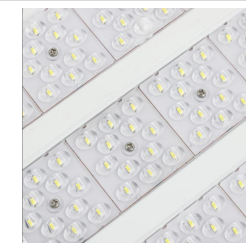

Order Model	Power Watt	LED QTY PCS	PF	IP Grade	Install Diameter
GR-SL-100WH-02	100W	112pcs	>0.95	IP66	Φ60mm
GR-SL-120WH-02	120W	168pcs	>0.95	IP66	Φ60mm
GR-SL-150WH-02	150W	224pcs	>0.95	IP66	Φ60mm

GR-SSL-E Series

Top level- All in Two



Order Model	Lumens Watt	LiFepo4 Battery	Solar Panel	IP Grade	Install height
GR-SSL-30WE	3000lm	12.8V 18AH	18V 40W	IP65	5-6m
GR-SSL-40WE	4000lm	12.8V 24AH	18V 50W	IP65	6-7m
GR-SSL-50WE	5000lm	12.8V 30AH	18V 65W	IP65	7-8m
GR-SSL-60WE	6000lm	12.8V 36AH	18V 80W	IP65	7-9m
GR-SSL-80WE	8000lm	12.8V 42AH	18V 100W	IP65	8-9m
GR-SSL-100WE	10000lm	12.8V 54AH	18V 130W	IP65	9-10m
GR-SSL-120WE	12000lm	12.8V 60AH	18V 170W	IP65	10-12m

GR-SSL-A Series

Top level-All in One



Order Model	Lumens Watt	LiFepo4 Battery	Solar Panel	IP Grade	Install height
GR-SSL-60WA	6000lm	12.8V 20AH	18V 60W	IP65	5-6m
GR-SSL-80WA	8000lm	12.8V 35AH	18V 80W	IP65	6-8m
GR-SSL-100WA	10000lm	12.8V 50AH	18V 100W	IP65	7-8m
GR-SSL-120WA	12000lm	12.8V 50AH	18V 130W	IP65	7-9m
GR-SSL-150WA	13000lm	12.8V 65AH	18V 170W	IP65	8-9m
GR-SSL-180WA	15000lm	12.8V 80AH	18V 200W	IP65	9-10m
GR-SSL-200WA	18000lm	25.6V 50AH	36V 220W	IP65	10-12m

GR-BD-R Series

Round aluminum body



Type 1



Type 2



Type 3

Order Model	Power Watt	Length mm	Materials	Input	IP Grade
GR-BD-12WR	12W	Ø225*H90	Aluminum+PC	100-240V	IP65
GR-BD-15WR	15W	Ø225*H90	Aluminum+PC	100-240V	IP65
GR-BD-18WR	18W	Ø275*H100	Aluminum+PC	100-240V	IP65
GR-BD-24WR	24W	Ø275*H100	Aluminum+PC	100-240V	IP65

GR-BD-S Series

Plastic body



Order Model	Shape	Power Watt	Length mm	Input	IP Grade
GR-BD-15WS-O	Oval	15W	215*115	100-240VAC	IP65
GR-BD-20WS-O	Oval	20W	270*145	100-240VAC	IP65
GR-BD-15WS-R	Round	15W	Ø165	100-240VAC	IP65
GR-BD-20WS-R	Round	20W	Ø220	100-240VAC	IP65

GR-BD-O Series

Oval aluminum body



Type 1



Type 2



Type 3

Order Model	Power Watt	Length mm	Materials	Input	IP Grade
GR-BD-12WO	12W	Ø225*W180	Aluminum+PC	100-240V	IP65
GR-BD-15WO	15W	Ø275*w180	Aluminum+PC	100-240V	IP65
GR-BD-18WO	18W	Ø275*w180	Aluminum+PC	100-240V	IP65

GR-BD-F Series

Square



Type 1



Type 2

Order Model	Power Watt	Length mm	Materials	Input	IP Grade
GR-BD-12WF	12W	Ø225*H90	Aluminum+PC	100-240VAC	IP65
GR-BD-15WF	15W	Ø225*H90	Aluminum+PC	100-240VAC	IP65
GR-BD-18WF	18W	Ø275*H100	Aluminum+PC	100-240VAC	IP65
GR-BD-24WF	24W	Ø275*H100	Aluminum+PC	100-240VAC	IP65



GR-BD-L-01 Series

Narrow Beam

Order Model	Power Watt	Dimension mm	Outcut mm	IP Grade
GR-BD-L-01	3W	185*40*H45	170*35*H50	IP65

GR-BD-L-02 Series

Rectangle



Order Model	Power Watt	Dimension mm	Outcut mm	IP Grade
GR-BD-L-02	5W	210*60*H55	205*55*H60	IP65

GR-BD-L-03 Series

Square



Order Model	Power Watt	Dimension mm	Outcut mm	IP Grade
GR-BD-L-03	3W	86*86*H45	80*80*H55	IP65

GR-BD-L-04 Series

Rectangle



Order Model	Power Watt	Dimension mm	Outcut mm	IP Grade
GR-BD-L-04	7W-18W	160*100*H60	155*95*H68	IP65

GR-BD-L-05 Series

Square

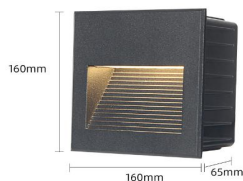

Order Model	Power Watt	Dimension mm	Outcut mm	IP Grade
GR-BD-L-05	12-18W	160*160*H65	155*155*H70	IP65

GR-BD-G Series

Long wall light

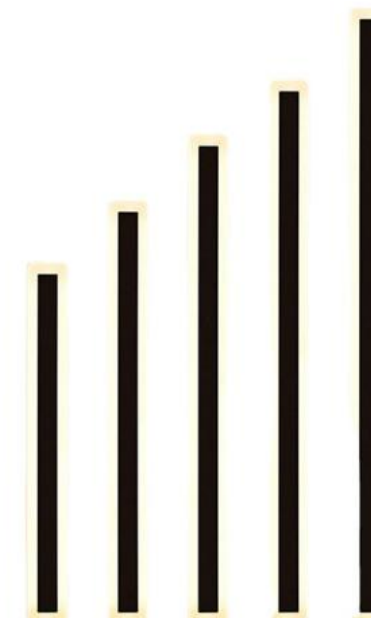

Order Model	Power Watt	Dimension mm	Input	IP Grade	Material
GR-BD-30G	6W	300*80*4.5	100-240V	IP65	Metal+PMMA
GR-BD-40G	9W	400*80*4.5	100-240V	IP65	Metal+PMMA
GR-BD-60G	12W	600*80*4.5	100-240V	IP65	Metal+PMMA
GR-BD-80G	15W	800*80*4.5	100-240V	IP65	Metal+PMMA
GR-BD-100G	20W	1000*80*4.5	100-240V	IP65	Metal+PMMA
GR-BD-120G	25W	1200*80*4.5	100-240V	IP65	Metal+PMMA
GR-BD-150G	28W	1500*80*4.5	100-240V	IP65	Metal+PMMA
GR-BD-180G	35W	1800*80*4.5	100-240V	IP65	Metal+PMMA

GR-BD-A Series

Up down Wall light



Order Model	Power Watt	Dimension mm	IP Grade
GR-BD-2x7WA	2x7W	Ø105*H85	IP66
GR-BD-2x10WA	2x10W	Ø110*H95	IP66
GR-BD-2x15WA	2x15W	Ø150*H100	IP66
GR-BD-2x20WA	2x20W	Ø195*H100	IP66

GR-BD-F Series

COB/ GU10 Outdoor Wall Light



Order Model	Power Watt	Dimension mm	IP Grade
GR-BD-5WF-Round	5W	L80*W70*H80	IP65
GR-BD-2x5WF-Round	2x5W	85*W70*H150	IP65
GR-BD-5WF-Square	5W	L80*W70*H80	IP65
GR-BD-2x5WF-Square	2x5W	85*W70*H150	IP65

GR-BD-B Series

Square Wall Light (Single or double heads)



Order Model	Power Watt	Dimension mm	IP Grade
GR-BD-2x7WB	2x7W	Ø105*H85	IP66
GR-BD-2x10WB	2x10W	Ø110*H95	IP66
GR-BD-2x15WB	2x15W	Ø150*H100	IP66
GR-BD-2x20WB	2x20W	Ø195*H100	IP66
GR-BD-2x15WB	2x15W	Ø150*H100	IP66
GR-BD-2x20WB	2x20W	Ø195*H100	IP66

GR-BD-T Series



Order Model	Power Watt	Cut out mm	IP Grade
GR-BD-20T	12W	200*50*H80	IP65
GR-BD-30T	18W	300*50*H80	IP65
GR-BD-50T	24W	500*50*H80	IP65

GR-BD-E Series

Adjustable beam angle

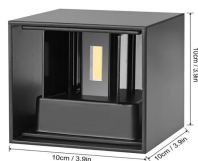

Order Model	Power Watt	Size mm	CRI	IP Grade
GR-BD-2x3WE	2x3W	L100*W100*H100	>80	IP66

GR-BD-P Series

Wall Pack



Order Model	Power Watt	Length mm	Materials	CRI	IP Grade
GR-BD-50WP	50W	336*216*182	Aluminum+PC	>80/90	IP65
GR-BD-70WP	70W	336*216*182	Aluminum+PC	>80/90	IP65
GR-BD-100WP	100W	385*247*195	Aluminum+PC	>80/90	IP65
GR-BD-120WP	120W	385*247*195	Aluminum+PC	>80/90	IP65

GR-BL-A Series

Modern Bollard light



Order Model	Power Watt	Dimension mm	IP Grade
GR-BL-600A	7W	Ø108*H600	IP65
GR-BL-800A	7W	Ø108*H600	IP65
GR-BL-1000A	7W/9w	Ø108*H1000	IP65

White/Black Housing options.

GR-BL-E Series

Bollard light

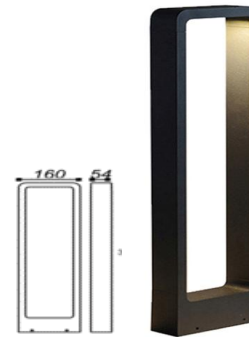

Order Model	Power Watt	Dimension mm	IP Grade
GR-BL-300E	7W	Ø108*H300	IP65
GR-BL-600E	7W	Ø108*H600	IP65
GR-BL-800E	7W	Ø108*H800	IP65

The other height like 1000mm 1200mm can be customzied

GR-BL-B Series

Bollard light



Order Model	Power Watt	Dimension mm	IP Grade
GR-BL-300B	7W	Ø108*H300	IP65
GR-BL-600B	9W	Ø108*H600	IP65
GR-BL-800B	9W	Ø108*H800	IP65

The other height like 1000mm 1200mm can be customzied
It is ok to be 2.5m/3m/4m height with 165mm Diameter

GR-BL-D Series

Square Bollard light



Order Model	Power Watt	Dimension mm	IP Grade
GR-BL-600D	9W	Ø120*H600	IP65
GR-BL-800D	9W	Ø120*H800	IP65
GR-BL-1000D	9W	Ø120*H1000	IP65

The other height like 1200mm 1500mm can be customzied
It is ok to be 2.5m/3m/3.5m/4m height with 200mm width

GR-BL-F Series

Bollard light

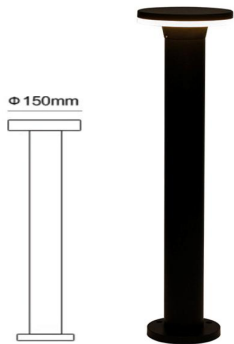

- GR-BL-300F 9W
- GR-BL-600F 9W
- GR-BL-800F 9W
- IP65 100-240VAC



GR-BL-F Series

Garden Bollard light

- 3/5W 100-240VAC
- Base/ Spike Installation
- IP65

GR-BL-M Series

Pillar Lights

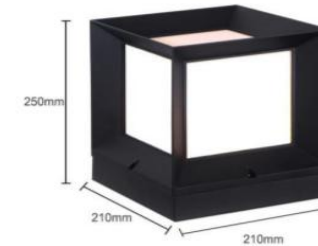

- Size:210*210*H250
- E27 Base or SMD Type
- 5W/7W IP65

GR-GL-A Series

Inground Light



Order Model	Power Watt	Outcut mm	IP Grade
GR-GL-3WA	3W	Ø105*H85	IP67
GR-GL-6WA	6W	Ø110*H95	IP67
GR-GL-9WA/12WA	9W/12W	Ø150*H100	IP67
GR-GL-18WA	18W	Ø195*H100	IP67
GR-GL-24WA	24W	Ø210*H100	IP67
GR-GL-36WA	36W	Ø240*H100	IP67
GR-GL-48WA	26W	Ø290*H100	IP67

GR-GL-F Series

Square Inground uplighter



Order Model	Power Watt	Outcut mm	IP Grade
GR-GL-3WF	3W	LW95*H80	IP67
GR-GL-5WF	5W	LW115*H80	IP67
GR-GL-9WF	9W	LW140*H85	IP67
GR-GL-12WF	12W	LW155*H85	IP67
GR-GL-18WF	18W	LW195*H90	IP67

GR-GL-H Series

COB Inground Light



Order Model	Power Watt	Outcut mm	IP Grade
GR-GL-10WH	10W	Ø145*H95	IP67
GR-GL-20WH	20W	Ø170*H100	IP67
GR-GL-30WH	30W	Ø210*H100	IP67
GR-GL-50WH	50W	Ø240*H100	IP67

GR-GL-L Series

Linear Inground uplighter



Order Model	Power Watt	Outcut mm	IP Grade
GR-GL-3WL	3W	L195*W75	IP67
GR-GL-6WL	6W	L290*W85	IP67
GR-GL-9WL	9W	L290*W85	IP67
GR-GL-12WL	12W	L490*W85	IP67
GR-GL-24WL	24W	L990*W85	IP67
GR-GL-36WL	36W	L990*W85	IP67

GR-GL- Series

Small Inground Light

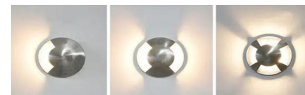

Order Model	Power Watt	Outcut mm	IP Grade
GR-GL-1WA42	1W	Ø38	IP67
GR-GL-1WA52	1W	Ø48	IP67
GR-GL-1WA62	1W	Ø58	IP67

GR-GL- Series

Mini Inground uplighter

AC/DC12V 24V



Order Model	Power Watt	Outcut mm	IP Grade
GR-GL-1WB42	1W	Ø38	IP67
GR-GL-1WB52	1W	Ø48	IP67
GR-GL-1WB62	1W	Ø58	IP67

GR-SP-A Series

Spike/ Surface Spot Light



Order Model	Power Watt	Outcut mm	IP Grade
GR-SP-5WA (COB)	5W	Ø105*H85	IP66
GR-SP-6WA	6W	Ø110*H95	IP66
GR-SP-9WA	9W	Ø150*H100	IP66
GR-SP-12WA	12W	Ø195*H100	IP66
GR-SP-18WA	18W	Ø210*H100	IP66
GR-SP-24WA	24W	Ø240*H100	IP66
GR-SP-36WA	26W	Ø290*H100	IP66

GR-SP-H Series

Top Quality Uplighter



Order Model	Power Watt	Voltage	IP Grade
GR-SP-10WH	9-10W	100-240V	IP66
GR-SP-15WH	15W	100-240V	IP66
GR-SP-20WH	18W-20W	100-240V	IP66

GR-SP-M Series

Narrow Beam Spot light



Order Model	Power Watt	Beam angle	IP Grade
GR-SP-10WM	10W	5°	IP67

GR-SP-Q Series

Commercial outdoor Spot light



Order Model	Power Watt	Diameter mm	Voltage V	CRI	IP Grade
GR-SP-10WQ	10W	Ø80	100-240V	>90	IP66
GR-SP-20WQ	20W	Ø100	100-240V	>90	IP66
GR-SP-30WQ	30W	Ø125	100-240V	>90	IP66

GR-SP-B Series



Order Model	Power Watt	Size mm	CRI	IP Grade
GR-SP-3WB	3W	Ø42*L80	>80	IP66
GR-SP-5WB	5W	Ø50*L90	>80	IP66
GR-SP-7WB	7W	Ø58*L120	>80	IP66
GR-SP-10WB	10W	Ø61*L140	>80	IP66
GR-SP-15WB	15W	Ø75*L160	>80	IP66

GR-UL-A Series

Surface Underwater light AC.DC12V 24 IP68/ Single color,RGB



Order Model	Power Watt	Dimension	IP Grade
GR-UL-6WA	6W	Ø120*H140	IP68
GR-UL-9WA	9W	Ø145*H180	IP68
GR-UL-12WA	12W	Ø145*H180	IP68
GR-UL-18WA	18W	Ø175*H210	IP68
GR-UL-24WA	24W	Ø210*H230	IP68

GR-UL-B Series

Inground Underwater light AC.DC12V 24 IP68 /Single color,RGB



Order Model	Power Watt	Output(mm)	IP Grade
GR-UL-6WA	6W	Ø115*H95	IP68
GR-UL-9WA	9W	Ø145*H115	IP68
GR-UL-12WA	12W	Ø155*H100	IP68
GR-UL-18WA	18W	Ø195*H115	IP68
GR-UL-24WA	24W	Ø195*H115	IP68

GR-UL-B Series

Swimming Pool light-wall mounted AC.DC12V 24 IP68 /Single color,RGB



Order Model	Power Watt	Dimension	IP Grade
GR-UL-9WE	9W	Ø230mm	IP68
GR-UL-12WE	12W	Ø230mm	IP68
GR-UL-18WE	18W	Ø295mm	IP68

GR-WW-B Series

DC12/24V Wall Washer light /Single color,RGB



Order Model	Power Watt	Length mm	Voltage	CRI	IP Grade
GR-WW-18WB	18W	1000	DC12/24V	>80	IP66
GR-WW-24WB	24W	1000	DC12/24V	>80	IP66
GR-WW-36WB	36W	1000	DC12/24V	>80	IP66
GR-WW-48WB	48W	1000	DC12/24V	>80	IP66

GR-WW-A Series

220V Wall Washer Light



Order Model	Power Watt	Length mm	Voltage	CRI	IP Grade
GR-WW-9WA	9W	500	100-240V	>80	IP66
GR-WW-12WA	12W	500	100-240V	>80	IP66
GR-WW-18WA	18W	1000	100-240V	>80	IP66
GR-WW-24WA	24W	1000	100-240V	>80	IP66
GR-WW-36WA	36W	1000	100-240V	>80	IP66