



Volume II

Appendix D.13

STS-107 In-Flight Options Assessment

During the course of the investigation, the Board heard several NASA officials say there was nothing that could have been done to save *Columbia's* crew, even if they had known about the damage. The Board therefore directed NASA to determine whether that opinion was valid. NASA was to design hypothetical on-orbit repair and rescue scenarios based on the premise that the wing damage events during launch were recognized early during the mission. The scenarios were to assume that a decision to repair or rescue the *Columbia* crew would be made quickly, with no regard to risk. These ground rules were not necessarily “real world,” but allowed the analysis to proceed without regard to political or managerial considerations. This report is the full result of that analysis; a summary was presented in Volume I of the report.

This is a NASA document and is published here as written, without editing by the Columbia Accident Investigation Board. The conclusions drawn in this report do not necessarily reflect the conclusions of the Board; when there is a conflict, the statements in Volume I of the Columbia Accident Investigation Board Report take precedence.

Executive Summary	395
Major assumptions / Initial conditions	396
Section 1.0 Columbia Consumables (available time in orbit)	397
1.1 Lithium Hydroxide / CO2 removal / Crew Health	397
1.2 Oxygen	398
1.3 Food / water	398
1.4 Propellant	398
Section 2.0 Decision Path Timeline	398
2.1 Powerdown Requirements	399
2.2 Description of Leading Edge Inspection via EVA	399
Section 3.0 Rescue Mission	400
3.1 Success Criteria	400
3.2 <i>Atlantis</i> configuration on STS-107 FD 4	400
3.3 Launch Vehicle Processing Timeline	400
3.4 Flight Software	400
3.5 Mission Control Center Software	401
3.6 Crew Size / Skills	401
3.7 Crew equipment	401
3.8 Launch Window / ET disposal	401
3.9 Rendezvous / Proximity Operations	402
3.10 Rescue EVA	403
3.11 <i>Atlantis</i> Return	404
3.12 <i>Columbia</i> Disposal	404
13.13 Aggregate Risk	404
13.14 Mission Firsts	404
13.15 The Launch Decision	405
Section 4.0 Columbia repair	405
4.1 Success Criteria	405
4.2 Materials Available	405
4.3 Options Considered	405
4.4 Best Option	406
4.5 EVA Techniques	406
4.6 Wing Coldsoak	407
4.7 Additional Entry Options – the “Cain Report”	407
4.8 Uncertified Options - Increased Alpha /Low drag profile	407
4.9 Thermal Analysis	407
4.10 Bailout	408
4.10.1 <i>Crew cabin configuration</i>	408
4.10.2 <i>Maximum Altitude</i>	408
Section 5.0 Other Considerations	408
5.1 LiOH Regeneration	408
5.2 Other vehicles (Soyuz, Ariane 4)	408
5.3 ISS Safe Haven	408
APPENDIX	
Appendix A Timeline of Events	408
Appendix B EVA Inspection Procedure	408
Appendix C EVA Transfer Procedure	410
Appendix D EVA Repair Procedure	410
Appendix E Rendezvous Burn Plans	411

LIST OF FIGURES

Figure 1	ppCO ₂ plot with 8 Hours of Crew Sleep	397
Figure 2	ppCO ₂ plot with 8 Hours of Crew Sleep	398
Figure 3	Decision Path Timeline	398
Figure 4	Mission Electrical Power Level	399
Figure 5	EV-1 Position Between Payload Bay Door and Wing Leading Edge	400
Figure 6	<i>Atlantis</i> Launch Windows	401
Figure 7	ET Disposal Area for 39 Degree Inclination Rendezvous Mission	402
Figure 8	Rendezvous Approach	403
Figure 9	Orbiter Orientation During Proximity Operations / Rescue EVA	403
Figure 10	Rescue EVA	404
Figure 11	Repair EVA	406
Figure 12	Relative Wing Leading Edge Temperature (No Boundary Layer Trip)	407

THIS PAGE INTENTIONALLY LEFT BLANK



STS-107 In-Flight Options Assessment

Submitted by the NASA Accident Investigation Team, Houston, Texas
May 22, 2003

EXECUTIVE SUMMARY

The NASA team was asked by the Columbia Accident Investigation Board (CAIB) to determine whether there were any options available to return the STS-107 crew. The one significant initial condition in this request was that engineers were aware that there was damage to the leading edge of the left wing that could be ascertained either through the use of national assets or through EVA inspection. Whether this was the actual condition on STS-107 is not known.

Two different options were studied: a rescue mission with the Space Shuttle *Atlantis*, and a repair by the STS-107 astronauts, using materials available onboard *Columbia*.

To determine the amount of on-orbit time available for each of these options, significant effort was spent in the analysis of how on-orbit consumables could be preserved. It was determined that the limiting consumable was lithium hydroxide (LiOH), which is used to remove carbon dioxide from the crew compartment atmosphere. Using real crew metabolic rates and an estimate of acceptable CO₂ concentration levels, it was determined that the maximum on-orbit lifetime was 30 days total Mission Elapsed Time (MET), or until the morning of February 15. Other consumables, such as oxygen, hydrogen, nitrogen, food, water, and propellant were assessed and determined to provide support beyond 30 days MET (*Columbia* Flight Day 30).

Several different timelines were then built and assessed against the consumable resources. The following timeline was used for the study:

On Flight Day (FD) 2 the NASA team would be notified that the left wing had been struck by debris. On FD 3 NASA would make an expedited request for national assets to inspect *Columbia*. To be conservative, it was assumed that this inspection was inconclusive and that an “inspection EVA” would be required. NASA would spend FD 4 developing procedures for the inspection EVA, which would be per-

formed on FD 5. This EVA consists of one crewmember translating down the port payload bay door and being a “human bridge” between the edge of the door and the wing. The second EVA crewmember would translate down the first EVA crewmember and inspect the lower half of the leading edge. It was assumed at this point that the damage was visible and a clear threat to the vehicle, although whether this was really the case with STS-107 is not known. The risk associated with this EVA was assessed to be low and the likelihood of success high. At this point, the crew would be instructed to power-down *Columbia*, begin conserving LiOH, and the ground teams would begin working two parallel paths: one to process *Atlantis* and develop rescue procedures, the other to develop possible repair techniques and test them for effectiveness.

For the rescue mission, the following processes were assessed: Launch vehicle processing, modification of flight software, Mission Control Center software and facility capability, systems integration requirements, crew size and skill mix, availability of required crew equipment, launch window availability, external tank disposal, rendezvous and proximity operations, EVA crew transfer procedures, weight and c.g. of *Atlantis* for the return, and *Columbia* disposal requirements. All of these areas were determined to be low to moderate risk with some significant schedule pressure. The team also assessed the “aggregate risk” of decreasing the preparation time for all of the required areas. While each of the individual areas could have supported a launch attempt, it was recognized that this was a “best-case” analysis, with very little margin, and it deviated greatly from the standard mission planning and preparation cycle.

It was determined that by accelerating the schedule for the above areas, a launch of *Atlantis* on February 10, 11, or 12 was possible. All three launch dates could have provided a rendezvous and EVA transfer of the crew prior to the depletion of consumables. Two major assumptions, apart from the already stated assumption that the damage had to be visible, have to be recognized – the first is that there were no prob-

lems during the preparation and rollout of *Atlantis*, and the second is the question of whether NASA and the government would have deemed it acceptable to launch *Atlantis* with exposure to the same events that had damaged *Columbia*. At this point, at least two of the last three flights (STS-112 and STS-107) had bipod ramp foam problems, and the flight in-between these two, STS-113, was a night launch without adequate imaging of the External Tank during ascent. This new risk to the Orbiter would weigh heavily in the decision process on launching another shuttle and crew. Based on CAIB direction, it was assumed that the *Atlantis* would have been launched without processing time added to modify the External Tank.

For the repair option, all of the materials onboard *Columbia* were considered for their usefulness in repairing leading edge damage. To bound the problem, a certain level of damage had to be assumed. After consulting with the aerothermal analysts, it was determined that two different damage conditions would be assessed for potential repair options: a six-inch diameter hole in the lower part of RCC panel #8, and a ten-inch long missing piece of T-seal between RCC panels #8 and #9. Whether these were the actual conditions on *Columbia* is not known.

The best repair options were determined to be the following:

Six-inch diameter hole in RCC panel 8: An EVA crew member would insert a stowage bag through the hole into the leading edge cavity and place as much metal as possible (tools, etc.) into it, he would then insert two or three Contingency Water Containers (CWC) into the hole in front of the bag of metal. A hose would be run from the airlock water supply to the EVA astronaut; this hose would be used to fill the CWCs with water. Insulation blankets removed from the top of the payload bay door would be used to fill the remaining hole and a Teflon foot loop would be placed over the hole to ensure that the insulation stays in place during subsequent vehicle maneuvers. The wing would then be “coldsoaked” to freeze the water and reduce the overall structural temperature of the wing. The theory behind this repair is that the insulation would burn away fairly quickly, but the thermal mass of the ice and metal, if it could block the plasma flow from reaching the spar, may extend the time until the spar burns through.

Missing T-seal: The gap between the RCC panels would be filled with tile fragments harvested from non-critical locations on *Columbia*. The tile fragments would be shaped by the crew IVA and then pushed into the gap during a second EVA. There are a number of uncertainties with this approach. Ground demonstrations indicate that a tight fit could be achieved. However, the fit achieved on orbit would be dependent of many variables and would be very difficult for the crew to assess or control. It would require a number of tile fragments to seal the gap. The crew would leave the smallest possible gap between the tile pieces. No testing has been done to determine how much friction is required to hold the tile in place or how large a gap between tiles would be acceptable.

The applicable repair would be used with other options, such as reducing the vehicle weight, lowering perigee, and increasing the angle of attack during entry to lower the overall heat on the leading edge of the vehicle and potentially provide structural integrity long enough to allow a bailout at 34,000 feet altitude.

Limited thermal analyses of the repair and entry modification options were inconclusive, as there are too many unknowns concerning the flow path of the plasma and the resulting structural effects. It is thought that the EVA procedures to execute this repair would be extremely difficult due to access problems and trying to work within the enclosed space of the leading edge. Therefore it is thought that the likelihood of success of this option would be low.

The best option for the return of the crew was to attempt to transfer them to *Atlantis*. Both of these plans however, rely on the assumption that the RCC problem would have been found and be unambiguous, and that it would be acceptable to launch *Atlantis* with exposure to the same condition.

MAJOR ASSUMPTIONS/INITIAL CONDITIONS

To determine whether there were any options available to return the STS-107 *Columbia* crew safely to Earth, two significant assumptions were directed by the CAIB:

Assumption #1: Damage Characteristics: The actual damage to the leading edge of *Columbia* is not known, nor is it likely to be known with a great deal of accuracy. However, NASA aerothermal modeling has demonstrated that the most likely damage size and locations are a six inch diameter hole in the lower surface of RCC panel #8 or a ten-inch piece of T-seal missing between RCC Panels #8 and #9. Both damage scenarios will be addressed in the “*Columbia* Repair” section of this study. Additionally, for the purposes of this assessment, it is assumed that the damage to the leading edge of the wing can be determined to be catastrophic by either national assets or astronaut inspection. This assumption rules out damage consisting of a crack, an intact deformation of the panel, or damage to the attachment structure of a leading-edge component.

The timing of discovering the damage is critical to this study. It is assumed that the Intercenter Imagery Working Group notified NASA management of the foam debris strike on Flight Day (FD) 2 and that national assets were requested on FD 3. Depending upon the size of the damage, these national assets may or may not have been conclusive in determining that the damage is potentially catastrophic. To address this uncertainty, two timelines have been developed. The first timeline assumes that the information provided by the national assets is conclusive. In this case, a powerdown is started immediately on *Columbia*, consumable assets are strictly conserved, and the ground teams begin working on the rescue and repair options. A second timeline has been developed for the case in which the information from the national assets is inconclusive; in this case the *Columbia* crew would begin a partial power-down of the vehicle while

the Mission Control Center developed procedures for an “inspection EVA” on FD 5. This visual inspection of the damage by the astronauts is assumed to be conclusive, and the powerdown and conservation of consumables would begin at the end of FD 5. In both cases, the ground activity to develop rescue and repair options would be identical, but for the case where the EVA astronaut inspection is required, the crew would lose consumables equivalent to approximately 30 hours and one EVA.

Assumption #2: Willingness to Launch *Atlantis* with Exposure to Bipod Ramp Debris: It is an important point in the discussion of a rescue mission to assume that it would be acceptable to launch *Atlantis* without a redesign to the ET bipod foam, even though this component is suspected to have caused the damage to *Columbia*. Undoubtedly, there would have been significant discussions on the risk trades of various modifications to the -Y bipod ramp. For the purpose of this study, the CAIB directed that *Atlantis* would be launched without any modification to the external tank. However, an inspection of *Atlantis*’ leading edge was inserted into the “Rescue EVA” timeline.

1.0 COLUMBIA CONSUMABLES (AVAILABLE TIME IN ORBIT)

“Consumables” is defined as non-replaceable resources that are required to keep the crew alive and to operate the Shuttle systems.

1.1 LITHIUM HYDROXIDE/CO₂ REMOVAL/CREW HEALTH

The limiting consumable on *Columbia* was lithium hydroxide (LiOH). LiOH is used for CO₂ removal in the crew compartment. There were 69 cans of LiOH available on *Columbia*. To determine how much time on-orbit was available from these cans, several assumptions have to be made about the crew’s CO₂ production levels and the high-

est percentage of CO₂ that could be tolerated by the crew over an extended period of time.

To determine CO₂ production, a metabolic rate halfway between the STS-107 actual sleep and wake levels was used. Two cases were run, one with the crewmembers awake for 16 hours and asleep for 8 hours, and the other with a 12-hour awake, 12 hour asleep cycle. It was assumed that there was no crew exercise, minimal activities planned, and no payload experiments. The live animals in the SPACEHAB would be euthanized.

The determination of the maximum allowable CO₂ percentage would have been more difficult. The mission rules require that a flight be terminated if the CO₂ level gets above 15 mmHg (~2.0%). For levels between 7.6 mmHg and 15 mmHg (~1.0%-2.0%), all crew activities are evaluated by the Flight Surgeon.

There are few relevant experiments to date on long-term exposure of humans to elevated CO₂ levels with a limited amount of activity in microgravity. However, the flight surgeons believe that a CO₂ percentage of 26.6 mmHg (3.5%) would not produce any long-term effects on the health of the crewmembers. Shortness of breath, fatigue, and headaches may have occurred. However, the crew did have access to pure-oxygen masks if symptoms became acute. It is also believed that the body would adapt over time to these elevated levels.

The plots show the relationship of metabolic rate and LiOH changeout level. If the metabolic rate could be kept to the equivalent of a 12 hour sleep, 12 hour awake rate, the on-board LiOH could be stretched to 30 days Mission Elapsed Time (MET) without violating the 15 mmHg Mission Rule limit. If the crew metabolic rate could not be reduced (by sleep, inactivity, or by medication), accepting the increased limit of 25 mmHg would also provide 30 days of on-orbit lifetime. Thirty days MET is equivalent to the morning of February 15.

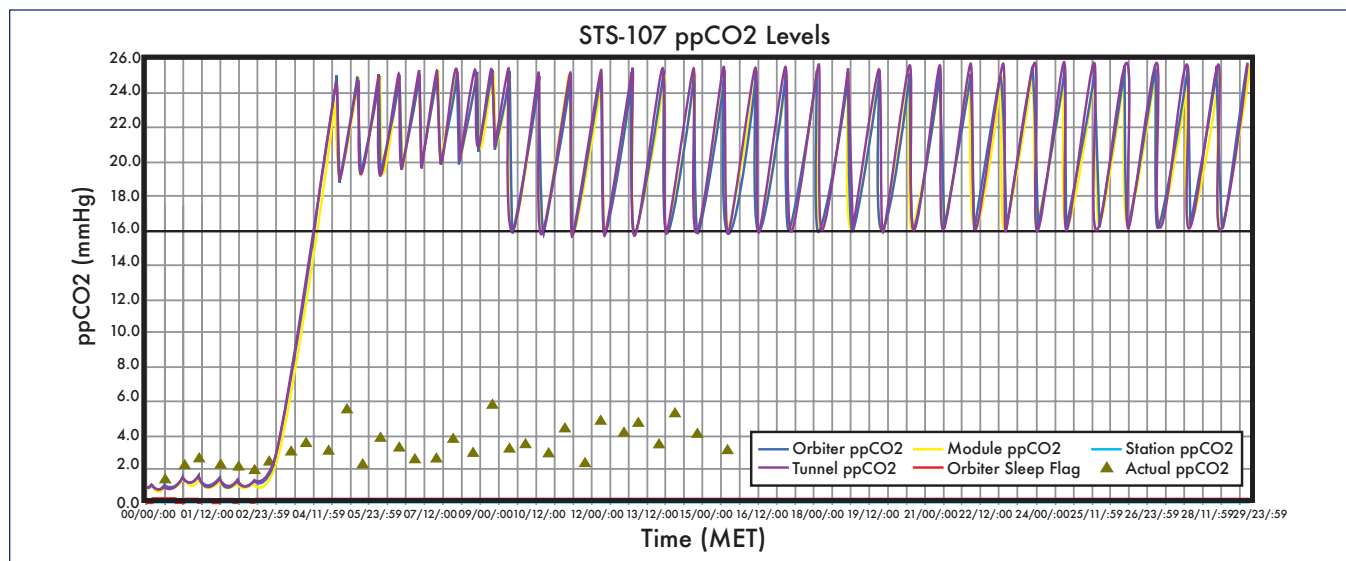

Figure 1. ppCO₂ plot with 8 hours of Crew Sleep.

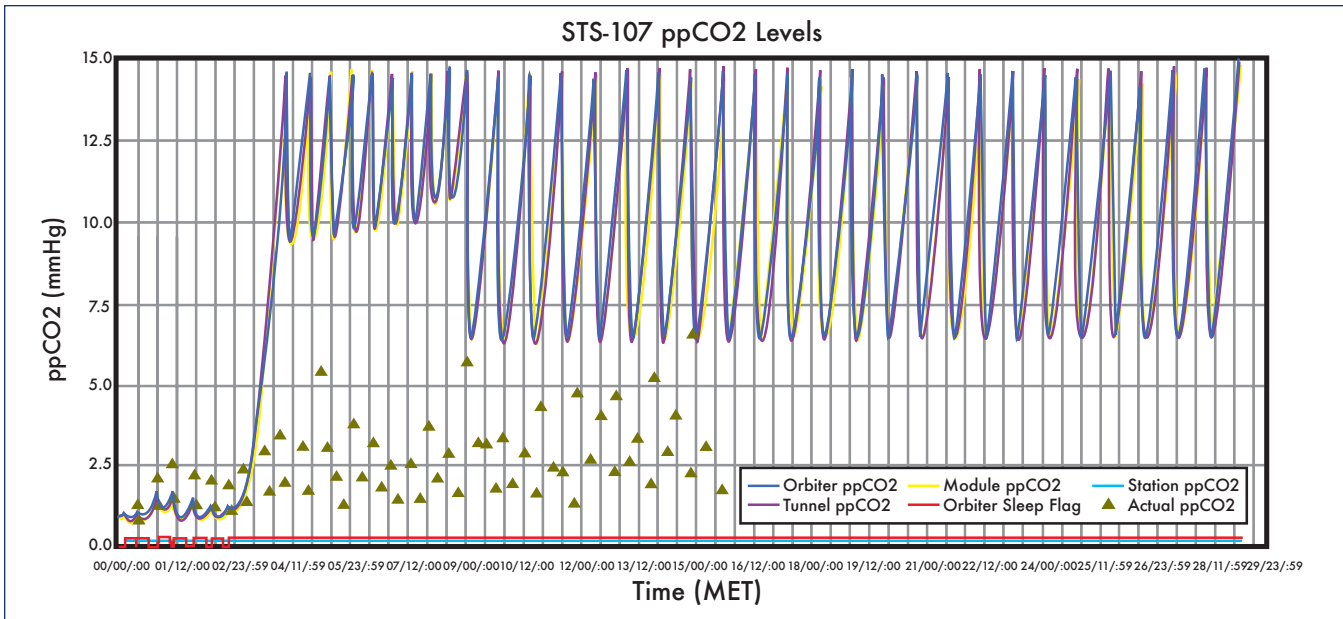

Figure 2. ppCO2 plot with 12 hours of Crew Sleep.

1.2 OXYGEN

Oxygen is the next most limited consumable. The oxygen onboard *Columbia* is used to replenish the crew atmosphere, to power fuel cells that provide electricity, and to provide potable water to the crew as a byproduct of the fuel cell reaction.

Columbia had an Extended Duration Orbiter (EDO) pallet located in the aft part of the payload bay that provided extra storage for cryogenic oxygen and hydrogen. Following the *Discovery* of critical damage to the leading edge of the wing, a power-down (Section 2.1) would have been performed to preserve the available oxygen and hydrogen. This power-down would have supported only the most basic vehicle control and crew support and communication equipment. The O₂ margin above 30 days (limited by LiOH) could have been used to power additional equipment or breathed by the crew through emergency masks periodically to offset the deleterious effects of the elevated CO₂ levels.

1.3 FOOD / WATER

There were no significant impacts to the timeline for food or water. At a low metabolic rate, sufficient food was available for more than 30 days. The minimal power level was sufficient to supply 3 gallons of potable water per crewmember per day as a byproduct of the fuel cell power reaction.

1.4 PROPELLANT

When the damage to the leading edge of the wing was discovered, in addition to performing the powerdown and modifying the LiOH changeout schedule, the orbiter would have been placed in a tail-down gravity gradient attitude that would require very little propellant. Sufficient propellant would have then been available to perform joint-rendezvous maneuvers, hold attitude for proximity operations or a cold-soak of the left wing, and eventual deorbit/disposal.

2.0 DECISION PATH TIMELINE

Figure 3 shows the anticipated decision timeline.

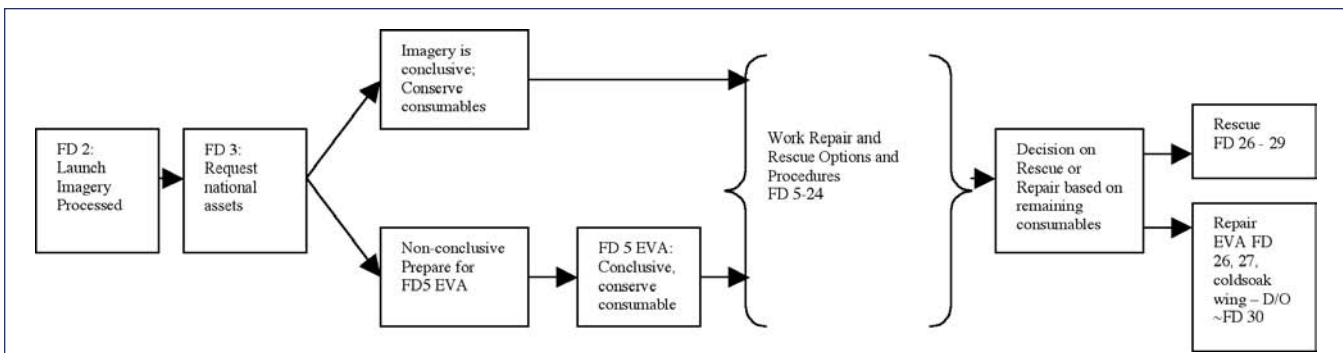

Figure 3. Decision path timeline.

2.1 POWERDOWN REQUIREMENTS

It was the opinion of the team that the launch video would be received on FD 2, national assets would be requested and delivered on FD 3. At this point, if the data was conclusive the following powerdown would be performed by the crew:

- All payload and related equipment is powered off
- A “Group C” systems power down is performed
- All camera’s, camera heaters, TV monitors, and video equipment off
- One General Purpose Computer (GPC) powered for vehicle control, one GPC running 25% for systems monitoring, GPC 5 in sleep mode, GPC’s 2 and 4 OFF.
- One crew monitor (IDP and MDU) on 50% of time
- 1 personal laptop computer powered 25% of time
- Inertial Measurement Unit (IMU) 1 is left ON, 2 and 3 are off
- The crew galley is off
- Avionics bay instrumentation is off
- KU Band antenna is stowed
- The Orbiter Cabin Air Cleaner (OCAC) fan is running at medium speed
- FWD and AFT Motor Controller are unpowered until deorbit day.
- Fuel Cell 3 and Freon Loop 2 are unpowered until deorbit day.

This powerdown would reduce the average mission power level to 9.4 kW. Protecting for 1 deorbit opportunity on the final day would result in a total oxygen capability of 34 days 10 hours.

If the data from the national assets were inconclusive, no power-down beyond the normal on-orbit configuration would be performed until the inspection EVA was completed. Not performing a power down would have preserved the science mission if the inspection EVA determined that there was no significant damage. For this case, the additional powered day plus one EVA from 14.7 psi cabin pressure would result in a total oxygen margin of 32 days, 11 hours.

Performing the above case plus four airlock depresses and three airlock represses for a rescue EVA, results in a total O2 margin of 31 days, 6 hours.

2.2 DESCRIPTION OF LEADING EDGE INSPECTION VIA EVA

The inspection EVA procedures would have been developed on FD 4 and executed on FD 5. It is anticipated that this would have been a maximum two-hour EVA, using a four-hour prebreathe protocol based on 14.7 psi cabin pressure. The first EVA crewmember (EV-1) would tape towels to his boots to protect the Orbiter wing. Upon egress from the airlock, EV-1 would translate out along the edge of the port payload bay door until above the wing leading edge area (approximate position of RCC panel 8). The upper surface of the wing leading edge would be inspected from this position. If no damage is observed on the upper surface, EV1 would gently place his right foot on the upper surface of the wing and his left foot in front of the leading edge, while holding onto the payload bay door. The upper surface of the wing is approximately four feet from the edge of the door. The second EVA crewmember (EV-2) would follow EV1 along the edge of the payload bay door and translate down EV-1 to visually inspect the lower surface of the leading edge structure. STS-107 did not have any EVA-compatible video cameras or digital cameras to record damage, so the inspection report would be verbal from EV-2. Because of the sharp edge hazard potential, and concern about further damaging the impact site, the EVA crew would make every effort not to contact the suspected damaged area.

A consideration in the planning for this task was the EVA training level of the *Columbia* crew. Although the two EVA crewmembers were fully trained for a standard set of Orbiter contingency tasks, none of these were specific to this inspection activity. There were no scheduled EVAs during the STS 107 mission. Additionally, *Columbia* was only equipped with a minimal set of EVA tools (i.e. no SAFERs, no EVA cameras, etc.).

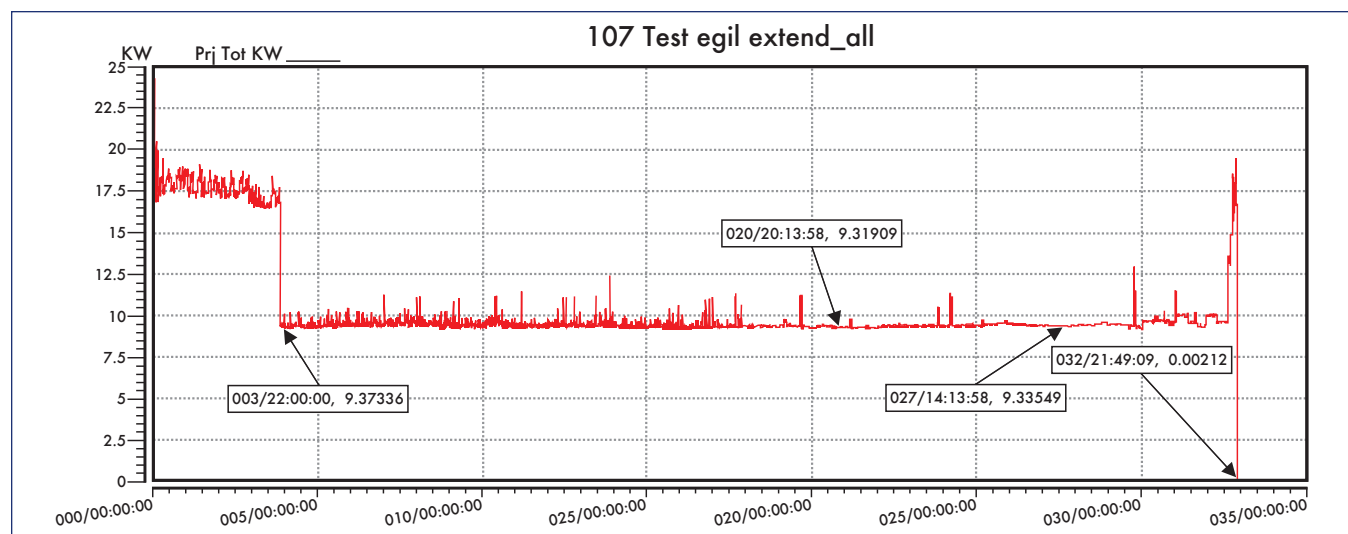

Figure 4. Mission Electrical Power level.

Two experienced EVA astronauts and two EVA flight controllers assessed this task in the Johnson Space Center virtual reality lab. The level of difficulty of the EVA inspection procedure is moderate. The risk of injury to crew is low and of further damage to the site is low to moderate. The expectation of mission success (providing conclusive information regarding damage severity) is judged to be high.

A detailed synopsis of the wing leading edge inspection procedure is included in Appendix B.

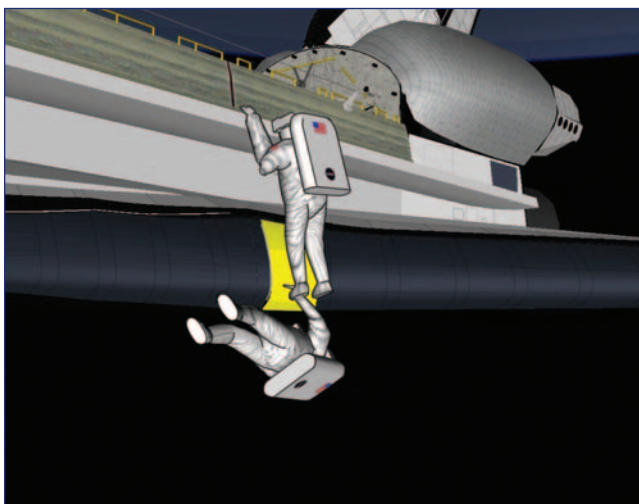

Figure 5. EV-1 position between payload bay door and wing leading edge.

3.0 RESCUE MISSION

3.1 SUCCESS CRITERIA

The safe return of the rescue vehicle (*Atlantis*) and both crews.

3.2 ATLANTIS CONFIGURATION ON STS-107 FD 4

On STS-107 Flight Day 4 (January 19th), the Space Shuttle *Atlantis* was in the Orbiter Processing Facility (OPF), being prepared for a launch to the International Space Station on March 1, 2003. The Space Shuttle Main Engines were installed and there were approximately ten days of routine orbiter processing required before the rollover to the Vertical Assembly Building (VAB). No payload elements or Remote Manipulator System were installed in the cargo bay. In the VAB, the External Tank (ET) and the Solid Rocket Boosters (SRB) had been mated on January 7th. The template for STS-114 processing called for the ET/SRB and *Atlantis* to undergo parallel processing until January 29th, when *Atlantis* would be rolled to the VAB and mated to the integrated stack. The cargo elements for the ISS were planned to be installed at the launch pad on February 17.

3.3 LAUNCH VEHICLE PROCESSING TIMELINE

The minimum time necessary to safely prepare *Atlantis* to be launched on a rescue mission were assessed by senior

government and contractor management at Kennedy Space Center (KSC). If notified on *Columbia* FD 5 (Monday, January 20th), KSC would begin 24/7 processing on the vehicle in the OPF. All standard vehicle checks would have been performed, including structural leakage tests, final closeouts of different areas of the vehicle, and a weight and c.g. assessment. An expedited schedule would have resulted in rollout to the VAB on January 26 (*Columbia* FD 11). The VAB flow would have been shortened from the standard five days to four days based on 24/7 support. Tests not performed at the pad, and the risk associated with this non-performance, are as follows:

- S0017 – Terminal Countdown Demonstration Test (TCDT) – no risk to eliminate. This is a practice countdown to allow new astronauts to get a feel for launch day activities.
- S0044 – Launch Countdown Simulation – low risk to eliminate. This is a practice for the Launch Control Team. The team is likely to be the same launch team that launched *Columbia* three weeks earlier.
- S0056 – Cryogenics Load Sim – low risk – Same rationale as the S0044
- V1202 – Helium Signature Test – no to low risk. This test checks for leaks in the Main Propulsion System (MPS). If there were a leak, it would be caught in the launch countdown. If a leak were found during this test, there would be insufficient time to fix it.
- S0007 – Launch Countdown – low risk – Planned launch holds would be reduced to the minimum and tailored to meet the desired rendezvous launch window.
- No Flight Readiness Review or Certification of Flight Readiness

A review of the weather conditions during the major milestones in this timeline show that there did not appear to be any violations of established criteria.

This flow results in a launch capability of approximately February 10 (*Columbia* FD 26).

3.4 FLIGHT SOFTWARE

The impact of changing the STS-114 Flight software was assessed and determined to be within the launch vehicle processing timeline. The STS-114 flight software load would be used, since this flight has the appropriate rendezvous information and STS-107 did not. The changes to the flight design: inclination, altitude, launch window and rendezvous information, and External Tank disposal criteria were assessed and could be developed and uplinked in the Day of Launch I-Load Update process (DOLILU). While these DOLILU I-Load updates are certified, this would be the largest DOLILU uplink ever performed. One additional patch to the software would have been required to change the main engine cutoff altitude to meet external tank heating constraints.

Additionally, time was available to perform prelaunch testing of the flight software and proposed uplinks in the Shuttle Avionics Integration Laboratory to verify launch, rendezvous and deorbit software integrity. Boeing Flight Software would provide an independent assessment. The overall risk level was assessed to be low.

3.5 MISSION CONTROL CENTER SOFTWARE

Mission Control Center software includes all of the vehicle control and monitoring data specific for a Shuttle mission. The STS-114 mission had a complete software load built and ready for the planned launch on March 1st. Flight Controllers had performed seven integrated simulations on this software load, including two ascents, prior to the launch of STS-107. The vehicle monitoring software would not be affected by a change in the mission content.

From a Mission Control Center facility standpoint, sufficient hardware capability was available to control the International Space Station, *Columbia*, and an *Atlantis* rescue mission.

3.6 CREW SIZE / SKILLS

Based on the unresolved launch debris risk and the constraints for crew seating during entry, *Atlantis* would be launched with the minimum required crew. Minimum crew size for the rescue mission, based on the rendezvous/proximity operations and EVA tasks, would be four astronauts – Commander (CDR), Pilot (PLT), and two EVA crewmembers (EV1 and EV2). Two EVA astronauts are required to perform the “Rescue EVA” transfer tasks. Two additional astronauts are required to simultaneously perform the rendezvous and extended proximity operations (8-9 hours of manual flying) and perform the EVA assist functions. These tasks would be performed by the CDR and PLT.

With a planned FD1 rendezvous and EVA, it would be important to have a high degree of confidence in the astronauts’ ability to quickly adapt to the micro-gravity environment. This factor, in combination with the minimum time available for training, would dictate the selection of EVA and rendezvous experienced astronauts with a high level of proficiency at the time of the STS-107 mission. There were 9 EVA astronauts, 7 CDRs, and 7 PLTs available in January 2003 who would have met these requirements.

3.7 CREW EQUIPMENT

Four EMUs would be launched on *Atlantis*; two for the *Atlantis* EVA crew and two for use in transferring *Columbia* crewmembers. Two SAFERS (Simplified Aid for EVA Rescue) and two wireless video helmet units would be included as well, for *Atlantis* EVA crew only. Two portable foot restraints would be launched on each side of the *Atlantis* payload bay. An EVA telescoping boom would be stowed on the forward bulkhead. The standard complement of notebook computers required for rendezvous and proximity operations would be stowed on *Atlantis*. Additional “core” stowage of habitability equipment would be stored in the middeck along with extra LiOH canisters for transfer to *Columbia*.

3.8 LAUNCH WINDOW / ET DISPOSAL

Three days prior to the anticipated launch of *Atlantis*, *Columbia* would execute a 74 feet per second translation maneuver

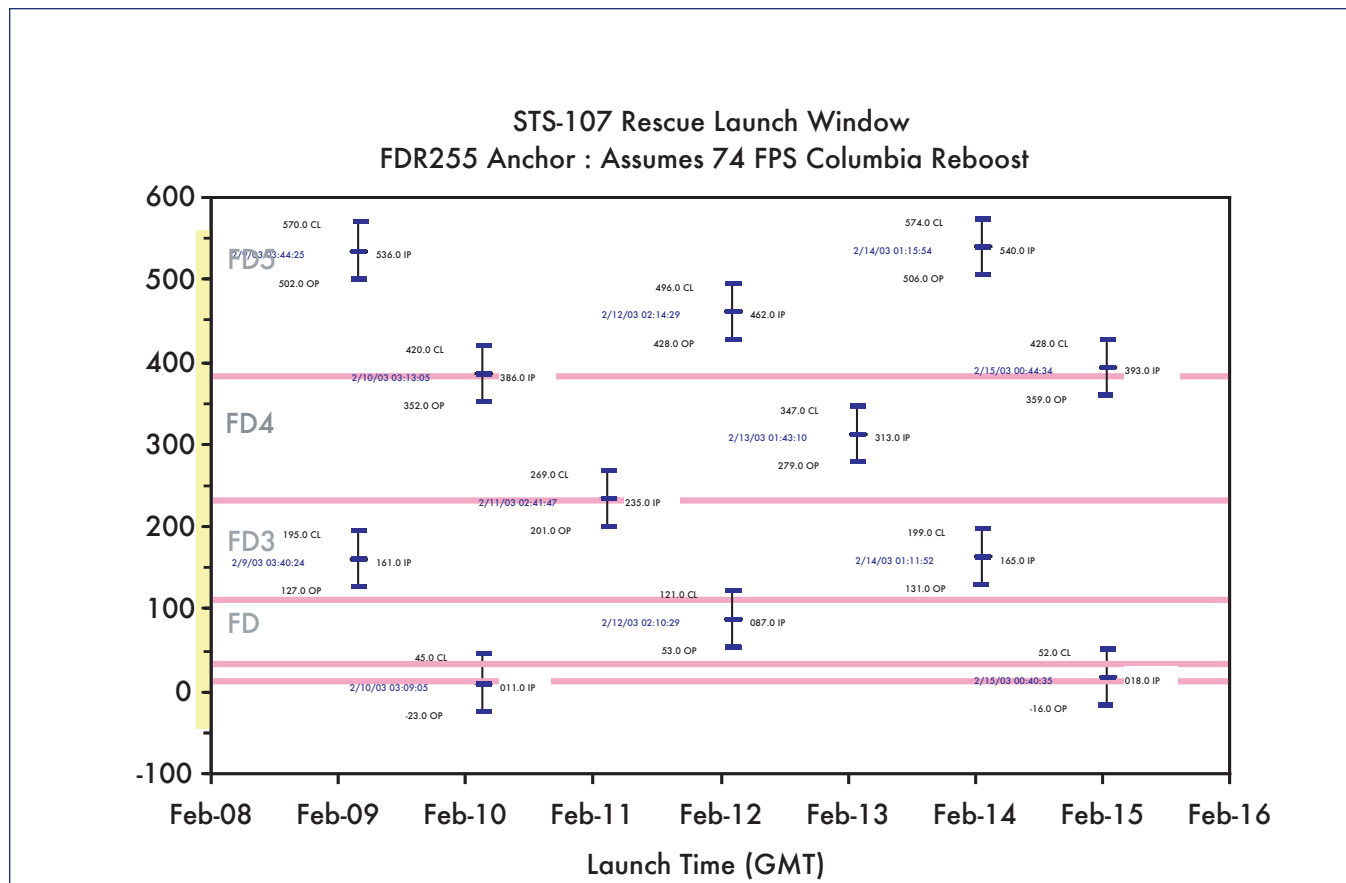

Figure 6. Atlantis Launch Windows.

to raise the orbit to 185 nautical miles by 139 nautical miles. This maneuver would increase the rendezvous windows available for the *Atlantis* launch. Assuming that the vehicle processing could support on or around February 10, the following rendezvous launch windows would be available:

- Launch February 10, 03:05:09 GMT (February 9, 10:05 p.m. EST) for rendezvous on February 10
- Launch February 11, 02:40:07 GMT (February 10, 9:40 p.m. EST) for rendezvous on February 13
- Launch February 12, 02:10:29 GMT (February 11, 9:05 p.m. EST) for rendezvous on February 13

The most desirable option would be to make the launch date of February 9, as it provides the earliest rendezvous option with *Columbia*. However, if vehicle processing could not support this date, the launch times for February 11 and 12 would both support a rendezvous on February 13, with an estimated 36 hours of margin available before depletion of the LiOH.

ET Disposal:

To provide adequate clearance of the ET impact point from landmasses, an uplink to change the Main Engine Cut-Off (MECO) velocity would be required. This is a certified ca-

pability that could be used on any mission. Additionally, a flight software patch would be implemented to change the MECO altitude target to 54 nautical miles, vice the planned STS-114 MECO altitude of 52 nautical miles, to maintain flight conditions within the certification envelope and provide ET impact point clearance from landmasses.

3.9 RENDEZVOUS / PROXIMITY OPERATIONS

The *Atlantis* would follow a standard rendezvous profile that would result in an approach from below *Columbia* (+Rbar approach). This approach is the easiest to fly for maintaining long duration proximity operations as orbital mechanics tend to slowly cause separation between the vehicles. This approach was used for all of the MIR docking missions and all of the ISS assembly missions up to STS-102. There would be minimal training required for a rendezvous experienced CDR.

Proximity operations are also straightforward, but of an unprecedented duration. The *Columbia* would be positioned wing-forward, payload bay to Earth under active attitude control. The *Atlantis* would approach nose forward with the payload bay facing *Columbia*. This ninety-degree “clocking” of the Orbiters allows a close approach without concerns over the vertical tail impacting the other vehicle. It

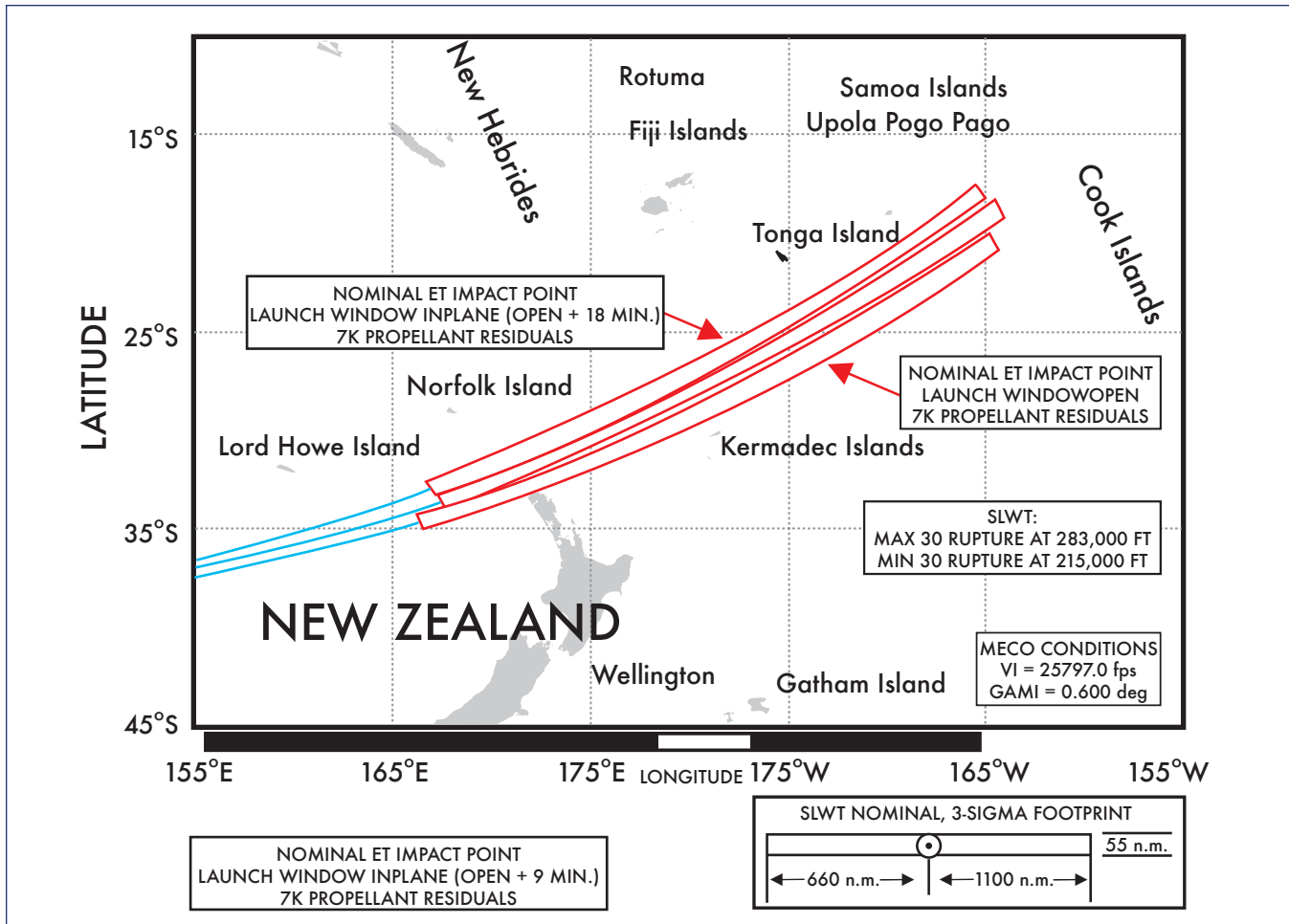

Figure 7. ET disposal area for 39 Degree Inclination Rendezvous Mission.

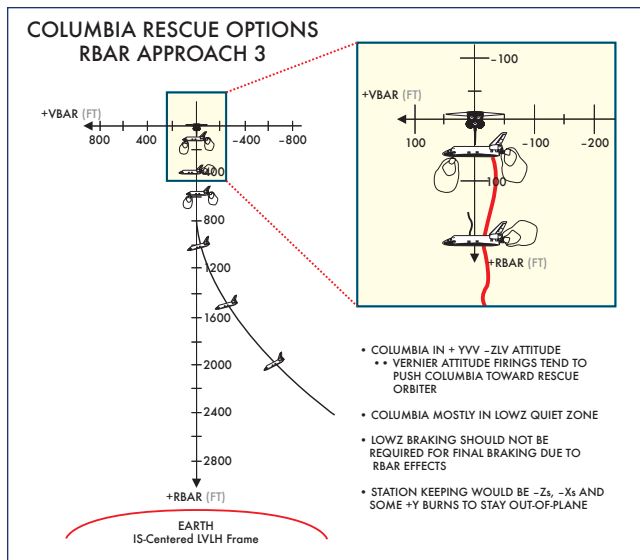

Figure 8. Rendezvous approach.

is believed, based on flight experience, that the two vehicles could be flown very close to each other (tens of feet). During ISS assembly missions, the Orbiter is typically held 30 feet from the ISS docking port in order for the CDR to manually fly out any rotational or position errors. Also, there have been at least two cases in which a payload has been “flown” into the reach of the EVA crewmember and several instances where a retrieved payload was flown to a point where the robotic arm could grapple it.

One concern would be the length of time in proximity operations (8-9 hours), which drives the crew requirement on *Atlantis* to four. To help mitigate this concern, a retro-reflector would be taken to *Columbia* on the first EVA and placed on top of the SPACEHAB module. The Trajectory Control System was installed on *Atlantis*, and could be used with the suite of rendezvous tools to assist in the proximity operations through the day/night cycles. Additionally, it is thought that *Columbia* crewmembers that are transferred early could assist in the station-keeping task.

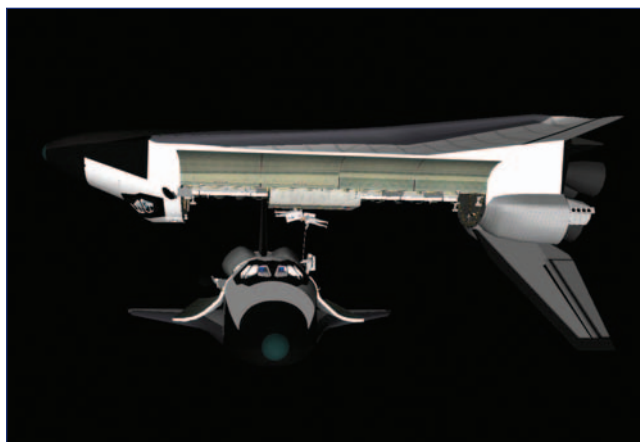

Figure 9. Orbiter Orientation during Proximity Operations / Rescue EVA.

3.10 RESCUE EVA

The EVA crewmembers on *Atlantis* would use a 10.2 psi cabin pressure EVA prebreathe protocol. If a FD1 rendezvous and EVA were attempted, the *Atlantis* EVA crew would need to prebreathe O₂, possibly beginning as early as Orbiter ingress on the pad, and *Atlantis* would be depressed to a 10.2 psi cabin pressure during post-insertion activities. The crew on *Columbia* would maintain a 14.7psi cabin pressure to minimize CO₂ percentage. The EMUs on *Columbia* would be approximately sized for the first two *Columbia* crewmembers (CM1 and CM2) to be transferred. CM1 and CM2 would don the EMUs in the *Columbia* airlock and be ready for depress upon the arrival of *Atlantis*. At the completion of the rendezvous, *Atlantis* and *Columbia* would be “clocked” 90 degrees with the payload bays facing each other at a distance of 20 feet from payload bay sill to payload bay sill.

EVA Overview:

The initial priority for the rescue EVA would be the transfer of replacement LiOH to *Columbia*. Both *Columbia* and *Atlantis* airlocks would be depressed to start the EVA. *Atlantis*’ EV2, using a portable foot restraint on the payload bay sill and the EVA boom to extend his reach, would transfer EV1, extra LiOH canisters, and two EMUs to *Columbia*. EV1 would assist CM1 and CM2 from the *Columbia* airlock, place the two spare EMUs and extra LiOH canisters in the airlock, and close the outer hatch. After repressing the *Columbia* airlock, the next two *Columbia* crewmembers (CM3 and 4) would don these EMUs.

CM1 and 2 would transfer to *Atlantis* (using the EVA boom and assisted by EV1), for airlock ingress and repress. Once inside *Atlantis*, the EMUs would be doffed and prepared for transfer back to *Columbia*.

This process would be repeated until all seven *Columbia* crewmembers were rescued. On the third transfer, only one *Columbia* crewmember is rescued, leaving two remaining to assist each other in donning the EMU’s.

Two additional tasks would be performed by the *Atlantis* EVA crew after the first transfer operation (while waiting for suit doffing and prep to be completed). EV1 and 2 would conduct a SAFER inspection of the *Atlantis* TPS, and install a portable TCS laser reflector onto *Columbia*.

Although a standard EVA prebreathe protocol could be used by the *Columbia* astronauts, a modified protocol that would minimize prebreathe duration could be approved by the flight surgeons and would expedite *Columbia* crew transfers substantially. EMUs that are transferred from *Atlantis* to *Columbia* empty, would need to be transferred powered up and pressurized to prevent water freeze up. It should be noted that not all of the *Columbia* crewmembers were EVA-trained so the *Atlantis* crew would be prime for all aspects of the EVA rescue. The complete transfer activity would require two EVAs unless all suit donning/doffing and transfers went exceptionally well and prebreathe times were minimized, in which case EVA duration for *Atlantis* EV crew would be 8.5-9 hours.

A detailed synopsis of the Rescue EVA procedure is included in Appendix C.

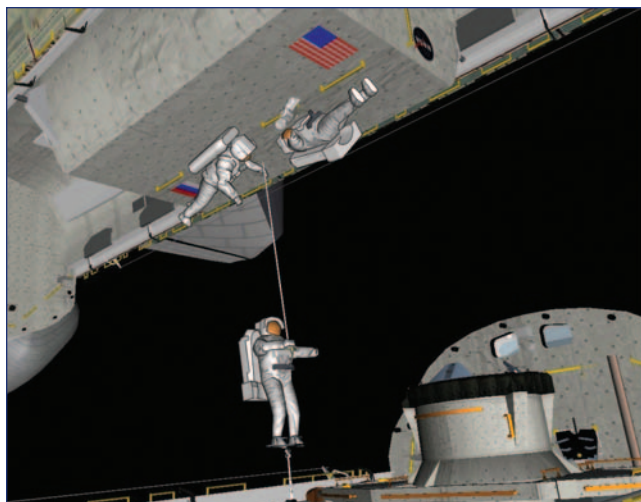

Figure 10. Rescue EVA.

3.11 Atlantis Return

An assessment was made concerning the resultant weight and center of gravity (c.g.) of *Atlantis* carrying 11 crewmembers, “core” middeck stowage, and six EMUs. The weight was 209,157 pounds and the c.g. was 1081.2 inches, within the certified requirements. No OMS or RCS ballasting would be required. Sufficient propellant would be available to allow normal deorbit targeting methods to be used.

3.12 Columbia Disposal

Prior to the last crewmember departing *Atlantis*, there would be a small number of switch configurations required to allow

the Mission Control Center (MCC) to command the deorbit of *Columbia*. The OMS and RCS systems would be pressurized for a burn, the OMS engines would be armed, and the onboard computer system would be configured to allow ground command of the necessary actions.

The MCC has the capability to autonomously command the required maneuvers. There would be no possibility of recovering *Columbia* however, as the ground does not have the capability to start auxiliary power units, deploy air data probes, or extend the landing gear. It is thought that the *Columbia* would be deorbited into the South Pacific.

3.13 “Aggregate Risk”

It should be noted that although each of the individual elements could be completed in a best-case scenario to allow a rescue mission to be attempted, the total risk of shortening training and preparation time is higher than the individual elements.

3.14 Mission “Firsts”

There would be a number of activities that would be attempted for the first time during this conceptual inspection and rescue mission. Among these are:

- Inspection EVA
 - EVA in the wing area of the Orbiter – unknown comm issues, tether routing around freon panels
 - Translation along the PLBD – no sharp edge inspection
- Rescue EVA
 - Crew members fully isolated outside of the ship (both airlock hatches sealed)
 - Translation using boom
- Mission profile
 - Full use of DOLILU for major configuration

Mission Task	Normal Template	Rescue Template	Risk Assessment
Orbiter Processing	10 days to VAB	7 days to VAB	Moderate, requires no failures
VAB Flow	5 days	4 days	Moderate, requires no failures
Pad Flow	Previous record – 14 days	11 days	Moderate, requires no failures
Flight S/W	6 months, but 114 work already completed	7-8 days for deltas and verification	Low
Systems Integration	6 months for loads 4-5 months for thermal Drawings – 10 months 114 work completed	8 days for deltas and verification	Low
MCC S/W	N/A	Already developed	Low
Training CDR/PLT	48-54 weeks	2 weeks	Moderate
Training EVA Crew	40-50 weeks	2 weeks	Moderate to High
COFR Process	12 – 15 weeks	2 weeks	Moderate

changes

- 11 person return, not all in seats
- Ground command of deorbit burn for *Columbia*
- Extended Proximity Operations (9-10 hours) between Orbiters (safe separation)

3.15 The Launch Decision

Additional considerations in making the decision to launch a rescue mission would be:

- The mission would launch at night
- The bipod foam problem was not well understood (what had changed?)
- The flow required many activities to be done faster than normal, demonstrated templates
- Several techniques would have their first use during the mission
- Risk to the second crew and vehicle must be considered fully.
- The timing of decisions and the information for their basis is critical and highly optimistic

4.0 COLUMBIA REPAIR

4.1 SUCCESS CRITERIA

Repair of the damage to the wing leading edge would be considered successful if spar burn through is delayed to allow the orbiter to reach an altitude in a sufficiently intact and controllable configuration to allow the crew to bail out.

4.2 MATERIALS AVAILABLE

There are three categories of material considered for repair:

First are materials capable of surviving the reentry environment that could be used to seal the damaged area of the wing. The only available material identified was tile harvested from less critical portions of the orbiter. While there is RCC located in less critical areas that might have been used for repair, these areas were not accessible to the crew. The other TPS components could not survive the reentry environment at the wing leading edge.

The second category is high thermal mass materials that could be used to temporarily interrupt the flow of hot gasses to the wing spar. There were a number of materials available. TPS materials like tile fragments and AFRSI blankets were considered and rejected due to their low thermal mass. Metals have the appropriate material properties. There were sufficient quantities of aluminum components that could have been inserted into the RCC cavity.

The third class of materials is sacrificial materials that could be used to temporarily seal the damage in the wing.

A final class of materials is materials to provide restraint. None of the adhesive materials on *Columbia* would have survived the reentry environment heating.

The following materials were considered as candidates:

Crew Compartment	Orbiter	Payload
Light Weight MAR Carbon Fiber Shell	Blanket Material AFRSI (1,500 °F) FRSI (9,00 °F)	SHAB - Titanium Shell
Teflon Sheet (contingency Kit)	Payload Bay Door Seal	PTCU Insulation
Silver Shield Gloves (contingency Kit) Norfoil - Al Foil	P/L Bay Thermal Liner	EOR/F or TEHM Doors
LiOH/Li Carbonate		Payload Thermal Mittens
CWC w/water - ICE		
Thermal Mittens		
ATCO Canister		
Charcoal Canister		
Tapes (Duct, Al, Kapton)		
Foam		

Material Thermal Limits

- Titanium* – 3,000 F
- Inconel* – 2,400 F
- Stainless* – 2,000 – 2,400 F
- Aluminum* – 1,000 F
- Carbon Fibers* < 1,000 F

4.3 OPTIONS CONSIDERED

The preferred option would be to seal the damaged area with a material capable of surviving reentry conditions. This option requires a repair material capable of surviving the reentry environment and a method of restraining that material in a manner that completely or nearly completely seals the damaged area. To seal the damage the material would have to be restrained in the hole. This might be accomplished by either a press or friction fit or by using an adhesive capable of surviving reentry conditions. There were no adhesives identified on board *Columbia* that could survive reentry conditions for any significant period of time. No friction fit method could be identified for restraining tile or in a hole in an RCC panel. However, a friction fit in the gap between panels could restrain shaped tile.

The other family of options focused on interrupting the flow of hot gasses to the spar. A number of options were identified for filling the cavity between the wing spar and RCC panel. The factors considered in choosing a material were 1) the material properties, 2) the ability to restrain the material between the hole in the RCC and the spar, and 3) the ability to insert the material through a small hole in the RCC panel. There are spanner beams at the edge of each RCC panel, which would tend to restrain large items or bags. Solid items could be placed in a jettison stowage bag installed in the hole, leaving the mouth of the bag outside the hole.

One of the desirable materials would be small pieces of titanium or other metal scavenged from the orbiter crew cabin. Because the cavity between the spar and RCC is open the length of the wing, the metal would have to be contained inside panel 8. This could be accomplished by inserting the bag that could then be filled with metal. This would keep the metal in place at least until the bag burned through.

There are several options for using ice to disrupt the flow of hot gases. There was enough hose on the vehicle to construct a hose that would reach from a test port in the airlock to RCC panel 8. The hose could either be used to fill a Contingency Water Container (CWC) or to spray free water into the RCC cavity. There were four CWCs on *Columbia*. Some or all could have been inserted empty through the hole in the RCC panel and then filled inside the wing. The water inside would have formed solid ice after 3-6 days. Free water could also be sprayed into the wing. The ice formed would be much less dense and would have to be restrained in some manner to keep it inside panel 8.

4.4 BEST OPTION

For a missing portion of T-seal, the best option would have been to fill the resulting gap between the RCC panels with tile fragments harvested by the EVA crew. The tile fragments would be shaped by the crew IVA and then pushed into the gap by the EVA crew. There are a number of uncertainties with this approach. Ground demonstrations indicate that a tight fit could be achieved. However, the fit achieved on orbit would be dependent of many variables and would be very difficult for the crew to assess or control. It would require a number of tile fragments to seal the gap. The crew would leave the smallest possible gap between the tile pieces. No testing has been done to determine how much friction is required to hold the tile in place or how large a gap between tiles would be acceptable.

For a six-inch hole in the RCC panel, the cavity between the RCC panel and spar would be filled with a combination of titanium and water (ice) and the hole would be sealed with AFRSI.

These repair techniques would delay spar heating and burn through. However, it is not possible to accurately determine whether the delay would be sufficient to allow the vehicle to successfully reach a bailout altitude. This is due to uncertainties inherent in the identified repair techniques, including but not limited to the following: Gaps between the inserted tiles; Securing the tiles in place; Distribution of materials in the RCC cavity; Shifting of materials once hot gas enters the cavity and melts the ice.

4.5 EVA TECHNIQUES

An attempt to repair damage to the wing leading edge would require two EVAs. The objectives of the first EVA would be to harvest the materials to be used in the repair (tiles, AFRSI, etc) and to retrieve the EVA tools / equipment from the payload bay stowage assembly (if not retrieved on the inspection EVA). The objective of the second EVA would be to execute the repair of the wing leading edge.

The EVA to harvest repair materials has been assessed to have a moderate to high level of difficulty. The degree of difficulty is directly dependent on the type and location of the materials to be harvested.

Prior to the second repair EVA, the crew would remove and modify the Orbiter middeck ladder for use as an on-site EVA restraint aid. The crew would wrap towels or foam near the top of the ladder to protect the Orbiter wing from direct contact. The crew would also securely attach EV1's mini-workstation (MWS) to the ladder on the upper rung.

Other required hardware for the repair is TBD (see 4.2 above), but might include CWCs, jettison stowage bags, hose/valve/nozzle assembly, metal, AFRSI, tiles, etc.

At the start of the EVA, the EV crew would egress the airlock, retrieve the required EVA tools from the payload bay and translate with the middeck ladder along the port payload bay door. The first activity would be to restrain the middeck ladder at the worksite. The ladder would be inverted with the foam-protected portion against the wing leading edge. The ladder would be secured to the payload bay door using EVA retention devices and would be carefully tensioned to pull the ladder against the wing leading edge. EV1 and 2 would then transfer the repair hardware to the worksite. EV1 would translate down the middeck ladder and, with assistance from EV2, attach the preintegrated MWS to the EMU fittings (thus restraining himself to the ladder near the worksite). EV2 would then help to stabilize EV1 and assist with repair materials and hardware as required.

The assessment of the level of difficulty of the repair operation is high. The level of risk to the crew is moderate and the risk of doing additional damage to the Orbiter is high (i.e. enlarging the wing leading edge breach). The overall assessment of the expectation of task success is moderate to low, depending on damage site characteristics and the required repair technique.

A detailed synopsis of the EVA repair procedure is included in Appendix D.

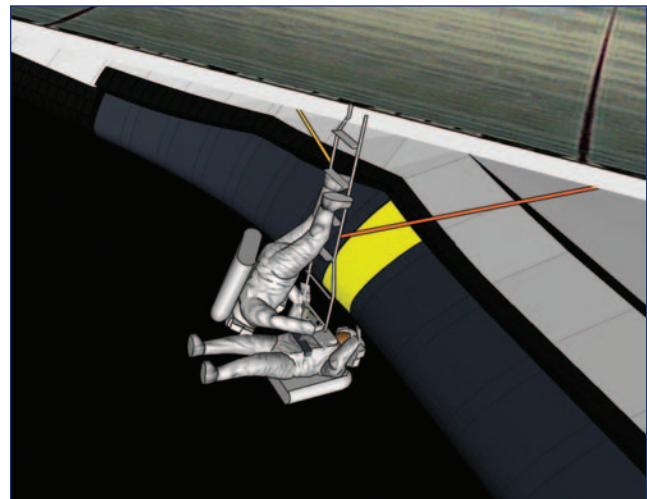

Figure 11. Repair EVA.

4.6 WING COLD SOAK

To freeze the water that was pumped into the CWC(s) in the left wing leading edge repair procedure, the left wing would have to be “coldsoaked” for three to six days. This coldsoak would result in a temperature decrease of the wing structure. In a typical flight, this type of coldsoak would not be performed, due to the impact on other systems like the main landing tires and wheels and the payload bay doors. However, for a known bailout case, tire and wheel temperature are not important and the thermal distortions of the payload bay doors may be acceptable. From the “Cain report” on entry options, it was determined that the maximum coldsoak would result in a 65 degree Fahrenheit decrease in the structural temperature at entry interface. This alone would not have been sufficient to maintain wing structural integrity, but coupled with the repair technique, weight jettison, and flying a 45-degree alpha profile, the structural heating may have been delayed sufficiently to allow a bailout.

4.7 ADDITIONAL ENTRY OPTIONS – THE “CAIN REPORT”

NASA Flight Director Leroy Cain presented the report from the “Entry Options Tiger Team” to the Orbiter Vehicle Engineering Working Group (OVEWG) on April 22. This report was a very complete analysis of the results of jettisoning most of the payload bay cargo and coldsoaking the wing. Although this report looked at options within the certified entry design envelope, the options presented required some very difficult EVA tasks like cutting power and fluid cables, cutting through a tunnel, and large mass handling. This study does not assess the feasibility of these tasks, but it simply notes that whatever jettison tasks that could be accomplished in any remaining time during the two “repair” EVAs would be performed, as this would decrease the entry heating by a small amount. As there is a very large uncer-

tainty band in the thermal analysis of a wing leading edge repair, it is sufficient to say that jettison of equipment would have occurred during any remaining EVA time, and this may have helped the overall total heat load.

4.8 UNCERTIFIED OPTIONS - INCREASED ANGLE OF ATTACK /LOW DRAG PROFILE

The Entry Options Tiger Team was requested to look at certified options only. The only uncertified entry flight design options that could significantly reduce the wing leading edge temperature would be to change guidance to fly a lower drag profile during entry or to raise the angle of attack (alpha) to a reference of 45 degrees, vice the standard 40 degrees. However, it should be noted that while flying either one of these entry profiles would reduce heating on the leading edge, the heat load would increase on another part of the TPS structure. A simplified analysis that does not account for heating effects due to boundary layer tripping from a damaged area shows that a wing leading edge peak temperature could be decreased from a reference of 2,900 degrees F to 2,578 degrees F. This would be considered as an additional tool in attempting to maintain the spar structural integrity. It should be noted that changing the reference alpha would require a significant software patch to entry guidance.

4.9 THERMAL ANALYSIS

As previously stated, the team does not believe that an accurate thermal analysis can be performed to determine the effectiveness of any repair option. Rather, this is the best option relative to the other candidates, and it is possible that the combination of the repair, coldsoaking the wing, deorbiting from the minimum perigee, jettisoning available cargo bay hardware, and flying a 45 degree angle of attack could potentially provide enough relief to reach an acceptable bailout altitude. Limited thermal analysis was done on the option,

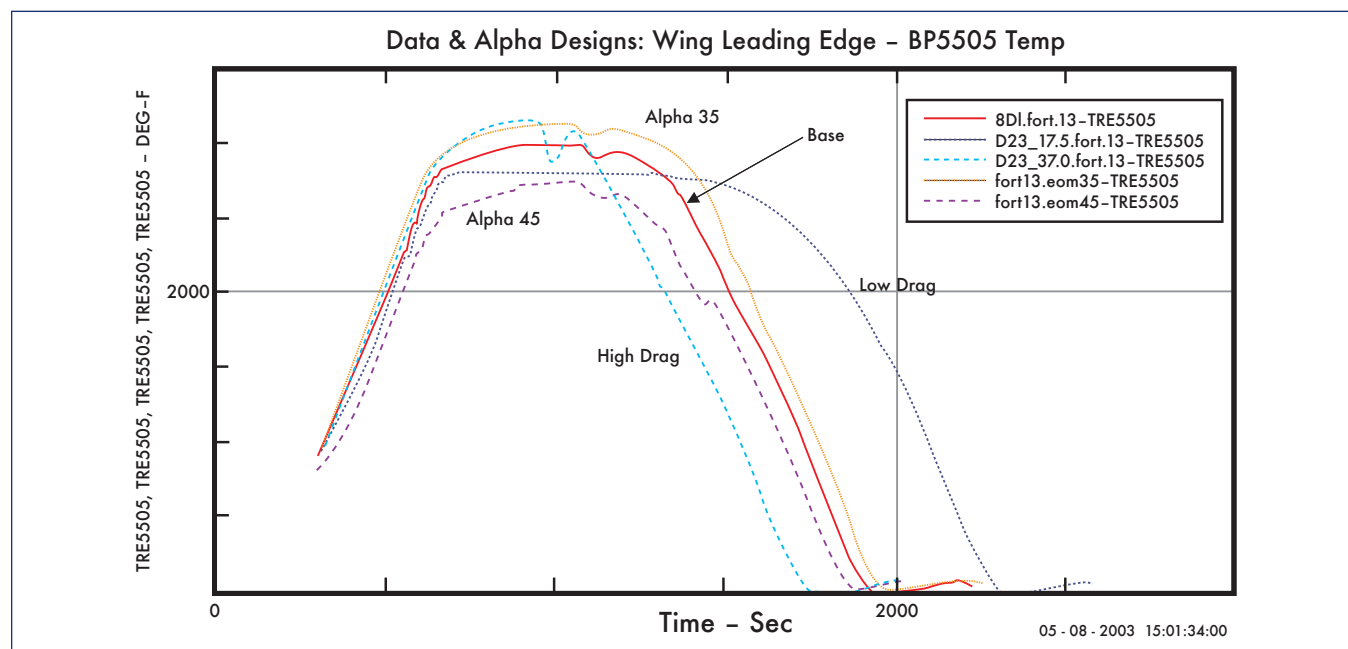

Figure 12. Relative Wing Leading Edge Temperature (No Boundary layer trip).

which assumed a flat plate of metal behind a flat plate of ice, behind a layer of AFRSI. The results while inconclusive, do not indicate this option was likely to succeed. However, the team believes it is sufficient to say that this would have been the best option to try, given the limited time and materials.

4.10 BAILOUT

4.10.1 Crew cabin configuration

For any repair option, it was the consensus of the team that the crew would be directed to bailout using standard procedures, due to the unknowns concerning structural damage to the wing and the landing gear. If the wing is damaged, the most probable time for failure is during final approach and landing. The dynamic pressure at landing is approximately 325 psf, while at bailout altitude (30K ft.) it is 225 psf.

For a planned bailout, or a potential vehicle breakup at an altitude higher than 30K feet, the following is the recommended procedure:

During D/O Prep, crewmembers would install seats and the escape pole as normal, and crewmembers would be strapped into seats as normal for entry. This would protect the crew in the event there is a loss of control or vehicle break-up. If there is a vehicle break-up (and the crew module survives intact), the crew could egress the crew module per the Break-up/LOC Cue Card.

During Entry, when the vehicle is at roughly 50k feet, the crew would start working the bailout portion of the emergency egress cue card. At 40k feet, they would vent the cabin. Working this step earlier, in the event of a vehicle breakup, would not be a good idea. If they started venting the cabin any earlier, it is likely that the cabin pressure would go low enough that their suits would begin to pressurize, making activity difficult. Venting at 40k feet keeps the cabin pressure high enough that the suits do not pressurize. At roughly 32k – 30k feet (as soon cabin pressure equalizes with ambient), they would jettison the hatch and bailout. Assuming the orbiter remains in controlled flight, there would be about 4 minutes from hatch jettison (~30k feet) to orbiter impact. In training, we typically see crews get out in about 2 minutes.

4.10.2 Maximum Altitude

Using the current Shuttle escape system, bailout (with the escape pole) must be done subsonic, and below 200 KEAS. Otherwise it is possible the pole may fail, crewmembers may contact the vehicle, crewmembers may experience flail injuries, or the suit and/or parachute may experience failures due to the wind speed. For a break-up scenario where the crewmember is egressing the separated crew module, it is still recommended to egress below 35K feet to reduce the possibility of flail injuries or suit/parachute failures. Also, bailing out at a higher altitude would be difficult. The suit will pressurize above 34K feet, limiting mobility and making it extremely difficult, if not impossible to get out the side hatch.

5.0 OTHER CONSIDERATIONS

5.1 LIOH REGENERATION

LiOH that has been exposed to CO₂ turns into lithium carbonate (Li₂CO₃). Research was performed at Ames Research Center to demonstrate that Li₂CO₃ could be converted to LiO using high temperature (1,250 degrees F) and a vacuum. The same researchers are now looking at the feasibility of conversion at lower temperatures. The maximum temperature for any part of the Orbiter payload bay environment is 250 degrees F. There is a potential that extended vacuum exposure could convert some of the Li₂CO₃ to LiO, which could then be hydrated to form LiOH. If it is determined that lower temperatures in a vacuum produce some conversion, the option of taking LiOH canisters into a hot part of the payload bay may provide additional LiOH capability. These tests are ongoing at this time.

5.2 OTHER VEHICLES (SOYUZ, ARIANE 4)

There has been some discussion regarding the possibility of sending supplies to *Columbia* using an expendable launch vehicle – to lengthen the amount of time available to execute a rescue mission. Because of *Columbia's* 39-degree orbital inclination, an expendable launch from a launch site with a latitude greater than 39 degrees would not be able to reach *Columbia*. This rules out a Soyuz/Progress launch. There was an Ariane 4 in French Guiana that successfully launched an Intelsat satellite on February 15. The challenge with developing a supply kit, building an appropriate housing and separation system, and reprogramming the Ariane seems very difficult in three weeks, although this option is still in work.

5.3 ISS SAFE HAVEN

The *Columbia's* 39 degree orbital inclination could not have been altered to the ISS 51.6 degree inclination without approximately 12,600 ft/sec of translational capability. *Columbia* had 448 ft/sec of propellant available.

APPENDIX

APPENDIX A – TABLE OF EVENTS

(Next page)

APPENDIX B: EVA INSPECTION PROCEDURE

- Pre-EVA, modify EV1 EMU to include an adjustable equipment tether (AET) secured around left EMU ankle (stabilization aid for EV2 at the inspection site), and towels gray-taped to right EMU boot (to protect the wing leading edge).
- EV1 egress airlock and transfer EV2's safety tether to port slidewire.
- EV1 and EV2 translate out and down the port Orbiter payload bay door (PLBD), first along the forward edge then aft along the outboard edge.
- Prior to reaching the wing leading edge, EV1 and 2 practice inspection technique with EV1 holding PLBD

Calendar Date	Columbia – Mission Elapsed Time (MET) at 10:39 a.m.	Columbia Flight Day	Events
Jan. 16	00/00:00	1	Columbia launch – 10:39 a.m. EST
Jan. 17	01/00:00	2	Notification of foam strike on left wing
Jan. 18	02/00:00	3	Request National Assets
Jan. 19	03/00:00	4	Plan Inspection EVA – notify KSC to begin processing Atlantis
Jan. 20	04/00:00	5	Perform Inspection EVA. Major powerdown begins, LiOH conservation
Jan. 21	05/00:00	6	
Jan. 22	06/00:00	7	Last day to notify KSC for vehicle processing (to make 2/14 7:40 p.m. FD 1 rendezvous window)
Jan. 23	07/00:00	8	
Jan. 24	08/00:00	9	
Jan. 25	09/00:00	10	
Jan. 26	10/00:00	11	Atlantis Rollover – OPF to VAB
Jan. 27	11/00:00	12	
Jan. 28	12/00:00	13	
Jan. 29	13/00:00	14	
Jan. 30	14/00:00	15	Atlantis Rollout – VAB to Pad
Jan. 31	15/00:00	16	
Feb. 1	16/00:00	17	
Feb. 2	17/00:00	18	
Feb. 3	18/00:00	19	
Feb. 4	19/00:00	20	
Feb. 5	20/00:00	21	
Feb. 6	21/00:00	22	
Feb. 7	22/00:00	23	
Feb. 8	23/00:00	24	
Feb. 9	24/00:00	25	First launch window – 11:09 p.m. EST, rendezvous on Feb. 10
Feb. 10	25/00:00	26	Second launch window – 10:40 p.m. EST, rendezvous on Feb. 13
Feb. 11	26/00:00	27	Third launch window – 10:05 p.m. EST, rendezvous on Feb. 13
Feb. 12	27/00:00	28	
Feb. 13	28/00:00	29	
Feb. 14	29/00:00	30	Last FD 1 rndz Window 8:40 p.m. EST
Feb. 15	30/00:00	31	LiOH depleted – morning

edge while EV2 translates down EV1.

- Complete the translation to wing leading edge near RCC panel 8, and visually survey the upper surface of the wing.
- EV1 remain holding on to PLBD using the passive centerline latch mechanism for primary stabilization (body orientation facing inboard, head toward Orbiter –Z. If

no damage noted on the upper surface, gently place right foot on the top of wing with left foot near wing leading edge.

- Using EV1 as translation aid, EV2 translate down EV1 to inspect panel (using AET on left leg as handling aid). EV2 provide verbal assessment of damage.
 - Note: If adequate stability achieved during practice

inspection, contact with the upper surface of the wing would not be required.

APPENDIX C: EVA TRANSFER PROCEDURE

EVA Transfer Procedure:

- Both *Columbia* and *Atlantis* airlocks are depressed at the start of EVA.
- *Atlantis* EV2, using PFR sill stack and EVA boom (to extend reach), transfers other *Atlantis* EV1, and then extra LiOH canisters and two spare EMUs to *Columbia*.
- EV1 assists the first *Columbia* crewmembers (CM1 and 2) from the *Columbia* airlock.
- EV1 puts spare EMUs and LiOH canisters in the airlock, which is then repressed. CM3 and 4 don these EMUs.
- CM1 and 2 transfer to *Atlantis* (accompanied by *Atlantis* EV1), repress the airlock, doff their EMUs and prepare them for transfer back to *Columbia*.
- *Atlantis* EV1 and 2 conduct SAFER inspection of *Atlantis* TPS, and when convenient, EV1 installs a TCS reflector on *Columbia* for subsequent rendezvous.
- The same general process for CM transfer is used to transfer the remaining *Columbia* crewmembers to *Atlantis*. On the third transfer, only one *Columbia* crewmember is rescued, leaving two remaining (CM6 and 7).
- EMU donning for CM6 and 7 will be difficult since no IV will be available to assist. *Columbia's* contingency EVA CMs would be best suited for this task. Consideration would be made to using EMU donning techniques developed for the first four Shuttle flights, while taking into account the recent ISS Expedition 7 EMU self-donning exercise.

APPENDIX D: EVA REPAIR PROCEDURES

Damaged RCC Panel

Pre-EVA:

- Remove Orbiter middeck ladder and wrap towels or foam near the top of the ladder (to protect Orbiter wing from direct contact).
- Required hardware for repair:
 1. 2-3 empty CWCs
 2. 2 empty jettison stowage bags
 3. Jettison stowage bag filled with various metal parts
 4. Hose/valve/nozzle assembly attached to water port on Airlock panel
- Prior EVA required to retrieve mini-workstations (MWS) from PSA.
- Attach EV1 MWS securely to ladder. (EV2 will begin EVA with MWS, EV1 without.)

EVA Repair Procedure:

- EVA crew egress airlock and retrieve required EVA tools from PSA.
- EVA crew harvest AFRSI from aft fuselage of Orbiter;

stow in bag

- EVA crew, with middeck ladder, translate out and down port Orbiter PLBD using same translation route used during inspection.
- Restrain middeck ladder at worksite:
 - Note: ladder is inverted with foam-protected top portion against wing leading edge.
 - Attach ladder to PLBD passive centerline latch mechanism using tethers.
 - Use aft bulkhead winch (or rope reel) and PRD routed from aft hinge of PLBD (under opened PLBD) to ladder close to the top of the wing and gently pull ladder against wing leading edge.
- Transfer repair hardware to worksite.
- EV1 translate down middeck ladder and, with assistance from EV2, attach MWS to EMU (thus restraining self to ladder and near worksite).
- EV2 help to stabilize EV1, and assist with repair materials and hardware as required.
- EV1 repair damaged panel:
 - Stuff empty jettison stowage bag in hole.
 - Fill jettison stowage bag with various metal parts (from other bag).
 - Stuff empty CWC in hole and fill with water.
 - Stuff additional CWC in hole and fill with water.
 - Seal hole with AFRSI.

Note: The assessment of the level of difficulty is high, level of risk to crew is moderate and the risk of doing additional damage to Orbiter is high (i.e. enlarging the wing leading edge breach). Overall assessment of the expectation of task success is moderate to low, depending on damage site characteristics.

Damaged T-seal

Pre-EVA:

- Remove Orbiter middeck ladder and wrap towels or foam near the top of the ladder (to protect Orbiter wing from direct contact).
- Required hardware for repair:
 1. Harvested tile sculpted to fit in T-seal
- Prior EVA required to retrieve mini-workstations (MWS) from PSA and harvest tile from canopy of Orbiter.
- Attach EV1 MWS securely to ladder. (EV2 will begin EVA with MWS, EV1 without.)

EVA Repair Procedure:

- EVA crew egress airlock and retrieve required EVA tools from PSA.
- EVA crew, with middeck ladder, translate out and down port Orbiter PLBD using same translation route used during inspection.
- Restrain middeck ladder at worksite:
 - Note: ladder is inverted with foam-protected top portion against wing leading edge.
 - Attach ladder to PLBD passive centerline latch mechanism using tethers.
 - Use aft bulkhead winch (or rope reel) and PRD

routed from aft hinge of PLBD (under opened PLBD) to ladder close to the top of the wing and gently pull ladder against wing leading edge.

- Transfer repair hardware (jettison stowage bag) to worksite.
- EV1 translate down middeck ladder and, with assistance from EV2, attach MWS to EMU (thus restraining self to ladder and near worksite).
- EV2 help to stabilize EV1, and assist with repair materials and hardware as required.
- EV1 repair damaged T-seal:
 - Insert tile into T-seal gap minimizing spaces between tile

Note: The assessment of the level of difficulty is high, level of risk to crew is moderate and the risk of doing additional damage to Orbiter is high (i.e. enlarging the wing leading edge breach). Overall assessment of the expectation of task success is moderate to low, depending on damage site characteristics.

APPENDIX E: RENDEZVOUS BURN PLANS

February 9th:

Launch Window Inplane Launch GMT: 40/03:40:24
Second window pane available (will require FD4 rndz)

Phase angle: 161 degrees (FD3 rndz)

OMS-2:	0/00:38 07 MET	150.4 fps
NC-1:	0/03:35:52 MET	6.0 fps
NC-2:	0/15:27:21 MET	3.0 fps
NPC:	0/19:04:29 MET	1.5 fps
NC-3:	0/22:52:01 MET	3.0 fps
NH:	1/13:24:45 MET	103.5 fps
NC-4:	1/13:57:09 MET	37.1 fps
Ti:	1/15:27:33 MET	9.0 fps

Total Cost (OMS-2 to Ti) = 313.5 fps

February 10th:

Launch Window Inplane Launch GMT: 41/03:09:05
Second window pane available (may require FD4 rndz)

FD1, 2, or 3 rndz available on this day.

Delay launch until a phase angle of 30 degrees was achieved (phase angle at the IP time was only 11 degrees)

Phase angle: 30 degrees (this plan reflects a FD3 rndz)

OMS-2:	0/00:38:08 MET	229.4 fps
NH (NC-1):	0/03:14:25 MET	50.9 fps
NC-2:	0/18:16:58 MET	6.0 fps
NPC:	0/21:39:48 MET	1.3 fps
NC-3:	1/03:18:48 MET	3.0 fps
NC-4:	1/16:02:24 MET	6.1 fps
Ti:	1/17:32:48 MET	9.0 fps

Total Cost (OMS-2 to Ti) = 305.7 fps

Note: For a FD2 or FD1 rndz, costs increase approximately 10 fps total.

February 11th:

Launch window Inplane Launch GMT: 42/02:41:47
Single pane day, FD3 rndz only.

Phase angle: 235 degrees

OMS-2:	0/00:38:07 MET	97.4 fps
NC-1:	0/03:34:46 MET	6.0 fps
NC-2:	0/15:21:41 MET	3.0 fps
NPC:	0/18:47:53 MET	1.3 fps
NC-3:	1/03:20:00 MET	3.0 fps
NH:	1/14:40:45 MET	145.7 fps
NC-4:	1/15:12:20 MET	68.8 fps
Ti:	1/16:42:43 MET	9.0 fps

Total Cost (OMS-2 to Ti) = 334.2 fps

February 12th:

Launch Window Inplane Launch GMT: 43/02:10:29
Second window pane available (FD4 rndz required)

Phase angle: 87 degrees (FD3 rndz)

OMS-2:	0/00:38:35 MET	165.8 fps
NC-1:	0/03:36:11 MET	6.0 fps
NC-2:	0/15:17:45 MET	89.0 fps
NPC:	0/18:22:15 MET	0.8 fps
NC-3:	1/01:47:52 MET	3.0 fps
NC-4:	1/14:21:06 MET	32.3 fps
Ti:	1/15:51:28 MET	9.1 fps

Total Cost (OMS-2 to Ti) = 305.9 fps

February 13th:

Launch window Inplane Launch GMT: 44/01:43:10
FD4 rndz only

However, we chose to phase from above (go higher than the target) and launch near the end of the window. This costs more propellant but preserves FD3 rndz.

FD1 or FD2 rndz not possible.

Richard, this case would involve some fancy IY generation.

Phase angle: -28 degrees

OMS-2:	0/00:38:35 MET	212.4 fps
NC-1:	0/03:29:00 MET	118.8 fps
NC-2:	0/15:36:01 MET	3.0 fps
NPC:	0/19:13:01 MET	1.0 fps
NC-3:	1/01:47:00 MET	3.0 fps
NH:	1/14:25:45 MET	81.38 fps
		(retrograde)
NC-4:	1/14:45:00 MET	29.7 fps
Ti:	1/16:21:47 MET	9.0 fps

Total Cost (OMS-2 to Ti) = 458.3 fps

Note: FD4 rndz would be more in line with the other plans (cost ~330 fps)

February 14th:

Launch Window Inplane Launch GMT: 45/01:11:52

Plan virtually identical to February 9th. No significant deltas.

THIS PAGE INTENTIONALLY LEFT BLANK