

Chi

contour_order

”

midway interpolation

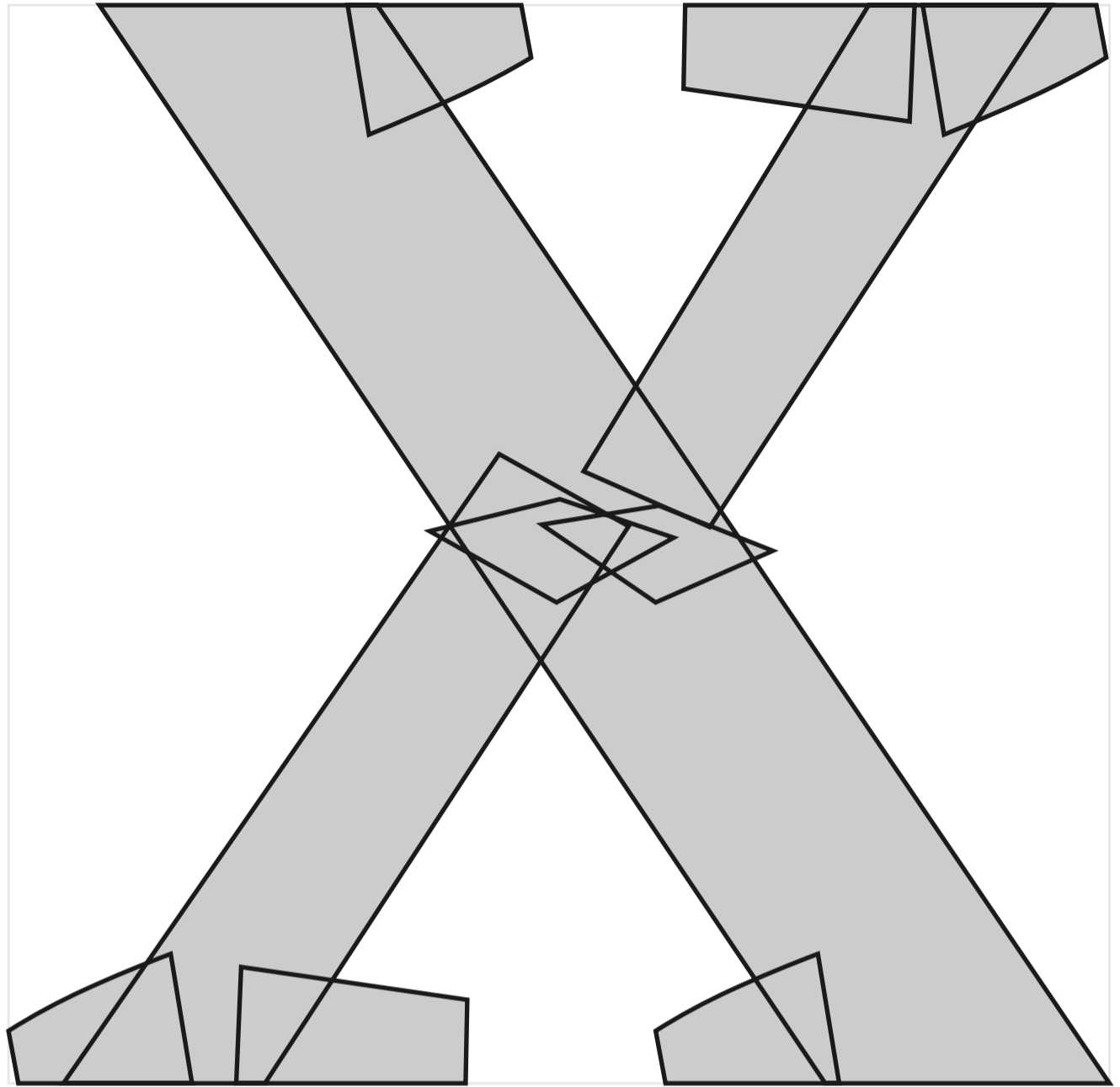
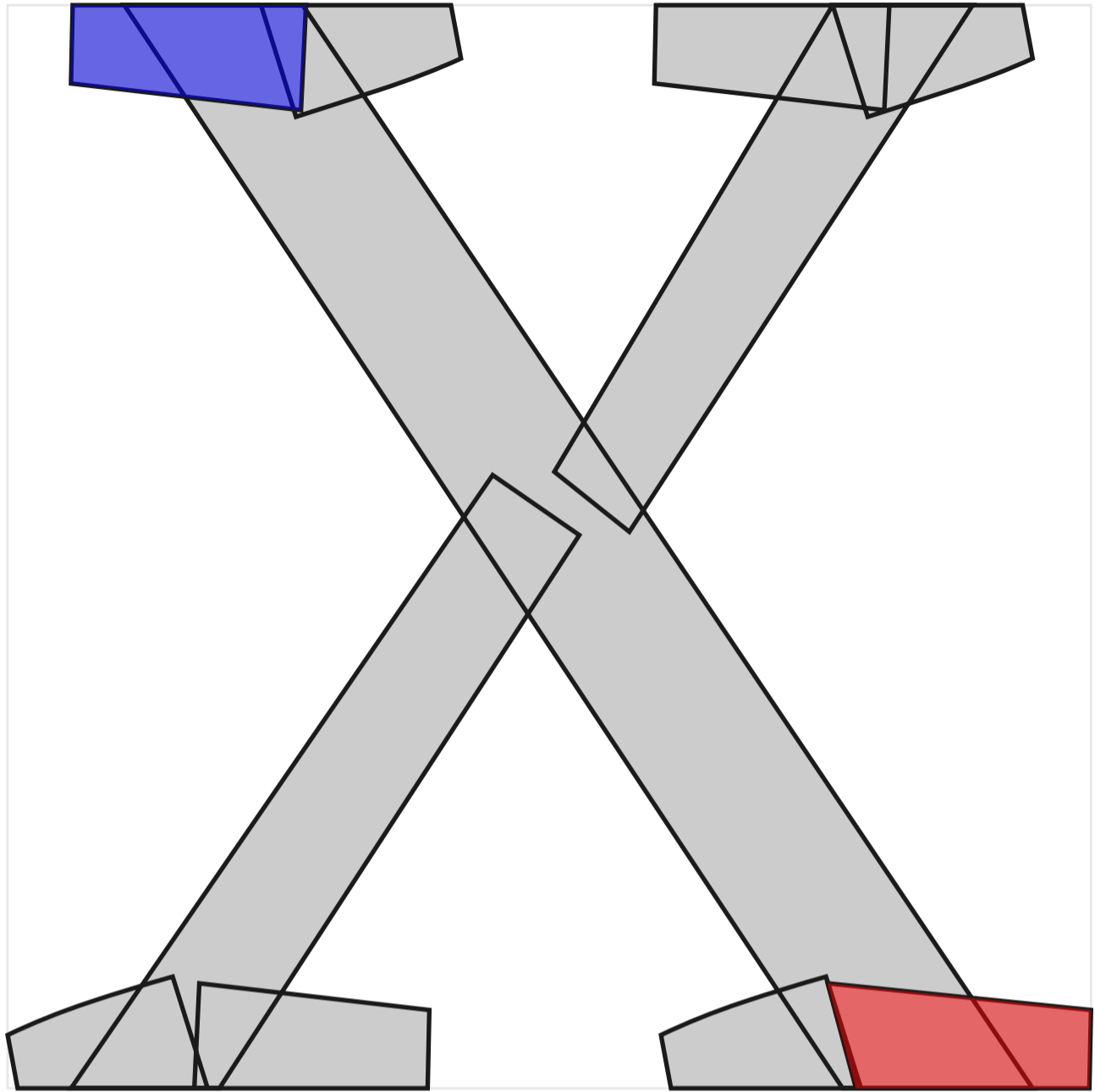

'wght=800.0'

proposed fix

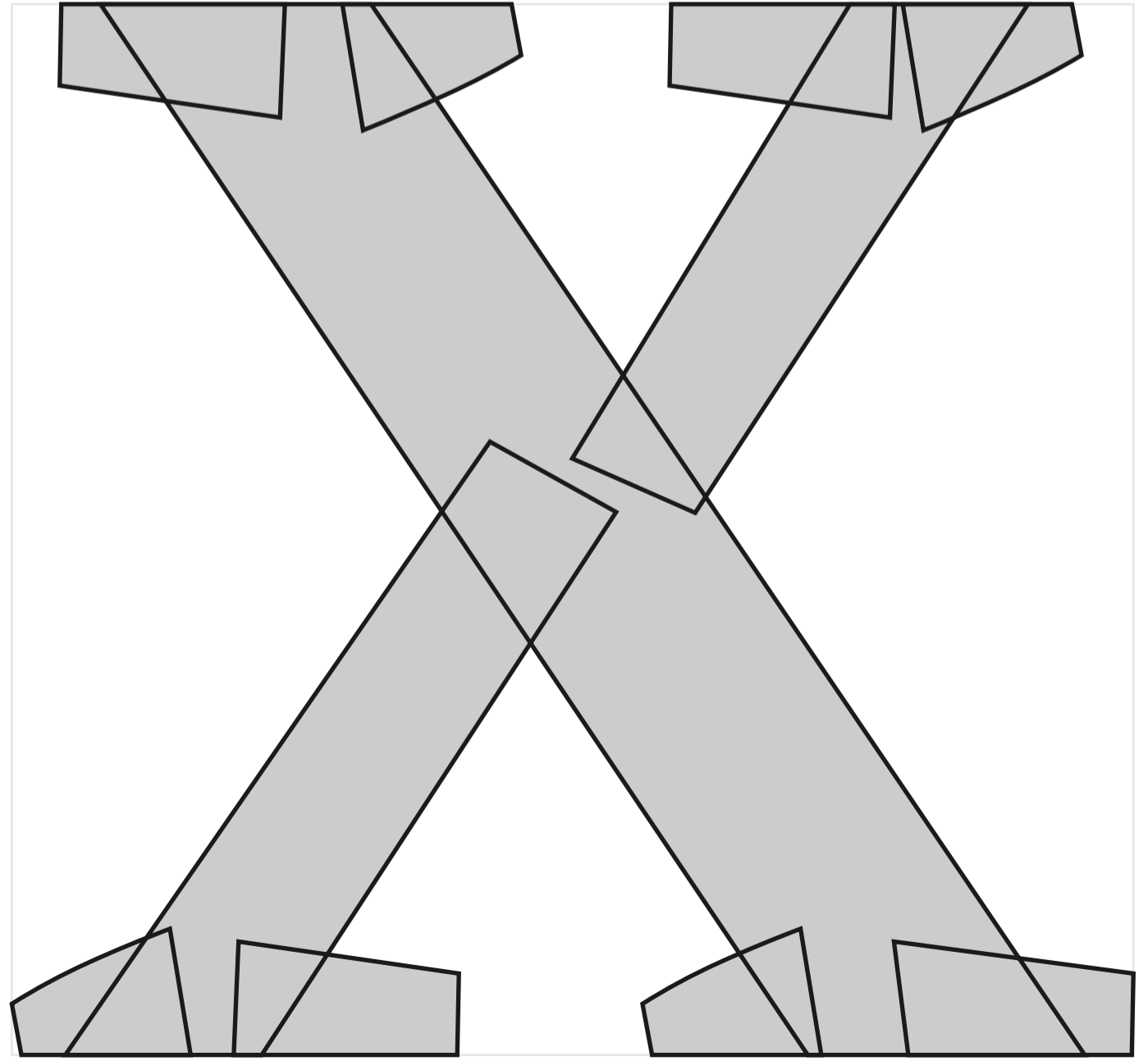
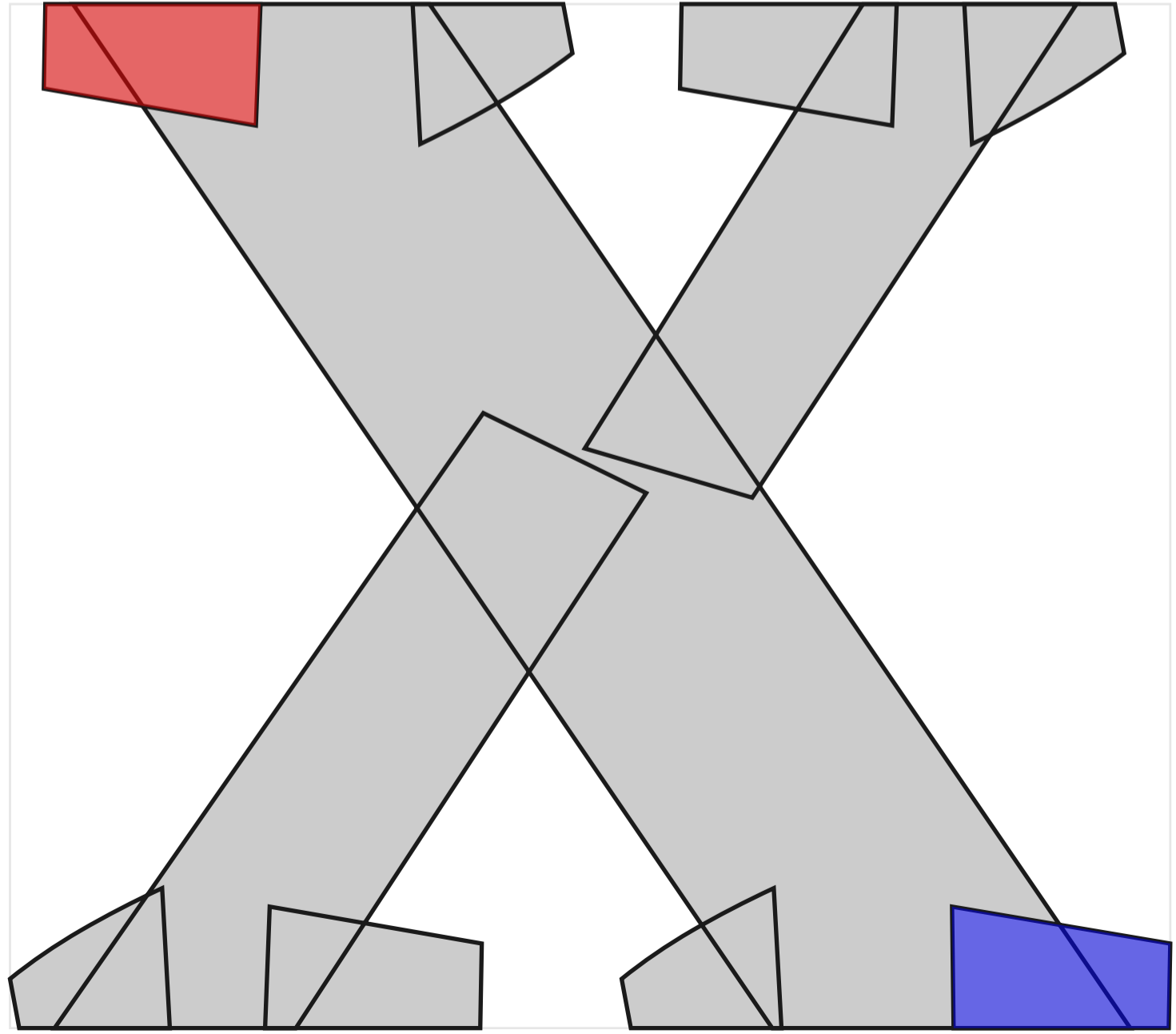

Kappa

contour_order

”

midway interpolation

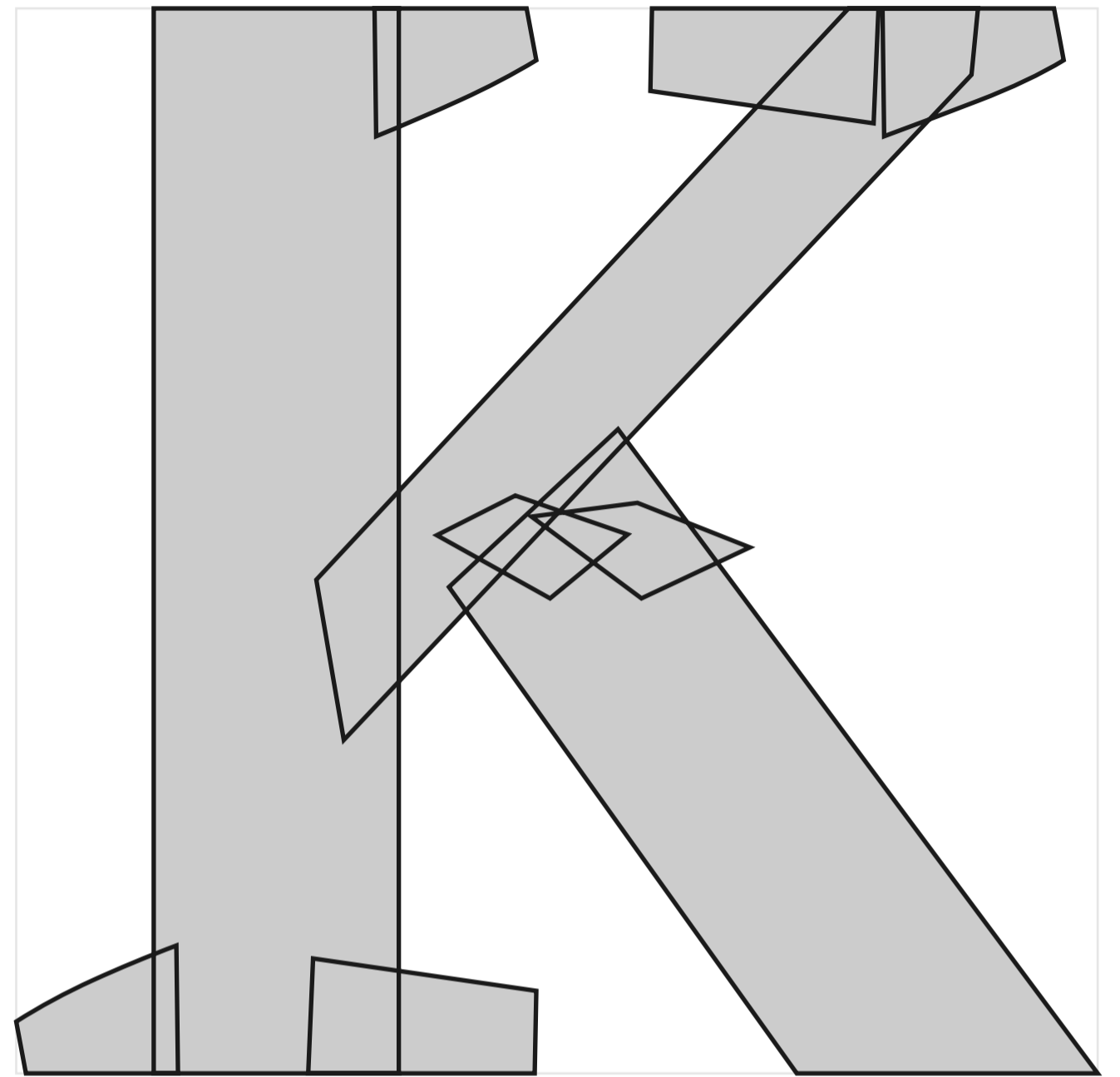
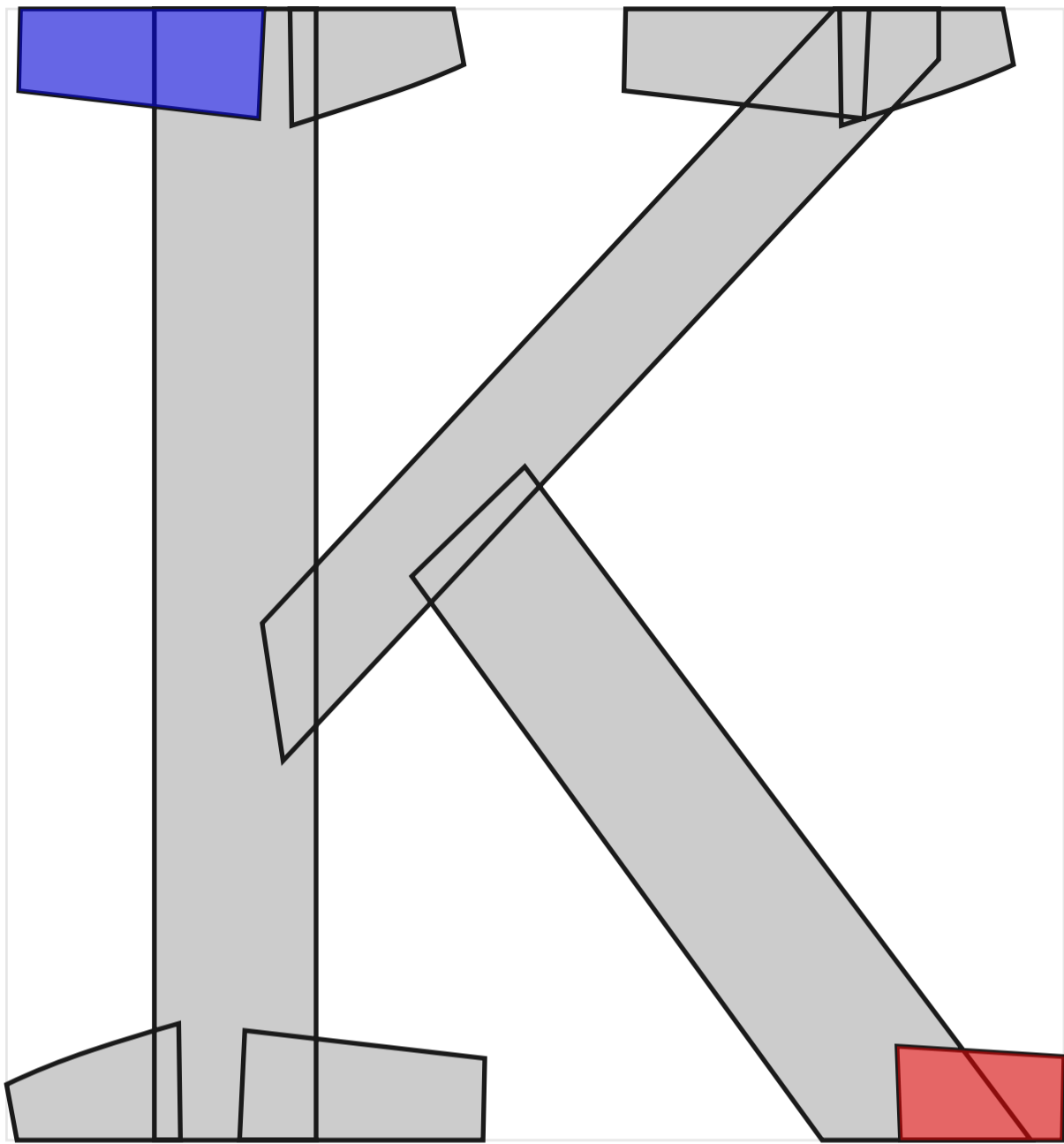

'wght=800.0'

proposed fix

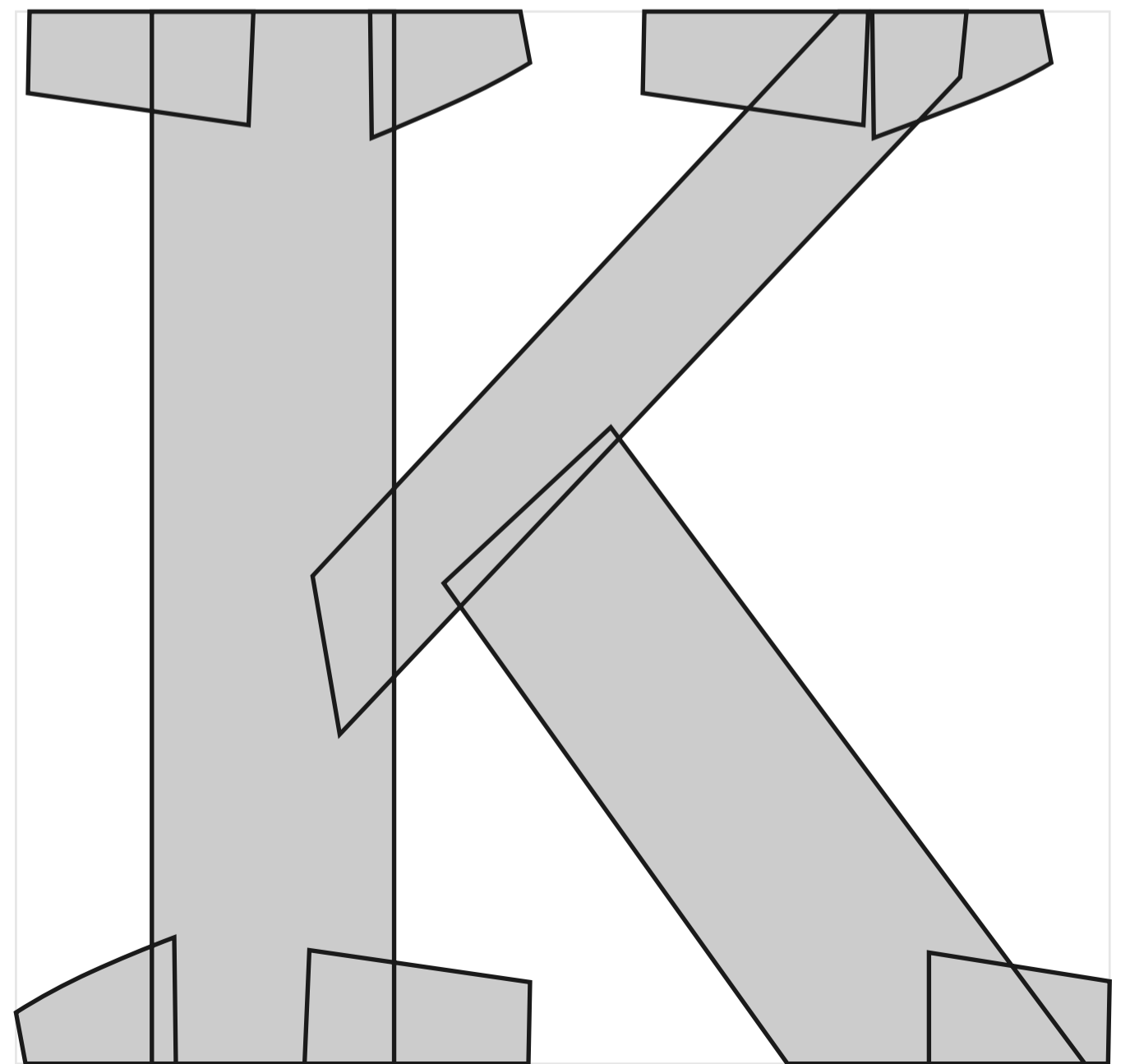
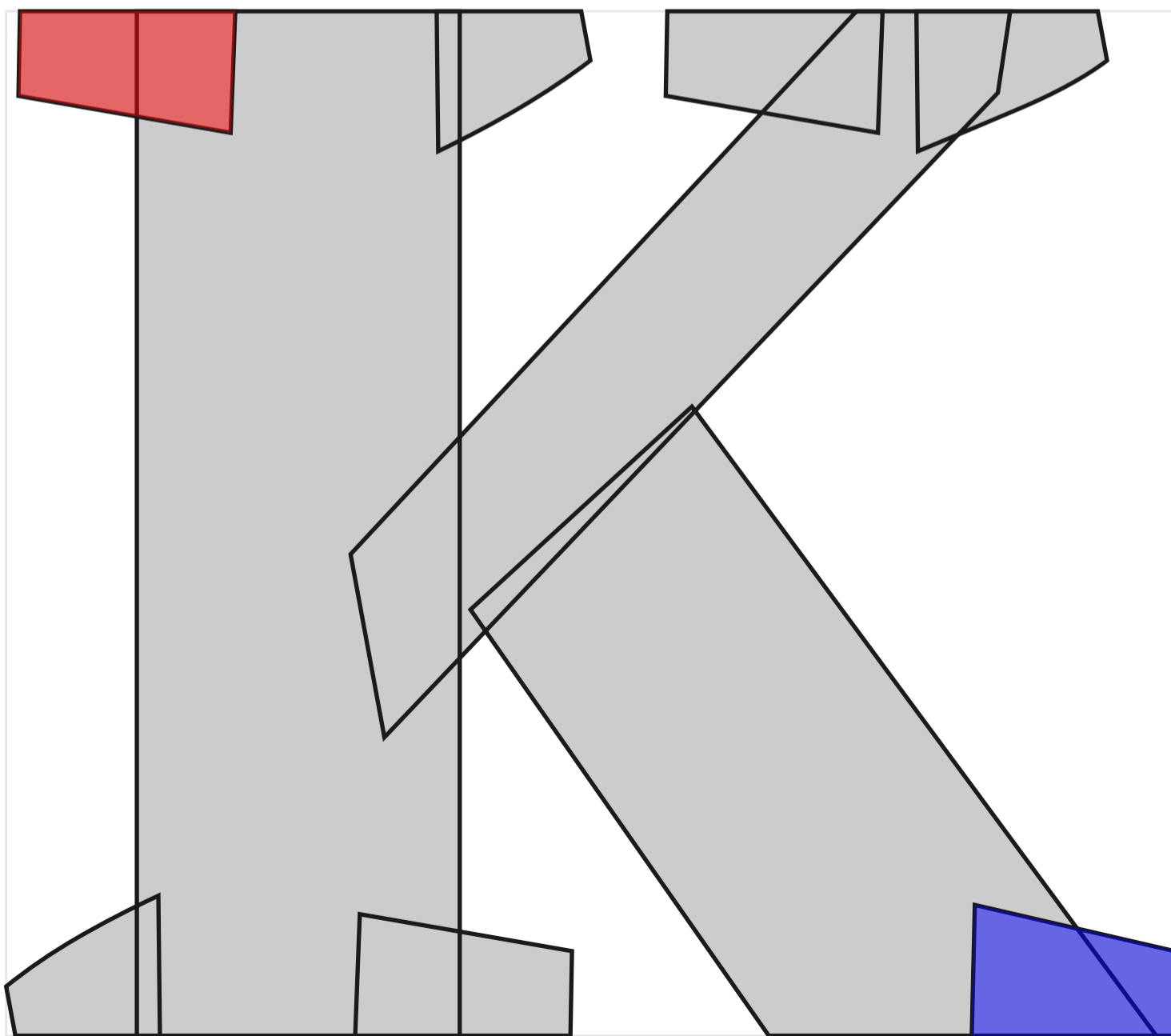

Mu

contour_order

”

midway interpolation

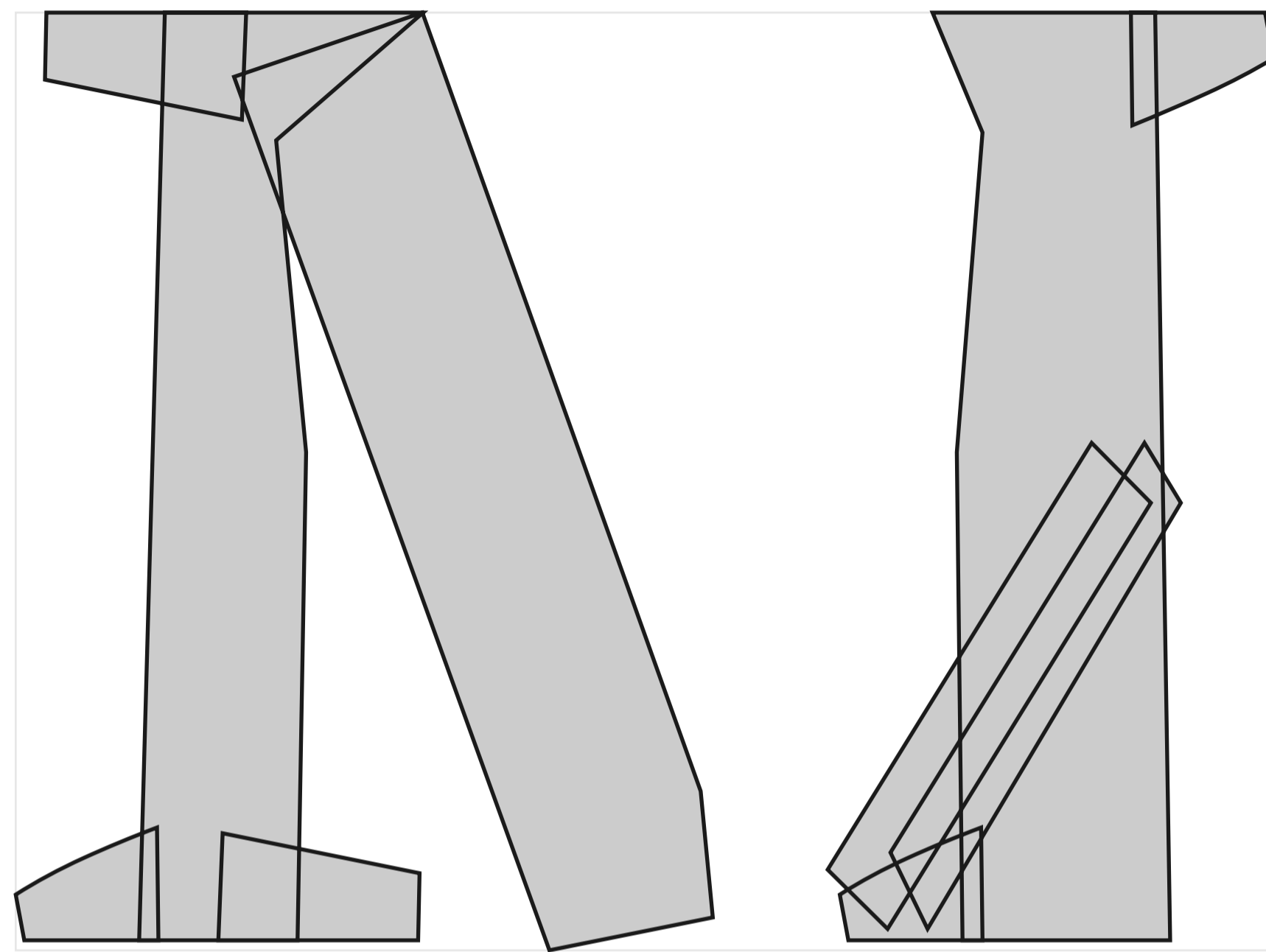
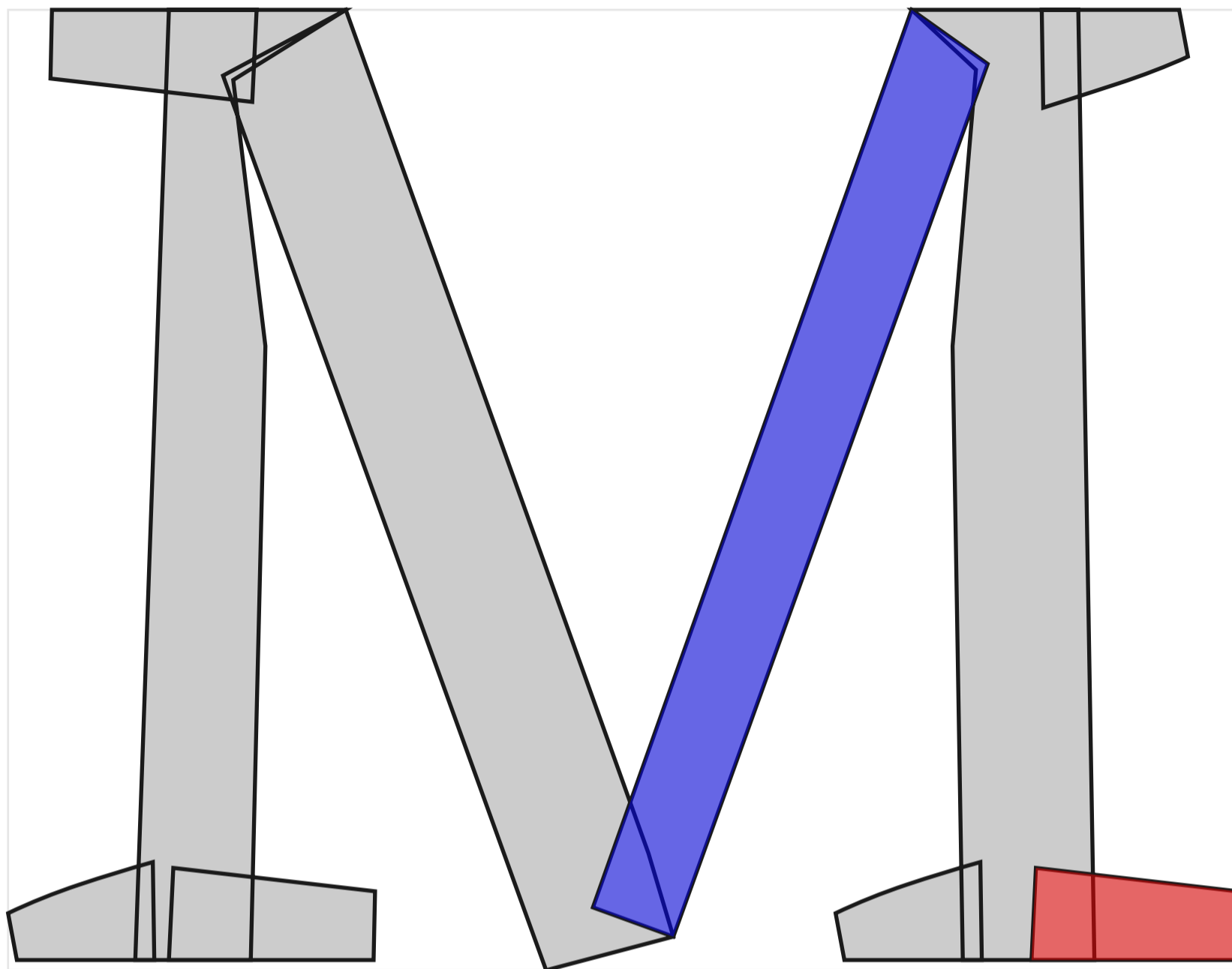

'wght=800.0'

proposed fix

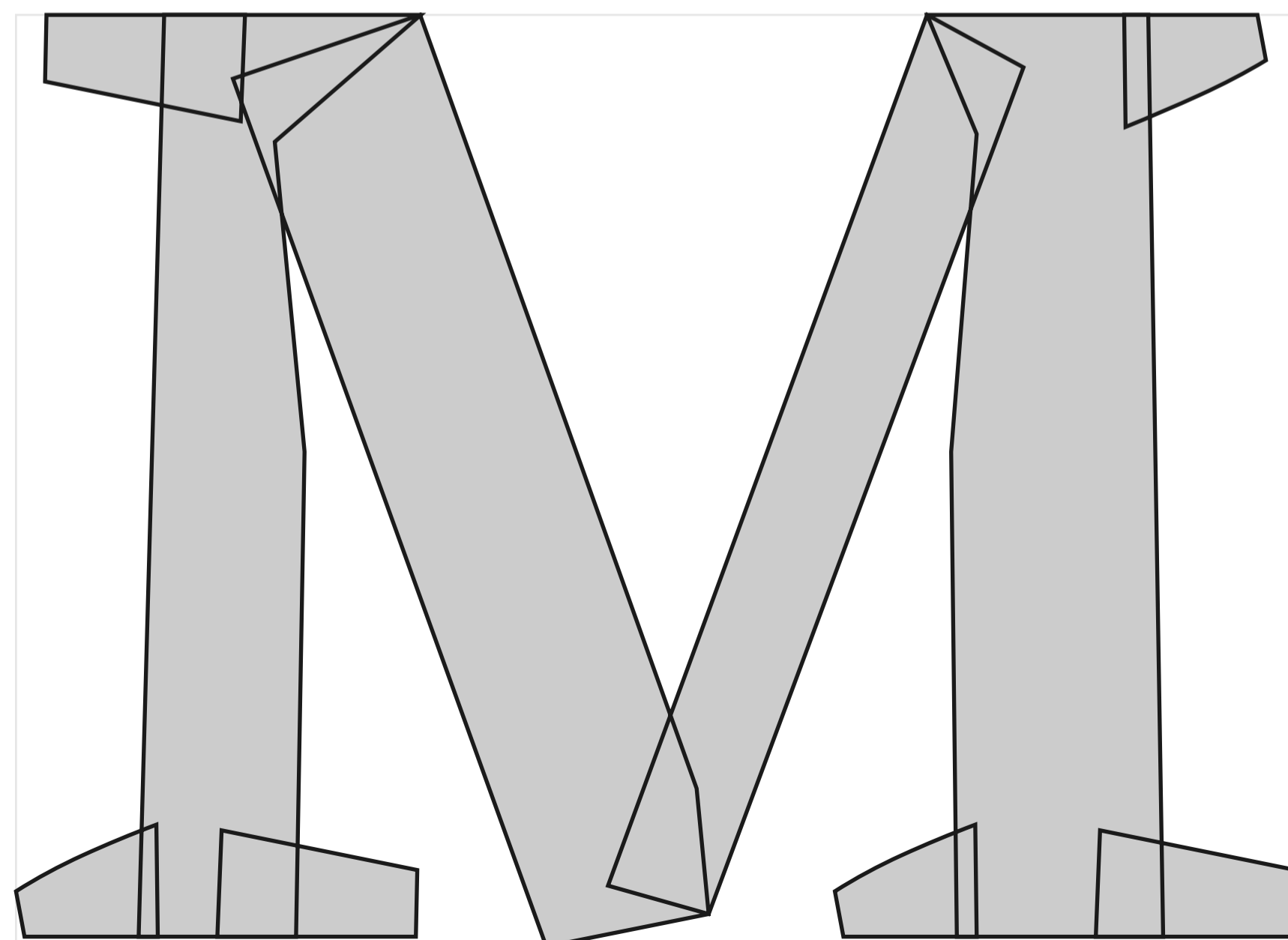
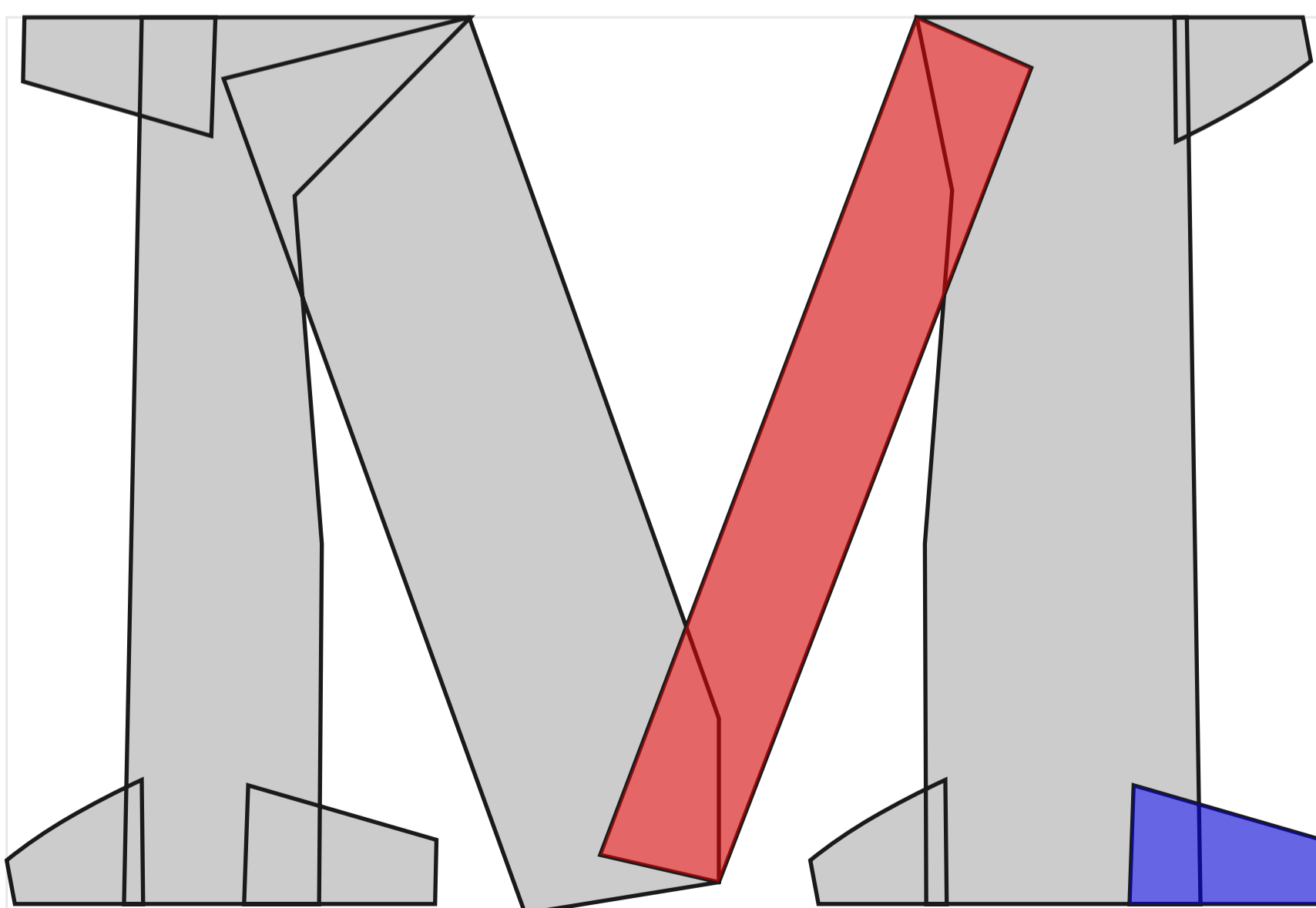

Upsilon

contour_order

”

midway interpolation

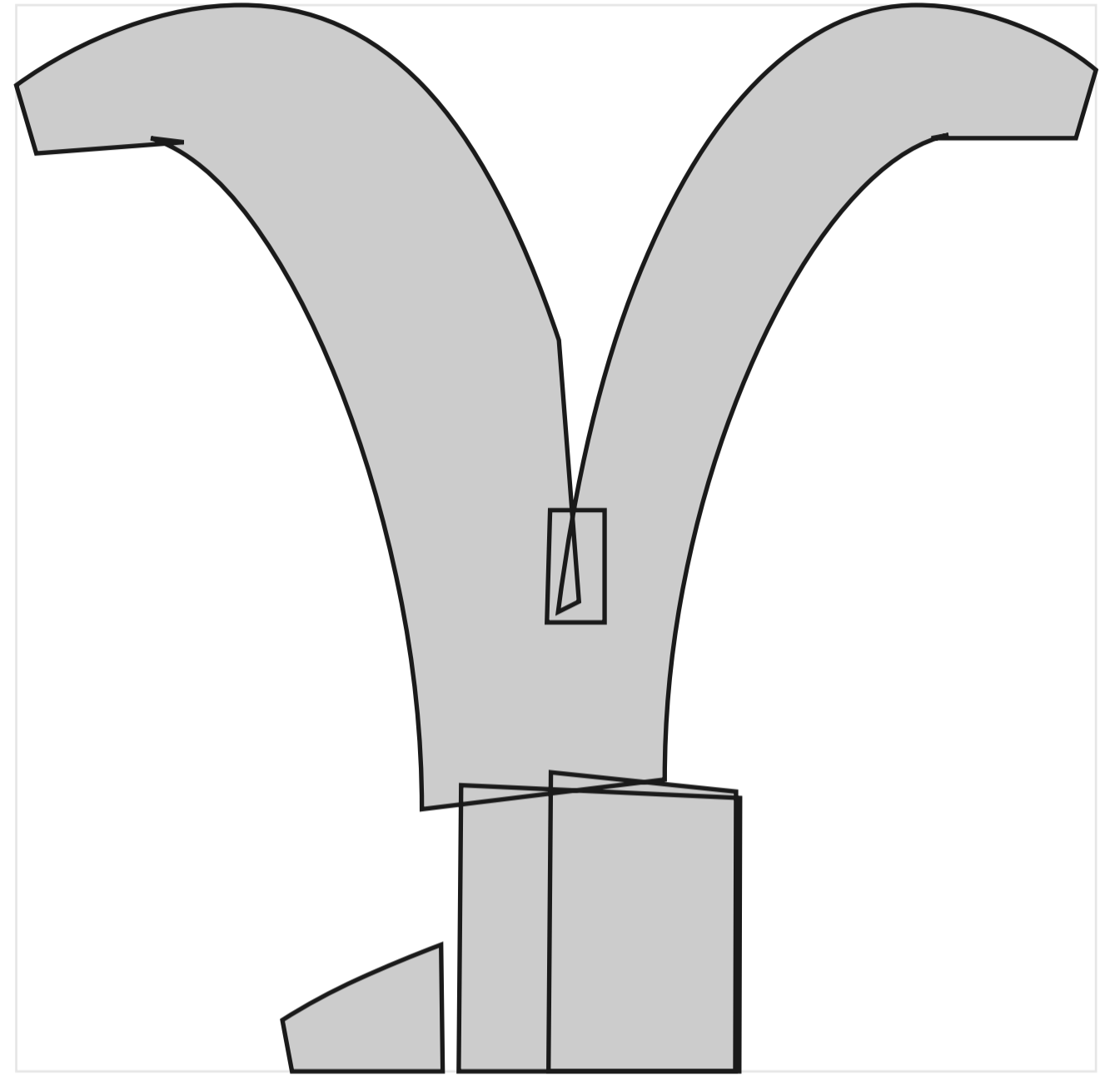
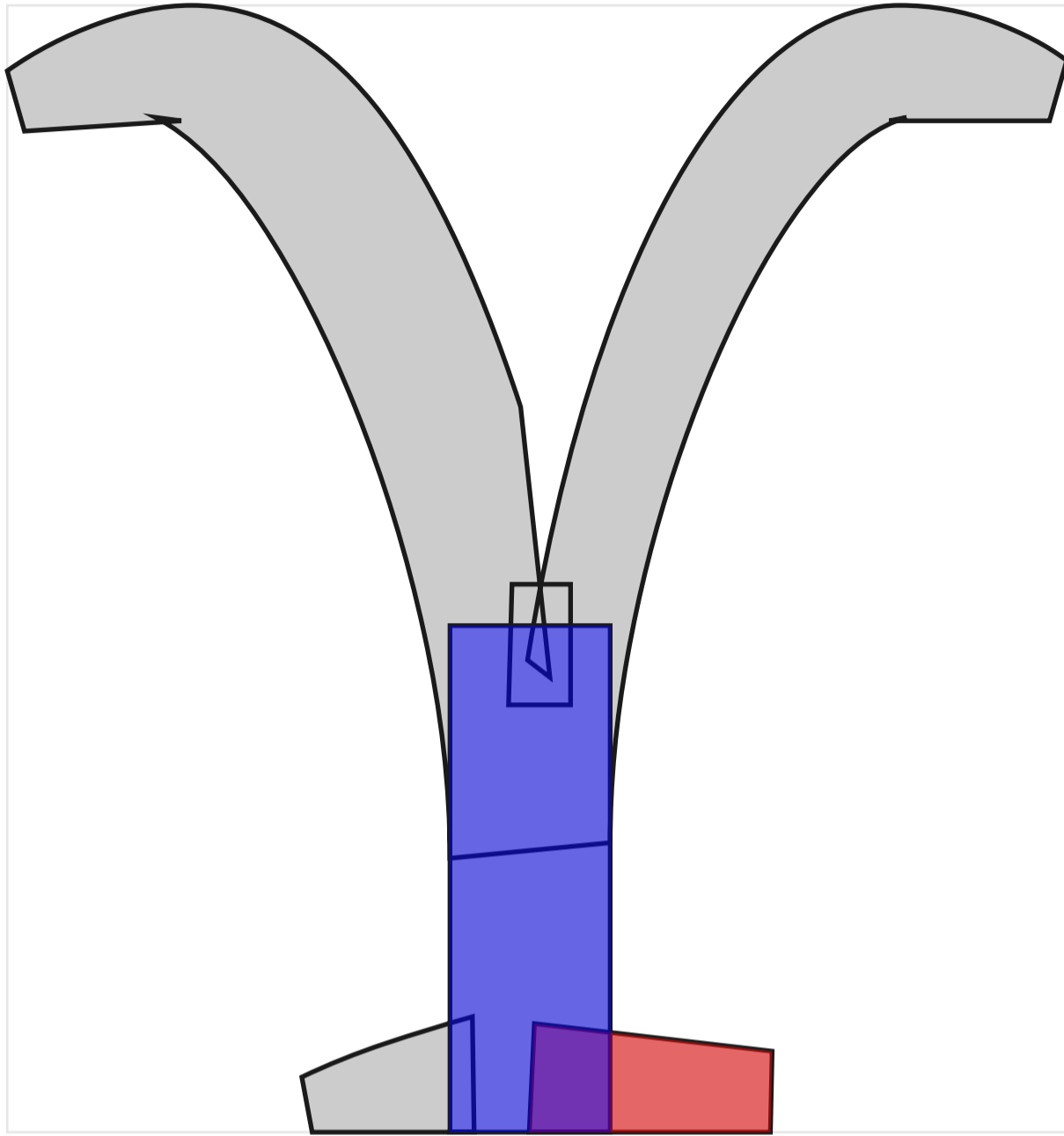

'wght=800.0'

proposed fix

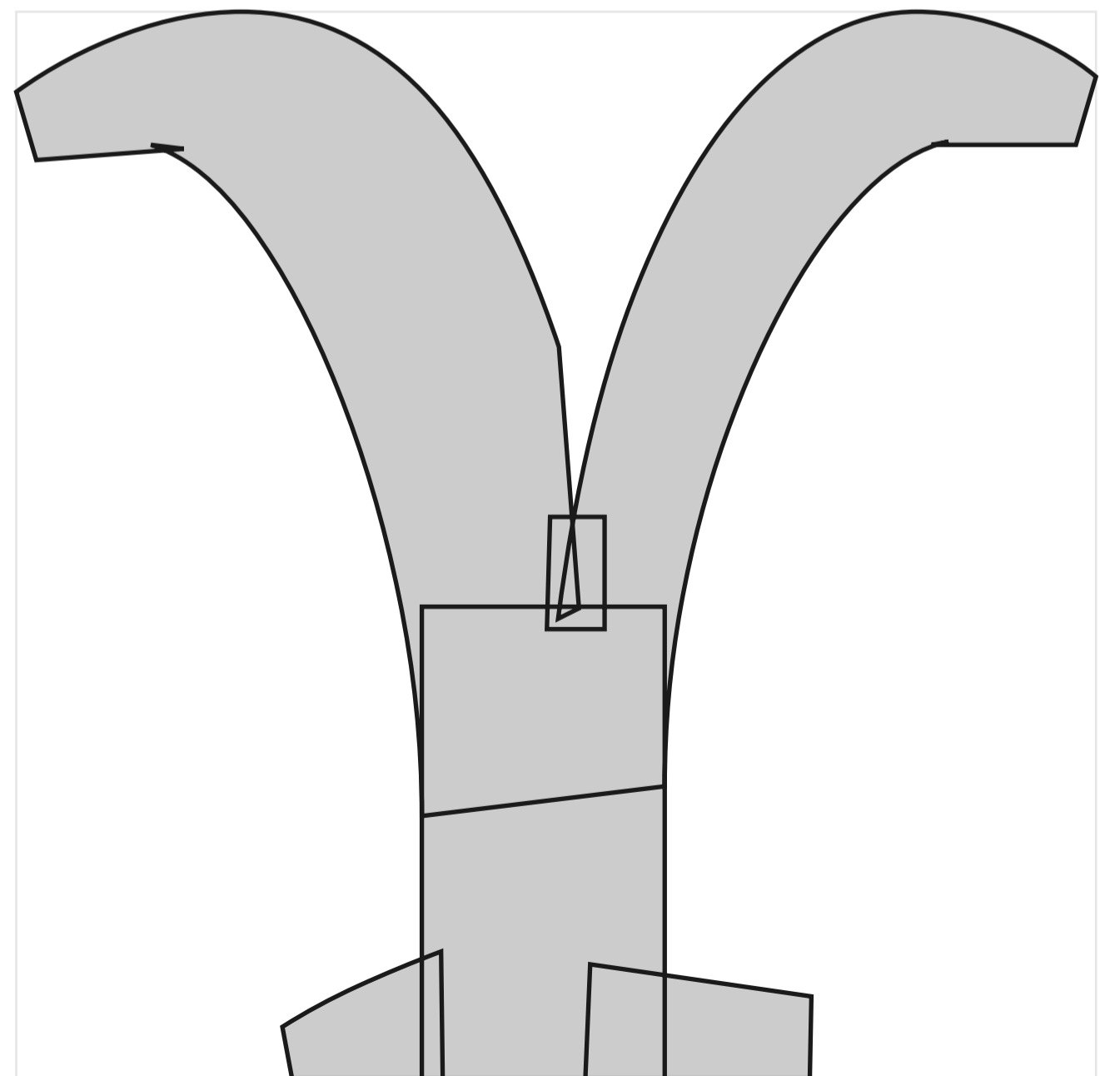
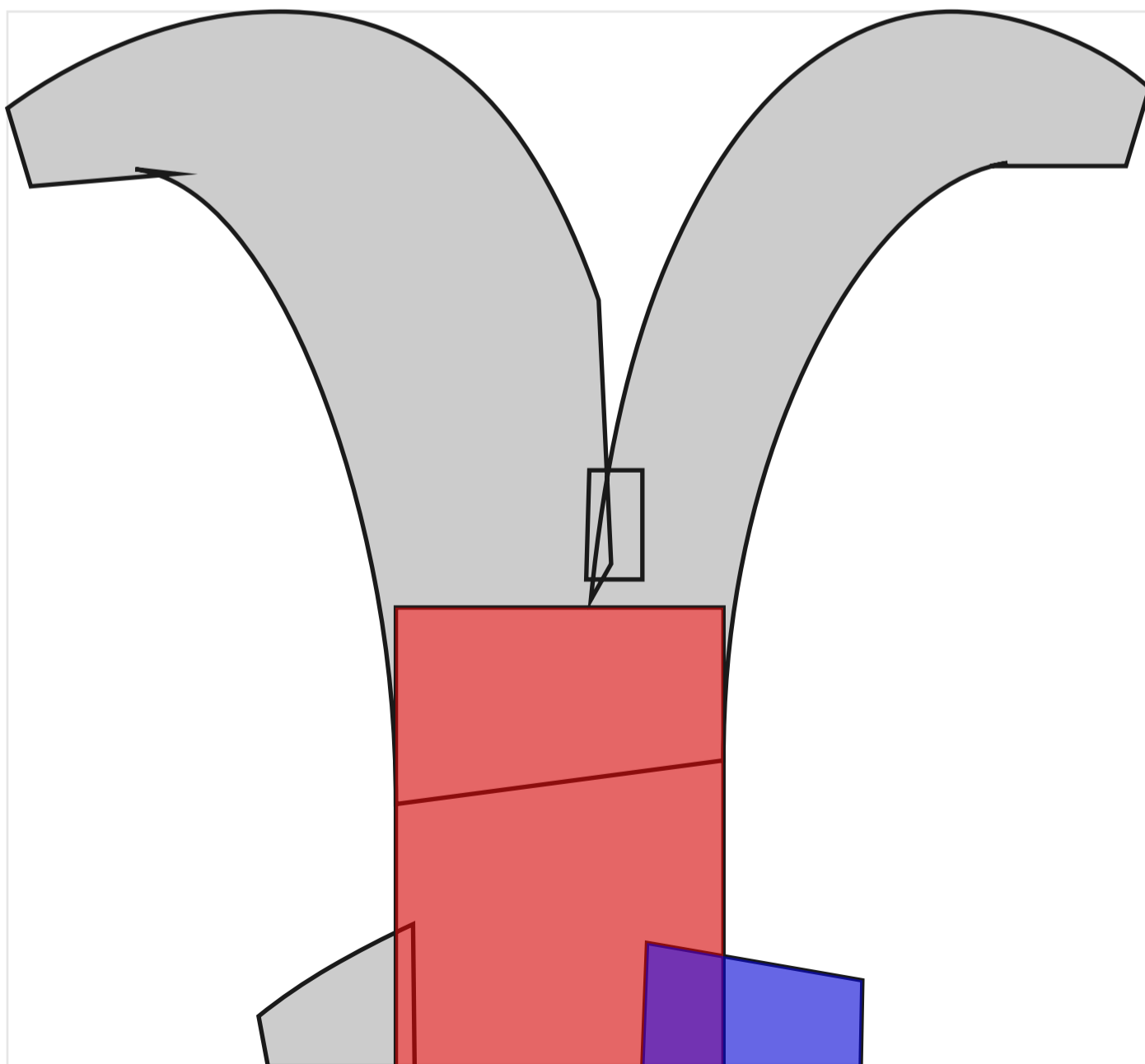

asterisk

”

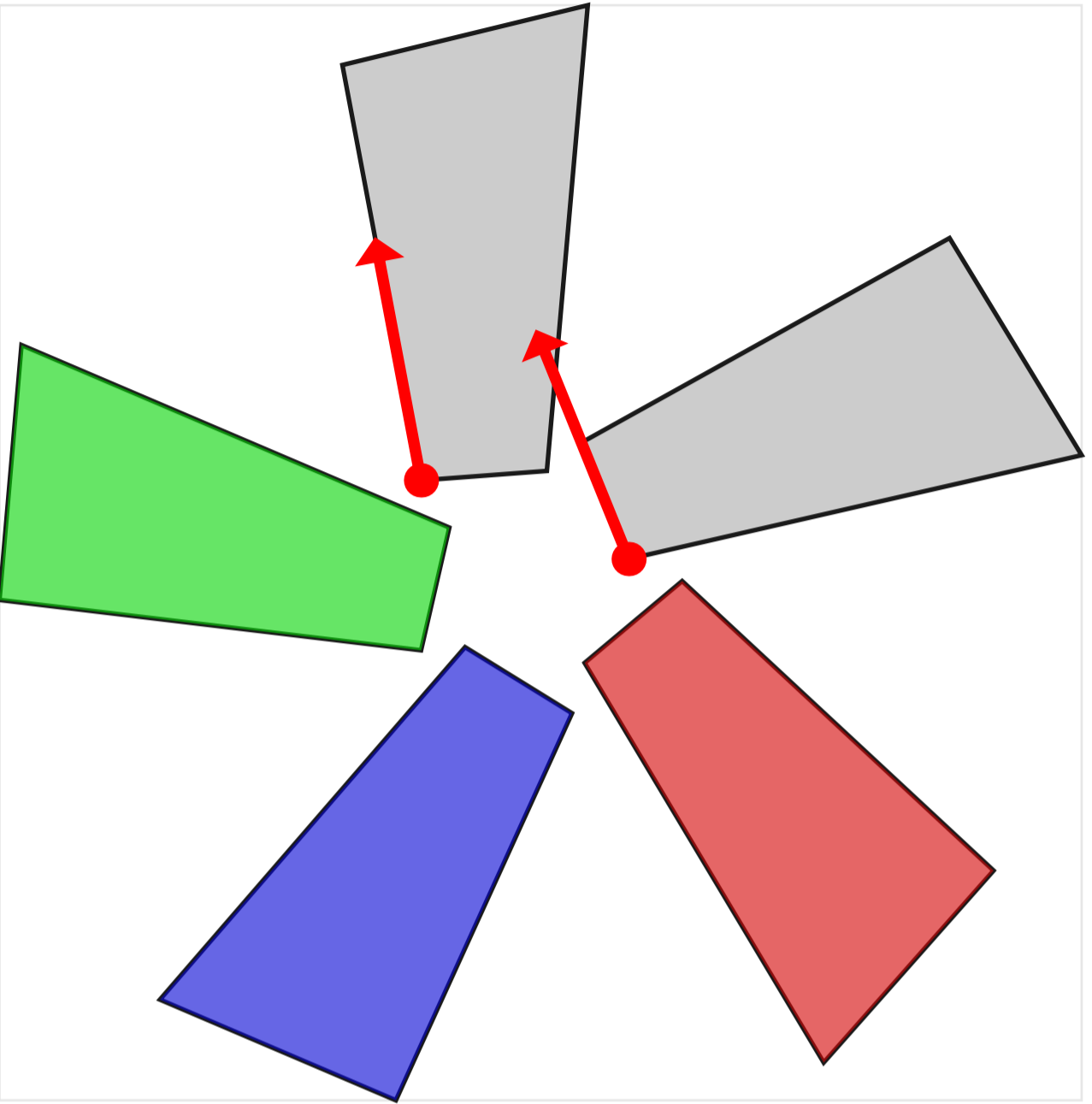

'wght=800.0'

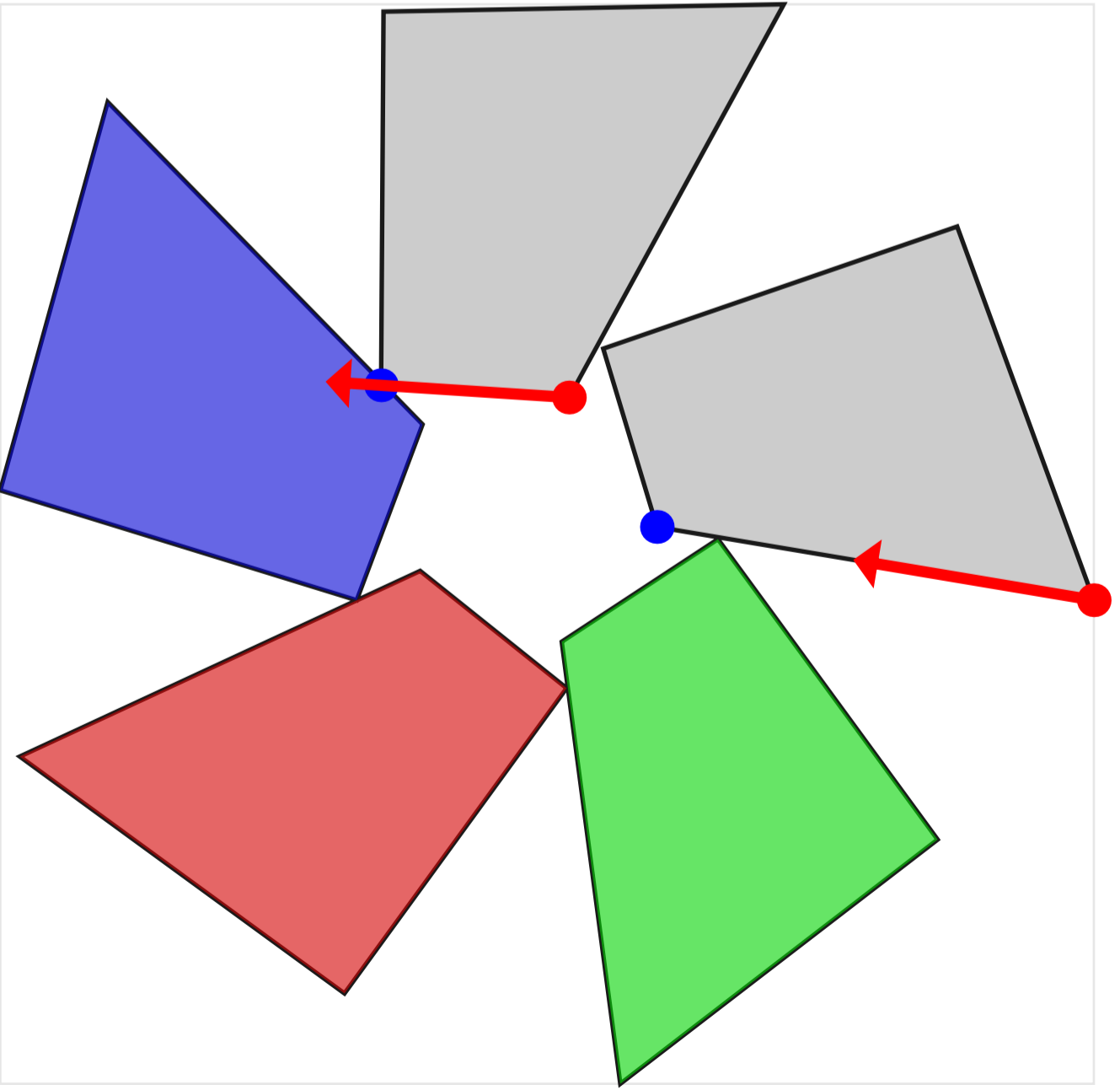

contour_order, wrong_start_point

midway interpolation

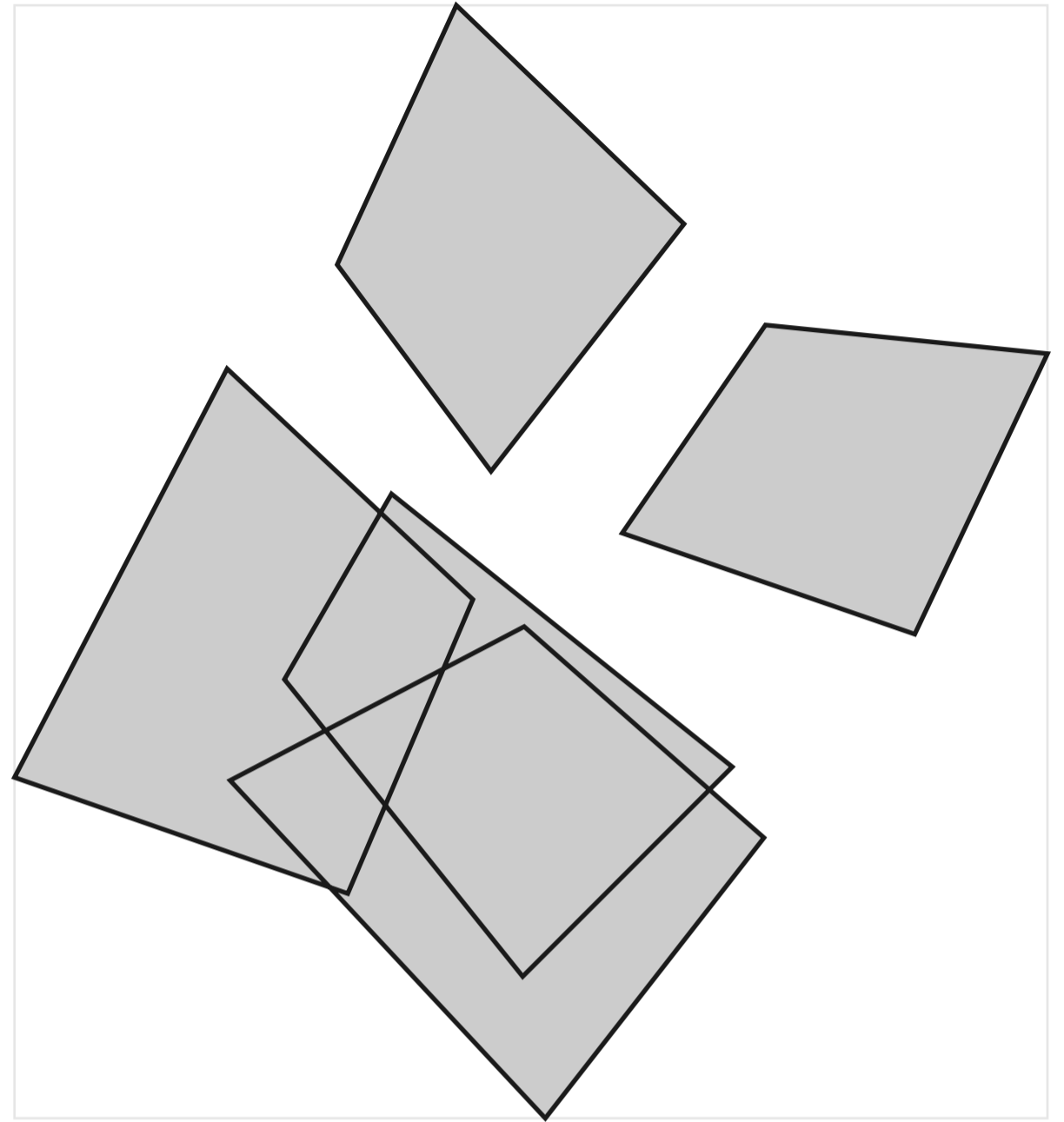

proposed fix

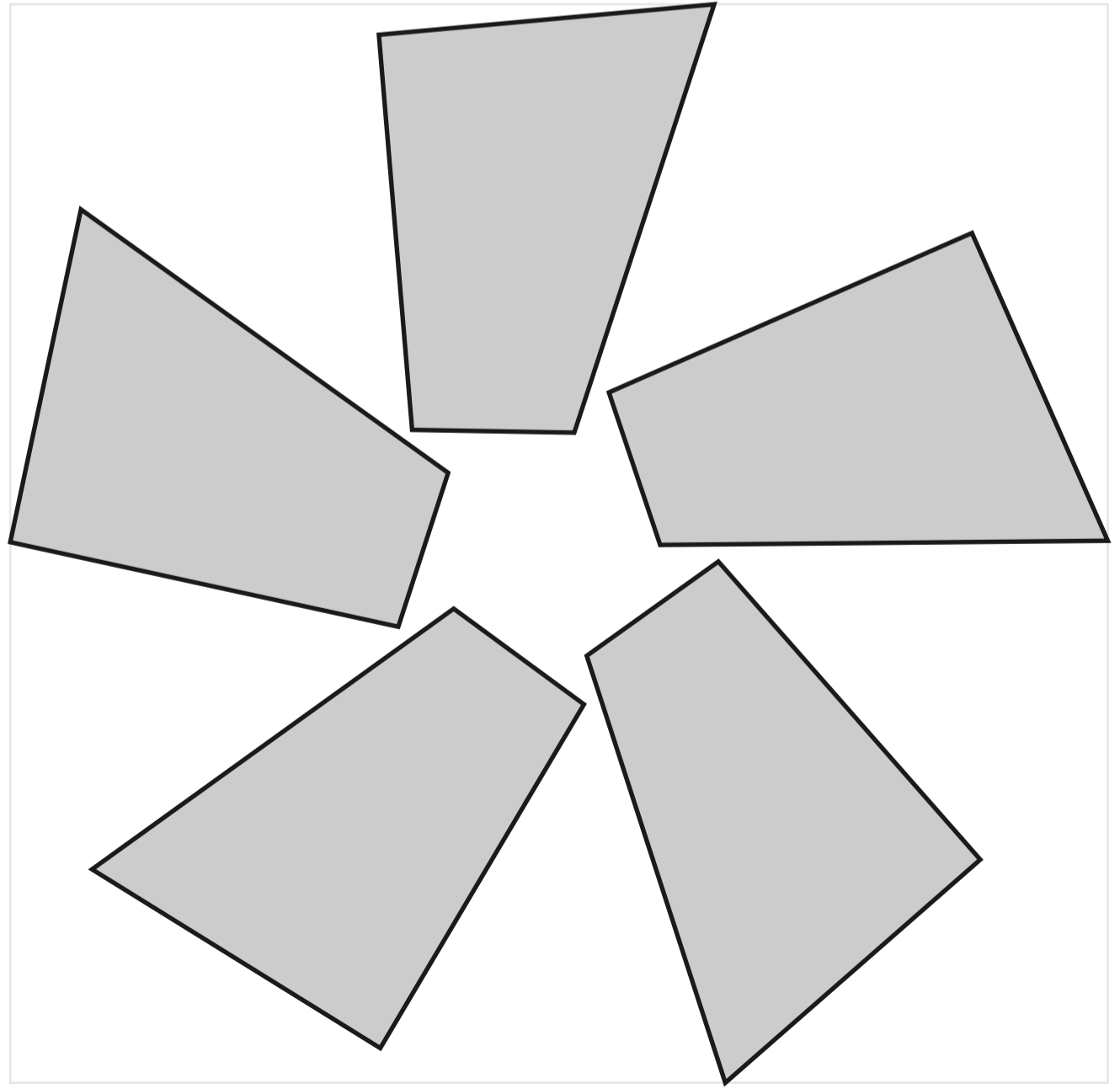

dvDGRa

contour_order

”

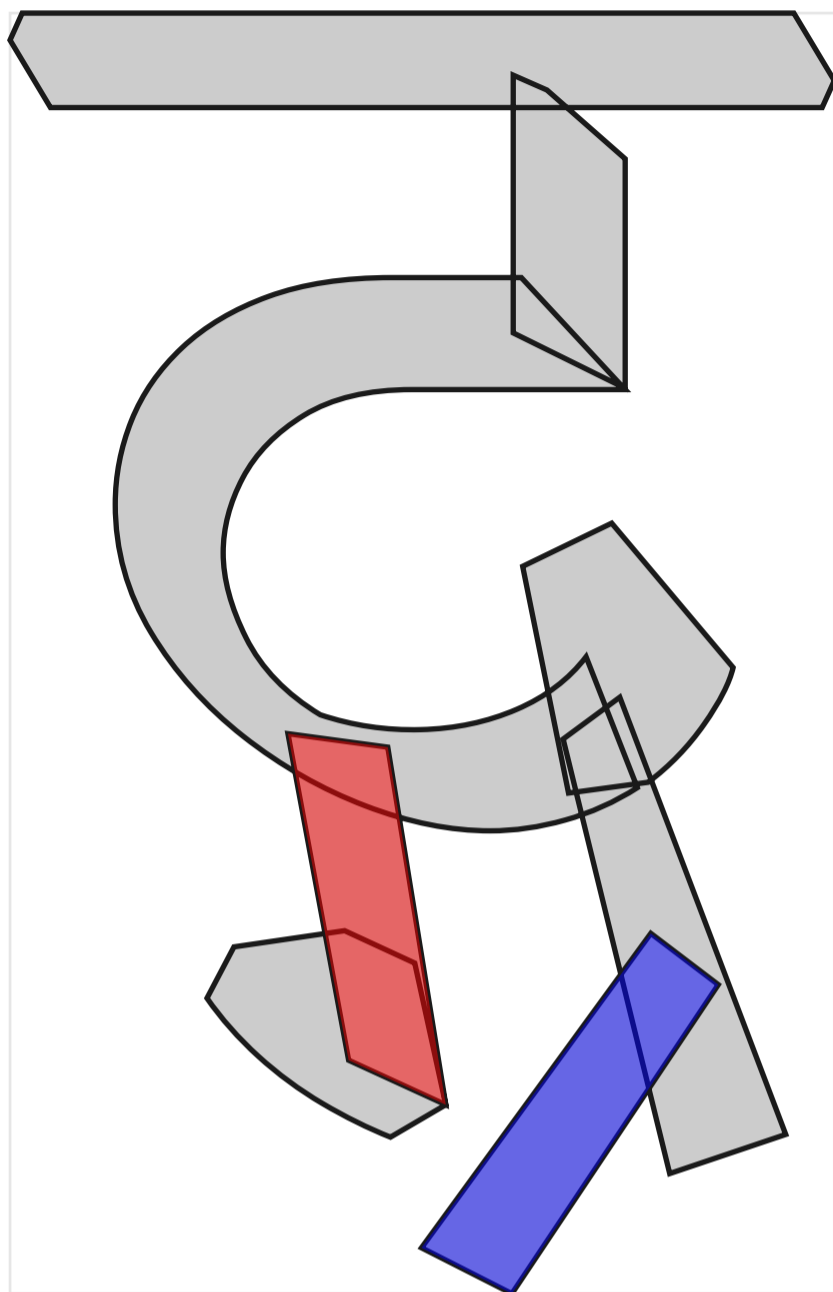

'wght=800.0'

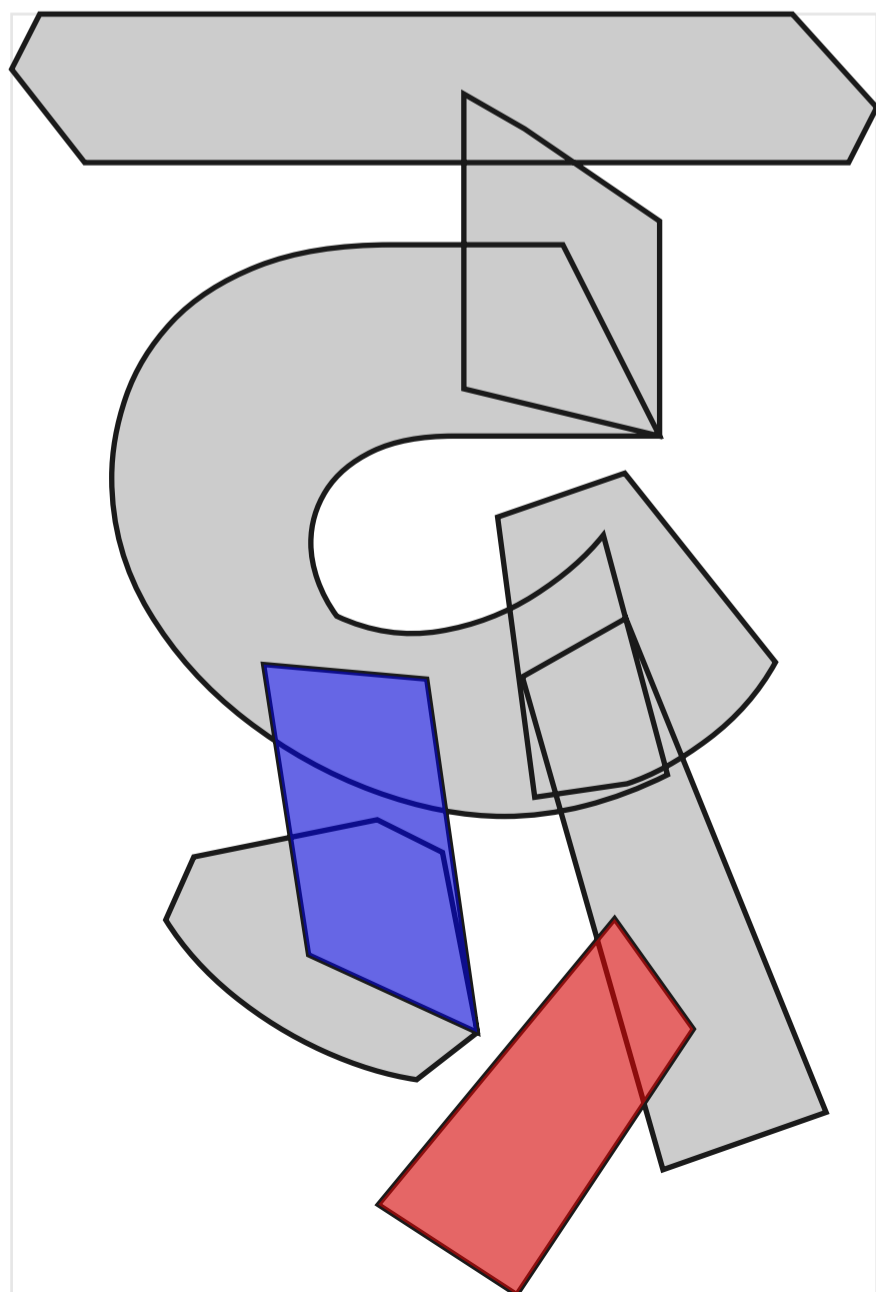

midway interpolation

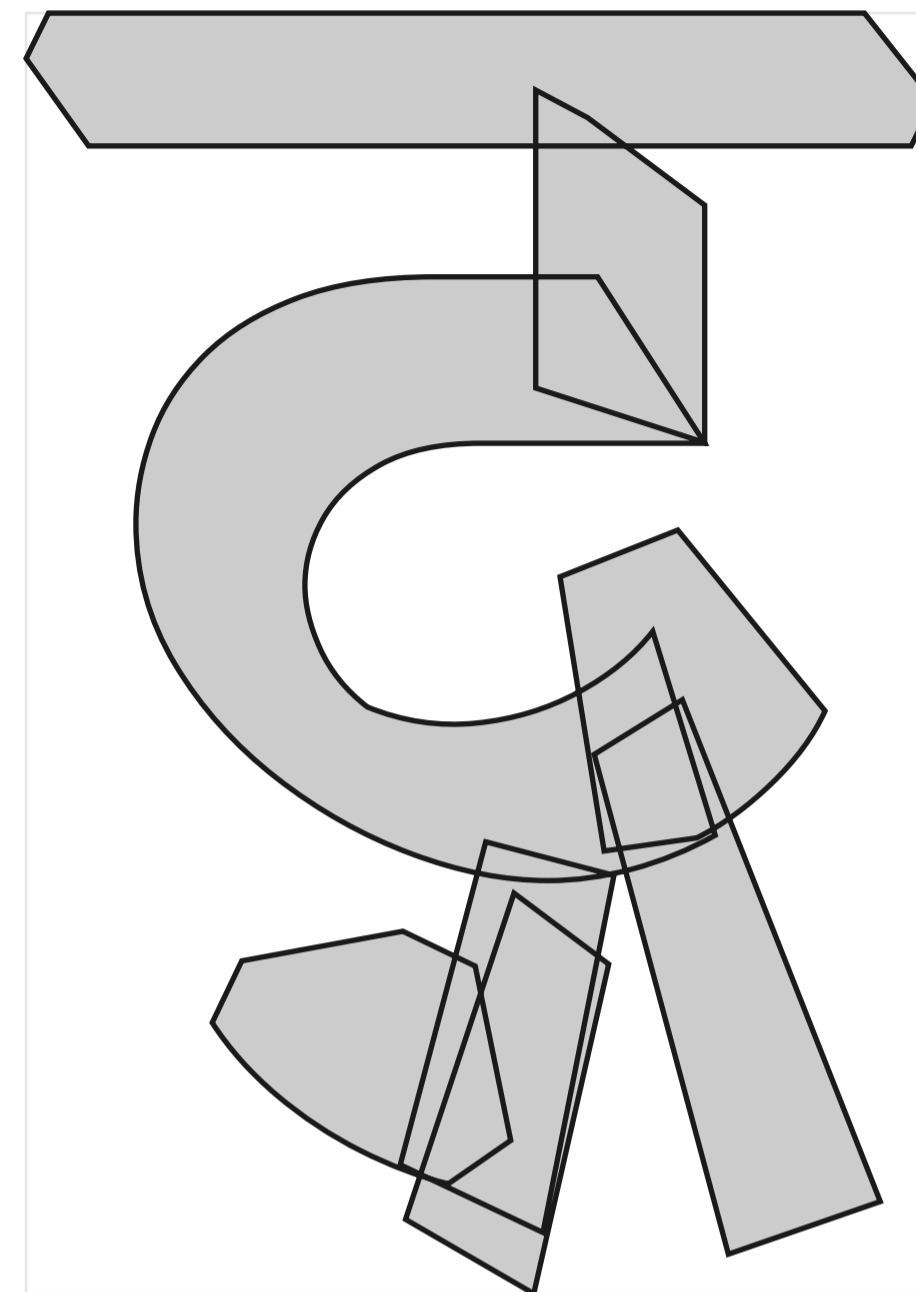

proposed fix

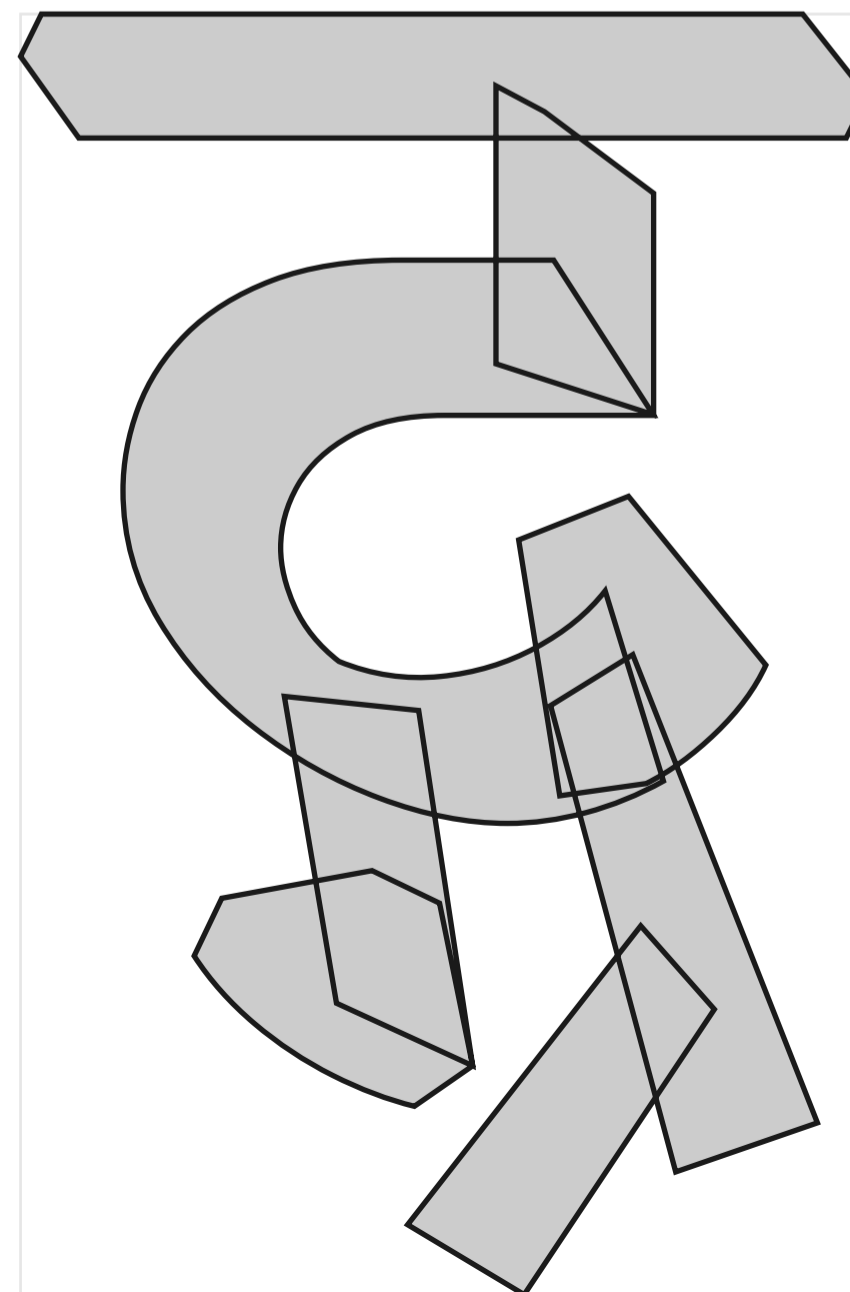

dvKSDda

”

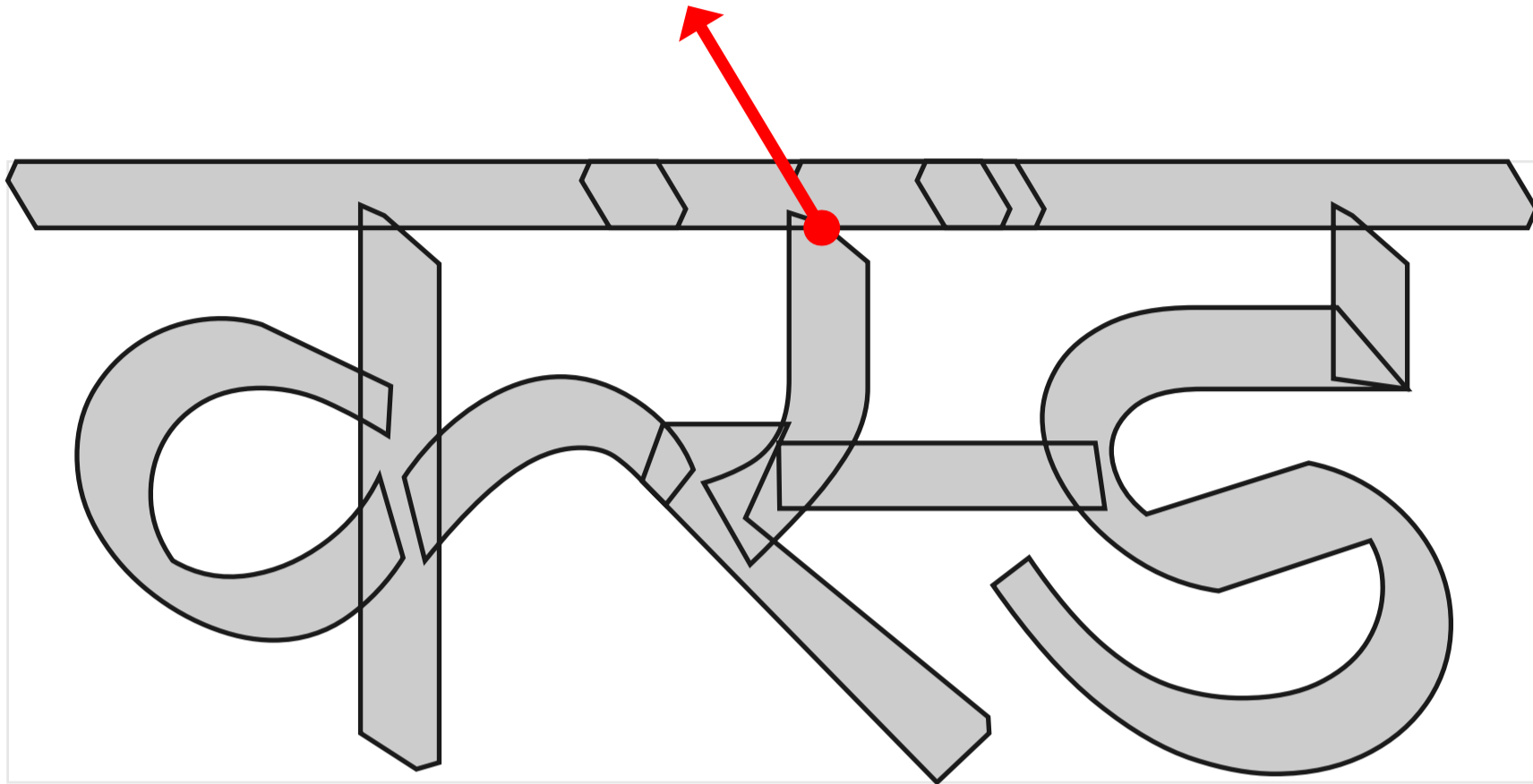

wrong_start_point

midway interpolation

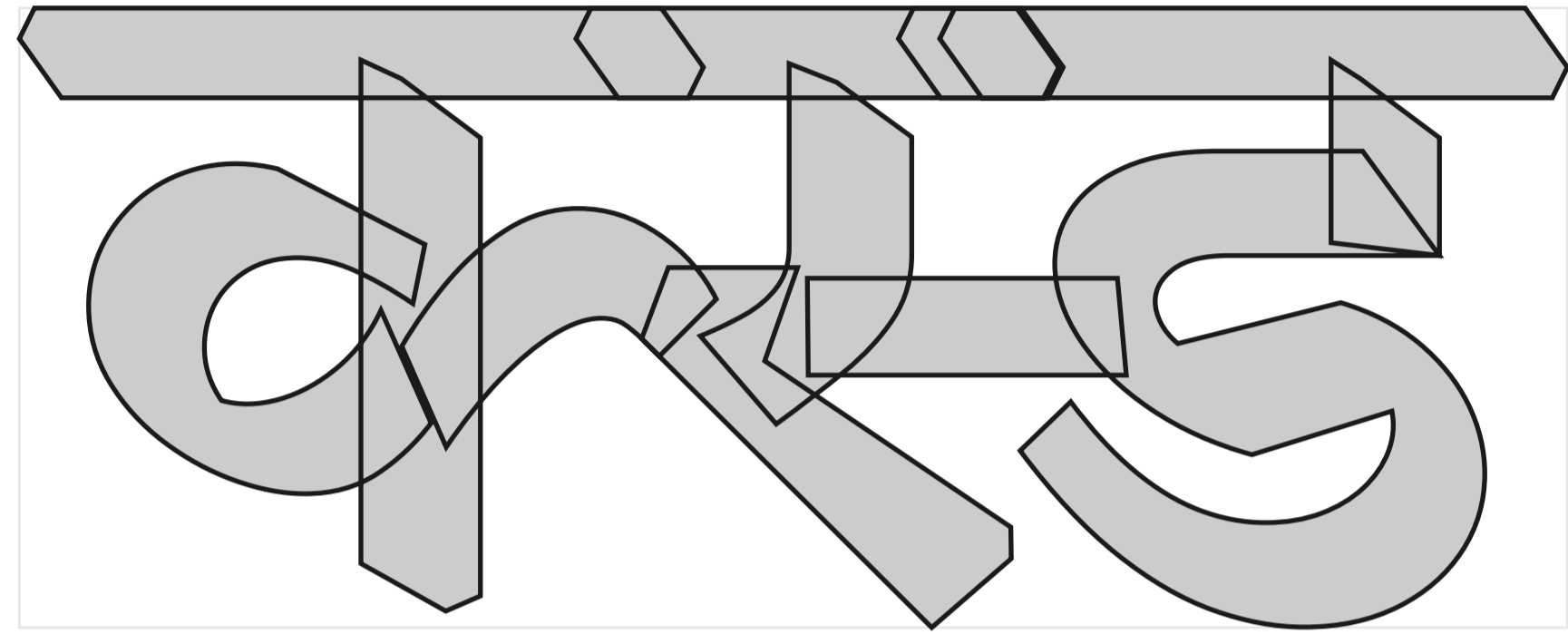

'wght=800.0'

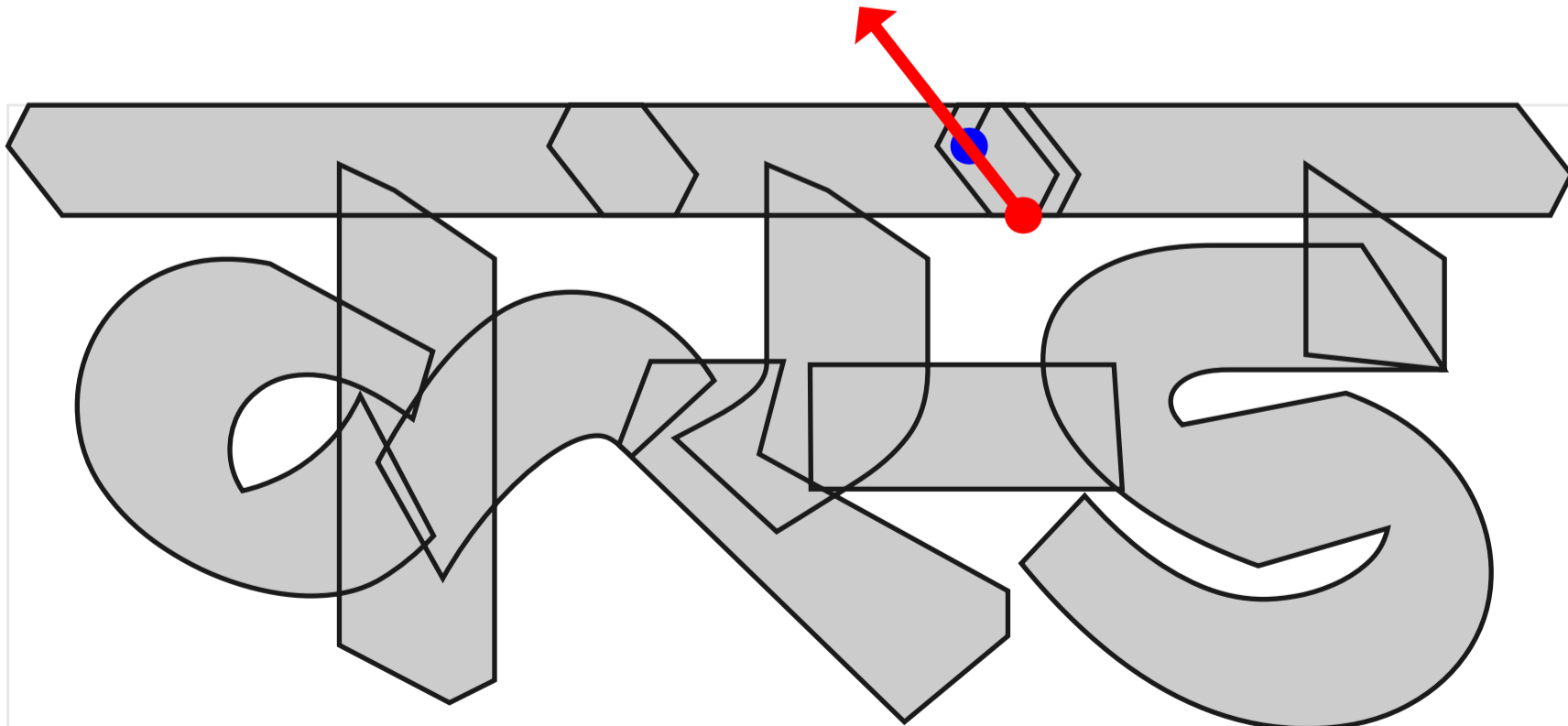

proposed fix

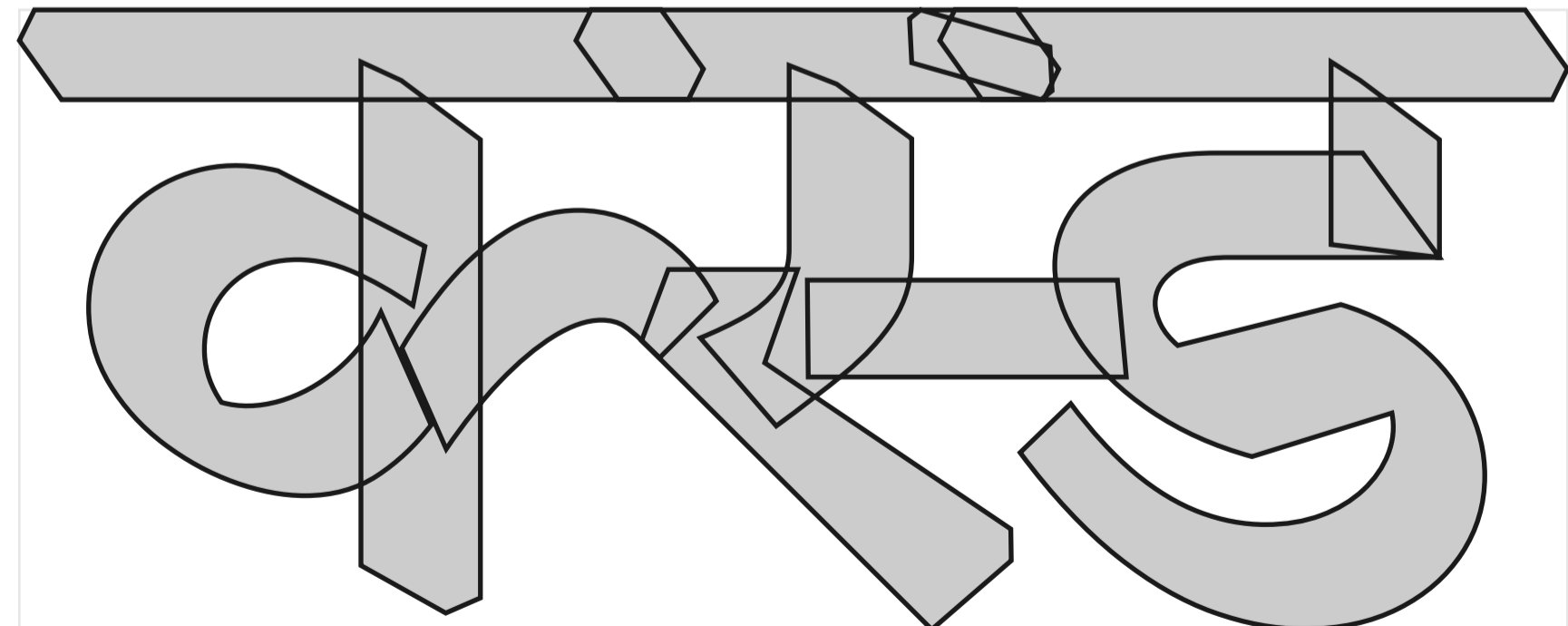

dvKSTa

”

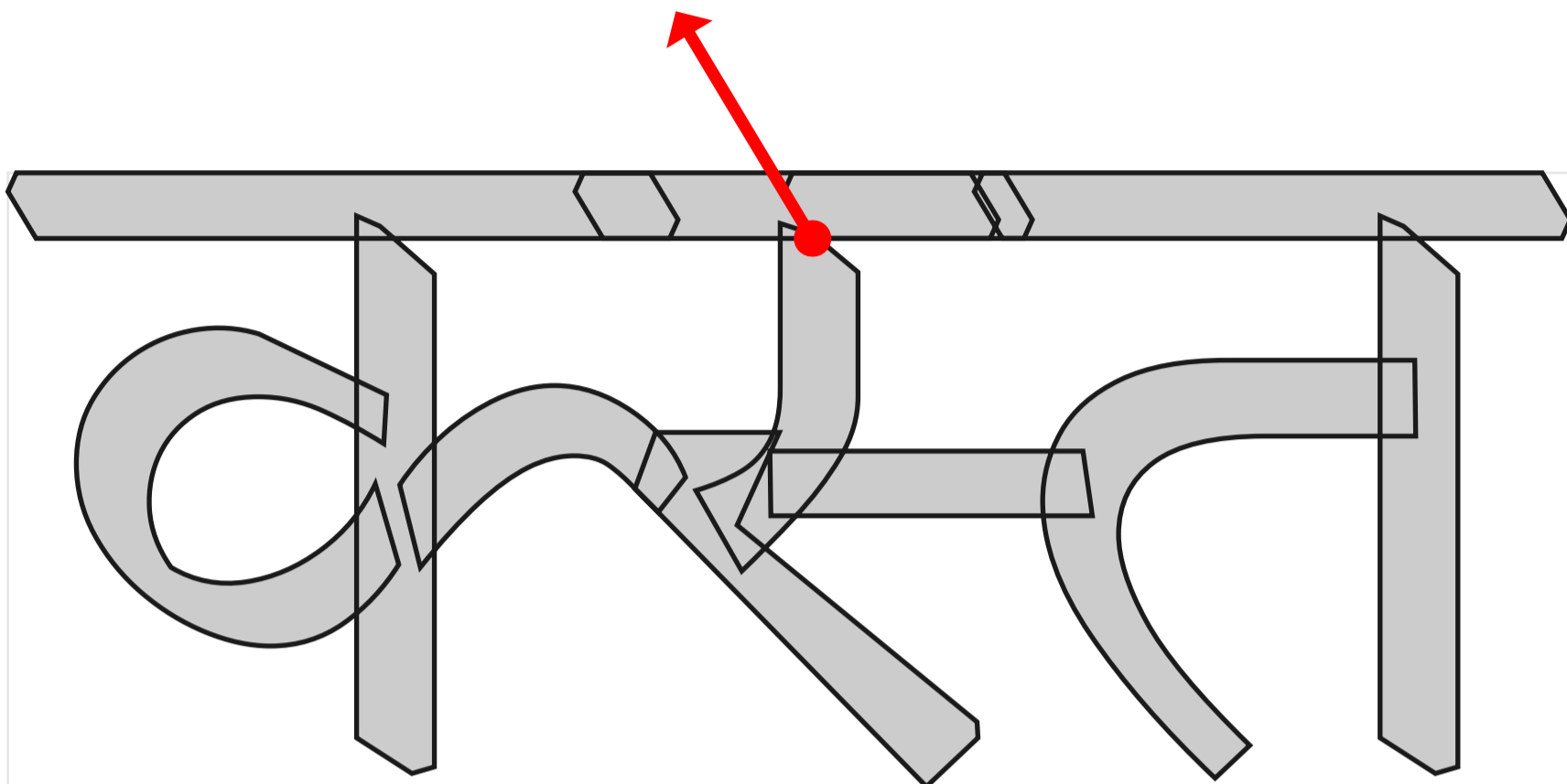

wrong_start_point

midway interpolation

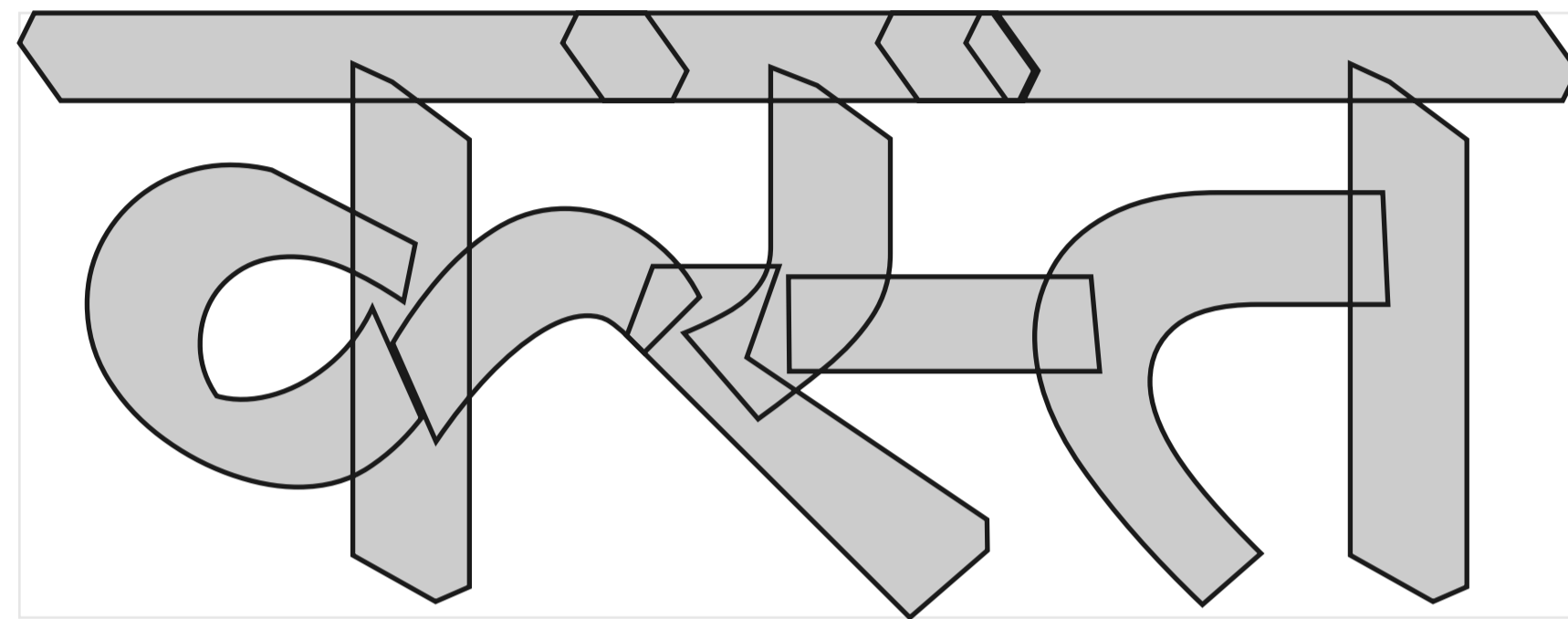

'wght=800.0'

proposed fix

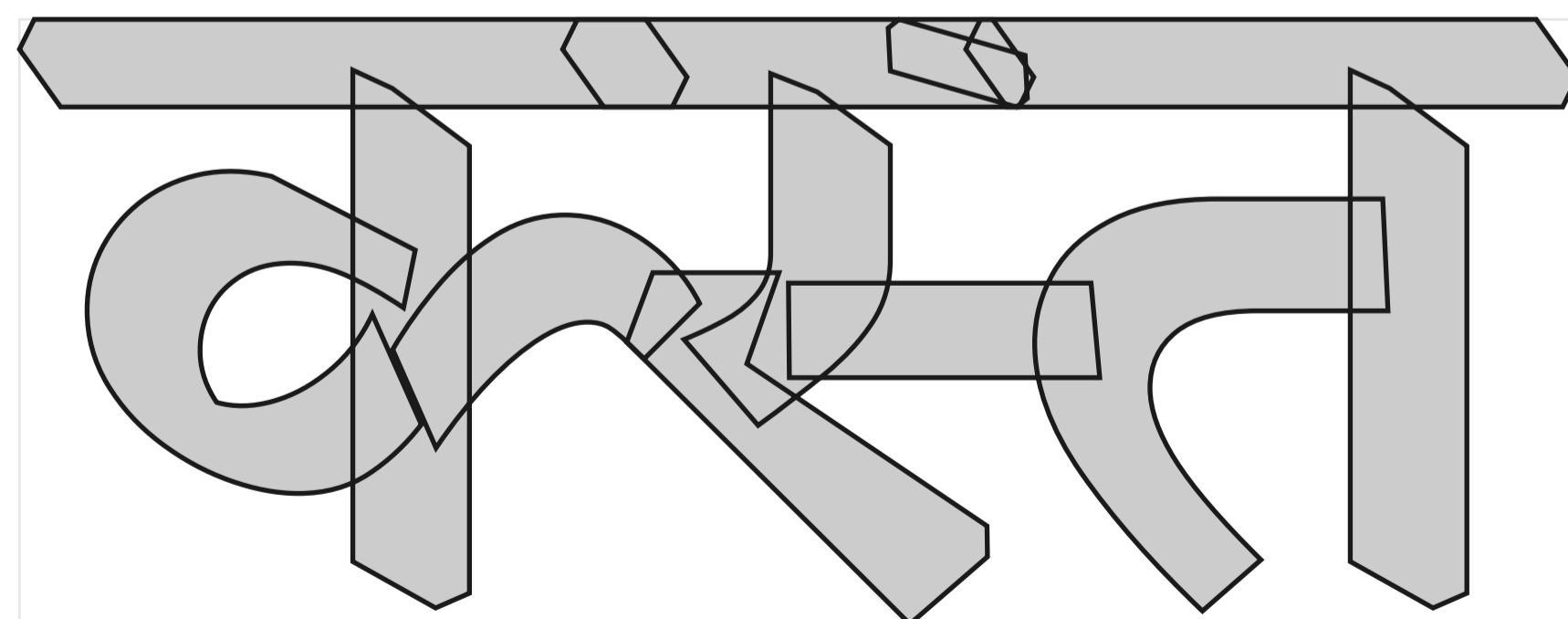
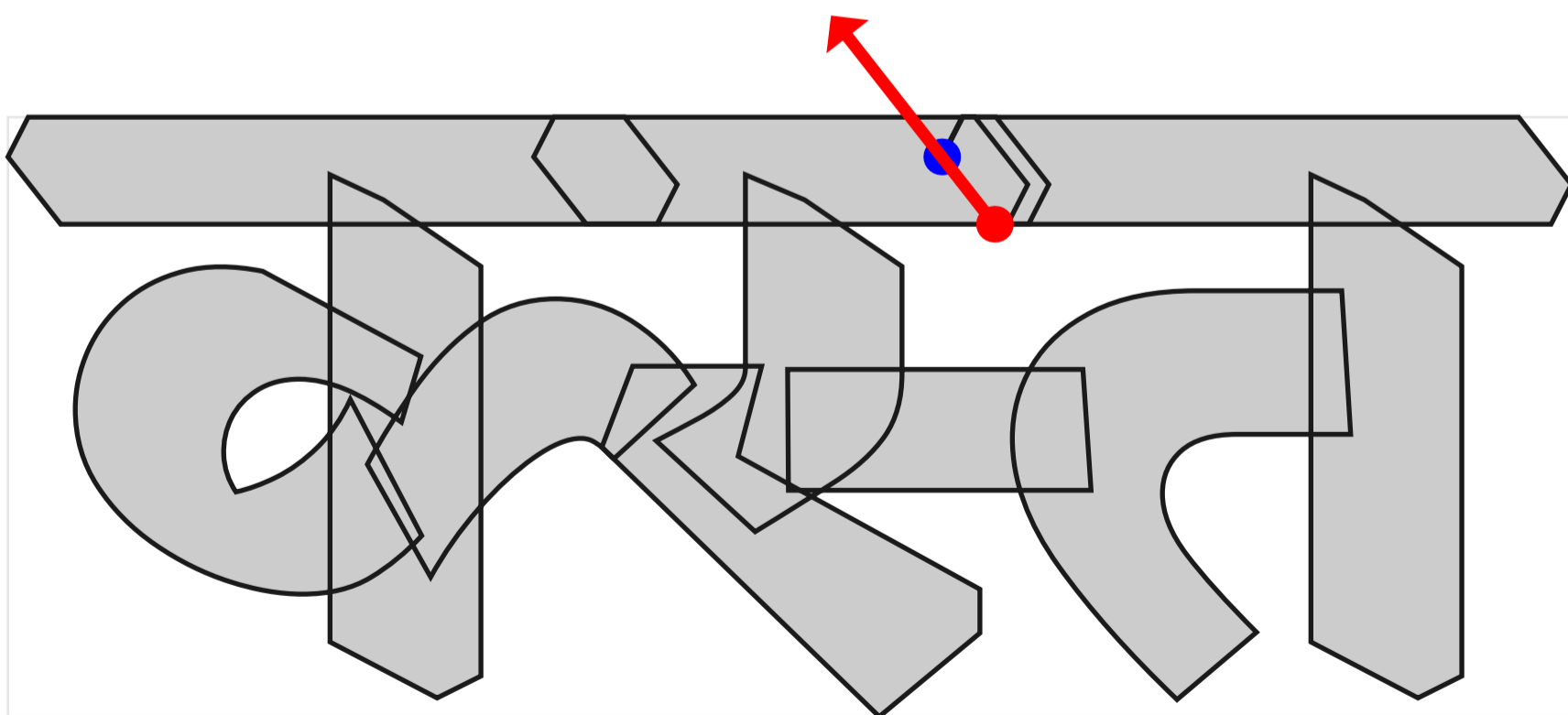

dvKSTta

”

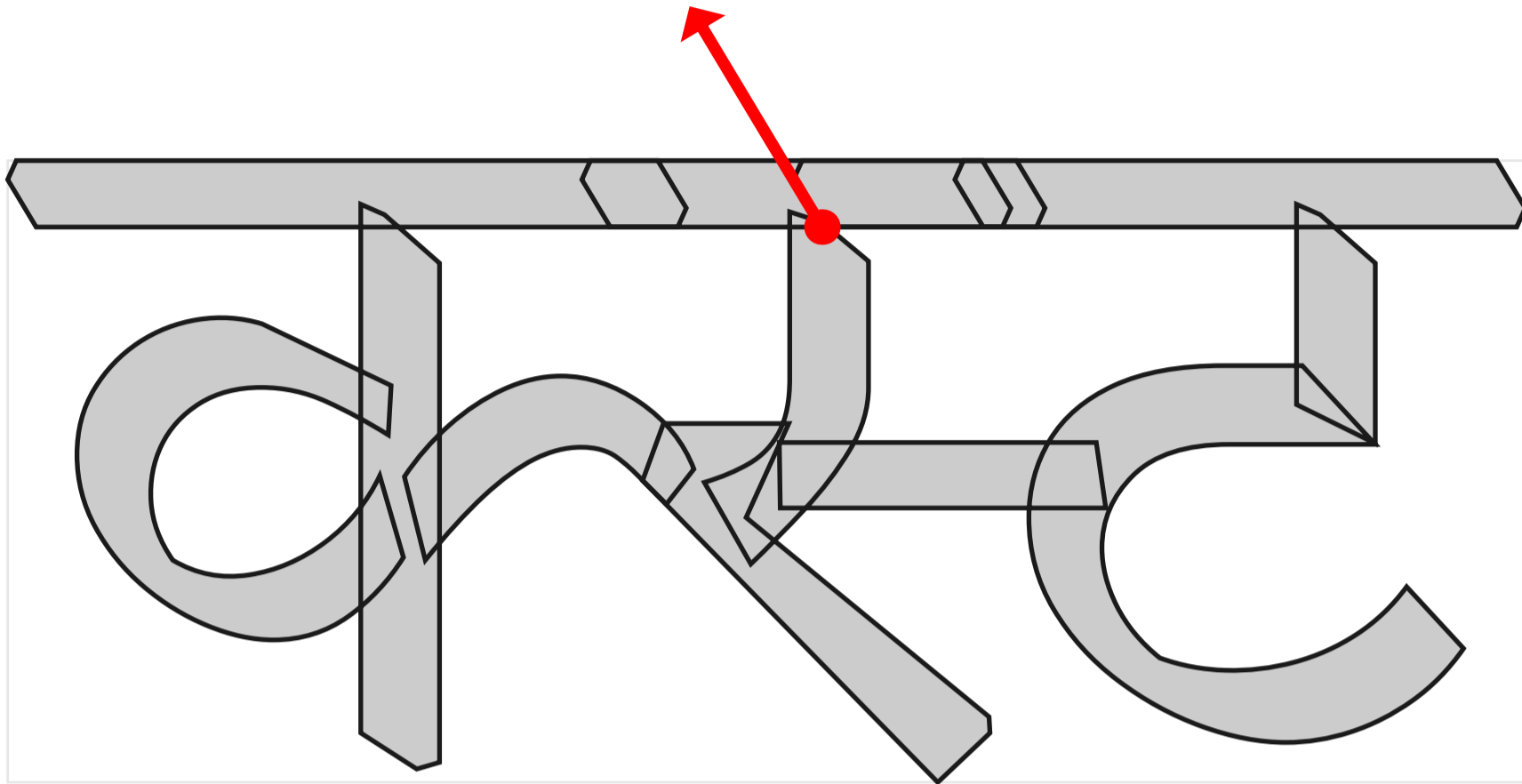

wrong_start_point

midway interpolation

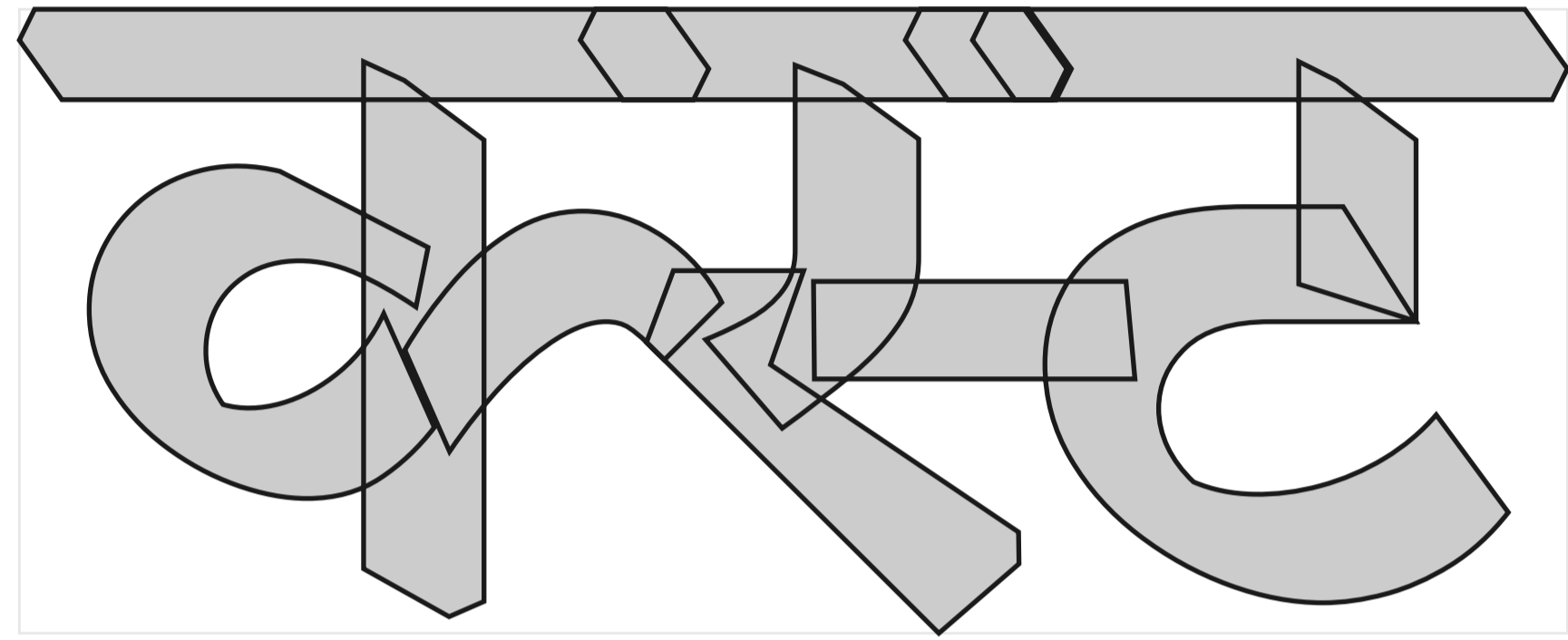

'wght=800.0'

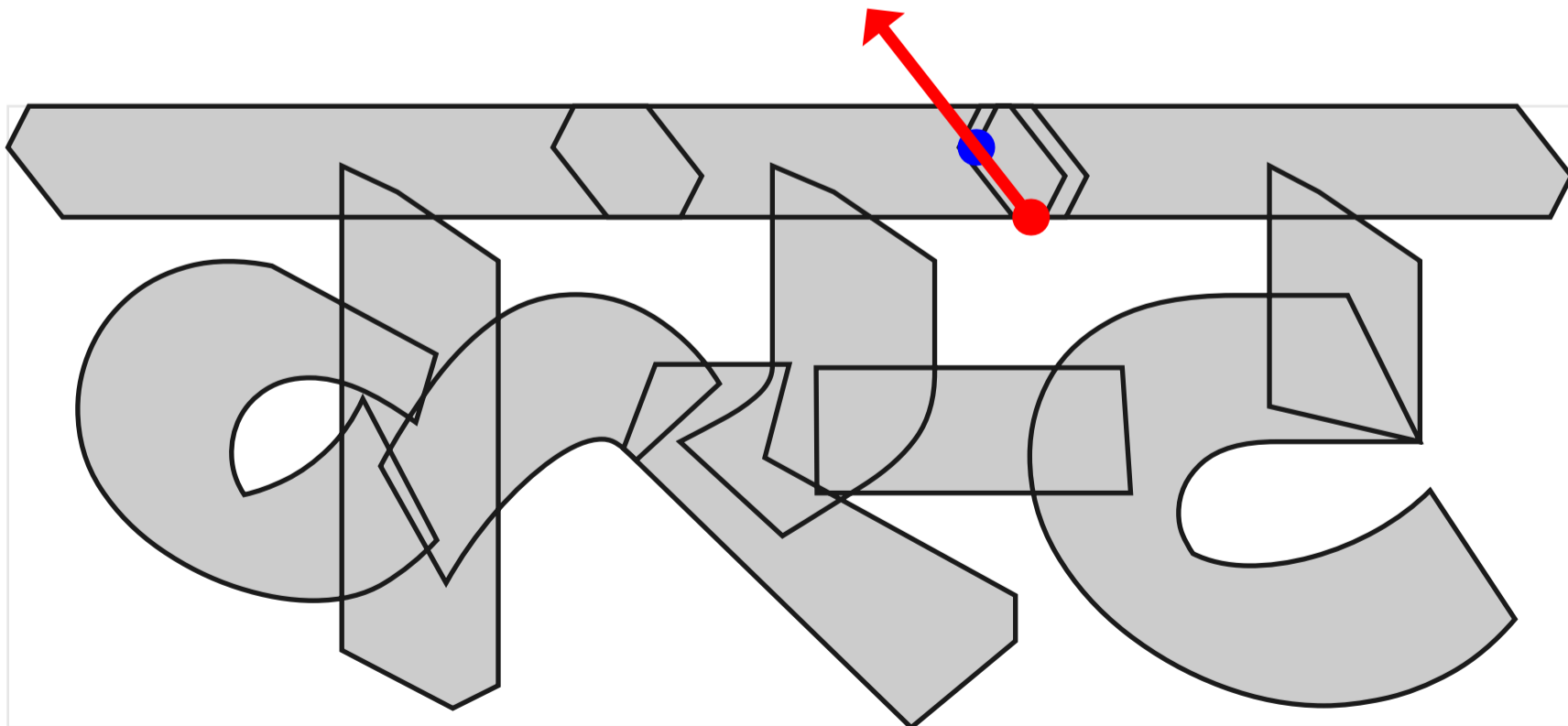

proposed fix

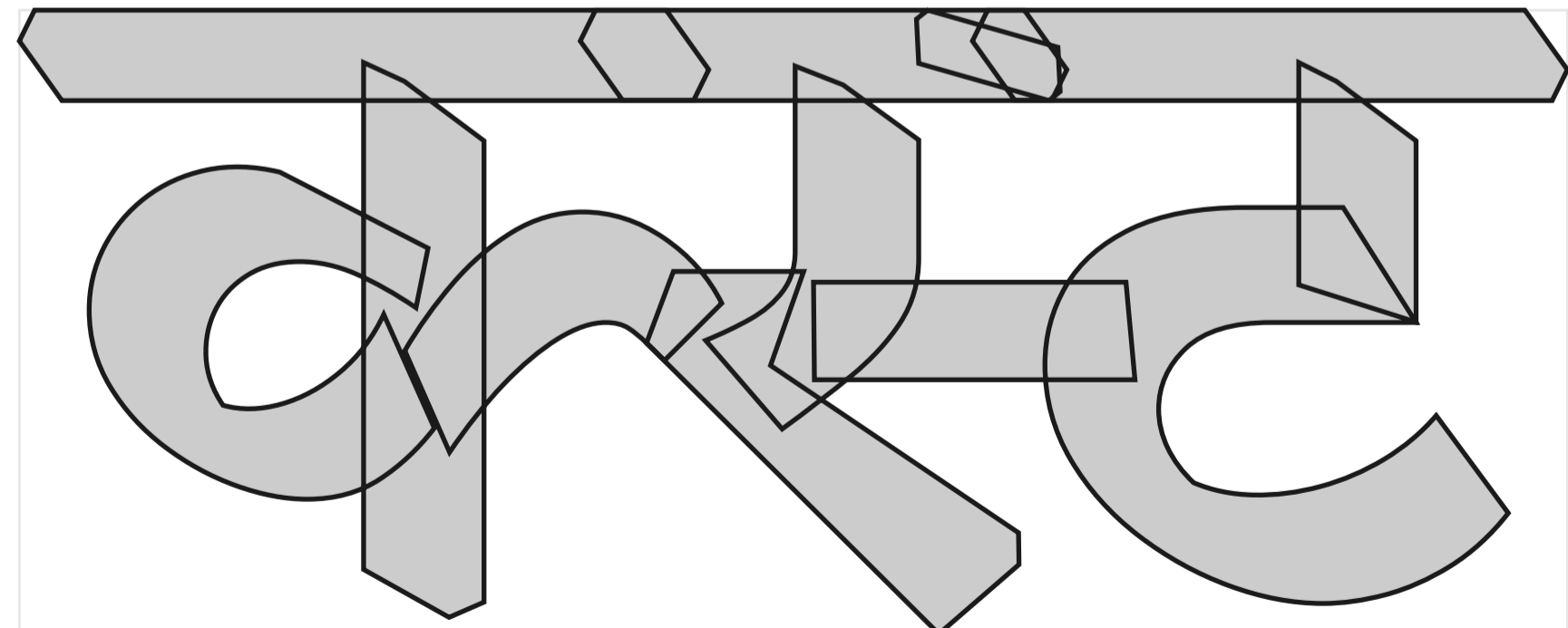

dvNSMYa

”

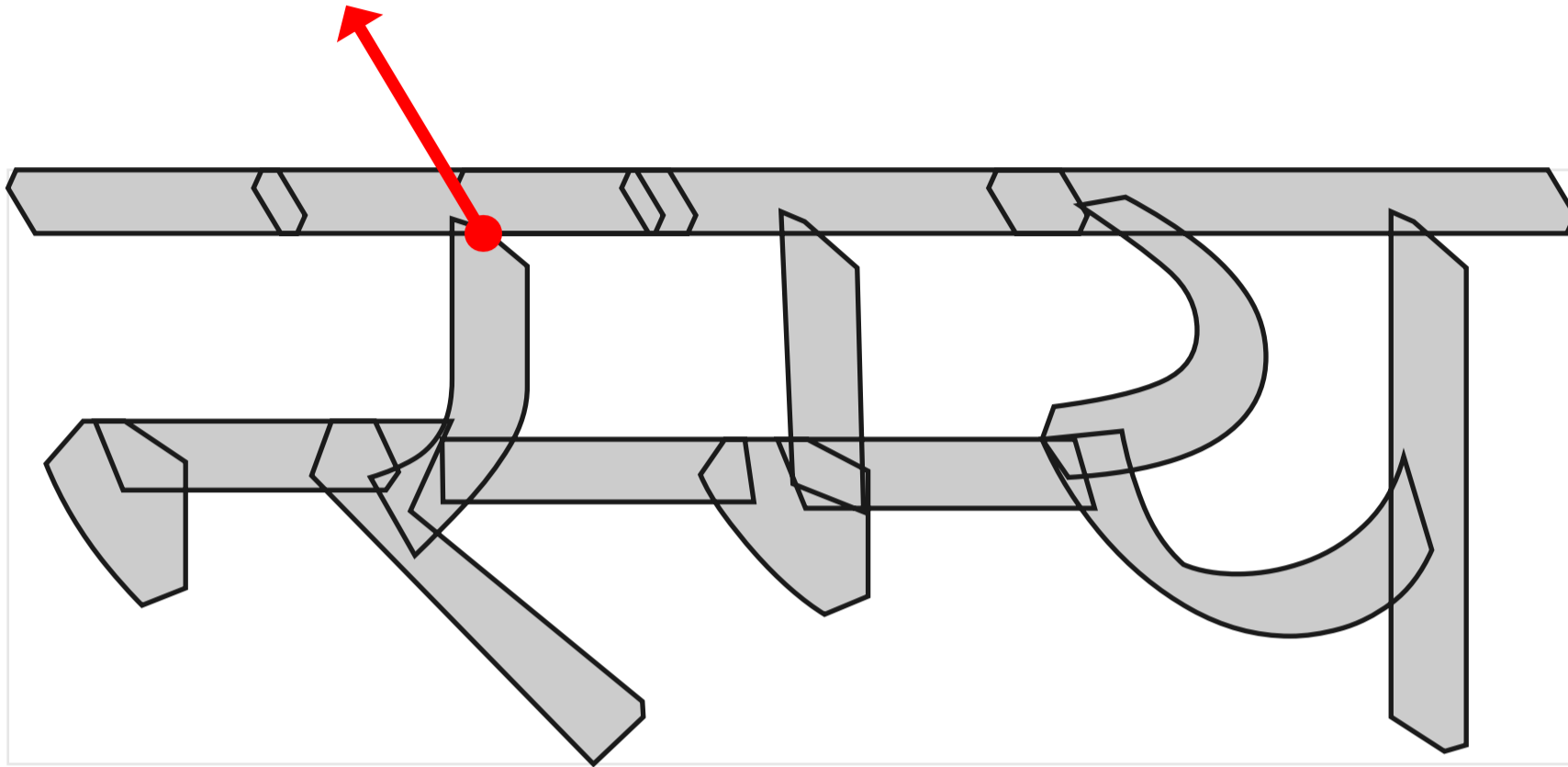

wrong_start_point

midway interpolation

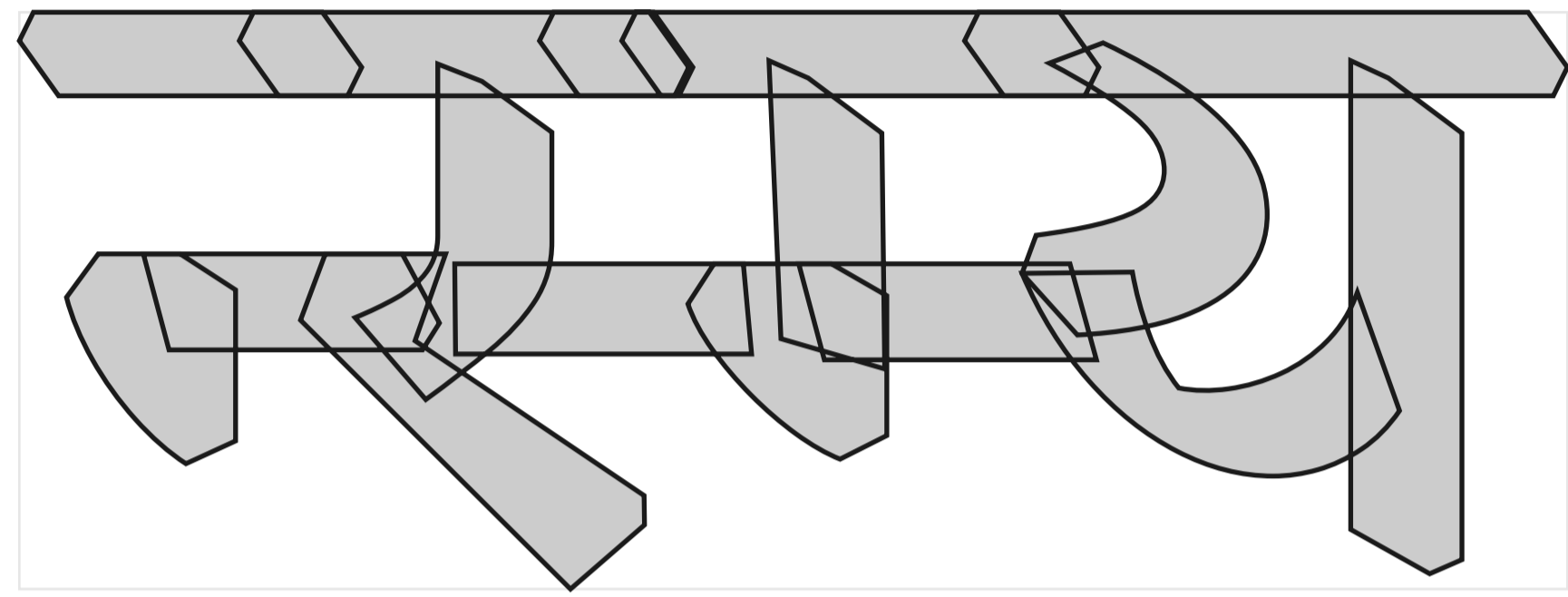

'wght=800.0'

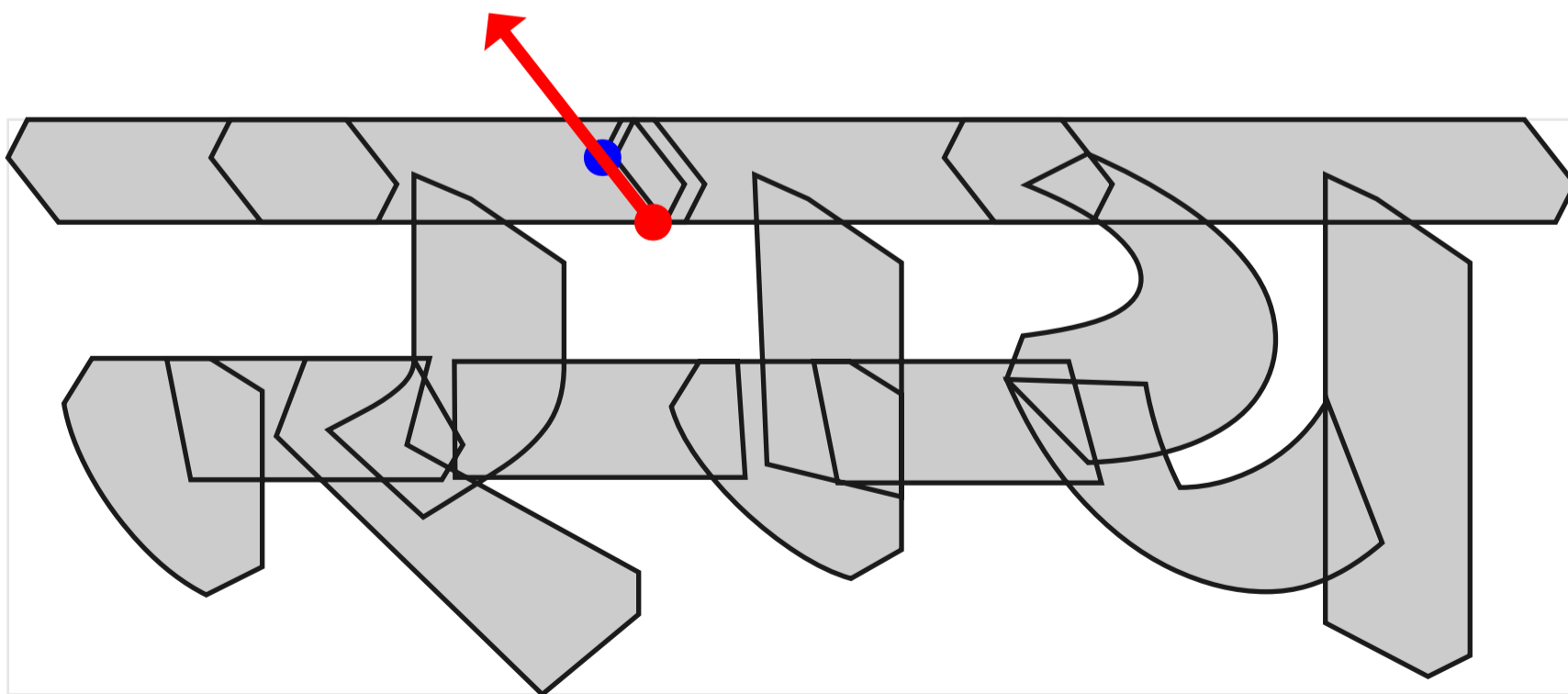

proposed fix

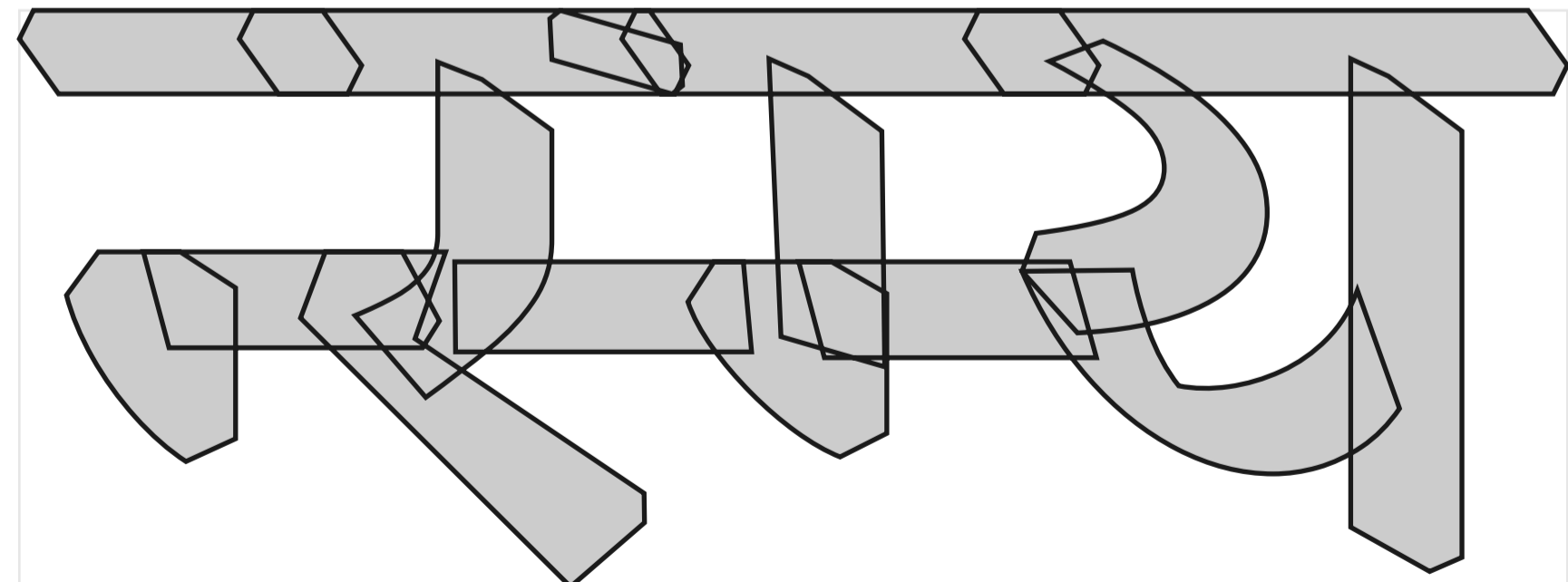

dvNgMa

wrong_start_point

”

midway interpolation

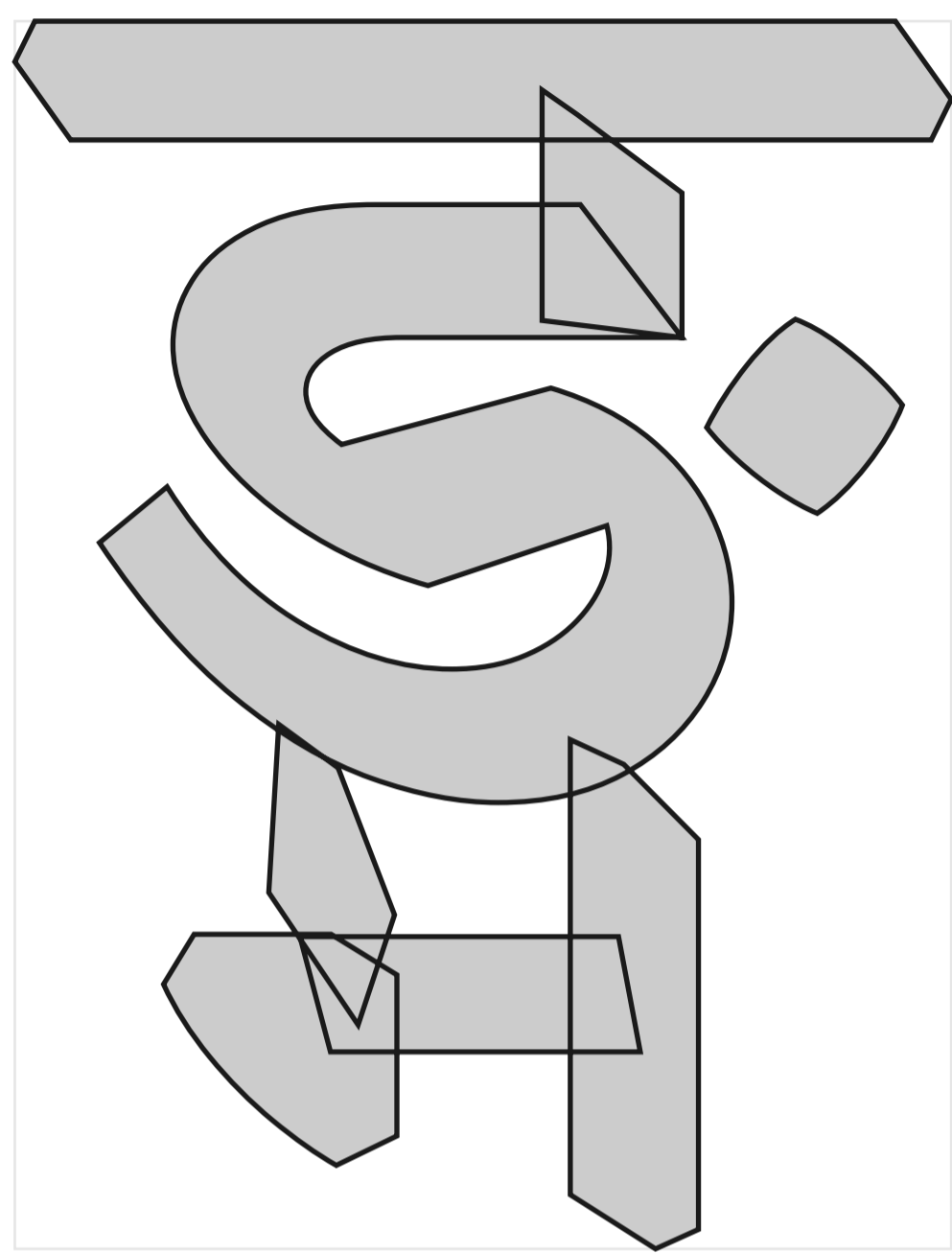
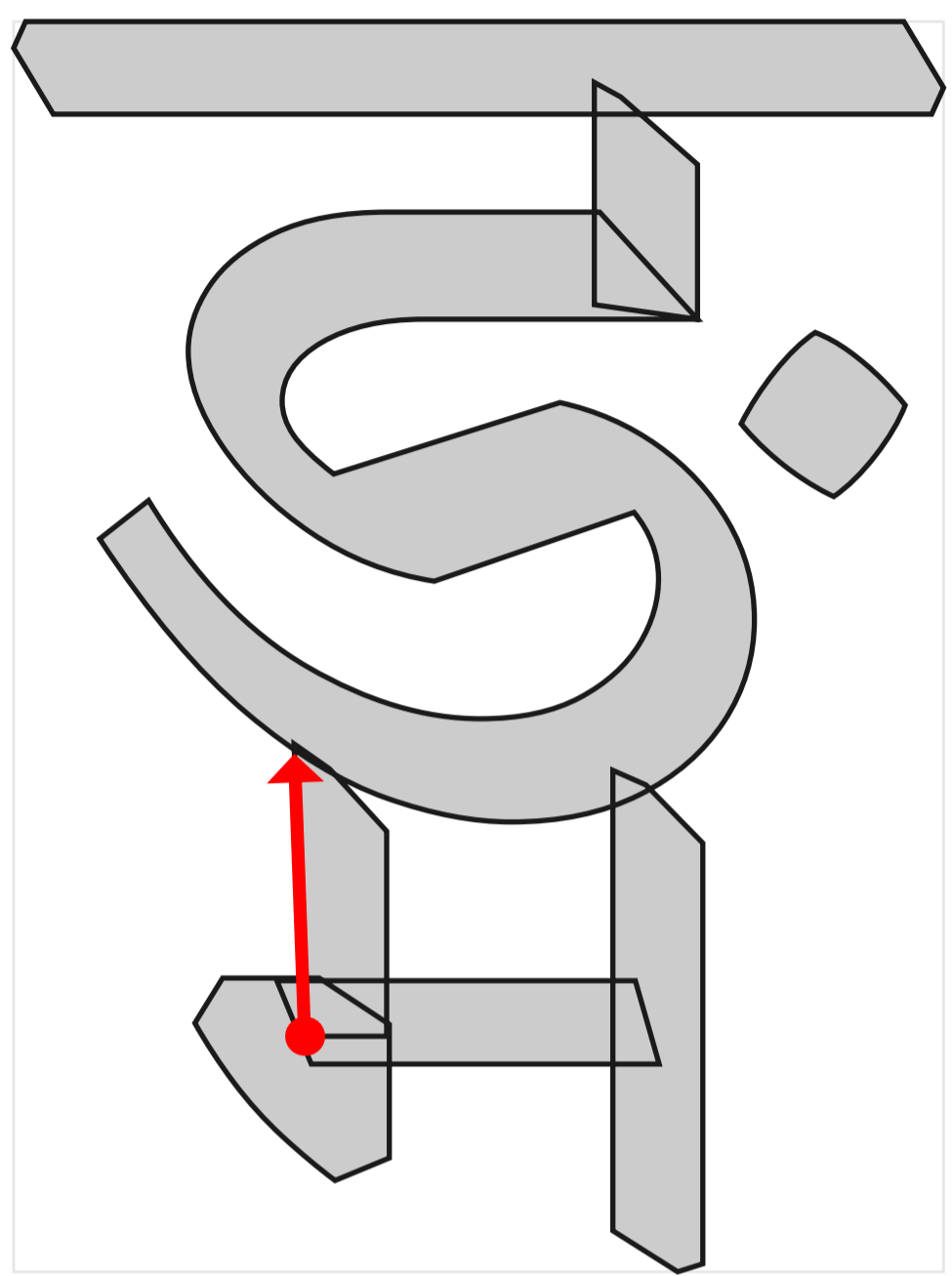

'wght=800.0'

proposed fix

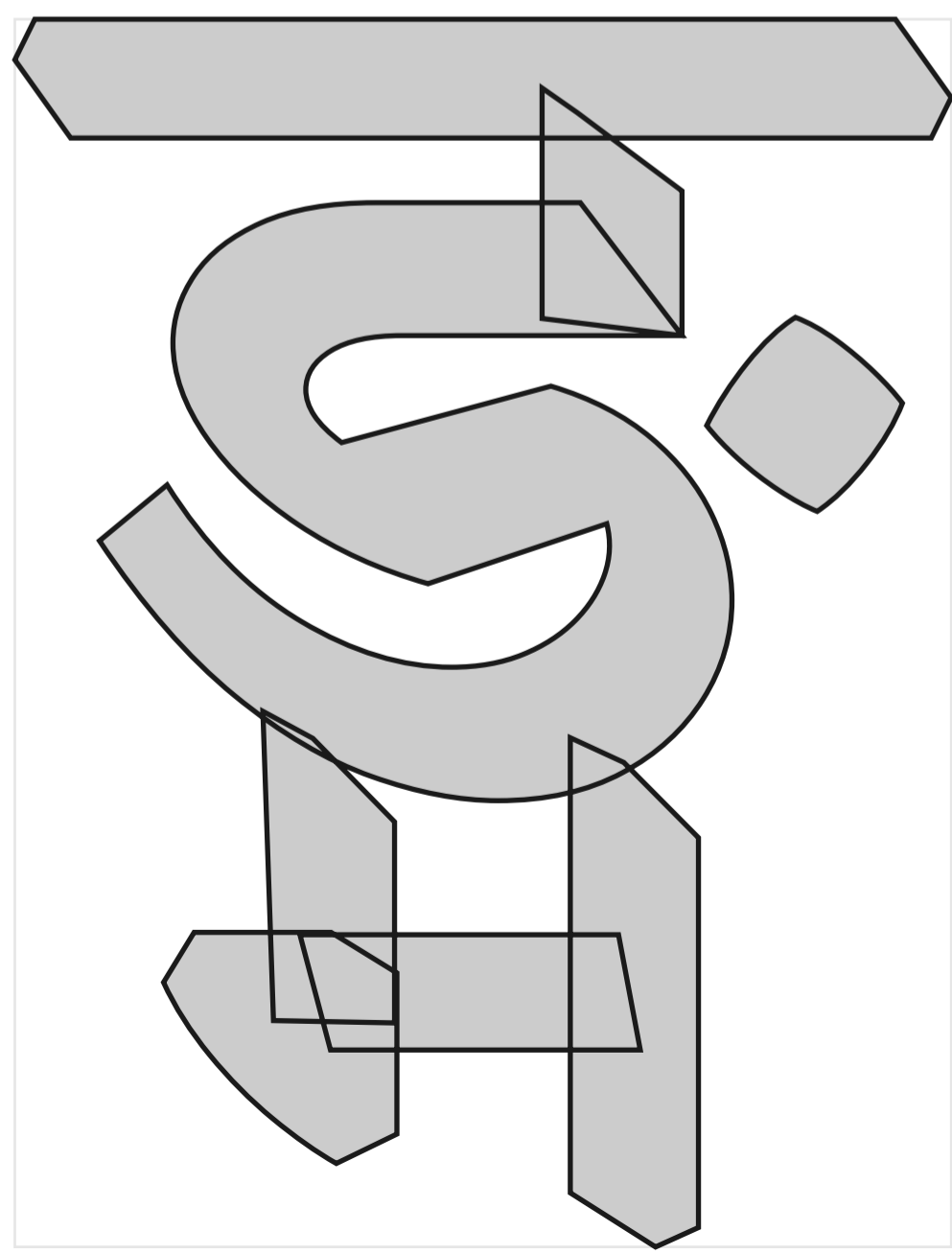
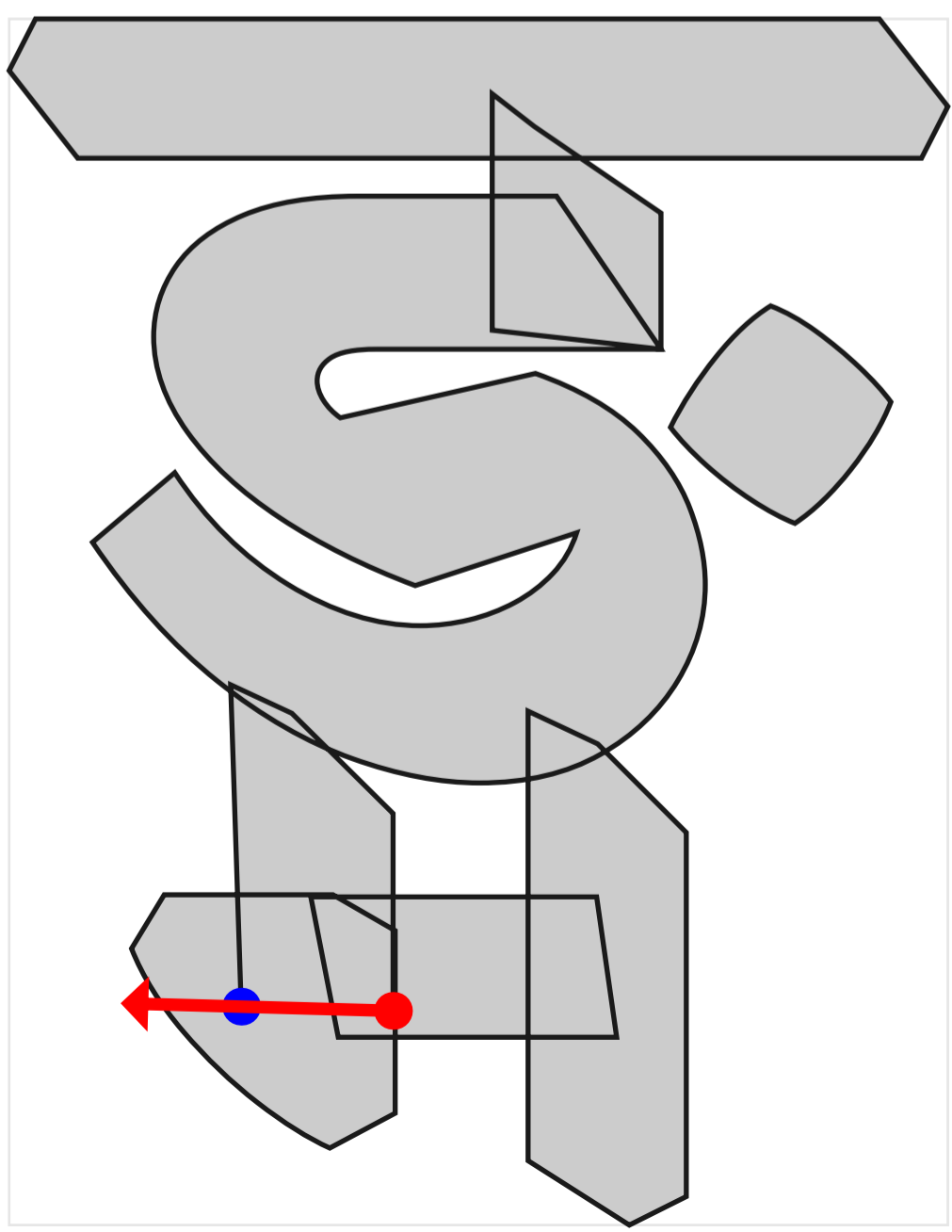

dvNyJYa

”

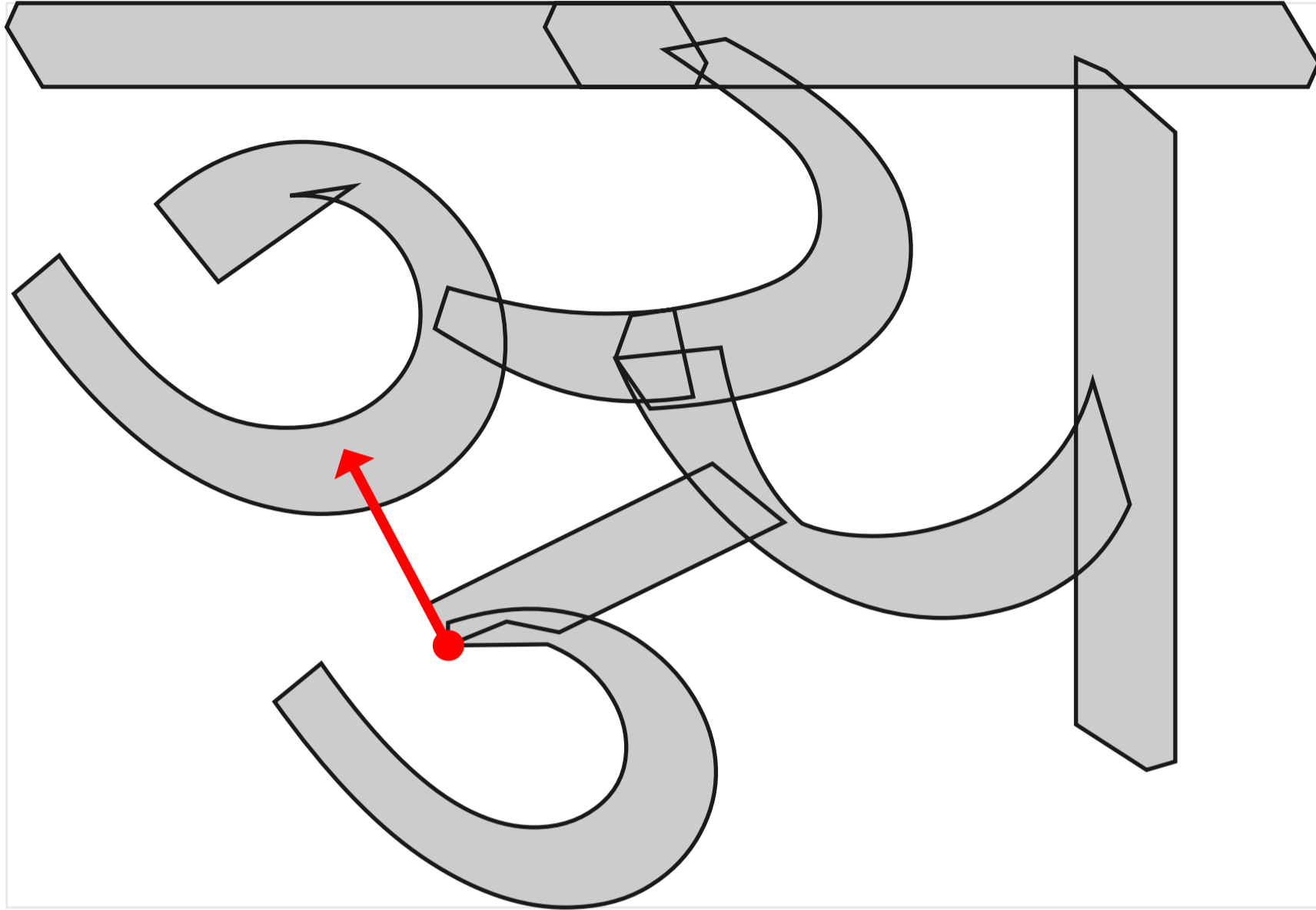

wrong_start_point

midway interpolation

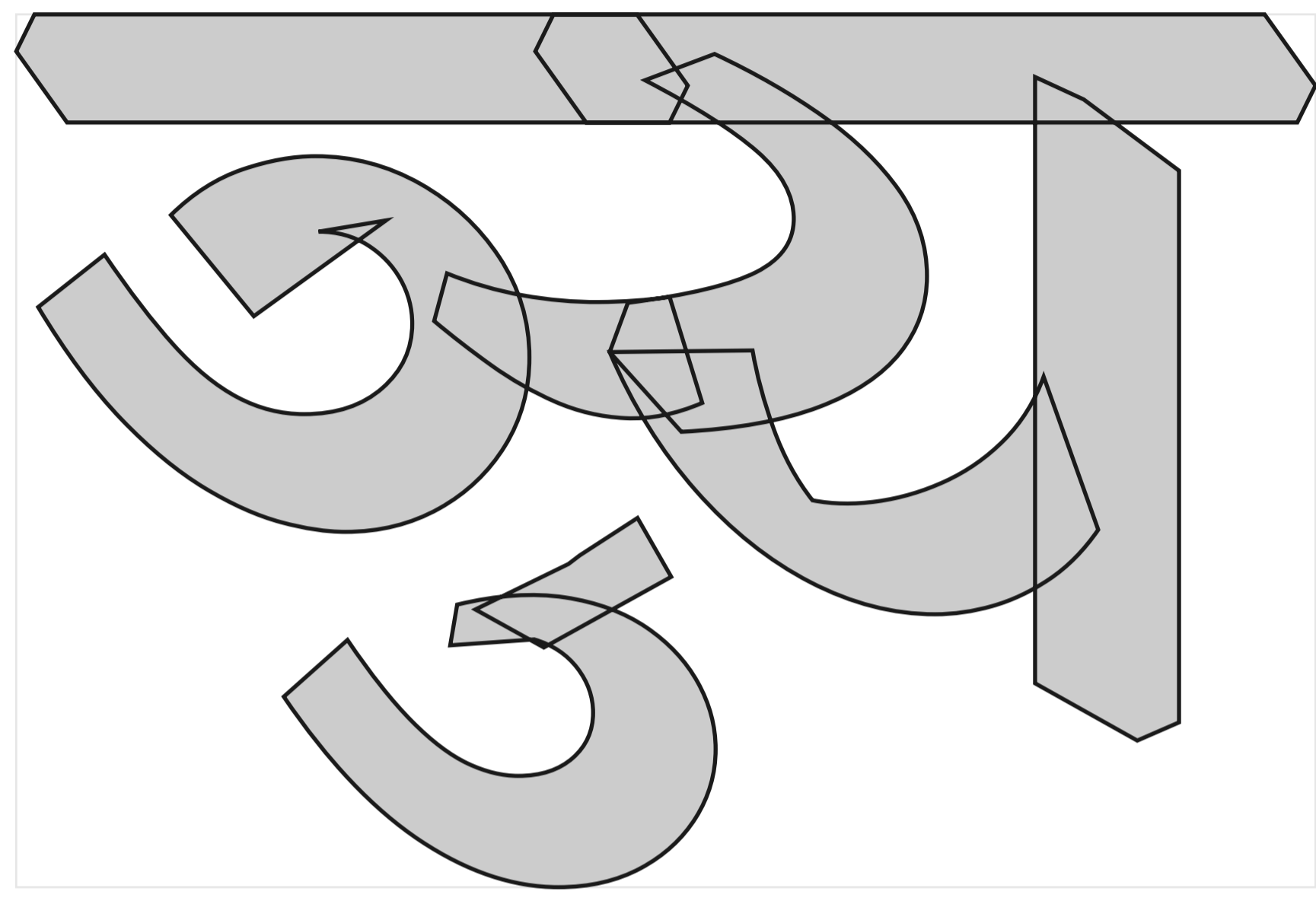

'wght=800.0'

proposed fix

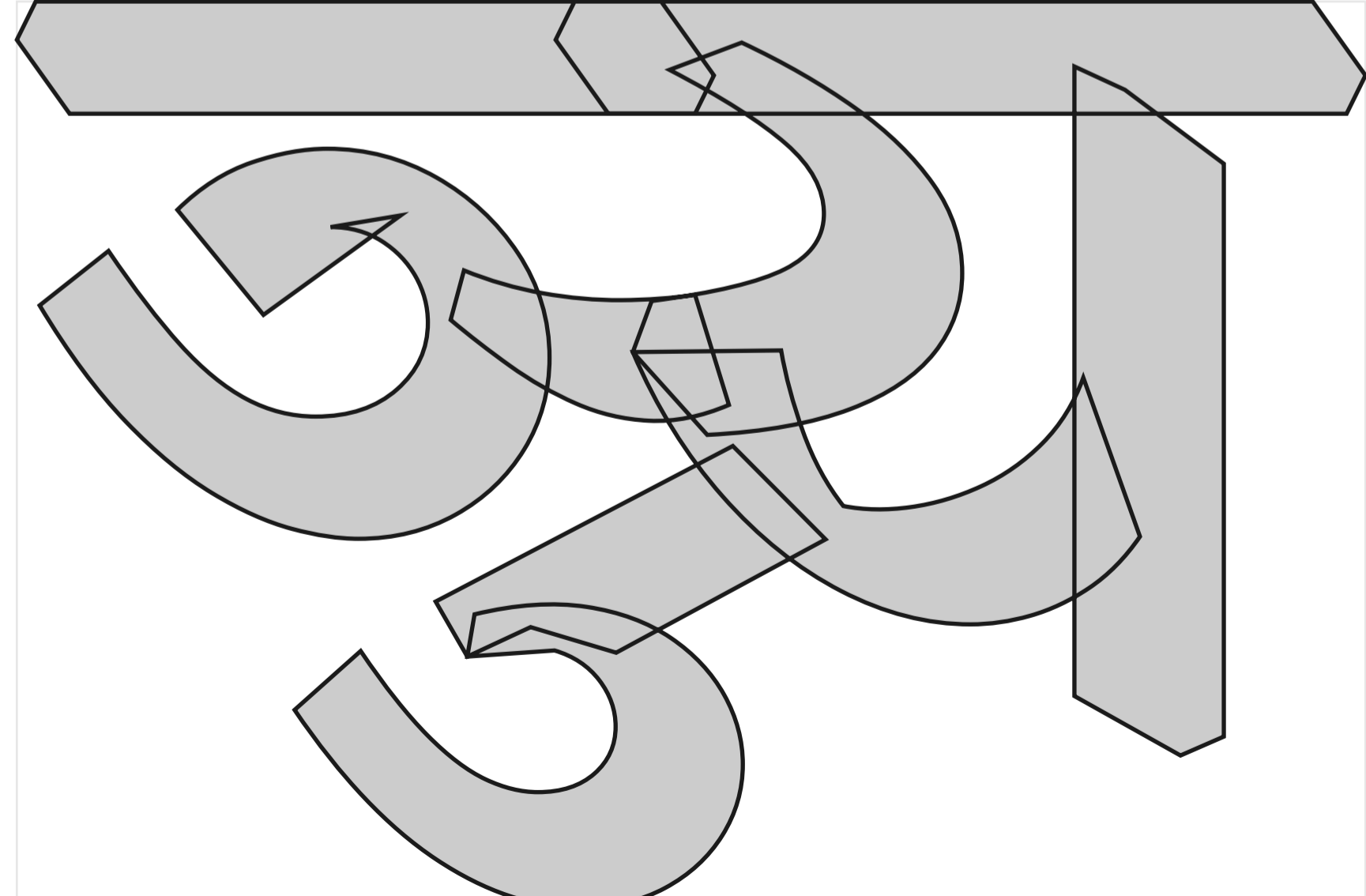
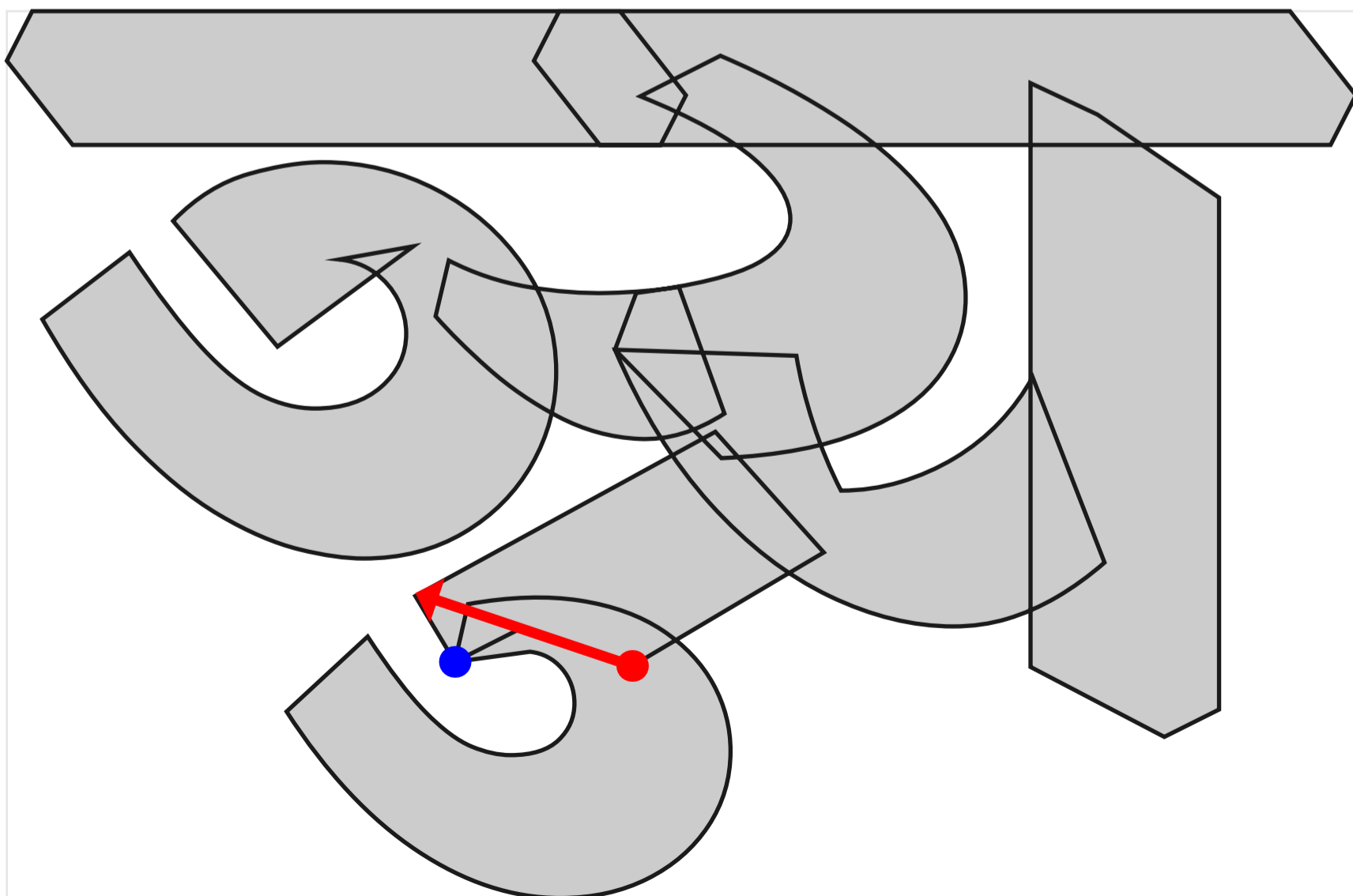

dvNyJa

wrong_start_point

”

midway interpolation

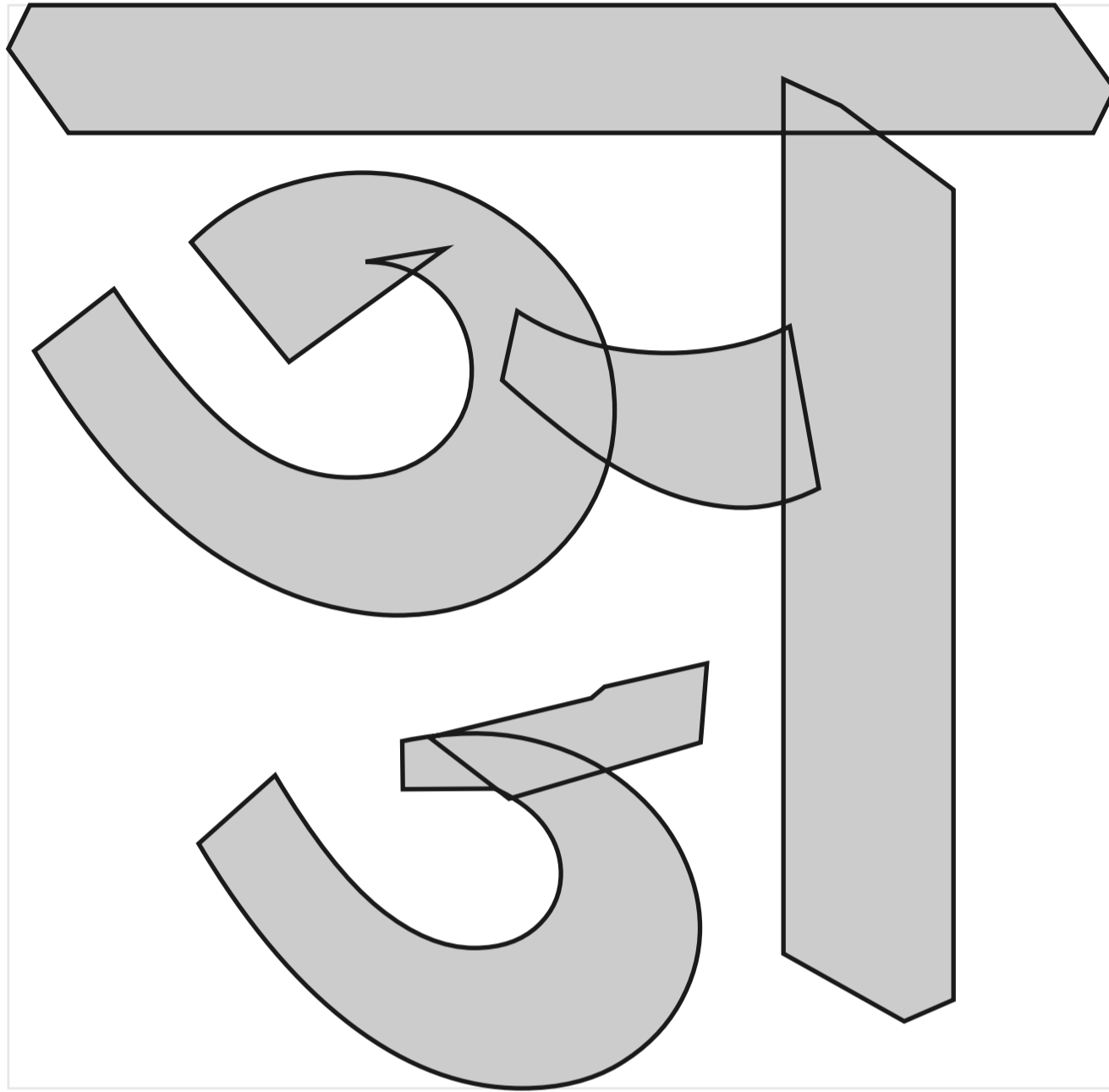
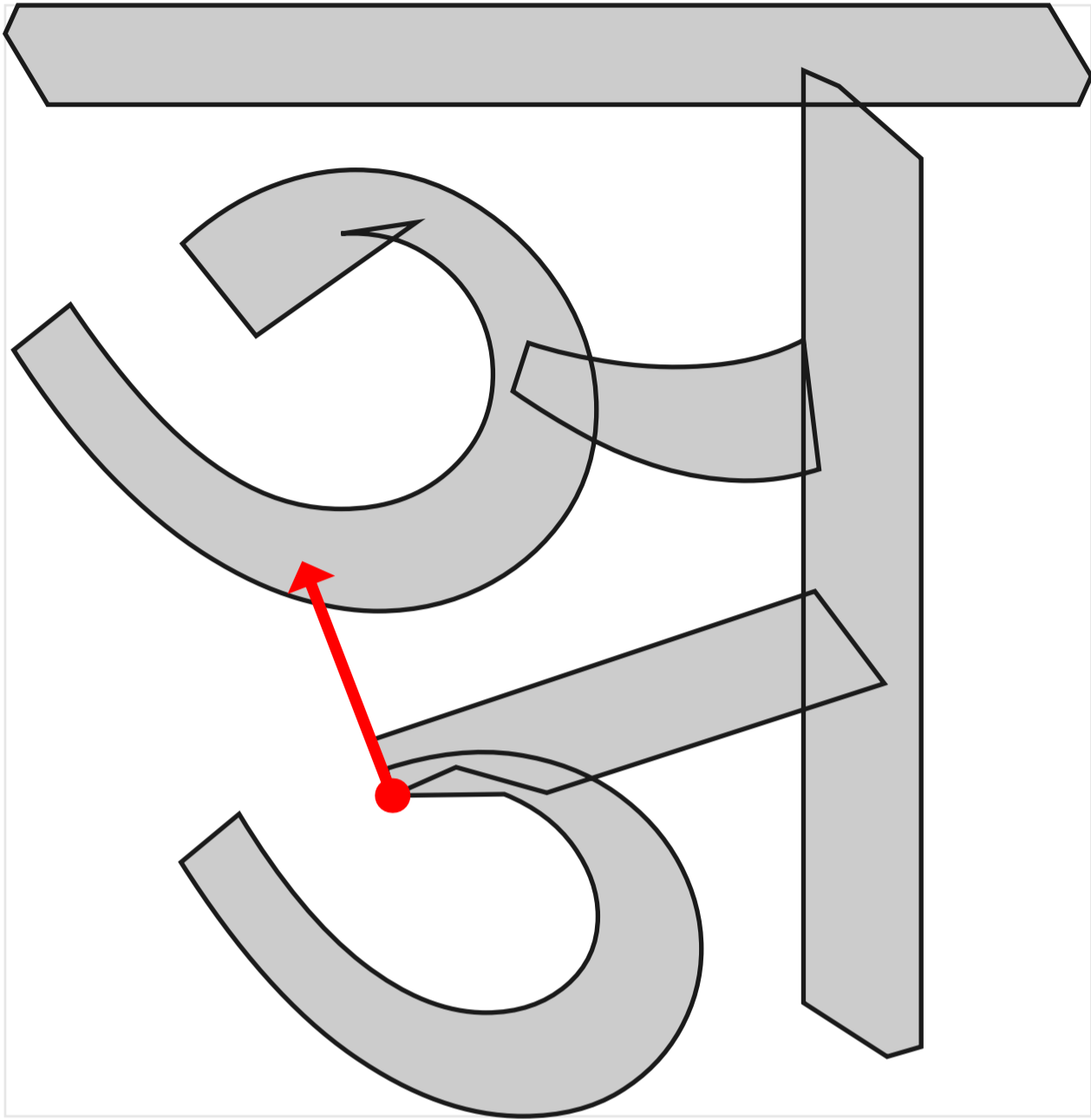

'wght=800.0'

proposed fix

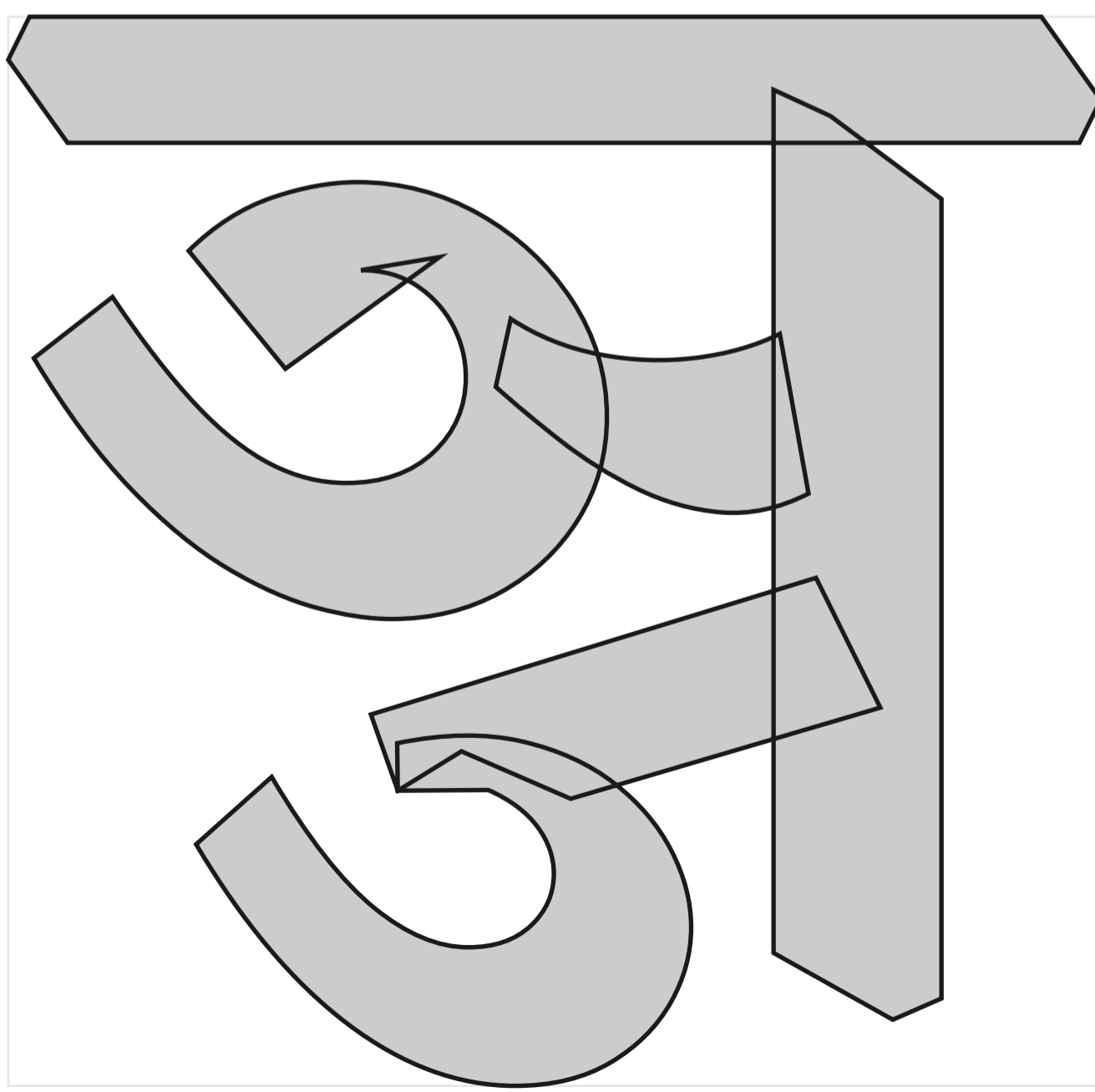
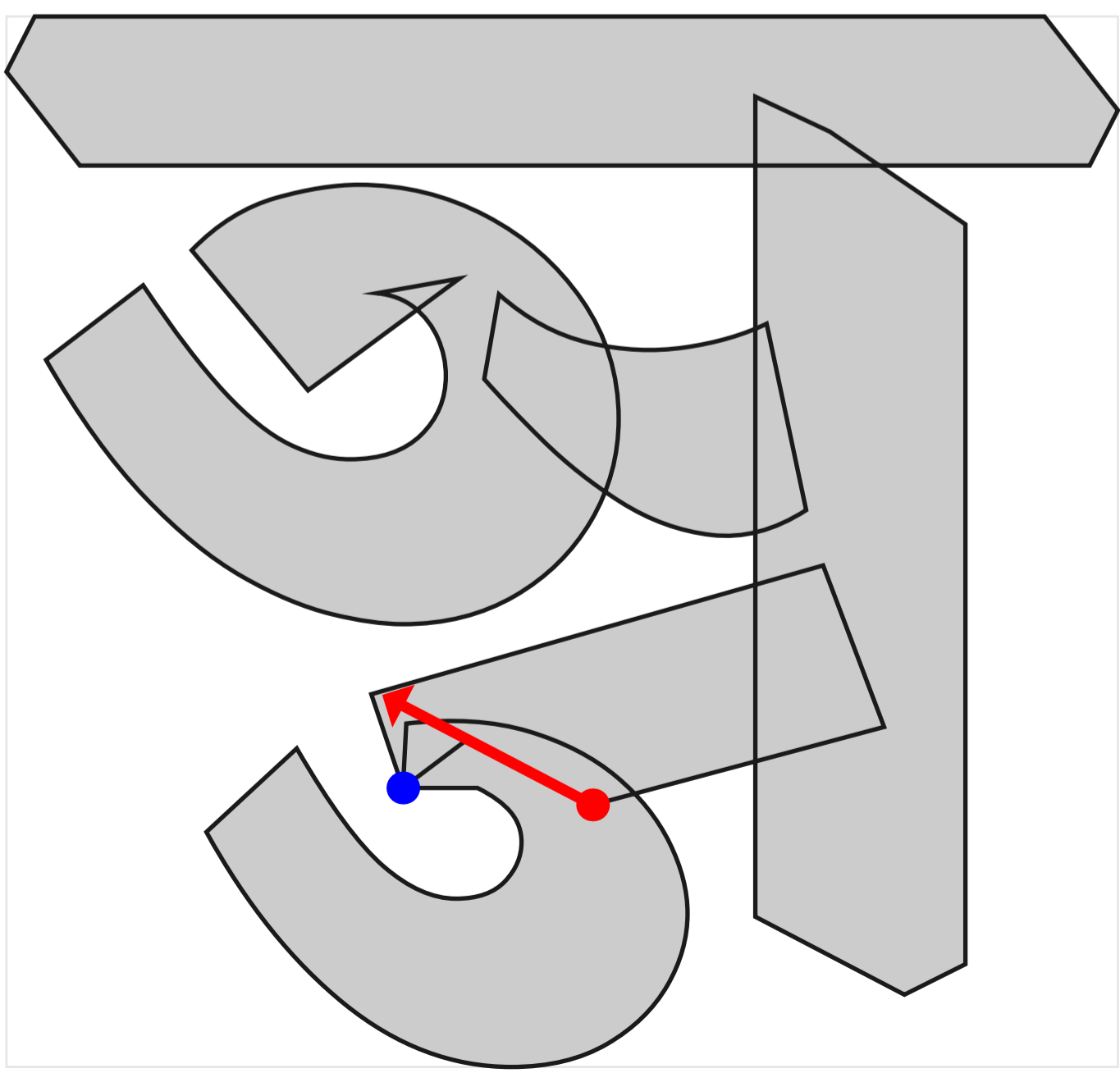

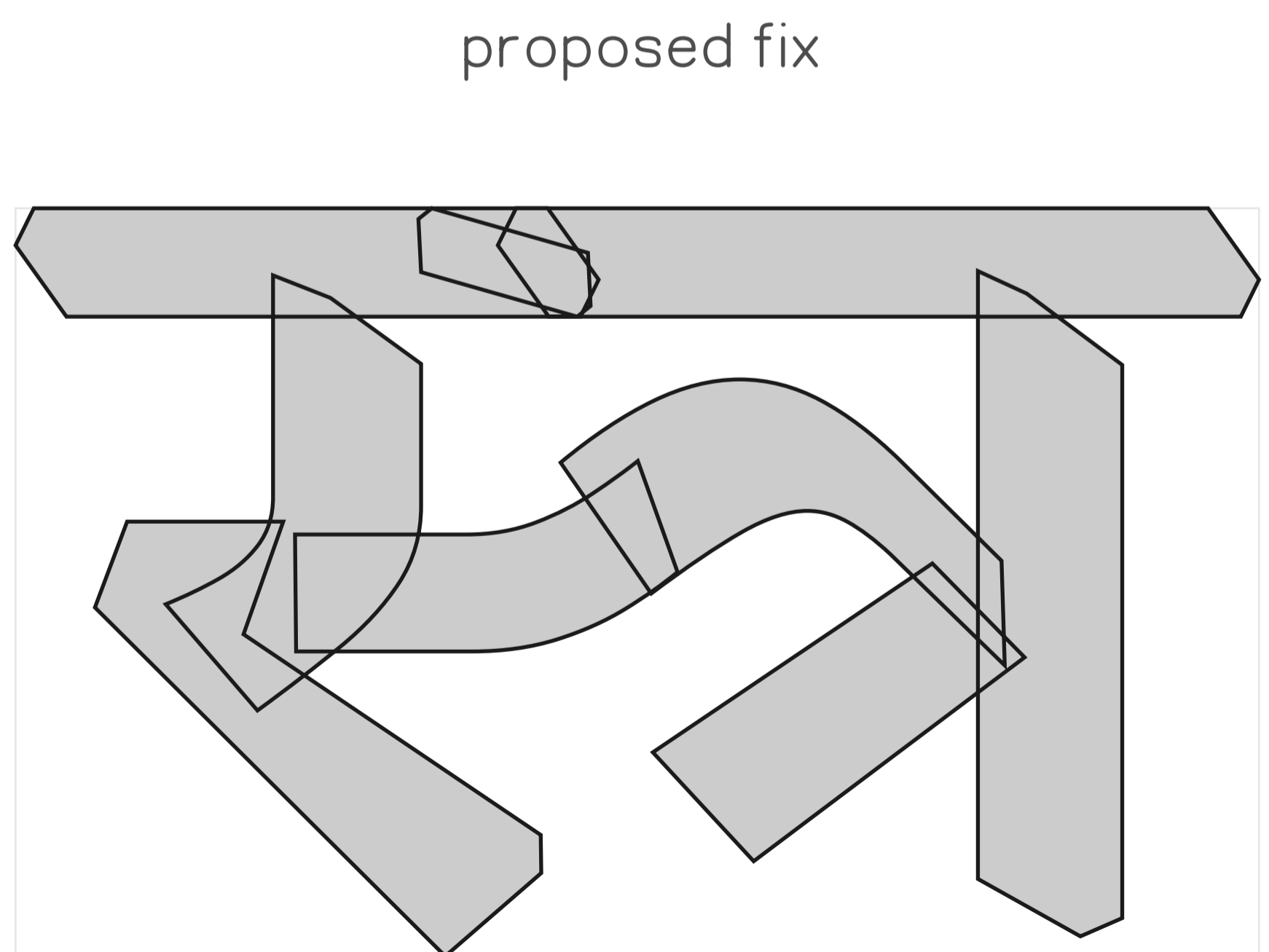
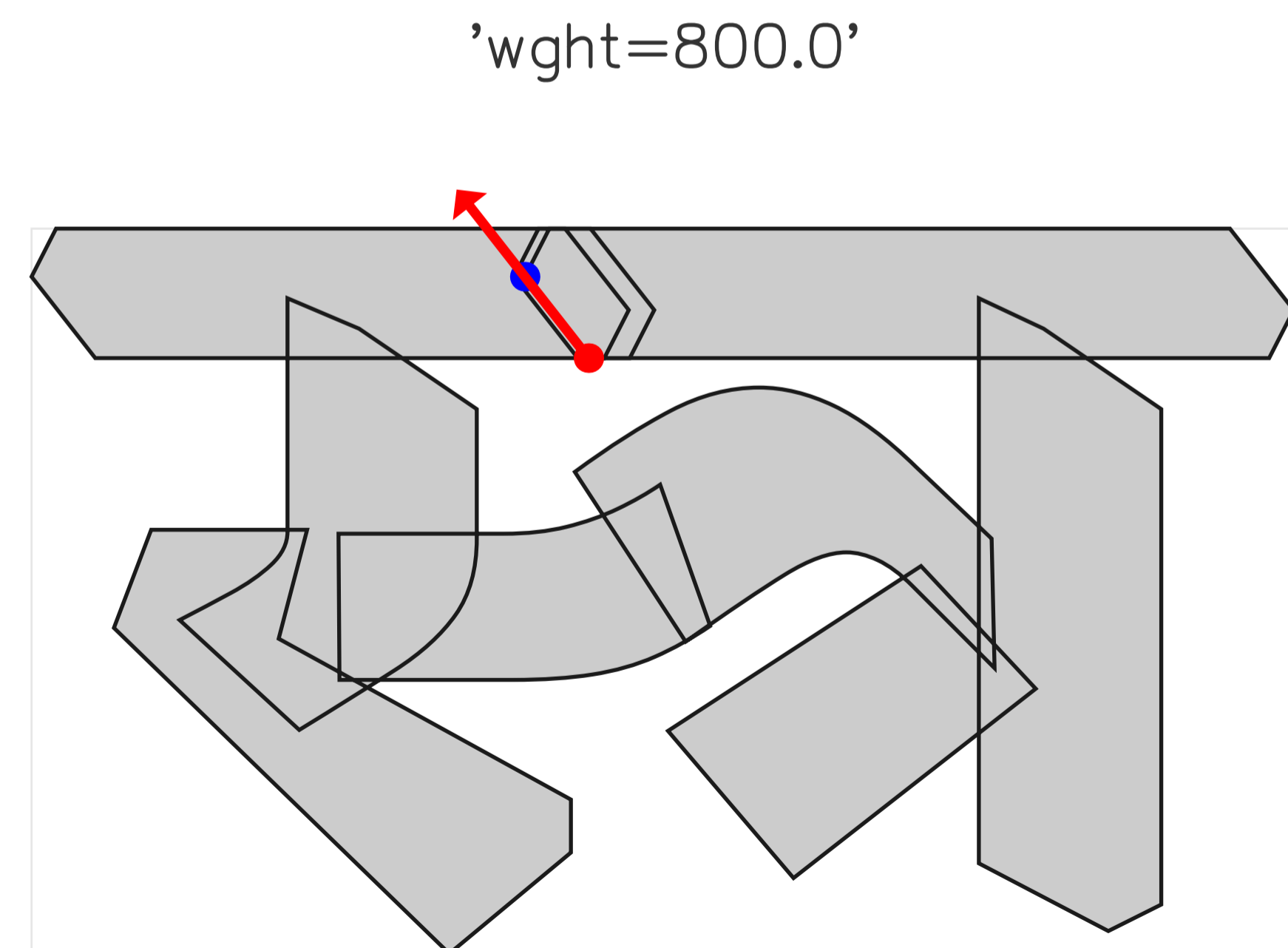
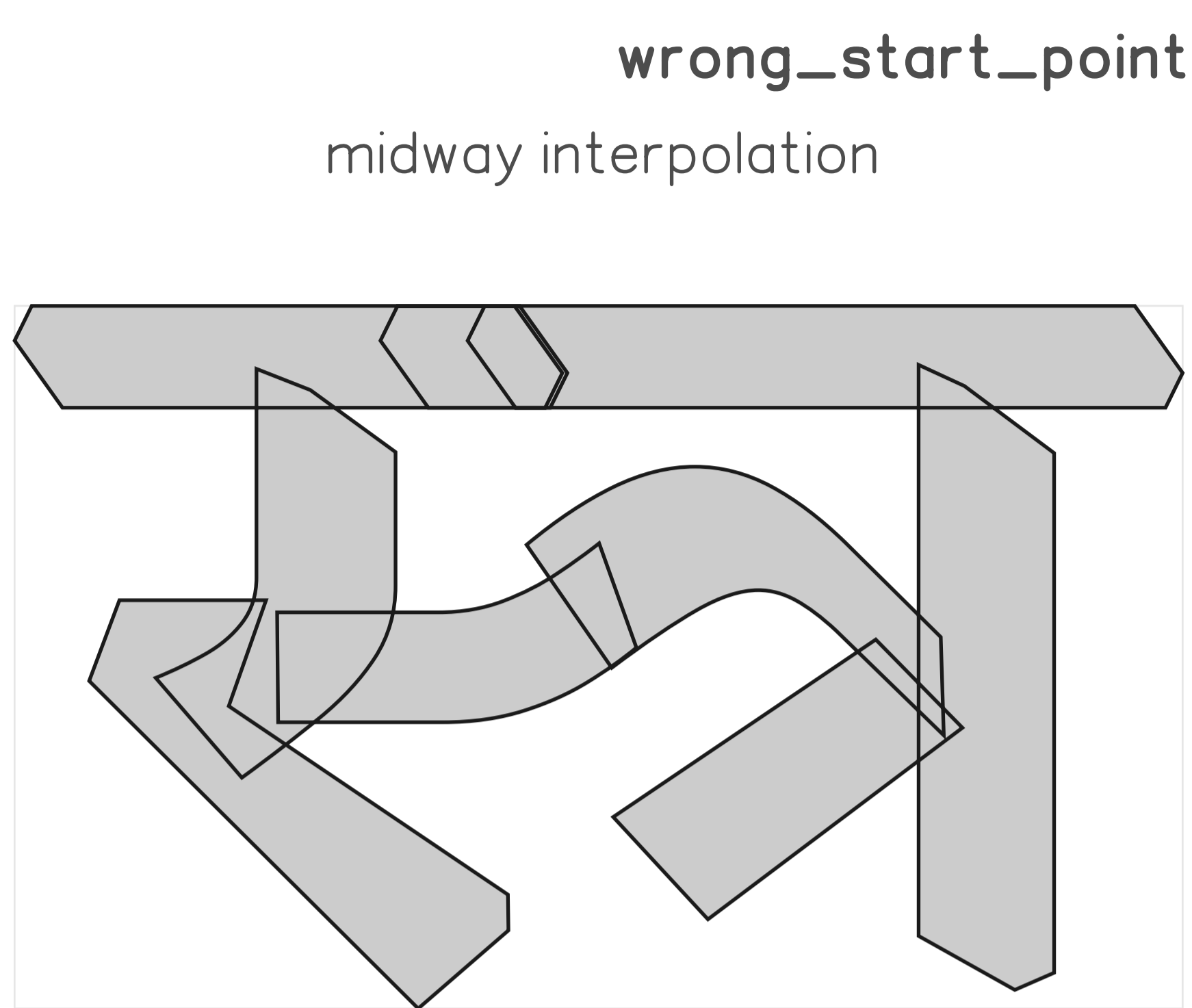
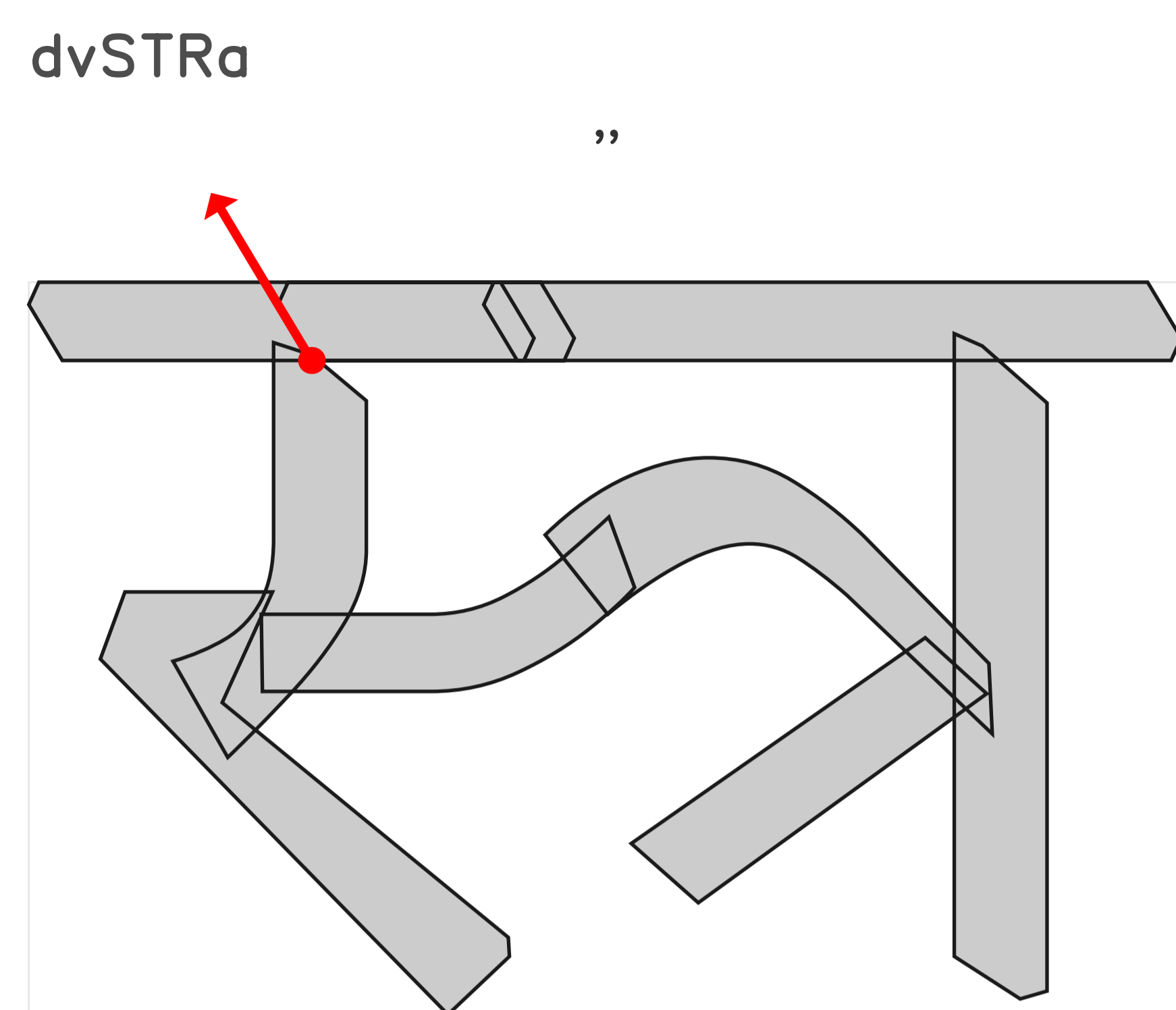

multiply

”

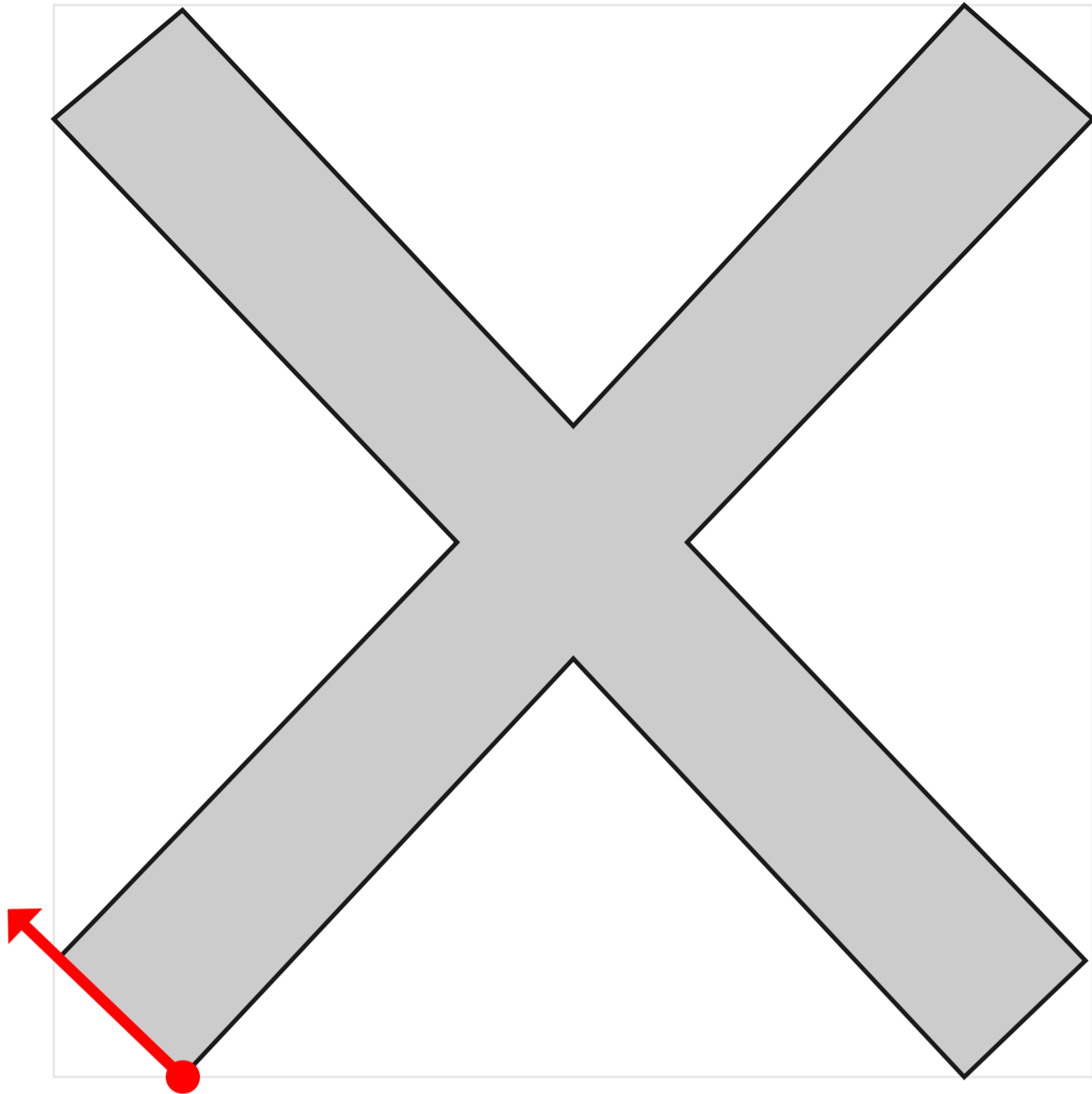

'wght=800.0'

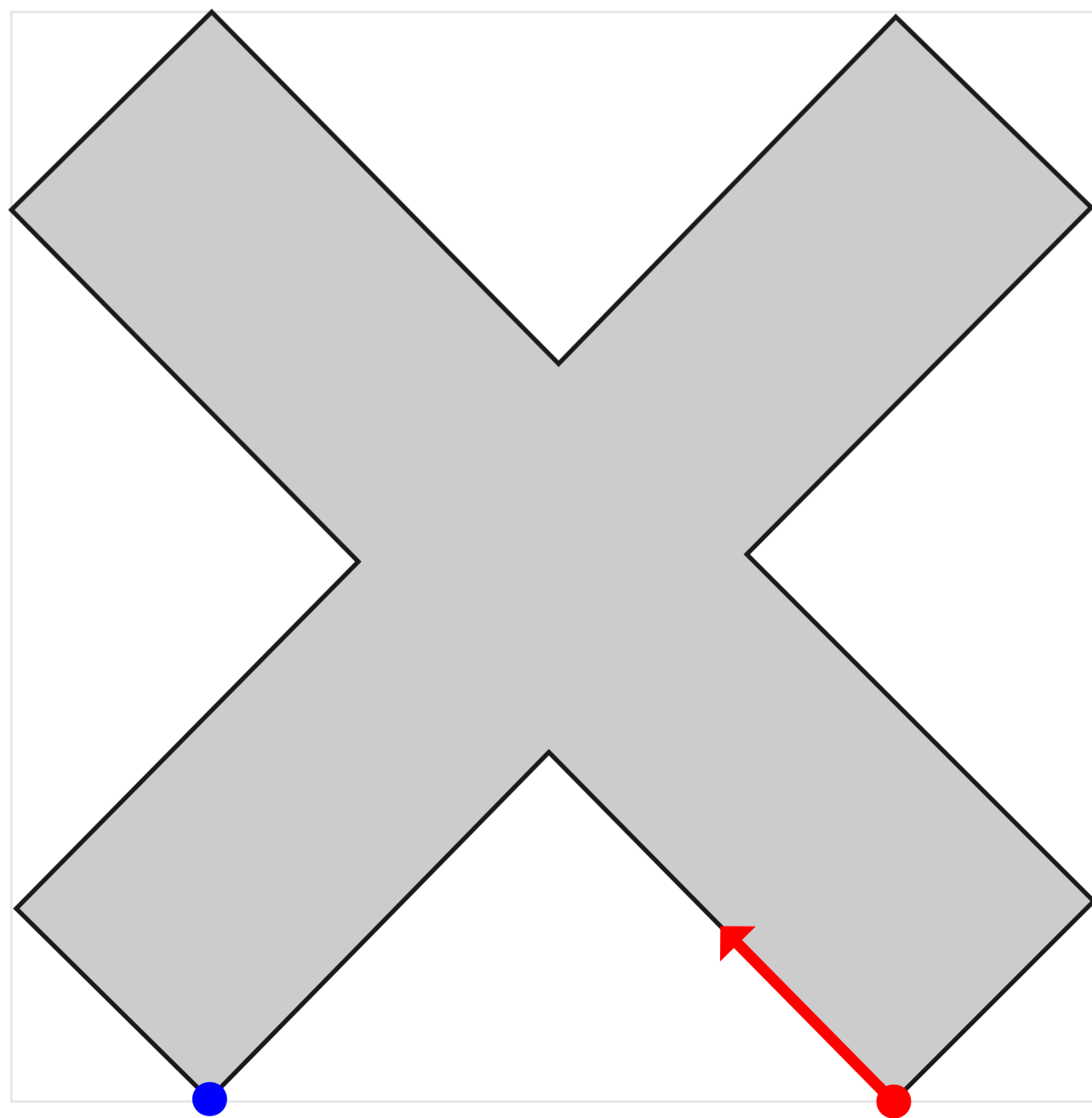

wrong_start_point

midway interpolation

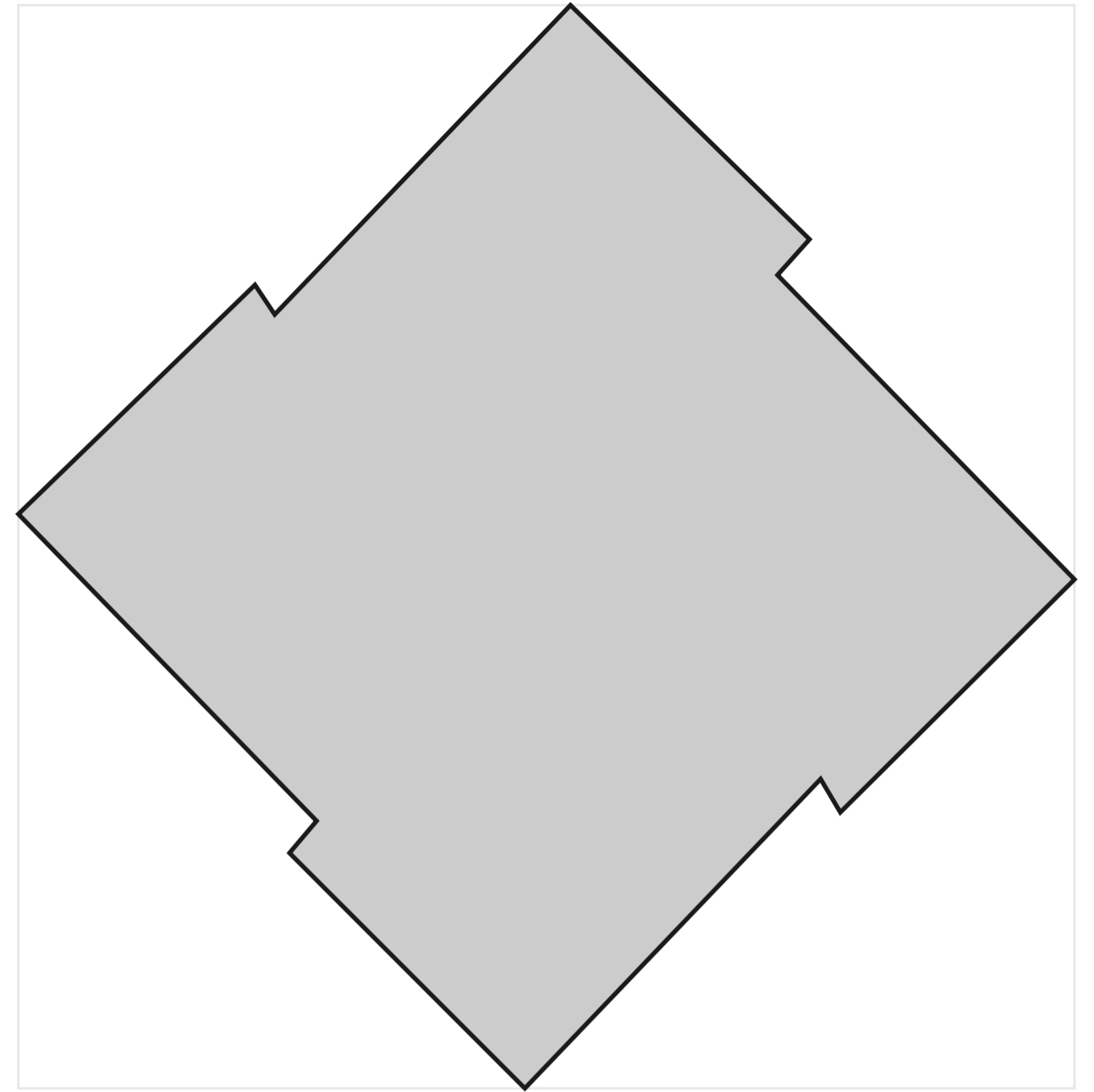

proposed fix

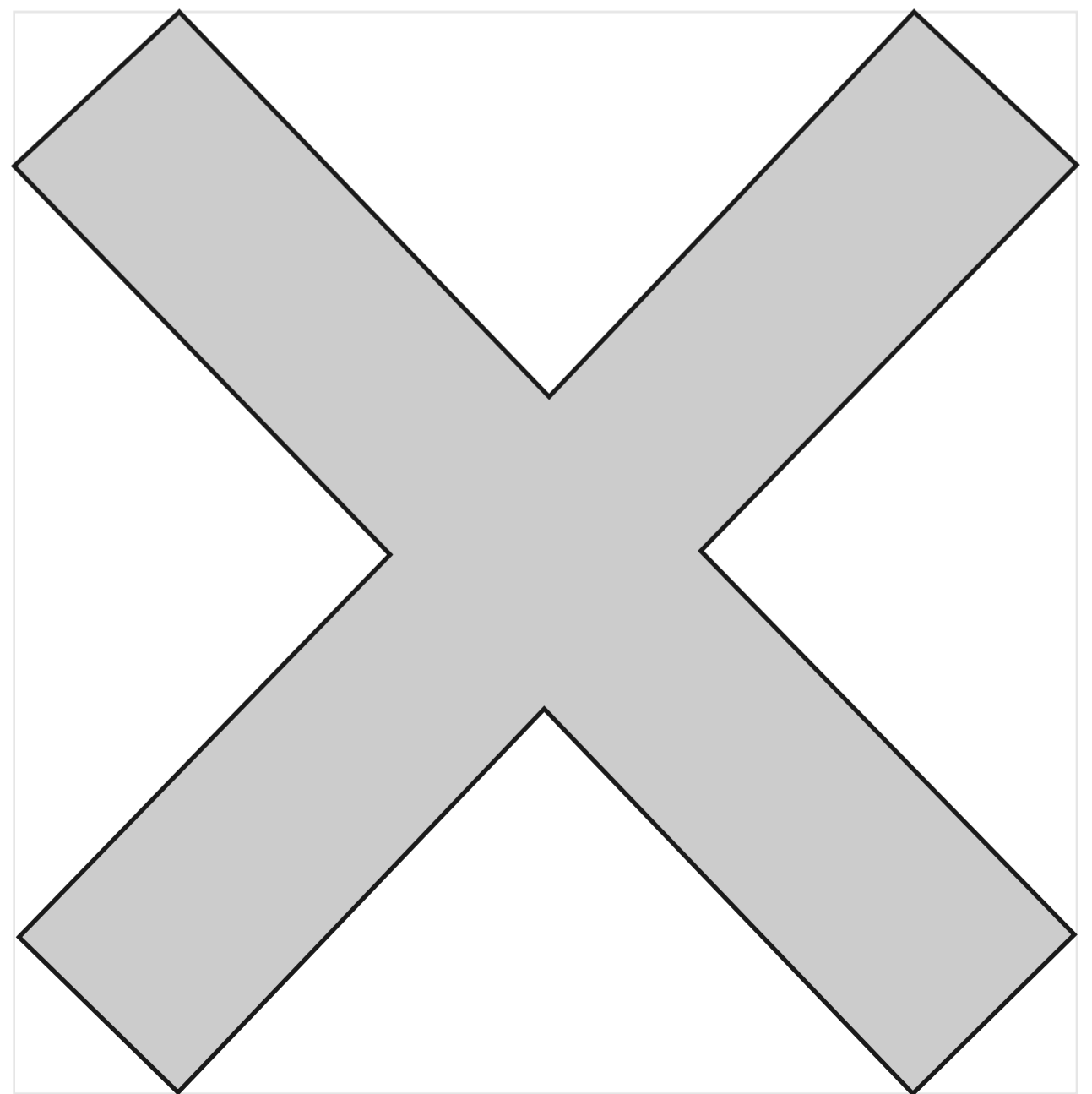

uni090B.ss06

”

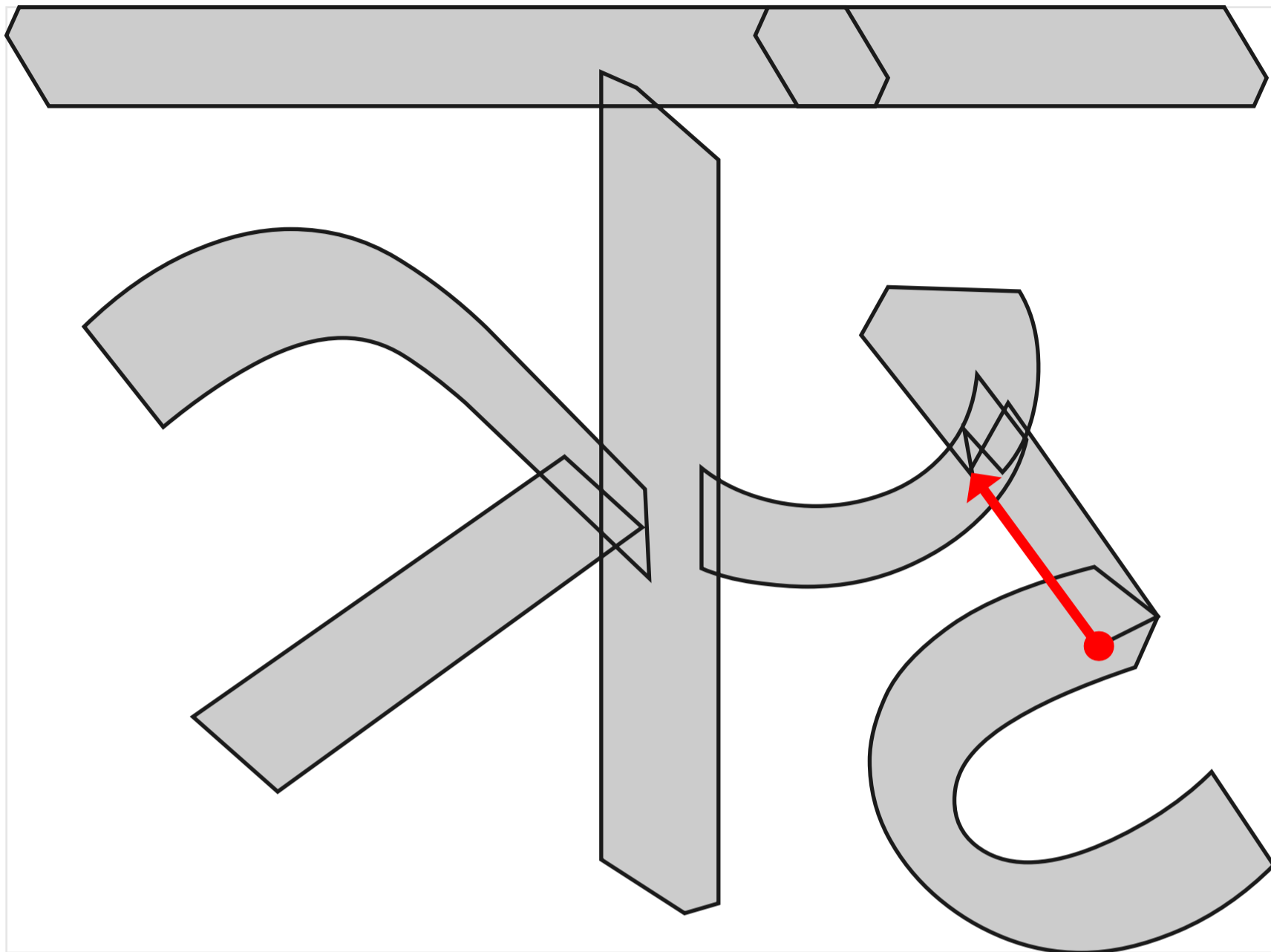

wrong_start_point

midway interpolation

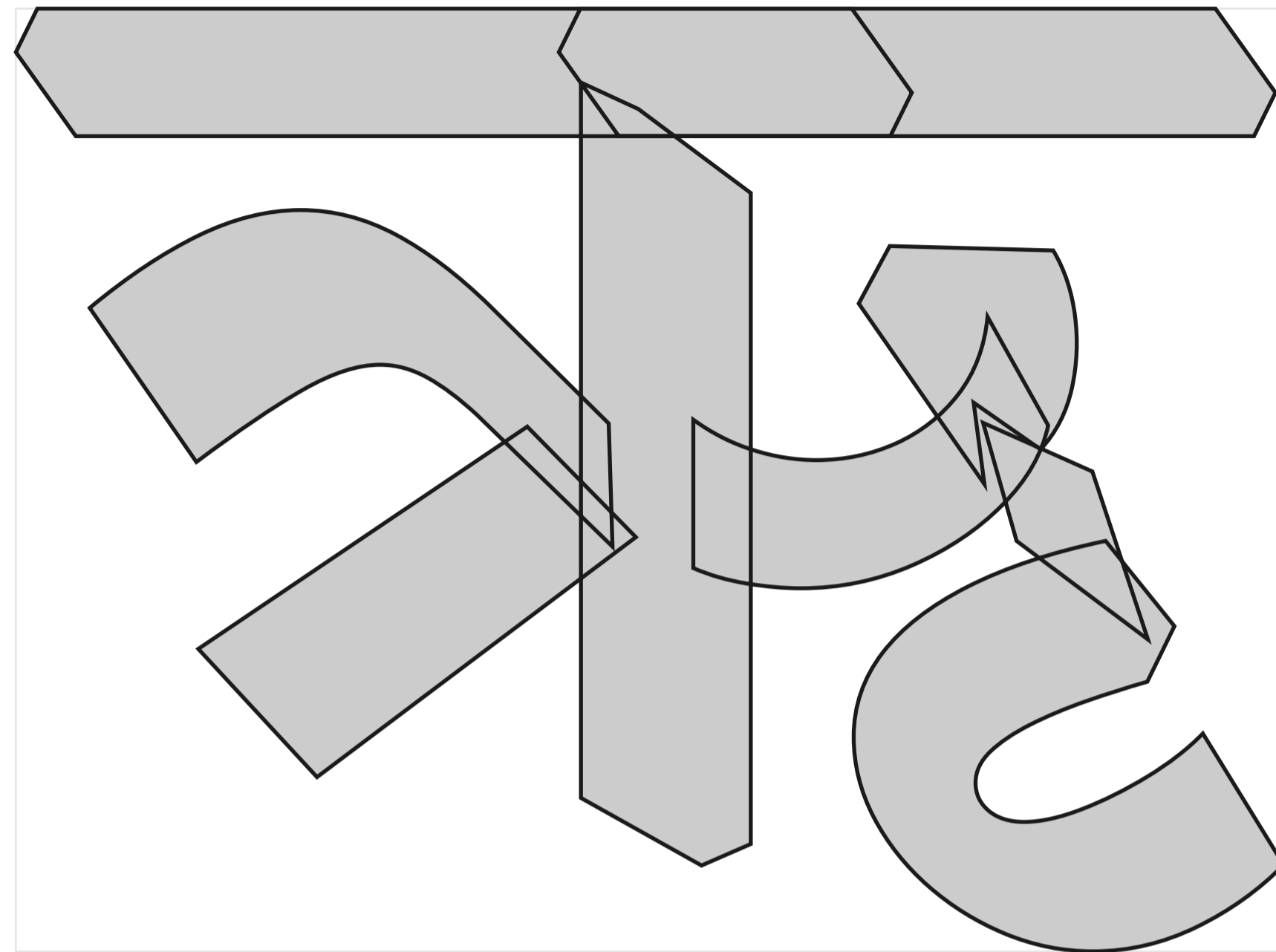

'wght=800.0'

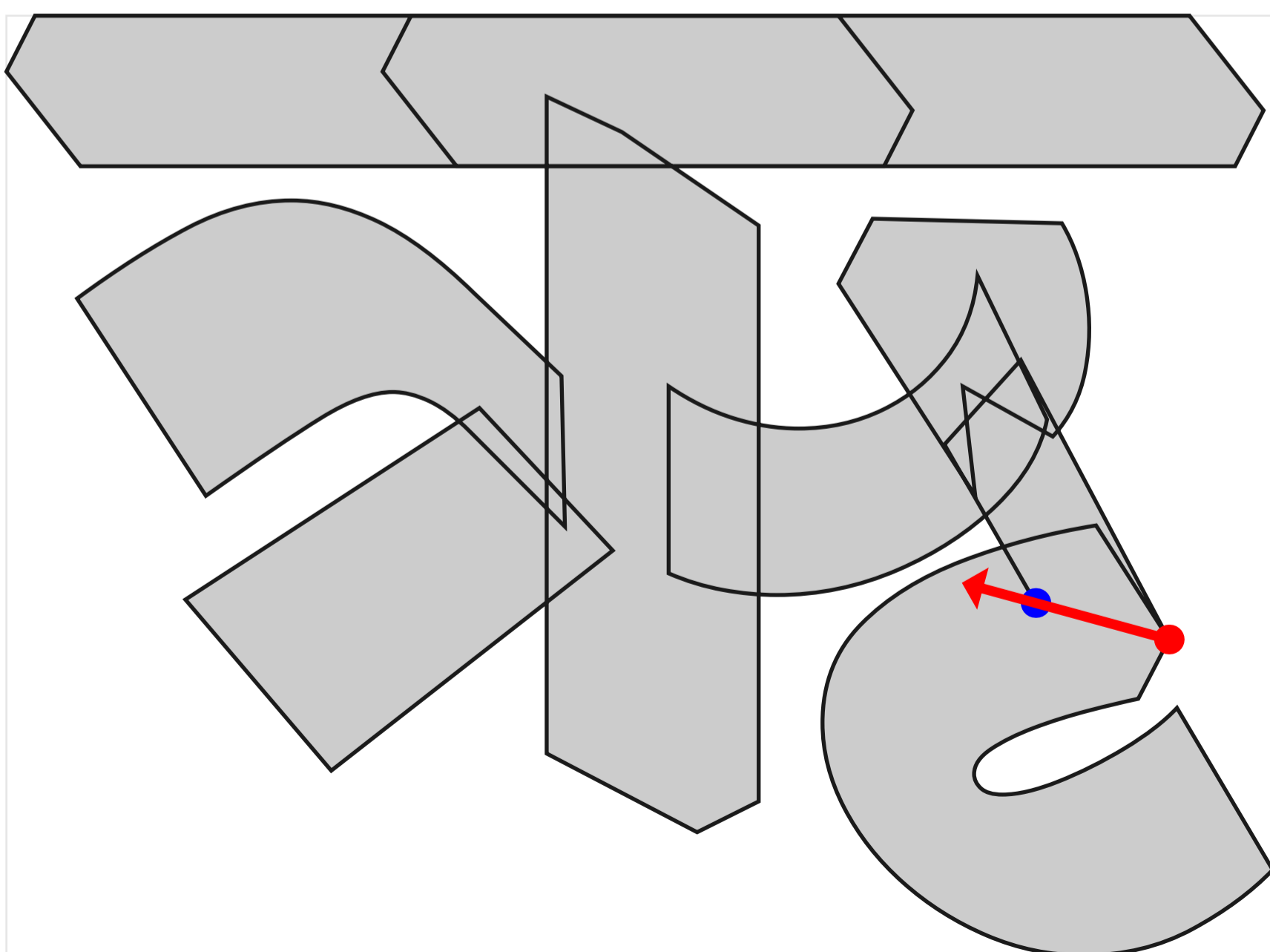

proposed fix

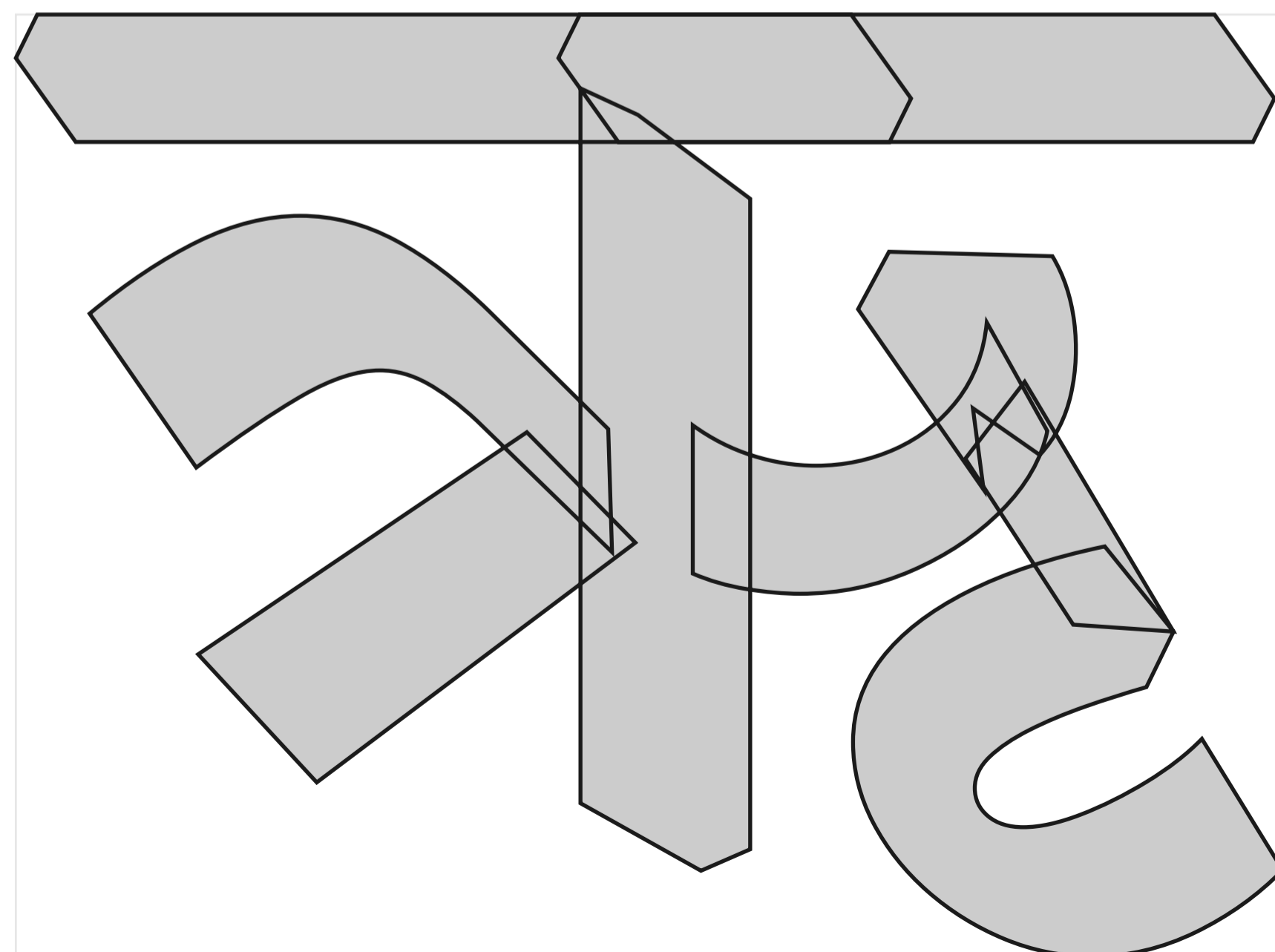

uni0937094D

”

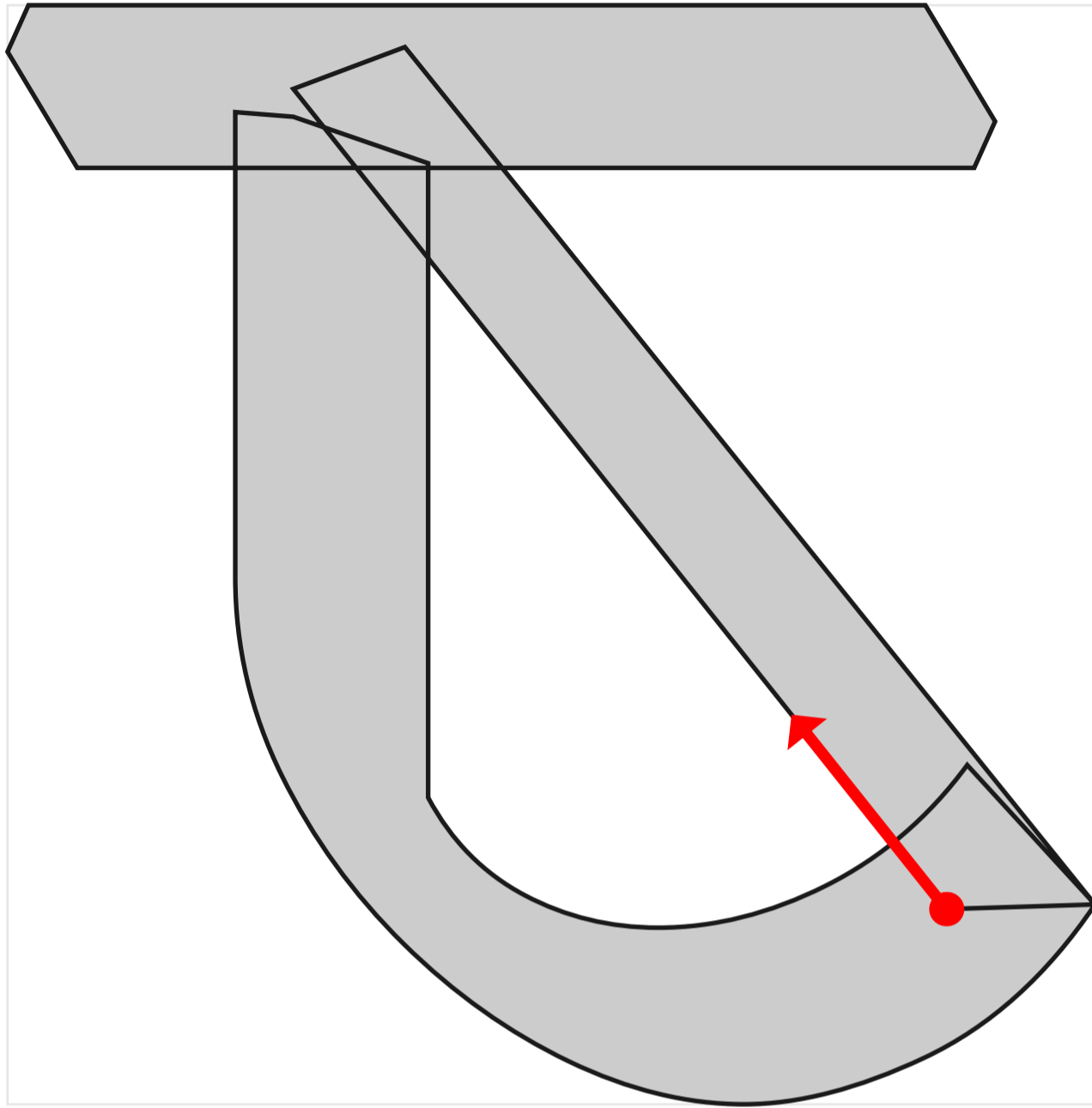

'wght=800.0'

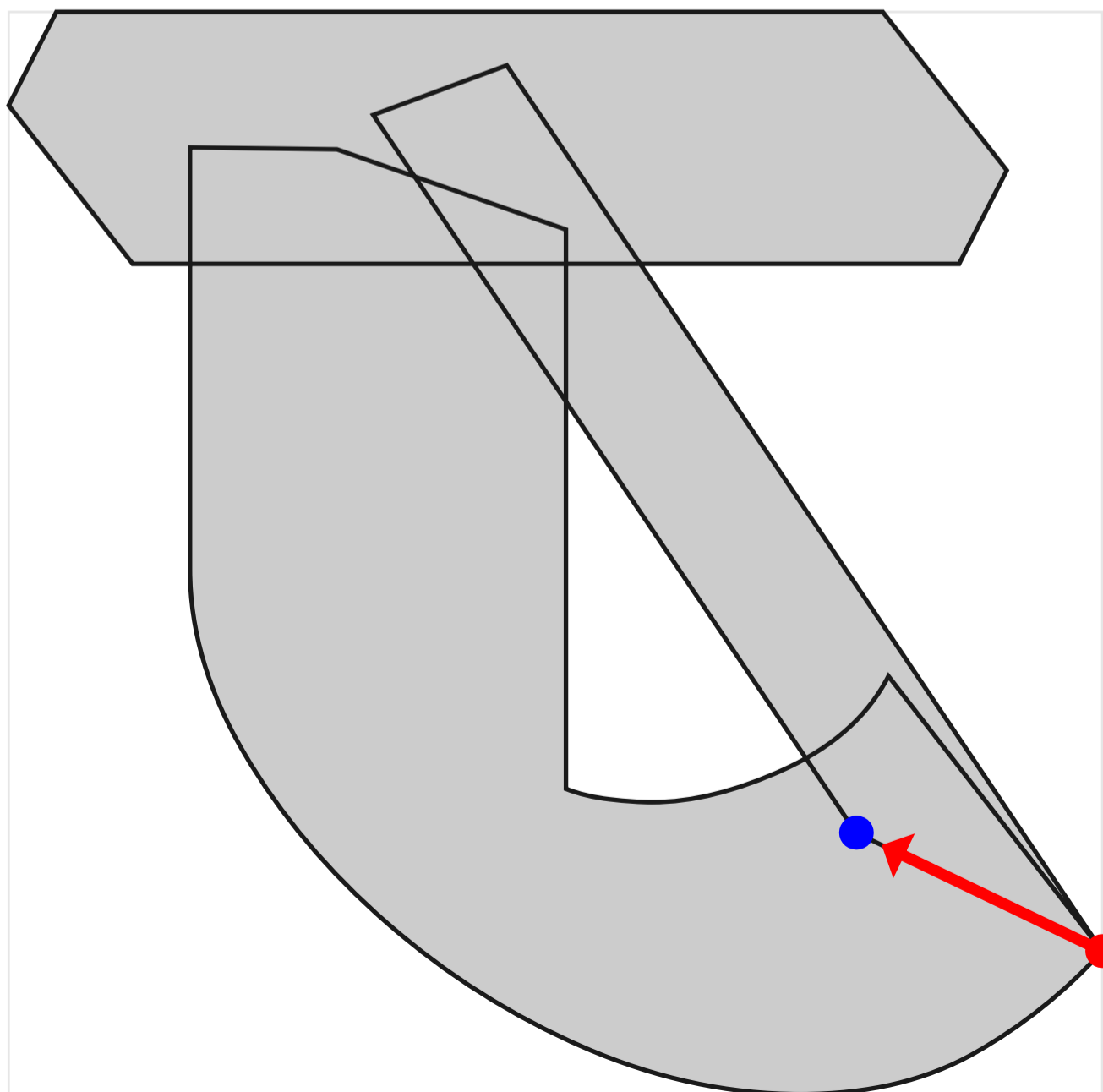

wrong_start_point

midway interpolation

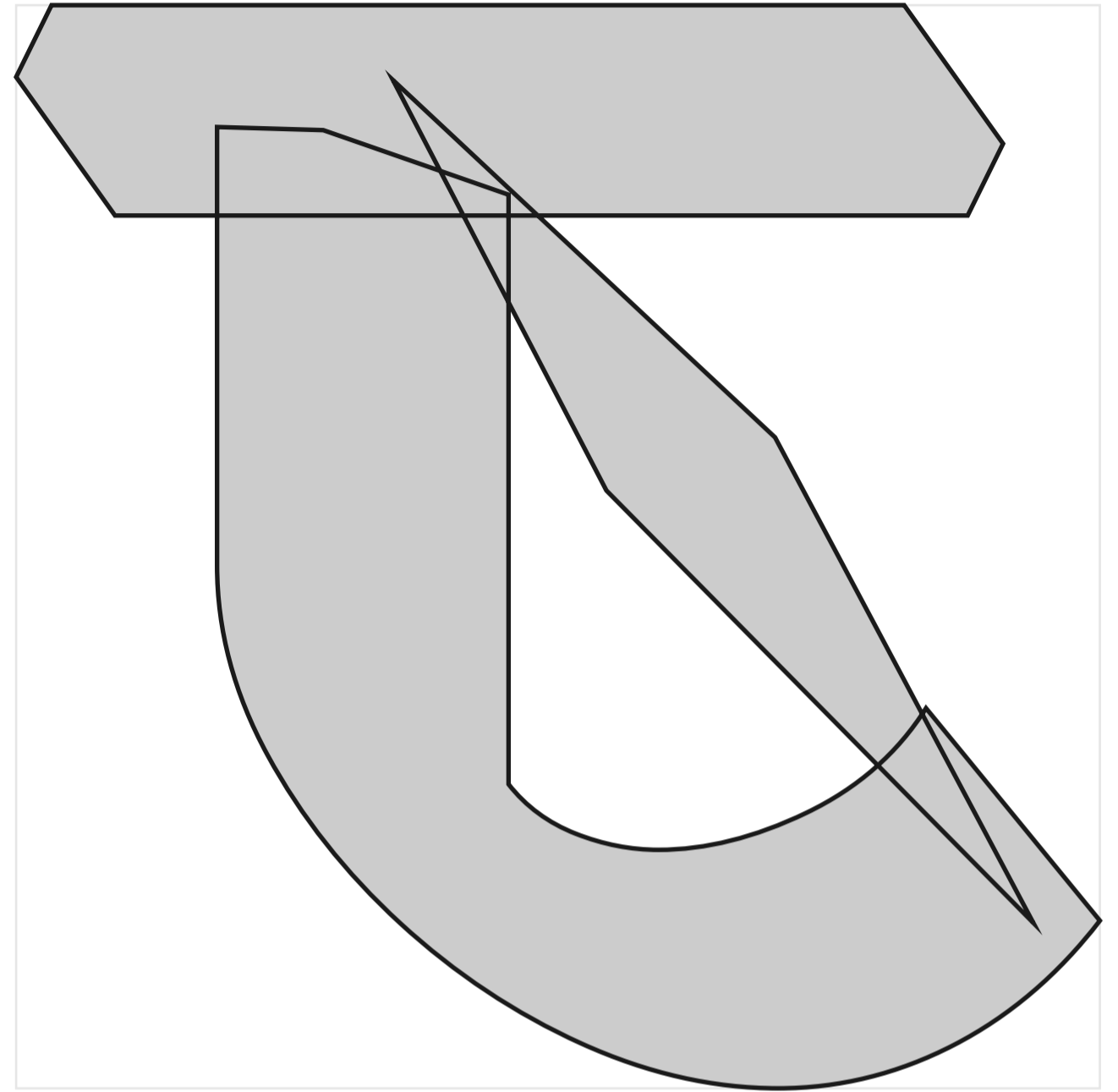

proposed fix

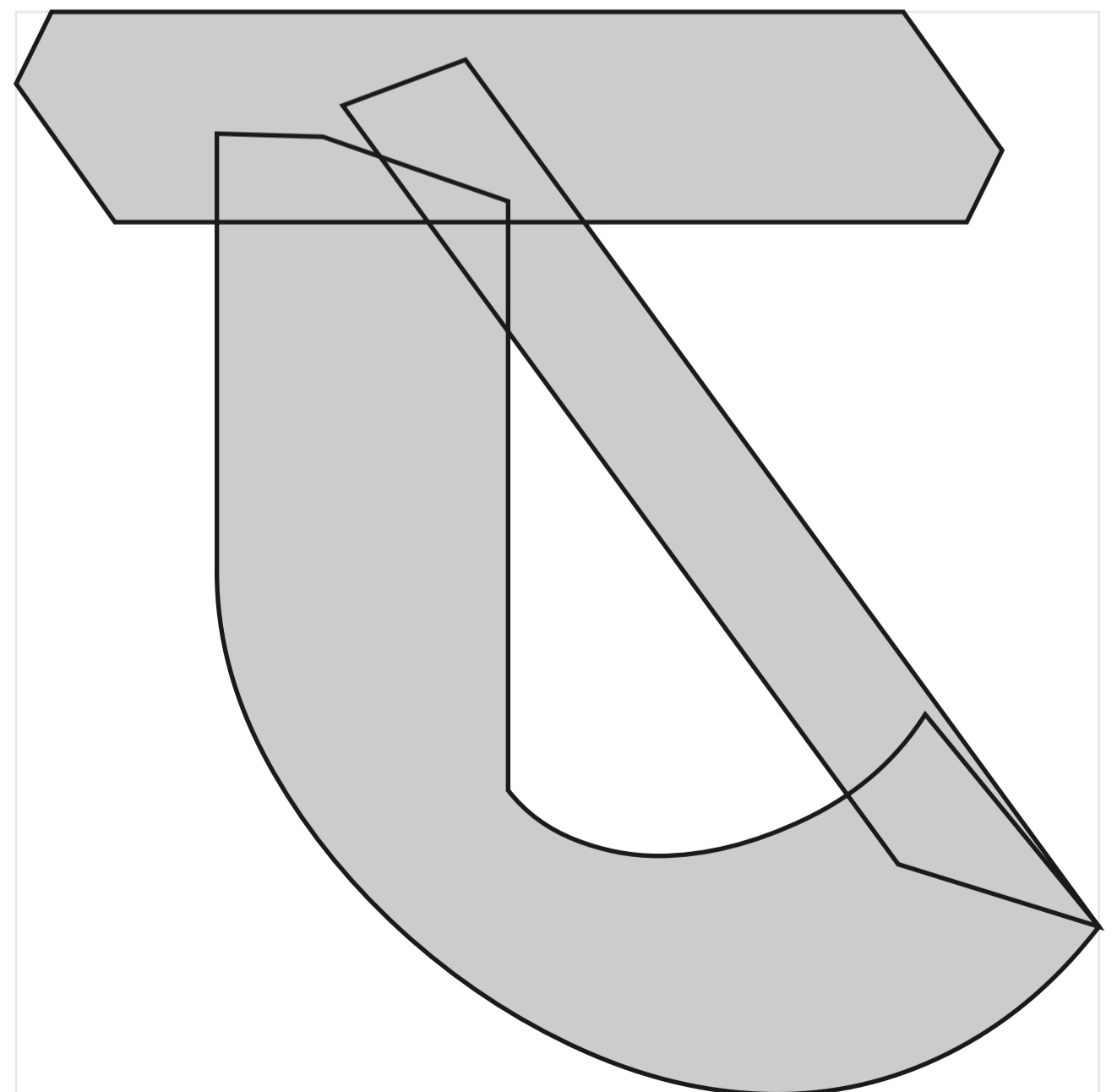

uni0938094D

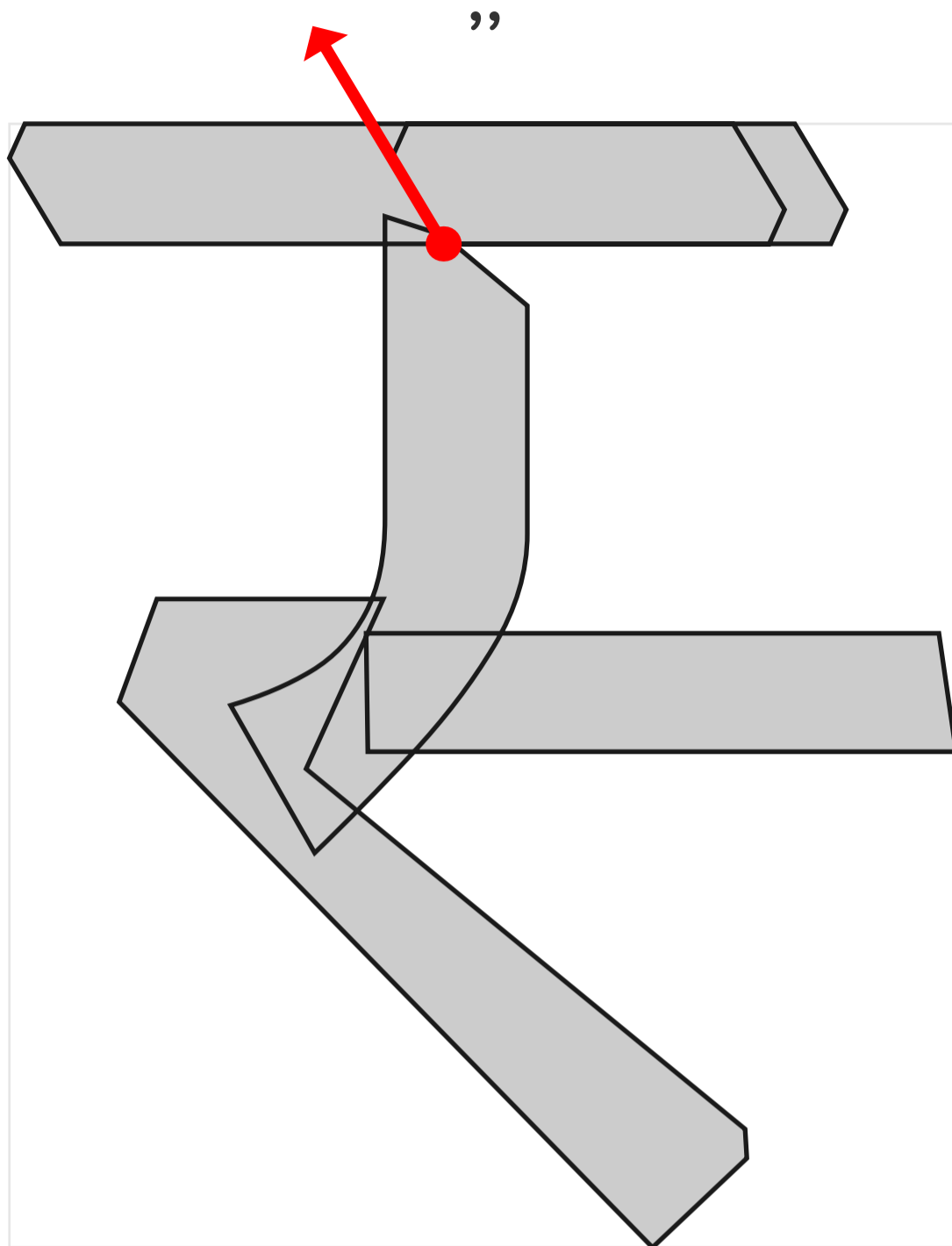

'wght=800.0'

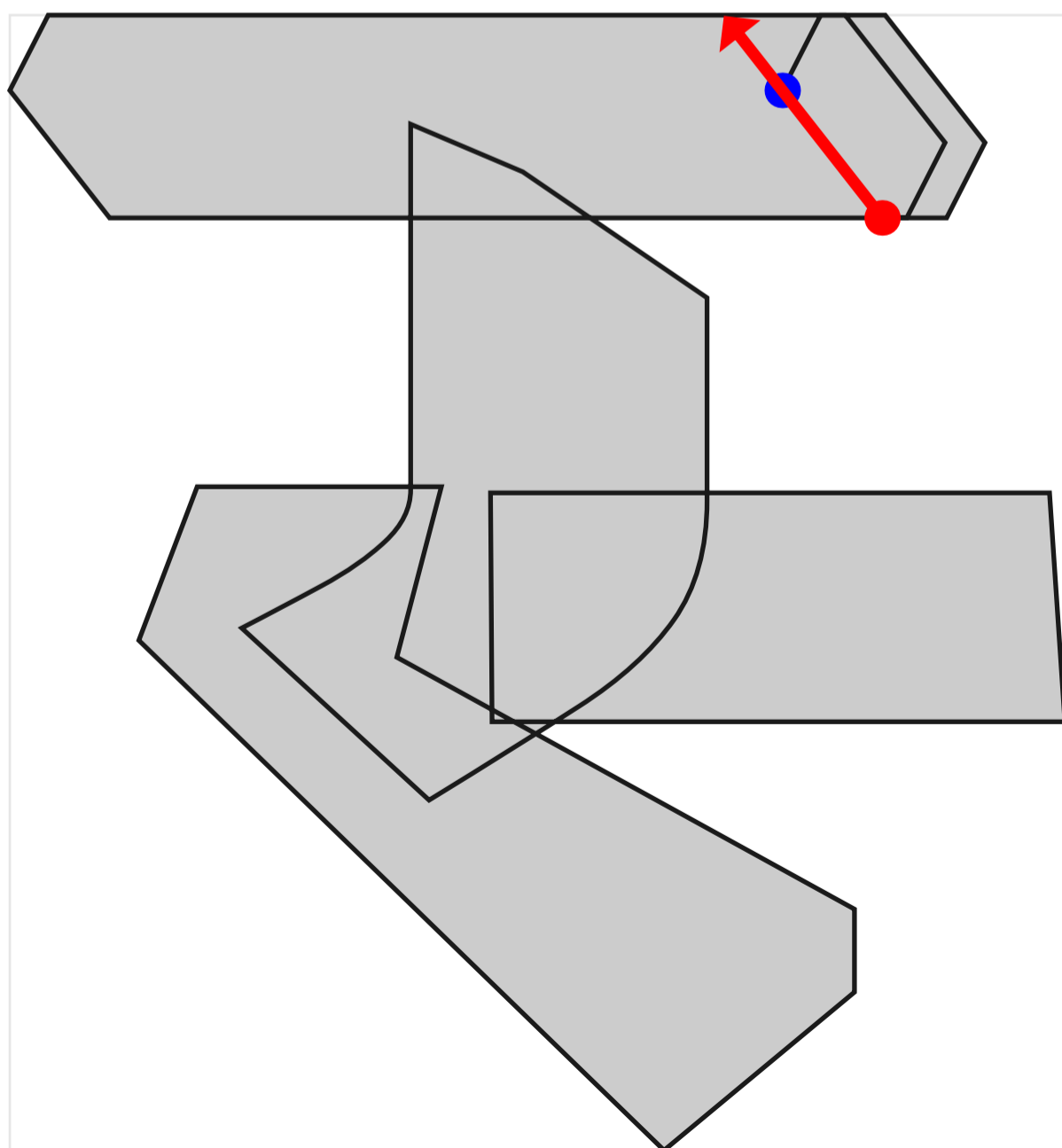

wrong_start_point

midway interpolation

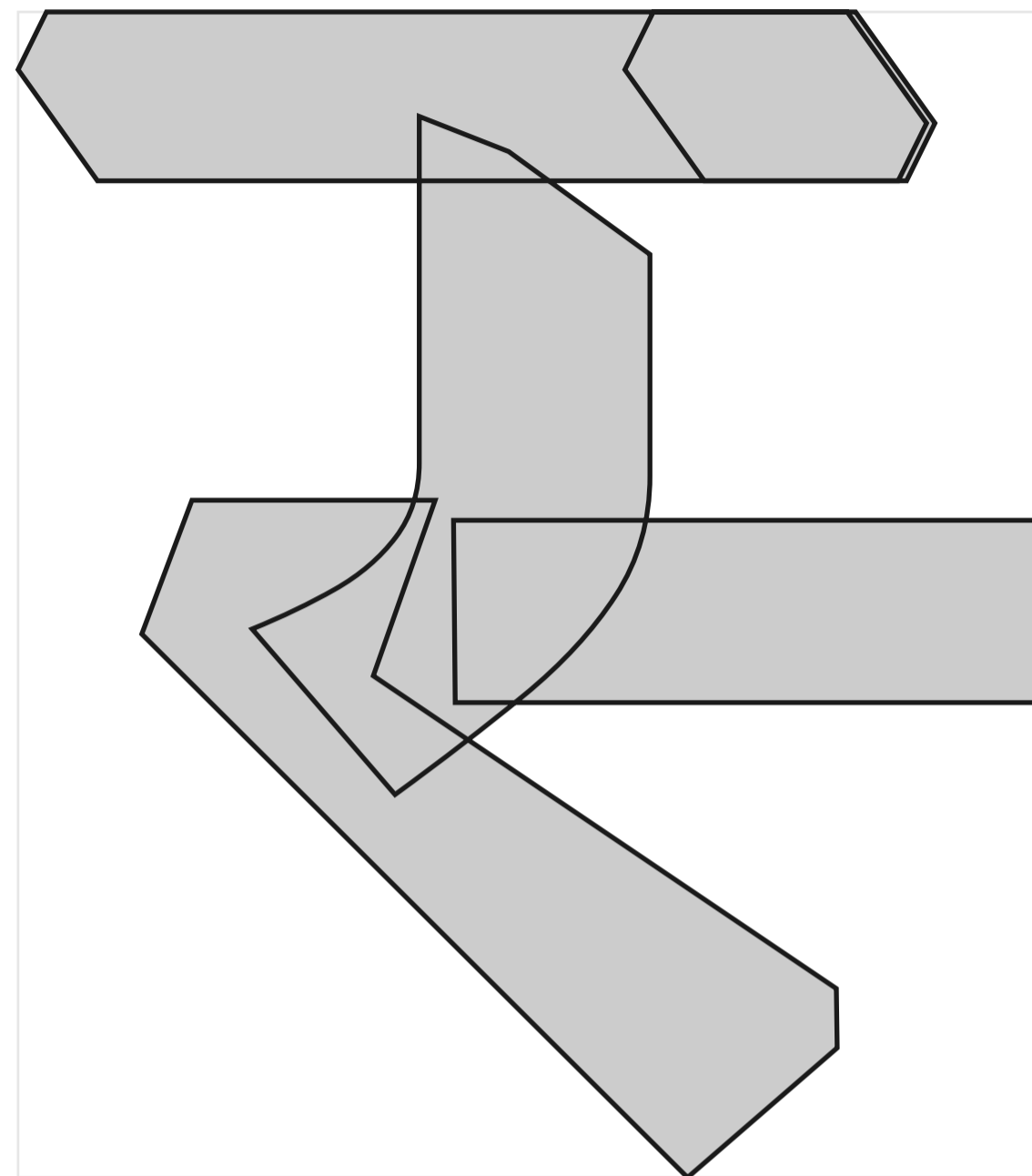

proposed fix

