

# SPACE X NON-GEOSTATIONARY SATELLITE SYSTEM

## ATTACHMENT A TECHNICAL INFORMATION TO SUPPLEMENT SCHEDULE S

### A.1 SCOPE AND PURPOSE

This attachment contains the information required under Part 25 of the Commission’s rules that cannot be fully captured by the associated Schedule S.

### A.2 OVERALL DESCRIPTION

The SpaceX non-geostationary orbit (“NGSO”) satellite system (the “SpaceX System”) consists of a constellation of 4,425 satellites (plus in-orbit spares)<sup>1</sup> operating in 83 orbital planes (at altitudes ranging from 1,110 km to 1,325 km), as well as associated ground control facilities, gateway earth stations and end user earth stations. The overall constellation will be configured as follows:

SPACE X SYSTEM CONSTELLATION					
Parameter	Initial Deployment (1,600 satellites)	Final Deployment (2,825 satellites)			
Orbital Planes	32	32	8	5	6
Satellites per Plane	50	50	50	75	75
Altitude	1,150 km	1,110 km	1,130 km	1,275 km	1,325 km
Inclination	53°	53.8°	74°	81°	70°

This constellation will enable SpaceX to provide full and continuous global coverage, utilizing a minimum elevation angle of 40 degrees.

---

<sup>1</sup> SpaceX will provision to launch up to two extra spacecraft per plane to replenish the constellation in the event of on-orbit failures. If a case arises wherein a spare is not immediately needed, it will remain dormant in the same orbit and will perform station-keeping and debris avoidance maneuvers along with the rest of the active constellation. Because these spare satellites will not operate their communications payloads, and the TT&C facilities communicate in turn with a fixed number of satellites at all times, the addition of spare satellites will not affect the interference analyses for TT&C operations presented in this application.

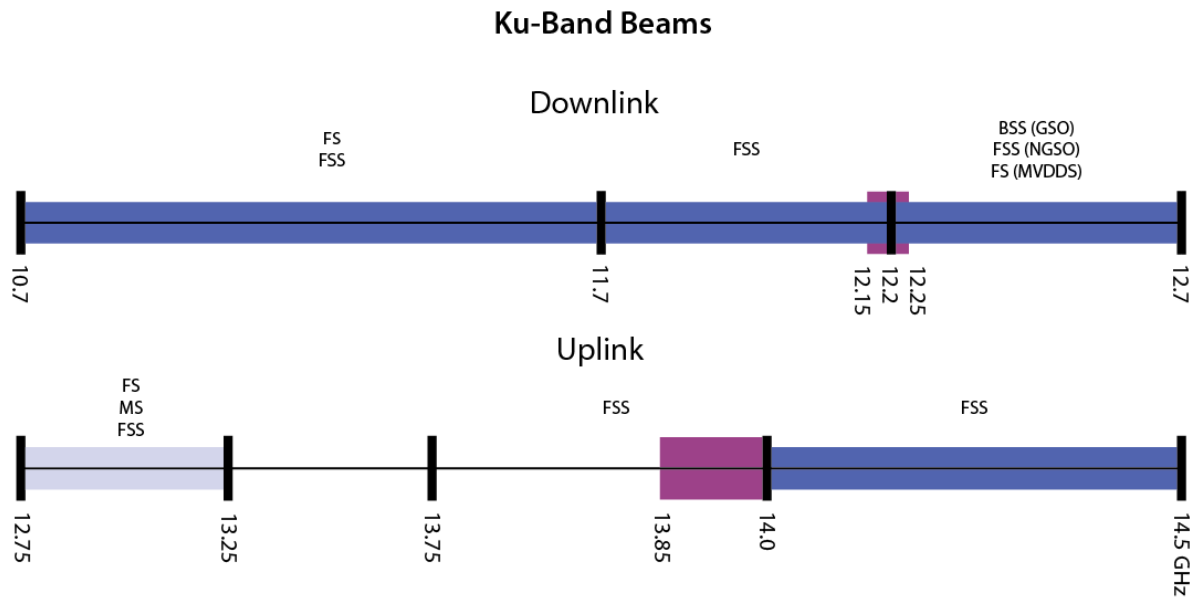
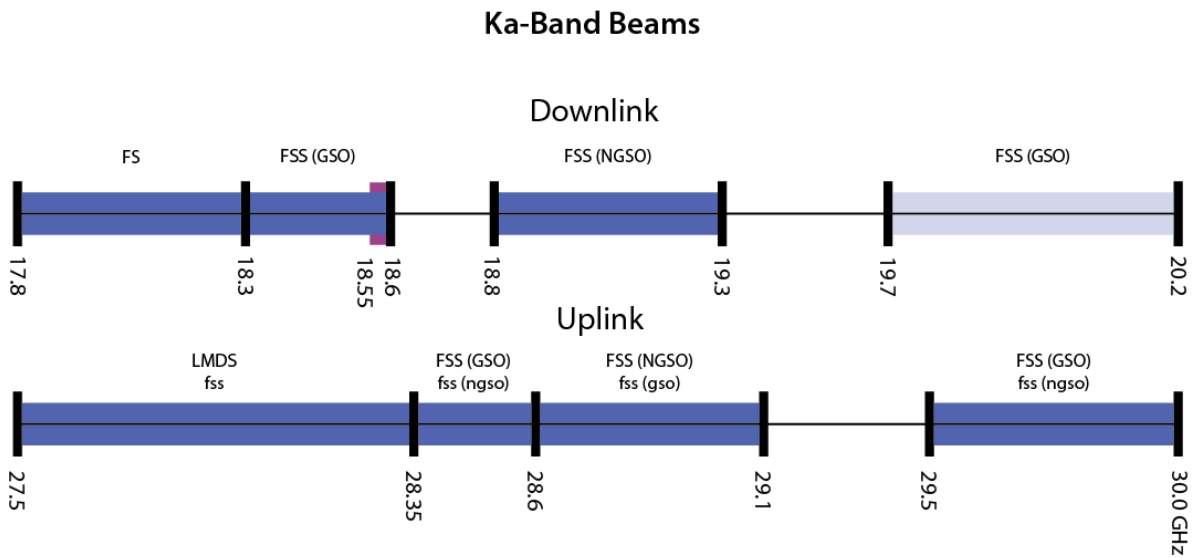
The system is designed to provide a wide range of broadband and communications services for residential, commercial, institutional, governmental and professional users worldwide. Advanced phased array beam-forming and digital processing technologies within the satellite payload give the system the ability to make highly efficient use of Ku- and Ka-band spectrum resources and the flexibility to share that spectrum with other licensed users. User terminals operating with the SpaceX System will use similar phased array technologies to allow for highly directive, steered antenna beams that track the system's low-Earth orbit satellites. Gateway earth stations also apply advanced phased array technologies to generate high-gain steered beams to communicate with multiple NGSO satellites from a single gateway site. The system will also employ optical inter-satellite links for seamless network management and continuity of service, which will also aid in complying with emissions constraints designed to facilitate spectrum sharing with other systems.

The frequency ranges used by the SpaceX System are summarized in Table A.2-1 below. Figure A.2-1 depicts the spectrum used for gateway and user beams and for telemetry, tracking, and control ("TT&C") operations, along with an indication of the U.S. frequency allocations and designations that exist in these bands. The detailed channelized frequency plan is provided in the associated Schedule S.

<b><u>Type of Link and Transmission Direction</u></b>	<b><u>Frequency Ranges</u></b>
User Downlink Satellite-to-User Terminal	10.7 – 12.7 GHz
Gateway Downlink Satellite to Gateway	17.8 – 18.6 GHz 18.8 – 19.3 GHz
User Uplink User Terminal to Satellite	14.0 – 14.5 GHz
Gateway Uplink Gateway to Satellite	27.5 – 29.1 GHz 29.5 – 30.0 GHz
TT&C Downlink	12.15 – 12.25 GHz 18.55 – 18.60 GHz
TT&C Uplink	13.85 – 14.00 GHz

**Table A.2-1: Frequency Bands Used by the SpaceX System**

**Figure A.2-1—Frequency Plans and FCC Spectrum Allocations**



Key:	
FS – Terrestrial Fixed Service	SpaceX Communications Frequencies
FSS – Fixed Satellite Service	SpaceX TT&C Frequencies
FSS (GSO) – Geostationary Orbit Fixed Satellite Service	Additional SpaceX Frequencies
FSS (NGSO) – Non-Geostationary Orbit Fixed Satellite Service	
LMDS – Local Multipoint Distribution Service	
MS – Mobile Service	
MVDDS – Multichannel Video and Data Delivery Service	

SpaceX recognizes that not all of the frequencies that it proposes to use are designated in the United States for use by NGSO FSS systems on a primary basis. As discussed below, SpaceX believes that its system can operate without causing harmful interference to or requiring protection from any other service duly licensed in these bands with higher priority.<sup>2</sup>

### **A.3 PREDICTED SPACE STATION ANTENNA GAIN CONTOURS**

All satellites in the SpaceX System have been designed with the same transmit and receive antenna beams. The antenna gain contours for the transmit and receive beams for a representative space station are embedded in the associated Schedule S, as required by Section 25.114(c)(4)(vi)(B). The contours for all transmit and receive beams are essentially the same for satellites operating in all planes and altitudes. Below we describe the methodology for their presentation in the associated Schedule S.

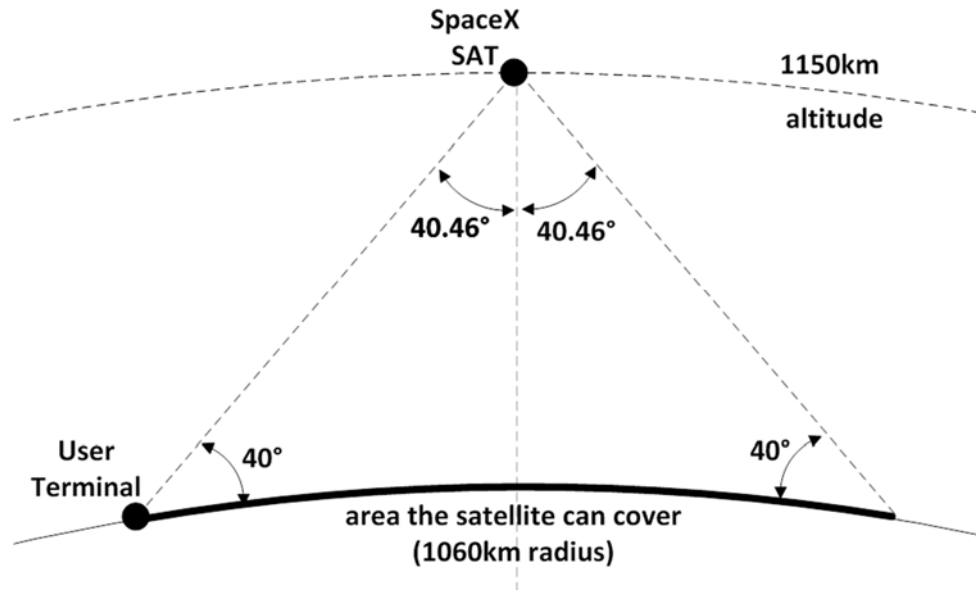
#### **A.3.1 Ku-Band User Beams**

All Ku-band downlink spot beams on each SpaceX satellite are independently steerable over the full field of view of the Earth. However, user terminals at the customers' premises communicate only with satellites at an elevation angle of at least 40 degrees. Consequently, as shown in Figure A.3.1-1 below, each satellite operating at an altitude of 1,150 km will provide service only up to 40.46 degrees away from boresight (nadir), covering an area of about 3.5 million square kilometers (1,060 km radius).<sup>3</sup>

---

<sup>2</sup> Where appropriate, SpaceX has requested waivers for non-conforming use of spectrum.

<sup>3</sup> While the 40 degree minimum elevation angle remains the same from the earth station point of view, the maximum angle from boresight at which service can be provided from the satellite changes slightly depending upon altitude. Thus, satellites operating at 1,110 km, 1,130 km, 1,275 km, and 1,325 km altitude can provide service up to 40.72, 40.59, 39.67, and 39.36 degrees away from boresight, respectively.



**Figure A.3.1-1: Steerable Service Range of Ku-band Beams (1,150 km)**

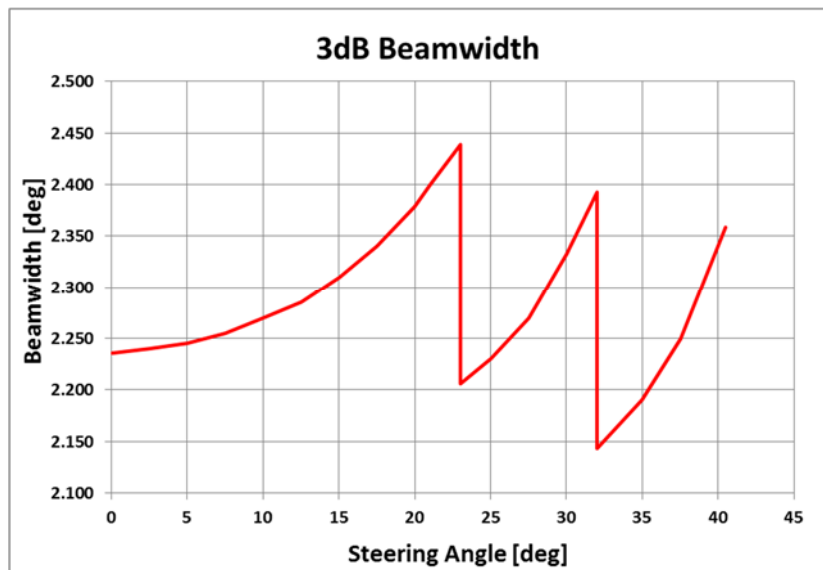
Generally, beams from antennas using phased arrays widen incrementally as they are steered away from boresight.<sup>4</sup> However, this widening occurs only in the plane formed by boresight and the center of the beam (“elevation”), and not in the plane normal to that plane formed by boresight and the center of the beam (“azimuth”). As a result, the shape of a phased array beam at boresight is circular but becomes increasingly elliptical when steered away from boresight.

This beam widening behavior with phased array antennas creates several effects that must be offset in order to achieve efficient use of spectrum through frequency re-use. As the beam widens, the size of the spot on the ground increases due to the increased distance to the Earth’s surface, and the curvature of the Earth enhances this effect. For transmitting antennas, this results in transmission of radiofrequency energy over a wider area, which increases both the potential to interfere with other systems and the potential for interference with other beams of the SpaceX System using the same frequencies. Conversely, for receiving antennas, this results in

<sup>4</sup> For this purpose, we use “boresight” to refer to the direction normal to the phased array plane.

reception of radiofrequency energy from a wider area, which increases both the susceptibility to interference from other systems and the potential for self-interference from user terminal uplink transmissions.

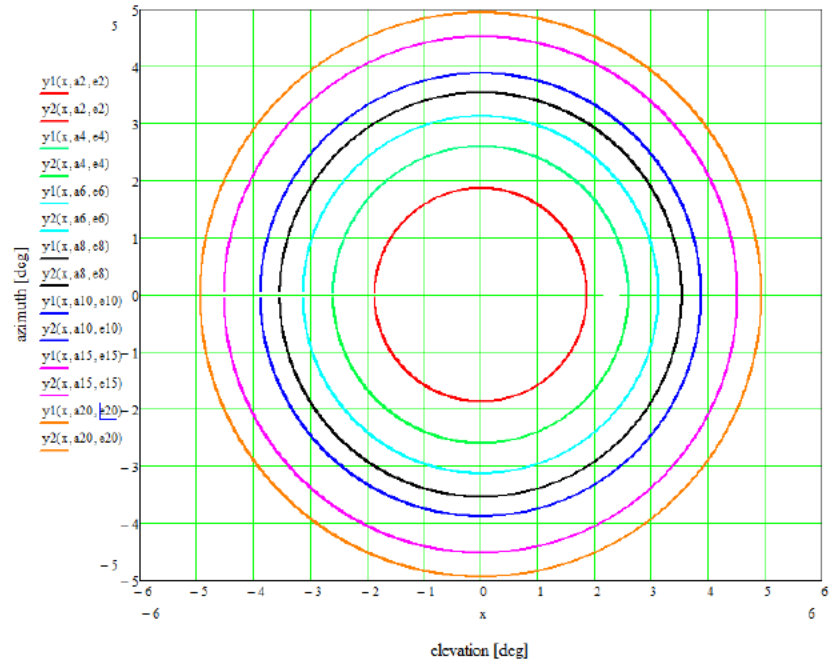
The SpaceX System offsets these beamwidth variations by switching antenna elements in the phased array on and off at certain steering angles. By ensuring that radio energy is transmitted in the desired direction, this switching helps to mitigate interference with other systems. Specifically, as shown in Figure A.3.1-2 below, additional elements are turned on when the angle reaches 23 degrees, and then again when it reaches 32 degrees. (Note this applies for both transmit and receive antennas on each satellite.)



**Figure A.3.1-2: Beamwidth Variation at Various Steering Angles**

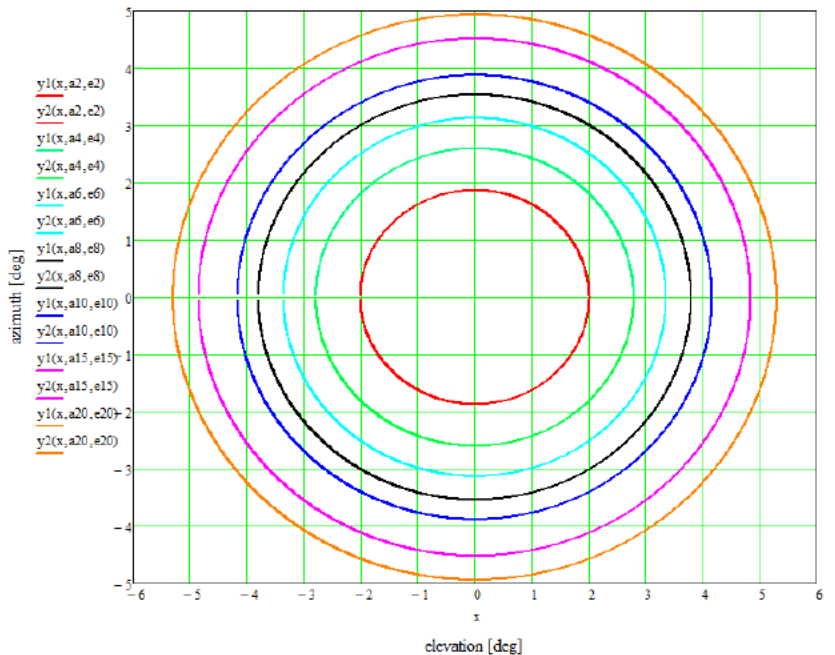
The following figures illustrate this dynamic by plotting antenna gain contours (for both uplink and downlink beams) at key steering angles, in each case at a roll off of -2 dB, -4 dB, -6 dB, -8 dB, -10 dB, -15 dB, and -20 dB.

Figure A.3.1-3 shows the antenna gain contour with the beam pointed to nadir (boresight, or zero steering angle).



**Figure A.3.1-3: Beam Contour at Nadir**

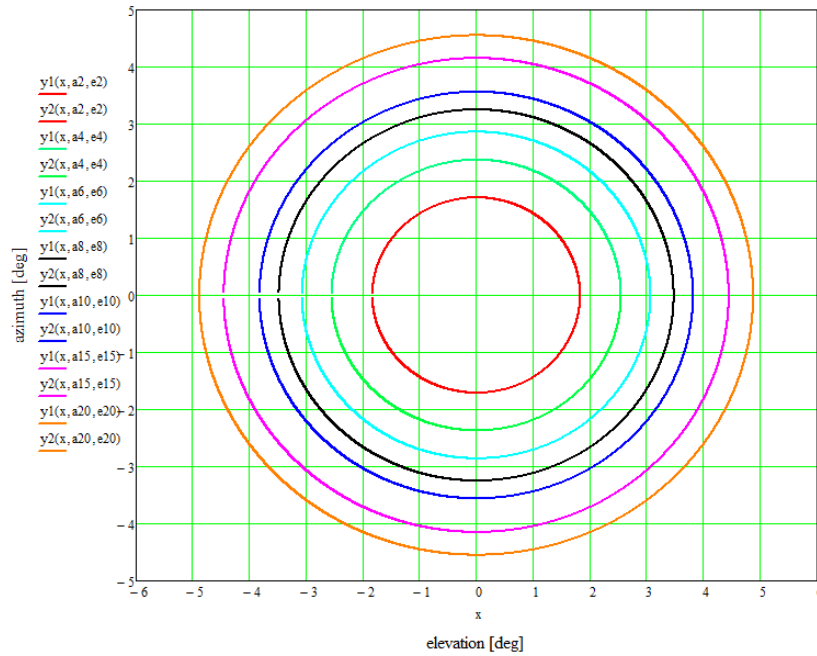
Figure A.3.1-4 shows a plot for the same beam when it is steered to 23 degrees away from nadir, just before additional elements are engaged.



**Figure A.3.1-4: Beam Contour at 23 Degrees Elevation Before Additional Elements Turned ON**

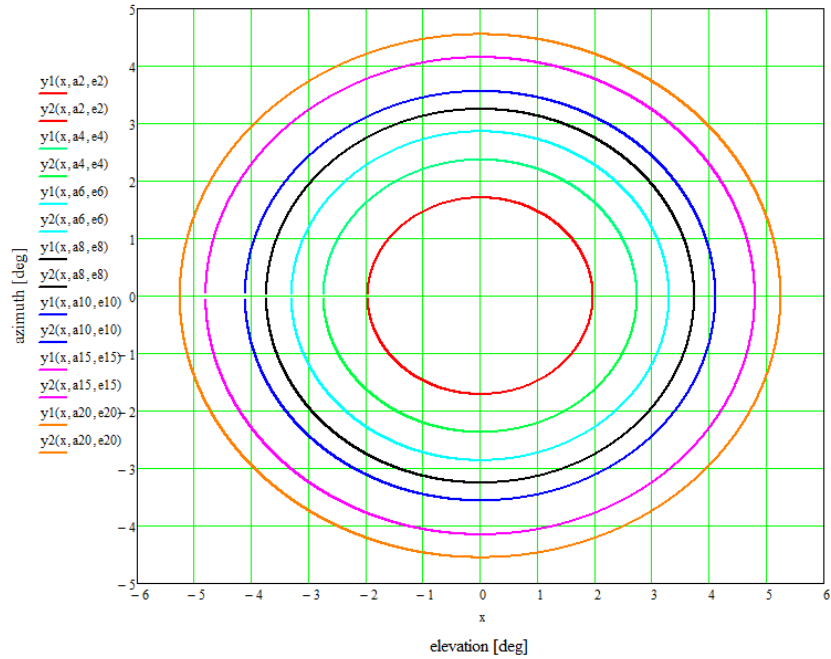


Figure A.3.1-5 shows the same plot, but after additional elements of the phased array antenna have been turned on to reduce beamwidth.

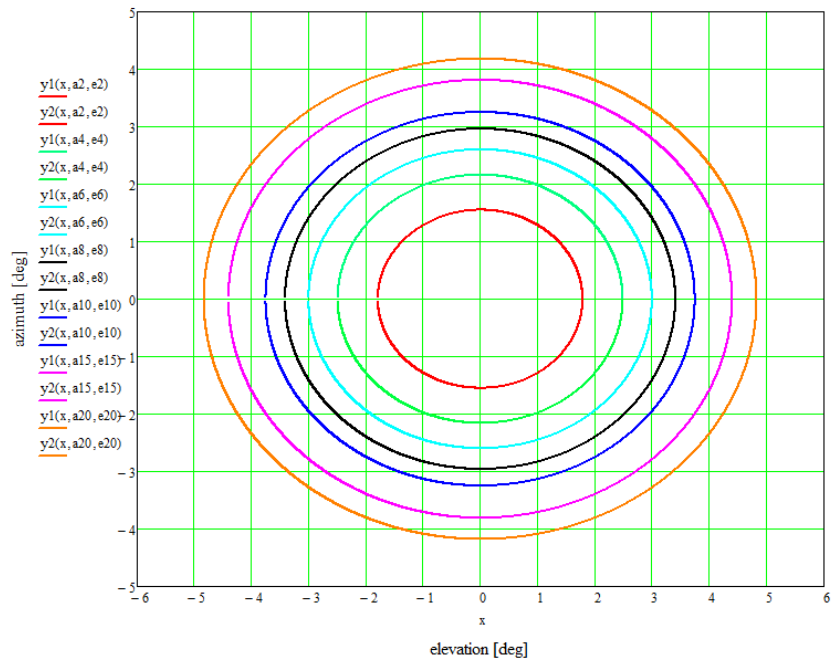


**Figure A.3.1-5: Beam Contour at 23 Degrees Elevation After Additional Elements Turned ON**

Similarly, Figures A.3.1-6 and A.3.1-7 below show the same beam when it has been steered to 32 degrees, first without the additional elements turned on and then with them turned on to reduce beamwidth.

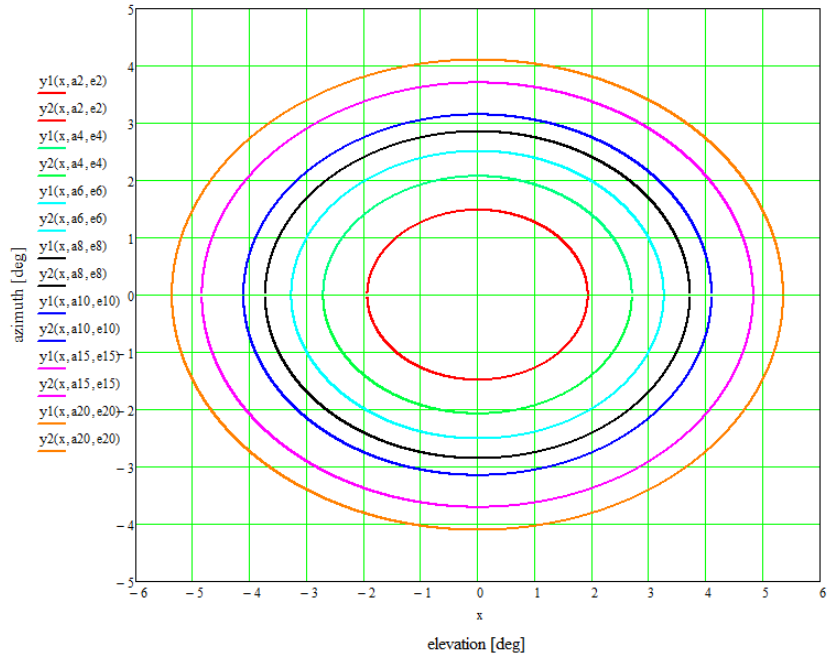


**Figure A.3.1-6: Beam Contour at 32 Degrees Elevation Before Additional Elements Turned ON**



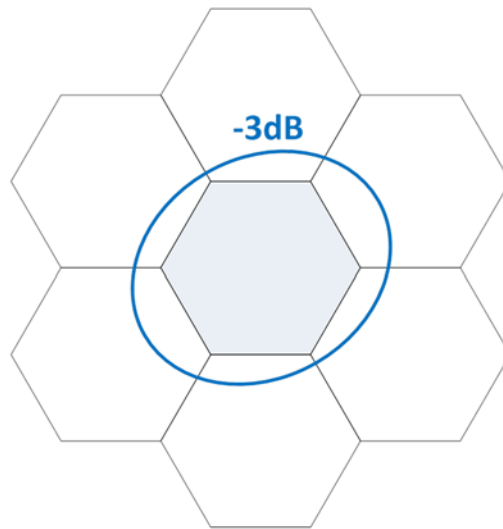
**Figure A.3.1-7: Beam Contour at 32 Degrees Elevation After Additional Elements Turned ON**

Finally, Figure A.3.1.8 below shows the antenna gain contour when the beam is steered to its maximum angle of 40.46 degrees, where it has the greatest beamwidth.



**Figure A.3.1-8: Beam Contour at 40.46 Degrees Elevation**

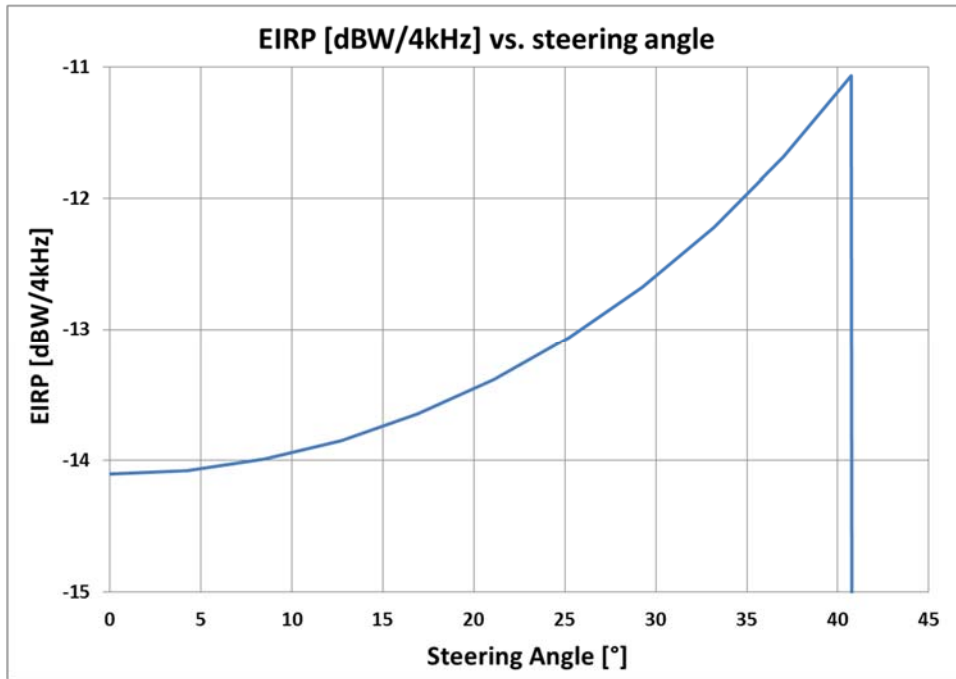
The intended coverage area for each beam is a cell inside the -3 dB contour, as illustrated in figure A.3.1-9 below. At a given frequency, only a single beam (with right hand circular polarization (“RHCP”) on the downlink<sup>5</sup>) would cover a single cell on the ground.



**Figure A.3.1-9: Intended Beam Coverage Area**

<sup>5</sup> The user terminal Ku-band uplinks operate with left hand circular polarization (“LHCP”).

As illustrated in Figure A.3.1-10 below, as the transmitting beam is steered, the power is adjusted to maintain a constant power flux-density (“PFD”) at the surface of the Earth, compensating for variations in antenna gain and path loss associated with the steering angle. The highest equivalent isotropically radiated power (“EIRP”) density (-11.07 dBW/4kHz) occurs at maximum slant.<sup>6</sup>



**Figure A.3.1-10: EIRP Density Variation by Beam Steering Angle**

For receiving beams, the antenna gain drops slightly as the beam slants away from nadir. As a result, the maximum G/T (9.8 dB/K) occurs at nadir, while the minimum G/T (8.7 dB/K) occurs at maximum slant.<sup>7</sup>

<sup>6</sup> This maximum EIRP level occurs at maximum slant for beams in the 10.7-12.2 GHz band at latitudes below  $\pm 55^\circ$ . At higher latitudes, the maximum EIRP in this band is -13.07 dBW/4kHz. In the 12.2-12.7 GHz band, the maximum EIRP is -12.57 dBW/4kHz and -16.07 dBW/4kHz for latitudes below and above  $\pm 55^\circ$ , respectively. Because the 10.7-12.2 GHz band at latitudes below  $\pm 55^\circ$  provides a worst case, Figure A.3.1-10 relates to that scenario.

<sup>7</sup> Section 25.114(c)(4)(v) requires both the minimum and maximum saturation flux density (“SFD”) values for each space station receive antenna that is connected to transponders. The concept of SFD only applies to “bent pipe” satellite systems, and thus is not relevant to the SpaceX System. However, because the Schedule S software requires a numerical entry for SFD (which must be different for maximum and minimum), SpaceX has

### **A.3.2 Ka-Band Gateway Beams**

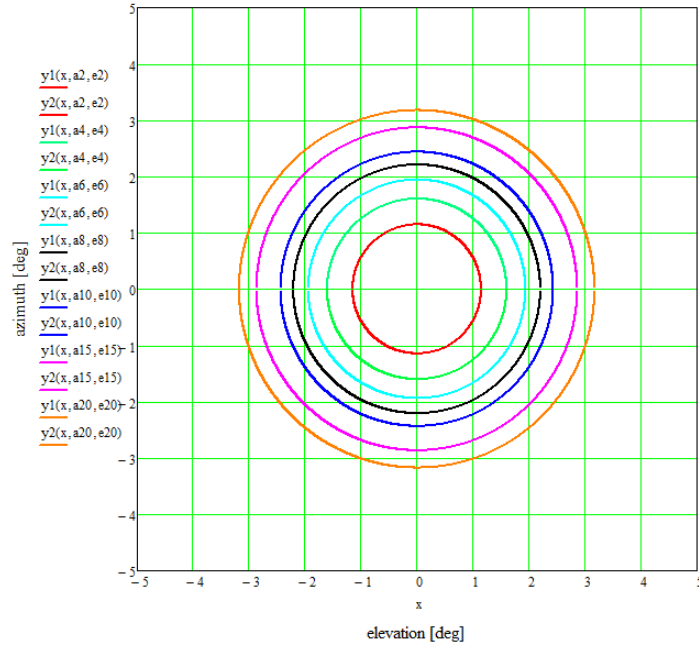
As with the Ku-band user beams discussed above, all Ka-band gateway downlink spot beams on SpaceX satellites are independently steerable over the full field of view of the Earth. As with user terminals, gateways communicate only with satellites at an elevation angle of at least 40 degrees. Consequently, as discussed above, each satellite can be supported by gateways located only up to a certain limit away from boresight (nadir), which varies slightly by operating altitude. Each satellite transmits two beams at the same frequency (with right hand and left hand circular polarization (“RHCP and LHCP”)). Up to four satellites can beam transmissions to the gateway location, for a maximum of eight co-frequency beams.

As with Ku-band user beams, the shape of the Ka-band gateway beam becomes elliptical as it is steered away from the boresight as a consequence of the phased array technology employed. It widens in the elevation plane, but not the azimuth plane. However, unlike the Ku-band user beams, SpaceX does not adjust the elements of the Ka-band phased array gateway antenna in order to limit beamwidth variation. While each Ku-band user beam is designed to cover a number of users within a cell, each Ka-band beam is used to communicate with a single gateway at a time, and is optimized to be as close to beam-center-to-beam-center as possible with that link, using a beam as narrow as practical.

Figure A.3.2-1 shows the antenna gain contour (for both uplink and downlink gateway beams) with the beam pointed to nadir (boresight, or zero steering angle).

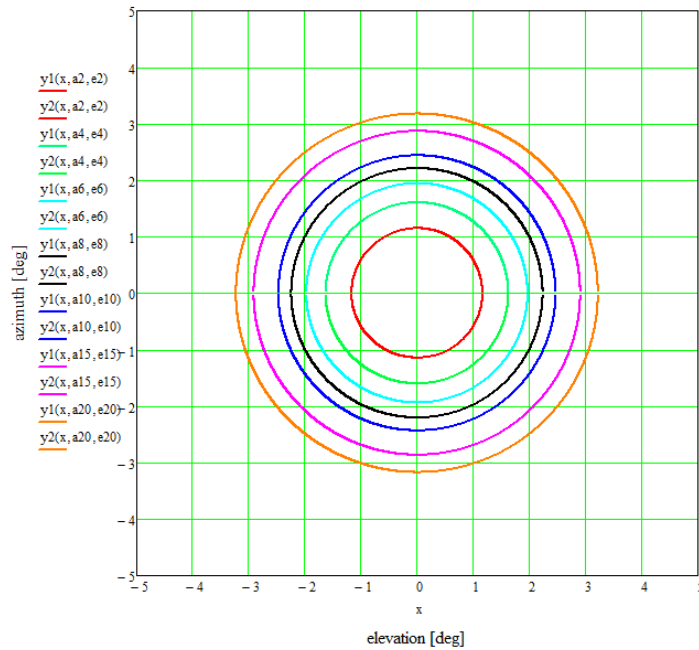
---

entered values of “0” and “-0.1.”

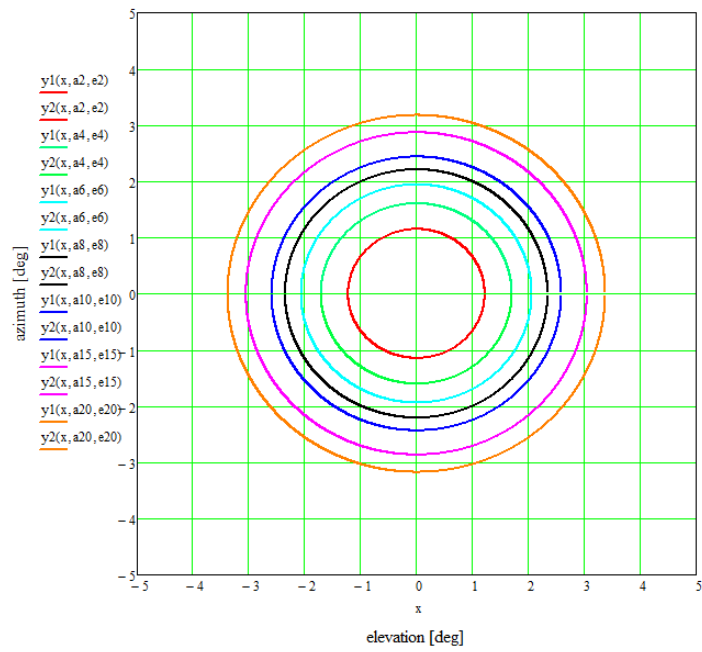


**Figure A.3.2-1: Beam Contour at Nadir**

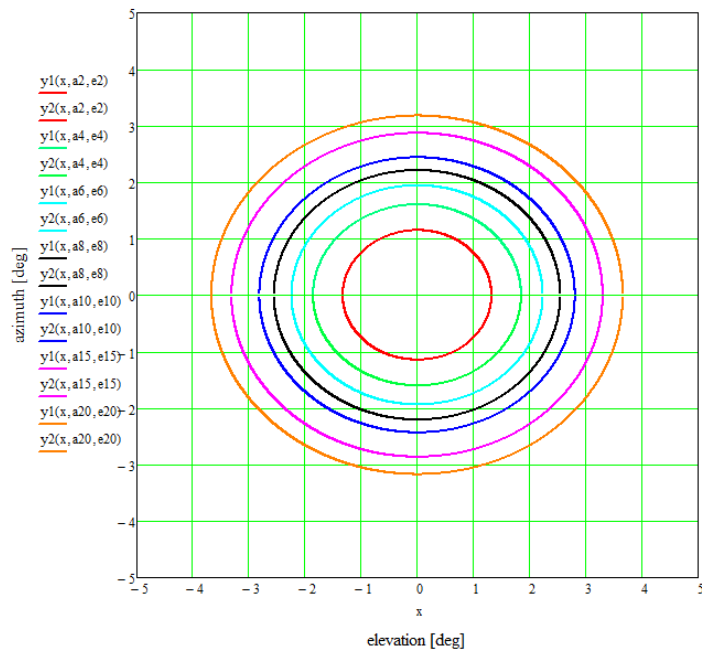
Figures A.3.2-2 through A.3.2-5 likewise show plots for the same gateway beam when it is steered to 10, 20, 30, and 40.46 degrees away from nadir. As these figures show, the beam becomes increasingly elliptical as the angle increases.



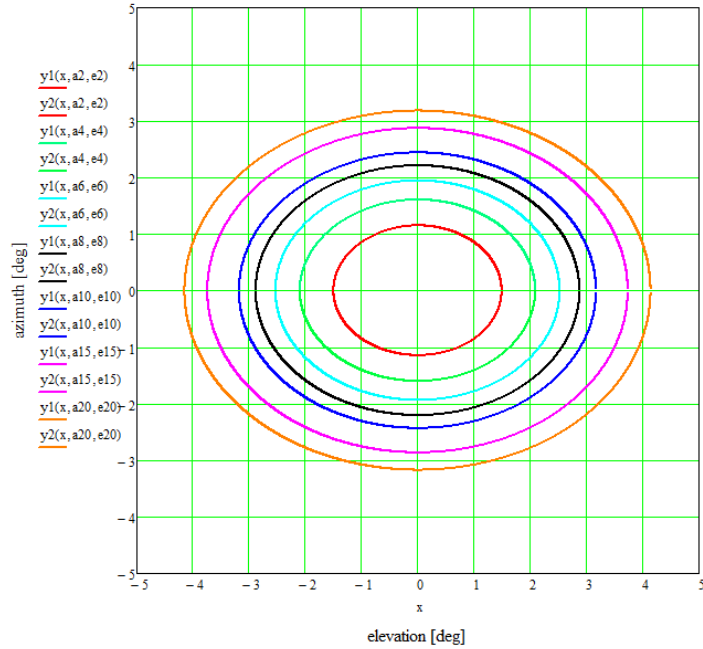
**Figure A.3.2-2: Beam Contour at 10 Degrees Elevation**



**Figure A.3.2-3: Beam Contour at 20 Degrees Elevation**

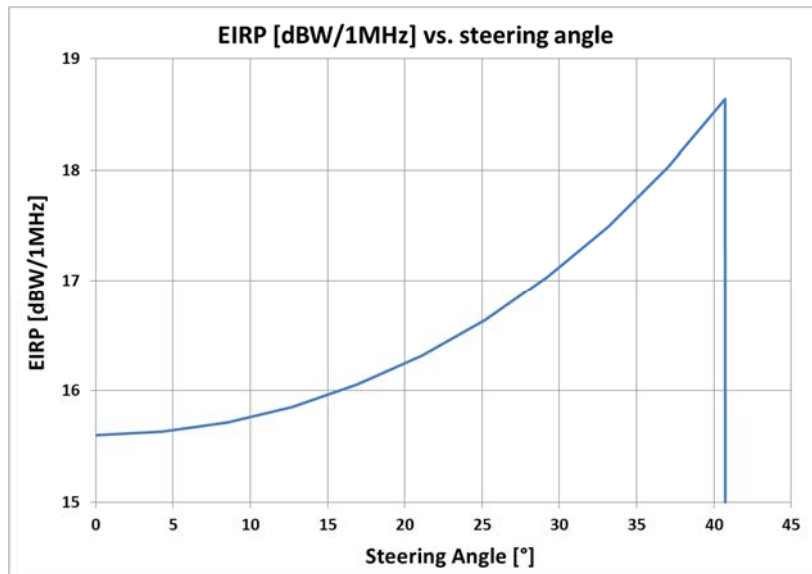


**Figure A.3.2-4: Beam Contour at 30 Degrees Elevation**



**Figure A.3.2-5: Beam Contour at 40.46 Degrees Elevation**

As with the Ku-band beams, as the transmitting beam is steered, the power (in both polarizations) is adjusted to maintain a constant PFD at the surface of the Earth, compensating for variations in antenna gain and path loss associated with the steering angle. As illustrated in Figure A.3.2-6 below, the highest EIRP density (18.64 dBW/1MHz) occurs at maximum slant.



**Figure A.3.2-6: EIRP Density Variation by Beam Steering Angle**



For receiving beams, the antenna gain drops slightly as the beam slants away from nadir. As a result, the maximum G/T (13.7 dB/K) occurs at nadir, while the minimum G/T (11.4 dB/K) occurs at maximum slant.

### **A.3.3 Ku-Band and Ka-Band TT&C Beams**

The SpaceX System's TT&C subsystem has omni-directional antennas on each satellite that are designed to be able to communicate with earth stations at virtually any attitude (95% lowest of the 4 pi steradian antenna-gain sphere). The maximum transmit EIRP density, maximum and minimum G/T for receiving beams, and diagrams of the antenna gain contours are provided with the associated Schedule S.<sup>8</sup> Communication to and from the TT&C earth stations will be restricted to an elevation above the local horizon of at least five degrees.<sup>9</sup>

### **A.4 GEOGRAPHIC COVERAGE**

At Final Deployment, the SpaceX System will meet the Commission's geographic coverage requirements set forth in Section 25.145(c) for Ka-band and Section 25.146(i) for Ku-band operations.<sup>10</sup> They are essentially the same for both frequency bands, and require the applicant to demonstrate that:

- (1) the proposed system is capable of providing Fixed-Satellite Service on a continuous basis throughout the fifty states, Puerto Rico and the U.S. Virgin Islands; and
- (2) the proposed system is capable of providing Fixed-Satellite Services to all locations as far north as 70° North Latitude and as far south as 55° South Latitude for at least 75 percent of every 24-hour period.

---

<sup>8</sup> The one exception is the maximum transmit EIRP density for the Ku-band TT&C downlink beams, which is -6.67 dBW. However, Schedule S requires that the maximum transmit EIRP value for a beam be greater than 0 dBW. In order to accommodate this limitation, SpaceX has entered a value of "0" in Schedule S with respect to this parameter.

<sup>9</sup> See 47 C.F.R. § 25.205(a) (establishing presumption that earth station antennas normally will not be authorized for transmissions at elevation angles less than five degrees).

<sup>10</sup> To the extent necessary, SpaceX has requested a waiver of these requirements with respect to the Initial Deployment.

Because the Ku-band user links and Ka-band gateway links are conceptually distinct for purposes of this analysis, we discuss them separately below.

### **Ku-Band Geographic Coverage**

As discussed above, SpaceX intends to begin providing commercial broadband service in the U.S. and internationally after launching 800 satellites of the Initial Deployment. With those satellites, SpaceX could provide service in the areas between approximately 60° North Latitude and 15° North Latitude and between 15° South Latitude and 60° South Latitude. This would be sufficient to cover the contiguous United States (“CONUS”), Hawaii, Puerto Rico, and the U.S. Virgin Islands, but would not cover the region near the equator or areas at more extreme latitudes (including portions of Alaska). Once the Initial Deployment has been completed, the system will provide continuous FSS service from approximately 60° North Latitude to 60° South Latitude. This is sufficient to cover CONUS, Hawaii, Puerto Rico, and the U.S. Virgin Islands, as well as the southernmost areas required by the rule. However, the system will not yet provide continuous coverage to the northernmost areas required by the rule (including portions of Alaska) until service from one of the more inclined orbital constellations is launched.

Once fully deployed, the SpaceX System will pass over virtually all parts of the Earth’s surface and therefore, in principle, have the ability to provide ubiquitous global service. Because of the combination of orbital planes used in the SpaceX System, including the use of near-polar orbits, every point on the Earth’s surface will see, at all times, a SpaceX satellite at an elevation no less than 40 degrees, with increasing minimum elevation angles at lower latitude. This will satisfy the Commission’s geographic coverage requirements.

## **Ka-Band Geographic Coverage**

The gateway earth stations of the SpaceX System provide the necessary communications links back from the SpaceX satellites to the global Internet. SpaceX intends to install sufficient gateway sites in the U.S. and around the world to ensure that the SpaceX satellites have a visible gateway earth station with which they can communicate from all parts of their orbits. The actual number of gateways will scale with user demand and system deployment. For example, SpaceX estimates that it will deploy approximately 200 gateways in the United States to support the Initial Deployment. At Final Deployment, the SpaceX Ka-band gateway links will be sufficient to serve SpaceX satellites at all latitudes, which meets the requirements of Section 25.145(c)(1) and (2) as far as these rules can be applied to such types of links.

### **A.5 TT&C CHARACTERISTICS**

The SpaceX TT&C subsystem provides for communications with the spacecraft during pre-launch, transfer orbit, and on-station operations, as well as during spacecraft emergencies.<sup>11</sup>

During all phases of the mission, this subsystem uses the following frequencies:

- For space-to-Earth: 12.15-12.25 GHz and 18.55-18.6 GHz.<sup>12</sup>
- For Earth-to-space: 13.85-14.0 GHz.<sup>13</sup>

TT&C operations will cause no more interference and require no greater protection than the ordinary communications traffic in those bands. This ensures compliance with the requirements

---

<sup>11</sup> The information provided in this section complements that provided in the associated Schedule S submission.

<sup>12</sup> The 18.3-18.6 GHz band has been designated for primary use by GSO FSS systems. SpaceX has requested a waiver for operations on a non-conforming basis – *i.e.*, on a non-harmful interference, non-protected basis relative to any service allocated in the band.

<sup>13</sup> These frequencies are adjacent to the 14.0-14.5 GHz band used for uplinks from user terminals. To the extent necessary, SpaceX has requested a waiver for their use. In addition, SpaceX will not claim protection for its satellites from radiolocation transmitting stations operating in this band in accordance with the U.S. Table of Frequency Allocations. *See* 47 C.F.R. § 2.106, n. US356.

of Section 25.202(g). SpaceX will use a very limited number of TT&C ground station facilities located at various points around the world, with primary and back-up locations in the United States and several more locations distributed internationally.

#### **A.6 CESSATION OF EMISSIONS**

Each active satellite transmission chain (channel amplifiers and associated solid state power amplifier) can be individually turned on and off by ground telecommand, thereby causing cessation of emissions from the satellite, as required by Section 25.207 of the Commission's rules.

#### **A.7 COMPLIANCE WITH PFD LIMITS**

Both the Commission and the ITU have established limits on the PFD of satellite downlink transmissions at the surface of the Earth. The application of these limits to the SpaceX System is discussed below.

##### ***Downlink PFD Limits for User Links in Ku-band***

The Ku-band downlink user beams on each SpaceX satellite are designed to transmit only for angles of arrival between 40 degrees and 90 degrees above the horizontal plane (*i.e.*, to be received by customer earth stations at an elevation angle of 40 degrees or more). In addition, the system adjusts the transmit power between slant and nadir depending on the angle of arrival to keep the PFD at the surface of the Earth constant. This accounts for variations in antenna gain with the steering angle and beam shaping and in dispersion loss when the angle of arrival changes. Table A.7-1 below shows the PFD calculations for the SpaceX System at the surface of the Earth, both at the maximum slant of 40 degree angle of arrival and at the nadir of 90 degree angle of arrival. For this purpose, we have used the satellites operating at the lowest planned altitude of 1,110 km in the 10.7-12.2 GHz band serving latitudes up to  $\pm 55^\circ$ , which presents a

worst case, maximum PFD scenario, as satellites operating at higher altitudes, higher latitudes, and higher Ku-band frequencies will produce lower PFD.

	at slant	at nadir
EIRP density [dBW/Hz]	-47.09	-50.13
EIRP in 4kHz [dBW/4kHz]	-11.07	-14.11
EIRP in 1MHz [dBW/MHz]	12.91	9.87
Distance to Earth [km]	1574.58	1110.00
Spreading loss [dB]	-134.94	-131.90
PFD in 4 kHz [dB(W/m <sup>2</sup> /4kHz)]	-146.00	-146.00
PFD in 1 MHz [dB(W/m <sup>2</sup> /1MHz)]	-122.02	-122.02

**Table A.7-1. PFD at the Surface of the Earth Produced by Ku-band Downlink User Transmissions (1,110 km)**

In addition, because the satellite downlink transmit power is adjustable on orbit, SpaceX has the ability to manage the satellites’ PFD levels during all phases of the mission, as needed. Further, inter-satellite links enable the management of traffic on-orbit to ensure that communications are not interrupted during any of the interference mitigation techniques discussed herein.

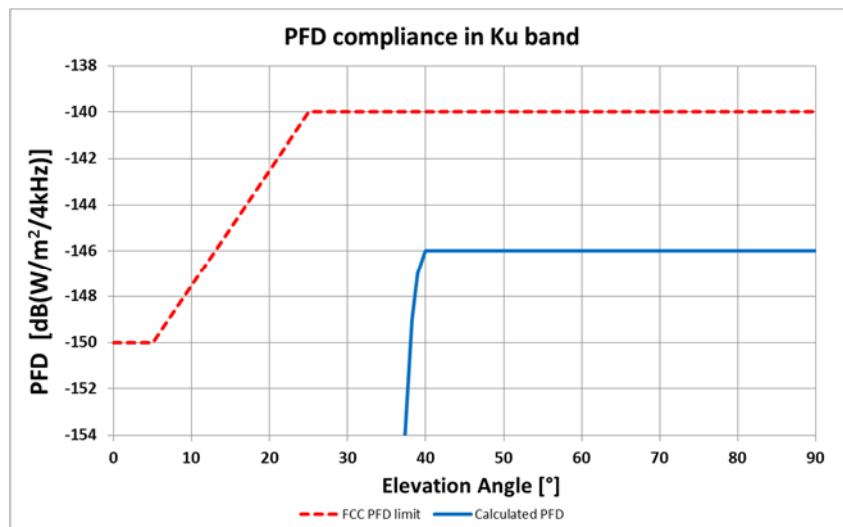
The Commission has adopted different downlink PFD limits for different portions of the Ku-band spectrum used by the SpaceX System. The first set of limits, which applies across the 10.7-11.7 GHz band, is set forth in Section 25.208(b) as follows:

- -150 dB(W/m<sup>2</sup>) in any 4 kHz band for angles of arrival between 0 and 5 degrees above the horizontal plane;
- $-150+(\delta-5)/2$  dB(W/m<sup>2</sup>) in any 4 kHz band for angles of arrival  $\delta$  (in degrees) between 5 and 25 degrees above the horizontal plane; and
- -140 dB(W/m<sup>2</sup>) in any 4 kHz band for angles of arrival between 25 and 90 degrees above the horizontal plane.

The ITU PFD limits applicable to NGSO systems operating in the 10.7-11.7 GHz band, which are provided in Table 21-4 of the ITU Radio Regulations, are effectively the same as the

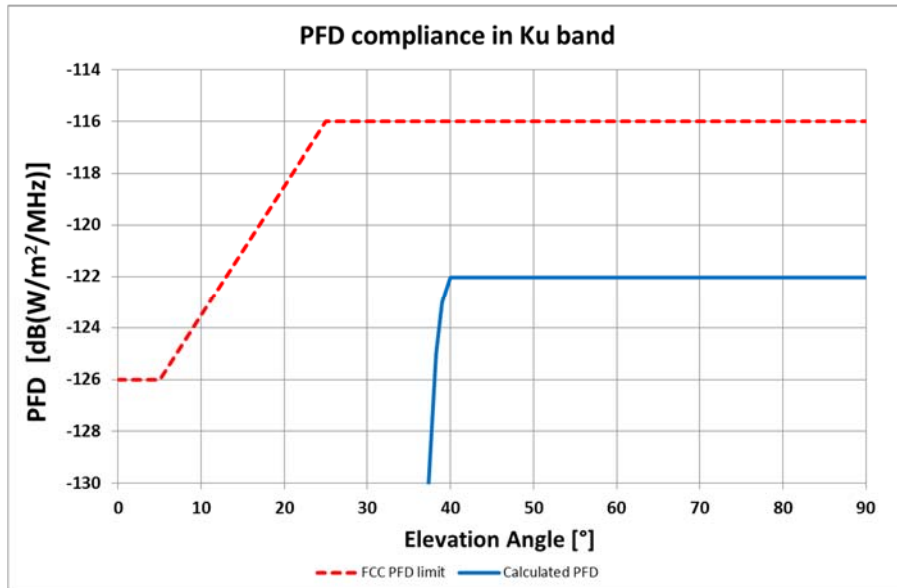
Commission's PFD limits mentioned above, though stated in a different bandwidth.<sup>14</sup>

The worst-case PFD values in Table A.7-1 are lower than the limits set forth above. For ease of reference, Figures A.7-1 and A.7-2 below plot the worst-case PFD of the SpaceX System in this band (*i.e.*, assuming satellites operating at 1,110 km in the 10.7-11.2 GHz band serving latitudes up to  $\pm 55^\circ$ ) against elevation angles in the 4 kHz bandwidth used by Section 25.208(b) and the 1 MHz bandwidth used by ITU Table 21-4, respectively.



**Figure A.7-1. SpaceX System Compliance with Downlink PFD Limits in Section 25.208(b)**

<sup>14</sup> Section 25.208(b) states the limits using both 4 kHz and 1 MHz as the reference bandwidth, while Table 21-4 uses only 1 MHz.



**Figure A.7-2. SpaceX System Compliance with Downlink PFD Limits in ITU Table 21-4**

Note that PFD is constant at any position between slant and nadir and satisfies the Commission and ITU limits.

The Commission’s rules do not include any PFD limits in the 11.7-12.2 GHz downlink frequency band. The ITU Radio Regulations do, however, include PFD limits across the 11.7-12.7 GHz band which are effectively 2 dB higher than the Commission’s PFD limits in the 10.7-11.7 GHz band.<sup>15</sup> Accordingly, given that the SpaceX System complies with the limits in Section 25.208(b), it will also comply with these ITU PFD limits across the entire 11.7-12.7 GHz band.

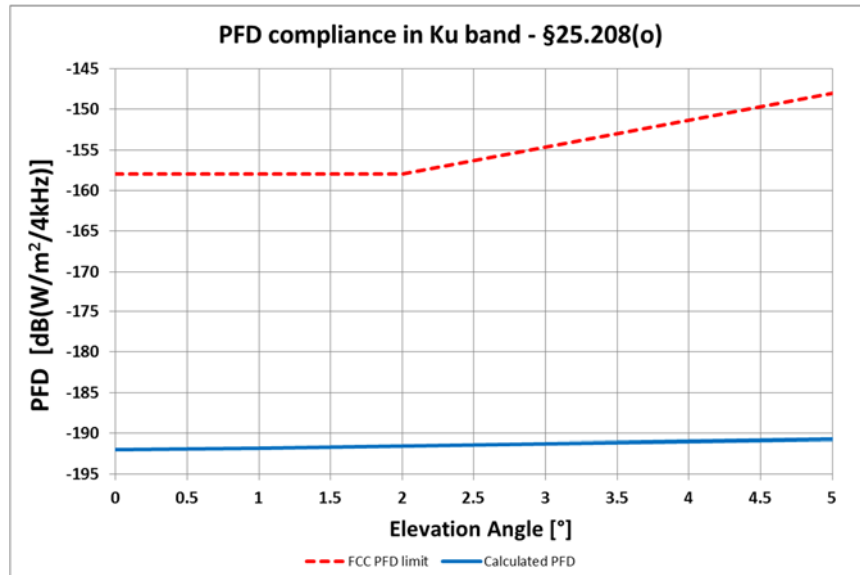
Section 25.208(o) of the Commission’s rules specifies low elevation PFD limits that apply in the 12.2-12.7 GHz band in order to protect the Multichannel Video and Data Distribution Service (“MVDDS”). These limits, which relate to the PFD into an actual operational MVDDS receiver, are defined as follows:

- -158 dB(W/m<sup>2</sup>) in any 4 kHz band for angles of arrival between 0 and 2 degrees above the horizontal plane;

<sup>15</sup> See ITU Radio Regs., Table 21-4.

- $-158+3.33(\delta-2)$  dB(W/m<sup>2</sup>) in any 4 kHz band for angles of arrival  $\delta$  (in degrees) between 2 and 5 degrees above the horizontal plane.

Figure A.7-3 below shows that the SpaceX System will comply with these low elevation PFD limits as well.



**Figure A.7-3. SpaceX System Compliance with Downlink PFD Limits in Section 25.208(o)**

Therefore, all the Ku-band downlink user transmissions from the SpaceX satellites comply with all Commission and ITU PFD limits.

#### ***Downlink PFD Limits for TT&C Links in Ku-band***

In the Ku-band, SpaceX will operate TT&C downlinks in the 12.15-12.25 GHz band. This same spectrum is also used for downlinks to provide service to users. SpaceX will coordinate its internal operations such that the user links make opportunistic use of these frequencies when not needed for TT&C. Moreover, the maximum EIRP for the TT&C links is always below the minimum EIRP radiated in any direction by the user links. As a result, the PFD created when TT&C links in this band are active falls significantly below the PFD created due to user links in all cases. Because, as demonstrated above, the Ku-band user links comply with the applicable PFD limits, the TT&C downlinks necessarily will do so as well.



SpaceX recognizes that 50 MHz of the Ku-band spectrum used for TT&C is shared in the U.S. with MVDDS. Even though SpaceX may operate its TT&C stations at elevation angles as low as five degrees, this should not adversely affect MVDDS operations. First, SpaceX plans to deploy only two TT&C earth stations in the U.S. – one on the East coast and one on the West coast. Areas outside the immediate vicinity of these facilities would be unaffected by their operations. Second, as demonstrated above, the SpaceX System will comply with the PFD limits in Section 25.208(o), which were adopted to protect MVDDS operations even for transmissions at elevation angles below five degrees. Accordingly, SpaceX's TT&C operations in this band should prompt no concerns.

***Downlink PFD Limits for Gateway Links in Ka-band***

As in the Ku-band, the Ka-band gateway downlink transmitters on each SpaceX satellite are designed to transmit only for angles of arrival between 40 degrees and 90 degrees above the horizontal plane (*i.e.*, to be received by gateway earth stations at an elevation angle of 40 degrees or more), and the system adjusts the transmit power between slant and nadir depending on the angle of arrival to keep the PFD at the surface of the Earth constant. Table A.7-2 below shows the PFD calculations at the surface of the Earth, at both maximum slant (*i.e.*, 40 degree angle of arrival) and nadir (*i.e.*, 90 degree angle of arrival), for the SpaceX System across the portion of the 17.8-19.3 GHz band used by the SpaceX System. Note that the calculation includes both polarizations (LHCP and RHCP) and reflects satellites operating at 1,110 km in order to present a worst case (*i.e.*, maximum PFD) scenario, demonstrating that satellites operating at higher altitudes will comply of necessity.

	at slant	at nadir
EIRP density [dBW/Hz]	-41.36	-44.40
EIRP in 1MHz [dBW/MHz]	18.64	15.60
Distance to Earth [km]	1574.58	1110.00
Spreading loss [dB]	-134.94	-131.90
PFD in 1 MHz [dB(W/m <sup>2</sup> /1MHz)]	-116.30	-116.30

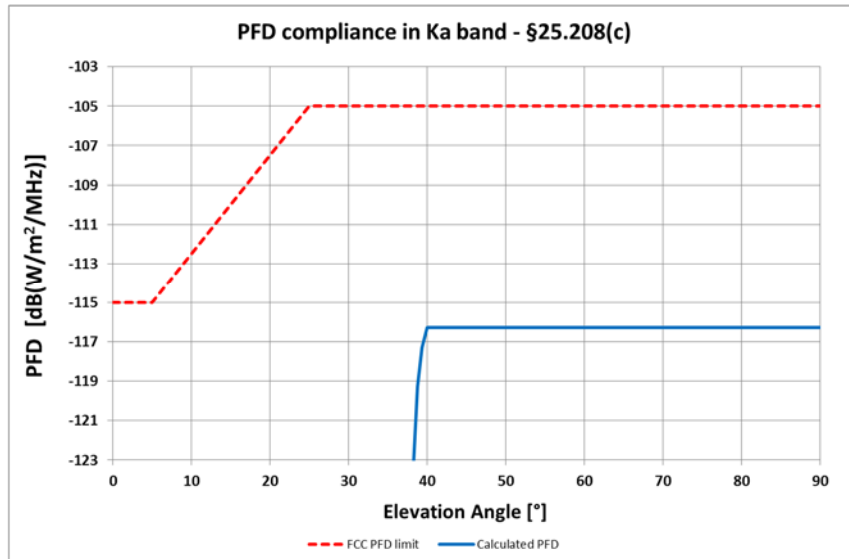
**Table A.7-2. PFD at the Surface of the Earth Produced by Ka-band Gateway Downlink Transmissions (1,110 km)**

In addition, because the transmit power is adjustable on orbit, SpaceX has the ability to manage the satellites' PFD levels during all phases of the mission, as needed.

The Commission has adopted different downlink PFD limits for different portions of the Ka-band spectrum used by the SpaceX System. The first set of limits, which applies across the 18.3-18.6 GHz band, is set forth in Section 25.208(c) as follows:

- -115 dB(W/m<sup>2</sup>) in any 1 MHz band for angles of arrival between 0 and 5 degrees above the horizontal plane;
- $-115+0.5(\delta-5)$  dB(W/m<sup>2</sup>) in any 1 MHz band for angles of arrival  $\delta$  (in degrees) between 5 and 25 degrees above the horizontal plane; and
- -140 dB(W/m<sup>2</sup>) in any 4 kHz band for angles of arrival between 25 and 90 degrees above the horizontal plane.

Figures A.7-4 below plots the PFD of the SpaceX System gateway transmissions against various elevation angles to demonstrate compliance with the limits in Section 25.208(c).



**Figure A.7-4. SpaceX Gateway Compliance with Downlink PFD Limits in Section 25.208(c)**

Note that PFD is constant at any position between slant and nadir and satisfies the Commission limits.

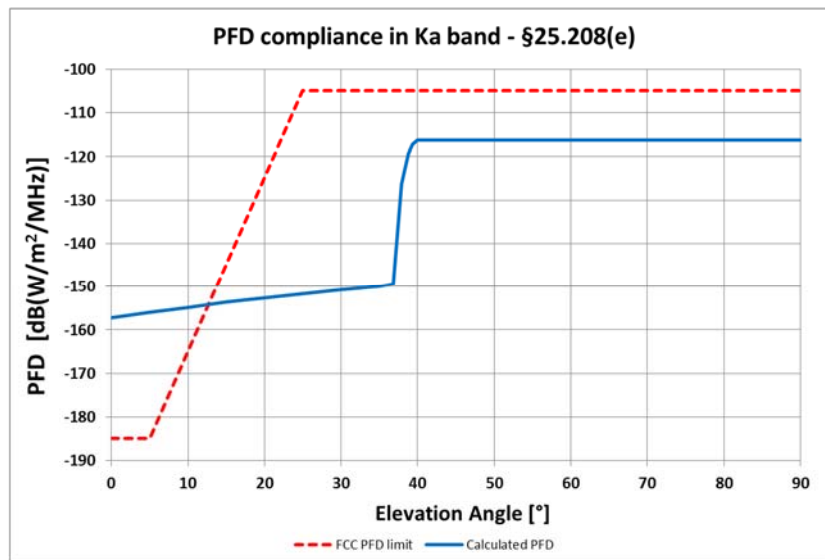
While the Commission has no PFD limits for the 17.8-18.3 GHz band, Section 25.208(e) establishes PFD limits for the 18.8-19.3 GHz band. By comparison, a single set of PFD limits in Article 21 of the ITU Radio Regulations applies to NGSO systems across the entire 17.7-19.3 GHz band, which encompasses the Ka-band downlink bands requested herein for the SpaceX System. The PFD limits in Section 25.208(e) are identical to these limits in Article 21 of the ITU Radio Regulations. In both cases, the methodology used to calculate interference is expressed purely as a function of the number of satellites in the NGSO system, without any consideration to whether the satellites are in view of the victim FS system or whether the satellites are turned on or off. This inclusion of all NGSO satellites in a constellation is a recognized flaw in this calculation, yielding limits in Section 25.208(e) and in Article 21 of the ITU Radio Regulations that are effectively more constraining than those in Section 25.208(c). These limits can be stated as follows:

- $-115-X \text{ dB(W/m}^2\text{)}$  in any 1 MHz band for angles of arrival between 0 and 5 degrees above the horizontal plane;
- $-115-X+((10+X)/20)(\delta-5) \text{ dB(W/m}^2\text{)}$  in any 1 MHz band for angles of arrival  $\delta$  (in degrees) between 5 and 25 degrees above the horizontal plane; and
- $-105 \text{ dB(W/m}^2\text{)}$  in any 1 MHz band for angles of arrival between 25 and 90 degrees above the horizontal plane.

Where X is defined as a function of the number of satellites in the NGSO FSS constellation, n, as follows:

- $X = 0 \text{ dB}$  for  $n \leq 50$
- $X = (5/119) (n - 50) \text{ dB}$  for  $50 < n \leq 288$
- $X = (1/69) (n + 402) \text{ dB}$  for  $n > 288$

For the SpaceX System, the value of “n” is 4,425 and therefore X is equal to 69.96 dB according to the above formulae. This results in the PFD mask shown in Figure A.7-5 below.



**Figure A.7-5. SpaceX Gateway Compliance with Downlink PFD Limits in Section 25.208(e) and ITU Table 21-4**

As shown in Figure A.7-5, the SpaceX System complies with the PFD limits specified by the Commission and the ITU at most elevation angles, with a margin of at least 10 dB. However, at

very low elevation angles – below about twelve degrees – the system appears (using the flawed calculation technique) to exceed the limit. The technique includes calculated interference from satellites not in view and does not account for satellites that may be turned off, because the methodology was not developed with capability to scale up for application to larger, dynamically controlled constellations. When taking such factors into account, SpaceX does not anticipate that its system would cause any actual interference to an FS system operating in this band.

The PFD limits in Article 21 were developed during a time when proposed NGSO systems featured far fewer satellites. The Article 21 PFD limits were developed in the study cycle prior to WRC-2000 and formalized in Recommendation SF.1483,<sup>16</sup> which the Commission imported directly into Section 25.208.<sup>17</sup> That recommendation makes clear that the scaling function (*i.e.*, the variable “X” in the PFD formula above for systems with more than 288 satellites) “was developed on the basis of non-GSO FSS satellite constellations with 96, 288 and 840 satellites,”<sup>18</sup> with no consideration of larger constellations. In addition, the underlying analysis was based upon a number of very conservative assumptions that were recognized to result in calculated PFD levels much higher than an actual system would produce.

It must be noted that the pfd mask analysis is overly conservative in that it computes interference (both long-term and short-term) that exceeds what would be produced by an operating non-GSO FSS system. This is because the analysis assumes that all the visible satellites of the non-GSO FSS satellite constellation radiate simultaneously the maximum pfd limit, in the direction of the FS system under consideration, which is unrealistic. In addition, such an assumption does not take into account the patterns of the real satellite antenna, the power limitations of each satellite or the restrictions that self-interference would impose on a non-GSO satellite system.<sup>19</sup>

---

<sup>16</sup> See “Maximum Allowable Values of PFD Produced at the Earth’s Surface by Non-GSO Satellites in the FSS Operating in the 17.7-19.3 GHz Band,” Rec. ITU-R SF.1483 (2000) (“Rec. SF.1483”).

<sup>17</sup> See *Redesignation of the 17.7-19.7 GHz Frequency Band*, 15 FCC Rcd. 13430, ¶ 86 and Appendix A (2000).

<sup>18</sup> Rec. SF.1483 at Annex 1, Sec. 5.

<sup>19</sup> *Id.* at Annex 1, Sec. 3.

As a result, the recommendation itself states that “[a]nalyzes taking into account the actual operational characteristics of the non-GSO network have shown that substantially lower aggregate power flux-density (apfd) levels will be produced.”<sup>20</sup> SpaceX concurs with this conclusion.

In his report to WRC-15, the Director of the ITU’s Radiocommunication Bureau recognized the flaw in the scaling methodology in Article 21 for PFD calculations and highlighted it for the Conference. Specifically, with respect to the scaling function that had been developed based on NGSO constellations with no more than 840 satellites, he noted that current PFD limits may become very low for recently-filed constellations with significantly more satellites, leading to a conclusion that such systems exceed the limit.<sup>21</sup> This is because strict application of the equation in Article 21 (and Section 25.208(e)) would consider energy transmitted by all satellites in a very large NGSO constellation, rather than only those in view, which could actually contribute simultaneously to potential interference at a given point on the Earth. As a result, this methodology significantly overestimates the potential for interference to terrestrial FS systems.

Accordingly, the Director advised that the Conference “may wish considering reviewing or confirming the pertinence of the assumptions that lead to the current values of Articles 21 and 22 power limits” in light of the characteristics of these recently-submitted systems.<sup>22</sup> However, the WRC-15 Conference took no action to address the flawed PFD calculations and the ITU

---

<sup>20</sup> *Id.* at Note 3.

<sup>21</sup> *See* Director, Radiocommunication Bureau, “Report of the Director on the Activities of the Radiocommunication Sector, Part 2 – Experience in the Application of Procedures and Other Related Matters (rev. 1),” at 29 (Sep. 29, 2015), available at <http://www.itu.int/md/R15-WRC15-C-0004/en>.

<sup>22</sup> *Id.* at 30.

rules have not yet been modified to reflect more realistic protection levels where very large NGSO constellations are involved. As a result, the ITU BR had no discretion to apply a more rational methodology and was obliged to assign an “unfavorable finding” to certain frequency groups in the network filings submitted for the SpaceX System based on this flawed, but still mandated, approach.

By correcting for just one variable in the calculation – such that only satellites with a direct line of sight to a given location on the ground are considered – the same PFD analysis shows that the SpaceX System would not pose any risk of interference to terrestrial networks operating in the band. Based on simulations of the constellation operating with Final Deployment, SpaceX has determined that at most 420 satellites will be above the horizon at the constellation’s full deployment and therefore potentially have direct line of sight to any point on the Earth. Using this worst-case figure as “n” in the equation in Section 25.208(e) and Recommendation SF.1483, the resulting PFD limit is  $-126.91 \text{ dBW/m}^2/\text{MHz}$  for elevation angles from 0 to 5 degrees, which would steadily increase as elevation angles increase from 5 to 25 degrees. As shown in Figure A.7-5, even when the PFD level is calculated without limiting the number of satellites to those with direct line of sight, the SpaceX System operates at a PFD level of no more than  $-159 \text{ dBW/m}^2/\text{MHz}$  for all elevation angles of 25 degrees or less. Accordingly, it would satisfy this more realistic PFD limit by at least 30 dB.

Even this corrected PFD analysis would overstate the potential for the SpaceX System actually to affect terrestrial FS networks, as it does not take into consideration several additional factors that would reduce PFD still further, including the fact that SpaceX satellites only point beams at locations on the Earth where the elevation angle is 40 degrees or more, and that not all satellites in view will be transmitting at a given point in time. Accordingly, the Commission

should conclude that the SpaceX System does not pose an interference threat to terrestrial FS systems, notwithstanding its noncompliance with a strict application of the PFD limits set forth in Section 25.208(e) and Article 21.<sup>23</sup>

***Downlink PFD Limits for TT&C Links in Ka-band***

The Ka-band TT&C downlink transmitters on each SpaceX satellite are omni-directional. SpaceX intends to use them for communications only at angles of arrival at least 5 degrees above the horizontal plane (*i.e.*, to be received by a TT&C earth station at an elevation angle of 5 degrees or more). However, for purposes of this PFD analysis, we make the worst-case assumption that the transmissions will reach the Earth’s surface with no minimum elevation. Table A.7-6 below shows the PFD calculations at the surface of the Earth. Note that the calculation reflects satellites operating at nadir (*i.e.*, 90 degree angle of arrival) at an altitude of 1,110 km in order to present a worst case (*i.e.*, maximum PFD) scenario, demonstrating that satellites operating at higher altitudes will comply of necessity.

	at nadir
EIRP density [dBW/Hz]	-80.02
EIRP in 1MHz [dBW/MHz]	-20.02
Distance to Earth [km]	1,110
Spreading loss [dB]	-131.90
PFD in 1 MHz [dB(W/m <sup>2</sup> /1MHz)]	-151.92

**Table A.7-6. PFD at the Surface of the Earth Produced by Ka-band TT&C Downlink Transmissions (1,110 km)**

In addition, because the transmit power is adjustable on orbit, SpaceX has the ability to manage the satellites’ PFD levels during all phases of the mission, as needed.

As discussed above, the Commission has adopted different downlink PFD limits for different portions of the Ka-band spectrum used by the SpaceX System. The limits relevant to the

---

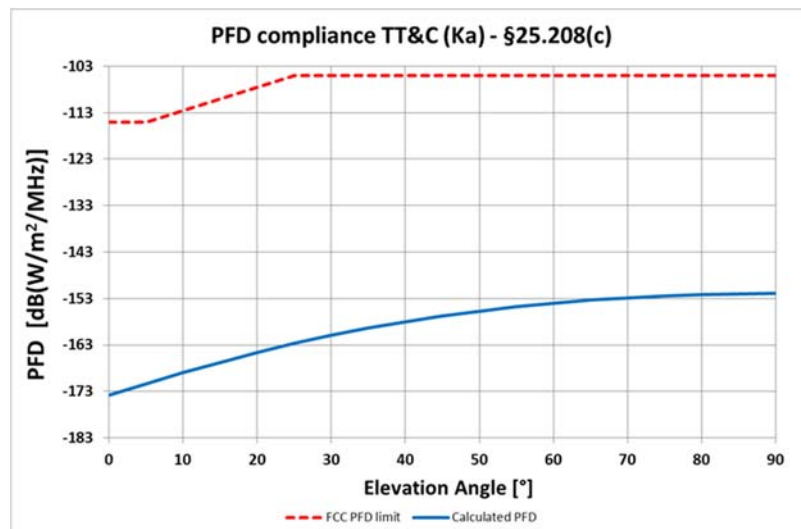
<sup>23</sup> SpaceX has also requested a waiver of these PFD limits.



TT&C frequencies used by SpaceX (in the 18.3-18.6 GHz band) are set forth in Section 25.208(c) as follows:

- $-115 \text{ dB(W/m}^2\text{)}$  in any 1 MHz band for angles of arrival between 0 and 5 degrees above the horizontal plane;
- $-115+0.5(\delta-5) \text{ dB(W/m}^2\text{)}$  in any 1 MHz band for angles of arrival  $\delta$  (in degrees) between 5 and 25 degrees above the horizontal plane; and
- $-140 \text{ dB(W/m}^2\text{)}$  in any 4 kHz band for angles of arrival between 25 and 90 degrees above the horizontal plane.

Figure A.7-7 below plots the PFD of the SpaceX System against various elevation angles to demonstrate compliance with the limits in Section 25.208(c).

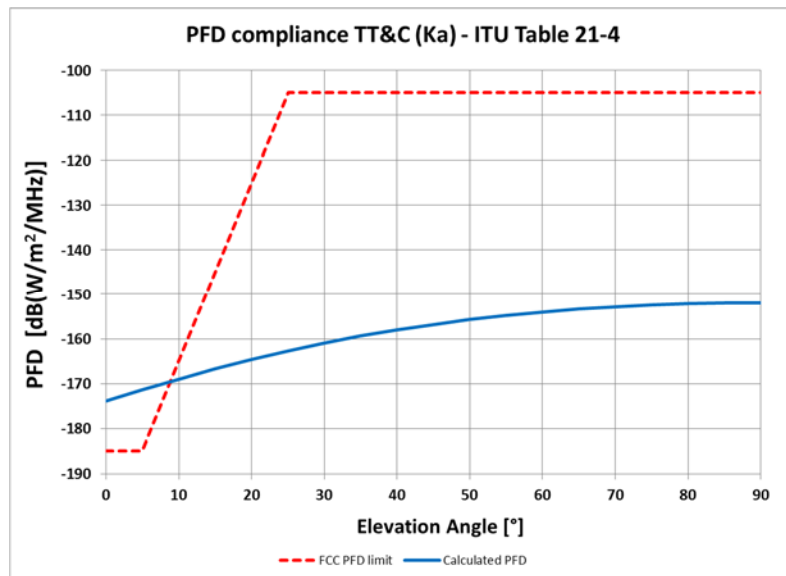


**Figure A.7-7. SpaceX TT&C Compliance with Downlink PFD Limits in Section 25.208(c)**

Article 21 of the ITU Radio Regulations also has a set of PFD limits, which apply to NGSO systems across the entire 17.7-19.3 GHz band.<sup>24</sup> As discussed above, the methodology used to calculate interference is expressed purely as a function of the number of satellites in the NGSO system, without any consideration to whether the satellites are in view of the victim FS

<sup>24</sup> The parallel provisions in Section 25.208(e) only apply in the band 18.8-19.3 GHz, which is not relevant to the Ka-band frequencies used by SpaceX for TT&C.

system or whether the satellites are turned on or off. This inclusion of all NGSO satellites in a constellation is a recognized flaw in this calculation as applied to larger, dynamically controlled constellations. Applying that calculation to Ka-band TT&C operations for the 4,425 satellites in the SpaceX System results in the PFD mask shown in Figure A.7-8 below.



**Figure A.7-8. SpaceX TT&C Compliance with Downlink PFD Limits in ITU Table 21-4**

As shown in Figure A.7-8, the SpaceX System complies with the PFD limits specified by the ITU at most elevation angles, with a typical margin of 45 dB. However, at very low elevation angles – below about nine degrees – the system appears (using the flawed calculation technique) to exceed the limit. As discussed above with respect to the Ka-band gateway links, the technique includes calculated interference from satellites not in view and does not account for satellites that may be turned off, because the system was not developed with capability to scale up for application to larger, dynamically controlled constellations. In the TT&C context, the calculation makes the further assumption that all of the peak gain of the omni-directional antenna is pointed at the same location on Earth. When taking such factors into account, SpaceX does

not anticipate that its system would cause any actual interference to a terrestrial FS system operating in this band.

The assumption that all satellites are constantly transmitting signals is particularly problematic with respect to TT&C, given that only a very small number of SpaceX satellites will actively be transmitting TT&C signals at the same time. SpaceX estimates that it will have fewer than ten TT&C sites around the world with approximately five antennas each, meaning that no more than 50 satellites would be active at a given time. Using this worst-case figure as “n” in the equation in ITU Article 21 and Recommendation SF.1483, the resulting PFD limit is -115 dBW/m<sup>2</sup>/MHz for elevation angles from 0 to 5 degrees, which would steadily increase as elevation angles increase from 5 to 25 degrees. As shown in Figure A.7-8, even when the PFD level is calculated without limiting the number of satellites to those with direct line of sight, the SpaceX System operates at a PFD level of no more than -160 dBW/m<sup>2</sup>/MHz for all elevation angles of 30 degrees or less. Accordingly, it would satisfy this more realistic PFD limit by at least 45 dB. Accordingly, the Commission should conclude that the SpaceX System does not pose an interference threat to terrestrial FS systems, notwithstanding its noncompliance with a strict application of the PFD limits set forth in Article 21.<sup>25</sup>

## **A.8 INTERFERENCE ANALYSES**

As shown in Figure A.2-1 above, the frequency ranges SpaceX proposes to use in Ku-band and Ka-band are shared with other services in the U.S. table of frequency allocations. The SpaceX system design has been engineered to achieve a high degree of flexibility in order to protect other authorized satellite and terrestrial systems under reasonable coordination arrangements and facilitate spectrum sharing. For example, the system has the following attributes:

---

<sup>25</sup> SpaceX has also requested a waiver of these PFD limits.

- *Operation at high elevation angles.* The SpaceX System constellation is designed to provide service at minimum operational elevation angles of 40 degrees for all gateway and user earth stations.
- *Highly directional earth station beams.* The earth stations used to communicate with the SpaceX System will operate with aperture sizes that enable narrow, highly-directional beams with strong sidelobe suppression. Combined with the fact that these beams will be steered to track NGSO satellites at elevation angles of at least 40 degrees, the system will provide significant off-axis isolation to other GSO and NGSO satellites. This will ensure that interference to other satellite systems could only occur in cases where there is an in-line event for satellites from each system.
- *Ability to select from multiple visible satellites for service.* With over 4,400 satellites, the SpaceX System will provide multiple NGSO satellites in the field of view of any given earth station. Where appropriate, the system will have the intelligence to select the specific satellite that would avoid a potential in-line interference event with GSO and other NGSO operations.

Applying these and other sharing mechanisms, SpaceX is confident that it can successfully coordinate its system with other authorized satellite and terrestrial networks. Below we discuss the SpaceX System's compliance with international operating parameters designed to prevent harmful interference to other systems operating in Ku-band and Ka-band spectrum.

#### **A.8.1 Interference Protection for GSO Satellite Networks**

The SpaceX System has been designed to provide all necessary interference protection to GSO satellite networks in both Ku-band and Ka-band as required under Article 22 of the ITU Radio Regulations. In addition, in the Ku-band, the SpaceX System will fully comply with the similar requirements in Sections 25.146 and 25.208 of the Commission's rules. In the following

sections, we will demonstrate compliance with the Equivalent Power Flux-Density (“EPFD”) limits set forth in Article 22 of the ITU Radio Regulations and in Section 25.146 (for the Ku-band). In addition, we will demonstrate compliance with the EPFD<sub>is</sub> limits for the Ku-band and parts of the Ka-band that exist in the ITU Radio Regulations but which are not referenced in the Commission’s rules.

Specifically, No. 22.5C and 22.5I of the Radio Regulations define EPFD limits for the downlink transmissions from an NGSO satellite system in certain Ku- and Ka-band downlink frequency ranges that must be met in order to avoid causing unacceptable interference to GSO satellite networks.<sup>26</sup> The ITU’s Ku-band EPFD<sub>down</sub> limits are also reflected in Sections 25.146, 25.208(g), 25.208(i), 25.208(j), and 25.208(l) of the Commission’s rules. In addition, the Commission defines in Sections 25.208(h) and 25.208(m) aggregate EPFD<sub>down</sub> limits arising from multiple co-frequency NGSO systems operating in the Ku-band.

Similarly, No. 22.5D of the Radio Regulations defines corresponding EPFD limits applicable to the uplinks from an NGSO satellite system, in certain Ku- and Ka-band uplink frequency ranges. These ITU Ku-band EPFD<sub>up</sub> limits are also reflected in Sections 25.146 and 25.208(k) of the Commission’s rules.<sup>27</sup>

There are also EPFD limits in No. 22.5F of the Radio Regulations,<sup>28</sup> applicable to certain parts of the Ku- and Ka-band frequency ranges, that are designed to protect GSO satellites using these frequency ranges in the opposite transmission direction. These EPFD<sub>is</sub> limits are not reflected in the Commission’s rules for NGSO systems.

---

<sup>26</sup> These limits are referred to in the Commission’s rules as “EPFD<sub>down</sub>” limits, and in the ITU Radio Regulations as “EPFD<sub>↓</sub>”.

<sup>27</sup> These limits are referred to in the Radio Regulations as “EPFD<sub>↑</sub>” limits.

<sup>28</sup> These limits are referred to in the Radio Regulations as “EPFD<sub>is</sub>” limits. They protect the “inter-satellite interference paths” that exist in certain bands with transmitting NGSO satellites and receiving GSO satellites.

SpaceX will meet all the EPFD limits that apply within the frequency ranges used by the SpaceX System, and all other obligations of the ITU Radio Regulations and the Commission's Part 25 rules in this regard within the frequency ranges where such limits apply. Below, we provide an explanation of the techniques SpaceX will use to comply with the EPFD limits separately for Ku-band and Ka-band operations. Note that these techniques are used to protect GSO satellite networks from interference from the SpaceX System and have the effect also of protecting the SpaceX System from GSO interference, as they are based on the principle of avoiding inline and near-inline events. In addition, SpaceX has begun to provide initial briefings on the operational parameters of its system to GSO satellite operators whose systems use the same Ku- and Ka-band frequency ranges as the SpaceX System, and is confident that compatibility with all GSO satellite networks in these bands can be achieved.

Finally, Section 25.208 of the Commission's rules and Resolution 76 of the ITU Radio Regulations include limits on aggregate EPFD<sub>down</sub> produced by all co-frequency satellites of all NGSO FSS systems operating in certain Ku- and Ka-bands.<sup>29</sup> SpaceX is prepared to work with other NGSO FSS operators in order to ensure compliance with the applicable limits.

#### **A.8.1.1 EPFD Compliance in Ku-Band**

Annex 1 provides a detailed analysis of the EPFD levels produced by the SpaceX System in Ku-band, and how they comply with the single-entry EPFD validation limits referenced in Section 25.146(a)(1) and (2). Annex 1 also addresses other related aspects of Section 25.146. These EPFD limits exist across both the FSS and BSS portions of the Ku-band, which vary in frequency allocation across the three ITU Regions of the world. For example, in the United States (Region 2), the FSS limits apply across the band 10.7-12.2 GHz and the BSS limits across

---

<sup>29</sup> See 47 C.F.R. § 25.208(h) and (m); ITU Rad. Regs., Res. 76.

the band 12.2-12.7 GHz. SpaceX complies with both the FSS and BSS EPFD limits. Below we explain the principles by which the SpaceX system protects GSO satellite networks from interference in Ku-band.<sup>30</sup>

In order for an NGSO satellite system to comply with the EPFD limits for the protection of GSO satellite networks (for both uplink and downlink), it must ensure that there is sufficient angular separation between the transmissions from the NGSO satellites (in the downlink bands) and user earth stations (in the uplink bands) relative to the potential victim GSO earth stations (in the downlink bands) and satellites (in the uplink bands), respectively. A key factor to achieving this goal is the number of SpaceX satellites in the NGSO constellation relative to the service areas being covered. The SpaceX constellation has sufficient satellites to ensure that there are always multiple SpaceX satellites visible from any point in the service area at a high elevation angle – always greater than 40 degrees. In concert with the ability to turn specific antenna elements off and manage traffic across multiple satellites utilizing inter-satellite links, SpaceX can serve a user by selecting a satellite that offers sufficient angular separation from the GSO arc to avoid the line of sight between GSO earth stations and their corresponding GSO satellites without interrupting service.

At higher latitudes, this is less of an issue as there is an inherent interference isolation due to the angular separation from the GSO arc for all SpaceX satellites. In these situations, GSO earth stations would only potentially receive low-power signals from the far-out sidelobes of the SpaceX satellites that are in the main beam of the GSO earth station, and maximum power signals only from the SpaceX satellites that appear in the far-out sidelobes of the GSO earth station. Similarly, because the transmitting SpaceX earth stations point well away from the GSO

---

<sup>30</sup> Note that the following discussion relates to user beams. TT&C beams in this band operate differently, as described herein and in Annex 1, yet are also shown in Annex 1 to comply with applicable EPFD limits.

arc when communicating with SpaceX satellites at higher latitudes, receiving GSO satellites benefit from uplink isolation as well. Using its advanced phased array antennas, the SpaceX System further minimizes any potential interference through precision beamforming and by using sidelobe nulling to suppress unwanted signals from both satellites and user terminals in the direction of the GSO arc.

As the SpaceX satellites approach lower latitudes, they move closer to the line of sight between GSO earth stations and their corresponding GSO satellites. Accordingly, in addition to the sidelobe nulling discussed above, the SpaceX System will implement GSO arc avoidance to protect against interference into GSO systems. Specifically, SpaceX will turn off the transmit beam on the satellite and user terminal whenever the angle between the boresight of a GSO earth station (assumed to be collocated with the SpaceX user) and the direction of the SpaceX satellite transmit beam is 22 degrees or less. Because of the number and configuration of satellites in the SpaceX System, there will be ample alternate satellites in view to provide uninterrupted service to a user from satellites operating outside of the exclusion zone around the GSO arc.

#### **A.8.1.2 EPFD Compliance in Ka-Band**

Annex 2 provides a detailed analysis of the EPFD levels produced by the SpaceX System in Ka-band, and how they comply with the single-entry EPFD validation limits in Article 22 of the ITU Radio Regulations. Below we explain the principles by which the SpaceX system protects GSO satellite networks from interference in Ka-band.<sup>31</sup>

---

<sup>31</sup> Note that the following discussion relates to gateway beams. TT&C beams operate differently, as described herein and in Annex 2, yet are also shown in Annex 2 to comply with applicable EPFD limits. SpaceX recognizes that its use of the 28.35-28.6 GHz and 29.5-30.0 GHz bands will be on a secondary basis with respect to GSO FSS systems. *See* 47 C.F.R. § 25.202(a)(1) n.2. Accordingly, it will neither cause harmful interference to, nor be protected against harmful interference from, authorized GSO FSS operations in these bands.



As explained above in relation to Ku-band, in order for an NGSO satellite system to comply with the Ka-band EPFD limits for the protection of GSO satellite networks (for both uplink and downlink), it must ensure that there is sufficient angular separation between the the NGSO and GSO system assets. SpaceX uses a straightforward GSO arc avoidance strategy, combined with sophisticated sidelobe nulling, to protect GSO satellite networks from interference in the Ka-band. This approach depends upon careful choice of the SpaceX gateway sites and placing modest constraints on the positions of SpaceX satellites with which each gateway site is allowed to communicate. Because of the characteristics of the system, including suppression of potentially interfering satellite and earth station transmissions through the application of sidelobe nulling, the necessary GSO arc avoidance angle is 22 degrees. This angle is used as the basis of the EPFD compliance analysis provided in Annex 2.

#### **A.8.1.3 Ka-Band Frequency Ranges Where No EPFD Limits Exist**

The SpaceX System frequency plan includes some portions of Ka-band spectrum where no EPFD limits exist in the ITU Radio Regulations. These are the 28.6-29.1 GHz uplink and 18.8-19.3 GHz downlink frequency bands, which are allocated to NGSO satellites on a primary basis according to the Commission's Ka-band frequency plan.<sup>32</sup> According to ITU procedures applicable to these frequency ranges, coordination between NGSO and GSO networks is on a first-come, first-served basis, depending on the ITU date priority of the relevant ITU filings.<sup>33</sup> SpaceX has provided initial briefings to various GSO satellite operators that use these frequency ranges, and is confident that compatibility with all GSO satellite networks in these bands can be achieved using the GSO arc avoidance strategies discussed above.

---

<sup>32</sup> GSO satellite networks may operate on a secondary basis in the 28.6-29.1 GHz range and on a non-conforming basis in the 18.8-19.3 GHz range. *See* 47 C.F.R. § 25.202(a)(1) and n.3.

<sup>33</sup> *See* ITU Radio Regs. No. 9.11A.

## **A.8.2 Interference with Respect to Other NGSO Satellite Systems**

The ITU has procedures for coordination amongst NGSO systems operating in all of the Ku-band and Ka-band frequency ranges to be used by the SpaceX system.<sup>34</sup> In addition, Section 25.261 of the Commission’s rules anticipates that sharing between NGSO satellite systems in the 28.6-29.1 GHz uplink and 18.8-19.3 GHz downlink bands should be achievable, using whatever means can be coordinated between the operators to avoid in-line interference events, or by resorting to band segmentation in the absence of any such coordination agreement.<sup>35</sup>

SpaceX has engineered its system with the technical flexibility that will facilitate the necessary coordination with other NGSO satellite systems, and is committed to achieving mutually satisfactory agreements. Currently, there are no other NGSO satellite systems licensed by the Commission, or granted access to the U.S. market, that operate within the Ku-band frequency ranges to be used by SpaceX.<sup>36</sup> In the Ka-band frequency ranges to be used by SpaceX, the Commission has only licensed or granted U.S. market access to one NGSO satellite system – the 12-satellite O3b MEO system, which operates in an equatorial orbit at an altitude of 8,062 km.<sup>37</sup> SpaceX has provided O3b an initial briefing on the operational parameters of its system and is confident that mutually agreeable coordination conditions can be

---

<sup>34</sup> *See id.* at No. 9.12.

<sup>35</sup> The Commission has clarified that the requirements of Section 25.261(b)-(d), which by their terms relate to parts of the Ka-band only, will also be applied to Ku-band NGSO FSS systems. *See* Public Notice, “International Bureau provides guidance concerning avoidance of in-line interference events among Ku-band NGSO FSS systems,” 30 FCC Rcd. 11534 (Int’l Bur. 2015).

<sup>36</sup> OneWeb has applied for market access for its NGSO FSS system. *See* Public Notice, “OneWeb Petition Accepted for Filing,” 31 FCC Rcd. 7666 (Int’l Bur. 2016). Although not licensed by the Commission, there is a U.S. government NGSO satellite system with which coordination is required under FCC footnote 334. This is addressed in Section A.9 below.

<sup>37</sup> Here again, there is a U.S. government NGSO satellite system which is addressed in Section A.9 below.

agreed with O3b to allow interference-free coexistence of these two NGSO systems. The GSO orbit avoidance strategies employed by SpaceX to meet EPFD limits will inherently also serve to facilitate coordination with the O3b network, as it also operates in the equatorial plane.

**A83 Interference with Respect to Terrestrial Networks in the 10.7-11.7 GHz Band**

The 10.7-11.7 GHz downlink spectrum used by the SpaceX System is shared with terrestrial Fixed Service (“FS”) in the U.S. on a co-primary basis. By rule, only gateway earth stations may operate with NGSO FSS systems in this band.<sup>38</sup> The rationale for this restriction was to limit the number of earth stations that would need interference protection from terrestrial FS transmissions, thereby avoiding constraints on future deployment of the FS in this band.<sup>39</sup> To the extent necessary, SpaceX is requesting a waiver of this restriction, based on the fact that SpaceX proposes to operate its user terminal earth stations in the 10.7-11.7 GHz band on a non-interference, non-protected basis.

**A84 Interference with Respect to Terrestrial Networks in the 12.2-12.7 GHz Band**

Section 101.1409 of the Commission’s rules provides that no new applications for point-to-point FS licenses in the 12.2-12.7 GHz band will be accepted, and that FS licensees in the band that were licensed prior to NGSO FSS satellite stations are not entitled to protection from harmful interference caused by later NGSO FSS entrants, except for legacy public safety stations which must be protected. According to the Commission’s Universal Licensing System, there are currently 26 grandfathered public safety FS licenses in the 12.2-12.7 GHz band that

---

<sup>38</sup> See 47 C.F.R. § 25.202(a) n.6.

<sup>39</sup> *Amendment of Parts 2 and 25 of the Commission’s Rules to Permit Operation of NGSO FSS Systems Co-Frequency with GSO and Terrestrial Systems in the Ku-band Frequency Range*, 16 FCC Rcd. 4096, ¶ 29 (2000).

remain active,<sup>40</sup> and SpaceX will accept any interference caused by these links. As discussed in Section A.7 above, the SpaceX downlink transmissions in the 12.2-12.7 GHz band will comply with the ITU PFD limits, which are designed to protect FS operations in the band and so will ensure there is no downlink interference into these 26 legacy FS links.

The Commission has also authorized the Multichannel Video Distribution and Data Service (“MVDDS”) in the 12.2-12.7 GHz band. Under the technical and service rules adopted for this service, MVDDS providers must share the 12 GHz band with new NGSO FSS operators on a co-primary basis.<sup>41</sup> To account for the particular interference mechanisms between MVDDS and NGSO systems, the Commission adopted the following operating requirements for the respective systems.

*MVDDS Operating Requirements:*

- To accommodate co-primary NGSO FSS earth stations in the band, the PFD of an MVDDS transmitting system must not exceed  $-135 \text{ dBW/m}^2$  in any 4 kHz band measured at a reference point at the surface of the Earth at a distance greater than 3 km from the MVDDS transmitting site.
- The maximum MVDDS EIRP shall not exceed 14 dBm per 24 MHz.
- The MVDDS transmitting antenna may not be installed within 10 km of any pre-existing NGSO FSS receiver unless the affected licensees agree to a closer separation.<sup>42</sup>

*NGSO FSS Operating Requirements:*

- Later-in-time NGSO FSS receivers must accept any interference resulting from pre-existing MVDDS transmitting antennas.
- For angles of arrival between  $0^\circ$  to  $2^\circ$  above the horizontal plane, NGSO FSS downlinks in the 12.2-12.7 GHz band must meet a reduced PFD level of  $-158 \text{ dBW/m}^2$  in any 4kHz

---

<sup>40</sup> See *Amendment of Parts 2 and 25 of the Commission’s Rules to Permit Operation of NGSO FSS Systems Co-Frequency with GSO and Terrestrial Systems in the Ku-Band Frequency Range*, 17 FCC Rcd. 9614, App. I (2002) (“*NGSO-MVDDS Sharing Order*”) (listing grandfathered call signs).

<sup>41</sup> See *id.* ¶ 26.

<sup>42</sup> See 47 C.F.R. §§ 101.105(a)(4)(i), 101.113 n.11, and 101.129(b).

band, and for angles of arrival between from 2° to 5° above the horizontal plane, a reduced PFD level of  $-158 + 3.33 (\delta - 2)$  dBW/m<sup>2</sup> in any 4kHz band, where  $\delta$  is the angle of arrival above the horizontal plane in degrees.<sup>43</sup>

In order to facilitate information sharing necessary to implement these requirements, both MVDDS and NGSO FSS operators must maintain and share databases of their respective transmitters and receivers.<sup>44</sup> SpaceX is committed to this sharing arrangement and will comply with the requirements of the Commission's rules, including the low-angle PFD limits (as demonstrated in Section A.7 above).

#### **A85 Interference with Respect to Terrestrial Networks in the 17.8-18.3 GHz Band**

Among the Ka-band spectrum to be used by the SpaceX System for its gateway operations is the 17.8-18.3 GHz band, which is allocated to FS on a primary basis in the U.S. SpaceX seeks authority to use this band on a non-conforming basis, as described in the waiver requests associated with this application.

SpaceX will use this band for transmissions in the space-to-Earth direction to a relatively small number of gateway earth stations in the U.S. The Commission has adopted the PFD limits in Section 25.208 to protect FS operations in the neighboring 18.3-18.8 GHz band. As explained in Section A.7 above, the same ITU PFD limits extend across the entire 17.8-18.8 GHz band with the objective of protecting terrestrial FS receivers. Because the SpaceX System will comply with these limits, it will protect FS receivers from downlink interference from the SpaceX system across the entire 17.8-18.3 GHz band. In addition, in the unlikely event that a SpaceX gateway earth station experiences interference from an FS transmitter in this band, SpaceX will accept such interference and take the necessary measures to prevent it from affecting earth station operations. Such necessary technical measures may include adjusting the

---

<sup>43</sup> See *id.* at § 25.208(o); *NGSO-MVDDS Sharing Order*, ¶ 123.

<sup>44</sup> See 47 C.F.R. §§ 101.103(f)(1), 25.139(a).

minimum operational elevation angles, frequency avoidance, power level adjustment, earth station shielding, or some combination thereof.

#### **A86 Interference with Respect to Terrestrial Networks in the 27.5-28.35 GHz Band**

The SpaceX System also uses the 27.5-28.35 GHz band for gateway links. Although FSS, FS, and Mobile services share this band on a co-primary basis, the Commission has designated this band for primary use in the U.S. by the FS (and specifically by the Upper Microwave Flexible Use Service (“UMFUS”)) and to the FSS on a secondary basis.<sup>45</sup> UMFUS systems are licensed by the Commission on a geographic area basis. As SpaceX uses this frequency band in the Earth-to-space direction only for gateway links with a minimum uplink elevation of 40 degrees, the only potential interference path from SpaceX is from the sidelobes of the transmitting SpaceX gateway earth station into the UMFUS receivers.

As a secondary service under Section 2.105(c)(2)(i), FSS uplinks from gateway earth stations located in the United States must generally be operated so as not to cause harmful interference to any current or future licensed UMFUS station. However, the Commission has adopted a mechanism under which FSS earth stations will be able to deploy new gateways in limited circumstances without being required to take any additional actions to provide interference protection to UMFUS licensees.<sup>46</sup> The Commission concluded that “it should be possible for satellite and terrestrial services to share the 28 GHz band with *de minimis*

---

<sup>45</sup> See *Use of Spectrum Bands Above 24 GHz For Mobile Radio Services, et al.*, 31 FCC Rcd. 8014 (2016) (“*Spectrum Frontiers R&O*”). Before creation of the UMFUS earlier this year, FSS operations were designated as secondary to the Local Multipoint Distribution Service in this band. See *Amendment of Parts 1, 2, 21, and 25 of the Commission’s Rules to Redesignate the 27.5-29.5 GHz Frequency Band, to Reallocate the 29.5-30.0 GHz Frequency Band, to Establish Rules and Policies for Local Multipoint Distribution Service and for Fixed Satellite Service*, 11 FCC Rcd. 19005 (1996).

<sup>46</sup> See 47 C.F.R. § 25.136(a)(4).

impairment of each other's operations.”<sup>47</sup> SpaceX will comply with the Commission's rules for deployment of gateway earth stations, and put in place procedures to protect UMFUS operations in the 27.5-28.35 GHz frequency band. These will involve careful site selection, shielding, and coordination with any UMFUS operators in the area where gateway earth stations are proposed. Any future SpaceX gateway earth station application that proposes operations in this band will demonstrate how potential interference to UMFUS systems has been addressed.

As a secondary user (under Section 2.105(c)(2)(ii)), SpaceX must also accept incoming interference from UMFUS operations. Although transmitting UMFUS stations are not likely to cause harmful interference into the transmitting FSS earth stations in this band, the aggregation of transmissions from UMFUS stations could be sufficient to interfere with the receiving spot beam of SpaceX's satellites. At present, given that no new UMFUS licenses have been issued (and only a limited number of LMDS links have been deployed), SpaceX does not anticipate that such interference will be a problem. Nevertheless, it undertakes to accept this risk and will not seek protection from such interference in the event it occurs, subject to further Commission consideration of this issue.<sup>48</sup>

#### **A8.7 Interference with Respect to the Radio Astronomy Service**

Several footnotes to the U.S. Table of Frequency Allocations address the need for satellite downlink transmissions to adequately protect the Radio Astronomy Service (“RAS”) at specific sites in the U.S. We discuss each footnote in turn below.

---

<sup>47</sup> *Spectrum Frontiers R&O*, ¶ 52.

<sup>48</sup> *See id.* ¶ 69 (directing the International Bureau, the Office of Engineering and Technology, and the Wireless Telecommunications Bureau “to jointly establish a separate docket that parties can use to file the relevant data and analyses, and we reserve the right to revisit this [aggregate interference] issue should additional information or other circumstances warrant further Commission review or action”).

Footnote US131 addresses NGSO systems operating in the 10.7-11.7 GHz band and the need to coordinate with and protect a list of specific RAS observatories, which operate in the adjacent 10.6-10.7 GHz band. SpaceX has provided representatives of the RAS community, including the National Science Foundation Spectrum Management Office, the National Radio Astronomy Observatory, and the Arecibo Observatory an initial briefing on the operational parameters of its system, and discussed preliminary views on coordination strategies that could be used to protect RAS. SpaceX will continue to coordinate with the RAS community in the U.S. to achieve mutually acceptable agreements regarding the protection of these important radio astronomy operations and their contribution to the space and Earth sciences.

Footnotes 5.149, US211, and US342 address the more general matter of taking all practical steps to protect RAS observatories in the U.S. which operate adjacent to the frequency ranges listed in those footnotes.<sup>49</sup> SpaceX will take this into account in determining the specifications of its satellite transmitters and, as necessary, its operations with respect to the specific geographic locations where RAS systems operate.

#### **A88 Coordination With GSO FSS Earth Stations in the 10.7-12.75 GHz Band**

Section 25.146(f) requires coordination between NGSO FSS systems and certain GSO FSS earth stations with very large antennas operating in the 10.7-12.75 GHz band. SpaceX is optimistic that such coordination can be completed in a mutually acceptable manner, and will inform the Commission once that has been accomplished.

---

<sup>49</sup> Footnote US211 also makes reference to footnote US74 regarding the extent of the protection needed. Footnote US74, in turn, refers to footnote US385, which lists the geographic locations at which such RAS observations are performed.



## **A.9 COORDINATION WITH U.S. GOVERNMENT SATELLITE NETWORKS**

Footnote US334 of the U.S. Table of Frequency Allocations requires SpaceX to coordinate its NGSO system with U.S. government satellite networks, both GSO and NGSO, in portions of the Ka-band spectrum.

SpaceX has provided various U.S. government agencies initial information on the operational parameters of its system, and is committed to successful coordination with all government satellite networks operating in these bands to protect critical national security and government systems. SpaceX will inform the Commission when coordination has been completed.

## **A.10 ITU FILINGS FOR SPACEX**

The SpaceX System will operate under network filings made on its behalf with the ITU by the administrations of the U.S. (under the satellite network name USASAT NGSO-3) and Norway (under the satellite network name STEAM). Taken together, these U.S. and Norway network filings encompass all the frequencies SpaceX proposes to use in this application.

## **A.11 ORBITAL DEBRIS MITIGATION**

SpaceX's launch and space experience provides the knowledge base for implementing an aggressive and effective space-debris mitigation plan. The company's current and planned space-based activities underscore its unparalleled commitment to safe space. SpaceX has had extensive experience in safe-flight design and operation through many missions of both the Falcon 9 launch vehicle and the Dragon spacecraft carrying out missions to the International Space Station ("ISS"). The company is highly experienced with cutting-edge debris mitigation practices and has deep ties with the domestic and international institutions tasked with ensuring the continued safety of space operations. SpaceX has a long-standing collaborative working relationship with the Joint Space Operations Center ("JSPOC"), a multinational focal point for

management of space traffic, debris, and other space coordination functions associated with the U.S. Department of Defense. It also has existing relationships with both NASA and the Air Force Center for Space Situational Awareness in the support of its space-based activities, and will continue to utilize these experiences and relationships as resources while developing the SpaceX System and spacecraft.

SpaceX will largely be using recommendations set forth in both NASA Technical Standard 8719.14A and AIR FORCE INSTRUCTION 91-217, typically choosing the more restrictive of the two and, where deemed applicable, choosing a more restrictive value than either reference due to the scope of the project. SpaceX intends to incorporate the material objectives set forth in this application into the technical specifications established for design and operation of the SpaceX System. SpaceX will internally review orbit debris mitigation as part of the preliminary design review and critical design review for the spacecraft, and incorporate these objectives, as appropriate, into its operational plans. Because this mitigation statement is necessarily forward looking, the process of designing, building, and testing may result in minor changes to the parameters discussed herein. In addition, SpaceX will continue to stay current with the Space Situational Awareness community and technology and, if appropriate, SpaceX will modify this mitigation statement to continue its leadership in this area.

### ***Spacecraft Hardware Design***

SpaceX has assessed and limited the amount of debris released in a planned manner during normal operations, and does not intend to release debris during the planned course of operations of the satellite constellation.

SpaceX will also consider the possibility of its system becoming a source of debris by collisions with small debris or meteoroids that could either create jetsam or cause loss of control

of the spacecraft and prevent post-mission disposal. As such, SpaceX will take steps to address this possibility by incorporating redundancy, shielding, separation of components, and other physical characteristics into the satellites' design. For example, the on-board command receivers, telemetry transmitters, and the bus control electronics will be fully redundant and appropriately shielded to minimize the probability of the spacecraft becoming flotsam due to a collision. SpaceX will continue to review these aspects of on-orbit operations throughout the spacecraft manufacturing process and will make such adjustments and improvements as appropriate to assure that its spacecraft will not become a source of debris during operations or become derelict in space due to a collision.

### ***Minimizing Accidental Explosions***

SpaceX will seek an overall spacecraft design that limits the probability of accidental explosion. The key areas reviewed for this purpose will include leakage of propellant as well as battery pressure vessels. The basic propulsion design (including the placement of propellant inside a central cylinder which provides a shielding from the bus walls), propulsion subsystem component construction, preflight verification through both proof testing and analysis, and quality standards will be designed to ensure a very low risk of propellant leakage that can result in an energetic discharge of the inert propellant. During the mission, batteries and various critical areas of the propulsion subsystem will be instrumented with fault detection, isolation, and recovery (similar or in many cases identical to flight-proven methods utilized onboard the SpaceX Dragon capsule for its missions to ISS) to continually monitor and preclude conditions that could result in the remote possibility of energetic discharge and subsequent generation of debris. Through this process, SpaceX will assess and limit the possibility of accidental explosions during mission operations and assure that all stored energy at the end of the satellite's

operation will be removed.

### ***Safe Flight Profiles***

SpaceX takes seriously the responsibility of deploying large numbers of satellites into space, and intends to exceed best practices to ensure the safety of space. It will assess and limit the probability of its system becoming a source of debris by collisions with large debris or other operational space stations through detailed and conscientious mission planning. It will maintain the accuracy of its orbital parameters at a level that will allow operations with sufficient spacing to minimize the risk of conjunction with adjacent satellites in the constellation and other constellations. SpaceX has and will continue to work closely with JSpOC to ensure the service provided for conjunction assessment to SpaceX and all operators is robust, reliable, and secure. Significant coordination must be performed with other satellite operators in nearby orbits to safely ascend and descend through constellations and to ensure any altitude perturbations do not result in unnecessarily close approaches. SpaceX is willing to engage with any operators of nearby constellations to ensure safe and coordinated space operations.

SpaceX has reviewed the list of licensed systems and systems that are under consideration by the Commission for the orbital planes it has requested. In addition, in order to address non-U.S. licensed systems, SpaceX has reviewed the list of NGSO satellite networks for which a request for coordination has been published by the ITU. As a consequence of this review, it has been determined that no other system is currently licensed by the Commission for, is currently operating in, or has submitted a request for coordination to the ITU with respect to the same nominal orbital planes sought by SpaceX.

### ***Post-Mission Disposal***

Each satellite in the SpaceX System is designed for a useful lifetime of five to seven years. SpaceX intends to dispose of satellites through atmospheric reentry at end of life. As suggested by the Commission,<sup>50</sup> SpaceX intends to comply with Section 4.6 and 4.7 of NASA Technical Standard 8719.14A with respect to this reentry process. In particular, SpaceX anticipates that its satellites will reenter the Earth's atmosphere within approximately one year after completion of their mission – much sooner than the international standard of 25 years. After the mission is complete, the spacecraft (regardless of operational altitude) will be moved to a 1,075 km circular orbit in its operational inclination, then gradually lower perigee until the propellant is exhausted, achieving a perigee of at most 300 km. After all propellant is consumed, the spacecraft will be reoriented to maximize the vehicle's total cross-sectional area, a configuration also stable in the direction of aerodynamic drag. Finally, the spacecraft will begin to passivate itself by de-spinning reaction wheels and drawing batteries down to a safe level and powering down. Over the following months, the denser atmosphere will gradually lower the satellite's perigee until its eventual atmospheric demise.

SpaceX has conducted an assessment using NASA's Debris Assessment Software ("DAS"). That analysis indicates a total spacecraft Risk of Human Casualty rate of between 1:18,200 and 1:31,200 depending upon operational altitude – satisfying the requirement of 1:10,000 established by NASA. This analysis will be conducted regularly throughout the spacecraft design life cycle to ensure continued compliance. The results of the analysis done to date is included on the following pages.

---

<sup>50</sup> *Mitigation of Orbital Debris*, 19 FCC Rcd. 11567, ¶ 88 (2004).

***Orbital Lifetime Calculation***

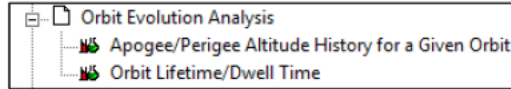
Table A.11-1 below sets forth the characteristics of a SpaceX satellite relevant to the orbital lifetime calculation, as well as the result of that calculation. The subsequent discussion walks through the elements of that calculation.

<b>Satellite Body Dimensions</b>						
Length	4.0					m
Width	1.8					m
Height	1.2					m
<b>Solar Array Dimensions</b>						
Length	6.0					m
Width	2.0					m
Area	12.0					m <sup>2</sup>
Quantity	2					
<b>Overall Vehicle Area</b>						
Max Vehicle Area	28.3					m <sup>2</sup>
Min Vehicle Area	2.6					m <sup>2</sup>
Average Vehicle Area	15.45					m <sup>2</sup>
<b>Vehicle Mass</b>						
Mass	386					kg
<b>Area-to-Mass (A/M) Ratios</b>						
Max A/M	0.0733					m <sup>2</sup> /kg
Min A/M	0.0067					m <sup>2</sup> /kg
Average A/M	0.0400					m <sup>2</sup> /kg
<b>Orbit</b>						
Altitude	1,150	1,110	1,325	1,130	1,275	km
Inclination	53	53.8	70	74	81	deg
<b>Orbital Lifetime</b>						
(Calculated using NASA DAS)						
Nominal Operations	5.0-7.0					years
Nominal Disposal (Solar-Max)	0.94	0.94	1.0	1.0	1.0	years

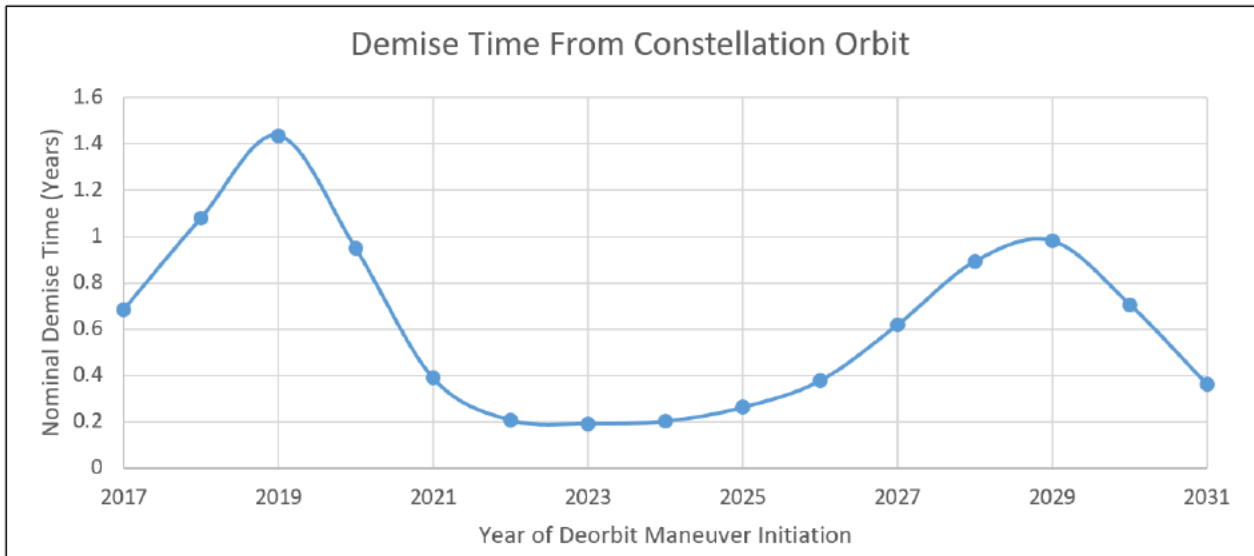
**Table A.11-1. Orbital Lifetime Calculation Parameters**

**Re-Entry Timeline Estimates / Orbit Dwell Time**

NASA’s DAS provides tools to estimate spacecraft post-mission dwell time prior to atmospheric re-entry:



The solar cycle has a dynamic influence on the duration to demise of a spacecraft due to atmospheric reentry. During solar-max, the atmosphere swells up, making re-entry occur much more rapidly than during periods of solar-min. Figure A.11-1 shows a nominal re-entry time estimate using DAS across the foreseeable future. Periods of solar-min become evident at 2019/2029, while a favorable period of solar-max is anticipated around 2022-24.



**Figure A.11-1. Demise Time from Constellation Orbit**

SpaceX satellites have a designed expected lifespan of between 5 and 7 years. Those satellites launched in 2019 that reach the end of life in 2024 will have a favorable de-orbit duration due to coincidence with solar-max. However, in the interest of margin, the de-orbit estimates provided below are calculated for 2029, corresponding to a local maximum for the following solar-min period. Because satellites are anticipated to reach end-of-life prior to 2029,

satellite de-orbit performance is anticipated to exceed these reported values. Throughout the deorbit phase, the satellite area to mass ratio is  $0.0733 \text{ m}^2/\text{kg}$  and is used in the following DAS input.

Orbit Lifetime/Dwell Time

Input

Start Year (ex: 2005.4)

Perigee Altitude  km

Apogee Altitude  km

Inclination  deg

P. A. of Ascending Node  deg

Argument of Perigee  deg

Area-to-Mass   $\text{m}^2/\text{kg}$

Output

Calculated Orbit Lifetime  yr

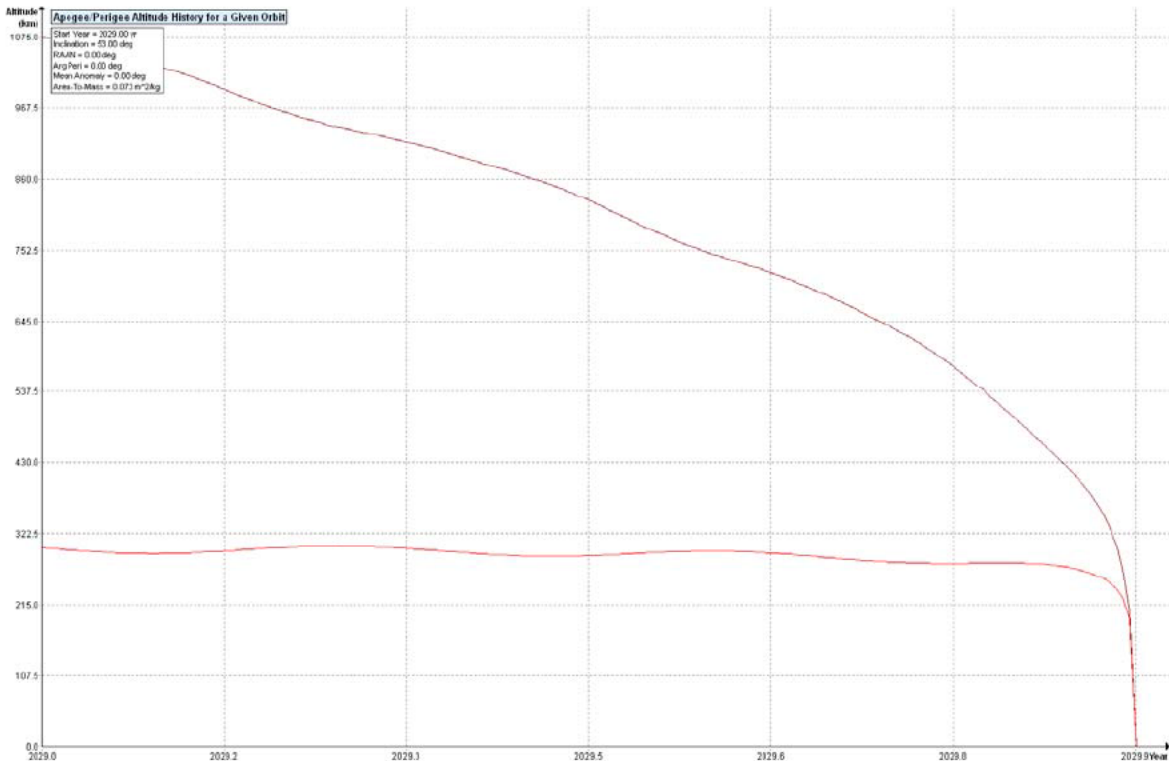
Calculated Orbit Dwell Time  yr

Last year of propagation  yr

Messages

Object reentered.

**53 Degree Inclination DAS Input**



**53 Degree Inclination DAS Output**



Orbit Lifetime/Dwell Time

Input

Start Year (ex: 2005.4)

Perigee Altitude  km

Apogee Altitude  km

Inclination  deg

R. A. of Ascending Node  deg

Argument of Perigee  deg

Area-to-Mass  m<sup>2</sup>/kg

Run    Reset    Help

Output

Calculated Orbit Lifetime  yr

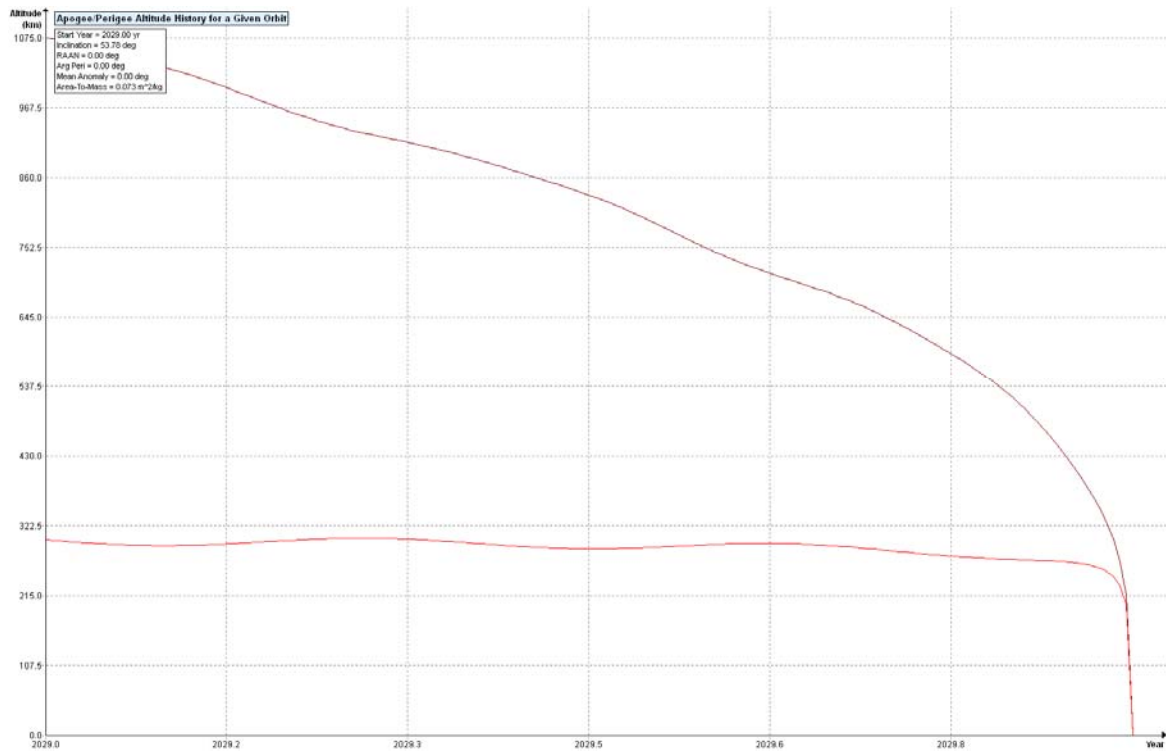
Calculated Orbit Dwell Time  yr

Last year of propagation  yr

Messages

Object reentered.

### 53.8 Degree Inclination DAS Input



### 53.8 Degree Inclination DAS Output

Orbit Lifetime/Dwell Time

Input

Start Year (ex: 2005.4)

Perigee Altitude  km

Apogee Altitude  km

Inclination  deg

R. A. of Ascending Node  deg

Argument of Perigee  deg

Area-to-Mass  m<sup>2</sup>/kg

Output

Calculated Orbit Lifetime  yr

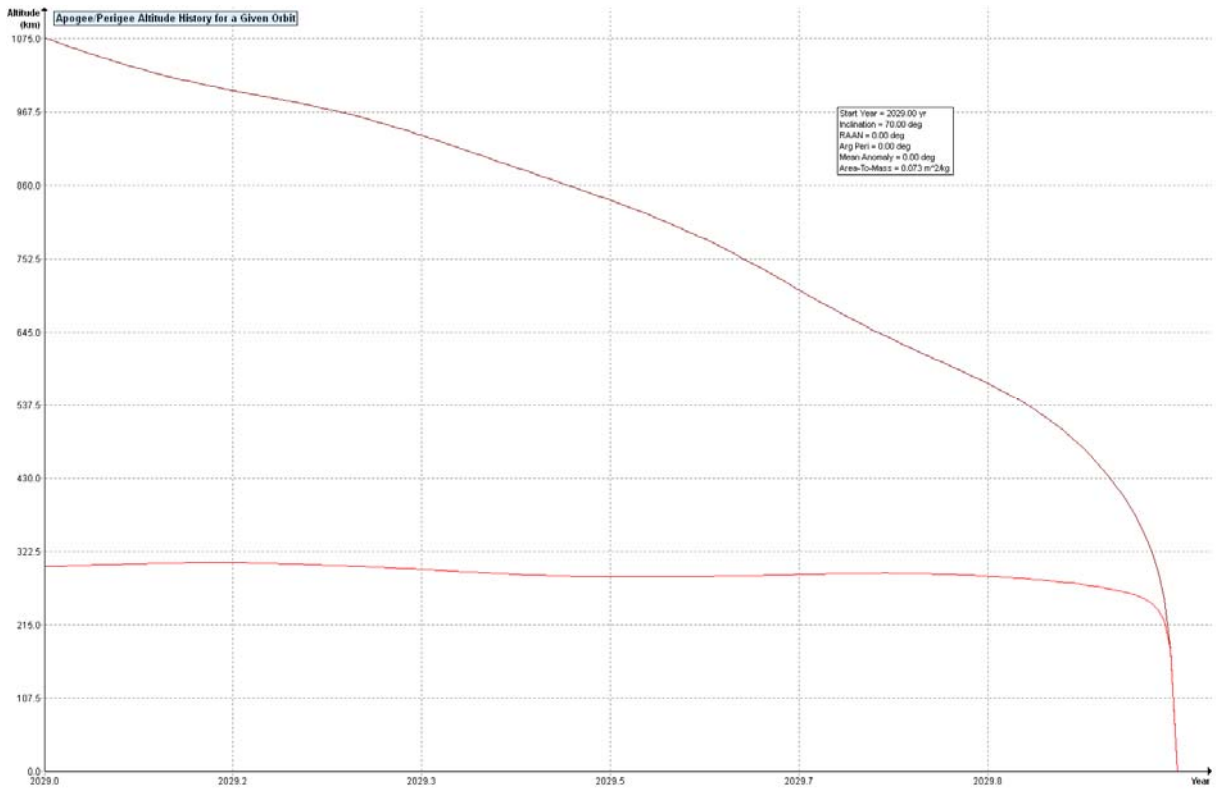
Calculated Orbit Dwell Time  yr

Last year of propagation  yr

Messages

Object reentered.

### 70 Degree Inclination DAS Input



### 70 Degree Inclination DAS Output

Orbit Lifetime/Dwell Time

Input

Start Year (ex: 2005.4)

Perigee Altitude  km

Apogee Altitude  km

Inclination  deg

R. A. of Ascending Node  deg

Argument of Perigee  deg

Area-to-Mass  m<sup>2</sup>/kg

Run    Reset    Help

Output

Calculated Orbit Lifetime  yr

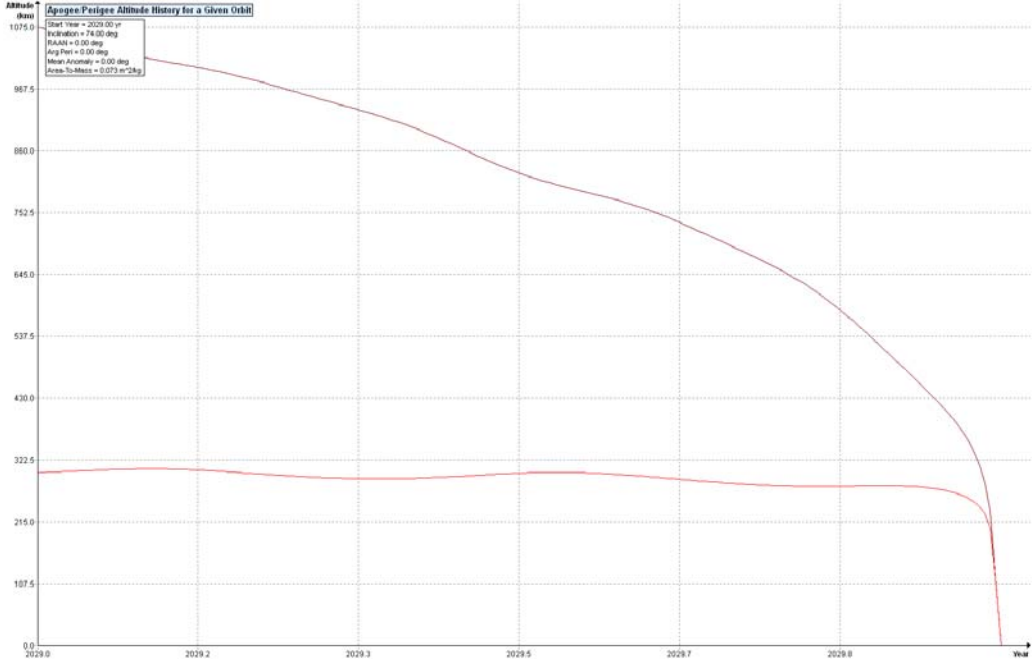
Calculated Orbit Dwell Time  yr

Last year of propagation  yr

Messages

Object reentered.

**74 Degree Inclination DAS Input**



**74 Degree Inclination DAS Output**

Orbit Lifetime/Dwell Time

Input

Start Year (ex: 2005.4)

Perigee Altitude  km

Apogee Altitude  km

Inclination  deg

R. A. of Ascending Node  deg

Argument of Perigee  deg

Area-to-Mass  m<sup>2</sup>/kg

Run    Reset    Help

Output

Calculated Orbit Lifetime  yr

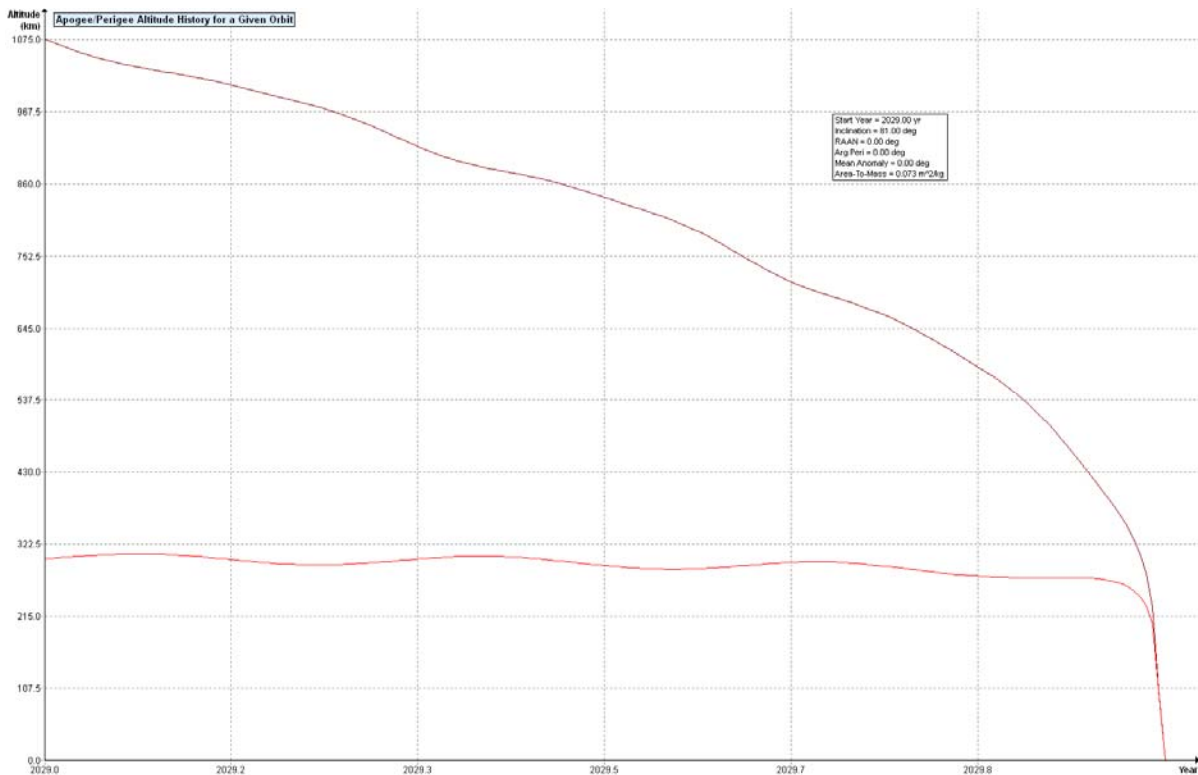
Calculated Orbit Dwell Time  yr

Last year of propagation  yr

Messages

Object reentered.

### 81 Degree Inclination DAS Input



### 81 Degree Inclination DAS Output

Re-entry timelines are also provided for several disposal perigees in proximity of the target. The 300 km target does not account for a fuel margin stack-up reserved for other uses. In the vast majority of cases, any remaining margin would allow satellites to push their perigee even lower than 300 km. Nonetheless, satellites would hold some fuel in reserve for conjunction avoidance during the active de-orbit phase. Re-entry estimates for the year 2029 are set forth in the tables below.

**53 Degree Inclination**

Disposal Perigee	Time to Re-entry
200 km	22 days
250 km	100 days
> 300 km <	344 days
350 km	2.0 years
400 km	2.9 years

**53.8 Degree Inclination**

Disposal Perigee	Time to Re-entry
200 km	22 days
250 km	98 days
> 300 km <	342 days
350 km	2.0 years
400 km	2.9 years

**70 Degree Inclination**

Disposal Perigee	Time to Re-entry
200 km	24 days
250 km	118 days
> 300 km <	1.0 year
350 km	2.1 years
400 km	2.9 years

**74 Degree Inclination**

Disposal Perigee	Time to Re-entry
200 km	26 days
250 km	112 days
> 300 km <	1.0 year
350 km	2.1 years
400 km	2.9 years

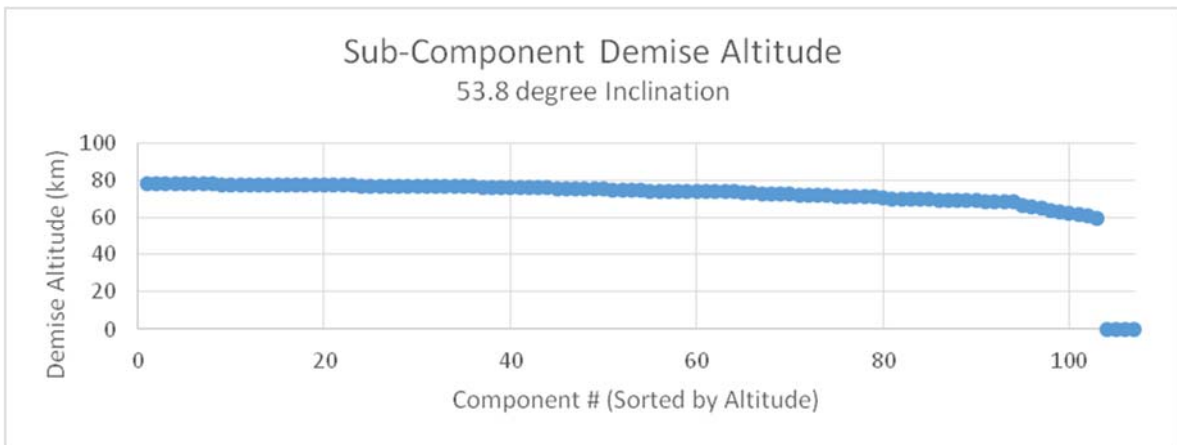
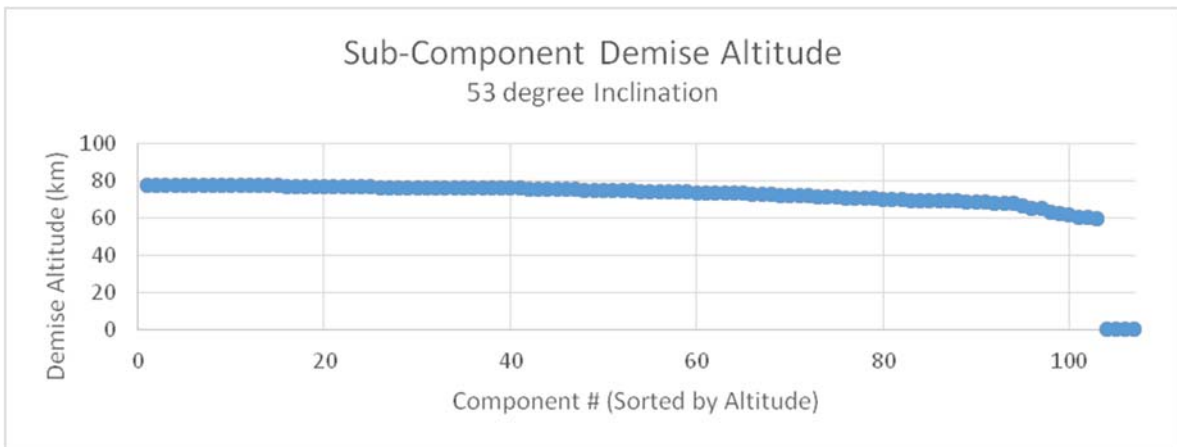
**81 Degree Inclination**

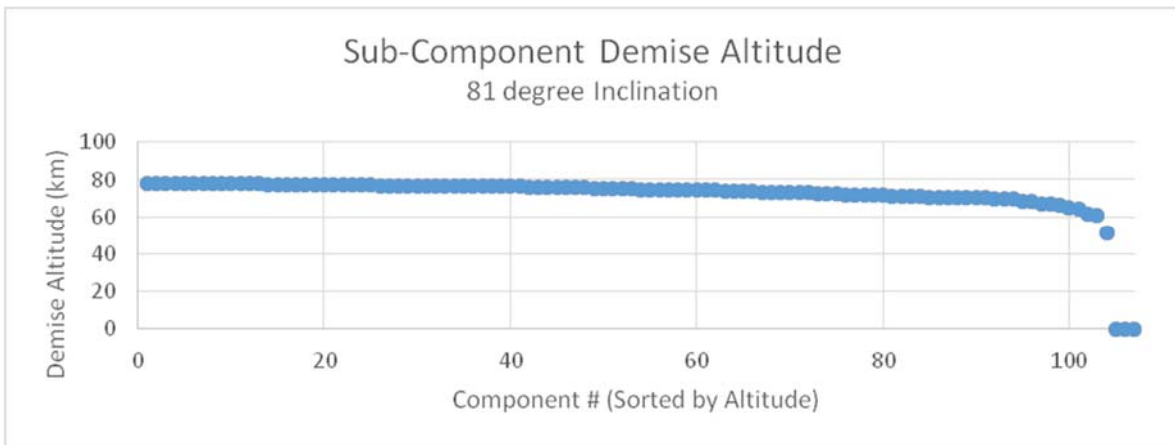
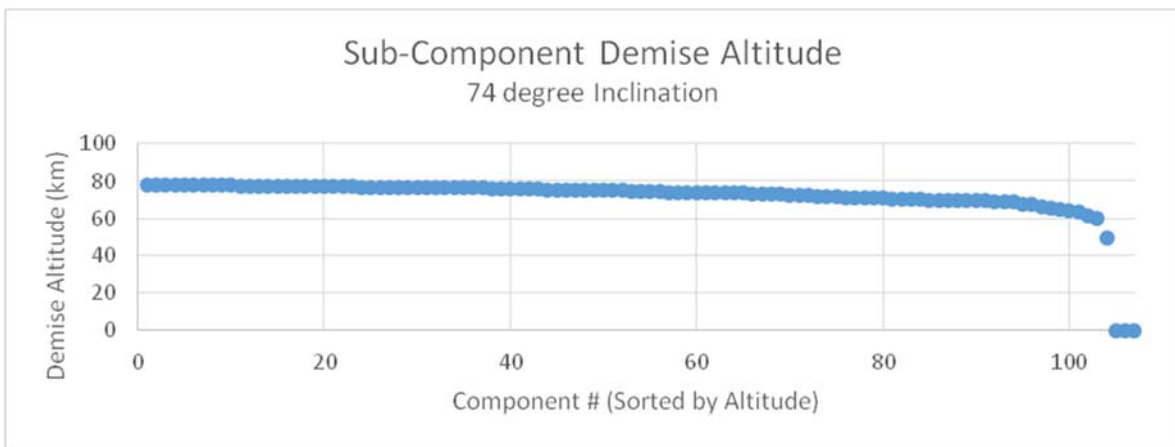
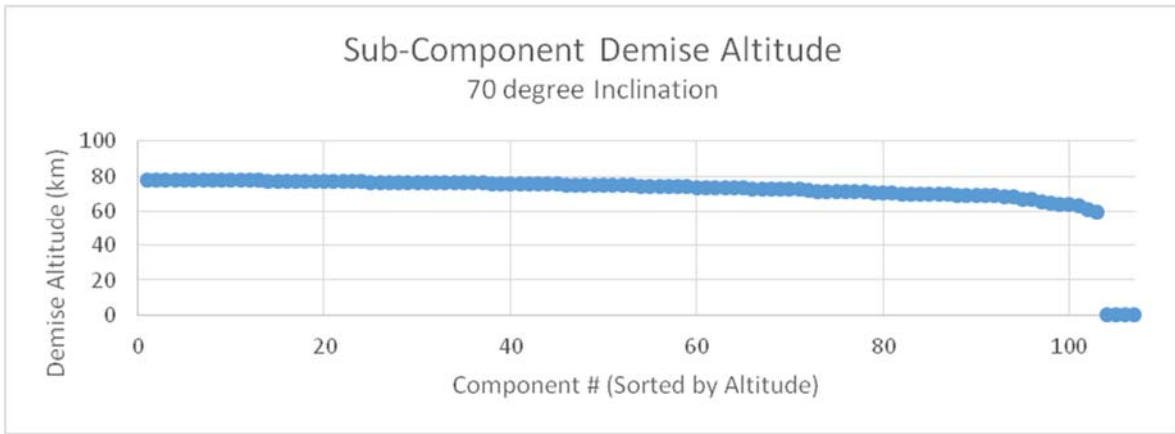
Disposal Perigee	Time to Re-entry
200 km	28 days
250 km	110 days
> 300 km <	1.0 year
350 km	2.1 years
400 km	2.9 years

***Atmospheric Demise***

The spacecraft’s small mass and predominantly aluminum construction make atmospheric demise a likely scenario upon re-entry. To verify this, SpaceX also utilized NASA’s DAS. The satellite was broken down into approximately 100 major components, each

defined with its own shape, material, mass and dimensions. Components were modeled in a nested fashion; a child component would not be exposed to the environment until its parent burned up. This enabled conservative re-entry survivability analysis of common problematic components, such as spherical fuel tanks contained within an enclosed spacecraft bus. DAS models the release of all root components 79 km above the surface; the demise altitudes of all modeled components at all inclinations is shown in the following figures:





Several objects were identified as components of interest. This reflected objects which had a distinct mass, quantity, or shape factor which made them of particular concern during re-entry analysis. Those components and their corresponding demise altitudes are provided in the tables below:

### 53 Degree Inclination

Component	Demise (km)
First Bus Panel	76.6
Reaction Wheels	74.4
Batteries	70.9
Propellant Tank	70.9
Last Bus Panel	70.3

### 53.8 Degree Inclination

Component	Demise (km)
First Bus Panel	76.6
Reaction Wheels	74.4
Batteries	71.0
Propellant Tank	70.9
Last Bus Panel	70.3

### 70 Degree Inclination

Component	Demise (km)
First Bus Panel	76.4
Reaction Wheels	74.2
Batteries	71.3
Propellant Tank	70.8
Last Bus Panel	70.3

### 74 Degree Inclination

Component	Demise (km)
First Bus Panel	76.4
Reaction Wheels	74.2
Batteries	71.6
Propellant Tank	71.0
Last Bus Panel	70.7

### 81 Degree Inclination

Component	Demise (km)
First Bus Panel	76.7
Reaction Wheels	74.6
Batteries	72.1
Propellant Tank	71.7
Last Bus Panel	71.3

Although a major effort was made to avoid the use of components resistant to disintegration, some scenarios were unavoidable. DAS analysis indicates that four components may have a chance of reaching the Earth's surface; these components are listed in the tables below. Of the four, only two contribute substantially to the total Debris Casualty Area ("DCA") calculation.<sup>51</sup>

---

<sup>51</sup> The debris casualty area is a function of the dimensions of an average person and of the specific debris fragment. The model does not consider more complicated aspects, such as sheltering within structures. The total casualty area is the sum of the casualty areas of all surviving debris fragments which reach the ground with kinetic energy greater than 15 joules.



### 53 Degree Inclination

Component	Qty.	Material	Mass (kg)	Total DCA (m <sup>2</sup> )	Energy (J)
Thruster Internals	1	Iron	1.66	0.47	2733
Comms. Component	5	Silicon Carbide	1.50	2.79	961
Rotor Bearing	5	Stainless Steel	0.07	2.45	8
Strut Fitting	12	Titanium	0.03	4.92	6

### 53.8 Degree Inclination

Component	Qty.	Material	Mass (kg)	Total DCA (m <sup>2</sup> )	Energy (J)
Thruster Internals	1	Iron	1.66	0.47	2733
Comms. Component	5	Silicon Carbide	1.50	2.79	961
Rotor Bearing	5	Stainless Steel	0.07	2.45	8
Strut Fitting	12	Titanium	0.03	4.92	6

### 70 Degree Inclination

Component	Qty.	Material	Mass (kg)	Total DCA (m <sup>2</sup> )	Energy (J)
Thruster Internals	1	Iron	1.66	0.47	2733
Comms. Component	5	Silicon Carbide	1.50	2.79	961
Rotor Bearing	5	Stainless Steel	0.07	2.45	8
Strut Fitting	12	Titanium	0.03	4.92	6

### 74 Degree Inclination

Component	Qty.	Material	Mass (kg)	Total DCA (m <sup>2</sup> )	Energy (J)
Comms. Component	5	Silicon Carbide	1.50	2.79	961
Rotor Bearing	5	Stainless Steel	0.07	2.45	8
Strut Fitting	12	Titanium	0.03	4.92	6

### 81 Degree Inclination

Component	Qty.	Material	Mass (kg)	Total DCA (m <sup>2</sup> )	Energy (J)
Comms. Component	5	Silicon Carbide	1.50	2.79	961
Rotor Bearing	5	Stainless Steel	0.07	2.45	8
Strut Fitting	12	Titanium	0.03	4.92	6

The DCA model does not consider components characterized by a ground impact energy of less than 15 joules. The two components in the simulation that meet this criterion are rotor bearings and strut fittings. The former may survive re-entry due to being nested in a larger sub-assembly, while the latter may survive because they are made of titanium. These components are 70 and 30 grams respectively, causing their impact at terminal velocity to remain benign.

Two other components with a chance of re-entry survivability are iron thruster internals and a set of silicon carbide communications components. While the majority of the thruster is expected to burn up in the atmosphere, the nested nature of the assembly leaves a chance of survivability for internal components. Fortunately, the DCA of these components is relatively small at 0.47 m<sup>2</sup>. At higher inclinations, DAS indicates the thruster internals are no longer a risk, which is reflected by the disappearance of that row from the tables of 74 and 81 degrees of inclination. The high survivability of the silicon carbide communications components stems from the material properties, primarily its very high melting point of 2,730 °C.

The four components discussed above are the main contributors to the satellite’s total DCA, set forth in Table A.11-2 below.

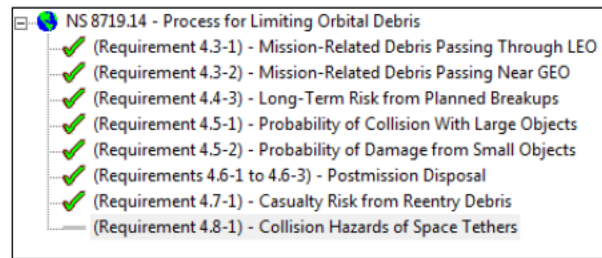
Inclination	DCA (m <sup>2</sup> )	Risk of Human Casualty
53°	3.26	1:18,200
53.8°	3.26	1:18,200
70°	2.79	1:24,700
74°	2.79	1:29,900
81°	2.79	1:31,200

**Table A.11-2. Summary of Human Casualty Risk Assessment**

Yet even with these components, the total spacecraft Risk of Human Casualty is no more than 1:18,200, satisfying the requirement of 1:10,000 established by NASA.

## *DAS Accordance*

As shown in the screen shot below, the DAS assessment concludes that SpaceX's anticipated de-orbit plan satisfies all applicable requirements under NASA-STD-8719.14 for each inclination.<sup>52</sup>



---

<sup>52</sup> Requirement 4.8-1, related to Collision Hazards of Space Tethers, does not apply to SpaceX's satellites.

## ANNEX I

### Demonstration of EPFD Compliance for Ku-Band Operations

This annex provides a detailed explanation of the equivalent power flux-density (“EPFD”) levels produced by the SpaceX System in Ku-band, and how they comply with the single-entry EPFD validation limits defined in Section 25.146(a)(1) and (2). This comprehensive technical showing demonstrates that the SpaceX system will not exceed the validation EPFD limits in Ku-band as specified in Sections 25.208 (g), (k), and (l) for the space-to-Earth direction ( $EPFD_{down}$ ) and the Earth-to-space direction ( $EPFD_{up}$ ).<sup>1</sup> SpaceX also demonstrates that its system will not exceed the limits established by the ITU covering transmissions between satellites in orbit where spectrum is allocated bi-directionally ( $EPFD_{is}$ ).

In order for a non-geostationary orbit (“NGSO”) satellite system to comply with the EPFD limits for the protection of geostationary orbit (“GSO”) satellite networks, it must ensure that there is sufficient angular separation between the transmissions to and from the NGSO satellites relative to the potential victim GSO earth stations and satellites. Accordingly, SpaceX will turn off the user downlink beam on the satellite and uplink beam on the user terminal whenever the angle between the boresight of a GSO earth station (assumed to be collocated with the SpaceX user) and the direction of the SpaceX satellite transmit beam is 22 degrees or less. Because of the number and configuration of satellites in the SpaceX System, there will always be a satellite available to provide service to a user from

---

<sup>1</sup> The EPFD limits for the transmissions to and from an NGSO satellite system defined in the Commission’s rules reflect the limits set forth in Nos. 22.5C and 22.5D of the ITU Radio Regulations.

outside the exclusion zone around the GSO arc with a minimum elevation angle of 40 degrees and the use of inter-satellite links will ensure continuity of service throughout any interference mitigation activities.

In addition, SpaceX will use its advanced phased array antennas to further minimize any potential interference through precision beamforming and by using sidelobe nulling to suppress unwanted signals from both satellites and user terminals in the direction of the GSO arc. The sidelobe nulling will reduce the sidelobe level by an additional 10 dB in a  $\pm 2$  degree zone around the GSO arc. SpaceX will also carefully coordinate its TT&C operations and broadband transmissions in the band to limit overall energy of the system and remain within EPFD restrictions. The combination of these strategies ensures that EPFD levels produced by the SpaceX System comply with the prescribed limits as demonstrated below.<sup>2</sup>

#### **EPFD<sub>down</sub> Compliance for User Links**

This section demonstrates SpaceX's compliance with the single-entry EPFD limits with respect to Ku-band user downlinks. The ITU has not yet approved a computer program for determining compliance with the single-entry EPFD validation limits, although it is in the process of developing such a program in accordance with the specification stipulated in the most recent version of ITU-R Recommendation S.1503 (S.1503-2, issued in December 2013). The ITU is reportedly in the process of final testing of this program. SpaceX has conducted its EPFD analyses using the most recent version of this computer program available, and is submitting with this application an

---

<sup>2</sup> The following description of Ku-band EPFD compliance reflects service-link operations. Because TT&C operations in this band will occur at lower radiated power levels in all cases, this analysis establishes SpaceX's compliance with the relevant EPFD limits for TT&C links as well.

executable copy of that program. This version of the software is likely to be very close to the final version that the ITU will approve, as the software developer, Transfinite Systems (“Transfinite”), is one of the two companies that has been working with the ITU in the development of the code.<sup>3</sup> At this time, this is the most reliable way to demonstrate compliance with the relevant EPFD limits as currently applied. SpaceX is prepared to provide all necessary assistance to the Commission in running this computer program.

In order to demonstrate compliance with the single-entry validation EPFD<sub>down</sub> limits, SpaceX is also submitting the computer files that contain the sets of Ku-band power flux-density (“PFD”) masks for each space station in the SpaceX System. These masks are one of the data inputs to the EPFD validation software program required to calculate the EPFD<sub>down</sub> levels in Ku-band. They define the maximum satellite downlink PFD in Ku-band over the surface of the Earth that is visible to the satellite, and are expressed as a function of the azimuth (“Az”) and elevation (“El”) angles as viewed from the satellite towards the Earth relative to nadir direction.<sup>4</sup> The SpaceX System user beams are designed to maintain a constant PFD at the surface of the Earth for all elevation angles above 40 degrees.

These PFD masks have been generated in accordance with the specification stipulated in Recommendation S.1503-2 using the following methodology and

---

<sup>3</sup> Due to software licensing restrictions, SpaceX does not have access to the source code for this computer program (June 6, 2016 version), and thus cannot provide it to the Commission. However, this computer program is available for purchase and should be very close to being the final version that the ITU will approve.

<sup>4</sup> Azimuth is in the East-West direction and elevation is in the North-South direction, as seen at the sub-satellite point.

assumptions related to the actual design and real-world operation of the SpaceX System:

1. We start with the two dimensional (as a function of Az/EI) EIRP density mask for a single SpaceX Ku-band satellite transmit user beam at the maximum operational transmit EIRP level (for all conditions of modulation and traffic patterns). This will vary for each of the beams on the satellite because of their slightly different pointing directions.
2. The different spatial frequency re-use patterns used within each SpaceX satellite are then taken into account to derive a set of different aggregate EIRP density masks, one for each combination of co-frequency beams that is used. These satellite-aggregate EIRP masks will be different for each re-use pattern because of the relative pointing directions of the different beams.
3. As discussed above, user beams are turned off when the separation angle to the GSO arc is 22 degrees or less. In addition, the satellites radiate lower sidelobes towards the GSO arc, within a  $\pm 2$ deg zone around the GSO arc. These measures are reflected in the EIRP masks.
4. At latitudes above  $\pm 55^\circ$ , user beam EIRP is reduced by 2 dB for the 10.7-12.2 GHz band and by 3.5 dB for 12.2-12.7 GHz band.
5. The different EIRP masks are then converted to PFD masks (also as a function of Az/EI) by taking account of the spreading loss from the satellite to the surface of the Earth. The resulting PFD masks for each set of satellites are therefore a function of Az/EI and sub-satellite latitude.

SpaceX is also submitting the input data file containing the orbital parameters and other information concerning the SpaceX System necessary to run the EPFD validation software.

The data contained in this file is as follows:

1. The orbital parameters of the SpaceX System, consistent with the associated Schedule S.
2. The parameter entitled “nbr\_op\_sat” in Recommendation S.1503-2 (in Appendix 4 of the ITU Radio Regulations this is referred to as A.4.b.6.a). This is defined as the “[m]aximum number of non-geostationary satellites transmitting with overlapping frequencies to a given location within the latitude range.” The SpaceX System is designed such that only one satellite transmits to a given location in all latitude ranges. Accordingly, this parameter is set to 1 for purposes of the EPFD validation analysis.

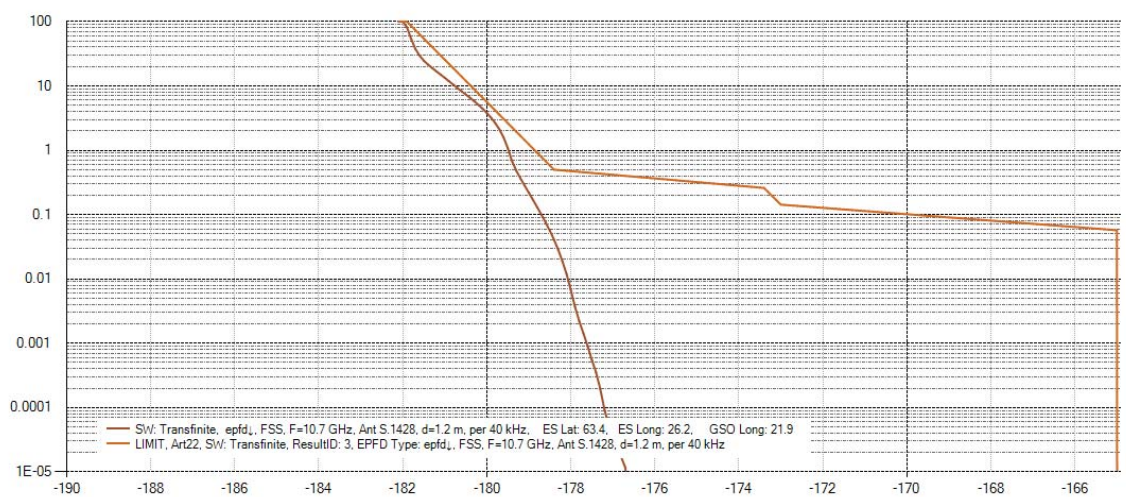
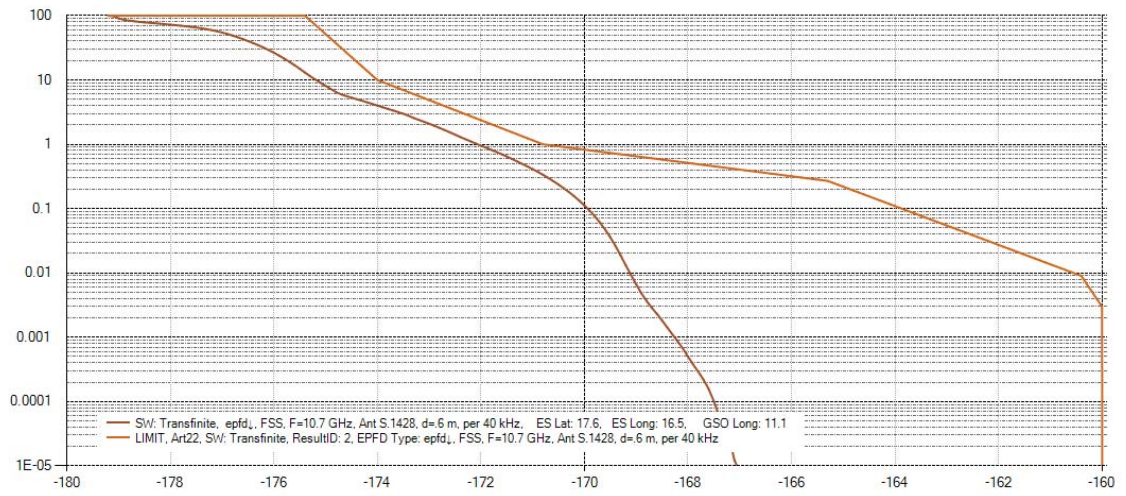
3. The parameter entitled “elev\_min” in Recommendation S.1503-2 (in Appendix 4 of the ITU Radio Regulations this is referred to as A.14.b.4). This is defined as the “[m]inimum elevation angle at which any associated earth station can transmit to a non-geostationary satellite.” This parameter is set to a value of 40° for both uplink and downlink transmissions.

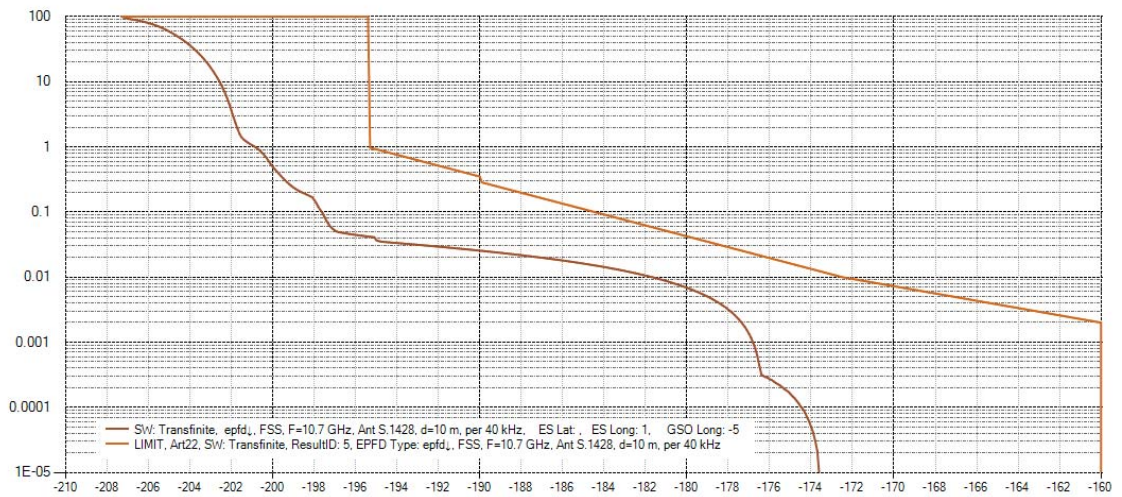
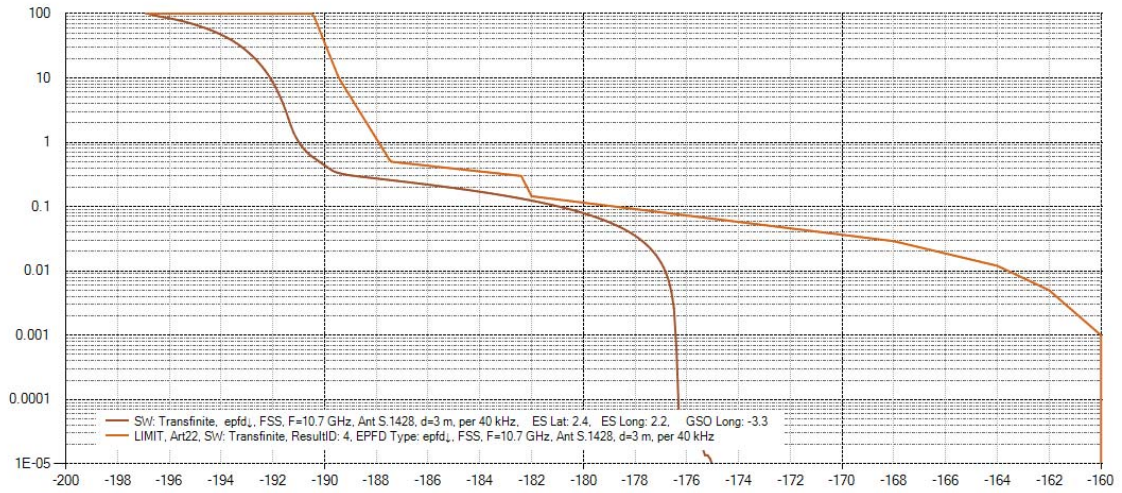
The Ku-band EPFD<sub>down</sub> results from the EPFD validation computer program using the input data described above are shown below, first for Fixed-Satellite Service (“FSS”) limits and then for Broadcasting-Satellite Service (“BSS”) limits.

Each plot corresponds to one of the GSO reference earth station antenna sizes from the EPFD limits. The labeling of each diagram provides the relevant details for each analysis generated by the software. On each diagram, the resulting EPFD level is shown by the red curve and the EPFD mask that applies is shown by the orange line. The determination by the EPFD validation software of the worst-case EPFD<sub>down</sub> results, as shown below, also takes into account the high latitude EPFD limits given in Table 2G of Section 25.208(g) for the GSO FSS and Table 21 of Section 25.208(l) for the GSO BSS, assuring compliance with all applicable limits.

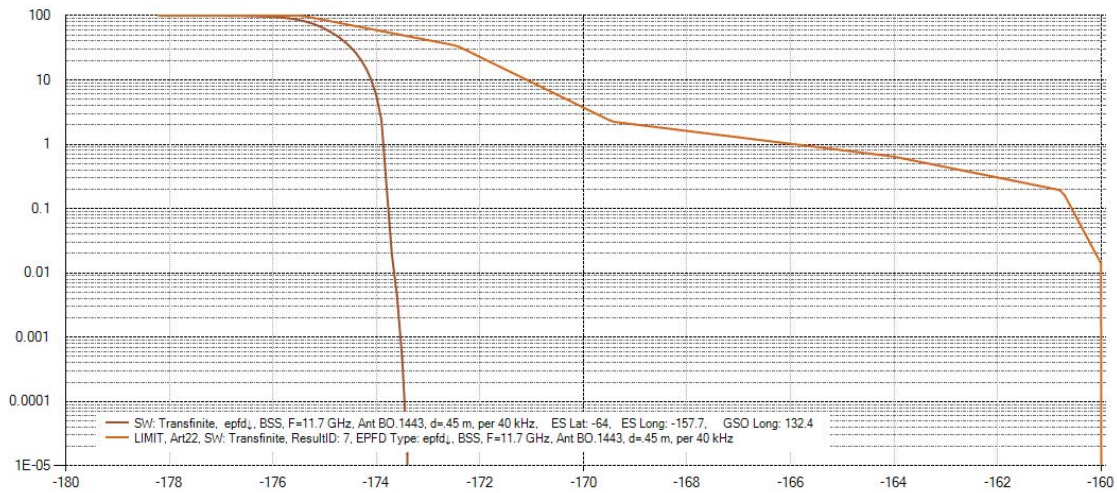
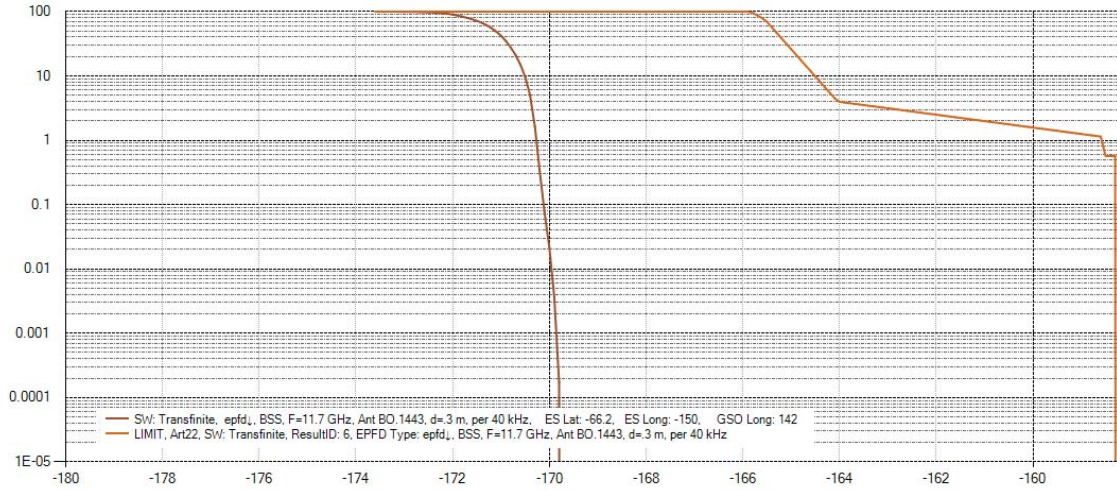


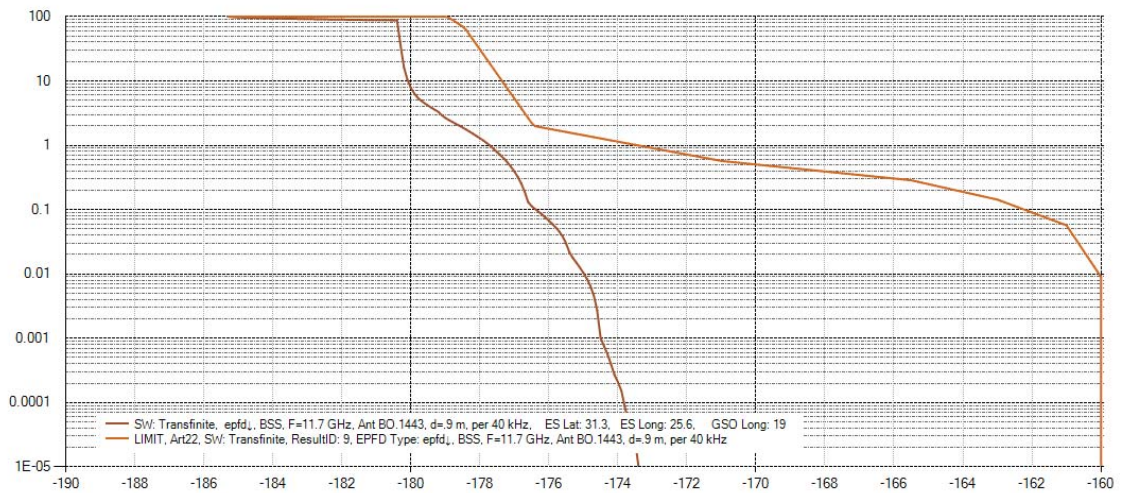
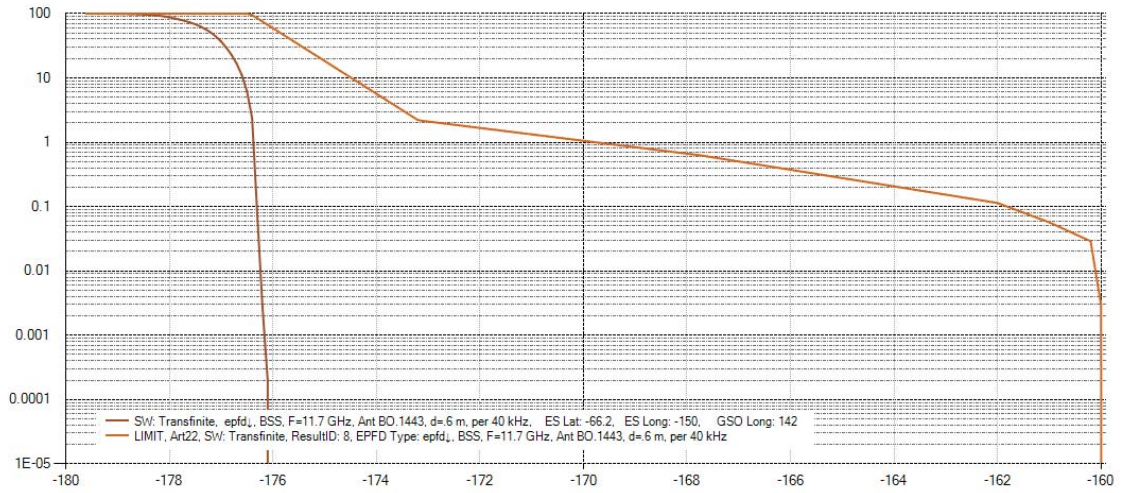
## Outputs for EPFD Assessment of FSS Limits

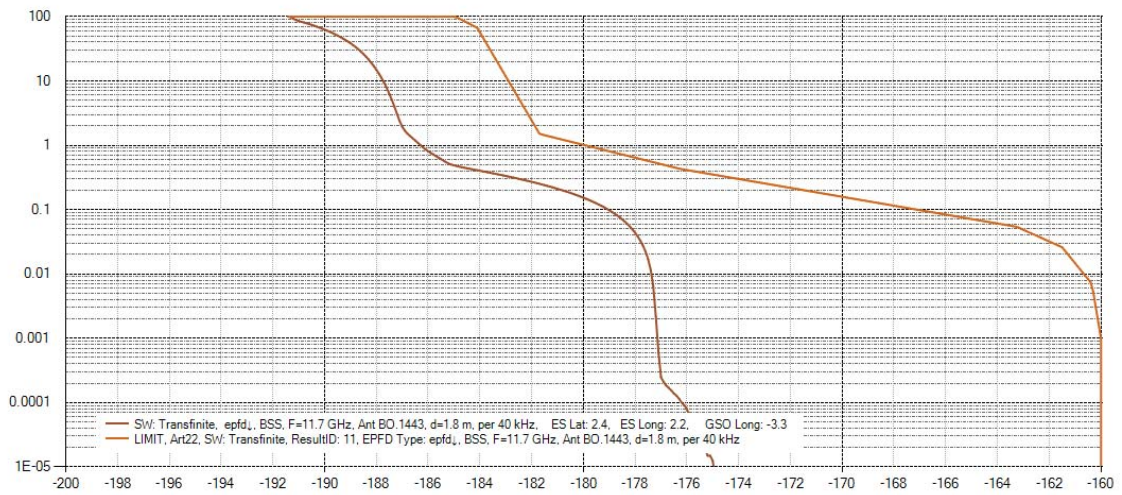
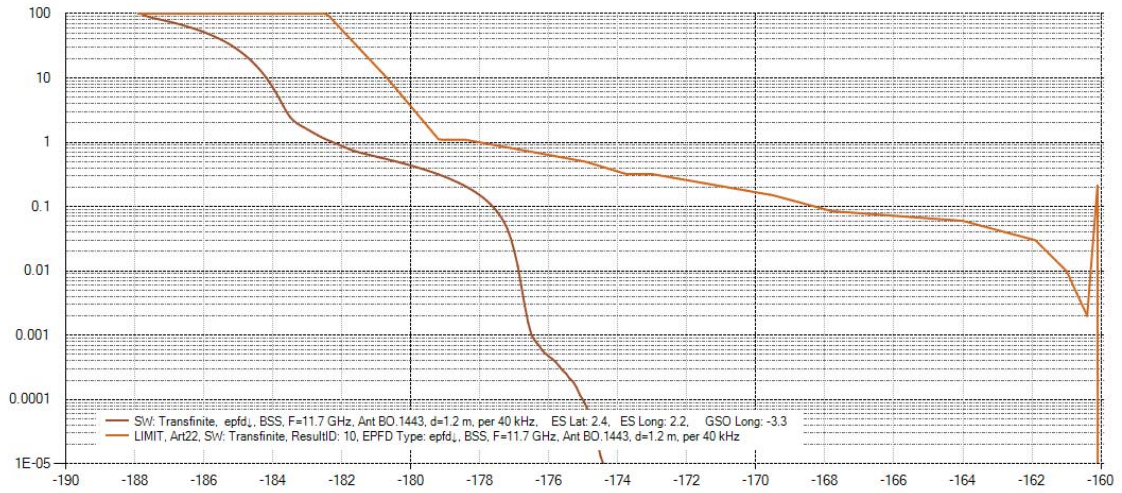


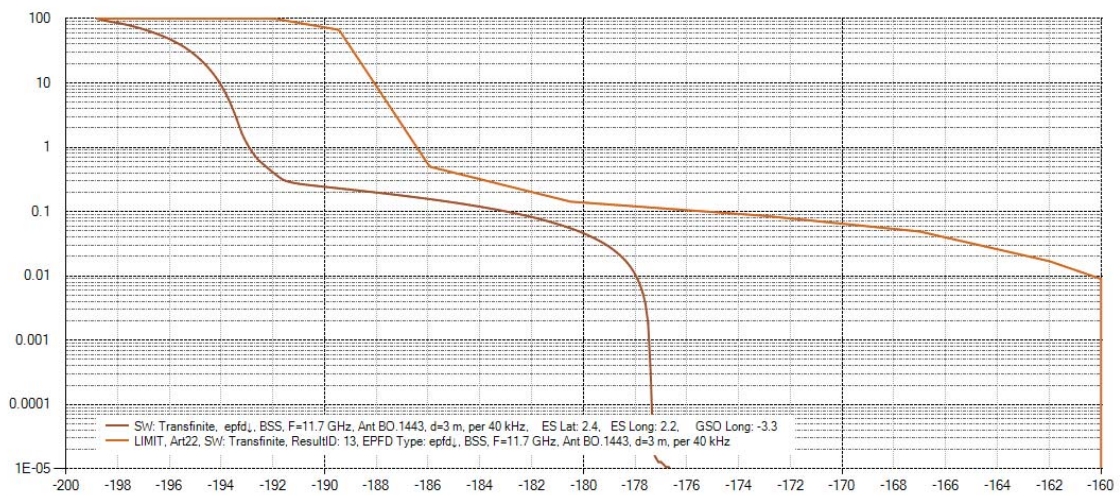
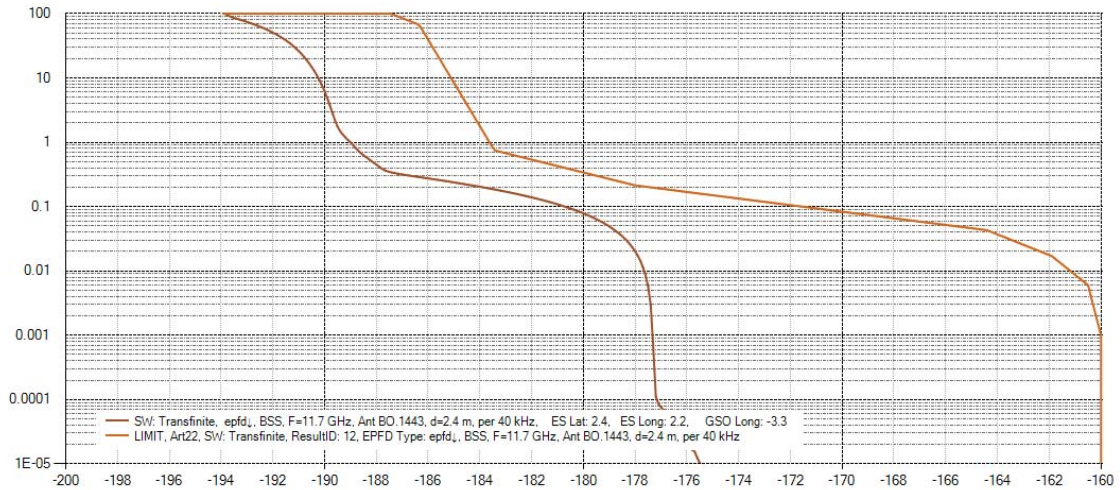


## Outputs for EPFD Assessment of BSS Limits









**EPFD<sub>up</sub> Compliance for User Links**

This section demonstrates SpaceX’s compliance with the single-entry EPFD limits with respect to Ku-band user uplinks. As discussed above, although the ITU has not yet approved a computer program for determining compliance with the EPFD validation limits, SpaceX has used the latest version of the Transfinite software under development for purposes of its EPFD analysis. SpaceX is submitting an executable copy of the

latest version of this computer program, along with input files necessary to demonstrate compliance with the single-entry validation EPFD limits in the Earth-to-space direction.

The first set of files contains the Ku-band earth station maximum off-axis EIRP masks for the user earth stations anticipated for use in the SpaceX System. These masks have been generated in accordance with the specification stipulated in Recommendation S.1503-2. The EIRP masks define the off-axis EIRP density of the Ku-band transmitting user earth stations as a function of off-axis angle. They were derived using a composite antenna pattern taking into account, for each angle off-boresight, the highest off-axis gain in all directions around that boresight. The masks then assume the off-axis gain is rotationally symmetric around the boresight of the antenna, and therefore represent a worst-case situation. According to Recommendation S.1503-2, they may be constant or variable as a function of the earth station latitude, but the simulations assume the same EIRP mask at all latitudes. A single EIRP mask is created that represents the highest on-axis and off-axis EIRP density levels (per 40 kHz) for any of the Ku-band transmitting user terminal earth stations, which does not depend upon earth station latitude, but is inclusive of all conditions of modulation and traffic patterns.

As discussed above, SpaceX will use advanced beam forming antenna technology to suppress sidelobe energy in the direction of the GSO arc. The nulling zone moves around as needed when the user earth station antenna is steered. This achieves an additional 10 dB sidelobe rejection for an area approximately  $\pm 2$  degrees around the GSO arc. Unfortunately, the software program used for this EPFD analysis does not capture this sidelobe nulling by earth stations used in the SpaceX System. However, as the earth station EIRP mask is only

used to calculate the earth station emissions toward the GSO arc, SpaceX has been able to model EIRP beyond the 22 degree GSO arc avoidance angle based on the sidelobe level in the nulling zone.

In addition, SpaceX is submitting a file that contains the orbital parameters and other data concerning the SpaceX System necessary to run the EPFD validation software.

The data contained in this file is as follows:

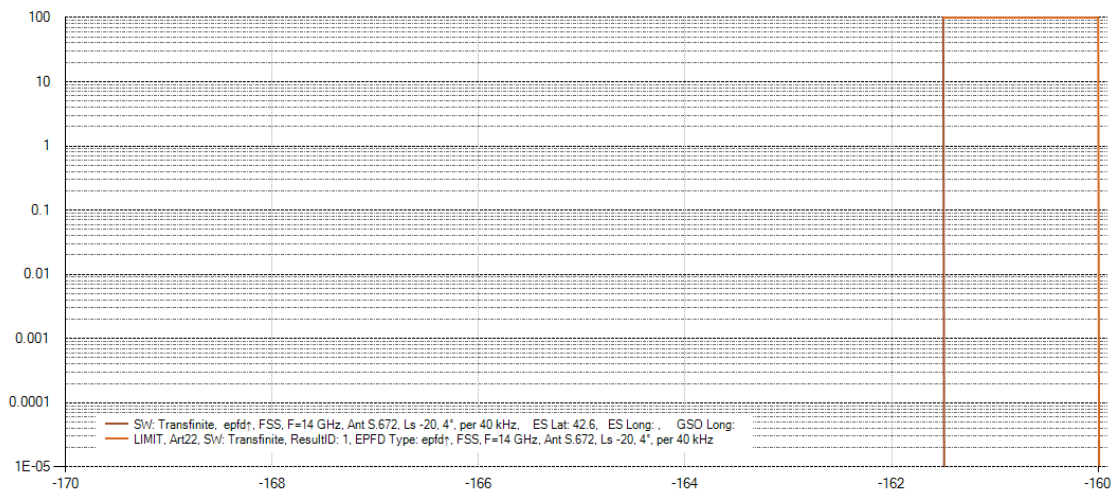
1. The orbital parameters of the SpaceX constellation, consistent with the associated Schedule S submission.
2. The parameter entitled “nbr\_sat\_td” in Recommendation S.1503-2 (in Appendix 4 of the ITU Radio Regulations this is referred to as A.4.b.7.a). This is defined as the “[m]aximum number of co-frequency tracked non-geostationary satellites receiving simultaneously.” The SpaceX System is designed such that only one satellite provides service to a given location. Accordingly, this parameter is set to 1 for purposes of the EPFD validation analysis.
3. The parameter entitled “density” in Recommendation S.1503-2 (in Appendix 4 of the ITU Radio Regulations this is referred to as A.4.b.7.b). This is defined as the “[a]verage number of associated earth stations transmitting with overlapping frequencies per km<sup>2</sup> in a cell.” The value of this parameter is related directly to the size of the aggregate beam coverage area from each SpaceX satellite, which is a hexagonal cell with a diameter of 45 km, and the maximum number of times an uplink frequency can be spatially re-used within this area. It is conservatively assumed that any uplink frequency will be re-used every other cell. Therefore, the average density will be  $1/((45)^2 * 3 * \sqrt{3}/4) = 0.000380$  earth stations per square kilometer.
4. The parameter entitled “avg\_dist” in Recommendation S.1503-2 (in Appendix 4 of the ITU Radio Regulations this is referred to as A.4.b.7.c). This is defined as the “[a]verage distance between co-frequency cells in kilometres.” The value of this parameter is directly related to the “density” value described above, and is in fact the square root of the inverse of the density value. This gives a value of 51.3 km as the average distance between co-frequency transmitting earth stations.
5. The parameter entitled “elev\_min” in Recommendation S.1503-2 (in Appendix 4 of the ITU Radio Regulations this is referred to as A.14.b.4). This is defined as the “[m]inimum elevation angle at which any associated earth station can



transmit to a non-geostationary satellite.” For the SpaceX Ku-band user terminals this parameter is set to 40°.

6. The parameter entitled “x\_zone” in Recommendation S.1503-2 (in Appendix 4 of the ITU Radio Regulations this is referred to as A.4.b.7.d.2). This is defined as the “[w]idth of the exclusion zone in degrees,” and is meant to reflect the minimum GSO avoidance angle measured at the surface of the Earth. For the SpaceX Ku-band user terminals this parameter is set to 22°.

The Ku-band EPFD<sub>up</sub> results from the EPFD validation computer program using the input data discussed above are shown below. The labeling of the diagram provides the relevant details for the analysis generated by the software. The resulting EPFD level is shown by the red curve and the EPFD mask is shown by the orange line.



**EPFD<sub>is</sub>:**

This section demonstrates SpaceX’s compliance with the EPFD<sub>is</sub> limits established in the ITU Radio Regulations for the Ku-band frequencies used by the SpaceX System.<sup>5</sup> These limits are intended to protect satellite operators in frequency ranges allocated to satellite

<sup>5</sup> The relevant bidirectional allocations exist in the 10.7-11.7 GHz and 12.5-12.7 GHz bands in ITU Region 1. See ITU Rad. Regs. No. 22.5F, Table 22-3.

services bi-directionally (*i.e.*, for both uplinks and downlinks). Although the Commission's rules applicable to Ku-band NGSO FSS systems do not include any reference to these EPFD<sub>is</sub> limits, we demonstrate below compliance with the -160 dBW/m<sup>2</sup>/40kHz limit that exists in the ITU Radio Regulations.

As discussed above, although the ITU has not yet approved a computer program for determining compliance with the EPFD validation limits, SpaceX has used the latest version of the software under development for purposes of its EPFD analysis. SpaceX is submitting with this application an executable copy of the latest version of this Transfinite computer program, along with input files necessary to demonstrate compliance with the single-entry validation for EPFD<sub>is</sub>.

The first set of files contains the Ku-band space vehicle maximum off-axis EIRP masks for the user earth stations anticipated for use in the SpaceX System. These masks have been generated in accordance with the specification stipulated in Recommendation S.1503-2. The EIRP masks define the off-axis EIRP density of the Ku-band transmitting earth stations as a function of off-axis angle. They were derived using a composite antenna pattern taking into account, for each angle off-boresight, the highest off-axis gain in all directions around that boresight. The masks then assume the off-axis gain is rotationally symmetric around the boresight of the antenna, and therefore represent a worst-case situation. According to Recommendation S.1503-2, they may be constant or variable as a function of the satellite latitude, but the simulations assume the same EIRP mask at all latitudes. A single EIRP mask is created that represents the highest on-axis and off-axis EIRP density levels (per 40 kHz) for any of the Ku-band transmitting satellites,

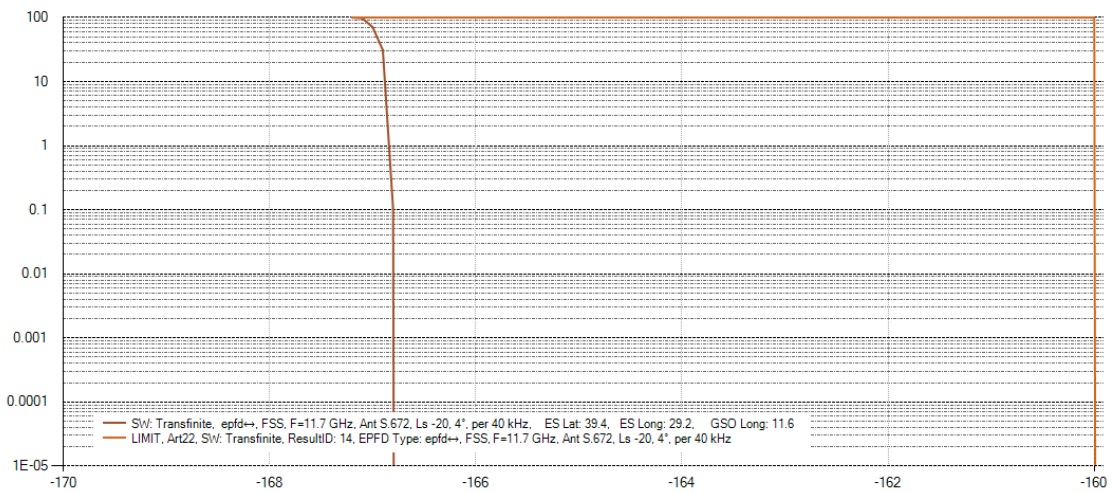
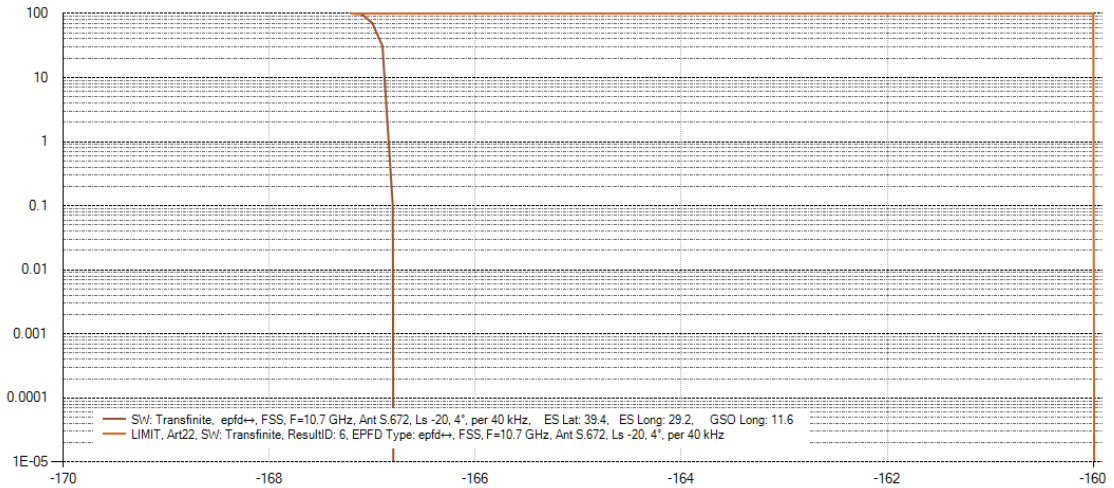
which does not depend upon satellite latitude, but is inclusive of all conditions of modulation and traffic patterns.

In addition, SpaceX is submitting a file that contains the orbital parameters and other data concerning the SpaceX System necessary to run the EPFD validation software.

The data contained in this file is as follows:

1. The orbital parameters of the SpaceX constellation, consistent with the associated Schedule S submission.
2. The parameter entitled “elev\_min” in Recommendation S.1503-2 (in Appendix 4 of the ITU Radio Regulations this is referred to as A.14.b.4). This is defined as the “[m]inimum elevation angle at which any associated earth station can transmit to a non-geostationary satellite.” For the SpaceX Ku-band user terminals this parameter is set to 40°.
3. The parameter entitled “x\_zone” in Recommendation S.1503-2 (in Appendix 4 of the ITU Radio Regulations this is referred to as A.4.b.7.d.2). It is defined as the “[w]idth of the exclusion zone in degrees,” and is meant to reflect the minimum GSO avoidance angle measured at the surface of the Earth. For the SpaceX Ku-band user terminals this parameter is set to 22°.

The Ku-band EPFD<sub>is</sub> results from the EPFD validation computer program using the input data discussed above are shown below. The labeling of each diagram provides the relevant details for each analysis generated by the software. The resulting EPFD level is shown by the red curve and the EPFD mask is shown by the orange line.



### EPFD<sub>up</sub> Compliance for TT&C Links

This section demonstrates SpaceX’s compliance with the single-entry EPFD limits with respect to Ku-band TT&C links. As discussed above, although the ITU has not yet approved a computer program for determining compliance with the EPFD validation limits, SpaceX has used the latest version of the Transfinite software under development for purposes of its EPFD analysis. SpaceX is submitting an executable copy of the

latest version of this computer program, along with input files necessary to demonstrate compliance with the single-entry validation EPFD limits in the Earth-to-space direction.<sup>6</sup>

The first set of files contains the Ku-band earth station maximum off-axis EIRP masks for the TT&C earth stations anticipated for use in the SpaceX System. These masks have been generated in accordance with the specification stipulated in Recommendation S.1503-2. The EIRP masks define the off-axis EIRP density of the Ku-band transmitting user earth stations as a function of off-axis angle. They were derived using a composite antenna pattern taking into account, for each angle off-boresight, the highest off-axis gain in all directions around that boresight. The masks then assume the off-axis gain is rotationally symmetric around the boresight of the antenna, and therefore represent a worst-case situation. According to Recommendation S.1503-2, they may be constant or variable as a function of the earth station latitude, but the simulations assume the same EIRP mask at all latitudes. A single EIRP mask is created that represents the highest on-axis and off-axis EIRP density levels (per 40 kHz) for any of the Ku-band transmitting TT&C earth stations, which does not depend upon earth station latitude, but is inclusive of all conditions of modulation and traffic patterns.

In addition, SpaceX is submitting a file that contains the orbital parameters and other data concerning the SpaceX System necessary to run the EPFD validation software.

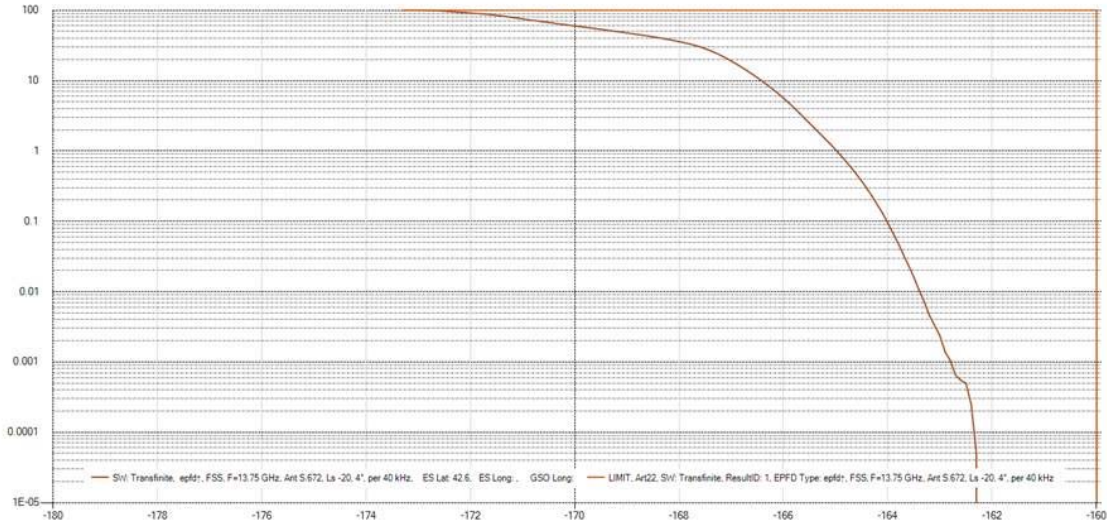
The data contained in this file is as follows:

---

<sup>6</sup> The discussion in this section relates solely to uplink operations, but the files required to run the EPFD validation software require information for both uplink and downlink. Accordingly, SpaceX is submitting the information discussed in this section for its TT&C uplinks along with dummy information with respect to the downlinks.

1. The orbital parameters of the SpaceX constellation, consistent with the associated Schedule S submission.
2. The parameter entitled “nbr\_sat\_td” in Recommendation S.1503-2 (in Appendix 4 of the ITU Radio Regulations this is referred to as A.4.b.7.a). This is defined as the “[m]aximum number of co-frequency tracked non-geostationary satellites receiving simultaneously.” The SpaceX System is designed such that its TT&C stations support only five satellites at a time from a given location. Accordingly, this parameter is set to 5 for purposes of the EPFD validation analysis.
3. The parameter entitled “avg\_dist” in Recommendation S.1503-2 (in Appendix 4 of the ITU Radio Regulations this is referred to as A.4.b.7.c). This is defined as the “[a]verage distance between co-frequency cells in kilometres.” Conservatively, we use 3600 km, which is the minimum distance between two TT&C sites.
4. The parameter entitled “density” in Recommendation S.1503-2 (in Appendix 4 of the ITU Radio Regulations this is referred to as A.4.b.7.b). This is defined as the “[a]verage number of associated earth stations transmitting with overlapping frequencies per km<sup>2</sup> in a cell.” The value of this parameter is directly related to the average distance described above, and is in fact the square of the inverse of the average distance value. Therefore, the average density will be  $1/3600^2 = 7.716 \times 10^{-8}$  earth stations per square kilometer.
5. The parameter entitled “elev\_min” in Recommendation S.1503-2 (in Appendix 4 of the ITU Radio Regulations this is referred to as A.14.b.4). This is defined as the “[m]inimum elevation angle at which any associated earth station can transmit to a non-geostationary satellite.” For the SpaceX Ku-band TT&C stations this parameter is set to 5° as TT&C links only operate at elevations over 5deg.
6. The parameter entitled “x\_zone” in Recommendation S.1503-2 (in Appendix 4 of the ITU Radio Regulations this is referred to as A.4.b.7.d.2). This is defined as the “[w]idth of the exclusion zone in degrees,” and is meant to reflect the minimum GSO avoidance angle measured at the surface of the Earth. For the SpaceX Ku-band TT&C stations this parameter is set to 12°.

The Ku-band EPFD<sub>up</sub> results from the EPFD validation computer program using the input data discussed above are shown below. The labeling of the diagram provides the relevant details for the analysis generated by the software. The resulting EPFD level is shown by the red curve and the EPFD mask is shown by the orange line.



**Other Rules Related to EPFD:**

SpaceX will comply at the appropriate time with the requirements of Sections 25.146(b) and 25.146(g) of the Commission’s rules for additional submissions ninety days prior to the initiation of service to the public.

SpaceX confirms, consistent with Section 25.146(e), that it is not claiming interference protection from GSO FSS and BSS networks operating in accordance with the Commission’s Part 25 rules and the ITU Radio Regulations.

SpaceX confirms it will coordinate with the very large GSO FSS earth stations in the 10.7-12.75 GHz band under the conditions described in Section 25.146(f).

## ANNEX 2

### **Demonstration of EPFD Compliance for Ka-Band Operations**

This annex provides a detailed explanation of the equivalent power flux-density (“EPFD”) levels produced by the SpaceX System in Ka-band and how they comply with applicable single-entry EPFD validation limits. This comprehensive technical showing demonstrates that the SpaceX System will not exceed the single-entry validation EPFD limits in Ka-band as specified in Nos. 22.5C, 22.5D and 22.5F of the ITU Radio Regulations<sup>1</sup> for the space-to-Earth direction (EPFD<sub>down</sub>), the Earth-to-space direction (EPFD<sub>up</sub>), and for transmissions between satellites in orbit where spectrum is allocated bi-directionally (EPFD<sub>is</sub>). As discussed in Annex 1, SpaceX employs several strategies to reduce EPFD levels of its system. These include a GSO arc avoidance area of  $\pm 22$  degrees, as well as sophisticated beam forming and sidelobe nulling by the phased array antennas used by the system that achieve an additional 10 dB sidelobe rejection in the area closest to the GSO arc.

#### **EPFD<sub>down</sub> Compliance for Gateway Links**

This section demonstrates SpaceX’s compliance with the single-entry EPFD limits with respect to its Ka-band gateway downlinks. As discussed in Annex 1, although the ITU has not yet approved a computer program for determining compliance with the single-entry EPFD validation limits, SpaceX has used the latest version of the Transfinite software under development for purposes of its EPFD analysis. SpaceX is submitting an executable copy of the latest version of this computer program, along with input files

---

<sup>1</sup> There are no EPFD limits for Ka-band in the Commission’s Part 25 rules.



necessary to demonstrate compliance with the single-entry validation EPFD limits in the space-to-Earth direction (EPFD<sub>down</sub>) in the Ka-band.

The first set of computer files contains the sets of Ka-band power flux-density (“PFD”) masks for each space station in the SpaceX System. These masks define the maximum satellite downlink PFD in Ka-band over the surface of the Earth that is visible to the satellite and capture contributions from transmissions using both polarizations (RHCP and LHCP) used for Ka-band gateway links. The PFD masks are expressed as a function of the azimuth (“Az”) and elevation (“El”) angles as viewed from the satellite towards the Earth relative to nadir.<sup>2</sup>

The PFD masks submitted with this application have been generated in accordance with the specification stipulated in Recommendation S.1503-2, using the following methodology and assumptions related to the actual design and real-world operation of the SpaceX System:

1. We start with the two dimensional (as a function of Az/El) EIRP density mask for a single SpaceX Ka-band satellite gateway transmit beam at the maximum operational transmit EIRP level (for all conditions of modulation and traffic patterns). This will vary for each of the beams on the satellite because of their slightly different pointing directions.
2. The different spatial frequency re-use patterns used within each SpaceX satellite are then taken into account to derive a set of different aggregate EIRP density masks, one for each combination of co-frequency beams that is used. These satellite-aggregate EIRP masks will be different for each re-use pattern because of the relative pointing directions of the different beams.
3. As discussed above, gateway beams are turned off when the separation angle to the GSO arc is 22 degrees or less. In addition, the satellites radiate lower sidelobes

---

<sup>2</sup> Azimuth is in the East-West direction and elevation is in the North-South direction, as seen at the sub-satellite point.

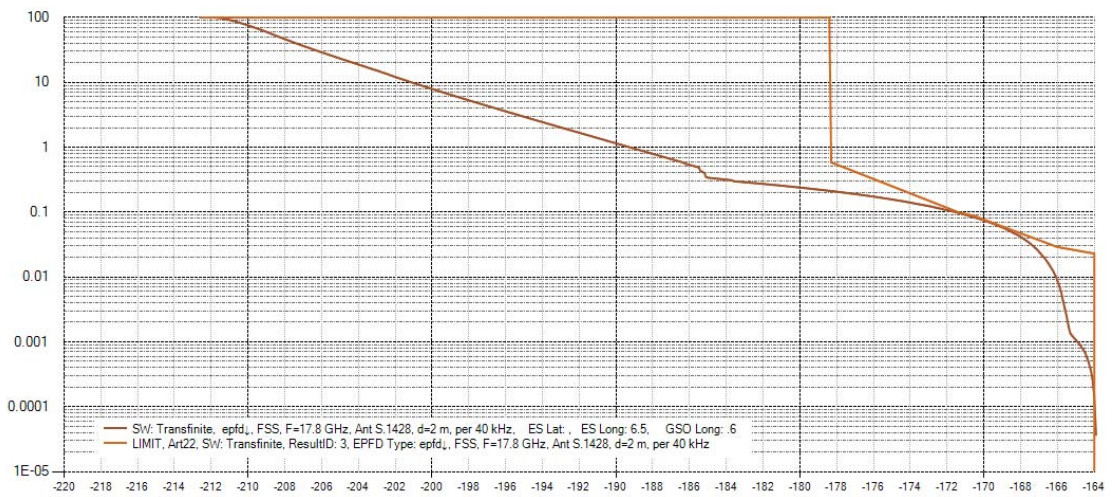
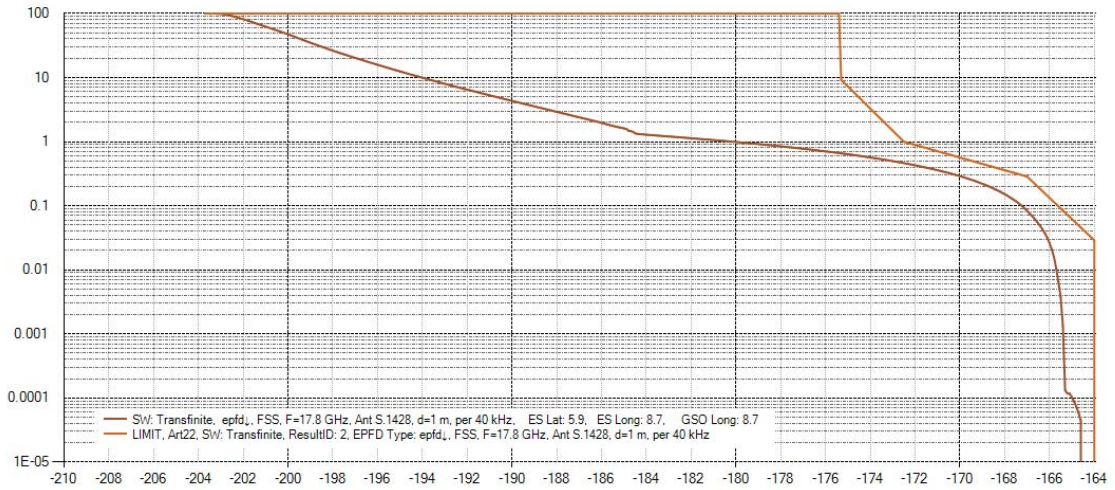
toward the GSO arc, within a  $\pm 2$  degree zone around the GSO arc. These measures are reflected in the EIRP masks.

4. The different EIRP masks are then converted to PFD masks (also as a function of Az/EI) by taking account of the spreading loss from the satellite to the surface of the Earth. The resulting PFD masks for each set of satellites are therefore a function of Az/EI and sub-satellite latitude.

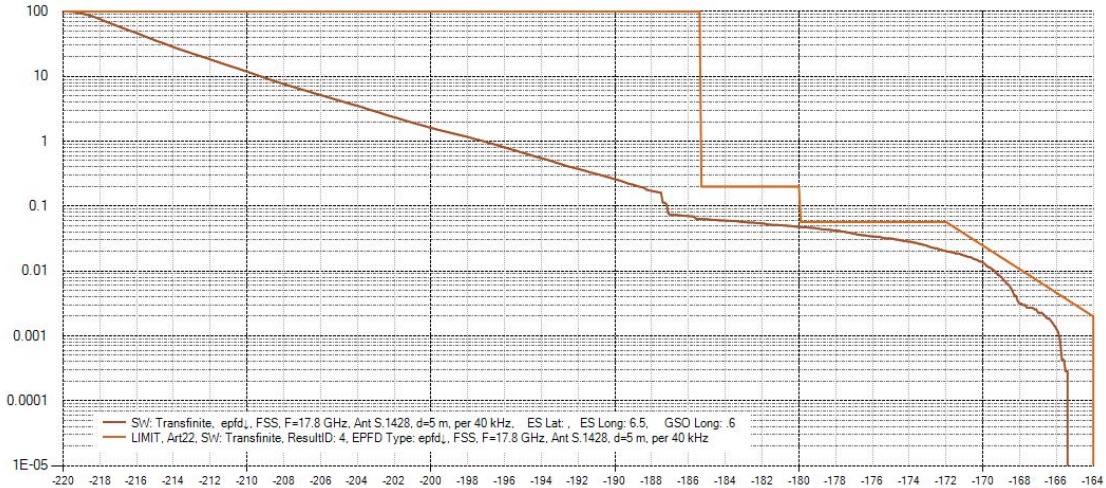
SpaceX is also submitting the input data file needed to run the EPFD analysis to validate the EPFD<sub>down</sub> levels. This file contains the orbital parameters and other data concerning the SpaceX System necessary to run the EPFD validation software. The data contained in this file is as follows:

1. The orbital parameters of the SpaceX System, consistent with the associated Schedule S.
2. The parameter entitled “nbr\_op\_sat” in Recommendation S.1503-2 (in Appendix 4 of the ITU Radio Regulations this is referred to as A.4.b.6.a). This is defined as the “[m]aximum number of non-geostationary satellites transmitting with overlapping frequencies to a given location within the latitude range.” The SpaceX System is designed such that no more than four satellites are supported by a given gateway location. Accordingly, this parameter is set to 4 for purposes of the EPFD validation analysis.
3. The parameter entitled “elev\_min” in Recommendation S.1503-2 (in Appendix 4 of the ITU Radio Regulations this is referred to as A.14.b.4). This is defined as the “[m]inimum elevation angle at which any associated earth station can transmit to a non-geostationary satellite.” This parameter is set to a value of 40° for both uplink and downlink gateway transmissions.

The Ka-band EPFD<sub>down</sub> results from the EPFD validation computer program using the input data described above are shown below. Each plot corresponds to one of the GSO reference earth station antenna sizes from the EPFD limits. The labeling of each diagram provides the relevant details for each analysis generated by the software. The resulting EPFD level is shown by the red curve and the EPFD mask that applies is shown by the orange line.



Annex 2-4



### EPFD<sub>up</sub> Compliance

This section demonstrates SpaceX’s compliance with the single-entry EPFD limits with respect to Ka-band gateway uplinks. As discussed above, although the ITU has not yet approved a computer program for determining compliance with the EPFD validation limits, SpaceX has used the latest version of the Transfinite EPFD validation software under development for purposes of its analysis. SpaceX is submitting an executable copy of the latest version of this computer program, along with input files necessary to demonstrate compliance with the single-entry validation EPFD limits in the Earth-to-space direction (EPFD<sub>up</sub>).

The first set of files contains the Ka-band earth station maximum off-axis EIRP masks for the gateway earth stations anticipated for use in the SpaceX System. These masks have been generated in accordance with the specification stipulated in Recommendation S.1503-2. The EIRP masks define the off-axis EIRP density of the Ka-band transmitting earth stations as a function of off-axis angle. They were derived

using a composite antenna pattern taking into account, for each angle off-boresight, the highest off-axis gain in all directions around that boresight. The masks then assume the off-axis gain is rotationally symmetric around the boresight of the antenna, and therefore represent a worst-case situation. According to Recommendation S.1503-2, they may be constant or variable as a function of the earth station latitude, but the simulations assume the same EIRP mask at all latitudes. A single EIRP mask is created that represents the highest on-axis and off-axis EIRP density levels (per 40 kHz) for any of the Ka-band transmitting gateway earth stations, which does not depend upon earth station latitude, but is inclusive of all conditions of modulation and traffic patterns.

As discussed above, SpaceX will use advanced beam forming antenna technology to suppress sidelobe energy in the direction of the GSO arc. The nulling zone moves around as needed when the gateway earth station antenna is steered. This achieves an additional 10 dB sidelobe rejection for an area approximately  $\pm 2$  degrees around the GSO arc. Unfortunately, the software program used for this EPFD analysis does not capture this sidelobe nulling by earth stations used in the SpaceX System. However, as the earth station EIRP mask is only used to calculate the earth station emissions toward the GSO arc, SpaceX has been able to model EIRP beyond the 22 degree GSO arc avoidance angle based on the sidelobe level in the nulling zone.

In addition, SpaceX is submitting a file that contains the orbital parameters and other data concerning the SpaceX System necessary to run the EPFD validation software.

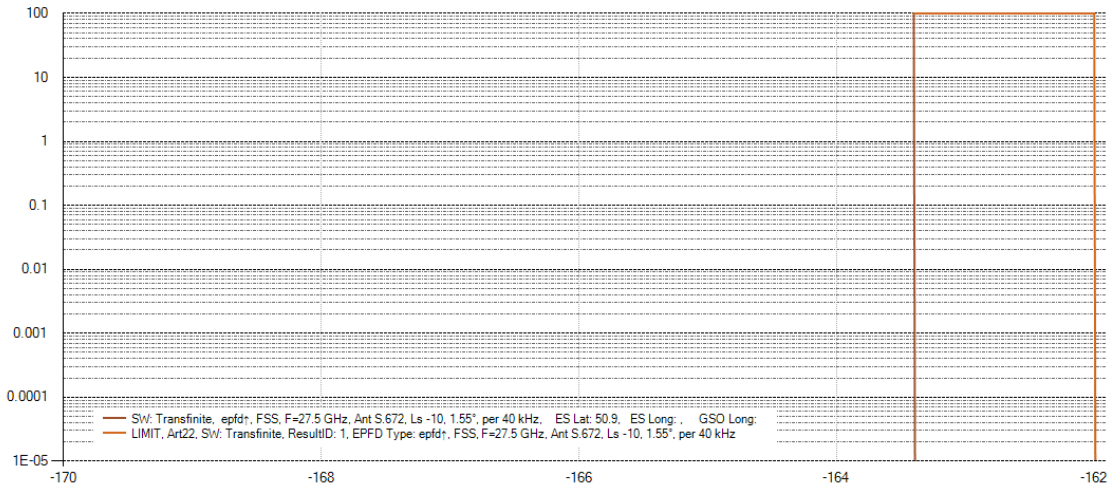
The data contained in this file is as follows:

1. The orbital parameters of the SpaceX constellation, consistent with the associated Schedule S submission.

2. The parameter entitled “nbr\_sat\_td” in Recommendation S.1503-2 (in Appendix 4 of the ITU Radio Regulations this is referred to as A.4.b.7.a). This is defined as the “[m]aximum number of co-frequency tracked non-geostationary satellites receiving simultaneously.” The SpaceX System is designed such that no more than four satellites are supported by a given gateway location. Accordingly, this parameter is set to 4 for purposes of the EPFD validation analysis.
3. The parameter entitled “density” in Recommendation S.1503-2 (in Appendix 4 of the ITU Radio Regulations this is referred to as A.4.b.7.b). This is defined as the “[a]verage number of associated earth stations transmitting with overlapping frequencies per km<sup>2</sup> in a cell.” In order to determine a value for this parameter, SpaceX estimated the number of satellites that would be visible at an elevation angle of at least 40 degrees across the contiguous United States (“CONUS”) in the fully-deployed constellation in order to estimate the number of gateway earth stations in CONUS that would be used to support those satellites. SpaceX estimates that 340 satellites would be visible in CONUS, and would be supported by a maximum simultaneous number of 170 total gateways. Assuming that the area of CONUS is approximately 8,000,000 km<sup>2</sup>, the average density can be estimated as  $170/8,000,000=0.00002125$  earth stations per square kilometer. Conservatively, we use 0.00003 in simulations.
4. The parameter entitled “avg\_dist” in Recommendation S.1503-2 (in Appendix 4 of the ITU Radio Regulations this is referred to as A.4.b.7.c). This is defined as the “[a]verage distance between co-frequency cells in kilometres.” The value of this parameter is directly related to the “density” value described above, and is in fact the square root of the inverse of the density value. This gives a value of 183 km as the average distance between co-frequency transmitting earth stations.
5. The parameter entitled “elev\_min” in Recommendation S.1503-2 (in Appendix 4 of the ITU Radio Regulations this is referred to as A.14.b.4). This is defined as the “[m]inimum elevation angle at which any associated earth station can transmit to a non-geostationary satellite.” For the SpaceX Ka-band gateways this parameter is set to 40°.
6. The parameter entitled “x\_zone” in Recommendation S.1503-2 (in Appendix 4 of the ITU Radio Regulations this is referred to as A.4.b.7.d.2). It is defined as the “[w]idth of the exclusion zone in degrees,” and is meant to reflect the minimum GSO avoidance angle measured at the surface of the Earth. For the SpaceX Ku-band gateways this parameter is set to 22°.

The Ka-band EPFD<sub>up</sub> results from the EPFD validation computer program using the input data discussed above are shown below. The labeling of each diagram provides

the relevant details for each analysis generated by the software. The resulting EPFD level is shown by the red curve and the EPFD mask is shown by the orange line.



### EPFD<sub>is</sub>:

In this section, we demonstrate that the SpaceX System complies with the EPFD<sub>is</sub> limit established in the ITU Radio Regulations for the Ka-band frequencies used by the SpaceX System.<sup>3</sup> These limits are intended to protect satellite operators in frequency ranges allocated to satellite services bi-directionally (*i.e.*, for both uplinks and downlinks). Although the Commission’s rules applicable to Ka-band NGSO FSS systems do not include any reference to these EPFD<sub>is</sub> limits, we demonstrate below compliance with the -160 dBW/m<sup>2</sup>/40kHz limit that exists in the ITU Radio Regulations.

As discussed above, although the ITU has not yet approved a computer program for determining compliance with the EPFD validation limits, SpaceX has used the latest

<sup>3</sup> The relevant bi-directional allocations exist in the 17.8-18.4 GHz band in all ITU Regions. See ITU Rad. Regs. No. 22.5F, Table 22-3.

version of the Transfinite software under development for purposes of its EPFD analysis. SpaceX is submitting with this application an executable copy of the latest version of this computer program, along with input files necessary to demonstrate compliance with the single-entry validation for EPFD<sub>is</sub>.

The first set of files contains the Ka-band space vehicle maximum off-axis EIRP masks for the earth stations anticipated for use in the SpaceX System. These masks have been generated in accordance with the specification stipulated in Recommendation S.1503-2. The EIRP masks define the off-axis EIRP density of the Ku-band transmitting earth stations as a function of off-axis angle. They were derived using a composite antenna pattern taking into account, for each angle off-boresight, the highest off-axis gain in all directions around that boresight. The masks then assume the off-axis gain is rotationally symmetric around the boresight of the antenna, and therefore represent a worst-case situation. According to Recommendation S.1503-2, they may be constant or variable as a function of the satellite latitude, but the simulations assume the same EIRP mask at all latitudes. A single EIRP mask is created that represents the highest on-axis and off-axis EIRP density levels (per 40 kHz) for any of the Ku-band transmitting satellites, which does not depend upon satellite latitude, but inclusive of all conditions of modulation and traffic patterns.

In addition, SpaceX is submitting a file that contains the orbital parameters and other data concerning the SpaceX System necessary to run the EPFD validation software.

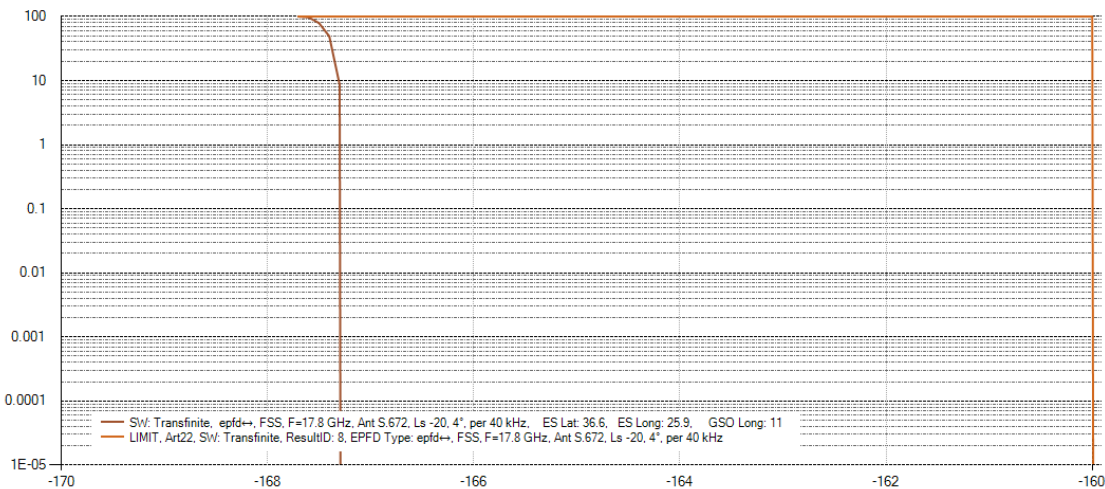
The data contained in this file is as follows:

1. The orbital parameters of the SpaceX constellation, consistent with the associated Schedule S.



2. The parameter entitled “elev\_min” in Recommendation S.1503-2 (in Appendix 4 of the ITU Radio Regulations this is referred to as A.14.b.4). This is defined as “the minimum elevation angle at which any associated earth station can transmit to a non-geostationary satellite.” For the SpaceX Ka-band gateways this parameter is set to 40°.
3. The parameter entitled “x\_zone” in Recommendation S.1503-2 (in Appendix 4 of the ITU Radio Regulations this is referred to as A.4.b.7.d.2). It is defined as the “[w]idth of the exclusion zone in degrees,” and is meant to reflect the minimum GSO avoidance angle measured at the surface of the Earth. For the SpaceX Ka-band gateways this parameter is set to 22°.

The Ka-band EPFD<sub>is</sub> results from the EPFD validation computer program using the input data discussed above are shown below. The labeling of each diagram provides the relevant details for each analysis generated by the software. The resulting EPFD level is shown by the red curve and the EPFD mask is shown by the orange line.



### EPFD<sub>down</sub> Compliance for TT&C Operations

This section demonstrates SpaceX’s compliance with the single-entry EPFD limits with respect to its Ka-band TT&C operations. SpaceX is submitting an executable copy of the latest version of the computer program for determining

compliance with the EPFD validation limits discussed above, along with input files necessary to demonstrate compliance with the single-entry validation EPFD limits in the space-to-Earth direction ( $EPFD_{down}$ ) in the Ka-band.<sup>4</sup>

The first set of computer files submitted with respect to TT&C contains the sets of Ka-band power flux-density (“PFD”) masks for each space station in the SpaceX System.<sup>5</sup> These masks define the maximum satellite downlink PFD in Ka-band over the surface of the Earth that is visible to the satellite. The PFD masks are expressed as a function of the azimuth (“Az”) and elevation (“El”) angles as viewed from the satellite towards the Earth relative to nadir.<sup>6</sup>

The PFD masks submitted with this application have been generated in accordance with the specification stipulated in Recommendation S.1503-2, using the following methodology and assumptions related to the actual design and real-world operation of the SpaceX System:

1. We start with the two dimensional (as a function of Az/El) EIRP density mask for a single SpaceX Ka-band satellite TT&C transmit beam at the maximum operational transmit EIRP level (for all conditions of modulation and traffic patterns).

---

<sup>4</sup> The discussion in this section relates solely to downlink operations, but the files required to run the EPFD validation software require information for both uplink and downlink. Accordingly, SpaceX is submitting the information discussed in this section for its TT&C downlinks along with dummy information with respect to the uplinks. Note that the Ka-band spectrum used for TT&C operations (18.55-18.6 GHz) falls outside the bands for which ITU regulations define  $EPFD_{is}$  limits (18.8-19.3 GHz). Accordingly, there is no corresponding discussion of  $EPFD_{up}$  and  $EPFD_{is}$  compliance with respect to TT&C operations.

<sup>5</sup> Note that the SpaceX satellite TT&C antennas are omni-directional and are designed to be able to communicate with earth stations at virtually any attitude in order to ensure continued communications capability.

<sup>6</sup> Azimuth is in the East-West direction and elevation is in the North-South direction, as seen at the sub-satellite point.

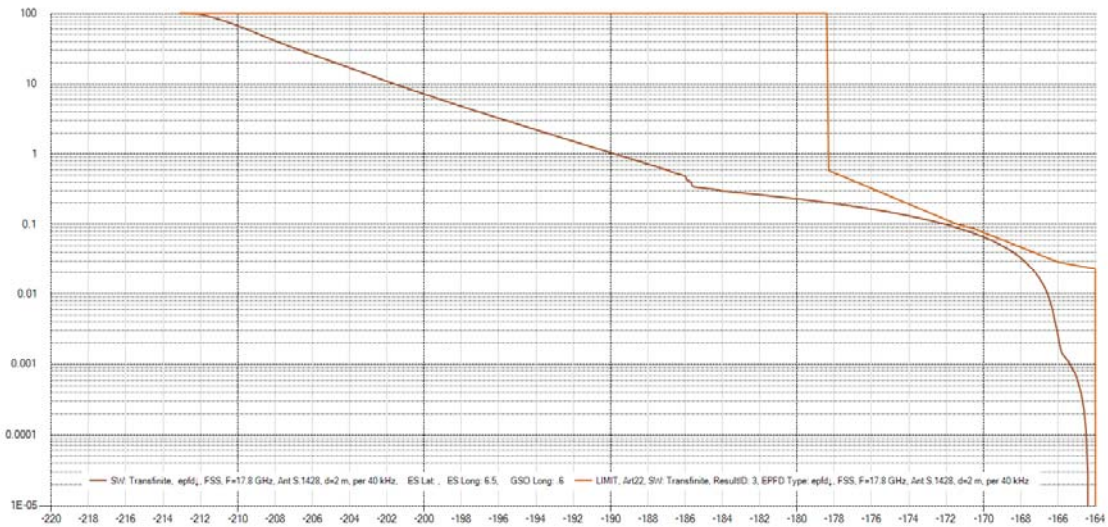
2. Unlike the gateway links discussed above, SpaceX's TT&C beams use omnidirectional antennas that will radiate toward the GSO arc. Accordingly, the EIRP mask does not reflect any GSO separation angle or sidelobe suppression effects. Conservatively, given that TT&C has to work when satellite has lost attitude control, we use the maximum EIRP when generating the PFD masks.
3. The EIRP mask is then converted to a PFD (also as a function of Az/EI) by taking account of the spreading loss from the satellite to the surface of the Earth. The resulting PFD mask is therefore a function of Az/EI and sub-satellite latitude.

SpaceX is also submitting the input data file needed to run the EPFD analysis to validate the EPFD<sub>down</sub> levels for its TT&C operations in the Ka-band. This file contains the orbital parameters and other data concerning the SpaceX System necessary to run the EPFD validation software. The data contained in this file is as follows:

1. The orbital parameters of the SpaceX System, consistent with the associated Schedule S.
2. The parameter entitled "nbr\_op\_sat" in Recommendation S.1503-2 (in Appendix 4 of the ITU Radio Regulations this is referred to as A.4.b.6.a). This is defined as the "[m]aximum number of non-geostationary satellites transmitting with overlapping frequencies to a given location within the latitude range." The SpaceX System is designed such that no more than five satellites at a time will communicate with a TT&C facility at a given location. Accordingly, this parameter is set to 5 for purposes of the EPFD validation analysis.
3. The parameter entitled "elev\_min" in Recommendation S.1503-2 (in Appendix 4 of the ITU Radio Regulations this is referred to as A.14.b.4). This is defined as the "[m]inimum elevation angle at which any associated earth station can transmit to a non-geostationary satellite." In order to capture a worst case, this parameter is set to a value of 0° for downlink transmissions.

The Ka-band EPFD<sub>down</sub> results from the EPFD validation computer program using the input data described above are shown below. Each plot corresponds to one of the GSO reference earth station antenna sizes from the EPFD limits. The labeling of each diagram provides the relevant details for each analysis generated by the software. The

resulting EPFD level is shown by the red curve and the EPFD mask that applies is shown by the orange line.





**Other Rules Related to EPFD:**

SpaceX confirms that it is not claiming interference protection from GSO FSS and BSS networks operating in accordance with the Commission’s Part 25 rules and the ITU Radio Regulations.

SpaceX also confirms that it will coordinate with very large GSO FSS earth stations in the 17.8-18.6 GHz band, consistent with Appendix 5, Table 5-1, Nos. 9.7A and 9.7B, of the ITU Radio Regulations.

## ENGINEERING CERTIFICATION

I hereby certify that I am the technically qualified person responsible for preparation of the engineering information contained in this application, that I am familiar with Part 25 of the Commission's rules, that I have either prepared or reviewed the engineering information submitted in this application, and that it is complete and accurate to the best of my knowledge and belief.

*/s/ Mihai Albulet*

---

Mihai Albulet, PhD  
Principal RF Engineer  
SPACE EXPLORATION TECHNOLOGIES CORP.

November 15, 2016

---

Date