

# An Overview of Limited Feedback in Wireless Communication Systems

David J. Love, *Member, IEEE*, Robert W. Heath Jr, *Senior Member, IEEE*, Vincent K. N. Lau, *Senior Member, IEEE*, David Gesbert, *Senior Member, IEEE*, Bhaskar D. Rao, *Fellow, IEEE*, and Matthew Andrews, *Member, IEEE*

**Abstract**—It is now well known that employing channel adaptive signaling in wireless communication systems can yield large improvements in almost any performance metric. Unfortunately, many kinds of channel adaptive techniques have been deemed impractical in the past because of the problem of obtaining channel knowledge at the transmitter. The transmitter in many systems (such as those using frequency division duplexing) can not leverage techniques such as training to obtain channel state information. Over the last few years, research has repeatedly shown that allowing the receiver to send a small number of information bits about the channel conditions to the transmitter can allow near optimal channel adaptation. These practical systems, which are commonly referred to as limited or finite-rate feedback systems, supply benefits nearly identical to unrealizable perfect transmitter channel knowledge systems when they are judiciously designed. In this tutorial, we provide a broad look at the field of limited feedback wireless communications. We review work in systems using various combinations of single antenna, multiple antenna, narrowband, broadband, single-user, and multiuser technology. We also provide a synopsis of the role of limited feedback in the standardization of next generation wireless systems.

**Index Terms**—Wireless communications, Limited feedback, MIMO systems, Quantized precoding, Multiuser MIMO systems.

## I. INTRODUCTION

THE INCREASES in wireless data rates over the years have been accompanied by large steps in communication system design. Past improvements in coding, modulation, and scheduling have led to the current systems deployed today.

Manuscript received June 23, 2008; revised August 26, 2008. This material is based in part upon work supported by the National Science Foundation under grants CCF-0513916, CCF-514194, and CNS-626797; Samsung Electronics; the AT&T Foundation; UC Discovery Grant, com07-10241; the DARPA IT-MANET program, Grant W911NF-07-1-0028; RGC fund 615105; and by the U. S. Army Research Office under the Multi-University Research Initiative (MURI) grant-W911NF-04-1-0224.

D. J. Love is with the School of Electrical and Computer Engineering, Purdue University, West Lafayette, IN 47907 USA (e-mail: djlove@ecn.purdue.edu).

R. W. Heath, Jr. is with the Wireless Networking and Communications Group, Department of Electrical and Computer Engineering, The University of Texas at Austin, Austin, TX 78712 USA (e-mail: rheath@ece.utexas.edu).

V. K. N. Lau is with the Dept of Electrical & Electronic Engineering, Hong Kong University of Science and Technology, Hong Kong (e-mail: eeknau@ee.ust.hk).

D. Gesbert is with the Depart. Mobile Communications, Eurecom Institute, Sophia Antipolis, France (e-mail: gesbert@eurecom.fr).

B. D. Rao is with the Electrical and Computer Engineering Department, University of California, San Diego, La Jolla, CA 92093 USA (e-mail: brao@ece.ucsd.edu).

M. Andrews is with Alcatel-Lucent Bell Labs, Murray Hill, NJ 07974 USA (e-mail: andrews@research.bell-labs.com).

Digital Object Identifier 10.1109/JSAC.2008.081002.

Next generation systems are poised to make use of a variety of channel adaptive techniques. These sorts of signaling approaches allow the transmitter to adapt to the propagation conditions. This implies that the transmitter requires some form of knowledge of the wireless channel conditions, often referred to as channel state information (CSI) at the transmitter (CSIT). Employing most kinds of channel adaptive techniques has been impossible in the past because two-way communication is accomplished using frequency division duplexing (FDD). The forward and reverse links in FDD generally have highly uncorrelated channels because they are separated in frequency.

One way of overcoming this problem is by using other forms of reciprocity (e.g., statistical reciprocity). These sorts of systems use the fact that the forward and reverse links often share the same fading distribution. Statistical approaches can perform very well in situations where the channel exhibits some form of (slowly varying) structure, such as having a large mean component (i.e., a large Rician K-factor) or strong correlation (either in space, time, or frequency). Generally, however, statistical adaptation comes with a non-negligible performance loss compared with adaptation techniques that use the instantaneous channel realization.

The big innovation that has overcome the challenge of making instantaneous channel adaptation practical is the use of feedback. A system employing feedback uses a low rate data stream on the reverse side of the link to provide information to the transmitter of the forward side of the link. This information conveys some notion of the forward link condition (e.g., channel state, received power, interference level, etc.), and the transmitter uses the information to adapt forward link transmission. The value of feedback varies with the system scenario. However, generally speaking, the value is greater when the channel introduces some form of disturbance (such as spatial interference, intersymbol interference, multiuser interference, etc.) that cannot be handled by the receiver alone. The feedback information itself can be digital or analog. In this tutorial, we concentrate on digital feedback, which is commonly referred to as limited feedback or finite-rate feedback.

The history of feedback in communication systems traces back to Shannon [289], [290] and other early work such as [106], [285], [286], [326], [327]. Interest has continued to grow in the uses of feedback. Feedback has had broad impact in areas such as control systems, source coding, information theory, and communication theory. We concentrate and summarize the present state of research into applications of

limited feedback in wireless communication systems, where its interest has recently seen much revival, particularly in relation with multiple-input multiple-output (MIMO) systems. Our goal is to examine what has been accomplished and make some comments on the direction of this area of research.

We will divide the work into two main areas: single-user (see Section II) and multiuser communication (see Section III). Because the true measure of the impact of research is in the applications it generates, we look at the role of limited feedback in current and future standardized wireless systems in Section IV. We provide some concluding remarks in Section V.

Throughout the paper we use some common notation. The complex numbers are denoted by  $\mathbb{C}$ . The transpose of a vector is denoted by a superscript  $T$ , and the conjugate transpose by a superscript  $*$ . A diagonal matrix is created from a vector with the function  $\text{diag}(\cdot)$ . The two-norm of a vector (or matrix) is represented by  $\|\cdot\|_2$ , and the Frobenius norm of a matrix is represented by  $\|\cdot\|_F$ . The ceiling function is written as  $\lceil \cdot \rceil$ , and the floor function is similarly written as  $\lfloor \cdot \rfloor$ . The base two logarithm is written  $\log_2(\cdot)$ . The determinant of a matrix is evaluated with  $\det(\cdot)$ .

## II. FEEDBACK IN SINGLE-USER WIRELESS SYSTEMS

The design of single-user wireless systems has a long and storied history. We address the role of limited feedback in single and multiple antenna systems.

### A. Single Antenna Systems

Single antenna wireless links are the most commonly found wireless links. Single-user wireless systems are often split into the categories of narrow and broadband depending on the relationship between the bandwidth and delay spread of the propagation channel. For this reason, the benefits of channel adaptation using limited feedback will be divided into narrowband and broadband systems.

1) *Narrowband Systems*: The  $k$ th channel use of a narrowband system is mathematically modeled as

$$y[k] = h[k]x[k] + n[k]. \quad (1)$$

where  $y[k]$  is the complex received symbol,  $h[k]$  is the complex channel response,  $x[k]$  is the transmitted symbol, and  $n[k]$  is noise distributed according to  $\mathcal{CN}(0, 1)$  (assuming the noise is normalized to unit variance). The transmitted signal  $x[k]$  is subject to a long term power constraint where  $\mathbb{E}_{h,x}[|x[k]|^2] \leq \rho$ . To allow the receiver to perform coherent detection, channel estimation techniques are usually performed. Most of the work on limited feedback assumes that the receiver has perfect knowledge of the  $h[k]$  for all  $k$ . We will note when discussing work that makes other assumptions. Additionally, various ergodicity and stationarity assumptions must hold for the process  $\{h[k]\}$ , but these are beyond the scope of this paper.

Because our focus is on adapting the transmitted signal to the channel conditions, modeling how the channel varies across a codeword block is critical. We primarily focus on a block-fading channel model, where the channel is constant for

several channel uses before changing independently. Therefore, the  $t$ th channel block satisfies  $h[tK_{ch}] = h[tK_{ch} + 1] = \dots = h[(t+1)K_{ch} - 1] = h(t)$  where  $K_{ch}$  is the length of the fading block. The transmitted data will also have a block structure. Let  $K_{bl}$  denote the codeword block length. We refer to the vector  $[x[0] x[1] \dots x[K_{bl} - 1]]$  as the transmitted codeword. The relationship between the channel block length  $K_{ch}$  and the codeword block length  $K_{bl}$  is important. In this tutorial, we will refer to the case when  $K_{ch} = K_{bl}$  as the *slow-fading* scenario and the case when  $\frac{K_{ch}}{K_{bl}} \rightarrow 0$  when  $K_{bl} \rightarrow \infty$  as the *fast-fading* scenario. More discussion on the relation between codeword block length and time variation of the fading process is available in [48] and the references therein.

Depending on the time evolution properties of the channel, both power and/or rate control provide benefits. For the  $t$ th channel block, denote the average power constraint as  $\mathbb{E}_x[|x[k]|^2 | h[k] = h(t)] \leq \rho_t$  where the expectation is over all possible codewords. To satisfy the long-term power constraint, we have to require that  $\mathbb{E}_h[\rho_t] \leq \rho$ . If the transmitter has knowledge of the channel conditions for each channel block,  $\rho_t$  could be adaptively chosen to maximize performance. Variable rate encoding is also very common. In this kind of framework, the rate is varied according to the instantaneous channel conditions.

Assuming perfect knowledge of the channel at the transmitter and receiver, the ergodic capacity is [51], [98]

$$R = \mathbb{E}_h \left[ \log_2 \left( 1 + \rho(h) |h|^2 \right) \right] \quad (2)$$

where  $\rho(h)$  is a function that allocates power subject to water-filling. Interestingly, this rate can be achieved asymptotically with fixed rate encoding [49]. For the fast-fading case, we can construct the codewords as

$$x[k] = \sqrt{\rho(h[k])} s[k] \quad (3)$$

where  $\{s[k]\}_{k=0}^{K_{bl}-1}$  is a codeword designed independently of the channel conditions (but whose rate is determined using distribution information) such that  $\mathbb{E}_s[|s[k]|^2] \leq 1$  and  $\rho(h[k])$  is chosen according to the waterfilling algorithm.

The problem with capacity achieving power allocation frameworks is that they require the transmitter to perfectly know  $h[k]$  (or at least its magnitude). As mentioned earlier, in systems such as those using FDD, this knowledge is not available. For this reason, the solution is for the receiver to utilize the reverse link as a feedback channel, send channel state information on this channel, and give the transmitter some kind of side information  $u[k]$  about the current channel realization  $h[k]$ . A general scheme is shown in Figure 1. The receiver can obtain some level of channel information using techniques such as training. Using this knowledge, the receiver can design feedback to be sent as overhead on the reverse link.

The problem of codeword design with side information was brought up in [49]. This paper considers more general channel models than just (1), without restriction to block fading. In addition, [49] does not require the receiver to perfectly know  $h[k]$  but instead assumes the receiver has access to some side information  $w[k]$ . Thus, the problem becomes one of encoding and decoding using this side information along with knowledge of the joint probability density function  $p(h, u, w)$ .

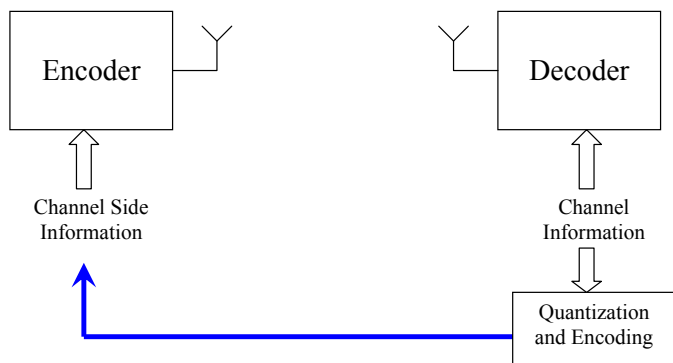

Fig. 1. Block diagram of a single antenna limited feedback system. The receiver obtains information about the wireless channel (either perfect or imperfect) through techniques such as training. This receiver channel information is then fed into a quantizer that returns a small number of feedback bits to be sent as overhead on the reverse link. The transmitter can use the received feedback bits to adapt the transmitted signal to the forward channel.

This work was later extended to the fast-fading case (through a block-fading construction) in [172] adding the additional requirement of a cardinality constraint on the side information  $u[k]$ . The problem of properly designing the side information  $u[k]$  is shown to be one of scalar quantization that can be solved using the Lloyd algorithm. The fast-fading assumption employed in this paper allows the codeword rate to be fixed because a codeword block spans a large number of channel realizations.

Extensive analysis of the flat-fading single antenna system has been conducted in [155] when the transmitter is provided with a quantized version of the magnitude of  $h[k]$ . This quantized version is taken by dividing up the non-negative part of the real line into quantization regions. This quantization approach is similar to techniques used in the temporal water-filling proof in [98], which took the limit as the quantization noise goes to zero. In [155], the power allocation strategy then uses the quantized channel realization subject to either a short-term power constraint (where  $\rho_t \leq \rho$  for any channel block  $t$ ) or a long-term power constraint (where the power allocated to the  $t$ th channel block  $\rho_t$  is restricted in expected value to be bounded by  $\rho$ ). An overview of the possible power constraints is available in [48].

A model other than block fading was discussed in [267]. This work assumed periodic feedback, where feedback is sent every fixed number of channel uses. The channel model considered was a finite-state first-order Markov model.

From a practical perspective, another approach to the problem of adapting to the channel conditions is to concentrate on selecting from a fixed set of per channel use constellations and varying the density (or equivalently the average energy) of these constellations. On-off rate adaptation was proposed in [37], where the transmission was turned on and off subject to the channel conditions. A more general system where the rate of the transmitter is adjusted based on the channel is addressed in [52]. Here the effect on the probability of error subject to an average rate constraint is analyzed. These ideas were later extended to take into account queue length [53]. Various other works have looked at the application of rate variation [18], [48], [147], [237], [299], [300], [311], some using specific constellation families and some combining the

rate variation with adaptive power allocation. Analysis of adaptive modulation with feedback imperfections has been studied in [84], [238]. Discussion can also be found in the overview paper [85]. A diversity-based approach is given in [293].

Work taking practical code designs into account has been relatively limited. Adaptive  $M$ -ary orthogonal coding for high bandwidth expansion systems (such as CDMA) has been proposed in [171], and adaptive trellis coded modulation for high bandwidth efficiency has been studied in [17], [95], [169], [170], [232]. These works consider joint optimization of the coding rate and modulation level coding based on maintaining a target average error rate or average throughput requirement. Outdated knowledge of channel state information has been considered.

In addition to the performance benefit associated with adaptive coded modulation systems, there is another important benefit of channel state knowledge at the transmitter. In [229], the authors studied the concept of incorporating knowledge of channel side information at the transmitter on the LDPC code design. It is shown that substantial reduction of LDPC decoding complexity can be obtained utilizing the side information.

Another approach to feedback is the use of repeat requests when channel conditions cause codeword errors. In fact, regardless of the availability of explicit CSIT, there is always ACK/NAK signaling exchange in the upper layers in most communication systems. Such ACK/NAK exchange is used for automatic repeat request (ARQ) in the upper layers so that an error-free logical channel can be presented to the application layers. In fact, the ACK/NAK signaling exchange can also be utilized at the physical layer of the transmitter to *learn* about the actual channel conditions. This information is particularly useful when the CSIT (through explicit feedback [FDD] or implicit feedback [TDD]) is not perfect.

Consider the case when the channel state information obtained by limited feedback (or finite-rate feedback) may be outdated or suffering from feedback errors. Because of these errors, the transmitter must adapt the transmit power and/or data rate according to this imperfect CSIT. In order to effectively exploit the imperfect channel information at the transmitter, it is important to take into account the error statistics of the CSIT in the adaptation. However, it is very difficult for the transmitter to obtain and keep track of the error statistics because they usually depend on the channel environment and Doppler spectrum. In such cases, the ACK/NAK signaling from the upper layer ARQ is very useful to provide a truly closed-loop adaptation. For example, if the transmitter is overly aggressive in the adaptation (e.g., in adjusting the data rate), the packet will be corrupted at the receiver and a NAK will result. Based on the NAK information, the transmitter can reduce the data rate and/or increase the transmit power until an ACK is received. Such an approach is very robust to CSIT errors and does not require explicit knowledge of CSIT error statistics at the transmitter. In fact, this closed-loop adaptation framework has been commercially deployed in IS95 in outer-loop power control.

Selective repeat ARQ is studied in [27]. ARQ schemes with reliable and unreliable feedback are studied in [26]. Power and rate adaptation utilizing ACK/NAK feedback has appeared in

[102], [125], [358]. In [141], the authors considered a two level stochastic scheduling based on learning automata. In [338], the authors modeled the power, rate adaptation (as well as user selection) using Markov Decision Process (MDP) and obtained an optimal as well as low complexity control policy. From these works, it is found that robust performance can be obtained by jointly considering both limited CSIT feedback as well as ACK/NAK signaling in the design of transmitter adaptation policy.

2) *Broadband and Wideband Systems*: A single antenna broadband model is complicated by the fact that previously transmitted symbols interfere with the current symbols. A discrete-time model for this kind of set-up is

$$y[k] = \sum_{\ell=0}^L h[k, \ell]x[k - \ell] + n[k]. \quad (4)$$

where the channel is now frequency selective and represented by an  $(L + 1)$ -tap finite impulse response filter  $[h[k, 0] \cdots h[k, L]]$  at the  $k$ th channel use.

Because of the difficulty in dealing with the intersymbol interference resulting from frequency selective channels, especially for recently standardized wideband systems (UMTS-LTE, WiMAX, WiFi), industry and academia have turned toward the use of orthogonal frequency division multiplexing (OFDM). In OFDM, the signal  $x[k]$  is jointly designed over  $K_{sc} + L$  channel uses assuming that the channel is constant during a block of  $K_{ch}$  channel uses with  $K_{ch} \geq K_{sc} + L$ . The transmitter constructs a  $K_{sc}$  collection of parallel subchannels in the frequency domain. The  $\tilde{k}$ th transmission across the parallel subchannels can be written  $\tilde{\mathbf{x}} = [\tilde{x}_0[\tilde{k}] \cdots \tilde{x}_{K_{sc}-1}[\tilde{k}]]^T$ . This vector is then multiplied by an inverse discrete Fourier transform (DFT) matrix, and the last  $L$  entries of the transformed signal are appended to the beginning of the vector (termed a cyclic prefix).

After reception, the receiver removes this cyclic prefix and multiplies the signal by a DFT matrix. This then gives a post-processing input-output relation in the frequency domain of

$$\tilde{\mathbf{y}}[\tilde{k}] = \text{diag}(\tilde{\mathbf{h}}[\tilde{k}]) \tilde{\mathbf{x}}[\tilde{k}] + \tilde{\mathbf{n}}[\tilde{k}] \quad (5)$$

at OFDM channel use  $\tilde{k}$ . Here vector notation has been used where the  $v$ th entry of each vector corresponds to the input-output relation for the  $v$ th subcarrier.

Adapting the subcarrier powers with limited feedback has been the focus of several works. Using a one bit per subcarrier (or per block of subcarriers) design that simply turns subchannels off and on was proposed by [177]. Later work on quantized feedback in OFDM to activate or deactivate subchannels was the focus of [306], [307]. More general schemes for jointly quantizing the per subcarrier power allocations have been discussed in [61], [201], [207], [262]. A sub-channel grouping approach was developed in [3], [4]. Techniques used to address the problem of adaptation with unquantized (but stale or imperfect) CSIT studied in [348] can also be employed. The case of using feedback for bit interleaved coded OFDM was addressed in [310]. An overview of adaptive modulation with OFDM is available in [270].

With the emergence of systems such as ultra-wideband (UWB) there has been an increased interest in adaptive

signaling over very large bandwidths (often on the order of  $10^9$  Hertz). One possible approach to signaling in these systems is to send a narrowband signal over an adaptively chosen frequency band. When a narrowband channel is chosen by probing over a wideband channel, feedback allows the transmitter to choose a frequency band with good performance (generally defined as having a large signal-to-interference plus noise ratio (SINR)). The low signal-to-noise ratio (SNR) scaling of the maximum achievable rate is the focus of [44]. Training a wideband channel with feedback to optimize rate is discussed in [5]. Extending feedback analysis to wideband channels that are sparse in the delay and Doppler domains is considered in [103].

## B. Multiple Antenna Systems

The application of limited feedback to multiple antenna wireless systems has received much attention in the recent past. The spatial degree-of-freedom and the potentially sizable benefits available by adapting over it make limited feedback a very attractive option.

The degrees of freedom with multiple antenna systems can be exploited to offer rate and diversity benefits as well as beamforming and interference canceling capabilities. While the diversity gain can be typically extracted without the need of CSIT feedback (e.g., space time codes), CSIT plays a crucial role for beamforming and interference mitigation at the transmitter side, as will be clarified below.

1) *Narrowband Systems*: A single-user narrowband multiple antenna system can be represented by an expression of the form

$$\mathbf{y}[k] = \mathbf{H}[k]\mathbf{x}[k] + \mathbf{n}[k] \quad (6)$$

at the  $k$ th channel use. Assuming  $M_t$  transmit antennas and  $M_r$  receive antennas,  $\mathbf{y}[k]$  is an  $M_r$ -dimensional receive vector,  $\mathbf{H}[k]$  is an  $M_r \times M_t$  channel response matrix,  $\mathbf{x}[k]$  is an  $M_t$ -dimensional transmit vector, and  $\mathbf{n}[k]$  is  $M_r$ -dimensional noise. We assume the noise to have i.i.d. normalized entries distributed according to  $\mathcal{CN}(0, 1)$ . The transmitter power constraint requires that  $\mathbb{E}_{\mathbf{H}, \mathbf{x}}[\|\mathbf{x}[k]\|_2^2] \leq \rho$ . As in the single antenna case, we concentrate on the scenario where the receiver has access to  $\mathbf{H}[k]$ . Given this, there are a variety of ways to design  $\mathbf{x}[k]$  if the transmitter is given access to some quantized information relating to  $\mathbf{H}[k]$ .

Again, this analysis will depend on the time evolution model of the channel. If we use our previous notation of block-fading, the  $t$ th channel block satisfies  $\mathbf{H}[tK_{ch}] = \mathbf{H}[tK_{ch} + 1] = \cdots = \mathbf{H}[(t + 1)K_{ch} - 1] = \mathbf{H}(t)$  where  $K_{ch}$  is the length of the fading block. For power constraint reasons,  $\mathbb{E}_{\mathbf{x}}[\|\mathbf{x}[k]\|_2^2 | \mathbf{H}[k] = \mathbf{H}(t)] \leq \rho_t$  for the  $t$ th block. Varying  $\rho_t$  to perform temporal water-filling provides capacity benefits, but unless otherwise noted, our discussion assumes  $\rho_t = \rho$  for all channel blocks.

### 1a) Covariance Quantization

When the transmitter and receiver both perfectly know the channel, the ergodic capacity is [96], [320]

$$R = \mathbb{E}_{\mathbf{H}} \left[ \max_{\mathbf{Q}: \text{tr}(\mathbf{Q}) \leq 1, \mathbf{Q}^* = \mathbf{Q}, \mathbf{Q} \succeq 0} \log_2 \det(\mathbf{I} + \rho \mathbf{H} \mathbf{Q} \mathbf{H}^*) \right]. \quad (7)$$

Here  $\mathbf{Q}$  is the covariance of the transmitted signal for each individual instantaneous channel realization. The covariance of the transmitted signal could incorporate both the spatial power allocation as well as unitary precoding. Note that spatial power allocation is important especially for cases when the number of transmit antennas is greater than the number of receive antennas. From an encoding point of view,  $\mathbf{x}[k] = \sqrt{\rho}(\mathbf{Q}[k])^{1/2}\mathbf{s}[k]$ ,  $k = 0, \dots, K_{bl} - 1$ , where  $\mathbf{Q}[k]$  solves the optimization (based on channel feedback)

$$\mathbf{Q}[k] = \underset{\mathbf{Q}: \text{tr}(\mathbf{Q}) \leq 1, \mathbf{Q}^* = \mathbf{Q}, \mathbf{Q} \succeq 0}{\text{argmax}} \log_2 \det(\mathbf{I} + \rho \mathbf{H}[k] \mathbf{Q} \mathbf{H}^*[k])$$

and  $\mathbf{s}[k]$  is the  $k$ th channel use of an open-loop codeword. This codeword set is chosen according to some spatial power constraint criteria such that  $\mathbb{E}_{\mathbf{s}}[\mathbf{s}[k] (\mathbf{s}[k])^*] = \mathbf{I}$  and such that the encoding rate per channel block approaches the achievable rate of the instantaneous channel. For fast-fading, a fixed rate codeword set can be used satisfying similar conditions to those above but with a fixed encoding rate.

One of the first looks at trying to design the covariance matrix using imperfect channel information was the covariance design for multiple-input single-output (MISO) systems using statistical information published in [331]. For a limited rate feedback approach, the general idea is to use the fact that the receiver knows  $\mathbf{H}[k]$  through procedures such as training. Using this channel knowledge, the receiver can quantize some function of  $\mathbf{H}[k]$  using vector quantization (VQ) techniques.

Naturally, the aspects of the channel that the transmitter cares about are those that allow the design of the covariance for the  $t$ th channel block [294]. Using this line of reasoning, the receiver can determine a rate maximizing covariance and feed this back to the transmitter. Employing a codebook of possible covariance matrices  $\mathcal{Q} = \{\mathbf{Q}_1, \dots, \mathbf{Q}_{2^B}\}$  that is known to both the transmitter and receiver, the receiver can search for the codebook index that solves

$$n_{opt}[k] = \underset{1 \leq n \leq 2^B}{\text{argmax}} \log_2 \det(\mathbf{I} + \rho \mathbf{H}[k] \mathbf{Q}_n \mathbf{H}^*[k])$$

and send the  $B$  bit binary label corresponding to covariance  $\mathbf{Q}_{n_{opt}[k]}$  to the transmitter. This gives a maximum achievable rate in bits per channel use of

$$R_{\mathcal{Q}} = \mathbb{E}_{\mathbf{H}} \left[ \max_{\mathbf{Q} \in \mathcal{Q}} \log_2 \det(\mathbf{I} + \rho \mathbf{H} \mathbf{Q} \mathbf{H}^*) \right] \quad (8)$$

using a codebook  $\mathcal{Q}$  known to both the transmitter and receiver.

The covariance codebook can be either fixed or randomly generated (using a seed known to both the transmitter and receiver). Designing a fixed covariance codebook to maximize the average rate is a challenging problem that depends on the stationary distribution of the channel [40], [168]. Vector quantization approaches using the Lloyd algorithm have been shown to efficiently generate codebooks that achieve a large rate [168]. Random approaches for covariance design have also been proposed [69] using ideas pioneered in [278]. In fact, it was shown in [69] that the rate loss with  $B$  bits of feedback decreases exponentially with the number of feedback bits.

While the codebook approach is optimal for a block-to-block independently fading channel, temporal correlation

between channel realizations can improve quantization. Feedback approaches based on tracking the channel using gradient analysis are studied in [31], [32]. Alternative approaches to subspace tracking are discussed in [346], [352]. The use of switched codebooks, where the codebook is changed or adapted over time is proposed in [216]. Beamforming codebooks with adaptive localized codebook caps, the orientation and radius of the cap changing over time, were considered in [268]. Markov models to analyze the effects of feedback delay and channel time evolution were proposed in [121]–[123]. These models can be used to implement feedback compression by using Markov chain compression. Statistical characterizations of the feedback side information can be further leveraged [356].

As a final remark, many of the above works considered block-fading channels and optimize the ergodic capacity in the covariance optimization problem under limited feedback. However, ergodic capacity may not be an appropriate performance measure in non-ergodic channels (such as the slow-fading case). In slow-fading channels, there are systematic packet errors due to channel outages despite the use of powerful channel coding. This happens because given limited CSIT there is still uncertainty about the actual CSI, and the transmitted packet will be corrupted whenever the data rate exceeds the instantaneous mutual information. In addition to limited CSIT feedback, there might be feedback error due to noisy feedback links. This will also contribute to packet errors due to channel outage. When there is a noisy feedback link, the index mapping is also an important design parameter that will affect the robustness of the CSIT feedback. As a result, joint adaptation between the data rate, covariance matrix, and feedback index mapping is important to control the packet errors to a reasonable target. In order to account for the potential penalty of packet errors, it is important to consider system goodput (b/s/Hz successfully delivered to the receiver) instead of ergodic capacity as the system performance measure in the optimization framework. The design of robust limited feedback schemes and the joint rate, covariance, and feedback index mapping optimization for system goodput is a relatively unexplored topic. In [342], the authors extend the VQ optimization framework to consider joint rate and covariance adaptation using Lloyd's algorithm for slow-fading MIMO channels.

### 1b) Beamforming

While optimal covariance quantization is of interest to analyze how close to perfect transmitter channel knowledge a limited feedback system can perform, limited feedback can have immediate impact enhancing existing closed-loop signaling approaches. Beamforming is characterized by the use of a rank one covariance matrix. Note that using a rank one  $\mathbf{Q}$  matrix is optimal whenever the single-user channel is itself rank one. This notably occurs when the user terminal is equipped with a single antenna. In this situation the availability of CSIT is critical.

In beamforming, the single-user MIMO expression in (6) is restricted so that  $\mathbf{x}[k] = \sqrt{\rho} \mathbf{f}[k] s[k]$  where  $\mathbf{f}[k]$  is a channel dependent vector referred to as a beamforming vector and  $s[k]$  is a single-dimensional complex symbol chosen independently of the instantaneous channel conditions. For power constraint

reasons,  $\mathbb{E}_s \left[ |s[k]|^2 \right] \leq 1$  and  $\mathbf{f}[k]$  is restricted such that  $\|\mathbf{f}[k]\|_2 = 1$ .

Much of the early beamforming work focused on the MISO case when there is only a single receive antenna. In this case, (6) can be reformulated as

$$y[k] = \sqrt{\rho} \mathbf{h}^T[k] \mathbf{f}[k] s[k] + n[k] \quad (9)$$

where a lower case bold symbol has been used to show that  $\mathbf{h}[k]$  is a column vector. With this configuration, the receive SNR at channel use  $k$  (averaged with respect to the transmitted signal and noise) is given by

$$\text{SNR}[k] = \rho |\mathbf{h}^T[k] \mathbf{f}[k]|^2.$$

For MIMO beamforming and combining, a receive-side combining vector  $\mathbf{z}[k]$  (sometimes, but not necessarily, unit norm) is used so that after processing

$$y[k] = \sqrt{\rho} \mathbf{z}^*[k] \mathbf{H}[k] \mathbf{f}[k] s[k] + \mathbf{z}^*[k] \mathbf{n}[k]. \quad (10)$$

Various forms of combiners exist (e.g., see the discussion in [199], [292] and the references therein).

Allowing the receiver to send some feedback to assist the transmitter's design was proposed early in [89] and later in works such as [88], [116], [117], [226]–[228], [231]. The simplest form of this feedback is transmit antenna selection [295], [321]. In this scenario, the transmit beamforming vector is restricted such that only one entry is non-zero. With this kind of set-up in a MISO system, the optimal solution is to send data on the antenna that maximizes the receiver SNR meaning all data (and all power) is sent on antenna  $m_{opt}[k]$  where

$$m_{opt}[k] = \underset{1 \leq m \leq M_t}{\text{argmax}} |h_m[k]|^2$$

where  $h_m[k]$  denotes the  $m$ th antenna entry of the channel vector  $\mathbf{h}[k]$ . Using this approach, the optimal selected antenna can be designed at the receiver and sent back to the transmitter using  $\lceil \log_2(M_t) \rceil$  bits. Typically these bits are assumed error free, but work has been done in compensating for errors [179]. Error rates with antenna selection for spatially uncorrelated set-ups have been analyzed in [60], [203], [292].

Clearly antenna selection is limited in terms of its benefits to the overall capacity as it does not allow for the full beamforming gain. If there exists a feedback link, more complicated forms of channel dependent feedback should improve performance. In [230], it was proposed to quantize the channel vector for a MISO system into a set of normalized column vectors  $\mathcal{H} = \{\mathbf{h}_1, \dots, \mathbf{h}_{2^B}\}$ . Because the system has only a single receive antenna, the channel vector  $\mathbf{h}[k]$  can be quantized over this set by selecting the codebook vector  $\mathbf{h}_{n_{opt}[k]}$  using a phase invariant distortion such that

$$n_{opt}[k] = \underset{1 \leq n \leq 2^B}{\text{argmax}} |\mathbf{h}_n^* \mathbf{h}[k]|^2. \quad (11)$$

The transmitter can then pick a beamforming vector that solves

$$\begin{aligned} \mathbf{f}[k] &= \underset{\mathbf{f}: \|\mathbf{f}\|=1}{\text{argmax}} \log_2 \left( 1 + \rho \left| \mathbf{h}_{n_{opt}[k]}^T \mathbf{f} \right|^2 \right) \\ &= \frac{\left( \mathbf{h}_{n_{opt}[k]}^T \right)^*}{\left\| \mathbf{h}_{n_{opt}[k]} \right\|_2}. \end{aligned} \quad (12)$$

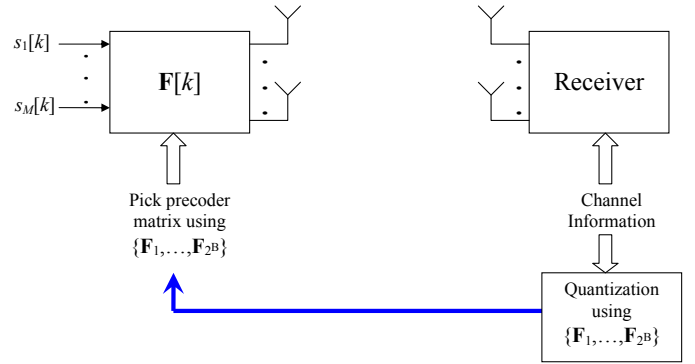

Fig. 2. A block diagram of a limited feedback linear precoded MIMO system is shown above. The receiver uses its channel estimate to pick the optimal transmitter-side linear precoder from a codebook known to the transmitter and receiver. For a codebook of size  $2^B$ , the  $B$ -bit binary label of the chosen precoder is sent over the feedback channel. Note that the rate and/or SNR must also be known as side information to facilitate communication and is often fed back.

Later work analyzed the effect of training, feedback, and power quantization on these types of designs [39] and other issues of signal design in [221].

Another early form of limited feedback beamforming was the use of MISO per antenna phase quantization in [109]. Equal gain approaches that attempt to co-phase the signals received from various antennas can give excellent performance. The work in [109] used this concept to quantize the phases of each  $h_m[k]$ ,  $m = 1, \dots, M_t$ , using uniform phase quantization on the unit circle.

These new channel quantization approaches marked a change in thinking. Since the codebooks in [109], [230], [295], [321] fundamentally do nothing more than allow the receiver to directly design the beamforming vector and send this designed vector back to the transmitter, the problem could be approached differently as one of beamforming vector quantization rather than channel quantization. The main idea is to restrict  $\mathbf{f}[k]$  to lie in a set or codebook  $\mathcal{F} = \{\mathbf{f}_1, \dots, \mathbf{f}_{2^B}\}$ . The receiver can use its channel knowledge to pick the optimal vector from this codebook. This kind of approach is demonstrated in Figure 2 (using the interpretation that beamforming is rank one precoding). The receiver now, in some sense, controls how the signal is adapted to the channel. This makes sense because the receiver will nearly always have higher quality CSI than the transmitter.

This change in thinking lead to significant advances in feedback techniques. Phase quantization codebooks were created in [199] for MIMO beamforming and combining. This extended some of the concepts in [109] by jointly quantizing the phases across all the transmit antennas and guaranteed full diversity. Quantized equal gain codebooks were later thoroughly analyzed in [224]. An analysis and summary of designs in quantized equal gain beamforming is available in [366].

While equal gain approaches are of interest, a general design framework is needed. Work in [222] for the MISO case and [202] for the MIMO case showed that for a spatially uncorrelated Rayleigh fading channel, the outage minimizing, SNR maximizing, and rate maximizing design is to i) think of the set  $\mathcal{F}$  as a collection of lines in the Euclidean space  $\mathbb{C}^{M_t}$  and ii) maximize the angular separation of the two closest lines.

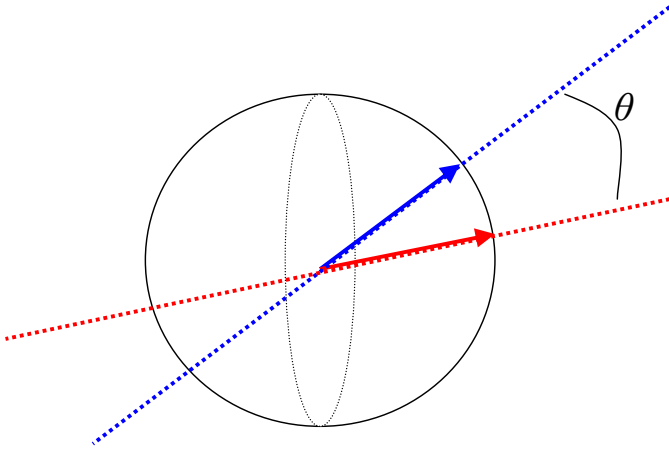

Fig. 3. In narrowband beamforming, the system performance is independent of the phase of the beamforming vector. In the figure, two vectors are shown in three-dimensional real space. Because of phase invariance and the norm constraint on the vectors, performance only depends on the line that passes through the vector and its angular separation from the optimal beamforming vector's line.

This problem is actually well known in applied mathematics as the Grassmannian line packing problem. Mathematically, this means that the set  $\mathcal{F}$  is chosen to maximize its minimum distance defined as

$$d(\mathcal{F}) = \sqrt{1 - \max_{1 \leq i < j \leq 2^B} |\mathbf{f}_i^* \mathbf{f}_j|^2} = \min_{1 \leq i < j \leq 2^B} \sin(\theta_{i,j})$$

where  $\theta_{i,j}$  is the angle between the lines generated by the column spaces of  $\mathbf{f}_i$  and  $\mathbf{f}_j$ . An example is shown in Figure 3. Each beamforming vector is a point on the sphere because of the transmit power constraint. The column space of each beamforming vector corresponds to a line. Therefore, the codebook minimum distance is a function of the minimum angular separation between codebook lines.

The design of optimal or near-optimal Grassmannian line packings is in general a challenging problem. One approach is construction based on difference sets [303], [344]. Another approach is to use a numerical alternating projection algorithm [325]. Modified line packing codebooks that deal with statistical correlation knowledge via rotations and normalizations are proposed in [197]. The correlation design concept was extended to a systematic codebook design approach in [251].

Several special cases of limited feedback beamforming have been significantly analyzed. Necessary and sufficient conditions that beamforming vector codebooks must satisfy to yield full diversity are derived in [200]. In fact, for any channel, the maximum diversity order is achieved when the rank of the matrix  $[\mathbf{f}_1 \cdots \mathbf{f}_{2^B}]$  constructed from the set of beamforming vectors has a rank of  $M_t$ . Receiver SNR degradation analysis is available in [372]. Insights from the problem of Grassmannian line packing designs can be used to assist analysis [217]. Closed-form integral expressions can be obtained by modeling the feedback problem as one of correlated antenna selection [22]. Other performance analysis results with limited feedback beamforming include [127].

An alternative approach to Grassmannian codebooks is to construct the codebooks using vector quantization (VQ) techniques. A general VQ framework for codebook design

was proposed in [260]. The idea is to formulate a distortion function (usually related to rate loss or SNR loss) and then iteratively minimize this distortion function to obtain locally optimal solutions. Using multiple iterations with different (possibly randomized) initial settings usually yields an approximately globally optimal codebook. Because of the unit vector constraints on the beamforming vector set, this is actually a problem in spherical vector quantization [343].

VQ designs also have very nice analytical properties when the codebook size (or quantizer resolution) increases. High resolution analysis and codebook design were successfully leveraged in [363] to give new insight into codebook behavior. Spatially correlated VQ designs are presented in [364]. Ref. [129] analyzed the symbol error probability using insights from high resolution quantization. The effect of estimation error and/or feedback delay is discussed in [128], [204], [211]. Approaches for mitigating the effects of feedback errors are discussed in [174], [373].

Grassmannian and VQ limited feedback designs assume codebooks that are fixed and do not vary as the channel changes. Another approach is to randomly generate the codebook at each block (with the randomly generated codebook perfectly known to both the transmitter and receiver). This sort of codebook design technique is known as random vector quantization (RVQ) and was first proposed in [278], [280]. The idea here is to generate the  $2^B$  codebook vectors independently and all identically distributed according to the stationary distribution of the optimal unquantized beamforming vector.

For example, a MISO system with perfect channel information at the transmitter and receiver will use a beamforming vector  $\mathbf{f}[k] = \frac{(\mathbf{h}^T[k])^*}{\|\mathbf{h}[k]\|_2}$  (known as maximum ratio transmission). When the channel distribution is spatially uncorrelated Rayleigh (i.e., each entry of  $\mathbf{h}[k]$  is i.i.d.  $\mathcal{CN}(0, 1)$ ), this vector follows a uniform distribution on the unit sphere in  $\mathbb{C}^{M_t}$ . Thus, the RVQ codebook would be constructed by taking  $2^B$  independently and uniformly generated points on the unit sphere. These kinds of codebooks have very nice asymptotic properties as the number of antennas scales to infinity [278], [280]. Closed-form analysis is also possible when the channel follows a spatially uncorrelated Rayleigh model [24].

Several other codebook designs have been considered as alternatives to Grassmannian line packings, vector quantization, and RVQ. Equiangular frame based codebooks were suggested in [218] based on the observation that (in the real case) codebooks from equiangular frames maximize the mutual information between the true beamforming vector and the quantized precoding vector. In certain cases Grassmannian line packing also leads to equiangular frames [303]. Fourier concepts for codebook design were first introduced in [199]. Using codebooks based on the Fourier concept for limited feedback was later generalized in [202], [222], based on a design in [114]. The key idea (in [202], [222]) is to recognize the noncoherent MIMO space-time code design problem is also the problem of finding packings on the Grassmann manifold (e.g., [12], [36], [212], [365]). DFT codebooks [199], [202] introduce additional structure in Fourier codebooks, further simplifying their design.

A quantized version of a basis selection algorithm is discussed in [124]. Adaptive modulation has been combined

with beamforming codebooks (relating to the mean feedback adaptive modulation work in [369]) as discussed in [345]. Techniques for dealing with time variation of the channel during the feedback phase are studied in [184].

### *1c) Linear Precoding for Spatial Multiplexing*

In beamforming, a data stream is sent spatially by projecting the data symbol onto a beamforming vector. Linear precoding extends beamforming ideas to sending multiple data streams spatially [284]. Mathematically, the input-output model is

$$\mathbf{y}[k] = \sqrt{\rho}\mathbf{H}[k]\mathbf{F}[k]\mathbf{s}[k] + \mathbf{n}[k]. \quad (13)$$

Here,  $\mathbf{F}[k]$  is an  $M_t \times M$  matrix (with  $M \leq M_t$ ) known as the precoding matrix. The signal vector  $\mathbf{s}[k]$  is chosen independently of the channel conditions (with the exception of the rate of the codeword set in a slow-fading channel) and typically satisfies  $\mathbb{E}_{\mathbf{s}}[\mathbf{s}[k]\mathbf{s}^*[k]] = \frac{1}{M}\mathbf{I}$ . This kind of open-loop modulation is commonly referred to as spatial multiplexing. To satisfy a sum power constraint, the matrix  $\mathbf{F}[k]$  should satisfy  $\text{tr}(\mathbf{F}[k]\mathbf{F}^*[k]) = \|\mathbf{F}[k]\|_F^2 \leq M$ .

The simplest form of linear precoding is antenna subset selection [213], [272]. In this kind of configuration  $\mathbf{F}[k]$  consists of  $M$  unique columns chosen from the  $M_t \times M_t$  identity matrix  $\mathbf{I}$ . Thus, there are  $\binom{M_t}{M}$  possible antenna subset selection matrices. The receiver can use its channel knowledge to select the subset using some criterion and feed back the chosen subset using  $\left\lceil \log_2 \binom{M_t}{M} \right\rceil$  bits of feedback.

Unlike single antenna selection, selection of an antenna subset is challenging because it is not clear what performance metric to use. Early work in [99], [110] considered various designs. The capacity with antenna subset selection was analyzed in [41], [214]. Limited feedback antenna subset selection with power control is the focus of [349].

Various papers have analyzed antenna subset selection systems for different models. Transmit and receive antenna selection analysis and the resulting capacity are studied in [101]. The capacity growth and capacity degradation with antenna subset selection are derived in [274]. Antenna subset selection in keyhole channels has been studied in [273]. Antenna subset selection with correlation was analyzed in [239].

Another issue with antenna subset selection is the choice of the dimension  $M$ . Typically, this subset value is fixed for all times. Removing this constraint (i.e., allowing  $M$  to vary with the channel conditions) can provide large achievable rate or error rate improvements. Antenna subset selection for spatial multiplexing with a varying number of spatial data streams was proposed [108] under the terminology of multi-mode antenna subset selection (where  $M$  is termed the mode of the system). Techniques for selecting the mode using limited feedback are given in [158], [239], [254].

Another form of simplified linear precoding is the use of a diagonal  $\mathbf{F}[k]$  that only adjusts per antenna powers. This form of adaptation (sometimes referred to as per antenna rate and power control) is a natural addition to spatial multiplexing. Varying the power of open-loop spatial multiplexing using finite-rate feedback with an outage design criteria is the focus of [81].

The best form of performance generally comes when  $\mathbf{F}[k]$  is designed to direct data over “good” channel subspace

directions. Like [230], the first ideas behind limited feedback linear precoding focused on quantizing  $\mathbf{H}[k]$  [139]. The idea being that the receiver would quantize the channel, feed back the quantized value to the transmitter, and then have the transmitter pick the precoder assuming that this quantized side information is the perfect channel realization. The work in [252] further elaborates on the notion of “good” and “bad” channels for a precoding scheme in a correlated channel setting.

Like beamforming, performance improves by using a codebook approach to choose the linear precoder directly. The receiver can use its knowledge of  $\mathbf{H}[k]$  to pick the linear precoder from a set or codebook  $\mathbf{F}[k] \in \{\mathbf{F}_1, \dots, \mathbf{F}_{2^B}\}$ , known to both the transmitter and receiver, using some performance criterion. The  $B$  bit binary label of the optimal codebook matrix can be sent to the transmitter over a feedback channel. This is shown in Figure 2.

A common precoding framework is the use of multidimensional eigenbeamforming. The idea is to use  $M$  orthonormal unit vectors to spatially signal  $M$  data streams. This means  $\mathbf{F}^*[k]\mathbf{F}[k] = \mathbf{I}$  where  $\mathbf{I}$  is the  $M \times M$  dimensional identity matrix. Generally most performance metrics depend only on the product  $\mathbf{F}[k]\mathbf{F}^*[k]$ . For this reason, right multiplication of  $\mathbf{F}[k]$  by any unitary matrix does not change the performance metric. Using this invariance, the performance is dependent only on the subspace spanned by the columns of  $\mathbf{F}[k]$  not the exact formulation of  $\mathbf{F}[k]$ . The concepts employed in Grassmannian line packing beamforming codebooks in [202], [222] can therefore be extended to the case of  $M$ -dimensional subspace packing [195].

Unlike lines, defining the distance between two subspaces is more complex. There is one principal angle per subspace dimension (for a total of  $M$  principal angles). Various distances can be defined using these angles [33]. It was shown in [195] that these various distances (which incidently yield very similar codebooks) can optimize different performance criteria.

The problem of designing  $\mathcal{F} = \{\mathbf{F}_1, \dots, \mathbf{F}_{2^B}\}$  has continued to be a focus of research. The relation between limited feedback precoding and the Grassmannian manifold was taken into account in [71]. Fourier approaches exploiting the relationship between non-coherent code design in [114] and Grassmannian subspace packing were used in [194], [195]. These codebooks are extensively simulated in [67].

New precoder designs for spatially correlated channels were the focus of [253]. A bit error rate (BER) minimizing design with linear receivers and quadrature amplitude modulation (QAM) constellations was analyzed in [370]. Unitary rotation precoding with Givens rotations is studied in [266]. An alternative feedback precoding scheme was proposed in [173]. New insights into parameterizing the channel and precoding matrix were given in [261]. Expansions of codebooks using Householder reflections have been used to generate a unitary matrix from a beamforming vector, to enable multimode precoding and certain kinds of multiuser MIMO feedback. Code designs based on mutually unbiased bases or Kerdock codes have been proposed to provide small alphabet near-Grassmannian codebooks that also facilitate multimode precoding (see the following multimode discussion) and rank adaptation [126],



[219]. Other designs are discussed in [66], [93], [178], [223]. Enhanced unitary precoding is studied in [94]. Several of these codebooks and other codebooks, often resulting from compromises among different companies, have been included in several wireless standards (see Section IV).

RVQ analysis can also be extended to linear precoding [278], [279]. Again, the codebook  $\mathcal{F}$  has i.i.d. entries following the distribution of the capacity maximizing precoder. This precoder is given by the  $M$  right singular vectors corresponding to the  $M$  largest singular values. In the case of a spatially uncorrelated Rayleigh fading channel, this  $M$ -dimensional matrix is uniformly distributed on the set of  $M$ -dimensional matrices with orthonormal columns (a kind of Stiefel manifold [105]). Again, this kind of precoding has nice properties that make asymptotic analysis tractable.

Like antenna subset selection, varying the dimensionality (or mode)  $M$  of the precoder gives substantial improvement. Ref. [196] discusses precoder design that includes mode feedback as a function of the channel conditions. An analysis of the optimal number of substreams is given in [74].

*Id) Improved Space-Time Coding*

Typically, space-time codes are designed without channel information, as theory shows that diversity gain can be extracted from the MIMO channel without CSIT (also the case for the single-user spatial multiplexing gain).

Space-time codes, however, can also be enhanced by adapting to channel conditions. If a high rate feedback channel is unavailable, it is possible to limit adaptation to channel statistics which are by nature slow varying, or perhaps even uplink-downlink reciprocal. Channel spatial statistics convey important information about antenna correlation, mean and standard deviation of angles of departure/arrival which can be exploited in the design of a precoding matrix so as to minimize BER, maximize mutual information, etc. Such work was done in, e.g., [183], [269], [335], [367], [368].

In most works, a simplified spatial correlation model known as the Kronecker model is assumed, which assumes decoupling between transmit and receive antenna correlation structure and leads to closed-form precoders. To deal with arbitrary propagation scenarios (non-Kronecker) alternative algorithms minimizing the BER were proposed in [113].

Beyond exploiting channel statistical information, instantaneous channel adaptation can yield further improvements. Initial work proposed a general model covering both the cases of statistical and instantaneous feedback in [137] and quantized feedback in [138]. Instantaneous channel feedback appears in the form of channel matrix estimate whose distance (error) to the true channel is arbitrary, but with known statistics.

The simplest form of closed-loop space-time coding is again antenna subset selection. In this case, an  $M$ -antenna space-time code is sent over  $M_t$  antennas (with  $M_t > M$ ) antennas. The most popular form of space-time coding, orthogonal space-time block codes (see [16], [167], [242], [319]), is a perfect fit for antenna subset selection particularly because certain values of  $M$  lead to “better” code designs. The most popular choice would be  $M = 2$  where the simple rate one Alamouti space-time code is available [16]. Antenna subset selection with orthogonal space-time block coding was proposed in [100]. Later, extended orthogonal space-time block

codes designed using antenna grouping ideas were proposed in [193], [318].

One of the benefits of orthogonal space-time block codes with antenna subset selection is that they are amenable to closed-form performance analysis. Analysis of the error probability of orthogonal space-time block codes with antenna subset selection has been studied in [142], [190]. The capacity was analyzed in [246].

Like spatial multiplexing, space-time codes also can be linearly precoded for the purpose of achieving both the diversity and beamforming gains. In the case of strong transmit antenna correlation, a precoder based on the knowledge of the correlation matrix alone (like the work mentioned earlier in this section) will achieve some beamforming gain already. However full beamforming capability in general requires instantaneous CSIT.

In this configuration with a space-time code sent over  $K_{ST}$  channel uses, the received codeword matrix

$$\mathbf{Y}[k] = \sqrt{\rho}\mathbf{H}[k]\mathbf{F}[k]\mathbf{S}[k] + \mathbf{N}[k]. \tag{14}$$

where  $\mathbf{Y}[k]$  and  $\mathbf{N}[k]$  are  $M_r \times K_{ST}$  matrices and  $\mathbf{S}[k]$  is the  $M_t \times K_{ST}$  space-time code matrix. The entries of  $\mathbf{N}[k]$  are assumed normalized to be i.i.d.  $\mathcal{CN}(0, 1)$ . With limited feedback, the precoder  $\mathbf{F}[k]$  is restricted to lie in a set  $\mathcal{F} = \{\mathbf{F}_1, \dots, \mathbf{F}_{2^B}\}$ .

Quantized feedback for precoded orthogonal space-time block codes was first proposed in [136], [166]. Like the case of precoded spatial multiplexing, when the codebook precoders are restricted such that  $\mathbf{F}^*[k]\mathbf{F}[k] = \mathbf{I}$ , the problem of designing the codebooks has been shown to relate to the problem of Grassmannian subspace packing [194]. For precoded orthogonal space-time block coding, however, the distance metric used for subspace packing is chordal distance (unlike precoded spatial multiplexing codebooks that use projection two-norm or Fubini-Study distance).

For arbitrary codebooks with precoded orthogonal space-time block codes, necessary and sufficient conditions to guarantee full diversity conditions were derived in [193]. The general idea is that the columns of all codebook precoders should span all of  $\mathbb{C}^{M_t}$ . Conditions for optimal precoding were derived in [271]. A partially precoded form of space-time code design is proposed in [83].

An interesting alternative to using precoding is to switch between multiplexing and space-time coding (primarily using orthogonal space-time codes) [111]. The idea is to compare the receive minimum distance of both multiplexing and space-time coding given a fixed rate. To minimize the probability of error, the signaling architecture with the maximum receive minimum distance is chosen. In fact, it is shown in [130] that the optimal signaling approach given quantized feedback in a MISO setting will vary in rank.

In [14], a technique for extending any  $M$  antenna orthogonal space-time block code to any  $M_t$  antenna transmitter (satisfying that  $\frac{M_t}{M}$  is an integer) is discussed. This approach uses a technique more general than standard linear precoding that requires  $\frac{M_t}{M} - 1$  bits of feedback. The idea behind this approach is to use group coherent codes which preserve the low complexity decoding of orthogonal space-time codes while enjoying some partial beamforming gain. Additionally,

this technique can also be modified to apply to non-orthogonal space-time block codes.

One other enhancement to space-time codes is rate adaptation. The idea being that limited feedback can be sent from the receiver to the transmitter to vary the rate. These techniques were studied in [157] taking delay (i.e., outdated feedback) into account.

There has been some work on codes other than orthogonal space-time block codes. Power allocation using limited feedback for linear dispersion codes is the focus of [182]. Linear dispersion codes with limited feedback are also discussed in [205]. Quasi-orthogonal space-time block codes are adapted with feedback in [29], [30], [322]. Space-time bit interleaved coded modulation with finite feedback is addressed in [153], [154] using a precoding-like structure. Space-time trellis coding using quantized phase information (in a way similar to the work in quantized equal gain beamforming) was studied in [186].

#### 1e) Feedback Overhead Loss

In understanding the benefits of finite rate feedback, it is also important to characterize the detriments. Using feedback creates overhead on one side of the link to benefit the achievable data rate on the other side. This overhead can often be non-negligible. The first work on analyzing the overhead of feedback was for the SISO case in [52]. In this paper, rate degradation was taken into account in a symmetric way by adjusting the fraction of channel resources used for feedback. A symmetric MIMO FDD model was used in [191] to analyze the penalty (in bits per second) of feedback. Training and feedback overhead were optimized in [282], [283] assuming a symmetric RVQ system. These papers used an asymptotic (large number of antennas) analysis to gain insight. A numerical approach to trading off resources for training, feedback, and transmission was given in [23]. The role of overhead is analyzed using an RVQ beamforming assumption in [192]. Related work also has looked at time division cases [301]. Single antenna multicarrier overhead analysis is available in [4]. Initial work in analyzing feedback overhead and delay in the multiuser MIMO downlink is discussed in [220].

2) *Broadband Systems*: Fourth generation (4G) and beyond cellular standards are expected to use MIMO-OFDM technology. As mentioned during the single antenna OFDM feedback discussion, fully characterizing the complete channel state information for any OFDM system can be challenging.

Generalizing the input-output relation of (5) to MIMO for the  $v$ th subcarrier yields

$$\tilde{\mathbf{y}}_v[\tilde{k}] = \tilde{\mathbf{H}}_v[\tilde{k}] \tilde{\mathbf{x}}_v[\tilde{k}] + \tilde{\mathbf{n}}_v[\tilde{k}] \quad (15)$$

for OFDM channel use  $\tilde{k}$ . In (15),  $\tilde{\mathbf{y}}_v[\tilde{k}]$  is an  $M_r$ -dimensional received signal for subcarrier  $v$ ,  $\tilde{\mathbf{H}}_v[\tilde{k}]$  is an  $M_r \times M_t$  channel realization (in the frequency domain) for the  $v$ th subcarrier,  $\tilde{\mathbf{x}}_v[\tilde{k}]$  is an  $M_t$ -dimensional transmitted signal for subcarrier  $v$ , and  $\tilde{\mathbf{n}}_v[\tilde{k}]$  is  $M_r$ -dimensional normalized additive noise with i.i.d.  $\mathcal{CN}(0,1)$  entries.

MIMO channel adaptation must be done on a per-subcarrier basis. For example, a linear precoded spatial multiplexing

system would set

$$\tilde{\mathbf{x}}_v[\tilde{k}] = \sqrt{\rho_v} \tilde{\mathbf{F}}_v[\tilde{k}] \tilde{\mathbf{s}}_v[\tilde{k}]$$

where  $\rho_v$  is the SNR on subcarrier  $v$ ,  $\tilde{\mathbf{F}}_v[\tilde{k}]$  is the  $M_t \times M$  precoder on subcarrier  $v$ , and  $\tilde{\mathbf{s}}_v[\tilde{k}]$  is an  $M$ -dimensional transmitted spatial multiplexing vector satisfying  $\mathbb{E}_{\tilde{\mathbf{s}}_v}[\tilde{\mathbf{s}}_v[\tilde{k}]\tilde{\mathbf{s}}_v^*[\tilde{k}]] = \frac{1}{M}\mathbf{I}$ . The precoder  $\tilde{\mathbf{F}}_v[\tilde{k}]$  must be adapted directly to  $\tilde{\mathbf{H}}_v[\tilde{k}]$ .

Like the single antenna case, MIMO-OFDM feedback systems often send feedback only for pilot subcarriers  $v_0, \dots, v_{K_{pilot}-1}$  where  $K_{pilot}$  is the number of pilots. For example, a precoding system using limited feedback with a common codebook for all pilots of  $\mathcal{F} = \{\mathbf{F}_1, \dots, \mathbf{F}_{2^B}\}$  would send  $B$  bits for each pilot subcarrier for a total feedback load of  $BK_{pilot}$  bits per channel block. Given this information, the challenge is determining the precoders for non-pilots.

The first paper to address this problem was for the case of beamforming in [62]. Inspired by spherical interpolation, the idea was to weight and sum together the feedback beamforming vectors from the two nearest pilots. The weights were designed to maximize the receive SNR of the subcarrier halfway between the two pilots. A transform domain quantization approach was discussed in [215]. In [235], the precoder interpolation problem was formulated as a weighted least squares problem. The weights correspond to the distance (in number of subcarriers) from the different pilot precoders. The technique in [62] was later generalized to larger rank precoding interpolation techniques in [63]. A geodesic approach (i.e., linear interpolation on the Grassmann manifold) was the focus of [236]. Other interpolation ideas are also available in [45], [54]. Instead of trying to interpolate a much simpler approach is clustering [215], [236], where a common precoder is chosen for several contiguous subcarriers. Interestingly, the clustering approach can yield an antenna subset selection criterion when the cluster is extended to cover all subcarriers (i.e., only one pilot) and the precoding codebook has the  $\binom{M_t}{M}$  antenna subset matrices.

The general idea behind interpolation is demonstrated in Figure 4. Sending precoder feedback only on a subset of the subcarriers, the transmitter must use this information and the channel correlation in the frequency domain to recreate all precoders as shown in Figure 4 (a). One way (though not necessarily general) of thinking of interpolation is shown in Figure 4 (b). In this figure, the beamforming vector for a subcarrier is found from the point on the unit sphere corresponding to a line drawn on the surface of the sphere between the points generated by the closest pilots' beamformers. As shown in a variety of works, computing this line exactly or even approximately can be quite complex.

Clustering is explained in Figure 5. In this case, the transmitter and receiver divide (or cluster) the subcarriers in a predetermined way. All narrowband channels within the cluster use the same feedback and use the same precoding matrix. The receiver can then design the feedback to choose a precoder that is mutually beneficial (e.g., with respect to sum rate).

Alternative techniques besides clustering and interpolation have also been addressed. Work in using trellis techniques for precoder interpolation are discussed in [371]. The work in

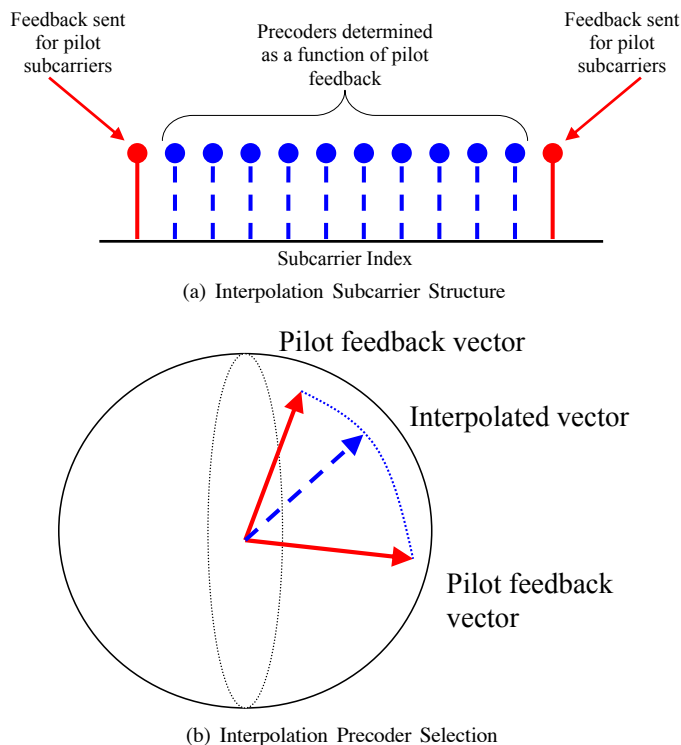

Fig. 4. Figure (a) shows an example of an interpolation MIMO-OFDM limited feedback system. Feedback is only sent for a select number of subcarriers (called pilots here). The pilot feedback information is used to design precoders for all subcarriers. In Figure (b), a beamforming example (i.e., rank one precoding) shows one way of choosing the beamforming vector using the pilot information. A line is traced on the surface of the sphere. The beamforming vectors for subcarriers between the pilots are chosen from this line using the subcarrier index.

[187] uses a different approach called successive beamforming to take into account correlation in time and frequency. A reduced CSI feedback approach for MIMO-OFDM is proposed in [355] that takes into account the fact that highly correlated channels will have highly correlated feedback values; thus, the number of bits can be effectively reduced by taking the actual correlation between binary sequences into account.

The multi-mode precoding problem is even more difficult to quantize. In this scenario, both the matrix and the rank of the matrix can evolve over the OFDM symbol subcarriers. An interpolation framework for multi-mode precoding was published in [143].

While OFDM is the most popular MIMO broadband approach, single carrier systems are still of interest. Beamforming concepts (assuming receiver equalization) have been extended to these systems in [180], [181]. Here the beamforming is actually a finite impulse response filter. Feedback techniques similar to the narrowband scenario can be employed for these systems.

### III. FEEDBACK IN MULTIUSER WIRELESS SYSTEMS

Adapting the transmitted signal across multiple users is an additional degree-of-freedom that can be leveraged in most communication systems. Clearly, the level of channel knowledge required typically increases proportionally to the number of users. This creates challenging problems in practical system implementations when the transmitter does not have a priori

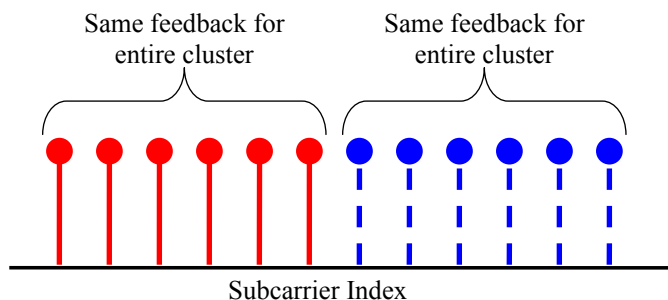

Fig. 5. In a clustered MIMO-OFDM feedback system, subcarriers are clustered together and share a common feedback link. The feedback sent on this common link chooses the same precoder for all cluster subcarriers.

channel information. In this section, we discuss applications of limited feedback in multiuser systems.

#### A. Single Antenna Scheduling and Spectrum Sharing

In multiuser systems, users compete for resources to ensure larger rates and/or better reliability. In a cellular framework with single antennas, the maximum throughput decision is to transmit to the users with the largest receive SNR at each channel use in order to achieve the so-called multiuser diversity gain [156]. To perform this scheduling, the base station needs knowledge of users' SNR conditions.

One solution proposed in [87], [90], [91] is for the users to threshold their receive SNRs and notify the base station only if their SNR exceeds some predetermined threshold. This is a very rudimentary approach to SNR (or channel magnitude) quantization since it is basically a one bit per user feedback set-up. One issue is that there is a small probability that no user will report their SNR thereby leaving the scheduler with no CSIT. A multiple-stage version of this threshold-based technique solves this problem at the expense of some extra latency [104]. These one bit feedback techniques are very bandwidth efficient. Using more feedback bits as discussed in [87], however, may offer diminishing returns. In [276], the benefits of employing only one feedback bit per user and the minor rate enhancements of more feedback bits are analyzed. Related work can be found in [15]. Another use of feedback is to vary the rate and power to minimize outage [255]. Capacity analysis of the broadcast channel with feedback is analyzed in [8]. Opportunistic feedback approaches for designing uplink user transmission policies are discussed in [7]. An excellent overview of feedback and the compression of feedback in multiuser wireless systems is available in [86]. More discussion on channel aware scheduling and cross-layer design is contained in [339].

Multiple antenna enhancements of these limited feedback scheduling works generally are enhanced versions of opportunistic beamforming [333]. Random opportunistic beamforming offers a way of handling both the beamforming and scheduling problems simultaneously with scalar-only SNR feedback. A limited feedback version of opportunistic beamforming was studied in [233], [275]. A comparison of diversity versus opportunistic beamforming is in [159]. The problem of scheduling in multiuser MIMO systems is visited later in this paper.

In broadband systems with multiple access in frequency, users can be scheduled in various subchannels. Feedback

and subcarrier allocation in orthogonal frequency division multiple access (OFDMA) can be done using limited feedback [58]. Additionally, opportunistic scheduling techniques can be combined with OFDM [276]. The problem of using feedback with OFDMA i) scheduling and/or ii) adaptive coding and modulation is also discussed in [10], [132], [175], [176], [206], [208], [309]. The effect of channel variation over time is considered for OFDMA scheduling using feedback in [131]. A thorough summary of the design issues facing multiuser 3G and beyond OFDMA systems is available in [302].

When multiple access is done in the time domain, limited feedback can allow the system to map users to time slots and adapt coding and modulation [210]. This allows the average transmit power to be minimized. As well, transmit power minimizing solutions can be derived for data fusion in sensor networks when the problem is thought of as one of distributed antenna beamforming [209].

Another interesting area is signature optimization using limited feedback (e.g., [20], [248], [249], [256], [257], [263], [264], [328], [332], [341]). In fact, spreading code design using randomly generated codes formed the basis behind the development of RVQ ideas [281]. The performance of an RVQ signature codebook is analyzed in [277]. Limited feedback has also been applied to peer-to-peer multicarrier CDMA [243]. Reduced rank signature optimization leads to further designs using subspace concepts [308]. Performance analysis of signature optimization with CDMA can be found in [72]. Other work on interference avoidance with limited feedback is available in [247]. In CDMA systems, power control is also critical. Feedback approaches to CDMA power control have been widely studied (e.g., [21], [297], [304], [334]).

One issue in multiple access systems where possibly many users are sending feedback to a central controller (e.g., base station) is the issue of limited feedback resources. Clearly multiple access strategies are necessary when users must compete for limited feedback channels. Shared feedback resources were first examined in [314] using a shared random access feedback channel. A code division framework is available in [240]. Other channel aware scheduling ideas can be found in [250]. In [59], both sequential and contention feedback protocols are proposed for OFDMA.

An exciting area where feedback can have impact is in spectrum access aware cognitive radio systems. One of the big problems among open-access systems is determining how users can adequately share spectrum resources. In [6], a technique allowing users to compete for access to spectrum using limited feedback is discussed.

## B. Multiuser Multiple-Input Multiple-Output Systems

While single-user multiple antenna systems provide many benefits, multiuser multiple antennas systems can provide even larger total system rates when the spatial resources are spread among multiple users. Often, the user terminals have limited or no (if single antenna, as considered below) interference canceling capability by themselves. In the downlink, this leaves the base station with the task of precoding the signals in view of suppressing the inter-user interference. CSIT is crucial for this task. Thus, for cellular systems that commonly use

FDD, limited feedback is critical to making multiuser MIMO practical.

1) *Single Receive Antennas*: A downlink multiuser MIMO system with each user possessing a single receive antenna and normalized noise will give the  $i$ th user an input-output relation

$$y_i[k] = \mathbf{h}_i^T[k] \mathbf{x}[k] + n_i[k] \quad (16)$$

where the subscript denotes the user number. The transmitted signal is restricted such that  $\mathbb{E}_{\mathbf{h}, \mathbf{x}} [\|\mathbf{x}[k]\|_2^2] \leq \rho$ . Typically,  $\{\mathbf{x}[k]\}$  is designed to support at most  $M_t$  users per block length.

Various signaling approaches can be employed to divide the spatial resources. Most relate to using at least some form of precoding. In this case,  $\mathbf{x}[k] = \sqrt{\rho} \mathbf{F}[k] \mathbf{s}[k]$ . Here  $\mathbf{F}[k]$  is the linear precoding matrix. The signal  $\{\mathbf{s}[k]\}$  could have independently generated rows that correspond to different users or do more complicated interference mitigation schemes such as dirty paper coding (e.g., see [50], [68], [298], [330], [340], [351]).

Most limited feedback multiuser MIMO schemes fall into two categories. The first category is to let users quantize some function of  $\mathbf{h}_i[k]$  and send this channel information to the base station. The problem is that the purpose of  $\mathbf{F}[k]$  is to (in some sense) orthogonalize the various user signals. When the channel is quantized, the user signals can not be perfectly orthogonalized due to inherent quantization error [79], [133]. This leads to a sum rate ceiling as the SNR increases.

Improving this sum rate ceiling is a difficult problem. When the number of users increases, scheduling users with channels that satisfy near orthogonality conditions provides many improvements [312], [313], [323], [350]. Other more general approaches such as those in [38], [336] can also be employed. Further interesting aspects on multiuser scheduling are discussed later in this paper. The sum rate ceiling can also be raised by leveraging quantization distortion in an MMSE-type of precoder design [70].

Innovative work has also been done characterizing what type of and how much feedback should be used. A comparison between quantized and analog feedback methods with sum rate maximization is available in [46]. The effect of training, feedback quantization, and feedback error on sum rate is analyzed in [47].

The broad second category is a multiuser version of the opportunistic beamforming approach mentioned earlier (as initially discussed in [291]). In the approach of [291],  $\mathbf{F}[k]$  is chosen randomly according to a known distribution. Pilots are sent out on all of the spatial beams (i.e., columns of the precoder). Users then measure their receive SINRs on the columns and report this information back to the base station. The base station picks the subset of users that maximizes the sum rate. The best property of this algorithm is that it approaches the optimal sum rate scaling as the number of users increases assuming independently fading spatially uncorrelated Rayleigh channels. Single feedback bit versions of this work can be found in [77], [240], [359]. Multiple feedback bit analysis is contained in [189]. This technique can also be extended to probe with multiple precoders [119]. This will allow the sum rate to scale faster as the number of users increases.

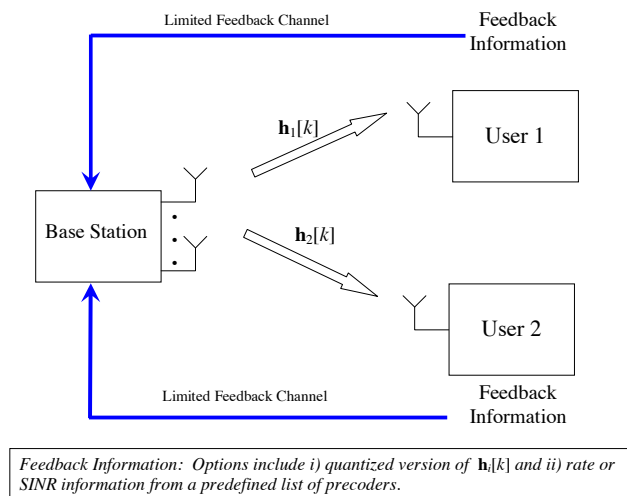

Fig. 6. An example limited feedback precoding multiuser MIMO system is shown. The base station sends data to the users via a linear precoding matrix. There are two typical approaches to feedback design. One option is for the users to send quantized versions of their channel estimates. The base station can use these quantized versions to pick the best precoding matrix according to some defined criterion. An alternative approach is to restrict the precoder to a finite number of choices. The users can then send information on the feedback link relating to the maximum achievable rate (e.g., SINR information) computed using the channel estimate or obtained through channel sounding.

Multiuser opportunistic beamforming techniques typically exhibit a degradation of performance when the number of users is low. This is because some of the random beams fail to “hit” a user. To mitigate this problem, several approaches were proposed including enhancing the randomly launched beams with a power control algorithm allowing to reduce the resource allocated to the beams for which no user reported a good enough SINR [163]. Another method improves the beam design with the help of known statistical information. The correlation matrices associated with the transmit channel of some users reveal a great deal about the mean separability of these users. Such information can be exploited both for scheduling and precoder design [162].

This kind of probing idea relates to the popular industrial feedback technique known as Per User Unitary Rate Control (PU2RC) in [148]. Typically PU2RC systems use a deterministic (rather than random) codebook [146]. They can be designed using probing or allowing the users to perform channel estimation and then compute SINRs for all codeword matrices. The throughput scaling of PU2RC was analyzed in [118] for both the noise limited and interference limited regimes.

These similarities and differences in multiuser MIMO approaches are roughly described in Figure 6. The primary difference is in the information that is fed back. Channel quantization does not constrain the form of the multiuser MIMO precoding matrix, but it often leads to inferior performance due to quantization error. Channel sounding allows users to measure (or compute) actual SINR performance. This typically comes at the expense of constraining the precoder to a finite set (or codebook). A thorough comparison is available in [78].

2) *Multiple Receive Antennas*: When users have multiple receive antennas, performance of multiuser MIMO systems can be improved by leveraging the added degrees-of-freedom

at the receiver. With enough receive antennas even simple per antenna scheduling without precoding can provide good performance [107]. It was shown in [134] that combining the signals received at the multiple receive antennas provides substantial sum rate benefit because the negative effect of channel quantization error is reduced. Block diagonalized multiuser transmission with limited feedback is discussed in [258], which takes into account that each receive antenna should not be treated as a separate user when the antennas are co-located. Limited feedback can also be employed with regularized block diagonalization [296]. A vector quantization framework combined with improved scheduling is discussed in [151]. The amount of feedback necessary to avoid a sum rate ceiling is asymptotically analyzed in [34]. Alternative selection and precoding techniques are discussed in [35], [43], [324], [347].

A recent technique for multiuser MIMO with multiple receive antenna users is coordinated beamforming with limited feedback. In coordinated beamforming, both the transmit beamformers and receive combining vectors are jointly optimized to maximize sum rate under a zero interference constraint [234]. When implemented with limited feedback [56], the users send limited feedback by sending to the base station the quantized coefficients of a certain normalized Hermitian symmetric matrix that is a function of their channel coefficients. The base station then uses the channel conditions of multiple users to solve for the transmit beamforming and receive combining vectors for each user. Both iterative algorithms [55] and direct solutions can be employed [56]. The receive combining vectors are quantized as part of the joint optimization and subsequently broadcast to the users in what is called limited feedforward [55]. The joint design improves performance versus receive antenna selection [134] while incurring only a small feedback overhead.

An enhanced version of PU2RC using multiple receive antennas was proposed in [149]. WCDMA/HSDPA approaches to include multiuser MIMO with feedback are studied in [150]. Note that practical systems will still suffer from the problem of many users competing for limited feedback resource. Contention feedback approaches for multiuser MIMO, where users compete to send feedback on a shared contention feedback channel may solve this problem [240], [315]. These relate to the opportunistic feedback techniques in [9].

Feedback designs have also been studied for MIMO-CDMA systems, assuming single antenna subscriber units. For example, antenna partitioning based on limited feedback from the subscriber has been proposed to improve the receive SINR of each user by assigning them to the best transmit antenna [64].

The multiuser MIMO discussion above has concentrated on the downlink. In the uplink, user synchronization makes the feedback problem almost identical to those studied for point-to-point MIMO as discussed in [145]. The primary difference is that the codebook precoders are geographically distributed with different precoder columns corresponding to different users. The multiuser MIMO uplink also represents another form of spatial division multiple access [120]. This view provides intuition into system throughput scaling and scheduling. The diversity-multiplexing tradeoff of the uplink was analyzed in [11].

### C. Scheduling in Multiuser Multiple-Input Multiple-Output Systems

When the number of users actively receiving or transmitting packets exceeds the number of antennas at the base station, it becomes necessary to select a subset of terminals that will be allowed to communicate with the base station in any given time or frequency slot. Although this selection could in principle be realized without any prior information on the channel state of the users (as in round-robin scheduling for instance), it has been shown that multiple antenna systems can extract a substantial capacity gain from using carefully designed selection rules. In brief, a rate maximizing scheduler will aim at realizing a good compromise between the multiuser diversity gain, by selecting users with high received power levels, and the multiplexing gain, by choosing the users with sufficiently orthogonal channels, in view of, e.g., linear precoding.

In a precoded SDMA-type system lacking CSIT, feedback must be used to i) perform scheduling and ii) design the proper multiuser MIMO precoding matrix. Clearly, the required feedback resolution for each of these two tasks is different. Scheduling typically requires only rough quantization resolution to distinguish between high and low rate users (e.g., see the discussion in [91]). Precoding, however, requires higher resolution accuracy to mitigate the problems caused by interuser interference. This motivates flexible feedback designs that optimally partition the feedback bit budget across those used for scheduling and those for precoding [353].

There is also a non-trivial optimization problem related to how many users should be scheduled given the quantization level. Scheduling more simultaneous users can sometimes create more interuser interference and not actually enhance the achievable sum rate. The tradeoff between multiuser diversity and multiplexing gain is analyzed in [160]. Work in beam selection using SINR feedback has been done in [65]. Scheduling with limited feedback information for multiuser MIMO has been enhanced in [161]. Another way to enhance the performance is by actively varying the rank of the precoder (which corresponds to the number of users selected) using interference prediction approaches [25] or other techniques [57]. A thresholding technique for the decision of multiuser MIMO feedback is discussed in [337]. The optimal number of users to support was characterized in [73].

Another way of exploring the trade-off between multiuser diversity gain and user multiplexing gain was proposed in [259]. In this work, the total feedback bit budget is divided equally across a subset of users, while users outside the subset are dropped from the system. As the considered subset size is reduced, more weight is given on multiplexing gain and less on the multiuser diversity. The optimum trade-off point is a function of the SNR and other system parameters. This relates to the idea of rate-adaptive feedback which considers an average, rather than fixed, feedback bit budget per user [354].

### D. Relaying

There has been much recent interest in allowing nodes in wireless networks to relay information to other users. In

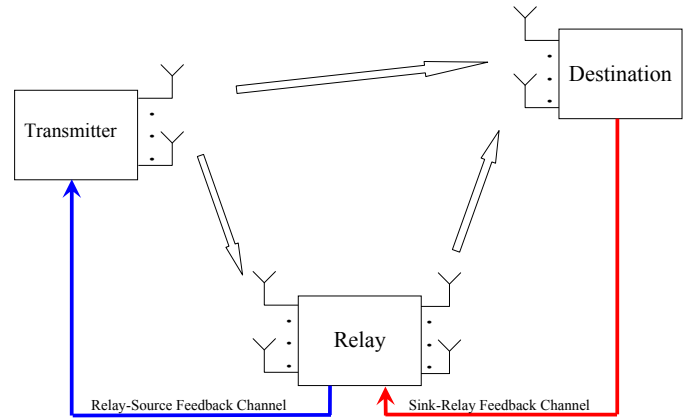

Fig. 7. Block diagram of a limited feedback multiple antenna relay system. Notice that multiple feedback links are possible. Feedback could assist the relay and source in adaptive transmission techniques such as power control and precoding.

a wireless relay channel, a helper node (often without data to send) acts as a relay between a source and a destination as shown in Figure 7. There are three channels in the basic relay channel: the source-to-relay channel, the relay-to-destination channel, and the source-to-destination channel. More sophisticated relay channels may involve multiple relays, multiple stages of relaying, bidirectional relaying, and MIMO relays. Relays have different levels of assumed sophistication. Amplify-and-forward relays (also known by other names) generally apply some kind of analog transformation to the received signal while decode-and-forward relays detect the transmitted bits and re-encode. Relays may operate under full-duplex assumptions (transmitting and receiving at the same time) or more practical half-duplex assumptions (transmitting or receiving). Relaying is now being considered for cellular coverage enhancement through efforts like IEEE 802.16j [244]. Relaying is an extensive area in its own right, and this section discusses some applications of limited feedback in relay channels.

A rough block diagram of a limited feedback relay system is shown in Figure 7. The general idea is to enhance the rate and/or reliability of a transmitter and destination terminal with poor channel conditions. The relay retransmits (and possibly reencodes) the source signal meant for the destination node. Limited feedback links could be used for sink-to-relay feedback and relay-to-source feedback. Because of the poor channel conditions sink-to-source feedback is unusual.

Exploiting limited feedback concepts in relay channels is challenging due to the number of different channels. There are multiple channels to be estimated, feedback may be required at multiple nodes, and feedback information may traverse multiple paths. Further, relays are often assumed to be incapable of complex physical layer and medium access control operations, making the amount and type of possible training and feedback more restricted than in other channel models.

While there remain many open problems in the area, research in limited feedback for relay systems has made significant progress in just the past few years. The seminal paper [165] shows that a single bit of feedback from destination to relay allows decode-and-forward to achieve the

full diversity available in the single-antenna relay channel. In [13], the authors derive finite-rate feedback for power control to reduce the probability of outage in the single-antenna amplify-and-forward relay channel, finding that just one bit of feedback can double the diversity order and deriving a strategy that accommodates any size of desired feedback. A similar scenario for the decode-and-forward channel is studied in [152], where it is shown that very low levels of feedback can make simple orthogonal decode-and-forward strategies competitive with dynamic decode-and-forward [28].

Limited feedback beamforming for amplify-and-forward relaying was studied for the distributed single-antenna case in [361], whereas the single-relay multi-antenna case is addressed in this issue [144]. For distributed single antenna relays performing beamforming, [361] compares codebooks generated using the Generalized Lloyd Algorithm, random codebooks, and relay selection codebooks. While codebooks designed using the Lloyd algorithm outperform selection with a few bits of feedback, random codebooks require large amounts of feedback to compete with selection. This leads to the conclusion that selection may be the method of choice for distributed beamforming given its good balance of performance and synchronization requirements.

A linear single-relay multi-antenna relay channel is considered in [144], and the optimal beamforming vector is shown to be uniformly distributed on the unit hypersphere, making Grassmannian codebooks attractive as in the point-to-point case. It is shown that the relay can quantize only one of the eigenvectors of the source-relay channel, instead of the entire channel, to feed forward to the destination. The use of three different quantizations makes the gap between optimal and limited feedback beamforming much larger in the relay channel than in the point-to-point channel, while more than tripling the amount of required feedback. To combat the growth of feedback, [245] proposes transmit antenna selection at both source and relay, which allows an analog forwarding of source-relay channel state information instead of the quantized method of [144]. The penalty is, expectedly, an SNR loss at the destination.

More complex relay networks may involve multiple relays between the source and destination. One application of limited feedback in these networks is to select the relay that will be used to help communication between source and destination, which is known as relay selection. In one relay selection approach, relays contend to send parity information upon receiving feedback that a packet was not decoded correctly [360]. In another approach, a handshaking protocol can be used to determine the best node to forward packets to the destination [316], [317]. As an alternative to relay selection, multiple relays can be co-phased based on limited feedback when a certain amount of synchronization is available to improve [164]. Multiple relays with limited feedback are also discussed in [362].

#### IV. CODEBOOK BASED FEEDBACK IN STANDARDS

In the past five years, several applications of feedback have appeared in emerging wireless standards including adaptive coding and modulation, power control, hybrid automatic repeat

request, and codebook based limited feedback precoding. In this section we review codebook based limited feedback precoding concepts that have been decided or are under consideration in several emerging standards.

##### A. 3GPP Release - 99

3GPP (third generation partnership program) is the name for the official evolution of the GSM system. It features a wideband CDMA physical layer with 5MHz channel bandwidths. It uses fast power control feedback on both the uplink and downlink. It is also the first standard to support codebook based beamforming on the downlink with two transmit antennas [76].

Two types of codebook based feedback are supported in the standard [115]. Mode 1 uses a type of quantized equal gain combining [109], [199], [225], where the phase of the second antenna is adjusted based on the average of two one bit feedback commands, effectively implementing a two-bit codebook. Mode 2 uses a type of quantized maximum ratio combining. By averaging over multiple feedback slots, effectively two bits of amplitude information and three bits for phase information are realized. These modes are analyzed in [80].

##### B. IEEE 802.11n

IEEE 802.11n is a developing standard that is an extension to the IEEE 802.11 wireless local area network standard with a stated goal of achieving 100 Mbps of *effective* throughput [241]. It uses a MIMO-OFDM physical layer and supports two-to-four transmit antennas and two-to-four receive antennas. It supports two flavors of single-user feedback based MIMO precoding (generically called beamforming in the standard): implicit and explicit [305].

Implicit feedback precoding uses the channel reciprocity that results from TDD operation. In theory, with reciprocity there is no limited feedback required. In practice though, the RF chains at the transmitter and receiver require calibration to ensure reciprocity across the entire analog signal path. Reciprocity is enabled through the use of feedback. Specifically, two users exchange training information. Then each user sends its quantized channel estimate per subcarrier to the other user. Based on this feedback, each user is able to calibrate its baseband, and precoding can be performed using reciprocity. Note that the calibration procedure must be performed during a coherence time but does not have to be performed frequently (perhaps repeated in minutes or hours).

There are three different explicit feedback precoding modes of operation. The first mode is called CSI Matrices feedback and consists of sending back for each subcarrier a quantized maximum amplitude (3 bits) and the quantized channel matrix (4-8 bits per scaled real and imaginary entry). The second mode is called non-compressed beamforming matrix feedback. In this case the receiver computes the precoder with orthogonal columns, quantizes each entry, and sends this information back. In the final mode of operation, known as compressed beamforming matrix feedback, the receiver represents the precoder with orthogonal columns using Givens rotations (inspired by [261]). The parameters (called angles)

are then quantized and sent back. The CSI Matrix mode is the most general and allows the transmitter to compute its own precoder. The non-compressed mode reduces the amount of feedback required to adjust the precoder while the compressed mode further reduces feedback and preserves orthogonality of the columns with quantization.

### C. IEEE 802.16e / WiMAX

IEEE 802.16e is the mobile extension to IEEE 802.16 for wireless metropolitan area networks [1], [19]. It is also commonly referred to as WiMAX (Worldwide Interoperability for Microwave Access), coming from the WiMAX Forum, which is an industry consortium selecting certain subsets of IEEE 802.16e for interoperability and certification. IEEE 802.16e has several different physical layers and MIMO modes of operation. The current WiMAX mobile profile 1.0 supports OFDMA and some basic MIMO features. The next release will likely support some of the codebook feedback modes included in the standard.

Several single-user codebook based limited feedback techniques are supported in IEEE 802.16e in the downlink. Codebooks are given in the standard for several configurations. Two, three, and four antenna three bit codebooks are listed; they appear to be Grassmannian codebooks. Six bit beamforming codebooks for three and four antennas are derived from a generator vector multiplied by a Householder reflection matrix, exponentiated diagonal matrix, and another Householder reflection matrix. This approach saves some storage. Precoding codebooks for three and six bits for up to four antennas are found by taking subsets of the columns of a Householder reflection matrix generated using the beamforming codebook. This results in codebooks that can be generated from the beamforming codebooks; storing precoding codebooks is not required. Note that Householder reflection matrices are unitary, meaning that the precoders constructed from them have orthogonal columns.

### D. 3GPP Long Term Evolution

3GPP Long Term Evolution (LTE) is the name for release 8 of the 3GPP standard, the evolution of 3GPP Release 99. 3GPP LTE has a MIMO-OFDMA physical layer on the downlink and supports various single and multiple user MIMO modes of operation [92].

Several different single-user codebook based limited feedback techniques are supported in 3GPP LTE. 3GPP LTE has support for codebook based precoding on the downlink with two or four transmit antennas. In the case of two antennas, a beamforming codebook with six vectors (including two corresponding to antenna selection) and a precoding codebook with three matrices. For four antennas, a four bit codebook is specified for beamforming and precoding with two, three, and four streams. The precoding codebooks are built by taking specific subsets of Householder reflection matrices generated from the beamforming entries. The subsets are chosen to have a nested structure. For example, for a given generating vector, the two stream codebook will include the original vector and an additional vector. The three stream codebook will add an additional vector and so on. This facilitates multi-mode rank

adaptation, where the base station can change the number of active streams, and may offer some computational savings.

A major difference between the 3GPP LTE and IEEE 802.16e codebooks is that the 3GPP codebooks have a finite alphabet structure, which makes them easy to store and simplifies computation. This structure is preserved even in the calculation of the reflection matrices, thus can be exploited in the precoding case as well.

### E. 3GPP2 Ultra Mobile Broadband

3GPP2 (third generation partnership program 2) Ultra Mobile Broadband (UMB) is the name for the next generation evolution of the cdma2000 standard. UMB also uses a MIMO-OFDMA physical layer along with some CDMA control channels. It supports codebook based precoding for single-user and multiuser systems on the downlink with two or four antennas. It supports rank adaptation and adaptive switching between single-user and multiuser modes.

Two different precoding codebooks are supported: a knockdown codebook and a readymade codebook. A knockdown codebook consists of multiple unitary matrices. The receiver chooses a preferred matrix and columns from that matrix to indicate its preferred precoder. Two default codebooks are a Fourier-based codebook with multiple phase shifted discrete Fourier Transform matrices (inspired from constructions in [194], [195]) and an identity codebook (corresponding to antenna selection). A readymade precoding codebook consists of up to 64 matrices. For a given rank  $r$ , the receiver sends back the preferred matrix to the transmitter. The transmitter uses the first  $r$  columns of the chosen matrix as the precoder. Interestingly, unlike other standards, 3GPP2 UMB has downloadable codebooks (a mandatory feature) so the default codebooks in the standard can be changed. This means though that hardware can not exploit special structure in the codebooks since a codeword search at the receiver must support the downloaded codebook.

Multiuser MIMO, or SDMA, is also supported using the knockdown codebook and an appropriate channel quality indicator. In this case users are scheduled onto different beams of a single matrix, inspired by the PU2RC multiuser algorithm [148].

### F. IEEE 802.16m / 4G

IEEE 802.16m is tasked with developing an advanced air interface for IEEE 802.16 [2]. It is one of what will likely be several fourth generation cellular standards (versus 3GPP LTE and 3GPP2 UMB that are generally considered to be 3.5 generation standards). While it is still early in the standardization process, it appears that IEEE 802.16m (and other 4G standards) will pick up where IEEE 802.16e left off. It is likely that the physical layer will use MIMO-OFDMA but will support more advanced techniques like adaptive feedback, multiuser MIMO, relaying (discussed in Section III-D), and base station cooperation, each with more sophisticated limited feedback requirements.

The aforementioned standards implement limited feedback precoding methods that are essentially one-shot quantization techniques. As discussed in Section II-B1, there are adaptive



techniques that can exploit temporal correlation in the channel to reduce feedback requirements [31], [32], [216], [268]. There are several different approaches including quantizing gradients [31], [32], using localized codebooks [185], [188], [268], or adaptive codebook structures [216]. Most of this work is for the case of beamforming; adaptive precoding has received less attention. The area of adaptive feedback is still a fertile ground for research.

Multiuser MIMO communication, also called SDMA, was discussed during development of IEEE 802.16m, 3GPP LTE, and 3GPP2 UMB. Only UMB seems to have included it explicitly. A major challenge with limited feedback based multiuser MIMO is that quantization errors create multiuser interference, which can cause throughput ceilings at high SNRs [79], [133], [258]. Reducing these error effects requires either large codebooks, which scale in size with SNR, a substantial amount of multiuser diversity [350], or a combination of multiuser diversity and structured codebooks like with PU2RC [118], [148]. Practically implementing large codebooks remains a challenge. QAM codebooks using fast vector search algorithms are attractive for realizing each to search codebooks [265], while hierarchical codebooks [42], successive refinement [185], [188], or progressive refinement [112] may support multiple resolutions of feedback. Adaptive methods may also be useful in implementing feedback reduction. The practical realization of large codebooks for multiuser beamforming and precoding is still under investigation.

Base station coordination [135], [287], [288], [357], also called network MIMO [140], [329], creates base station coordination clusters to treat the system like a “super” MIMO system, leveraging high capacity base station backhauls. Interference is eliminated in coordination clusters since users receive signals from all the base stations and there is effectively no interference. Unfortunately, implementing base station coordination on the downlink requires a substantial amount of CSI about the channel between every user and every base station in the coordination cluster. Further this information must be exchanged by all the base stations. Research is only now being conducted on issues like codebook based feedback techniques and the impact of codebook size. Given that base station coordination is an extension of multiuser MIMO with more effective transmitters and users, it is likely that large codebooks will also be required. Analysis of base station coordination with limited feedback as well as the development of codebook based limited feedback strategies remains a topic of interest.

## V. CONCLUSIONS

In this paper, we presented a look at the state of limited feedback research in wireless communication systems. Interest in applications of limited feedback has exploded over the last few years and is sure to grow with the standardization and deployment of 4G and beyond wireless networks.

Many problems still remain. At present there is no general theory of single or multiuser wireless feedback communication networks. This problem may or may not be tractable. It is complicated by issues such as fundamental problems in source coding, interaction between forward and reverse links, effect

of delay and the accompanying necessity for small feedback signal blocklengths, effect of errors in the feedback messages, and uncertainty in the optimal way to jointly encode message information with channel state feedback. Practical issues in the deployment of limited feedback systems often tie directly with the quality of the channel model assumed in the system design. Changes and mismatches in the channel distribution must be anticipated and accounted for in a reliable system.

## ACKNOWLEDGEMENTS

The authors would like to thank Nihar Jindal, Kyeongyeon Kim, Marios Kountouris, Vasanthan Raghavan, Shahab Sanayei, and Randa Zakhour for reviewing this document. Their comments and those of the anonymous reviewers improved the paper throughout.

## REFERENCES

- [1] IEEE-SA Standards Board, “IEEE Standard for Local and metropolitan area networks Part 16: Air Interface for Fixed and Mobile Broadband Wireless Access Systems Amendment for Physical and Medium Access Control Layers for Combined Fixed and Mobile Operation in Licensed Bands,” IEEE Std 802.16e-2005, Feb. 2006.
- [2] IEEE-SA Standards Board, “IEEE 802.16 Task Group m,” <http://wirelessman.org/tgm/>.
- [3] M. Agarwal, D. Guo, and M. L. Honig, “Channel state and receiver state feedback for frequency-selective block fading channels,” in *Proc. IEEE Int. Symp. Info. Th.*, July 2008, pp. 270–274.
- [4] M. Agarwal, D. Guo, and M. L. Honig, “Multi-carrier transmission with limited feedback: Power loading over sub-channel groups,” in *Proc. IEEE Int. Conf. on Commun.*, May 2008, pp. 981–985.
- [5] M. Agarwal and M. L. Honig, “Wideband fading channel capacity with training and partial feedback,” in *Proc. of Allerton Conf. on Comm. Cont. and Comp.*, Sept.–Oct. 2005.
- [6] —, “Spectrum sharing on a wideband fading channel with limited feedback,” in *UCSD Info. Theory and Appl. Workshop*, Jan.–Feb. 2008.
- [7] R. Agarwal, V. Abhishek, R. Vannithamby, and J. Cioffi, “Opportunistic feedback protocol for minimizing power in uplink with heterogeneous traffic,” in *Proc. IEEE Veh. Technol. Conf.*, Sept.–Oct. 2007, pp. 1882–1886.
- [8] R. Agarwal and J. Cioffi, “Capacity of fading broadcast channels with limited rate feedback,” in *Proc. of Allerton Conf. on Comm. Cont. and Comp.*, Sept.–Oct. 2006.
- [9] R. Agarwal, C. Hwang, and J. Cioffi, “Opportunistic feedback protocol for achieving sum-capacity of the MIMO broadcast channel,” in *Proc. IEEE Veh. Technol. Conf.*, Sept.–Oct. 2007, pp. 606–610.
- [10] R. Agarwal, R. Vannithamby, and J. Cioffi, “Optimal allocation of feedback bits for downlink OFDMA systems,” in *Proc. IEEE Int. Symp. Info. Th.*, July 2008, pp. 1686–1690.
- [11] V. Aggarwal and A. Sabharwal, “Diversity order gain with noisy feedback in multiple access channels,” in *Proc. IEEE Int. Symp. Info. Th.*, July 2008, pp. 404–408.
- [12] D. Agrawal, T. J. Richardson, and R. L. Urbanke, “Multiple-antenna signal constellations for fading channels,” *IEEE Trans. Inform. Theory*, vol. 47, no. 6, pp. 2618–2626, Sept. 2001.
- [13] N. Ahmed, M. A. Khojastepour, A. Sabharwal, and B. Aazhang, “Outage minimization with limited feedback for the fading relay channel,” *IEEE Trans. Commun.*, vol. 54, no. 4, pp. 659–669, April 2006.
- [14] J. Akhtar and D. Gesbert, “Extending orthogonal block codes with partial feedback,” *IEEE Trans. Wireless Comm.*, vol. 3, no. 6, pp. 1959–1962, Nov. 2004.
- [15] Y. Al-Harathi, A. Tewfik, and M. Alouini, “Multiuser diversity with quantized feedback,” in *Proc. IEEE Glob. Telecom. Conf.*, vol. 6, Nov.–Dec. 2005.
- [16] S. M. Alamouti, “A simple transmit diversity technique for wireless communications,” *IEEE J. Select. Areas Commun.*, vol. 16, no. 8, pp. 1451–1458, Oct. 1998.
- [17] S. M. Alamouti and S. Kallel, “Adaptive trellis-coded multiple-phase-shift keying for Rayleigh fading channels,” *IEEE Trans. Commun.*, vol. 42, no. 6, pp. 2305–2314, June 1994.

- [18] M. Alouini, X. Tang, and A. J. Goldsmith, "An adaptive modulation scheme for simultaneous voice and data transmission over fading channels," *IEEE J. Select. Areas Commun.*, vol. 17, no. 5, pp. 837–850, May 1999.
- [19] J. G. Andrews, A. Ghosh, and R. Muhamed, *Fundamentals of WiMAX: Understanding Broadband Wireless Networking*. Upper Saddle River, NJ: Prentice Hall, 2007.
- [20] P. Anigstein and V. Anantharam, "Ensuring convergence of the MMSE iteration for interference avoidance to the global optimum," *IEEE Trans. Inform. Theory*, vol. 49, no. 4, pp. 873–885, April 2003.
- [21] S. Ariyavisitakul and L. F. Chang, "Signal and interference statistics of a CDMA system with feedback power control," *IEEE Trans. Commun.*, vol. 41, no. 11, pp. 1626–1634, 1993.
- [22] C. K. Au-Yeung and D. J. Love, "A performance analysis framework for limited feedback beamforming in correlated fading," *IEEE Commun. Lett.*, vol. 10, no. 5, pp. 344–346, May 2006.
- [23] —, "Design and analysis of two-way limited feedback beamforming systems," in *Proc. IEEE Asilomar Conf. on Signals, Systems, and Comp.*, Nov. 2007.
- [24] —, "On the performance of random vector quantization limited feedback beamforming in a MISO system," *IEEE Trans. Wireless Commun.*, vol. 6, pp. 458–462, Feb. 2007.
- [25] C. K. Au-Yeung, S. Y. Park, and D. J. Love, "A simple multiuser and single-user dual-mode downlink system with limited feedback," in *Proc. IEEE Glob. Telecom. Conf.*, Nov. 2007, pp. 3791–3795.
- [26] K. Ausavapattanakun and A. Nosratinia, "Analysis of Go-Back-N ARQ in block fading channels," *IEEE Trans. Wireless Commun.*, vol. 6, no. 8, pp. 2793–2797, Aug. 2007.
- [27] —, "Analysis of selective-repeat ARQ via matrix signal-flow graphs," *IEEE Trans. Commun.*, vol. 55, no. 1, pp. 198–204, Jan. 2007.
- [28] K. Azarian, H. El Gamal, and P. Schniter, "On the achievable diversity-multiplexing tradeoff in half-duplex cooperative channels," *IEEE Trans. Inform. Theory*, vol. 51, no. 12, pp. 4152–4172, Dec. 2005.
- [29] B. Badic, P. Fuxjaeger, and H. Weinrichter, "Performance of quasi-orthogonal space-time code with antenna selection," *Electronic Letters*, vol. 40, no. 20, pp. 1282–1284, Sept. 2004.
- [30] B. Badic, M. Rupp, and H. Weinrichter, "Extended Alamouti codes in correlated channels using partial feedback," in *Proc. IEEE Int. Conf. on Commun.*, vol. 2, June 2004, pp. 896–900.
- [31] B. C. Banister and J. R. Zeidler, "Feedback assisted transmission subspace tracking for MIMO systems," *IEEE J. Select. Areas Commun.*, vol. 21, no. 3, pp. 452–463, April 2003.
- [32] —, "A simple gradient sign algorithm for transmit antenna weight adaptation with feedback," *IEEE Trans. Signal Processing*, vol. 51, no. 5, pp. 1156–1171, May 2003.
- [33] A. Barg and D. Y. Nogin, "Bounds on packings of spheres in the Grassmann manifold," *IEEE Trans. Inform. Theory*, vol. 48, no. 9, pp. 2450–2454, Sept. 2002.
- [34] A. Bayesteh and A. K. Khandani, "How much feedback is required in MIMO broadcast channels?" in *Proc. IEEE Int. Symp. Info. Th.*, July 2006, pp. 1310–1314.
- [35] —, "On the user selection for MIMO broadcast channels," *IEEE Trans. Inform. Theory*, vol. 54, no. 3, pp. 1086–1107, March 2008.
- [36] M. Beko, J. Xavier, and V. Barroso, "Noncoherent communication in multiple-antenna systems: Receiver design and codebook construction," *IEEE Trans. Signal Processing*, vol. 55, no. 12, pp. 5703–5715, Dec. 2007.
- [37] P. A. Bello and W. M. Cowan, "Theoretical study of on/off transmission over Gaussian multiplicative circuits," in *Proc. IRE Not. Commun. Symp.*, Oct. 1962.
- [38] N. Benvenuto, E. Conte, S. Tomasin, and M. Trivellato, "Predictive channel quantization and beamformer design for MIMO-BC with limited feedback," in *Proc. IEEE Glob. Telecom. Conf.*, Nov. 2007, pp. 3607–3611.
- [39] S. Bhashyam, A. Sabharwal, and B. Aazhang, "Feedback gain in multiple antenna systems," *IEEE Trans. Commun.*, vol. 50, no. 5, pp. 785–798, May 2002.
- [40] R. S. Blum, "MIMO with limited feedback of channel state information," in *Proc. IEEE Int. Conf. Acoust., Speech and Sig. Proc.*, vol. 4, April 2003, pp. 89–92.
- [41] R. S. Blum and J. H. Winters, "On optimum MIMO with antenna selection," *IEEE Commun. Lett.*, vol. 6, no. 8, pp. 322–324, Aug. 2002.
- [42] F. Boccardi, H. Huang, and A. Alexiou, "Hierarchical quantization and its application to multiuser eigenmode transmissions for MIMO broadcast channels with limited feedback," in *Proc. IEEE Int. Symp. Personal, Indoor, and Mobile Radio Commun.*, Sept. 2007.
- [43] F. Boccardi, H. Huang, and M. Trivellato, "Multiuser eigenmode transmission for MIMO broadcast channels with limited feedback," in *Proc. IEEE Int. Workshop on Signal Proc. Adv. Wireless Commun.*, June 2007.
- [44] S. Borade and L. Zheng, "Wideband fading channels with feedback," in *Proc. of Allerton Conf. on Comm. Cont. and Comp.*, Oct. 2004, pp. 512–521.
- [45] M. Borgmann and H. Bolcskei, "Interpolation-based efficient matrix inversion for MIMO-OFDM receivers," in *Proc. IEEE Asilomar Conf. on Signals, Systems, and Comp.*, vol. 2, Nov. 2004, pp. 1941–1947.
- [46] G. Caire, N. Jindal, and M. Kobayashi, "Achievable rates of MIMO downlink beamforming with non-perfect CSI: A comparison between quantized and analog feedback," in *Proc. IEEE Asilomar Conf. on Signals, Systems, and Comp.*, Oct.–Nov. 2006, pp. 354–358.
- [47] G. Caire, N. Jindal, M. Kobayashi, and N. Ravindran, "Achievable throughput of MIMO downlink beamforming with limited channel information," in *Proc. IEEE Int. Symp. Personal, Indoor, and Mobile Radio Commun.*, Sept. 2007.
- [48] G. Caire and K. R. Kumar, "Information theoretic foundations of adaptive coded modulation," *Proc. IEEE*, vol. 85, no. 12, pp. 2274–2298, Dec. 2007.
- [49] G. Caire and S. Shamai, "On the capacity of some channels with channel state information," *IEEE Trans. Inform. Theory*, vol. 45, no. 6, pp. 2007–2019, Sept. 1999.
- [50] —, "On the achievable throughput of a multi-antenna Gaussian broadcast channel," *IEEE Trans. Inform. Theory*, vol. 49, pp. 1691–1706, July 2003.
- [51] G. Caire, G. Taricco, and E. Biglieri, "Optimum power control over fading channels," *IEEE Trans. Inform. Theory*, vol. 5, no. 45, pp. 1468–1489, July 1999.
- [52] J. Cavers, "Variable-rate transmission for Rayleigh fading channels," *IEEE Trans. Commun.*, vol. 20, no. 1, pp. 15–22, Feb. 1972.
- [53] J. K. Cavers and S. K. Lee, "A simple buffer control for variable-rate communication systems," *IEEE Trans. Commun.*, vol. 24, no. 9, pp. 1045–1048, Sept. 1976.
- [54] D. Cascato, M. Borgmann, H. Bolcskei, J. Hansen, and A. Burg, "Interpolation-based QR decomposition in MIMO-OFDM systems," in *Proc. IEEE Int. Workshop on Signal Proc. Adv. Wireless Commun.*, June 2005, pp. 945–949.
- [55] C. B. Chae, D. Mazzarese, and R. W. Heath, Jr., "Coordinated beamforming for multiuser MIMO systems with limited feedback," in *Proc. IEEE Asilomar Conf. on Signals, Systems, and Comp.*, Oct.–Nov. 2006, pp. 1511–1515.
- [56] C. B. Chae, D. Mazzarese, N. Jindal, and R. W. Heath, Jr., "Coordinated beamforming with limited feedback in the MIMO broadcast channel," *IEEE J. Select. Areas Commun.*, vol. 26, no. 8, Oct. 2008.
- [57] H. Chae, Y. Kim, J. H. Yang, B. Ihm, and D. K. Kim, "Multimode random beamforming for multiuser downlink MIMO system with limited feedback," in *Proc. IEEE Veh. Technol. Conf.*, May 2008, pp. 837–841.
- [58] J. Chen, R. A. Berry, and M. L. Honig, "Large system performance of downlink OFDMA with limited feedback," in *Proc. IEEE Int. Symp. Info. Th.*, July 2006, pp. 1399–1403.
- [59] —, "Performance of limited feedback schemes for downlink OFDMA with finite coherence time," in *Proc. IEEE Int. Symp. Info. Th.*, June 2007, pp. 2751–2755.
- [60] S. Chennakeshu and J. B. Anderson, "Error rates for Rayleigh fading multichannel reception of MPSK signals," *IEEE Trans. Commun.*, vol. 43, no. 2,3,4, pp. 338–346, Feb./March/April 1995.
- [61] E. H. Choi, W. Choi, J. G. Andrews, and B. F. Womack, "Power loading using order mapping in OFDM systems with limited feedback," *IEEE Sig. Proc. Lett.*, vol. 15, pp. 545–548, 2008.
- [62] J. Choi and R. W. Heath, Jr., "Interpolation based transmit beamforming for MIMO-OFDM with limited feedback," *IEEE Trans. Signal Processing*, vol. 53, no. 11, pp. 4125–4135, Nov. 2005.
- [63] J. Choi, B. Mondal, and R. W. Heath, Jr., "Interpolation based unitary precoding for spatial multiplexing MIMO-OFDM with limited feedback," *IEEE Trans. Signal Processing*, vol. 54, no. 12, pp. 4730–4740, Dec. 2006.
- [64] W. Choi, J. G. Andrews, and R. W. Heath, Jr., "Multiuser antenna partitioning for cellular MIMO-CDMA systems," *IEEE Trans. Veh. Technol.*, vol. 56, no. 5, pp. 2448–2456, Sept. 2007.
- [65] W. Choi, A. Forenza, J. G. Andrews, and R. W. Heath, Jr., "Opportunistic space-division multiple access with beam selection," *IEEE Trans. Commun.*, vol. 55, no. 12, pp. 2371–2380, Dec. 2007.
- [66] B. Clerckx, Y. X. Zhou, and S. Kim, "Practical codebook design for limited feedback spatial multiplexing," in *Proc. IEEE Int. Conf. on Commun.*, May 2008, pp. 3982–3987.

- [67] G. Colman and T. J. Willink, "Limited feedback precoding in realistic MIMO channel conditions," in *Proc. IEEE Int. Conf. on Commun.*, June 2007, pp. 4363–4368.
- [68] M. Costa, "Writing on dirty paper," *IEEE Trans. Inform. Theory*, vol. 29, no. 3, pp. 439–441, May 1983.
- [69] A. D. Dabagh and D. J. Love, "Feedback rate-capacity loss tradeoff for limited feedback MIMO systems," *IEEE Trans. Inform. Theory*, vol. 52, no. 5, pp. 2190–2202, May 2006.
- [70] —, "Multiple antenna MMSE based downlink precoding with quantized feedback or channel mismatch," *IEEE Trans. Commun.*, Nov. 2008, to appear.
- [71] W. Dai, Y. Liu, and B. Rider, "Quantization bounds on Grassmann manifolds and applications to MIMO communications," *IEEE Trans. Inform. Theory*, vol. 54, no. 3, pp. 1108–1123, March 2008.
- [72] —, "Performance analysis of CDMA signature optimization with finite rate feedback," in *Proc. Conf. Info. Sciences and Systems*, March 2006, pp. 426–431.
- [73] —, "How many users should be turned on in a multi-antenna broadcast channel," in *Proc. Conf. Info. Sciences and Systems*, March 2007, pp. 806–811.
- [74] W. Dai, Y. Liu, B. Rider, and V. Lau, "On the information rate of MIMO systems with finite rate channel state feedback and power on/off strategy," in *Proc. IEEE Int. Symp. Info. Th.*, Sept. 2005, pp. 1549–1553.
- [75] A. de Baynast, A. Sabharwal, and B. Aazhang, "Analysis of decision-feedback based broadband OFDM systems," in *Proc. IEEE Asilomar Conf. on Signals, Systems, and Comp.*, Oct.–Nov. 2005, pp. 692–696.
- [76] R. T. Derryberry, S. D. Gray, D. M. Ionescu, G. Mandyam, and B. Raghathan, "Transmit diversity in 3G CDMA systems," *IEEE Comm. Mag.*, vol. 40, no. 4, pp. 68–75, April 2002.
- [77] J. Diaz, O. Simeone, and Y. Bar-Ness, "Asymptotic analysis of reduced-feedback strategies for MIMO Gaussian broadcast channels," *IEEE Trans. Inform. Theory*, vol. 54, no. 3, pp. 1308–1316, March 2008.
- [78] G. Dietl and G. Bauch, "Linear precoding in the downlink of limited feedback multiuser MIMO systems," in *Proc. IEEE Glob. Telecom. Conf.*, Nov. 2007, pp. 4359–4364.
- [79] P. Ding, D. J. Love, and M. D. Zoltowski, "Multiple antenna broadcast channels with shape feedback and limited feedback," *IEEE Trans. Signal Processing*, vol. 55, no. 7, pp. 3417–3428, July 2007.
- [80] A. A. Dowhuszko, G. Corral-Briones, J. Hamalainen, and R. Wichman, "Outage probability analysis of practical multiuser scheduling schemes with limited feedback," in *Proc. IEEE Veh. Technol. Conf.*, April 2007, pp. 1036–1040.
- [81] S. Ekbatani, F. Etemadi, and H. Jafarkhani, "Outage behavior of quasi-static fading channels with partial power control and noisy feedback," in *Proc. IEEE Glob. Telecom. Conf.*, Nov. 2007, pp. 1556–1560.
- [82] —, "Transmission over slowly fading channels using unreliable quantized feedback," in *IEEE Data Compression Conf.*, March 2007, pp. 353–362.
- [83] S. Ekbatani and H. Jafarkhani, "Space-time coding and beamforming using noisy rate-limited feedback," in *Proc. IEEE Asilomar Conf. on Signals, Systems, and Comp.*, Oct.–Nov. 2006, pp. 1501–1505.
- [84] A. E. Ekpenyong and Y. Huang, "Feedback-detection strategies for adaptive modulation systems," *IEEE Trans. Commun.*, vol. 54, no. 10, pp. 1735–1740, Oct. 2006.
- [85] —, "Feedback constraints for adaptive transmission," *IEEE Sig. Proc. Mag.*, vol. 34, no. 3, pp. 69–78, May 2007.
- [86] T. Eriksson and T. Ottosson, "Compression of feedback for adaptive transmission and scheduling," *Proc. IEEE*, vol. 85, no. 12, pp. 2314–2321, Dec. 2007.
- [87] F. Floren, O. Edfors, and B. Molin, "The effect of feedback quantization on the throughput of a multiuser diversity scheme," in *Proc. IEEE Glob. Telecom. Conf.*, vol. 1, Dec. 2003, pp. 497–501.
- [88] C. D. Frank, "Optimal transmit array weighting for DS-CDMA with channel feedback," in *Proc. Conf. Info. Sciences and Systems*, March 2000.
- [89] D. Gerlach and A. Paulraj, "Adaptive transmitting antenna arrays with feedback," *IEEE Sig. Proc. Lett.*, vol. 1, no. 10, pp. 150–152, Oct. 1994.
- [90] D. Gesbert and M. Alouini, "Selective multi-user diversity," in *Proc. IEEE Int. Symp. Signal Proc. Info. Theory*, Dec. 2003, pp. 162–165.
- [91] —, "How much feedback is multi-user diversity really worth?" in *Proc. IEEE Int. Conf. on Commun.*, vol. 1, June 2004, pp. 234–238.
- [92] D. Gesbert, C. V. Rensburg, F. Tosato, and F. Kaltenberger, "Multiple antenna techniques," in *UMTS Long Term Evolution (LTE): From Theory to Practice*, S. Sesia, I. Toufik, and M. Baker, Eds. Wiley, 2008, ch. 7.
- [93] A. Ghaderipour, M. Hajiaghayi, and C. Tellambura, "Unitary matrix design via genetic search for differential space-time modulation and limited feedback," in *Proc. IEEE Veh. Technol. Conf.*, Sept. 2006.
- [94] A. Ghaderipour and C. Tellambura, "Minimum distance-based limited-feedback precoder for MIMO spatial multiplexing systems," in *Proc. IEEE Veh. Technol. Conf.*, Sept. 2006.
- [95] D. L. Goeckel, "Adaptive coding for time-varying channels using outdated fading estimates," *IEEE Trans. Commun.*, vol. 47, no. 4, pp. 844–855, June 1999.
- [96] A. Goldsmith, S. A. Jafar, N. Jindal, and S. Vishwanath, "Capacity limits of MIMO channels," *IEEE J. Select. Areas Commun.*, vol. 21, no. 5, pp. 684–702, June 2003.
- [97] A. J. Goldsmith and M. Medard, "Capacity of time-varying channels with causal channel side information," *IEEE Trans. Inform. Theory*, vol. 53, no. 3, pp. 881–899, March 2007.
- [98] A. J. Goldsmith and P. P. Varaiya, "Capacity of fading channels with channel side information," *IEEE Trans. Inform. Theory*, vol. 43, no. 6, pp. 1986–1992, Nov. 1997.
- [99] D. A. Gore, R. W. Heath, Jr., and A. J. Paulraj, "Transmit selection in spatial multiplexing systems," *IEEE Commun. Lett.*, vol. 6, no. 11, pp. 491–493, Nov. 2002.
- [100] D. A. Gore and A. J. Paulraj, "MIMO antenna subset selection with space-time coding," *IEEE Trans. Signal Processing*, vol. 50, no. 10, pp. 2580–2588, Oct. 2002.
- [101] A. Gorokhov, M. Collados, D. Gore, and A. Paulraj, "Transmit/receive MIMO antenna subset selection," in *Proc. IEEE Int. Conf. Acoust., Speech and Sig. Proc.*, vol. 2, May 2004, pp. III3–III6.
- [102] M. Haleem and R. Chandramouli, "Adaptive downlink scheduling and rate selection: Cross-layer design," *IEEE J. Select. Areas Commun.*, vol. 23, no. 6, pp. 1572–1581, June 2006.
- [103] G. Hariharan, V. Raghavan, and A. Sayeed, "Capacity of sparse wideband channels with partial channel feedback," *European Trans. Telecommun.*, vol. 19, no. 4, pp. 475–493, 2008.
- [104] V. Hassel, D. Gesbert, M. Alouini, and G. E. Oien, "A threshold-based channel state feedback algorithm for modern cellular systems," *IEEE Trans. Wireless Commun.*, vol. 6, no. 7, pp. 2422–2426, July 2007.
- [105] A. Hatcher, *Algebraic Topology*. New York: Cambridge University Press, 2001.
- [106] J. Hayes, "Adaptive feedback communications," *IEEE Trans. Commun.*, vol. 16, no. 1, pp. 29–34, Feb. 1968.
- [107] R. W. Heath, Jr., M. Airy, and A. J. Paulraj, "Multiuser diversity for MIMO wireless systems with linear receivers," in *Proc. IEEE Asilomar Conf. on Signals, Systems, and Comp.*, vol. 2, Nov. 2001, pp. 1194–1199.
- [108] R. W. Heath, Jr. and D. J. Love, "Multimode antenna selection for spatial multiplexing systems with linear receivers," *IEEE Trans. Signal Processing*, vol. 53, no. 8, pp. 3042–3056, Aug. 2005.
- [109] R. W. Heath, Jr. and A. Paulraj, "A simple scheme for transmit diversity using partial channel feedback," in *Proc. IEEE Asilomar Conf. on Signals, Systems, and Comp.*, vol. 2, Nov. 1998, pp. 1073–1078.
- [110] R. W. Heath, Jr., S. Sandhu, and A. Paulraj, "Antenna selection for spatial multiplexing systems with linear receivers," *IEEE Commun. Lett.*, vol. 5, no. 4, pp. 142–144, April 2001.
- [111] —, "Switching between diversity and multiplexing in MIMO systems," *IEEE Trans. Commun.*, vol. 53, no. 6, pp. 962–968, June 2005.
- [112] R. W. Heath Jr., T. Wu, and A. Soong, "Progressive feedback for high resolution limited feedback in MIMO systems," Oct. 2008, to appear in the Asilomar Conf. on Sig. Sys. and Comp.
- [113] A. Hjørungnes and D. Gesbert, "Precoding of orthogonal space-time block codes in arbitrarily correlated MIMO channels: Iterative and closed-form solutions," *IEEE Trans. Wireless Commun.*, vol. 6, pp. 1072–1082, March 2007.
- [114] B. M. Hochwald, T. L. Marzetta, T. J. Richardson, W. Sweldens, and R. Urbanke, "Systematic design of unitary space-time constellations," *IEEE Trans. Inform. Theory*, vol. 46, no. 6, pp. 1962–1973, Sep. 2000.
- [115] H. Holma and A. Toskala, *WCDMA for UMTS: Radio Access for Third Generation Mobile Communications*. West Sussex, England: John Wiley, 2002.
- [116] A. Hottinen, O. Tirkkonen, and R. Wichman, "Closed-loop transmit diversity techniques for multi-element transceivers," in *Proc. IEEE Veh. Technol. Conf.*, vol. 1, Sept. 2000, pp. 70–73.
- [117] A. Hottinen and R. Wichman, "Transmit diversity using filtered feedback weights in the FDD/WCDMA system," in *Proc. Int. Zurich Seminar on Broadband Commun.*, Feb. 2000, pp. 15–21.
- [118] K. Huang, R. W. Heath, Jr., and J. G. Andrews, "Performance of orthogonal beamforming for SDMA with limited feedback," *IEEE Trans. on Veh. Technol.*, to appear.

- [119] —, "Space division multiple access with a sum feedback rate constraint," *IEEE Trans. Signal Processing*, vol. 55, no. 7, pp. 3879–3891, July 2007.
- [120] —, "Uplink SDMA with limited feedback: Throughput scaling," *EURASIP Journal on Adv. Signal Proc.*, 2008.
- [121] K. Huang, B. Mondal, R. W. Heath, Jr., and J. G. Andrews, "Effect of feedback delay on multi-antenna limited feedback for temporally-correlated channels," in *Proc. IEEE Glob. Telecom. Conf.*, Nov. 2006.
- [122] —, "Markov models for limited feedback MIMO systems," in *Proc. IEEE Int. Conf. Acoust., Speech and Sig. Proc.*, vol. 4, May 2006.
- [123] —, "Multi-antenna limited feedback for temporally-correlated channels: Feedback compression," in *Proc. IEEE Glob. Telecom. Conf.*, Nov. 2006.
- [124] K. C. Hwang and K. B. Lee, "Efficient weight vector representation for closed-loop transmit diversity," *IEEE Trans. Commun.*, vol. 52, no. 1, pp. 9–16, Jan. 2004.
- [125] S. Hwang, B. H. Kim, and Y. Kim, "A hybrid ARQ scheme with power ramping," *Proc. IEEE Veh. Technol. Conf.*, vol. 3, pp. 1579–1538, Oct. 2001.
- [126] T. Inoue and R. W. Heath Jr., "Kerdock codes for limited feedback MIMO systems," in *Proc. IEEE Int. Conf. Acoust., Speech and Sig. Proc.*, March–April 2008, pp. 3113–3116.
- [127] Y. Isupapalli, R. Annavajjala, and B. D. Rao, "Average SEP and BEP analysis of transmit beamforming for MISO systems with imperfect feedback and M-PSK constellation," in *Proc. IEEE Int. Symp. Personal, Indoor, and Mobile Radio Commun.*, Sept. 2007.
- [128] Y. Isupapalli and B. D. Rao, "Finite rate feedback for spatially and temporally correlated MISO channels in the presence of estimation errors and feedback delay," in *Proc. IEEE Glob. Telecom. Conf.*, Nov. 2007, pp. 2791–2795.
- [129] Y. Isupapalli, J. Zheng, and B. D. Rao, "Average SEP loss analysis of transmit beamforming for finite rate feedback MISO systems with QAM constellation," in *Proc. IEEE Int. Conf. Acoust., Speech and Sig. Proc.*, vol. 3, April 2007, pp. III425–III428.
- [130] S. A. Jafar and S. Srinivasa, "On the optimality of beamforming with quantized feedback," *IEEE Trans. Commun.*, vol. 55, no. 12, pp. 2288–2302, Dec. 2007.
- [131] E. W. Jang, Y. Cho, J. Choi, and J. M. Cioffi, "Scheduling algorithms for time-varying downlink channels," *IEEE Trans. Wireless Comm.*, vol. 7, no. 6, pp. 2063–2068, June 2008.
- [132] E. W. Jang, C. Hwang, and J. M. Cioffi, "Flexible adaptive-modulation-and-coding tables for a wireless network," in *Proc. IEEE Int. Conf. on Commun.*, May 2008, pp. 3378–3382.
- [133] N. Jindal, "MIMO broadcast channels with finite-rate feedback," *IEEE Trans. Inform. Theory*, vol. 52, no. 11, pp. 5045–5060, Nov. 2006.
- [134] —, "Antenna combining for the MIMO downlink channel," *IEEE Trans. Wireless Commun.*, 2008, to appear.
- [135] S. Jing, D. Tse, J. B. Soriaga, J. Hou, J. E. Smee, and R. Padovani, "Multicell downlink capacity with coordinated processing," *EURASIP Journal Wireless Commun. Networking*, 2008.
- [136] G. Jöngren and M. Skoglund, "Quantized feedback information in orthogonal space-time block coding," *IEEE Trans. Inform. Theory*, vol. 50, no. 10, pp. 2473–2486, Oct. 2004.
- [137] G. Jöngren, M. Skoglund, and B. Ottersten, "Combining beamforming and orthogonal space-time block coding," *IEEE Trans. Inform. Theory*, vol. 48, no. 3, pp. 611–627, March 2002.
- [138] —, "Design of channel-estimate-dependent space-time block codes," *IEEE Trans. Commun.*, vol. 52, no. 7, pp. 1191–1203, July 2004.
- [139] C. A. Jotten, P. W. Baier, M. Meurer, T. Weber, and M. Haardt, "Efficient representation and feedback signaling of channel state information in frequency division duplexing MIMO systems," in *Proc. IEEE Int. Symp. Wireless Personal Multimedia Commun.*, vol. 2, Oct. 2002, pp. 444–448.
- [140] K. Karakayali, G. J. Foschini, and R. A. Valenzuela, "Network coordination for spectrally efficient communications in cellular systems," *IEEE Wireless Commun.*, pp. 56–61, Aug. 2006.
- [141] A. K. Karmokar and V. K. Bhargava, "Coding rate adaptation for hybrid ARQ systems over time varying fading channels with partially observable state," *Proc. IEEE Int. Conf. on Commun.*, vol. 4, pp. 2797–2801, May 2005.
- [142] S. Kaviani and C. Tellambura, "Closed-form BER analysis for antenna selection using orthogonal space-time block codes," *IEEE Commun. Lett.*, vol. 10, no. 10, pp. 704–706, Oct. 2006.
- [143] N. Khaled, B. Mondal, G. Leus, R. W. Heath, Jr., and F. Petre, "Interpolation-based multi-mode precoding for MIMO-OFDM systems with limited feedback," *IEEE Trans. Wireless Comm.*, vol. 6, no. 3, pp. 1003–1013, March 2007.
- [144] B. Khoshnevis, W. Yu, and R. Adve, "Grassmannian beamforming for MIMO amplify-and-forward relaying," *IEEE J. Select. Areas Commun.*, vol. 26, no. 8, Oct. 2008.
- [145] I. H. Kim and D. J. Love, "On the capacity and design of limited feedback multiuser MIMO uplinks," *IEEE Trans. Inform. Theory*, vol. 54, no. 10, pp. 4712–4724, Oct. 2008.
- [146] I. H. Kim, S. Y. Park, D. J. Love, and S. J. Kim, "Partial channel state information unitary precoding and codebook design for MIMO broadcast systems," in *Proc. IEEE Glob. Telecom. Conf.*, Nov. 2007, pp. 1607–1611.
- [147] J. Kim, I. Kim, S. Ro, D. Hong, and C. Kang, "Effects of multipath diversity on adaptive QAM in frequency selective Rayleigh fading channels," *IEEE Commun. Lett.*, vol. 6, no. 9, pp. 364–366, Sept. 2002.
- [148] J. S. Kim, H. Kim, and K. B. Lee, "Limited feedback signaling for MIMO broadcast channels," in *Proc. IEEE Int. Workshop on Signal Proc. Adv. Wireless Commun.*, June 2005, pp. 855–859.
- [149] J. S. Kim, H. Kim, C. S. Park, and K. B. Lee, "Adaptive precoding for wireless MIMO broadcast channels with limited feedback," *IEICE Transactions*, vol. 88-B, no. 11, pp. 4237–4245, Nov. 2005.
- [150] —, "On the performance of multiuser MIMO systems in WCDMA/HSDPA: Beamforming, feedback and user diversity," *IEICE Transactions*, vol. 89-B, no. 8, pp. 2161–2169, Aug. 2006.
- [151] T. T. Kim, M. Bengtsson, and M. Skoglund, "Quantized feedback design for MIMO broadcast channels," in *Proc. IEEE Int. Conf. Acoust., Speech and Sig. Proc.*, vol. 3, April 2007, pp. III1–III4.
- [152] T. T. Kim, G. Caire, and M. Skoglund, "On the outage exponent of fading relay channels with partial channel state information," in *Proc. IEEE Info. Theory Workshop*, Sept. 2007, pp. 620–625.
- [153] T. T. Kim, G. Jöngren, and M. Skoglund, "On the convergence behavior of weighted space-time bit-interleaved coded modulation," in *Proc. IEEE Asilomar Conf. on Signals, Systems, and Comp.*, vol. 1, Nov. 2004, pp. 1257–1261.
- [154] —, "Weighted space-time bit-interleaved coded modulation," in *IEEE Info. Theory Workshop*, Oct. 2004, pp. 375–380.
- [155] T. T. Kim and M. Skoglund, "On the expected rate of slowly fading channels with quantized side information," *IEEE Trans. Commun.*, vol. 55, no. 4, pp. 820–829, April 2007.
- [156] R. Knopp and P. A. Humblet, "Information capacity and power control in single-cell multiuser communications," in *Proc. IEEE Int. Conf. on Commun.*, vol. 1, June 1995, pp. 331–335.
- [157] Y. Ko and C. Tepedelenlioglu, "Orthogonal space-time block coded rate-adaptive modulation with outdated feedback," *IEEE Trans. Wireless Commun.*, vol. 5, no. 2, pp. 290–295, Feb. 2006.
- [158] —, "Threshold-based substream selection for closed-loop spatial multiplexing," *IEEE Trans. Veh. Technol.*, vol. 57, no. 1, pp. 215–226, Jan. 2008.
- [159] M. Kobayashi, G. Caire, and D. Gesbert, "Transmit diversity versus opportunistic beamforming in data packet mobile downlink transmission," *IEEE Trans. Commun.*, vol. 55, no. 1, pp. 151–157, Jan. 2007.
- [160] M. Kountouris, R. de Francisco, D. Gesbert, D. Slock, and T. Salzer, "Multiuser diversity - multiplexing tradeoff in MIMO broadcast channels with limited feedback," in *Proc. IEEE Asilomar Conf. on Signals, Systems, and Comp.*, Oct.–Nov. 2006, pp. 364–368.
- [161] —, "Efficient metrics for scheduling in MIMO broadcast channels with limited feedback," in *Proc. IEEE Int. Conf. Acoust., Speech and Sig. Proc.*, vol. 3, April 2007, pp. III109–III112.
- [162] M. Kountouris, D. Gesbert, and L. Pittman, "Transmit correlation-aided opportunistic beamforming and scheduling," in *Proc. European Signal Processing Conf.*, Sept. 2006.
- [163] M. Kountouris, D. Gesbert, and T. Salzer, "Enhanced multiuser random beamforming: Dealing with the not-so-large number of users case," *IEEE J. Select. Areas Commun.*, vol. 26, no. 8, Oct. 2008.
- [164] E. Koyuncu, Y. Jing, and H. Jafarkhani, "Distributed beamforming in wireless relay networks with quantized feedback," *IEEE J. Select. Areas Commun.*, vol. 26, no. 8, Oct. 2008.
- [165] J. N. Laneman, D. N. C. Tse, and G. W. Wornell, "Cooperative diversity in wireless networks: Efficient protocols and outage behavior," *IEEE Trans. Inform. Theory*, vol. 50, no. 12, pp. 3062–3080, Dec. 2004.
- [166] E. G. Larsson, G. Ganesan, P. Stoica, and W.-H. Wong, "On the performance of orthogonal space-time block coding with quantized feedback," *IEEE Commun. Lett.*, vol. 6, no. 11, pp. 487–489, Nov. 2002.
- [167] E. G. Larsson and P. Stoica, *Space-Time Block Coding for Wireless Communications*. New York: Cambridge University Press, 2003.
- [168] V. Lau, Y. Liu, and T.-A. Chen, "On the design of MIMO block-fading channels with feedback-link capacity constraint," *IEEE Trans. Commun.*, vol. 52, no. 1, pp. 62–70, Jan. 2004.

- [169] V. Lau, "Performance analysis of variable rate, symbol-by-symbol bit-interleaved coded modulation for Rayleigh fading channels," *IEEE Trans. Veh. Technol.*, vol. 49, no. 9, pp. 877–887, May 2002.
- [170] V. Lau and M. D. Macleod, "Variable-rate adaptive trellis coded QAM for flat-fading channels," *IEEE Trans. Commun.*, vol. 49, no. 9, pp. 1550–1560, Sept. 2001.
- [171] V. Lau and S. Maric, "Adaptive m-ary orthogonal modulation for DS-CDMA," *IEEE Trans. Commun.*, vol. 47, no. 4, pp. 577–589, Apr. 1999.
- [172] V. Lau, Y. Liu, and T.-A. Chen, "Capacity of memoryless channels and block-fading channels with designable cardinality-constrained channel state feedback," *IEEE Trans. Inform. Theory*, vol. 50, no. 9, pp. 2038–2049, Sept. 2004.
- [173] H. Lee, S. Park, and I. Lee, "Orthogonalized spatial multiplexing for closed-loop MIMO systems," *IEEE Trans. Commun.*, vol. 55, no. 5, pp. 1044–1052, May 2007.
- [174] J. Lee and Y.-C. Ko, "Performance improvement of transmit beamforming MISO system using optimum codebook indexing over feedback error channel," in *Proc. IEEE Int. Symp. Info. Th.*, July 2008, pp. 2558–2562.
- [175] K. S. Lee, B.-H. Ryu, and C.-H. Lee, "Power efficient frequency domain packet scheduling for OFDMA systems," in *Proc. Int. Conf. Convergence Information Technology*, Nov. 2007, pp. 1906–1911.
- [176] J. Leinonen, J. Hamalainen, and M. Juntti, "Performance analysis of downlink OFDMA frequency scheduling with limited feedback," in *Proc. IEEE Int. Conf. on Commun.*, May 2008, pp. 3318–3322.
- [177] A. Leke and J. M. Cioffi, "A maximum rate loading algorithm for discrete multitone modulation systems," in *Proc. IEEE Glob. Telecom. Conf.*, vol. 3, Nov. 1997, pp. 1514–1518.
- [178] J. Letessier, B. Vrigneau, P. Rostaing, and G. Burel, "Limited feedback unitary matrix applied to MIMO dmin-based precoder," in *Proc. IEEE Asilomar Conf. on Signals, Systems, and Comp.*, Oct.-Nov. 2006, pp. 1531–1535.
- [179] Y. Li, N. B. Mehta, A. F. Molisch, and J. Zhang, "Optimal signaling and selection verification for single transmit-antenna selection," *IEEE Trans. Commun.*, vol. 55, no. 4, pp. 778–789, April 2007.
- [180] Y.-W. Liang, R. Schober, and W. Gerstacker, "FIR beamforming for frequency-selective channels with linear equalization," *IEEE Commun. Lett.*, vol. 11, no. 7, pp. 633–624, July 2007.
- [181] —, "Transmit beamforming for frequency-selective channels with decision-feedback equalization," *IEEE Trans. Wireless Commun.*, vol. 6, no. 12, pp. 4402–4411, Dec. 2007.
- [182] C. Lin, V. Raghavan, and V. Veeravalli, "Optimal power allocation for linear dispersion codes over correlated MIMO channels with channel state feedback," in *Proc. IEEE Glob. Telecom. Conf.*, Nov. 2007, pp. 1602–1606.
- [183] L. Liu and H. Jafarkhani, "Application of quasi-orthogonal space-time block codes in beamforming," *IEEE Trans. Commun.*, vol. 53, no. 1, pp. 54–63, Jan. 2005.
- [184] —, "Novel transmit beamforming schemes for time-selective fading multi-antenna systems," *IEEE Trans. Signal Processing*, vol. 54, no. 12, pp. 4767–4781, Dec. 2006.
- [185] —, "Novel transmit beamforming schemes for time-varying fading channels," in *Proc. IEEE Int. Conf. on Commun.*, vol. 3, June 2006, pp. 1306–1311.
- [186] —, "Space-time trellis codes based on channel-phase feedback," *IEEE Trans. Commun.*, vol. 54, no. 12, pp. 2186–2198, Dec. 2006.
- [187] —, "Successive transmit beamforming algorithms for multiple-antenna OFDM systems," *IEEE Trans. Wireless Commun.*, vol. 6, no. 4, pp. 1512–1522, April 2007.
- [188] —, "Novel successive transmit beamforming algorithms for MISO-OFDM systems," in *Proc. IEEE Int. Conf. on Commun.*, vol. 12, June 2006, pp. 5336–5341.
- [189] J. Lopez Vicario, R. Bosisio, U. Spagnolini, and C. Anton-Haro, "A throughput analysis for opportunistic beamforming with quantized feedback," in *Proc. IEEE Int. Symp. Personal, Indoor, and Mobile Radio Commun.*, Sept. 2006.
- [190] D. J. Love, "On the probability of error of antenna-subset selection with space-time block codes," *IEEE Trans. Commun.*, vol. 53, no. 11, pp. 1799–1803, Nov. 2005.
- [191] —, "Duplex distortion models for limited feedback MIMO communication," *IEEE Trans. Signal Processing*, vol. 54, no. 2, pp. 766–774, Feb. 2006.
- [192] D. J. Love and C. K. Au-Yeung, "On resource allocation in two-way limited feedback beamforming systems," in *UCSD Info. Theory and Appl. Workshop*, Jan.-Feb. 2008.
- [193] D. J. Love and R. W. Heath, Jr., "Diversity performance of precoded orthogonal space-time block codes using limited feedback," *IEEE Commun. Lett.*, vol. 8, no. 5, pp. 305–307, May 2004.
- [194] —, "Limited feedback unitary precoding for orthogonal space-time block codes," *IEEE Trans. Signal Processing*, vol. 53, no. 1, pp. 64–73, Jan. 2005.
- [195] —, "Limited feedback unitary precoding for spatial multiplexing systems," *IEEE Trans. Inform. Theory*, vol. 51, no. 8, pp. 2967–2976, Aug. 2005.
- [196] —, "Multimode precoding for MIMO wireless systems," *IEEE Trans. Signal Processing*, vol. 53, no. 10, pp. 3674–3687, Oct. 2005.
- [197] —, "Limited feedback diversity techniques for correlated channels," *IEEE Trans. Veh. Technol.*, vol. 55, no. 2, pp. 718–722, March 2006.
- [198] D. J. Love, R. W. Heath, Jr., W. Santipach, and M. L. Honig, "What is the value of limited feedback for MIMO channels?" *IEEE Comm. Mag.*, vol. 42, no. 10, pp. 54–59, Oct. 2004.
- [199] D. J. Love and R. W. Heath, Jr., "Equal gain transmission in multiple-input multiple-output wireless systems," *IEEE Trans. Commun.*, vol. 51, no. 7, pp. 1102–1110, July 2003.
- [200] —, "Necessary and sufficient conditions for full diversity order in correlated Rayleigh fading beamforming and combining systems," *IEEE Trans. Wireless Commun.*, vol. 4, no. 1, pp. 20–23, Jan. 2005.
- [201] —, "OFDM power loading using limited feedback," *IEEE Trans. on Veh. Technol.*, vol. 54, no. 5, pp. 1773–1780, Sept. 2005.
- [202] D. J. Love, R. W. Heath Jr., and T. Strohmer, "Grassmannian beamforming for multiple-input multiple-output wireless systems," *IEEE Trans. Inform. Theory*, vol. 49, no. 10, pp. 2735–2747, Oct. 2003.
- [203] J. Lu, T. T. Tjhung, and C. C. Chai, "Error probability performance of 1-branch diversity reception of MQAM in Rayleigh fading," *IEEE Trans. Commun.*, vol. 46, no. 2, pp. 179–181, Feb. 1998.
- [204] Y. Ma and D. Zhang, "Error rate of transmit beamforming with delayed and limited feedback," in *Proc. IEEE Glob. Telecom. Conf.*, Nov. 2007, pp. 4071–4075.
- [205] R. Machado, B. F. Uchoa-Filho, and T. M. Duman, "Linear dispersion codes for MIMO channels with limited feedback," in *Proc. IEEE Wireless Comm. and Net. Conf.*, March-April 2008, pp. 199–204.
- [206] V. Majjigi, R. Agarwal, R. Vannithamby, and J. Cioffi, "Persistent resource allocation in OFDMA networks for real-time and non-real-time traffic," in *Proc. IEEE Asilomar Conf. on Signals, Systems, and Comp.*, Nov. 2007, pp. 280–284.
- [207] A. G. Marques, F. F. Digham, and G. B. Giannakis, "Optimizing power efficiency of OFDM using quantized channel state information," *IEEE J. Select. Areas Commun.*, vol. 24, no. 8, pp. 1581–1592, Aug. 2006.
- [208] A. G. Marques, G. B. Giannakis, F. F. Digham, and F. J. Ramos, "Power-efficient wireless OFDMA using limited-rate feedback," *IEEE Trans. Wireless Commun.*, vol. 7, no. 2, pp. 685–696, Feb. 2008.
- [209] A. G. Marques, X. Wang, and G. B. Giannakis, "Minimizing transmit-power for coherent communications in wireless sensor networks using quantized channel state information," in *Proc. IEEE Int. Conf. Acoust., Speech and Sig. Proc.*, vol. 3, April 2007, pp. III529–III532.
- [210] —, "Optimizing energy efficiency of TDMA with finite rate feedback," in *Proc. IEEE Int. Conf. Acoust., Speech and Sig. Proc.*, vol. 3, April 2007, pp. III117–III120.
- [211] Y. May, A. Leith, and R. Schober, "Predictive feedback for transmit beamforming with delayed feedback and channel estimation errors," in *Proc. IEEE Int. Conf. on Commun.*, May 2008, pp. 4678–4682.
- [212] M. L. McCloud, M. Brehler, and M. K. Varanasi, "Signal design and convolutional coding for noncoherent space-time communication on the block-Rayleigh-fading channel," *IEEE Trans. Inform. Theory*, vol. 48, no. 5, pp. 1186–1194, May 2002.
- [213] A. F. Molisch and M. Z. Win, "MIMO systems with antenna selection," *IEEE Microwave Mag.*, vol. 5, no. 1, pp. 46–56, March 2004.
- [214] A. F. Molisch, M. Z. Win, Y. Choi, and J. H. Winters, "Capacity of MIMO systems with antenna selection," *IEEE Trans. Wireless Commun.*, vol. 4, no. 4, pp. 1759–1772, July 2005.
- [215] B. Mondal and R. W. Heath, Jr., "Algorithms for quantized precoded MIMO-OFDM systems," in *Proc. IEEE Asilomar Conf. on Signals, Systems, and Comp.*, Oct.-Nov. 2005, pp. 381–385.
- [216] —, "Channel adaptive quantization for limited feedback MIMO beamforming systems," *IEEE Trans. Signal Processing*, vol. 54, no. 12, pp. 4717–4729, Dec. 2006.
- [217] —, "Performance analysis of quantized beamforming MIMO systems," *IEEE Trans. Signal Processing*, vol. 54, no. 12, pp. 4753–4766, Dec. 2006.
- [218] B. Mondal, R. Samanta, and R. W. Heath Jr., "Frame theoretic quantization for limited feedback MIMO beamforming systems," in *Proc. of the International Conference on Wireless Networks, Communications and Mobile Computing*, vol. 2, June 2005, pp. 1065–1070.

- [219] B. Mondal, T. A. Thomas, and M. Harrison, "Rank-independent Codebook Design from a Quaternary Alphabet," in *Proc. IEEE Asilomar Conf. on Signals, Systems, and Comp.*, Nov. 2007, pp. 297–301.
- [220] A. Mukherjee and H. M. Kwon, "Sum-rate distortion in MIMO broadcast channels with irregular limited feedback," in *Proc. IEEE Glob. Telecom. Conf.*, Nov. 2007, pp. 3205–3209.
- [221] K. K. Mukkavilli, A. Sabharwal, and B. Aazhang, "Design of multiple antenna coding schemes with channel feedback," in *Proc. IEEE Asilomar Conf. on Signals, Systems, and Comp.*, vol. 2, Nov. 2001, pp. 1009–1013.
- [222] K. K. Mukkavilli, A. Sabharwal, E. Erkip, and B. Aazhang, "On beamforming with finite rate feedback in multiple antenna systems," *IEEE Trans. Inform. Theory*, vol. 49, pp. 2562–2579, Oct. 2003.
- [223] C. Mun, J. Han, and D. Kim, "Quantized principal component selection precoding for limited feedback spatial multiplexing," in *Proc. IEEE Int. Conf. on Commun.*, vol. 9, June 2006, pp. 4149–4154.
- [224] C. R. Murthy and B. D. Rao, "Quantization methods for equal gain transmission with finite rate feedback," *IEEE Trans. Signal Processing*, vol. 55, no. 1, pp. 233–245, Jan. 2007.
- [225] C. R. Murthy, J. Zheng, and B. D. Rao, "Performance of quantized methods for equal gain transmission with noisy feedback channels," *IEEE Trans. Signal Processing*, vol. 56, no. 6, pp. 2451–2460, June 2008.
- [226] S. Nagaraj and Y.-F. Huang, "Downlink transmit beamforming with selective feedback," in *Proc. IEEE Asilomar Conf. on Signals, Systems, and Comp.*, vol. 2, Oct.–Nov. 2000, pp. 1608–1612.
- [227] —, "Downlink transmit diversity: Feedback efficiency and robustness," in *Proc. IEEE Conf. Personal Wireless Commun.*, Dec. 2000, pp. 14–18.
- [228] —, "Prediction error based feedback for downlink transmit beamforming," in *Proc. IEEE Int. Conf. Acoust., Speech and Sig. Proc.*, vol. 5, May 2001, pp. 2969–2972.
- [229] V. Nagarajan, Y. Liu, and J. Hou, "The effect of channel side information at transmitter on coding complexity," *Proc. IEEE Int. Symp. Info. Th.*, p. 148, June. 2004.
- [230] A. Narula, M. J. Lopez, M. D. Trott, and G. W. Wornell, "Efficient use of side information in multiple-antenna data transmission over fading channels," *IEEE J. Select. Areas Commun.*, vol. 16, no. 8, pp. 1423–1436, Oct. 1998.
- [231] E. N. Onggosanusi, A. Gatherer, A. G. Dabak, and S. Hosur, "Performance analysis of closed-loop transmit diversity in the presence of feedback delay," *IEEE Trans. Commun.*, vol. 49, pp. 1618–1630, Sept. 2001.
- [232] P. Ormeci, X. Liu, D. L. Goeckel, and R. D. Wesel, "Adaptive bit-interleaved coded modulation," *IEEE Trans. Commun.*, vol. 49, no. 4, pp. 1572–1581, Sept. 2001.
- [233] O. Ozdemir and M. Torlak, "Performance of opportunistic beamforming with quantized feedback," in *Proc. IEEE Glob. Telecom. Conf.*, Nov. 2006, pp. 1–5.
- [234] Z. Pan, K.-K. Wong, and T.-S. Ng, "Generalized multiuser orthogonal space-division multiplexing," *IEEE Trans. Wireless Commun.*, vol. 3, no. 6, pp. 1969–1973, Nov. 2004.
- [235] T. Pande, D. J. Love, and J. V. Krogmeier, "A weighted least squares approach to precoding with pilots for MIMO-OFDM," *IEEE Trans. Signal Processing*, vol. 54, no. 10, pp. 4067–4073, Oct. 2006.
- [236] —, "Reduced feedback MIMO-OFDM precoding and antenna selection," *IEEE Trans. Signal Processing*, vol. 55, no. 5, pp. 2284–2293, May 2007.
- [237] J. F. Paris, M. del Carmen Aguayo-Torres, and J. T. Entrambasaguas, "Optimum discrete-power adaptive QAM scheme for Rayleigh fading channels," *IEEE Commun. Lett.*, vol. 5, no. 7, pp. 281–283, July 2001.
- [238] —, "Impact of channel estimation error on adaptive modulation performance in flat fading," *IEEE Trans. Commun.*, vol. 52, no. 5, pp. 716–720, May 2004.
- [239] C. S. Park and K. B. Lee, "Statistical transmit antenna subset selection for limited feedback MIMO systems," in *Proc. Asia-Pacific Conf. Commun.*, Aug. 2006.
- [240] S. Y. Park, D. Park, and D. J. Love, "On scheduling for multiple-antenna wireless networks using contention-based feedback," *IEEE Trans. Commun.*, vol. 55, no. 6, pp. 1174–1190, June 2007.
- [241] T. K. Paul and T. Ogunfunmi, "Wireless LAN Comes of Age: Understanding the IEEE 802.11n Amendment," *IEEE Circuits Syst. Mag.*, vol. 8, no. 1, pp. 28–54, First Quarter 2008.
- [242] A. Paulraj, R. Nabar, and D. Gore, *Introduction to Space-Time Wireless Communications*. New York: Cambridge University Press, 2003.
- [243] M. Peacock, I. B. Collings, and M. L. Honig, "Analysis of multiuser peer-to-peer MC-CDMA with limited feedback," in *Proc. IEEE Int. Conf. on Commun.*, vol. 2, June 2004, pp. 968–972.
- [244] S. W. Peters and R. W. Heath Jr., "The future of WiMAX: Multihop relaying with IEEE 802.16j," submitted to *IEEE Commun. Mag.*.
- [245] S. W. Peters and R. W. Heath, Jr., "Nonregenerative MIMO relaying with optimal transmit antenna selection," *IEEE Signal Processing Lett.*, vol. 15, pp. 421–424, 2008.
- [246] K. T. Phan and C. Tellambura, "Capacity analysis for transmit antenna selection using orthogonal space-time block codes," *IEEE Commun. Lett.*, vol. 11, no. 5, pp. 423–425, May 2007.
- [247] D. C. Popescu, S. Koduri, and D. B. Rawat, "Interference avoidance with limited feedback," in *Proc. IEEE Asilomar Conf. on Signals, Systems, and Comp.*, Nov. 2007, pp. 1046–1049.
- [248] D. C. Popescu, O. Popescu, and C. Rose, "Interference avoidance and multiaccess vector channels," *IEEE Trans. Commun.*, vol. 55, no. 8, pp. 1466–1471, Aug. 2007.
- [249] D. C. Popescu and C. Rose, "Codeword optimization for uplink CDMA dispersive channels," *IEEE Trans. Wireless Comm.*, vol. 4, no. 4, pp. 1563–1574, July 2005.
- [250] X. Qin and R. Berry, "Distributed approaches for exploiting multiuser diversity in wireless networks," *IEEE Trans. Inform. Theory*, vol. 52, no. 2, pp. 392–413, Feb. 2006.
- [251] V. Raghavan, R. W. Heath, Jr., and A. M. Sayeed, "Systematic codebook designs for quantized beamforming in correlated MIMO channels," *IEEE J. Select. Areas Commun.*, vol. 25, no. 7, pp. 1298–1310, Sept. 2007.
- [252] V. Raghavan, A. Sayeed, and V. Veeravalli, "Low-complexity structured precoding for spatially correlated MIMO channels," *IEEE Trans. Inform. Theory*, 2008, submitted.
- [253] V. Raghavan, A. M. Sayeed, and V. Veeravalli, "Limited feedback precoder design for spatially correlated MIMO channels," in *Proc. Conf. Info. Sciences and Systems*, March 2007, pp. 113–118.
- [254] V. Raghavan, V. V. Veeravalli, and R. W. Heath, Jr., "Reduced rank signaling in spatially correlated MIMO channels," in *Proc. IEEE Int. Symp. Info. Th.*, June 2007, pp. 1081–1085.
- [255] D. Rajan, A. Sabharwal, and B. Aazhang, "Outage behavior with delay and CSIT," in *Proc. IEEE Int. Conf. on Commun.*, vol. 1, June 2004, pp. 578–582.
- [256] G. S. Rajappan and M. L. Honig, "Signature sequence adaptation for DS-CDMA with multipath," *IEEE J. Select. Areas Commun.*, vol. 20, no. 2, pp. 384–395, Feb. 2002.
- [257] P. B. Rapajic and B. S. Vucetic, "Linear adaptive transmitter-receiver structures for asynchronous CDMA systems," *European Trans. Telecommun.*, vol. 6, no. 1, pp. 21–28, Jan.–Feb. 1995.
- [258] N. Ravindran and N. Jindal, "Limited feedback-based block diagonalization for the MIMO broadcast channel," *IEEE J. Select. Areas Commun.*, vol. 26, no. 8, Oct. 2008.
- [259] —, "Multi-user diversity vs. Accurate channel feedback for MIMO broadcast channels," in *Proc. IEEE Int. Conf. on Commun.*, May 2008.
- [260] J. C. Roh and B. D. Rao, "Transmit beamforming in multiple-antenna systems with finite rate feedback: A VQ-based approach," *IEEE Trans. Inform. Theory*, vol. 52, no. 3, pp. 1101–1112, March 2006.
- [261] —, "Efficient feedback methods for MIMO channels based on parameterization," *IEEE Trans. Wireless Comm.*, vol. 6, no. 1, pp. 282–292, Jan. 2007.
- [262] Y. Rong, S. A. Vorobyov, and A. B. Gershman, "Adaptive OFDM techniques with one-bit-per-subcarrier channel-state feedback," *IEEE Trans. Commun.*, vol. 54, no. 11, pp. 1993–2003, Nov. 2006.
- [263] C. Rose, "CDMA codeword optimization: Interference avoidance and convergence via class warfare," *IEEE Trans. Inform. Theory*, vol. 47, no. 6, pp. 2368–2382, Sept. 2001.
- [264] C. Rose, S. Ulukus, and R. D. Yates, "Wireless systems and interference avoidance," *IEEE Trans. Wireless Comm.*, vol. 1, no. 3, pp. 415–428, July 2002.
- [265] D. J. Ryan, I. V. L. Clarkson, I. B. Collings, D. Guo, and M. L. Honig, "QAM Codebooks for Low-complexity Limited Feedback MIMO Beamforming," in *Proc. IEEE Int. Conf. on Commun.*, Jun. 2007, pp. 4162–4167.
- [266] M. A. Sadrabadi, A. K. Khandani, and F. Lahouti, "Channel feedback quantization for high data rate MIMO systems," *IEEE Trans. Wireless Comm.*, vol. 5, no. 12, pp. 3335–3338, Dec. 2006.
- [267] M. A. Sadrabadi, M. A. Maddah-Ali, and A. K. Khandani, "On the capacity of time-varying channels with periodic feedback," *IEEE Trans. Inform. Theory*, vol. 53, no. 8, pp. 2910–2915, Aug. 2007.
- [268] R. Samanta and R. W. Heath Jr., "Codebook Adaptation for Quantized MIMO Beamforming Systems," in *Proc. IEEE Asilomar Conf. on Signals, Systems, and Comp.*, Oct./Nov. 2005, pp. 376–380.
- [269] H. Sampath and A. Paulraj, "Linear precoding for space-time coded systems with known fading correlations," in *Proc. IEEE Asilomar Conf. on Signals, Systems, and Comp.*, vol. 1, 2001, pp. 246–251.

- [270] S. Sampei and H. Harada, "System design issues and performance evaluations for adaptive modulation in new wireless access systems," *Proc. IEEE*, vol. 85, no. 12, pp. 2456–2471, Dec. 2007.
- [271] S. Sanayei, D. J. Love, and A. Nosratinia, "On the design of linear precoders for orthogonal space-time block codes with limited feedback," in *Proc. IEEE Wireless Comm. and Net. Conf.*, vol. 1, March 2005, pp. 489–493.
- [272] S. Sanayei and A. Nosratinia, "Antenna selection in MIMO systems," *IEEE Commun. Mag.*, vol. 42, no. 10, pp. 68–73, Oct. 2004.
- [273] —, "Antenna selection in keyhole channels," *IEEE Trans. Commun.*, vol. 55, no. 3, pp. 404–408, March 2007.
- [274] —, "Capacity of MIMO channels with antenna selection," *IEEE Trans. Inform. Theory*, vol. 53, no. 11, pp. 4356–4362, Nov. 2007.
- [275] —, "Opportunistic beamforming with limited feedback," *IEEE Trans. Wireless Commun.*, vol. 6, no. 8, pp. 2765–2771, Aug. 2007.
- [276] —, "Opportunistic downlink transmission with limited feedback," *IEEE Trans. Inform. Theory*, vol. 53, no. 11, pp. 4363–4372, Nov. 2007.
- [277] W. Santipach, "Asymptotic performance of DS-CDMA with linear MMSE receiver and limited feedback," in *Proc. IEEE Int. Conf. on Commun.*, May 2008, pp. 1393–1397.
- [278] W. Santipach and M. L. Honig, "Asymptotic performance of MIMO wireless channels with limited feedback," in *Proc. IEEE Mil. Comm. Conf.*, vol. 1, Oct. 2003, pp. 141–146.
- [279] —, "Achievable rates for MIMO fading channels with limited feedback," in *Proc. IEEE Int. Symp. Spread Spectrum Tech. and Appl.*, Aug.-Sept. 2004, pp. 1–6.
- [280] —, "Asymptotic capacity of beamforming with limited feedback," in *Proc. IEEE Int. Symp. Info. Th.*, June-July 2004, p. 290.
- [281] —, "Signature optimization for CDMA with limited feedback," *IEEE Trans. Inform. Theory*, vol. 51, no. 10, pp. 3475–3492, Oct. 2005.
- [282] —, "Capacity of beamforming with limited training and feedback," in *Proc. IEEE Int. Symp. Info. Th.*, July 2006, pp. 376–380.
- [283] —, "Optimization of training and feedback for beamforming over a MIMO channel," in *Proc. IEEE Wireless Comm. and Net. Conf.*, March 2007, pp. 1139–1143.
- [284] A. Scaglione, P. Stoica, S. Barbarossa, G. B. Giannakis, and H. Sampath, "Optimal designs for space-time linear precoders and decoders," *IEEE Trans. Signal Processing*, vol. 50, no. 5, pp. 1051–1064, May 2002.
- [285] J. Schalkwijk, "Coding scheme for additive noise channels with feedback - Part II: Band-limited signals," *IEEE Trans. Inform. Theory*, vol. 12, pp. 183–189, April 1966.
- [286] J. Schalkwijk and T. Kailath, "A coding scheme for additive noise channels with feedback - Part I: No bandwidth constraint," *IEEE Trans. Inform. Theory*, vol. 12, pp. 172–183, April 1966.
- [287] S. Shamai (Shitz), O. Somekh, and B. M. Zaidel, "Multi-cell communications: An information theoretic perspective," in *Joint Workshop on Communications and Coding (JWCC)*, Florence, Italy, Oct. 2004.
- [288] S. Shamai (Shitz) and B. M. Zaidel, "Enhancing the cellular downlink capacity via co-processing at the transmitting end," in *Proc. IEEE Veh. Technol. Conf.*, Rhodes, Greece, May 2001, pp. 1745–1749.
- [289] C. E. Shannon, "The zero error capacity of a noisy channel," *IRE Trans. Inform. Theory*, vol. 2, no. 3, pp. 8–19, Sept. 1956.
- [290] —, "Channels with side information at the transmitter," *IBM Journal Research and Dev.*, vol. 2, pp. 289–293, 1958.
- [291] M. Sharif and B. Hassibi, "On the capacity of MIMO broadcast channels with partial side information," *IEEE Trans. Inform. Theory*, vol. 51, no. 2, pp. 506–522, Feb. 2005.
- [292] M. K. Simon and M. Alouini, *Digital Communication over Fading Channels*. New York, NY: John Wiley and Sons, Inc., 2004.
- [293] T. Skinner and J. Cavers, "Selective diversity for Rayleigh fading channels with a feedback link," *IEEE Trans. Commun.*, vol. 21, pp. 117–126, Feb. 1973.
- [294] M. Skoglund and G. Jöngren, "On the capacity of a multiple-antenna communication link with channel side information," *IEEE J. Select. Areas Commun.*, vol. 21, no. 3, pp. 395–405, April 2003.
- [295] N. R. Sollenberger, "Diversity and automatic link transfer for a TDMA wireless access link," in *Proc. IEEE Glob. Telecom. Conf.*, vol. 1, Nov.-Dec. 1993, pp. 532–536.
- [296] B. Song, F. Roemer, and M. Haardt, "Efficient channel quantization scheme for multi-user MIMO broadcast channels with RBD precoding," in *Proc. IEEE Int. Conf. Acoust., Speech and Sig. Proc.*, March-April 2008, pp. 2389–2392.
- [297] L. Song, N. B. Mandayam, and Z. Gajic, "Analysis of an up/down power control algorithm for the CDMA reverse link under fading," *IEEE J. Select. Areas Commun.*, vol. 19, no. 2, pp. 277–286, 2001.
- [298] Q. H. Spencer, C. B. Peel, A. L. Swindlehurst, and M. Haardt, "An introduction to the multi-user MIMO downlink," *IEEE Commun. Mag.*, vol. 42, no. 10, pp. 60–67, Oct. 2004.
- [299] R. Srinivasan, "Feedback communications over fading channels," *IEEE Trans. Commun.*, vol. 29, no. 1, pp. 50–57, Jan. 1981.
- [300] R. Srinivasan and R. Brewster, "Feedback communications in fading channels," *IEEE Trans. Commun.*, vol. 22, no. 1, pp. 93–95, Jan. 1974.
- [301] C. Steger and A. Sabharwal, "Two-way fading channels: Training protocol and diversity-multiplexing performance," in *Proc. IEEE Asilomar Conf. on Signals, Systems, and Comp.*, Nov. 2007, pp. 1941–1945.
- [302] M. Sternad, T. Svensson, T. Ottosson, A. Ahlen, A. Svensson, and A. Brunstrom, "Towards systems beyond 3G based on adaptive OFDMA transmission," *Proc. IEEE*, vol. 85, no. 12, pp. 2432–2455, Dec. 2007.
- [303] T. Strohmer and R. W. Heath, Jr., "Grassmannian frames with applications to coding and communications," *Applied and Computational Harmonic Analysis*, vol. 14, no. 3, pp. 257–275, May 2003.
- [304] H.-J. Su and E. Geraniotis, "Adaptive closed-loop power control with quantized feedback and loop filtering," *IEEE Trans. Wireless Commun.*, vol. 1, no. 1, pp. 76–86, Jan. 2002.
- [305] X. Sun, L. J. Cimini, L. J. Greenstein, D. S. Chan, and B. Douglas, "Performance Evaluation of Quantized Feedback Beamforming in IEEE 802.11n Wireless Networks," in *Proc. Conf. Info. Sciences and Systems*, Baltimore, MD, Mar. 2007, pp. 884–888.
- [306] Y. Sun and M. L. Honig, "Asymptotic capacity of multicarrier transmission over a fading channel with feedback," in *Proc. IEEE Int. Symp. Info. Th.*, June-July 2003, p. 40.
- [307] —, "Minimum feedback rates for multicarrier transmission with correlated frequency-selective fading," in *Proc. IEEE Glob. Telecom. Conf.*, vol. 3, Dec. 2003, pp. 1628–1632.
- [308] —, "Reduced-rank space-time signature and receiver adaptation," in *Proc. IEEE Mil. Comm. Conf.*, vol. 2, Oct.-Nov. 2004, pp. 948–954.
- [309] Y. Sun, W. Xiao, R. Love, K. Stewart, A. Ghosh, R. Ratasuk, and B. Classon, "Multi-user scheduling for OFDM downlink with limited feedback for evolved UTRA," in *Proc. IEEE Veh. Technol. Conf.*, Sept. 2006.
- [310] C. K. Sung, S. Chung, J. Heo, and I. Lee, "Adaptive bit-interleaved coded OFDM with reduced feedback information," *IEEE Trans. Commun.*, vol. 55, no. 9, pp. 1649–1655, Sept. 2007.
- [311] A. Svensson, "An introduction to adaptive QAM modulation schemes for known and predicted channels," *Proc. IEEE*, vol. 85, no. 12, pp. 2322–2336, Dec. 2007.
- [312] C. Swannack, G. W. Wornell, and E. Uysal-Biyikoglu, "Efficient quantization for feedback in MIMO broadcasting systems," in *Proc. IEEE Asilomar Conf. on Signals, Systems, and Comp.*, Oct.-Nov. 2006, pp. 784–788.
- [313] —, "MIMO broadcast scheduling with quantized channel state information," in *Proc. IEEE Int. Symp. Info. Th.*, July 2006, pp. 1788–1792.
- [314] T. Tang and R. W. Heath, Jr., "Opportunistic feedback for downlink multiuser diversity," *IEEE Commun. Lett.*, vol. 9, no. 10, pp. 948–950, Oct. 2005.
- [315] T. Tang, R. W. Heath, Jr., S. Cho, and S. Yun, "Opportunistic feedback for multiuser MIMO systems with linear receivers," *IEEE Trans. Commun.*, vol. 55, no. 5, pp. 1020–1032, May 2007.
- [316] R. Tannious and A. Nosratinia, "Spectrally efficient relay selection protocols in wireless networks," in *Proc. IEEE Int. Conf. Acoust., Speech and Sig. Proc.*, March-April 2008, pp. 3225–3228.
- [317] —, "Spectrally-efficient relay selection with limited feedback," *IEEE J. Select. Areas Commun.*, vol. 26, no. 8, Oct. 2008.
- [318] M. Tao, Q. Li, and H. K. Garg, "Extended space-time block coding with transmit antenna selection over correlated fading channels," *IEEE Trans. Wireless Commun.*, vol. 6, no. 9, pp. 3137–3141, Sept. 2007.
- [319] V. Tarokh, H. Jafarkhani, and A. R. Calderbank, "Space-time block codes from orthogonal designs," *IEEE Trans. Inform. Theory*, vol. 45, no. 5, pp. 1456–1467, July 1999.
- [320] I. E. Telatar, "Capacity of multi-antenna Gaussian channels," *European Trans. Telecommun.*, vol. 10, no. 6, pp. 585–595, 1999.
- [321] S. Thoen, L. Van der Perre, B. Gyselinckx, and M. Engels, "Performance analysis of combined transmit-SC/receive-MRC," *IEEE Trans. Commun.*, vol. 49, no. 1, pp. 5–8, Jan. 2001.
- [322] C. Toker, S. Lambbotharan, and J. A. Chambers, "Closed-loop quasi-orthogonal STBCs and their performance in multipath fading environments and when combined with turbo codes," *IEEE Trans. Wireless Commun.*, vol. 3, no. 6, pp. 1890–1896, Nov. 2004.
- [323] M. Trivellato, F. Boccardi, and F. Tosato, "User selection schemes for MIMO broadcast channels with limited feedback," in *Proc. IEEE Veh. Technol. Conf.*, April 2007, pp. 2089–2093.

- [324] M. Trivellato, H. Huang, and F. Boccardi, "Antenna combining and codebook design for the MIMO broadcast channel with limited feedback," in *Proc. IEEE Asilomar Conf. on Signals, Systems, and Comp.*, Nov. 2007.
- [325] J. Tropp, I. Dhillon, R. W. Heath Jr., and T. Strohmer, "Constructing packings in grassmannian manifolds via alternating projections," *Experimental Mathematics*, 2008.
- [326] G. L. Turin, "Signal design for sequential detection systems with feedback," *IEEE Trans. Inform. Theory*, vol. 11, pp. 401–408, July 1965.
- [327] —, "Comparison of sequential and nonsequential detection systems with uncertainty feedback," *IEEE Trans. Inform. Theory*, vol. 12, pp. 5–8, Jan. 1966.
- [328] S. Ulukus and R. D. Yates, "Iterative construction of optimum signature sequence sets in asynchronous CDMA systems," *IEEE Trans. Inform. Theory*, vol. 47, no. 5, pp. 1989–1998, July 2001.
- [329] S. Venkatesan, A. Lozano, and R. Valenzuela, "Network MIMO: Overcoming intercell interference in indoor wireless systems," in *Proc. IEEE Asilomar Conf. on Signals, Systems, and Comp.*, Nov. 2007, pp. 83–87.
- [330] S. Vishwanath, N. Jindal, and A. Goldsmith, "Duality, achievable rates, and sum-rate capacity of Gaussian MIMO broadcast channels," *IEEE Trans. Inform. Theory*, vol. 49, no. 10, pp. 2658–2668, Oct. 2003.
- [331] E. Visotsky and U. Madhow, "Space-time transmit precoding with imperfect feedback," *IEEE Trans. Inform. Theory*, vol. 47, no. 6, pp. 2632–2639, Sept. 2001.
- [332] P. Viswanath and V. Anantharam, "Optimal sequences for CDMA under colored noise: A Schur-saddle function property," *IEEE Trans. Inform. Theory*, vol. 48, no. 6, pp. 1295–1318, June 2002.
- [333] P. Viswanath, D. Tse, and R. Laroia, "Opportunistic beamforming using dumb antennas," *IEEE Trans. Inform. Theory*, vol. 48, no. 6, pp. 1277–1294, June 2002.
- [334] A. J. Viterbi, *CDMA: Principles of Spread Spectrum Communication*. Reading, MA: Addison Wesley Longman, Inc., 1995.
- [335] M. Vu and A. Paulraj, "MIMO wireless linear precoding," *IEEE Signal Processing Mag.*, vol. 24, no. 5, pp. 86–105, Sept. 2007.
- [336] N. Vucic and H. Boche, "Downlink precoding for multiuser MISO systems with imperfect channel knowledge," in *Proc. IEEE Int. Conf. Acoust., Speech and Sig. Proc.*, March–April 2008, pp. 3121–3124.
- [337] C. Wang and R. D. Murch, "MU-MISO transmission with limited feedback," *IEEE Trans. Wireless Commun.*, vol. 6, no. 11, pp. 3907–3913, Nov. 2007.
- [338] R. Wang and V. Lau, "Robust optimal cross layer designs for TDD-OFDMA systems with imperfect csit and unknown interference: State-space approach based on 1-bit ACK/NAK feedbacks," *IEEE Trans. Commun.*, vol. 56, no. 5, pp. 754–761, 2008.
- [339] X. Wang, G. B. Giannakis, and A. G. Marques, "A unified approach to QoS-guaranteed scheduling for channel-adaptive wireless networks," *Proc. IEEE*, vol. 95, no. 12, pp. 2410–2431, Dec. 2007.
- [340] H. Weingarten, Y. Steinberg, and S. Shamai, "The capacity region of the Gaussian multiple-input multiple-output broadcast channel," *IEEE Trans. Inform. Theory*, vol. 52, no. 9, pp. 3936–3964, Sept. 2006.
- [341] T. F. Wong and T. M. Lok, "Transmitter adaptation in multicode DS-CDMA systems," *IEEE J. Select. Areas Commun.*, vol. 19, no. 1, pp. 69–82, Jan. 2001.
- [342] T. Wu and V. Lau, "Robust rate, power and precoder adaptation in slow fading MIMO channels with noisy limited feedback," *IEEE Trans. Wireless Commun.*, vol. 7, no. 6, pp. 1572–1581, June 2008.
- [343] P. Xia and G. B. Giannakis, "Design and analysis of transmit-beamforming based on limited-rate feedback," *IEEE Trans. Signal Processing*, vol. 54, no. 5, pp. 1853–1863, May 2006.
- [344] P. Xia, S. Zhou, and G. B. Giannakis, "Achieving the Welch bound with difference sets," *IEEE Trans. Inform. Theory*, vol. 51, no. 5, pp. 1900–1907, May 2005.
- [345] —, "Multiantenna adaptive modulation with beamforming based on bandwidth-constrained feedback," *IEEE Trans. Commun.*, vol. 53, no. 3, pp. 526–536, May 2005.
- [346] J. Yang and D. B. Williams, "Transmission subspace tracking for MIMO systems with low-rate feedback," *IEEE Trans. Commun.*, vol. 55, no. 8, pp. 1629–1639, Aug. 2007.
- [347] Y. Yang, L. Tian, J. Zhou, Y. Sun, J. Shi, and Z. Li, "An efficient transmission scheme with limited feedback in multiuser MIMO systems," in *Proc. IEEE Int. Conf. on Commun.*, May 2008, pp. 3367–3371.
- [348] Y. Yao and G. B. Giannakis, "Rate-maximizing power allocation in OFDM based on partial channel knowledge," *IEEE Trans. Wireless Comm.*, vol. 4, no. 3, pp. 1073–1083, May 2005.
- [349] R. Yellapantula, Y. Yao, and R. Ansari, "Antenna selection and power control for limited feedback MIMO systems," in *Proc. IEEE Veh. Technol. Conf.*, Sept. 2006.
- [350] T. Yoo, N. Jindal, and A. Goldsmith, "Multi-antenna downlink channels with limited feedback and user selection," *IEEE J. Select. Areas Commun.*, vol. 25, no. 7, pp. 1478–1491, Sept. 2007.
- [351] W. Yu and J. Cioffi, "Sum capacity of Gaussian vector broadcast channels," *IEEE Trans. Inform. Theory*, vol. 50, no. 9, pp. 1875–1892, Sept. 2004.
- [352] E. Zaccarias, S. Werner, and R. Wichman, "Partial update adaptive transmit beamforming with limited feedback," in *Proc. IEEE Int. Conf. Acoust., Speech and Sig. Proc.*, vol. 4, May 2006.
- [353] R. Zakhour and D. Gesbert, "A two-stage approach to feedback design in multi-user MIMO channels with limited channel state information," in *Proc. IEEE Int. Symp. Personal, Indoor, and Mobile Radio Commun.*, Sept. 2007.
- [354] —, "Adaptive feedback rate control in MIMO broadcast systems with user scheduling," in *UCSD Info. Theory and Appl. Workshop*, Jan.–Feb. 2008.
- [355] H. Zhang, Y. Li, V. Stulpman, and N. Van Waes, "A reduced CSI feedback approach for precoded MIMO-OFDM systems," *IEEE Trans. Wireless Commun.*, vol. 6, no. 1, pp. 55–58, Jan. 2007.
- [356] H. Zhang, S. Wei, G. Ananthaswamy, and D. L. Goeckel, "Adaptive signaling based on statistical characterizations of outdated feedback in wireless communications," *Proc. IEEE*, vol. 85, no. 12, pp. 2337–2353, Dec. 2007.
- [357] H. Zhang and H. Dai, "Cochannel interference mitigation and cooperative processing in downlink multicell multiuser MIMO networks," *European Journal on Wireless Communications and Networking*, no. 2, pp. 222–235, 4th Quarter 2004.
- [358] J. Zhang, Z. Fang, and B. Bensaou, "Adaptive power control for single channel ad hoc networks," in *Proc. IEEE Int. Conf. on Commun.*, vol. 5, May 2005, pp. 3156–3160.
- [359] W. Zhang and K. B. Letaief, "MIMO broadcast scheduling with limited feedback," *IEEE J. Select. Areas Commun.*, vol. 25, no. 7, pp. 1457–1467, Sept. 2007.
- [360] B. Zhao and M. C. Valenti, "Practical relay networks: a generalization of hybrid-ARQ," *IEEE J. Select. Areas Commun.*, vol. 23, no. 1, pp. 7–18, Jan. 2005.
- [361] Y. Zhao, R. Adve, and T. J. Lim, "Beamforming with limited feedback in amplify-and-forward cooperative networks," in *Proc. IEEE Glob. Telecom. Conf.*, Nov. 2007, pp. 3457–3461.
- [362] E. Zheng, S. Zhu, and M. Xu, "Impact of limited feedback on multiple relay zero-forcing precoding systems," in *Proc. IEEE Int. Conf. on Commun.*, May 2008, pp. 4992–4997.
- [363] J. Zheng, E. R. Duni, and B. D. Rao, "Analysis of multiple-antenna systems with finite-rate feedback using high-resolution quantization theory," *IEEE Trans. Signal Processing*, vol. 55, no. 4, pp. 1461–1476, April 2007.
- [364] J. Zheng and B. D. Rao, "Analysis of multiple antenna systems with finite-rate channel information feedback over spatially correlated fading channels," *IEEE Trans. Signal Processing*, vol. 55, no. 9, pp. 4612–4626, Sept. 2007.
- [365] L. Zheng and D. N. C. Tse, "Communication on the Grassmann manifold: a geometric approach to the noncoherent multiple-antenna channel," *IEEE Trans. Inform. Theory*, vol. 48, no. 2, pp. 359–383, Feb. 2002.
- [366] X. Zheng, Y. Xie, J. Li, and P. Stoica, "MIMO transmit beamforming under uniform elemental power constraint," *IEEE Trans. Signal Processing*, vol. 55, no. 11, pp. 5395–5406, Nov. 2007.
- [367] S. Zhou and G. B. Giannakis, "Optimal transmitter eigen-beamforming and space-time block coding based on channel mean feedback," *IEEE Trans. Signal Processing*, vol. 50, no. 10, pp. 2599–2613, Oct. 2002.
- [368] —, "Optimal transmitter eigen-beamforming and space-time block coding based on channel correlations," *IEEE Trans. Inform. Theory*, vol. 49, no. 7, pp. 1673–1690, July 2003.
- [369] —, "Adaptive modulation for multiantenna transmissions with channel mean feedback," *IEEE Trans. Wireless Comm.*, vol. 3, no. 5, pp. 1626–1636, Sept. 2004.
- [370] S. Zhou and B. Li, "BER criterion and codebook construction for finite-rate precoded spatial multiplexing with linear receivers," *IEEE Trans. Signal Processing*, vol. 54, no. 5, pp. 1653–1665, May 2006.
- [371] S. Zhou, B. Li, and P. Willett, "Recursive and trellis-based feedback reduction for MIMO-OFDM with rate-limited feedback," *IEEE Trans. Wireless Commun.*, vol. 5, no. 12, pp. 3400–3405, Dec. 2006.
- [372] S. Zhou, Z. Wang, and G. B. Giannakis, "Quantifying the power loss when transmit beamforming relies on finite-rate feedback," *IEEE Trans. Wireless Comm.*, vol. 4, no. 4, pp. 1948–1957, July 2005.



- [373] P. Zhu, L. Tang, Y. Wang, X. You, and J. Hua, "Pseudo-gray coding for beamforming systems," in *Proc. IEEE Int. Conf. on Commun.*, May 2008, pp. 4689–4695.



**David J. Love (S'98 - M'05)** was born in Garland, TX. He received the B.S. (with highest honors), M.S.E., and Ph.D. degrees in electrical engineering from the University of Texas at Austin, in 2000, 2002, and 2004, respectively. During the summers of 2000 and 2002, he was with the Texas Instruments DSPS R&D Center, Dallas, TX. Since August 2004, he has been with the School of Electrical and Computer Engineering, Purdue University, West Lafayette, IN, as an Assistant Professor. His research interests are in the design and analysis of communication systems. Dr. Love is a member of Tau Beta Pi and Eta Kappa Nu. In 2003, he received the IEEE Vehicular Technology Society Daniel Noble Fellowship.

communication systems. Dr. Love is a member of Tau Beta Pi and Eta Kappa Nu. In 2003, he received the IEEE Vehicular Technology Society Daniel Noble Fellowship.



**David Gesbert (S'96 - M'99 - SM'05)** is Professeur at Eurecom, France. He obtained the Ph.D degree from Ecole Nationale Supérieure des Telecommunications, in 1997. From 1997 to 1999, he has been a research fellow at the Information Systems Laboratory, Stanford University. He was a founding engineer of Iospan Wireless Inc, San Jose, Ca., pioneering MIMO-OFDM. From 2001 to 2003 he has been with the University of Oslo as an adjunct professor. D. Gesbert has published about 140 papers and several patents all in the area of signal processing and communications. D. Gesbert co-edited several special issues for IEEE JSAC (2003, 2008), EURASIP JASP (2004, 2007), IEEE Wireless Communications (2006). He is a member of the IEEE Signal Processing for Communications Technical Committee. He authored or co-authored papers winning the 2004 IEEE Best Tutorial Paper Award (Communications Society), 2005 Best Paper (Young Author) Award for Signal Proc. Society journals, and the Best Paper Award for the 2004 ACM MSWiM Conference.



**Robert W. Heath Jr. (S'96 - M'01 - SM'06)** received the B.S. and M.S. degrees from the University of Virginia, Charlottesville, VA, in 1996 and 1997 respectively, and the Ph.D. from Stanford University, Stanford, CA, in 2002, all in electrical engineering.

From 1998 to 2001, he was a Senior Member of the Technical Staff then a Senior Consultant at Iospan Wireless Inc, San Jose, CA where he worked on the design and implementation of the physical and link layers of the first commercial MIMO-OFDM communication system. In 2003 he founded MIMO Wireless Inc, a consulting company dedicated to the advancement of MIMO technology. Since January 2002, he has been with the Department of Electrical and Computer Engineering at The University of Texas at Austin where he is currently an Associate Professor and Associate Director of the Wireless Networking and Communications Group. His research interests include several aspects of MIMO communication: limited feedback techniques, multihop networking, multiuser MIMO, antenna design, and scheduling algorithms as well as 60GHz communication techniques and multi-media signal processing.

Dr. Heath has been an Editor for the IEEE Transactions on Communication and an Associate Editor for the IEEE Transactions on Vehicular Technology. He is a member of the Signal Processing for Communications Technical Committee in the IEEE Signal Processing Society. He was a technical co-chair for the 2007 Fall Vehicular Technology Conference, general chair of the 2008 Communication Theory Workshop, and is a general co-chair and co-organizer of the 2009 Signal Processing for Wireless Communications Workshop. He is the recipient of the David and Doris Lybarger Endowed Faculty Fellowship in Engineering and is a registered Professional Engineer in Texas.



**Bhaskar D. Rao (S'80 - M'83 - SM'91 - F'00)** received the B.Tech. degree in electronics and electrical communication engineering from the Indian Institute of Technology, Kharagpur, India, in 1979 and the M.S. and Ph.D. degrees from the University of Southern California, Los Angeles, in 1981 and 1983, respectively. Since 1983, he has been with the University of California at San Diego, La Jolla, where he is currently a Professor with the Electrical and Computer Engineering Department and holder of the Ericsson endowed chair in wireless access

networks. His interests are in the areas of digital signal processing, estimation theory, and optimization theory, with applications to digital communications, speech signal processing, and human-computer interactions.

His paper received the best paper award at the 2000 speech coding workshop and his students have received student paper awards at both the 2005 and 2006 International conference on Acoustics, Speech and Signal Processing conference as well as the best student paper award at NIPS 2006. A paper he co-authored with B. Song and R. Cruz received the 2008 Stephen O. Rice Prize Paper Award in the Field of Communications Systems. He also received the graduate teaching award from the graduate students in the Electrical Engineering department at UCSD in 1998. He was elected to the fellow grade in 2000 for his contributions in high resolution spectral estimation. Dr. Rao has been a member of the Statistical Signal and Array Processing technical committee, the Signal Processing Theory and Methods technical committee as well as the Communications technical committee of the IEEE Signal Processing Society. He currently serves on the editorial board of the EURASIP Signal Processing Journal.



**Vincent K. N. Lau (M'97 - SM'01)** graduated from the Dept of EEE, University of Hong Kong with a B.Eng (Distinction 1st Hons) in 1992. He joined the HK Telecom after graduation for three years as project engineer and later promoted to system engineer. He obtained the Sir Edward Youde Memorial Fellowship and the Croucher Foundation in 95 and went to the University of Cambridge for a Ph.D. in mobile communications. He completed the Ph.D. degree in two years and joined the Lucent Technologies - Bell labs (ASIC department) as

member of technical staff in 1997. In 2004, he joined the Department of Electrical and Electronic Engineering, Hong Kong University of Science and Technology. At the same time, he is a technology advisor of HK-ASTRI on the R&D of wireless LAN access infrastructure with smart antenna. He has a total of seven years industrial experience and three years of academic experience. His research interests include adaptive modulation and channel coding, information theory with state feedback, multi-user MIMO scheduling, crosslayer optimization, baseband SoC design (UMTS base station ASIC, 3G1x mobile ASIC, Wireless LAN MIMO ASIC). He is the principal author of a book on MIMO Technologies (to be published by John Wiley and Sons) as well as the chapter author of two books on wideband CDMA technologies. He has published more than 40 papers in IEEE transactions and journals and 47 papers in international conference, 14 Bell Labs Technical Memos and received two best paper awards. He has eight US patents pending and is currently a senior member of IEEE.



**Matthew Andrews** is a distinguished member of technical staff in the Complex Systems Analysis & Optimization Department at Bell Labs in Murray Hill, NJ. He received his B.A., First Class Honours, in mathematics from Oxford University in 1993 and his Ph.D. in theoretical computer science from the Massachusetts Institute of Technology in 1997. His research interests include wireless resource allocation, packet scheduling and approximation algorithms. His recent work includes algorithms for joint scheduling and congestion control in ad-hoc

networks and complexity theoretic results on the hardness of network design. He holds a range of patents in the area of telecommunications.