

From: Charmley, William

Sent: Thursday, July 12, 2018 3:47 PM

To: Achanta, Chandana L. EOP/OMB <Chandana.L.Achanta@omb.eop.gov>; 'Whiteman, Chad S. EOP/OMB' <Chad.S.Whiteman@omb.eop.gov>; Laity, Jim A. EOP/OMB <James.A.Laity@omb.eop.gov>

Cc: Hengst, Benjamin <Hengst.Benjamin@epa.gov>; Burch, Julia <Burch.Julia@epa.gov>; Sutton, Tia <sutton.tia@epa.gov>

Subject: EPA comments on the first version of the draft Preliminary RIA from NHTSA for the joint CAFE/GHG NPRM on light-duty vehicles

Dear Chad, Chandana and Jim –

Attached are EPA's comments on the draft NHTSA Preliminary RIA.

These are comments on the previous version EPA received as part of the interagency review of the CAFE/GHG NPRM – not the version that Chandana provided today.

We will begin looking at that new version now.

Thanks
Bill Charmley
US EPA



U.S. Department of Transportation
National Highway Traffic Safety Administration



U.S. Environmental Protection Agency
Office of Transportation and Air Quality

Preliminary Regulatory Impact Analysis

Commented [A1]: Please see the comments below on page 2 from EPA.

Corporate Average Fuel Economy Standards and CO₂ Standards for Model Year 2021 – 2026 Passenger Cars and Light Trucks

May 2018

EPA Comments for DOT-NHTSA and OMB

This Preliminary RIA is a work product of DOT and NHTSA, and was not authored by EPA. The Preliminary RIA is based on the independent technical assessment from DOT-NHTSA, and the document should reflect appropriately who has authored the Preliminary RIA. EPA's name and logo should be removed from the DOT-NHTSA Preliminary Regulatory Impact Analysis document. EPA is relying upon the technical analysis performed by DOT-NHTSA for the Notice of Proposed Rulemaking.

EPA has provided a number of technical recommendations/observations on the DOT analysis. This includes the EPA staff February 1, 2018 technical memorandum, the March 1, 2018 technical memorandum, the April 16, 2018 technical presentation for OIRA, the June 18, 2018 presentation to OIRA, and the June 18, 2018 technical memorandum. In addition, at the request of DOT and OMB, EPA also provided during February 2018 and March 2018 more than 65 technical reports, papers, presentations, spreadsheets and models regarding EPA-sponsored or published work and analysis, including technology cost and effectiveness assessments and inputs, powertrain benchmarking testing results, consumer research, manufacturer learning-by-doing research, technology tear-down assessments, and other work. To the extent DOT has utilized the EPA technical work or considered the recommendations and observations from EPA, it does not change the fact that the analysis and assessment in this Preliminary RIA is the work product of DOT-NHTSA, and not of EPA.

*** EO 12866 Review – Draft – Do Not Cite, Quote or Release During Review ***

EXECUTIVE SUMMARY	5
1 Overview	94
2 Need for this Regulatory Action	95
3 Proposed and Alternative CAFE and CO2 standards for MYs 2021-2026	109
4 Effect of Other Governmental Vehicle Standards On Fuel Economy	153
5 Corporate Average Fuel Economy Compliance Simulation Modeling in Response to Regulatory Alternatives	161
6 Manufacturer CAFE Capabilities	515
7 Economic Analysis of Regulatory Alternatives.....	801
8 Cost Impacts.....	947
9 Benefits	1046
10 Impact of CAFE Standards on Vehicle Safety	1183
11 Net Impacts	1259
12 Sensitivity Analysis	1397
13 Flexibilities	1415
14 Regulatory Flexibility Act and Unfunded Mandates Reform Act Analysis	1449

*** EO 12866 Review – Draft – Do Not Cite, Quote or Release During Review ***

EXECUTIVE SUMMARY

This Proposed Regulatory Impact Analysis (PRIA) has been prepared to assess the potential and anticipated consequences of proposed and alternative Corporate Average Fuel Economy (CAFE) standards and carbon dioxide (CO₂) standards for passenger cars and light trucks for model years (MY) 2021 through 2026. Regulatory analysis is a tool used to anticipate and evaluate likely consequences of rules. It provides a formal way of organizing the evidence on the key effects, positive and negative, of the various alternatives that are considered in developing regulations. The goal of this PRIA is to consolidate that evidence to help inform decision-makers of those potential consequences of choosing among the considered regulatory paths.

Both agencies are required by law to take regulatory action and do not have discretion not to set standards. NHTSA is required to set CAFE standards by the Energy Policy and Conservation Act of 1975 (EPCA), as amended by the Energy Independence and Security Act of 2007 (EISA). CAFE standards must be set at least 18 months prior to the beginning of the model year; must be set separately for each model year and for passenger cars and light trucks; must be “attribute-based and defined by a mathematical function,” and must be set at the maximum feasible level that NHTSA determines manufacturers can reach for that fleet in that model year, among other requirements.¹ EPA, having found that CO₂ endangers public health and welfare,² must set CO₂ emissions standards for passenger cars and light trucks under section 202 (a) of the Clean Air Act (CAA) ((42 U.S.C. 7521 (a)), and under its authority to measure passenger car and passenger car fleet fuel economy pursuant to EPCA.³

This assessment examines the costs and benefits of proposed and alternative CAFE and CO₂ standards levels for passenger cars and light trucks for MYs 2021 through 2026. In this rulemaking, NHTSA proposes to revise the existing CAFE standards for MY 2021, and propose new standards for MYs 2022-2026. EPA proposes to revise the existing CO₂ standards for MYs 2021-2025, and propose new standards for MY 2026. This assessment examines the costs and benefits of setting fuel economy and CO₂ standards for passenger cars and light trucks that change at a variety of different rates during those model years.⁴ This assessment includes a discussion of the technologies that can improve fuel economy/reduce CO₂ emissions, as well as analysis of the potential impacts on vehicle retail prices, safety, lifetime fuel savings and their value to consumers, and other societal benefits such as improved energy security and reduced emissions of

¹ See 49 U.S.C. § 32902 and Section V of the preamble that this PRIA accompanies for more information. 2 74 FR 66496, 66518 (December 15, 2009).

³ 49 U.S.C. § 32904 (c).

⁴ Throughout this PRIA, cost and benefit analyses are presented for individual model years as well as the cumulative total for all model years through MY 2029.

pollutants and greenhouse gases.⁵ Estimating impacts also involves consideration of the response of consumers — e.g., whether consumers will purchase the vehicles, and in what quantities.

As explained above, EISA requires NHTSA to set attribute-based CAFE standards that are based on a mathematical function; EPA also sets CO₂ standards following this approach in the interest of regulatory harmonization. The proposed CAFE and CO₂ standards and alternative standards for MYs 2021-2026 passenger cars and light trucks are based on vehicle footprint, as were the CAFE standards for MYs 2011-2021⁶ and the GHG standards for MYs 2012-2025. The mathematical function or “curve” representing the footprint-based standards is a constrained linear function that provides a separate fuel economy target for each vehicle footprint, generally with more stringent targets for smaller vehicles and less stringent targets for larger vehicles.

Different parameters for the continuous mathematical function are derived. Individual manufacturers will be required to comply with a unique fuel economy level for each of its fleets that is based on the distribution of its production for that year among the footprints of its vehicles. Although a manufacturer’s compliance obligation is determined in the same way for both passenger cars and light trucks, the footprint target curves for those fleets are established with different continuous mathematical functions that are intended to be specific to the vehicles’ design capabilities, to reflect the statutory requirement that the standards are supposed to be “maximum feasible” for each fleet separately.

To evaluate the costs and benefits of the rule, an analysis fleet representing the light-duty fleet in detail was constructed. This fleet provides the starting point for the simulation of manufacturers’ year-by-year response through model year 2032⁷ to standards defining each regulatory alternative. The analysis fleet is comprised of the best information available as of mid-2017 regarding the model year 2016 fleet, and, for each of nearly 1,700 specific model/configurations,⁸ contains information such as production volumes, fuel economy ratings, dimensions (footprint), curb weight and GVWR, engine characteristics, transmission characteristics, and other key engineering information. For each regulatory alternative, the CAFE model was used to simulate manufacturers’ year-by-year application of technology that improves fuel economy/reduces CO₂ emissions, assuming that manufacturers would respond

⁵ This analysis does not contain NHTSA’s assessment of the potential environmental impacts of the proposed rule for purposes of the National Environmental Policy Act (NEPA), 42 U.S.C. 4321-4347, which is contained in the agency’s Draft Environmental Impact Statement (EIS) accompanying the proposed rule.

⁶ Vehicle Footprint is defined as the wheelbase (the distance from the center of the front axle to the center of the rear axle) times the average track width (the distance between the centerline of the tires) of the vehicle (in square feet).

⁷ As in NHTSA’s analysis presented in the 2016 Draft TAR, today’s analysis exercises the CAFE model using inputs that extend the explicit compliance simulation through MY 2032 – six years beyond the last year for which we propose to issue new standards. This has been done because some products are on design cycles well beyond six years, and especially with credits being able to be carried forward for up to five years, some manufacturers may not achieve full MY 2026 compliance until well beyond MY 2026.

⁸ For example, a given pickup truck model might be offered in RWD and 4WD versions with a variety of cab and bed configurations, engines, transmissions, resulting in potentially many distinct configurations of this model.

both to the year-by-year series of standards defining the regulatory alternative, and also to buyers’ willingness to pay for a portion of the fuel savings expected to occur over vehicles’ useful lives. In the analyses, it was assumed that, beyond any regulatory requirements, manufacturers would voluntarily supply technologies that have a consumer payback (defined by fuel savings exceeding retail price increases) in 30 months or less. This estimate equates to a willingness to pay for approximately a quarter of available fuel savings.

NHTSA examined eight regulatory alternatives, covering a variety of alternate annual percentage increases separately for passenger cars and light trucks. These alternatives are summarized in the following table:

TABLE E-1 - CAFE REGULATORY ALTERNATIVES CURRENTLY UNDER CONSIDERATION

Alternative	Change in stringency	A/C efficiency and off-cycle provisions
Baseline/ No-Action	MY 2021 standards remain in place; MYs 2022-2025 augural CAFE standards are finalized; MY 2026 standards are set at MY 2025 levels	No change
1 (Proposed)	Existing standards through MY 2020, then 0%/year increases for both passenger cars and light trucks, for MYs 2021-2026	No change
2	Existing standards through MY 2020, then 0.5%/year increases for both passenger cars and light trucks, for MYs 2021-2026	No change
3	Existing standards through MY 2020, then 0.5%/year increases for both passenger cars and light trucks, for MYs 2021-2026	Phase out these adjustments over MYs 2022-2026
4	Existing standards through MY 2020, then 1%/year increases for passenger cars and 2%/year increases for light trucks, for MYs 2021-2026	No change
5	Existing standards through MY 2021, then 1%/year increases for passenger cars and 2%/year increases for light trucks, for MYs 2022-2026	No change
6	Existing standards through MY 2020, then 2%/year increases for passenger cars and 3%/year increases for light trucks, for MYs 2021-2026	No change
7	Existing standards through MY 2020, then 2%/year increases for passenger cars and 3%/year increases for light trucks, for MYs 2021-2026	Phase out these adjustments over MYs 2022-2026
8	Existing standards through MY 2021, then 2%/year increases for passenger cars and 3%/year increases for light trucks, for MYs 2022-2026	No change

*** EO 12866 Review – Draft – Do Not Cite, Quote or Release During Review ***

EPA also examined eight regulatory alternatives, covering a variety of alternate annual percentage increases separately for passenger cars and light trucks. These alternatives are summarized in the following table:

TABLE E-2 – CO₂ REGULATORY ALTERNATIVES CURRENTLY UNDER CONSIDERATION⁹

Alternative	Change in stringency	A/C efficiency and off-cycle provisions
Baseline/ No-Action	GHG standards remain unchanged; MY 2026 standards are set at MY 2025 levels	No change
1 (Proposed)	Existing standards through MY 2020, then 0%/year increases for both passenger cars and light trucks, for MYs 2021-2026	No change
2	Existing standards through MY 2020, then 0.5%/year increases for both passenger cars and light trucks, for MYs 2021-2026	No change
3	Existing standards through MY 2020, then 0.5%/year increases for both passenger cars and light trucks, for MYs 2021-2026	Phase out these adjustments over MYs 2022-2026
4	Existing standards through MY 2020, then 1%/year increases for passenger cars and 2%/year increases for light trucks, for MYs 2021-2026	No change
5	Existing standards through MY 2021, then 1%/year increases for passenger cars and 2%/year increases for light trucks, for MYs 2022-2026	No change
6	Existing standards through MY 2020, then 2%/year increases for passenger cars and 3%/year increases for light trucks, for MYs 2021-2026	No change
7	Existing standards through MY 2020, then 2%/year increases for passenger cars and 3%/year increases for light trucks, for MYs 2021-2026	Phase out these adjustments over MYs 2022-2026
8	Existing standards through MY 2021, then 2%/year increases for passenger cars and 3%/year increases for light trucks, for MYs 2022-2026	No change

⁹ The alternatives would apply to CO₂ emissions.

*** EO 12866 Review – Draft – Do Not Cite, Quote or Release During Review ***

This PRIA is generally organized to provide overall background information, methodologies, and data inputs, as well as results of the various technical and economic analyses. A summary of each chapter of the PRIA subsequent to this one follows:

Chapter 2 - Need for this Regulatory Action. This chapter discusses the need for the regulatory action, and provides background information on U.S. oil consumption and CO₂ emissions.

Chapter 3 - Proposed and Alternative CAFE and CO₂ Standards for MYs 2021-2026. This chapter discusses the form of the CAFE and CO₂ standards (i.e., the footprint-based constrained linear functions that are the standards for each fleet and for each model year), and how the forms of the standards were developed for this proposal. This chapter also presents the proposed standards for both agencies and defines the alternative standards considered.

Chapter 4 - Effect of Other Governmental Vehicle Standards on Fuel Economy. Pursuant to EPCA, as amended by EISA, NHTSA is obligated to consider the effect of other motor vehicle standards of the Government on fuel economy. This chapter looks at the effect that those standards would have on manufacturers' ability to improve their fuel economy levels.

Chapter 5 - Simulation Modeling in Response to Regulatory Alternatives. This chapter takes an in-depth look at the analysis of technologies that could be used by industry to improve their fuel economy levels/reduce their CO₂ emissions levels. This chapter also describes how the the CAFE model was used to assess potential effects associated with different regulatory alternatives, and how the CAFE model works in general. It further describes how the “analysis fleet” was developed. The analysis fleet provides the basis for subsequent analysis by the CAFE model.

Chapter 6 - Manufacturer CAFE Capabilities. Focusing on the baseline and proposed standards, this chapter presents the results of the modeling in terms of each manufacturer's estimated CAFE and average CO₂ requirements for each covered fleet in each model year, and in terms of the resultant estimated application of technology, achieved CAFE and average CO₂ levels, regulatory costs, and resultant average vehicle prices.

Chapter 7 - Economic Analysis of Regulatory Alternatives. This chapter describes the approach for measuring the various economic costs and benefits that are likely to result from adopting the different regulatory alternatives considered. It also reports the values of the economic parameters used to calculate each category of costs and benefits, describes the sources relied on for estimates of the values of these parameters, and discusses the uncertainty surrounding those values.

Some of the more significant economic and related assumptions in this analysis include:

*** EO 12866 Review – Draft – Do Not Cite, Quote or Release During Review ***

1. The price of gasoline - The main analysis uses the Reference Case AEO 2018 estimate for the price of gasoline.
2. GDP - The main analysis assumes GDP grow rates will transition from levels just below 3% in the short term to levels just above 2% by the early 2020s, remaining at such levels thereafter.
3. Discount rates - The analysis of benefits and costs considers discount rates of 3% and 7%.
4. The rebound effect - The main analysis uses a rebound effect of 20 percent to project increased miles traveled as the cost per mile decreases.
5. On-road “gap” - The main analysis assumes operation on gasoline or diesel fuel achieves fuel economy 20% below rated values, and applies a 30% on-road gap for operation on electricity.
6. The value of CO₂ benefits - The unit values (or social costs) of emissions of CO₂ that are used to convert these increased emissions to economic costs were estimated by EPA for use in its recent regulatory analysis of that agency’s proposed review of its Clean Power Plan. These values are lower than those used previously by the agencies to estimate benefits from the reductions in emissions of CO₂ anticipated to result from previous increases to CAFE and GHG standards, primarily because the new values reflect only reductions in potential climate-related economic damages to the U.S., rather than to the entire world economy.
7. The military security component - The analysis does not assign a specific value to the military security benefits of reducing fuel consumption. This view concurs with the conclusions of most recent studies of military-related costs to protect U.S. oil imports, which generally conclude that savings in military spending are unlikely to result from incremental reductions in U.S. consumption of petroleum products resulting from any of the CAFE or CO₂ standards considered in this proposal.
8. Consumer benefit - The main analysis assumes there is no loss in value of other attributes to consumers resulting from vehicles that have an increase in price and higher fuel economy/lower CO₂ emissions.
9. Technology cost markup - The analysis applies a factor of 1.5 to “mark up” direct costs when estimating the equivalent retail price.

Chapter 8 - Costs of Alternative CAFE and CO₂ Standards. This chapter presents both direct and indirect costs of alternative CAFE and CO₂ standards. It also discusses the approach to “marking up” direct costs associated with application of vehicle technologies, and to “learning” (i.e., the rates at which application of technologies become cheaper over time as manufacturers gain experience with using and applying them).

*** EO 12866 Review – Draft – Do Not Cite, Quote or Release During Review ***

Chapter 9 - Benefits of Alternative CAFE and CO₂ Standards. This chapter presents the private and social benefits that are associated with alternative CAFE and CO₂ standards.

Chapter 10 - Impacts of CAFE and CO₂ Standards on Safety. This chapter includes a comprehensive measure of safety impacts of potential CAFE and CO₂ standards. A number of factors can influence motor vehicle safety directly by influencing vehicle design or indirectly by influencing consumer behavior. This chapter discusses these factors and estimates their individual and combined effects. Previous CAFE and CO₂ rulemakings have examined the impact of mass reduction on safety in the on-road vehicle fleet. This analysis continues and updates that analysis, but also expands the examination of safety impacts to include the effect of higher vehicle prices on sales of newer, safer vehicles and the retention of older, less safe vehicles. The potential impact of the rebound effect on safety is examined, though added driving is a consumer choice and not directly imposed by CAFE and CO₂ standards. A social cost of \$9.9m is applied to each estimated fatality resulting from a highway vehicle crash.

Chapter 11 - Net Benefits of Alternative CAFE and CO₂ Standards. This chapter compares the costs of technologies needed to make improvements in fuel economy/reductions in CO₂ emissions with the potential benefits, expressed in total costs (millions of dollars) from a societal perspective for each model year. These are incremental costs and benefits compared to the adjusted baseline of MY 2016. A payback period is calculated, from the consumer's perspective.

Chapter 12 - Sensitivity Analysis. Recognizing that the inputs to this analysis are uncertain, this chapter examines the effects that different CAFE and CO₂ standards could have if those inputs changed in various ways. The sensitivity analysis examines alternative inputs for the following factors:

- Valuation of Consumer Benefit - Degree (as percentage, with 100% applied for reference case) to which consumers will value the calculated benefits they receive. Sensitivity analysis cases consider lower percentages.
- Inclusion of Fleet Share and Sales Response Models - A sensitivity analysis case disables these models.
- Oil Prices - Reference case from DOE/EIA's Annual Energy Outlook 2017. Sensitivity analysis cases consider low and high oil price cases.
- GDP - Sensitivity analysis cases consider slower and faster GDP growth.
- On Road Gap - Sensitivity analysis cases consider smaller and larger gaps between laboratory and real-world fuel economy (and CO₂ emissions)

*** EO 12866 Review – Draft – Do Not Cite, Quote or Release During Review ***

- Payback Period - Using the payback period as a proxy, sensitivity analysis cases consider lesser and greater tendency of manufacturers to apply more technology than needed to meet standards.
- Rebound Effect - Sensitivity analysis cases consider lesser and greater tendencies of vehicle owners to drive more when the fuel costs of driving decrease.
- Redesign Cadence - Sensitivity analysis cases consider decelerated and accelerated product design cycles.
- Safety Coefficients - Sensitivity analysis cases consider cases reflecting the confidence interval of the statistical analysis of impacts of vehicle mass on highway safety as well as the impact of future safety trends on fatalities related to delayed purchase of new vehicles.
- Social Cost of Carbon - Sensitivity analysis cases consider lower and higher valuation of damages of CO₂ emissions.
- HEV Battery Costs - Sensitivity analysis cases consider lower and higher costs for HEV batteries.
- Strong Hybrids - One sensitivity analysis case excludes “strong” hybrid electric vehicles.
- HCR2 (“Futured” High Compression Ratio) Engines - One sensitivity analysis case includes a hypothetical “future” high CR (Atkinson cycle) engine.
- Technology Cost Markup - Sensitivity analysis cases consider lower and higher factors to mark up technology costs.

Chapter 13 - Flexibilities Meeting the standard. This chapter discusses compliance flexibilities that manufacturers can use to achieve compliance with CAFE standards beyond applying fuel economy-improving technologies. Some compliance flexibilities are statutorily mandated by Congress through EPCA and EISA, specifically program credits, including the ability to carry-forward, carry-back, trade and transfer credits, and special fuel economy calculations for dual- and alternative-fueled vehicles.

Chapter 14 - Regulatory Flexibility Act and Unfunded Mandates Reform Act Analysis. This chapter presents the analysis of the potential effects of the proposed rules on small businesses, small organizations, and small government jurisdictions, as well as an assessment of statutory obligations under the Unfunded Mandates Reform Act of 1995.

The agencies’ proposed standards for MYs 2021-2026 are coordinated, with a goal of enabling all manufacturers to build a single fleet of vehicles that would comply with both the CAFE and

*** EO 12866 Review – Draft – Do Not Cite, Quote or Release During Review ***

CO₂ standards, helping to reduce costs and regulatory complexity. The coordinated program would achieve important reductions in regulatory costs and vehicle prices, and achieve significant societal and consumer net benefits. It is important to note throughout this analysis that there is significant overlap in costs and benefits for NHTSA's CAFE program and EPA's CO₂ program, and therefore combined program costs and benefits are not a sum of the two individual programs.

Table E-3 and Table E-4 present the total costs (technology and social), benefits, and net benefits for NHTSA's 2021-2026 preferred alternative CAFE and CO₂ levels, relative to the MY 2022-2025 augural standards and current MY 2021 standard. The values in Table E-3 and Table E-4 display (in total and annualized forms) costs for all MY 1977-2029 vehicles and the benefits and net benefits represent the impacts of the standards over the full lifetimes of the vehicles sold or projected to be sold during model years 1977-2029.

For this rulemaking, the baseline for cost and benefit reporting is the augural standards. Several approaches were considered, but the approach it is believed will be most consistent with the forward-looking augural baseline was settled upon. For this analysis, negative signs are used for changes in costs or benefits that decrease from those that would have resulted from the augural standards for MY 2022-2026, or the existing standard for MY 2021. Any changes that would increase either costs or benefits are shown as positive changes. Thus, an alternative that decreases both costs and benefits, will show declines (i.e., a negative sign) in both categories. From Table E-3 and Table E-4, the preferred alternative (Alternative 1) is estimated to decrease costs relative to the augural baseline by from \$307 to \$541 billion over the lifetime of MYs 1977-2029 passenger vehicles (range determined by discount rate across both CAFE and CO₂ programs). It will also decrease benefits by from \$177-\$326 billion over the life of these MY fleets. The net impact will be an increase of from \$130 to \$215 billion in total net benefits to society over this roughly 45-year timeframe. Annualized, this amounts to roughly \$7.2-\$11.5 billion per year.

*** EO 12866 Review – Draft – Do Not Cite, Quote or Release During Review ***

Table E-5 and Table E-6 lists costs, benefits and net benefits for all 8 alternatives that were examined. Alternative 1, the preferred alternative, provides the largest net benefit among these alternatives. A variety of other more detailed impacts of the preferred alternative are shown in

Table E-73 through Table E-78.

Detailed results by model year and alternative are provided in Table E-7 through Table E-72. Table E-7 through

list the average required MPG by model year and alternative for passenger cars, light trucks, and the combined light vehicle fleet. Table E-13 through Table E-18 list the average achieved MPG for these same categories. Table E-19 through Table E-24 list the average incremental technology costs and civil penalties per vehicle by model year and alternative for each light vehicle category.

Table E-25 through Table E-30 list the incremental total costs (at 3% discount rate) of each alternative by model year from a societal perspective, which excludes civil penalties because they are transfer payments from one societal component to another. Table E-31 through Table E-36 list the present value (at 3% discount rate) of the lifetime societal benefits by model year and alternative. Table E-37 through Table E-42 list the present value of net total benefits (at 3% discount rate). Table E-43 through Table E-48 list the incremental total costs at 7% discount rate) from the societal perspective (excluding fines). Table E-49 through Table E-54 list the present value (at 7% discount rate) of the lifetime societal benefits by model year and alternative. Table E-55 through Table E-60 list the present value of net total benefits (at 7% discount rate). Table E-61 through Table E-66 list the billions of gallons of liquid fuel saved by each alternative by model year. Table E-67 through Table E-72 list the change in electricity consumption (GW-h) for each alternative by model year.

TABLE E-3 - ESTIMATED 1977-2029 MODEL YEAR COSTS, BENEFITS, AND NET BENEFITS UNDER THE PREFERRED ALTERNATIVE, CAFE STANDARDS (BILLIONS OF 2016\$)

Cumulative Across MYs 1977-2029				
	Totals		Annualized	
	3% Discount Rate	7% Discount Rate	3% Discount Rate	7% Discount Rate
Costs	-540.9	-363.9	-20.7	-26.2
Benefits	-326.2	-204.1	-12.5	-14.7
Net Benefits	214.6	159.7	8.2	11.5

TABLE E-4 - ESTIMATED 1977-2029 MODEL YEAR COSTS, BENEFITS, AND NET BENEFITS UNDER THE PREFERRED ALTERNATIVE, CO2 STANDARDS (BILLIONS OF 2016\$)

Cumulative Across MYs 1977-2029		
	Totals	Annualized

*** EO 12866 Review – Draft – Do Not Cite, Quote or Release During Review ***

	3% Discount Rate	7% Discount Rate	3% Discount Rate	7% Discount Rate
Costs	-473.3	-306.8	-18.1	-22.1
Benefits	-283.7	-176.6	-10.8	-12.7
Net Benefits	189.6	130.2	7.2	9.4

*** EO 12866 Review – Draft – Do Not Cite, Quote or Release During Review ***

TABLE E-5 - TOTAL COSTS, BENEFITS, AND NET BENEFITS PASSENGER CARS AND LIGHT TRUCKS, MYS 1977-2029, CAFE STANDARDS (BILLIONS OF 2016\$)

Alternative	3% Discount Rate			7% Discount Rate		
	Costs	Benefits	Net Benefits	Costs	Benefits	Net Benefits
0.0%PC/0.0%LT, MYS 2021-2026	-540.9	-326.2	214.6	-363.9	-204.1	159.7
0.5%PC/0.5%LT, MYS 2021-2026	-513.4	-307.1	206.3	-346.1	-191.8	154.3
0.5%PC/0.5%LT, MYS 2021-2026, AC/Off-Cycle Phaseout	-483.4	-290.3	193.1	-326.2	-181.4	144.8
1.0%PC/2.0%LT, MYS 2021-2026	-431.8	-250.7	181.1	-294.3	-156.7	137.6
1.0%PC/2.0%LT, MYS 2022-2026	-343.8	-186.1	157.6	-235.3	-115.5	119.9
2.0%PC/3.0%LT, MYS 2021-2026	-301.9	-171.3	130.6	-209.6	-108.0	101.6
2.0%PC/3.0%LT, MYS 2021-2026, AC/Off-Cycle Phaseout	-188.0	-119.9	68.1	-135.0	-76.2	58.8
2.0%PC/3.0%LT, MYS 2022-2026	-203.8	-113.0	90.7	-141.5	-70.2	71.3

TABLE E-6 - TOTAL COSTS, BENEFITS, AND NET BENEFITS PASSENGER CARS AND LIGHT TRUCKS, MYS 1977-2029, CO2 STANDARDS (BILLIONS OF 2016\$)

Alternative	3% Discount Rate			7% Discount Rate		
	Costs	Benefits	Net Benefits	Costs	Benefits	Net Benefits
0.0%PC/0.0%LT, MYS 2021-2026	-473.3	-283.7	189.6	-306.8	-176.6	130.2
0.5%PC/0.5%LT, MYS 2021-2026	-453.9	-271.4	182.5	-294.0	-168.7	125.3
0.5%PC/0.5%LT, MYS 2021-2026, AC/Off-Cycle Phaseout	-421.1	-250.3	170.9	-274.9	-155.9	119.0
1.0%PC/2.0%LT, MYS 2021-2026	-343.9	-197.2	146.7	-226.6	-122.6	104.0
1.0%PC/2.0%LT, MYS 2022-2026	-232.6	-118.2	114.3	-150.6	-72.8	77.8
2.0%PC/3.0%LT, MYS 2021-2026	-215.4	-116.4	98.9	-145.3	-72.3	73.0
2.0%PC/3.0%LT, MYS 2021-2026, AC/Off-Cycle Phaseout	-113.9	-69.7	44.3	-80.7	-43.2	37.4
2.0%PC/3.0%LT, MYS 2022-2026	-114.4	-59.0	55.4	-76.4	-36.1	40.3

*** EO 12866 Review – Draft – Do Not Cite, Quote or Release During Review ***

TABLE E-7 - ESTIMATED REQUIRED AVERAGE FOR THE PASSENGER CAR FLEET, IN MPG, CAFE

Passenger Cars	MY 2017	MY 2018	MY 2019	MY 2020	MY 2021	MY 2022	MY 2023	MY 2024	MY 2025	MY 2026	MY 2027	MY 2028	MY 2029
0.00%/Y Pc and 0.00%/Y Lt During 2021-2026	39.1	40.5	42.0	43.7	43.7	43.7	43.7	43.7	43.7	43.7	43.7	43.7	43.7
0.50%/Y Pc and 0.50%/Y Lt During 2021-2026	39.1	40.5	42.0	43.7	43.9	44.1	44.3	44.5	44.8	45.0	45.0	45.0	45.0
0.50%/Y Pc and 0.50%/Y Lt During 2021-2026 with AC and Off-Cycle Adj. Phaseout but No Target Offset	39.1	40.5	42.0	43.7	43.9	44.1	44.3	44.5	44.8	45.0	45.0	45.0	45.0
1.00%/Y Pc and 2.00%/Y Lt During 2021-2026	39.1	40.5	42.0	43.7	44.1	44.5	45.0	45.5	45.9	46.4	46.4	46.4	46.4
1.00%/Y Pc and 2.00%/Y Lt During 2022-2026	39.1	40.5	42.0	43.7	45.5	46.0	46.4	46.9	47.4	47.9	47.9	47.9	47.9
2.00%/Y Pc and 3.00%/Y Lt During 2021-2026	39.1	40.5	42.0	43.7	44.5	45.5	46.4	47.3	48.3	49.3	49.3	49.3	49.3
2.00%/Y Pc and 3.00%/Y Lt During 2021-2026 with AC and Off-Cycle Adj. Phaseout but No Target Offset	39.1	40.5	42.0	43.7	44.5	45.5	46.4	47.3	48.3	49.3	49.3	49.3	49.3
2.00%/Y Pc and 3.00%/Y Lt During 2022-2026	39.1	40.5	42.0	43.7	45.5	46.4	47.4	48.4	49.4	50.4	50.4	50.4	50.4

*** EO 12866 Review – Draft – Do Not Cite, Quote or Release During Review ***

TABLE E-8 - ESTIMATED REQUIRED AVERAGE FOR THE PASSENGER CAR FLEET, IN MPG, CO₂

Passenger Cars	MY 2017	MY 2018	MY 2019	MY 2020	MY 2021	MY 2022	MY 2023	MY 2024	MY 2025	MY 2026	MY 2027	MY 2028	MY 2029
0.00%/Y Pc and 0.00%/Y Lt During 2021-2026	39.1	40.5	42.0	43.7	43.7	43.7	43.7	43.7	43.7	43.7	43.7	43.7	43.7
0.50%/Y Pc and 0.50%/Y Lt During 2021-2026	39.1	40.5	42.0	43.7	43.9	44.1	44.3	44.5	44.8	45.0	45.0	45.0	45.0
0.50%/Y Pc and 0.50%/Y Lt During 2021-2026 with AC and Off-Cycle Adj. Phaseout but No Target Offset	39.1	40.5	42.0	43.7	43.9	44.1	44.3	44.5	44.8	45.0	45.0	45.0	45.0
1.00%/Y Pc and 2.00%/Y Lt During 2021-2026	39.1	40.5	42.0	43.7	44.1	44.5	45.0	45.5	45.9	46.4	46.4	46.4	46.4
1.00%/Y Pc and 2.00%/Y Lt During 2022-2026	39.1	40.5	42.0	43.7	45.5	46.0	46.4	46.9	47.4	47.9	47.9	47.9	47.9
2.00%/Y Pc and 3.00%/Y Lt During 2021-2026	39.1	40.5	42.0	43.7	44.5	45.5	46.4	47.3	48.3	49.3	49.3	49.3	49.3
2.00%/Y Pc and 3.00%/Y Lt During 2021-2026 with AC and Off-Cycle Adj. Phaseout but No Target Offset	39.1	40.5	42.0	43.7	44.5	45.5	46.4	47.3	48.3	49.3	49.3	49.3	49.3
2.00%/Y Pc and 3.00%/Y Lt During 2022-2026	39.1	40.5	42.0	43.7	45.5	46.4	47.4	48.4	49.4	50.4	50.4	50.4	50.4

*** EO 12866 Review – Draft – Do Not Cite, Quote or Release During Review ***

TABLE E-9 - ESTIMATED REQUIRED AVERAGE FOR THE LIGHT TRUCK FLEET, IN MPG, CAFE

Light Trucks	MY 2017	MY 2018	MY 2019	MY 2020	MY 2021	MY 2022	MY 2023	MY 2024	MY 2025	MY 2026	MY 2027	MY 2028	MY 2029
0.00%/Y Pc and 0.00%/Y Lt During 2021-2026	29.5	30.1	30.6	31.3	31.3	31.3	31.3	31.3	31.3	31.3	31.3	31.3	31.3
0.50%/Y Pc and 0.50%/Y Lt During 2021-2026	29.5	30.1	30.6	31.3	31.4	31.6	31.7	31.9	32.0	32.2	32.2	32.2	32.2
0.50%/Y Pc and 0.50%/Y Lt During 2021-2026 with AC and Off-Cycle Adj. Phaseout but No Target Offset	29.5	30.1	30.6	31.3	31.4	31.6	31.7	31.9	32.0	32.2	32.2	32.2	32.2
1.00%/Y Pc and 2.00%/Y Lt During 2021-2026	29.5	30.1	30.6	31.3	31.9	32.6	33.2	33.9	34.6	35.3	35.3	35.3	35.3
1.00%/Y Pc and 2.00%/Y Lt During 2022-2026	29.5	30.1	30.6	31.3	33.3	34.0	34.7	35.4	36.1	36.9	36.9	36.9	36.9
2.00%/Y Pc and 3.00%/Y Lt During 2021-2026	29.5	30.1	30.6	31.3	32.2	33.2	34.3	35.3	36.4	37.5	37.5	37.5	37.5
2.00%/Y Pc and 3.00%/Y Lt During 2021-2026 with AC and Off-Cycle Adj. Phaseout but No Target Offset	29.5	30.1	30.6	31.3	32.2	33.2	34.3	35.3	36.4	37.5	37.5	37.5	37.5
2.00%/Y Pc and 3.00%/Y Lt During 2022-2026	29.5	30.1	30.6	31.3	33.3	34.4	35.4	36.5	37.6	38.8	38.8	38.8	38.8

*** EO 12866 Review – Draft – Do Not Cite, Quote or Release During Review ***

TABLE E-10 - ESTIMATED REQUIRED AVERAGE FOR THE LIGHT TRUCK FLEET, IN MPG, CO2

Light Trucks	MY 2017	MY 2018	MY 2019	MY 2020	MY 2021	MY 2022	MY 2023	MY 2024	MY 2025	MY 2026	MY 2027	MY 2028	MY 2029
0.00%/Y Pc and 0.00%/Y Lt During 2021-2026	29.5	30.1	30.6	31.3	31.3	31.3	31.3	31.3	31.3	31.3	31.3	31.3	31.3
0.50%/Y Pc and 0.50%/Y Lt During 2021-2026	29.5	30.1	30.6	31.3	31.4	31.6	31.7	31.9	32.0	32.2	32.2	32.2	32.2
0.50%/Y Pc and 0.50%/Y Lt During 2021-2026 with AC and Off-Cycle Adj. Phaseout but No Target Offset	29.5	30.1	30.6	31.3	31.4	31.6	31.7	31.9	32.0	32.2	32.2	32.2	32.2
1.00%/Y Pc and 2.00%/Y Lt During 2021-2026	29.5	30.1	30.6	31.3	31.9	32.6	33.2	33.9	34.6	35.3	35.3	35.3	35.3
1.00%/Y Pc and 2.00%/Y Lt During 2022-2026	29.5	30.1	30.6	31.3	33.3	34.0	34.7	35.4	36.1	36.9	36.9	36.9	36.9
2.00%/Y Pc and 3.00%/Y Lt During 2021-2026	29.5	30.1	30.6	31.3	32.2	33.2	34.3	35.3	36.4	37.5	37.5	37.5	37.5
2.00%/Y Pc and 3.00%/Y Lt During 2021-2026 with AC and Off-Cycle Adj. Phaseout but No Target Offset	29.5	30.1	30.6	31.3	32.2	33.2	34.3	35.3	36.4	37.5	37.5	37.5	37.5
2.00%/Y Pc and 3.00%/Y Lt During 2022-2026	29.5	30.1	30.6	31.3	33.3	34.4	35.4	36.5	37.6	38.8	38.8	38.8	38.8

*** EO 12866 Review – Draft – Do Not Cite, Quote or Release During Review ***

TABLE E-11 - ESTIMATED REQUIRED AVERAGE FOR THE COMBINED FLEET, IN MPG, CAFE

Passenger Cars and Light Trucks	MY 2017	MY 2018	MY 2019	MY 2020	MY 2021	MY 2022	MY 2023	MY 2024	MY 2025	MY 2026	MY 2027	MY 2028	MY 2029
0.00%/Y Pc and 0.00%/Y Lt During 2021-2026	34.0	34.9	35.8	36.9	36.9	36.9	36.9	37.0	37.0	37.0	37.0	37.0	37.0
0.50%/Y Pc and 0.50%/Y Lt During 2021-2026	34.0	34.9	35.8	36.9	37.1	37.3	37.5	37.7	37.9	38.1	38.1	38.1	38.1
0.50%/Y Pc and 0.50%/Y Lt During 2021-2026 with AC and Off-Cycle Adj. Phaseout but No Target Offset	34.0	34.9	35.8	36.9	37.1	37.3	37.5	37.7	37.9	38.1	38.1	38.1	38.1
1.00%/Y Pc and 2.00%/Y Lt During 2021-2026	34.0	34.9	35.8	36.9	37.5	38.1	38.7	39.3	39.9	40.6	40.5	40.5	40.5
1.00%/Y Pc and 2.00%/Y Lt During 2022-2026	34.0	34.9	35.8	36.9	39.0	39.5	40.2	40.8	41.4	42.1	42.1	42.1	42.1
2.00%/Y Pc and 3.00%/Y Lt During 2021-2026	34.0	34.9	35.8	36.9	37.9	38.9	39.9	40.9	42.0	43.1	43.0	43.0	43.0
2.00%/Y Pc and 3.00%/Y Lt During 2021-2026 with AC and Off-Cycle Adj. Phaseout but No Target Offset	34.0	34.9	35.8	36.9	37.9	38.9	39.9	40.9	42.0	43.1	43.0	43.0	42.9
2.00%/Y Pc and 3.00%/Y Lt During 2022-2026	34.0	34.9	35.8	36.9	39.0	40.0	41.0	42.1	43.2	44.3	44.2	44.2	44.2

*** EO 12866 Review – Draft – Do Not Cite, Quote or Release During Review ***

TABLE E-12 - ESTIMATED REQUIRED AVERAGE FOR THE COMBINED FLEET, IN MPG, CO₂

Passenger Cars and Light Trucks	MY 201 7	MY 201 8	MY 201 9	MY 202 0	MY 202 1	MY 202 2	MY 202 3	MY 202 4	MY 202 5	MY 202 6	MY 202 7	MY 202 8	MY 202 9
0.00%/Y Pc and 0.00%/Y Lt During 2021-2026	34.0	34.9	35.8	36.9	37.0	37.0	37.0	37.0	37.0	37.0	37.0	37.0	37.0
0.50%/Y Pc and 0.50%/Y Lt During 2021-2026	34.0	34.9	35.8	36.9	37.1	37.3	37.5	37.7	37.9	38.1	38.1	38.1	38.1
0.50%/Y Pc and 0.50%/Y Lt During 2021-2026 with AC and Off-Cycle Adj. Phaseout but No Target Offset	34.0	34.9	35.8	36.9	37.1	37.3	37.5	37.7	37.9	38.1	38.1	38.1	38.1
1.00%/Y Pc and 2.00%/Y Lt During 2021-2026	34.0	34.9	35.8	36.9	37.5	38.1	38.7	39.3	39.9	40.5	40.5	40.5	40.5
1.00%/Y Pc and 2.00%/Y Lt During 2022-2026	34.0	34.9	35.8	36.9	39.0	39.6	40.2	40.8	41.4	42.1	42.1	42.0	42.0
2.00%/Y Pc and 3.00%/Y Lt During 2021-2026	34.0	34.9	35.8	36.9	37.9	38.9	39.9	40.9	41.9	43.1	43.0	43.0	43.0
2.00%/Y Pc and 3.00%/Y Lt During 2021-2026 with AC and Off-Cycle Adj. Phaseout but No Target Offset	34.0	34.9	35.8	36.9	37.9	38.9	39.9	40.9	41.9	43.1	43.0	43.0	42.9
2.00%/Y Pc and 3.00%/Y Lt During 2022-2026	34.0	34.9	35.8	36.9	39.0	40.0	41.0	42.0	43.1	44.2	44.2	44.2	44.1

*** EO 12866 Review – Draft – Do Not Cite, Quote or Release During Review ***

TABLE E-13 - PROJECTED ACHIEVED HARMONIC AVERAGE FOR THE PASSENGER CAR FLEET, IN MPG, CAFE

Passenger Cars	MY 2017	MY 2018	MY 2019	MY 2020	MY 2021	MY 2022	MY 2023	MY 2024	MY 2025	MY 2026	MY 2027	MY 2028	MY 2029
0.00%/Y Pc and 0.00%/Y Lt During 2021-2026	39.7	41.3	42.2	43.9	45.0	45.5	46.0	46.1	46.2	46.5	46.6	46.6	46.7
0.50%/Y Pc and 0.50%/Y Lt During 2021-2026	39.7	41.3	42.2	43.9	45.1	45.7	46.1	46.2	46.4	46.7	46.8	46.8	46.9
0.50%/Y Pc and 0.50%/Y Lt During 2021-2026 with AC and Off-Cycle Adj. Phaseout but No Target Offset	39.7	41.3	42.2	43.9	45.2	45.8	46.2	46.2	46.0	45.6	45.7	45.8	45.8
1.00%/Y Pc and 2.00%/Y Lt During 2021-2026	39.7	41.3	42.3	44.0	45.3	46.0	46.5	46.6	46.8	47.3	47.5	47.6	47.6
1.00%/Y Pc and 2.00%/Y Lt During 2022-2026	39.8	41.7	42.8	44.6	46.3	47.1	47.5	47.7	47.9	48.4	48.5	48.6	48.6
2.00%/Y Pc and 3.00%/Y Lt During 2021-2026	39.7	41.4	42.4	44.1	45.8	46.8	47.6	48.2	48.5	49.4	49.5	49.6	49.6
2.00%/Y Pc and 3.00%/Y Lt During 2021-2026 with AC and Off-Cycle Adj. Phaseout but No Target Offset	39.8	41.4	42.4	44.2	46.1	47.3	48.2	48.8	48.8	49.0	49.1	49.2	49.2
2.00%/Y Pc and 3.00%/Y Lt During 2022-2026	39.8	41.7	42.9	44.7	46.8	47.9	48.6	49.0	49.4	50.3	50.4	50.5	50.6

*** EO 12866 Review – Draft – Do Not Cite, Quote or Release During Review ***

TABLE E-14 - PROJECTED ACHIEVED HARMONIC AVERAGE FOR THE PASSENGER CAR FLEET, IN MPG, CO₂

Passenger Cars	MY 2017	MY 2018	MY 2019	MY 2020	MY 2021	MY 2022	MY 2023	MY 2024	MY 2025	MY 2026	MY 2027	MY 2028	MY 2029
0.00%/Y Pc and 0.00%/Y Lt During 2021-2026	39.7	40.9	41.8	43.0	44.5	45.0	45.3	45.5	45.5	45.7	45.8	45.9	45.9
0.50%/Y Pc and 0.50%/Y Lt During 2021-2026	39.7	40.9	41.9	43.1	44.6	45.1	45.5	45.7	45.7	46.0	46.1	46.1	46.2
0.50%/Y Pc and 0.50%/Y Lt During 2021-2026 with AC and Off-Cycle Adj. Phaseout but No Target Offset	39.7	40.9	41.9	43.2	44.7	45.4	45.8	46.1	45.9	45.3	45.5	45.6	45.6
1.00%/Y Pc and 2.00%/Y Lt During 2021-2026	39.7	41.0	41.9	43.3	44.9	45.6	46.0	46.5	46.9	47.3	47.5	47.6	47.7
1.00%/Y Pc and 2.00%/Y Lt During 2022-2026	39.8	41.5	42.6	44.1	45.9	46.8	47.4	48.0	48.1	48.7	48.8	48.9	48.9
2.00%/Y Pc and 3.00%/Y Lt During 2021-2026	39.7	41.3	42.4	43.9	45.7	46.7	47.5	48.2	48.5	49.2	49.5	49.6	49.7
2.00%/Y Pc and 3.00%/Y Lt During 2021-2026 with AC and Off-Cycle Adj. Phaseout but No Target Offset	39.8	41.4	42.4	44.0	46.0	47.3	48.2	48.9	49.0	49.0	49.3	49.5	49.6
2.00%/Y Pc and 3.00%/Y Lt During 2022-2026	39.8	41.5	42.6	44.2	46.3	47.5	48.4	49.2	49.5	50.3	50.6	50.7	50.8

*** EO 12866 Review – Draft – Do Not Cite, Quote or Release During Review ***

TABLE E-15 - PROJECTED ACHIEVED HARMONIC AVERAGE FOR THE LIGHT TRUCK FLEET, IN MPG, CAFE

Light Trucks	MY 2017	MY 2018	MY 2019	MY 2020	MY 2021	MY 2022	MY 2023	MY 2024	MY 2025	MY 2026	MY 2027	MY 2028	MY 2029
0.00%/Y Pc and 0.00%/Y Lt During 2021-2026	28.6	29.8	30.7	31.6	32.6	32.9	33.1	33.2	33.2	33.5	33.6	33.6	33.6
0.50%/Y Pc and 0.50%/Y Lt During 2021-2026	28.6	30.0	30.9	31.8	32.9	33.2	33.3	33.4	33.5	34.0	34.0	34.1	34.1
0.50%/Y Pc and 0.50%/Y Lt During 2021-2026 with AC and Off-Cycle Adj. Phaseout but No Target Offset	28.6	30.0	31.1	32.0	33.1	33.4	33.5	33.5	33.3	33.3	33.3	33.4	33.4
1.00%/Y Pc and 2.00%/Y Lt During 2021-2026	28.6	30.1	31.2	32.3	33.8	34.2	34.4	34.6	34.8	35.4	35.5	35.6	35.7
1.00%/Y Pc and 2.00%/Y Lt During 2022-2026	28.7	30.3	31.5	32.7	34.6	35.0	35.3	35.6	35.9	36.6	36.7	36.8	36.9
2.00%/Y Pc and 3.00%/Y Lt During 2021-2026	28.6	30.3	31.6	32.7	34.7	35.3	35.7	36.1	36.4	37.3	37.4	37.5	37.6
2.00%/Y Pc and 3.00%/Y Lt During 2021-2026 with AC and Off-Cycle Adj. Phaseout but No Target Offset	28.6	30.4	31.8	33.1	35.3	36.1	36.3	36.5	36.6	37.1	37.2	37.3	37.3
2.00%/Y Pc and 3.00%/Y Lt During 2022-2026	28.7	30.5	31.9	33.3	35.7	36.3	36.7	37.1	37.4	38.3	38.4	38.5	38.6

*** EO 12866 Review – Draft – Do Not Cite, Quote or Release During Review ***

TABLE E-16 - PROJECTED ACHIEVED HARMONIC AVERAGE FOR THE LIGHT TRUCK FLEET, IN MPG, CO₂

Light Trucks	MY 2017	MY 2018	MY 2019	MY 2020	MY 2021	MY 2022	MY 2023	MY 2024	MY 2025	MY 2026	MY 2027	MY 2028	MY 2029
0.00%/Y Pc and 0.00%/Y Lt During 2021-2026	28.5	29.7	30.6	31.4	32.5	32.9	33.0	33.1	33.1	33.3	33.3	33.4	33.4
0.50%/Y Pc and 0.50%/Y Lt During 2021-2026	28.5	29.8	30.6	31.4	32.6	33.0	33.1	33.2	33.3	33.5	33.6	33.6	33.7
0.50%/Y Pc and 0.50%/Y Lt During 2021-2026 with AC and Off-Cycle Adj. Phaseout but No Target Offset	28.5	29.8	30.7	31.5	32.7	33.0	33.1	33.2	32.9	32.9	33.0	33.1	33.1
1.00%/Y Pc and 2.00%/Y Lt During 2021-2026	28.6	29.9	30.9	32.0	33.6	34.1	34.3	34.5	34.7	35.2	35.5	35.6	35.8
1.00%/Y Pc and 2.00%/Y Lt During 2022-2026	28.6	30.0	31.2	32.4	34.4	35.1	35.4	35.8	35.9	36.7	36.9	37.2	37.3
2.00%/Y Pc and 3.00%/Y Lt During 2021-2026	28.6	30.0	31.1	32.3	34.2	34.9	35.2	35.7	35.9	36.7	37.3	37.6	37.9
2.00%/Y Pc and 3.00%/Y Lt During 2021-2026 with AC and Off-Cycle Adj. Phaseout but No Target Offset	28.6	30.1	31.4	32.6	34.6	35.4	35.7	36.0	36.0	36.3	37.0	37.4	37.7
2.00%/Y Pc and 3.00%/Y Lt During 2022-2026	28.6	30.1	31.4	32.7	35.1	36.0	36.4	36.9	37.2	38.0	38.5	38.9	39.2

*** EO 12866 Review – Draft – Do Not Cite, Quote or Release During Review ***

TABLE E-17 - PROJECTED ACHIEVED HARMONIC AVERAGE FOR THE COMBINED FLEET, IN MPG, CAFE

Passenger Cars and Light Trucks	MY 2017	MY 2018	MY 2019	MY 2020	MY 2021	MY 2022	MY 2023	MY 2024	MY 2025	MY 2026	MY 2027	MY 2028	MY 2029
0.00%/Y Pc and 0.00%/Y Lt During 2021-2026	33.7	35.0	36.0	37.2	38.3	38.7	39.0	39.1	39.2	39.5	39.6	39.6	39.7
0.50%/Y Pc and 0.50%/Y Lt During 2021-2026	33.7	35.2	36.1	37.4	38.5	39.0	39.2	39.3	39.5	39.9	40.0	40.0	40.0
0.50%/Y Pc and 0.50%/Y Lt During 2021-2026 with AC and Off-Cycle Adj. Phaseout but No Target Offset	33.7	35.2	36.2	37.5	38.7	39.1	39.4	39.4	39.2	39.0	39.1	39.2	39.2
1.00%/Y Pc and 2.00%/Y Lt During 2021-2026	33.7	35.3	36.4	37.7	39.1	39.7	40.0	40.2	40.4	41.1	41.1	41.2	41.2
1.00%/Y Pc and 2.00%/Y Lt During 2022-2026	33.9	35.5	36.7	38.2	40.1	40.6	40.9	41.2	41.5	42.2	42.2	42.3	42.3
2.00%/Y Pc and 3.00%/Y Lt During 2021-2026	33.8	35.4	36.6	38.0	39.9	40.7	41.2	41.8	42.1	43.0	43.0	43.1	43.2
2.00%/Y Pc and 3.00%/Y Lt During 2021-2026 with AC and Off-Cycle Adj. Phaseout but No Target Offset	33.8	35.4	36.8	38.3	40.4	41.4	41.9	42.2	42.3	42.7	42.7	42.8	42.8
2.00%/Y Pc and 3.00%/Y Lt During 2022-2026	33.9	35.6	37.0	38.6	41.0	41.8	42.3	42.6	43.0	43.9	44.0	44.1	44.1

*** EO 12866 Review – Draft – Do Not Cite, Quote or Release During Review ***

TABLE E-18 - PROJECTED ACHIEVED HARMONIC AVERAGE FOR THE COMBINED FLEET, IN MPG, CO₂

Passenger Cars and Light Trucks	MY 2017	MY 2018	MY 2019	MY 2020	MY 2021	MY 2022	MY 2023	MY 2024	MY 2025	MY 2026	MY 2027	MY 2028	MY 2029
0.00%/Y Pc and 0.00%/Y Lt During 2021-2026	33.7	34.8	35.8	36.7	38.1	38.5	38.7	38.8	38.9	39.1	39.2	39.2	39.3
0.50%/Y Pc and 0.50%/Y Lt During 2021-2026	33.7	34.9	35.8	36.8	38.2	38.6	38.8	39.0	39.1	39.4	39.5	39.5	39.5
0.50%/Y Pc and 0.50%/Y Lt During 2021-2026 with AC and Off-Cycle Adj. Phaseout but No Target Offset	33.7	34.9	35.8	36.9	38.3	38.8	39.0	39.1	38.9	38.7	38.8	38.9	39.0
1.00%/Y Pc and 2.00%/Y Lt During 2021-2026	33.7	35.0	36.0	37.3	38.9	39.5	39.8	40.1	40.3	40.9	41.1	41.2	41.3
1.00%/Y Pc and 2.00%/Y Lt During 2022-2026	33.8	35.2	36.5	37.9	39.8	40.5	41.0	41.5	41.6	42.3	42.4	42.6	42.7
2.00%/Y Pc and 3.00%/Y Lt During 2021-2026	33.7	35.2	36.3	37.7	39.6	40.4	41.0	41.5	41.7	42.5	42.9	43.2	43.4
2.00%/Y Pc and 3.00%/Y Lt During 2021-2026 with AC and Off-Cycle Adj. Phaseout but No Target Offset	33.7	35.2	36.5	37.9	40.0	41.0	41.5	41.9	42.0	42.2	42.7	43.0	43.2
2.00%/Y Pc and 3.00%/Y Lt During 2022-2026	33.8	35.3	36.6	38.1	40.4	41.4	42.0	42.6	42.9	43.8	44.1	44.4	44.6

*** EO 12866 Review – Draft – Do Not Cite, Quote or Release During Review ***

**TABLE E-19 - AVERAGE INCREMENTAL TECHNOLOGY COSTS AND CIVIL PENALTIES PER VEHICLE,
PASSENGER CARS, CAFE (2016\$)**

Passenger Cars	MY 2017	MY 2018	MY 2019	MY 2020	MY 2021	MY 2022	MY 2023	MY 2024	MY 2025	MY 2026	MY 2027	MY 2028	MY 2029
0.00%/Y Pc and 0.00%/Y Lt During 2021-2026	-\$98	-\$206	-\$291	-\$609	-\$1,029	-\$1,324	-\$1,556	-\$1,659	-\$1,759	-\$1,772	-\$1,744	-\$1,716	-\$1,686
0.50%/Y Pc and 0.50%/Y Lt During 2021-2026	-\$96	-\$199	-\$282	-\$593	-\$998	-\$1,290	-\$1,513	-\$1,617	-\$1,717	-\$1,725	-\$1,699	-\$1,669	-\$1,638
0.50%/Y Pc and 0.50%/Y Lt During 2021-2026 with AC and Off-Cycle Adj. Phaseout but No Target Offset	-\$85	-\$184	-\$267	-\$577	-\$967	-\$1,252	-\$1,457	-\$1,559	-\$1,651	-\$1,621	-\$1,590	-\$1,556	-\$1,527
1.00%/Y Pc and 2.00%/Y Lt During 2021-2026	-\$91	-\$182	-\$261	-\$571	-\$958	-\$1,238	-\$1,440	-\$1,537	-\$1,613	-\$1,562	-\$1,515	-\$1,475	-\$1,439
1.00%/Y Pc and 2.00%/Y Lt During 2022-2026	-\$47	-\$105	-\$171	-\$460	-\$796	-\$1,049	-\$1,236	-\$1,324	-\$1,386	-\$1,335	-\$1,303	-\$1,266	-\$1,232
2.00%/Y Pc and 3.00%/Y Lt During 2021-2026	-\$68	-\$152	-\$230	-\$515	-\$833	-\$1,033	-\$1,183	-\$1,215	-\$1,272	-\$1,146	-\$1,112	-\$1,071	-\$1,040
2.00%/Y Pc and 3.00%/Y Lt During 2021-2026 with AC and Off-Cycle Adj. Phaseout but No Target Offset	-\$70	-\$156	-\$211	-\$476	-\$730	-\$885	-\$974	-\$984	-\$969	-\$754	-\$729	-\$699	-\$677
2.00%/Y Pc and 3.00%/Y Lt During 2022-2026	-\$35	-\$92	-\$148	-\$416	-\$664	-\$843	-\$965	-\$1,012	-\$1,030	-\$907	-\$882	-\$846	-\$821

*** EO 12866 Review – Draft – Do Not Cite, Quote or Release During Review ***

**TABLE E-20 - AVERAGE INCREMENTAL TECHNOLOGY COSTS AND CIVIL PENALTIES PER VEHICLE,
PASSENGER CARS, CO₂ (2016\$)**

Passenger Cars	MY 2017	MY 2018	MY 2019	MY 2020	MY 2021	MY 2022	MY 2023	MY 2024	MY 2025	MY 2026	MY 2027	MY 2028	MY 2029
0.00%/Y Pc and 0.00%/Y Lt During 2021-2026	-\$79	-\$194	-\$258	-\$476	-\$696	-\$980	-\$1,186	-\$1,321	-\$1,451	-\$1,591	-\$1,652	-\$1,675	-\$1,661
0.50%/Y Pc and 0.50%/Y Lt During 2021-2026	-\$66	-\$180	-\$238	-\$443	-\$652	-\$935	-\$1,142	-\$1,278	-\$1,405	-\$1,539	-\$1,601	-\$1,625	-\$1,613
0.50%/Y Pc and 0.50%/Y Lt During 2021-2026 with AC and Off-Cycle Adj. Phaseout but No Target Offset	-\$66	-\$180	-\$236	-\$432	-\$634	-\$895	-\$1,089	-\$1,197	-\$1,312	-\$1,435	-\$1,486	-\$1,498	-\$1,482
1.00%/Y Pc and 2.00%/Y Lt During 2021-2026	-\$64	-\$168	-\$219	-\$405	-\$594	-\$854	-\$1,047	-\$1,138	-\$1,223	-\$1,325	-\$1,375	-\$1,388	-\$1,356
1.00%/Y Pc and 2.00%/Y Lt During 2022-2026	\$17	-\$24	-\$51	-\$210	-\$372	-\$610	-\$796	-\$874	-\$987	-\$1,059	-\$1,114	-\$1,126	-\$1,112
2.00%/Y Pc and 3.00%/Y Lt During 2021-2026	-\$41	-\$94	-\$127	-\$286	-\$455	-\$654	-\$773	-\$837	-\$914	-\$939	-\$959	-\$943	-\$912
2.00%/Y Pc and 3.00%/Y Lt During 2021-2026 with AC and Off-Cycle Adj. Phaseout but No Target Offset	-\$36	-\$85	-\$104	-\$251	-\$373	-\$500	-\$569	-\$601	-\$623	-\$587	-\$592	-\$586	-\$557
2.00%/Y Pc and 3.00%/Y Lt During 2022-2026	\$17	-\$20	-\$46	-\$157	-\$279	-\$435	-\$542	-\$597	-\$667	-\$669	-\$696	-\$684	-\$659

*** EO 12866 Review – Draft – Do Not Cite, Quote or Release During Review ***

**TABLE E-21 - AVERAGE INCREMENTAL TECHNOLOGY COSTS AND CIVIL PENALTIES PER VEHICLE,
LIGHT TRUCKS, CAFE (2016\$)**

Light Trucks	MY 2017	MY 2018	MY 2019	MY 2020	MY 2021	MY 2022	MY 2023	MY 2024	MY 2025	MY 2026	MY 2027	MY 2028	MY 2029
0.00%/Y Pc and 0.00%/Y Lt During 2021-2026	-\$94	-\$488	-\$833	-\$1,111	-\$1,770	-\$1,902	-\$1,987	-\$2,097	-\$2,219	-\$2,284	-\$2,247	-\$2,212	-\$2,164
0.50%/Y Pc and 0.50%/Y Lt During 2021-2026	-\$89	-\$425	-\$758	-\$1,038	-\$1,696	-\$1,828	-\$1,914	-\$2,024	-\$2,139	-\$2,165	-\$2,131	-\$2,091	-\$2,045
0.50%/Y Pc and 0.50%/Y Lt During 2021-2026 with AC and Off-Cycle Adj. Phaseout but No Target Offset	-\$81	-\$360	-\$656	-\$940	-\$1,579	-\$1,712	-\$1,801	-\$1,908	-\$2,018	-\$2,010	-\$1,977	-\$1,940	-\$1,897
1.00%/Y Pc and 2.00%/Y Lt During 2021-2026	-\$88	-\$349	-\$613	-\$843	-\$1,401	-\$1,515	-\$1,605	-\$1,688	-\$1,777	-\$1,706	-\$1,661	-\$1,622	-\$1,568
1.00%/Y Pc and 2.00%/Y Lt During 2022-2026	-\$53	-\$271	-\$522	-\$699	-\$1,112	-\$1,228	-\$1,271	-\$1,315	-\$1,364	-\$1,276	-\$1,235	-\$1,201	-\$1,158
2.00%/Y Pc and 3.00%/Y Lt During 2021-2026	-\$69	-\$241	-\$360	-\$547	-\$955	-\$1,016	-\$1,061	-\$1,099	-\$1,140	-\$992	-\$962	-\$923	-\$889
2.00%/Y Pc and 3.00%/Y Lt During 2021-2026 with AC and Off-Cycle Adj. Phaseout but No Target Offset	-\$57	-\$142	-\$177	-\$317	-\$530	-\$526	-\$588	-\$605	-\$570	-\$307	-\$293	-\$272	-\$259
2.00%/Y Pc and 3.00%/Y Lt During 2022-2026	-\$29	-\$95	-\$146	-\$249	-\$434	-\$477	-\$528	-\$556	-\$605	-\$498	-\$469	-\$437	-\$421

*** EO 12866 Review – Draft – Do Not Cite, Quote or Release During Review ***

**TABLE E-22 - AVERAGE INCREMENTAL TECHNOLOGY COSTS AND CIVIL PENALTIES PER VEHICLE,
LIGHT TRUCKS, CO₂ (2016\$)**

Light Trucks	MY 2017	MY 2018	MY 2019	MY 2020	MY 2021	MY 2022	MY 2023	MY 2024	MY 2025	MY 2026	MY 2027	MY 2028	MY 2029
0.00%/Y Pc and 0.00%/Y Lt During 2021-2026	-\$39	-\$215	-\$527	-\$736	-\$1,177	-\$1,302	-\$1,431	-\$1,519	-\$1,585	-\$1,802	-\$1,949	-\$2,110	-\$2,174
0.50%/Y Pc and 0.50%/Y Lt During 2021-2026	-\$27	-\$188	-\$498	-\$702	-\$1,137	-\$1,264	-\$1,395	-\$1,479	-\$1,540	-\$1,734	-\$1,882	-\$2,045	-\$2,111
0.50%/Y Pc and 0.50%/Y Lt During 2021-2026 with AC and Off-Cycle Adj. Phaseout but No Target Offset	-\$27	-\$182	-\$493	-\$693	-\$1,119	-\$1,246	-\$1,368	-\$1,432	-\$1,483	-\$1,646	-\$1,768	-\$1,924	-\$1,983
1.00%/Y Pc and 2.00%/Y Lt During 2021-2026	-\$23	-\$147	-\$388	-\$526	-\$890	-\$989	-\$1,101	-\$1,147	-\$1,194	-\$1,297	-\$1,396	-\$1,526	-\$1,556
1.00%/Y Pc and 2.00%/Y Lt During 2022-2026	-\$15	-\$94	-\$206	-\$322	-\$537	-\$620	-\$682	-\$709	-\$758	-\$795	-\$866	-\$983	-\$1,035
2.00%/Y Pc and 3.00%/Y Lt During 2021-2026	-\$22	-\$111	-\$306	-\$421	-\$665	-\$709	-\$772	-\$792	-\$790	-\$791	-\$741	-\$801	-\$798
2.00%/Y Pc and 3.00%/Y Lt During 2021-2026 with AC and Off-Cycle Adj. Phaseout but No Target Offset	-\$22	-\$66	-\$123	-\$237	-\$428	-\$424	-\$466	-\$460	-\$379	-\$282	-\$160	-\$154	-\$123
2.00%/Y Pc and 3.00%/Y Lt During 2022-2026	-\$15	-\$62	-\$101	-\$172	-\$244	-\$246	-\$267	-\$269	-\$256	-\$244	-\$183	-\$250	-\$271

*** EO 12866 Review – Draft – Do Not Cite, Quote or Release During Review ***

**TABLE E-23 - AVERAGE INCREMENTAL TECHNOLOGY COSTS AND CIVIL PENALTIES PER VEHICLE,
COMBINED, CAFE (2016\$)**

Passenger Cars and Light Trucks	MY 2017	MY 2018	MY 2019	MY 2020	MY 2021	MY 2022	MY 2023	MY 2024	MY 2025	MY 2026	MY 2027	MY 2028	MY 2029
0.00%/Y Pc and 0.00%/Y Lt During 2021-2026	-\$96	-\$337	-\$540	-\$839	-\$1,370	-\$1,591	-\$1,755	-\$1,862	-\$1,973	-\$2,011	-\$1,980	-\$1,950	-\$1,912
0.50%/Y Pc and 0.50%/Y Lt During 2021-2026	-\$93	-\$304	-\$501	-\$797	-\$1,320	-\$1,538	-\$1,699	-\$1,806	-\$1,914	-\$1,931	-\$1,903	-\$1,870	-\$1,832
0.50%/Y Pc and 0.50%/Y Lt During 2021-2026 with AC and Off-Cycle Adj. Phaseout but No Target Offset	-\$83	-\$265	-\$446	-\$744	-\$1,249	-\$1,464	-\$1,617	-\$1,722	-\$1,823	-\$1,804	-\$1,773	-\$1,739	-\$1,704
1.00%/Y Pc and 2.00%/Y Lt During 2021-2026	-\$89	-\$260	-\$423	-\$696	-\$1,162	-\$1,366	-\$1,517	-\$1,609	-\$1,692	-\$1,633	-\$1,587	-\$1,548	-\$1,504
1.00%/Y Pc and 2.00%/Y Lt During 2022-2026	-\$50	-\$182	-\$333	-\$570	-\$941	-\$1,132	-\$1,253	-\$1,321	-\$1,378	-\$1,312	-\$1,275	-\$1,239	-\$1,201
2.00%/Y Pc and 3.00%/Y Lt During 2021-2026	-\$68	-\$193	-\$290	-\$530	-\$889	-\$1,026	-\$1,128	-\$1,164	-\$1,213	-\$1,079	-\$1,045	-\$1,004	-\$971
2.00%/Y Pc and 3.00%/Y Lt During 2021-2026 with AC and Off-Cycle Adj. Phaseout but No Target Offset	-\$64	-\$149	-\$196	-\$403	-\$638	-\$720	-\$798	-\$811	-\$788	-\$551	-\$527	-\$500	-\$482
2.00%/Y Pc and 3.00%/Y Lt During 2022-2026	-\$32	-\$93	-\$147	-\$339	-\$558	-\$674	-\$764	-\$802	-\$835	-\$721	-\$690	-\$655	-\$634

*** EO 12866 Review – Draft – Do Not Cite, Quote or Release During Review ***

**TABLE E-24 - AVERAGE INCREMENTAL TECHNOLOGY COSTS AND CIVIL PENALTIES PER VEHICLE,
COMBINED, CO₂ (2016\$)**

Passenger Cars and Light Trucks	MY 2017	MY 2018	MY 2019	MY 2020	MY 2021	MY 2022	MY 2023	MY 2024	MY 2025	MY 2026	MY 2027	MY 2028	MY 2029
0.00%/Y Pc and 0.00%/Y Lt During 2021-2026	-\$61	-\$204	-\$382	-\$595	-\$916	-\$1,128	-\$1,300	-\$1,414	-\$1,514	-\$1,691	-\$1,793	-\$1,882	-\$1,906
0.50%/Y Pc and 0.50%/Y Lt During 2021-2026	-\$48	-\$184	-\$358	-\$562	-\$874	-\$1,086	-\$1,259	-\$1,372	-\$1,469	-\$1,631	-\$1,735	-\$1,826	-\$1,852
0.50%/Y Pc and 0.50%/Y Lt During 2021-2026 with AC and Off-Cycle Adj. Phaseout but No Target Offset	-\$48	-\$181	-\$354	-\$552	-\$856	-\$1,056	-\$1,218	-\$1,307	-\$1,392	-\$1,535	-\$1,620	-\$1,701	-\$1,722
1.00%/Y Pc and 2.00%/Y Lt During 2021-2026	-\$45	-\$158	-\$297	-\$461	-\$729	-\$916	-\$1,073	-\$1,144	-\$1,211	-\$1,316	-\$1,389	-\$1,458	-\$1,457
1.00%/Y Pc and 2.00%/Y Lt During 2022-2026	\$2	-\$57	-\$122	-\$262	-\$448	-\$615	-\$744	-\$799	-\$882	-\$939	-\$1,000	-\$1,063	-\$1,080
2.00%/Y Pc and 3.00%/Y Lt During 2021-2026	-\$32	-\$102	-\$209	-\$348	-\$551	-\$679	-\$773	-\$817	-\$857	-\$873	-\$860	-\$880	-\$862
2.00%/Y Pc and 3.00%/Y Lt During 2021-2026 with AC and Off-Cycle Adj. Phaseout but No Target Offset	-\$30	-\$76	-\$112	-\$245	-\$398	-\$465	-\$522	-\$536	-\$511	-\$448	-\$391	-\$384	-\$353
2.00%/Y Pc and 3.00%/Y Lt During 2022-2026	\$2	-\$39	-\$71	-\$164	-\$263	-\$348	-\$415	-\$445	-\$476	-\$473	-\$457	-\$481	-\$477

*** EO 12866 Review – Draft – Do Not Cite, Quote or Release During Review ***

**TABLE E-25 - INCREMENTAL TOTAL COSTS BY SOCIETAL PERSPECTIVE, PASSENGER CARS,
3% DISCOUNT RATE, CAFE (BILLIONS OF 2016\$)**

Passenger Cars	MY 1977- 2016	MY 2017	MY 2018	MY 2019	MY 2020	MY 2021	MY 2022	MY 2023	MY 2024	MY 2025	MY 2026	MY 2027	MY 2028	MY 2029	MY TOTAL
0.0%PC/0.0%LT, MYs 2021-2026	-58.9	-7.3	-8.6	-9.6	-13.6	-19.4	-21.1	-21.5	-20.2	-18.6	-16.3	-14.0	-13.2	-12.4	-254.8
0.5%PC/0.5%LT, MYs 2021-2026	-56.1	-6.9	-8.2	-9.3	-13.2	-18.7	-20.5	-20.9	-19.6	-18.1	-15.8	-13.9	-13.0	-12.3	-246.5
0.5%PC/0.5%LT, MYs 2021-2026, AC/Off-Cycle Phaseout	-52.6	-6.4	-7.7	-8.8	-12.7	-18.0	-19.7	-19.9	-18.6	-17.1	-14.4	-13.3	-12.5	-11.8	-233.5
1.0%PC/2.0%LT, MYs 2021-2026	-47.5	-5.8	-6.8	-7.9	-11.8	-17.2	-19.0	-19.3	-18.1	-16.7	-14.3	-13.7	-13.2	-12.8	-223.9
1.0%PC/2.0%LT, MYs 2022-2026	-37.8	-4.2	-4.7	-5.4	-9.1	-13.7	-16.7	-17.2	-16.3	-15.3	-13.0	-12.9	-12.5	-12.1	-190.7
2.0%PC/3.0%LT, MYs 2021-2026	-32.8	-3.9	-4.9	-6.0	-9.6	-14.1	-15.2	-15.3	-13.4	-13.2	-10.6	-11.7	-11.2	-11.0	-173.0
2.0%PC/3.0%LT, MYs 2021-2026, AC/Off-Cycle Phaseout	-20.4	-2.4	-3.5	-4.4	-7.9	-11.4	-12.0	-11.2	-9.2	-8.5	-5.6	-8.4	-7.8	-7.8	-120.5
2.0%PC/3.0%LT, MYs 2022-2026	-20.9	-2.4	-2.9	-3.5	-7.0	-10.5	-12.6	-12.8	-11.7	-10.8	-8.4	-9.7	-9.3	-9.3	-131.8

*** EO 12866 Review – Draft – Do Not Cite, Quote or Release During Review ***

**TABLE E-26 - INCREMENTAL TOTAL COSTS BY SOCIETAL PERSPECTIVE, PASSENGER CARS,
3% DISCOUNT RATE, CO₂ (BILLIONS OF 2016\$)**

Passenger Cars	MY 1977- 2016	MY 2017	MY 2018	MY 2019	MY 2020	MY 2021	MY 2022	MY 2023	MY 2024	MY 2025	MY 2026	MY 2027	MY 2028	MY 2029	MY TOTAL
0.0%PC/0.0%LT, MYs 2021-2026	-48.8	-6.7	-8.4	-9.3	-12.2	-15.4	-17.4	-17.0	-16.8	-15.6	-14.6	-14.0	-12.9	-10.9	-254.8
0.5%PC/0.5%LT, MYs 2021-2026	-46.8	-6.3	-8.0	-8.8	-11.6	-14.6	-16.9	-16.6	-16.5	-15.2	-14.0	-13.7	-12.5	-10.5	-246.5
0.5%PC/0.5%LT, MYs 2021-2026, AC/Off-Cycle Phaseout	-44.3	-5.9	-7.6	-8.3	-10.9	-13.8	-15.8	-15.3	-14.6	-13.2	-12.3	-12.1	-11.0	-9.2	-233.5
1.0%PC/2.0%LT, MYs 2021-2026	-36.9	-4.8	-6.4	-7.1	-9.4	-12.2	-14.7	-14.7	-14.0	-13.1	-12.1	-12.0	-11.1	-9.7	-223.9
1.0%PC/2.0%LT, MYs 2022-2026	-24.8	-2.5	-2.9	-3.2	-5.3	-7.7	-11.6	-12.0	-11.6	-11.8	-10.3	-12.0	-11.4	-10.4	-190.7
2.0%PC/3.0%LT, MYs 2021-2026	-24.1	-2.9	-3.3	-3.7	-5.7	-8.1	-10.1	-9.9	-9.6	-9.6	-8.2	-9.4	-8.9	-8.4	-173.0
2.0%PC/3.0%LT, MYs 2021-2026, AC/Off-Cycle Phaseout	-13.5	-1.4	-1.9	-2.0	-4.0	-5.7	-6.7	-5.9	-5.2	-4.7	-2.9	-6.0	-5.9	-5.8	-120.5
2.0%PC/3.0%LT, MYs 2022-2026	-12.1	-0.8	-1.2	-1.4	-3.0	-4.8	-7.7	-7.6	-7.7	-7.4	-5.8	-7.8	-7.7	-7.4	-131.8

*** EO 12866 Review – Draft – Do Not Cite, Quote or Release During Review ***

**TABLE E-27 - INCREMENTAL TOTAL COSTS BY SOCIETAL PERSPECTIVE, LIGHT TRUCKS,
3% DISCOUNT RATE, CAFE (BILLIONS OF 2016\$)**

Light Trucks	MY 1977- 2016	MY 2017	MY 2018	MY 2019	MY 2020	MY 2021	MY 2022	MY 2023	MY 2024	MY 2025	MY 2026	MY 2027	MY 2028	MY 2029	MY TOTAL
0.0%PC/0.0%LT, MYs 2021-2026	-28.3	-3.4	-7.3	-10.6	-13.2	-19.7	-21.1	-22.5	-23.7	-25.4	-26.8	-27.5	-28.3	-28.5	-286.1
0.5%PC/0.5%LT, MYs 2021-2026	-25.7	-3.0	-6.2	-9.3	-12.0	-18.5	-19.9	-21.3	-22.5	-24.1	-25.2	-25.8	-26.6	-26.7	-266.8
0.5%PC/0.5%LT, MYs 2021-2026, AC/Off-Cycle Phaseout	-24.5	-2.8	-5.5	-8.3	-11.0	-17.2	-18.7	-20.1	-21.4	-23.0	-23.8	-24.2	-24.7	-24.7	-249.9
1.0%PC/2.0%LT, MYs 2021-2026	-20.0	-2.3	-4.7	-7.2	-9.3	-14.8	-15.9	-17.4	-18.4	-19.7	-19.8	-19.4	-19.6	-19.4	-207.9
1.0%PC/2.0%LT, MYs 2022-2026	-14.2	-1.4	-3.4	-5.7	-7.4	-11.5	-12.3	-12.9	-13.6	-14.3	-14.3	-14.1	-14.1	-13.9	-153.1
2.0%PC/3.0%LT, MYs 2021-2026	-13.4	-1.4	-3.0	-4.1	-5.9	-10.0	-10.5	-11.6	-12.2	-12.5	-11.7	-11.1	-10.8	-10.6	-128.9
2.0%PC/3.0%LT, MYs 2021-2026, AC/Off-Cycle Phaseout	-8.2	-0.8	-1.6	-1.9	-3.3	-5.7	-5.7	-7.0	-7.5	-7.2	-5.3	-4.9	-4.3	-4.2	-67.5
2.0%PC/3.0%LT, MYs 2022-2026	-7.5	-0.7	-1.3	-1.9	-2.9	-5.1	-5.4	-6.1	-6.8	-7.6	-7.2	-6.8	-6.4	-6.2	-71.9

*** EO 12866 Review – Draft – Do Not Cite, Quote or Release During Review ***

**TABLE E-28 - INCREMENTAL TOTAL COSTS BY SOCIETAL PERSPECTIVE, LIGHT TRUCKS,
3% DISCOUNT RATE, CO₂ (BILLIONS OF 2016\$)**

Light Trucks	MY 1977- 2016	MY 2017	MY 2018	MY 2019	MY 2020	MY 2021	MY 2022	MY 2023	MY 2024	MY 2025	MY 2026	MY 2027	MY 2028	MY 2029	MY TOTAL
0.0%PC/0.0%LT, MYs 2021-2026	-26.7	-3.3	-5.1	-8.1	-10.1	-14.3	-15.5	-18.3	-20.1	-21.4	-24.9	-26.9	-28.6	-30.0	-286.1
0.5%PC/0.5%LT, MYs 2021-2026	-25.0	-3.0	-4.6	-7.6	-9.5	-13.7	-14.8	-17.6	-19.3	-20.5	-23.8	-25.8	-27.6	-29.0	-266.8
0.5%PC/0.5%LT, MYs 2021-2026, AC/Off-Cycle Phaseout	-22.9	-2.6	-4.1	-7.2	-9.0	-13.1	-14.3	-16.9	-18.5	-19.6	-22.5	-24.0	-25.5	-26.7	-249.9
1.0%PC/2.0%LT, MYs 2021-2026	-16.4	-1.7	-2.8	-5.0	-6.1	-9.4	-10.1	-12.5	-13.8	-14.4	-16.6	-18.0	-19.1	-19.7	-207.9
1.0%PC/2.0%LT, MYs 2022-2026	-9.8	-1.1	-1.9	-2.9	-3.8	-5.7	-6.0	-7.1	-7.8	-7.9	-9.4	-9.8	-10.4	-11.3	-153.1
2.0%PC/3.0%LT, MYs 2021-2026	-8.4	-0.8	-1.6	-3.3	-4.3	-6.5	-6.8	-8.2	-8.8	-8.3	-9.5	-8.8	-8.9	-9.1	-128.9
2.0%PC/3.0%LT, MYs 2021-2026, AC/Off-Cycle Phaseout	-4.1	-0.2	-0.6	-1.1	-2.1	-3.8	-3.8	-5.1	-5.5	-4.5	-4.8	-3.0	-2.1	-1.7	-67.5
2.0%PC/3.0%LT, MYs 2022-2026	-3.7	-0.4	-0.7	-1.1	-1.7	-2.3	-2.0	-2.6	-2.8	-2.5	-3.5	-2.7	-2.8	-2.8	-71.9

*** EO 12866 Review – Draft – Do Not Cite, Quote or Release During Review ***

**TABLE E-29 - INCREMENTAL TOTAL COSTS BY SOCIETAL PERSPECTIVE, COMBINED,
3% DISCOUNT RATE, CAFE (BILLIONS OF 2016\$)**

Passenger Cars and Light Trucks	MY 1977- 2016	MY 2017	MY 2018	MY 2019	MY 2020	MY 2021	MY 2022	MY 2023	MY 2024	MY 2025	MY 2026	MY 2027	MY 2028	MY 2029	MY TOTAL
0.0%PC/0.0%LT, MYs 2021-2026	-87.2	-10.6	-15.8	-20.2	-26.7	-39.1	-42.2	-44.1	-43.9	-44.0	-43.1	-41.5	-41.5	-40.9	-540.9
0.5%PC/0.5%LT, MYs 2021-2026	-81.9	-10.0	-14.4	-18.6	-25.1	-37.2	-40.4	-42.2	-42.1	-42.2	-41.0	-39.7	-39.6	-39.0	-513.4
0.5%PC/0.5%LT, MYs 2021-2026, AC/Off-Cycle Phaseout	-77.0	-9.3	-13.2	-17.1	-23.6	-35.3	-38.4	-40.0	-40.0	-40.0	-38.2	-37.5	-37.2	-36.6	-483.4
1.0%PC/2.0%LT, MYs 2021-2026	-67.5	-8.0	-11.6	-15.1	-21.1	-31.9	-34.9	-36.7	-36.5	-36.4	-34.1	-33.2	-32.8	-32.1	-431.8
1.0%PC/2.0%LT, MYs 2022-2026	-51.9	-5.6	-8.1	-11.1	-16.4	-25.2	-28.9	-30.1	-30.0	-29.6	-27.3	-26.9	-26.5	-26.0	-343.8
2.0%PC/3.0%LT, MYs 2021-2026	-46.2	-5.3	-8.0	-10.1	-15.6	-24.0	-25.7	-26.8	-25.6	-25.8	-22.3	-22.8	-22.0	-21.6	-301.9
2.0%PC/3.0%LT, MYs 2021-2026, AC/Off-Cycle Phaseout	-28.6	-3.2	-5.1	-6.3	-11.2	-17.1	-17.7	-18.2	-16.7	-15.7	-10.8	-13.3	-12.1	-12.0	-188.0
2.0%PC/3.0%LT, MYs 2022-2026	-28.4	-3.0	-4.3	-5.4	-10.0	-15.6	-18.0	-18.9	-18.5	-18.3	-15.6	-16.5	-15.7	-15.5	-203.8

*** EO 12866 Review – Draft – Do Not Cite, Quote or Release During Review ***

**TABLE E-30 - INCREMENTAL TOTAL COSTS BY SOCIETAL PERSPECTIVE, COMBINED,
3% DISCOUNT RATE, CO₂ (BILLIONS OF 2016\$)**

Passenger Cars and Light Trucks	MY 1977-2016	MY 2017	MY 2018	MY 2019	MY 2020	MY 2021	MY 2022	MY 2023	MY 2024	MY 2025	MY 2026	MY 2027	MY 2028	MY 2029	MY TOTAL
0.0%PC/0.0%LT, MYs 2021-2026	-75.4	-10.0	-13.4	-17.4	-22.3	-29.6	-32.9	-35.3	-37.0	-37.0	-39.5	-41.0	-41.6	-40.9	-540.9
0.5%PC/0.5%LT, MYs 2021-2026	-71.7	-9.3	-12.6	-16.5	-21.1	-28.3	-31.8	-34.2	-35.8	-35.7	-37.9	-39.5	-40.1	-39.5	-513.4
0.5%PC/0.5%LT, MYs 2021-2026, AC/Off-Cycle Phaseout	-67.2	-8.5	-11.7	-15.5	-19.9	-26.9	-30.0	-32.2	-33.1	-32.8	-34.8	-36.2	-36.5	-35.9	-483.4
1.0%PC/2.0%LT, MYs 2021-2026	-53.3	-6.5	-9.2	-12.1	-15.5	-21.6	-24.8	-27.2	-27.8	-27.6	-28.7	-29.9	-30.3	-29.5	-431.8
1.0%PC/2.0%LT, MYs 2022-2026	-34.6	-3.7	-4.8	-6.1	-9.1	-13.5	-17.7	-19.1	-19.4	-19.6	-19.8	-21.9	-21.8	-21.6	-343.8
2.0%PC/3.0%LT, MYs 2021-2026	-32.5	-3.6	-4.9	-7.0	-10.0	-14.7	-16.9	-18.2	-18.4	-18.0	-17.7	-18.2	-17.8	-17.5	-301.9
2.0%PC/3.0%LT, MYs 2021-2026, AC/Off-Cycle Phaseout	-17.6	-1.7	-2.5	-3.1	-6.0	-9.4	-10.4	-11.0	-10.7	-9.2	-7.6	-9.1	-8.0	-7.5	-188.0
2.0%PC/3.0%LT, MYs 2022-2026	-15.9	-1.2	-1.9	-2.5	-4.7	-7.1	-9.7	-10.3	-10.5	-9.9	-9.4	-10.5	-10.5	-10.2	-203.8

*** EO 12866 Review – Draft – Do Not Cite, Quote or Release During Review ***

**TABLE E-31 - PRESENT VALUE OF LIFETIME SOCIETAL BENEFITS, PASSENGER CARS,
3% DISCOUNT RATE, CAFE (BILLIONS OF 2016\$)**

Passenger Cars	MY 1977 - 2016	MY 201 7	MY 201 8	MY 201 9	MY 202 0	MY 202 1	MY 202 2	MY 202 3	MY 202 4	MY 202 5	MY 202 6	MY 202 7	MY 202 8	MY 202 9	MY TOTA L
0.0%PC/0.0%LT, MYs 2021-2026	25.9	1.6	-0.4	-1.8	-5.3	-11.1	-14.8	-17.0	-18.7	-19.8	-20.4	-20.3	-19.9	-19.7	-141.7
0.5%PC/0.5%LT, MYs 2021-2026	24.7	1.4	-0.4	-1.9	-5.3	-10.8	-14.4	-16.5	-18.2	-19.3	-19.9	-19.6	-19.2	-19.0	-138.4
0.5%PC/0.5%LT, MYs 2021-2026, AC/Off-Cycle Phaseout	23.1	1.3	-0.5	-1.9	-5.4	-10.7	-14.1	-16.1	-17.9	-18.9	-19.0	-18.4	-17.9	-17.7	-134.1
1.0%PC/2.0%LT, MYs 2021-2026	20.8	1.0	-0.5	-1.9	-5.3	-10.4	-13.7	-15.5	-17.0	-18.0	-17.8	-17.0	-16.4	-16.0	-127.8
1.0%PC/2.0%LT, MYs 2022-2026	16.6	1.1	0.5	-0.2	-3.2	-7.2	-10.0	-12.1	-13.5	-14.4	-14.2	-13.6	-13.1	-12.8	-96.1
2.0%PC/3.0%LT, MYs 2021-2026	14.4	0.4	-0.9	-2.2	-5.3	-9.4	-11.4	-12.6	-12.5	-13.0	-11.7	-10.8	-10.3	-10.0	-95.3
2.0%PC/3.0%LT, MYs 2021-2026, AC/Off-Cycle Phaseout	8.9	-0.2	-1.5	-2.6	-5.6	-8.9	-10.3	-11.0	-10.6	-10.4	-8.2	-7.0	-6.7	-6.5	-80.7
2.0%PC/3.0%LT, MYs 2022-2026	9.2	0.5	0.0	-0.5	-3.3	-6.1	-7.9	-9.2	-10.1	-10.4	-9.1	-8.3	-7.9	-7.6	-70.9

*** EO 12866 Review – Draft – Do Not Cite, Quote or Release During Review ***

**TABLE E-32 - PRESENT VALUE OF LIFETIME SOCIETAL BENEFITS, PASSENGER CARS,
3% DISCOUNT RATE, CO₂ (BILLIONS OF 2016\$)**

Passenger Cars	MY 1977- 2016	MY 2017	MY 2018	MY 2019	MY 2020	MY 2021	MY 2022	MY 2023	MY 2024	MY 2025	MY 2026	MY 2027	MY 2028	MY 2029	MY TOTAL
0.0%PC/0.0%LT, MYs 2021-2026	21.5	1.8	-0.2	-1.3	-3.8	-7.2	-11.0	-13.8	-16.5	-19.6	-21.1	-22.0	-22.4	-22.5	-138.2
0.5%PC/0.5%LT, MYs 2021-2026	20.6	1.9	-0.1	-1.1	-3.5	-6.8	-10.5	-13.2	-16.0	-18.9	-20.1	-21.0	-21.4	-21.7	-131.7
0.5%PC/0.5%LT, MYs 2021-2026, AC/Off- Cycle Phaseout	19.5	1.7	-0.3	-1.2	-3.2	-6.4	-9.7	-12.3	-14.2	-16.9	-18.2	-18.6	-18.8	-18.9	-117.6
1.0%PC/2.0%LT, MYs 2021-2026	16.2	1.3	-0.5	-1.4	-3.2	-6.2	-9.2	-11.7	-13.3	-15.1	-16.0	-16.4	-16.6	-16.4	-108.4
1.0%PC/2.0%LT, MYs 2022-2026	10.9	1.4	1.1	0.9	-0.6	-3.0	-5.2	-7.1	-8.2	-10.7	-11.3	-11.6	-11.9	-11.9	-67.2
2.0%PC/3.0%LT, MYs 2021-2026	10.6	0.7	0.3	-0.1	-1.6	-4.0	-6.0	-7.2	-8.1	-10.1	-10.2	-10.1	-10.1	-9.8	-65.7
2.0%PC/3.0%LT, MYs 2021-2026, AC/Off- Cycle Phaseout	5.9	0.2	-0.2	-0.4	-1.7	-3.5	-4.8	-5.5	-5.9	-7.2	-6.3	-5.7	-5.8	-5.4	-46.5
2.0%PC/3.0%LT, MYs 2022-2026	5.3	0.7	0.5	0.3	-0.8	-2.4	-3.4	-4.5	-5.1	-7.2	-6.9	-6.9	-7.0	-6.7	-44.1

*** EO 12866 Review – Draft – Do Not Cite, Quote or Release During Review ***

**TABLE E-33 - PRESENT VALUE OF LIFETIME SOCIETAL BENEFITS, LIGHT TRUCKS,
3% DISCOUNT RATE, CAFE (BILLIONS OF 2016\$)**

Light Trucks	MY 1977- 2016	MY 2017	MY 2018	MY 2019	MY 2020	MY 2021	MY 2022	MY 2023	MY 2024	MY 2025	MY 2026	MY 2027	MY 2028	MY 2029	MY TOTAL
0.0%PC/0.0%LT, MYs 2021-2026	17.5	0.0	-4.2	-7.6	-10.5	-18.3	-19.3	-19.6	-20.4	-21.5	-21.7	-20.6	-19.6	-18.7	-184.6
0.5%PC/0.5%LT, MYs 2021-2026	16.0	-0.1	-3.2	-6.2	-9.2	-16.9	-18.0	-18.4	-19.2	-20.2	-19.7	-18.7	-17.8	-17.0	-168.7
0.5%PC/0.5%LT, MYs 2021-2026, AC/Off-Cycle Phaseout	15.2	-0.2	-3.0	-5.6	-8.6	-15.8	-16.8	-17.1	-17.9	-18.8	-18.0	-17.2	-16.5	-15.8	-156.2
1.0%PC/2.0%LT, MYs 2021-2026	12.5	-0.5	-2.8	-4.9	-6.8	-12.7	-13.2	-13.6	-14.1	-14.9	-13.7	-13.2	-12.7	-12.1	-122.9
1.0%PC/2.0%LT, MYs 2022-2026	8.9	0.1	-1.6	-3.6	-5.1	-8.8	-10.1	-10.3	-10.4	-11.1	-10.0	-9.7	-9.3	-8.9	-90.0
2.0%PC/3.0%LT, MYs 2021-2026	8.3	-0.8	-2.2	-3.2	-4.9	-8.8	-8.6	-8.6	-8.3	-9.1	-7.8	-7.6	-7.3	-7.0	-76.0
2.0%PC/3.0%LT, MYs 2021-2026, AC/Off-Cycle Phaseout	5.1	-1.0	-1.8	-2.2	-3.5	-6.1	-5.2	-5.3	-4.9	-4.8	-2.5	-2.4	-2.4	-2.3	-39.2
2.0%PC/3.0%LT, MYs 2022-2026	4.7	-0.1	-0.8	-1.4	-2.2	-4.1	-4.6	-4.9	-5.1	-5.9	-4.7	-4.5	-4.3	-4.2	-42.1

*** EO 12866 Review – Draft – Do Not Cite, Quote or Release During Review ***

**TABLE E-34 - PRESENT VALUE OF LIFETIME SOCIETAL BENEFITS, LIGHT TRUCKS,
3% DISCOUNT RATE, CO₂ (BILLIONS OF 2016\$)**

Light Trucks	MY 1977- 2016	MY 2017	MY 2018	MY 2019	MY 2020	MY 2021	MY 2022	MY 2023	MY 2024	MY 2025	MY 2026	MY 2027	MY 2028	MY 2029	MY TOTAL
0.0%PC/0.0%LT, MYs 2021-2026	16.5	1.2	-1.1	-4.6	-7.8	-13.6	-15.5	-15.8	-16.7	-16.9	-17.4	-17.7	-18.3	-17.9	-145.6
0.5%PC/0.5%LT, MYs 2021-2026	15.5	1.3	-0.9	-4.3	-7.4	-13.0	-15.1	-15.4	-16.3	-16.4	-16.4	-16.8	-17.4	-17.0	-139.6
0.5%PC/0.5%LT, MYs 2021-2026, AC/Off-Cycle Phaseout	14.2	1.0	-1.0	-4.4	-7.4	-12.8	-14.9	-15.1	-15.5	-15.5	-15.0	-15.0	-15.7	-15.4	-132.6
1.0%PC/2.0%LT, MYs 2021-2026	10.2	0.6	-0.8	-3.2	-4.6	-8.6	-10.0	-10.3	-10.6	-10.8	-9.9	-9.9	-10.5	-10.2	-88.8
1.0%PC/2.0%LT, MYs 2022-2026	6.1	0.4	-0.4	-1.5	-2.4	-4.5	-5.6	-5.7	-5.8	-6.5	-5.5	-6.0	-6.8	-6.8	-51.0
2.0%PC/3.0%LT, MYs 2021-2026	5.3	0.1	-0.8	-2.3	-3.3	-5.7	-6.2	-6.2	-6.2	-6.4	-5.2	-4.5	-4.9	-4.5	-50.7
2.0%PC/3.0%LT, MYs 2021-2026, AC/Off-Cycle Phaseout	2.6	-0.2	-0.4	-0.9	-1.9	-3.7	-3.9	-3.7	-3.5	-3.3	-1.7	-0.7	-1.0	-0.8	-23.2
2.0%PC/3.0%LT, MYs 2022-2026	2.4	0.0	-0.2	-0.7	-1.3	-1.7	-1.9	-1.9	-2.0	-2.1	-1.2	-1.1	-1.6	-1.7	-14.9

*** EO 12866 Review – Draft – Do Not Cite, Quote or Release During Review ***

**TABLE E-35 - PRESENT VALUE OF LIFETIME SOCIETAL BENEFITS, COMBINED,
3% DISCOUNT RATE, CAFE (BILLIONS OF 2016\$)**

Passenger Cars and Light Trucks	MY 1977 - 2016	MY 201 7	MY 201 8	MY 201 9	MY 202 0	MY 202 1	MY 202 2	MY 202 3	MY 202 4	MY 202 5	MY 202 6	MY 202 7	MY 202 8	MY 202 9	MY TOTA L
0.0%PC/0.0%LT, MYs 2021-2026	43.4	1.5	-4.6	-9.4	-15.9	-29.3	-34.1	-36.6	-39.1	-41.3	-42.1	-40.9	-39.5	-38.4	-326.2
0.5%PC/0.5%LT, MYs 2021-2026	40.6	1.3	-3.6	-8.1	-14.6	-27.7	-32.4	-34.9	-37.4	-39.5	-39.5	-38.4	-37.0	-36.0	-307.1
0.5%PC/0.5%LT, MYs 2021-2026, AC/Off-Cycle Phaseout	38.3	1.1	-3.5	-7.5	-14.0	-26.4	-30.9	-33.3	-35.8	-37.7	-37.0	-35.7	-34.5	-33.5	-290.3
1.0%PC/2.0%LT, MYs 2021-2026	33.3	0.5	-3.3	-6.8	-12.1	-23.1	-26.9	-29.1	-31.1	-32.9	-31.6	-30.2	-29.1	-28.1	-250.7
1.0%PC/2.0%LT, MYs 2022-2026	25.5	1.2	-1.1	-3.8	-8.3	-15.9	-20.1	-22.4	-23.9	-25.5	-24.3	-23.3	-22.5	-21.7	-186.1
2.0%PC/3.0%LT, MYs 2021-2026	22.7	-0.4	-3.2	-5.5	-10.3	-18.3	-20.0	-21.1	-20.8	-22.0	-19.5	-18.4	-17.6	-17.0	-171.3
2.0%PC/3.0%LT, MYs 2021-2026, AC/Off-Cycle Phaseout	14.0	-1.2	-3.2	-4.8	-9.0	-15.0	-15.5	-16.3	-15.5	-15.2	-10.8	-9.4	-9.1	-8.8	-119.9
2.0%PC/3.0%LT, MYs 2022-2026	13.9	0.4	-0.8	-2.0	-5.6	-10.2	-12.5	-14.1	-15.1	-16.4	-13.9	-12.8	-12.2	-11.8	-113.0

*** EO 12866 Review – Draft – Do Not Cite, Quote or Release During Review ***

**TABLE E-36 - PRESENT VALUE OF LIFETIME SOCIETAL BENEFITS, COMBINED,
3% DISCOUNT RATE, CO₂ (BILLIONS OF 2016\$)**

Passenger Cars and Light Trucks	MY 1977 - 2016	MY 201 7	MY 201 8	MY 201 9	MY 202 0	MY 202 1	MY 202 2	MY 202 3	MY 202 4	MY 202 5	MY 202 6	MY 202 7	MY 202 8	MY 202 9	MY TOTA L
0.0%PC/0.0%LT, MYs 2021-2026	38.0	3.0	-1.4	-5.9	-11.6	-20.8	-26.6	-29.6	-33.2	-36.4	-38.6	-39.6	-40.7	-40.4	-283.7
0.5%PC/0.5%LT, MYs 2021-2026	36.1	3.1	-1.0	-5.4	-10.9	-19.8	-25.6	-28.6	-32.2	-35.3	-36.5	-37.8	-38.9	-38.7	-271.4
0.5%PC/0.5%LT, MYs 2021-2026, AC/Off-Cycle Phaseout	33.7	2.7	-1.3	-5.7	-10.7	-19.2	-24.6	-27.4	-29.7	-32.4	-33.2	-33.7	-34.5	-34.3	-250.3
1.0%PC/2.0%LT, MYs 2021-2026	26.4	1.9	-1.3	-4.6	-7.8	-14.7	-19.2	-22.0	-23.9	-26.0	-25.9	-26.3	-27.0	-26.7	-197.2
1.0%PC/2.0%LT, MYs 2022-2026	17.1	1.8	0.7	-0.6	-3.0	-7.6	-10.7	-12.8	-14.1	-17.2	-16.8	-17.6	-18.7	-18.7	-118.2
2.0%PC/3.0%LT, MYs 2021-2026	15.9	0.9	-0.5	-2.4	-4.8	-9.7	-12.2	-13.4	-14.3	-16.6	-15.3	-14.6	-15.0	-14.3	-116.4
2.0%PC/3.0%LT, MYs 2021-2026, AC/Off-Cycle Phaseout	8.5	0.0	-0.6	-1.4	-3.6	-7.3	-8.6	-9.2	-9.4	-10.6	-8.1	-6.4	-6.8	-6.2	-69.7
2.0%PC/3.0%LT, MYs 2022-2026	7.7	0.7	0.2	-0.4	-2.1	-4.1	-5.3	-6.4	-7.1	-9.2	-8.1	-8.0	-8.6	-8.4	-59.0

*** EO 12866 Review – Draft – Do Not Cite, Quote or Release During Review ***

**TABLE E-37 - PRESENT VALUE OF NET TOTAL BENEFITS, PASSENGER CARS,
3% DISCOUNT RATE, CAFE (BILLIONS OF 2016\$)**

Passenger Cars	MY 1977- 2016	MY 2017	MY 2018	MY 2019	MY 2020	MY 2021	MY 2022	MY 2023	MY 2024	MY 2025	MY 2026	MY 2027	MY 2028	MY 2029	MY TOTAL
0.0%PC/0.0%LT, MYs 2021-2026	84.8	8.8	8.2	7.8	8.2	8.3	6.3	4.6	1.5	-1.1	-4.1	-6.2	-6.7	-7.3	113.1
0.5%PC/0.5%LT, MYs 2021-2026	80.8	8.4	7.8	7.4	7.8	8.0	6.1	4.4	1.3	-1.2	-4.1	-5.7	-6.2	-6.7	108.2
0.5%PC/0.5%LT, MYs 2021-2026, AC/Off- Cycle Phaseout	75.7	7.7	7.2	6.8	7.3	7.4	5.6	3.8	0.7	-1.8	-4.5	-5.1	-5.5	-5.8	99.4
1.0%PC/2.0%LT, MYs 2021-2026	68.3	6.7	6.3	6.0	6.5	6.8	5.3	3.8	1.1	-1.4	-3.6	-3.2	-3.2	-3.3	96.1
1.0%PC/2.0%LT, MYs 2022-2026	54.3	5.3	5.2	5.2	5.8	6.5	6.7	5.0	2.9	0.9	-1.2	-0.7	-0.7	-0.7	94.5
2.0%PC/3.0%LT, MYs 2021-2026	47.2	4.3	4.0	3.8	4.3	4.7	3.8	2.7	0.9	0.2	-1.1	0.9	0.9	1.0	77.7
2.0%PC/3.0%LT, MYs 2021-2026, AC/Off- Cycle Phaseout	29.3	2.3	2.1	1.8	2.3	2.4	1.7	0.2	-1.4	-1.9	-2.7	1.4	1.1	1.3	39.7
2.0%PC/3.0%LT, MYs 2022-2026	30.1	2.8	2.9	3.0	3.7	4.4	4.7	3.6	1.6	0.4	-0.8	1.5	1.4	1.6	60.9

*** EO 12866 Review – Draft – Do Not Cite, Quote or Release During Review ***

**TABLE E-38 - PRESENT VALUE OF NET TOTAL BENEFITS, PASSENGER CARS,
3% DISCOUNT RATE, CO₂ (BILLIONS OF 2016\$)**

Passenger Cars	MY 1977- 2016	MY 2017	MY 2018	MY 2019	MY 2020	MY 2021	MY 2022	MY 2023	MY 2024	MY 2025	MY 2026	MY 2027	MY 2028	MY 2029	MY TOTAL
0.0%PC/0.0%LT, MYs 2021-2026	70.3	8.5	8.1	8.0	8.4	8.2	6.4	3.2	0.3	-3.9	-6.5	-7.9	-9.4	-11.6	113.1
0.5%PC/0.5%LT, MYs 2021-2026	67.4	8.2	7.8	7.7	8.1	7.8	6.5	3.4	0.5	-3.7	-6.1	-7.3	-8.9	-11.2	108.2
0.5%PC/0.5%LT, MYs 2021-2026, AC/Off- Cycle Phaseout	63.8	7.6	7.2	7.1	7.6	7.4	6.0	2.9	0.4	-3.7	-5.8	-6.5	-7.8	-9.7	99.4
1.0%PC/2.0%LT, MYs 2021-2026	53.1	6.1	5.9	5.7	6.3	6.1	5.5	3.0	0.7	-2.0	-3.9	-4.5	-5.4	-6.7	96.1
1.0%PC/2.0%LT, MYs 2022-2026	35.7	4.0	4.0	4.1	4.7	4.7	6.4	4.8	3.4	1.1	-1.0	0.4	-0.4	-1.5	94.5
2.0%PC/3.0%LT, MYs 2021-2026	34.7	3.6	3.6	3.6	4.2	4.1	4.1	2.7	1.6	-0.5	-2.0	-0.7	-1.3	-1.4	77.7
2.0%PC/3.0%LT, MYs 2021-2026, AC/Off- Cycle Phaseout	19.3	1.6	1.7	1.6	2.2	2.1	1.9	0.4	-0.7	-2.5	-3.5	0.4	0.1	0.4	39.7
2.0%PC/3.0%LT, MYs 2022-2026	17.5	1.5	1.6	1.7	2.2	2.4	4.3	3.2	2.6	0.3	-1.1	0.8	0.7	0.7	60.9

*** EO 12866 Review – Draft – Do Not Cite, Quote or Release During Review ***

**TABLE E-39 - PRESENT VALUE OF NET TOTAL BENEFITS, LIGHT TRUCKS,
3% DISCOUNT RATE, CAFE (BILLIONS OF 2016\$)**

Light Trucks	MY 1977- 2016	MY 2017	MY 2018	MY 2019	MY 2020	MY 2021	MY 2022	MY 2023	MY 2024	MY 2025	MY 2026	MY 2027	MY 2028	MY 2029	MY TOTAL
0.0%PC/0.0%LT, MYs 2021-2026	45.8	3.4	3.0	3.0	2.6	1.4	1.8	2.9	3.3	3.9	5.1	6.9	8.7	9.8	101.6
0.5%PC/0.5%LT, MYs 2021-2026	41.7	2.9	3.0	3.1	2.7	1.6	1.9	2.9	3.3	3.9	5.5	7.1	8.7	9.7	98.1
0.5%PC/0.5%LT, MYs 2021-2026, AC/Off-Cycle Phaseout	39.6	2.6	2.5	2.7	2.4	1.5	1.9	3.0	3.5	4.2	5.7	7.0	8.2	8.9	93.7
1.0%PC/2.0%LT, MYs 2021-2026	32.5	1.8	2.0	2.3	2.5	2.1	2.7	3.8	4.3	4.8	6.1	6.2	6.8	7.3	85.0
1.0%PC/2.0%LT, MYs 2022-2026	23.1	1.5	1.8	2.1	2.3	2.7	2.2	2.7	3.2	3.3	4.3	4.3	4.7	5.0	63.1
2.0%PC/3.0%LT, MYs 2021-2026	21.7	0.6	0.8	0.9	1.0	1.1	1.9	3.0	3.9	3.5	4.0	3.4	3.6	3.7	52.9
2.0%PC/3.0%LT, MYs 2021-2026, AC/Off-Cycle Phaseout	13.4	-0.3	-0.2	-0.3	-0.1	-0.4	0.5	1.7	2.7	2.4	2.7	2.5	1.9	1.9	28.4
2.0%PC/3.0%LT, MYs 2022-2026	12.3	0.6	0.6	0.4	0.7	1.0	0.8	1.2	1.7	1.6	2.4	2.2	2.1	2.1	29.8

*** EO 12866 Review – Draft – Do Not Cite, Quote or Release During Review ***

**TABLE E-40 - PRESENT VALUE OF NET TOTAL BENEFITS, LIGHT TRUCKS,
3% DISCOUNT RATE, CO₂ (BILLIONS OF 2016\$)**

Light Trucks	MY 1977- 2016	MY 2017	MY 2018	MY 2019	MY 2020	MY 2021	MY 2022	MY 2023	MY 2024	MY 2025	MY 2026	MY 2027	MY 2028	MY 2029	MY TOTAL
0.0%PC/0.0%LT, MYs 2021-2026	43.2	4.5	3.9	3.5	2.2	0.7	0.0	2.6	3.5	4.5	7.5	9.3	10.3	12.1	101.6
0.5%PC/0.5%LT, MYs 2021-2026	40.4	4.3	3.7	3.4	2.1	0.7	-0.3	2.2	3.0	4.2	7.4	9.0	10.2	12.0	98.1
0.5%PC/0.5%LT, MYs 2021-2026, AC/Off-Cycle Phaseout	37.1	3.7	3.1	2.8	1.6	0.3	-0.6	1.8	3.0	4.1	7.5	9.0	9.7	11.3	93.7
1.0%PC/2.0%LT, MYs 2021-2026	26.6	2.3	1.9	1.8	1.5	0.9	0.1	2.1	3.2	3.6	6.7	8.1	8.6	9.5	85.0
1.0%PC/2.0%LT, MYs 2022-2026	16.0	1.5	1.4	1.4	1.4	1.2	0.5	1.4	1.9	1.4	3.9	3.8	3.6	4.5	63.1
2.0%PC/3.0%LT, MYs 2021-2026	13.7	0.9	0.8	1.0	1.0	0.8	0.5	2.1	2.6	1.9	4.3	4.3	4.1	4.7	52.9
2.0%PC/3.0%LT, MYs 2021-2026, AC/Off-Cycle Phaseout	6.8	0.1	0.1	0.2	0.2	0.0	-0.1	1.4	2.0	1.1	3.1	2.3	1.1	0.9	28.4
2.0%PC/3.0%LT, MYs 2022-2026	6.1	0.4	0.5	0.5	0.4	0.6	0.2	0.7	0.7	0.4	2.4	1.7	1.2	1.1	29.8

*** EO 12866 Review – Draft – Do Not Cite, Quote or Release During Review ***

**TABLE E-41 - PRESENT VALUE OF NET TOTAL BENEFITS, COMBINED,
3% DISCOUNT RATE, CAFE (BILLIONS OF 2016\$)**

Passenger Cars and Light Trucks	MY 1977-2016	MY 2017	MY 2018	MY 2019	MY 2020	MY 2021	MY 2022	MY 2023	MY 2024	MY 2025	MY 2026	MY 2027	MY 2028	MY 2029	MY TOTAL
0.0%PC/0.0%LT, MYs 2021-2026	130.6	12.2	11.2	10.8	10.8	9.7	8.1	7.5	4.8	2.8	1.1	0.7	2.0	2.5	214.6
0.5%PC/0.5%LT, MYs 2021-2026	122.5	11.2	10.8	10.5	10.6	9.5	8.0	7.3	4.7	2.8	1.4	1.4	2.6	3.0	206.3
0.5%PC/0.5%LT, MYs 2021-2026, AC/Off-Cycle Phaseout	115.3	10.4	9.7	9.5	9.7	8.9	7.5	6.8	4.2	2.4	1.2	1.8	2.7	3.1	193.1
1.0%PC/2.0%LT, MYs 2021-2026	100.8	8.5	8.3	8.3	9.0	8.8	8.0	7.5	5.3	3.4	2.5	2.9	3.7	4.0	181.1
1.0%PC/2.0%LT, MYs 2022-2026	77.4	6.8	7.0	7.3	8.1	9.2	8.8	7.7	6.1	4.1	3.0	3.6	4.1	4.3	157.6
2.0%PC/3.0%LT, MYs 2021-2026	69.0	4.9	4.8	4.6	5.3	5.8	5.7	5.7	4.8	3.7	2.8	4.4	4.4	4.6	130.6
2.0%PC/3.0%LT, MYs 2021-2026, AC/Off-Cycle Phaseout	42.6	2.0	1.9	1.4	2.2	2.0	2.2	1.9	1.2	0.5	0.1	3.8	3.0	3.2	68.1
2.0%PC/3.0%LT, MYs 2022-2026	42.3	3.5	3.5	3.4	4.4	5.4	5.6	4.8	3.4	2.0	1.7	3.7	3.5	3.7	90.7

*** EO 12866 Review – Draft – Do Not Cite, Quote or Release During Review ***

**TABLE E-42 - PRESENT VALUE OF NET TOTAL BENEFITS, COMBINED,
3% DISCOUNT RATE, CO₂ (BILLIONS OF 2016\$)**

Passenger Cars and Light Trucks	MY 1977-2016	MY 2017	MY 2018	MY 2019	MY 2020	MY 2021	MY 2022	MY 2023	MY 2024	MY 2025	MY 2026	MY 2027	MY 2028	MY 2029	MY TOTAL
0.0%PC/0.0%LT, MYs 2021-2026	113.4	13.0	12.1	11.5	10.6	8.9	6.4	5.8	3.7	0.6	0.9	1.3	0.9	0.5	214.6
0.5%PC/0.5%LT, MYs 2021-2026	107.8	12.4	11.6	11.1	10.2	8.5	6.2	5.5	3.5	0.5	1.3	1.8	1.2	0.8	206.3
0.5%PC/0.5%LT, MYs 2021-2026, AC/Off-Cycle Phaseout	100.9	11.2	10.4	9.9	9.2	7.7	5.4	4.8	3.4	0.4	1.6	2.5	2.0	1.6	193.1
1.0%PC/2.0%LT, MYs 2021-2026	79.7	8.5	7.8	7.5	7.7	6.9	5.6	5.1	3.9	1.6	2.7	3.6	3.2	2.8	181.1
1.0%PC/2.0%LT, MYs 2022-2026	51.7	5.5	5.4	5.5	6.2	5.9	6.9	6.3	5.3	2.5	2.9	4.3	3.1	3.0	157.6
2.0%PC/3.0%LT, MYs 2021-2026	48.4	4.5	4.4	4.6	5.2	4.9	4.7	4.8	4.2	1.4	2.4	3.6	2.8	3.2	130.6
2.0%PC/3.0%LT, MYs 2021-2026, AC/Off-Cycle Phaseout	26.1	1.7	1.8	1.8	2.4	2.2	1.8	1.8	1.3	-1.4	-0.4	2.6	1.2	1.3	68.1
2.0%PC/3.0%LT, MYs 2022-2026	23.6	1.9	2.2	2.1	2.6	3.0	4.5	3.9	3.4	0.7	1.3	2.5	1.9	1.9	90.7

*** EO 12866 Review – Draft – Do Not Cite, Quote or Release During Review ***

**TABLE E-43 - INCREMENTAL TOTAL COSTS BY SOCIETAL PERSPECTIVE, PASSENGER CARS,
7% DISCOUNT RATE, CAFE (BILLIONS OF 2016\$)**

Passenger Cars	MY 1977- 2016	MY 2017	MY 2018	MY 2019	MY 2020	MY 2021	MY 2022	MY 2023	MY 2024	MY 2025	MY 2026	MY 2027	MY 2028	MY 2029	MY TOTAL
0.0%PC/0.0%LT, MYs 2021-2026	-37.0	-4.4	-5.5	-6.3	-9.5	-14.0	-15.1	-15.2	-13.9	-12.6	-10.8	-9.0	-8.2	-7.4	-168.9
0.5%PC/0.5%LT, MYs 2021-2026	-35.3	-4.2	-5.3	-6.1	-9.3	-13.6	-14.7	-14.8	-13.5	-12.2	-10.4	-8.9	-8.1	-7.3	-163.8
0.5%PC/0.5%LT, MYs 2021-2026, AC/Off-Cycle Phaseout	-33.0	-3.9	-5.0	-5.8	-9.0	-13.1	-14.2	-14.1	-12.9	-11.6	-9.6	-8.5	-7.7	-7.1	-155.6
1.0%PC/2.0%LT, MYs 2021-2026	-29.9	-3.6	-4.5	-5.3	-8.5	-12.7	-13.9	-13.8	-12.7	-11.4	-9.5	-8.8	-8.2	-7.5	-150.4
1.0%PC/2.0%LT, MYs 2022-2026	-23.8	-2.5	-3.0	-3.5	-6.6	-10.2	-12.2	-12.4	-11.5	-10.5	-8.7	-8.3	-7.7	-7.1	-127.9
2.0%PC/3.0%LT, MYs 2021-2026	-20.9	-2.5	-3.4	-4.3	-7.3	-10.7	-11.3	-11.2	-9.6	-9.2	-7.2	-7.5	-6.9	-6.5	-118.4
2.0%PC/3.0%LT, MYs 2021-2026, AC/Off-Cycle Phaseout	-13.3	-1.7	-2.7	-3.4	-6.3	-8.9	-9.3	-8.5	-6.9	-6.2	-4.0	-5.4	-4.8	-4.6	-86.0
2.0%PC/3.0%LT, MYs 2022-2026	-13.2	-1.5	-2.0	-2.5	-5.4	-8.1	-9.5	-9.4	-8.4	-7.6	-5.8	-6.3	-5.8	-5.5	-91.1

*** EO 12866 Review – Draft – Do Not Cite, Quote or Release During Review ***

**TABLE E-44 - INCREMENTAL TOTAL COSTS BY SOCIETAL PERSPECTIVE, PASSENGER CARS,
7% DISCOUNT RATE, CO₂ (BILLIONS OF 2016\$)**

Passenger Cars	MY 1977- 2016	MY 2017	MY 2018	MY 2019	MY 2020	MY 2021	MY 2022	MY 2023	MY 2024	MY 2025	MY 2026	MY 2027	MY 2028	MY 2029	MY TOTAL
0.0%PC/0.0%LT, MYs 2021-2026	-30.1	-3.9	-5.3	-6.0	-8.3	-10.6	-12.1	-11.7	-11.3	-10.3	-9.5	-8.8	-7.9	-6.6	-168.9
0.5%PC/0.5%LT, MYs 2021-2026	-28.8	-3.6	-5.1	-5.6	-7.8	-10.0	-11.7	-11.4	-11.0	-10.0	-9.1	-8.6	-7.7	-6.3	-163.8
0.5%PC/0.5%LT, MYs 2021-2026, AC/Off-Cycle Phaseout	-27.4	-3.4	-4.8	-5.4	-7.4	-9.6	-11.0	-10.5	-9.9	-8.7	-8.1	-7.7	-6.8	-5.6	-155.6
1.0%PC/2.0%LT, MYs 2021-2026	-22.8	-2.9	-4.2	-4.7	-6.6	-8.6	-10.4	-10.3	-9.6	-8.8	-7.9	-7.6	-6.9	-5.8	-150.4
1.0%PC/2.0%LT, MYs 2022-2026	-15.1	-1.2	-1.5	-1.7	-3.5	-5.3	-8.1	-8.3	-7.9	-7.8	-6.8	-7.5	-6.9	-6.1	-127.9
2.0%PC/3.0%LT, MYs 2021-2026	-15.1	-1.7	-2.2	-2.4	-4.1	-5.9	-7.4	-7.2	-6.8	-6.6	-5.5	-6.0	-5.5	-5.0	-118.4
2.0%PC/3.0%LT, MYs 2021-2026, AC/Off-Cycle Phaseout	-8.7	-1.0	-1.4	-1.5	-3.1	-4.4	-5.1	-4.5	-3.9	-3.5	-2.2	-3.9	-3.7	-3.5	-86.0
2.0%PC/3.0%LT, MYs 2022-2026	-7.5	-0.3	-0.6	-0.8	-2.2	-3.6	-5.6	-5.6	-5.5	-5.2	-4.0	-5.0	-4.7	-4.4	-91.1

*** EO 12866 Review – Draft – Do Not Cite, Quote or Release During Review ***

**TABLE E-45 - INCREMENTAL TOTAL COSTS BY SOCIETAL PERSPECTIVE, LIGHT TRUCKS,
7% DISCOUNT RATE, CAFE (BILLIONS OF 2016\$)**

Light Trucks	MY 1977- 2016	MY 2017	MY 2018	MY 2019	MY 2020	MY 2021	MY 2022	MY 2023	MY 2024	MY 2025	MY 2026	MY 2027	MY 2028	MY 2029	MY TOTAL
0.0%PC/0.0%LT, MYs 2021-2026	-17.2	-2.0	-5.7	-8.5	-10.5	-15.7	-16.2	-16.6	-16.9	-17.4	-17.6	-17.3	-17.0	-16.4	-194.9
0.5%PC/0.5%LT, MYs 2021-2026	-15.6	-1.8	-4.8	-7.5	-9.6	-14.8	-15.4	-15.8	-16.1	-16.6	-16.6	-16.3	-16.0	-15.4	-182.2
0.5%PC/0.5%LT, MYs 2021-2026, AC/Off-Cycle Phaseout	-14.9	-1.7	-4.2	-6.6	-8.8	-13.8	-14.4	-14.9	-15.3	-15.8	-15.7	-15.3	-14.9	-14.3	-170.6
1.0%PC/2.0%LT, MYs 2021-2026	-12.2	-1.4	-3.8	-5.9	-7.5	-12.0	-12.4	-13.0	-13.2	-13.7	-13.1	-12.4	-11.9	-11.3	-143.9
1.0%PC/2.0%LT, MYs 2022-2026	-8.5	-0.8	-2.7	-4.8	-6.1	-9.4	-9.7	-9.8	-10.0	-10.1	-9.6	-9.1	-8.7	-8.2	-107.5
2.0%PC/3.0%LT, MYs 2021-2026	-8.3	-1.0	-2.5	-3.4	-4.9	-8.2	-8.3	-8.8	-8.9	-8.8	-7.9	-7.2	-6.7	-6.3	-91.2
2.0%PC/3.0%LT, MYs 2021-2026, AC/Off-Cycle Phaseout	-5.3	-0.7	-1.4	-1.6	-2.9	-4.8	-4.6	-5.3	-5.5	-5.1	-3.5	-3.1	-2.7	-2.5	-49.0
2.0%PC/3.0%LT, MYs 2022-2026	-4.5	-0.4	-1.0	-1.5	-2.4	-4.2	-4.3	-4.7	-5.0	-5.3	-4.8	-4.4	-4.0	-3.7	-50.4

*** EO 12866 Review – Draft – Do Not Cite, Quote or Release During Review ***

**TABLE E-46 - INCREMENTAL TOTAL COSTS BY SOCIETAL PERSPECTIVE, LIGHT TRUCKS,
7% DISCOUNT RATE, CO₂ (BILLIONS OF 2016\$)**

Light Trucks	MY 1977- 2016	MY 2017	MY 2018	MY 2019	MY 2020	MY 2021	MY 2022	MY 2023	MY 2024	MY 2025	MY 2026	MY 2027	MY 2028	MY 2029	MY TOTAL
0.0%PC/0.0%LT, MYs 2021-2026	-15.9	-1.7	-3.3	-6.0	-7.6	-10.9	-11.5	-13.1	-13.9	-14.2	-15.9	-16.5	-16.9	-17.0	-194.9
0.5%PC/0.5%LT, MYs 2021-2026	-14.9	-1.5	-3.0	-5.7	-7.2	-10.5	-11.0	-12.6	-13.3	-13.6	-15.2	-15.9	-16.4	-16.5	-182.2
0.5%PC/0.5%LT, MYs 2021-2026, AC/Off-Cycle Phaseout	-13.7	-1.3	-2.7	-5.4	-6.9	-10.1	-10.7	-12.2	-12.8	-13.1	-14.4	-14.8	-15.1	-15.2	-170.6
1.0%PC/2.0%LT, MYs 2021-2026	-9.7	-0.8	-1.9	-3.9	-4.7	-7.4	-7.7	-9.2	-9.7	-9.7	-10.8	-11.2	-11.5	-11.4	-143.9
1.0%PC/2.0%LT, MYs 2022-2026	-5.7	-0.5	-1.2	-2.2	-2.9	-4.4	-4.6	-5.2	-5.5	-5.4	-6.1	-6.2	-6.3	-6.6	-107.5
2.0%PC/3.0%LT, MYs 2021-2026	-5.0	-0.4	-1.1	-2.7	-3.5	-5.3	-5.3	-6.1	-6.3	-5.8	-6.2	-5.5	-5.4	-5.3	-91.2
2.0%PC/3.0%LT, MYs 2021-2026, AC/Off-Cycle Phaseout	-2.5	-0.2	-0.5	-0.9	-1.8	-3.2	-3.0	-3.9	-4.0	-3.1	-3.1	-1.8	-1.3	-1.0	-49.0
2.0%PC/3.0%LT, MYs 2022-2026	-2.1	-0.2	-0.6	-0.9	-1.4	-1.8	-1.6	-2.0	-2.0	-1.7	-2.3	-1.7	-1.7	-1.7	-50.4

*** EO 12866 Review – Draft – Do Not Cite, Quote or Release During Review ***

**TABLE E-47 - INCREMENTAL TOTAL COSTS BY SOCIETAL PERSPECTIVE, COMBINED,
7% DISCOUNT RATE, CAFE (BILLIONS OF 2016\$)**

Passenger Cars and Light Trucks	MY 1977-2016	MY 2017	MY 2018	MY 2019	MY 2020	MY 2021	MY 2022	MY 2023	MY 2024	MY 2025	MY 2026	MY 2027	MY 2028	MY 2029	MY TOTAL
0.0%PC/0.0%LT, MYs 2021-2026	-54.2	-6.4	-11.2	-14.8	-20.1	-29.7	-31.3	-31.8	-30.7	-29.9	-28.4	-26.3	-25.2	-23.8	-363.9
0.5%PC/0.5%LT, MYs 2021-2026	-50.9	-6.0	-10.1	-13.7	-18.9	-28.4	-30.1	-30.6	-29.6	-28.8	-27.1	-25.2	-24.1	-22.7	-346.1
0.5%PC/0.5%LT, MYs 2021-2026, AC/Off-Cycle Phaseout	-47.9	-5.6	-9.2	-12.5	-17.8	-27.0	-28.7	-29.0	-28.2	-27.4	-25.3	-23.8	-22.6	-21.3	-326.2
1.0%PC/2.0%LT, MYs 2021-2026	-42.2	-5.0	-8.3	-11.2	-16.1	-24.6	-26.3	-26.8	-25.9	-25.1	-22.7	-21.2	-20.1	-18.8	-294.3
1.0%PC/2.0%LT, MYs 2022-2026	-32.3	-3.3	-5.7	-8.3	-12.7	-19.6	-21.9	-22.2	-21.4	-20.6	-18.3	-17.3	-16.3	-15.3	-235.3
2.0%PC/3.0%LT, MYs 2021-2026	-29.2	-3.5	-5.9	-7.7	-12.2	-18.9	-19.7	-19.9	-18.5	-18.0	-15.1	-14.7	-13.6	-12.8	-209.6
2.0%PC/3.0%LT, MYs 2021-2026, AC/Off-Cycle Phaseout	-18.6	-2.4	-4.2	-5.0	-9.2	-13.7	-13.9	-13.8	-12.4	-11.2	-7.5	-8.5	-7.5	-7.1	-135.0
2.0%PC/3.0%LT, MYs 2022-2026	-17.8	-1.9	-3.1	-4.0	-7.9	-12.3	-13.8	-14.1	-13.4	-13.0	-10.6	-10.7	-9.8	-9.2	-141.5

*** EO 12866 Review – Draft – Do Not Cite, Quote or Release During Review ***

**TABLE E-48 - INCREMENTAL TOTAL COSTS BY SOCIETAL PERSPECTIVE, COMBINED,
7% DISCOUNT RATE, CO₂ (BILLIONS OF 2016\$)**

Passenger Cars and Light Trucks	MY 1977-2016	MY 2017	MY 2018	MY 2019	MY 2020	MY 2021	MY 2022	MY 2023	MY 2024	MY 2025	MY 2026	MY 2027	MY 2028	MY 2029	MY TOTAL
0.0%PC/0.0%LT, MYs 2021-2026	-46.0	-5.6	-8.7	-12.0	-15.9	-21.5	-23.6	-24.8	-25.2	-24.5	-25.3	-25.4	-24.9	-23.6	-363.9
0.5%PC/0.5%LT, MYs 2021-2026	-43.7	-5.2	-8.0	-11.3	-15.0	-20.5	-22.8	-24.0	-24.4	-23.6	-24.3	-24.5	-24.0	-22.8	-346.1
0.5%PC/0.5%LT, MYs 2021-2026, AC/Off-Cycle Phaseout	-41.1	-4.8	-7.6	-10.8	-14.3	-19.7	-21.7	-22.7	-22.7	-21.8	-22.5	-22.5	-22.0	-20.8	-326.2
1.0%PC/2.0%LT, MYs 2021-2026	-32.6	-3.7	-6.1	-8.6	-11.3	-16.0	-18.1	-19.4	-19.3	-18.5	-18.7	-18.8	-18.3	-17.2	-294.3
1.0%PC/2.0%LT, MYs 2022-2026	-20.7	-1.7	-2.7	-3.9	-6.4	-9.8	-12.7	-13.6	-13.4	-13.2	-12.9	-13.7	-13.3	-12.7	-235.3
2.0%PC/3.0%LT, MYs 2021-2026	-20.0	-2.1	-3.3	-5.1	-7.6	-11.2	-12.6	-13.3	-13.1	-12.4	-11.8	-11.5	-10.9	-10.3	-209.6
2.0%PC/3.0%LT, MYs 2021-2026, AC/Off-Cycle Phaseout	-11.2	-1.1	-1.9	-2.4	-4.9	-7.6	-8.2	-8.4	-7.9	-6.6	-5.3	-5.8	-4.9	-4.4	-135.0
2.0%PC/3.0%LT, MYs 2022-2026	-9.7	-0.5	-1.2	-1.7	-3.5	-5.4	-7.2	-7.5	-7.5	-6.9	-6.3	-6.6	-6.4	-6.0	-141.5

*** EO 12866 Review – Draft – Do Not Cite, Quote or Release During Review ***

**TABLE E-49 - PRESENT VALUE OF LIFETIME SOCIETAL BENEFITS, PASSENGER CARS,
7% DISCOUNT RATE, CAFE (BILLIONS OF 2016\$)**

Passenger Cars	MY 1977- 2016	MY 2017	MY 2018	MY 2019	MY 2020	MY 2021	MY 2022	MY 2023	MY 2024	MY 2025	MY 2026	MY 2027	MY 2028	MY 2029	MY TOTAL
0.0%PC/0.0%LT, MYs 2021-2026	16.1	0.5	-0.9	-1.9	-4.3	-8.1	-10.3	-11.3	-11.9	-12.1	-12.0	-11.5	-10.9	-10.4	-89.0
0.5%PC/0.5%LT, MYs 2021-2026	15.3	0.5	-0.9	-1.9	-4.3	-7.9	-10.0	-11.0	-11.6	-11.8	-11.7	-11.1	-10.5	-10.0	-86.9
0.5%PC/0.5%LT, MYs 2021-2026, AC/Off- Cycle Phaseout	14.4	0.4	-0.9	-1.9	-4.3	-7.8	-9.8	-10.7	-11.4	-11.5	-11.2	-10.4	-9.8	-9.3	-84.2
1.0%PC/2.0%LT, MYs 2021-2026	13.0	0.3	-0.8	-1.8	-4.2	-7.6	-9.5	-10.3	-10.8	-11.0	-10.5	-9.6	-8.9	-8.4	-80.0
1.0%PC/2.0%LT, MYs 2022-2026	10.3	0.4	0.0	-0.4	-2.6	-5.2	-6.9	-8.0	-8.5	-8.8	-8.3	-7.7	-7.1	-6.7	-59.5
2.0%PC/3.0%LT, MYs 2021-2026	9.1	0.0	-1.0	-1.9	-4.1	-6.7	-7.8	-8.3	-7.9	-7.9	-6.8	-6.1	-5.6	-5.2	-60.2
2.0%PC/3.0%LT, MYs 2021-2026, AC/Off- Cycle Phaseout	5.7	-0.3	-1.3	-2.1	-4.1	-6.3	-7.0	-7.1	-6.6	-6.3	-4.8	-3.9	-3.6	-3.4	-51.1
2.0%PC/3.0%LT, MYs 2022-2026	5.8	0.2	-0.2	-0.6	-2.5	-4.4	-5.4	-6.0	-6.3	-6.3	-5.3	-4.6	-4.3	-4.0	-44.0

*** EO 12866 Review – Draft – Do Not Cite, Quote or Release During Review ***

**TABLE E-50 - PRESENT VALUE OF LIFETIME SOCIETAL BENEFITS, PASSENGER CARS,
7% DISCOUNT RATE, CO₂ (BILLIONS OF 2016\$)**

Passenger Cars	MY 1977- 2016	MY 2017	MY 2018	MY 2019	MY 2020	MY 2021	MY 2022	MY 2023	MY 2024	MY 2025	MY 2026	MY 2027	MY 2028	MY 2029	MY TOTAL
0.0%PC/0.0%LT, MYs 2021-2026	13.1	0.7	-0.8	-1.5	-3.3	-5.5	-7.8	-9.3	-10.6	-12.0	-12.5	-12.5	-12.2	-11.8	-89.0
0.5%PC/0.5%LT, MYs 2021-2026	12.6	0.8	-0.7	-1.4	-3.0	-5.1	-7.4	-8.9	-10.2	-11.6	-11.9	-11.9	-11.7	-11.4	-86.9
0.5%PC/0.5%LT, MYs 2021-2026, AC/Off-Cycle Phaseout	11.9	0.7	-0.8	-1.4	-2.8	-4.9	-6.9	-8.3	-9.1	-10.4	-10.7	-10.6	-10.3	-9.9	-84.2
1.0%PC/2.0%LT, MYs 2021-2026	9.9	0.5	-0.8	-1.4	-2.7	-4.6	-6.5	-7.8	-8.5	-9.3	-9.4	-9.3	-9.0	-8.6	-80.0
1.0%PC/2.0%LT, MYs 2022-2026	6.6	0.8	0.5	0.4	-0.7	-2.3	-3.7	-4.8	-5.3	-6.6	-6.7	-6.6	-6.5	-6.2	-59.5
2.0%PC/3.0%LT, MYs 2021-2026	6.6	0.3	0.0	-0.3	-1.3	-3.0	-4.1	-4.8	-5.1	-6.2	-6.0	-5.7	-5.5	-5.1	-60.2
2.0%PC/3.0%LT, MYs 2021-2026, AC/Off-Cycle Phaseout	3.8	0.0	-0.3	-0.4	-1.3	-2.5	-3.2	-3.6	-3.7	-4.3	-3.7	-3.2	-3.1	-2.8	-51.1
2.0%PC/3.0%LT, MYs 2022-2026	3.3	0.4	0.2	0.1	-0.7	-1.8	-2.4	-2.9	-3.2	-4.3	-4.0	-3.9	-3.8	-3.5	-44.0

*** EO 12866 Review – Draft – Do Not Cite, Quote or Release During Review ***

**TABLE E-51 - PRESENT VALUE OF LIFETIME SOCIETAL BENEFITS, LIGHT TRUCKS,
7% DISCOUNT RATE, CAFE (BILLIONS OF 2016\$)**

Light Trucks	MY 1977- 2016	MY 2017	MY 2018	MY 2019	MY 2020	MY 2021	MY 2022	MY 2023	MY 2024	MY 2025	MY 2026	MY 2027	MY 2028	MY 2029	MY TOTAL
0.0%PC/0.0%LT, MYs 2021-2026	10.6	-0.5	-3.6	-5.9	-7.8	-12.8	-13.0	-12.7	-12.7	-12.9	-12.5	-11.4	-10.5	-9.6	-115.1
0.5%PC/0.5%LT, MYs 2021-2026	9.7	-0.5	-2.8	-4.9	-6.8	-11.8	-12.1	-11.9	-11.9	-12.0	-11.3	-10.4	-9.5	-8.7	-104.9
0.5%PC/0.5%LT, MYs 2021-2026, AC/Off-Cycle Phaseout	9.2	-0.5	-2.6	-4.4	-6.3	-11.0	-11.3	-11.1	-11.1	-11.2	-10.4	-9.5	-8.8	-8.1	-97.2
1.0%PC/2.0%LT, MYs 2021-2026	7.6	-0.7	-2.3	-3.9	-5.0	-8.8	-8.9	-8.8	-8.7	-8.9	-7.9	-7.3	-6.8	-6.2	-76.7
1.0%PC/2.0%LT, MYs 2022-2026	5.3	-0.1	-1.4	-2.8	-3.7	-6.1	-6.8	-6.6	-6.5	-6.6	-5.8	-5.4	-5.0	-4.6	-56.0
2.0%PC/3.0%LT, MYs 2021-2026	5.1	-0.8	-1.8	-2.5	-3.6	-6.1	-5.8	-5.5	-5.2	-5.4	-4.5	-4.2	-3.9	-3.6	-47.7
2.0%PC/3.0%LT, MYs 2021-2026, AC/Off-Cycle Phaseout	3.3	-0.9	-1.4	-1.6	-2.5	-4.2	-3.4	-3.4	-3.0	-2.8	-1.5	-1.3	-1.3	-1.2	-25.1
2.0%PC/3.0%LT, MYs 2022-2026	2.9	-0.1	-0.7	-1.1	-1.6	-2.9	-3.1	-3.2	-3.1	-3.5	-2.7	-2.5	-2.3	-2.1	-26.1

*** EO 12866 Review – Draft – Do Not Cite, Quote or Release During Review ***

**TABLE E-52 - PRESENT VALUE OF LIFETIME SOCIETAL BENEFITS, LIGHT TRUCKS,
7% DISCOUNT RATE, CO₂ (BILLIONS OF 2016\$)**

Light Trucks	MY 1977- 2016	MY 2017	MY 2018	MY 2019	MY 2020	MY 2021	MY 2022	MY 2023	MY 2024	MY 2025	MY 2026	MY 2027	MY 2028	MY 2029	MY TOTAL
0.0%PC/0.0%LT, MYs 2021-2026	9.8	0.4	-1.3	-3.8	-5.9	-9.6	-10.5	-10.3	-10.4	-10.2	-10.1	-9.8	-9.8	-9.2	-115.1
0.5%PC/0.5%LT, MYs 2021-2026	9.2	0.5	-1.1	-3.6	-5.6	-9.2	-10.2	-10.0	-10.2	-9.8	-9.5	-9.3	-9.3	-8.7	-104.9
0.5%PC/0.5%LT, MYs 2021-2026, AC/Off-Cycle Phaseout	8.5	0.4	-1.1	-3.6	-5.6	-9.0	-10.0	-9.8	-9.7	-9.3	-8.7	-8.3	-8.4	-7.9	-97.2
1.0%PC/2.0%LT, MYs 2021-2026	6.0	0.2	-0.9	-2.6	-3.5	-6.0	-6.7	-6.7	-6.6	-6.5	-5.7	-5.5	-5.6	-5.2	-76.7
1.0%PC/2.0%LT, MYs 2022-2026	3.5	0.1	-0.5	-1.2	-1.8	-3.2	-3.8	-3.7	-3.6	-3.9	-3.2	-3.3	-3.6	-3.5	-56.0
2.0%PC/3.0%LT, MYs 2021-2026	3.1	0.0	-0.7	-1.8	-2.4	-4.0	-4.2	-4.0	-3.8	-3.8	-3.0	-2.5	-2.6	-2.3	-47.7
2.0%PC/3.0%LT, MYs 2021-2026, AC/Off-Cycle Phaseout	1.6	-0.2	-0.3	-0.7	-1.3	-2.6	-2.6	-2.3	-2.2	-2.0	-1.0	-0.4	-0.5	-0.4	-25.1
2.0%PC/3.0%LT, MYs 2022-2026	1.4	-0.1	-0.2	-0.5	-0.9	-1.2	-1.3	-1.3	-1.3	-1.2	-0.7	-0.6	-0.9	-0.9	-26.1

*** EO 12866 Review – Draft – Do Not Cite, Quote or Release During Review ***

**TABLE E-53 - PRESENT VALUE OF LIFETIME SOCIETAL BENEFITS, COMBINED,
7% DISCOUNT RATE, CAFE (BILLIONS OF 2016\$)**

Passenger Cars and Light Trucks	MY 1977-2016	MY 2017	MY 2018	MY 2019	MY 2020	MY 2021	MY 2022	MY 2023	MY 2024	MY 2025	MY 2026	MY 2027	MY 2028	MY 2029	MY TOTAL
0.0%PC/0.0%LT, MYs 2021-2026	26.7	0.1	-4.5	-7.9	-12.1	-20.9	-23.3	-24.0	-24.6	-25.0	-24.5	-22.9	-21.3	-20.0	-204.1
0.5%PC/0.5%LT, MYs 2021-2026	25.0	-0.1	-3.7	-6.8	-11.1	-19.7	-22.1	-22.8	-23.5	-23.9	-23.0	-21.5	-20.0	-18.7	-191.8
0.5%PC/0.5%LT, MYs 2021-2026, AC/Off-Cycle Phaseout	23.6	-0.1	-3.5	-6.4	-10.7	-18.8	-21.1	-21.8	-22.5	-22.8	-21.5	-20.0	-18.6	-17.4	-181.4
1.0%PC/2.0%LT, MYs 2021-2026	20.6	-0.4	-3.2	-5.7	-9.2	-16.4	-18.3	-19.0	-19.6	-19.9	-18.4	-16.9	-15.7	-14.6	-156.7
1.0%PC/2.0%LT, MYs 2022-2026	15.7	0.3	-1.4	-3.2	-6.3	-11.3	-13.6	-14.6	-15.0	-15.4	-14.1	-13.1	-12.1	-11.3	-115.5
2.0%PC/3.0%LT, MYs 2021-2026	14.2	-0.8	-2.8	-4.4	-7.7	-12.9	-13.6	-13.8	-13.1	-13.3	-11.3	-10.3	-9.5	-8.8	-108.0
2.0%PC/3.0%LT, MYs 2021-2026, AC/Off-Cycle Phaseout	9.0	-1.2	-2.6	-3.7	-6.6	-10.5	-10.4	-10.5	-9.6	-9.1	-6.3	-5.3	-4.9	-4.6	-76.2
2.0%PC/3.0%LT, MYs 2022-2026	8.6	0.0	-0.8	-1.7	-4.2	-7.2	-8.5	-9.2	-9.5	-9.8	-8.1	-7.2	-6.6	-6.1	-70.2

*** EO 12866 Review – Draft – Do Not Cite, Quote or Release During Review ***

**TABLE E-54 - PRESENT VALUE OF LIFETIME SOCIETAL BENEFITS, COMBINED,
7% DISCOUNT RATE, CO₂ (BILLIONS OF 2016\$)**

Passenger Cars and Light Trucks	MY 1977-2016	MY 2017	MY 2018	MY 2019	MY 2020	MY 2021	MY 2022	MY 2023	MY 2024	MY 2025	MY 2026	MY 2027	MY 2028	MY 2029	MY TOTAL
0.0%PC/0.0%LT, MYs 2021-2026	22.9	1.1	-2.1	-5.3	-9.2	-15.1	-18.3	-19.6	-21.1	-22.2	-22.5	-22.3	-22.0	-21.0	-204.1
0.5%PC/0.5%LT, MYs 2021-2026	21.8	1.3	-1.8	-4.9	-8.6	-14.4	-17.6	-18.9	-20.4	-21.4	-21.4	-21.2	-21.0	-20.1	-191.8
0.5%PC/0.5%LT, MYs 2021-2026, AC/Off-Cycle Phaseout	20.4	1.1	-1.9	-5.0	-8.4	-13.9	-16.9	-18.1	-18.8	-19.7	-19.4	-18.9	-18.6	-17.8	-181.4
1.0%PC/2.0%LT, MYs 2021-2026	16.0	0.7	-1.7	-4.0	-6.1	-10.6	-13.2	-14.5	-15.1	-15.7	-15.1	-14.8	-14.6	-13.8	-156.7
1.0%PC/2.0%LT, MYs 2022-2026	10.1	0.9	0.0	-0.9	-2.5	-5.6	-7.4	-8.5	-8.9	-10.4	-9.9	-9.9	-10.1	-9.7	-115.5
2.0%PC/3.0%LT, MYs 2021-2026	9.7	0.3	-0.8	-2.1	-3.7	-7.0	-8.3	-8.8	-9.0	-10.0	-8.9	-8.2	-8.1	-7.4	-108.0
2.0%PC/3.0%LT, MYs 2021-2026, AC/Off-Cycle Phaseout	5.4	-0.1	-0.6	-1.1	-2.7	-5.1	-5.8	-5.9	-5.9	-6.3	-4.7	-3.6	-3.7	-3.2	-76.2
2.0%PC/3.0%LT, MYs 2022-2026	4.6	0.3	0.0	-0.4	-1.6	-3.0	-3.6	-4.2	-4.5	-5.6	-4.7	-4.5	-4.6	-4.3	-70.2

*** EO 12866 Review – Draft – Do Not Cite, Quote or Release During Review ***

**TABLE E-55 - PRESENT VALUE OF NET TOTAL BENEFITS, PASSENGER CARS,
7% DISCOUNT RATE, CAFE (BILLIONS OF 2016\$)**

Passenger Cars	MY 1977- 2016	MY 2017	MY 2018	MY 2019	MY 2020	MY 2021	MY 2022	MY 2023	MY 2024	MY 2025	MY 2026	MY 2027	MY 2028	MY 2029	MY TOTAL
0.0%PC/0.0%LT, MYs 2021-2026	53.1	4.9	4.6	4.4	5.2	5.9	4.8	3.9	1.9	0.5	-1.2	-2.5	-2.7	-3.0	79.9
0.5%PC/0.5%LT, MYs 2021-2026	50.6	4.7	4.4	4.2	5.0	5.7	4.7	3.8	1.9	0.4	-1.3	-2.2	-2.4	-2.6	77.0
0.5%PC/0.5%LT, MYs 2021-2026, AC/Off-Cycle Phaseout	47.4	4.3	4.1	3.9	4.7	5.4	4.4	3.4	1.5	0.1	-1.6	-1.9	-2.0	-2.2	71.4
1.0%PC/2.0%LT, MYs 2021-2026	43.0	3.8	3.7	3.5	4.3	5.1	4.4	3.6	1.9	0.4	-0.9	-0.8	-0.8	-0.9	70.4
1.0%PC/2.0%LT, MYs 2022-2026	34.1	3.0	3.0	3.1	4.0	5.0	5.3	4.4	2.9	1.7	0.4	0.6	0.5	0.4	68.3
2.0%PC/3.0%LT, MYs 2021-2026	30.0	2.5	2.4	2.3	3.2	3.9	3.6	2.9	1.7	1.3	0.3	1.4	1.3	1.2	58.1
2.0%PC/3.0%LT, MYs 2021-2026, AC/Off-Cycle Phaseout	19.0	1.5	1.5	1.3	2.1	2.6	2.3	1.3	0.2	-0.1	-0.8	1.5	1.2	1.2	34.9
2.0%PC/3.0%LT, MYs 2022-2026	19.0	1.7	1.8	2.0	2.9	3.7	4.1	3.4	2.1	1.3	0.4	1.6	1.5	1.5	47.0

*** EO 12866 Review – Draft – Do Not Cite, Quote or Release During Review ***

**TABLE E-56 - PRESENT VALUE OF NET TOTAL BENEFITS, PASSENGER CARS,
7% DISCOUNT RATE, CO₂ (BILLIONS OF 2016\$)**

Passenger Cars	MY 1977- 2016	MY 2017	MY 2018	MY 2019	MY 2020	MY 2021	MY 2022	MY 2023	MY 2024	MY 2025	MY 2026	MY 2027	MY 2028	MY 2029	MY TOTAL
0.0%PC/0.0%LT, MYs 2021-2026	43.2	4.7	4.5	4.5	5.0	5.1	4.3	2.4	0.7	-1.7	-3.0	-3.6	-4.3	-5.3	79.9
0.5%PC/0.5%LT, MYs 2021-2026	41.4	4.5	4.4	4.3	4.8	4.9	4.3	2.5	0.8	-1.6	-2.8	-3.3	-4.0	-5.1	77.0
0.5%PC/0.5%LT, MYs 2021-2026, AC/Off-Cycle Phaseout	39.3	4.2	4.1	4.0	4.6	4.7	4.1	2.2	0.8	-1.6	-2.7	-2.9	-3.4	-4.4	71.4
1.0%PC/2.0%LT, MYs 2021-2026	32.8	3.4	3.4	3.2	3.9	4.0	3.9	2.5	1.1	-0.5	-1.5	-1.7	-2.1	-2.8	70.4
1.0%PC/2.0%LT, MYs 2022-2026	21.7	1.9	2.0	2.1	2.8	3.0	4.5	3.6	2.6	1.3	0.1	0.9	0.5	-0.1	68.3
2.0%PC/3.0%LT, MYs 2021-2026	21.7	2.0	2.1	2.1	2.8	3.0	3.2	2.4	1.6	0.4	-0.4	0.3	0.0	-0.1	58.1
2.0%PC/3.0%LT, MYs 2021-2026, AC/Off-Cycle Phaseout	12.4	1.0	1.1	1.1	1.8	1.9	1.9	0.9	0.2	-0.8	-1.5	0.7	0.5	0.6	34.9
2.0%PC/3.0%LT, MYs 2022-2026	10.8	0.7	0.9	0.9	1.5	1.8	3.3	2.6	2.2	0.8	0.0	1.1	1.0	0.9	47.0

*** EO 12866 Review – Draft – Do Not Cite, Quote or Release During Review ***

**TABLE E-57 - PRESENT VALUE OF NET TOTAL BENEFITS, LIGHT TRUCKS,
7% DISCOUNT RATE, CAFE (BILLIONS OF 2016\$)**

Light Trucks	MY 1977- 2016	MY 2017	MY 2018	MY 2019	MY 2020	MY 2021	MY 2022	MY 2023	MY 2024	MY 2025	MY 2026	MY 2027	MY 2028	MY 2029	MY TOTAL
0.0%PC/0.0%LT, MYs 2021-2026	27.8	1.5	2.1	2.6	2.7	2.9	3.2	3.9	4.2	4.5	5.2	5.9	6.5	6.8	79.8
0.5%PC/0.5%LT, MYs 2021-2026	25.3	1.3	2.1	2.6	2.8	3.0	3.3	3.9	4.2	4.5	5.3	5.9	6.5	6.7	77.3
0.5%PC/0.5%LT, MYs 2021-2026, AC/Off-Cycle Phaseout	24.1	1.2	1.6	2.2	2.5	2.8	3.2	3.9	4.2	4.6	5.3	5.7	6.1	6.2	73.4
1.0%PC/2.0%LT, MYs 2021-2026	19.8	0.7	1.4	2.1	2.5	3.1	3.6	4.2	4.5	4.8	5.3	5.0	5.1	5.1	67.3
1.0%PC/2.0%LT, MYs 2022-2026	13.8	0.7	1.3	2.0	2.4	3.3	3.0	3.2	3.5	3.5	3.8	3.7	3.7	3.6	51.5
2.0%PC/3.0%LT, MYs 2021-2026	13.4	0.2	0.7	0.9	1.3	2.1	2.6	3.2	3.7	3.4	3.4	2.9	2.8	2.7	43.5
2.0%PC/3.0%LT, MYs 2021-2026, AC/Off-Cycle Phaseout	8.6	-0.2	0.0	0.0	0.4	0.7	1.2	2.0	2.5	2.2	2.0	1.8	1.4	1.3	23.8
2.0%PC/3.0%LT, MYs 2022-2026	7.4	0.3	0.4	0.4	0.8	1.4	1.2	1.5	1.8	1.8	2.1	1.9	1.7	1.6	24.3

*** EO 12866 Review – Draft – Do Not Cite, Quote or Release During Review ***

**TABLE E-58 - PRESENT VALUE OF NET TOTAL BENEFITS, LIGHT TRUCKS,
7% DISCOUNT RATE, CO₂ (BILLIONS OF 2016\$)**

Light Trucks	MY 1977- 2016	MY 2017	MY 2018	MY 2019	MY 2020	MY 2021	MY 2022	MY 2023	MY 2024	MY 2025	MY 2026	MY 2027	MY 2028	MY 2029	MY TOTAL
0.0%PC/0.0%LT, MYs 2021-2026	25.8	2.1	2.0	2.2	1.6	1.3	1.0	2.8	3.4	4.0	5.8	6.7	7.2	7.8	79.8
0.5%PC/0.5%LT, MYs 2021-2026	24.0	2.0	1.9	2.1	1.6	1.3	0.8	2.6	3.2	3.8	5.7	6.5	7.1	7.7	77.3
0.5%PC/0.5%LT, MYs 2021-2026, AC/Off-Cycle Phaseout	22.2	1.7	1.6	1.8	1.3	1.1	0.7	2.5	3.2	3.8	5.8	6.5	6.8	7.3	73.4
1.0%PC/2.0%LT, MYs 2021-2026	15.8	1.0	1.0	1.3	1.3	1.4	1.0	2.5	3.1	3.3	5.0	5.7	5.9	6.1	67.3
1.0%PC/2.0%LT, MYs 2022-2026	9.2	0.6	0.7	0.9	1.1	1.2	0.8	1.5	1.8	1.5	2.9	2.8	2.7	3.1	51.5
2.0%PC/3.0%LT, MYs 2021-2026	8.1	0.3	0.4	0.9	1.1	1.3	1.1	2.2	2.5	2.0	3.2	3.1	2.8	3.0	43.5
2.0%PC/3.0%LT, MYs 2021-2026, AC/Off-Cycle Phaseout	4.2	0.0	0.1	0.2	0.5	0.6	0.5	1.5	1.8	1.1	2.1	1.4	0.7	0.6	23.8
2.0%PC/3.0%LT, MYs 2022-2026	3.5	0.1	0.3	0.3	0.4	0.6	0.3	0.7	0.7	0.5	1.6	1.1	0.8	0.8	24.3

*** EO 12866 Review – Draft – Do Not Cite, Quote or Release During Review ***

**TABLE E-59 - PRESENT VALUE OF NET TOTAL BENEFITS, COMBINED,
7% DISCOUNT RATE, CAFE (BILLIONS OF 2016\$)**

Passenger Cars and Light Trucks	MY 1977-2016	MY 2017	MY 2018	MY 2019	MY 2020	MY 2021	MY 2022	MY 2023	MY 2024	MY 2025	MY 2026	MY 2027	MY 2028	MY 2029	MY TOTAL
0.0%PC/0.0%LT, MYs 2021-2026	81.0	6.5	6.7	7.0	7.9	8.8	8.0	7.8	6.1	5.0	3.9	3.4	3.9	3.8	159.7
0.5%PC/0.5%LT, MYs 2021-2026	75.9	6.0	6.5	6.8	7.8	8.7	8.0	7.7	6.1	5.0	4.0	3.7	4.1	4.0	154.3
0.5%PC/0.5%LT, MYs 2021-2026, AC/Off-Cycle Phaseout	71.5	5.5	5.7	6.1	7.1	8.2	7.6	7.3	5.7	4.6	3.7	3.8	4.0	4.0	144.8
1.0%PC/2.0%LT, MYs 2021-2026	62.7	4.6	5.1	5.5	6.9	8.3	8.0	7.8	6.4	5.2	4.3	4.3	4.4	4.2	137.6
1.0%PC/2.0%LT, MYs 2022-2026	48.0	3.7	4.3	5.1	6.3	8.2	8.3	7.6	6.4	5.2	4.2	4.3	4.2	4.1	119.9
2.0%PC/3.0%LT, MYs 2021-2026	43.4	2.7	3.1	3.3	4.5	6.0	6.1	6.2	5.4	4.7	3.8	4.4	4.1	4.0	101.6
2.0%PC/3.0%LT, MYs 2021-2026, AC/Off-Cycle Phaseout	27.7	1.2	1.5	1.3	2.6	3.3	3.4	3.3	2.7	2.1	1.2	3.2	2.6	2.5	58.8
2.0%PC/3.0%LT, MYs 2022-2026	26.4	1.9	2.2	2.4	3.7	5.1	5.4	4.9	3.9	3.1	2.6	3.5	3.2	3.1	71.3

*** EO 12866 Review – Draft – Do Not Cite, Quote or Release During Review ***

**TABLE E-60 - PRESENT VALUE OF NET TOTAL BENEFITS, COMBINED,
7% DISCOUNT RATE, CO₂ (BILLIONS OF 2016\$)**

Passenger Cars and Light Trucks	MY 1977-2016	MY 2017	MY 2018	MY 2019	MY 2020	MY 2021	MY 2022	MY 2023	MY 2024	MY 2025	MY 2026	MY 2027	MY 2028	MY 2029	MY TOTAL
0.0%PC/0.0%LT, MYs 2021-2026	69.0	6.8	6.5	6.7	6.7	6.4	5.2	5.2	4.1	2.3	2.8	3.1	2.9	2.6	159.7
0.5%PC/0.5%LT, MYs 2021-2026	65.5	6.5	6.2	6.4	6.4	6.2	5.1	5.0	4.0	2.2	3.0	3.3	3.0	2.7	154.3
0.5%PC/0.5%LT, MYs 2021-2026, AC/Off-Cycle Phaseout	61.5	5.9	5.6	5.8	6.0	5.8	4.8	4.7	3.9	2.2	3.1	3.6	3.3	3.0	144.8
1.0%PC/2.0%LT, MYs 2021-2026	48.6	4.5	4.3	4.5	5.2	5.4	4.9	5.0	4.2	2.8	3.5	4.0	3.8	3.4	137.6
1.0%PC/2.0%LT, MYs 2022-2026	30.9	2.6	2.7	3.0	3.9	4.2	5.3	5.1	4.5	2.8	3.0	3.8	3.2	3.0	119.9
2.0%PC/3.0%LT, MYs 2021-2026	29.7	2.4	2.5	3.0	3.8	4.3	4.3	4.6	4.1	2.4	2.8	3.3	2.8	2.9	101.6
2.0%PC/3.0%LT, MYs 2021-2026, AC/Off-Cycle Phaseout	16.6	1.0	1.3	1.4	2.3	2.5	2.4	2.5	2.1	0.3	0.6	2.2	1.3	1.2	58.8
2.0%PC/3.0%LT, MYs 2022-2026	14.3	0.8	1.2	1.3	1.9	2.4	3.6	3.3	3.0	1.3	1.6	2.1	1.8	1.7	71.3

*** EO 12866 Review – Draft – Do Not Cite, Quote or Release During Review ***

**TABLE E-61 - BILLIONS OF GALLONS OF LIQUID FUEL SAVED, PASSENGER CARS,
UNDISCOUNTED OVER THE LIFETIME OF THE MODEL YEAR, CAFE**

Passenger Cars	MY 1977- 2016	MY 2017	MY 2018	MY 2019	MY 2020	MY 2021	MY 2022	MY 2023	MY 2024	MY 2025	MY 2026	MY 2027	MY 2028	MY 2029	MY TOTAL
0.0%PC/0.0%LT, MYs 2021-2026	10.7	0.9	0.5	0.1	-0.7	-2.1	-3.1	-3.9	-4.5	-5.1	-5.5	-5.7	-5.7	-5.8	-29.7
0.5%PC/0.5%LT, MYs 2021-2026	10.2	0.9	0.4	0.1	-0.8	-2.1	-3.0	-3.8	-4.4	-5.0	-5.3	-5.5	-5.5	-5.5	-29.3
0.5%PC/0.5%LT, MYs 2021-2026, AC/Off-Cycle Phaseout	9.6	0.8	0.4	0.0	-0.8	-2.1	-3.0	-3.7	-4.4	-4.9	-5.2	-5.1	-5.1	-5.1	-28.7
1.0%PC/2.0%LT, MYs 2021-2026	8.6	0.6	0.3	0.0	-0.8	-2.1	-3.0	-3.6	-4.2	-4.7	-4.8	-4.7	-4.6	-4.6	-27.7
1.0%PC/2.0%LT, MYs 2022-2026	6.9	0.6	0.4	0.3	-0.5	-1.4	-2.1	-2.8	-3.3	-3.7	-3.9	-3.7	-3.7	-3.6	-20.6
2.0%PC/3.0%LT, MYs 2021-2026	5.9	0.4	0.0	-0.3	-1.0	-2.0	-2.6	-3.0	-3.2	-3.4	-3.2	-2.9	-2.9	-2.8	-21.0
2.0%PC/3.0%LT, MYs 2021-2026, AC/Off-Cycle Phaseout	3.6	0.1	-0.2	-0.5	-1.2	-2.0	-2.5	-2.8	-2.9	-2.9	-2.4	-1.9	-1.9	-1.8	-19.3
2.0%PC/3.0%LT, MYs 2022-2026	3.8	0.3	0.2	0.0	-0.6	-1.3	-1.8	-2.2	-2.6	-2.8	-2.6	-2.3	-2.2	-2.1	-16.2

*** EO 12866 Review – Draft – Do Not Cite, Quote or Release During Review ***

**TABLE E-62 - BILLIONS OF GALLONS OF LIQUID FUEL SAVED, PASSENGER CARS,
UNDISCOUNTED OVER THE LIFETIME OF THE MODEL YEAR, CO₂**

Passenger Cars	MY 1977- 2016	MY 2017	MY 2018	MY 2019	MY 2020	MY 2021	MY 2022	MY 2023	MY 2024	MY 2025	MY 2026	MY 2027	MY 2028	MY 2029	MY TOTAL
0.0%PC/0.0%LT, MYs 2021-2026	9.0	1.0	0.5	0.3	-0.3	-1.1	-2.1	-3.1	-3.9	-4.9	-5.6	-6.0	-6.3	-6.6	-29.4
0.5%PC/0.5%LT, MYs 2021-2026	8.6	1.0	0.5	0.3	-0.3	-1.0	-2.0	-2.9	-3.8	-4.8	-5.4	-5.8	-6.1	-6.4	-28.0
0.5%PC/0.5%LT, MYs 2021-2026, AC/Off-Cycle Phaseout	8.2	0.9	0.4	0.2	-0.3	-1.0	-1.9	-2.8	-3.4	-4.3	-4.9	-5.2	-5.4	-5.6	-25.0
1.0%PC/2.0%LT, MYs 2021-2026	6.8	0.7	0.3	0.1	-0.3	-1.1	-1.8	-2.6	-3.2	-3.9	-4.3	-4.5	-4.7	-4.8	-23.4
1.0%PC/2.0%LT, MYs 2022-2026	4.6	0.6	0.5	0.5	0.1	-0.4	-0.9	-1.5	-1.9	-2.6	-3.0	-3.1	-3.2	-3.4	-13.7
2.0%PC/3.0%LT, MYs 2021-2026	4.4	0.4	0.3	0.2	-0.1	-0.7	-1.2	-1.7	-2.0	-2.6	-2.8	-2.8	-2.8	-2.8	-14.3
2.0%PC/3.0%LT, MYs 2021-2026, AC/Off-Cycle Phaseout	2.4	0.1	0.0	0.0	-0.3	-0.8	-1.1	-1.4	-1.6	-2.0	-1.9	-1.6	-1.6	-1.6	-11.3
2.0%PC/3.0%LT, MYs 2022-2026	2.2	0.3	0.2	0.2	-0.1	-0.5	-0.7	-1.0	-1.2	-1.9	-1.9	-1.9	-1.9	-1.9	-9.9

*** EO 12866 Review – Draft – Do Not Cite, Quote or Release During Review ***

**TABLE E-63 - BILLIONS OF GALLONS OF LIQUID FUEL SAVED, LIGHT TRUCKS,
UNDISCOUNTED OVER THE LIFETIME OF THE MODEL YEAR, CAFE**

Light Trucks	MY 1977- 2016	MY 2017	MY 2018	MY 2019	MY 2020	MY 2021	MY 2022	MY 2023	MY 2024	MY 2025	MY 2026	MY 2027	MY 2028	MY 2029	MY TOTAL
0.0%PC/0.0%LT, MYs 2021-2026	7.4	0.3	-0.8	-1.7	-2.5	-4.5	-4.8	-5.0	-5.3	-5.6	-5.7	-5.4	-5.1	-4.8	-43.5
0.5%PC/0.5%LT, MYs 2021-2026	6.8	0.2	-0.6	-1.3	-2.2	-4.2	-4.5	-4.7	-5.0	-5.3	-5.2	-4.9	-4.6	-4.4	-40.0
0.5%PC/0.5%LT, MYs 2021-2026, AC/Off-Cycle Phaseout	6.4	0.2	-0.5	-1.2	-2.0	-3.9	-4.3	-4.4	-4.7	-5.0	-4.8	-4.5	-4.3	-4.1	-37.1
1.0%PC/2.0%LT, MYs 2021-2026	5.3	0.0	-0.6	-1.1	-1.6	-3.2	-3.4	-3.5	-3.7	-4.0	-3.7	-3.6	-3.4	-3.3	-29.8
1.0%PC/2.0%LT, MYs 2022-2026	3.8	0.2	-0.3	-0.8	-1.2	-2.2	-2.7	-2.7	-2.8	-3.1	-2.8	-2.7	-2.6	-2.5	-22.6
2.0%PC/3.0%LT, MYs 2021-2026	3.5	-0.1	-0.5	-0.8	-1.2	-2.3	-2.3	-2.3	-2.2	-2.5	-2.2	-2.2	-2.1	-2.0	-19.3
2.0%PC/3.0%LT, MYs 2021-2026, AC/Off-Cycle Phaseout	2.1	-0.3	-0.5	-0.6	-0.9	-1.7	-1.4	-1.4	-1.3	-1.3	-0.7	-0.6	-0.7	-0.6	-9.9
2.0%PC/3.0%LT, MYs 2022-2026	2.0	0.0	-0.1	-0.3	-0.5	-1.1	-1.2	-1.3	-1.4	-1.7	-1.3	-1.3	-1.3	-1.2	-10.8

*** EO 12866 Review – Draft – Do Not Cite, Quote or Release During Review ***

**TABLE E-64 - BILLIONS OF GALLONS OF LIQUID FUEL SAVED, LIGHT TRUCKS,
UNDISCOUNTED OVER THE LIFETIME OF THE MODEL YEAR, CO₂**

Light Trucks	MY 1977- 2016	MY 2017	MY 2018	MY 2019	MY 2020	MY 2021	MY 2022	MY 2023	MY 2024	MY 2025	MY 2026	MY 2027	MY 2028	MY 2029	MY TOTAL
0.0%PC/0.0%LT, MYs 2021-2026	7.1	0.7	0.1	-0.8	-1.7	-3.2	-3.7	-3.8	-4.1	-4.1	-4.2	-4.3	-4.5	-4.3	-30.8
0.5%PC/0.5%LT, MYs 2021-2026	6.6	0.7	0.1	-0.7	-1.6	-3.0	-3.7	-3.7	-4.0	-4.0	-4.0	-4.1	-4.3	-4.1	-29.7
0.5%PC/0.5%LT, MYs 2021-2026, AC/Off-Cycle Phaseout	6.1	0.6	0.1	-0.8	-1.6	-3.0	-3.7	-3.7	-3.8	-3.8	-3.6	-3.6	-3.9	-3.7	-28.7
1.0%PC/2.0%LT, MYs 2021-2026	4.4	0.4	0.0	-0.6	-1.0	-2.1	-2.5	-2.6	-2.7	-2.7	-2.4	-2.4	-2.6	-2.5	-19.3
1.0%PC/2.0%LT, MYs 2022-2026	2.7	0.2	0.0	-0.2	-0.5	-1.1	-1.4	-1.4	-1.5	-1.7	-1.4	-1.6	-1.9	-1.8	-11.5
2.0%PC/3.0%LT, MYs 2021-2026	2.3	0.1	-0.1	-0.5	-0.8	-1.4	-1.6	-1.6	-1.6	-1.7	-1.3	-1.1	-1.3	-1.2	-11.8
2.0%PC/3.0%LT, MYs 2021-2026, AC/Off-Cycle Phaseout	1.1	0.0	-0.1	-0.2	-0.5	-1.0	-1.0	-1.0	-0.9	-0.8	-0.3	-0.1	-0.2	-0.1	-5.1
2.0%PC/3.0%LT, MYs 2022-2026	1.0	0.0	0.0	-0.1	-0.3	-0.4	-0.5	-0.5	-0.6	-0.6	-0.2	-0.2	-0.4	-0.5	-3.3

*** EO 12866 Review – Draft – Do Not Cite, Quote or Release During Review ***

**TABLE E-65 - BILLIONS OF GALLONS OF LIQUID FUEL SAVED, COMBINED,
UNDISCOUNTED OVER THE LIFETIME OF THE MODEL YEAR, CAFE**

Passenger Cars and Light Trucks	MY 1977-2016	MY 2017	MY 2018	MY 2019	MY 2020	MY 2021	MY 2022	MY 2023	MY 2024	MY 2025	MY 2026	MY 2027	MY 2028	MY 2029	MY TOTAL
0.0%PC/0.0%LT, MYs 2021-2026	18.2	1.2	-0.4	-1.5	-3.2	-6.6	-8.0	-8.8	-9.8	-10.7	-11.2	-11.1	-10.8	-10.6	-73.2
0.5%PC/0.5%LT, MYs 2021-2026	17.0	1.1	-0.2	-1.3	-2.9	-6.3	-7.6	-8.5	-9.4	-10.3	-10.6	-10.4	-10.1	-9.9	-69.2
0.5%PC/0.5%LT, MYs 2021-2026, AC/Off-Cycle Phaseout	16.0	1.0	-0.2	-1.2	-2.8	-6.0	-7.3	-8.1	-9.1	-9.9	-9.9	-9.7	-9.4	-9.3	-65.8
1.0%PC/2.0%LT, MYs 2021-2026	13.9	0.7	-0.3	-1.1	-2.5	-5.3	-6.4	-7.1	-7.9	-8.7	-8.5	-8.3	-8.1	-7.8	-57.4
1.0%PC/2.0%LT, MYs 2022-2026	10.6	0.7	0.1	-0.5	-1.7	-3.6	-4.8	-5.5	-6.2	-6.8	-6.6	-6.5	-6.3	-6.1	-43.2
2.0%PC/3.0%LT, MYs 2021-2026	9.4	0.2	-0.5	-1.0	-2.3	-4.3	-4.9	-5.3	-5.4	-6.0	-5.4	-5.1	-5.0	-4.8	-40.3
2.0%PC/3.0%LT, MYs 2021-2026, AC/Off-Cycle Phaseout	5.7	-0.2	-0.7	-1.1	-2.1	-3.7	-3.9	-4.2	-4.2	-4.2	-3.1	-2.6	-2.6	-2.5	-29.1
2.0%PC/3.0%LT, MYs 2022-2026	5.8	0.3	0.0	-0.3	-1.2	-2.4	-3.0	-3.5	-4.0	-4.5	-3.9	-3.6	-3.5	-3.4	-27.0

*** EO 12866 Review – Draft – Do Not Cite, Quote or Release During Review ***

**TABLE E-66 - BILLIONS OF GALLONS OF LIQUID FUEL SAVED, COMBINED,
UNDISCOUNTED OVER THE LIFETIME OF THE MODEL YEAR, CO₂**

Passenger Cars and Light Trucks	MY 1977-2016	MY 2017	MY 2018	MY 2019	MY 2020	MY 2021	MY 2022	MY 2023	MY 2024	MY 2025	MY 2026	MY 2027	MY 2028	MY 2029	MY TOTAL
0.0%PC/0.0%LT, MYs 2021-2026	16.1	1.7	0.6	-0.5	-2.0	-4.3	-5.9	-6.9	-8.0	-9.1	-9.8	-10.3	-10.8	-11.0	-60.2
0.5%PC/0.5%LT, MYs 2021-2026	15.3	1.6	0.6	-0.4	-1.8	-4.1	-5.7	-6.7	-7.8	-8.8	-9.3	-9.8	-10.4	-10.5	-57.8
0.5%PC/0.5%LT, MYs 2021-2026, AC/Off-Cycle Phaseout	14.2	1.5	0.5	-0.6	-1.9	-4.1	-5.6	-6.5	-7.2	-8.2	-8.5	-8.8	-9.3	-9.3	-53.7
1.0%PC/2.0%LT, MYs 2021-2026	11.2	1.1	0.3	-0.6	-1.4	-3.1	-4.4	-5.2	-5.9	-6.6	-6.7	-6.9	-7.3	-7.3	-42.8
1.0%PC/2.0%LT, MYs 2022-2026	7.3	0.8	0.6	0.3	-0.3	-1.5	-2.3	-3.0	-3.4	-4.4	-4.4	-4.6	-5.1	-5.2	-25.2
2.0%PC/3.0%LT, MYs 2021-2026	6.7	0.5	0.2	-0.3	-0.9	-2.2	-2.8	-3.3	-3.6	-4.3	-4.1	-3.9	-4.1	-4.0	-26.1
2.0%PC/3.0%LT, MYs 2021-2026, AC/Off-Cycle Phaseout	3.5	0.1	-0.1	-0.2	-0.8	-1.8	-2.1	-2.4	-2.5	-2.9	-2.2	-1.6	-1.8	-1.7	-16.5
2.0%PC/3.0%LT, MYs 2022-2026	3.3	0.3	0.2	0.0	-0.4	-0.9	-1.1	-1.5	-1.8	-2.4	-2.1	-2.1	-2.3	-2.3	-13.2

*** EO 12866 Review – Draft – Do Not Cite, Quote or Release During Review ***

TABLE E-67 - CHANGE IN ELECTRICITY CONSUMPTION (GW-H), PASSENGER CARS, UNDISCOUNTED OVER THE LIFETIME OF THE MODEL YEAR, CAFE

Passenger Cars	MY 1977-2016	MY 2017	MY 2018	MY 2019	MY 2020	MY 2021	MY 2022	MY 2023	MY 2024	MY 2025	MY 2026	MY 2027	MY 2028	MY 2029	MY TOTAL
0.0%PC/0.0%LT, MYs 2021-2026	-148	-159	-153	-300	-306	-1,393	-1,471	-1,695	-2,093	-2,886	-2,798	-2,704	-2,656	-2,627	-21,389
0.5%PC/0.5%LT, MYs 2021-2026	-142	-153	-147	-294	-299	-1,390	-1,472	-1,699	-2,096	-2,890	-2,802	-2,722	-2,675	-2,650	-21,429
0.5%PC/0.5%LT, MYs 2021-2026, AC/Off-Cycle Phaseout	-133	-142	-137	-284	-288	-1,365	-1,461	-1,545	-1,943	-2,754	-2,668	-2,615	-2,581	-2,562	-20,477
1.0%PC/2.0%LT, MYs 2021-2026	-119	-126	-120	-267	-269	-1,365	-1,462	-1,664	-2,069	-2,876	-2,807	-2,786	-2,771	-2,762	-21,462
1.0%PC/2.0%LT, MYs 2022-2026	-95	-101	-96	-243	-244	-1,354	-1,497	-1,569	-1,986	-2,812	-2,748	-2,734	-2,722	-2,718	-20,919
2.0%PC/3.0%LT, MYs 2021-2026	-79	-83	-78	-224	-224	-1,216	-1,331	-1,406	-1,823	-2,679	-2,640	-2,671	-2,657	-2,660	-19,771
2.0%PC/3.0%LT, MYs 2021-2026, AC/Off-Cycle Phaseout	-42	-42	-38	-184	-182	-871	-992	-1,078	-1,497	-2,362	-2,189	-2,275	-2,261	-2,266	-16,280
2.0%PC/3.0%LT, MYs 2022-2026	-51	-53	-50	-197	-197	-1,110	-1,262	-1,361	-1,787	-2,634	-2,599	-2,635	-2,624	-2,630	-19,190

*** EO 12866 Review – Draft – Do Not Cite, Quote or Release During Review ***

**TABLE E-68 - CHANGE IN ELECTRICITY CONSUMPTION (GW-H), PASSENGER CARS,
UNDISCOUNTED OVER THE LIFETIME OF THE MODEL YEAR, CO₂**

Passenger Cars	MY 1977- 2016	MY 2017	MY 2018	MY 2019	MY 2020	MY 2021	MY 2022	MY 2023	MY 2024	MY 2025	MY 2026	MY 2027	MY 2028	MY 2029	MY TOTAL
0.0%PC/0.0%LT, MYs 2021-2026	-133	-138	-113	-114	-172	-203	-156	-51	15	102	-65	-15	-281	-232	-1,555
0.5%PC/0.5%LT, MYs 2021-2026	-129	-134	-109	-110	-116	-146	-109	-9	55	144	-24	20	-242	-192	-1,102
0.5%PC/0.5%LT, MYs 2021-2026, AC/Off-Cycle Phaseout	-122	-126	-100	-101	-107	-137	-132	-35	29	108	-71	-40	-321	-281	-1,435
1.0%PC/2.0%LT, MYs 2021-2026	-102	-106	-80	-81	-85	-115	-125	-43	13	57	-127	-101	-395	-380	-1,669
1.0%PC/2.0%LT, MYs 2022-2026	-75	-78	-76	-77	-81	-120	-166	-102	-66	-43	-230	-265	-572	-565	-2,516
2.0%PC/3.0%LT, MYs 2021-2026	-64	-65	-62	-61	-62	-93	-111	-59	-28	-10	-219	-249	-568	-596	-2,247
2.0%PC/3.0%LT, MYs 2021-2026, AC/Off-Cycle Phaseout	-30	-29	-26	-24	-22	-53	-72	-22	7	12	-208	-303	-633	-669	-2,071
2.0%PC/3.0%LT, MYs 2022-2026	-33	-34	-32	-32	-32	-71	-128	-87	-74	-50	-265	-315	-645	-674	-2,472

*** EO 12866 Review – Draft – Do Not Cite, Quote or Release During Review ***

**TABLE E-69 - CHANGE IN ELECTRICITY CONSUMPTION (GW-H), LIGHT TRUCKS,
UNDISCOUNTED OVER THE LIFETIME OF THE MODEL YEAR, CAFE**

Light Trucks	MY 1977- 2016	MY 2017	MY 2018	MY 2019	MY 2020	MY 2021	MY 2022	MY 2023	MY 2024	MY 2025	MY 2026	MY 2027	MY 2028	MY 2029	MY TOTAL
0.0%PC/0.0%LT, MYs 2021-2026	-52	-57	-191	-190	-184	-175	-178	-188	-1,642	-1,646	-1,655	-1,689	-1,726	-1,751	-11,324
0.5%PC/0.5%LT, MYs 2021-2026	-47	-51	-187	-186	-180	-171	-173	-182	-1,637	-1,640	-1,651	-1,684	-1,718	-1,742	-11,248
0.5%PC/0.5%LT, MYs 2021-2026, AC/Off-Cycle Phaseout	-44	-48	-184	-183	-177	-168	-170	-179	-1,634	-1,638	-1,649	-1,679	-1,710	-1,732	-11,194
1.0%PC/2.0%LT, MYs 2021-2026	-34	-36	-173	-172	-168	-160	-162	-171	-1,625	-1,627	-1,637	-1,657	-1,682	-1,701	-11,007
1.0%PC/2.0%LT, MYs 2022-2026	-24	-27	-165	-164	-160	-155	-151	-155	-1,609	-1,607	-1,615	-1,635	-1,656	-1,672	-10,795
2.0%PC/3.0%LT, MYs 2021-2026	-20	-19	-157	-156	-152	-145	-149	-156	-1,613	-1,608	-1,612	-1,625	-1,644	-1,657	-10,714
2.0%PC/3.0%LT, MYs 2021-2026, AC/Off-Cycle Phaseout	-9	-6	-144	-143	-140	-135	-140	-147	-1,605	-1,602	-1,610	-1,624	-1,636	-1,646	-10,587
2.0%PC/3.0%LT, MYs 2022-2026	-12	-13	-152	-152	-150	-147	-145	-148	-1,602	-1,599	-1,603	-1,618	-1,634	-1,645	-10,619

*** EO 12866 Review – Draft – Do Not Cite, Quote or Release During Review ***

**TABLE E-70 - CHANGE IN ELECTRICITY CONSUMPTION (GW-H), LIGHT TRUCKS,
UNDISCOUNTED OVER THE LIFETIME OF THE MODEL YEAR, CO₂**

Light Trucks	MY 1977- 2016	MY 2017	MY 2018	MY 2019	MY 2020	MY 2021	MY 2022	MY 2023	MY 2024	MY 2025	MY 2026	MY 2027	MY 2028	MY 2029	MY TOTAL
0.0%PC/0.0%LT, MYs 2021-2026	-56	-56	-55	-56	-50	-45	-43	-1,861	-1,875	-1,889	-1,914	-1,942	-1,961	-1,991	-13,793
0.5%PC/0.5%LT, MYs 2021-2026	-53	-53	-52	-53	-48	-42	-39	-1,856	-1,870	-1,884	-1,911	-1,937	-1,957	-1,987	-13,743
0.5%PC/0.5%LT, MYs 2021-2026, AC/Off-Cycle Phaseout	-47	-47	-45	-46	-41	-35	-33	-1,849	-1,865	-1,879	-1,905	-1,929	-1,947	-1,974	-13,642
1.0%PC/2.0%LT, MYs 2021-2026	-33	-32	-30	-28	-25	-21	-17	-1,832	-1,846	-1,855	-1,878	-1,901	-1,916	-1,938	-13,352
1.0%PC/2.0%LT, MYs 2022-2026	-22	-22	-21	-21	-19	-16	-12	-1,821	-1,830	-1,830	-1,851	-1,864	-1,871	-1,891	-13,090
2.0%PC/3.0%LT, MYs 2021-2026	-15	-15	-13	-12	-11	-8	-7	-1,818	-1,828	-1,827	-1,848	-1,862	-1,870	-1,887	-13,019
2.0%PC/3.0%LT, MYs 2021-2026, AC/Off-Cycle Phaseout	-5	-4	-3	-2	0	2	2	-1,809	-1,820	-1,821	-1,841	-1,776	-1,777	-1,788	-12,643
2.0%PC/3.0%LT, MYs 2022-2026	-7	-7	-6	-6	-5	-5	-3	-1,809	-1,816	-1,214	-1,234	-1,239	-1,239	-1,246	-9,835

*** EO 12866 Review – Draft – Do Not Cite, Quote or Release During Review ***

**TABLE E-71 - CHANGE IN ELECTRICITY CONSUMPTION (GW-H), COMBINED,
UNDISCOUNTED OVER THE LIFETIME OF THE MODEL YEAR, CAFE**

Passenger Cars and Light Trucks	MY 1977-2016	MY 2017	MY 2018	MY 2019	MY 2020	MY 2021	MY 2022	MY 2023	MY 2024	MY 2025	MY 2026	MY 2027	MY 2028	MY 2029	MY TOTAL
0.0%PC/0.0%LT, MYs 2021-2026	-200	-216	-344	-490	-490	-1,568	-1,649	-1,883	-3,735	-4,532	-4,453	-4,394	-4,382	-4,378	-32,713
0.5%PC/0.5%LT, MYs 2021-2026	-190	-204	-333	-480	-478	-1,560	-1,645	-1,880	-3,732	-4,530	-4,453	-4,405	-4,393	-4,393	-32,677
0.5%PC/0.5%LT, MYs 2021-2026, AC/Off-Cycle Phaseout	-177	-190	-320	-467	-465	-1,533	-1,631	-1,725	-3,577	-4,392	-4,317	-4,294	-4,291	-4,294	-31,671
1.0%PC/2.0%LT, MYs 2021-2026	-153	-162	-294	-439	-437	-1,524	-1,625	-1,835	-3,694	-4,503	-4,444	-4,443	-4,453	-4,463	-32,469
1.0%PC/2.0%LT, MYs 2022-2026	-120	-128	-261	-407	-404	-1,509	-1,647	-1,723	-3,595	-4,419	-4,363	-4,369	-4,378	-4,390	-31,714
2.0%PC/3.0%LT, MYs 2021-2026	-99	-102	-234	-380	-376	-1,361	-1,479	-1,563	-3,436	-4,287	-4,252	-4,296	-4,302	-4,318	-30,485
2.0%PC/3.0%LT, MYs 2021-2026, AC/Off-Cycle Phaseout	-51	-49	-182	-328	-322	-1,005	-1,132	-1,226	-3,102	-3,965	-3,799	-3,899	-3,896	-3,913	-26,867
2.0%PC/3.0%LT, MYs 2022-2026	-63	-66	-202	-349	-347	-1,258	-1,407	-1,508	-3,390	-4,233	-4,202	-4,253	-4,258	-4,275	-29,809

*** EO 12866 Review – Draft – Do Not Cite, Quote or Release During Review ***

**TABLE E-72 - CHANGE IN ELECTRICITY CONSUMPTION (GW-H), COMBINED,
UNDISCOUNTED OVER THE LIFETIME OF THE MODEL YEAR, CO₂**

Passenger Cars and Light Trucks	MY 1977-2016	MY 2017	MY 2018	MY 2019	MY 2020	MY 2021	MY 2022	MY 2023	MY 2024	MY 2025	MY 2026	MY 2027	MY 2028	MY 2029	MY TOTAL
0.0%PC/0.0%LT, MYs 2021-2026	-189	-195	-167	-169	-223	-247	-199	-1,912	-1,860	-1,787	-1,979	-1,956	-2,242	-2,223	-15,348
0.5%PC/0.5%LT, MYs 2021-2026	-182	-188	-161	-163	-164	-189	-148	-1,865	-1,816	-1,741	-1,935	-1,917	-2,199	-2,179	-14,845
0.5%PC/0.5%LT, MYs 2021-2026, AC/Off-Cycle Phaseout	-168	-173	-145	-147	-148	-172	-165	-1,884	-1,836	-1,771	-1,976	-1,969	-2,268	-2,255	-15,078
1.0%PC/2.0%LT, MYs 2021-2026	-135	-138	-111	-108	-111	-136	-143	-1,875	-1,833	-1,797	-2,005	-2,002	-2,310	-2,317	-15,022
1.0%PC/2.0%LT, MYs 2022-2026	-96	-100	-97	-98	-100	-136	-178	-1,923	-1,896	-1,873	-2,080	-2,129	-2,443	-2,456	-15,606
2.0%PC/3.0%LT, MYs 2021-2026	-80	-80	-75	-73	-73	-100	-117	-1,877	-1,856	-1,837	-2,067	-2,111	-2,438	-2,483	-15,267
2.0%PC/3.0%LT, MYs 2021-2026, AC/Off-Cycle Phaseout	-35	-33	-28	-26	-23	-51	-70	-1,831	-1,813	-1,809	-2,049	-2,079	-2,410	-2,457	-14,714
2.0%PC/3.0%LT, MYs 2022-2026	-41	-41	-39	-38	-37	-75	-131	-1,896	-1,889	-1,264	-1,498	-1,554	-1,884	-1,920	-12,308

*** EO 12866 Review – Draft – Do Not Cite, Quote or Release During Review ***

TABLE E-73 - PREFERRED ALTERNATIVE, COST AND BENEFIT ESTIMATES, 3% DISCOUNT RATE, PASSENGER CARS AND LIGHT TRUCKS COMBINED, CAFE (BILLIONS 2016\$)

Passenger Cars and Light Trucks	MY 1977-2016	MY 2017	MY 2018	MY 2019	MY 2020	MY 2021	MY 2022	MY 2023	MY 2024	MY 2025	MY 2026	MY 2027	MY 2028	MY 2029	MY TOTAL
Societal Costs															
Technology Costs	0.0	-1.6	-5.7	-9.0	-13.6	-21.6	-24.2	-25.8	-26.3	-26.8	-26.7	-25.6	-24.6	-23.5	-255.1
Advanced Technology Value Loss	0.0	-0.2	-0.3	-0.5	-1.0	-2.1	-2.5	-3.1	-3.7	-4.4	-4.7	-4.5	-4.4	-4.3	-35.9
Congestion Costs	-17.4	-1.9	-2.0	-2.3	-2.6	-3.3	-3.3	-3.2	-2.9	-2.6	-2.4	-2.3	-2.5	-2.7	-51.3
Noise Costs	-0.2	0.0	0.0	0.0	0.0	0.0	0.0	0.0	0.0	0.0	0.0	0.0	0.0	0.0	-0.7
Non-Rebound Fatality Costs	-28.1	-2.5	-2.1	-1.9	-1.7	-1.2	-0.7	-0.4	0.1	0.6	0.9	0.9	0.5	0.2	-35.4
Non-Rebound Non-Fatal Crash Costs	-43.9	-3.9	-3.4	-3.0	-2.6	-1.9	-1.1	-0.7	0.2	0.9	1.5	1.4	0.7	0.3	-55.4
Rebound Fatality Costs	0.9	-0.2	-0.8	-1.4	-2.1	-3.5	-4.0	-4.2	-4.4	-4.5	-4.6	-4.4	-4.3	-4.2	-41.7
Non-Fatal Crash Costs	1.5	-0.3	-1.3	-2.1	-3.2	-5.5	-6.2	-6.6	-6.9	-7.1	-7.1	-6.9	-6.8	-6.6	-65.3
Total Societal Costs	-87.2	-10.6	-15.8	-20.2	-26.7	-39.1	-42.2	-44.1	-43.9	-44.0	-43.1	-41.5	-41.5	-40.9	-540.9
Societal Benefits															
Pre-Tax Fuel Savings	32.7	1.8	-1.2	-3.5	-6.6	-12.9	-15.3	-16.5	-17.9	-19.2	-19.7	-19.0	-18.2	-17.5	-133.1
Rebound Fuel Benefit ¹	0.1	-0.2	-1.1	-1.8	-2.7	-4.8	-5.5	-5.9	-6.2	-6.5	-6.7	-6.6	-6.6	-6.5	-61.1
Refueling Time Benefit	0.2	0.1	-0.1	-0.2	-0.4	-0.7	-0.8	-0.9	-0.9	-1.0	-1.0	-1.0	-0.9	-0.9	-8.5
Rebound Fatality Costs, Off-setting Benefit ²	0.9	-0.2	-0.8	-1.4	-2.1	-3.5	-4.0	-4.2	-4.4	-4.5	-4.6	-4.4	-4.3	-4.2	-41.7
Rebound Non-Fatal Crash Costs, Off-setting Benefit ²	1.5	-0.3	-1.3	-2.1	-3.2	-5.5	-6.2	-6.6	-6.9	-7.1	-7.1	-6.9	-6.8	-6.6	-65.3
Petroleum Market Externality	2.6	0.1	-0.1	-0.3	-0.5	-1.1	-1.2	-1.3	-1.5	-1.6	-1.6	-1.6	-1.5	-1.4	-11.0
CO2 Damage Reduction Benefit	1.1	0.1	0.0	-0.1	-0.2	-0.4	-0.5	-0.5	-0.6	-0.6	-0.6	-0.6	-0.6	-0.6	-4.3
NOx Damage Reduction Benefit	1.1	0.1	0.0	0.0	0.0	0.0	0.0	0.0	-0.1	-0.1	-0.1	-0.1	-0.1	-0.1	0.8

*** EO 12866 Review – Draft – Do Not Cite, Quote or Release During Review ***

VOC Damage Reduction Benefit	0.4	0.0	0.0	0.0	0.0	0.0	0.0	0.0	0.0	0.0	0.0	0.0	0.0	0.0	0.1
PM Damage Reduction Benefit	2.1	0.2	0.1	0.0	0.0	-0.2	-0.2	-0.2	-0.2	-0.3	-0.3	-0.2	-0.2	-0.2	0.3
SO2 Damage Reduction Benefit	0.7	0.0	0.0	-0.1	-0.2	-0.3	-0.3	-0.3	-0.3	-0.3	-0.3	-0.3	-0.3	-0.3	-2.4
Total Social Benefits	43.4	1.5	-4.6	-9.4	-15.9	-29.3	-34.1	-36.6	-39.1	-41.3	-42.1	-40.9	-39.5	-38.4	-326.2
Net Total Benefits	130.6	12.2	11.2	10.8	10.8	9.7	8.1	7.5	4.8	2.8	1.1	0.7	2.0	2.5	214.6

¹ This value includes both the value of the fuel spent to drive rebound miles, and the consumer surplus representing the additional amount consumers would have, but did not spend to drive the additional miles.

² It is assumed that consumers that drive rebound miles fully internalize fatal and non-fatal crash costs. The miles are driven because they receive an equal and offsetting benefit from driving the miles. These cells report the magnitude of the offsetting benefits.

*** EO 12866 Review – Draft – Do Not Cite, Quote or Release During Review ***

**TABLE E-74 - PREFERRED ALTERNATIVE, COST AND BENEFIT ESTIMATES, 3% DISCOUNT RATE,
PASSENGER CARS AND LIGHT TRUCKS COMBINED, CO₂ (BILLIONS 2016\$)**

Passenger Cars and Light Trucks	MY 1977 - 2016	MY 2017	MY 2018	MY 2019	MY 2020	MY 2021	MY 2022	MY 2023	MY 2024	MY 2025	MY 2026	MY 2027	MY 2028	MY 2029	MY TOTAL
Societal Costs															
Technology Costs	0.0	-1.0	-3.4	-6.3	-9.6	-14.5	-17.2	-19.3	-20.4	-21.1	-22.9	-23.7	-24.2	-23.8	-207.5
Advanced Technology Value Loss	0.0	-0.1	-0.1	-0.3	-0.5	-0.9	-1.2	-1.9	-2.0	-2.1	-2.4	-2.3	-2.3	-2.3	-18.2
Congestion Costs	-15.1	-1.9	-2.1	-2.3	-2.5	-3.0	-3.0	-2.9	-2.9	-2.7	-2.8	-2.9	-3.0	-2.9	-50.0
Noise Costs	-0.2	0.0	0.0	0.0	0.0	0.0	0.0	0.0	0.0	0.0	0.0	0.0	0.0	0.0	-0.7
Non-Rebound Fatality Costs	-24.2	-2.6	-2.5	-2.3	-2.1	-1.8	-1.3	-0.9	-0.7	-0.1	-0.1	-0.2	-0.1	-0.1	-39.0
Non-Rebound Non-Fatal Crash Costs	-37.9	-4.1	-3.9	-3.6	-3.3	-2.8	-2.0	-1.4	-1.0	-0.2	-0.1	-0.3	-0.2	-0.1	-61.0
Rebound Fatality Costs	0.8	-0.1	-0.6	-1.0	-1.6	-2.6	-3.2	-3.5	-3.9	-4.2	-4.4	-4.5	-4.6	-4.5	-37.8
Non-Fatal Crash Costs	1.3	-0.1	-0.9	-1.6	-2.6	-4.1	-5.0	-5.5	-6.1	-6.5	-6.8	-7.0	-7.1	-7.1	-59.1
Total Societal Costs	-75.4	-10.0	-13.4	-17.4	-22.3	-29.6	-32.9	-35.3	-37.0	-37.0	-39.5	-41.0	-41.6	-40.9	-473.3
Societal Benefits															
Pre-Tax Fuel Savings	28.7	2.6	0.5	-1.6	-4.4	-8.6	-11.5	-13.0	-14.8	-16.4	-17.4	-17.9	-18.4	-18.2	-110.4
Rebound Fuel Benefit ¹	0.1	-0.1	-0.7	-1.4	-2.2	-3.7	-4.5	-5.0	-5.5	-6.0	-6.4	-6.6	-6.9	-7.0	-56.0
Refueling Time Benefit	0.2	0.1	0.0	-0.1	-0.2	-0.4	-0.6	-0.7	-0.8	-0.9	-0.9	-0.9	-0.9	-0.9	-7.1
Rebound Fatality Costs, Off-setting Benefit ²	0.8	-0.1	-0.6	-1.0	-1.6	-2.6	-3.2	-3.5	-3.9	-4.2	-4.4	-4.5	-4.6	-4.5	-37.8
Rebound Non-Fatal Crash Costs, Off-setting Benefit ²	1.3	-0.1	-0.9	-1.6	-2.6	-4.1	-5.0	-5.5	-6.1	-6.5	-6.8	-7.0	-7.1	-7.1	-59.1
Petroleum Market Externality	2.3	0.2	0.0	-0.1	-0.4	-0.7	-0.9	-1.1	-1.2	-1.3	-1.4	-1.5	-1.5	-1.5	-9.0
CO2 Damage Reduction Benefit	0.9	0.1	0.0	0.0	-0.1	-0.3	-0.4	-0.4	-0.5	-0.5	-0.6	-0.6	-0.6	-0.6	-3.6
NOx Damage Reduction Benefit	1.0	0.1	0.1	0.0	0.0	0.0	0.0	0.0	0.0	-0.1	-0.1	-0.1	-0.1	-0.1	0.8

*** EO 12866 Review – Draft – Do Not Cite, Quote or Release During Review ***

VOC Damage Reduction Benefit	0.3	0.0	0.0	0.0	0.0	0.0	0.0	0.0	0.0	0.0	0.0	0.0	0.0	0.0	0.1
PM Damage Reduction Benefit	1.8	0.2	0.1	0.1	0.0	-0.1	-0.1	-0.1	-0.2	-0.2	-0.2	-0.2	-0.2	-0.2	0.6
SO2 Damage Reduction Benefit	0.6	0.1	0.0	-0.1	-0.1	-0.2	-0.3	-0.2	-0.3	-0.3	-0.3	-0.3	-0.3	-0.3	-2.1
Total Social Benefits	38.0	3.0	-1.4	-5.9	-11.6	-20.8	-26.6	-29.6	-33.2	-36.4	-38.6	-39.6	-40.7	-40.4	-283.7
Net Total Benefits	113.4	13.0	12.1	11.5	10.6	8.9	6.4	5.8	3.7	0.6	0.9	1.3	0.9	0.5	189.6

¹ This value includes both the value of the fuel spent to drive rebound miles, and the consumer surplus representing the additional amount consumers would have, but did not spend to drive the additional miles.

² It is assumed that consumers that drive rebound miles fully internalize fatal and non-fatal crash costs. The miles are driven because they receive an equal and offsetting benefit from driving the miles. These cells report the magnitude of the offsetting benefits.

*** EO 12866 Review – Draft – Do Not Cite, Quote or Release During Review ***

**TABLE E-75 - PREFERRED ALTERNATIVE, COST AND BENEFIT ESTIMATES, 7% DISCOUNT RATE,
PASSENGER CARS AND LIGHT TRUCKS COMBINED, CAFE (BILLIONS 2016\$)**

Passenger Cars and Light Trucks	MY 1977-2016	MY 2017	MY 2018	MY 2019	MY 2020	MY 2021	MY 2022	MY 2023	MY 2024	MY 2025	MY 2026	MY 2027	MY 2028	MY 2029	MY TOTAL
Societal Costs															
Technology Costs	0.0	-1.6	-5.5	-8.4	-12.1	-18.6	-20.0	-20.5	-20.1	-19.8	-19.0	-17.5	-16.2	-14.9	-194.2
Advanced Technology Value Loss	0.0	-0.2	-0.3	-0.5	-0.9	-1.8	-2.1	-2.5	-2.8	-3.3	-3.3	-3.1	-2.9	-2.7	-26.4
Congestion Costs	-10.8	-1.0	-1.1	-1.3	-1.5	-2.0	-2.0	-1.8	-1.6	-1.4	-1.2	-1.1	-1.2	-1.2	-29.2
Noise Costs	-0.1	0.0	0.0	0.0	0.0	0.0	0.0	0.0	0.0	0.0	0.0	0.0	0.0	0.0	-0.4
Non-Rebound Fatality Costs	-17.5	-1.2	-1.0	-0.8	-0.7	-0.4	-0.1	0.0	0.4	0.6	0.8	0.7	0.4	0.3	-18.5
Non-Rebound Non-Fatal Crash Costs	-27.3	-1.9	-1.5	-1.3	-1.0	-0.6	-0.2	0.1	0.6	1.0	1.2	1.1	0.7	0.4	-28.9
Rebound Fatality Costs	0.6	-0.2	-0.7	-1.0	-1.5	-2.5	-2.7	-2.8	-2.8	-2.8	-2.7	-2.5	-2.3	-2.2	-25.9
Non-Fatal Crash Costs	0.9	-0.3	-1.0	-1.6	-2.3	-3.8	-4.2	-4.3	-4.3	-4.3	-4.2	-3.9	-3.6	-3.4	-40.4
Total Societal Costs	-54.2	-6.4	-11.2	-14.8	-20.1	-29.7	-31.3	-31.8	-30.7	-29.9	-28.4	-26.3	-25.2	-23.8	-363.9
Societal Benefits															
Pre-Tax Fuel Savings	20.1	0.5	-1.7	-3.2	-5.3	-9.3	-10.5	-10.9	-11.3	-11.6	-11.5	-10.7	-9.8	-9.1	-84.4
Rebound Fuel Benefit ¹	0.0	-0.2	-0.8	-1.3	-1.9	-3.3	-3.7	-3.8	-3.8	-3.9	-3.8	-3.7	-3.5	-3.4	-37.1
Refueling Time Benefit	0.1	0.0	-0.1	-0.2	-0.3	-0.5	-0.6	-0.6	-0.6	-0.6	-0.6	-0.6	-0.5	-0.5	-5.5
Rebound Fatality Costs, Off-setting Benefit ²	0.6	-0.2	-0.7	-1.0	-1.5	-2.5	-2.7	-2.8	-2.8	-2.8	-2.7	-2.5	-2.3	-2.2	-25.9
Rebound Non-Fatal Crash Costs, Off-setting Benefit ²	0.9	-0.3	-1.0	-1.6	-2.3	-3.8	-4.2	-4.3	-4.3	-4.3	-4.2	-3.9	-3.6	-3.4	-40.4
Petroleum Market Externality	1.6	0.0	-0.1	-0.3	-0.4	-0.8	-0.9	-0.9	-0.9	-1.0	-0.9	-0.9	-0.8	-0.7	-6.9
CO2 Damage Reduction Benefit	0.7	0.0	-0.1	-0.1	-0.2	-0.3	-0.3	-0.3	-0.4	-0.4	-0.4	-0.4	-0.3	-0.3	-2.7
NOx Damage Reduction Benefit	0.7	0.0	0.0	0.0	0.0	0.0	0.0	0.0	0.0	0.0	0.0	0.0	0.0	0.0	0.4

*** EO 12866 Review – Draft – Do Not Cite, Quote or Release During Review ***

VOC Damage Reduction Benefit	0.3	0.0	0.0	0.0	0.0	0.0	0.0	0.0	0.0	0.0	0.0	0.0	0.0	0.0	0.1
PM Damage Reduction Benefit	1.3	0.1	0.0	0.0	-0.1	-0.1	-0.1	-0.1	-0.2	-0.2	-0.2	-0.1	-0.1	-0.1	0.0
SO2 Damage Reduction Benefit	0.5	0.0	-0.1	-0.1	-0.1	-0.2	-0.2	-0.2	-0.2	-0.2	-0.2	-0.2	-0.2	-0.2	-1.6
Total Social Benefits	26.7	0.1	-4.5	-7.9	-12.1	-20.9	-23.3	-24.0	-24.6	-25.0	-24.5	-22.9	-21.3	-20.0	-204.1
Net Total Benefits	81.0	6.5	6.7	7.0	7.9	8.8	8.0	7.8	6.1	5.0	3.9	3.4	3.9	3.8	159.7

¹ This value includes both the value of the fuel spent to drive rebound miles, and the consumer surplus representing the additional amount consumers would have, but did not spend to drive the additional miles.

² It is assumed that consumers that drive rebound miles fully internalize fatal and non-fatal crash costs. The miles are driven because they receive an equal and offsetting benefit from driving the miles. These cells report the magnitude of the offsetting benefits.

*** EO 12866 Review – Draft – Do Not Cite, Quote or Release During Review ***

**TABLE E-76 - PREFERRED ALTERNATIVE, COST AND BENEFIT ESTIMATES, 7% DISCOUNT RATE,
PASSENGER CARS AND LIGHT TRUCKS COMBINED, CO₂ (BILLIONS 2016\$)**

Passenger Cars and Light Trucks	MY 1977-2016	MY 2017	MY 2018	MY 2019	MY 2020	MY 2021	MY 2022	MY 2023	MY 2024	MY 2025	MY 2026	MY 2027	MY 2028	MY 2029	MY TOTAL
Societal Costs															
Technology Costs	0.0	-1.0	-3.3	-5.8	-8.6	-12.4	-14.3	-15.3	-15.6	-15.6	-16.3	-16.2	-15.9	-15.1	-155.4
Advanced Technology Value Loss	0.0	-0.1	-0.1	-0.3	-0.4	-0.8	-1.0	-1.5	-1.5	-1.5	-1.7	-1.6	-1.5	-1.5	-13.4
Congestion Costs	-9.2	-1.0	-1.1	-1.2	-1.4	-1.7	-1.7	-1.6	-1.6	-1.4	-1.4	-1.5	-1.4	-1.4	-27.7
Noise Costs	-0.1	0.0	0.0	0.0	0.0	0.0	0.0	0.0	0.0	0.0	0.0	0.0	0.0	0.0	-0.4
Non-Rebound Fatality Costs	-14.8	-1.3	-1.2	-1.0	-0.9	-0.7	-0.4	-0.2	-0.1	0.2	0.2	0.1	0.1	0.1	-19.8
Non-Rebound Non-Fatal Crash Costs	-23.2	-2.0	-1.9	-1.6	-1.4	-1.1	-0.6	-0.3	-0.1	0.4	0.4	0.2	0.2	0.2	-30.9
Rebound Fatality Costs	0.5	-0.1	-0.4	-0.8	-1.2	-1.8	-2.2	-2.3	-2.4	-2.5	-2.5	-2.5	-2.5	-2.3	-23.1
Non-Fatal Crash Costs	0.8	-0.1	-0.7	-1.2	-1.9	-2.9	-3.4	-3.6	-3.8	-3.9	-4.0	-3.9	-3.9	-3.7	-36.1
Total Societal Costs	-46.0	-5.6	-8.7	-12.0	-15.9	-21.5	-23.6	-24.8	-25.2	-24.5	-25.3	-25.4	-24.9	-23.6	-306.8
Societal Benefits															
Pre-Tax Fuel Savings	17.3	1.1	-0.4	-1.9	-3.8	-6.5	-8.1	-8.7	-9.5	-10.1	-10.2	-10.1	-10.0	-9.5	-70.3
Rebound Fuel Benefit ¹	0.0	-0.1	-0.5	-1.0	-1.6	-2.6	-3.0	-3.2	-3.4	-3.6	-3.7	-3.7	-3.7	-3.6	-33.6
Refueling Time Benefit	0.1	0.1	0.0	-0.1	-0.2	-0.3	-0.4	-0.5	-0.5	-0.5	-0.5	-0.5	-0.5	-0.5	-4.5
Rebound Fatality Costs, Off-setting Benefit ²	0.5	-0.1	-0.4	-0.8	-1.2	-1.8	-2.2	-2.3	-2.4	-2.5	-2.5	-2.5	-2.5	-2.3	-23.1
Rebound Non-Fatal Crash Costs, Off-setting Benefit ²	0.8	-0.1	-0.7	-1.2	-1.9	-2.9	-3.4	-3.6	-3.8	-3.9	-4.0	-3.9	-3.9	-3.7	-36.1
Petroleum Market Externality	1.4	0.1	0.0	-0.2	-0.3	-0.5	-0.7	-0.7	-0.8	-0.8	-0.8	-0.8	-0.8	-0.8	-5.8
CO2 Damage Reduction Benefit	0.6	0.0	0.0	-0.1	-0.1	-0.2	-0.3	-0.3	-0.3	-0.3	-0.3	-0.3	-0.3	-0.3	-2.3
NOx Damage Reduction Benefit	0.6	0.0	0.0	0.0	0.0	0.0	0.0	0.0	0.0	0.0	0.0	0.0	0.0	0.0	0.4

*** EO 12866 Review – Draft – Do Not Cite, Quote or Release During Review ***

VOC Damage Reduction Benefit	0.2	0.0	0.0	0.0	0.0	0.0	0.0	0.0	0.0	0.0	0.0	0.0	0.0	0.0	0.1
PM Damage Reduction Benefit	1.1	0.1	0.0	0.0	0.0	-0.1	-0.1	-0.1	-0.1	-0.1	-0.1	-0.1	-0.1	-0.1	0.1
SO2 Damage Reduction Benefit	0.4	0.0	0.0	-0.1	-0.1	-0.2	-0.2	-0.2	-0.2	-0.2	-0.2	-0.2	-0.2	-0.2	-1.4
Total Social Benefits	22.9	1.1	-2.1	-5.3	-9.2	-15.1	-18.3	-19.6	-21.1	-22.2	-22.5	-22.3	-22.0	-21.0	-176.6
Net Total Benefits	69.0	6.8	6.5	6.7	6.7	6.4	5.2	5.2	4.1	2.3	2.8	3.1	2.9	2.6	130.2

¹ This value includes both the value of the fuel spent to drive rebound miles, and the consumer surplus representing the additional amount consumers would have, but did not spend to drive the additional miles.

² It is assumed that consumers that drive rebound miles fully internalize fatal and non-fatal crash costs. The miles are driven because they receive an equal and offsetting benefit from driving the miles. These cells report the magnitude of the offsetting benefits.

*** EO 12866 Review – Draft – Do Not Cite, Quote or Release During Review ***

TABLE E-77 - PREFERRED ALTERNATIVE, SUMMARY OF IMPACTS, CAFE

Category	Light Truck	Passenger Car	Combined Fleet
Required MPG for MY 2026+	31.3	43.7	37.0
Achieved MPG for MY 2026+	33.6	46.7	39.7
Achieved MPG for MY 2020	31.6	43.9	37.2
Per Vehicle Price Increase	-\$2,114	-\$1,648	-\$1,869
MY 2030 Lifetime Fuel Savings (per vehicle), Discounted at 3%	-\$2,101	-\$1,119	-\$1,468
MY 2030 Lifetime Fuel Savings (per vehicle), Discounted at 7%	-\$1,700	-\$948	-\$1,211
MY 2030 Lifetime Net Consumer Savings (per vehicle), Discounted at 3%	\$110	\$810	\$644
MY 2030 Lifetime Net Consumer Savings (per vehicle), Discounted at 7%	\$605	\$1029	\$965
Total Lifetime Fuel Savings (bGallons)	-44	-30	-73
Total Lifetime CO2 Reductions (million metric tons)	-482	-329	-810
Fatalities (Excluding Rebound Miles)	-3,134	-3,227	-6,361
Fatalities (Including Rebound Miles)	-3,276	-3,068	-6,345
Total Technology Costs (\$b), Discounted at 3%	-\$141	-\$114	-\$255
Total Technology Costs (\$b), Discounted at 7%	-\$108	-\$86	-\$194
Total Net Societal Benefits (\$b), Discounted at 3%	\$102	\$113	\$215
Total Net Societal Benefits (\$b), Discounted at 7%	\$80	\$80	\$160

*** EO 12866 Review – Draft – Do Not Cite, Quote or Release During Review ***

TABLE E-78 - PREFERRED ALTERNATIVE, SUMMARY OF IMPACTS, CO₂

Category	Light Truck	Passenger Car	Combined Fleet
Required MPG for MY 2026+	31.3	43.7	37.1
Achieved MPG for MY 2026+	33.4	45.9	39.3
Achieved MPG for MY 2020	31.4	43.0	36.7
Per Vehicle Price Increase	-\$2,144	-\$1,633	-\$1,879
MY 2030 Lifetime Fuel Savings (per vehicle), Discounted at 3%	-\$2,121	-\$1,259	-\$1,519
MY 2030 Lifetime Fuel Savings (per vehicle), Discounted at 7%	-\$1,719	-\$1,061	-\$1,254
MY 2030 Lifetime Net Consumer Savings (per vehicle), Discounted at 3%	-\$102	\$475	\$418
MY 2030 Lifetime Net Consumer Savings (per vehicle), Discounted at 7%	\$397	\$731	\$753
Total Lifetime Fuel Savings (bGallons)	-31	-29	-60
Total Lifetime CO ₂ Reductions (million metric tons)	-341	-326	-667
Fatalities (Excluding Rebound Miles)	-4,163	-2,932	-7,095
Fatalities (Including Rebound Miles)	-2,854	-2,954	-5,808
Total Technology Costs (\$b), Discounted at 3%	-\$110	-\$98	-\$207
Total Technology Costs (\$b), Discounted at 7%	-\$82	-\$73	-\$155
Total Net Societal Benefits (\$b), Discounted at 3%	\$108	\$82	\$190
Total Net Societal Benefits (\$b), Discounted at 7%	\$74	\$56	\$130

*** EO 12866 Review – Draft – Do Not Cite, Quote or Release During Review ***

1 Overview

[TEXT FORTHCOMING]

2 Need for this Regulatory Action

NHTSA and EPA are required by statute to set CAFE and CO₂ standards, respectively, for the model years in question. Executive Order 12866 states that “Federal agencies should promulgate only such regulations as are required by law, or are made necessary by compelling need, such as material failures of private markets to protect or improve the health and safety of the public, the environment, or the wellbeing of the American people. . . .” NHTSA is required by the Energy Policy and Conservation Act (EPCA) of 1975, as amended by the Energy Independence and Security Act (EISA) of 2007, to set maximum feasible passenger car and light truck CAFE standards for every model year. In the absence of regulatory action by NHTSA, there are no CAFE standards for the model year in question. EPA is required by the Clean Air Act (CAA) to set emissions standards applicable to mobile sources (such as passenger cars and light trucks) when it has determined that emissions of a given pollutant cause or contribute to air pollution which may reasonably be anticipated to endanger public health or welfare. EPA has made such an endangerment finding for greenhouse gases, of which CO₂ is the primary GHG pollutant for mobile sources.¹⁰ Therefore, both agencies must promulgate standards as required by law.

The question of whether a market failure exists that these standards can correct is a difficult one. The CAFE program was originally intended to address the risk of gasoline price shocks in the wake of the oil embargoes of the 1970s. The GHG program is intended to address the risk of global climate change. To the extent that a market failure exists, it would appear to be that consumers do not voluntarily purchase enough fuel economy when buying new vehicles to protect -

- themselves if gasoline prices suddenly rise significantly, in the case of the CAFE standards; or
- the planet from the risks of unchecked climate change, in the case of the CO₂ standards.

Consumer failure to purchase enough fuel economy to protect themselves against the risk of gasoline price shocks would, theoretically, be a lack of information about the significance or magnitude of that risk. Congress decreed in EPCA that part of the solution to that problem was to increase the fuel economy of the fleet as a whole, and after a certain period, to set standards at “maximum feasible levels,” taking into account a number of factors including “the need of the United States to conserve energy.” Consumer failure to purchase enough fuel economy to protect the planet from climate change would presumably count both as an externality (insofar as individual consumers’ decisions about which vehicle to purchase lead to greater or fewer CO₂ emissions and thus to less or more climate change for the planet as a whole) and as a lack of

¹⁰ Endangerment and Cause or Contribute Findings for Greenhouse Gases Under Section 202(a) of the Clean Air Act, 74 FR 66496, 66518 (December 15, 2009); “Technical Support Document for Endangerment and Cause or Contribute Findings for Greenhouse Gases Under Section 202(a) of the Clean Air Act,” Docket ID No. EPA-HQ-OAR-2009-0472-11292. See also *Coalition for Responsible Regulation*, 684 F.3d at 114; *Massachusetts v. EPA*, 549 U.S. at 533.

information (insofar as some individual consumers might be more inclined to purchase more fuel economy if they realized the effect that fuel economy had on climate change). The CAA requires EPA to regulate emissions once EPA has made an “endangerment finding,” as mentioned above, which suggests that Congress is concerned about the externality aspect of pollution.

The sections below discuss the statutory needs for CAFE and CO₂ standards and, in doing so, also discuss how the standards address the potential market failures to which Congress was responding in requiring regulation.

EPA and NHTSA have also previously discussed a concept called the “energy paradox,” whereby consumers appear to undervalue investments in energy conservation even if those investments would pay off in the relatively near term.¹¹ Recent research disagrees about whether there is such an energy paradox with fuel economy – that is, whether buyers of new vehicles consider the full lifetime value of fuel savings they would experience from purchasing models that feature higher fuel economy – and about how extensive it might be. Most studies produce a range of estimates for the percentage of discounted future fuel savings offered by models with higher fuel economy that buyers appear to value, drawing their estimates from one of three sources - (1) buyers’ choices among competing models with different purchase prices, fuel economy, and other features; (2) statistically “decomposing” vehicle prices into the values of their individual features, including fuel economy; or (3) analyzing changes in selling prices for vehicles with different fuel economy that occur when fuel prices vary. Of course, some of this range may simply reflect variation among buyers’ preferences for different vehicle features (such as fuel economy, size, or utility), in the financial constraints they face, or – most obviously – how much they drive. Taken as a whole, the ranges estimated by the most careful recent studies suggest that on average, buyers appear to undervalue the savings from higher fuel economy only slightly (and perhaps not at all), once the influence of vehicles’ other attributes on prices and purchasing decisions are accounted for.

2.1 EPCA and the Need of the United States to Conserve Energy

EPCA states that: “When deciding maximum feasible average fuel economy...the Secretary of Transportation shall consider technological feasibility, economic practicability, the effect of other motor vehicle standards of the Government on fuel economy, and the need of the nation to conserve energy.”¹² All factors should be considered, in the manner appropriate, and then the maximum feasible standards should be determined. “The need of the United States to conserve energy,” specifically, means “the consumer cost, national balance of payments, environmental, and foreign policy implications of our need for large quantities of petroleum, especially imported

¹¹ See, e.g., EPA Final Regulatory Impact Assessment for the 2012 final rule establishing GHG standards for MYs 2017-2025, available at <https://nepis.epa.gov/Exe/ZyPDF.cgi/P1006V2V.PDF?Dockkey=P1006V2V.PDF>.

¹² 49 U.S.C. 32902(f)

petroleum.”¹³ The following sections discuss NHTSA’s interpretation of each of those elements, and then consider the need of the United States to conserve energy as it stands today.

2.1.1 Consumer costs and fuel prices

Fuel for vehicles costs money for vehicle owners and operators. All else equal, consumers benefit from vehicles that need less fuel to perform the same amount of work. Future fuel prices are a critical input into the economic analysis of potential CAFE standards, because they determine the value of fuel savings both to new vehicle buyers and to society, and inform NHTSA about the “consumer cost...of our need for large quantities of petroleum.” In this proposal, NHTSA relies in its analysis on fuel price projections from the U.S. Energy Information Administration’s (EIA) Annual Energy Outlook (AEO) for 2017. Federal government agencies generally use EIA’s projections in their assessment of future energy-related policies.

2.1.2 National balance of payments

Historically, the need of the United States to conserve energy has included consideration of the “national balance of payments” because of concerns that importing large amounts of oil left the country economically vulnerable.¹⁴ As recently as 2009, nearly half the U.S. trade deficit was driven by petroleum,¹⁵ yet this concern has largely laid fallow in more recent CAFE actions, arguably in part because other factors besides petroleum consumption have since played a bigger role in the U.S. trade deficit. Given significant recent increases in U.S. oil production and corresponding decreases in oil imports, this concern seems likely to remain fallow for the foreseeable future.¹⁶ Some commenters have lately raised concerns about potential economic consequences for automaker and supplier operations in the U.S. due to disparities between CAFE standards at home and their counterpart fuel economy/efficiency and GHG standards abroad. NHTSA finds these concerns more relevant to technological feasibility and economic practicability than to the national balance of payments. Moreover, to the extent that an automaker decides to globalize a vehicle platform to meet more stringent standards in other countries, that automaker would comply with United States standards and additionally generate overcompensation credits that it can save for future years if facing compliance concerns, or sell to other automakers. While CAFE standards are set at maximum feasible rates, efforts of

¹³ 42 Fed. Reg. 63184, 63188 (Dec. 15, 1977).

¹⁴ See 42 Fed. Reg. 63184, 63192 (Dec. 15, 1977) (“A major reason for this need [to reduce petroleum consumption] is that the importation of large quantities of petroleum creates serious balance of payments and foreign policy problems. The United States currently spends approximately \$45 billion annually for imported petroleum. But for this large expenditure, the current large U.S. trade deficit would be a surplus.”)

¹⁵ See EIA, “Today in Energy - Recent improvements in petroleum trade balance mitigate U.S. trade deficit,” July 21, 2014. Available at <https://www.eia.gov/todayinenergy/detail.php?id=17191> (last accessed Mar. 26, 2018).

¹⁶ For an illustration of recent increases in U.S. production, see, e.g., EIA’s Short Term Energy Outlook, at <https://www.eia.gov/outlooks/steo/images/fig13.png>. While it could be argued that reducing oil consumption frees up more domestically-produced oil for exports, and thereby raises U.S. GDP, that is neither the focus of the CAFE program nor consistent with Congress’ original intent in EPCA.

manufacturers to exceed those standards are rewarded not only with additional credits, but a market advantage in that consumers who place a large weight on fuel savings will find such vehicles that much more attractive.

2.1.3 Environmental implications

Higher fleet fuel economy can reduce U.S. emissions of various pollutants by reducing the amount of oil that is produced and refined for the U.S. vehicle fleet, but can also increase emissions by reducing the cost of driving, which can result in increased vehicle miles traveled (i.e., the rebound effect). It also raises per-vehicle costs, which results in fewer new vehicle purchases and more people remaining in older, dirtier vehicles for longer and purchasing used replacement vehicles. Thus, the net effect of more stringent CAFE standards on emissions of each pollutant depends on the relative magnitudes of its reduced emissions in fuel refining and distribution, and increases in its emissions from vehicle use. Fuel savings from CAFE standards also necessarily results in lower emissions of CO₂, the main GHG emitted as a result of refining, distribution, and use of transportation fuels. Reducing fuel consumption directly reduces CO₂ emissions, because the primary source of transportation-related CO₂ emissions is fuel combustion in internal combustion engines.

NHTSA has considered environmental issues, both within the context of EPCA and the context of the National Environmental Policy Act (NEPA), in making decisions about the setting of standards since the earliest days of the CAFE program. As courts of appeal have noted in three decisions stretching over the last 20 years,¹⁷ NHTSA defined “the need of the United States to conserve energy” in the late 1970s as including, among other things, environmental implications. In 1988, NHTSA included climate change concepts in its CAFE notices and prepared its first environmental assessment addressing that subject.¹⁸ It cited concerns about climate change as one of its reasons for limiting the extent of its reduction of the CAFE standard for MY 1989 passenger cars.¹⁹ Since then, NHTSA has considered the effects of reducing tailpipe emissions of CO₂ in its fuel economy rulemakings pursuant to the need of the United States to conserve energy by reducing petroleum consumption.

2.1.4 Foreign policy implications

U.S. consumption and imports of petroleum products impose costs on the domestic economy that are not reflected in the market price for crude petroleum, or in the prices paid by consumers for petroleum products such as gasoline. These costs include (1) higher prices for petroleum products resulting from the effect of U.S. oil import demand on world oil prices, (2) the risk of

¹⁷ *CAS*, 793 F.2d 1322, 1325 n. 12 (D.C. Cir. 1986); *Public Citizen*, 848 F.2d 256, 262-63 n. 27 (D.C. Cir. 1988) (noting that “NHTSA itself has interpreted the factors it must consider in setting CAFE standards as including environmental effects”); *CBD*, 538 F.3d 1172 (9th Cir. 2007).

¹⁸ 53 Fed. Reg. 33080, 33096 (Aug. 29, 1988).

¹⁹ 53 Fed. Reg. 39275, 39302 (Oct. 6, 1988).

disruptions to the U.S. economy caused by sudden reductions in the supply of imported oil to the U.S., and (3) expenses for maintaining a U.S. military presence to secure imported oil from unstable regions, and for maintaining the strategic petroleum reserve (SPR) to provide a response option should a disruption in commercial oil supplies threaten the U.S. economy, to allow the U.S. to meet part of its International Energy Agency obligation to maintain emergency oil stocks, and to provide a national defense fuel reserve. Higher U.S. imports of crude oil or refined petroleum products increase the magnitude of these external economic costs, thus increasing the true economic cost of supplying transportation fuels above the resource costs of producing them. Conversely, *reducing* U.S. imports of crude oil or refined petroleum products or reducing fuel consumption can reduce these external costs.

While these costs are considerations, the United States has significantly increased oil production capabilities in recent years, to the extent that the U.S. is currently producing enough oil to satisfy nearly all of its energy needs and is projected to continue to do so, or become a net energy exporter. Further, recent analyses conclude that petroleum imports do not significantly affect military expenditures (see, e.g., Chapter 8.11.3 below). Therefore, the United States has significantly reduced these costs and reduced the urgency. This issue is discussed in greater detail below and in Section V of the NPRM.

2.1.5 The Current State of Energy Production:

Table 2-1 presents historical trend data and the most recent projections of the production and consumption of petroleum from the U.S. Department of Energy. U.S. Petroleum consumption is expected to remain relatively stable over the next three decades, while increases in domestic petroleum production are expected to continue through this period as technological advances allow for easier and more cost-effective production of oil from conventional and unconventional resources. This increase in domestic production is projected to decrease U.S. reliance on foreign oil substantially over the next two decades. Net imports accounted for 24.1% of U.S. domestic production in 2015, but are projected to decline to 3.4% by 2025, and the U.S. is projected to become a net exporter of petroleum and petroleum products by 2030.

TABLE 2-1 - PETROLEUM PRODUCTION AND SUPPLY (MILLION BARRELS PER DAY)²⁰

	Domestic Petroleum Production ^{21, 22}	Net Petroleum Imports ^{23, 24}	U.S. Petroleum Consumption ^{25, 26}	World Petroleum Consumption ^{27, 28}	Net Imports as a Share of U.S. Consumption ^{29, 30}
1975	10.0	5.8	16.3	56.2	35.8%
1985	10.6	4.3	15.7	60.0	27.3%
1995	8.3	7.9	17.7	70.0	44.5%
2005	6.9	12.5	20.8	84.4	60.3%
2010	7.5	9.4	19.2	89.0	49.2%
2012	8.9	7.4	18.5	91.0	40.0%
2014	11.8	5.1	19.1	93.6	26.5%
2015	12.8	4.7	19.5	95.3	24.1%
2016	12.4	4.8	19.7	96.9	24.4%
2017	13.1	4.2	19.9	98.3	21.1%
2020 (projected)	17.9	2.3	20.3	100.0	11.5%
2025 (projected)	18.9	0.7	19.7	101.9	3.4%
2030 (projected)	19.4	-0.2	19.2	104.2	-0.9%
2035 (projected)	19.7	-0.6	19.1	108.0	-3.2%

²⁰ Petroleum data in Table 2-1 is categorized under *Petroleum and Other Liquids* by the U.S. Department of Energy, Energy Information Administration (EIA). Defined as all petroleum including crude oil and products of petroleum refining, natural gas liquids, biofuels, and liquids derived from other hydrocarbon sources (including coal to liquids and gas to liquids). Not included are liquefied natural gas (LNG) and liquid hydrogen.
<https://www.eia.gov/tools/glossary/> (last accessed May 4, 2018).

²¹ U.S. Department of Energy, Energy Information Administration (EIA), *Petroleum and Other Liquids*, Supply and Disposition, see “Field Production” for historical data.
https://www.eia.gov/dnav/pet/pet_sum_snd_d_nus_mbbldpd_a_cur-5.htm (last accessed May 4, 2018).

²² Ibid. *Annual Energy Outlook 2017*, see Table 21 and “Petroleum and Other Liquids Production” for projection data. https://www.eia.gov/outlooks/aeo/tables_ref.php (last accessed May 4, 2018).

²³ Ibid. *Petroleum and Other Liquids*, U.S. Net Imports by Country.
https://www.eia.gov/dnav/pet/pet_move_net_i_a_ep00_IMN_mbbldpd_a.htm (last accessed May 4, 2018).

²⁴ Ibid. *Annual Energy Outlook 2017*, see Table 11 and “Total Net Imports” for projection data.
https://www.eia.gov/outlooks/aeo/tables_ref.php (last accessed May 4, 2018).

²⁵ Ibid. *Petroleum and Other Liquids*, U.S. Product Supplied of Crude Oil and Petroleum Products. EIA uses product supplied as a proxy for U.S. petroleum consumption. Product supplied measures the disappearance of these products from petroleum refineries, natural gas processing plants, blending plants, pipelines, and bulk terminals.
<https://www.eia.gov/dnav/pet/hist/LeafHandler.ashx?n=PET&s=MTTUPUS2&f=A> (last accessed May 4, 2018).

²⁶ Ibid. *Annual Energy Outlook 2017*, see Table 11 and “Product Supplied” for projection data.
https://www.eia.gov/outlooks/aeo/tables_ref.php (last accessed May 4, 2018).

²⁷ Ibid. *Petroleum and Other Liquids*, see International Energy Statistics. <https://www.eia.gov/petroleum/data.php> (last accessed May 4, 2018).

²⁸ Ibid. *Annual Energy Outlook 2017*, see Table 21. https://www.eia.gov/outlooks/aeo/tables_ref.php (last accessed May 4, 2018).

²⁹ Ibid. *Petroleum and Other Liquids*, U.S. Net Imports by Country.
https://www.eia.gov/dnav/pet/pet_move_net_i_a_ep00_IMN_mbbldpd_a.htm (last accessed May 4, 2018).

³⁰ Ibid. *Annual Energy Outlook 2017*, see Table 11 and “Net Import Share of Product Supplied” for projection data.
https://www.eia.gov/outlooks/aeo/tables_ref.php (last accessed May 4, 2018).

As NHTSA understands Congress' original intent for the CAFE program, the goal was to raise fleet-wide fuel economy levels in response to the Arab oil embargo in the 1970s and protect the country from further gasoline price shocks. Those price shocks, while they were occurring, were disruptive to the U.S. economy and significantly affected consumers' daily lives. Congress therefore sought to keep U.S. energy consumption in a safe and sound state for the sake of consumers and the economy, and avoid such shocks in the future. The need of the U.S. to conserve energy, as a factor in determining maximum feasible standards, originally flowed from those concerns.

Today, the conditions that led both to those price shocks and to U.S. energy vulnerability overall have changed significantly. In the late 1970s, the U.S. was a major oil importer, importing 35.8 percent of its oil in 1975, and changes (intentional or not) in the global oil supply had massive domestic consequences, as Congress saw. While oil consumption exceeded domestic production for many years after that, net energy imports peaked in 2005, and since then, oil imports have declined while exports have increased. U.S. domestic oil production began rising in 2009 with more cost-effective drilling and production technologies.³¹

Domestic oil production became more cost-effective for two basic reasons. First, technology improved - the use of horizontal drilling in conjunction with hydraulic fracturing has greatly expanded the ability of producers to profitably recover natural gas and oil from low-permeability geologic plays - particularly, shale plays - and consequently, oil production from shale plays has grown rapidly in recent years.³² And second, rising global oil prices themselves made using those technologies more feasible. As a hypothetical example, if it costs \$79 per barrel to extract oil from a shale play, when the market price for that oil is \$60 per barrel, it is not worth the producer's cost to extract the oil; when the market price is \$80 per barrel, it becomes cost-effective.

Recent analysis further suggests that the U.S. oil supply response to a rise in global prices is much larger now due to the shale revolution, as compared to what it was when U.S. production depended entirely on conventional wells. Unconventional wells may be not only capable of

³¹ Energy Information Administration, "U.S. Energy Facts Explained," <https://www.eia.gov/energyexplained/index.cfm> (last accessed Feb. 20, 2018).

³² Energy Information Administration, "Review of Emerging Resources - U.S. Shale Gas and Shale Oil Plays," July 8, 2011. <https://www.eia.gov/analysis/studies/usshalegas/> (last accessed Feb. 20, 2018). Practical application of horizontal drilling to oil production began in the early 1980s, by which time the advent of improved downhole drilling motors and the invention of other necessary supporting equipment, materials, and technologies (particularly, downhole telemetry equipment) had brought some applications within the realm of commercial viability. *Id.* EIA's AEO 2018 projects that by the early 2040s, tight oil production will account for nearly 70% of total U.S. production, up from 54% of the U.S. total in 2017. *See* "Tight oil remains the leading source of future U.S. crude oil production," EIA, Feb. 22, 2018, available at <https://www.eia.gov/todayinenergy/detail.php?id=35052> (last accessed Feb. 22, 2018).

producing more oil over time, but also may be capable of responding faster to price shocks. One 2017 study concluded that “The long-run price responsiveness of supply is approximately 6 times larger for tight oil on a per well basis, and approximately 9 times larger when also accounting for the rise in unconventional-directed drilling.” That same study further found that “Given a price rise to \$80 per barrel, U.S. oil production could rise by 0.5 million barrels per day in 6 months, 1.2 million in 1 year, 2 million in 2 years, and 3 million in 5 years.”³³ Some analysts suggest that shale drillers can respond more quickly to market conditions because, unlike conventional drillers, they do not need to spend years looking for new deposits, because there are simply so many shale oil wells being drilled, and because they are more productive (although their supply may be exhausted more quickly than a conventional well, the sheer numbers appear likely to make up for that concern).³⁴ Some commenters disagree and suggest that the best deposits are already known and tapped.³⁵ Other commenters raise the possibility that even if the most productive deposits are already tapped, any rises in global oil prices should spur technology development that improves output of less productive deposits.³⁶ Moreover, even if U.S. production increases more slowly than, for example, EIA currently estimates, all increases in U.S. production help to temper global prices and the risk of oil shocks, because they reduce the influence of other producing countries who might seek to raise prices by reducing supply.³⁷

These changes in U.S. oil production methodologies and capacity cannot entirely insulate consumers from the potential for price shocks at the gas pump, because although domestic production may be able to satisfy domestic energy demand, we cannot predict whether domestically produced oil will be distributed domestically or more broadly to the global market. But it appears that domestic supply may dampen the potential for price shocks. As global per-barrel oil prices rise, U.S. production is now much better able to (and does) ramp up in response, pulling those prices back down. Corresponding per-gallon gas prices may not fall overnight,³⁸

³³ Newell, Richard G. and Brian C. Prest, “The Unconventional Oil Supply Boom - Aggregate Price Response from Microdata,” Working Paper 23973, National Bureau of Economic Research, October 2017. Available at <http://www.nber.org/papers/w23973> (last accessed Feb. 22, 2018).

³⁴ See Greg Ip, “America’s Emerging Petro Economy Flips the Impact of Oil,” Wall Street Journal, Feb. 21, 2018. Available at <https://www.wsj.com/articles/americas-emerging-petro-economy-flips-the-impact-of-oil-1519209000> (last accessed Feb. 22, 2018).

³⁵ See, e.g., “Shale Trailblazer Turns Skeptic on Soaring U.S. Oil Production,” Wall Street Journal, Mar. 5, 2018, available at <https://www.wsj.com/articles/shale-trailblazer-turns-skeptic-on-soaring-u-s-oil-production-1520257595>

³⁶ See Raoul LeBlanc, “In the Sweet Spot - The Key to Shale,” Mar. 6, 2018, available at <http://partners.wsj.com/ceraweek/connection/sweet-spot-key-shale/>.

³⁷ See, e.g., Christopher Alessi and Alison Sider, “U.S. Oil Output Expected to Surpass Saudi Arabia, Rivaling Russia for Top Spot,” Wall Street Journal, Jan. 19, 2018, available at <https://www.wsj.com/articles/u-s-crude-production-expected-to-surpass-saudi-arabia-in-2018-1516352405>.

³⁸ To be clear, the fact that the risk of gasoline price shocks may now be lower than in the past is different from arguing that gasoline prices will never rise again at all. The Energy Information Administration tracks and reports on pump prices around the country and we refer readers to their website for the most up-to-date information. EIA projects that the structural changes in the oil market will keep prices below \$4/gallon through 2050. Prices will foreseeably continue to rise and fall with supply and demand changes; the relevant question for the need of the U.S.

but it is certainly foreseeable that they could moderate over time, and likely respond faster than prior to the shale revolution. EIA’s Annual Energy Outlook for 2018 acknowledges uncertainty regarding these new oil sources, but projects that while retail prices of gasoline and diesel will increase between 2018 and 2050, gasoline prices would not exceed \$4/gallon during that timeframe under “reference case” assumptions, i.e., what EIA expects the world to look like given currently-available information.³⁹ The International Energy Agency (IEA)’s Oil 2018 report suggests some concern that excessive focus on investing in U.S. shale oil production may increase price volatility after 2023 if investment is not applied more broadly, but also states that U.S. shale oil is capable of and expected to respond quickly to rising prices in the future, and that American influence on global oil markets is expected to continue to rise.⁴⁰ From the supply side, it is possible that the oil market conditions that created the price shocks in the 1970s may no longer exist.

Regardless of changes in the oil supply market, on the demand side, conditions are also significantly different from the 1970s. If gas prices increase suddenly, American consumers have more options for fuel-efficient new vehicles. Fuel-efficient vehicles were available to purchasers in the 1970s, but they were generally small entry-level vehicles with features that did not meet the needs and preferences of many consumers. Today, manufacturers have responded to fuel economy standards, and offer a wide array of fuel-efficient vehicles in different segments and with a wide range of features. Generally, consumers in 2018 do not have to sacrifice as much as consumers did in the 1970s in terms of other vehicle attributes in order to obtain a fuel-efficient vehicle. If oil prices rise, and consumers decide that they need to buy a more fuel-efficient vehicle in response to that rise, they have options to do so. To some extent, this is a mark of the success of the CAFE program.

Global demand conditions are also different than in previous years. Countries that had very small markets for new light-duty vehicles in the 1970s are now driving global production as their economies improve and growing numbers of middle-class consumers are able to purchase vehicles for personal use. The global increase in drivers inevitably affects global oil demand, which affects oil prices. However, these changes generally occur gradually over time, unlike a disruption that causes a gasoline price shock. Market growth happens relatively gradually and is subject to many different factors. Oil supply markets likely have time to adjust to increases in demand from higher vehicle sales in countries like China and India, and in fact, those increases in demand may temper global prices by keeping production increasing more steadily than if

to conserve energy is not whether there will be *any* movement in prices, but whether that movement is likely to be sudden and large.

³⁹ AEO 2018 at 57, 58. Available at https://www.eia.gov/outlooks/aeo/pdf/AEO2018_FINAL_PDF.pdf (last accessed Feb. 22, 2018).

⁴⁰ See IEA, “Oil 2018 - Analysis and Forecasts to 2023,” Executive Summary. Available at <http://www.iea.org/Textbase/npsum/oil2018MRSsum.pdf> (last accessed Mar. 6, 2018). See also Sarah Kent and Timothy Puko, “U.S. Will Be the World’s Largest Oil Producer by 2023, Says IEA,” Wall Street Journal, March 5, 2018, reporting on remarks at the 2018 CERAWEEK energy conference by IEA Executive Director Fatih Birol.

demand was less certain – clear demand rewards increased production, and increased production can help to reduce the risk of sudden price spikes. It therefore seems unlikely that growth in these vehicle markets could lead to gasoline price shocks. Moreover, even as these vehicle markets grow, it is possible that these and other vehicle markets may be moving away from petroleum usage under the direction of their governments. If this occurs, and global oil production does not fall in response to (theoretically) reduced global demand, then (still theoretically) a higher percentage of global oil production will be available for consumption by the U.S. vehicle fleet. This, too, would seem likely to reduce the risk of gasoline price shocks.

Considering all of the above factors, if gasoline price shocks are no longer as much of a risk as they were when EPCA was originally passed – indeed, if they are no longer much of a risk at all – it seems reasonable to reconsider the need of the United States to conserve oil is today and going forward. Looking to the discussion above on what elements are relevant to the need of the United States to conserve oil, national balance of payments considerations are likely drastically less important than they were in the 1970s, at least in terms of oil imports and vehicle fuel economy. Foreign policy considerations appear to have shifted along with the supply shifts also discussed above.

Whether and how environmental considerations create a need for CAFE standards is, perhaps, more complicated. As discussed earlier in this document, carbon dioxide is a direct byproduct of the combustion of carbon-based fuels in vehicle engines.⁴¹ Many argue that it is likely that human activities, especially emissions of greenhouse gases like carbon dioxide, contribute to the observed climate warming since the mid-20th century.⁴² Even taking that premise as given, it is reasonable to ask whether rapid ongoing increases in CAFE stringency (or even, for that matter, electric vehicle mandates) can sufficiently address climate change to merit their costs.

Some commenters have argued essentially that any petroleum use is destructive because it all adds incrementally to climate change. They argue that as CAFE standards increase, petroleum use will decrease, therefore CAFE standard stringency should increase as rapidly as possible. Other commenters, recognizing that economic practicability is also relevant, have argued essentially that because more stringent CAFE standards produce less CO₂ emissions, NHTSA should simply set CAFE standards to increase at the most rapid of the alternative rates that NHTSA cannot prove is economically devastating. The question here, again, is whether the *additional* fuel saved (and CO₂ emissions avoided) by more rapidly increasing CAFE standards better satisfies the U.S.'s need to avoid destructive or wasteful use of energy than more moderate approaches that more appropriately balance other statutory considerations.

⁴¹ Depending on the energy source, it may also be a byproduct of consumption of electricity by vehicles.

⁴² USGCRP, 2017 - *Climate Science Special Report - Fourth National Climate Assessment, Volume I* [Wuebbles, D.J., D.W. Fahey, K.A. Hibbard, D.J. Dokken, B.C. Stewart, and T.K. Maycock (eds.)]. U.S. Global Change Research Program, Washington, DC, USA, 470 pp, doi - [10.7930/J0J964J6](https://doi.org/10.7930/J0J964J6). Available at <https://science2017.globalchange.gov/> (last accessed Feb. 23, 2018).

In the context of climate change, it is hard to say that increasing CAFE standards is necessary to avoid destructive or wasteful use of energy as compared to somewhat-less-rapidly-increasing CAFE standards. The most stringent of the regulatory alternatives considered in the 2012 final rule and FRIA (under much more optimistic assumptions about technology effectiveness), which would have required a 7 percent average annual fleetwide increase in fuel economy for MYs 2017-2025 compared to MY 2016 standards, was forecasted to only decrease global temperatures in 2100 by 0.02°C in 2100. Under NHTSA’s current proposal, the agency anticipates that global temperatures would increase by only 0.003°C in 2100 compared to the augaral standards. As reported in NHTSA’s Draft EIS, compared to the average global mean surface temperature for 1986-2005, global surface temperatures are still forecast to increase by 3.484-3.487°C, depending on the alternative. Because the impacts of any standards are extremely small, and in fact several-orders-of-magnitude smaller, as compared to the overall forecast increases, this makes it hard for NHTSA to conclude that the climate change effects potentially attributable to the additional energy used, even over the full lifetimes of the vehicles in question, is “destructive or wasteful” enough that the “need of the U.S. to conserve energy” requires NHTSA to place an outsized emphasis on this consideration as opposed to others.⁴³

For example, consider that the U.S. light-duty vehicle fleet currently accounts for roughly 8 percent of world petroleum consumption, and only 3 percent of world CO₂ production. Current DOE projections indicate further declines in these proportions as China, India, and other countries increase motor vehicle ownership and use. Whatever action is taken with respect to U.S. CAFE standards will thus influence only an increasingly small part of worldwide CO₂ production.

TABLE 2-2 - U.S. LIGHT VEHICLE FLEET SHARE OF WORLD PETROLEUM CONSUMPTION⁴⁴

	U.S. Light Vehicle	U.S. Petroleum Consumption	Share of U.S. Petroleum Consumption	World Petroleum Consumption	Share of World Petroleum Consumption

⁴³ The question of whether or how rapidly to increase CAFE stringency is different from the question of whether to set CAFE standards at all. *Massachusetts v. EPA*, 549 U.S. 497 (2007) (“Agencies, like legislatures, do not generally resolve massive problems in one fell regulatory swoop.”)

⁴⁴Sources - U.S. Department of Energy, Energy Information Administration, *Monthly Energy Review*, April 2012. See http://www.eia.gov/totalenergy/data/monthly/pdf/sec3_3.pdf (last accessed April 13, 2018); U.S. Department of Energy, Energy Information Administration, *International Energy Statistics*, Total Petroleum Consumption. See <http://www.eia.gov/cfapps/ipdbproject/IEDIndex3.cfm?tid=5&pid=5&aid=2> (last accessed, May 16, 2012); U.S. Department of Energy, Energy Information Administration, *Annual Energy Outlook 2016* and *Annual Energy Outlook 2018*, Table A11 and Transportation Sector Key Indicators and Delivered Energy Consumption. Available at [https://www.eia.gov/outlooks/aeo/pdf/0383\(2016\).pdf](https://www.eia.gov/outlooks/aeo/pdf/0383(2016).pdf) and <https://www.eia.gov/outlooks/aeo/pdf/appa.pdf> (last accessed April 13, 2018); U.S. Department of Energy, Energy Information Administration, *International Energy Outlook 2017*, Table A5. Available at https://www.eia.gov/outlooks/ieo/pdf/ieotab_5.pdf (last accessed April 13, 2018); U.S. Department of Energy, Office of Energy Efficiency and Renewable Energy, *Transportation Energy*

*** EO 12866 Review – Draft – Do Not Cite, Quote or Release During Review ***

	Petroleum Consumption				
1975	6.1	16.3	37.3%	56.2	10.8%
1985	6.5	15.7	41.1%	60.1	10.7%
1995	7.4	17.7	41.9%	70.1	10.6%
2005	8.9	20.8	42.7%	84.1	10.6%
2009	8.7	18.8	46.2%	84.3	10.3%
2014	8.2	19.1	43.0%	94.4	8.7%
2015	8.0	19.5	41.3%	95.3	8.4%

Data Book, Table 1.16. Available at <http://cta.ornl.gov/data/chapter1.shtml> (last accessed April 13, 2018); U.S. Department of Energy, Energy Information Administration, *Performance Profiles of Major Energy Producers 2009*, Report No. DOE/EIA-0206(09). Available at <https://www.eia.gov/finance/performanceprofiles/pdf/020609.pdf> (last accessed April 16, 2018).

TABLE 2-3 - U.S. LIGHT-DUTY VEHICLE SHARE OF WORLD CO₂ EMISSIONS⁴⁵

	U.S. Light-Duty Vehicle CO ₂ Emissions (million metric tons per year)	U.S. CO ₂ Emissions (million metric tons per year)	Share of U.S. CO ₂ Emissions	World CO ₂ Emissions (million metric tons per year)	Share of World CO ₂ Emissions
1990	888.1	5,121	17.3%	21,689	4.1%
2005	1260.9	6,132	20.6%	28,479	4.4%
2015	1083.5	5,421	20.0%	32,722	3.3%

Consumer costs are the remaining issue considered in the context of the need of the U.S. to conserve energy. NHTSA has argued in the past, somewhat paternalistically, that CAFE standards help to solve consumers’ “myopia” about the value of fuel savings they could receive, when buying a new vehicle, if they chose a more fuel-efficient model. There has been extensive debate over how much consumers do (and/or should) value fuel savings and fuel economy as an attribute in new vehicles, and that debate is addressed in Chapter 7. For purposes of considering the need of the U.S. to conserve energy, the question of consumer costs may be closer to whether U.S. consumers *so need* to save money on fuel that they must be required to save substantially more fuel (through purchasing a new vehicle made more fuel-efficient by more stringent CAFE standards) than they would otherwise choose.

Again, when EPCA originally passed, Congress was trying to protect U.S. consumers from the negative effects of another gasoline price shock. It appears much more likely today that oil prices will rise only moderately in the future, and that price shocks are less likely. Accordingly, it is reasonable to believe that U.S. consumers value future fuel savings accurately, and choose new vehicles based on that view. This is particularly true, because federal law requires that new vehicles be posted with a window sticker providing estimated costs or savings over a five year period compared to average new vehicles.⁴⁶ Even if consumers do not explicitly think to themselves “this new car will save me \$5,000 in fuel costs over its lifetime compared to that other new car,” gradual and relatively predictable fuel price increases in the foreseeable future

⁴⁵ Sources - Environmental Protection Agency, Greenhouse Gas Data Explorer. Available at <https://www3.epa.gov/climatechange/ghgemissions/inventoryexplorer/#allsectors/allgas/econsect/all> (last accessed April 16, 2018); Environmental Protection Agency, *Inventory of U.S. Greenhouse Gas Emissions and Sinks - 1990-2015*, Report No. EPA 430-P-17-001. Available at https://www.epa.gov/sites/production/files/2017-02/documents/2017_complete_report.pdf (last accessed April 16, 2018); U.S. Department of Energy, Energy Information Administration, International Energy Statistics. Available at <https://www.eia.gov/beta/international/data/browser/index.cfm#/> (last accessed April 16, 2018); U.S. Department of Energy, Energy Information Administration, *Annual Energy Outlook 2018*. Available at <https://www.eia.gov/outlooks/aeo/data> (last accessed April 16, 2018); U.S. Department of Energy, Energy Information Administration, *International Energy Outlook 2017*. Available at <https://www.eia.gov/outlooks/aeo/data> (last accessed April 16, 2018).

⁴⁶ 49 CFR 575.401; 40 CFR 600.302-12.

*** EO 12866 Review – Draft – Do Not Cite, Quote or Release During Review ***

allow consumers to roughly estimate the comparative value of fuel savings among vehicles and choose the amount of fuel savings that they want, in light of the other vehicle attributes they value. It seems, then, that consumer cost as an element of the need of the U.S. to conserve energy is also less urgent in the context of the structural changes in oil markets over the last several years.

Given the discussion above, NHTSA tentatively concludes that the need of the U.S. to conserve energy may no longer function as assumed in previous considerations of what CAFE standards would be maximum feasible. The overall risks associated with the need of the U.S. to conserve oil have entered a new paradigm with the risks substantially lower today and projected into the future than when CAFE standards were first issued and in the recent past. The effectiveness of CAFE standards in reducing the demand for fuel combined with the increase in domestic oil production have contributed significantly to the current situation and outlook for the near- and mid-term future. The world has changed, and the need of the U.S. to conserve energy, at least in the context of the CAFE program, has also changed.

2.2 The CAA and Climate Change Resulting from Light-Duty Vehicle Use

[text will be forthcoming]

3 Proposed and Alternative CAFE and CO₂ standards for MYs 2021-2026

3.1 Form of the Standards

NHTSA and EPA are proposing the form of the CAFE and CO₂ standards for MYs 2021-2026 would follow the form of those standards in prior model years. NHTSA has specific statutory requirements for the form of CAFE standards - specifically, EPCA, as amended by EISA, requires CAFE standards be issued separately for passenger cars and light trucks, and each standard must be specified as a mathematical function expressed in terms of one or more vehicle attributes related to fuel economy. While the CAA includes no specific requirements regarding GHG regulation, EPA has chosen to adopt standards consistent with the EPCA/EISA requirements in the interest of simplifying compliance for the industry since 2010.⁴⁷

For MYs since 2011 for CAFE and since 2012 for CO₂, standards have taken the form of fuel economy and CO₂ targets expressed as functions of vehicle footprint (the product of vehicle wheelbase and average track width). NHTSA and EPA continue to believe footprint is the most appropriate attribute on which to base the proposed standards, as discussed in Preamble Section II.C. Under footprint-based standards, the function defines a CO₂ or fuel economy performance target for each unique footprint combination within a car or truck model type. Using the functions, each manufacturer will have a CAFE and CO₂ average standard for each year that is unique to each of its fleets,⁴⁸ depending on the footprints and production volumes of the vehicle models produced by that manufacturer. A manufacturer will have separate footprint-based standards for cars and for trucks. The functions are mostly sloped, so that generally, larger vehicles (i.e., vehicles with larger footprints) will be subject to lower CAFE mpg targets and higher CO₂ grams/mile targets than smaller vehicles. This is because, generally speaking, smaller vehicles are more capable of achieving higher levels of fuel economy/lower levels of CO₂ emissions because they tend not to have to work as hard to perform their driving tasks. Although a manufacturer's fleet average standards could be estimated throughout the model year based on the projected production volume of its vehicle fleet (and are estimated as part of EPA's certification process), the standards to which the manufacturer must comply will be determined by its final model year production figures. A manufacturer's calculation of its fleet average standards as well as its fleet's average performance at the end of the model year will be based on the production-weighted average target and performance of each model in its fleet.⁴⁹

⁴⁷ Such an approach is permissible under Section 202(a) of the CAA, and EPA has used the attribute-based approach in issuing standards under analogous provisions of the CAA.

⁴⁸ EPCA/EISA requires NHTSA to separate passenger cars into domestic and import passenger car fleets whereas EPA combines all passenger cars into one fleet.

⁴⁹ As in prior rulemakings, a manufacturer may have some vehicle models that exceed their target, and some that are below their target. Compliance with a fleet average standard is determined by comparing the fleet average standard (based on the production-weighted average of the target levels for each model) with fleet average performance (based on the production-weighted average of the performance of each model).

For passenger cars, consistent with prior rulemakings, NHTSA is proposing to define fuel economy targets as follows:

EQUATION 3-1 - PASSENGER CAR FUEL ECONOMY TARGET CALCULATION

$$TARGET_{FE} = \frac{1}{MIN \left[MAX \left(c \times FOOTPRINT + d, \frac{1}{a} \right), \frac{1}{b} \right]}$$

where

$TARGET_{FE}$ is the fuel economy target (in mpg) applicable to a specific vehicle model type with a unique footprint combination,

a is a minimum fuel economy target (in mpg),

b is a maximum fuel economy target (in mpg),

c is the slope (in gallons per mile per square foot, or gpm, per square foot) of a line relating fuel consumption (the inverse of fuel economy) to footprint, and

d is an intercept (in gpm) of the same line.

Here, MIN and MAX are functions that take the minimum and maximum values, respectively, of the set of included values. For example, $MIN[40,35] = 35$ and $MAX(40, 25) = 40$, such that $MIN[MAX(40, 25), 35] = 35$.

For light trucks, also consistent with prior rulemakings, NHTSA is proposing to define fuel economy targets as follows:

EQUATION 3-2 - LIGHT TRUCK FUEL ECONOMY TARGET CALCULATION

$$TARGET_{FE} = MAX \left(\frac{1}{MIN \left[MAX \left(c \times FOOTPRINT + d, \frac{1}{a} \right), \frac{1}{b} \right]}, \frac{1}{MIN \left[MAX \left(g \times FOOTPRINT + h, \frac{1}{e} \right), \frac{1}{f} \right]} \right)$$

where

$TARGET_{FE}$ is the fuel economy target (in mpg) applicable to a specific vehicle model type with a unique footprint combination,

$a, b, c,$ and d are as for passenger cars, but taking values specific to light trucks,

e is a second minimum fuel economy target (in mpg),

f is a second maximum fuel economy target (in mpg),

g is the slope (in gpm per square foot) of a second line relating fuel consumption (the inverse of fuel economy) to footprint, and

h is an intercept (in gpm) of the same second line.

Although the general model of the target function equation is the same for each vehicle category (passenger cars and light trucks) and each model year, parameters of the function equation differ

*** EO 12866 Review – Draft – Do Not Cite, Quote or Release During Review ***

for cars and trucks. For MYs 2020-2026, parameters are unchanged, resulting in the same stringency in each of those model years.

Mathematical functions defining the proposed CO₂ targets are expressed as functions that are similar, with coefficients *a-h* corresponding to those listed above.⁵⁰ For passenger cars, EPA is proposing to define CO₂ targets as follows:

EQUATION 3-3 - PASSENGER CAR CO₂ TARGET

$$TARGET_{CO_2} = MIN[b, MAX[a, c \times FOOTPRINT + d]]$$

where

TARGET_{CO2} is the CO₂ target (in grams per mile, or g/mi) applicable to a specific vehicle model configuration,

a is a minimum CO₂ target (in g/mi),

b is a maximum CO₂ target (in g/mi),

c is the slope (in g/mi, per square foot) of a line relating CO₂ emissions to footprint, and

d is an intercept (in g/mi) of the same line.

For light trucks, CO₂ targets are defined as follows:

EQUATION 3-4 - LIGHT TRUCK CO₂ TARGET

$$TARGET_{CO_2} = MIN[MIN[b, MAX[a, c \times FOOTPRINT + d]], MIN[f, MAX[e, g \times FOOTPRINT + h]]$$

where

TARGET_{CO2} is the CO₂ target (in g/mi) applicable to a specific vehicle model configuration,

a, *b*, *c*, and *d* are as for passenger cars, but taking values specific to light trucks,

e is a second minimum CO₂ target (in g/mi),

f is a second maximum CO₂ target (in g/mi),

g is the slope (in g/mi per square foot) of a second line relating CO₂ emissions to footprint, and

h is an intercept (in g/mi) of the same second line.

To be clear, as has been the case since the agencies began establishing attribute-based standards, no single vehicle needs to meet the specific applicable fuel economy or CO₂ targets because compliance with either CAFE or CO₂ standards is determined based on corporate average fuel economy or average CO₂ emission rates. The required CAFE level applicable to a given fleet in a given model year is determined by calculating the production-weighted harmonic average of fuel economy targets applicable to specific vehicle model configurations in the fleet, as follows:

⁵⁰ EPA regulations use a different but mathematically equivalent approach to specify targets. Rather than using a function with nested minima and maxima functions, EPA regulations specify requirements separately for different ranges of vehicle footprint. Because these ranges reflect the combined application of the listed minima, maxima, and linear functions, it is mathematically equivalent and more efficient to present targets as in this section.

EQUATION 3-5 - REQUIRED FLEET FUEL ECONOMY TARGET

$$CAFE_{required} = \frac{\sum_i PRODUCTION_i}{\sum_i \frac{PRODUCTION_i}{TARGET_{FE,i}}}$$

where

$CAFE_{required}$ is the CAFE level the fleet is required to achieve,
 i refers to specific vehicle model/configurations in the fleet,
 $PRODUCTION_i$ is the number of model configuration i produced for sale in the U.S.,

and

$TARGET_{FE,i}$ the fuel economy target (as defined above) for model configuration i .

Similarly, the required average CO₂ level applicable to a given fleet in a given model year is determined by calculating the production-weighted average (not harmonic) of CO₂ targets applicable to specific vehicle model configurations in the fleet, as follows:

EQUATION 3-6 - REQUIRED FLEET CO₂ TARGET

$$CO2_{required} = \frac{\sum_i PRODUCTION_i \times TARGET_{CO2,i}}{\sum_i PRODUCTION_i}$$

where

$CO2_{required}$ is the average CO₂ level the fleet is required to achieve,
 i refers to specific vehicle model/configurations in the fleet,
 $PRODUCTION_i$ is the number of model configuration i produced for sale in the U.S., and
 $TARGET_{CO2,i}$ is the CO₂ target (as defined above) for model configuration i .

The NPRM seeks comment on these alternatives and on the analysis presented therein, in addition to any relevant information and data. That review could lead the agencies to select one of the other regulatory alternatives for the final rule.

3.2 Reconsideration of Footprint Curve Shapes

As a part of this *de novo* rulemaking process, NHTSA is committed to reconsidering the mathematical function relating the fuel economy target for a given model to the chosen attribute for MY's 2021 through 2026 standards. In efforts to harmonize with NHTSA, EPA has also reconsidered the attribute relationship used to define CO₂ standards. This reconsideration included both the attribute chosen to define the standards, and the specific mathematical function used to do so. increase with increasing footprint), is theoretically vague, and quantitatively uncertain; in other words, not so precise as to *a priori* yield only a single possible curve.

The decision of how to specify this mathematical function therefore reflects some amount of judgment. The agencies can specify the function with a view toward achieving different

environmental and petroleum reduction goals, encouraging different levels of application of fuel-saving technologies, avoiding any adverse effects on overall highway safety, reducing disparities of manufacturers' compliance burdens, and preserving consumer choice, among other aims. The following are among the specific technical concerns and resultant policy tradeoffs considered in selecting the details of specific past and future curve shapes -

- Flatter standards (i.e., curves) increase the risk that both the size of vehicles will be reduced, potentially compromising highway safety, and reducing any utility consumers would have gained from a larger vehicle.
- Steeper footprint-based standards may create incentives to upsize vehicles, potentially oversupplying vehicles of certain footprints beyond what consumers would naturally demand, and thus increasing the possibility that fuel savings and CO₂ reduction benefits will be forfeited artificially.
- Given the same industry-wide average required fuel economy or CO₂ standard, flatter standards tend to place greater compliance burdens on full-line manufacturers.
- Given the same industry-wide average required fuel economy or CO₂ standard, dramatically steeper standards tend to place greater compliance burdens on limited-line manufacturers (depending of course, on which vehicles are being produced).
- If cutpoints are adopted, given the same industry-wide average required fuel economy, moving small-vehicle cutpoints to the left (*i.e.*, up in terms of fuel economy, down in terms of CO₂ emissions) discourages the introduction of small vehicles, and reduces the incentive to downsize small vehicles in ways that could compromise overall highway safety.
- If cutpoints are adopted, given the same industry-wide average required fuel economy, moving large-vehicle cutpoints to the right (*i.e.*, down in terms of fuel economy, up in terms of CO₂ emissions) better accommodates the design requirements of larger vehicles—especially large pickups—and extends the size range over which downsizing is discouraged.

3.3 What mathematical functions have the agencies previously used, and why?

Data should inform any target curve, but how relevant data is defined and interpreted, as well as the choice of methodology for fitting a curve to that data, must include some consideration of specific policy goals. This section summarizes the methodologies and policy concerns considered in developing previous target curves, including those that define the MYs 2017-2021 CAFE standards and the MYs 2022-2025 augural CAFE standards (for a complete discussion see the 2012 FRIA). For further context, Figure 3-1 and Figure 3-2 show the history of final light duty footprint-based curves specified in MPG rather than gpm for MYs 2011-2021 for light trucks and passenger cars, respectively.

*** EO 12866 Review – Draft – Do Not Cite, Quote or Release During Review ***

FIGURE 3-1 - FINAL LIGHT TRUCK MPG TARGET CURVES FOR MYs 2011-2021

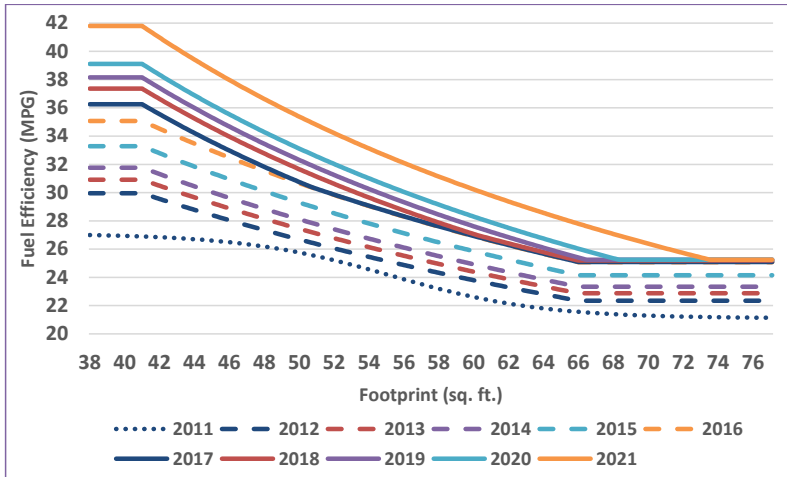
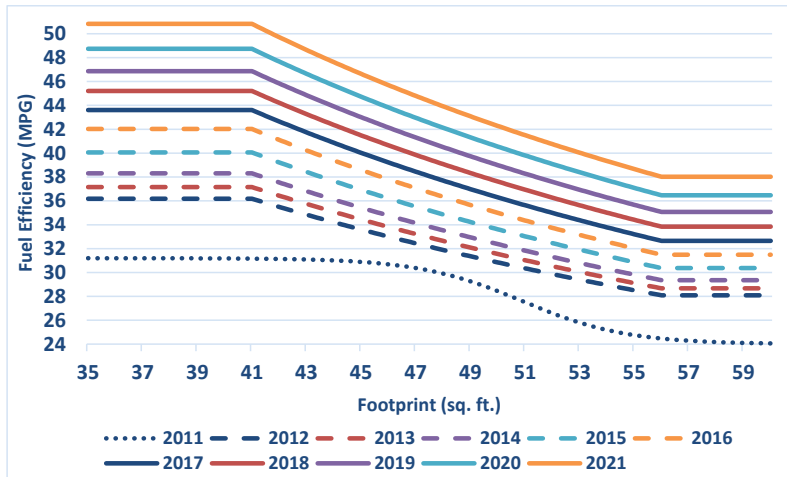

FIGURE 3-2 - FINAL PASSENGER CAR MPG TARGET CURVES FOR MYs 2011-2021



As discussed below, the MY 2011 final curves followed a constrained logistic function defined specifically in the final rule.⁵¹ The MY 2012-2021 final standards and the MY 2022-2025 proposed augural standards are defined by constrained linear target functions of footprint as defined below⁵²:

EQUATION 3-7 - CONSTRAINED LINEAR TARGET FUNCTION

$$Target = \frac{1}{\min\left(\max\left(c * Footprint + d, \frac{1}{a}\right), \frac{1}{b}\right)}$$

Here, Target is the fuel economy target applicable to vehicles of a given footprint in square feet (Footprint). The upper asymptote, a, and the lower asymptote, b, are specified in MPG; the reciprocal of these values represent the lower and upper asymptotes, respectively, when the curve is instead specified in gallons per mile (gpm). The slope, c, and the intercept, d, of the linear portion of the curve are specified as gpm per change in square feet, and gpm, respectively.

The min and max functions will take the minimum and maximum values within their associated parentheses. Thus, the max function will first find the maximum of the fitted line at a given footprint value and the lower asymptote from the perspective of gpm. If the fitted line is below the lower asymptote it is replaced with the floor, which is also the minimum of the floor and the ceiling by definition so that the target in MPG space will be the reciprocal of the floor in mpg space, or simply, a. If, however, the fitted line is not below the lower asymptote, the fitted value is returned from the max function and the min function takes the minimum value of the upper asymptote (in gpm space) and the fitted line. If the fitted value is below the upper asymptote, it is between the two asymptotes and the fitted value is appropriately returned from the min function, making the overall target in MPG the reciprocal of the fitted line in gpm. If the fitted value is above the upper asymptote, the upper asymptote is returned is returned from the min function, and the overall target in MPG is the reciprocal of the upper asymptote in gpm space, or b.

In this way curves specified as constrained linear functions are specified by the following parameters:

- a* = upper limit (mpg)
- b* = lower limit (mpg)
- c* = slope (gpm per sq. ft.)
- d* = intercept (gpm)

⁵¹ See 74 FR 14196, 14363-14370 (Mar., 30, 2009) for NHTSA discussion of curve fitting in the MY 2011 CAFE final rule.

⁵² The right cutpoint for the light truck curve was moved further to the right for MY's 2017-2021, so that more possible footprints would fall on the sloped part of the curve. In order to ensure that, for all possible footprints, future standards would be at least as high as MY 2016 levels, the final standards for light trucks for MY's 2017-2021 is the maximum of the MY 2016 target curves and the target curves for the give MY standard. This is defined further in the 2012 FRM.

The slope and intercept are specified as gpm per sq. ft. and gpm instead of MPG per sq. ft. and MPG because CAFE requirements are specified on an mpg basis, but the agencies have expressed the relationship to footprint as being linear with respect to the reciprocal of fuel economy — i.e., gpm. Notice that the sloped portion of the target curves in and is non-linear. Compare Figure 3-3 and Figure 3-4, below, with Figure 3-1 and Figure 3-2, above, and notice that the sloped parts of the target curves are linear when specified as a gpm target rather than as a MPG target.

FIGURE 3-3 - FINAL LIGHT TRUCK GPM TARGET CURVES FOR MYS 2011-2021

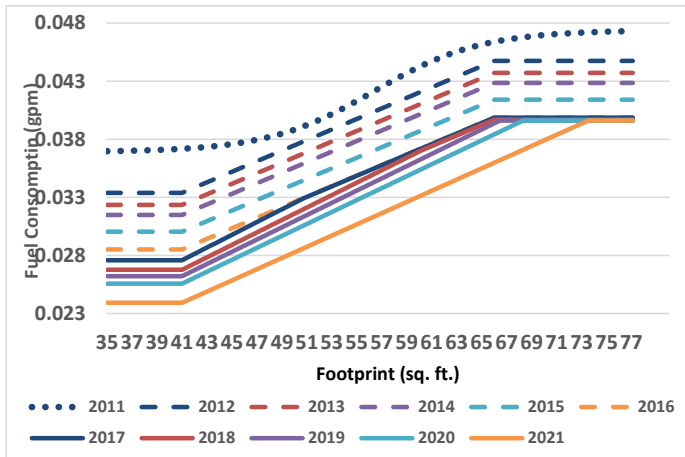
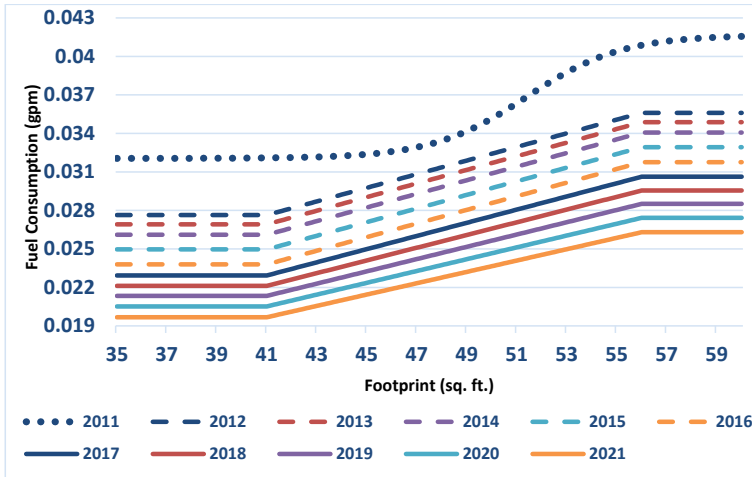

FIGURE 3-4 - FINAL PASSENGER CAR GPM TARGET CURVES FOR MYs 2011-2021



3.3.1 NHTSA in MY 2008 and MY 2011 CAFE (constrained logistic)

For the MY 2011 CAFE rule, NHTSA estimated fuel economy levels by footprint from the MY 2008 fleet after normalization for differences in technology,⁵³ but did not make adjustments to reflect other vehicle attributes (e.g., power-to-weight ratios). Starting with the technology-adjusted passenger car and light truck fleets, NHTSA used minimum absolute deviation (MAD) regression without sales weighting to fit a logistic form as a starting point to develop mathematical functions defining the standards. NHTSA then identified footprints at which to apply minimum and maximum values (rather than letting the standards extend without limit) and transposed these functions vertically (i.e., on a gallons-per-mile basis, uniformly downward) to produce the promulgated standards. In the preceding rule, for MYs 2008-2011 light truck standards, NHTSA examined a range of potential functional forms, and concluded that, compared to other considered forms, the constrained logistic form provided the expected and appropriate trend (decreasing fuel economy as footprint increases), but avoided creating “kinks” the agency was concerned would provide distortionary incentives for vehicles with neighboring footprints.⁵⁴

3.3.2 MYs 2012-2016 Light Duty GHG/CAFE (constrained linear)

⁵³ See 74 FR 14196, 14363-14370 (Mar., 30, 2009) for NHTSA discussion of curve fitting in the MY 2011 CAFE final rule.

⁵⁴ See 71 FR 17556, 17609-17613 (Apr. 6, 2006) for NHTSA discussion of “kinks” in the MYs 2008-2011 light truck CAFE final rule (there described as “edge effects”). A “kink”, as used here, is a portion of the curve where a small change in footprint results in a disproportionately large change in stringency.

For the MYs 2012-2016 rule, the agencies jointly reevaluated potential methods for specifying mathematical functions to define fuel economy and GHG standards. NHTSA fit these methods to the same MY 2008 data as the MY 2011 standard. Considering these further specifications, NHTSA concluded that the constrained logistic form, if applied to post-MY 2011 standards, would likely contain a steep mid-section that would provide undue incentive to increase the footprint of midsize passenger cars.⁵⁵ The agencies judged that a range of methods to fit the curves would be reasonable, and used a minimum absolute deviation (MAD) regression without sales weighting on a technology-adjusted car and light truck fleet to fit a linear equation. This equation was used as a starting point to develop mathematical functions defining the standards. The agencies then identified footprints at which to apply minimum and maximum values (rather than letting the standards extend without limit). Finally, the agencies transposed these constrained/piecewise linear functions vertically (i.e., on a gpm or CO₂ basis, uniformly downward) by multiplying the initial curve by a single factor for each MY standard to produce the final attribute-based targets for passenger cars and light trucks described in the final rule.⁵⁶ The agencies typically present these transformations as percentage improvements over a previous MY target curve.

3.3.3 MYs 2017-2021 and Proposed MYs 2022-2025 Light Duty GHG/CAFE (constrained linear)

The mathematical functions finalized for the MYs 2017-2021 standards, and proposed as the augural MYs 2022-2025 standards, changed somewhat from the functions for the MYs 2012-2016 standards. These changes were made to both address comments from stakeholders, and to further consider some of NHTSA's technical concerns and policy goals judged more preeminent under the increased uncertainty of the impacts of finalizing and proposing standards for model years further into the future.⁵⁷ The agencies recognized full-line OEM concerns and concluded that further increases in the stringency of the light truck standards would be more feasible if the light truck curve is made steeper than the MY 2016 truck curve and the right (large footprint) cut-point is extended over time to larger footprints. To accommodate these considerations, NHTSA chose for the 2012 final rule to finalize the slope fit to the MY 2008 fleet using a sales-weighted, ordinary least-squares regression, using a fleet that had technology applied to make the technology application across the fleet more uniform, and after adjusting the data for the effects of weight-to-footprint. The agencies also considered information from an updated MY 2010 fleet to support this decision. As the agencies vertically shifted the curve (with fuel economy

⁵⁵ 75 FR at 25362.

⁵⁶ See generally 74 FR at 49491-96; 75 FR at 25357-62.

⁵⁷ The MYs 2012-2016 final standards were signed April 1, 2010 — putting 6.5 years between its signing and the last affected model year, and the MYs 2017-2021 final standards were signed August 28th, 2012 — giving just over 9 years between its signing and the last affected final standards. NHTSA also proposed standards MY 2022-2025 with the understanding that they would be revisited concurrent with EPA's mid-term evaluation so changes could be made if the proposed standards were no longer deemed appropriate. The next section fulfills the commitment to consider new mathematical functions for MY 2022-2025.

specified as MPG instead of gpm or CO₂ emissions) upwards, the agencies progressively moved the right cutpoint for the light truck curves with successive model years, reaching the final endpoint for MY 2021, as shown in Figure 3-1, above. These decisions for the 2012 final rule are defended further in the supporting 2012 Technical Support Document (TSD), where other considered curves are also presented.⁵⁸

3.4 How did the agencies reconsider the curves for the final MYs 2022-2025 standards?

3.4.1 Why is it important to reconsider the footprint curve shape?

By shifting the developed curves by a single factor, as described above, it is assumed that the underlying relationship of fuel consumption (in gallons per mile) to vehicle footprint does not change significantly from the model year data used to fit the curves to the range of model years for which the shifted curve shape is applied to develop the standards. However, the relationship between vehicle footprint and fuel economy is not necessarily constant over time; newly developed technologies, and changes in consumer demand could influence the observed relationships between the two vehicles characteristics. For example, if certain technologies are more effective or more marketable for certain types of vehicles, their application may not be uniform over the range of vehicle footprints. Further, if market demand has shifted between vehicle types, so that certain vehicles make up a larger share of the fleet, any underlying technological or market restrictions which inform the average shape of the curves could change. That is, changes in the technology or market restrictions themselves, or a mere re-weighting of different vehicles types could reshape the fit curves.

For the above reasons, the curve shapes were reconsidered using the newest available data, from MY 2016. With a view toward corroboration through different techniques, a range of descriptive statistical analyses that do not require underlying engineering models of how fuel economy and footprint might be expected to be related were conducted. Also a separate analysis that uses vehicle simulation results as the basis to estimate the relationship from a perspective more explicitly informed by engineering theory was conducted. Despite changes in the new vehicle fleet both in terms of technologies applied and in market demand, the underlying statistical relationship between footprint and fuel economy has not changed significantly since the MY 2008 fleet used for the 2012 final rule, and therefore it is proposed to continue to use the curve shapes fit in 2012. The analysis and reasoning supporting this decision are as follows.

3.4.2 What statistical analyses did the agencies consider?

⁵⁸ EPA and NHTSA, Joint Technical Support Document for Final Rulemaking for 2017-2025 Light-Duty Vehicle Greenhouse Gas Emission Standards and Corporate Average Fuel Economy Standards, EPA-420-R-12-901, 2012, Chapter 2.

In assessing how to address the various policy concerns discussed above, the analysis considered data from the MY 2016 fleet and performed a number of descriptive statistical analyses (i.e., involving observed fuel economy levels and footprints) using various statistical methods, weighting schemes, and adjustments to the data to make the fleets less technologically heterogeneous. There were several adjustments to the data that were common to all of the statistical analyses considered.

With a view toward isolating the relationship between fuel economy and footprint, the few diesels in the fleet, as well as the limited number of vehicles with partial or full electric propulsion were excluded. When the fleet is normalized so that technology is more homogenous, application of these technologies is not allowed. This is consistent with the methodology used in the 2012 final rule.

The above adjustments were applied to all statistical analyses the agencies considered, regardless of the specifics of each of the methods, weights, and technology level of the data, used to view the relationship of vehicle footprint and fuel economy. Table 3-1, below, summarizes the different assumptions we considered and the key attributes of each. The analysis was performed considering all possible combinations of these assumptions, producing a total of eight footprint curves.

TABLE 3-1 - SUMMARY OF ASSUMPTIONS CONSIDERED IN THE STATISTICAL ANALYSIS OF THE CURRENT FOOTPRINT-FE RELATIONSHIP

Varying Assumptions	Regression Type		Regression Weights		Technology Level	
	<i>OLS</i>	<i>MAD</i>	<i>Production-weighted</i>	<i>Model-weighted</i>	<i>Current Technology</i>	<i>Max. Technology</i>
Alternatives Considered						
Details	Ordinary Least Squares Regression	Minimum Absolute Deviation Regression	Points weighted by production volumes of each model.	Equal weight for each model; collapses points with similar - footprint, FE, and curb weight. ⁵⁹	Current MY 2016 tech., excluding - HEV, PHEV, BEV, and FCV.	Maximum tech. applied, excluding - HEV, PHEV, BEV, and FCV.
Key Attributes	Describes the average relationship between footprint and fuel economy; outliers can skew results.	Describes the median relationship between footprint and fuel economy; does not give outliers as much weight.	Tends towards higher-volume models; may systematically disadvantage manufacturers who produce fewer vehicles.	Tends towards the space of the joint distribution of footprint and FE with the most models; gives low-volume models equal weight.	Describes current market, including demand factors; may miss changes in curve shape due to advanced technology application.	Captures relationship with homogenous technology application; may miss varying demand considerations for different segments.

⁵⁹ We assume models from the same manufacturer where the footprint is within 0.1 square feet, fuel consumption is within 3% and curb weights are within 1000 pounds are variants of the same model. We collapse the fuel consumption and footprint values to be the production-weighted average of all models that meet this criterion. This ensures that manufacturers who have many models which vary slightly by footprint and/or fuel economy do not have these models counted multiple times in the model-weighted regressions.

3.4.2.1 Current Technology Level Curves

In this next section the analysis compares the “current technology” level curves built using both regression types and both regression weight methodologies from the MY 2008, MY 2010, and MY 2016 fleets. The current technology level curves exclude HEV, PHEV, BEV, and FCV vehicles, and adjust diesel vehicle fuel economy values as discussed above, but make no other changes to each model year fleet. Comparing the MY 2016 curves to ones built under the same methodology from previous model year fleets, allows us to discern whether the observed curve shape has changed significantly over time as standards have become more stringent. Importantly, these curves will include any market forces which make technology application variable over the distribution of footprint. These market forces will not be present in the “maximum technology” level curves; by making technology levels homogenous, we remove this variation. Figure 3-5 and

Figure 3-6 show the slope of the production-weighted regressions using an ordinary least squares (OLS) and minimum absolute deviation (MAD) regressions, respectively, for the MY 2008, MY 2010, and MY 2016 light truck fleets. The size of the points varies with the production of that vehicle model. Both production-weighted regressions suggest that the slope of the curves have gotten progressively steeper for light trucks over time. Notice the increase in the production of smaller, more efficient vehicles on the light truck curve for MY 2016 relative to MY’s 2010 or 2008. Recent trends in vehicle sales include higher sales of crossover vehicles, likely driving this result.

FIGURE 3-5 - LIGHT TRUCK CURVES FIT WITH A SALES-WEIGHTED OLS REGRESSION FROM THE FULL DATASET

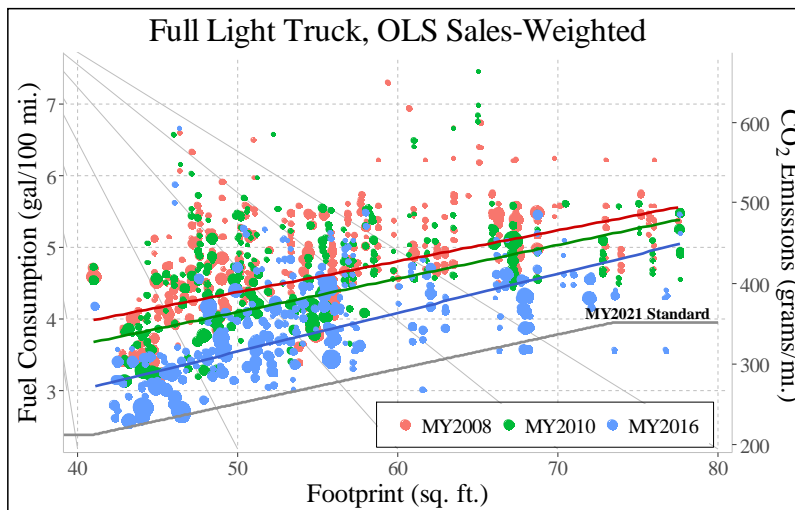
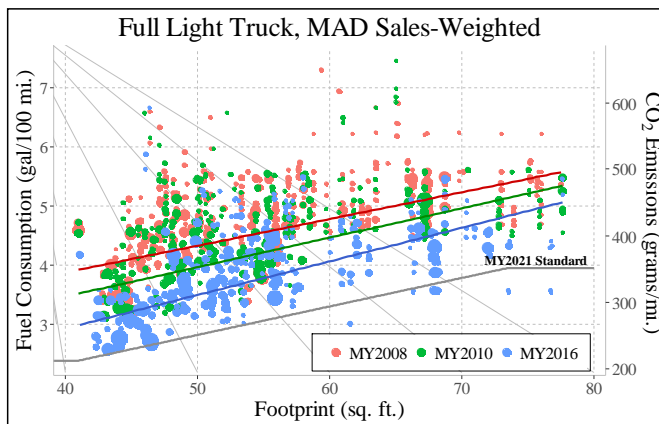

FIGURE 3-6 - LIGHT TRUCK CURVES FIT WITH A SALES-WEIGHTED MAD REGRESSION FROM THE FULL DATASET



WHILE A CHANGE IN CONSUMER DEMAND HAS SHIFTED THE FITTED LINES FOR LIGHT TRUCKS SO THAT THEY HAVE A STEEPER SLOPE, WHEN CONSIDERING REGRESSIONS WHERE EACH UNIQUE MODEL IS WEIGHTED EQUALLY THE SLOPE HAS NOT NOTICEABLY CHANGED BECAUSE IT WAS BUILT FROM THE MY 2010 FLEET, SEE FIGURE 3-7 AND

Figure 3-8. This suggests that the slope of the linear relationship of the average and median achieved fuel economy of a model to its footprint has not significantly changed—manufacturers appear to have applied technologies evenly across the fleet, and the change in the production-weighted slopes are largely due to changes in fleet mix across the joint distribution of footprint and fuel economy.

FIGURE 3-7 - LIGHT TRUCK CURVES FIT WITH AN UNWEIGHTED OLS REGRESSION FROM THE COLLAPSED DATASET

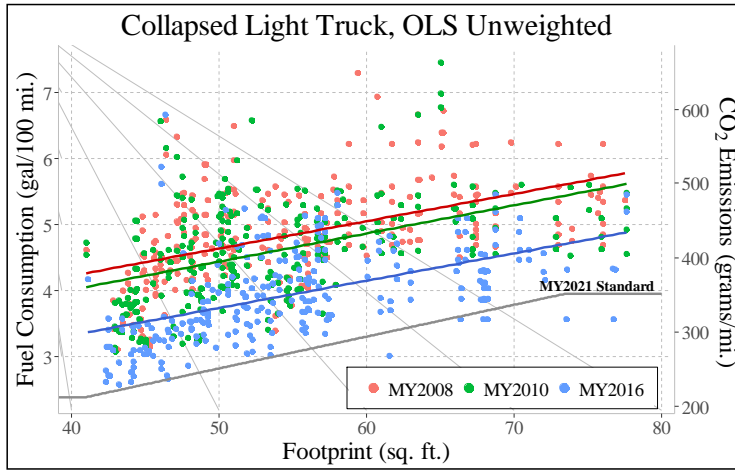
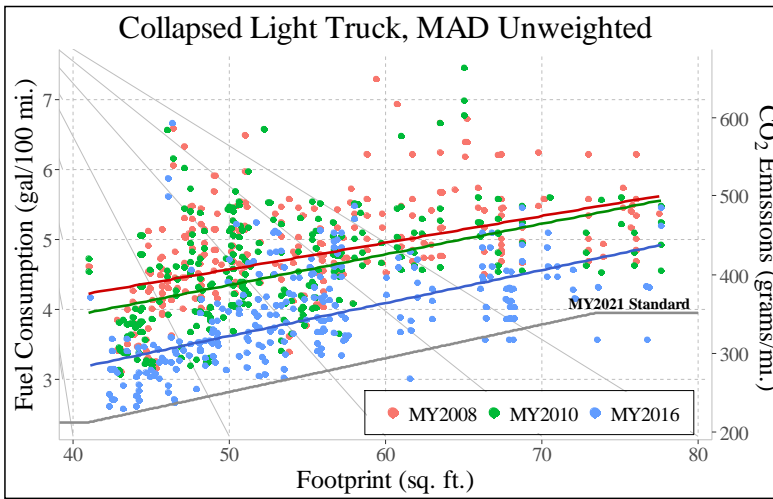

FIGURE 3-8 - LIGHT TRUCK CURVES FIT WITH AN UNWEIGHTED MAD REGRESSION FROM THE COLLAPSED DATASET



The production-weighted passenger car curves suggest that the average relationship between fuel economy and footprint (represented by the OLS regression in Figure 3-9) has become shallower

*** EO 12866 Review – Draft – Do Not Cite, Quote or Release During Review ***

over time, and that the median relationship between fuel economy and footprint (represented by the MAD regression in

Figure 3-10) has become steeper over time. This suggests that there is no obvious directional change in the production-weighted slope.

FIGURE 3-9 - PASSENGER CAR CURVES FIT WITH A SALES-WEIGHTED OLS REGRESSION FROM THE FULL DATASET

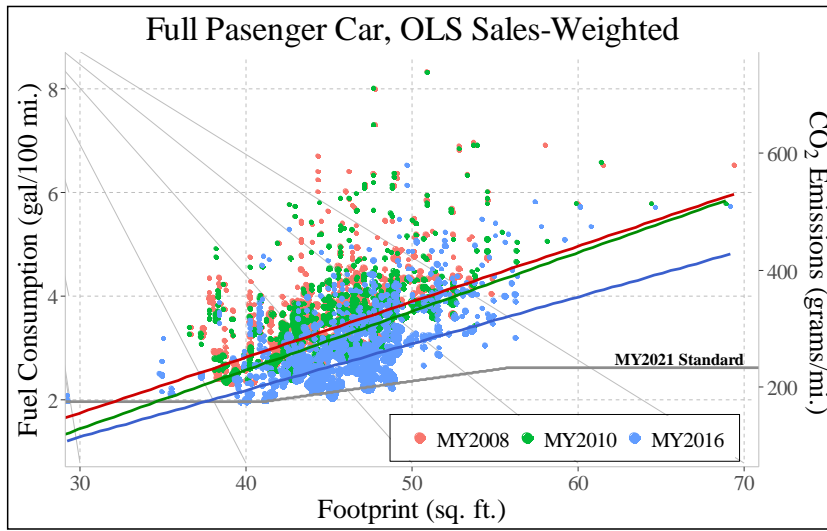
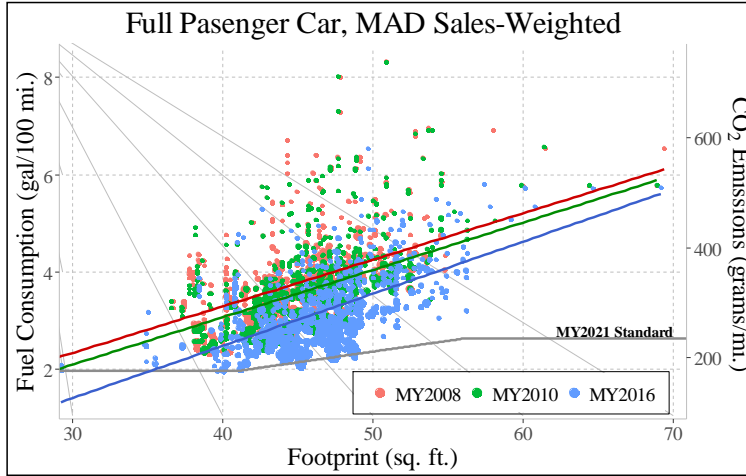

FIGURE 3-10 - PASSENGER CAR CURVES FIT WITH A SALES-WEIGHTED MAD REGRESSION FROM THE FULL DATASET



The model-weighted regressions suggest that the average relationship between footprint and fuel economy for passenger cars has become slightly shallower over time (as shown in Figure 3-11), and that the median relationship between footprint and fuel economy has become very slightly steeper over time (as shown in Figure 3-12). The small changes in the slopes of the model-weighted regressions suggest that technology application has been largely uniform over the fleet.

FIGURE 3-11 - PASSENGER CAR CURVES FIT WITH AN UNWEIGHTED OLS REGRESSION FROM THE COLLAPSED DATASET

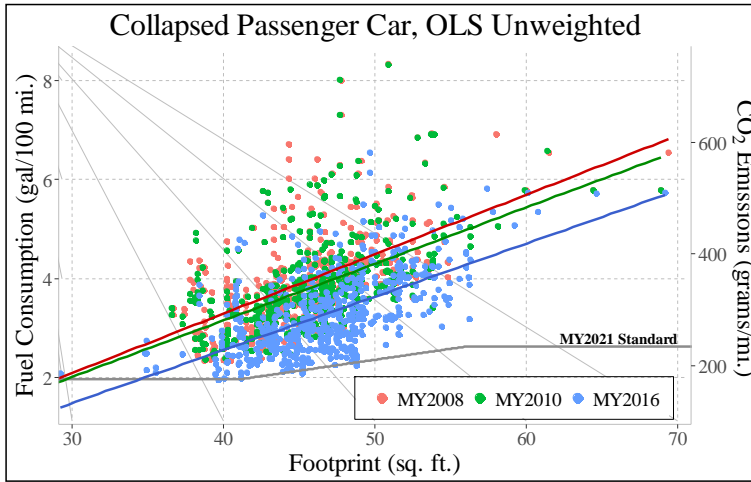
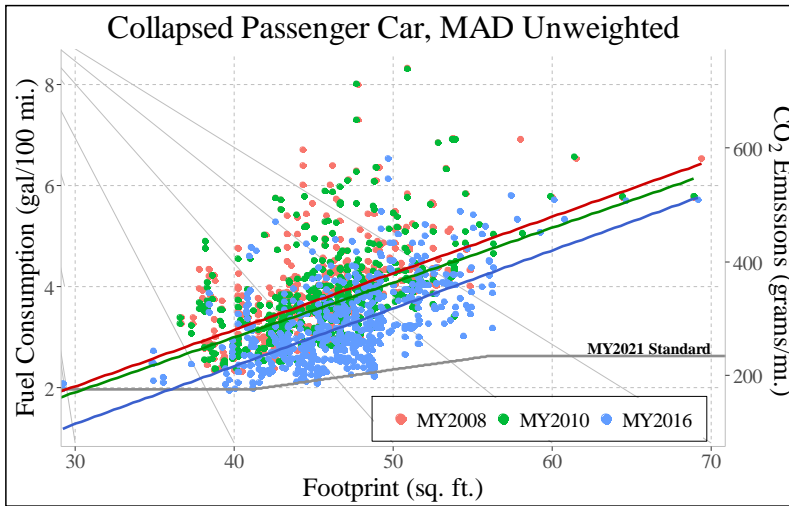

FIGURE 3-12 - PASSENGER CAR CURVES FIT WITH AN UNWEIGHTED MAD REGRESSION FROM THE COLLAPSED DATASET



3.4.2.2 Maximum Technology Level Curves

Technology differences between vehicle models to be a significant factor producing uncertainty regarding the relationship between fuel consumption and footprint were considered. Noting that attribute-based standards are intended to encourage the application of additional technology to improve fuel efficiency and reduce CO₂ emissions across the distribution of footprint in the fleet, the analysis considered approaches in which technology application is simulated for purposes of curve fitting in order to produce fleets that are less varied in technology content. This approach helps to reduce “noise” (i.e., dispersion) in the plot of vehicle footprints and fuel consumption levels and to identify a more technology-neutral relationship between footprint and fuel consumption.

Figure 3-13 and Figure 3-14, below, show the production-weighted light truck curves built from the MY 2016 fleet using either regression type are slightly shallower than the MY 2021 standard finalized in the MY 2017-2021 final rule when maximum technology is applied to the fleet. This suggests that the shape of the sales-weighted relationship between footprint and fuel economy for a homogenous technology fleet has changed slightly since the curves were developed from the MY 2008 and MY 2010 fleets.

FIGURE 3-13 - LIGHT TRUCK CURVES FIT WITH A SALES-WEIGHTED OLS REGRESSION FROM THE FULL DATASET

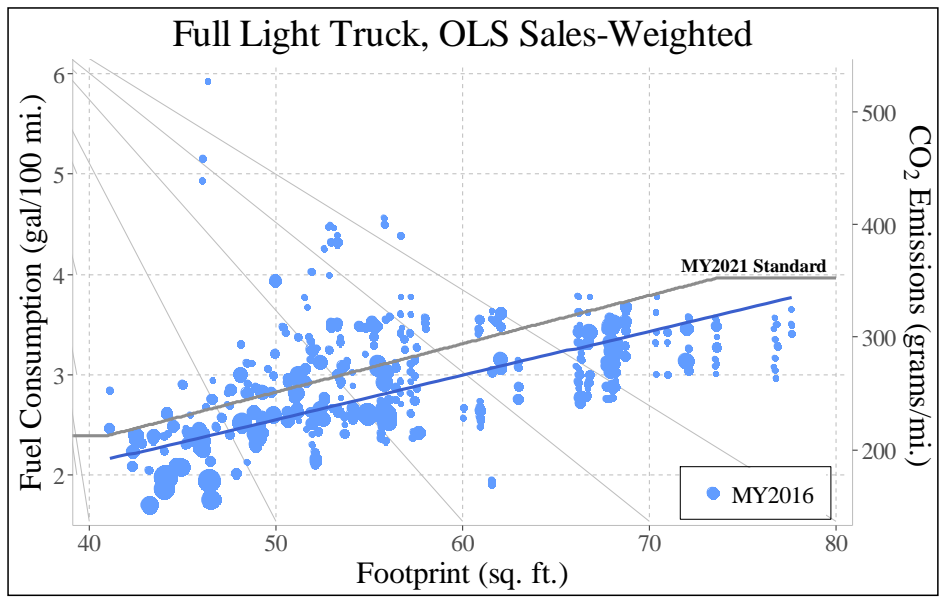

FIGURE 3-14 - LIGHT TRUCK CURVES FIT WITH A SALES-WEIGHTED MAD REGRESSION FROM THE FULL DATASET

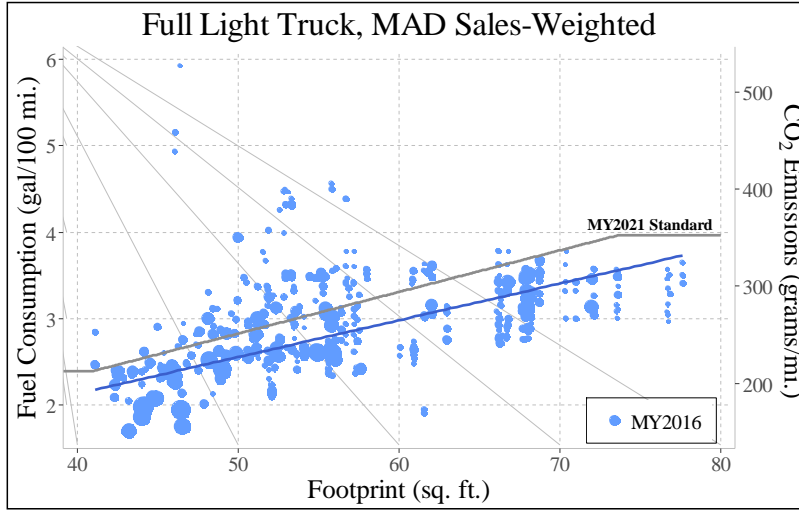

Figure 3-15 and Figure 3-16, below, show the model-weighted relationship between footprint and fuel economy using an OLS and MAD regression, respectively, for light trucks. Both regression types suggest that the relationship of footprint to fuel economy is shallower for light trucks than it was in the 2017-2021 final rule.

FIGURE 3-15 - LIGHT TRUCK CURVES FIT WITH AN UNWEIGHTED OLS REGRESSION FROM THE COLLAPSED DATASET

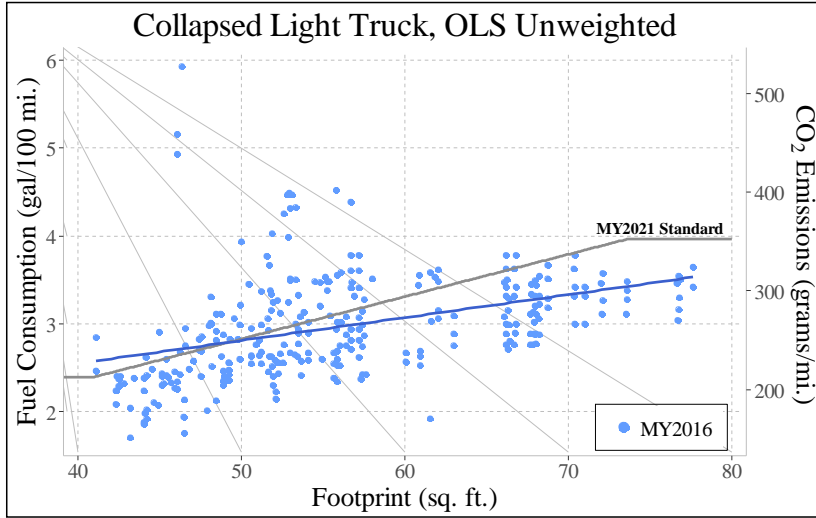

FIGURE 3-16 - LIGHT TRUCK CURVES FIT WITH AN UNWEIGHTED MAD REGRESSION FROM THE COLLAPSED DATASET

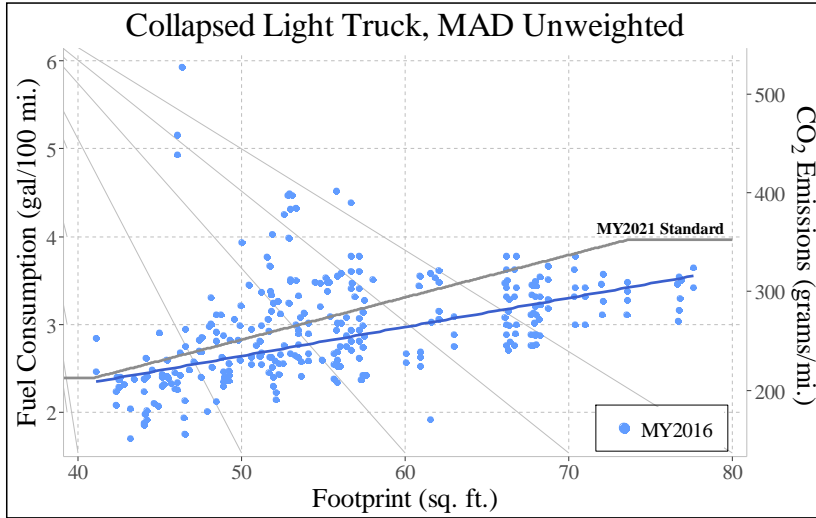

Figure 3-17 and Figure 3-18, below, shows the production-weighted curves for passenger cars when maximum technology is applied to make the technology level of the fleet more

homogenous. Both production-weighted curves suggest that the production-weighted relationship of footprint to fuel economy has become steeper over time. Reasons for this change are discussed further below.

FIGURE 3-17 - PASSENGER CAR CURVES FIT WITH A SALES-WEIGHTED OLS REGRESSION FROM THE FULL DATASET

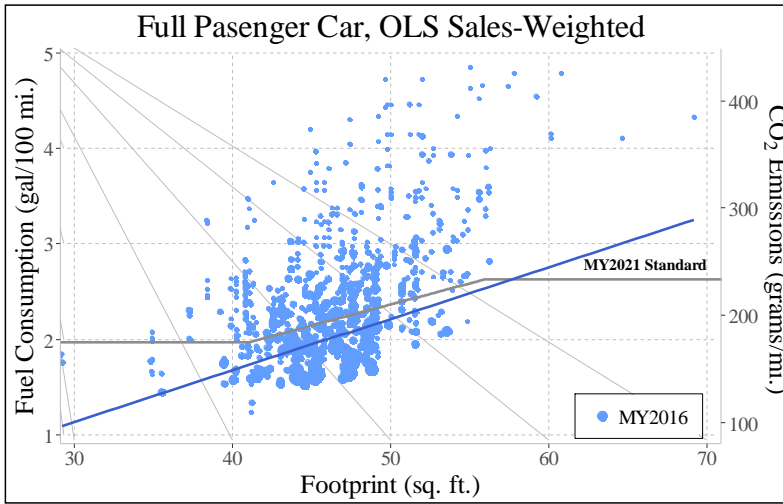

FIGURE 3-18 - PASSENGER CAR CURVES FIT WITH A SALES-WEIGHTED MAD REGRESSION FROM THE FULL DATASET

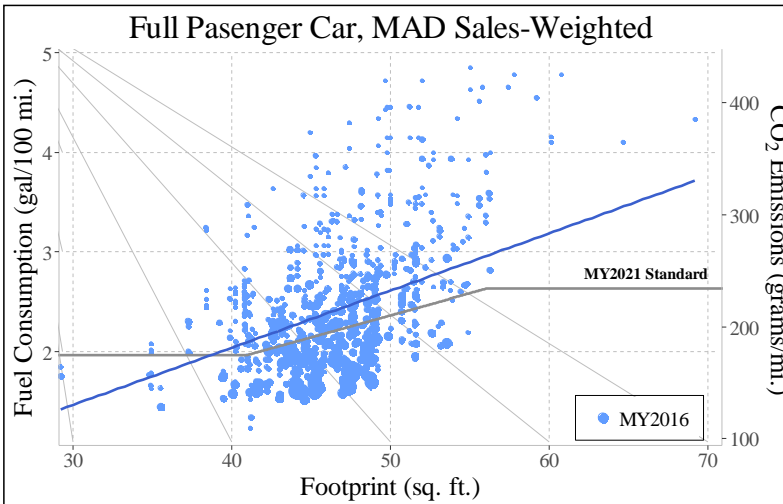

Figure 3-19 and Figure 3-20 show the model-weighted passenger car curves when maximum technology is applied. Under both regression types, the passenger car curve appears to have become steeper over time.

FIGURE 3-19 - PASSENGER CAR CURVES FIT WITH AN UNWEIGHTED OLS REGRESSION FROM THE COLLAPSED DATASET

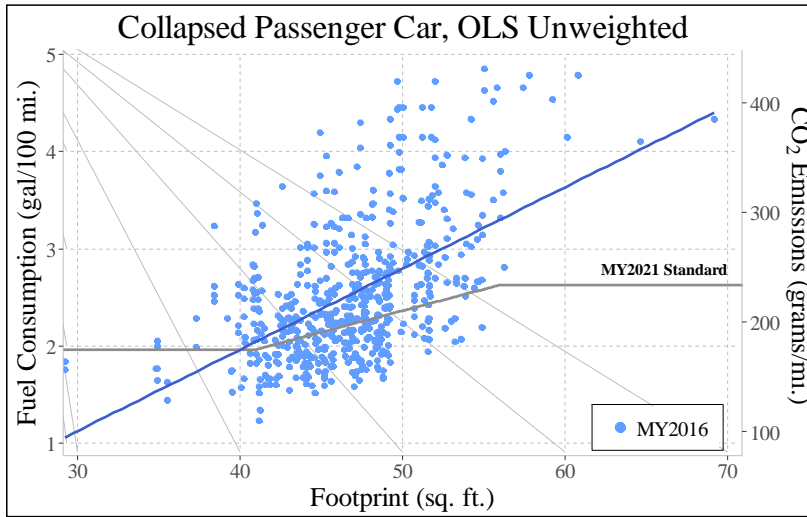
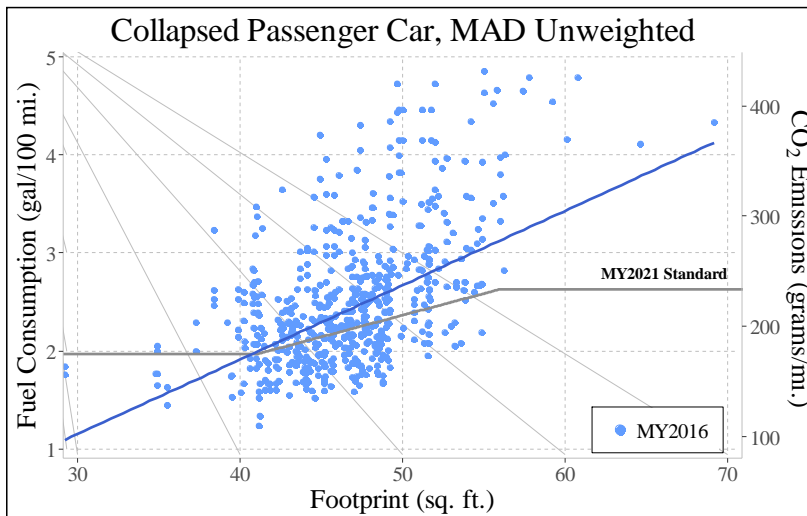

FIGURE 3-20 - PASSENGER CAR CURVES FIT WITH AN UNWEIGHTED MAD REGRESSION FROM THE COLLAPSED DATASET



*** EO 12866 Review – Draft – Do Not Cite, Quote or Release During Review ***

The statistical methods used above show how the average and median model-weighted and production-weighted relationship of footprint to fuel consumption change for different model year fleets. When technology application is not homogenized there is no consistent trend in the change in the slope of the relationship over time. However, when technology is homogenized, it appears that the relationship for passenger cars is steeper than the MY 2021 passenger car curve finalized in the 2017-2021 final rule, and the light truck relationship for the MY 2016 fleet is shallower than the MY 2021 light truck curve finalized in the 2017-2021 final rule.

The cause of the change in slopes for passenger cars and light trucks is likely due to the increase of crossovers and SUVs which can be classified as either passenger cars or light trucks depending on the specific attributes of the vehicle. Consumers expect these vehicles to fulfill a variety of utilities, and in this way they have some of the characteristics of passenger cars and some of the characteristics of light trucks. This makes them tend to perform poorer on passenger car curves and better on light truck curves (given the same technology application), creating an incentive for OEMs to make more crossovers and SUVs fall on the less stringent light truck curves. The shallower is either curve, while maintaining the same industry level requirement, the larger is the incentive to make crossover and SUVs fall on the light truck curve. Given this potential to game the standards, the agencies have opted not to make the light truck curves shallower to follow the change in the statistical relationship when technology is homogenized.

Making the passenger car steeper and holding the industry standard constant would require that the smallest vehicles face a more stringent standard. There are several reasons this may produce adverse policy effects. First, the smallest vehicles already face the most stringent standards and there are real limits on the ability of vehicles to meet more stringent targets, particularly as standards continue to increase. Second, smaller vehicles tend to be less expensive. Increasing the burden on the smallest vehicles may mean that more consumers are priced out of the market, or that manufacturers stop production on some of their smaller models altogether, affecting consumer choice. Given these concerns, and the fact that curve shapes have not changed consistently or significantly when technology levels are not homogenized (this method captures any current market limitation to applying technology along the distribution of footprint in either passenger car or the light truck fleet), the passenger car curves have not been made steeper.

3.4.3 What Other Methodologies did the Agencies Consider?

As noted in the 2012 final rule, numerous manufacturers have confidentially shared what they described as “physics-based” curves, with each OEM showing significantly different shapes for the footprint-fuel economy relationships. This variation suggests either that manufacturers face different curves given the other attributes of the vehicles in their fleets (i.e. performance characteristics) and/or that their curves reflected different levels of technology application. In reconsidering the shapes of the proposed MYs 2022-2026 standards, the analysis takes pains to develop a similar estimation of physics-based curves leveraging third party simulation work form

Argonne National Laboratories (ANL). Developing estimations of physics-based curve ensures that technology and performance are held constant for all footprints.

Tractive energy is the amount of energy it will take to move a vehicle. Here tractive energy effectiveness is defined as the share of the energy content of fuel consumed which is converted into mechanical energy, and used to move a vehicle—for ICE vehicles this will vary with the relative efficiency of specific engines. Data from ANL simulations suggest that the limits of tractive energy effectiveness are approximately 25% for vehicles with internal combustion engines which do not possess ISG, other hybrid, plug-in, pure electric, or fuel cell technology.

Volpe developed a tractive energy prediction model; given a vehicle’s mass, frontal area, aerodynamic drag coefficient, and rolling resistance as inputs, the model will predict the amount of tractive energy required for the vehicle to complete the federal test cycle. This model was used to predict the tractive energy required for the average vehicle of a given footprint⁶⁰ and “body technology package” to complete the cycle. The body technology packages considered are defined in Table 3-2, below. Using the absolute tractive energy predicted and tractive energy effectiveness values spanning possible ICE engines, NHTSA then estimated fuel economy values for different body technology packages and engine tractive energy effectiveness values.

**TABLE 3-2 - SUMMARY OF BODY TECHNOLOGY PACKAGES
CONSIDERED FOR TRACTIVE ENERGY ANALYSIS**

Body Tech. Package	Mass Reduction Level	Aerodynamics Level	Roll. Resistance Level
1	0%	0%	0%
2	0%	10%	10%
3	10%	10%	10%
4	10%	15%	20%
5	15%	20%	20%

Figure 3-21 through Figure 3-24 show the resultant CAFE levels estimated for the vehicle classes ANL simulates for Volpe and NHTSA at different footprint values and by vehicle “box.” Pickups are considered 1-box, hatchbacks and minivans are 2-box, and sedans are 3-box. These estimates are compared with the MY 2021 standards finalized in the 2012 FRM. Figure 3-21, below, shows the CAFE for moderate body packages using an advanced ICE engine. As can be seen, few vehicles with body technology package 2 with an advanced technology package meet the MY 2021 passenger car standard finalized in 2012, and the majority of 2-box and nearly all 1-box vehicles — the majority of vehicles on the light truck curve — do not meet the MY 2021

⁶⁰ The mass reduction curves used elsewhere in this analysis were used to predict the mass of a vehicle with a given footprint, body style box, and mass reduction level. The ‘Body style Box’ is 1 for hatchbacks and minivans, 2 for pickups, and 3 for sedans — it is an important predictor of aerodynamic drag. Mass is an essential input in the tractive energy calculation.

*** EO 12866 Review – Draft – Do Not Cite, Quote or Release During Review ***

light truck standard finalized in 2012. Technology package 3 with an advanced ICE engine performs better.

FIGURE 3-21 - ESTIMATED CAFE FOR MODERATE BODY TECHNOLOGY PACKAGES, ADVANCED ICE ENGINE

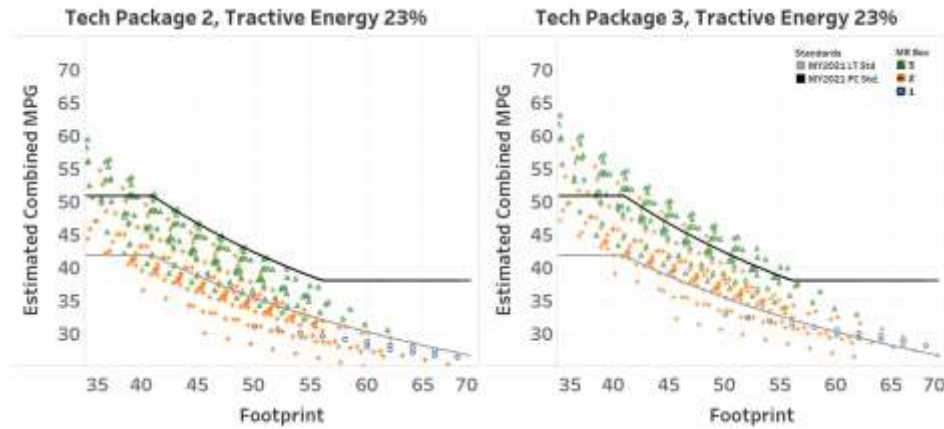

Figure 3-22 shows advanced body packages with advanced ICE engines. With technology package 4 the MY 2021 standards finalized in 2012 look achievable, and nearly all vehicles meet the standards with technology package 5. It is important to note that the advanced body style packages may not be feasible for vehicles of all types, particularly for pickups which have a body style with inherent limits on aerodynamic efficiency improvements. Further, the ANL simulations do not simulate the full range of vehicle performance characteristics, but instead a performance and non-performance version of each vehicle body style.

*** EO 12866 Review – Draft – Do Not Cite, Quote or Release During Review ***

FIGURE 3-22 - ESTIMATED CAFE FOR ADVANCED BODY TECHNOLOGY PACKAGES, ADVANCED ICE ENGINE

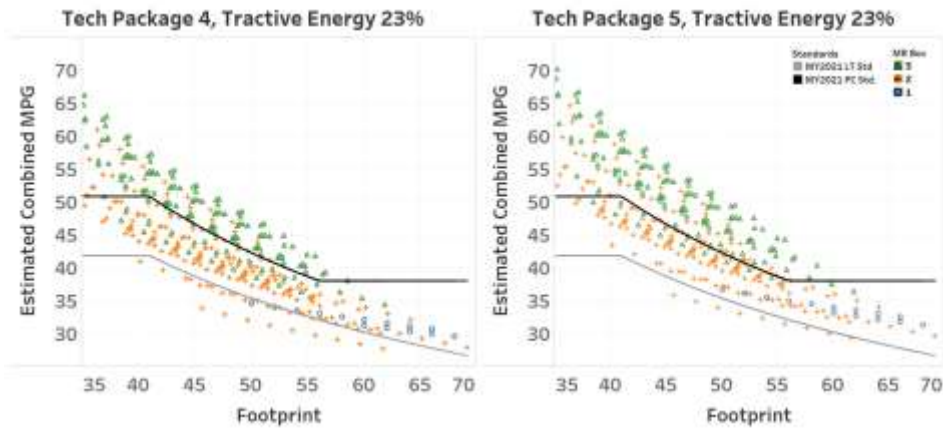

Figure 3-23 shows the predicted CAFE for moderate body technology packages and a 'best-in-class' ICE engine. Both appear to meet the MY 2021 standards finalized in 2012. However, it may not be possible for every manufacturer to use the most efficient ICE technologies where there are intellectual property rights. Again, as stated above, the ANL simulations may not fully capture the range of vehicle performance.

FIGURE 3-23 - ESTIMATED CAFE FOR MODERATE BODY TECHNOLOGY PACKAGES WITH 'BEST-IN-CLASS' ICE ENGINE

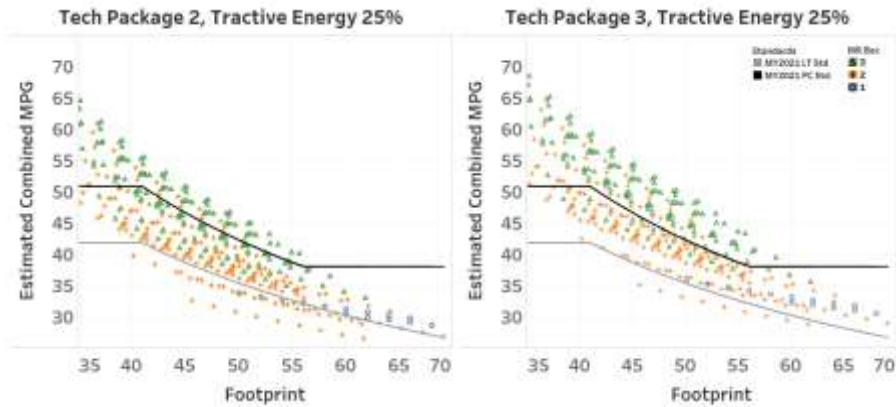
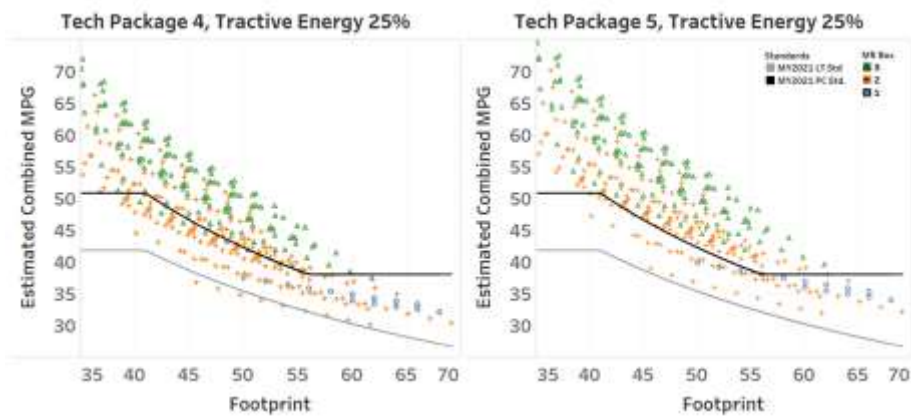

Figure 3-24, below, shows advanced body technology packages with a ‘best-in-class’ ICE engine. Most ANL simulated vehicles exceed the MY 2021 standards finalized in 2012. However, the same caveats listed above also apply here. Not all vehicle body styles can achieve the body-level improvements of technology packages 4 and 5; not all vehicles/manufacturers may be able to use the most advanced ICE engines; and the full range of performance values are not represented in the ANL simulations.

FIGURE 3-24 - ESTIMATED CAFE FOR ADVANCED BODY TECHNOLOGY PACKAGES, ‘BEST-IN-CLASS’ ICE ENGINE



Given the caveats of the analysis above, it should not be taken as any evidence about the appropriateness of the level of the previous MY 2021 standards. However, notice that the general trend of the simulated data points follows the pattern of the previous MY 2021 standards for all technology packages and tractive energy effectiveness values presented here. For brevity’s sake, all technology packages were not included, nor tractive energy effectiveness values analyzed. It should be noted that the values not presented here also tracked the curve shape of the MY 2021 standards finalized in 2012. The above tractive energy curves are NHTSA and Volpe’s attempt at validating the curve shapes against a physics-based alternative, and the presented figures suggest that the curve shape track the physical relationship between fuel economy and tractive energy for different footprint values.

Note - Physical limitations are not the only forces manufacturers face; they must also produce vehicles that consumers will purchase. For this reason, in setting future standards, NHTSA should continue to consider information from statistical analyses which do not homogenize technology applications in addition to statistical analyses which do and a tractive energy analysis similar to the one presented above. The analysis of curves built without homogenizing technology levels suggests that including current market limitations, the relationship of footprint to fuel economy has not changed over time in a consistent way across considered methodologies,

*** EO 12866 Review – Draft – Do Not Cite, Quote or Release During Review ***

nor has it changed by a large magnitude under any single methodology that does homogenize technology levels. This further supports the decision to keep the curve shapes developed for the 2017-2021 final rule.

3.5 Proposed Standards

3.5.1 Passenger car standards

For passenger cars, NHTSA and EPA are proposing CAFE and CO₂ standards, respectively, for MYs 2021-2026 as defined by the following coefficients:

TABLE 3-3 - CHARACTERISTICS OF PREFERRED ALTERNATIVE – PASSENGER CARS

	2021	2022	2023	2024	2025	2026
Fuel Economy Targets						
a (mpg)	48.74	48.74	48.74	48.74	48.74	48.74
b (mpg)	36.47	36.47	36.47	36.47	36.47	36.47
c (gpm per s.f.)	0.000460	0.000460	0.000460	0.000460	0.000460	0.000460
d (gpm)	0.00164	0.00164	0.00164	0.00164	0.00164	0.00164
CO₂ Targets						
a (g/mi)	182	182	182	182	182	182
b (g/mi)	244	244	244	244	244	244
c (g/mi per s.f.)	4.09	4.09	4.09	4.09	4.09	4.09
d (g/mi)	14.6	14.6	14.6	14.6	14.6	14.6

Section II.C of the Preamble accompanying this PRIA discusses how coefficients in Table 3-3 were developed for this proposal. The coefficients result in the footprint-dependent targets shown graphically below for MYs 2021-2026. The MYs 2017-2020 standards are shown for comparison.

*** EO 12866 Review – Draft – Do Not Cite, Quote or Release During Review ***

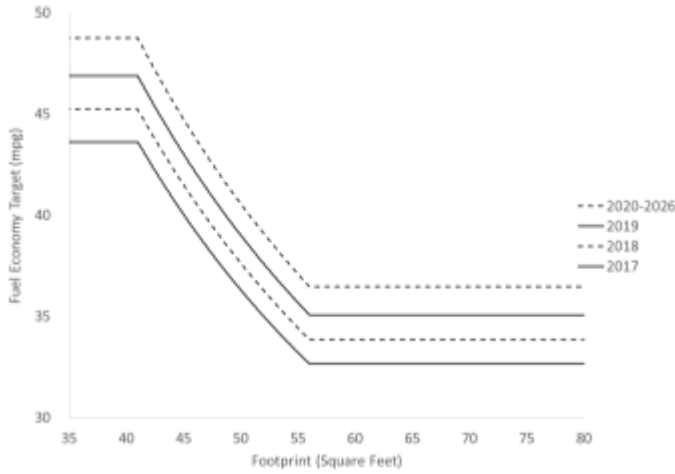

FIGURE 3-25 - PASSENGER CAR FUEL ECONOMY TARGETS

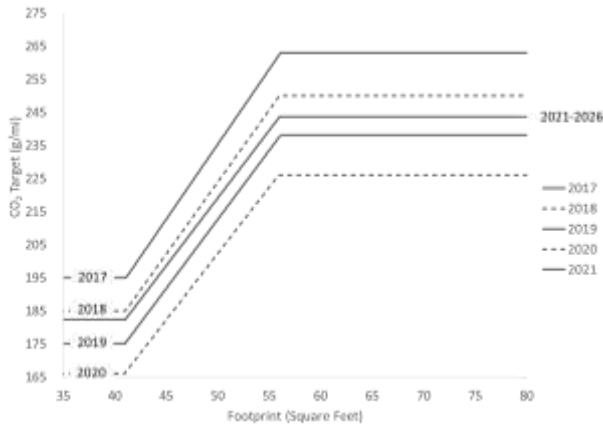

FIGURE 3-26 - PASSENGER CAR CO₂ TARGETS⁶¹

While we do not know yet with certainty what CAFE and CO₂ levels will be required of individual manufacturers, because those levels will depend on the mix of vehicles they produce for sale in future model years, based on the market forecast of future sales NHTSA and EPA have used to examine today's proposed standards, we currently estimate the target functions

⁶¹ Prior to MY 2021, average achieved CO₂ levels include adjustments reflecting the use of automotive refrigerants with reduced global warming potential (GWP) and/or the use of technologies that reduce the refrigerant leaks.

*** EO 12866 Review – Draft – Do Not Cite, Quote or Release During Review ***

shown above would result in the following average required fuel economy and CO₂ emissions levels for individual manufacturers during MYs 2021-2026.⁶²

TABLE 3-4 - AVERAGE OF OEMS' CAFE AND CO₂ REQUIREMENTS FOR PASSENGER CARS

Model Year	Avg. of OEMs' Requirements	
	CAFE (mpg)	CO ₂ (g/mi)
2017	39.1	220
2018	40.5	210
2019	42.0	201
2020	43.7	193
2021	43.7	204
2022	43.7	204
2023	43.7	204
2024	43.7	204
2025	43.7	204
2026	43.7	204

We emphasize again that the values in these tables are estimates and not necessarily the ultimate levels with which each of these manufacturers will have to comply, for reasons described above.

3.5.1.1 Minimum domestic passenger car standards

EPCA has long required manufacturers to meet the passenger car CAFE standard with their domestically-manufactured and imported passenger car fleets – that is, domestic and imported passenger car fleets must comply separately with the passenger car CAFE standard in each model year.⁶³ In doing so, they may use whatever flexibilities are available to them under the CAFE program, such as the application of CAFE credits “carried forward” from prior model years, transferred from other fleets, or acquired from other manufacturers. On top of this requirement, EISA expressly requires each manufacturer to meet a minimum flat fuel economy standard for domestically manufactured passenger cars.⁶⁴ According to the statute, the minimum standard shall be the greater of (A) 27.5 miles per gallon; or (B) 92% of the average fuel economy projected by DOT for the combined domestic and nondomestic passenger automobile fleets manufactured for sale in the United States by all manufacturers in the model year, which projection shall be published in the Federal Register when the standard for that model year is

⁶² The estimated averages of CAFE requirements reflect the “standard setting” analysis that sets aside the potential to apply CAFE credits after MY 2020, and that sets aside the potential to build alternative fuel vehicles beyond those present in the MY 2016 fleet.

⁶³ 49 U.S.C. 32904(b).

⁶⁴ Transferred or traded credits may not be used, pursuant to 49 U.S.C. 32903(g)(4) and (f)(2), to meet the domestically manufactured passenger automobile minimum standard specified in 49 U.S.C. 32902(b)(4) and in 49 CFR 531.5(d).

*** EO 12866 Review – Draft – Do Not Cite, Quote or Release During Review ***

promulgated.⁶⁵ NHTSA discusses this requirement in more detail in Section V.A of the Preamble.

The following table lists the proposed minimum domestic passenger car standards (which very likely will be updated for the final rule as the agency updates its overall analysis and resultant projection), highlighted as “Preferred (Alternative 3),” and also calculates what those standards would be under the no action alternative (as issued in 2012, and as updated by today’s analysis) and under the other alternatives discussed below.

TABLE 3-5 - MINIMUM STANDARDS FOR DOMESTIC PASSENGER CAR FLEETS

Alternative	2021	2022	2023	2024	2025	2026
No Action (2012)	42.7	44.7	46.8	49.0	51.3	
No Action (updated)	41.9	43.8	45.9	48.0	50.3	50.3
Preferred (Alternative 1)	40.2	40.2	40.2	40.2	40.2	40.2
Alternative 2	40.4	40.6	40.8	41.0	41.2	41.4
Alternative 3	40.4	40.6	40.8	41.0	41.2	41.4
Alternative 4	40.6	41.0	41.4	41.8	42.2	42.7
Alternative 5	41.9	42.3	42.7	43.1	43.6	44.0
Alternative 6	41.0	41.8	42.7	43.5	44.4	45.3
Alternative 7	41.0	41.8	42.7	43.5	44.4	45.3
Alternative 8	41.9	42.7	43.6	44.5	45.4	46.3

3.5.2 Light truck standards

For light trucks, NHTSA and EPA are proposing CAFE and CO₂ standards, respectively, for MYs 2021-2026 as defined by the following coefficients:

TABLE 3-6 - CHARACTERISTICS OF PREFERRED ALTERNATIVE – LIGHT TRUCKS

	2021	2022	2023	2024	2025	2026
Fuel Economy Targets						
a (mpg)	39.11	39.11	39.11	39.11	39.11	39.11
b (mpg)	25.25	25.25	25.25	25.25	25.25	25.25
c (gpm per s.f.)	0.000514	0.000514	0.000514	0.000514	0.000514	0.000514
d (gpm)	0.00449	0.00449	0.00449	0.00449	0.00449	0.00449
e (mpg)	35.41	35.41	35.41	35.41	35.41	35.41
f (mpg)	25.25	25.25	25.25	25.25	25.25	25.25
g (gpm per s.f.)	0.000455	0.000455	0.000455	0.000455	0.000455	0.000455
h (gpm)	0.00960	0.00960	0.00960	0.00960	0.00960	0.00960
CO ₂ Targets						
a (g/mi)	227	227	227	227	227	227
b (g/mi)	352	352	352	352	352	352
c (g/mi per s.f.)	4.57	4.57	4.57	4.57	4.57	4.57

⁶⁵ 49 U.S.C. 32902(b)(4).

d (g/mi)	39.9	39.9	39.9	39.9	39.9	39.9
e (g/mi)	251	251	251	251	251	251
f (g/mi)	352	352	352	352	352	352
g (g/mi per s.f.)	4.04	4.04	4.04	4.04	4.04	4.04
h (g/mi)	85.3	85.3	85.3	85.3	85.3	85.3

Section II.C and III of the Preamble discusses how coefficients in Table 3-6 were developed for this proposal. The coefficients result in the footprint-dependent targets shown graphically below for MYs 2021-2026. The MYs 2017-2020 standards are shown for comparison.

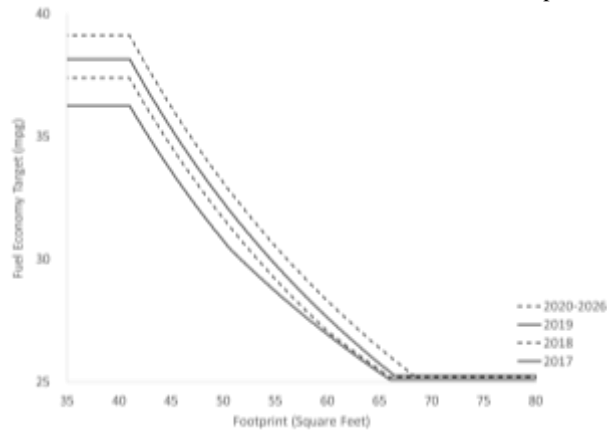
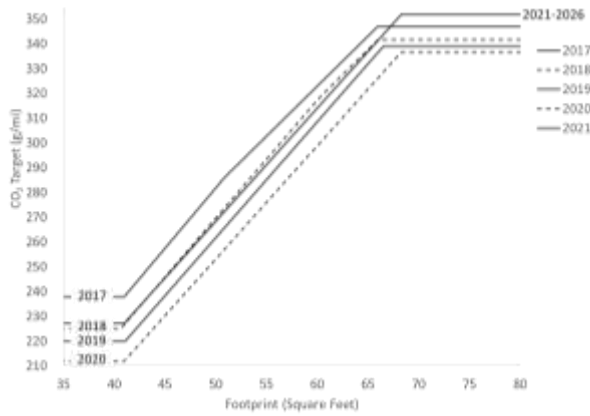

FIGURE 3-27 - LIGHT TRUCK FUEL ECONOMY TARGETS



*** EO 12866 Review – Draft – Do Not Cite, Quote or Release During Review ***

FIGURE 3-28 - LIGHT TRUCK CO₂ TARGETS⁶⁶

While we do not know yet with certainty what CAFE and CO₂ levels will ultimately be required of individual manufacturers because those levels will depend on the mix of vehicles they produce for sale in future model years, based on the market forecast of future sales NHTSA and EPA have used to examine today's proposed standards, we currently estimate the target functions shown above would result in the following average required fuel economy and CO₂ emissions levels for individual manufacturers during MYs 2021-2026.^{67, 68}

⁶⁶ Prior to MY 2021, average achieved CO₂ levels include adjustments reflecting the use of automotive refrigerants with reduced global warming potential (GWP) and/or the use of technologies that reduce the refrigerant leaks. Because EPA is today proposing separate regulations to address air conditioner leakage, CO₂ targets and resultant fleet average requirements for model years 2021 and beyond do not reflect these adjustments.

⁶⁷ The estimated averages of CAFE requirements reflect the "standard setting" analysis that sets aside the potential to apply CAFE credits after MY 2020 and that sets aside the potential to build alternative fuel vehicles beyond those present in the MY 2016 fleet.

⁶⁸ Prior to MY 2021, average achieved CO₂ levels include adjustments reflecting the use of automotive refrigerants with reduced global warming potential (GWP) and/or the use of technologies that reduce the refrigerant leaks. Because EPA is today proposing separate regulations to address air conditioner leakage, CO₂ targets and resultant fleet average requirements for model years 2021 and beyond do not reflect these adjustments.

TABLE 3-7 - AVERAGE OF OEMS’ CAFE AND CO₂ REQUIREMENTS FOR LIGHT TRUCKS

Model Year	Avg. of OEMs’ Requirements	
	CAFE (mpg)	CO ₂ (g/mi)
2017	29.5	294
2018	30.1	284
2019	30.6	277
2020	31.3	271
2021	31.3	284
2022	31.3	284
2023	31.3	284
2024	31.3	284
2025	31.3	284
2026	31.3	284

We emphasize again that the values in these tables are estimates and not necessarily the ultimate levels with which manufacturers will have to comply for reasons described above.

3.5.3 Alternative Standards Considered

Agencies typically consider regulatory alternatives in proposals as a way of evaluating comparative effects of different potential ways of accomplishing their desired goal.⁶⁹ Alternatives analysis begins with a “no-action” alternative, typically described as what would occur in the absence of any regulatory action. Today’s proposal includes a no-action alternative, described below, as well as seven “action alternatives” besides the proposal. The proposal may, in places, be referred to as the “preferred alternative,” which is NEPA parlance, but NHTSA and EPA intend “proposal,” “proposed action,” and “preferred alternative” to be used interchangeably for purposes of this rulemaking.

Today’s notice also presents the results of analysis estimating effects under a range of other regulatory alternatives the agencies are considering. Aside from the no-action alternative, NHTSA and EPA defined the different regulatory alternatives in terms of percent-increases in CAFE and CO₂ stringency from year to year. Under some alternatives, the rate of increase is the same for both passenger cars and light trucks; under others, the rate of increase differs. Two alternatives involve a gradual discontinuation of CAFE and average CO₂ adjustments reflecting the application of technologies that improve air conditioner efficiency or, in other ways, improve fuel economy under conditions not represented by long-standing fuel economy test procedures. For increased harmonization with NHTSA CAFE standards, under Alternatives 1-8, EPA would regulate tailpipe CO₂ only. Under the no action alternative, EPA would continue to regulate AC

⁶⁹ As Section V.A of the Preamble explains, NEPA requires agencies to compare the potential environmental impacts of their proposed actions to those of a reasonable range of alternatives. Executive Orders 12866 and 13563 and OMB Circular A-4 also encourage agencies to evaluate regulatory alternatives in their rulemaking analyses.

*** EO 12866 Review – Draft – Do Not Cite, Quote or Release During Review ***

refrigerant leakage, nitrous oxide, and methane emissions under the CO₂ standard.⁷⁰ Like the baseline no-action alternative, the alternatives are more stringent than the preferred alternative.

The agencies have examined these alternatives because the agencies intend to continue considering them as options for the final rule. Comment is sought on the analysis presented here. Review of comments could lead to the selection of one of the other regulatory alternatives for the final rule.

Table 3-8 shows the different alternatives evaluated in this proposal.

TABLE 3-8 - REGULATORY ALTERNATIVES CURRENTLY UNDER CONSIDERATION⁷¹

Alternative	Change in stringency	A/C efficiency and off-cycle provisions
Baseline/ No-Action	MY 2021 standards remain in place; MYs 2022-2025 augural CAFE standards are finalized and CO ₂ standards remain unchanged; MY 2026 standards are set at MY 2025 levels	No change
1 (Proposed)	Existing standards through MY 2020, then 0%/year increases for both passenger cars and light trucks, for MYs 2021-2026	No change
2	Existing standards through MY 2020, then 0.5%/year increases for both passenger cars and light trucks, for MYs 2021-2026	No change
3	Existing standards through MY 2020, then 0.5%/year increases for both passenger cars and light trucks, for MYs 2021-2026	Phase out these adjustments over MYs 2022-2026
4	Existing standards through MY 2020, then 1%/year increases for passenger cars and 2%/year increases for light trucks, for MYs 2021-2026	No change
5	Existing standards through MY 2021, then 1%/year increases for passenger cars and 2%/year increases for light trucks, for MYs 2022-2026	No change

⁷⁰ For the CAFE program, carbon-based tailpipe emissions (including CO₂, CH₄ and CO) are measured and fuel economy is calculated using a carbon balance equation. EPA uses carbon-based emissions (CO₂, CH₄ and CO, the same as for CAFE) to calculate tailpipe CO₂ for its standards. In addition, under the no action alternative, EPA adds CO₂ equivalent (using Global Warming Potential (GWP) adjustment) for AC refrigerant leakage, and optionally nitrous oxide and methane emissions. The CAFE program does not include AC refrigerant leakage, nitrous oxide, and methane emissions because they do not affect fuel economy. Under Alternatives 1-8, standards are completely aligned for gasoline because compliance is based on tailpipe CO₂, CH₄, and CO for both programs. Diesel and alternative fuel vehicles would continue to be treated differently between the CAFE and CO₂ programs.

⁷¹ These alternatives would apply to CO₂.

*** EO 12866 Review – Draft – Do Not Cite, Quote or Release During Review ***

6	Existing standards through MY 2020, then 2%/year increases for passenger cars and 3%/year increases for light trucks, for MYs 2021-2026	No change
7	Existing standards through MY 2020, then 2%/year increases for passenger cars and 3%/year increases for light trucks, for MYs 2021-2026	Phase out these adjustments over MYs 2022-2026
8	Existing standards through MY 2021, then 2%/year increases for passenger cars and 3%/year increases for light trucks, for MYs 2022-2026	No change

3.6 Definition of alternatives

3.6.1 No-Action Alternative

The No-Action Alternative applies the augural CAFE and final CO₂ targets announced in 2012 for MYs 2021-2025. For MY 2026, this alternative applies the same targets as for MY 2025. Carbon dioxide equivalent of air conditioning refrigerant leakage, nitrous oxide, and methane emissions are included for compliance with EPA standards for all model years under the baseline/no action alternative.

*** EO 12866 Review – Draft – Do Not Cite, Quote or Release During Review ***

TABLE 3-9 - CHARACTERISTICS OF NO-ACTION ALTERNATIVE – PASSENGER CARS

	2021	2022	2023	2024	2025	2026
Fuel Economy Targets						
a (mpg)	50.83	53.21	55.71	58.32	61.07	61.07
b (mpg)	38.02	39.79	41.64	43.58	45.61	45.61
c (gpm per s.f.)	0.000442	0.000423	0.000404	0.000387	0.000370	0.000370
d (gpm)	0.00155	0.00146	0.00137	0.00129	0.00121	0.00121
CO ₂ Targets						
a (g/mi)	157	150	143	137	131	131
b (g/mi)	215	205	196	188	179	179
c (g/mi per s.f.)	3.84	3.69	3.54	3.40	3.26	3.26
d (g/mi)	-0.4	-1.1	-1.8	-2.5	-3.2	-3.2

TABLE 3-10 - CHARACTERISTICS OF NO-ACTION ALTERNATIVE – LIGHT TRUCKS

	2021	2022	2023	2024	2025	2026
Fuel Economy Targets						
a (mpg)	41.80	43.79	45.89	48.09	50.39	50.39
b (mpg)	25.25	26.29	27.53	28.83	30.19	30.19
c (gpm per s.f.)	0.000482	0.000461	0.000440	0.000421	0.000402	0.000402
d (gpm)	0.00416	0.00394	0.00373	0.00353	0.00334	0.00334
e (mpg)	35.41	35.41	35.41	35.41	35.41	35.41
f (mpg)	25.25	25.25	25.25	25.25	25.25	25.25
g (gpm per s.f.)	0.000455	0.000455	0.000455	0.000455	0.000455	0.000455
h (gpm)	0.00960	0.00960	0.00960	0.00960	0.00960	0.00960
CO ₂ Targets						
a (g/mi)	195	186	176	168	159	159
b (g/mi)	335	321	306	291	277	277
c (g/mi per s.f.)	4.28	4.09	3.91	3.74	3.58	3.58
d (g/mi)	19.8	17.8	16.0	14.2	12.5	12.5
e (g/mi)	318	318	318	318	318	318
f (g/mi)	342	342	342	342	342	342
g (g/mi per s.f.)	4.04	4.04	4.04	4.04	4.04	4.04
h (g/mi)	75.0	75.0	75.0	75.0	75.0	75.0

3.6.2 Alternative 1 (Proposed)

Alternative 1 holds the stringency of targets constant and MY 2020 levels through MY 2026. This alternative would apply to CO₂ beginning in MY 2021. Section 3.5 defines this alternative in greater detail.

3.6.3 Alternative 2

Alternative 2 increases the stringency of targets annually during MYs 2021-2026 (on a gallon per mile basis, starting from MY 2020) by 0.5% for passenger cars and 0.5% for light trucks. This alternative would apply to CO₂ beginning in MY 2021.

TABLE 3-11 - CHARACTERISTICS OF ALTERNATIVE 2 – PASSENGER CARS

	2021	2022	2023	2024	2025	2026
Fuel Economy Targets						
a (mpg)	48.99	49.23	49.48	49.73	49.98	50.23
b (mpg)	36.65	36.84	37.02	37.21	37.39	37.58
c (gpm per s.f.)	0.000458	0.000456	0.000453	0.000451	0.000449	0.000447
d (gpm)	0.00163	0.00163	0.00162	0.00161	0.00160	0.00159
CO₂ Targets						
a (g/mi)	181	181	180	179	178	177
b (g/mi)	242	241	240	239	238	236
c (g/mi per s.f.)	4.07	4.05	4.03	4.01	3.99	3.97
d (g/mi)	14.5	14.5	14.4	14.3	14.2	14.2

TABLE 3-12 - CHARACTERISTICS OF ALTERNATIVE 2 – LIGHT TRUCKS

	2021	2022	2023	2024	2025	2026
Fuel Economy Targets						
a (mpg)	39.31	39.51	39.70	39.90	40.10	40.31
b (mpg)	25.37	25.50	25.63	25.76	25.89	26.02
c (gpm per s.f.)	0.000511	0.000509	0.000506	0.000504	0.000501	0.000499
d (gpm)	0.00447	0.00445	0.00443	0.00440	0.00438	0.00436
e (mpg)	35.41	35.41	35.41	35.41	35.41	35.41
f (mpg)	25.25	25.25	25.25	25.25	25.25	25.25
g (gpm per s.f.)	0.000455	0.000455	0.000455	0.000455	0.000455	0.000455
h (gpm)	0.00960	0.00960	0.00960	0.00960	0.00960	0.00960
CO₂ Targets						
a (g/mi)	226	225	224	223	222	220
b (g/mi)	350	348	347	345	343	342
c (g/mi per s.f.)	4.55	4.52	4.50	4.48	4.45	4.43
d (g/mi)	39.7	39.5	39.3	39.1	38.9	38.8
e (g/mi)	251	251	251	251	251	251
f (g/mi)	352	352	352	352	352	352
g (g/mi per s.f.)	4.04	4.04	4.04	4.04	4.04	4.04
h (g/mi)	85.3	85.3	85.3	85.3	85.3	85.3

3.6.4 Alternative 3

*** EO 12866 Review – Draft – Do Not Cite, Quote or Release During Review ***

Alternative 3 phases out A/C and off-cycle adjustments and increases the stringency of targets annually during MYs 2021-2026 (on a gallon per mile basis, starting from MY 2020) by 0.5% for passenger cars and 0.5% for light trucks. This alternative would apply to CO₂ beginning in MY 2021.

TABLE 3-13 - CHARACTERISTICS OF ALTERNATIVE 3 – PASSENGER CARS

	2021	2022	2023	2024	2025	2026
Fuel Economy Targets						
a (mpg)	48.99	49.23	49.48	49.73	49.98	50.23
b (mpg)	36.65	36.84	37.02	37.21	37.39	37.58
c (gpm per s.f.)	0.000458	0.000456	0.000453	0.000451	0.000449	0.000447
d (gpm)	0.00163	0.00163	0.00162	0.00161	0.00160	0.00159
CO ₂ Targets						
a (g/mi)	181	181	180	179	178	177
b (g/mi)	242	241	240	239	238	236
c (g/mi per s.f.)	4.07	4.05	4.03	4.01	3.99	3.97
d (g/mi)	14.5	14.5	14.4	14.3	14.2	14.2

TABLE 3-14 - CHARACTERISTICS OF ALTERNATIVE 3 – LIGHT TRUCKS

	2021	2022	2023	2024	2025	2026
Fuel Economy Targets						
a (mpg)	39.31	39.51	39.70	39.90	40.10	40.31
b (mpg)	25.37	25.50	25.63	25.76	25.89	26.02
c (gpm per s.f.)	0.000511	0.000509	0.000506	0.000504	0.000501	0.000499
d (gpm)	0.00447	0.00445	0.00443	0.00440	0.00438	0.00436
e (mpg)	35.41	35.41	35.41	35.41	35.41	35.41
f (mpg)	25.25	25.25	25.25	25.25	25.25	25.25
g (gpm per s.f.)	0.000455	0.000455	0.000455	0.000455	0.000455	0.000455
h (gpm)	0.00960	0.00960	0.00960	0.00960	0.00960	0.00960
CO ₂ Targets						
a (g/mi)	226	225	224	223	222	220
b (g/mi)	350	348	347	345	343	342
c (g/mi per s.f.)	4.55	4.52	4.50	4.48	4.45	4.43
d (g/mi)	39.7	39.5	39.3	39.1	38.9	38.8
e (g/mi)	251	251	251	251	251	251
f (g/mi)	352	352	352	352	352	352
g (g/mi per s.f.)	4.04	4.04	4.04	4.04	4.04	4.04
h (g/mi)	85.3	85.3	85.3	85.3	85.3	85.3

3.6.5 Alternative 4

*** EO 12866 Review – Draft – Do Not Cite, Quote or Release During Review ***

Alternative 4 increases the stringency of targets annually during MYs 2021-2026 (on a gallon per mile basis, starting from MY 2020) by 1.0% for passenger cars and 2.0% for light trucks. This alternative would apply to CO₂ beginning in MY 2021.

TABLE 3-15 - CHARACTERISTICS OF ALTERNATIVE 4 – PASSENGER CARS

	2021	2022	2023	2024	2025	2026
Fuel Economy Targets						
a (mpg)	49.23	49.73	50.23	50.74	51.25	51.77
b (mpg)	36.84	37.21	37.58	37.96	38.35	38.73
c (gpm per s.f.)	0.000456	0.000451	0.000447	0.000442	0.000438	0.000433
d (gpm)	0.00163	0.00161	0.00159	0.00158	0.00156	0.00155
CO ₂ Targets						
a (g/mi)	181	179	177	175	173	172
b (g/mi)	241	239	236	234	232	229
c (g/mi per s.f.)	4.05	4.01	3.97	3.93	3.89	3.85
d (g/mi)	14.5	14.3	14.2	14.0	13.9	13.7

TABLE 3-16 - CHARACTERISTICS OF ALTERNATIVE 4 – LIGHT TRUCKS

	2021	2022	2023	2024	2025	2026
Fuel Economy Targets						
a (mpg)	39.91	40.72	41.56	42.40	43.27	44.15
b (mpg)	25.76	26.29	26.82	27.37	27.93	28.50
c (gpm per s.f.)	0.000504	0.000494	0.000484	0.000474	0.000465	0.000455
d (gpm)	0.00440	0.00432	0.00423	0.00415	0.00406	0.00398
e (mpg)	35.41	35.41	35.41	35.41	35.41	35.41
f (mpg)	25.25	25.25	25.25	25.25	25.25	25.25
g (gpm per s.f.)	0.000455	0.000455	0.000455	0.000455	0.000455	0.000455
h (gpm)	0.00960	0.00960	0.00960	0.00960	0.00960	0.00960
CO ₂ Targets						
a (g/mi)	223	218	214	210	205	201
b (g/mi)	345	338	331	325	318	312
c (g/mi per s.f.)	4.48	4.39	4.30	4.21	4.13	4.05
d (g/mi)	39.1	38.4	37.6	36.8	36.1	35.4
e (g/mi)	251	251	251	251	251	251
f (g/mi)	352	352	352	352	352	352
g (g/mi per s.f.)	4.04	4.04	4.04	4.04	4.04	4.04
h (g/mi)	85.3	85.3	85.3	85.3	85.3	85.3

3.6.6 Alternative 5

*** EO 12866 Review – Draft – Do Not Cite, Quote or Release During Review ***

Alternative 5 increases the stringency of targets annually during MYs 2022-2026 (on a gallon per mile basis, starting from MY 2021) by 1.0% for passenger cars and 2.0% for light trucks. This alternative would apply to CO₂ beginning in MY 2021.

TABLE 3-17 - CHARACTERISTICS OF ALTERNATIVE 5 – PASSENGER CARS

	2021	2022	2023	2024	2025	2026
Fuel Economy Targets						
a (mpg)	50.83	51.34	51.86	52.39	52.92	53.45
b (mpg)	38.02	38.40	38.79	39.18	39.58	39.98
c (gpm per s.f.)	0.000442	0.000437	0.000433	0.000429	0.000425	0.000420
d (gpm)	0.00155	0.00154	0.00152	0.00151	0.00149	0.00148
CO ₂ Targets						
a (g/mi)	175	173	171	170	168	166
b (g/mi)	234	231	229	227	225	222
c (g/mi per s.f.)	3.93	3.89	3.85	3.81	3.77	3.73
d (g/mi)	13.8	13.7	13.5	13.4	13.3	13.1

TABLE 3-18 - CHARACTERISTICS OF ALTERNATIVE 5 – LIGHT TRUCKS

	2021	2022	2023	2024	2025	2026
Fuel Economy Targets						
a (mpg)	41.80	42.65	43.52	44.41	45.32	46.24
b (mpg)	25.25	25.76	26.29	26.82	27.37	27.93
c (gpm per s.f.)	0.000482	0.000472	0.000463	0.000454	0.000445	0.000436
d (gpm)	0.00416	0.00408	0.00400	0.00392	0.00384	0.00376
e (mpg)	35.41	35.41	35.41	35.41	35.41	35.41
f (mpg)	25.25	25.25	25.25	25.25	25.25	25.25
g (gpm per s.f.)	0.000455	0.000455	0.000455	0.000455	0.000455	0.000455
h (gpm)	0.00960	0.00960	0.00960	0.00960	0.00960	0.00960
CO ₂ Targets						
a (g/mi)	213	208	204	200	196	192
b (g/mi)	352	345	338	331	325	318
c (g/mi per s.f.)	4.28	4.20	4.11	4.03	3.95	3.87
d (g/mi)	37.0	36.3	35.5	34.8	34.1	33.4
e (g/mi)	251	251	251	251	251	251
f (g/mi)	352	352	352	352	352	352
g (g/mi per s.f.)	4.04	4.04	4.04	4.04	4.04	4.04
h (g/mi)	85.3	85.3	85.3	85.3	85.3	85.3

3.6.7 Alternative 6

*** EO 12866 Review – Draft – Do Not Cite, Quote or Release During Review ***

Alternative 6 increases the stringency of targets annually during MYs 2021-2026 (on a gallon per mile basis, starting from MY 2020) by 2.0% for passenger cars and 3.0% for light trucks. This alternative would apply to CO₂ beginning in MY 2021.

TABLE 3-19 - CHARACTERISTICS OF ALTERNATIVE 7 – PASSENGER CARS

	2021	2022	2023	2024	2025	2026
Fuel Economy Targets						
a (mpg)	49.74	50.75	51.79	52.84	53.92	55.02
b (mpg)	37.21	37.97	38.75	39.54	40.34	41.17
c (gpm per s.f.)	0.000451	0.000442	0.000433	0.000425	0.000416	0.000408
d (gpm)	0.00161	0.00158	0.00155	0.00152	0.00149	0.00146
CO ₂ Targets						
a (g/mi)	179	175	172	168	165	162
b (g/mi)	239	234	229	225	220	216
c (g/mi per s.f.)	4.01	3.93	3.85	3.77	3.70	3.62
d (g/mi)	14.3	14.0	13.7	13.5	13.2	12.9

TABLE 3-20 - CHARACTERISTICS OF ALTERNATIVE 6 – LIGHT TRUCKS

	2021	2022	2023	2024	2025	2026
Fuel Economy Targets						
a (mpg)	40.32	41.57	42.85	44.18	45.55	46.95
b (mpg)	26.03	26.83	27.66	28.52	29.40	30.31
c (gpm per s.f.)	0.000499	0.000484	0.000469	0.000455	0.000441	0.000428
d (gpm)	0.00436	0.00423	0.00410	0.00398	0.00386	0.00374
e (mpg)	35.41	35.41	35.41	35.41	35.41	35.41
f (mpg)	25.25	25.25	25.25	25.25	25.25	25.25
g (gpm per s.f.)	0.000455	0.000455	0.000455	0.000455	0.000455	0.000455
h (gpm)	0.00960	0.00960	0.00960	0.00960	0.00960	0.00960
CO ₂ Targets						
a (g/mi)	220	214	207	201	195	189
b (g/mi)	341	331	321	312	302	293
c (g/mi per s.f.)	4.43	4.30	4.17	4.04	3.92	3.80
d (g/mi)	38.7	37.6	36.5	35.4	34.3	33.3
e (g/mi)	251	251	251	251	251	251
f (g/mi)	352	352	352	352	352	352
g (g/mi per s.f.)	4.04	4.04	4.04	4.04	4.04	4.04
h (g/mi)	85.3	85.3	85.3	85.3	85.3	85.3

3.6.8 Alternative 7

*** EO 12866 Review – Draft – Do Not Cite, Quote or Release During Review ***

Alternative 7 phases out A/C and off-cycle adjustments and increases the stringency of targets annually during MYs 2021-2026 (on a gallon per mile basis, starting from MY 2020) by 1.0% for passenger cars and 2.0% for light trucks. This alternative would apply to CO₂ beginning in MY 2021.

TABLE 3-21 - CHARACTERISTICS OF ALTERNATIVE 7 – PASSENGER CARS

	2021	2022	2023	2024	2025	2026
Fuel Economy Targets						
a (mpg)	49.74	50.75	51.79	52.84	53.92	55.02
b (mpg)	37.21	37.97	38.75	39.54	40.34	41.17
c (gpm per s.f.)	0.000451	0.000442	0.000433	0.000425	0.000416	0.000408
d (gpm)	0.00161	0.00158	0.00155	0.00152	0.00149	0.00146
CO ₂ Targets						
a (g/mi)	179	175	172	168	165	162
b (g/mi)	239	234	229	225	220	216
c (g/mi per s.f.)	4.01	3.93	3.85	3.77	3.70	3.62
d (g/mi)	14.3	14.0	13.7	13.5	13.2	12.9

TABLE 3-22 - CHARACTERISTICS OF ALTERNATIVE 7 – LIGHT TRUCKS

	2021	2022	2023	2024	2025	2026
Fuel Economy Targets						
a (mpg)	40.32	41.57	42.85	44.18	45.55	46.95
b (mpg)	26.03	26.83	27.66	28.52	29.40	30.31
c (gpm per s.f.)	0.000499	0.000484	0.000469	0.000455	0.000441	0.000428
d (gpm)	0.00436	0.00423	0.00410	0.00398	0.00386	0.00374
e (mpg)	35.41	35.41	35.41	35.41	35.41	35.41
f (mpg)	25.25	25.25	25.25	25.25	25.25	25.25
g (gpm per s.f.)	0.000455	0.000455	0.000455	0.000455	0.000455	0.000455
h (gpm)	0.00960	0.00960	0.00960	0.00960	0.00960	0.00960
CO ₂ Targets						
a (g/mi)	220	214	207	201	195	189
b (g/mi)	341	331	321	312	302	293
c (g/mi per s.f.)	4.43	4.30	4.17	4.04	3.92	3.80
d (g/mi)	38.7	37.6	36.5	35.4	34.3	33.3
e (g/mi)	251	251	251	251	251	251
f (g/mi)	352	352	352	352	352	352
g (g/mi per s.f.)	4.04	4.04	4.04	4.04	4.04	4.04
h (g/mi)	85.3	85.3	85.3	85.3	85.3	85.3

3.6.9 Alternative 8

*** EO 12866 Review – Draft – Do Not Cite, Quote or Release During Review ***

Alternative 8 increases the stringency of targets annually during MYs 2022-2026 (on a gallon per mile basis, starting from MY 2021) by 2.0% for passenger cars and 3.0% for light trucks. This alternative would apply to CO₂ beginning in MY 2021.

TABLE 3-23 - CHARACTERISTICS OF ALTERNATIVE 8 – PASSENGER CARS

	2021	2022	2023	2024	2025	2026
Fuel Economy Targets						
a (mpg)	50.83	51.87	52.93	54.01	55.11	56.23
b (mpg)	38.02	38.80	39.59	40.40	41.22	42.06
c (gpm per s.f.)	0.000442	0.000433	0.000424	0.000416	0.000408	0.000399
d (gpm)	0.00155	0.00152	0.00149	0.00146	0.00143	0.00141
CO ₂ Targets						
a (g/mi)	175	171	168	165	161	158
b (g/mi)	234	229	224	220	216	211
c (g/mi per s.f.)	3.93	3.85	3.77	3.70	3.62	3.55
d (g/mi)	13.8	13.5	13.3	13.0	12.7	12.5

TABLE 3-24 - CHARACTERISTICS OF ALTERNATIVE 8 – LIGHT TRUCKS

	2021	2022	2023	2024	2025	2026
Fuel Economy Targets						
a (mpg)	41.80	43.09	44.42	45.80	47.21	48.67
b (mpg)	25.25	26.03	26.83	27.66	28.52	29.40
c (gpm per s.f.)	0.000482	0.000468	0.000453	0.000440	0.000427	0.000414
d (gpm)	0.00416	0.00404	0.00392	0.00380	0.00369	0.00358
e (mpg)	35.41	35.41	35.41	35.41	35.41	35.41
f (mpg)	25.25	25.25	25.25	25.25	25.25	25.25
g (gpm per s.f.)	0.000455	0.000455	0.000455	0.000455	0.000455	0.000455
h (gpm)	0.00960	0.00960	0.00960	0.00960	0.00960	0.00960
CO ₂ Targets						
a (g/mi)	213	206	200	194	188	183
b (g/mi)	352	341	331	321	312	302
c (g/mi per s.f.)	4.28	4.15	4.03	3.91	3.79	3.68
d (g/mi)	37.0	35.9	34.8	33.8	32.8	31.8
e (g/mi)	251	251	251	251	251	251
f (g/mi)	352	352	352	352	352	352
g (g/mi per s.f.)	4.04	4.04	4.04	4.04	4.04	4.04
h (g/mi)	85.3	85.3	85.3	85.3	85.3	85.3

4 Effect of Other Governmental Vehicle Standards On Fuel Economy

4.1 Introduction

The Energy Policy and Conservation Act (EPCA or the Act) requires fuel economy standards for passenger cars and light trucks be set at the maximum feasible level after considering the following criteria: (1) technological feasibility, (2) economic practicability, (3) the effect of other government standards on fuel economy, and (4) the need of the nation to conserve energy. This chapter discusses effects of other government regulations on model year (MY) 2021-2026 passenger cars and light trucks in terms of added vehicle weight, using MY 2016 as the baseline (or the model year to be compared with). The analysis includes the cost for offsetting the vehicle weight increase caused by other government regulations as part of the application of mass reduction technology. For mass reduction technology, the net amount of mass reduction includes the mass reduction associated with material substitution and redesign and the increase in mass associated with meeting requirements imposed by finalized safety regulations and voluntary National Highway Traffic Safety Administration (NHTSA) and IIHS guidelines. For other safety technology, this analysis assumes manufacturers choosing to add those safety features will remove enough weight from vehicles to offset the added weight of those technologies. This analysis notes this assumption was made in the analysis for the 2012 final regulatory impact analysis (FRIA) for the MY 2017 and later CAFE rule.

4.2 The Effect on Weight of Safety Standards and Voluntary Safety Improvements

Safety improvements affect a manufacturer's ability to improve fuel economy to the extent technologies that improve fuel economy increase vehicle weight, therefore, reducing fuel economy. The agency's estimates of how much weight various safety improvements might add are based on NHTSA-sponsored cost and weight tear-down studies. The studies are conducted on vehicles representing an average application of safety technology, so the weight and costs are representative of average applications.

Regarding safety standards, this analysis has broken down into two parts - First, those NHTSA final rules with known effective dates between MY 2016 and MY 2026; second, proposed rules or potential rules that could become effective before MY 2026 but do not currently have effective dates.

4.2.1 Weight Effects of Required Safety Standards (Final Rules with Known Effective Dates)

NHTSA has issued two safety standards becoming effective for passenger cars and light trucks between MY 2016 and MY 2025. This analysis examined the potential effect of these final rules on the vehicle weight of passenger cars and light trucks using MY 2016 as the baseline. The safety standards with effective dates are summarized in Table 4-1.

TABLE 4-1 - SAFETY STANDARDS AND EFFECTIVE DATES USING MY 2016 VEHICLES AS BASELINE FLEET

Safety Standard	Effective Date
FMVSS No.141, Minimum Sound Requirements for Hybrid and Electric Vehicles, final rule ⁷²	This rule is effective September 1, 2020. ⁷³
FMVSS No. 111, Rear Visibility	This rule became effective June 6, 2016. ⁷⁴

4.2.2 FMVSS 141, Minimum Sound Requirements for Hybrid and Electric Vehicles

To reduce the risk of pedestrian crashes, especially for the blind and visually-impaired, and to satisfy the mandate in the Pedestrian Safety Enhancement Act (PSEA) of 2010, NHTSA issued a new Federal Motor Vehicle Safety Standard (FMVSS) setting minimum sound requirements for hybrid and electric vehicles. The new standard requires hybrid and electric passenger cars, light trucks and vans (LTVs), and low speed vehicles (LSVs) to produce sounds meeting the requirements of this standard. This final rule applies to electric vehicles (EVs) and to hybrid vehicles (HVs) capable of propulsion in any forward or reverse gear without the vehicle’s internal combustion engine (ICE) operating. This standard will help ensure blind, visually impaired, and other pedestrians are able to detect and recognize nearby hybrid and electric vehicles, as required by the PSEA.

The addition of wiring and a speaker will add weight to vehicles, which would consequently increase their lifetime use of fuel. The average weight gain for a light vehicle is estimated to be 1.5 pounds (based upon a similar waterproof speaker used for marine purposes).⁷⁵

4.2.3 FMVSS 111, Rear Visibility

⁷² Docket No. NHTSA–2016–0125, RIN 2127–AK93.

⁷³ Compliance date - Compliance with FMVSS No. 141 and related regulations, is required for all hybrid and electric vehicles to which the regulations are applicable beginning September 1, 2020. (The initial compliance date for newly manufactured vehicles under the 50-percent phase-in as specified in FMVSS No. 141 is delayed by one year to September 1, 2019.) A 50-percent phase-in must be achieved by September 1, 2019, and the deadline date for full compliance of all vehicles subject to requirements of the safety standard is September 1, 2020.

<https://www.federalregister.gov/documents/2018/02/26/2018-03721/federal-motor-vehicle-safety-standard-no-141-minimum-sound-requirements-for-hybrid-and-electric>

⁷⁴ Compliance Date - Compliance is required, in accordance with the phase-in schedule, beginning May 1, 2016. Full compliance is required May 1, 2018. The phase-in - 0% of vehicles manufactured before May 1, 2016; 10% of the vehicles manufactured on or after May 1, 2016, and before May 1, 2017; 40% of vehicles manufactured on or after May 1, 2017, and before May 1, 2018; and 100% of vehicles manufactured on or after May 1, 2018.

<https://www.federalregister.gov/documents/2014/04/07/2014-07469/federal-motor-vehicle-safety-standards-rear-visibility>

⁷⁵ For the final regulatory analysis (FRIA), see - <https://www.regulations.gov/document?D=NHTSA-2016-0125-0011>.

*** EO 12866 Review – Draft – Do Not Cite, Quote or Release During Review ***

To reduce the risk of backover crashes involving vulnerable populations (including young children) and to satisfy the mandate of the Cameron Gulbransen Kids Transportation Safety Act of 2007, NHTSA issued a final rule expanding the required field of view for all passenger cars, trucks, multipurpose passenger vehicles, buses, and low speed vehicles with a gross vehicle weight of less than 10,000 pounds.⁷⁶ The agency anticipates the final rule will significantly reduce backover crashes involving children, persons with disabilities, the elderly, and other pedestrians, who currently have the highest risk associated with backover crashes. Specifically, the rule specifies an area behind the vehicle must be visible to the driver when the vehicle is placed into reverse and other related performance requirements. The agency anticipates, in the near term, vehicle manufacturers will use rearview video systems and in-vehicle visual displays to meet requirements.

As part of the rear visibility rulemaking effort, NHTSA performed a teardown study. The objective of the study was to provide cost estimates for 3 ultrasonic sensor systems and 3 camera systems.⁷⁷ The weight of the ultrasonic sensor systems ranges from 0.8683 lb. to 1.4803 lb.; the weight of the radar systems ranges from 1.3882 lb. (with camera and display in the mirror) to 7.2209 lb. (camera and navigational display system).

4.2.4 Weight Effects of Proposed Rules or Voluntary Safety Improvements Potentially Affecting MY 2021 and Later Vehicles

NHTSA has proposed 31 motor vehicle-related safety rules during the last 7 years, September 1, 2012, to February 8, 2018. Among the 31 proposed rules, only two proposed rules, V2V Communications (V2V) and Event Data Recorders (EDR, Part 563), could affect the weight of MY 2021 and later model year vehicles. For these two proposed rules, only V2V is considered for the CAFE rulemaking because any weight added to meet the proposed EDR rule would be insignificant.

FMVSS No. 150 would mandate vehicle-to-vehicle (V2V) communications for new light vehicles and standardization of the message and format of V2V transmissions. This would create an information environment where vehicle and device manufacturers could create and implement applications to improve safety, mobility, and the environment.

The agency estimated V2V requirements would add 3.06 lbs. to 3.38 lbs., for each vehicle,⁷⁸ as shown in

Table 4-2.

⁷⁶ 49 CFR Part 571, Docket No. NHTSA–2010–0162, RIN 2127–AK43, Federal Motor Vehicle Safety, Standards; Rear Visibility. The final rule became effective June 6, 2014. Compliance Date - Compliance was required, in accordance with the phase-in schedule, beginning on May 1, 2016. Full compliance is required May 1, 2018.

⁷⁷ For the FRIA, see - <https://www.regulations.gov/document?D=NHTSA-2010-0162-0255>.

⁷⁸ 49 CFR Part 571, Docket No. NHTSA–2016–0126, RIN 2127–AL55.

TABLE 4-2 - SUMMARY OF V2V COMPONENT CONSUMER COSTS PER AFFECTED VEHICLE

Items	Weight (lbs.)	
	One radio system	Two radio system
Parts	2.91	3.23
Installation hardware	0.26	0.26
Total	3.17	3.49

4.2.5 Voluntary measures that could affect weight

There are other voluntary measures some manufacturers identified as potentially increasing weight substantially. These include:

- **Voluntary Safety Improvements** - On September 12, 2017, NHTSA released Automated Driving Systems 2.0 - A Vision for Safety (ADS 2.0) and requested public comment. NHTSA issued ADS 2.0 as the next step on the path forward for the safe testing and deployment of automated driving systems (ADSs).⁷⁹ ADS 2.0 provides voluntary guidance to support the automotive industry and other key stakeholders as they consider and design best practices for the testing and deployment of ADSs, best practices for legislatures, as well as a framework for states to develop procedures and considerations for the safe operation of ADSs on public roadways. However, we note ADS 2.0 is non-binding guidance that will be revised over time. Nevertheless, we included estimates of additional weight that might be because of these ADSs to be conservative as to the potential effects of these ADSs on fuel economy. However, these additional weight estimates were not included in the passenger car or light duty truck cost curve, or these weights added to the resulting curb weight after mass reduction in the Autonomie drive cycle simulations to estimate increase in fuel consumption.
- **New Car Assessment Program (NCAP)** - NHTSA issued a request for comments (RFC) in December 2015 to seek comments on NHTSA’s proposed plan to advance capabilities and safety outcomes of NCAP. These have yet to be proposed, so their effect is unknown.⁸⁰

⁷⁹ Department of Transportation National Highway Traffic Safety Administration, Docket No. NHTSA–2017–0082, Automated Driving Systems 2.0 - A Vision for Safety; Listening Session.

⁸⁰ NHTSA’s NCAP provides comparative information on the safety of new vehicles to assist consumers with vehicle purchasing decisions and encourage motor vehicle manufacturers to make vehicle safety improvements. To keep pace with advancements in occupant protection and the introduction of advanced technologies, NHTSA has periodically updated the program. For additional information, see <https://www.federalregister.gov/documents/2015/12/16/2015-31323/new-car-assessment-program>.

*** EO 12866 Review – Draft – Do Not Cite, Quote or Release During Review ***

- IIHS Testing of a Narrow Frontal Overlap Test - The test is to improve occupant protections in frontal crashes when the front left corner of a vehicle collides with another vehicle or an object like a tree or utility pole. NHTSA used the MY 2011 Honda Accord⁸¹ to estimate the countermeasure mass addition to meet IIHS narrow frontal overlap test (also known as small overlap test). This study estimated the mass addition of 6.6kg to passenger car vehicles. The cost curves developed for passenger cars and full-size light duty trucks⁸² includes the mass addition from the countermeasure to meet the IIHS narrow frontal overlap test, light-weighting technology applied to the countermeasure and cost associated with light-weighting.
- Pedestrian Protection - The agency may propose the Global Technical Regulation on pedestrian protection. Effective dates are undetermined. Potential weight increases for pedestrian head and leg protection have not yet been identified, but the leg protection part of the standard has the potential to add weight to the front of the vehicle by changing the material used on front end to a softer material.

There are several advanced driver assistance systems being developed or implemented, as partially listed below:

- Forward Collision Warning and Automated Braking,
- Lane Departure Warning, and
- Intelligent Headlamps.

Forward Collision Warning and Automated Braking - As a NHTSA research project, we the agency examined forward collision warning (FCW) and automated braking (AEB). As part of the effort, the agency conducted a cost teardown study of a variety of these systems. The cost teardown study shows these technologies would add less than one pound (0.694lbs., FCW only) to 0.64 pounds, as shown in Table 4-3⁸³

Forward Collision Warning and Automated Braking - As a NHTSA research project, we examined forward collision warning (FCW) and automated braking (AEB). As part of the effort, the agency conducted a cost teardown study of a variety of these systems. The cost teardown study shows these technologies would add less than one pound (0.694lbs., FCW only) to 0.64 pounds, as shown in Table 4-3.⁸⁴

TABLE 4-3 - WEIGHT OF FCW AND AUTOMATED BRAKES

Vehicle	System	Features	
---------	--------	----------	--

⁸¹ DOT HS 812 237.

⁸² DOT HS 812 487.

⁸³ Docket no. - NHTSA-2011-0066-0011. www.regulations.gov.

⁸⁴ Docket no. - NHTSA-2011-0066-0011. www.regulations.gov.

	Camera	Radar	FCW	Dynamic Brake Support (DBS) ⁸⁵	Crash Imminent Braking (CIB)	Weight (lbs.)
2012 Chevy Equinox LTZ	Yes	No	Yes	No	No	0.694
2010 Ford Taurus	No	Yes	Yes	Yes	No	3.598
2010 Lexus ES	No	Yes	Yes	yes	No	2.610
2010 Audi A6	Yes	Yes	Yes	Yes	Yes	4.762
2010 Volvo S80	Yes	Yes	Yes	Yes	Yes	6.449

Lane Departure Warning - This is another research project that led to the conclusion lane departure warning systems could add 0.31 (0.3081) pounds to 3.00 (2.9708) pounds to each vehicle, on average of 1.22 (1.2226) pounds. It could use the same camera behind the mirror that might be used for a forward collision warning system, discussed above.⁸⁶

Intelligent Headlamps - There are several different types of intelligent headlamps being developed by vehicle manufactures. In general, these intelligent headlight systems automatically adjust depending on traffic conditions and environment. Although these technologies would add a certain amount of weight to the front of a vehicle, weight data is unavailable.

4.3 Summary – Overview of Anticipated Weight Increases

Table 4-4 through Table 4-6 summarizes estimates made by NHTSA regarding the weight added by the above discussed standards or potential voluntary safety improvements with the MY 2016 baseline, which would have weight effects on MY 2021 and later MY vehicles. NHTSA estimates weight additions required by final rules will add 2.37-8.72 pounds for light vehicles (passenger cars and light trucks). Additionally, the proposed FMVSS No. 150 and the ADSs considered would add 3.17-3.49 pounds and 1.92-7.68 pounds, respectively.

⁸⁵ If the driver brakes, but not hard enough to avoid the crash, DBS automatically supplements the driver’s braking in an effort to avoid the crash. If the driver does not take any action to avoid the crash, CIB automatically applies the vehicle’s brakes to slow or stop the car, avoiding the crash or reducing its severity. In 2015, 33.4% of all police-reported crashes involved a rear-end collision with another vehicle as the first harmful event in the crash. NHTSA believes advanced crash avoidance and mitigation technologies like DIB and CBS systems could help in this area. NHTSA’s extensive research on this technology and on relevant performance measures showed a number of AEB systems available in the marketplace are capable of avoiding or reducing the severity of rear-end crashes in certain situations.

⁸⁶ Docket - NHTSA-2011-0066 <https://www.regulations.gov/document?D=NHTSA-2011-0066-0033>.

*** EO 12866 Review – Draft – Do Not Cite, Quote or Release During Review ***

**TABLE 4-4 - SUMMARY WEIGHT ADDITIONS BECAUSE OF FINAL RULES
COMPARING MY 2021 TO MY 2016 BASELINE FLEET**

Final Rules by FMVSS No.	Passenger Cars Added Weight (pounds)*	Passenger Cars Added Weight (kilograms)	Light Trucks Added Weight (pounds)	Light Trucks Added Weight (kilograms)
FMVSS 141	1.50	0.68	1.50	0.68
FMVSS 111	4.60 ⁸⁷	2.09	4.60	2.09
Final Rules Subtotal	6.1	2.77	6.1	2.77

* The numbers were rounded to two decimal points.

**TABLE 4-5 - SUMMARY WEIGHT ADDITIONS BECAUSE OF PROPOSED RULES
COMPARING MY 2021 TO MY 2016 BASELINE FLEET**

Final Rules by FMVSS No.	Passenger Cars Added Weight (pounds)	Passenger Cars Added Weight (kilograms)	Light Trucks Added Weight (pounds)	Light Trucks Added Weight (kilograms)
FMVSS 150	3.17-3.49	1.44-1.58	3.17-3.49	1.44-1.58

**TABLE 4-6 - SUMMARY WEIGHT ADDITIONS BECAUSE OF VOLUNTARY SAFETY
IMPROVEMENTS COMPARING MY 2021 TO MY 2016 BASELINE FLEET**

Technology	Passenger Cars Added Weight (pounds)	Passenger Cars Added Weight (kilograms)	Light Trucks Added Weight (pounds)	Light Trucks Added Weight (kilograms)
FCW/AEB	0.69-6.45	0.31-2.93	0.69-6.45	0.31-2.93
Lane Departure Warning	1.226	0.55	1.226	0.55

⁸⁷ DOT HS 812 354.

5 Corporate Average Fuel Economy Compliance Simulation Modeling in Response to Regulatory Alternatives

This analysis made significant use of results produced by the CAFE Compliance and Effects Model (commonly referred to as the “CAFE model”), which DOT’s Volpe National Transportation Systems Center developed specifically to support NHTSA’s CAFE rulemakings, and has since updated to account for EPA’s regulatory CO₂ compliance provisions. Further discussion of the decision to jointly rely on the CAFE model for compliance simulation is located in Preamble Section II.A.

The CAFE model is designed to simulate compliance with a given set of CAFE or CO₂ standards for each manufacturer that sells vehicles in the United States. The model begins with a representation of the MY 2016 vehicle model offerings for each manufacturer that includes the specific engines and transmissions on each model variant, observed sales volumes, and all fuel economy improvement technology that is already present on those vehicles. From there it adds technology, in response to the standards being considered, in a way that minimizes the cost of compliance and reflects many real-world constraints faced by automobile manufacturers. The model addresses fleet year-by-year compliance, taking into consideration vehicle refresh and redesign schedules and shared platforms, engines and transmissions among vehicles.

This analysis evaluated a wide array of technologies that manufacturers could use to improve the fuel economy of new vehicles, in both the near future and the timeframe of this proposed rulemaking, to meet the fuel economy and CO₂ standards proposed in this rulemaking. The analysis evaluated costs for these technologies, and examined how these costs may change over time. How fuel-saving technologies may be used on many types of vehicles (ranging from small cars to trucks) was also considered, and how the technologies may perform in improving fuel economy and CO₂ in combination with other technologies was considered as well. With cost and effectiveness estimates for technologies, the analysis forecasts how manufacturers may respond to potential standards and can estimate the associated costs and benefits related to technology and equipment changes. This assists the assessment of technological feasibility and is a building block for the consideration of economic practicability of potential standards.

An updated version of the Autonomie model was also used for this analysis - an improved version of what NHTSA presented in the 2016 Draft TAR - to assess technology effectiveness of technologies and combinations of technologies. The Department of Energy’s Argonne National Laboratory (ANL) developed Autonomie, and the underpinning model assumptions leveraged research from the DOE’s Vehicle Technologies Office and feedback from the public. Autonomie is commercially available and widely used; third parties such as suppliers, automakers, and academic researchers (who publish findings in peer reviewed academic journals) commonly use the Autonomie simulation software.

This analysis also uses an updated, peer-reviewed model developed by Argonne National Laboratory for the Department of Energy to provide a ~~more rigorous~~ estimate for battery costs. The new battery model estimates future battery costs for hybrids, plug-in hybrids and electric vehicles, taking into account the different battery design characteristics, and taking into account the size of the battery for different applications.

Commented [A2]: Suggest striking the text “provide a more rigorous” In previous analyses, both NHTSA and EPA used the latest version of BatPaC available at the time, so while it is accurate to say the new work is ‘updated’, a change in language will avoid giving impression that the previous work was not rigorous.

The following chapter discusses in detail the approach to compliance simulation modeling for this proposed rulemaking, including an overview of Autonomie’s full vehicle simulation modeling to support vehicle simulation modeling with the CAFE model. The chapter also discusses in detail assumptions related to fuel-economy improving technology cost and effectiveness.

Commented [A3]: New to NHTSA’s analysis, but not to the joint Draft TAR or PD analysis. Stating it this way makes it sound like BatPac is an entirely new development for the PRIA.

5.1 Technology Effectiveness based on Full Vehicle Simulation and Modeling

Many of today’s automotive control-system simulation tools are suitable for modeling, but they provide rather limited support for model building and management. Setting up a simulation model requires more than writing down state equations⁸⁸ and running them on a computer. With the introduction of hybrid and electric vehicles the number of components populating a vehicle has increased considerably, and more components translate into more possible drivetrain configurations and powertrain control options. Additionally, building hardware is expensive. Traditional design paradigms in the automotive industry often delay control-system design until late in the process — in some cases requiring several costly hardware iterations. To reduce costs and improve time to market, placing greater emphasis on modeling and simulation is imperative. This becomes truer as time goes on because of the increasing complexity of vehicles and number of vehicle configurations.

With the large number of possible advanced vehicle architectures as well as time and cost constraints, it is impossible to manually build every powertrain configuration model. As a result, portions of the fleet-wide analysis were automated.

Autonomie is a MATLAB©-based software environment and framework for automotive control-system design, simulation, and analysis.⁸⁹ The tool is designed for rapid and easy integration of models with varying levels of detail (low to high fidelity) and abstraction (from subsystems to systems and entire architectures), as well as processes (e.g., calibration, validation). Developed by Argonne National Laboratory (ANL) in collaboration with General Motors, Autonomie was designed to serve as a single tool to meet requirements of automotive engineering throughout the

⁸⁸ In engineering, a state equation or state-space representation is a mathematical model of a physical system as a set of input, output, and state variables related by first order differential equations or difference equations.

⁸⁹ Halbach, S. Sharer, P. Pagerit, P., Folkerts, C. & Rousseau, A. “*Model Architecture, Methods, and Interfaces for Efficient Math-Based design and Simulation of Automotive Control Systems*,” SAE 2010-01-0241, SAE World Congress, Detroit, April, 2010.

development process from modeling to control. Autonomie was built to accomplish the following -

- Support multiple modeling methods, from model-in-the-loop, software-in-the-loop, and hardware-in-the-loop to rapid-control prototyping;
- Integrate math-based engineering activities through development, from feasibility studies to production release;
- Promote re-use and exchange of models industry-wide through its modeling architecture and framework;
- Support users' customization of the entire software package, including system architecture, processes, and post-processing;
- Mix and match models of different levels of abstraction for execution efficiency with higher-fidelity models where analysis and high-detail understanding are critical;
- Link with commercial off-the-shelf software applications, including GT-Power®, AMESim®, and CarSim®, for detailed, physically-based models;
- Provide configuration and database management.

By building models automatically, Autonomie allows the quick simulation of a large number of component technologies and powertrain configurations. Autonomie -

- Simulates subsystems, systems, or entire vehicles;
- Predicts and analyzes fuel efficiency and performance;
- Performs analyses and tests for virtual calibration, verification, and validation of hardware models and algorithms;
- Supports system hardware and software requirements;
- Links to optimization algorithms; and
- Supplies libraries of models for propulsion architectures of conventional powertrains as well as EDVs.

Autonomie is used to assess the energy consumption of advanced powertrain technologies. Autonomie has been validated for several powertrain configurations and vehicle classes using Argonne's Advanced Powertrain Research Facility (APRF) vehicle test data.⁹⁰

With more than 400 pre-defined powertrain configurations, Autonomie is an ideal tool for analyzing advantages and drawbacks of different options within each family, including

⁹⁰ Kim, N, Jeong, J, Rousseau, A. & Lohse-Busch, H. "Control Analysis and Thermal Model Development of PHEV," SAE 2015-01-1157, SAE World Congress, Detroit, April15; Kim, N., Rousseau, A. & Lohse-Busch, H. "Advanced Automatic Transmission Model Validation Using Dynamometer Test Data," SAE 2014-01-1778, SAE World Congress, Detroit, Apr14.; Lee, D, Rousseau, A. & Rask, E. "Development and Validation of the Ford Focus BEV Vehicle Model," 2014-01-1809, SAE World Congress, Detroit, Apr14; Kim, N., Kim, N., Rousseau, A., & Duoba, M. "Validating Volt PHEV Model with Dynamometer Test Data using Autonomie," SAE 2013-01-1458, SAE World Congress, Detroit, Apr13.; Kim, N., Rousseau, A., & Rask, E. "Autonomie Model Validation with Test Data for 2010 Toyota Prius," SAE 2012-01-1040, SAE World Congress, Detroit, Apr12; Karbowski, D., Rousseau, A, Pagerit, S., & Sharer, P. "Plug-in Vehicle Control Strategy - From Global Optimization to Real Time Application," 22th International Electric Vehicle Symposium (EVS22), Yokohama, (October 2006).

conventional, parallel, series, and power-split Hybrid Electric Vehicles (HEVs). Various approaches have been used in previous studies to compare options ranging from global optimization to rule-based control.⁹¹

Autonomie also allows users to evaluate the effect of component sizing on fuel consumption for different powertrain technologies as well as to define component requirements (e.g., power, energy) to maximize fuel displacement for a specific application.⁹² To properly evaluate any powertrain-configuration or component-sizing influence, the vehicle-level control is critical, especially for EDVs. Argonne has extensive expertise in developing vehicle-level controls based on different approaches, from global optimization to instantaneous optimization, rule-based optimization, and heuristic optimization.⁹³

The ability to simulate a large number of powertrain configurations, component technologies, and vehicle-level controls over numerous drive cycles has been used to support many DOE and manufacturer studies. These studies focused on fuel efficiency, cost-benefit analysis, or greenhouse gases.⁹⁴ Developments performed in simulation can be implemented in hardware to account for non-modeled parameters, such as emissions and temperature.⁹⁵

⁹¹ Karbowski, D., Kwon, J., Kim, N., & Rousseau, A. "Instantaneously Optimized Controller for a Multimode Hybrid Electric Vehicle," SAE paper 2010-01-0816, SAE World Congress, Detroit, April 2010. 607. Nelson, P., Amine, K., Rousseau, A., & Yomoto, H. (EnerDel Corp.), "Advanced lithium-ion batteries for plug-in hybrid-electric vehicles," 23rd International Electric Vehicle Symposium (EVS23), Anaheim, CA, (Dec. 2007); Karbowski, D., Haliburton, C., & Rousseau, A. "Impact of Component Size on Plug-in Hybrid Vehicles Energy Consumption using Global Optimization," 23rd International Electric Vehicle Symposium (EVS23), Anaheim, CA, (Dec. 2007).

⁹² Nelson, P., Amine, K., Rousseau, A., & Yomoto, H. (EnerDel Corp.), "Advanced Lithium-ion Batteries for Plug-in Hybrid-electric Vehicles," 23rd International Electric Vehicle Symposium (EVS23), Anaheim, CA, (Dec. 2007); Karbowski, D., Haliburton, C., & Rousseau, A. "Impact of Component Size on Plug-in Hybrid Vehicles Energy Consumption using Global Optimization," 23rd International Electric Vehicle Symposium (EVS23), Anaheim, CA, (Dec. 2007).

⁹³ Karbowski, D., Kwon, J., Kim, N., & Rousseau, A., "Instantaneously Optimized Controller for a Multimode Hybrid Electric Vehicle," SAE paper 2010-01-0816, SAE World Congress, Detroit, April 2010; Sharer, P., Rousseau, A., Karbowski, D., & Pagerit, S. "Plug-in Hybrid Electric Vehicle Control Strategy - *Comparison between EV and Charge-Depleting Options*," SAE paper 2008-01-0460, SAE World Congress, Detroit (April 2008); and Rousseau, A., Shidore, N., Carlson, R., & Karbowski, D. "Impact of Battery Characteristics on PHEV Fuel Economy," AABC08.

⁹⁴ Delorme et al. 2008, Rousseau, A., Sharer, P., Pagerit, S., & Das, S. "Trade-off between Fuel Economy and Cost for Advanced Vehicle Configurations," 20th International Electric Vehicle Symposium (EVS20), Monaco (April 2005); Elgowainy, A., Burnham, A., Wang, M., Molburg, J., & Rousseau, A. "Well-To-Wheels Energy Use and Greenhouse Gas Emissions of Plug-in Hybrid Electric Vehicles," SAE 2009-01-1309, SAE World Congress, Detroit, April 2009.

⁹⁵ Vijayagopal, R., Kwon, J., Rousseau, A., & Maloney, P. "Maximizing Net Present Value of a Series PHEV by Optimizing Battery Size and Vehicle Control Parameters," SAE 2010-01-2310, SAE Convergence Conference, Detroit (October 2010).

*** EO 12866 Review – Draft – Do Not Cite, Quote or Release During Review ***

Autonomie is the primary vehicle simulation tool selected by DOE to support its U.S. DRIVE Program and Vehicle Technologies Office (VTO). Autonomie has been used for numerous studies to provide the U.S. government with guidance for future research.⁹⁶

The vehicle models in Autonomie are developed in Matlab/Simulink/Stateflow and are open for users to view and modify equations or algorithms. Several hundred powertrain configurations and more than 100 full vehicle models, including controls are available in the tool.

5.2 Autonomie Full Vehicle Simulation for the MY 2021-2026 rulemaking

5.2.1 Overview

In the analysis supporting the 2012 final rule for MYs 2017 and beyond, the agencies applied technology effectiveness estimates to the DOT's CAFE model and EPA's OMEGA using EPA's lumped parameter model. To support its analysis, EPA updated its lumped parameter model and calibrated it with updated vehicle simulation work performed by Ricardo, PLC. As in the MYs 2012-2016 rulemaking, DOT calibrated inputs, including synergy factors, to the CAFE model to as fully as practical align with estimates produced by EPA's lumped parameter model.⁹⁷

NHTSA structured its analysis in the final rule for MYs 2017 and beyond so that each successive technology was added to the preceding technology and the fuel consumption reduction effectiveness values were dependent on and incremental to each of the previous technologies that have already been applied. In many cases, this means accounting for synergies among technologies.⁹⁸ For the 2015 National Academies of Sciences (NAS) study on the cost, effectiveness, and deployment of fuel economy technologies for light-duty vehicles, the NAS committee overseeing the study contracted with experts at the University of Michigan's Department of Mechanical Engineering (U of M) to use full system simulation modeling to analyze the effects of technologies and further understand fuel consumption benefits.⁹⁹ The committee recognized that as more technologies are added to vehicles that are aimed at reducing the same type of losses, the possibility of overestimating fuel consumption reduction becomes greater. Based on U of M's findings, the NAS committee recommended that both agencies use full vehicle simulation to improve the analysis method of estimating effectiveness technologies. The committee acknowledged that developing and executing tens or hundreds of thousands of

⁹⁶ U.S. Department of Energy Argonne National Laboratory, Autonomie, www.autonomie.net.

⁹⁷ "2012 Joint TSD - Final Rulemaking for 2017-2025 Light-Duty Vehicle Greenhouse Gas Emission Standards and Corporate Average Fuel Economy Standards" (August 2012).

⁹⁸ Two or more technologies applied together might be negatively synergistic, meaning that the sum of their effects is less than the effect of the individual technologies. Or, they might be positively synergistic, meaning that the sum of the technologies' affects are greater than the influence of individual technologies (in this case, contributes more to reducing fuel consumption).

⁹⁹ National Research Council. 2015. Cost, Effectiveness, and Deployment of Fuel Economy Technologies for Light-Duty Vehicles. Washington, DC - The National Academies Press. <https://doi.org/10.17226/21744>. p. 263.

constantly changing vehicle packages models in real-time is extremely challenging, but important for analysis of a heterogeneous fleet.

While initially this approach was not considered practical to implement, the process developed by Argonne in collaboration with NHTSA and the DOT Volpe Center does exactly that. This approach offers multiple advantages, including the ability to apply varying levels of technologies across the vehicle fleet to account for the full range of vehicle attributes and performance requirements. Today's analysis uses Autonomie full vehicle simulations to estimate technology effectiveness values and to assess complex interactions between fuel saving technologies.

The objective of the modeling described in this section is to determine the effectiveness of all possible combinations of technologies that are available to improve fuel economy, and make that data available for use as an input to the CAFE model, which identifies pathways manufacturers could use to comply with potential CAFE and CO₂ standards. To achieve this objective, individual vehicles were simulated to represent every combination of vehicle, powertrain, and component technologies considered for the assessment. The sequential addition of these technologies to the ten vehicle classes currently considered generates more than 140,000 unique vehicle combinations. In addition, simulation modeling was conducted to determine the appropriate amount of engine downsizing needed to maintain overall vehicle performance when vehicle mass reduction was applied. Running the Autonomie powertrain sizing algorithms increased the total number of simulation runs to more than one million. The result of this work is a useful dataset identifying the impacts of combinations of vehicle technologies on energy consumption that can be referenced as an input to the CAFE model for assessing regulatory compliance alternatives.

The impact of engine technologies on fuel consumption, torque and other metrics was characterized using GT-POWER© simulation modeling conducted by IAV Automotive Engineering, Inc. (IAV). GT-Power is a commercially available engine simulation tool with detailed cylinder model and combustion analysis. GT-POWER is used to characterize and provide data on engine metrics including power, torque, airflow, volumetric efficiency, fuel consumption, turbocharger performance and matching and pumping losses, and other parameters. ANL used the engine maps resulting from this analysis as inputs for the Autonomie full vehicle simulation modeling.

For this analysis, vehicle system simulations include:

- 10 vehicle classes
 - Standard - Compact, Midsize, Small SUV, Midsize SUV, Pickup
 - Performance - Compact, Midsize, Small SUV, Midsize SUV, Pickup
- 17 engine technologies
- 11 electrification levels
- 18 transmission technologies
- 6 light weighting levels

*** EO 12866 Review – Draft – Do Not Cite, Quote or Release During Review ***

- 3 rolling resistance levels
- 5 aerodynamic levels

This analysis reflects a number of updates to modeling inputs based on the detailed assessment of comments received to the Draft TAR and new work. The agencies continue to research new technologies through vehicle benchmarking, review new studies and data as they become available, and consider stakeholder comments as they are received.

The process used for this analysis includes the following steps:

1. Select technology performance and component assumptions;
2. Build the vehicle models;
3. Size the reference vehicles to all meet the given technical specifications;
4. Inherit corresponding vehicles to represent the sized vehicle;
5. Run each vehicle model on the UDDS and HWFET driving cycles;
6. Create a database with all the required inputs for the CAFE model; and
7. Create a post-processing tool to validate the database content and the modeling results.

Distributed computing was used to complete the modeling of more than 1 million combinations on a timely basis.

The remaining subsections of this chapter describe each step of the analysis method. Further details on the Autonomie simulation methods can be found in the ANL documentation report;¹⁰⁰ further details on the CAFE model functionalities are discussed in 5.4.3 of this chapter, and can also be found in the CAFE model documentation.¹⁰¹

5.2.1.1 Plant Model Overview

Autonomie was designed for full plug-and-play support. Models in the standard format create building blocks, which are assembled at run time into a simulation model of a vehicle, system, or subsystem. All parts of the user interface are designed to be flexible to support architectures, systems, subsystems, and processes not yet envisioned. The software can be molded to individual uses, so it can grow as requirements increase and technical knowledge expands. This flexibility also allows for implementation of legacy models, including plant and controls.

5.2.1.2 Internal Combustion Engine Model

All Autonomie engine models use performance maps to predict fuel rate, operating temperature and, in some cases when maps are available, emissions. The output torque of the engine is computed from the engine controller command, which takes a percentage of the spread between

¹⁰⁰ Islam S. Ehsan, Moawad, Ayman, Kim, Namdoo, Rousseau, Aymeric. "A Detailed Vehicle Simulation Process to Support CAFE Standards." ANL/ESD-18/6. Energy Systems Division, Argonne National Laboratory. 2018 [docket ID]

¹⁰¹ [insert CAFE model documentation docket ID].

*** EO 12866 Review – Draft – Do Not Cite, Quote or Release During Review ***

the maximum engine torque map and the minimum engine torque map. These maps are based primarily on two sources - test data that are measured from engines running at steady state points on an engine dynamometer (dyno), or from high fidelity engine models such as GT-POWER®. These GT-POWER engine maps can incorporate technologies such as gasoline direct injection (GDI), variable valve lift (VVL), variable valve timing (VVT), camless internal combustion engine and other engine technologies. In addition to these performance maps, engine models include a single time constant to represent the transient response of the engine output torque to the engine command.

However, some engine models use specific logic to represent specific technology or fuels. For example, Autonomie uses a specific model for spark ignition engine with a turbo charger. The maps for turbo technologies were developed using GT-POWER. With turbo engines, there is a 'lag' in torque delivery due to the operation of the turbo charger. This affects vehicle performance, as well as the vehicle's ability to shift during aggressive cycles. Turbo lag has been modelled for turbo systems based on principles of a first order delay, where the turbo lag kicks in after the naturally aspirated torque limit of turbo engines has been reached. The model also accounts for the change in an internal combustion engine's turbo response with engine speed (i.e., at higher speeds, the turbo response is faster because of higher exhaust flow rates).

Autonomie also uses a specific engine model for cylinder deactivation, as this model has a more advanced fuel calculation subsystem, including different maps. Because of noise, vibration, and harshness (NVH) considerations in production vehicles, cylinder deactivation operation is not performed during several vehicle operation modes, like vehicle warm-up, lower gear operation, idle, and low engine speed. To provide a realistic evaluation of benefits of cylinder deactivation technology, cylinder deactivation is not used under the following vehicle and engine conditions:

- Cylinder deactivation is disabled if the engine is at idle or any speed below 1,000 RPM or above 3,000 RPM.
- Cylinder deactivation is disabled if the vehicle is in 1st or the 2nd gear.
- Cylinder deactivation is disabled if the engine load is above half the max BMEP of the engine (and a certain hysteresis is maintained to prevent constant activation and deactivation).

Typically, cylinder deactivation is not performed during the vehicle warm up phase, i.e. initially following a cold start. Because simulations considered in this study assume a 'hot start', wherein the engine coolant temperature is steady around 95 degrees Celsius (C), the cold start condition was not a factor for simulations. The impact of cold engine friction and operation is address through a cold start adjustment, which is discussed in the Autonomie model documentation.¹⁰² In

¹⁰² Islam S. Ehsan, Moawad, Ayman, Kim, Namdo, Rousseau, Aymeric. "A Detailed Vehicle Simulation Process to Support CAFE Standards." ANL/ESD-18/6. Energy Systems Division, Argonne National Laboratory. 2018.

addition, changes in the transmission shifting calibration (like lugging speed limits) and additional torque converter slippage during cylinder deactivation have also been disregarded.

Autonomie also has a separate engine model for the spark ignition engine with fuel cut off. This engine model has a specific torque calculation to simulate engine torque loss when the engine fuel is cut off during deceleration events. In general, engine models in Autonomie are of two types, throttled engines and un-throttled engines. As shown in the figure below, both types of models provide motoring torque when fuel is cut to the engine (e.g. fuel cut off during deceleration). With throttled engines, the motoring torque is a function of throttle position.

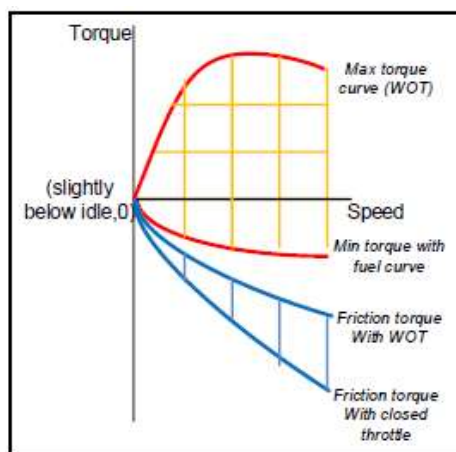

FIGURE 5-1 - ENGINE OPERATING REGIONS FOR THROTTLED ENGINES

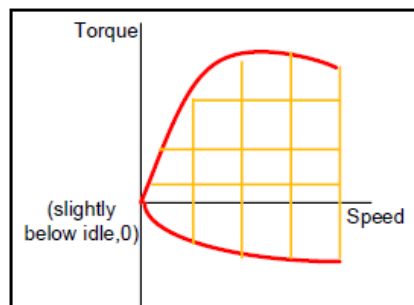

FIGURE 5-2 - ENGINE OPERATING REGION FOR UN-THROTTLED ENGINES

5.2.1.2.1 Component Sizing Algorithm

Components must be properly sized to achieve the greatest improvements in energy consumption and effectiveness. On this basis, several automated sizing algorithms were developed to assure all technologies are sized consistently for efficiency while also maintaining vehicle performance, utility and functionality. Algorithms have been defined depending on the powertrain (e.g., conventional, power split, series, electric) and application (e.g., HEV, PHEV).

All algorithms are based on the same concept - the vehicle is built from the bottom up, meaning each component assumption (e.g., specific power, efficiency) is taken into account to define the entire set of vehicle attributes (e.g., weight). This process is iterative as the main component characteristics (e.g., maximum power, vehicle weight) are modified until all vehicle technical specifications are met. The transmission gear span or ratios are currently not modified to be optimized with specific engine technologies. On average, the algorithm takes between five and 10 iterations to converge.

5.2.1.2.2 Engine Displacement & Determining the Number of Engine Cylinders

This analysis limited engine displacement and downsizing in full vehicle simulation results to mimic powertrain portfolio complexity of full line vehicle manufacturers. Analytical and empirical data were used to develop engine displacement and downsizing assumptions. For each vehicle class, each engine has eight power values, with four dedicated for conventional vehicles and four for pre-transmission HEVs. Analytically, the engine power was defined using performance tests such as acceleration and gradeability, which represent max rate engine power. Empirically, the analysis defined all number of cylinders as a function of engine displacement based on the data from light duty vehicle population. Figure 5-3 below shows the distribution of all possible engine displacement developed for this analysis.

*** EO 12866 Review – Draft – Do Not Cite, Quote or Release During Review ***

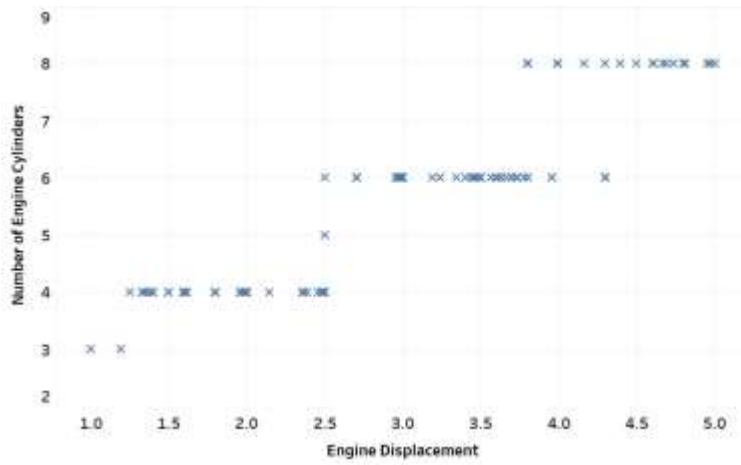

FIGURE 5-3 - ENGINE DISPLACEMENT VS. NUMBER OF ENGINE CYLINDERS RELATIONSHIP

The flowchart below shows the method to calculate the engine displacement and number of cylinders. Figure 5-4 shows the relationship of number of engine cylinders with respect to engine displacement from the existing vehicles in the U.S. market. Sizing of the engine is only dependent on four levels of mass reduction; MR0 to MR2 received one power level, while MR3, MR4, and MR5 each receive one power level. Once these engine power levels are defined, they are not changed due to change in transmission, aero, or tire technologies.

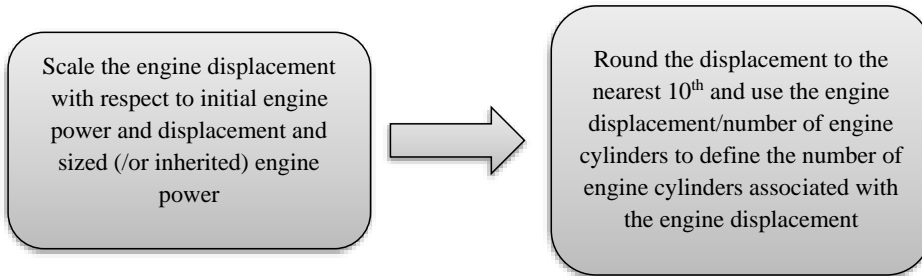

FIGURE 5-4 - ENGINE DISPLACEMENT / NUMBER OF ENGINE CYLINDER RELATIONSHIP

Using the relationship, certain thresholds are created to define the number (and type) of engine cylinders with respect to engine displacement. The thresholds are defined in table below:

TABLE 5-1 - ENGINE DISPLACEMENT VS. NUMBER OF ENGINE CYLINDERS THRESHOLD

(Type and) Number of engine cylinders	Engine displacement (L)
4-cylinder inline (I4)	1.2
	1.4
	1.6
	1.8
	2.0
	2.2
6 cylinder (V6)	2.5
	2.7
	2.9
	3.1
	3.3
	3.5
8 cylinder (V8)	3.7
	4.0
	4.5
	5.0
	5.5
	6.0
	6.5
	7.0

*** EO 12866 Review – Draft – Do Not Cite, Quote or Release During Review ***

Finally, Figure 5-5 below shows the engine displacement versus number of cylinders from all the simulation results across the different vehicle classes.

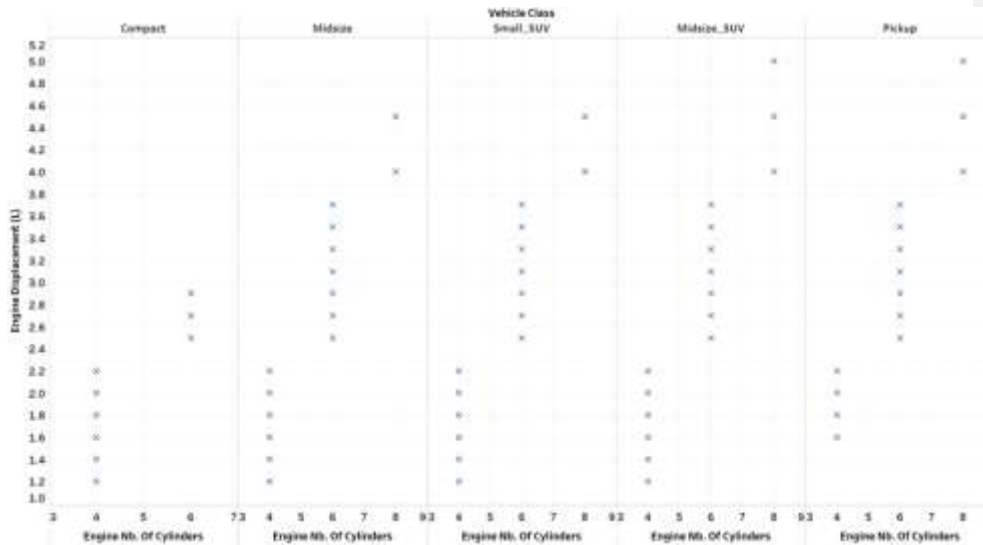

FIGURE 5-5 - ENGINE DISPLACEMENT VS. ENGINE # OF CYLINDERS FROM SIMULATION RESULTS

5.2.1.3 Transmission Models

5.2.1.3.1 Automatic Gearbox Model (AT)

The gearbox model allows for torque multiplication and speed division based on the gear number command from the powertrain controller. As for other models, losses are taken into account using torque losses to address regenerative conditions. Figure 5-6 shows the main input/output of the automatic gearbox model in Autonomie.



FIGURE 5-6 - AUTOMATIC GEARBOX MODEL INPUT/OUTPUT

The drivetrain is considered rigidly attached to the wheels. Because the wheel speed and acceleration are calculated in the wheel model and propagated backward throughout the rest of the drivetrain model, the gearbox unit is modeled as a sequence of mechanical torque gains. The torque and speed are multiplied and divided, respectively, by the current ratio for the selected gear. Furthermore, torque losses corresponding to the torque/speed operating point are subtracted from the torque input. Torque losses are defined on the basis of a three-dimensional efficiency lookup table that has shaft rotational speed, shaft torque, and gear number as inputs.

When a gear is selected, the input inertia is fed to the next component after being reflected to the output shaft using the square of the gear ratio. When the neutral gear is engaged, the input gearbox rotational speed is calculated on the basis of the input shaft inertia.

Because this is an automatic gearbox model, it can be shifted in sequence from one gear to another without having to pass through neutral and without a complete torque interruption at its output. The torque passing through the transmission during shifting is reduced, but does not go to zero as it does for a manual gearbox. Also, the torque converter model is separate from the automatic gearbox model.

5.2.1.3.2 Dual Clutch Transmission (DCT)

Dynamic models of the dual-clutch transmission (DCT) are obtained including the clutch and gear-train, but no synchronizer dynamics. Figure 5-7 illustrates an example of a DCT system that can be considered as a combination of two manual transmissions, with one providing odd gears connected to clutch1, and the other providing even gears connected to clutch2. With alternating control of the two clutches, the oncoming clutch engages, and the off-going clutch releases to complete the shift process without torque interruption. Preselecting gears is necessary to realize the benefits of the DCT system. The various DCT plant models and controls have been validated using vehicle test data.

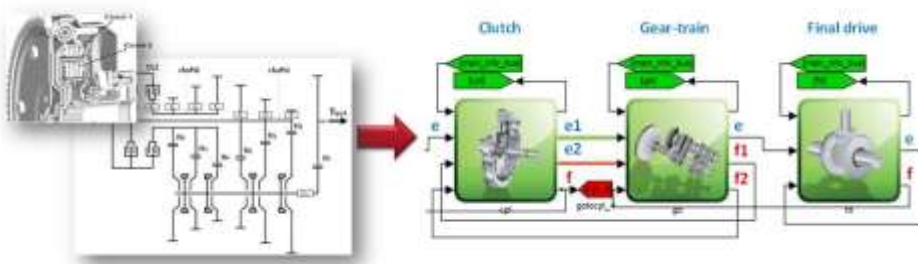

FIGURE 5-7 - DUAL CLUTCH GEARBOX MODEL INPUT/OUTPUT

*** EO 12866 Review – Draft – Do Not Cite, Quote or Release During Review ***

The pre-selection of gears can be implemented by considering operating conditions of the DCT system. For example, if the first synchronizer is at the first-gear position, and the third through fifth synchronizers are at the neutral position (as they must be), then the gear ratio between shaft1 and the output shaft is first gear. At the same time, the gear ratio between shaft2 and the output shaft can be selected in the same manner for the pre-selection mode. To achieve a desired input-output gear ratio, the corresponding synchronizer and clutch must be applied.

5.2.1.3.3 Continuously Variable Transmission (CVT)

The metal V-belt Continuously Variable Transmission (CVT) model considers hydraulic and mechanical loss. Hydraulic loss constitutes the majority of the total loss at low vehicle speed, whereas mechanical loss is the main source of inefficiency at high speed. Operating conditions of the metal V-belt CVT system can be described by the following parameters.

Generally, with the primary and secondary pulleys, the belt is clamped by forces produced by hydraulic pressures in cylinders. These two clamping forces, F_P and F_S , counteract each other. Therefore, when the pulley ratio is constant, there is a balance between F_P and F_S . A ratio change occurs when balance is lost:

- 1) Primary clamping force (F_P) or primary pressure (P_P);
- 2) Secondary clamping force (F_S) or secondary pressure (P_S);
- 3) Primary revolution speed (ω_P);
- 4) Input torque (T_{IN}); and
- 5) Pulley ratio (i).

The CVT ratio control and clamping force control strategies, including the CVT shift dynamics, focus in the following:

- The demanded CVT ratio is determined from the engine best efficient line;
- The secondary pressure is determined for the given input torque and CVT ratio; and
- The primary pressure is controlled to meet the required CVT ratio.

Figure 5-8 shows a block diagram of the model-based ratio control and plant block.

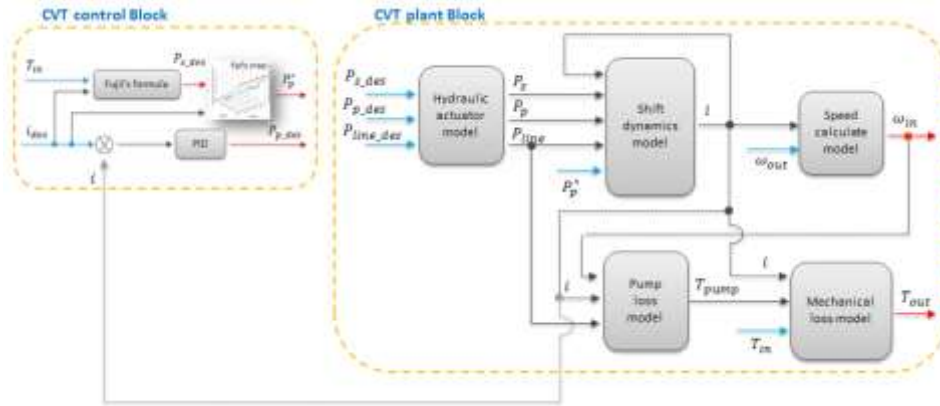

FIGURE 5-8 - CVT MODEL BLOCK DIAGRAM

5.2.1.3.4 Torque Converter

The torque converter is modeled as two separate rigid bodies when the coupling is unlocked and as one rigid body when the coupling is locked. The downstream portion of the torque converter unit is treated as being rigidly connected to the drivetrain. Therefore, there is only one degree of dynamic freedom, and the model has only one integrator. Figure 5-9 shows the main input/output of the torque converter model.



FIGURE 5-9 - AUTONOMIE TORQUE CONVERTER MODEL INPUT/OUTPUT

The effective inertias are propagated downstream until the point where integration takes place. When the coupling is unlocked, the engine inertia is propagated up to the coupling input, where it is used for calculating the rate of change of the input speed of the coupling. When the coupling is locked, the engine inertia is propagated to the wheels.

The torque converter model is based on a lookup table, which determines the output torque depending on the lockup command. The upstream acceleration during slip and the downstream acceleration are taken into account in calculating the output speed.

5.2.1.3.5 Torque Converter and Lock-up Assumptions

A torque converter is a hydrodynamic fluid coupling used to transfer rotating power from a prime mover, such as an internal combustion engine, to a rotating driven load. It is composed of an impeller (drive element); a turbine (driven component); and a stator, which assist the torque converter function. The torque converter is filled with oil and transmits the engine torque by means of the flowing force of the oil. The device compensates for speed differences between the engine and the other drivetrain components and is therefore ideally suited for start-up function.

The torque converter is modeled as two separate rigid bodies when the coupling is unlocked and as one rigid body when the coupling is locked. The downstream portion of the torque converter unit is treated as being rigidly connected to the drivetrain. Therefore, there is only one degree of dynamic freedom, and the model has only one integrator. This integrator is reset when the coupling is locked, which corresponds to the loss of the degree of dynamic freedom. Figure 5-10 shows the efficiency of the torque converter used for the study.

The effective inertias are propagated downstream until the point where actual integration takes place. When the coupling is unlocked, the engine inertia is propagated up to the coupling input, where it is used for calculating the rate of change of the input speed of the coupling. When the coupling is locked, the engine inertia is propagated to the wheels.

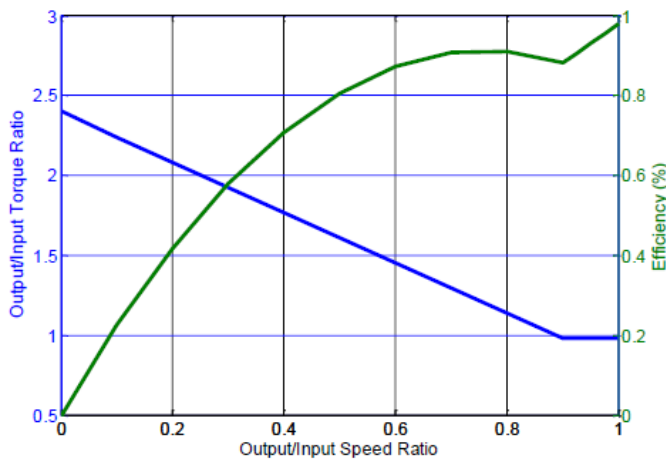

FIGURE 5-10 - TORQUE CONVERTER EFFICIENCY EXAMPLE

Figure 5-10 describes conditions under which the torque converter will be locked. The same algorithm is used to represent current torque converter lockup logic, as well as future aggressive lockup logic. The torque converter is used as a start-up device in the first gear, with low slip

(torque ratio of 0.95) at higher speeds, in the first gear. Recent trends in torque converter technology suggest operation in locked or controlled slip mode, in the 2nd and higher gears. In general, the torque converter is in controlled slip or mechanically locked based on vehicle speed and pedal position, for each gear apart from the 1st. To suggest advances in torque converter technology, it was assumed the torque converter would be in a mechanically locked state for the 2nd and higher gears. This approach was applied to transmissions with 6 or more gears.

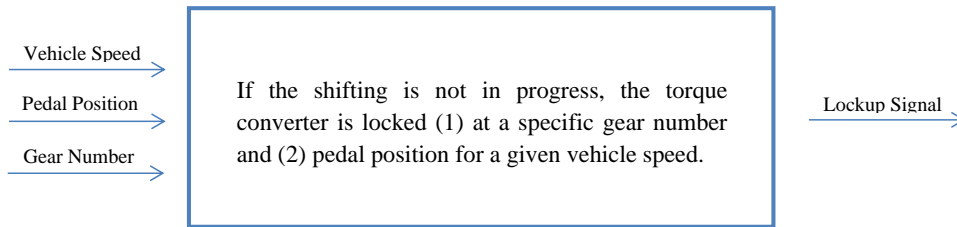

FIGURE 5-11 - TORQUE CONVERTER LOCKUP CONTROL ALGORITHM

5.2.1.4 Electric Machine Models

Electric machine plant models in Autonomie can take in torque or power as the command and produce a torque output. Operating speed of the motor is determined by components connected to the motor. In a vehicle, the vehicle speed and gear ratios determine the operating speed of the motor. The lookup table used in a motor model estimates operational losses over the entire operating region of the motor. This map is typically derived from the efficiency map provided in the initialization file. Figure 5-12 shows the main input/output of the electric machine model in Autonomie.



FIGURE 5-12 - AUTONOMIE ELECTRIC MACHINE MODEL INPUT/OUTPUT

Typically, every motor has a continuous operating region, and a transient region where the motor can operate for a short period of time (peak torque capability of a motor is defined for a specific duration, e.g. 30 seconds). The maximum torque output gets de-rated to continuous torque levels when the electric machine temperature increases. The electric machine model in Autonomie has this general logic built into it. Autonomie provides a logic to scale an existing motor to a

different power rating; the shape of the efficiency map is the same, but the torque axis is scaled to meet the desired power rating.

5.2.1.5 Energy Storage Models

Autonomie includes several energy storage models depending on the application (i.e. high power, high energy). The default battery model is a charge reservoir and an equivalent circuit whose parameters are a function of the remaining charge in the reservoir, also known as the state of charge (SOC). The equivalent circuit accounts for circuit parameters of the battery pack as if it were a perfect open circuit voltage source in series with an internal resistance. Another battery model in Autonomie is the one used for high energy batteries. The equations and schematic of this type of battery is shown in Figure 5-13. This model uses two time constants to represent the polarization behavior of the battery pack. This lumped parameter model can represent many different battery chemistries for internal resistances, capacitances, and open circuit voltage, which are all maps based on SOC and, in some cases, temperature.

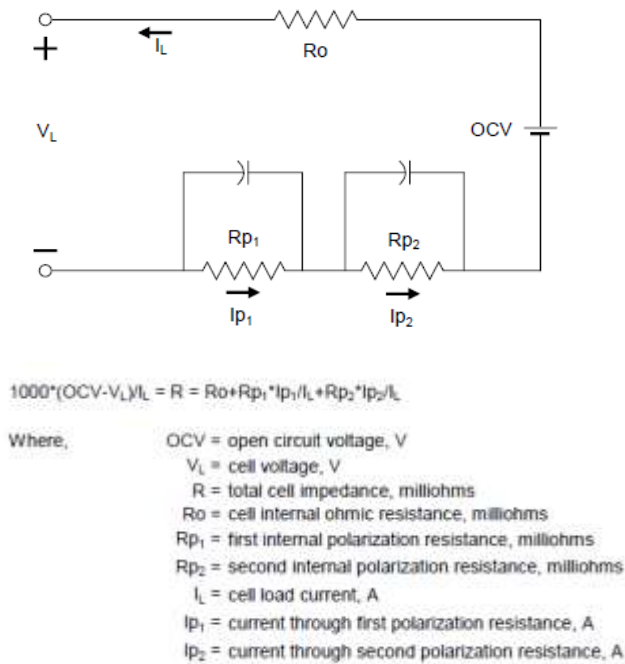

FIGURE 5-13 - HIGH ENERGY BATTERY MODEL SCHEMATIC

Another important aspect to consider for sizing is the pulse power limits of the battery pack. There are several different options to represent the maximum power of the battery in Autonomie. The most basic represents maximum power as a function of SOC. Other models introduce a time

*** EO 12866 Review – Draft – Do Not Cite, Quote or Release During Review ***

constraint for the maximum power. These battery packs have different power limits for 10 second, 2 second, and continuous power. The Autonomie model accounts for the duration of the pulse and limits power accordingly. This aspect is not necessarily a feature of the plant, but is handled by the low-level control and is dependent on the battery chemistry and plant's performance characteristics.

5.2.1.6 Chassis Models

The chassis plant model in Autonomie translates the force from wheel to vehicle acceleration and linear speed. Losses related to moving the vehicle are estimated in this model. Two types of initialization data can be used for estimating this behavior.

- Coefficients derived from a coast down test data. Losses estimated from these coefficients will cover both rolling resistance and aerodynamic losses. Dyno set values for nearly every vehicle are available from EPA.
- Values for coefficient of drag, frontal area, rolling resistance of tires etc.

Coast down testing is conducted on vehicles, so that modeling method is used for validation purposes, while values for aerodynamic drag, frontal area and rolling resistance are used for modeling to predict the impact of combinations of technologies on vehicles that do not currently exist.

5.2.1.7 Wheel Models

Just as there are two chassis models, there are two wheel models corresponding to the chassis models. The initialization data for the wheel rolling resistance can be provided by the user in many ways. Wheel radius can be provided by the user, or this could be computed by Autonomie from a sidewall label of the tire (e.g. P225/50/R17). The tire losses model uses a constant and a speed term to represent the losses.

5.2.1.8 Electrical Accessories Model

Most powertrains in Autonomie have two accessory models - mechanical accessories driven by the engine through a belt and electrical accessories connected to the lower voltage bus.

The main electrical accessory model in Autonomie is a constant power draw. If the vehicle has a high voltage bus, a step down power conditioner is connected between the high voltage bus and low voltage bus to supply electrical accessories. When a vehicle contains thermal models, a current draw is added to represent the electrical power draw of the cooling fans.

*** EO 12866 Review – Draft – Do Not Cite, Quote or Release During Review ***



FIGURE 5-14 - AUTONOMIE ELECTRICAL ACCESSORIES MODEL

5.2.1.9 Driver Models

Autonomie uses a look-ahead driver to better approximate the behavior of a real driver. Forward looking models are especially sensitive to how well the driver follows the trace and how aggressively the driver does so. Both factors can noticeably affect fuel economy results when simulating advanced vehicles. For example, a driver who is too aggressive can add additional engine on events for a hybrid or delay transmission shifts for a conventional engine; both of these events lower fuel economy. For this reason, Autonomie employs a look-ahead driver, which at its core, is a PI controller with a feedforward part that uses time advanced copies of the trace to replicate the ability of a human driver to look a few seconds ahead on the driver's aid to anticipate accelerations and decelerations. The result is a smoothing of the pedal demand from the driver, which leads to a more representative fuel economy. The added complexity yields several additional dimensions of tuning to the model because relative weightings of the time advanced copies have to be optimized.

The driver model also uses an additional layer of logic to manage the accelerator pedal demand, specifically, during shift events when the engine is disconnected from the wheels. On a manual transmission, during the shift through neutral, the driver must be capable of expecting a decrease in vehicle speed and not aggressively stomp on the accelerator pedal in an attempt to compensate for the decrease in vehicle speed.



FIGURE 5-15 - AUTONOMIE DRIVER MODEL

5.2.1.10 Environment Models

*** EO 12866 Review – Draft – Do Not Cite, Quote or Release During Review ***

The environment model in Autonomie outputs relative information about the operating environment of a vehicle during a simulation such as ambient temperature, ambient pressure, relative humidity, air density, and grade. There are two versions of the environment model in Autonomie, one for which the grade is a function of time, such as would be encountered on a chassis dynamometer test, which follows a preset grade schedule, and the other for which the grade is a function of distance as when following a mapped route.

5.2.1.11 Control Overview

All the vehicle-level control algorithms used in the study were developed based on vehicle test data collected at Argonne’s Advanced Powertrain Research Facility D3 database, lists some of the vehicles tested.¹⁰³ It is important to note that while the logic for the vehicle-level control algorithms were developed based on test data, only the logic has been used for the present study because the calibration parameters have been adapted for each vehicle to ensure energy consumption minimization with acceptable drive quality (i.e., number of engine on/off conditions, and shifting events).

5.2.1.12 Shift busyness - Total number of shifting events

The total number of shifting events (up-shift and down-shift) and the frequency of shift events can impact drive quality and consumer satisfaction. Acceptance criteria were established based on measuring the number of shifts observed on production vehicles. All of the modeling runs were compared to those criteria to assure the number of shifts did not exceed the criteria and thus the modeling reflects maintaining drive quality and consumer satisfaction.

5.2.1.12.1 Automatic Transmission Shifting

Figure 5-16 shows the total number of shifting events that occurred in the simulation modeling for each of the automatic transmission configurations that were modeled for the following vehicle configuration. The values reflect the combined total number of shifts over the UDDS.

- Vehicle class - Midsize
- Performance category - Non-performance
- Engine - Engine 01
- Mass Reduction - MR Level 0 (MR0)
- Aerodynamic Reduction - AERO Level 0 (AERO0)
- Rolling resistance reduction - ROLL Level 0 (ROLL0)

¹⁰³ Downloadable Dynamometer Database. <https://www.anl.gov/energy-systems/group/downloadable-dynamometer-database>

*** EO 12866 Review – Draft – Do Not Cite, Quote or Release During Review ***

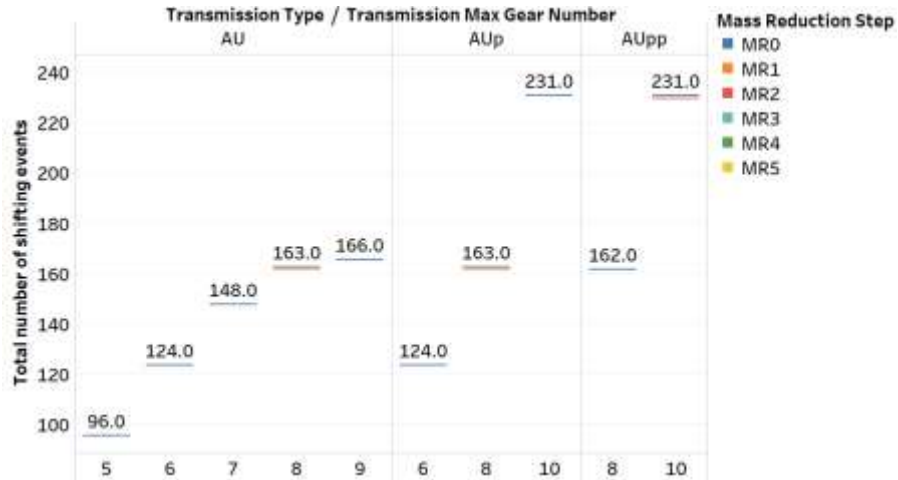

FIGURE 5-16 - TOTAL NUMBER OF SHIFTING EVENTS FOR AUTOMATIC TRANSMISSIONS

5.2.1.12.2 Manual Transmission Shifting

Figure 5-17 shows the total number of shifting events for each of the manual transmission (DM) configurations that were modeled.

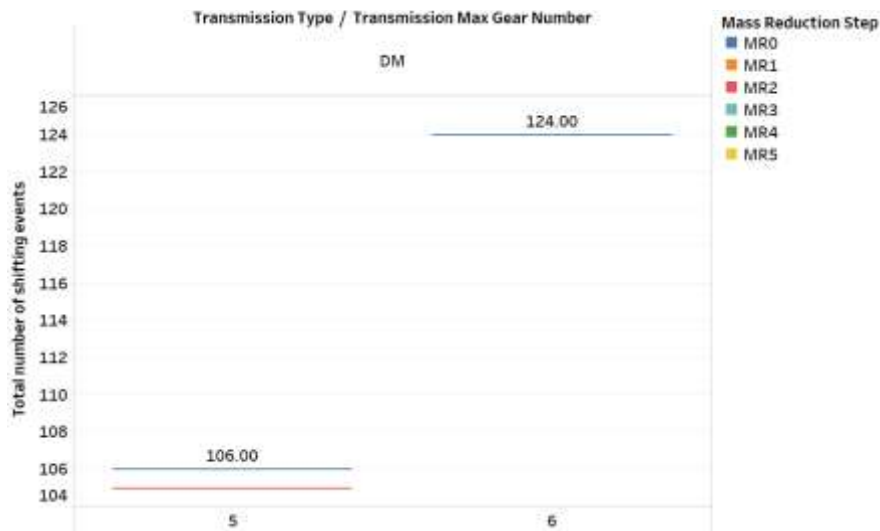

FIGURE 5-17 - TOTAL NUMBER OF SHIFTING EVENTS FOR MANUAL (DM) TRANSMISSIONS

5.2.1.12.3 DCT Transmission Shifting

Figure 5-18 shows the total number of shifting events for each of the DCT transmission configurations that were modeled.

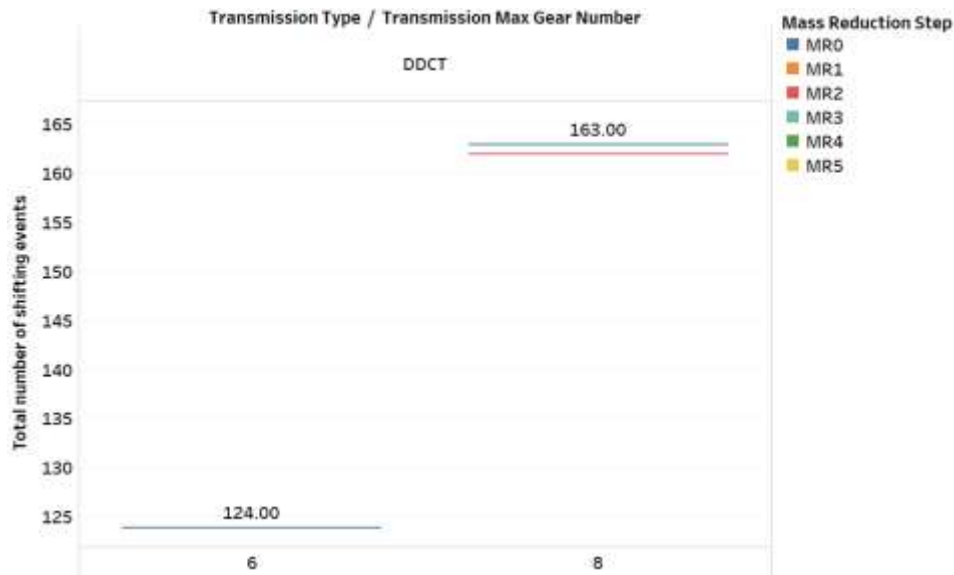

FIGURE 5-18 - TOTAL NUMBER OF SHIFTING EVENTS FOR DUAL CLUTCH TRANSMISSIONS

5.2.1.13 Fuel Cut-off Algorithm

Engine fuel cut-off control algorithms used in the study were developed on the basis of vehicle test data collected at Argonne’s Advanced Powertrain Research Facility. The fuel cut-off controller was implemented for gasoline and diesel engines through analysis as shown in Figure 5-19. In Autonomie, engine control and plant blocks are organized for idle fuel rate and fuel off conditions. Engine fuel is cut off under the following conditions:

- Vehicle is actively braking, for a certain minimum time.
- Engine speed is above a minimum threshold (e.g. 1000 RPM).

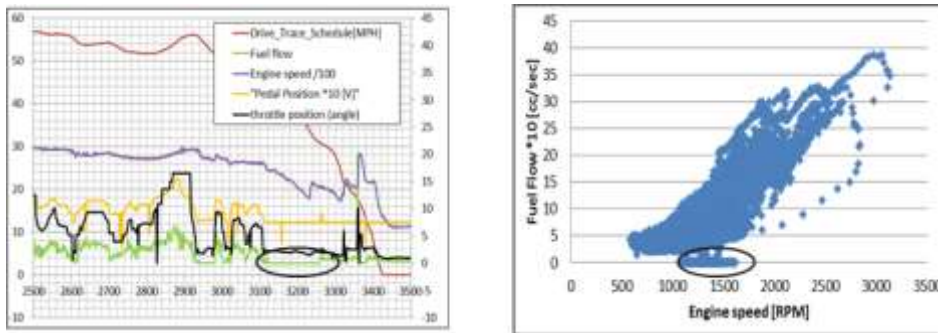

FIGURE 5-19 - ENGINE FUEL CUT-OFF ANALYSIS BASED ON TEST DATA (DATA SOURCE APRF)

5.2.1.14 Vehicle-Level Control for Electrified Powertrains

Achieving fuel savings with a hybrid architecture depends on the vehicle performance requirements and the type of powertrain selected, as well as the component sizes and technology, the vehicle control strategy, and the driving cycle. The overall vehicle-level control strategy is critical to minimize energy consumption while maintaining acceptable drive quality. During small accelerations, only the energy storage power is used (EV mode) and during braking, some of the energy is absorbed and stored. The engine does not start to operate during low power demands, owing to its poor efficiency compared to the electrical system. The engine is only used during medium and high power demands, where its efficiency is higher.

While different vehicle-level control strategy approaches have been studied for electric drive vehicles (e.g., rule-based, dynamic programming, instantaneous optimization), the vast majority of current and future electric drive vehicles are using, and are expected to use, rule-based control strategies. The vehicle-level control strategies logics used in the analysis are described below.

It is important to note that while the control algorithms have been developed based on extensive vehicle test data, the calibration parameters used for the Autonomie modeling were adapted to the component technologies and performance characteristics (i.e., power, energy, and efficiency) of each individual vehicle modeled.

5.2.1.14.1 Micro and Mild HEV

The vehicle-level control strategies of the micro- and mild (i.e., BISG and CISG) HEVs are similar in many aspects due to the low peak power and energy available from the energy storage system.

For the micro HEV case, the engine is turned off as soon as the vehicle is fully stopped and restarted as soon as the brake pedal is released. No regenerative braking is considered.

For the mild HEV cases, the engine is turned off as soon as the vehicle is fully stopped. However, because some regenerative braking energy is recovered, the vehicle is propelled by the electric machine during vehicle launch, allowing the engine to be restarted later. The electric machine also provides some limited assist during propelling to improve engine efficiency.

5.2.1.14.2 Single-mode Power-Split HEV

As shown in Figure 5-20, power split hybrids combine many components to create an extremely efficient system. The most common configuration, called an input split, is composed of a power split device (planetary gear transmission), two electric machines and an engine. Within this architecture, all these elements can operate differently. Indeed, the engine is not always on and the electricity from the generator may go directly to the wheels to help propel the vehicle, or go through an inverter to be stored in the battery. The operational phases for an input split configuration are the following:

During vehicle launch, when driving, or when the state of charge (SOC) of the battery is high enough, the ICE is not as efficient as electric drive, so the ICE is turned off and the electric machine alone propels the vehicle.

During normal operation, the ICE output power is split, with part going to drive the vehicle and part used to generate electricity. The electricity goes either to the electric machine, which assists in propelling the vehicle, or to charge the energy storage system. The generator also acts as a starter for the engine.

During full-throttle acceleration, the ICE and electric machine both power the vehicle, with the energy storage device (e.g., battery) providing extra energy.

During deceleration or braking, the electric machine acts as a generator, transforming the kinetic energy of the wheels into electricity to charge the energy storage system.

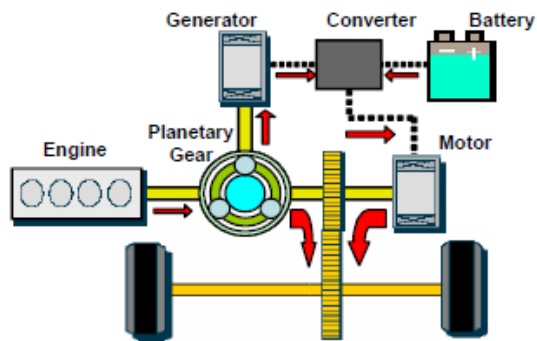

FIGURE 5-20 - POWER SPLIT HYBRID ELECTRIC VEHICLE

5.2.1.14.3 Single-mode power split PHEV

The vehicle-level control strategy algorithm of a single-mode power split PHEV was based on the Toyota Prius Prime. The control logic implemented can be divided into three areas - engine-on condition, battery SOC control, and engine operating condition. Each algorithm is described below.

5.2.1.14.3.1 Engine-On Condition

The operation of the engine determines the mode, such as pure electric vehicle (PEV) mode or HEV mode. The engine is simply turned on when the driver's power demand exceeds a predefined threshold. As shown in Figure 5-21, the engine is on only when the battery SOC is under 17%. It means that only the electric energy is used in more than 17% of battery SOC called charge sustaining (CS) mode. Once the operating mode by SOC is determined, the engine is turned on early if the driver's torque demand exceeds a predefined threshold, which means that the system is changed from PEV mode to HEV mode to meet the power demand.

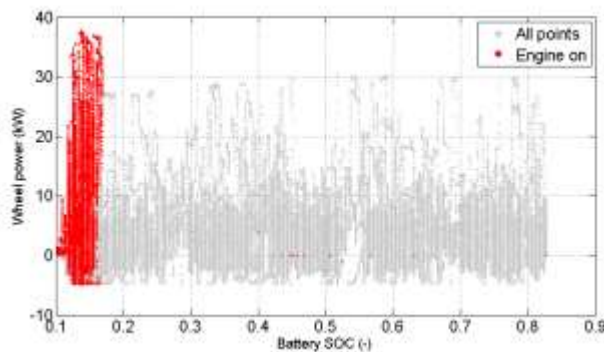

FIGURE 5-21 - ENGINE-ON CONDITION – 2017 PRIUS PRIME EXAMPLE BASED ON 25 TEST CYCLES

5.2.1.14.3.2 SOC Control

The desired output power of the battery is highly related to the energy management strategy. When the vehicle is in HEV mode, the battery power is determined by the current SOC, as shown in Figure 5-22. The overall trend shows that the energy management strategy tries to bring the SOC back to a regular value close to 14%. When the battery SOC decreases under 13.5%, the battery is charged 10kW to sustain battery SOC. As battery SOC is increasing, the charging power is decreasing and the battery is discharged when the battery SOC is more than 14.5%. If the battery output power is determined, engine output power can be calculated.

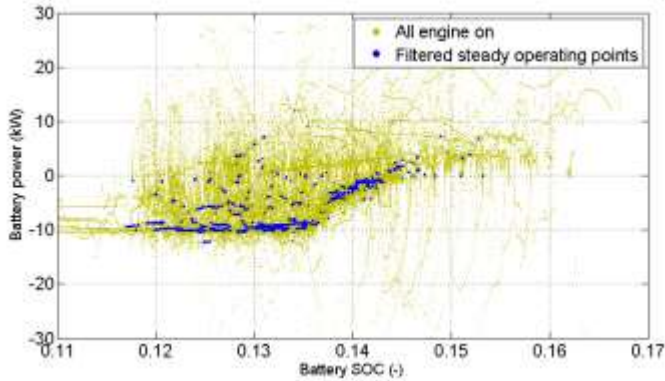

FIGURE 5-22 - SOC REGULATION ALGORITHM - 2017 PRIUS PRIME EXAMPLE BASED ON 25 TEST CYCLES

5.2.1.14.3 Engine Operation

The two previously described control concepts determine the power split ratio. The concepts do not, however, generate the target speed or torque of the engine because the power split system could have infinite control targets that produce the same power. Therefore, an additional algorithm is needed to determine the engine torque operating points according to the engine speed, as shown in Figure 5-23. An engine operating line is defined on the basis of the best efficiency curve to select the optimum engine speed for a specific engine power demand.

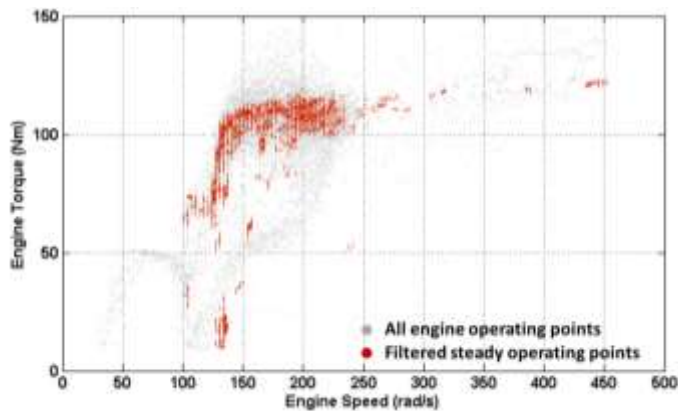

FIGURE 5-23 - EXAMPLE OF ENGINE OPERATING TARGET – 2017 PRIUS PRIME EXAMPLE BASED ON 25 TEST CYCLES

In summary, the engine is turned on based on the power demand at the wheel along with the battery SOC. If the engine is turned on, the desired output power of the battery is determined on

the basis of the current SOC and the engine should provide appropriate power to drive the vehicle. The engine operating targets are determined by a predefined line, so the controller can produce required torque values for the electric machine and the generator on the basis of the engine speed and torque target.

5.2.1.14.3.4 Pre-transmission HEV

The vehicle-level control strategy logic of a pre-transmission HEV is based on the Volkswagen Jetta HEV APRF test data analysis. In the pre-transmission HEV, the engine is a main power source and the electric machine assists the engine according to the vehicle operating conditions and the driver request. Three driving modes are used - EV mode, engine mode, and HEV mode. When the vehicle is driving at low speed or the demanded power is low, the vehicle is operated only by the electric machine in EV mode. During high-speed operation, start-up, or aggressive acceleration, the vehicle is operated by the engine in engine mode or HEV mode.

The driving mode control strategy is determined by the engine on/off state. When the vehicle drives at low speed, the system is operated only by the electric machine, without engine operation. Figure 5-24 (left panel) shows the vehicle speed and wheel demand torque when the engine is turned on. The right figure shows the operating area of pure electric driving in the same index.

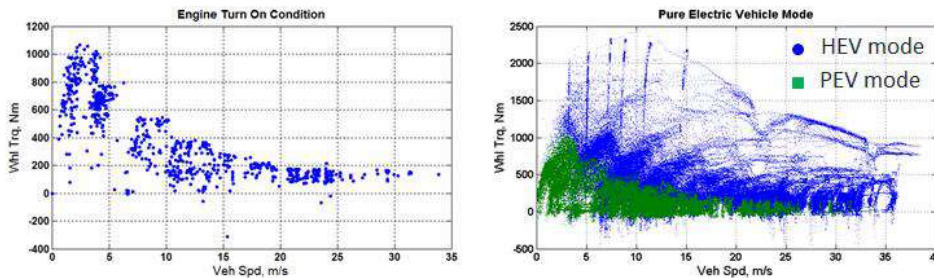

FIGURE 5-24 - CYCLES WHEEL TORQUE VS VEHICLE SPEED, 2014 JETTA HEV BASED ON TEST CYCLES (DATA SOURCE APRF)

In HEV and engine mode, the engine is operated to manage the demanded power at high speed or acceleration. In these modes, the engine is controlled to operate at higher engine thermal efficiency. However, because the range of the multi-gear transmission gear ratio is limited, the electric machine is used to provide additional control of the engine operating points.

5.2.1.14.3 Plug-in Hybrid Electric Vehicle - Range Extender PHEV

The 2nd generation of Voltec¹⁰⁴ consists of one engine, two motor-generators (MG), and one battery. The two electric machines are connected to a main transmission shaft using an individual planetary gear set, as shown in Figure 5-25. By activating the brake (BK) and clutches, the vehicle can be driven in various modes. Normally, MG1 drives the vehicle only by holding the BK. When the BK and one-way clutch (OWC) are locked, both electric machines can provide the maximum torque, called two-motor electric vehicle (EV) mode. An additional planetary gear set is used for a compound power-split mode in extended-range operation. According to the clutches or the BK activation status, the input split or the compound split mode is determined. The input-split mode is activated by the BK by holding the ring gear of the second planetary gear set. The compound-split mode is activated by the clutch (CL) when it connects the sun gear of the first planetary gear set to the ring gear of the second gear set.

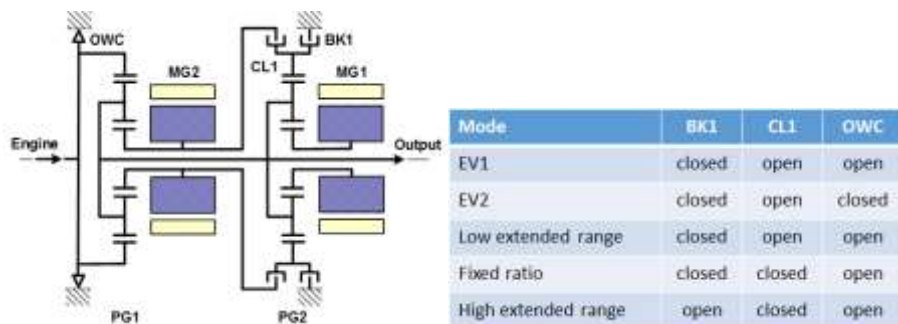

FIGURE 5-25 - CONFIGURATION OF THE CHEVROLET VOLT 2016 POWERTRAIN SYSTEM

Although a number of sophisticated control concepts were necessarily added to the supervisory control concepts, the main control flow of the vehicle based on test data can be summarized as shown in Figure 5-26. First, the engine on/off control is determined by the battery SOC and the driver's demand power. During EV driving, the use of two electric machines allows for two EV driving modes to provide maximum output torque or increased efficiency by torque distribution. If the engine is on after most of the battery energy has been depleted by EV driving, the operational state of the clutch or brakes is defined to select the extended-range mode. Energy management between the engine and the battery is controlled depending on the powertrain operation mode. Once the operation mode is chosen, the battery power demand is determined by the proportional control power, which also determines the engine power demand by subtracting the battery power demand from the driver power demand. Then, each component operates

¹⁰⁴ Voltec is General Motors' driveline for the Chevrolet Volt, and other plug-in hybrid vehicles. The system is one of highest production volume plug-in hybrid systems sold in the United States. ANL considered the Voltec system and 2nd generation Voltec system operation to model PHEV's with Autonomie.

according to an optimal target based on engine target and battery power demand. Finally, the entire powertrain model, including the vehicle-level controller was implemented into Autonomie.

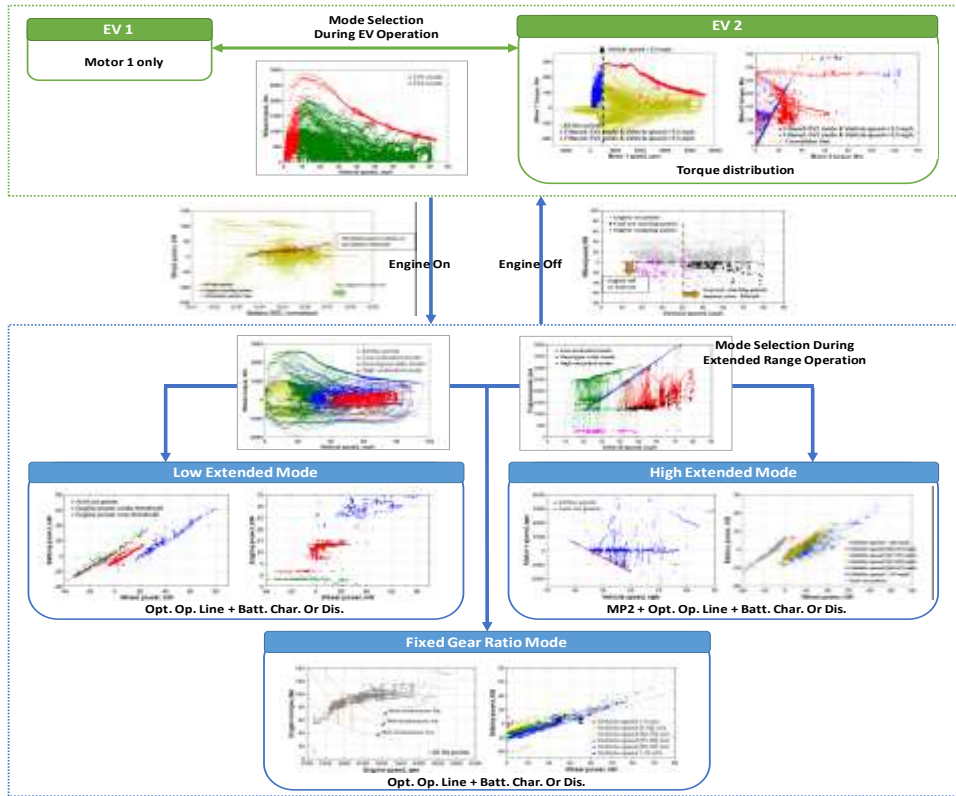

FIGURE 5-26 - SUMMARY OF CONTROL ANALYSIS FOR THE 2ND GENERATION OF VOLTEC SYSTEM

5.2.1.14.3.6 Fuel Cell Hybrid Electric Vehicle

Unlike the other vehicle-level controls previously discussed, the algorithm for the fuel cell HEVs was not derived from test data, due to the lack of test vehicles. Instead, dynamic programming was used to define the optimum vehicle-level control algorithms for a fuel cell vehicle. A rule-based control was then implemented to represent the rules issued from the dynamic programming. Overall, owing to the high efficiency of the fuel cell system, energy storage only recuperates energy during deceleration and propels the vehicle under low-load operations; the fuel cell system does not recharge the battery. Unlike electric drive powertrains with an engine, the battery does not smooth the transient demands. An example of fuel cell hybrid operations is shown in Figure 5-27.

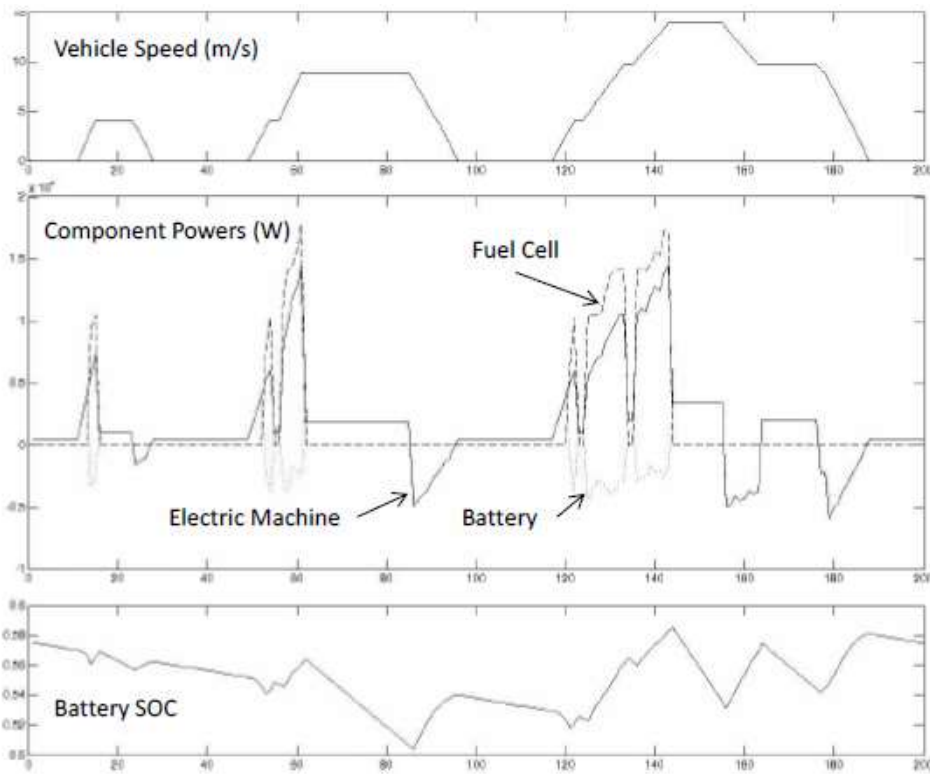

FIGURE 5-27 - COMPONENT OPERATING CONDITIONS OF A FCV ON THE URBAN EDC USING DYNAMIC PROGRAMMING

5.2.1.14.3.7 Vehicle Model Validation

Benchmarking is commonly used by vehicle manufacturers, automotive suppliers, national laboratories, and universities in order to gain a better understanding of how vehicles are engineered and to create large datasets that can be applied in modeling and other analyses. This analysis has leveraged extensive existing vehicle test data collected by Argonne National Laboratory under funding from the U.S. DOE Vehicle Technologies Office.¹⁰⁵ Specific instrumentation lists and test procedures have been developed over the past 20 years to collect sufficient information to be able to develop and validate full vehicle models. Additional vehicles

¹⁰⁵ A list of the vehicles that have been tested at the APRF can be found under <http://www.anl.gov/energy-systems/group/downloadable-dynamometer-database>. <http://www.anl.gov/energy-systems/group/downloadable-dynamometer-database>.

are likely to be benchmarked at DOE’s Advanced Powertrain Research Facility (APRF) to inform the final rule.

Since its inception in the nineties, the APRF has been focused on technology assessment of advanced technology vehicles for the U.S. Department of Energy and its partners through the generation and analysis of laboratory data. The staff also supports the development of automotive standards through its expertise and public data. The team has tested a large number of vehicles of different types, such as advanced technology conventional vehicles, hybrid electric vehicles, plug-in hybrid electric vehicles, battery electric vehicles, and alternative fuel vehicles.

The researchers at the APRF have developed a broad and fundamental expertise in the testing of the next generation of energy-efficient vehicles. Over the last twenty years, many methods of vehicle instrumentation and evaluation have continuously been refined. The instrumentation intends to capture component level information while the powertrain is in the vehicle. This “in-situ” instrumentation and testing approach enables the APRF to capture vehicle level and component level data over dynamic drive cycles as well as specific powertrain mapping tests.

5.2.2 Defining the base vehicles

For the full-vehicle simulations, Argonne National Labs worked to define reference vehicles (with vehicle attributes) that could be used to approximately model many production vehicles, spanning a range of equipment configurations. With reasonable baseline vehicle assumptions, ANL added combinations of technologies to estimate technology effectiveness values with full vehicle simulations, and the analysis used these simulation results to project effectiveness values for additional fuel savings technologies on production vehicles in the CAFE model.

5.2.2.1 Summary table of baseline assumptions for vehicle classes

For this NPRM analysis, vehicle classes were expanded to reflect a wider range of the vehicle performance levels. The analysis was also updated the performance values to better reflect the characteristics of the MY 2016 fleet. Table 5-2 and Table 5-3 below show the assumptions for the ten vehicle classes used in ANL Autonomie simulation modeling for the NPRM. The analysis suggests these specifications are more representative of the array of vehicles in the MY 2016 analysis fleet. This analysis does not have specifications for several of the parameters for the vehicles in the analysis fleet, for example, the electrical base accessories load, and estimates are based on vehicle testing by Argonne’s APRF.

TABLE 5-2 ANL - REFERENCE VEHICLE ASSUMPTIONS FOR NON-PERFORMANCE VEHICLE CLASSES

	Compact Car	Midsize Car	Small SUV	Midsize SUV	Pickup
Wheel mass (kg)	85	85	90	95	95
Wheel radius (m)	0.31725	0.31725	0.35925	0.3677	0.38165

*** EO 12866 Review – Draft – Do Not Cite, Quote or Release During Review ***

Glider mass (kg)	943	1155	1157	1200	1282
Frontal Area (m2)	2.3	2.35	2.65	2.85	3.25
Drag Coefficient (C_d)	0.31	0.3	0.36	0.38	0.42
Rolling resistance (C_r)	0.009	0.009	0.009	0.009	0.009
Electrical Base Acc Load (W)	240	240	240	240	240
EXTRA - Electrical Acc Load for cooling for EV & PHEV 30&40 (W)	220	220	220	220	220
Fuel Tank Size for Conventional (gal)	12	17	17	22	26
Fuel Tank Size for HEV/PHEVs (gal)	10	13	13	17	20
Fuel Tank size for Fuel Cell	320 miles	320 miles	320 miles	320 miles	320 miles
Payload (kg)	0	0	0	0	900
Towing Mass (kg)	0	0	0	0	3000

TABLE 5-3 - ANL - REFERENCE VEHICLE ASSUMPTIONS FOR PERFORMANCE VEHICLE CLASSES

	Compact Car	Midsize Car	Small SUV	Midsize SUV	Pickup
Wheel mass (kg)	85	85	90	95	95
Wheel radius (m)	0.31725	0.31725	0.35925	0.3677	0.38165
Glider mass (kg)	1002	1188	1222	1377	1527
Frontal Area (m2)	2.3	2.35	2.65	2.85	3.25
Drag Coefficient (C_d)	0.31	0.3	0.36	0.38	0.42
Rolling resistance (C_r)	0.009	0.009	0.009	0.009	0.009
Electrical Base Acc Load (W)	240	240	240	240	240
EXTRA - Electrical Acc Load for cooling for EV & PHEV 30&40 (W)	220	220	220	220	220
Fuel Tank Size for Conventional (gal)	12	17	17	22	26
Fuel Tank Size for HEV/PHEVs (gal)	10	13	13	17	20
Fuel Tank size for Fuel Cell	320 miles	320 miles	320 miles	320 miles	320 miles
Payload (kg)	0	0	0	0	900
Towing Mass (kg)	0	0	0	0	4350

Autonomie has multiple driver and chassis models that can either use vehicle dynamometer coefficients or aerodynamic equations. The first option is usually only selected when performing vehicle validation. The road load equation, leveraging C_d , Frontal Area, and C_r , were used to perform all simulations.

*** EO 12866 Review – Draft – Do Not Cite, Quote or Release During Review ***

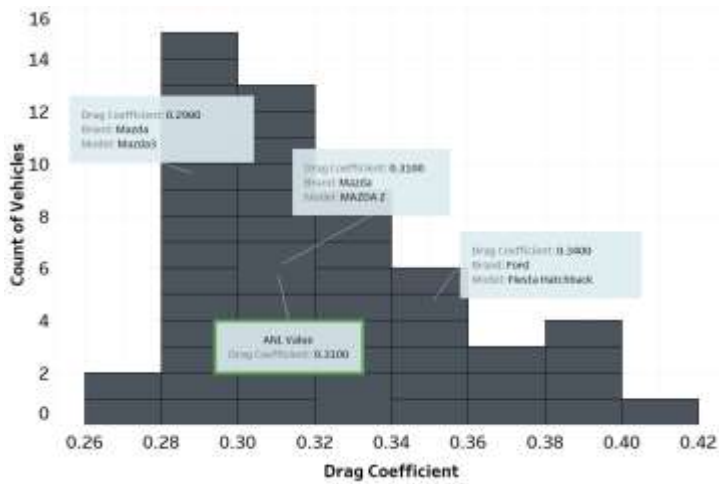

FIGURE 5-28 - EXAMPLE OF DRAG COEFFICIENTS FOR COMPACT BASE VEHICLE

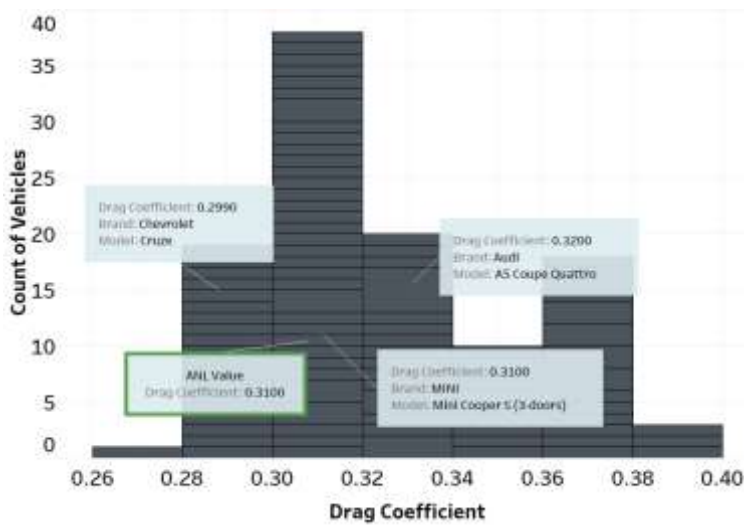

FIGURE 5-29 - EXAMPLE OF DRAG COEFFICIENTS FOR COMPACT PERFORMANCE VEHICLE

5.2.2.2 Vehicle classes and Attribute Selection

*** EO 12866 Review – Draft – Do Not Cite, Quote or Release During Review ***

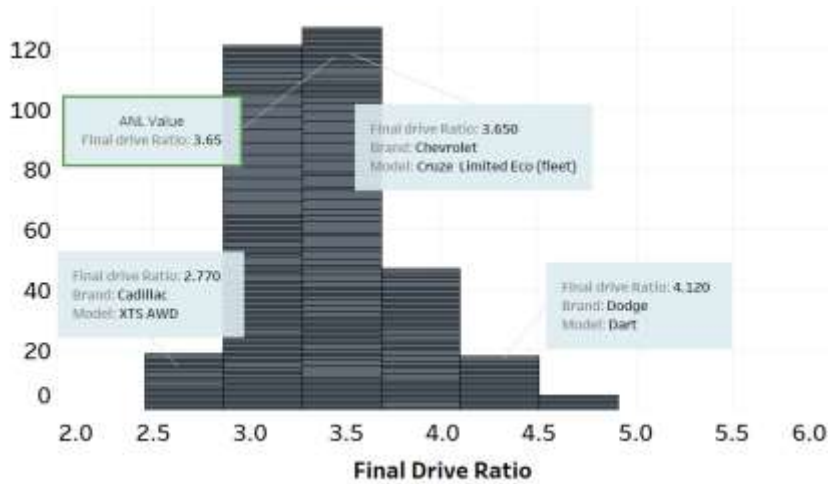

FIGURE 5-30 - EXAMPLE OF VEHICLE ATTRIBUTE ANALYSIS FOR FINAL DRIVE RATIO OF 6AU TRANSMISSION

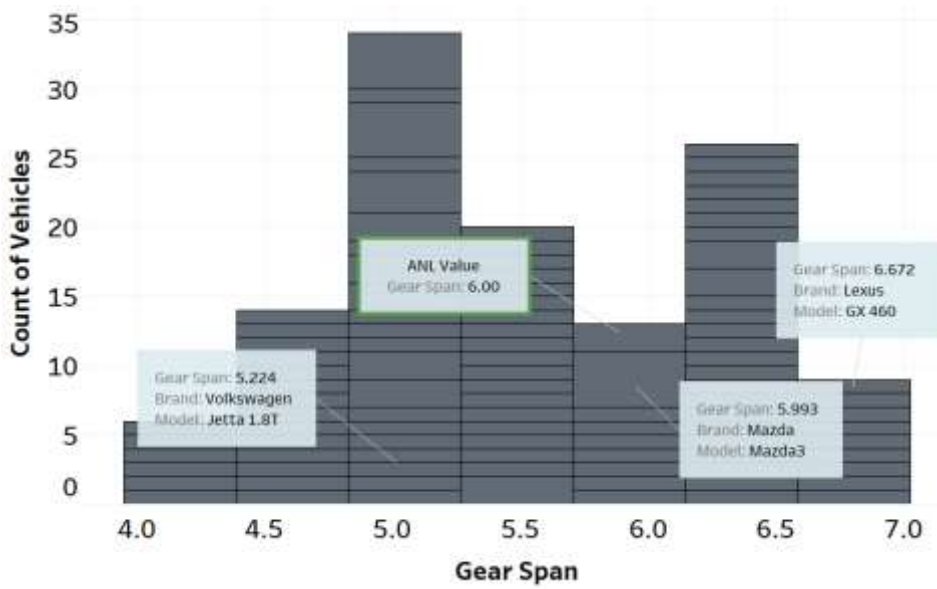

FIGURE 5-31 - EXAMPLE OF VEHICLE ATTRIBUTE ANALYSIS FOR GEAR SPAN OF 6AU TRANSMISSION

5.2.2.3 Vehicle Weights in Autonomie Analysis

In this this NPRM analysis, autonomie uses two set of weights in full vehicle simulation. The first weight is the test weight or loaded vehicle weight which defined by curb weight¹⁰⁶ plus 136 kilograms.¹⁰⁷ The test weight is reflective of the certification testing and it is used for the drive cycle simulations. The second weight is the gross vehicle weight rating (GVWR) and this is metric is used for drivability analysis. The relationship between curb weight and gross vehicle weight rating (GVWR) for current technology-configuration-powertrain combinations is modeled from the existing vehicles in the market and it forms the basis for estimating the GVWRs of future vehicle scenarios. For this analysis, the 2015 Model Year was utilized for conducting the regression and this is shown in the Figure 5-32 below.

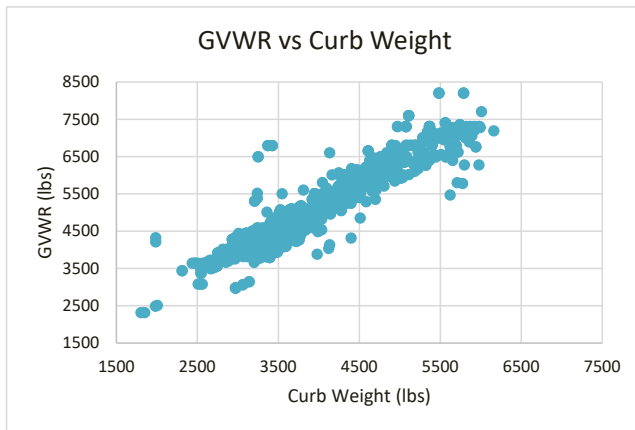

FIGURE 5-32 SHOWS THE RELATION OF GVWR

EQUATION 5-1 - EQUATION USED TO DEFINE GVWR OR TEST WEIGHT FOR AUTONOMIE SIMULATION

$$GVWR = 1.224 \times CurbWeight + 279.59$$

¹⁰⁶ Curb weight means the actual or the manufacturer's estimated weight of the vehicle in operational status with all standard equipment, and weight of fuel at nominal tank capacity, and the weight of optional equipment computed in accordance with § 86.1832-01; incomplete light-duty trucks shall have the curb weight specified by the manufacturer.

¹⁰⁷ 40 CFR 86.1803-01 - Definitions

5.2.2.4 Observed baseline curb weight, observed performance

For the 2016 Draft TAR, NHTSA defined and utilized the performance metrics in Autonomie shown below for all five vehicle classes:

- 0 - 60 mph time, by class (~9 seconds)
- 50 – 80 mph time, by class (~9 seconds)
- Hold speed at 6% grade at 65 mph at GVWR.

These criteria were used as a reference for determining the amount of engine downsizing that could be applied to maintain performance and capability similar to baseline vehicles, and to improve fuel economy. Although this method was simple and would work for some vehicle classes, the majority of the MY 2015 fleet had higher performance. Only 17% of the MY 2015 fleet were reasonably approximated by the performance criteria used for the Draft TAR analysis. The Alliance and Global Automakers commented that these criteria did not adequately represent the overall fleet, and a fuller representation was important to showing the impact of technologies on fuel economy. Similarly, other stakeholders commented that Draft TAR ANL simulations allowed for too much performance improvement as technologies were added. Based on these comments, this analysis expanded the simulation set (by adding more vehicle classes with diverse, but representative performance specifications similar to many production vehicles), and updated baseline vehicle performance assumptions for each class.

5.2.3 Technology groups in the Autonomie simulations and CAFE model

The CAFE model currently relies on six decision trees to represent component technology options, including:

- Powertrain Electrification
- Engine
- Transmission
- Light-weighting
- Aerodynamics
- Rolling resistance

In addition to the decision trees, the CAFE model accounts for synergies among technologies, recognizing that multiple technologies can address the same physical inefficiencies and some technology combinations can have greater impact than the sum of the technologies independently. For example, if an engine technology provides a 5% fuel consumption improvement and an advanced transmission provides a 4% improvement, the combination of both technologies may not provide 9% improvement – the actual improvement could be lower (negative synergy) or higher (positive synergy). Developing the relationships between multiple component technologies is challenging, but quantifying it is even more difficult, especially when

more than one technology is involved. As the number of technologies increases, the number of technology combinations increases exponentially. Thus, a large number of simulations may be required in order to calculate the complete set of synergy values for a modest number of technologies.

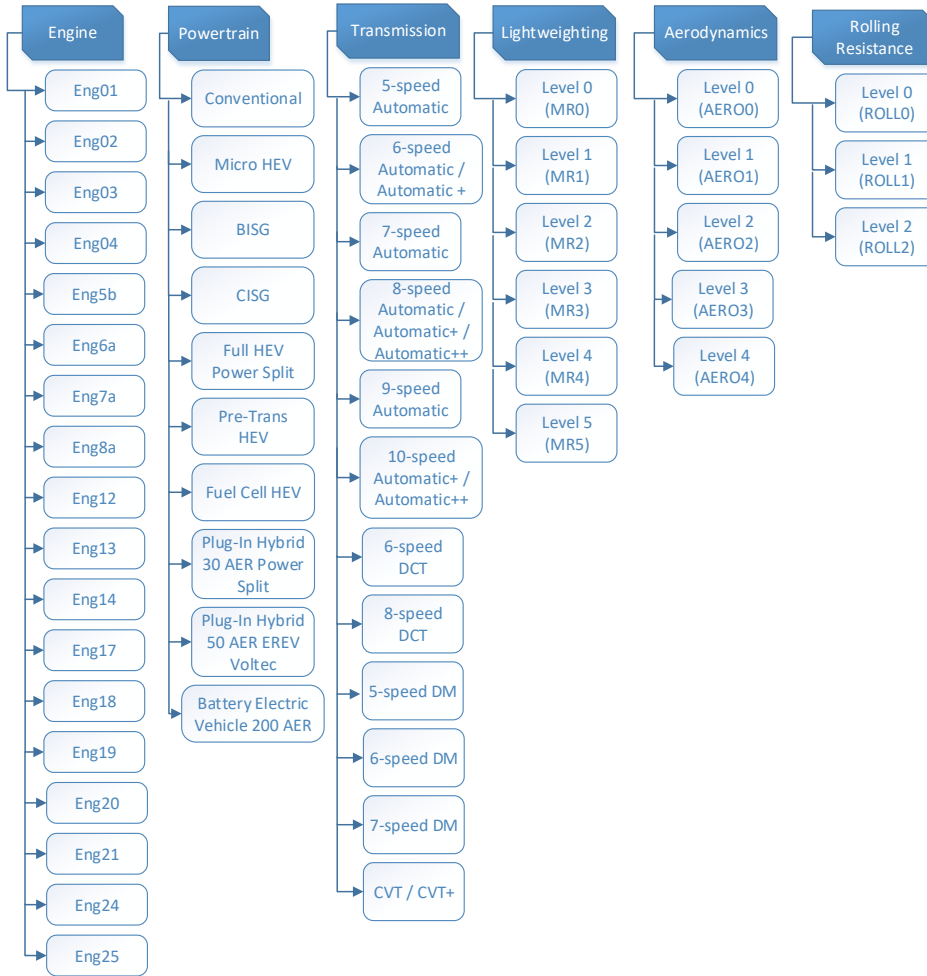

*** EO 12866 Review – Draft – Do Not Cite, Quote or Release During Review ***

FIGURE 5-33 - TECHNOLOGY COMBINATION TO REPRESENT THE CURRENT TECHNOLOGIES AND FUTURE OPTIONS¹⁰⁸

¹⁰⁸ Not all of the technologies in the CAFE model decision tree were evaluated by Argonne. Compressed natural gas, liquid natural gas, liquid propane gas, and LGDI were not modeled by Argonne and are not included in this tree.

5.2.3.1 Simulating performance neutrality

5.2.3.2 Towing capacity for trucks

For this NPRM analysis, the pickup and premium pickup class payload and towing capacity were updated. In the Ford F-150 that was tested for NHTSA,¹⁰⁹ three separate modes can be selected - Normal (default), Tow/Haul, and Sport. Specific testing was performed in order to determine vehicle operation and fuel consumption impact in each mode. The increased payload test was performed for a UDDS drive cycle and included three different cases - (1) standard vehicle weight of 5250lb with transmission in normal shift mode, (2) 10,000 lbs. vehicle weight with transmission in normal shift mode, and (3) 10,000 lbs. vehicle weight with transmission in tow mode.

The fuel economy results and transmission gear histogram for the three test cases are shown in Figure 5-34. The additional pay load of 4,750 lbs. reduced the fuel economy by 29% in normal shift mode and by 36% in the tow shift mode. With the additional payload, the fuel economy is higher in normal shift mode compared to the tow mode. The reason for this can be seen in the transmission gear histogram in Figure 5-34. In the test with the 10,000 lbs. vehicle weight and normal shift mode, the transmission operates in significantly higher gears which results in lower engine speed and higher torque with increased powertrain efficiency. Conversely, the lower gears selected in the tow mode result in higher engine speeds and lower engine loads, thus reducing the powertrain efficiency. The lower gear selection in tow mode reduces the mechanical and thermal loads on the powertrain due to lower torque output necessary from the engine.

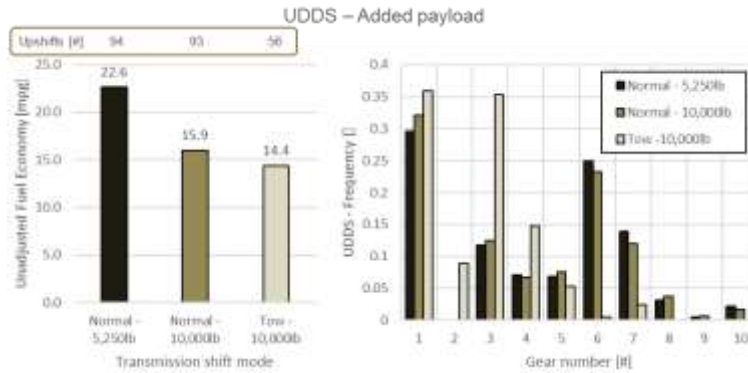

¹⁰⁹ NHTSA Benchmarking, “Laboratory Testing of a 2017 Ford F-150 3.5 V6 EcoBoost with a 10 speed transmission.”

FIGURE 5-34 - FUEL ECONOMY RESULTS AND TRANSMISSION GEAR HISTOGRAM FOR DIFFERENT PAYLOADS AND SHIFT MODES ON UDDS

The engine usage shifts dramatically between the three test cases as shown in Figure 5-35. At a normal vehicle weight of 5,250 lbs., the engine operates in a narrow region with a mean engine speed around 1,200 rpm and absolute engine load between 10% to 30%. Maximum absolute engine load is less than 100% and maximum engine speed is around 2,000 rpm on the UDDS drive cycle with no payload. With the additional 4,750 lbs. payload and the transmission in normal shift mode, the engine operational region increases significantly, with maximum absolute engine load more than 160% and maximum engine speed faster than 2,500 rpm. Finally, with the additional payload and the transmission in tow mode, the engine operation region shifts to significantly higher engine speed at lower loads where the maximum absolute engine load is approximately 110% and the maximum engine speed is 3,000 rpm. Additionally, when tow mode is selected, the engine idle stop function is disabled so that the powertrain is ready to pull a heavy load from a stop.

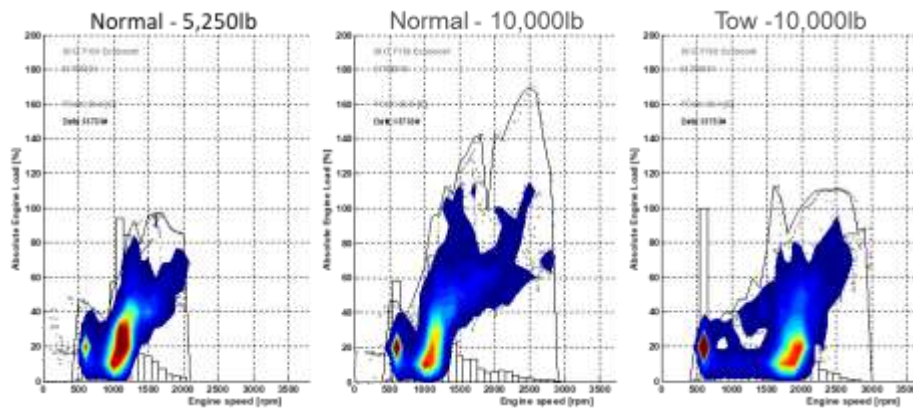

FIGURE 5-35 - ENGINE OPERATION FOR THE DIFFERENT PAYLOAD CONDITIONS ON UDDS CYCLE

5.3 Simulating technology effectiveness and application on a vehicle fleet

The objective of the modeling described in this section is to estimate the effectiveness of possible combinations of technologies that are currently available, or will be in the rulemaking timeframe, that could improve the fuel economy of light-duty vehicles in the US fleet. The modeling process is time-intensive, consists of many steps, a combination of tools, and employs the best data available at the time of this proposed rulemaking. The end result is a rich dataset that is utilized by the CAFE (“Volpe”) model to identify potential pathways manufacturers could

use to comply with potential CAFE standards. Figure 5-36 shows the potential technology pathways modeled in this NPRM analysis.

The technology simulation for this proposed rulemaking evaluated:

- 17 engine technologies
- 11 electrification levels (conventional is equivalent to no electrification level)
- 18 transmission technologies (applied to low electrification level vehicles only)
- 6 light weighting levels
- 3 rolling resistance levels
- 5 aerodynamic levels

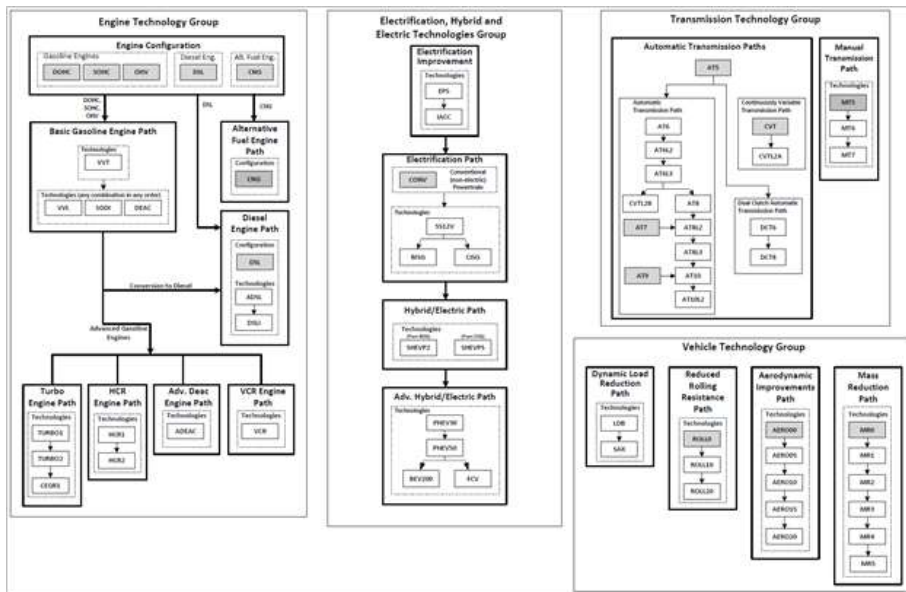

FIGURE 5-36 - OVERVIEW OF THE CAFE MODEL TECHNOLOGY POTENTIAL PATHWAY

The potential effectiveness of these technologies across 10 vehicle classes intended to represent the model types sold in the US light-duty market were modeled in this analysis. These 10 vehicle classes are:

- Compact and Performance Compact
- Midsize and Performance Midsize
- Small SUV and Performance Small SUV
- Midsize SUV and Performance Midsize SUV
- Pickup and Performance Pickup

The sequential addition of these technologies to the ten vehicle classes considered generated more than 140,000 unique vehicle combinations resulting in a large dataset identifying the potential impacts of vehicle technologies on energy consumption.¹¹⁰

5.3.1 Technology effectiveness simulation

Full-scale physics-based vehicle simulation modeling is considered a thorough approach for estimating potential benefits of a package of new technologies. This technique is used throughout the vehicle development community and is employed by a myriad commercially available and “in-house” developed toolsets. Simulation offers multiple advantages, including - the ability to apply varying levels of technologies for a range of vehicle attributes and performance levels, a mechanism for estimating the effectiveness of technologies that do not currently exist in the fleet or as prototypes, and a way to quantify the efficiency of individual technologies and their synergy with other technologies, all while foregoing the need to physically construct and test the various combinations (something that is often not feasible).

For this proposed rulemaking, IAV Automotive Engineering, Inc. (IAV) simulated the effect of potential engine technologies on fuel consumption using the GT-POWER© simulation modeling tool¹¹¹. GT-POWER is a commercially available engine simulation tool with detailed cylinder model and combustion analysis. GT-POWER is used to characterize and provide data on engine metrics including power, torque, airflow, volumetric efficiency, fuel consumption, turbocharger performance, and matching and pumping losses, among other parameters. The primary outputs of GT-POWER for this analysis are engine maps for each engine combination evaluated in Autonomie and in the CAFE model. The engine maps provide estimated operating characteristics of engines equipped with specific technologies. The engine maps are then used as an input to the established and widely used for Autonomie, a software simulation tool developed by Argonne National Laboratory for full vehicle simulation modeling.¹¹²

Finally, it is important to note that the analysis conducted for the proposed rulemaking reflects a number of updates to modeling inputs based on the detailed assessment of comments received to the Draft TAR. In addition, the analysis also incorporates learnings from new work conducted to support of this proposal. In an effort to ensure the analysis is using the best possible data and methods, research is continuing to be conducted through vehicle benchmarking, and new studies

¹¹⁰ Simulation modeling was also conducted to determine the appropriate amount of engine downsizing needed to maintain overall vehicle performance when vehicle mass reduction was applied, further increasing the total number of simulation runs to over one million

¹¹¹ GT-POWER© is the industry standard engine performance simulation and is used to predict engine performance quantities such as power, torque, airflow, volumetric efficiency, fuel consumption, turbocharger performance and matching, and pumping losses

¹¹² Autonomie is a system simulation tool for vehicle energy consumption and performance analysis. For further discussion of Autonomie, see sections 5.1 and 5.2, above.

and any new data are reviewed as they become available. Stakeholder comments submitted to this proposal will also be fully considered.

5.3.2 Engine Technology Effectiveness

According to the 2017 *Highlights of CO2 and Fuel Economy Trends* released by the EPA, the gasoline-fueled, spark ignition (SI) engine is the predominant powertrain in the U.S. While manufacturers have adapted and improved aspects of internal combustion engine technology over time, nearly all vehicles sold in MY 2016 still rely on some type of internal combustion engine as part of the powertrain.

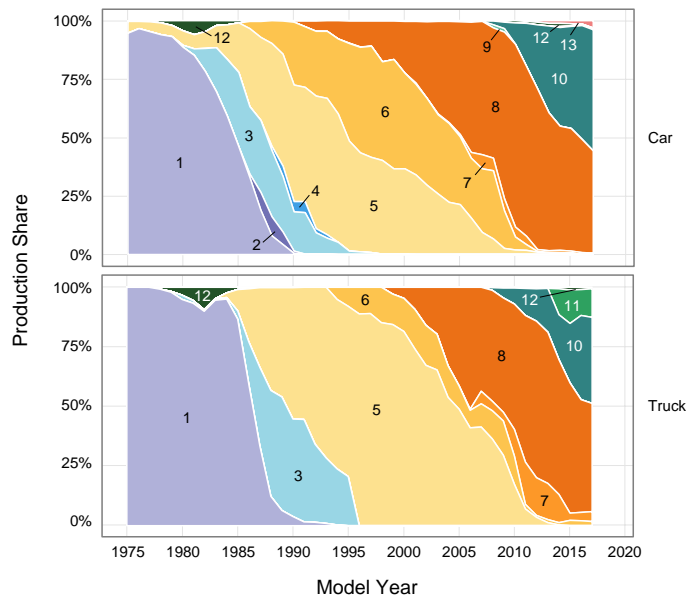

Fuel Delivery	Valve Timing	Number of Valves	Key
Carbureted	Fixed	Two-Valve	1
		Multi-Valve	2
Throttle Body Injection	Fixed	Two-Valve	3
		Multi-Valve	4
Port Fuel Injection	Fixed	Two-Valve	5
		Multi-Valve	6
	Variable	Two-Valve	7
		Multi-Valve	8
Gasoline Direct Injection (GDI)	Fixed	Multi-Valve	9
	Variable	Multi-Valve	10
		Two-Valve	11
Diesel	—	—	12
Alternative Fuel	—	—	13

FIGURE 5-37 - ENGINE TECHNOLOGY PRODUCTION SHARE, 1980-2017¹¹³

The brake thermal efficiency (BTE) of gasoline fueled, spark-ignition (SI) engines has historically been approximately 25%. Some researchers and manufacturers have suggested that there could be an opportunity to improve peak efficiency to 37% or above, for internal combustion engines.¹¹⁴ Many manufacturers continue to improve internal engine technology with efficiency improvements such as gasoline direct injection (GDI), turbo-charging smaller displacement engines, incorporating Atkinson and Miller Cycle valve timing strategies, integrating exhaust manifolds into cylinder heads, additional friction reduction, and cooled exhaust gas recirculation (EGR).¹¹⁵

5.3.2.1 Overview

Since the 2012 FRM, the agencies have continued to meet with automobile manufacturers, Tier 1 automotive suppliers, and automotive engineering services firms to review publicly available information, confidential business information and data on development of their products and applications of advanced internal combustion technologies. The agencies have also sponsored and conducted new studies to better understand emerging technologies. This new information and data has been considered and used to help inform this proposed rulemaking.

Several engine benchmarking programs that have produced detailed engine operating maps have been completed. In this analysis, some of the best performing engines in production, and representative engine maps have been used at inputs to the Autonomie toolset to estimate the effectiveness of modern powertrain technology along a wide spectrum of vehicle applications. In addition, industry and academia have published information^{116, 117} on recently launched engines now available to the public. The internal simulation results were often compared as a form of validation for this analysis' effectiveness estimations. Additionally, continued use of computer-aided engineering tools and the development and analysis of advanced engine technologies to verify the validity of proof-of-concept and applied research for potential for further engine improvements. Further details of some of these cases are provided in later sections.

¹¹³ U.S. Environmental Protection Agency "Highlights of CO2 and Fuel Economy Trends" <https://www.epa.gov/fuel-economy-trends/download-report-co2-and-fuel-economy-trends>, Accessed Jan 12, 2017.

¹¹⁴ "Mazda pitches Skyactiv-3 engine tech to rival EVs," <http://www.autonews.com/article/20180128/OEM06/180129795/mazda-pitches-skyactiv-3-engine-tech-to-rival-evs>, (last accessed - March 23, 2018).

¹¹⁵ "2016 Pentastar V6 adds new VVT, cooled EGR," <http://articles.sae.org/14322/>, (last accessed march 23, 2018)

¹¹⁶ "The New Toyota Inline 4-Cylinder 2.5L Gasoline Engine", SAE 2017-01-1021. March 28, 2017.

¹¹⁷ "Mazda 2.5L SKYACTIV-G Engine with New Boosting Technology." 2016 Internationales Wiener Motoren-symposium

*** EO 12866 Review – Draft – Do Not Cite, Quote or Release During Review ***

In the meetings with automobile manufacturers and Tier 1 suppliers, they provided information about the following engine technologies trends: In the meetings with automobile manufacturers and Tier 1 suppliers, the agencies learned about the following engine technologies trends:

In the near-term, many stakeholders discussed -

- Reducing engine friction and parasitic accessory loads on next generation engines, especially as manufacturers adopt Turbo systems and high compression ratio engine architectures.
- Considerable diversity of engine technologies in development for smaller light duty vehicles:
 - including turbocharged GDI engines, dual direct and port injected (dual GDI/PFI) engines^{118, 119, 120}
 - both turbocharged and naturally aspirated GDI engines with external cooled EGR, and engines that combine GDI with operation over the Atkinson Cycle and use of Atkinson Cycle outside of HEV applications
- Considerable diversity of engine technologies in development for larger, heavier vehicles, including full-size SUVs and pickup trucks with significant towing utility:
 - some manufacturers will rely on naturally aspirated GDI engines with cylinder deactivation
 - some will rely turbocharged-downsized engines,
 - and others will be use a variety of engine technologies, including light-duty diesels.

And in the longer view, vehicle manufacturers indicated they are at advanced stages of research with respect to -

- multi-mode combustion approaches¹²¹
- homogenous charge, compression ignition, lean-burn operation at light loads
- stratified-charge, lean-burn spark ignition at moderate loads
- stoichiometric homogenous charge, spark ignition at high loads
- variable-compression ratio (VCR) engines¹²²
- variable displacement engines

¹¹⁸ “Toyota Advances D4s with self-cleaning feature on Tacoma,” Aug. 27, 2015.

<http://wardsauto.com/technology/toyota-advances-d4s-self-cleaning-feature-tacoma>

¹¹⁹ “Ford F-150 and Expedition’s New Advanced Engines Maximize Lightweight Materials for Greater Performance, Efficiency” <https://media.ford.com/content/fordmedia/fna/us/en/news/2017/06/16/ford-f150-and-expedition-new-advanced-engines-maximize-lightweight-materials-greater-performance.pdf>

¹²⁰ Don Sherman, *Explained - Why Some Engines Have Both Port and Direct Injection*, Car and Driver (May 2, 2017) <https://blog.caranddriver.com/explained-why-some-engines-have-both-port-and-direct-injection/>.

¹²¹ i.e. Otto Cycle to Atkinson Cycle by using advanced VVT

¹²² Nissan Motor Corporation recently introduced a variable compression ratio engine to the US market, “VC-Turbo – The world’s first production-ready variable compression ratio engine,” 2017/12/13. <https://newsroom.nissan-global.com/releases/release-917079cb4af478a2d26bf8e5ac00ae49-vc-turbo-the-worlds-first-production-ready-variable-compression-ratio-engine>

*** EO 12866 Review – Draft – Do Not Cite, Quote or Release During Review ***

The 2012 final rule did not project diesel powertrains would be widely used to improve fuel economy and reduce CO₂ emissions, however, because then a number of new light-duty vehicles have been introduced to the U.S. market with diesel engines. These include the Ram 1500 full-size pickup truck, the Chevrolet Colorado mid-size pickup truck, the Jeep Grand Cherokee SUV, and the Chevrolet Cruze, with at least one more expected application in the Ford F-150.

Diesel engines are continuing to evolve by using technologies similar to those being introduced in new light-duty gasoline engines and heavy-duty diesel truck engines. This includes:

- the use of advanced friction reduction measures
- increased turbocharger boost pressures that enable smaller displacements
- engine “downspeeding,” or the use of advanced cooled EGR systems
- improved integration of charge air cooling into the air intake system
- and improved integration of exhaust emissions control systems for criteria pollutant control

The best BTE of advanced diesel engines under development for light duty applications is now 46% and thus is approaching that of heavy-duty diesel truck engines.¹²³ Despite recent compliance actions with respect to light-duty diesel NO_x emissions,¹²⁴ diesel engines are still considered to be a viable technology to improve fuel economy and reduce CO₂ emissions from light-duty vehicles.

Finally, this analysis re-evaluated all technology cost and effectiveness values considered in the 2012 final rule and 2016 Draft TAR for this proposed rulemaking. This re-assessment included evaluations of technologies where substantial new information has emerged, such as the potential application of cylinder deactivation and the potential application and effectiveness of Atkinson cycle engines, specifically what was modeled in the Draft TAR as HCR2.

5.3.2.2 Technologies modeled for the proposed rulemaking

5.3.2.2.1 Cylinder Deactivation (DEAC)

In conventional spark-ignited engines, throttling the airflow controls engine torque output. At partial loads, efficiency can be improved by using cylinder deactivation instead of throttling. Cylinder deactivation (DEAC) can improve engine efficiency by disabling or deactivating cylinders when the load is significantly less than the engine’s total torque capability. When the valves are kept closed and no fuel is injected, the trapped air within the deactivated cylinders is simply compressed and expanded as an air spring, with reduced friction and heat losses. The

¹²³ Stanton, D.W. “Light Duty Efficient, Clean Combustion.” Final Report by Cummins, Inc., to the U.S. Department of Energy, Report No. DE-FC26-07NT43279, June 3, 2011.
<http://www.osti.gov/scitech/servlets/purl/1038535/>.

¹²⁴ Advances in NO_x and PM emissions control technology are bringing light-duty diesels fully into compliance with Federal Tier 3 and California LEV III emissions 5-15 standards at a cost that is competitive with the cost-effectiveness other high efficiency, advanced engine technologies.

*** EO 12866 Review – Draft – Do Not Cite, Quote or Release During Review ***

active cylinders operate at higher loads to compensate for the deactivated cylinders. Pumping losses are significantly reduced as when the engine is operated in this “part-cylinder” mode.

Cylinder deactivation control strategy may use a maximum manifold absolute pressure or predicted torque threshold for enabling cylinder deactivation. Noise, vibration and harshness (NVH) issues (i.e., customer satisfaction considerations) reduce the operating range in which cylinder deactivation is enabled, although manufacturers continue exploring vehicle changes that enable increasing the amount of time that cylinder deactivation might be acceptable. Some manufacturers have adopted active engine mounts and/or active noise cancellations systems to address NVH concerns and to allow a greater operating range of activation.

5.3.2.2.2 Advanced Cylinder Deactivation (ADEAC)

Rolling or dynamic cylinder deactivation systems allow a further degree of cylinder deactivation which can vary the percentage of cylinders deactivated and the sequence in which cylinders are deactivated, which was not possible with previous cylinder deactivation system designs. This allows for additional fuel economy improvements by increasing the amount of time an engine can operate with lower pumping losses. The sequence of engine firing varies with ADEAC, and requires more sophisticated control algorithms and additional hardware to achieve acceptable NVH targets.

5.3.2.2.3 Application of DEAC and ADEAC

NHTSA has historically limited its analysis of cylinder deactivation to engines with six or more cylinders. There were concerns that application of cylinder deactivation to 3 or 4-cylinder engines would result in unacceptable NVH and there were no known sub-6 cylinder US market applications of cylinder deactivation.

In MY 2013, Volkswagen introduced their 1.4L TSI EA 211 turbocharged GDI engine with “active cylinder management” in Europe.¹²⁵ This engine is the first production application of cylinder deactivation to an I4 engine and can deactivate 2 cylinders via cam-shifting under light load conditions. VW recently introduced a Miller Cycle variant of the same EA211 engine family with cylinder deactivation, providing indication the system has been accepted in the European marketplace, thus far, and will continue to be offered.¹²⁶

Additionally, a system developed by Schaeffler employs a dynamic cylinder deactivation for I3 and I5 engines. The system alternates or “rolls” the deactivated cylinders allowing all cylinders to be deactivated after every ignition cycle and reactivated during the next cycle. Cylinder deactivation thus alternates within a single deactivation phase and not each time a new deactivation mode is introduced. The net result is that engines with an odd number of cylinders

¹²⁵ Volkswagen. 2015. <http://www.volkswagen.co.uk/technology/petrol/active-cylinder-technology-act>, last accessed January 19, 2018.

¹²⁶ Eichler, F., Demmelbauer-Ebner, W., Theobald, J., Stiebels, B., Hoffmeyer, H., Kreft, M. “*The New EA211 TSI® evo from Volkswagen.*” 37. Internationales Wiener Motorensymposium 2016.

can operate, on average, with half their cylinder displacement (for example, a 3-cylinder engine could drop down to “1.5” cylinders on average or an I5 can drop to “2.5” cylinders on average). Ford and Schaeffler investigated both rolling cylinder deactivation and a system to deactivate one cylinder with Ford’s EcoBoost 1.0L I3 engine and found that, with appropriate vibrational dampening, either strategy could be implemented with no NVH deterioration and with 3% or greater improvement in both real-world and EU drive cycle fuel economy.¹²⁷ Finally, Tula Technology has demonstrated a system, termed “Dynamic Skip Fire”, with the capability of deactivating any cylinder.^{128, 129} That system may see production implementation during the timeframe of this proposed rulemaking.

In light of these new, production-feasible developments, DEAC and ADEAC may be applied on engines with less than six cylinders in the NPRM analysis, though the modeling for ADEAC technology remains speculative at this time and will improve with additional benchmarking of production technologies.

5.3.2.2.4 Variable Valve Timing (VVT) Systems

Variable valve timing (VVT) is a family of valve-train designs that dynamically alter the opening and closing of the intake valve, exhaust valve, or both, in relation to piston travel. VVT uses a cam phaser to adjust the camshaft angular position relative to the crankshaft position, and is more generically referred to as “camshaft phasing.” The majority of current cam phaser applications use hydraulically-actuated units, powered by engine oil pressure and managed by a solenoid that controls the oil pressure supplied to the phaser.

VVT reduces pumping losses, increases specific power, increases control of the level of residual gases in the cylinder, and improves volumetric efficiency at higher engine speeds and load over the engine operating range and loading. Additionally, VVT can be used to alter (and optimize) the effective compression ratio where it is advantageous for certain engine operating modes.

VVT has now become a widely adopted technology in the U.S. fleet. In MY 2015, more than 98% of light-duty vehicles sold in the U.S. used some form of VVT.

5.3.2.2.5 Intake Cam Phasing (ICP)

Valvetrains with ICP modify the timing of the opening and closing of cylinder inlet valves.

5.3.2.2.6 Coupled Cam Phasing (CCP)

Coupled cam phasing results from applying cam phasing to an engine architecture that has only one camshaft actuating both intake and exhaust valves. Coupled cam phasing dynamically

¹²⁷ Schamel, A., Scheidt, M., Weber, C. & Faust, H. “*Is Cylinder Deactivation a Viable Option for a Downsized 3-Cylinder Engine?*” Vienna Motor Symposium, 2015.

¹²⁸ Wilcutts, M., Switkes, J., Shost, M. & Tripathi, A. “*Design and Benefits of Dynamic Skip Fire Strategies for Cylinder Deactivated Engines.*” SAE Int. J. Engines 6(1):2013, doi - 10.4271/2013-01-0359.

¹²⁹ Eisazadeh-Far, K. & Younkins, M., “*Fuel Economy Gains through Dynamic-Skip-Fire in Spark Ignition Engines.*” SAE Technical Paper 2016-01-0672, 2016, <https://doi.org/10.4271/2016-01-0672>.

adjusts the angular position of the camshaft in relation to the crankshaft which affects the timing of both the intake exhaust valve timing equally. CCP is the only VVT implementation option available and requires only one cam phaser, and can be more cost effective than two cam phasers depending on the application. However, its limited availability could outweigh its reduced cost and complexity.

5.3.2.2.7 Dual Cam Phasing (DCP)

The most flexible VVT design is dual (independent) cam phasing, where the intake and exhaust valve opening and closing events are controlled independently. This option allows the option of controlling valve overlap, which can be used as an internal EGR strategy. At low engine loads, DCP creates a reduction in pumping losses, resulting in improved fuel consumption. Increased internal EGR also results in lower engine-out NO_x emissions. The amount by which fuel consumption is improved and CO₂ emissions are reduced depends on the residual tolerance of the combustion system and on the combustion phasing achieved. Additional improvements are observed at idle, where low valve overlap could result in improved combustion stability, potentially reducing idle fuel consumption.

5.3.2.2.8 Variable Valve Lift (VVL)

Controlling the lift of the valves provides a potential for further efficiency improvements. By optimizing the valve-lift profile for specific engine operating regions, the pumping losses can be reduced by reducing the amount of throttling required to produce the desired engine power output. By moving the throttling losses further downstream of the throttle valve, the heat transfer losses that occur from the throttling process are directed into the fresh charge-air mixture just prior to compression, delaying the onset of knock-limited combustion. Variable valve lift control can also be used to induce in-cylinder mixture motion, which improves fuel-air mixing and can result in improved thermodynamic efficiency. Variable valve lift control can also potentially reduce overall valvetrain friction. At the same time, such systems may incur increased parasitic losses associated with their actuation mechanisms. A number of manufacturers have already implemented VVL into all (BMW) or portions of their fleets (Toyota, Honda, GM, and FCA), but overall this technology is still available for application to most vehicles. There are two major classifications of variable valve lift, discrete variable valve lift (DVVL, also known as cam profile switching, or CPS) and continuous variable valve lift (CVVL).

DVVL systems allow the selection between two or three discrete cam profiles by means of a hydraulically-actuated mechanical system. By optimizing the cam profile for specific engine operating regions, the pumping losses can be reduced by reducing the amount of throttling required to produce the desired engine power output. This increases the efficiency of the engine. These cam profiles may consist of a low and a high-lift lobe or other combinations of cam profiles, and may also include an inert or blank lobe to incorporate cylinder deactivation (in the case of a 3-step DVVL system). DVVL is normally applied together with VVT control. DVVL is a mature technology with low technical risk.

*** EO 12866 Review – Draft – Do Not Cite, Quote or Release During Review ***

In CVVL systems, valve lift is varied by means of a mechanical linkage or hydraulic actuators, driven by an actuator controlled by the engine control unit. The valve opening and phasing vary as the lift is changed and the relation depends on the geometry of the mechanical system. BMW has considerable production experience with CVVL systems and has versions of its “Valvetronic” CVVL system since 2001. CVVL allows the airflow into the engine to be regulated by means of intake valve opening reduction, which improves engine efficiency by reducing pumping losses from throttling the intake system further upstream as with a conventionally throttled engine. CVVL provides greater effectiveness than DVVL, because it can be fully optimized for all engine speeds and loads, and is not limited to a two or three step compromise. There may also be a small reduction in valvetrain friction when operating at low valve lift, resulting in improved low load fuel consumption for cam phase control with variable valve lift as compared to cam phase control only. Most of the fuel economy effectiveness is achieved with variable valve lift on the intake valves only; for example, FCA’s Multiair electrohydraulic system is implemented on the intake valves only. CVVL is only applicable to double overhead cam (DOHC) engines.

5.3.2.2.9 Stoichiometric Gasoline Direct Injection, SGDI or GDI

Stoichiometric gasoline direct injection (SGDI) engines inject fuel directly into the combustion chamber of the intake port, as in many current engines with port fuel injections. From MY 2012 to MY 2016, the penetration rate of SGDI has increased from 23% to 48% in both car and truck segments. Nearly all vehicles using turbocharged spark-ignition engines also used GDI to improve suppression of knocking combustion. GDI provides direct cooling of the in-cylinder charge via in-cylinder fuel vaporization.¹³⁰ Use of GDI allows an increase of compression ratio of approximately 0.5 to 1.5 points relative to naturally aspirated or turbocharged engines using port-fuel-injection (e.g., an increase from 9.9:1 for the 5.3L PFI GM Vortec 5300 to 11:1 for the 5.3L GDI GM Ecotec3 with similar 87 AKI gasoline octane requirements).

Toyota’s D-4S system combines GDI and PFI systems, with two injectors per cylinder (one directly in-cylinder and one immediately upstream of the intake port).^{131, 132, 133} As of 2015, all Toyota vehicles in the U.S. with GDI appear to be using a variation of the D-4S dual GDI/PFI fuel injection system. This system increases peak BMEP, provides additional flexibility with

¹³⁰ Yu, C., Park, K., Han, S., & Kim, W. “Development of Theta II 2.4L GDI Engine for High Power & Low Emission,” SAE Technical Paper 2009-01-1486, 2009, doi - 10.4271/2009-01-1486.

¹³¹ Saeki, T., Tsuchiya, T., Iwahashi, K., Abe, S. “Development of V6 3.5-Liter 2GR-FSE Engine.” Toyota Technical Review, Volume 55, No. 1, pp 94-99, November 2006.

¹³² Ikoma, T., Abe, S., Sonoda, Y., Suzuki, H. et al., “Development of V-6 3.5-liter Engine Adopting New Direct Injection System,” SAE Technical Paper 2006-01-1259, 2006, doi - 10.4271/2006-01-1259.

¹³³ Yamaguchi, J. “Lexus Gives V6 Dual Injection.” SAE Automotive Engineering International, January 2006, pp 17-20.

respect to calibration of the EMS for improved cold-start emissions and offers an efficiency improvement over GDI alone.

The recently redesigned Ford turbocharged 3.5L “EcoBoost™” engine in the 2017 Ford F150 also uses a dual GDI/PFI injection system to increase power, reduce emissions, and improve efficiency,¹³⁴ but other engines in Ford’s EcoBoost lineup use GDI. In MY 2015, Ford offered a version of the EcoBoost turbocharged GDI engines as standard or optional engines in nearly all of models of light-duty cars and trucks. Ford’s world-wide production of EcoBoost engines exceeded 200,000 units per month during CY 2015.¹³⁵ Figure 5-38 below shows NHTSA’s test data for the operation of dual fuel injection system of 2017 Ford F150 3.5L Ecoboost™ on UDDS, HWFET, and US06 test cycles. The figure shows the split of operation of DI and PFI system on the 2017 Ford F150 3.5L engine with outline of varies test cycles. It shows that combination of PFI and DI are required in standard federal 2-cycle tests. The PFI system provides the fuel to the engine when the absolute engine load is below 40%. The DI system is quickly blended in above 40% absolute engine load. Between 60% to 140% absolute load, 70% to 80% of the fuel is delivered through the DI system. At absolute engine loads above 140% the PFI system provides an increase proportion of the fuel up to 40%.

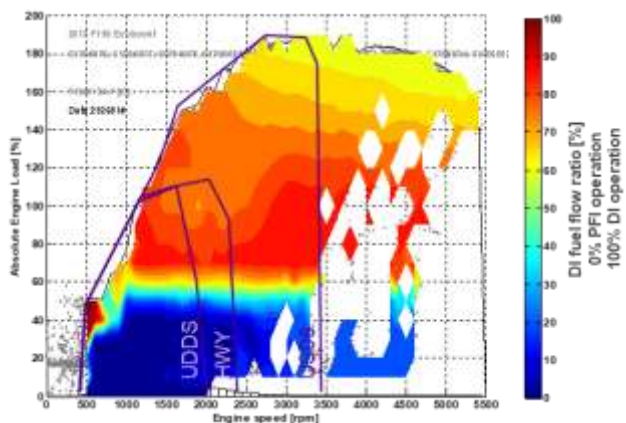

¹³⁴ Ford Motor Company. 2016. “More Torque and Better Boost - 2017 Ford F-150 to Debut with All-New 3.5-Liter EcoBoost Engine and 10-Speed Transmission.” <https://media.ford.com/content/fordmedia/fna/us/en/news/2016/05/03/2017-ford-f150-more-torque-better-boost.pdf>, last accessed July 5, 2016.

¹³⁵ Ford Motor Company. 2015. “Ford Marks Production Milestone as 5-Millionth EcoBoost-Equipped Vehicle Rolls Off Assembly Line.” <https://media.ford.com/content/fordmedia/fna/us/en/news/2015/03/17/ford-marks-production-milestone-as-5-millionth-ecoboost-equipped.pdf>, last accessed July 5, 2016.

FIGURE 5-38 - DI AND PFI USAGE MAP AS FUNCTION OF ENGINE SPEED AND LOAD FOR A 2017 FORD F150 3.5L ECOBOOST¹³⁶

5.3.2.2.10 Turbocharging and Downsizing

Turbocharging increases the engine airflow and specific power output, allowing engine displacement reductions while maintaining a desired level of performance. As a result, friction and pumping losses are reduced at lighter loads relative to a larger, naturally aspirated engine. Recent turbocharger improvements have included use of lower-mass, lower inertia components and lower friction ball bearings to reduce turbocharger lag and enable higher peak rotational speeds. Improvements have also been made to turbocharger compressor designs to improve compressor efficiency and to expand the limits of compressor operation by improving surge characteristics.

Turbochargers with variable nozzle turbines (VNT) or variable geometry turbocharger (VGT) use moveable vanes within the turbocharger to allow adjustment of the effective exhaust turbine aspect ratio, allowing the operation of the turbocharger to be better matched across the entire speed and load range of an engine. VNT turbochargers are commonly used in modern light-duty and heavy-duty diesel engines.

The use of head-integrated exhaust manifolds (IEM) and split-coolant loops within the engine and the use of cooled EGR (See sections 5.3.2.2.11) can reduce peak exhaust temperatures sufficiently to allow lower cost implementation of VNT turbochargers in spark ignition engines. There are also synergies between the application of VNT to Miller cycle operating engines, where increased low-speed torque, improved torque response are possible.¹³⁷

A comparison of the same 2.4L PFI engine with a more recent, MY 2017 Honda 1.5L Turbocharged GDI engine with IEM.^{138,139} The torque characteristics of the Honda engine are a closer match to the 2.4L PFI engine and the Honda engine represents approximately 37% downsizing relative to the 2.4L PFI engine due to turbocharging and includes other improvements (friction reduction, dual cam phasing, higher rates of internal EGR). The Honda 1.5L turbocharged GDI engine has significantly improved efficiency when comparing BTE across 20 speed and load points of significance for the regulatory drive cycles (1500 -2500 rpm and 2-bar to 8-bar BMEP as referenced to the 2.4l ENGINE). The BTE of the Honda 1.5L turbocharged engine showed an incremental effectiveness of 6% to 30% across this entire range

¹³⁶ NHTSA Benchmarking, “Laboratory Testing of a 2017 Ford F-150 3.5 V6 EcoBoost with a 10-speed transmission.”

¹³⁷ Eichler, F., Demmelbauer-Ebner, W., Theobald, J., Stiebels, B., Hoffmeyer, H., Kreft, M. “*The New EA211 TSI® evo from Volkswagen.*” 37. Internationales Wiener Motorensymposium 2016.

¹³⁸ Wada, Y., Nakano, K., Mochizuki, K., and Hata, R. “*Development of a New 1.5L I4 Turbocharged Gasoline Direct Injection Engine.*” SAE Technical Paper 2016-01-1020, 2016, doi - 10.4271/2016-01-1020.

¹³⁹ Nakano, K., Wada, Y., Jono, M., Narihiro, S. “*New In-Line 4-Cylinder Gasoline Direct Injection Turbocharged Downsizing Engine.*” *Honda R&D Technical Review*, April 2016, pp 139-146.

*** EO 12866 Review – Draft – Do Not Cite, Quote or Release During Review ***

of operation. The difference was more pronounced at lighter loads. Incremental effectiveness was 16% to 30% below 6-bar BMEP relative to the 2.4L engine.

5.3.2.2.11 EGR

Exhaust gas recirculation (EGR) is a broad term used for systems that control and vary the amount of inert, residual exhaust gases left in cylinder during combustion. EGR can improve efficiency at part-load by reducing pumping losses due to engine throttling. EGR also reduces combustion temperatures and thus reduces NO_x formation. The use of cooled EGR (cEGR) can reduce knocking combustion, thus allowing compression ratio and/or turbocharger boost pressure to be increased or spark timing to be advanced. EGR also slows the rate of combustion, so its use is often accompanied by other changes to the engine (e.g., inducing charge motion and turbulent combustion) to shorten combustion duration and allow improved combustion phasing. Internal EGR uses changes in independent cam-phasing to vary the overlap between intake and exhaust valve timing events, thus changing the amount of residual gases trapped in cylinder after cylinder scavenging. External EGR recirculates exhaust gases downstream of the exhaust valve back into the air induction system.

With turbocharged engines, there are variants of external EGR that use a low pressure loop, a high pressure loop or combinations of the two system. External EGR systems can also incorporate a heat-exchanger to lower the temperature of the recirculated exhaust gases (e.g., cooled EGR or cEGR), improving both volumetric efficiency and enabling higher rates of EGR. Nearly all light-duty diesel engines are equipped with cEGR as part of their NO_x emission control system. Some diesel applications also use relatively large amounts (>25%) of cEGR at light- to part-load conditions to enable dilute low-temperature combustion (see Section 5.3.2.2.18.5 for a more detailed description of light-duty diesel technologies). Research is also underway to apply similar forms of low-temperature combustion using high EGR rates to gasoline engine applications¹⁴⁰

The use of cEGR technology was analyzed for post-2017 light-duty vehicles with engines at 24-bar BMEP, primarily as a means to prevent pre-ignition at the high turbocharger boost levels needed at 24-bar BMEP and above. The analysis did take into account efficiency benefits from the use of cEGR with turbocharged engines due primarily to part-load reductions in pumping losses and the reduction or elimination of commanded fuel enrichment under high-load conditions.

Prior to 2012, there were no examples of production vehicles equipped with turbocharged GDI engines using cEGR. The PSA 1.2L EB PureTech Turbo engine was launched in the MY 2014 Peugeot 308 in Europe as the first high-volume production application of cEGR on a turbocharged GDI engine. This engine has over 24-bar BMEP and also operates using Miller

¹⁴⁰ Sellnau, M. "Advancement of Gasoline Direct Injection Compression Ignition (GDICI) for US 2025 CAFE and Tier 3 Emissions," SAE 2017 High Efficiency IC Engine Symposium. April 3, 2017.

Cycle (see Section 5.3.2.2.13 for a more detailed description of Miller-Cycle). The MY 2016 Mazda CX-9 2.5L SKYACTIV Turbo engine similarly combines the use of Miller Cycle with cEGR.¹⁴¹ In another variant, Chrysler has implemented liquid-cooled cEGR on the 2016 3.6L Pentastar V-6 with natural aspiration and PFI.¹⁴² Atkinson Cycle

Conventional 4-cycle internal combustion engines have an effective compression ratio and effective expansion ratio that are approximately equivalent. Current and past production Atkinson Cycle engines use changes in valve timing (e.g., late-intake-valve-closing or LIVC) to reduce the effective compression ratio while maintaining the expansion ratio (see Figure 5-39 and Figure 5-40)

This approach allows a reduction in top-dead-center (TDC) clearance ratio (e.g., increase in “mechanical” or “physical” compression ratio) to increase the effective expansion ratio without increasing the effective compression ratio to a point that knock-limited operation is encountered. Increasing the expansion ratio in this manner improves thermal efficiency but also lowers peak brake-mean-effective-pressure (BMEP), particularly at lower engine speeds.¹⁴³ Depending on how it is implemented, some Atkinson Cycle engines may also have sufficient cam-phasing authority to widely vary effective compression ratio and can use this variation as a means of load control without use of the standard throttle, resulting in additional pumping loss reductions.

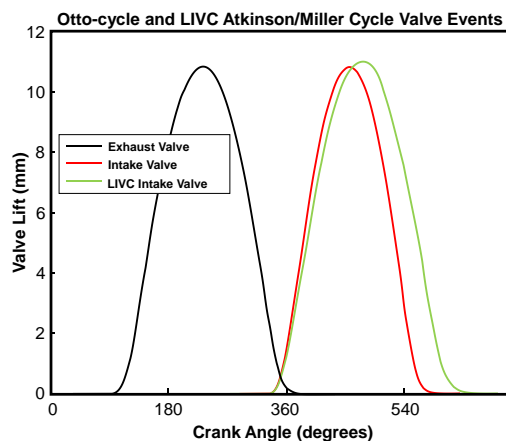

¹⁴¹ NHTSA Benchmarking, “Laboratory Testing of a 2016 Mazda CX9 2.5 I4 with a 6 Speed Transmission.”

¹⁴² “2016 Pentastar V6 adds new VVT, cooled EGR,” 01-Sept-2015. <http://articles.sae.org/14322/>

¹⁴³ BMEP is defined as torque normalized by cylinder displacement. It allows for emissions and efficiency comparisons between engines of different displacement.

FIGURE 5-39 - COMPARISON OF THE TIMING OF VALVE EVENTS FOR OTTO-CYCLE (BLACK AND ORANGE LINES) AND LIVC IMPLEMENTATIONS OF ATKINSON- OR MILLER-CYCLE (BLACK AND GREEN LINES).

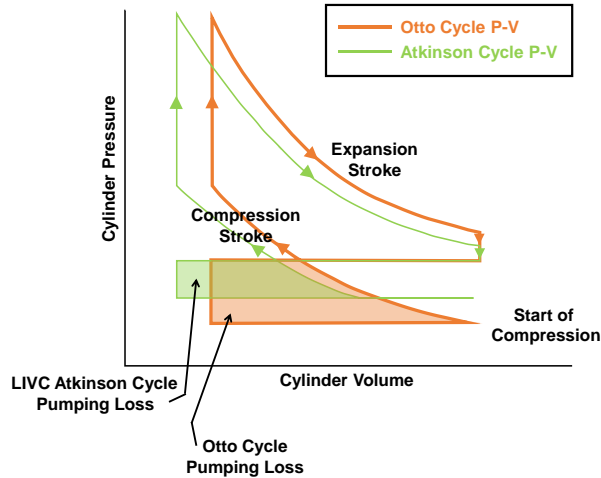

FIGURE 5-40 - DIAGRAMS OF CYLINDER PRESSURE VS. CYLINDER VOLUME FOR A CONVENTIONAL OTTO-CYCLE SI ENGINE (ORANGE LINE) COMPARED TO A LIVC IMPLEMENTATION OF ATKINSON CYCLE (GREEN LINE) HIGHLIGHTING THE REDUCTION IN PUMPING LOSSES.

Prior to 2012, the use of naturally-aspirated Atkinson Cycle engines has been limited to HEV and PHEV applications where the electric machine could be used to boost torque output, particularly at low engine speeds. Because of this, the 2012 FRM analyses did not include the use of Atkinson Cycle engines outside of HEV and PHEV applications. Nearly all HEV/PHEV applications in the U.S. use Atkinson Cycle, including the Honda Insight, Toyota Prius, Toyota Camry Hybrid, Lexus 400h, Hyundai Sonata Hybrid and Chevrolet Volt. The Toyota 2ZR-FXE used in the third-generation Toyota Prius and Lexus 200h uses a combination of LIVC Atkinson Cycle, cooled EGR, and port-fuel-injection (PFI) to achieve a peak BTE of 38.5%. Further refinements to this engine, including increased tumble to increase both the speed of combustion and EGR tolerance, have resulted in peak BTE of 40%.¹⁴⁴

¹⁴⁴ Takahashi, D., Nakata, K., Yoshihara, Y., Ohta, Y. et al. "Combustion Development to Achieve Engine Thermal Efficiency of 40% for Hybrid Vehicles," SAE Technical Paper 2015-01-1254, 2015, doi - 10.4271/2015-01-1254.

*** EO 12866 Review – Draft – Do Not Cite, Quote or Release During Review ***

Since 2012, Atkinson Cycle engines have been introduced into non-hybrid applications. These applications use camshaft-phasing with a high degree of authority together with GDI (e.g., Mazda SKYACTIV-G 1.5L, 2.0L and 2.5L engines) or a combination of PFI with cooled EGR (Toyota 1NR-FKE and 2NR-FKE engines). The effective compression ratio can be varied using camshaft phasing to increase BMEP and the use of GDI (Mazda) or cEGR (Toyota) are used, in part, for knock mitigation. These engines from Mazda and Toyota also incorporate other improvements, such as friction reduction from valvetrain and piston design enhancements. The Toyota 1NR-FKE 1.3L I3 and 2NR-FKE 1.5L I4 engines achieve a peak BTE of 38%, very close to the BTE achieved with the 2ZR-FXE engine used in the Toyota Prius.^{145,146} EPA testing of 2.0L and 2.5L variants of the Mazda SKYACTIV-G engine achieved peak BTE of 37% while using 92 AKI (96 RON) fuel. Note that on the UDDS and HWFET test cycles, the engine operates within the best BTE island a relatively small portion of the time, as shown in Figure 5-41 and Figure 5-42. In the case of the Mazda SKYACTIV-G engines, the use of GDI and cam-phasing resulted in increased BMEP and rated power relative to the previous PFI, non-Atkinson versions of this engine and allowed a small degree of engine downsizing (e.g., replacement of the previous 2.5L PFI engine with the 2.0 SKYACTIV-G) on some Mazda platforms with equal or improved performance. In the case of the Toyota 1NR-FKE, the use of cEGR and cam-phasing allowed BMEP to be maintained relative to peak BMEP of the Non-Atkinson Cycle engine it replaced and allowed the use of a lower cost PFI fuel system. Both the Mazda and Toyota Atkinson Cycle engines use electro-mechanical systems for camshaft phasing on the intake camshaft.

¹⁴⁴ Yamada, T., Adachi, S., Nakata, K., Kurauchi, T. et al. “*Economy with Superior Thermal Efficient Combustion (ESTEC)*,” SAE Technical Paper 2014-01-1192 doi - 10.4271/2014-01-1192.

¹⁴⁵ Takahashi, D., Nakata, K., Yoshihara, Y., Ohta, Y. et al. “*Combustion Development to Achieve Engine Thermal Efficiency of 40% for Hybrid Vehicles*,” SAE Technical Paper 2015-01-1254, 2015, doi - 10.4271/2015-01-1254.

¹⁴⁶ Yamada, T., Adachi, S., Nakata, K., Kurauchi, T. et al. “*Economy with Superior Thermal Efficient Combustion (ESTEC)*,” SAE Technical Paper 2014-01-1192 doi - 10.4271/2014-01-1192.

*** EO 12866 Review – Draft – Do Not Cite, Quote or Release During Review ***

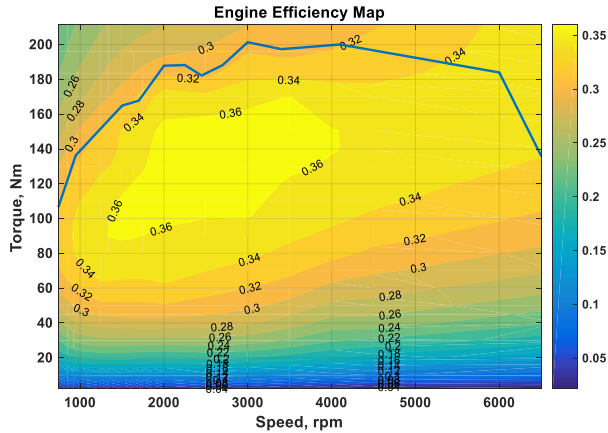

FIGURE 5-41 - BTE FOR A REPRESENTATIVE MY 2010 2.4L NA PFI TESTED BY EPA.^{147,148}

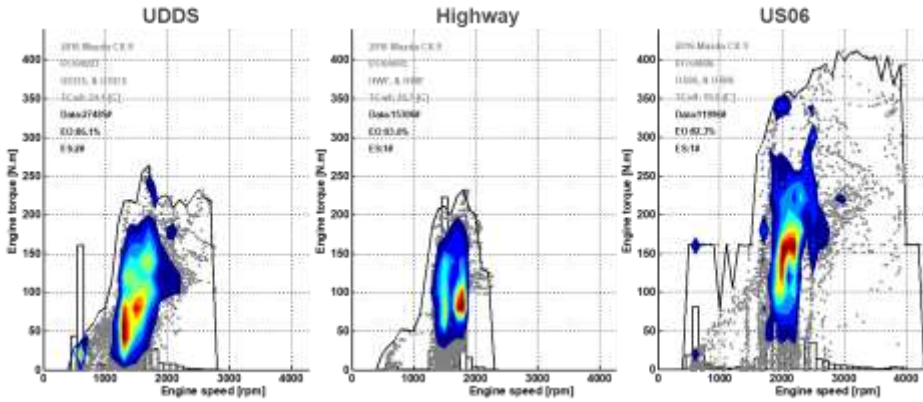

FIGURE 5-42 - ENGINE OPERATING AREA ON CERTIFICATION CYCLES OF 2016 MAZDA CX-9 BENCHMARKED BY NHTSA¹⁴⁹

In the Mazda SkyActiv powertrain design, Mazda noted that with the increase of compression ratio, the temperature at compression top dead center (TDC) also rises, increasing the probability of knocking. In order to lower the temperature at compression TDC, reducing the amount of hot

¹⁴⁷ Lee, S., Schenk, C., & McDonald, J. "Air Flow Optimization and Calibration in High-Compression-Ratio Naturally Aspirated SI Engines with Cooled-EGR," SAE Technical Paper 2016-01-0565, 2016, doi - 10.4271/2016-01-0565.

¹⁴⁸ Derived from EPA engine dynamometer data first presented by Lee et al. 2016.

¹⁴⁹ NHTSA Benchmarking, "Laboratory Testing of a 2016 Mazda CX9 2.5 I4 with a 6 Speed Transmission."

exhaust gas remaining inside the combustion chamber is effective. Mazda introduced a 4-2-1 exhaust system to mitigate the high temperature that leads to knocking. Figure 5-43 shows the difference between the tradition exhaust system and Mazda’s exhaust system designed to reduce high temperature exhaust residual. However, this long runner exhaust system could pose packaging issues for I4 vehicles with limited engine compartment space and for V6 or V8 engines. One major challenge with the 4-2-1 exhaust system is that the long distance cools the exhaust gas before it reaches the catalyst, delaying the catalyst light-off, particularly considering Tier 3 emission requirements.

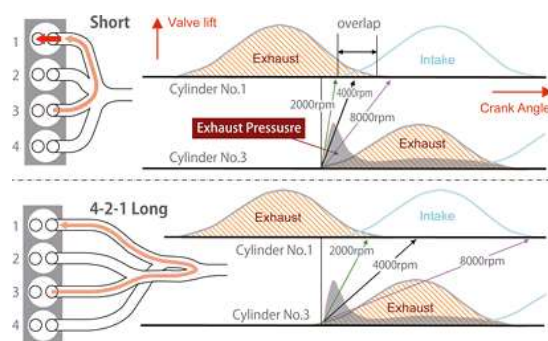

FIGURE 5-43 - MAZDA SKYACTIV 4-2-1 EXHAUST SYSTEM TO MITIGATE KNOCKING BY REDUCING RESIDUAL GAS.¹⁵⁰

EPA’s recent benchmarking analysis of a 2014 Mazda SKYACTIV-G naturally aspirated (NA) gasoline direct injection (GDI) engine showed a peak BTE of approximately 37%, relatively high for SI engines.^{151,152} This was in part due to an ability to use late-intake-valve-closing (LIVC) Atkinson-cycle operation to decouple the knock-limited effective CR from the expansion ratio available from a very high 14:1 geometric CR. The max BTE of approximately 37% was achieved using high-octane fuel in the European configuration of this SkyActiv engine (but note, Mazda uses a lower compression ratio engine in the US due to difference in fuel octane). The Mazda SKYACTIV-G is one of the first implementations of a naturally-aspirated, LIVC Atkinson-cycle engine in U.S. automotive applications outside of hybrid electric vehicles (HEV) and also appears to be the first Atkinson-cycle engine to use GDI. Port-fuel-injected (PFI) Atkinson-cycle engines have been used in hybrid electric vehicle applications in the U.S. for

¹⁵⁰ Mazda SkyActiv Tehcnology for SkyActiv-G.

<http://www.mazda.com/en/innovation/technology/skyactiv/skyactiv-g/>

¹⁵¹ Derived from EPA engine dynamometer data first presented by Lee et al. 2016.

¹⁵² Lee, S., Schenk, C., & McDonald, J. “Air Flow Optimization and Calibration in High-Compression-Ratio Naturally Aspirated SI Engines with Cooled-EGR,” SAE Technical Paper 2016-01-0565, 2016, doi - 10.4271/2016-01-0565.

*** EO 12866 Review – Draft – Do Not Cite, Quote or Release During Review ***

more than a decade. PFI/Atkinson-cycle engines have demonstrated peak BTE of approximately 39% in the 2015 Honda Accord HEV and 40% in the 2016 Toyota Prius HEV.

With a thermal efficiency of 40%,¹⁵³ the 2.5L, 13.5:1 compression ratio, SGDI in the 2018 Toyota Camry¹⁵⁴ is currently the highest thermal efficiency gasoline engine in the U.S. market. Notably, this engine used advanced manufacturing methods in the valves and engine head to produce a design with improved airflow and combustion.¹⁵⁵ The vehicle utilizes a number of technologies including a high compression ratio engine to provide high thermal efficiency, and an 8-speed automatic transmission.

5.3.2.2.12 Compression ignition gasoline engines

For many years, engine developers, researchers, manufacturers have explored ways to achieve the inherent efficiency of a diesel engine while maintaining the operating characteristics of a gasoline engine. A potential pathway for striking this balance is utilizing compression ignition for gasoline fueled engines, more commonly referred to as Homogeneous Charge Compression Ignition (HCCI).

Gasoline powered engines have used an electric spark to ignite a fuel and air mixture to produce power since their invention. A fuel and air mixture is drawn into an engine cylinder and ignited at a defined, precise moment releasing energy as a controlled explosion.¹⁵⁶ The energy released during this explosion is translated to the engine crankshaft and then out of the engine to perform whatever work the engine is tasked to do.

Diesel fueled engines ignite the fuel and air mixture without an electric spark. They rely on the heat generated by squeezing the fuel and air mixture until it ignites; this is commonly referred to auto-ignition. Diesel engines utilize very high compression ratios to achieve auto-ignition and, therefore, produce more power per unit of energy. Aside from efficiency, however, gasoline and diesel fueled engines maintain very distinct characteristics such as the rates (time) power is achieved, emissions, component weight, and more.

In ongoing, periodic discussions with manufacturers on future fuel saving technologies and powertrain, manufacturers' plans have, generally, included HCCI as part of a long-term strategy. The technology appears to always be a strong consideration as, in theory, it provides the "best of

¹⁵³“*Camry's Engine Tech will Spread across Toyota,*”

<http://www.autonews.com/article/20170801/OEM01/170809949/camrys-engine-tech-will-spread-across-toyota> . Accessed January 30, 2018.

¹⁵⁴“*All-New Toyota Camry Ignites the Senses,*”

<http://pressroom.toyota.com/releases/all-new-toyota-camry-ignites-senses.htm>. Accessed January 30, 2018.

¹⁵⁵ “*New 2.5-liter Direct-injection, Inline 4-cylinder Gasoline Engine*”

<https://newsroom.toyota.co.jp/en/powertrain/engine/> Published December 6, 2016.

¹⁵⁶ A spark is required because the air to fuel mixture contains too much gasoline (“rich”) to ignite without it but cannot be made lean enough to reliably, precisely and controllably ignite on its own.

*** EO 12866 Review – Draft – Do Not Cite, Quote or Release During Review ***

both worlds” – meaning a way to provide diesel engine efficiency with gasoline engine performance and emissions levels.

Developments in both the research and the potential production implementation of HCCI for the U.S. market are continually being monitored. In 2017, Mazda announced a significant production breakthrough regarding a gasoline-fueled engine employing HCCI for a portion of its normal operation.¹⁵⁷ Soon after, Mazda publicly stated they plan to introduce this engine as part of the Skyactiv family of engines in 2019.¹⁵⁸

However, HCCI has not been included in simulation and vehicle fleet modeling for past rulemakings and has not been included in this rulemaking as well; this is primarily due to the fact that manufacturers were not manufacturing HCCI engines at the time of the 2012 rulemaking, and accordingly there was a lack of conclusive and independently verifiable effectiveness, cost, and mass market implementation data available.

The NPRM requests comment on the potential use of HCCI technology in the analysis for the timeframe proposed for this rulemaking. More specifically, should HCCI be included in the final rulemaking analysis for this proposed rulemaking? Why or why not? Please provide supporting data, including effectiveness values, costs in relation to varying engine types and applications, and production timing that supports the timeframe of this rulemaking.

5.3.2.2.13 Miller Cycle

Like Atkinson Cycle, Miller Cycle engines use changes in valve timing to reduce the effective compression ratio while maintaining the expansion ratio. Automakers have investigated both early intake valve closing (EIVC) and LIVC variants. There is some disagreement over the application of the terms Atkinson or Miller Cycle to EIVC and LIVC valve event timing and sometimes the terms are used interchangeably. For the purpose of this analysis, Miller Cycle is a variant of Atkinson cycle with intake manifold pressure boosted by either a turbocharger and/or a mechanically or electrically driven supercharger. More simply, it is an extension of Atkinson Cycle to boosted engines. The first production vehicle offered using Miller Cycle was the MY 1995 Mazda Millenia S, which used the KJ-ZEM 2.3L PFI engine with a crankshaft-driven Lysholm compressor for supercharging. Until recently, no Miller Cycle gasoline SI engines were in mass production after 2003, and Miller Cycle was not evaluated as a potential gasoline engine technology as part of the rulemaking for MYs 2017-2025.

¹⁵⁷ “Mazda Next-Generation Technology-Press Information,” October 24, 2017, <https://insidemazda.mazdausa.com/press-release/mazda-next-generation-technology-press-information/> (last accessed - April 13, 2018)

¹⁵⁸ “Mazda Introduces Updated 2019 CX-3 at 2018 New York International Auto Show,,” March 28, 2018, <https://insidemazda.mazdausa.com/press-release/mazda-introduces-2019-cx-3-2018-new-york-auto-show/> (last accessed - April 13, 2018).

*** EO 12866 Review – Draft – Do Not Cite, Quote or Release During Review ***

As with Atkinson Cycle engines, the use of GDI and camshaft-phasing with a high degree of authority have significant synergies with Miller Cycle. Modern turbocharger and aftercooler systems allow Miller Cycle engines to attain BMEP levels approaching those of other modern, downsized, turbocharged GDI engines. The 1.2L I3 PSA “EB PureTech Turbo” Miller engine recently launched in Europe, N. Africa and S. America in the MY 2014 Peugeot 308.159 In addition to Miller Cycle, the engine also uses cEGR. This engine has a maximum BMEP of 24-bar and is similar in many respects to the Ford 1.0L I3 EcoBoost but achieves 35% BTE.

In MY 2016, VW launched a Miller Cycle variant of the 2.0L EA888 turbocharged GDI engine in the U.S. The VW implementation of Miller Cycle has a second Miller Cycle cam profile and uses camshaft lobe switching on the intake cam to go into and out of an EIVC version of Miller Cycle.^{160,161} The peak BTE of 37% is higher than that of the PSA Miller cycle engine, in part due to a higher expansion ratio (11.7:1 for the VW engine vs. 10.5:1 for the PSA engine). Like the PSA engine, the VW uses high-pressure cEGR. Peak BTE is comparable to the Mazda SKYACTIV-G engines but is available over a broader range of speed and load conditions. Both Atkinson and Miller Cycle engines show broad areas of operation at greater than 32% BTE.

Light-duty Diesel Engines

Diesel engines have characteristics that differ from gasoline spark ignition (SI) engines and allow improved fuel efficiency, particularly at part-load conditions. These include reduced pumping losses due to lack of (or greatly reduced) throttling, and a combustion cycle that operates at a higher compression ratio and at very lean air/fuel ratio when compared with an equivalent-performance gasoline engine. Operating with a lean-of-stoichiometric air/fuel ratio poses challenges with respect to NO_x control, requiring either a NO_x adsorption catalyst (NAC), urea or ammonia-based selective catalytic reduction (SCR) or some combination of NAC and SCR in order to meet Federal Tier 3 and California LEV III NO_x emissions standards. Beginning with Federal Tier 2 emission standards, it has also been necessary to equip light-duty diesels with catalyzed diesel particulate filters (CDPFs) in order to comply with light duty PM emission standards.

Detailed analysis of the vehicle simulation results used within the 2012 FRM uncovered some shortcomings within the MSC EASY5 vehicle simulations used as light-duty diesel vehicle GHG effectiveness inputs into the Ricardo Surface Response Model. The modeled light-duty diesel technology packages did not operate in the most efficient regions of engine operation. This may have been in part due to inconsistencies in the application of the optimized shift strategy and in part due to an oversight that resulted in the apparent oversizing of light-duty diesel engine

¹⁵⁹ Souhaite, P., Mokhtari, S. “*Combustion System Design of the New PSA Peugeot Citroën EB TURBO PURE TECH Engine*,” Proceedings - Internationaler Motorenkongress 2014, DOI - 10.1007/978-3-658-05016-0_5.

¹⁶⁰ Budack, R., Kuhn, M., Wurms, R., Heiduk, T. “*Optimization of the Combustion Process as Demonstrated on the New Audi 2.0l TFSI*,” 24th Aachen Colloquium Automobile and Engine Technology 2015.

¹⁶¹ Wurms, R., Budack, R., Grigo, M., Mendl, G., Heiduk, T., Knirsch, S. “*The New Audi 2.0l Engine with Innovative Rightsizing*,” 36. Internationales Wiener Motorensymposium 2015.

*** EO 12866 Review – Draft – Do Not Cite, Quote or Release During Review ***

displacements. For example, plotting the average engine speed and load operating points over the regulatory drive cycles for the MSC EASY5 diesel simulations on top of the diesel engine maps showed that there was significant potential for improvement in the choice of selected gear. These issues were addressed for the Draft TAR CAFE analysis, and for the CO₂ and CAFE analyses for this NPRM through the use of the Autonomie shift schedules and control models described in this chapter.

Light-duty diesel engines have also evolved considerably over the last five years, particularly in Europe. Modern light-duty diesel engine designs appear to be following similar trends to those of turbocharged GDI engines and, in some cases, heavy-duty diesel engine designs, including:

- 1) Engine downsizing (increased peak BMEP)
- 2) Engine down-speeding
- 3) Advanced friction reduction measures
- 4) Reduced parasitics
- 5) Improved thermal management
- 6) Use of a combination of both low- and high-pressure-loop cooled EGR
- 7) Advanced turbocharging, including the use of VNT and sequential turbocharging
- 8) Incorporation of highly-integrated exhaust catalyst systems with high NO_x and PM removal efficiencies
- 9) Adoption of high-pressure common rail fuel injection systems with higher injection pressures and increased capability (i.e., multiple injections per firing cycle)

The highest BMEP engines currently in mass-production for high-volume light-duty vehicle applications are all diesel engines. MY 2016-2017 light-duty diesel engines are available from Honda, BMW and Mercedes Benz in the EU with approximately 26-bar to 29-bar BMEP and peak cylinder pressures at or above 200-bar.^{162, 163, 164} The light-duty diesel technology packages used in the 2012 FRM analyses relied on engine data with peak BMEP in the range of 18 - 20 bar. These were engine configurations using single-stage turbocharging with electronic wastegate control, high-pressure or low-pressure (single-loop) cooled EGR, and common-rail fuel injection with an 1800 bar peak pressure. The cost analysis in the 2012 FRM for advanced light-duty diesel vehicles assumed use of using a DOC+DPF+SCR system for meeting emissions standards for criteria pollutants.

This NPRM analysis utilizes two diesel technology levels. The first technology level represents the modern diesel engines as offered in the current MY 2016 LD vehicles. The second level of

¹⁶² Hatano, J., Fukushima, H., Sasaki, Y., Nishimori, K., Tabuchi, T., Ishihara, Y. "The New 1.6L 2-Stage Turbo Diesel Engine for HONDA CR-V." 24th Aachen Colloquium - Automobile and Engine Technology 2015.

¹⁶³ Steinparzer, F., Nefischer, P., Hiemesch, D., Kaufmann, M., Steinmayr, T. "The New Six-Cylinder Diesel Engines from the BMW In-Line Engine Module." 24th Aachen Colloquium - Automobile and Engine Technology 2015.

¹⁶⁴ Eder, T., Weller, R., Spengel, C., Böhm, J., Herwig, H., Sass, H. Tiessen, J., Knauel, P. "Launch of the New Engine Family at Mercedes-Benz." 24th Aachen Colloquium - Automobile and Engine Technology 2015.

diesel would incorporate combination of low pressure and high pressure EGR, reduced parasitic loss, advanced friction reduction, incorporation of highly-integrated exhaust catalyst with low temp light off temperatures, and closed loop combustion control. In both of these packages, the analysis includes the cost of the after-treatment systems to meet the emissions standards for criteria pollutants.¹⁶⁵

5.3.2.2.14 Thermal Management

Most recent turbocharged engine designs now use head-integrated, water-cooled exhaust manifolds and coolant loops that separate the cooling circuits between the engine block and the head/exhaust manifold(s). Examples include the head-integrated exhaust manifolds (IEM) and split-coolant loops used with the Ford 1.0L I3, 1.5L I4, 2.0L I4 and 2.7L V6 EcoBoost engines, the 2.0L VW EA888 engine, the GM EcoTec SGE 1.0L 3-cylinder and 1.4L 4 cylinder engines, and the PSA 1.2L EB PureTech Turbo. The use of IEM and split-coolant-loops is now also migrating to some naturally aspirated GDI and PFI engines, including the GM 3.6L V6 LFX and EcoTec 1.5L engines and the 1.0L 3-cylinder Toyota 1KR-FE ESTEC. These types of thermal management systems were included in the 2012 final rule analysis of turbocharged GDI engines at BMEP levels of 24-bar and above but were not considered for turbocharged engines at lower BMEP levels or for naturally aspirated engines. Benefits include:

- Improved under-hood thermal management (reduced radiant heat-load)
- Reduced thermal gradients across the cylinder head
- Reduction in combustion chamber hot spots that can serve as pre-ignition sources
- Improved knock limited operation
- Reduce or eliminate enrichment required for component protection, particularly at low-speed/high-load conditions
 - Enable additional engine “down-speeding” without encountering enrichment
- Improved control of turbine inlet temperature (turbocharged engines only)
 - Enable use of lower-cost materials turbine and turbine housing materials
 - Enable use of variable-geometry turbines similar to light-duty diesel applications
- Improved catalyst durability
- Shorter time to catalyst light-off after cold-start
- Improved coolant warmup after cold start
- Reduced noise
- Lower cost and parts count
 - Improved durability (fewer gaskets to fail)
- Reduced weight (savings of approximately 1 kg/cylinder)

¹⁶⁵ National Research Council. 2015. Cost, Effectiveness, and Deployment of Fuel Economy Technologies for Light-Duty Vehicles. Washington, DC - The National Academies Press. <https://doi.org/10.17226/21744>. pg. 104.

*** EO 12866 Review – Draft – Do Not Cite, Quote or Release During Review ***

This analysis has not defined technology for thermal management in Autonomie, as available data varies significantly. The NPRM requests comment on data and cost of thermal management systems, in addition to how they could be incorporated with current technology offerings.

5.3.2.2.15 Low Friction Lubrications and Engine Friction reductions (LUBEFR)

One of the most basic methods of reducing fuel consumption in gasoline engines is the use of lower viscosity engine lubricants. More advanced multi-viscosity engine oils are available today with improved performance in a wider temperature band and with better lubricating properties. This can be accomplished by changes to the oil base stock (e.g., switching engine lubricants from a Group I base oils to lower-friction, lower viscosity Group III synthetic) and through changes to lubricant additive packages (e.g., friction modifiers and viscosity improvers). The use of 5W-30 motor oil is now widespread and auto manufacturers are introducing the use of even lower viscosity oils, such as 5W-20, and 0W-20 to improve cold-flow properties and reduce cold start friction.¹⁶⁶ However, in some cases, changes to the crankshaft, rod and main bearings and changes to the mechanical tolerances of engine components may be required. In all cases, durability testing is required to ensure that durability is not compromised. The shift to lower viscosity and lower friction lubricants also improve the effectiveness of valvetrain technologies such as cylinder deactivation, which rely on a minimum oil temperature (viscosity) for operation.

In addition to low friction lubricants, manufacturers can also reduce friction and improve fuel consumption by improving the design of engine components and subsystems. Approximately 8% of the fuel energy consumed by a vehicle is lost to friction, and just over half is due to frictional losses within the engine.¹⁶⁷ Examples include improvements in low-tension piston rings, piston skirt design, roller cam followers, improved crankshaft design and bearings, material coatings, material substitution, more optimal thermal management, and piston and cylinder surface treatments. Additionally, as computer-aided modeling software continues to improve, more opportunities for evolutionary friction reductions may become available.

¹⁶⁶ 2018 Toyota Camry 2.5L 4-cylinder (A25A-FKS engine) recommended engine oil selection. Page 543. <https://www.toyota.com/3Portal/document/om-s/OM06122U/pdf/OM06122U.pdf>

¹⁶⁷ National Research Council. 2015. Cost, Effectiveness, and Deployment of Fuel Economy Technologies for Light-Duty Vehicles. Washington, DC - The National Academies Press. <https://doi.org/10.17226/21744>.

*** EO 12866 Review – Draft – Do Not Cite, Quote or Release During Review ***

All reciprocating and rotating components in the engine are potential candidates for friction reduction, and minute improvements in several components can add up to a measurable fuel economy improvement.^{168, 169, 170, 171}

5.3.2.2.16 Sources of Engine Effectiveness Data

This analysis used engine data from a wide range of sources to update engine effectiveness for this assessment -

- Newly available public data (e.g., peer-reviewed journals, peer-reviewed technical papers, conference proceedings);
- Data directly acquired by EPA via engine dynamometer testing at EPA-NVFEEL or at contract laboratories;
- Benchmarking and simulation modeling of current and future engine configurations;
- EPA's benchmarking and simulation modeling of current transmission configuration;
- Confidential data from OEMs, Tier 1 suppliers, and major automotive engineering services firms;
- NHTSA benchmarking of production vehicles with advanced engine and transmission technologies;
- Data from the U.S. Department of Energy Vehicle Technologies Program; and
- Sources of engine effectiveness data used in the analysis supporting the light-duty CAFE and CO₂ rule covering MYs 2017 and beyond

Data gleaned from each source is discussed in turn, below.

5.3.2.2.16.1 Publicly available literature

A considerable amount of brake-specific fuel consumption (BSFC), brake-thermal efficiency (BTE) and chassis-dynamometer drive cycle fuel consumption data for advanced powertrains has been published in journals, technical papers and conference proceedings since the 2012 final rule. In some cases, published data includes detailed engine maps of BSFC and/or BTE over a wide area of engine operation. In addition, these publications provide a great deal of information regarding the specific design changes made to an engine which allow the engine to operate at an improved BSFC and vehicles to operate with improved fuel consumption. These design details often include changes to engine friction, changes to valvetrain and valve control, combustion chamber design and combustion control, boosting components and boosting control, and exhaust

¹⁶⁸ "Polyalkylene Glycol (PAG) Based Lubricant for Light- & Medium-Duty Axles," 2017 DOE Annual Merit Review. Ford Motor Company, Gangopadhyay, A., Ved, C., Jost, N.

https://energy.gov/sites/prod/files/2017/06/f34/ft023_gangopadhyay_2017_o.pdf

¹⁶⁹ "Power-Cylinder Friction Reduction through Coatings, Surface Finish, and Design," 2017 DOE Annual Merit Review. Ford Motor Company, Gangopadhyay, A. Erdemir, A.

https://energy.gov/sites/prod/files/2017/06/f34/ft050_gangopadhyay_2017_o.pdf

¹⁷⁰ "Nissan licenses energy-efficient engine technology to HELLER," <https://newsroom.nissan-global.com/releases/170914-01-e?lang=en-US&rss&la=1&downloadUrl=%2F170914-01-e%2Fdownload>. Last accessed April 2018

¹⁷¹ "Infiniti's Brilliantly Downsized V-6 Turbo Shines," <http://wardsauto.com/engines/infiniti-s-brilliantly-downsized-v-6-turbo-shines>. Last Accessed April 2018

*** EO 12866 Review – Draft – Do Not Cite, Quote or Release During Review ***

system modifications. This information provides an indication of which technologies to investigate in more detail and offer the opportunity to correlate testing and simulation results against currently available and future designs.

Literature is referenced throughout this RIA and Preamble. Additionally, CAFE model documentation and Autonomie model documentation also provide individual references for individual technologies. Many of these papers are published and publicly available from organization like Society of Automotive Engineers (SAE), American Society of Mechanical Engineers (ASME), International Wiener Motor Symposium, and others.

5.3.2.2.16.1.1 Engine and Chassis Dynamometer Testing

Since 2012, many examples of advanced engine technologies have gone into production for the U.S., European and Japanese markets. EPA has acquired many vehicles for chassis dynamometer testing and has developed a methodology for conducting detailed engine dynamometer testing of engines and engine/transmission combinations. Engine dynamometer testing was conducted both at the EPA-NVFL facility in Ann Arbor, MI and at other test facilities under contract with EPA. Engine dynamometer testing of production engines outside of the vehicle chassis required the use of a vehicle-to-engine (or vehicle-to-engine/transmission) wiring tether and simulated vehicle feedback signals in order to allow use of the vehicle manufacturer's engine management system and trained control parameters.

NHTSA conducted engine dynamometer testing of light-duty truck engines at Southwest Research Institute and vehicle testing at ANL Advanced Powertrain Research Facility (APRF). In addition to measuring fuel consumption and regulated emissions, many of the engines were also instrumented with piezo-electric cylinder pressure transducers and crankshaft position sensors to allow calculation of the apparent rate of heat release and combustion phasing. Engines with camshaft-phasing were also equipped with camshaft position sensors to allow monitoring of the timing of valve events. Engine dynamometer testing also incorporated hardware-in-the-loop simulation of drive cycles so that vehicle packages with varying transmission configurations and road-loads could be evaluated.

5.3.2.2.16.2 Confidential business information

While the confidential data provided by vehicle manufacturers, suppliers, and engineering firms cannot be published in the NPRM, these sources of data were important as they allowed the agency to perform quality and rationality checks against the data that we are making publicly available. In each case where a specific technology was benchmarked, the agencies met with the vehicle manufacturers.

In cases where expected combinations of future engine technologies were not available for testing from current production vehicles, a combination of proof-of-concept engine dynamometer testing and engine and vehicle Computer Aided Engineering (CAE) simulations were used to determine drive cycle effectiveness.

5.3.2.2.16.3 Benchmark data

NHTSA worked with ANL and IAV to develop the engine maps used for this NPRM analysis. IAV is one the world’s leading engineering services partners to the global automotive industry and has extensive experience in testing and modeling engines and combustion. NHTSA updated the list of engine technologies included in the NPRM analysis based on consultations with EPA, CARB, ANL and IAV. The technology list builds on the technologies that were considered in the 2012 final rule and includes new technologies that are being implemented or that are under development and to be feasible in that timeframe.

Commented [A4]: EPA has not been consulted by NHTSA regarding a list of engine technologies which NHTSA should consider for the purposes of this Notice of Proposed Rulemaking

IAV used benchmark production engine test data to develop a 1-D GT-POWER engine model for the baseline engine technology configuration. Technologies were incrementally added to the baseline model to assess the impacts of the various technologies on fuel consumption. Assumptions and inputs to the modeling and validation of results leveraged IAV’s global engine database that included benchmarking data, engine test data, single cylinder test data and prior modeling studies, and also technical publications and information presented in conferences.

The rulemaking analysis uses the incremental impact of technologies on fuel economy and CO₂ emissions and applies those incremental impacts to the fuel economy and emissions of each model in the MY 2016 analysis fleet. Using a single engine model as the reference for engine technologies provides a common base for all of the incremental technologies and anchors the incremental effectiveness values to a common reference.

The potential future MY fuel economy of each individual vehicle model is based on the vehicle model’s MY 2016 actual fuel economy and the incremental effectiveness of the combination of technologies that the CAFE model applies. Because each vehicle model in the analysis fleet has a unique technology configuration and fuel economy value, applying the same incremental set of technologies to two different vehicle models produces different fuel economy impacts results between the vehicles modeled.

5.3.2.2.16.4 IAV Process to Develop Engine Maps

For the Draft TAR analysis, all NHTSA engine models were derived from a single parent naturally aspirated engine and from a single parent turbocharged engine. The naturally aspirated and turbocharged engines were trained using engine test data in fixed ambient conditions of 25 degrees Celsius and 990 millibar. In the original modeling of the turbocharged engines, IAV had utilized 93 octane fuel to develop the fuel maps. As discussed above, for this NPRM the fuel maps have been updated for 87 AKI fuel to reflect the fuel that manufacturers specify for the majority of vehicles. Figure 5-44 shows the overview of the engine models utilized by IAV to develop engine maps for the Draft TAR and this NPRM analysis. In addition of use of GT-POWER, many other hardware models and computational fluid dynamic models were utilized to convert test data for use in the submodels shown below.

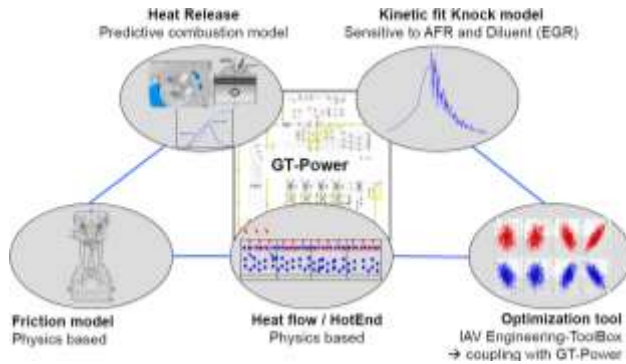

FIGURE 5-44 - OVERVIEW OF THE ENGINE MODEL DEVELOPMENT

Figure 5-45 below shows the first step in setup and calibration of the engine model. The first steps of the modeling involve defining the different characteristics of the geometries of an engine and correlating the model results with test data for gas exchange. This process has been automated in IAV’s analysis for this NPRM to minimize development time of each individual engine configuration. With the definition of geometries of any engine defined, the friction model is also trained based on combination of physics and empirical data.

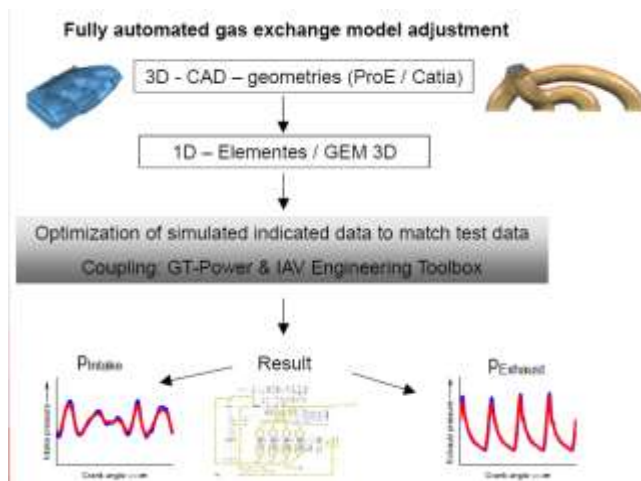

FIGURE 5-45 SHOWS THE GAS EXCHANGE SETUP AND CALIBRATION

The predictive combustion model is then used to calculate the premixed combustion in gasoline engines. This step involves modeling turbulence and flame propagation of the combustion based on the consideration of the geometrical characteristics of the combustion chamber.

The final and most important part of the engine modeling is the knock model. GT Kinetics Fit knock model, a modification of the Arrhenius function, was used to develop the maps based on the fuel properties defined in section 5.3.2.2.17. The model is further developed with test data to predict knocking behavior due to lean combustion process and cooled EGR. Knock modeling remains an important step in understanding the performance constraints of an engine, especially if the engine is aggressively down-sized in vehicle application or in simulation.

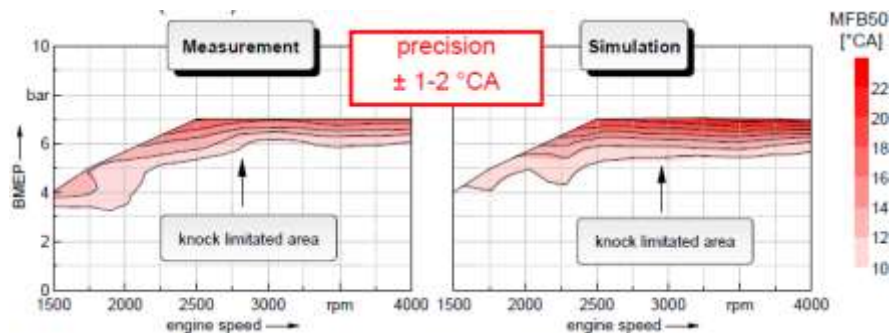

FIGURE 5-46 - EXAMPLE OF ADVANCED CALCULATION OF KNOCK TENDENCY DUE TO CYLINDER DEACTIVATION.

5.3.2.2.17 Fuel Octane

5.3.2.2.17.1 What is fuel octane level?

Gasoline octane levels are an integral part of potential engine performance. According to the United States Energy Information Administration (EIA), octane ratings are measures of fuel stability. These ratings are based on the pressure at which a fuel will spontaneously combust (auto-ignite) in a testing engine.¹⁷² Spontaneous combustion is an undesired condition that will lead to serious engine damage and costly repairs for consumers if not properly managed. The higher an octane number, the more stable the fuel, mitigating the potential for spontaneous combustion, also commonly known as “knock.” Modern engine control systems are sophisticated and allow manufacturers to detect when “knock” occurs during engine operation. These control systems are designed to adjust operating parameters to reduce or eliminate “knock” once detected.

In the United States, consumers are typically able to select from three distinct grades of fuel, each of which provides a different octane rating. The octane levels can vary from region to region, but on the majority, the octane levels offered are regular (the lowest octane fuel—generally 87 Anti-Knock Index (AKI) also expressed as (Research Octane + Motor Octane), midgrade (the middle range octane fuel—generally 89–90 AKI), and premium (the highest octane

¹⁷² “What is Octane?” United States Energy Information Administration https://www.eia.gov/energyexplained/index.cfm?page=gasoline_home#tab2 (last accessed - March 19, 2018).

fuel—generally 91–94 AKI).¹⁷³ At higher elevations, the lowest octane rating available can drop to 85 AKI.¹⁷⁴

Currently, throughout the United States, pump fuel is a blend of 90% gasoline and 10% ethanol. It is standard practice for refiners to manufacture gasoline and ship it, usually via pipelines, to bulk fuel terminals across the country. In many cases, refiners supply lower octane fuels than the minimum 87-octane required by law to these terminals. The terminals then perform blending operations to bring the fuel octane level up to the minimum required by law, and higher. In some cases, typically to lowest fuel grade, the “base fuel” is blended with ethanol, which has a typical octane rating of approximately 113. For example, in 2013, the State of Nebraska Ethanol Board defined requirements for refiners to 84-octane gas for blending to achieve 87-octane prior to final dispensing to consumers.¹⁷⁵

5.3.2.2.17.2 Fuel octane level and engine performance

A typical, overarching goal of optimal spark-ignited engine design and operation is to maximize the greatest amount of energy from the fuel available, without manifesting detrimental impacts to the engine over its expected operating conditions. Design factors, such as compression ratio, intake and exhaust valve control specifications, combustion chamber and piston characteristics, among others, all are impacted by octane (stability) of the fuel consumers are anticipated to use.¹⁷⁶

Vehicle manufacturers typically develop their engines and engine control system calibrations based on the fuel available to consumers. In many cases, manufacturers may recommend a fuel grade for best performance and to prevent potential damage. In some cases, manufacturers may *require* a specific fuel grade for best performance and/or to prevent potential engine damage.

Consumers, though, may or may not choose to follow the recommendation or requirement for a specific fuel grade. Additionally, regional fuel availability could also limit consumer choice or, in the case of higher elevation regions, present an opportunity for consumers to use a fuel grade that is below the minimum recommended. As such, vehicle manufacturers employ strategies for scenarios where a lower than recommended, or required, fuel grade is used, mitigating engine damage over the life of a vehicle.

¹⁷³ *Id.*

¹⁷⁴ 85 octane fuel is available in high-elevation regions where the barometric pressure is lower causing naturally aspirated engines to operate with less air and therefore at lower torque and power. This creates less benefit and need for higher octane fuels as compared to at lower elevations where engine airflow, torque and power levels are higher..., “*What is 85 octane, and is it safe to use in my vehicle?*” <https://www.fueleconomy.gov/feg/octane.shtml#85> (last accessed - March 19, 2018)

¹⁷⁵ “*Oil Refiners Change Nebraska Fuel Components,*” <http://ethanol.nebraska.gov/wordpress/oil-refiners-change-nebraska-fuel-components/> (last accessed - March 19, 2018).

¹⁷⁶ Additionally, Section 5.3.2.2.17.4 contains a brief discussion of fuel properties, octane levels used for engine simulation and in real-world testing, and how octane levels can impact performance under these test conditions.

*** EO 12866 Review – Draft – Do Not Cite, Quote or Release During Review ***

When knock (also referred to as detonation) is encountered during engine operation, at the most basic level, non-turbo charged engines can reduce or eliminate knock by adjusting the timing of the spark that ignites the fuel, as well as the amounts of fuel injected at each intake stroke (“fueling”). In turbo-charged applications, boost levels are typically reduced along with spark timing and fueling adjustments. Past CAFE rulemakings have also discussed other techniques that may be employed to allow higher compression ratios, more optimal spark timing to be used without knock, such as the addition of cooled exhaust gas recirculation (EGR). Regardless of the type of spark-ignition engine or technology employed, reducing or preventing knock results in the loss of potential power output, creating a “knock-limited” constraint on performance and efficiency.

In spite of the limits imposed by available fuel grades, manufacturers continue to make progress in extracting more power and efficiency from spark-ignited engines. Production engines are safely operating with regular 87 AKI fuel with compression ratios and boost levels once viewed as only possible with premium fuel. According to the Department of Energy, the average gasoline octane level has remained fundamentally flat starting in the early 1980’s and decreased slightly starting in the early 2000’s. During this time, however, the average compression ratio for the U.S. fleet has increased from 8.4 to 10.52, a more than 20% increase, yielding the statement that, “There is some concern that in the future, auto manufacturers will reach the limit of technological increases in compression ratios without further increases in the octane of the fuel.”¹⁷⁷

As such, manufacturers are still limited by the available fuel grades to consumers and the need to safeguard their products for all of the available fuels, thus, the potential improvement in the design of spark-ignition engines continues to be overshadowed by the fuel grades available to consumers.

5.3.2.2.17.3 Potential of higher octane fuels

Automakers and advocacy groups have expressed support for increases to fuel octane levels for the US market and are actively participating in Department of Energy research programs on the potential of higher octane fuel usage.^{178,179} Some positions for potential future octane levels include advocacy for today’s premium grade becoming the base grade of fuel available, which could enable low cost design changes that would improve fuel economy and CO₂. Challenges associated with this approach include the increased fuel cost to consumers who drive vehicles

¹⁷⁷ “Fact #940 - August 29, 2016 Diverging Trends of Engine Compression Ratio and Gasoline Octane Rating” *Department of Energy Fact of the Week*. <https://www.energy.gov/eere/vehicles/fact-940-august-29-2016-diverging-trends-engine-compression-ratio-and-gasoline-octane>, (last accessed - March 21, 2018)

¹⁷⁸ “High Octane Gas Coming — But You’ll Pay More for It” *Detroit Free Press*, April 25, 2017, <https://www.freep.com/story/money/cars/mark-phelan/2017/04/25/new-gasoline-promises-lower-emissions-higher-mpg-and-cost-octane-society-of-automotive-engineers/100716174/>, (last accessed - March 21, 2018)

¹⁷⁹ “The Octane Game - Auto Industry Lobbies for 95 as New Regular,” *Automotive News*, April 17, 2018, <http://www.autonews.com/article/20180417/BLOG06/180419780/the-octane-game-auto-industry-lobbies-for-95-as-new-regular> (last accessed - April 18, 2018).

*** EO 12866 Review – Draft – Do Not Cite, Quote or Release During Review ***

designed for current regular octane grade fuel that would not benefit from the use of the higher cost higher octane fuel. The net costs for a shift to higher octane fuel would persist well into the future. Net benefits for the transition would not be achieved until current regular octane fuel is not available in the North American market, and manufacturers then redesign all engines to operate the higher octane fuel, and then after those vehicles have been in production a sufficient number of model years to largely replace the current on-road vehicle fleet. The transition to net positive benefits could take many years.

In anticipation of this proposed rulemaking, organizations such as the High Octane Low Carbon Alliance (HOLC) and the Fuel Freedom Foundation, have met with the agencies to share their positions on the potential for making higher octane fuels available for the U.S. market. Other stakeholders also commented to past CAFE/GHG rulemakings and/or the Draft TAR regarding the potential for increasing octane levels for the U.S. market.

The NPRM seeks comment on the potential benefits, or dis-benefits, of considering the impacts of increased fuel octane levels available to consumers for purposes of the model. More specifically, comments are invited on how increasing fuel octane levels would play a role in product offerings and engine technologies. Are there potential improvements to fuel economy and CO2 reductions from higher octane fuels? Why or why not? What is an ideal octane level for mass-market consumption balanced against cost and potential benefits? What are the negatives associated with increasing the available octane levels and, potentially, eliminating today's lower octane fuel blends? Please provide supporting data for your position(s).

5.3.2.2.17.4 Fuel property comments to Draft TAR

The agencies received comments to the Draft TAR from the Alliance and Global Automakers that the engine maps used for the analysis over-estimated potential fuel economy improvements because they assumed engine specifications and calibrations would be developed for high octane Tier 2 certification fuel. The commenters stated engine maps should reflect engines that are specified and trained for regular octane pump fuel (87AKI) to assure they account for real world engine constraints that impact durability, drivability and noise, vibration and harshness. For rulemaking analyses, technology pathways were modeled that can improve fuel economy while maintaining vehicle performance, capability and other attributes. This includes assuming there would be no change in the fuel octane required to operate the vehicle. It is important to reflect these constraints, and for the NPRM analysis updated engine maps to reflect engine specifications and calibrations capable of operating on 87 AKI Tier 3 certification fuel. Using the updated criteria assures the NPRM analysis reflects the real world constraints and addresses the over-estimation of potential fuel economy improvements in the Draft TAR.

Table 5-4 shows the fuel specifications used for engine specification, calibration and for the development of engine maps. The impact of this change will be described in the later sections.

TABLE 5-4 - FUEL PROPERTIES FOR THE IAV MODELED ENGINES

Type of fluid	Composition Mass Fraction	Molecular Formula			Density Kg/M3	Lower Heating value MJ/kg
		C	H	O		
Hydrocarbon	0.903712493	8	14.851265	0	741.9	43.19
Ethanol	0.094801493	2	6	1	785	26.9
Water	0.001486014	0	2	1	1002.5	0
1						41.582

Because there is a difference in the energy content of 87 AKI Tier 3 used for engine maps and Tier 2 certification fuel which is the reference fuel for CAFE and CO₂ standards, compliance, and MY 2016 analysis fleet fuel economy values, it is necessary to adjust the modeling data to reflect Tier 2 certification fuel. This adjustment was applied to the Autonomie simulation modeling outputs and is reflected in the inputs used in the CAFE model. An adjustment factor was applied to the Autonomie simulation results to adjust them to reflect Tier 2 certification fuel. ANL adjusted the vehicle fuel economy results to represent certification fuel by using the ratio of the lower heating values of the test and certification fuels. For Tier 2 certification fuel, LHV of 43.10 MJ/kg recommended by DOE was used.

5.3.2.2.18 Engine packages used for full vehicle simulation modeling

5.3.2.2.18.1 DOHC Engine packages

A dual overhead camshaft (DOHC) valvetrain design is characterized by two camshafts located within the cylinder head with one operating the intake valves and the other operating the exhaust valves. In this NPRM analysis ten combinations of technologies that can improve the fuel economy of DOHC engines were considered, as shown in Table 2, below. Table 5-5 shows the summary of all engines considered in this analysis with more details defined in the later sections. Additionally, for this analysis four new engines were added that cover combinations of existing technologies that were not utilized in the Draft TAR. These new engines are eng18, eng19, eng20 and eng21.

TABLE 5-5 - NHTSA’S LIST OF DOHC ENGINES EVALUATED FOR THIS NPRM¹⁸⁰

Engines	Technologies	Notes	Engine Reference Peak Power (kW)
eng01	DOHC VVT	Parent NA engine, Gasoline, 2.0L, 4 cyl, NA, PFI, DOHC, VVT	108
eng02	DOHC VVT+VVL	VVL added to Eng01	108
eng03	DOHC VVT+VVL+GDI	DI added to Eng02	113

¹⁸⁰ ANL - Summary of Main Component Performance Assumptions excel file provides the raw data for commenters to review in detail.

*** EO 12866 Review – Draft – Do Not Cite, Quote or Release During Review ***

eng04	DOHC VVT+VVL+GDI+DEAC	Cylinder deactivation added to Eng03	113
eng18	DOHC VVT + SGDI	Gasoline, 2.0L, 4 cyl, NA, GDI, DOHC, VVT	113
eng19	DOHC VVT + DEAC	Cylinder deactivation added to Eng01	113
eng20	DOHC VVT + VVL + DEAC	Cylinder deactivation added to Eng02	113
eng21	DOHC VVT + SGDI + DEAC	Cylinder deactivation added to Eng18	113
eng24	Current SkyActiv 2.0l 93AKI	Non-HEV Atkinson, Gasoline, 2.0L, 4 cyl, DOHC, NA, GDI, VVT, CR 13.1, 93 AKI	101
eng25	Future SkyActiv 2.0l CEGR 93AKI+DEAC	Non-HEV Atkinson, Gasoline, 2.0L, 4 cyl, DOHC, NA, GDI, VVT, cEGR, DEAC CR 14.1, 93 AKI	101

5.3.2.2.18.1.1 Comments on the DOHC engine maps in the Draft TAR and Agency Responses

It is expected that engines with the same combination of technologies produced by different manufacturers will have differences in BSFC and performance due to differences in the design of engine hardware (e.g., intake runners and head ports, valves, combustion chambers including the piston top, compression ratios, exhaust runners and ports, turbochargers, etc.), control software and calibration. Therefore, it is expected that the engine maps developed for this analysis will differ from manufacturers' engine maps. However, it is intended and expected that the incremental improvements for the technologies and combinations of technologies will be similar for the modeling supporting this NPRM and manufacturers' engines. The NPRM seeks comment on whether this updated analysis accurately reflects the incremental changes in BSFC that would be achieved through the application of each of the technology combinations. All of the engine maps developed for the NPRM analysis reflect fully warmed up operation where the engine coolant temperature at 95 degrees Celsius. Cold start and transient operation is addressed through the use of a "cold start penalty" offset in the Autonomie modeling.

The Alliance of Automobile Manufactures (the Alliance) submitted several comments regarding the engine maps and assumptions used in the Draft TAR;¹⁸¹ this analysis discusses those comments in turn. The Alliance commented that for Eng01, "for low- to medium-load and sub-1,000 revolutions-per-minute (RPM) conditions, the brake specific fuel consumption (BSFC) data was optimistic for typical dual overhead cam (DOHC) engines. Also, that the Base Engine Map did not reflect cam control limitations that are typical of commercial calibrations." The Alliance provided the engine map in Figure 5-47, which shows their assessment of the BSFC differences between Draft TAR engine 01 and their own benchmarking data of an OEM 2.0L, four cylinder, naturally aspirated, port fuel injection, DOHC, dual cam variable valve timing (VVT), 10.2 CR engine. The Alliance appears to have extrapolated of data between idle and 1000 rpm.

This analysis notes that the Draft TAR engine maps did not include data below 1000 rpm. The maps did provide fuel flow (BSFC) down to 1 bar BMEP. Fuel flow data for idle and no load were provided separately, but they were not intended to be "blended" with the overall map, as was done by the Alliance in producing the engine map in Figure 5-47. Interpolating between the two sets to provide data below 1000rpm is not representative of the data that NHTSA used in the Draft TAR analysis. It is concluded that using engine map 01 (Eng01) and separate idle and no load fuel data accurately reflects the fuel consumption in those operating ranges, and those inputs were used for this NPRM analysis.

¹⁸¹ Alliance of Automobile Manufactures Comments on Draft Technical Assessment Report - Midterm Evaluation of Light-Duty Greenhouse Gas Emission Standards and Corporate Average Fuel Economy Standards for Model Years 2022-2025 (EPA-420-D-16-900, July 2016).

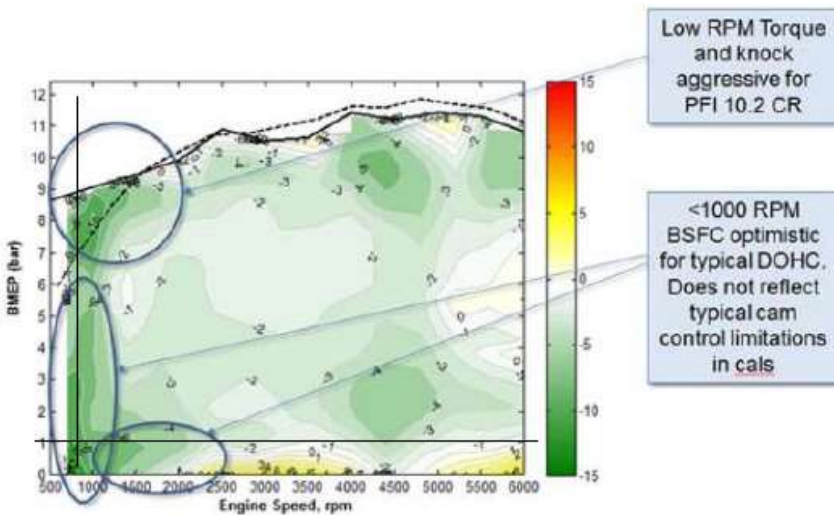

FIGURE 5-47 - ALLIANCE OF AUTOMOBILE MANUFACTURERS' COMPARISON OF ENG01 TO AN OEM 2.0L BENCHMARKED ENGINE AND COMMENTS

For Eng01, the Alliance also commented that the “[l]ow RPM torque and knock are aggressive for a port fuel injection (PFI) gasoline engine with 10.2 compression ratio (CR).” The analysis notes that the low speed torque is provided for the sake of completeness as it is possible to operate the engine at that torque level. However, for practical reasons due to excessive fuel consumption, poor NVH, shift scheduling, etc., the engine would not typically operate in that area of the map. While this region of the engine map could be addressed, there is no operation in that region in the 2-cycle Autonomie simulation modeling, or during performance simulation modeling. Addressing the identified region of the engine map would have no impact on the 2-cycle fuel consumption or vehicle performance. Therefore, this region of the engine map was not changed for the NPRM. The operation on 2-cycle tests is discussed in the ANL modeling Section 5.2.1.

Another Alliance comment on Eng01 was that “the NHTSA Base Engine Map is also very aggressive at lower loads. This is evidenced by a comparison of industry benchmark data for an engine that as the benefit of additional technology such as variable valve lift (VVL) and higher compression ratio.” The analysis notes that the AAM benchmark Honda Accord 2.4L is a larger displacement engine that is of higher performance. As such it will carry more friction which is especially detrimental at lower loads. The Honda engine is also a 2-step VVL system with a switching point that is speed dependent, therefore it is unclear whether there would be any BSFC

*** EO 12866 Review – Draft – Do Not Cite, Quote or Release During Review ***

benefits at low loads. Accordingly, this region of the engine map was not changed for the NPRM.

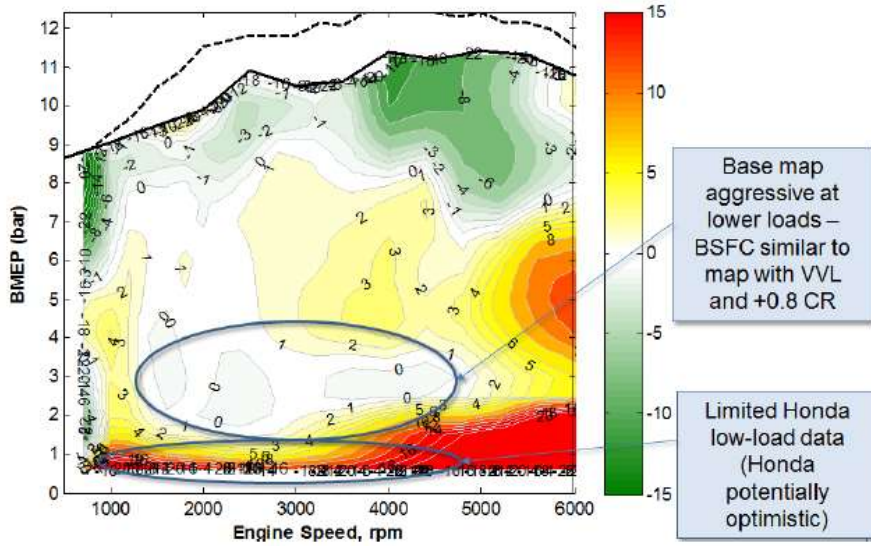

FIGURE 5-48 - ALLIANCE COMPARISON OF ENG01 TO HONDA ACCORD 2.4L ENGINE AND COMMENTS

*** EO 12866 Review – Draft – Do Not Cite, Quote or Release During Review ***

For Eng02, which adds VVL to Eng01, the Alliance commented that “the increased torque and knock relief levels at low RPM are aggressive for just the addition of VVL to the base engine.” For the same reasons addressed above in regards to Eng01, addressing these issues would have no impact on vehicle level fuel consumption modeling or performance for this NPRM analysis; accordingly, this region of the engine map was not changed for this NPRM.

The Alliance also commented regarding Eng02 that, “[a]t low load (less than two bar) the CVVL benefit modeled assumes excellent combustion, and the pumping work reduction with CVVL is overstated.” The analysis notes that the Honda VVL is a 2-step system that operates independent of load. IAV’s model is for an engine with continuous VVL that is optimized for each load and speed point, hence true benefits from “unthrottled” operation is realizable at low loads. Therefore, this region of the engine map was not changed for this NPRM.

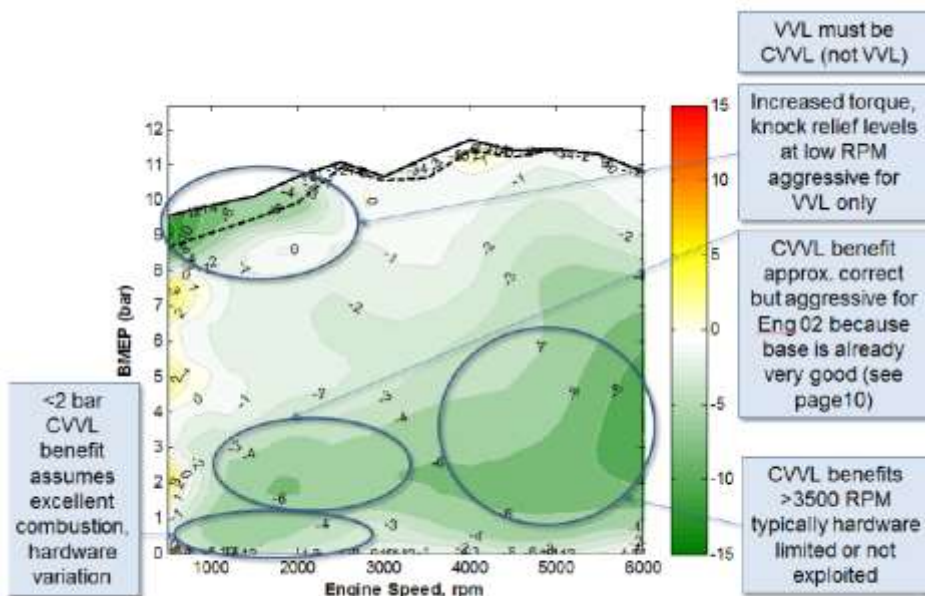

FIGURE 5-49 - ALLIANCE COMPARISON OF ENG02 MAP TO ENG01 AND COMMENTS

For Eng03, which adds SGDI to Eng02, the Alliance commented that “the GDI pump friction isn’t properly taken into account” and “optimistic knock relief assumptions are used.” The additional loading from a GDI pump in the low load region is very low at around 0.2kW. This is readily offset by the benefits from direct injection. At low speeds and high loads most engines are knock-limited; Eng03 is no exception. There are however many factors that will influence the knock tolerance, including volumetric efficiency, mixture formation, swirl, tumble, TKE, local hot spots in the combustion chamber, cooling, injection timing, and calibration. It was concluded that the modeled Eng03 and Honda engine are not directly comparable in this case; the modeled Eng03 performs better in some regions, while the Honda engine shows better results in others.

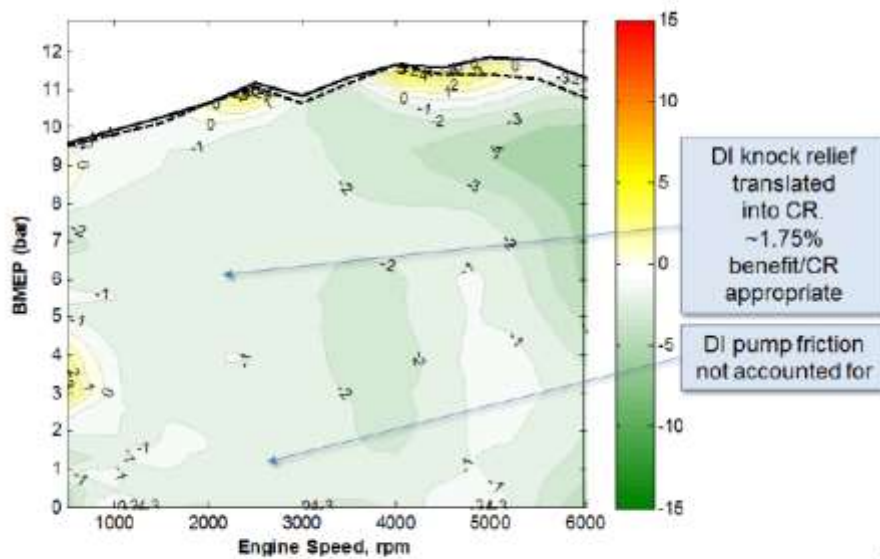

FIGURE 5-50 - ALLIANCE COMPARISON OF ENG03 TO ENG02 AND COMMENTS

Other Alliance comments regarding Eng03 centered on CVVL of this engine compared to the two-step VVL system. The Alliance stated that the “aggressive CVVL assumptions for the low load operation were made across the speed band,” and “[t]he pumping work reduction is overstated, especially considering that the benchmark Honda engine used for comparison here is already a 2-Step VVL engine.” This analysis concludes that with CVVL, it is possible to optimize phasing and lift to minimize pumping losses at all speeds and loads. Additionally, the CVVL system scales both lift and duration by the same ratio, i.e., if lift is reduced 50% then duration is also reduced by 50%. A 2-step VVL system has a reduced range of operation compared to a CVVL system. Furthermore, the Honda engine VVL switch point is speed-dependent. Therefore, for this analysis, this engine map was not changed.

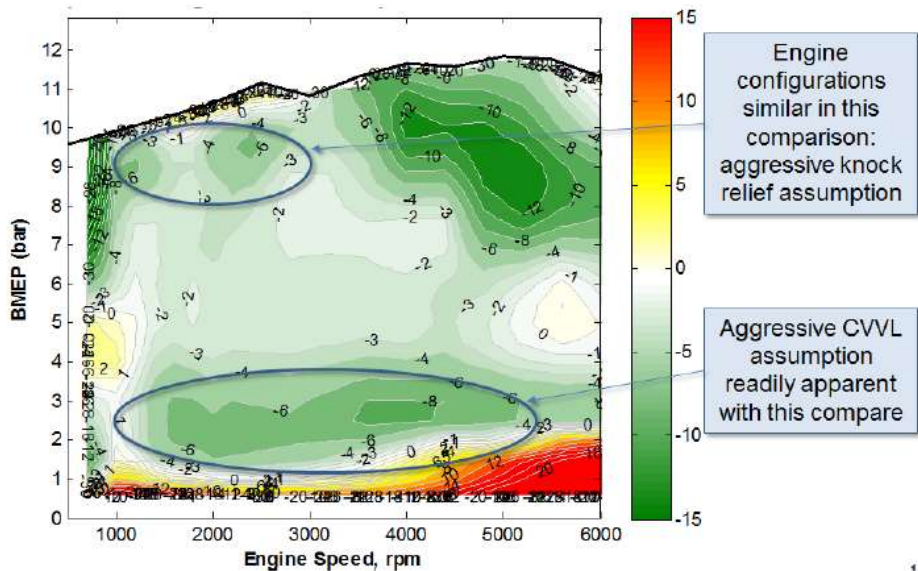

FIGURE 5-51 - ALLIANCE COMPARISON OF ENG03 TO HONDA ACCORD 2.4L ENGINE AND COMMENTS.

Other Alliance comments regarding DOHC engines concerned Eng04, which adds cylinder deactivation to Eng03. The Alliance indicated that “[t]he typical range of cylinder deactivation for production engines is limited to engine operation greater than 1,000 RPM to avoid idle interaction. However, IAV Engine4 Map does not display a low RPM limitation.” This analysis concludes that cylinder deactivation, due to NVH and efficiency considerations, is typically limited to 1000-3000rpm and below 4 bar BMEP. Also, it would be incorrect to interpolate data points that reside outside the immediate boundaries of cylinder deactivation operation. Outside the cylinder deactivation range, the Eng03 engine map should be used explicitly. The cylinder deactivation model in Autonomie has been updated. Details are provided in the simulation section 5.2.

The Alliance also commented that, “low load two-cylinder deactivation benefit is typically limited to the value seen at one bar brake mean effective pressure (BMEP). The IAV Engine4 map suggests benefits below the one bar threshold and the map is overly optimistic in this area.” This analysis concludes that operation of the engine in cylinder deactivation mode down to 0 bar BMEP is technically possible. However, the practical implementation is determined by noise, vibration and harshness limitations. In the Autonomie modeling, an engine lugging limit is specified that prevents low load operation.

The Alliance also noted that “[t]he cylinder deactivation control system hysteresis for the transitions in and out of cylinder deactivation mode has been neglected. Hysteresis is required to prevent frequent switching from normal to deactivated mode.” In this analysis hysteresis is incorporated in ANL’s simulation. The engine map provides the BSFC when cylinder deactivation is operating.

Finally, the Alliance noted that “[t]he approach of using a single map to characterize engines with cylinder deactivation technology may not take into account the transitional fuel usage during transitions in and out of cylinder deactivation mode.” This analysis concludes again that the Autonomie model uses both engine maps 3 and 4 with hysteresis to prevent frequent mode switching and address the transition of going in and out of cylinder deactivation. Therefore, the engine map was not changed for the NPRM.

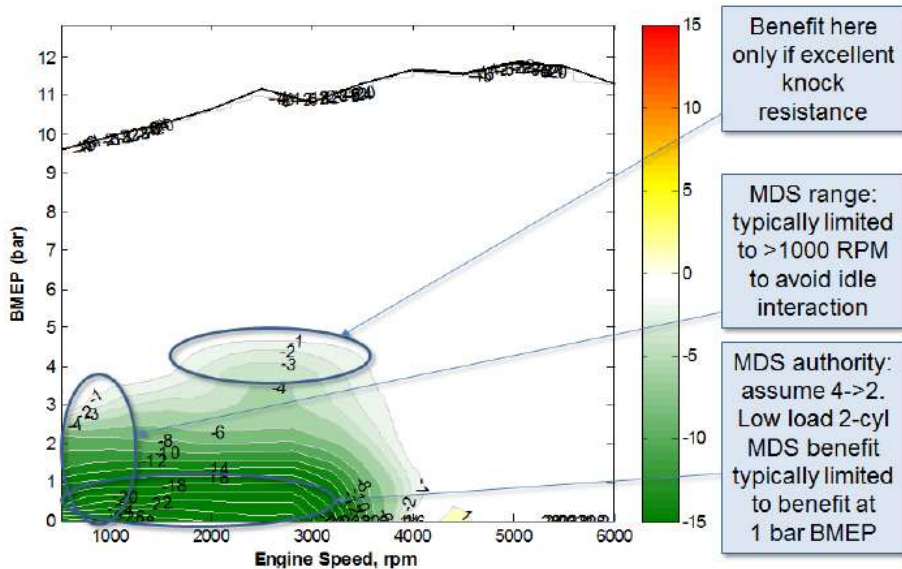

FIGURE 5-52 - ALLIANCE COMPARISON OF ENGINE 4 MAP TO ENGINE 3 MAP AND COMMENTS

5.3.2.2.18.2 SOHC Engine packages

In the 2016 Draft TAR, IAV modeled four engine maps for SOHC engines, as shown in Table 5-6 below. This NPRM analysis carried over the same four engines for the analysis without any changes. As mentioned above, cylinder deactivation in the Autonomie full vehicle simulation model has been updated to address comments.

Eng5b was developed to assess the impacts of reduced friction. Reduction in engine friction can be achieved through low-tension piston rings, roller cam followers, improved material coatings,

*** EO 12866 Review – Draft – Do Not Cite, Quote or Release During Review ***

more optimal thermal management, piston surface treatments, cylinder wall treatments and other improvements in the design of engine components and subsystems that improve engine operation. A SOHC engine with VVT was used and its FMEP reduced by 0.1 bar relative to over its entire operating range. Valve timing was optimized for a fixed overlap camshaft. Eng6a was developed to assess the friction reduction impact on Eng2. Reduced friction will improve efficiency at all load points as well as raise the full load line. Eng7a was developed to assess the friction reduction impact on Eng3. Eng8a was developed to assess the friction reduction impact on Eng4.

TABLE 5-6 - LIST OF SOHC ENGINES EVALUATED FOR THIS NPRM¹⁸²

Engines	Technologies	Notes	Engine Reference Peak Power (kW)
Eng5a	SOHC VVT+PFI	Eng01 converted to SOHC	Reference only
eng5b	SOHC VVT (level 1 Red. Friction)	Eng5a with valvetrain friction reduction (small friction reduction)	109
eng6a	SOHC VVT+VVL (level 1 Red. Friction)	Eng02 with valvetrain friction reduction (small friction reduction)	109
eng7a	SOHC VVT+VVL+GDI (level 1 Red. Friction)	Eng03 with valvetrain friction reduction (small friction reduction), addition of VVL and GDI	114
eng8a	SOHC VVT+VVL+GDI+DEAC (level 1 Red. Friction)	Eng04 with valvetrain friction reduction (small friction reduction), addition of DEAC	114

5.3.2.2.18.2.1 Comments on the SOHC engine maps in the Draft TAR and Agency Responses

The Alliance had several Draft TAR comments relating to the analyzed SOHC engine maps. The Alliance commented that “[l]ower RPM torque reduction does not appear to be accounted for accurately,” and “[t]he benefit in the 2-4 bar region appears to be overstated given that the cams cannot move relative to each other in SOHC engines.” NHTSA notes that the low speed torque is provided for the sake of completeness as it is possible to operate the engine at that torque level. However, for practical reasons due to excessive fuel consumption, poor NVH, shift scheduling, etc., the engine would not typically operate in that area of the map. While this region of the engine map could be addressed, there is no operation in that region in the 2-cycle Autonomie simulation modeling or in performance modeling. Doing so would have no impact on the 2-cycle fuel consumption or vehicle performance. Therefore, this region of the engine map was not changed for the NPRM. The operation on 2-cycle tests is discussed in the ANL modeling section 5.2.

¹⁸² ANL - Summary of Main Component Performance Assumptions excel file provides the raw data for commenters to review in detail.

Also, the Draft TAR engine maps did not include data below 1000 rpm. IAV’s maps provide fuel flow (BSFC) down to 1 bar BMEP. Fuel flow data for idle and no load were provided separately, but they were not intended to be “blended” with the overall map, as was done by the Alliance in producing the engine map in Figure 5-53. Interpolating between the two sets to provide data below 1000rpm is not representative of the data that NHTSA used in the Draft TAR analysis. The difference at 1000 rpm and 4 bar equates to a difference of 2g/kWh or 0.6%. The low RPM extrapolation exaggerates the small reduction. It is concluded that using the Draft TAR engine maps and separate idle and no load fuel data accurately reflects the fuel consumption in those operating ranges, and those inputs were used for this NPRM analysis.

The Alliance also commented, “[a]ll four engine maps assume a large friction reduction (0.1 bar) across the board,” and “[a]dditional losses, due to loss in Effective Expansion Ratio (EER) and the change to a fixed overlap volume (OLV), are not taken into account.” It is acknowledged that a 0.1 bar reduction in friction is fairly large amount. Improvements that could reduce friction include the combination of lower viscosity oil with added friction modifiers, improvements in low-tension piston rings, piston skirt design, roller cam followers, improved crankshaft design and bearings, material coatings, material substitution, more optimal thermal management, and piston and cylinder surface treatments. As mentioned in sections 5.3.2.2.14 and 5.3.2.2.15, technologies are being introduced to reduce friction. Comments are welcome on the current level of these technologies in the fleet and the potential further application of these technologies.

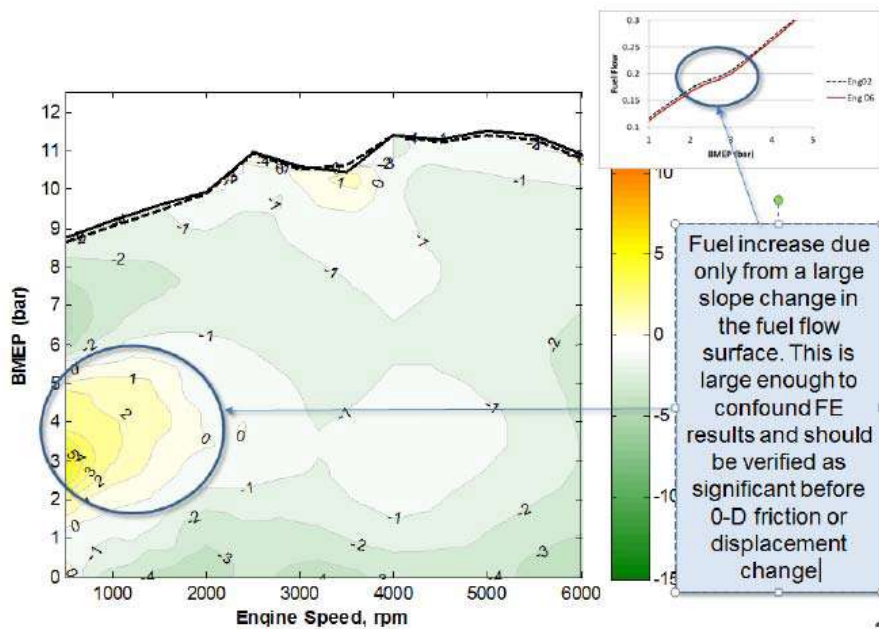

*** EO 12866 Review – Draft – Do Not Cite, Quote or Release During Review ***

FIGURE 5-53 - ALLIANCE COMPARISON OF ENG5B MAP TO ENG01 AND COMMENTS

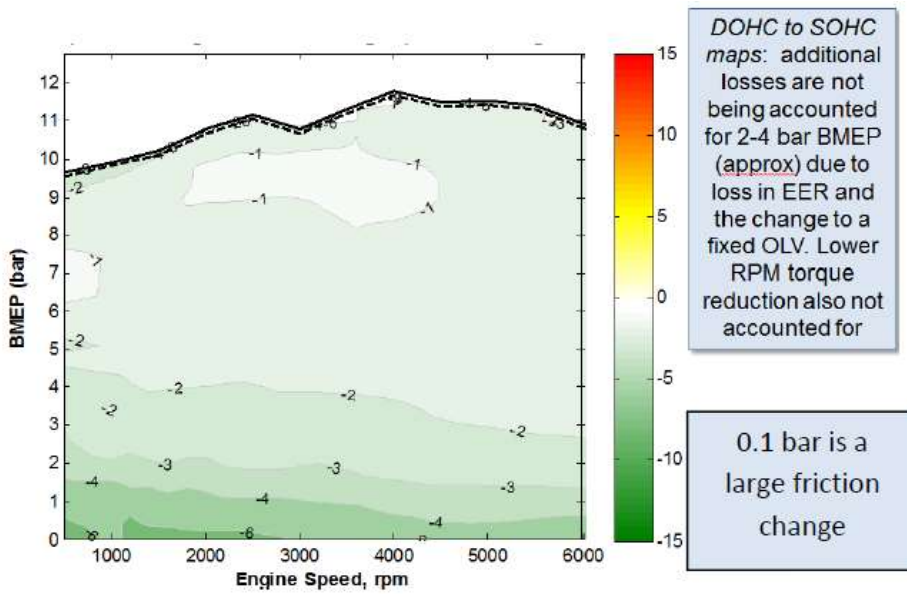

FIGURE 5-54 - ALLIANCE COMPARISON OF ENG6A MAP TO ENG02 AND COMMENTS

*** EO 12866 Review – Draft – Do Not Cite, Quote or Release During Review ***

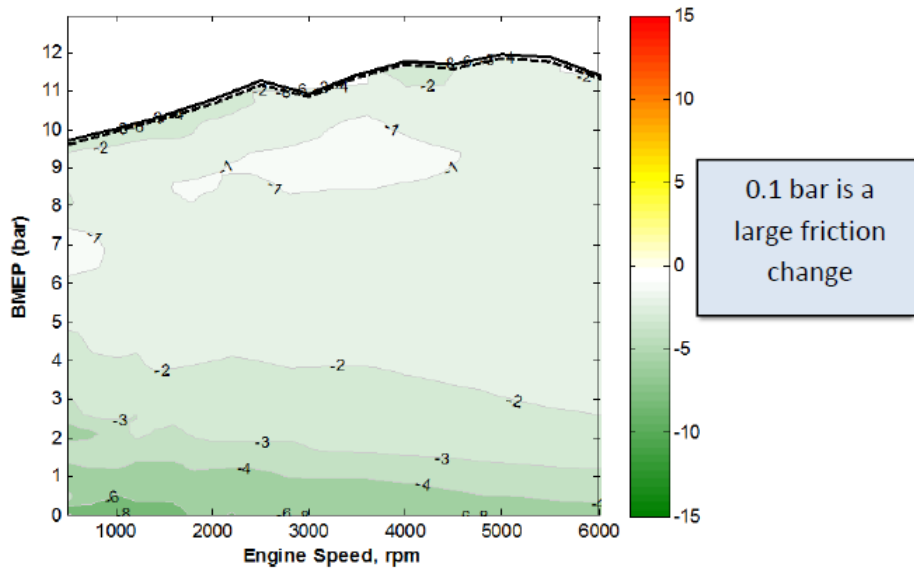

FIGURE 5-55 - ALLIANCE COMPARISON OF ENG7A TO ENG03 AND COMMENTS

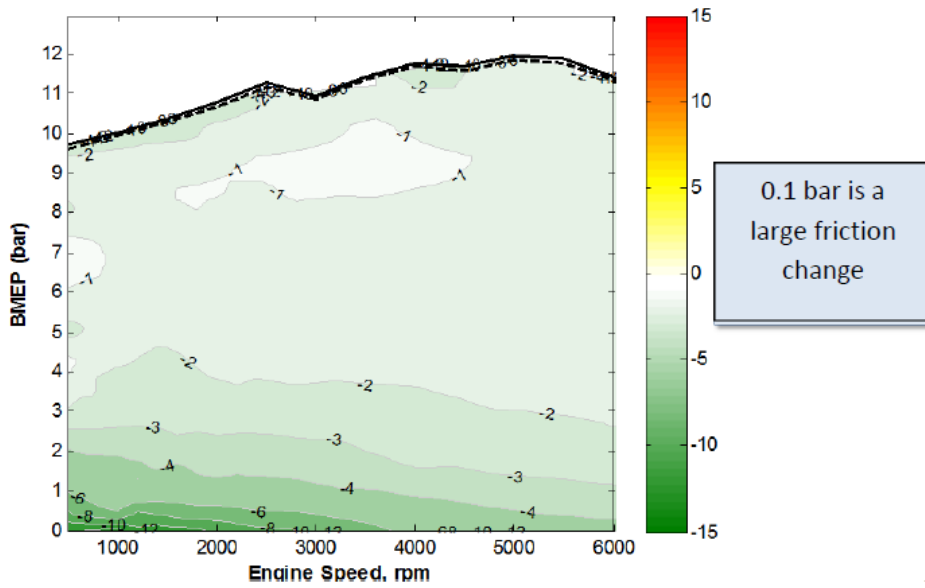

FIGURE 5-56 - ALLIANCE COMPARISON OF ENG8A TO ENG04 AND COMMENTS

5.3.2.2.18.3 Turbocharged and Downsized Engine Packages

In the 2016 Draft TAR analysis, NHTSA included three levels of turbocharged and downsized engine technologies, using engine maps developed by IAV for the Autonomie simulation modeling. The Alliance submitted several comments regarding the use of premium fuel for those engine maps, including specific concerns with IAV maps Engine12, Engine13, Engine14, and Engine15. The Alliance also submitted concerns that NHTSA modeled turbocharged engines with premium fuel that may not require premium fuel, and noted that “automakers have to design for much lower octane commercial fuel available in the marketplace and Tier 3 91 RON certification fuel, unless the engine is one that requires premium fuel.”

For rulemaking analyses, the modeled technology pathways can improve fuel economy while maintaining vehicle performance, capability and other attributes. This includes assuming there would be no change in the fuel octane required to operate the vehicle. For this analysis, it is agreed that it is important to reflect these constraints, and for the NPRM analysis, IAV updated engine maps to reflect engine specifications and calibrations capable of operating on 87 AKI Tier 3 certification fuel. Using the updated criteria assures the NPRM analysis reflects the real world constraints, and addresses the over-estimation of potential fuel economy improvements in the Draft TAR.

Because there is a difference in the energy content of 87 AKI Tier 3 used for engine maps and Tier 2 certification fuel, which is the reference fuel for CAFE standards, compliance and MY 2016 analysis fleet fuel economy values, it is necessary to adjust the modeling data to reflect Tier 2 certification fuel. This adjustment was applied to the Autonomie simulation modeling outputs and is reflected in the inputs used in the CAFE model. Details of the adjustments are discussed in Fuel Octane section.

Table 5-7 below provides a short description of the turbocharged and downsized engines used for this NPRM analysis. The details of the engines are described in the next section.

TABLE 5-7 - NHTSA’S LIST OF TURBOCHARGED ENGINES EVALUATED FOR THIS NPRM¹⁸³

Engines	Technologies	Notes	Engine Reference Peak Power (kW)
eng12	DOHC Turbo 1.6l 18bar	Parent Turbocharged Engine, Gasoline, 1.6L, 4 cyl, turbocharged, GDI, DOHC, dVVT, VVL	132
eng13	DOHC Turbo 1.2l 24bar	Eng12 downsized to 1.2L	133

¹⁸³ ANL - Summary of Main Component Performance Assumptions excel file provides the raw data for commenters to review in detail.

eng14	DOHC Turbo 1.2l 24bar + Cooled EGR	Cooled external EGR added to Eng13	133
-------	---------------------------------------	------------------------------------	-----

For this NPRM, the turbocharged engines outlined in Table 5-7 were modeled using 87 AKI fuel. Compression ratios of all engines remained at 10.5, the same level used for the Draft TAR. Continuous variable valve lift was used for intake valves with duration scaled to 1:1 with lift (i.e. 50% lift also results in 50% duration). The exhaust valve lift was fixed. Independent cam phasing on intake and exhaust was utilized. The most significant change from the Draft TAR is shifting from 93 octane fuel to 87 octane fuel.¹⁸⁴ For eng14, cooled external EGR was added at to higher speed where further reduction in combustion temperature was required.

Each knock model was trained on production and development engines tested at IAV to quantify the effects of different octane fuels. Below the knock threshold, there is no change to the fuel consumption maps. Generally, in the regions where the engine is knock-limited there are two major effects. First, spark timing is retarded causing a reduction in combustion efficiency and hence an increase in BSFC. Second, increase in combustion temperature requires fuel enrichment for the component protection a resultant increase in BSFC.

Exhaust gas temperatures and knock were primarily addressed via spark retard and fuel enrichment. With the dVVT, internal EGR was induced via a valve overlap through cam phasing. This was done at low speeds and loads as a means to improve breathing efficiency. For engines with cEGR, cEGR was added at the higher speeds where further reduction in combustion temperature was required. Due to the higher specific heat capacity of cEGR, it reduced the need for fuel enrichment by lowering combustion temperatures and limited the amount of spark retard necessary to manage spark knock. With increasing load, cEGR is also used as a means to lower combustion temperatures to reduce NOx emissions. Because IAV’s models are not trained for emissions, cEGR was only considered for areas that are knock-limited and/or to reduce combustion temperatures. Because cEGR has the impact of slowing down burn rates, the amount of cEGR that could be utilized was balanced in order to still maintain efficient combustion.

5.3.2.2.18.4HEV and PHEV Atkinson Cycle Gasoline Engine used in full vehicle simulation analysis

Atkinson engine technology was also used for power split hybrid powertrains. The engine map was developed based on APRF test data and published literature.^{185, 186} The engine was used with both pre-transmission hybrids and multi-mode hybrids that were simulated using Autonomie.

¹⁸⁴ Knock models are based on Gamma Technology’s kinetic fit model per the technical paper titled, “A combustion model for IC engine combustion simulations with multi-component fuels,” by YoungChul Ra, Rolf D. Reitz – Engine Research Center, University of Wisconsin-Madison.

¹⁸⁵ DOE ANL Autonomie Technical Publications on HEV, PHEV and EV.
<https://www.autonomie.net/publications/papers.html>

¹⁸⁶ Kim, N., Rousseau, A., & Rask, E., “Autonomie Model Validation with Test Data for 2010 Toyota Prius,” SAE Technical Paper 2012-01-1040, 2012, <https://doi.org/10.4271/2012-01-1040>.

*** EO 12866 Review – Draft – Do Not Cite, Quote or Release During Review ***

The eng26 HEV-Atkinson engine incorporates a many engine technologies and achieves a maximum of 40% BTE. The technologies include thermal management to reduce cold start friction, high compression ratio engine architecture, GDI and EGR.

TABLE 5-8 - NHTSA’S HYBRID AND PLUG-IN ENGINE EVALUATED FOR THIS NPRM¹⁸⁷

Engines	Technologies	Notes	Engine Reference Peak Power (kW)
eng26	Atkinson	HEV and PHEV Atkinson Engine Map 1.8L	73

5.3.2.2.18.5 Diesel Engine used in full vehicle simulation analysis

For this NPRM, the same diesel engine modeled in the Draft TAR is being used for this analysis. Diesel engines have several characteristics that give superior fuel efficiency, including reduced pumping losses due to lack of (or greatly reduced) throttling, and a combustion cycle that operates at a higher compression ratio, with a very lean air/fuel mixture, than an equivalent-performance gasoline engine. This technology requires additional enablers, such as NOx trap catalyst after-treatment or selective catalytic reduction NOx after-treatment. For the diesel engine, measured data, including engine speed, BMEP, brake torque, brake power, BSFC channels were provided.

TABLE 5-9 - NHTSA’S DIESEL ENGINE EVALUATED FOR THIS NPRM

Engines	Technologies	Notes	Engine Reference Peak Power (kW)
eng17	Diesel	Diesel, 2.2L (measured on test bed)	141

5.3.2.2.19 Advanced Cylinder Deactivation in full vehicle simulation

The advanced cylinder deactivation (ADEAC) discrete fuel consumption effectiveness values used for this NPRM analysis are based on IAV Eng04 with the adoption of ADEAC. The assumptions for ADEAC were based on published and supplier information on operating conditions where cylinder deactivation can be used on the 2-cycle test procedures.^{188,189} For this analysis, the effectiveness based on confidential business information, across different technologies classes and taking into account the engine architecture was estimated. In practice, the analysis took the effectiveness values as predicted by full vehicle simulations of a DEAC engine with SGDI, VVL, and VVT, and added 3% or 6% respectively for I-4 engines and V-6 or V-8 engines. Figure 5-57 below shows the effectiveness band of ADEAC across different technology classes in form of a box-and-whisker plot, with improvements referenced to a VVT

¹⁸⁷ ANL - Summary of Main Component Performance Assumptions excel file provides the raw data for commenters to review in detail.

¹⁸⁸ Fuschetto et al., 2017, Oral-Only Presentation, SAE World Congress

¹⁸⁹ “Delphi and Tula show NVH benefits from Dynamic Skip Fire,” <http://articles.sae.org/15485/> - 16 June 2017

engine. There is an intention to continue reviewing this technology effectiveness and application limitations.

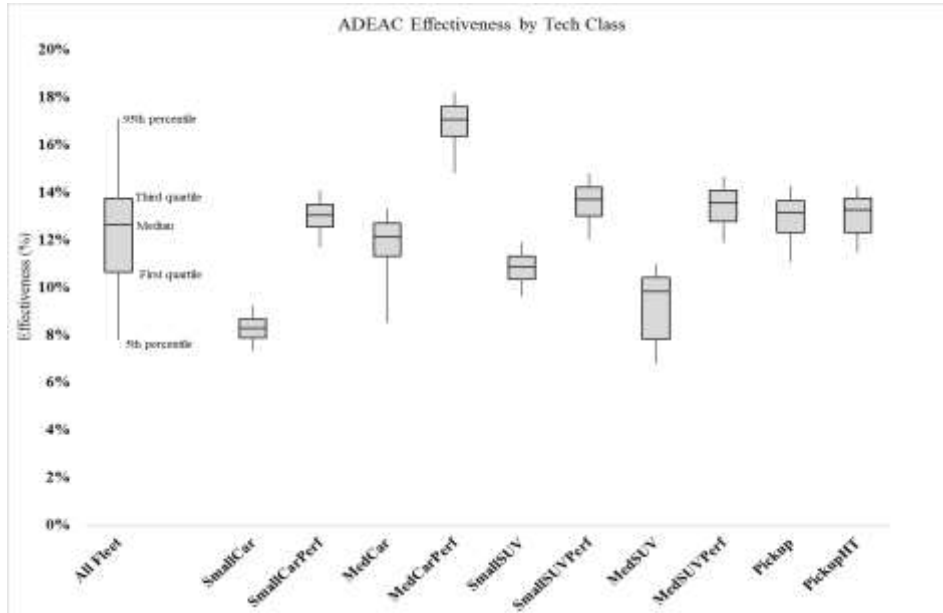

FIGURE 5-57 - ADVANCED CYLINDER DEACTIVATION EFFECTIVENESS RANGE ACROSS DIFFERENT TECH CLASSES

Advanced cylinder deactivation may be included in the full scale ANL full simulation modeling analysis for this final rule. Two approaches for incorporating ADEAC will be investigated; the first approach involves using a new IAV engine #25a, which was developed from the perspective of capturing the maximum benefits of advanced cylinder deactivation with several specific constraints. The engine specifications are show below.

IAV engine 25a– Advanced Variable Cylinder deactivation

- Fuel - Tier 3, 87 AKI
- Number of Cylinders - 4
- Displacement - 2.0 Liters
- Injection Type - SGDI
- Compression Ratio - 10.5:1
- Valvetrain - DOHC with dVVT
- Aspiration - Turbocharged 25 bar with cooled EGR

Figure 5-58 below shows preliminary engine 25a bsfc fuel map in normal operation with all four cylinders active.

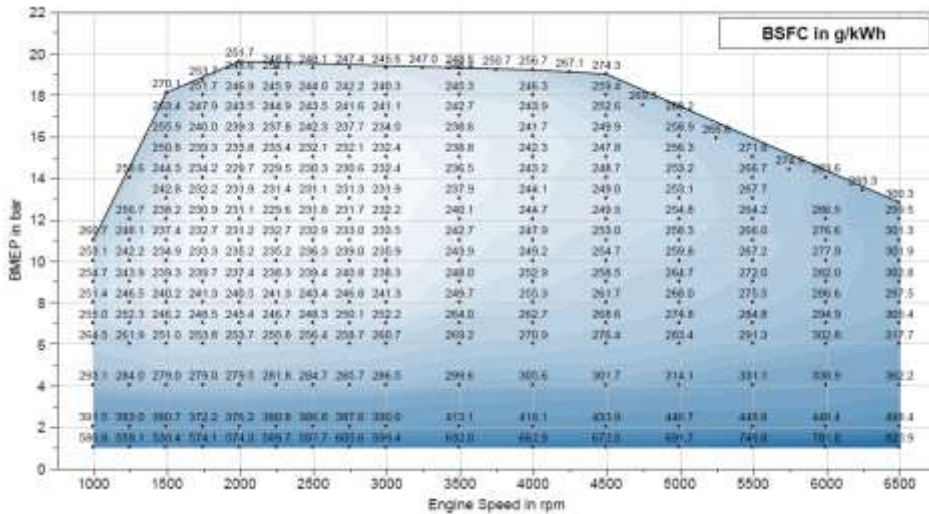
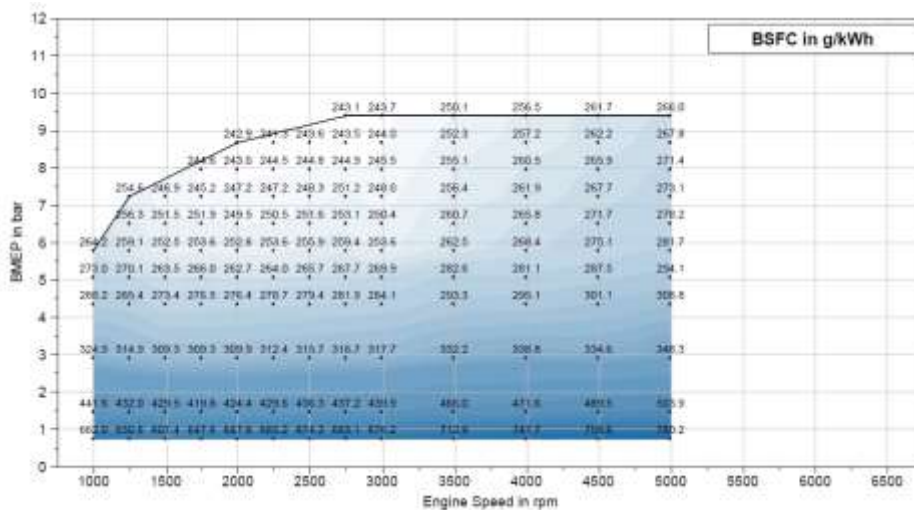

FIGURE 5-58 - IA V ENGINE 25A BSFC MAP IN 4-CYLINDER MODE

Figure 5-59 shows the preliminary engine 25a BSFC fuel map in cylinder deactivation mode with three cylinders active. Figure 5-60 shows the incremental difference between four and three-cylinder operation of IA V engine 25a.



*** EO 12866 Review – Draft – Do Not Cite, Quote or Release During Review ***

FIGURE 5-59 - IAV ENGINE 25A BSFC MAP IN 3-CYLINDER MODE

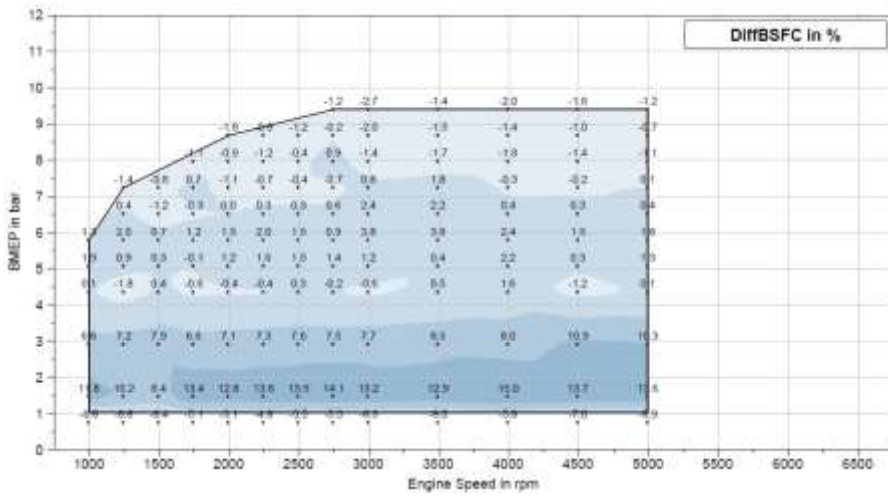

FIGURE 5-60 - IAV ENGINE 25A INCREMENTAL DIFFERENCE BETWEEN 4-CYLINDER MODE VERSUS 3-CYLINDER MODE

Figure 5-61 shows the preliminary engine 25a BSFC fuel map in cylinder deactivation mode with two cylinders being active.

*** EO 12866 Review – Draft – Do Not Cite, Quote or Release During Review ***

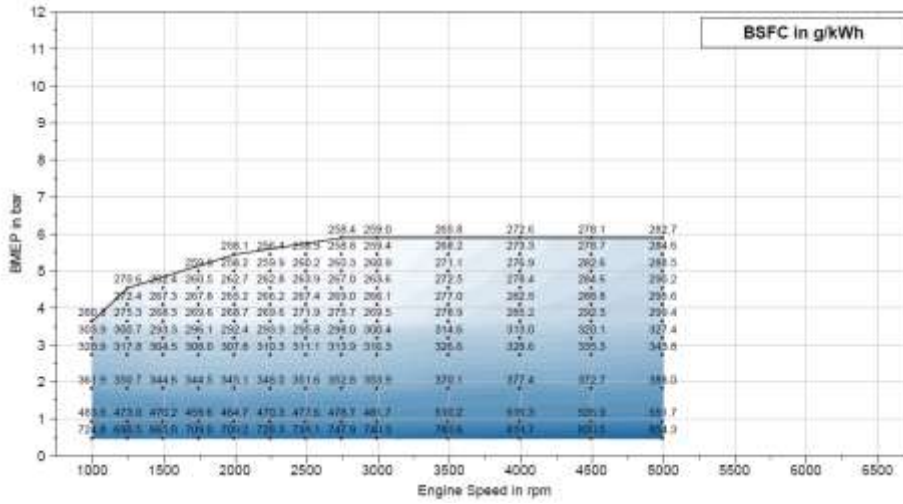

FIGURE 5-61 - IAV ENGINE 25A BSFC MAP IN 2-CYLINDER MODE

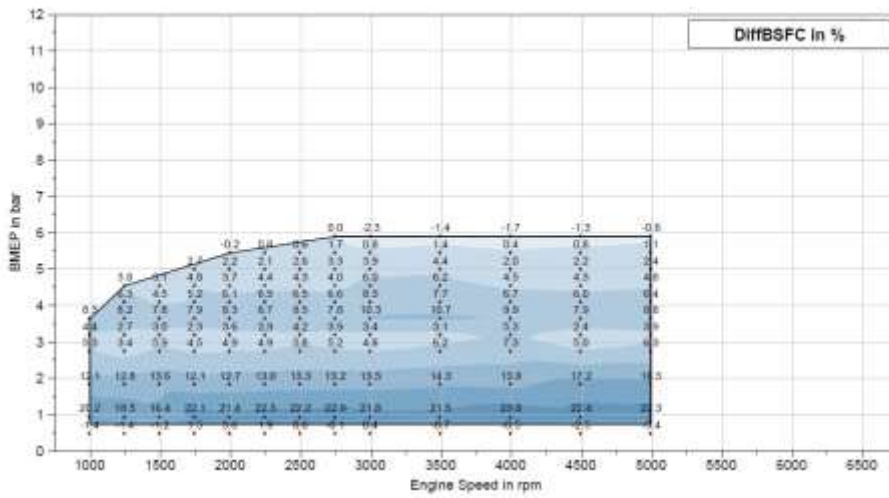

FIGURE 5-62 - IAV ENGINE 25A INCREMENTAL DIFFERENCE BETWEEN 3-CYLINDER MODE VERSUS 2-CYLINDER MODE

*** EO 12866 Review – Draft – Do Not Cite, Quote or Release During Review ***

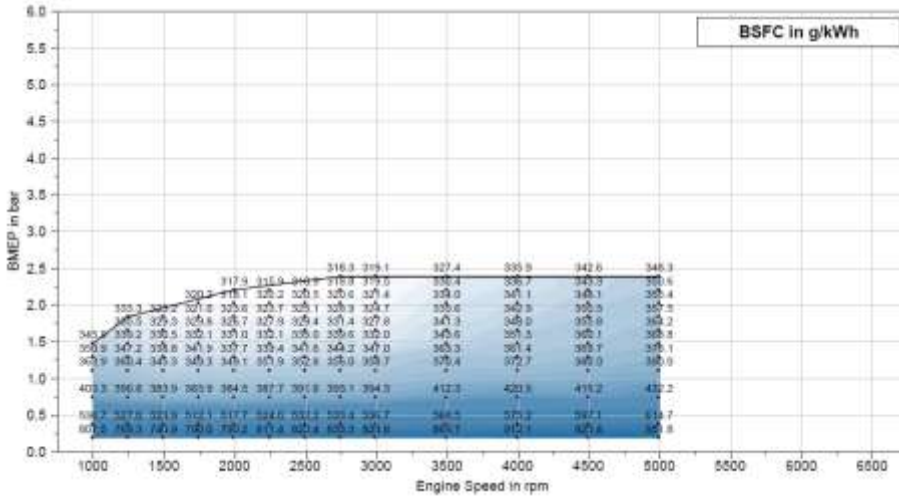

FIGURE 5-63 - IAV ENGINE 25A BSFC MAP IN 1-CYLINDER MODE

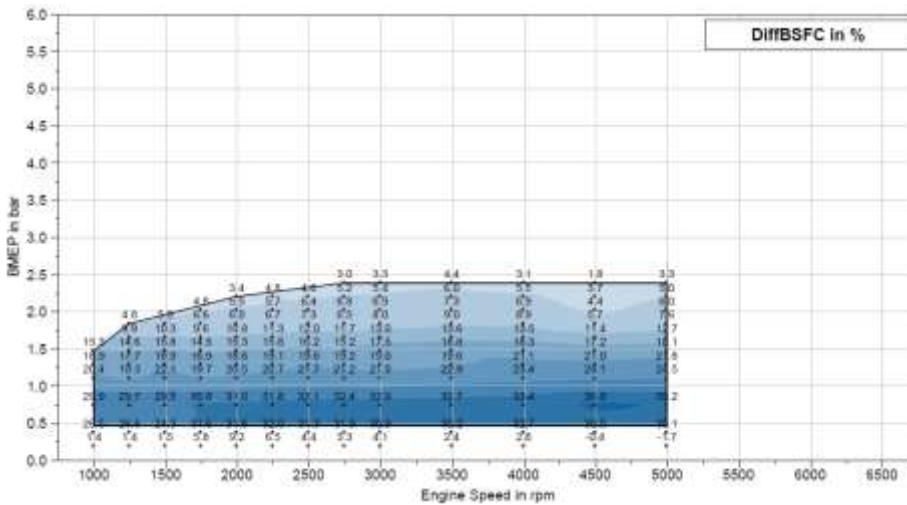

FIGURE 5-64 - IAV ENGINE 25A INCREMENTAL DIFFERENCE BETWEEN 2-CYLINDER MODE VERSUS 1-CYLINDER MODE

The second approach involves using a technique developed by ANL in coordination with NHTSA. This concept splits the overall engine data into individual cylinder data and computes overall torque and the fuel consumption rate by accounting for whether each cylinder is active or

inactive. The number of active cylinders is determined by a PI controller that matches delivered torque to required torque, and is uniquely derived for each vehicle class. Each cylinder is either at optimum load for BSFC or deactivated throughout the drive cycles. Figure 5-65 shows an example of this concept for an 8-cylinder engine. Cylinder deactivation would not be used during idling, first gear operation, or wide-open-throttle. The details of this approach are also expanded in the ANL model documentation.¹⁹⁰

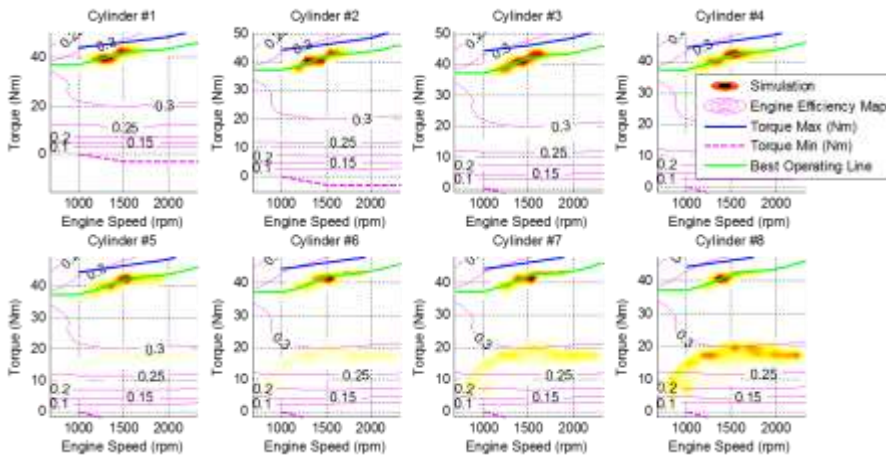

FIGURE 5-65 - EXAMPLE OF 8-CYLINDER ENERGY DENSITY OF CYLINDERS OPERATING POINTS IN OPTIMUM LOAD

The NPRM requests comment on using these approaches in the analysis to support the final rule to best capture the benefits of advanced cylinder deactivation.

5.3.2.2.20 Engine maps used for the rulemaking analysis

5.3.2.2.20.1 Engine 01 – DOHC, VVT, and PFI

Engine 1 is a naturally aspirated PFI 2.0-L gasoline engine with VVT, developed from a MY 2013 vehicle, which is consistent with the timeframe in which the engine technology was commonly used. A brake specific fuel consumption (BSFC) engine map was generated from dynamometer testing of the production engine, which then served as brake specific fuel consumption (i.e., baseline fuel map) for all simulated naturally aspirated engines (Engines 1-8a, 18-21). The engine calibrations were fully optimized for best BSFC and maximum torque.

Each subsequent engine (BSFC map) represents an incremental increase in technology advancement over the previous engine. Engines 2-4 add variable valve lift (VVL), direct

¹⁹⁰ ANL advanced engine maps phase 3 report.

injection (DI), and cylinder deactivation (deac) sequentially to the baseline engine. Engine 5a converts Engine 1 from DOHC to SOHC. Engines 5b, 6a, 7a, and 8a add some friction reduction to Engines 5a, 2, 3, and 4.¹⁹¹

Figure 5-66 - below shows the IAV engine 1 BSFC map used for this NPRM analysis.

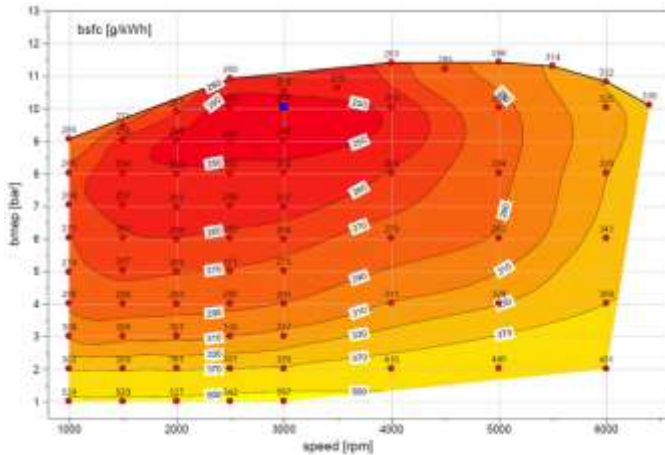

FIGURE 5-66 - ENGINE EFFICIENCY MAP FOR ENG01

5.3.2.2.20 Engine 02 – DOHC, VVT, VVL, and PFI

For Engine 2, a VVL system was added to the intake valves of Engine 1. Both valve lift and timing were optimized. The compression ratio was raised from 10.2 to 11.0. This engine allows for reduced pumping work at low loads and more torque at low speeds by using reduced intake duration and lift.

Figure 5-67 below shows the IAV engine 2 BSFC map used for this NPRM analysis.

¹⁹¹ In stage 1, FMEP is reduced by 0.1 bar and in level 2 FMEP is reduced by 25% over the entire operating range.

*** EO 12866 Review – Draft – Do Not Cite, Quote or Release During Review ***

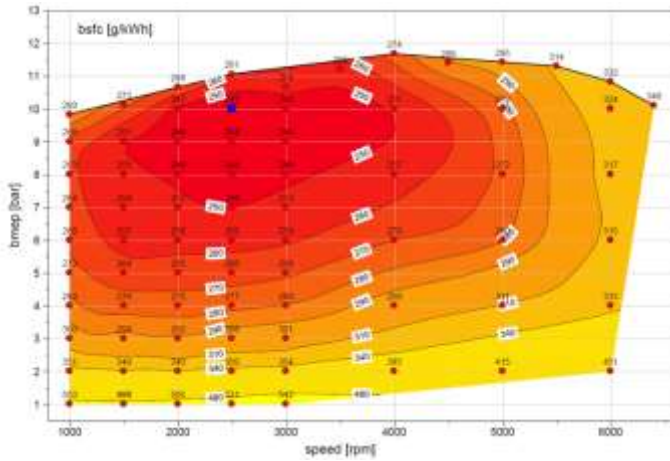

FIGURE 5-67 - ENGINE EFFICIENCY MAP FOR ENG02

Figure 5-68 shows the incremental difference BSFC and thermal efficiency between IAV engine 1 versus engine 2.

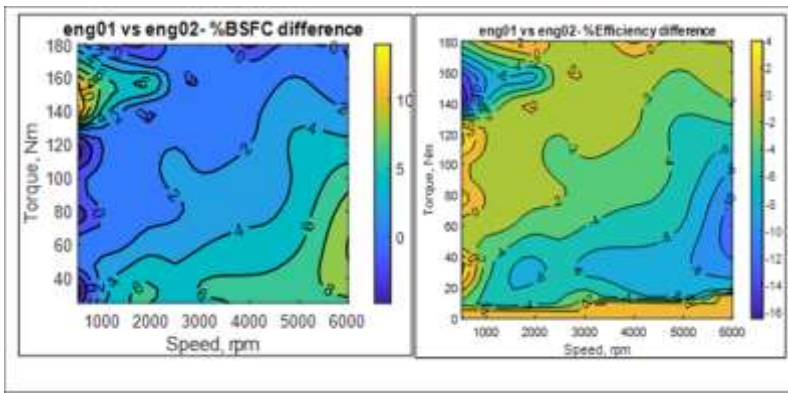

FIGURE 5-68 INCREMENTAL BSFC AND THERMAL EFFICIENCY DIFFERENCE BETWEEN ENG01 VERSUS ENG02

5.3.2.2.20.3 Engine 03 – DOHC, VVT, VVL, and DI

PFI Engine 2 was converted to direct injection to model engine 3. The compression ratio was raised from 10.2 to 11.0 and injection timing optimized. Direct injection provides greater knock tolerance, allowing higher compression ratio and increased efficiency over the entire operating range (map).

Figure 5-69 below shows the IAV engine 3 BSFC map used for this NPRM analysis.

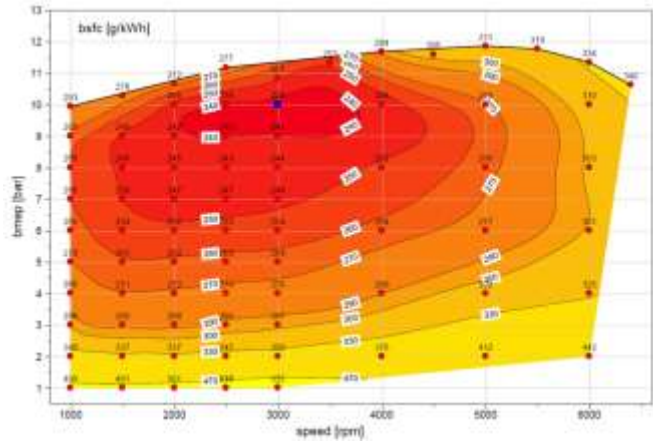

FIGURE 5-69 - ENGINE EFFICIENCY MAP FOR ENG03

Figure 5-70 shows the incremental difference BSFC and thermal efficiency between IAV engine 2 versus engine 3.

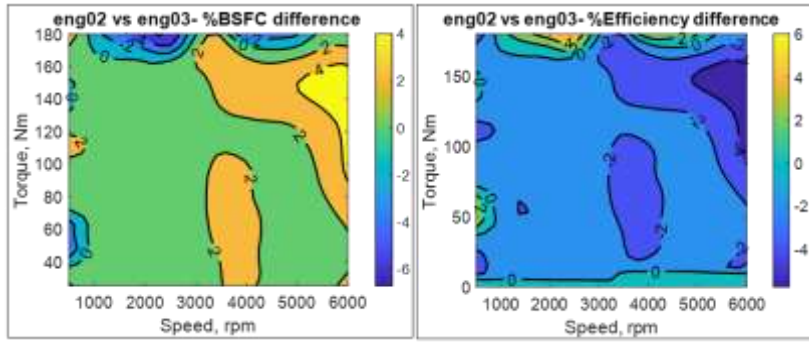

FIGURE 5-70 INCREMENTAL BSFC AND THERMAL EFFICIENCY DIFFERENCE BETWEEN ENG02 VERSUS ENG03

5.3.2.2.20.4 Engine 04 – DOHC, VVT, VVL, DI, and DEAC

Cylinder deactivation was added to engine 3 to model engine 4. Cylinder deactivation deactivates the intake and exhaust valves and prevents fuel injection into the deactivated cylinders during light-load operation. The engine runs temporarily as though it were a smaller displacement engine which substantially reduces pumping losses. For 4 cylinder applications, the engine fires only 2 cylinders at low loads and speeds below 3000 RPM and less than 5 bar

BMEP by deactivating valves on 2 cylinders. The main benefit is that the effective load is doubled on 2 cylinders reducing pumping work and increasing efficiency.

Figure 5-71 below shows the IAV engine 4 BSFC map used for this NPRM analysis.

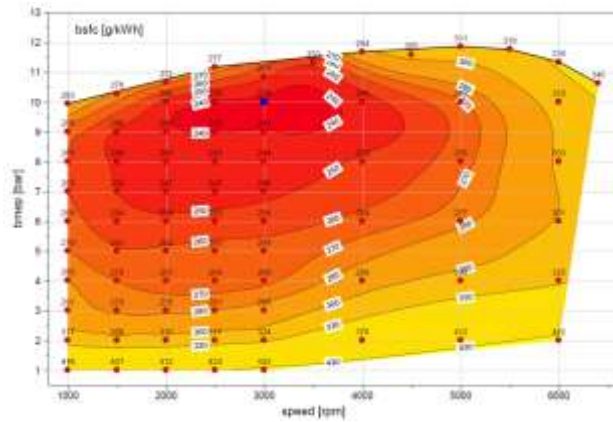

FIGURE 5-71 - ENGINE EFFICIENCY MAP FOR ENG04

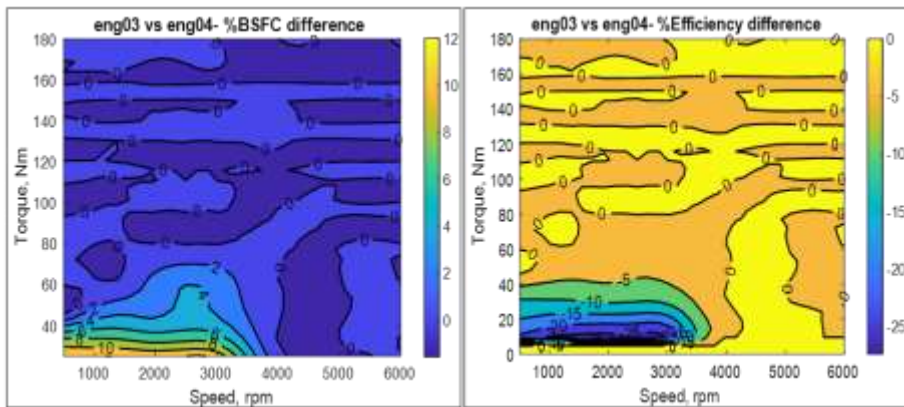

FIGURE 5-72 - INCREMENTAL BSFC AND THERMAL EFFICIENCY DIFFERENCE BETWEEN ENG03 VERSUS ENG04

5.3.2.2.20.5 Engine 5b – SOHC, VVT, and PFI

Engine 5b has reduced friction. Reduction in engine friction can be achieved through low-tension piston rings, roller cam followers, improved material coatings, more optimal thermal management, piston surface treatments, cylinder wall treatments and other improvements in the design of engine components and subsystems that reduce parasitic losses. A SOHC engine with

*** EO 12866 Review – Draft – Do Not Cite, Quote or Release During Review ***

VVT was used as the base and its FMEP was reduced by 0.1 bar over its entire operating range. Valve timing was optimized for a fixed overlap camshaft.

Figure 5-73 below shows the IAV engine 5b BSFC map used for this NPRM analysis.

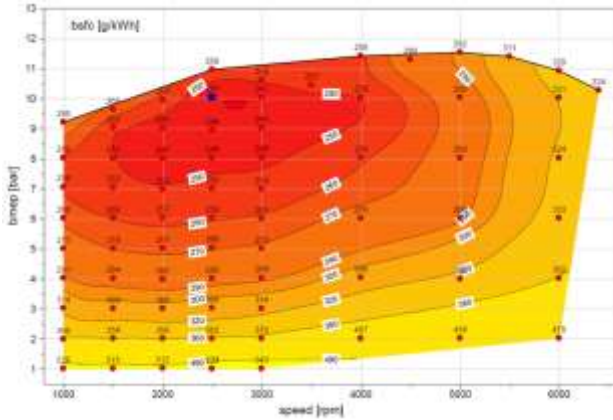

FIGURE 5-73 - ENGINE EFFICIENCY MAP FOR ENG5B

Figure 5-74 shows the incremental difference BSFC and thermal efficiency between IAV engine 4 versus engine 5b.

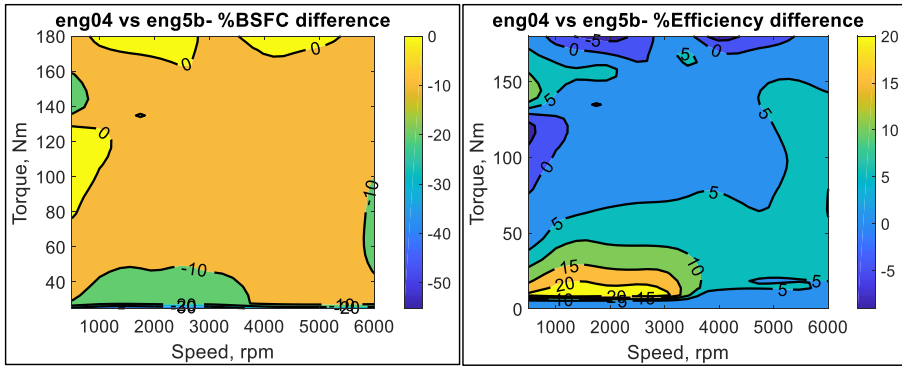

FIGURE 5-74- INCREMENTAL BSFC AND THERMAL EFFICIENCY DIFFERENCE BETWEEN ENG04 VERSUS ENG05B

5.3.2.2.0.6 Engine 6a – SOHC, VVT, VVL and PFI

Engine 6a reduces the friction of Engine 2. FMEP was reduced by 0.1 bar over its entire operating range. The engine also incorporated VVL technology. Reduced friction will improve efficiency at all load points as well as increase the full load torque.

Figure 5-75 below shows the IAV engine 4 BSFC map used for this NPRM analysis.

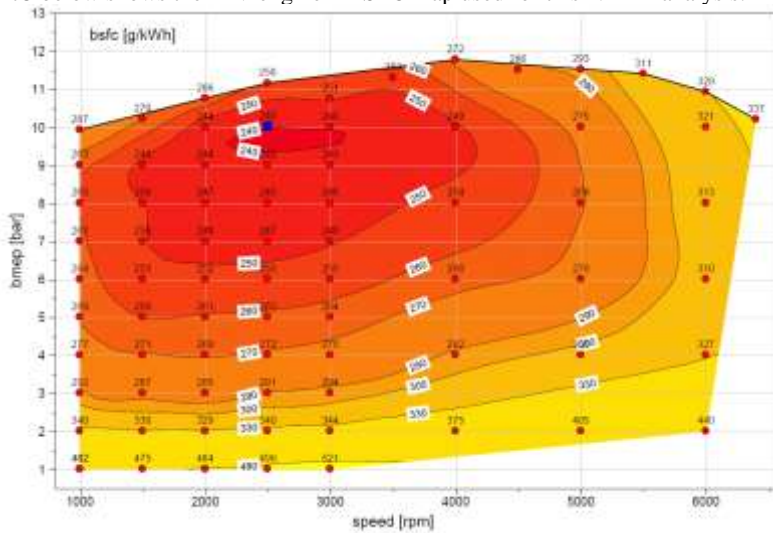
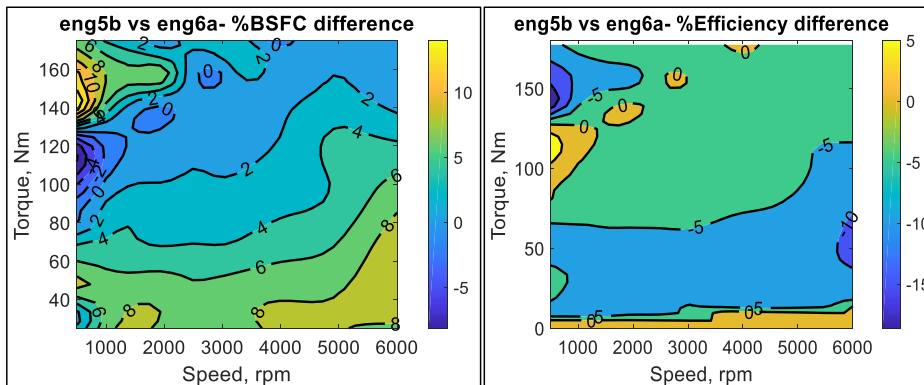

FIGURE 5-75 - ENGINE EFFICIENCY MAP FOR ENG6A

Figure 5-76 shows the incremental difference BSFC and thermal efficiency between IAV engine 5b versus engine 6a.



*** EO 12866 Review – Draft – Do Not Cite, Quote or Release During Review ***

FIGURE 5-76 - INCREMENTAL BSFC AND THERMAL EFFICIENCY DIFFERENCE BETWEEN ENG05B VERSUS ENG6A

5.3.2.2.0.7 Engine 7a – SOHC, VVT, VVL, and GDI

Engine 7a was developed to assess the friction reduction impact on Engine 3. FMEP was reduced by 0.1 bar over its entire operating range. Reduced friction will improve efficiency at all load points as well as increase the full load torque. Figure 5-77 below shows the IAV engine 7a BSFC map used for this NPRM analysis.

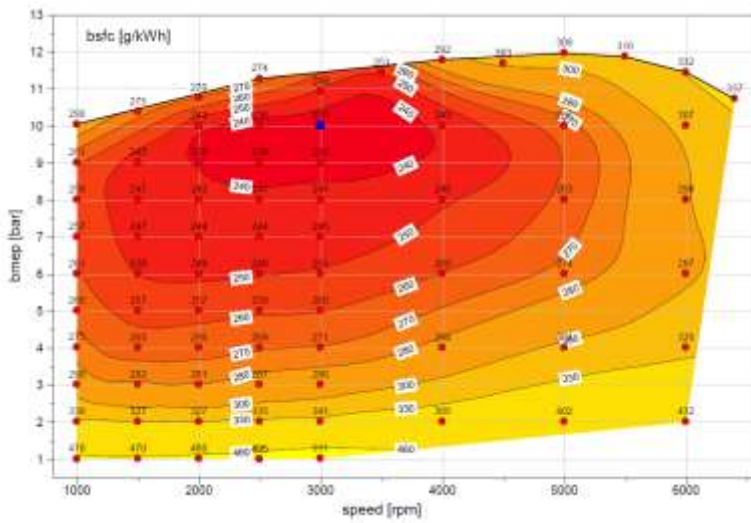

FIGURE 5-77 - ENGINE EFFICIENCY MAP FOR ENG7A

Figure 5-78 shows the incremental difference BSFC and thermal efficiency between IAV engine 6a versus engine 7a.

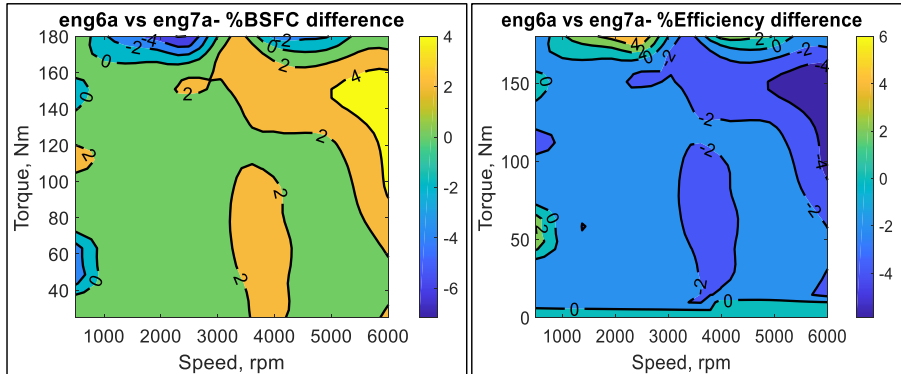

FIGURE 5-78 - INCREMENTAL BSFC AND THERMAL EFFICIENCY DIFFERENCE BETWEEN ENG6A VERSUS ENG7A

5.3.2.2.20.8 Engine 8a – SOHC, VVT, VVL, GDI and DEAC

Engine 8a was developed to assess the friction reduction impact on Engine 4. FMEP was reduced by 0.1 bar over its entire operating range. Reduced friction will improve efficiency at all load points as well as increase the full load torque. Figure 5-79 below shows the IAV engine 8a BSFC map used for this NPRM analysis.

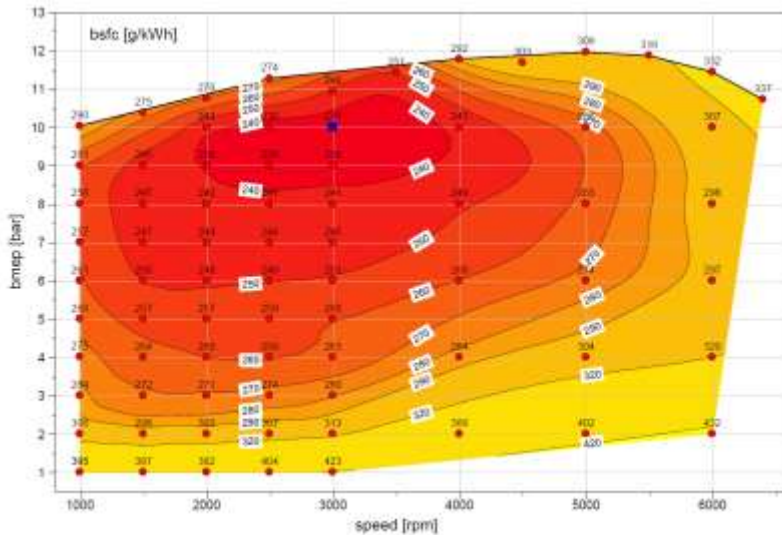

FIGURE 5-79 - ENGINE EFFICIENCY MAP FOR ENG8A

Figure 5-80 shows the incremental difference BSFC and thermal efficiency between IAV engine 7a versus engine 8a.

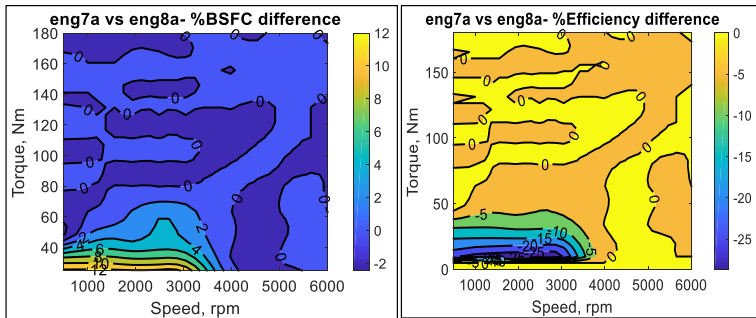

FIGURE 5-80 - INCREMENTAL BSFC AND THERMAL EFFICIENCY DIFFERENCE BETWEEN ENG7A VERSUS ENG8A

5.3.2.2.20.9 Engine 12 - Turbocharged, DOHC, VVT, VVL, and DI

IAV Engine 12 is the base engine for all the simulated turbocharged engines (Engines 13-16). The map was validated using engine dynamometer test data. Turbocharging and downsizing increases the available airflow and specific power, allowing a reduced engine size while maintaining performance. This also reduces pumping losses at lighter loads in comparison to a larger engine. Engine 12 is a 1.6L, 4 cylinder turbocharged, direct injection DOHC engine with dual cam VVT and intake VVL. The compression ratio is 10.5:1 and the engine uses side mounted direct fuel injectors and a twin scroll turbocharger. The calibrations were fully optimized for best BSFC. Figure 5-81 below shows the IAV engine 12 BSFC map used for this NPRM analysis.

Commented [A5]: Based on the information provided in this NPRM, the assumptions used for fuel octane, heating value, and carbon content do not appear to be internally consistent and representative of GHG performance of turbocharged engines over the certification cycles.

*** EO 12866 Review – Draft – Do Not Cite, Quote or Release During Review ***

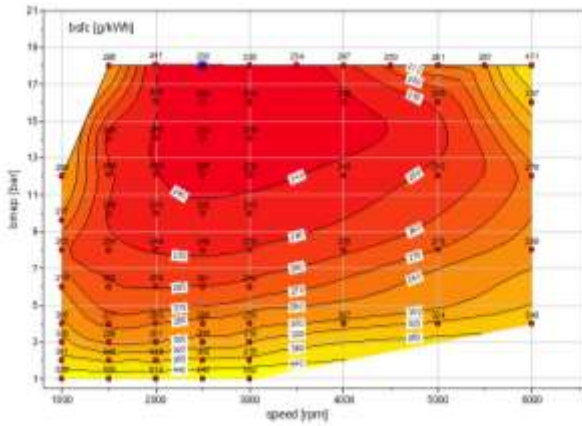

FIGURE 5-81 - ENGINE EFFICIENCY MAP FOR ENG12

Figure 5-82 shows the incremental difference BSFC and thermal efficiency between IAV engine 8a versus engine 12a.

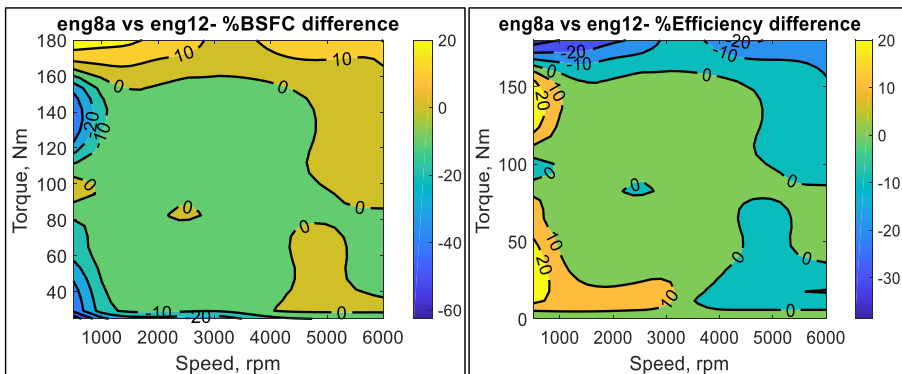

FIGURE 5-82 - INCREMENTAL BSFC AND THERMAL EFFICIENCY DIFFERENCE BETWEEN ENG8A VERSUS ENG12

Figure 5-83 below shows BSFC map of the 87 octane fuel and the 93 octane fuel for engine 12.

*** EO 12866 Review – Draft – Do Not Cite, Quote or Release During Review ***

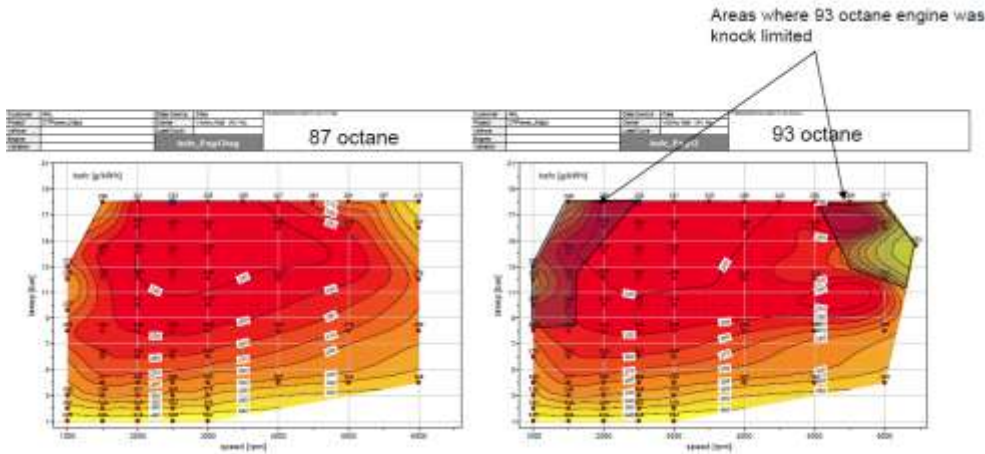

FIGURE 5-83 - BSFC OF 93 (RIGHT) VERSUS 87 (LEFT) OCTANE FUEL FOR ENG12

Figure 5-84 below shows the BSFC difference between the 87 octane and the higher octane fuel.

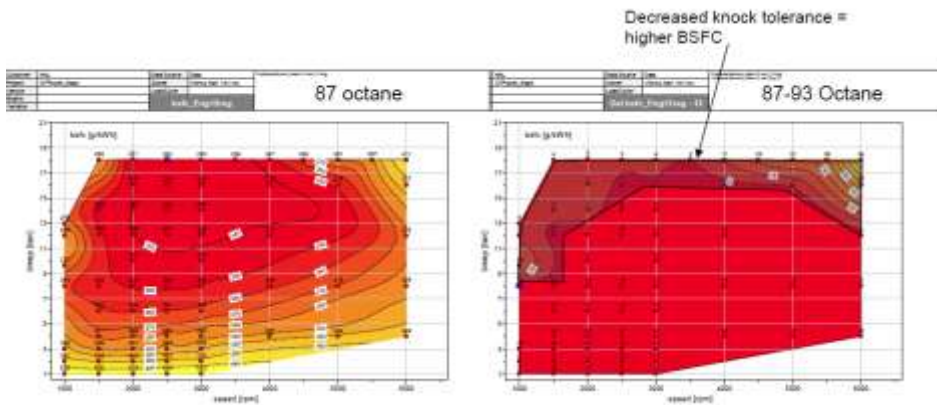

FIGURE 5-84 - DELTA BSFC OF 93 (RIGHT) VERSUS 87 (LEFT) OCTANE FUEL FOR ENG12

Figure 5-85 below shows the thermal efficiency difference between the new and old engine 12 maps.

*** EO 12866 Review – Draft – Do Not Cite, Quote or Release During Review ***

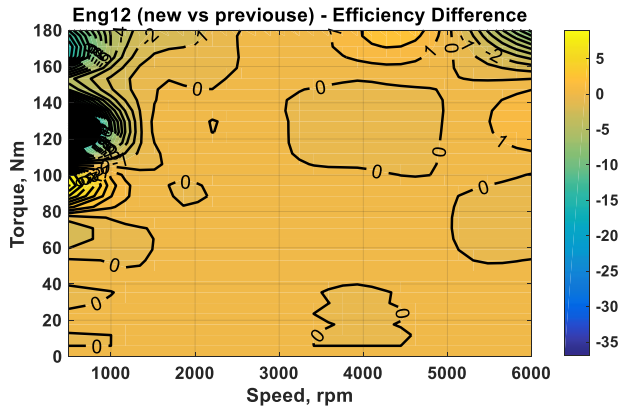

FIGURE 5-85 - ENGINE EFFICIENCY DIFFERENCE IN PERCENT FOR 93- VS. 87-OCTANE FUEL FOR ENGINE 12

5.3.2.2.20.10 Engine 13 – Turbocharged, Downsized, DOHC, VVT, VVL, and DI

Engine 12 has been further downsized to a 1.2L to create engine 13. The turbocharger maps scaled to improve torque at low engine speeds. All the turbocharged direct injection engines described below have been developed using 87 octane fuel.

Figure 5-86 below shows the IAV engine 13 BSFC map used for this NPRM analysis.

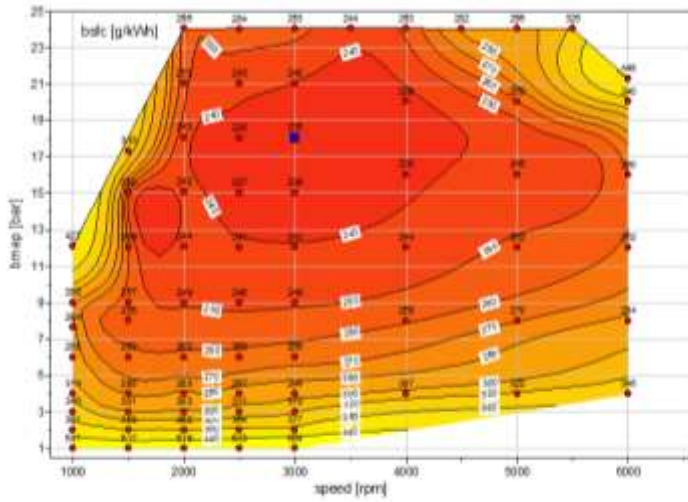

FIGURE 5-86 - ENGINE EFFICIENCY MAP FOR ENG13

*** EO 12866 Review – Draft – Do Not Cite, Quote or Release During Review ***

Figure 5-87 shows the incremental difference BSFC and thermal efficiency between IAV engine 12 versus engine 13.

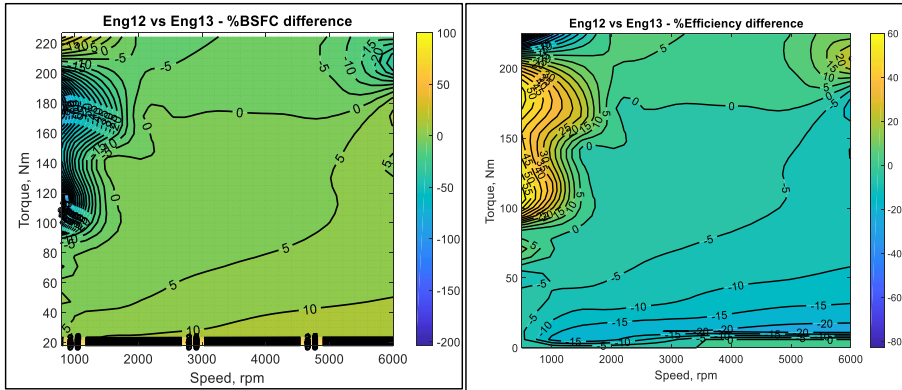

FIGURE 5-87 - INCREMENTAL BSFC AND THERMAL EFFICIENCY BETWEEN ENG12 AND ENG13

Figure 5-88 below shows BSFC map of the 87 octane fuel and the 93 octane fuel for engine 13.

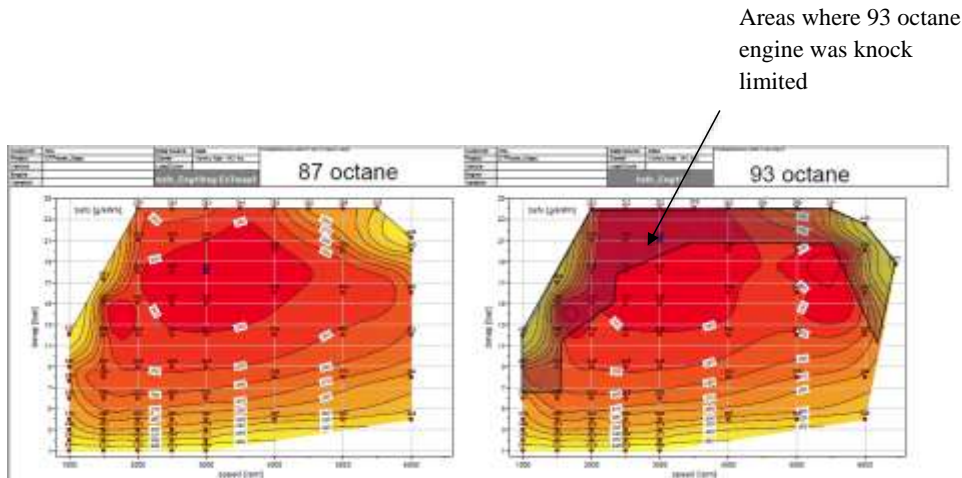

FIGURE 5-88 - BSFC OF 93 (RIGHT) VERSUS 87 (LEFT) OCTANE FUEL FOR ENG13

*** EO 12866 Review – Draft – Do Not Cite, Quote or Release During Review ***

Figure 5-89 below shows the BSFC difference between the 87 octane fuel and the higher octane fuel.

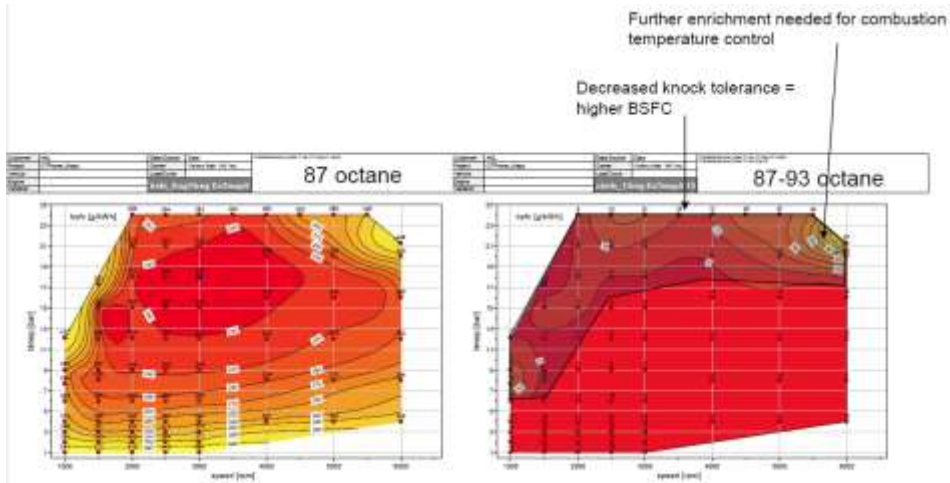

FIGURE 5-89 - DELTA BSFC OF 93 (RIGHT) VERSUS 87 (LEFT) OCTANE FUEL FOR ENG13

Figure 5-90 below shows the thermal efficiency difference between the new and old engine 13 maps.

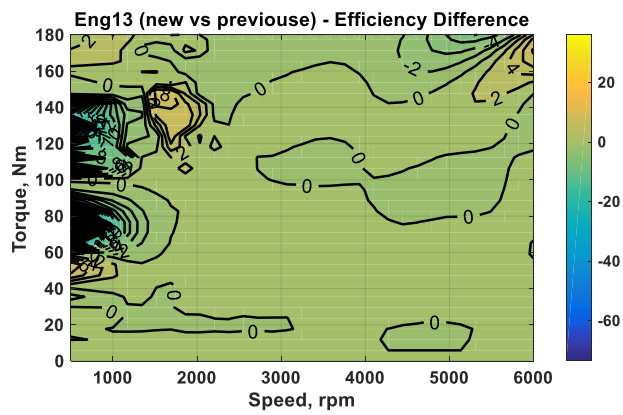

FIGURE 5-90 - ENGINE EFFICIENCY DIFFERENCE IN PERCENT FOR 93- VS. 87-OCTANE FUEL FOR ENGINE 13

5.3.2.2.20.11 Engine 14 – Turbocharged, Downsized, DOHC, VVT, VVL, DI, and cEGR

High pressure cooled EGR was added to engine 13 to develop engine 14. Exhaust gas recirculation boost increases the exhaust-gas recirculation used in the combustion process to increase thermal efficiency and reduce pumping losses. Levels of exhaust gas recirculation approach 25% by volume in these highly boosted engines (this, in turn raises the boost requirement by approximately 25%). Cooled EGR target set points were optimized for best BSFC and torque. Figure 5-91 below shows the IAV engine 13 BSFC map used for this NPRM analysis.

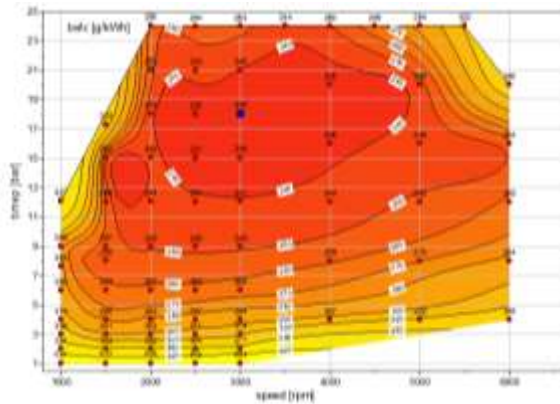

FIGURE 5-91 - ENGINE EFFICIENCY MAP FOR ENG14.

Figure 5-92 shows the incremental difference BSFC and thermal efficiency between IAV engine 13 versus engine 14.

*** EO 12866 Review – Draft – Do Not Cite, Quote or Release During Review ***

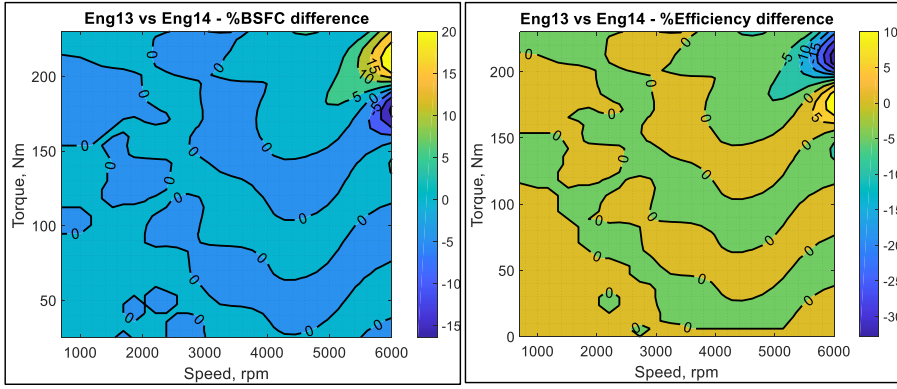

FIGURE 5-92 SHOWS INCREMENTAL BSFC AND THERMAL EFFICIENCY DIFFERENCE BETWEEN ENG13 VERSUS ENG14

Figure 5-93 below shows BSFC map of the 87 octane fuel and the 93 octane fuel for engine 14.

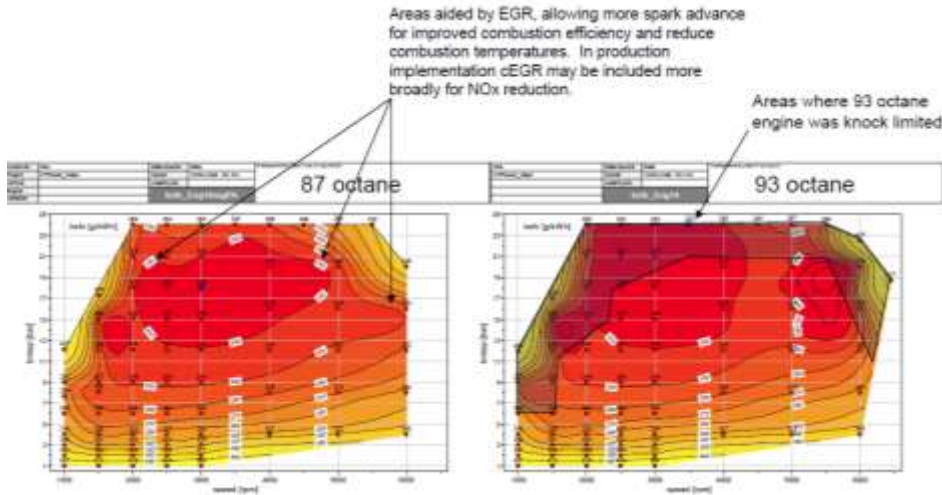

FIGURE 5-93 - BSFC OF 93 (RIGHT) VERSUS 87 (LEFT) OCTANE FUEL FOR ENG14

Figure 5-94 below shows the BSFC difference between the 87 octane fuel and the higher octane fuel.

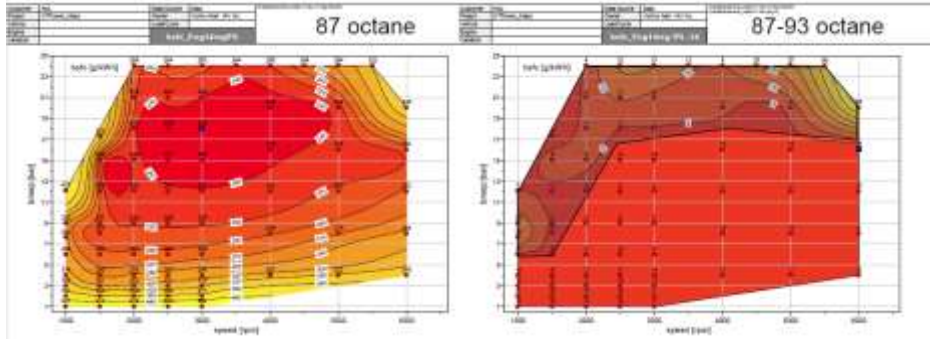

FIGURE 5-94 - DELTA BSFC OF 93 (RIGHT) VERSUS 87 (LEFT) OCTANE FUEL FOR ENG14

Figure 5-95 below shows the thermal efficiency difference between the new and old engine 14 maps.

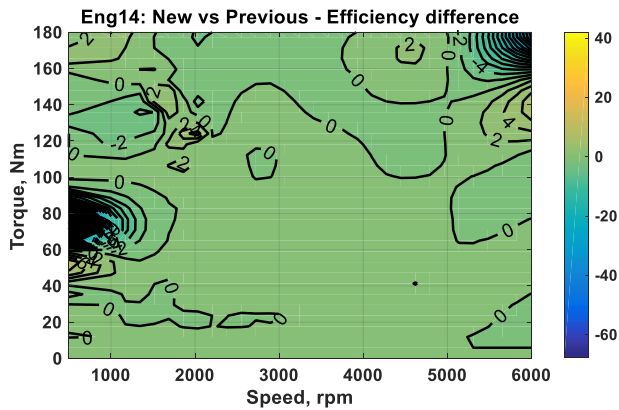

FIGURE 5-95 - ENGINE EFFICIENCY DIFFERENCE IN PERCENT FOR 93 VS. 87 OCTANE FUEL FOR ENGINE 14

5.3.2.2.20.12 Engine 17 – Diesel 2.2L

Diesel engines have several characteristics that give superior fuel efficiency, including reduced pumping losses due to lack of (or greatly reduced) throttling, and a combustion cycle that operates at a higher compression ratio, with a very lean air/fuel mixture, than an equivalent-performance gasoline engine. This technology requires emission controls, such as a NO_x trap catalyst after-treatment system or a selective catalytic reduction NO_x after-treatment system. Diesel engine maps were created from measured data, including engine speed, BMEP, brake torque, brake power, and BSFC.

Figure 5-96 below shows engine 17 BSFC map used for this NPRM analysis.

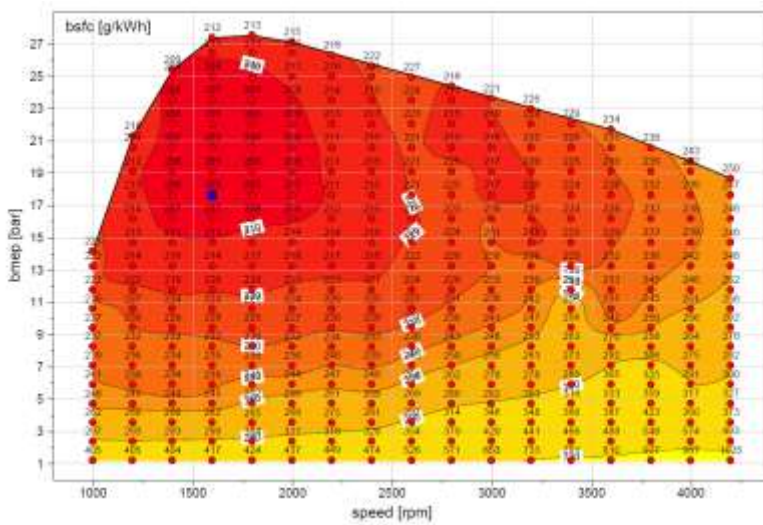

Figure 5-96 - Engine Efficiency map for eng17

Figure 5-97 shows the incremental difference BSFC and thermal efficiency between IAV engine 14 versus engine 17.

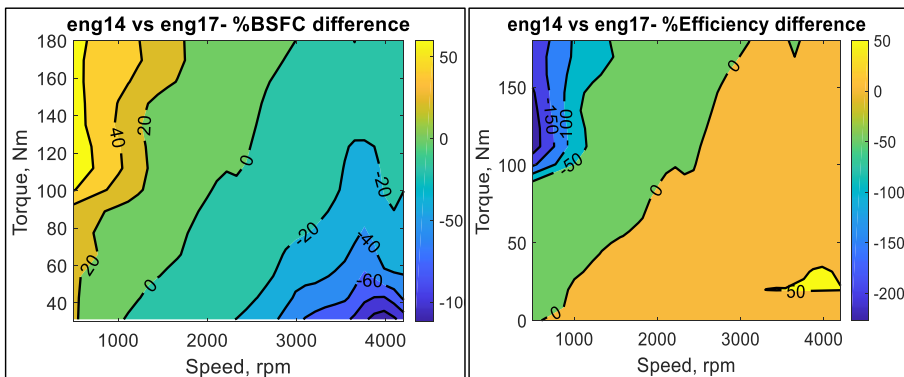

FIGURE 5-97 - INCREMENTAL BSFC AND THERMAL EFFICIENCY DIFFERENCE BETWEEN ENG14 VERSUS ENG17

5.3.2.2.20.13 Engine 18 – DOHC, VVT, DI

Eng18 adds SGDI to Eng1, and assumes open valve injection and homogeneous operation. SGDI improves knock tolerance and volumetric efficiency due to in cylinder vaporization of the fuel. The engine map is unchanged from the Draft TAR. Figure 5-98 below shows the IAV engine 18 BSFC map used for this NPRM analysis.

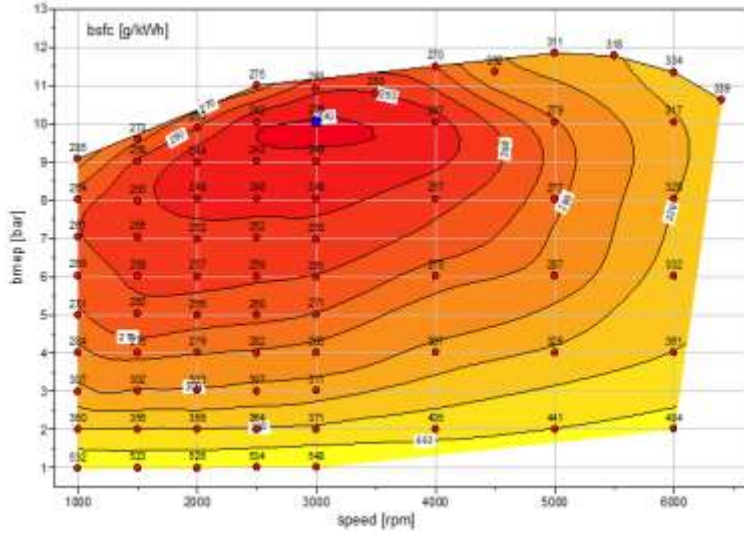

FIGURE 5-98 - ENGINE EFFICIENCY MAP FOR ENG18

Figure 5-99 shows the incremental difference BSFC and thermal efficiency between IAV engine 18 versus engine 1.

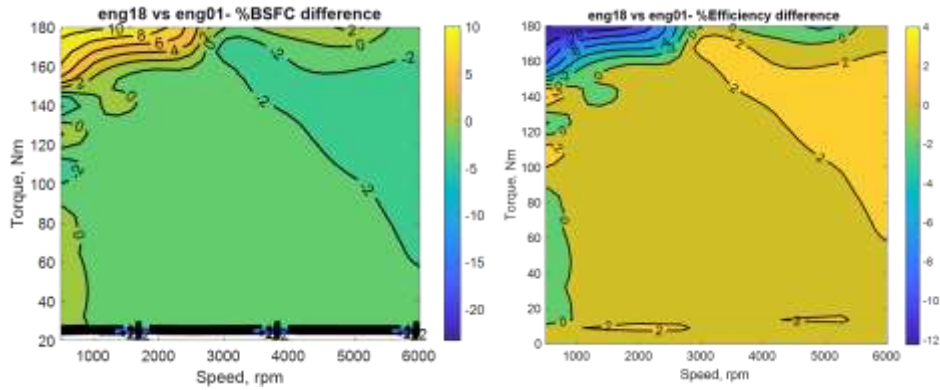

FIGURE 5-99 - INCREMENTAL BSFC AND THERMAL EFFICIENCY BETWEEN IAV ENG18 VERSUS ENG01

5.3.2.2.0.14 Engine 19 – DOHC, VVT, and DEAC

Eng19 was developed from Eng01 with the addition of cylinder deactivation. The VVT timing and IMEP of active cylinders are from Eng01, which does not have cylinder deactivation. The change in the manifold pressure dynamics is not large enough to warrant re-optimizing valve timing in the cylinder deactivation zone. Figure 5-100 below shows the IAV engine 19 BSFC map used for this NPRM analysis.

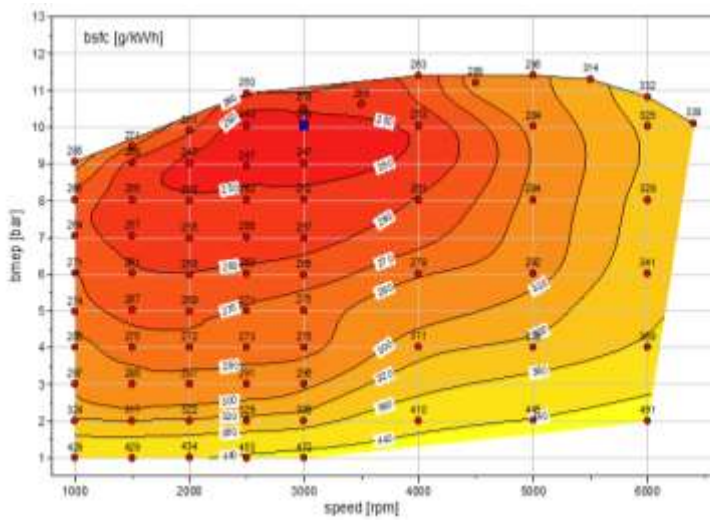

FIGURE 5-100 - ENGINE EFFICIENCY MAP FOR ENG19

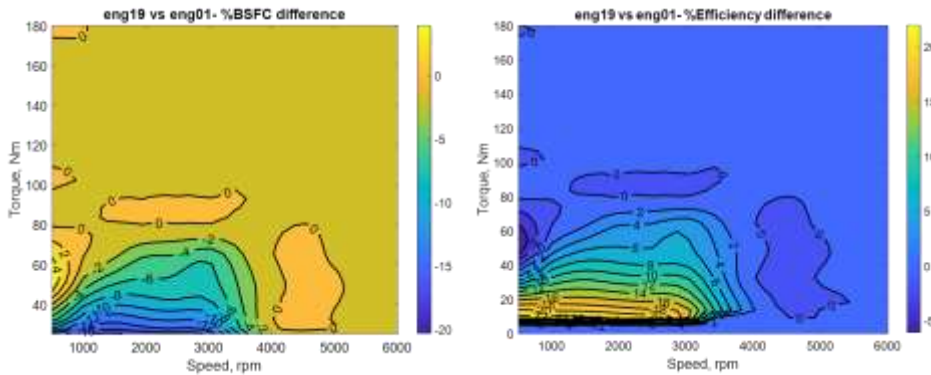

Figure 5-101 shows the incremental difference BSFC and thermal efficiency between IAV engine 19 versus engine 1.

*** EO 12866 Review – Draft – Do Not Cite, Quote or Release During Review ***

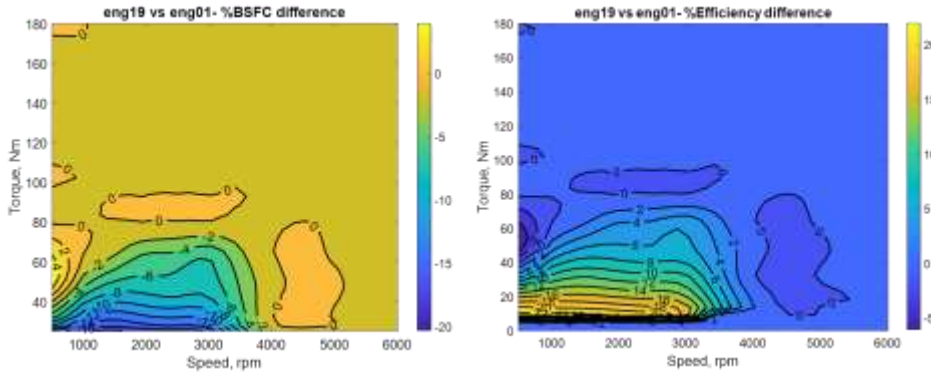

FIGURE 5-101 - ENGINE BSFC AND EFFICIENCY DIFFERENCE BETWEEN ENGINE 19 AND ENGINE 1

5.3.2.2.20.15 Engine 20 – DOHC, VVT, VVL and DEAC

Eng20 was developed from Eng02 with the addition of cylinder deactivation. The VVT timing and lift, and IMEP of active cylinders are from Eng02 which does not have cylinder deactivation. The change in the manifold pressure dynamics is not large enough to warrant re-optimizing valve timing in the cylinder deactivation zone. Figure 5-102 below shows the IAV engine 20 BSFC map used for this NPRM analysis.

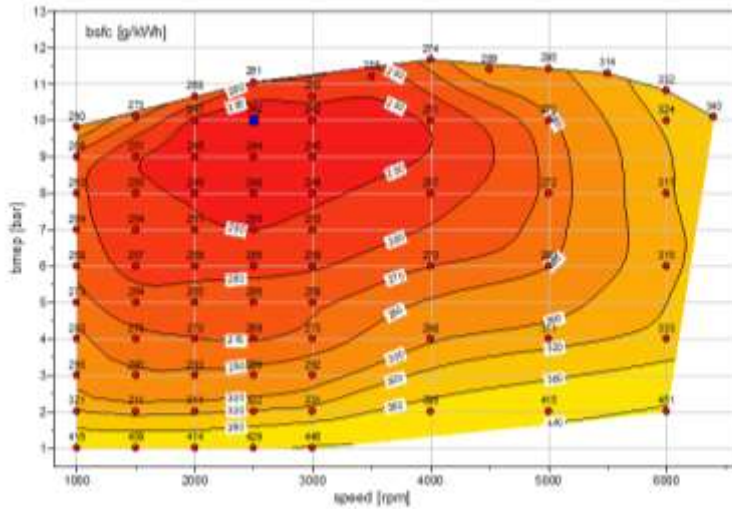

FIGURE 5-102 - ENGINE EFFICIENCY MAP FOR ENG20

Figure 5-103Error! Reference source not found. shows the incremental difference BSFC and thermal efficiency between IAV engine 20 versus engine 2.

*** EO 12866 Review – Draft – Do Not Cite, Quote or Release During Review ***

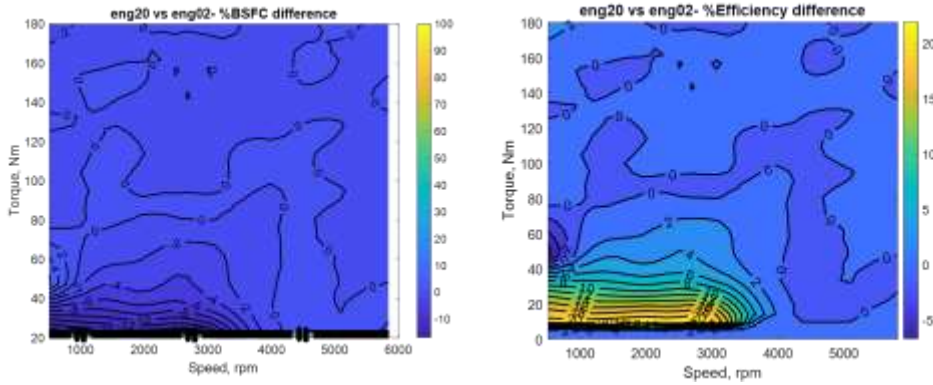

FIGURE 5-103 - ENGINE BSFC AND EFFICIENCY DIFFERENCE BETWEEN ENGINE 20 AND ENGINE 2

5.3.2.2.20.16 Engine 21 – DOHC, VVT, DI, and DEAC

Eng21 was developed from Eng18 with the addition of cylinder deactivation. The VVT timing and lift, and IMEP of active cylinders are from Eng18 which does not have cylinder deactivation. The change in the manifold pressure dynamics is not large enough to warrant re-optimizing valve timing in the cylinder deactivation zone.

Figure 5-104 below shows the IAV engine 21 BSFC map used for this NPRM analysis.

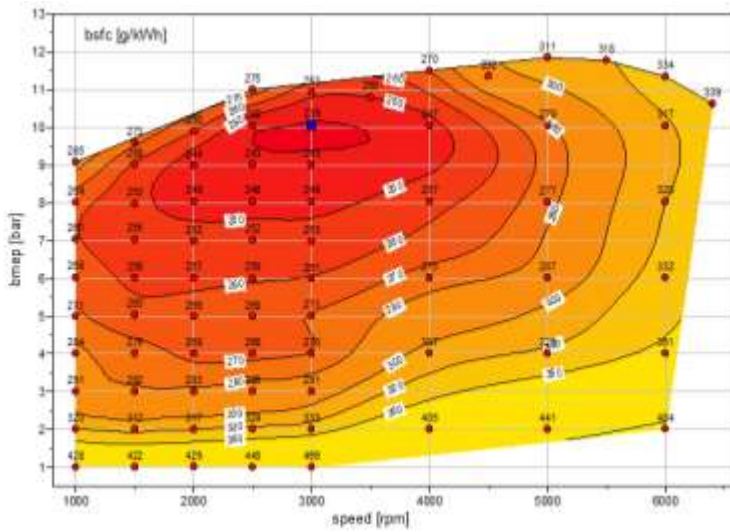

FIGURE 5-104 - ENGINE EFFICIENCY FOR ENG21

Figure 5-105 shows the incremental difference BSFC and thermal efficiency between IAV engine 21 versus engine 18.

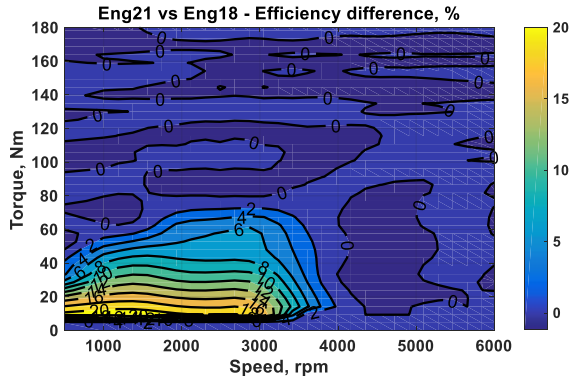

FIGURE 5-105 - ENGINE EFFICIENCY DIFFERENCE BETWEEN ENGINE 21 AND ENGINE 18

5.3.2.2.20.17 Engine 24 – HCR1

Engine 24 represents the current generation of non-HEV Atkinson cycle engine. The engine map for Eng24 was developed by EPA from testing of the 2.0L variate of the 2014 Mazda SkyActiv-G engine. This engine’s compression ratio is 13:1 with VVT and SGDI.

Figure 5-106 below shows the engine 24 BSFC map used for this NPRM analysis.

*** EO 12866 Review – Draft – Do Not Cite, Quote or Release During Review ***

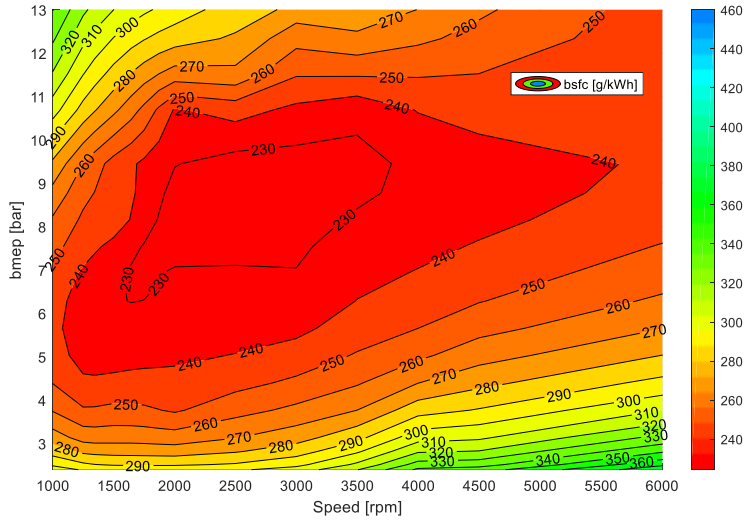

FIGURE 5-106 - ENGINE EFFICIENCY MAP FOR ENG24

Figure 5-107 shows the incremental difference BSFC and thermal efficiency between IAV engine 21 versus engine 24.

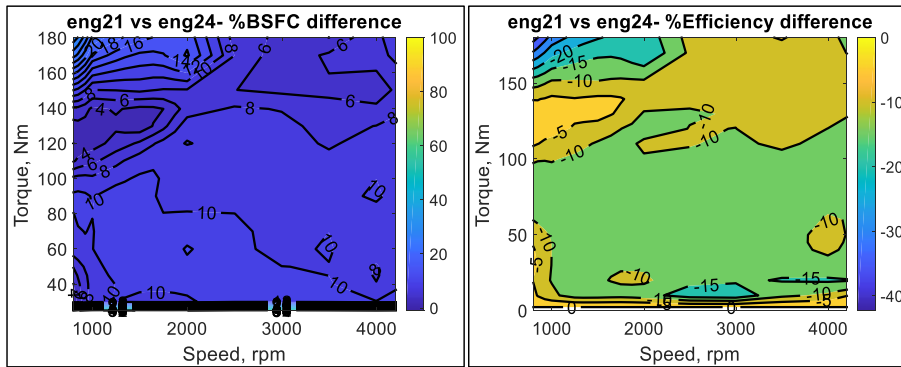

FIGURE 5-107 SHOWS INCREMENTAL BSFC AND THERMAL EFFICIENCY DIFFERENCE BETWEEN ENG21 VERSUS ENG24

5.3.2.2.20.18 Engine 25 – HCR2

The 2016 Draft TAR included a future Atkinson engine concept which compared to Atkinson engine 24, increased the engine compression ratio to 14:1 (compared to 13.0:1 for engine 24),

and added cooled EGR and cylinder deactivation. This engine was developed based on the Eng24 using GT-POWER by EPA staff as a theoretical engine. For this NPRM, this analysis did not include this technology because it was developed assuming high octane Tier 2 fuel, and had unresolved issues associated with knock mitigation and cylinder deactivation at the time of this NPRM analysis.

As discussed in section 5.3.2.2.17, this analysis is using Tier 3 87 AKI fuel as a constraint for engine technologies so as to retain the functionality of baseline vehicles, the majority of which are specified to operate on 87 AKI fuel. It is concluded that operating Engine 25 on Tier 3, 87 AKI fuel would likely impact BSFC, and there could potentially be engine durability issues if the engine was operated on Tier 3 fuel. As discussed in the EPA Proposed Determination Technical Support Document, the GT-POWER modeling that was used to develop the Engine 25 map did not use a validated kinetic knock model to indicate the knock limit of the higher compression ratio with cEGR; knock mitigation and fuel consumption benefits of cEGR are modest compared to benefits of high octane fuel. IAV's GT-POWER model incorporates validated kinetic knock model (see section 5.3.2.2.16.4), and shows combustion stability issues at higher coefficient of variation (COV).¹⁹² Under best case conditions, cEGR recovers only a fraction of the lost efficiency associated with low octane fuel.

Also, the cylinder deactivation concept used on Eng25 was derived from the 2014 Chevrolet Silverado. Because of the significant differences in vehicle architecture between full size pick-up trucks and other light trucks and passenger cars, it is concluded that noise, vibration and harshness (i.e., consumer acceptance issues) could limit the operation of cylinder deactivation on non-pick-up trucks. Engine 25 may overstate the potential improvement with cylinder deactivation technology for the other vehicle classes.

Figure 5-108 below shows the engine 24 BSFC map used for 2016 Draft TAR analysis.

Commented [A6]: It would be appropriate to include HCR2 engine technology in the primary analysis case as representative of Atkinson engine vehicles on the road today (2018 Camry and Corolla with cooled EGR and the 2019 Mazda CX5 and Mazda6 with cylinder deac) that are improved from the first generation, MY2012 vintage "HCR1" technology. While it is true that no current production vehicle has both cooled EGR and cylinder deac, as the EPA "HCR2" engine did, nonetheless, these existing engines demonstrate similar efficiency.

Commented [A7]: NHTSA's description of coefficient of variation of indicated mean effective pressure (COV of IMEP) and cEGR impact on knock tolerance for EPA's work in the PD is not accurate. EPA measured and reported COV of IMEP, knock characteristics, and model validation, all based on engine testing, within the DTAR, PD TSD, and within a peer-reviewed SAE technical paper.

¹⁹² IAV advanced engine modeling phase 3 test data comparison of cEGR and different combustion stability. Report submitted to docket.

*** EO 12866 Review – Draft – Do Not Cite, Quote or Release During Review ***

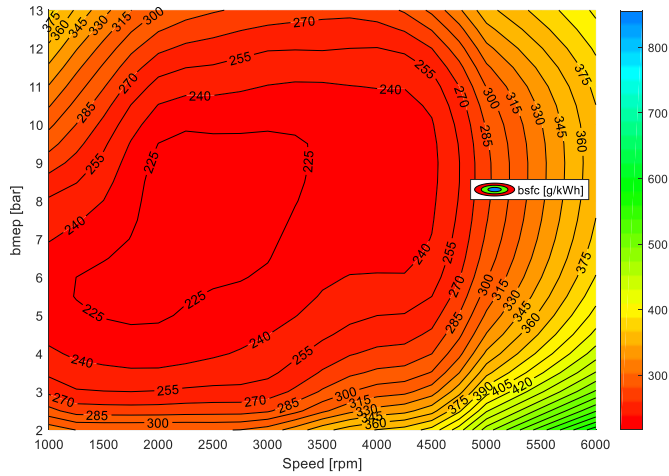

FIGURE 5-108 - ENGINE EFFICIENCY MAP FOR ENG25

Figure 5-109 shows the incremental difference BSFC and thermal efficiency between IAV engine 24 versus engine 25.

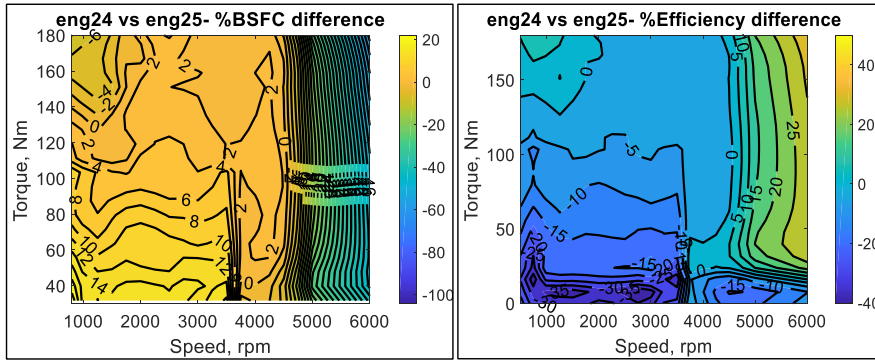

FIGURE 5-109 - INCREMENTAL BSFC AND THERMAL EFFICIENCY BETWEEN ENG24 AND ENG25

5.3.2.2.20.19 Engine 26 – Atkinson Cycle Engine- HEV and PHEV applications

Engine 26 is carry over from the 2016 Draft TAR and no updates were made to this change for this NPRM analysis. The engine test data was from 2010 Toyota Prius with 1.8-L, 4-cylinder 73KW Atkinson engine.¹⁹³

Figure 5-110 below shows the engine 26 BSFC map used for this NPRM analysis. As stated before, this map is only used for HEV and PHEV vehicle class.

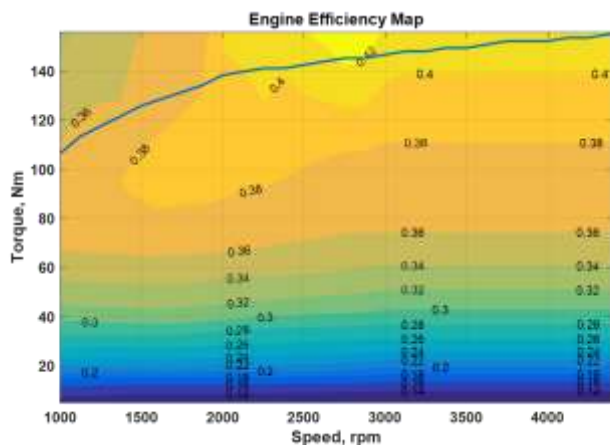

FIGURE 5-110 - ENGINE EFFICIENCY MAP FOR ENG26

5.3.2.2.20.20 Future and Emerging Engine Technologies Not Included in this NPRM analysis

5.3.2.2.20.20.1 IAV Engine 26a - Variable Compression Ratio Technology

Engines using variable compression ratio (VCR) technology appear to be at a production-intent stage of development, but also appear to be targeted primarily towards limited production, high performance and very high BMEP (27-30 bar) applications. At lower BMEP levels, other concepts (e.g., Atkinson Cycle for naturally aspirated applications, Miller Cycle for boosted applications) provide a similar means to vary effective compression ratio for knock mitigation at lower cost and complexity, however, have with some tradeoffs with respect to volumetric efficiency.

IAV is developing an engine map for variable compression ratio technology, using the following specifications. The NPRM seeks comment on the specifications that are being used for the modeling.

Variable Compression Ratio - Specifications for Modeling

¹⁹³ "2010 Toyota Prius". <http://www.anl.gov/energy-systems/group/downloadable-dynamometer-database/hybrid-electric-vehicles/2010-toyota-prius> Accessed April 2018

*** EO 12866 Review – Draft – Do Not Cite, Quote or Release During Review ***

- Fuel - Tier 3, 87 AKI
- Number of Cylinders - 4
- Displacement - 2.0 Liters
- Injection Type - SGDI
- Compression Ratio - 9:1 to 12:1
- Valvetrain - DOHC dVVT
- Aspiration - Turbocharged 27 bar BMEP with cooled EGR

Figure 5-111, Figure 5-112, and Figure 5-113 below shows the maps for this VCR technology that may be considered for final rulemaking.

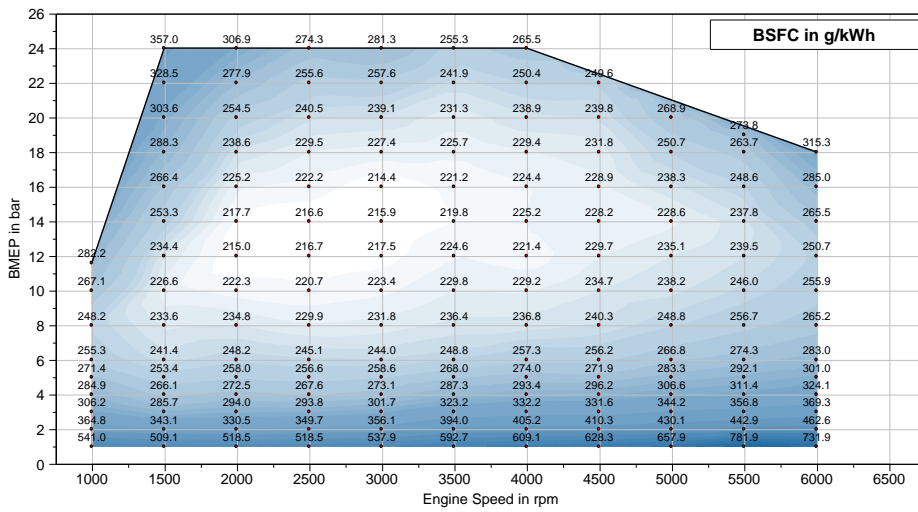

FIGURE 5-111 - IAV'S 2-STEP VCR ENGINE 26A MERGED IN NORMAL OPERATION

*** EO 12866 Review – Draft – Do Not Cite, Quote or Release During Review ***

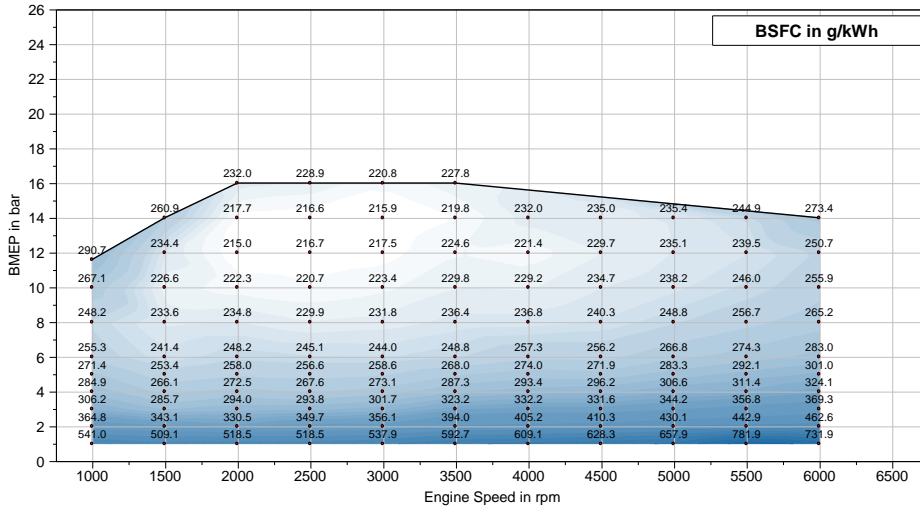

FIGURE 5-112 - IAV'S 2-STEP VCR ENGINE 26A IN 12:1 CR MODE

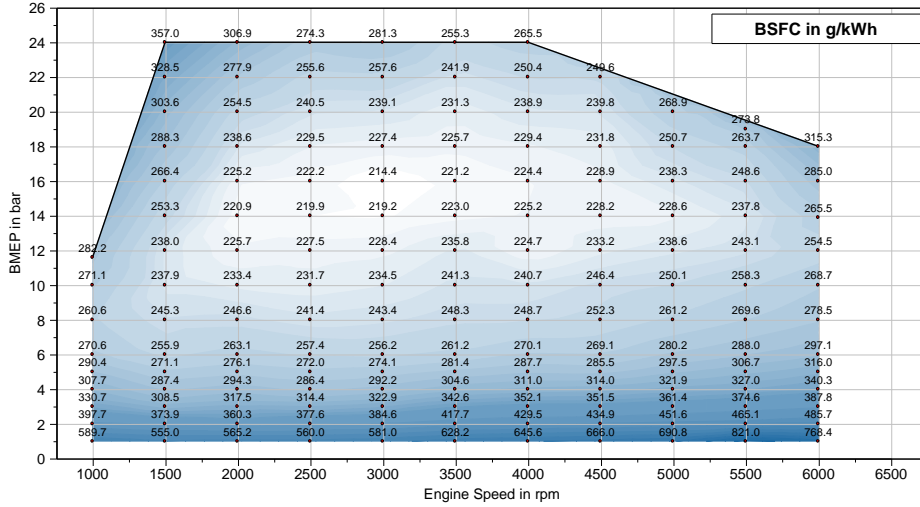

FIGURE 5-113 - IAV'S 2-STEP VCR ENGINE 26A IN 9:1 CR MODE

5.3.2.2.20.2.2 Other Engine Technologies

NHTSA is sponsoring work to develop engine maps for additional combinations of technologies. Below is a list of the engine specifications for the new modeling work. The NPRM seeks comment on the specifications that are being used for the modeling. In comparing the engine technology, this analysis uses incremental effectiveness from previous technology.

5.3.2.2.20.2.1 IAV engine 22b - High Compression Atkinson Cycle Engine

- Fuel - Tier 3, 87 AKI
- Number of Cylinders - 4
- Displacement - 2.5 Liters
- Injection Type - PFI
- Compression Ratio - 14:1
- Valvetrain - DOHC dVVT
- Aspiration - Naturally Aspirated 18 bar BMEP

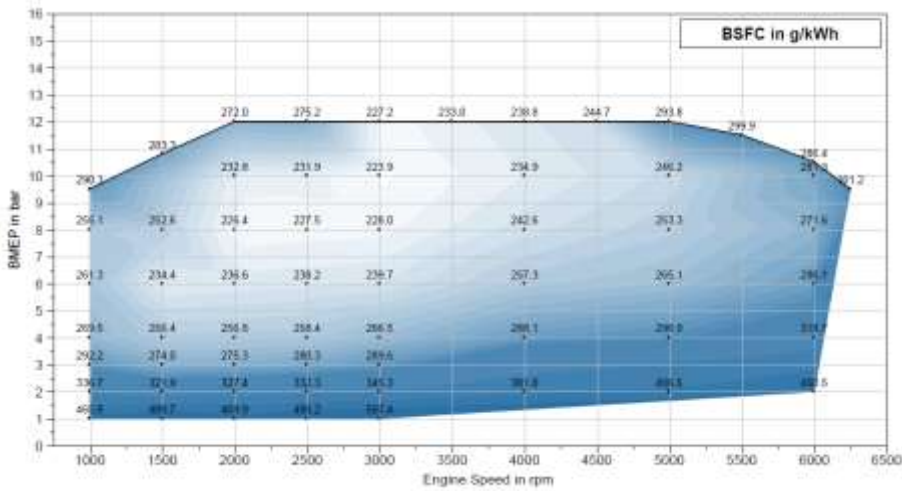

FIGURE 5-114 - IAV'S HIGH COMPRESSION ATKINSON CYCLE ENGINE 22B'S BSFC MAP

5.3.2.2.20.2.2.2 IAV engine 23b - High Compression Miller Cycle Engine with Variable Geometry Turbocharger

- Fuel - Tier 3, 87 AKI
- Number of Cylinders - 4
- Displacement - 2.0 Liters

*** EO 12866 Review – Draft – Do Not Cite, Quote or Release During Review ***

- Injection Type - SGDI
- Compression Ratio - 12:1
- Valvetrain - DOHC dVVT and VVL
- Aspiration - Turbocharged VGT 24 bar BMEP with cEGR

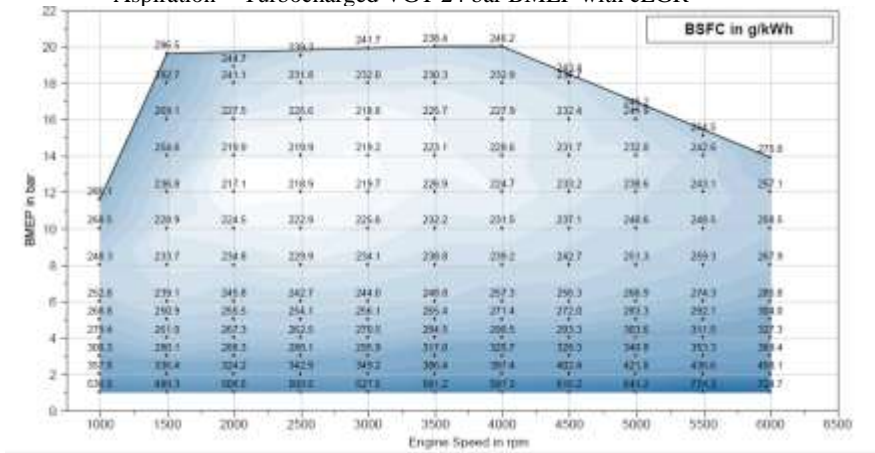

FIGURE 5-115 - IAV ENGINE 23B's BSFC MAP

5.3.2.2.20.20.2.3 IAV engine 24 - High Compression Miller Cycle Engine with Electric Supercharger

- Fuel - Tier 3, 87 AKI
- Number of Cylinders - 4
- Displacement - 2.0 Liters
- Injection Type - SGDI
- Compression Ratio - 12:1
- Valvetrain - DOHC dVVT
- Aspiration - Electric Supercharger 24 bar BMEP with cEGR

*** EO 12866 Review – Draft – Do Not Cite, Quote or Release During Review ***

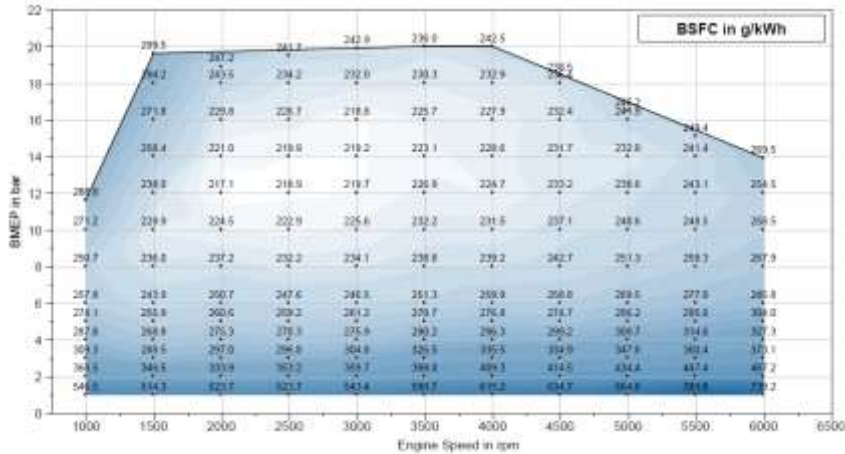

FIGURE 5-116 IAV'S HIGH COMPRESSION MILLER CYCLE ENGINE WITH E-BOOST 24'S BSFC MAP

5.3.2.2.20.20.3 Tractive energy Efficiency ranges for modeled engine technologies

In comments submitted in response to the Draft TAR, the Alliance of Automobile Manufacturers referenced work done by Novation Analytics and commented that NHTSA and EPA should implement “plausibility checks” using a measure of powertrain efficiency and apply some estimated limit criteria to the analysis’ modeling. The IAV engine modeling and ANL Autonomie vehicle modeling use a range of other constraints and criteria that impact inputs to the modeling and screen the modeling outputs and, on balance these other constraints avoid inappropriate results.^{194,195} Nevertheless, this analysis have incorporated the calculation of powertrain efficiency into the quality control processes to assure that the overall effectiveness values used in the NPRM analysis are appropriate.

Powertrain efficiency (η_p), as defined by Thomas,¹⁹⁶ is the ratio of the amount of propulsive energy exerted by a vehicle over a given set of driving conditions to the energy content of the expended fuel. The former term is also denoted as tractive energy ($E_{tractive}$), while the latter is denoted as fuel energy (E_{fuel}). Therefore:

¹⁹⁴ Reference CAFE Model Report

¹⁹⁵ Reference Autonomie Simulation Documentation

¹⁹⁶ Thomas, J. “Drive Cycle Powertrain Efficiencies and Trends Derived from EPA Vehicle Dynamometer Results,” SAE Int. J. Passeng. Cars - Mech. Syst. 7(4):2014, doi:10.4271/2014-01-2562.

EQUATION 2 POWERTRAIN EFFICIENCY

$$\eta_p = \frac{E_{tractive}}{E_{fuel}}$$

Thomas defines tractive energy ($E_{tractive}$, also referred to as powertrain energy) as the energy necessary propel the vehicle at a given rate while also overcoming the cumulative resistive forces acting on it. The difference between these two terms is equal to the total tractive energy that the vehicle exerts. In addition to estimating the tractive energy of the vehicle, the energy theoretically available in the fuel to determine powertrain efficiency must also be calculated. On a per-unit of distance traveled basis (here defined as fuel energy intensity E_{fuel}).

Figure 5-117 shows an example of distribution of all of the combinations of technologies modeled for automatic transmissions. ANL Autonomie documentation expands on other technology combinations.

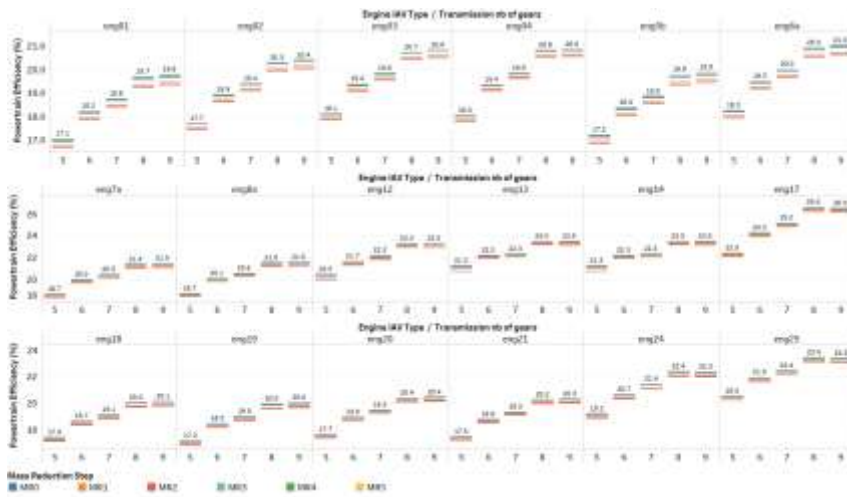

FIGURE 5-117 - POWERTRAIN EFFICIENCY VALUES OF DIFFERENT ENGINE TYPES WITH AUTOMATIC TRANSMISSIONS HAVING DIFFERENT NUMBERS OF GEARS

5.3.2.2.20.21 Effectiveness Summary for Engines

This analysis considered different ways to show the range of effectiveness for engine technologies and other technologies in this NPRM analysis. It was concluded to use box-and-whisker plot with designation for five points of interest in the distribution.¹⁹⁷ For each technology, the analysis show the 5%, 25%, 50%, 75% and 95% effectiveness values represented

¹⁹⁷ “Box Plot”, https://en.wikipedia.org/wiki/Box_plot. Last Accessed April 2018.

in the population of similar¹⁹⁸ simulations with the technology in the CAFE model. Figure 5-118 below shows the basic engine technology effectiveness by technology class or vehicle class relative to a basic engine with VVT, and similar complementary vehicle and transmission equipment. Please provide comments in representing CAFE model technology effectiveness this way.

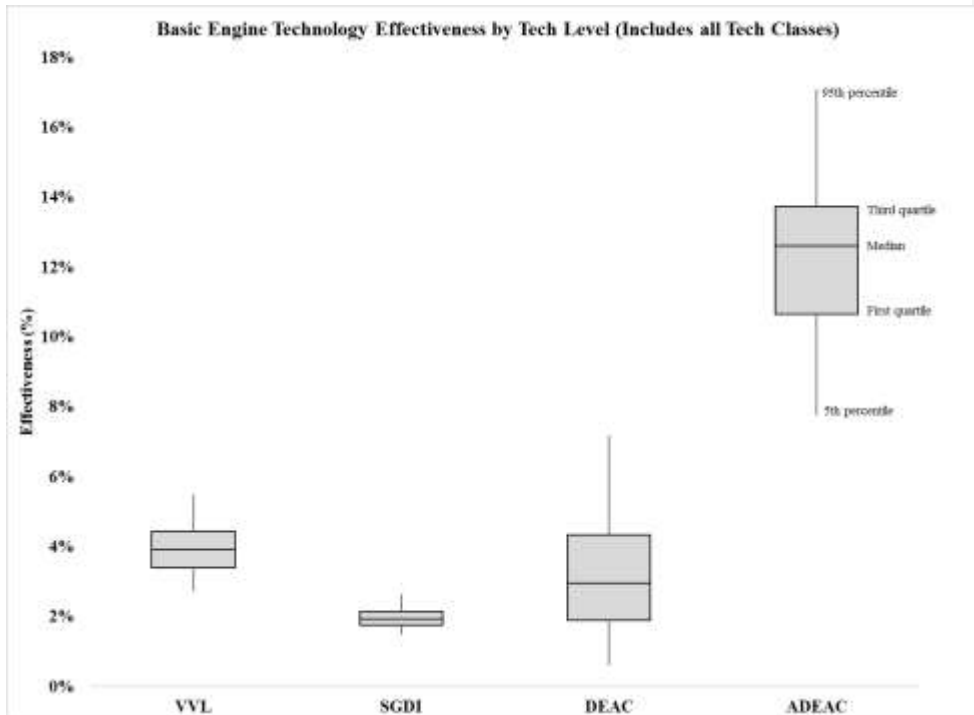

FIGURE 5-118 SHOWS THE EFFECTIVENESS OF ENGINE TECHNOLOGIES ACROSS DIFFERENT OTHER TECHNOLOGIES

Figure 5-119 shows the effectiveness range for advanced engine technologies used in this NPRM analysis.

¹⁹⁸ Holding all other technologies constant.

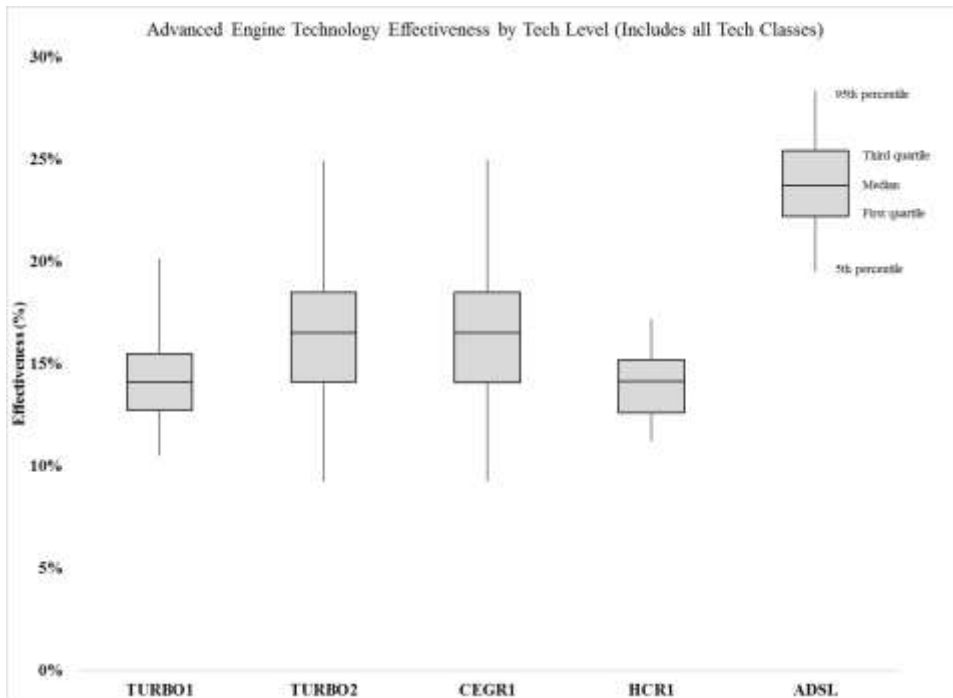

FIGURE 5-119 SHOWS THE EFFECTIVENESS OF ADVANCED ENGINE TECHNOLOGIES ACROSS DIFFERENT OTHER TECHNOLOGIES

5.3.2.2.20.22 Cost Summary for Engines

The following tables summarize incremental costs of engine technologies in 2016 dollars. These costs do not reflect the additional costs that the CAFE model applies over the previous step in the technology track for a specific piece of technology. The following cost tables show the direct manufacturing costs (DMC). The costs for all years are relevant inputs for the CAFE model.

Many technologies have projected costs that vary by application. For instance, the incremental cost of many engine technologies takes into account the engine configuration, like number of banks and number cylinders. Similarly, many advanced vehicle technologies have a specific cost for each vehicle

Table 5-10 below shows DMC used for this NPRM analysis for engine technologies.

*** EO 12866 Review – Draft – Do Not Cite, Quote or Release During Review ***

Table 5-11, Table 5-12, and Table 5-13 below show examples of absolute costs for this NPRM analysis for future years with learning and retail price equivalent taken into account. Table 5-10 - DMCs used for engine technologies in this NPRM analysis

Gasoline Engine Technologies - Direct Manufacturer Costs (2016\$)								
Tech	Basis	Unit DMC	DMC for	DMC for	DMC for	DMC for	DMC for	
			4-Cylinder	4-Cylinder	6-Cylinder	6-Cylinder	8-Cylinder	
			1-Bank Engine	2-Bank Engine	1-Bank Engine	2-Bank Engine	2-Bank Engine	Incremental To
LUBEFR1	cylinder	\$13.93	\$55.71	\$55.71	\$83.57	\$83.57	\$111.42	BaseE
LUBEFR2	cylinder	\$0.84	\$3.36	\$3.36	\$5.04	\$5.04	\$6.72	LUBEFR1
LUBEFR3	cylinder	\$0.76	\$3.02	\$3.02	\$4.54	\$4.54	\$6.05	LUBEFR2
VVT	bank	\$78.38	\$78.38	\$156.75	\$78.38	\$156.75	\$156.75	BaseE
VVL	cylinder	\$53.48	\$213.92	\$213.92	\$320.89	\$320.89	\$427.85	VVT
SGDI	cylinder	\$59.16	\$236.64	\$236.64	\$354.95	\$354.95	\$473.27	VVT
DEAC	none	\$29.39	\$29.39	\$29.39	\$29.39	\$29.39	\$29.39	VVT
ADEAC	cylinder	\$188.93-206.17	\$835.52	\$835.52	\$1,253.29	\$1,253.29	\$1,671.05	VVT
HCR	none	-	\$550.15	\$550.15	\$811.46	\$811.46	\$1,108.01	VVT
TURBO1	none	-	\$838.99	\$838.99	\$845.09	\$845.09	\$1,384.75	VVT
TURBO2	none	-	\$231.28	\$231.28	\$231.28	\$231.28	\$389.85	TURBO1
CEGR1	none	-	\$277.02	\$277.02	\$277.02	\$277.02	\$277.02	TURBO2
ADSL	none	-	\$3,328.34	\$3,328.34	\$3,925.09	\$3,925.09	\$4,178.32	VVT
DSL1	none	-	\$367.74	\$367.74	\$478.94	\$478.94	\$478.94	ADSL

*** EO 12866 Review – Draft – Do Not Cite, Quote or Release During Review ***

TABLE 5-11 - SUMMARY OF ABSOLUTE ENGINE TECHNOLOGY COST VS. I4 BASIC ENGINE, INCLUDING LEARNING EFFECTS AND RETAIL PRICE EQUIVALENT

Name	Technology Pathway	C-2017	C-2021	C-2025	C-2029
VVT	Basic Engine	\$ 111.97	\$ 108.79	\$ 106.24	\$ 104.13
VVL	Basic Engine	\$ 417.59	\$ 405.74	\$ 396.22	\$ 388.34
SGDI	Basic Engine	\$ 450.04	\$ 437.26	\$ 427.00	\$ 418.51
DEAC	Basic Engine	\$ 153.95	\$ 149.58	\$ 146.07	\$ 143.17
TURBO1	Turbocharged Engine	\$ 1,147.98	\$ 1,078.90	\$ 1,044.43	\$ 1,022.34
TURBO2	Turbocharged Engine	\$ 1,722.96	\$ 1,612.78	\$ 1,490.01	\$ 1,403.80
CEGR1	Turbocharged Engine	\$ 2,138.49	\$ 2,001.73	\$ 1,849.36	\$ 1,742.36
HCR1	HCR Engine	\$ 735.65	\$ 692.23	\$ 683.64	\$ 681.67
HCR2	HCR Engine	\$ 980.78	\$ 980.78	\$ 980.78	\$ 980.78
ADEAC	Adv. DEAC Engine	\$ 1,370.86	\$ 1,237.93	\$ 1,156.83	\$ 1,108.63
ADSL	Diesel Engine	\$ 5,110.08	\$ 5,110.08	\$ 5,110.08	\$ 5,110.08
DSLI	Diesel Engine	\$ 5,661.68	\$ 5,661.68	\$ 5,661.68	\$ 5,661.68
CNG	Alt. Fuel Engine	\$ 159.54	\$ 156.22	\$ 153.41	\$ 150.72

TABLE 5-12 - SUMMARY OF ABSOLUTE ENGINE TECHNOLOGY COST VS. V6 BASIC ENGINE, INCLUDING LEARNING EFFECTS AND RETAIL PRICE EQUIVALENT

Name	Technology Pathway	C-2017	C-2021	C-2025	C-2029
VVT	Basic Engine	\$ 223.94	\$ 217.58	\$ 212.48	\$ 208.25
VVL	Basic Engine	\$ 682.38	\$ 663.00	\$ 647.45	\$ 634.57
SGDI	Basic Engine	\$ 731.05	\$ 710.29	\$ 693.63	\$ 679.83
DEAC	Basic Engine	\$ 265.92	\$ 258.37	\$ 252.31	\$ 247.29
TURBO1	Turbocharged Engine	\$ 1,253.70	\$ 1,178.26	\$ 1,140.61	\$ 1,116.49
TURBO2	Turbocharged Engine	\$ 1,849.68	\$ 1,731.39	\$ 1,599.60	\$ 1,507.05
CEGR1	Turbocharged Engine	\$ 2,265.21	\$ 2,120.35	\$ 1,958.95	\$ 1,845.60
HCR1	HCR Engine	\$ 1,133.23	\$ 1,066.34	\$ 1,053.11	\$ 1,050.09
HCR2	HCR Engine	\$ 1,490.32	\$ 1,490.32	\$ 1,490.32	\$ 1,490.32
ADEAC	Adv. DEAC Engine	\$ 2,115.07	\$ 1,909.98	\$ 1,784.85	\$ 1,710.48
ADSL	Diesel Engine	\$ 6,122.76	\$ 6,122.76	\$ 6,122.76	\$ 6,122.76
DSLI	Diesel Engine	\$ 6,841.17	\$ 6,841.17	\$ 6,841.17	\$ 6,841.17
CNG	Alt. Fuel Engine	\$ 159.54	\$ 156.22	\$ 153.41	\$ 150.72

*** EO 12866 Review – Draft – Do Not Cite, Quote or Release During Review ***

TABLE 5-13 - SUMMARY OF ABSOLUTE ENGINE TECHNOLOGY COST VS. V8 BASIC ENGINE, INCLUDING LEARNING EFFECTS AND RETAIL PRICE EQUIVALENT

Name	Technology Pathway	C-2017	C-2021	C-2025	C-2029
VVT	Basic Engine	\$ 223.94	\$ 217.58	\$ 212.48	\$ 208.25
VVL	Basic Engine	\$ 835.19	\$ 811.47	\$ 792.44	\$ 776.68
SGDI	Basic Engine	\$ 900.08	\$ 874.52	\$ 854.01	\$ 837.03
DEAC	Basic Engine	\$ 265.92	\$ 258.37	\$ 252.31	\$ 247.29
TURBO1	Turbocharged Engine	\$ 1,929.02	\$ 1,812.94	\$ 1,755.01	\$ 1,717.90
TURBO2	Turbocharged Engine	\$ 2,897.03	\$ 2,711.76	\$ 2,505.34	\$ 2,360.38
CEGR1	Turbocharged Engine	\$ 3,312.55	\$ 3,100.71	\$ 2,864.69	\$ 2,698.94
HCR1	HCR Engine	\$ 1,480.31	\$ 1,392.94	\$ 1,375.66	\$ 1,371.71
HCR2	HCR Engine	\$ 1,935.14	\$ 1,935.14	\$ 1,935.14	\$ 1,935.14
ADEAC	Adv. DEAC Engine	\$ 2,741.71	\$ 2,475.87	\$ 2,313.66	\$ 2,217.26
ADSL	Diesel Engine	\$ 6,502.61	\$ 6,502.61	\$ 6,502.61	\$ 6,502.61
DSL1	Diesel Engine	\$ 7,221.02	\$ 7,221.02	\$ 7,221.02	\$ 7,221.02
CNG	Alt. Fuel Engine	\$ 159.54	\$ 156.22	\$ 153.41	\$ 150.72

5.3.2.2.20.23 Engine technology learning curve

Table 5-14 below shows the applied learning rates for the engine technologies analyzed for this NPRM. For details of learning methodology see chapter 7 of this RIA.

*** EO 12866 Review – Draft – Do Not Cite, Quote or Release During Review ***

TABLE 5-14 - LEARNING RATES FOR THIS NPRM'S ENGINE TECHNOLOGIES

Technology	Model Years																
	2016	2017	2018	2019	2020	2021	2022	2023	2024	2025	2026	2027	2028	2029	2030	2031	2032
LUBEFR1	0.8	0.76	0.74	0.72	0.71	0.69	0.68	0.67	0.66	0.65	0.64	0.64	0.63	0.62	0.62	0.61	0.61
LUBEFR2	1	1	1	0.86	0.78	0.72	0.67	0.64	0.62	0.6	0.58	0.57	0.56	0.55	0.54	0.53	0.53
LUBEFR3	1	1	1	1	1	1	1	1	0.85	0.77	0.72	0.68	0.66	0.64	0.62	0.61	0.59
VVT, VVL, SGDI, DEAC	0.97	0.96	0.95	0.94	0.94	0.93	0.93	0.92	0.91	0.91	0.9	0.9	0.89	0.89	0.89	0.88	0.88
ADEAC	1.06	1.04	1	0.97	0.95	0.92	0.9	0.88	0.87	0.86	0.84	0.83	0.82	0.82	0.81	0.8	0.8
HCR1	0.82	0.8	0.78	0.77	0.75	0.74	0.73	0.73	0.73	0.73	0.73	0.72	0.72	0.72	0.72	0.72	0.72
TURBO1	0.87	0.85	0.83	0.82	0.8	0.79	0.78	0.78	0.77	0.76	0.76	0.75	0.75	0.75	0.74	0.74	0.74
TURBO2, CEGR1	1.02	1.01	1	0.99	0.97	0.96	0.94	0.92	0.9	0.88	0.86	0.85	0.84	0.83	0.81	0.81	0.8
ADSL, DSLI	1	1	1	1	1	1	1	1	1	1	1	1	1	1	1	1	1

5.3.3 Transmission Technology Effectiveness

The function of a transmission system is to reduce the relatively high engine speed and increase the torque, so that the power output of the engine can be coupled to the wheels. The complete drivetrain includes a differential (integral to the transmission on front-wheel-drive vehicles; separate on rear-wheel-drive vehicles) which provides further speed reduction, and often a hydraulic torque converter which provides significant torque multiplication at low speed conditions. The complete drivetrain – torque converter, transmission, and differential – is designed as a set to best match the power available from the engine to that required to propel the vehicle.

Different transmission architectures are available for use in light duty vehicles. Conventional planetary gear automatic transmissions (ATs) are the most popular type, and still dominate the light-duty fleet, as seen in Figure 5-120. Manual transmissions (MTs), although less popular than in the past, are also still part of the fleet. Both ATs and MTs have, among other improvements, seen an increase in the number of gears employed. Figure 5-123 shows the recent gains in six, seven, and eight-speed transmissions in both the car and light truck segment. Recent introductions of nine-speed and ten-speed transmissions in the same market indicates that conventional automatic transmissions are going to be the dominant transmission type for the foreseeable future. The other transmission type that has also seen an increase in market share is the continuously variable transmissions (CVTs), which can vary their ratio to target any place within their overall spread. The CVT transmissions do have limited torque capacity which will limit their application on larger vehicle segments. Dual-clutch transmissions (DCTs), which have significantly lower parasitic losses than ATs, have decreased in overall penetration due past reliability issues and consumer acceptance of the shift quality.

Each of these four types of transmissions is discussed in more detail in the sections below.

*** EO 12866 Review – Draft – Do Not Cite, Quote or Release During Review ***

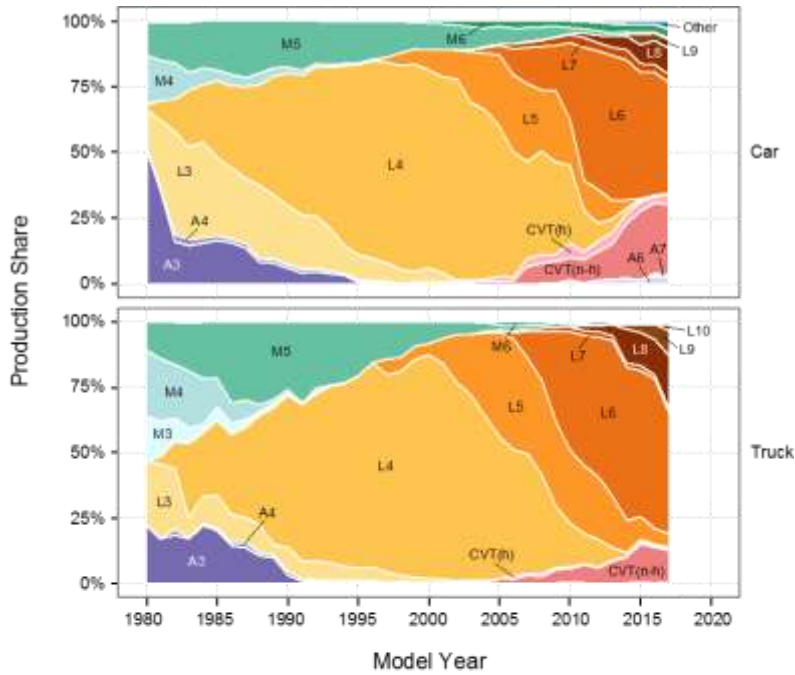

Transmission	Lockup?	Number of Gears	Key	
Automatic Semi-Automatic Automated Manual	No	3	A3	
		4	A4	
		5	A5	
		6	A6	
		7	A7	
		8	A8*	
		Yes	2	L2*
			3	L3
			4	L4
			5	L5
Manual	-	6	L6	
		7	L7	
		8	L8	
		9	L9	
		10	L10	
		3	M3	
		4	M4	
Continuously Variable (non-hybrid)	-	5	M5	
		6	M6	
		7	M7	
		-	CVT(n-h)	
Continuously Variable (hybrid)	-	-	CVT(h)	
Other	-	-	Other	

*Categories A8, L2, and M7 are too small to depict in the area plot.

*** EO 12866 Review – Draft – Do Not Cite, Quote or Release During Review ***

FIGURE 5-120 - TRANSMISSION TECHNOLOGY PRODUCTION SHARE, 1980-2017¹⁹⁹

5.3.3.1 Transmission Technologies

This analysis considered a number of types of transmissions.

- Six, seven, eight, nine and ten-speed automatic transmissions – the gear ratio spacing and transmission ratio are optimized to enable the engine to operate in a more efficient operating range over a broader range of vehicle operating conditions.
- Dual clutch transmission (DCT) - are similar to a manual transmission, but the vehicle controls shifting and launch functions. A dual-clutch automated shift manual transmission uses separate clutches for even-numbered and odd-numbered gears, so the next expected gear is pre-selected, which allows for faster, smoother shifting.
- Continuously Variable Transmission (CVT) – uses a belt between two variable ratio pulleys allowing an infinite set of gear ratios to enable the engine to operate in a more efficient operating range over a broad range of vehicle operating conditions.
- Manual 6 and 7-speed transmissions offers an additional gear ratio, often with a higher overdrive gear ratio, than a 5-speed manual transmission.
- 1st level and 2nd level High Efficiency Gearbox (automatic, DCT, CVT, or manual) – continuous improvement in seals, bearings and clutches, super finishing of gearbox parts, and development in the area of lubrication, all aimed at reducing frictional and other parasitic load in the system for an automatic, DCT or manual type transmission.

Notably, for each of these configurations, the analysis assumed that the high gear ratio remained approximately the same as the number of gears increased. In practice, manufacturers tend to be widening gear spreads as they increase the number of gears offered in transmissions, so the agencies are evaluating assumptions about low and high gear spreads for future simulation efforts. The comments are sought on assumed gear spreads and ratios, and seek information on advantages and disadvantages of changing low-high gear spreads as manufacturers offer transmissions with additional gears.

5.3.3.2 Sources of Transmission Effectiveness Data

In addition to the sources of transmission effectiveness data cited in the 2012 final rule and 2016 Draft TAR, this analysis also considered data from other sources to update and refine transmission effectiveness estimates for this analysis. These sources included:

- 1) Peer-reviewed journals, peer-reviewed technical papers, and conference proceedings presenting research and development findings;
- 2) Data obtained from transmission and vehicle testing programs, carried out at EPA-NVFEL, ANL, and other contract laboratories;

¹⁹⁹ “Highlights of CO₂ and Fuel Economy Trends,” <https://www.epa.gov/fuel-economy-trends/download-report-co2-and-fuel-economy-trends>, Accessed Jan 12, 2017.

*** EO 12866 Review – Draft – Do Not Cite, Quote or Release During Review ***

- 3) Modeling results from simulation of current and future transmission configurations; and
- 4) Confidential data obtained from OEMs and suppliers on transmission efficiency.

For transmission testing programs, EPA contracted with FEV Engine Technologies to test specific transmissions in a transmission component test stand. The testing program was primarily designed to determine transmission efficiency and torque loss over a range of input speeds, input loads, and temperatures. In addition, other driveline parameters, such as transmission rotational inertia and torque converter K-factor were characterized. Two automatic transmissions have been characterized in this test program, which is still on-going. Torque loss maps were generated for both a six-speed 6T40 GM automatic transmission and an eight-speed 845RE FCA automatic transmission, see Figure 5-121 and Figure 5-122.

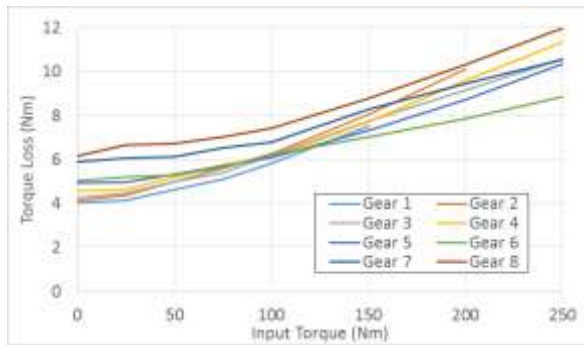

FIGURE 5-121 - AVERAGE TORQUE LOSSES IN EACH GEAR FOR AN EIGHT-SPEED 845RE TRANSMISSION²⁰⁰

²⁰⁰ From testing of a Ram pickup truck at 100 °C and with line pressures matching those measured in the vehicle. Torque losses are average more than 1000 rpm - 2500 rpm.

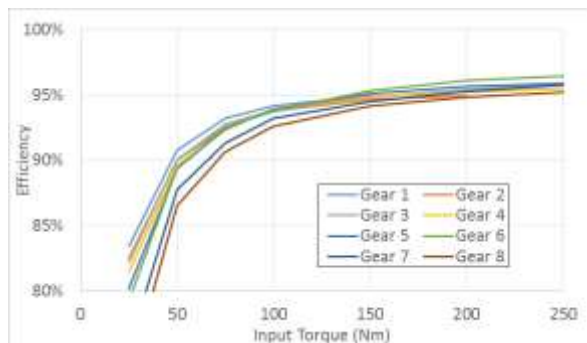

FIGURE 5-122 - AND EFFICIENCY (RIGHT) IN EACH GEAR FOR AN EIGHT-SPEED 845RE TRANSMISSION²⁰¹

In addition to contracting to test specific transmissions, NHTSA and EPA obtained torque loss maps and/or operational strategies for the current and future generation transmissions from manufacturers and suppliers. The estimates for effectiveness and assumptions on technology application in the CAFE model are partially informed by confidential business information supplied by vehicle manufacturers and suppliers and shared with the agencies. Information obtained from the manufacturers and suppliers included information on advanced CVTs and ATs.

This analysis has also leveraged work performed over the past 15 years by Argonne National Laboratory with Autonomie under funding from the U.S. Department of Energy. Argonne developed and validated shifting algorithms for multiple transmission technologies (i.e., automatic, CVT, DCT) and gear numbers (i.e., 6 and 8 speed transmissions), using vehicle test data from a large number of vehicles measured at Argonne’s Advanced Powertrain Research Facility.²⁰² Detailed instrumentation was also critical in developing component models and controls for advanced transmissions such as dual clutch.²⁰³ While specific transmission gear ratios and shifting algorithms were used during the validation process, a different approach was used to design the transmission gear ratios to properly quantify the effectiveness of the technology. Argonne used an algorithm published by Naunheimer, along with a range of

²⁰¹ From testing of a Ram pickup truck at 100 °C and with line pressures matching those measured in the vehicle. Torque losses are average more than 1000 rpm - 2500 rpm.

²⁰² Kim, N., Rousseau, N., Lohse-Bush, H. “Advanced Automatic Transmission Model Validation Using Dynamometer Test Data,” SAE 2014-01-1778, SAE World Congress, Detroit, April 2014.

²⁰³ Kim, N., Lohse-Bush, H., Rousseau, A. “Development of a model of the dual clutch transmission in Autonomie and validation with dynamometer test data,” *International Journal of Automotive Technologies*, March 2014, Volume 15, Issue 2, pp 263-271.

*** EO 12866 Review – Draft – Do Not Cite, Quote or Release During Review ***

constraints, to design their transmission gear ratios.²⁰⁴ A set of efficiencies for each gear was selected to represent today's leading technologies across all transmission types to ensure proper comparison. Calibration of the shifting algorithms was performed within a set of constraints to ensure proper driving quality. The constraints were defined based on vehicle test data.

Below is the list of transmissions that this analysis have considered for the NPRM analysis. The expansion of transmissions offerings are in line with industry developments and direction, and are expected to achieve fuel economy improvements, while also meeting durability, reliability, drivability and consumer acceptance needs. Further details of each transmission type are discussed below.

- 5-speed automatic (5AU)
- 6-speed automatic (6AU)
 - Level 1 Improvements
 - Level 2 Improvements
- 7-speed automatic (6AU)
- 8-speed automatic (8AU)
 - Level 1 Improvements
 - Level 2 Improvements
 - Level 3 Improvements
- 9-speed automatic (9AU)
- 10-speed automatic (10AU)
 - Level 1 Improvements
 - Level 2 Improvements
- 6-speed dual-clutch (6DCT)
- 8-speed dual-clutch (8DCT)
- Continuously variable (CVT)
 - Level 1 Improvements
 - Level 2 Improvements
- 5-speed manual (5DM)
- 6-speed manual (6DM)
- 7-speed manual (7DM)

Progressive transmission gear ratios have been designed for each transmission type considering trends in gear span and ratios, as well as expected differences in vehicle performance and energy consumption based on the transmission technology.

This analysis used the following criteria to select transmission gear ratios, final drive ratios, and shift parameters. The criteria were based on literature review and confidential business information from vehicle manufacturers and suppliers. In addition, this analysis used test data

²⁰⁴ Naunheimer, H. et al., "Automotive Transmissions – Fundamentals, Selection, Design and applications," Springer Publications.

*** EO 12866 Review – Draft – Do Not Cite, Quote or Release During Review ***

and information collected from multiple vehicles using Argonne’s APRF chassis dynamometer test facility.

- The vehicle should shift to top gear above a certain vehicle speed (i.e. 45 mph).
- In top gear, the engine should operate at or above a minimum engine speed (i.e. 1,250 rpm) to prevent engine lugging.
- The number of gear shifts for specific transmission on each cycle was defined using APRF vehicle test data. For example, for a 6-speed transmission, on the Urban Dynamometer Driving Schedule cycle, the number of shifts should be around 110 to 120 based on a review of chassis dynamometer test data. Note that this constraint is only evaluate after the simulations and is only used to highlight vehicles with potential drive quality issues.
- Gear span and final drive ratios should be based on industry trends.
- Engine operation will be restricted in the low-speed/high torque region to prevent noise, vibration, and harshness issues and ensure drive quality.
- The span of the 8-speed transmissions is higher than that of the 6-speed transmission.
- The span of the 8-speed DCT is slightly higher than the span of the 8-speed automatic to compensate for the lack of torque multiplication of the torque converter for the automatic transmission.
- DCT transmissions are modeled without a torque converter. As stated in Draft TAR, a significant majority of the DCT transmissions in the MY 2016 fleet do not use a torque converter device
- The vehicle should be able to meet or exceed Vehicle Technical Specifications (VTSs) related to grade (in first and top gear) and passing performance.
- For all advanced automatic transmissions, the torque converters lock-up in 2nd gear.
- For CVTs, vehicle application will have maximum torque limitations (i.e. less 250 ft-lbs)
- With introduction of performance classes to better capture the MY 2016 analysis fleet, the automatic transmissions will have two versions to be able to handler higher engine torques. This will be explained in the later sections for transverse versus longitudinal designs.

5.3.4 Automatic Transmissions

5.3.4.1 Automatic transmission overview

Conventional planetary automatic transmissions remain the most numerous type of transmission in the light duty fleet. These transmissions will typically contain at least three or four planetary gear sets, which are connected to provide the various gear ratios. Gear ratios are selected by activating solenoids which engage or release multiple clutches and brakes.

Automatic transmissions are packaged with torque converters, which provide a fluid coupling between the engine and the driveline, and provide a significant increase in launch torque. When transmitting torque through this fluid coupling, energy is lost due to the churning fluid. These

losses can be eliminated by engaging (“locking up”) the torque convertor clutch to directly connect the engine and transmission. A discussion of torque converter lockup is continued in the next section below.

In general, ATs with a greater number of forward gears (and the complementary larger ratio spread) offer more potential for fuel consumption reduction, but at the expense of higher control complexity. Transmissions with a higher number of gears offer a wider speed ratio and more opportunity to operate the engine near its most efficient point.

In the past few years, manufacturers have taken advantage of ATs with a greater number of forward gears to improve fuel economy. Four- and five-speed automatic transmissions, which dominated the market in 2005, have substantially declined in number, being replaced by six-speed and higher transmissions. In fact, the average number of AT gears in the fleet has rapidly increased, and in 2016 was above six for both cars and trucks.

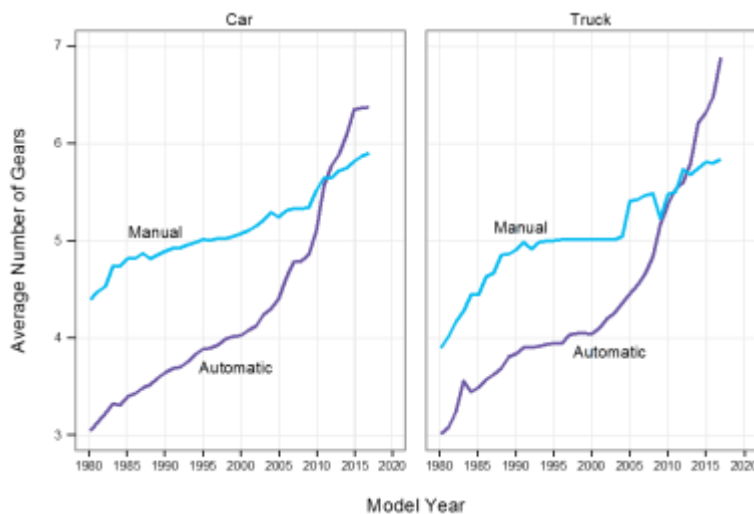

FIGURE 5-123 - AVERAGE NUMBER OF TRANSMISSION GEARS FOR NEW VEHICLES²⁰⁵

Seven-speed transmissions currently available include the RWD 7G-Tronic from Mercedes and the JATCO JR710E available in Nissan products. RWD eight-speed transmissions available include offerings from General Motors and Hyundai, as well as transmission suppliers Aisin and ZF. The ZF 8HP, introduced in 2009, has been incorporated into offerings from a range of manufacturers, including Fiat/Chrysler, Jaguar/Land Rover, and Volkswagen. ZF has begun

²⁰⁵ “Highlights of CO₂ and Fuel Economy Trends,” <https://www.epa.gov/fuel-economy-trends/download-report-co2-and-fuel-economy-trends>, Accessed Jan 12, 2017.

production of a second generation of 8HP transmissions (the 8HP50), which features a higher ratio spread, lower drag torque, and improved torsional vibration absorption compared to the first generation.²⁰⁶ Aisin also offers a FWD eight-speed used by multiple manufacturers. This includes use in the compact 2016 Mini Cooper Clubman, a vehicle smaller than those assumed eligible for eight-speed transmissions in the FRM.²⁰⁷

In the 2012 final rule for MYs 2017 and beyond, the agencies limited their consideration of the effect of additional gears to eight-speed transmissions. However, some ATs with more than eight gears are already in production, and more examples are in development. At this time, nine-speed transmissions are being manufactured by ZF²⁰⁸ (which produces a FWD nine-speed incorporated into Fiat/Chrysler, Honda, and Jaguar/Land Rover vehicles²⁰⁹) and Mercedes²¹⁰ (which produces a RWD nine-speed). In addition, Ford and General Motors have announced plans to jointly design and build nine-speed FWD transmissions and ten-speed RWD transmissions (2017 F150 and 2017 Camaro ZL1), and Honda is developing a ten-speed FWD transmission.²¹¹

Manufacturers have claimed substantial fuel consumption benefits associated with newer transmissions. ZF claims its first generation 8HP can reduce fuel consumption by 6% on the NEDC compared to a circa 2005 ZF 6HP, using the same engine, along with improving vehicle acceleration performance.²¹² ZF also outlined a series of potential improvements to the first generation 8HP that could provide an additional 5 to 6% fuel consumption reduction on the U.S. combined cycle.²¹³ The second generation ZF eight-speed²¹⁴ is expected to achieve up to 3% efficiency gain on the NEDC due to the improvements noted above; ZF also outlined additional

²⁰⁶ Start of Volume Production - New Generation of the ZF 8-Speed “Automatic Transmission in the BMW 5 Series,” August 21, 2014.

https://www.zf.com/corporate/en_de/magazine/magazin_artikel_viewpage_22067944.html.

²⁰⁷ Meiners, J. “2016 Mini Cooper Clubman Revealed - Another Bigger, Four-Door Mini,” *Car and Driver*, June 2015, <http://www.caranddriver.com/news/2016-mini-clubman-revealed-news>.

²⁰⁸ Gaertner, L. & Ebenhoch, M. “The ZF Automatic Transmission 9HP48 Transmission System, Design and Mechanical Parts,” *SAE Int. J. Passeng. Cars - Mech. Syst.* 6(2):908-917, 2013, doi - 10.4271/2013-01-1276.

²⁰⁹ “Land Rover to Demonstrate Latest Technical Innovation with The World’s First 9-Speed Automatic Transmission,” Land Rover Media Centre, February 27, 2013, http://newsroom.jaguarlandrover.com/en-in/land-rover/news/2013/02/tr_re_9-speed_transmission_270213/.

²¹⁰ Daimler. 2013. New Nine-Speed Automatic Transmission Debuts in the Mercedes-Benz E350 Blue Tec - Premier of the new 9G-Tronic. Daimler, July 24. <http://media.daimler.com/dcmmedia/0-921-1553299-1-1618134-1-0-1-0-0-0-1549054-0-1-0-0-0-0-0.html>.

²¹¹ Motor Authority - Technology Preview - We Drive Honda’s 10-Speed Automatic Transmission, http://www.motorauthority.com/news/1100878_technology-preview-we-drive-hondas-10-speed-automatic-transmission.

²¹² ZF, “Fuel Saving and Minimizing CO2 Emissions - 6% Lower Fuel Consumption,” <http://www.zf.com/>

²¹³ Dick, A., Greiner, J., Locher, A., & Jauch, F. “Optimization Potential for a State of the Art 8-Speed AT,” *SAE Int. J. Passeng. Cars - Mech. Syst.* 6(2):899-907, 2013, doi - 10.4271/2013-01-1272.

²¹⁴ The New Generation of 8-Speed Automatic Transmission, ZF http://www.zf.com/corporate/en_de/products/innovations/8hp_automatic_transmissions/8hp_automatic_transmission.html.

potential savings associated with a third generation eight-speed transmission.²¹⁵ Likewise, Mercedes claimed a 6.5% fuel consumption improvement on the NEDC with its nine-speed transmission compared to the previous seven-speed.²¹⁶ For the references in regards to fuel consumption improvement shown in NEDC, the values will be much higher than U.S. combined cycles due to a gap between NEDC and real-world.²¹⁷

In FWD vehicles, ZF claims its nine-speed FWD transmission reduces fuel consumption by 10% – 16% compared to an early- 2000s six-speed transmission.²¹⁸ Aisin claims its new FWD eight-speed transmission decreases fuel consumption 16.5% compared to an early generation six-speed, and nearly 10% compared to the previous generation six-speed.²¹⁹ In addition, the new eight-speed improves acceleration performance. BMW, using the Aisin FWD transmission, reports a 14% fuel consumption reduction on the NEDC over the previous six-speed transmission.²²⁰ Mercedes claims a total of 6.5% fuel economy improvement on the NEDC by using its nine-speed 9G-TRONIC in place of the earlier generation seven-speed.²²¹

These purported efficiency improvements are due to a range of design changes in the transmissions, in addition to improved interactions with complementary equipment. In addition to improving the engine operation efficiency through changing the number of gears, overall ratio, and shift points, these transmissions also reduce parasitic losses, change torque converter behavior, and/or shift to neutral during idle. Due to the complexity of interactions between the transmission and other vehicle technologies, this analysis relies on full vehicle simulations to estimate the effectiveness of additional transmission technology on a vehicle.

With the positive consumer acceptance, higher effectiveness, and increasing production of transmissions with up to ten forward gears, it may be possible that transmissions with even more gears will be designed and built before 2025. Researchers from General Motors have authored a study showing that there is some benefit to be gained from transmissions containing up to 10 speeds.²²² However, this appears to be near the limit for improved fuel consumption, and studies

²¹⁵ Greiner, J., Grumbach, M., Dick, A., & Sasse, C. “*Advancement in NVH- and Fuel-Saving Transmission and Driveline Technologies*,” SAE Technical Paper 2015-01-1087, 2015, doi - 10.4271/2015-01-1087.

²¹⁶ Dörr, C. “*The New Automatic Transmission 9G-TRONIC from Mercedes- Benz*,” presented at the 2014 CTI Symposium, Plymouth, MI.

²¹⁷ ICCT Report. “Real-world vehicle fuel consumption gap in Europe at all-time high.”

<http://www.theicct.org/publications/laboratory-road-2017-update>

²¹⁸ Greiner, J. & Grumbach, M. “*Automatic Transmission Systems Beyond 2020 - Challenges and Competition*,” SAE Technical Paper 2013-01-1273, 2013, doi - 10.4271/2013-01-1273.

²¹⁹ Driveline News, Jan 22 2014, “*BMW and Mini Strategy Revealed*,” <http://www.drivelinenews.com/transmission-insight/bmw-and-mini-transmission-strategy-revealed/>.

²²⁰ Nell, M. “BMW’s Flexible Powertrain Family with a New Generation of Transverse Automatic Transmissions,” presented at the 2014 Car Training Institute Transmission Symposium, Rochester, MI.

²²¹ Dörr, C. “*The New Automatic Transmission 9G-TRONIC*,” presented at the 2014 Car Training Institute Transmission Symposium, Rochester, MI.

²²² Robinette, D. & Wehrwein, D. “*Automatic Transmission Technology Selection Using Energy Analysis*,” presented at the CTI Symposium 9th International 2015 Automotive Transmissions, HEV and EV Drives.

have shown that there is no added potential for reduction in fuel consumption beyond nine or ten gears.^{223, 224} In fact, ZF CEO Stefan Sommer has stated that ZF would not design transmissions with more than nine gears - “We came to a limit where we couldn't gain any higher ratios. So the increase in fuel efficiency is very limited and almost eaten up by adding some weight and friction and even size of the transmission.”²²⁵ Although manufacturers may continue to add gears in response to consumer preference for other performance attributes, this analysis assumes that it is unlikely that further increases will provide fuel consumption benefits beyond that of optimized eight, nine or ten-speeds.

Recent development and publications by Aisin AW CO., Honda, Ford, and GM have identified release of new advanced transmissions into the mass market. Aisin AW Co. has introduced a new FWD 8-speed and RWD 10-speed transmission that have shown significant improvements in clutches and brakes, off-axis oil pump, reduction in mass, and increased area of torque converter lock-up area.^{226, 227} Honda has introduced the first FWD 10-speed automatic transmission. Compared to the previous 6-speed automatic, the 10AT is 22 lbs. lighter and has a 68% wider overall ratio range with a 43% lower first gear and a 17% taller top gear.²²⁸ Ford and GM has released a jointly developed RWD that has indicated fuel economy improvements over the existing 6-speed transmission.²²⁹ As discussed in these recent publications, these new transmissions are either replacing first level of 8-speed transmissions or 6-speed transmission in order to improvement fuel economy and performance.

5.3.4.2 Losses in ATs, Torque Converter, and Lockup Strategy

A study by ZF suggests that the largest sources of losses over the combined city/highway cycle in conventional automatic transmissions are the oil supply and the drag torque.²³⁰ This is followed by the creep torque (on the city cycle), with the electrical requirements and gearing efficiency being relatively minor.

²²³ Greiner, J., Grumbach, M., Dick, A. & Sasse, C. 2015, “*Advancement in NVH- and Fuel-Saving Transmission and Driveline Technologies*,” SAE technical paper 2015-01-1087

²²⁴ Robinette, D. 2014, “A DFSS Approach to Determine Automatic Transmission Gearing Content for Powertrain-Vehicle System Integration,” *SAE International Journal of Passenger Cars – Mechanical Systems* 7 (3).

²²⁵ Greimel, H. “ZF CEO - We're not chasing 10-speeds,” *Automotive News*, November 23, 2014, <http://www.autonews.com/article/20141123/OEM10/311249990/zf-ceo:-were-not-chasing-10-speeds>.

²²⁶ Masunaga, S., Miyazaki, T., Habata, Y., Yamada, K. et al. “Development of Innovative Toyota 10-Speed Longitudinal Automatic Transmission,” *SAE Int. J. Engines* 10(2):701-708, 2017, <https://doi.org/10.4271/2017-01-1099>.

²²⁷ Michikoshi, Y., Kusamoto, D., Ota, H., Ikemura, M. et al. “*Toyota New TNGA High-Efficiency Eight-Speed Automatic Transmission Direct Shift-8AT for FWD Vehicles*,” SAE Technical Paper 2017-01-1093, 2017, <https://doi.org/10.4271/2017-01-1093>.

²²⁸ “2018 Honda Accord Press Kit,” <http://hondanews.com/releases/2018-honda-accord-press-kit-overview>
²²⁹ <http://media.gm.com/media/us/en/gm/home.detail.html/content/Pages/news/us/en/2016/may/0511-10speed-gm.html>

²³⁰ Dick, A., Greiner, J., Locher, A., & Jauch, F. “Optimization Potential for a State of the Art 8-Speed AT,” *SAE Int. J. Passeng. Cars - Mech. Syst.* 6(2):899-907, 2013, doi - 10.4271/2013-01-1272.

For conventional ATs, power required to supply oil to the transmission is one of the largest sources of parasitic loss. An oil pump is required for lubrication and for hydraulic pressure for clamping the clutches. A baseline transmission would typically use a gerotor-type pump driven off the torque converter. Replacing or resizing the oil pump can result in a substantial decrease in torque losses. For example, Aisin claims a 33% reduction in torque loss in its new generation transmission from optimizing the oil pump,²³¹ and Mercedes claims a 2.7% increase in fuel economy on the NEDC by changing the pumping system.²³² Pump-related losses can be reduced by substituting a more efficient vane pump for the gerotor. Losses can be further reduced with a variable-displacement vane pump, and by reducing the pressure of the system. Losses can be further decreased by using an on-demand electric pump - Mercedes claims an additional 0.8% increase in fuel economy on the NEDC by implementing a lubrication on demand system.²³³ Another way to reduce losses from the pump is by reducing leakage in the system. Reducing leakage reduces parasitic losses by reducing the amount of fluid that needs to be pumped through the system to maintain the needed pressure.

A second large source of parasitic loss in ATs is the drag torque in the transmission from the clutches, brakes, bearings, and seals. These components have the potential to be redesigned for lower frictional losses. New clutch designs offer potential reductions in clutch drag, promising up to a 90% reduction in drag.²³⁴ Replacing bearings can reduce the associated friction by 50 to 75%. New low-friction seals for can reduce friction by 50% to provide an overall reduction in bearing friction loss of approximately 10%.²³⁵

Optimizing shift elements improved fuel economy on the Mercedes 9G-TRONIC by 1% over the NEDC.²³⁶

Drag torque can be further reduced by decreasing the viscosity of the automatic transmission fluid used to lubricate the transmission. A study of transmission losses indicates that an approximate 2% fuel consumption reduction was obtained on the FTP 75 cycle by switching to

²³¹ Aoki, T., Kato, H., Kato, N., & Masaru, M. “*The World’s First Transverse 8-Speed Automatic Transmission*,” SAE Technical Paper 2013-01-1274, 2013, doi - 10.4271/2013-01-1274.

²³² Dörr, C. “*The New Automatic Transmission 9G-TRONIC*,” presented at the 2014 Car Training Institute Transmission Symposium, Rochester, MI.

²³³ Dörr, C. “*The New Automatic Transmission 9G-TRONIC*,” presented at the 2014 Car Training Institute Transmission Symposium, Rochester, MI.

²³⁴ Martin, K. 2012. “*Transmission Efficiency Developments*,” SAE Transmission and Driveline Symposium - Competition for the Future, October 17-18. Detroit, Michigan. [as cited in NAS (2015), Prepublication Copy, p. 5-22.].

²³⁵ NSK Europe. 2014. “*New Low-Friction TM-Seal for Automotive Transmissions*,” <http://www.nskeurope.com/transmission-bearings-low-friction-tm-seal-2373.htm>.

²³⁶ Dörr, C. “*The New Automatic Transmission 9G-TRONIC*,” presented at the 2014 Car Training Institute Transmission Symposium, Rochester, MI.

the lowest viscosity oil.²³⁷ However, reduction of transmission fluid viscosity may have an adverse effect on long-term reliability.

Torque converters are typically associated with conventional ATs and CVTs, although they have appeared on Honda's newest eight-speed DCT. Torque converters provide increased torque to the wheels at launch, and serve as a torsional vibration damper at low engine speeds. However, this comes at the cost of energy loss in the torque converter fluid, and modern torque converters typically have a lockup clutch that mechanically locks the impeller and turbine together, bypassing the fluid coupling.

Although in the past torque converters remained unlocked up to high vehicle speeds, recent trends are to lock at much lower speeds. Improvements in torsional vibration dampers, and the ability to utilize micro-slip across the lockup clutch has enabled lower lockup speeds. Mazda, for example, claims torque converter lockup as low as 5 mph for its SKYACTIV-Drive AT.²³⁸ Although not as aggressive, BMW claims a 1% reduction in CO₂ from an early torque converter lockup.²³⁹

5.3.4.3 Automatic transmissions for Autonomie modeling

In the 2016 Draft TAR analysis, NHTSA had identified five automatic transmission technologies for adoption in the light duty fleet for MYs 2017-2025 – AT5, AT6, AT6P, AT8 and AT8P. For the NPRM analysis, it has been expanded the number of transmission technologies to include ten automatic transmission configurations based on new literature, press information, and information acquired in meetings with manufacturers and suppliers. Going from five to ten automatic transmissions allows this analysis to both capture the updated transmission technologies in the MY 2016 analysis fleet, and to incorporate future improvements in friction, lubrication, packaging, torque loss reduction and other incremental improvements.

TABLE 5-15 - FINAL DRIVE RATIO OF AUTOMATIC TRANSMISSIONS

Transmission Type	Number of Gears	ANL Final Drive Ratio Value
Automatic	5	3.31
Automatic	6	3.65
Automatic	7	3.13
Automatic	8	3.6
Automatic	9	3.3

²³⁷ Noles, J. 2013. "Development of Transmission Fluids Delivering Improved Fuel Efficiency by Mapping Transmission Response to Viscosity and Additive Changes," Presentation at the SAE Transmission & Driveline Symposium, Troy, Michigan, October 16-17. [as cited in NAS (2015), Prepublication Copy, p. 5-25.].

²³⁸ Weissler, P. 2011. "2012 Mazda3 Skyactiv achieves 40 mpg without stop/start." *Automotive Engineering Magazine*, October 28.

²³⁹ Nell, M. "BMW's Flexible Powertrain Family with a New Generation of Transverse Automatic Transmissions," presented at the 2014 Car Training Institute Transmission Symposium, Rochester, MI

*** EO 12866 Review – Draft – Do Not Cite, Quote or Release During Review ***

Automatic	10	3.31
-----------	----	------

*** EO 12866 Review – Draft – Do Not Cite, Quote or Release During Review ***

TABLE 5-16 - SUMMARY OF SIMULATION AUTOMATIC TRANSMISSION GEAR RATIOS

Simulation Name	Gear									
	1	2	3	4	5	6	7	8	9	10
5AU	3.85	2.3262	1.5039	1.0403	0.77					
5DM	3.85	2.2714	1.4339	0.9685	0.7					
6AU	4.074	2.4867	1.6241	1.135	0.8487	0.679				
6DM	4.074	2.4867	1.6241	1.135	0.8487	0.679				
6DCT	4.074	2.4867	1.6241	1.135	0.8487	0.679				
7AU	4.78	3.10	1.98	1.37	1.00	0.87	0.78			
7DM	4.298	2.624	1.7141	1.1981	0.8961	0.7171	0.614			
8AU	4.284	2.6593	1.7763	1.2553	0.9546	0.7768	0.6763	0.63		
8DCT	4.284	2.6593	1.7763	1.2553	0.9546	0.7768	0.6763	0.63		
9AU	4.69	2.902	1.9213	1.3611	1.0317	0.8368	0.7262	0.6743	0.67	
10AU	4.7	2.99	2.15	1.8	1.52	1.28	1	0.85	0.69	0.64
CVT	Ratios from 0.529 to 3.172									
CVTp	Ratios from 0.45 to 3.6									
Planetary Gear	Sun = 30, Ring = 78									
Voltec	Sun = 37, Ring = 83									

TABLE 5-17 - SUMMARY OF SIMULATION AUTOMATIC TRANSMISSION GEAR SPAN VALUES

Transmission Type	Number of Gears	ANL Value
Automatic	5	5.00
Automatic	6	6.00
Automatic	7	6.16
Automatic	8	6.80
Automatic	9	7.00
Automatic	10	7.34

TABLE 5-18 - SIMULATION AUTOMATIC TRANSMISSION SELECTIONS

Simulation Name	Transmission Type	Description/ Source
5AU	5-speed automatic (premium class)	1:1 ratio efficiency from 6AU (premium) and use rule to generate the efficiency for other ratios
6AU	6-speed automatic (base class)	Transmission used for low-torque engines. Source - U.S. EPA test data – GM 6T40
6AU	6-speed automatic (premium class)	Transmission used for high-torque engines Source -
6AU _p	6-speed automatic+	1:1 ratio efficiency from 8AU+ and use rule to generate the efficiency for other ratios
7AU _p	7-speed automatic+	1:1 ratio efficiency from 8AU+ and use rule to generate the efficiency for other ratios
8AU	8-speed automatic	Source - U.S. EPA test data – Ram 845RE
8AU _p	8-speed automatic+	845RE (8AU) with improved efficiency (NHTSA data)
8AU _{pp}	8-speed automatic++	845RE (8AU) with improved efficiency (NHTSA data)
9AU _p	9-speed automatic+	1:1 ratio efficiency from 8AU+ and use rule to generate the efficiency for other ratios
10AU _p	10-speed automatic+	1:1 ratio efficiency from 8AU+ and use rule to generate the efficiency for other ratios
10AU _{pp}	10-speed automatic++	1:1 ratio efficiency from 8AU++ and use rule to generate the efficiency for other ratios

Like engines, transmissions in the market always include multiple improvements from one generation to the next (such as increased gear number and efficiency). The objective of the transmission selection was to separate the benefits of increased gear number from those of improved efficiency. For example, 6AT to 8AT is used to quantify the effectiveness of increased gear span and gear number while 8AT to 8AT Level 2 quantifies the impact of efficiency. As a result, while the test data were used to model several transmissions, a rule was used to develop some transmission models to ensure appropriate effectiveness value.

5.3.4.3.1 Automatic transmission efficiency

In the equations below, τ is the normalized torque (Torque/Max rated input torque). In the specific data set that was used to generate these equations, the maximum torque was taken to be 450 Nm.

The maximum efficiency is given by

$$\eta = 100 - 1.385 \times \tau^{-1.0127} \quad (1)$$

The temperature dependence is considered as a function of torque for temperatures ranging from $T = 38\text{ }^{\circ}\text{C}$ to $T = 93\text{ }^{\circ}\text{C}$:

$$\Delta\eta = 0.3612 \times \tau^{-0.9238} \quad (2)$$

The speed dependence is a function of input torque, for speeds ranging from 500 rpm to 5000 rpm:

$$\Delta\eta = 0.6394 \times \tau^{-1.3068} \quad (3)$$

The efficiency data is generated using the following steps:

- Start with the “maximum efficiency curve,” which essentially represents the efficiency for direct drive (1:1 ratio) at 93°C.
- The temperature offset is applied when calculating efficiency at 38°C.
- The speed offset is applied.
- The gear ratio other than the direct drive is scaled.

Figure 5-124 shows the plot of the efficiency for direct drive, for the range of temperatures and speeds considered. For other gears, the results are scaled down by a factor ranging between 0.97 and 1.0.

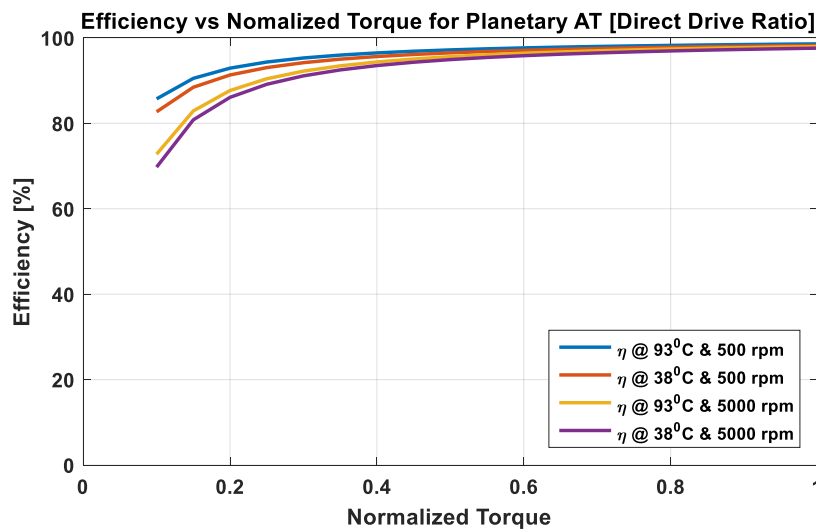

FIGURE 5-124 - EFFICIENCY FOR DIRECT DRIVE

5.3.4.4 TRANSMISSION – 5AU Base and Performance

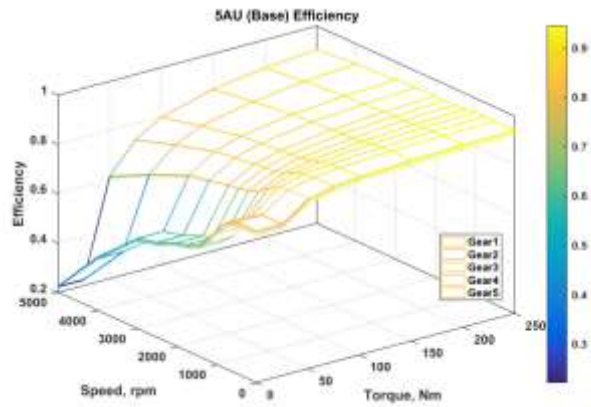

FIGURE 5-125 - EFFICIENCY MAP OF 5-SPEED AUTOMATIC - NON-PERFORMANCE CLASSES

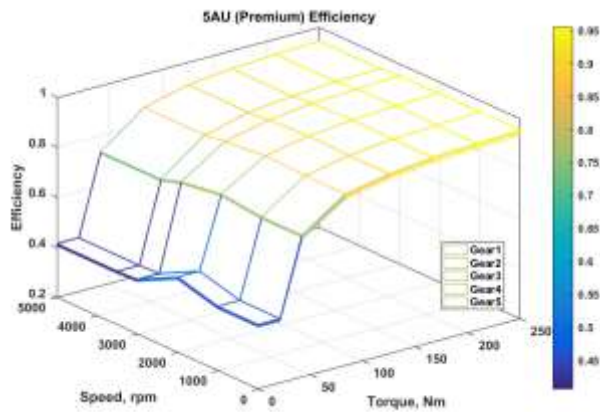

FIGURE 5-126 - EFFICIENCY MAP OF 5-SPEED AUTOMATIC - PERFORMANCE CLASSES

For this NPRM analysis, NHTSA’s 5-speed transmission has been carried over from the 2016 Draft TAR for the base vehicles and new performance transmission maps have been developed. This technology is still utilized by the low-cost vehicles that are still part of the MY 2016 analysis fleet. These transmissions were developed based on the benchmarked 6-speed automatic as discussed in section 5.3.3.2 using the 1:1 ratio of each gear.

5.3.4.5 TRANSMISSION – AU6 Level 1 and Level 2

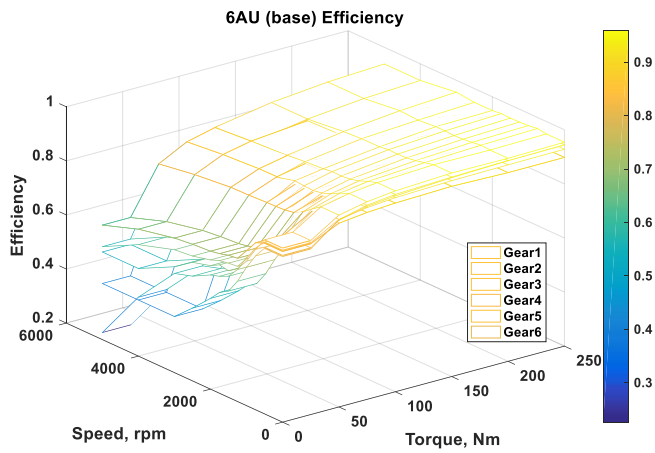

FIGURE 5-127 - EFFICIENCY MAP - BASE 6-SPEED AUTOMATIC LEVEL 1

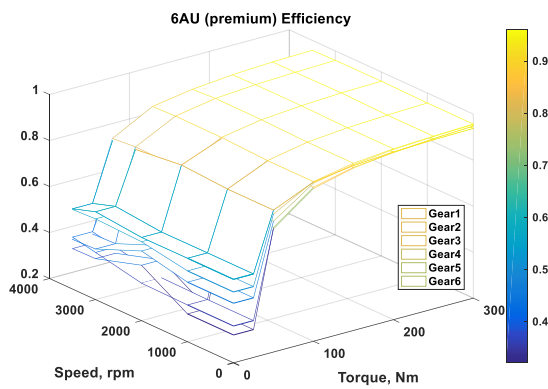

FIGURE 5-128 - EFFICIENCY MAP - PERFORMANCE 6-SPEED AUTOMATIC LEVEL 1

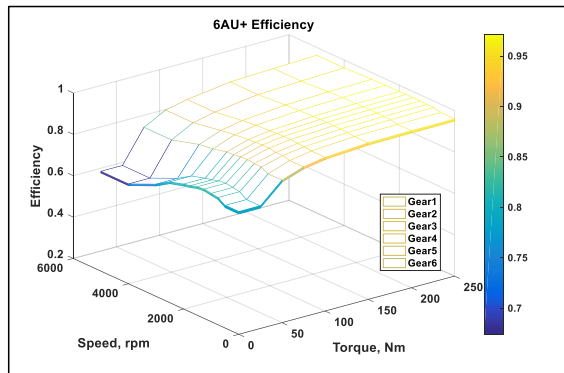

FIGURE 5-129 - EFFICIENCY MAP - 6-SPEED AUTOMATIC LEVEL 2

For this NPRM analysis, we carried over the 2016 Draft TAR six-speed transmission. Figure 5-120 shows that the six-speed transmission is still a dominant option for gearbox in MY 2016. For the two levels of improvements in the six-speed transmission, NHTSA differentiated the two by the drivetrain configuration of RWD and FWD, for cars and trucks. The agencies received feedback from vehicle manufacturers on the potential torque limitation of vehicles with advanced six-speed transmissions that also have towing performance requirements. Some supporting information for this feedback included confidential business information shared with the agencies.

5.3.4.6 TRANSMISSION – AU7

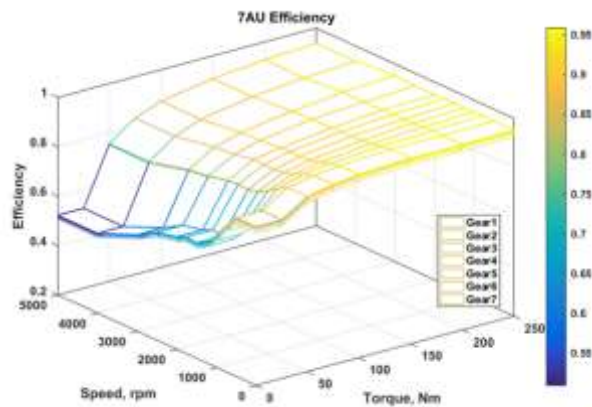

FIGURE 5-130 - EFFICIENCY MAP - 7-SPEED AUTOMATIC

The seven-speed transmission developed for this NPRM is based on the efficiencies of the eight-speed transmission level 2. In the MY 2016 analysis fleet, manufacturers have incorporated seven-speed automatics transmissions that NHTSA would consider an improvement over the existing five or six-speed transmissions. In practice, this transmission was meant to simulate 7-speed transmissions typically found in European sedans in MY 2016. The CAFE model does not build additional 7-speed automatic transmissions.

5.3.4.7 TRANSMISSION – AU8 Level 1, Level 2 and Level 3

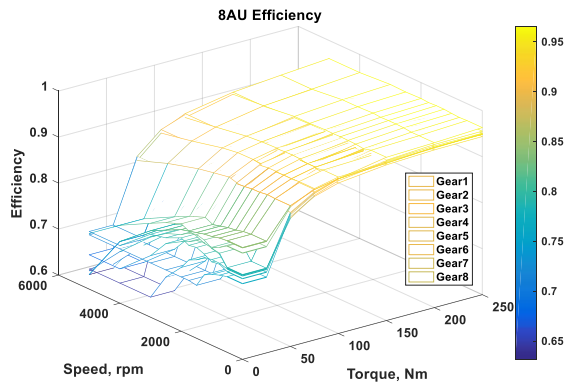

FIGURE 5-131 - EFFICIENCY MAP - 8-SPEED AUTOMATIC LEVEL 1

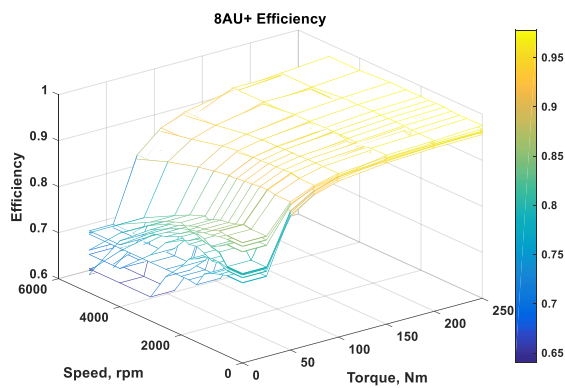

FIGURE 5-132 - EFFICIENCY MAP - 8-SPEED AUTOMATIC LEVEL 2

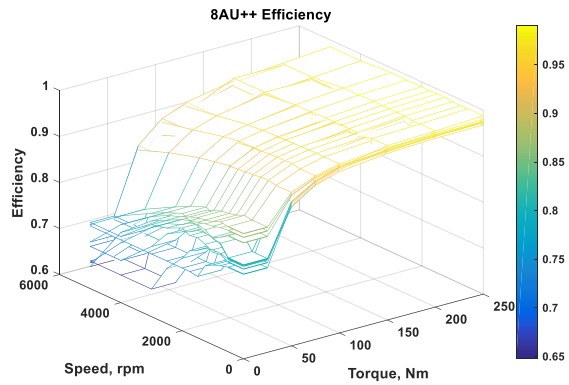

FIGURE 5-133 - EFFICIENCY MAP - 8-SPEED AUTOMATIC LEVEL 3

In the 2016 Draft TAR analysis, NHTSA offered two levels of eight-speed transmission. For the NPRM analysis, we have split the eight-speed transmission into three levels. The first level represents the first generation of eight-speed transmissions introduced in market. The second level introduces improvements oil supply and drag losses. The third level further improves oil supply and drag losses over the second-level eight-speed.

5.3.4.8 TRANSMISSION – AU9

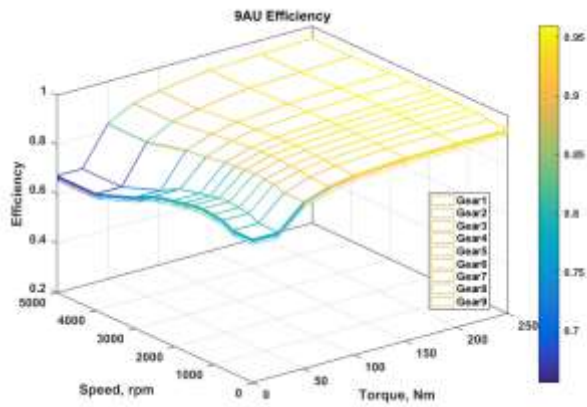

FIGURE 5-134 - EFFICIENCY MAP FOR THE 9-SPEED AUTOMATIC

Like the seven-speed automatic transmission, this nine-speed transmission was developed based on the efficiencies of the eight-speed transmission level 2. In the MY 2016 analysis fleet, manufacturers have incorporated nine-speed automatics transmissions that NHTSA would consider an improvement over the existing five or six-speed transmissions. The CAFE model does not build additional 9-speed automatic transmissions.

5.3.4.9 TRANSMISSION – AU10 Level 1 and Level 2

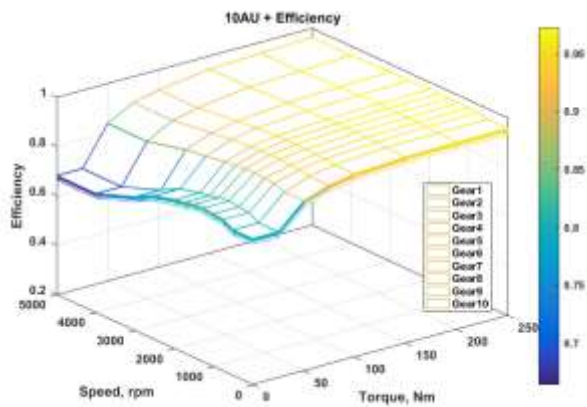

FIGURE 5-135 - EFFICIENCY MAP FOR THE 10-SPEED AUTOMATIC LEVEL 1

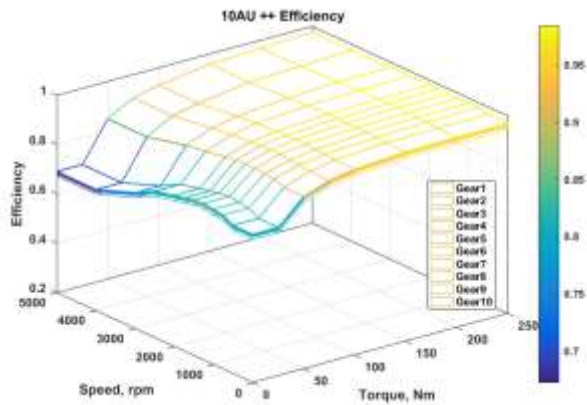

FIGURE 5-136 - EFFICIENCY MAP FOR THE 10-SPEED AUTOMATIC LEVEL 2

In the 2016 Draft TAR analysis, NHTSA did not model any ten-speed transmissions. For this NPRM analysis, two efficiency levels of the ten-speed automatic transmission was introduced. The first level represents the first generation of ten-speed transmissions introduced in market, with the efficiency values based on the efficiencies of the eight-speed transmission level 2. The second level of the ten-speed transmission is based on the eight-speed transmission level 3.

5.3.4.10 Torque Converter Lock-up Maps

Torque converter lock-up maps have been updated since the 2016 Draft TAR using test data.

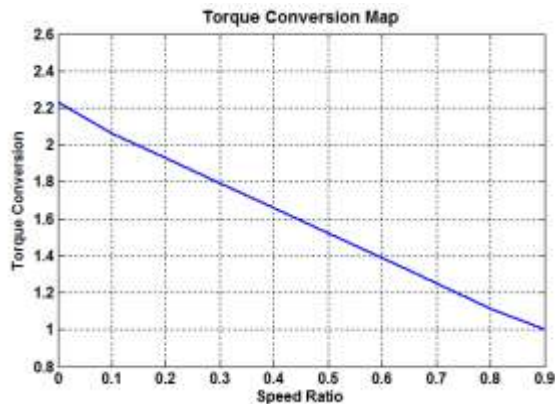

FIGURE 5-137 - BASE VEHICLE TORQUE CONVERTER LOCK UP MAP

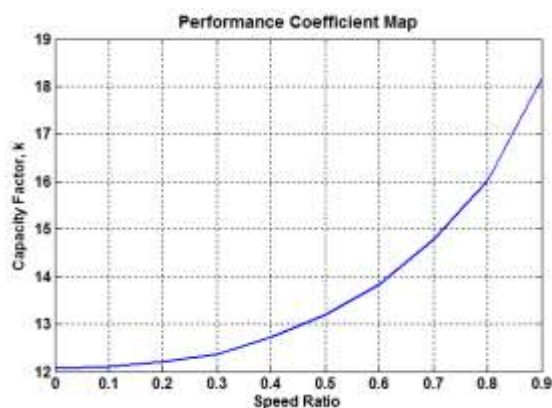

FIGURE 5-138 - PERFORMANCE VEHICLE TORQUE CONVERTER LOCK UP MAP

5.3.5 Continuously Variable Transmissions (CVT)

Conventional continuously variable transmissions consist of two cone-shaped pulleys, connected with a belt or chain. Moving the pulley halves allows the belt to ride inward or outward radially on each pulley, effectively changing the speed ratio between the pulleys. This ratio change is smooth and continuous, unlike the step changes of other transmission varieties. CVTs were not chosen in the fleet modeling for the MY 2017-2025 analysis because of the predicted low effectiveness associated with CVTs (due to the high internal losses and narrow ratio spans of CVTs in the fleet at that time). However, improvements in CVTs in the current fleet have increased their effectiveness, leading to increased adoption rates in the fleet. In their 2015 report, the NAS recommended CVTs be added to the list of considered technologies, and the agencies are accordingly re-evaluating the cost and effectiveness numbers for this analysis.

One advantage of CVTs is that they continue to transmit torque during ratio changes. In ATs and some DCTs, energy from the engine is wasted during a ratio change or shift. ATs and some DCTs have a hesitation during shifts caused by the torque disruption during gear changes. As mentioned above, ATs' efficiency peaks with 9 to 10 gears, while going to a CVT (with an effectively "infinite" number of gear steps) adds a new level of efficiency to the overall system. This is in part due to the fact that CVTs do not need to stop transmitting torque to change ratios.

Another advantage of a CVT is that, within its ratio range, it can maintain engine operation closer to the maximum efficiency for the required power. CVTs were not considered in the final rule for MYs 2017 and beyond because, at the time, CVTs had a ratio range of near 4.0, limiting

the range where the engine operation could be optimized. In addition, the CVTs were less than 80% efficient,²⁴⁰ and thus required more total output energy from the engine.

However, CVTs have demonstrated some limitations. The launch, acceleration and ratio variation characteristics of powertrains with CVTs may be significantly different than ATs leading to consumer complaints. Several manufacturers have told the agencies that they employ strategies that mimic AT shifting under some conditions for to address these issues. Also, some manufacturers have encountered significant engineering challenges in employing CVTs for use in high torque or high load applications.

Nonetheless, in the recent past, manufacturers and suppliers have intensified development of CVTs, reducing the parasitic losses and increasing the ratio spread. The current generation of CVT is now nearly 85% efficient, with ongoing work by suppliers to push that number to 90%.²⁴¹ Ratio spreads for new CVTs from Honda, Toyota, and JATCO now range between 6.0 and 7.0.^{242, 243, 244} JATCO has introduced a very small CVT that has a two speed output with take a CVT with a small ratio spread and doubles it for an overall ratio spread of 7.3²⁴⁵ in the base version and 8.7 in the “wide range” version.²⁴⁶ As in ATs and DCTs, it is expected that additional increase in ratio range above the current ranges will not significantly decrease fuel consumption and resulting CO₂ emissions.²⁴⁷

Reducing losses in CVTs has been a particular focus of manufacturers. The JATCO CVT8 featured a 40% reduction in mechanical losses compared to their earlier generation CVT.²⁴⁸ The losses were reduced by decreasing the size of the oil pump, implementing a new, higher efficiency belt, and reducing the fluid churning losses. Honda's new compact car CVT increased efficiency 1% to 1.5% at higher vehicle speeds compared to their previous generation CVT.²⁴⁹

²⁴⁰ Morihiro, S. “*Fuel Economy Improvement by Transmission*,” presented at the CTI Symposium 8th International 2014 Automotive Transmissions, HEV and EV Drives.

²⁴¹ Nakasaki, M. & Oota, Y. “*Key Technologies Supporting Belt-type CVT Evolution*,” presented at the 2014 Car Training Institute Transmission Symposium, Rochester MI.

²⁴² Maruyama, F., Kojima, M., & Kanda, T. “*Development of New CVT for Compact Car*,” SAE Technical Paper 2015-01-1091, 2015, doi - 10.4271/2015-01-1091.

²⁴³ Hakamagi, J., Kono, T., Habuchi, R., Nishimura, N. et al. “*Development of New Continuously Variable Transmission for 2.0-Liter Class Vehicles*,” SAE Technical Paper 2015-01-1101, 2015, doi - 10.4271/2015-01-1101.

²⁴⁴ Shimokawa, Y. “*Technology Development to Improve JATCO CVT8 Efficiency*,” SAE Technical Paper 2013-01-0364, 2013, doi - 10.4271/2013-01-0364.

²⁴⁵ Brooke, L. “JATCO's Next-Gen CVTs bring High Ratio Spreads, More Efficiency,” *Automotive Engineering Magazine*, April 23, 2012, <http://articles.sae.org/10947/>.

²⁴⁶ Naotoshi, P. “*Development of a New Generation CVT with Auxiliary Gear Box*,” SAE Technical Paper 2016-01-1109, 2016, doi - 10.4271/2016-01-1109.

²⁴⁷ Naotoshi, P. “*Development of a New Generation CVT with Auxiliary Gear Box*,” SAE Technical Paper 2016-01-1109, 2016, doi - 10.4271/2016-01-1109.

²⁴⁸ Shimokawa, Y. “*Technology Development to Improve JATCO CVT8 Efficiency*,” SAE Technical Paper 2013-01-0364, 2013, doi - 10.4271/2013-01-0364.

²⁴⁹ Maruyama, F., Kojima, M., and Kanda, T. “*Development of New CVT for Compact Car*,” SAE Technical Paper 2015-01-1091, 2015, doi - 10.4271/2015-01-1091.

The increased efficiency was primarily due to a reduction in oil pump losses and bearing friction. Honda's new midsize CVT increased efficiency by up to 5% compared to the earlier generation CVT, primarily by reducing the required hydraulic pressure (by up to 38%).²⁵⁰ Toyota's new K114 CVT reduced torque losses by 22%, compared to the earlier generation of CVTs, primarily by reducing the losses associated with the oil pump, and reducing the size of the bearings.²⁵¹

The JATCO CVT8 demonstrated a 10% improvement in fuel economy for both the highway and city cycles compared to earlier generation CVTs.²⁵² Honda's new compact car CVT increased fuel economy approximately 7% compared to the earlier generation CVT over both the U.S. test cycle and the Japanese JC08 test cycle.²⁵³ Honda's new midsize CVT increased fuel economy 10% over the earlier generation 5AT on the U.S. cycle, and 5% compared to the earlier generation CVT on the Japanese JC08 test cycle.²⁵⁴ Toyota's new K114 CVT increased fuel economy by 17% on the Japanese JC08 test cycle compared to the earlier generation CVT.²⁵⁵ Similar to other automatic transmissions, this analysis rely on full-vehicle simulations to consider complex interactions between CVT's and complementary engine and vehicle technologies to assess effectiveness values.

Initial introductions of CVTs suffered from consumer acceptance issues, where customers complained of the "rubber band" feel of the transmission, due to the indirect connection between the driver's throttle input and the vehicle's acceleration response. To combat this perception, vehicle manufacturers have added a shift feel calibration to the CVT control strategy, which mimics the feel of a conventional AT.²⁵⁶ This calibration, although having a slight effect on fuel economy, has improved consumer acceptance.²⁵⁷

Nissan continued improving their third generation of The Xtronic CVT with D-Step Logic Control in both performance and fuel economy.²⁵⁸ As discussed by Nissan, "In the 2016 Versa and 2016 Sentra models equipped with third-generation XTRONIC transmission, the gear ratio

²⁵⁰ Inukai, K., Shibahara, A., Uchino, T., Keiichi, N. et al. "Development of High-Efficiency New CVT for Midsize Vehicle," SAE Technical Paper 2013-01-0365, 2013, doi - 10.4271/2013-01-0365.

²⁵¹ Hakamagi, J., Kono, T., Habuchi, R., Nishimura, N. et al. "Development of New Continuously Variable Transmission for 2.0-Liter Class Vehicles," SAE Technical Paper 2015-01-1101, 2015, doi - 10.4271/2015-01-1101.

²⁵² Shimokawa, Y. "Technology Development to Improve JATCO CVT8 Efficiency," SAE Technical Paper 2013-01-0364, 2013, doi - 10.4271/2013-01-0364.

²⁵³ Maruyama, F., Kojima, M., and Kanda, T. "Development of New CVT for Compact Car," SAE Technical Paper 2015-01-1091, 2015, doi - 10.4271/2015-01-1091.

²⁵⁴ Inukai, K., Shibahara, A., Uchino, T., Keiichi, N. et al. "Development of High-Efficiency New CVT for Midsize Vehicle," SAE Technical Paper 2013-01-0365, 2013, doi - 10.4271/2013-01-0365.

²⁵⁵ Hakamagi, J., Kono, T., Habuchi, R., Nishimura, N. et al. "Development of New Continuously Variable Transmission for 2.0-Liter Class Vehicles," SAE Technical Paper 2015-01-1101, 2015, doi - 10.4271/2015-01-1101.

²⁵⁶ Inoue, M. "Advanced CVT Control to Achieve Both Fuel Economy and Drivability," presented at the 2015 Car Training Institute Transmission Symposium, Novi, MI.

²⁵⁷ Nakasaki, M. & Oota, Y. "Key Technologies Supporting Belt-type CVT Evolution," presented at the 2014 Car Training Institute Transmission Symposium, Rochester, MI.

²⁵⁸ "The Xtronic Continuously Variable Transmission®" July 13, 2017 <https://www.nissanusa.com/blog/xtronic-cvt-continuously-variable-transmission> Accessed February 21, 2018.

*** EO 12866 Review – Draft – Do Not Cite, Quote or Release During Review ***

range from low to high is expanded. In fact, the transmission ratio is 7.3:1, which is a broader ratio than you'll find in an average automatic, and far superior to the 6.0:1 you'd find in a similar model vehicle. The CVT is more streamlined, too, as it is 13% lighter and 10% smaller. The goal is to ensure the fuel efficiency improves at least 10%.” Nissan’s Xtronic CVT has been equipped in all of the passenger and crossover vehicles offered in MY 2016, MY 2017 and MY 2018.

In this document, only conventional belt or chain CVTs are considered. At least two other technologies – toroidal CVTs and Dana’s VariGlide® technology²⁵⁹ – are under development and may be available in the 2020-2025 timeframe. The Dana VariGlide is considered a CVP (Continuously Variable Planetary), with the major design difference being that it uses balls to transmit torque and vary the ratio.

5.3.5.1 Losses in CVTs

CVTs tend to have higher losses than either ATs or DCTs, in large part due to the high oil pressures required to keep the belt and pulleys securely clamped. These losses increase significantly at high input torques, as even higher pressures are required to maintain the clamping force.²⁶⁰

A study by JATCO suggests that losses in the CVT are dominated by oil pump torque and losses in the belt-pulley system, with fluid churning losses as the next largest player.²⁶¹ By reducing leakage in the oil system and reducing line pressure when possible, JATCO’s CVT8 was able to run with a reduced size oil pump and considerable reduction in oil pump torque loss. JATCO also redesigned the belt for lower loss, and reduced the oil level and viscosity to reduce churning losses. The overall result was a 40% reduction in mechanical losses compared to the earlier generation CVT.

Honda developed a new CVT using a comparable strategy.²⁶² They decreased the required pulley thrust by refining the control strategy and by using a fluid with increased coefficient of friction, which combined for a transmission efficiency increase of 2.8%. They also altered the belt trajectory around the pulley for an added 0.4% efficiency increase.

5.3.5.2 CVT definition in Autonomie

Table below shows the assumptions for the CVT technologies.

²⁵⁹ Dana Holding Corp. 2014. “Dana Advances Development of VariGlide™ Continuously Variable Planetary Technology,” PR Newswire, May 19. <http://www.prnewswire.com/news-releases/dana-advances-development-of-varioglide-continuously-variable-planetary-technology-259791981.html>.

²⁶⁰ NAS (2015), Prepublication Copy, p. 5-27.

²⁶¹ Shimokawa, Y. “Technology Development to Improve JATCO CVT8 Efficiency,” SAE Technical Paper 2013-01-0364, 2013, doi - 10.4271/2013-01-0364.

²⁶² Ando, T., Yagasaki, T., Ichijo, S., Sakagami, K. et al. “Improvement of Transmission Efficiency in CVT Shifting Mechanism Using Metal Pushing V-Belt,” *SAE Int. J. Engines* 8(3):1391-1397, 2015, doi - 10.4271/2015-01-1103.

*** EO 12866 Review – Draft – Do Not Cite, Quote or Release During Review ***

TABLE 5-19 - NPRM CVT SELECTION

Simulation Name	Transmission Type	Description/ Source
CVT	CVT	Source - ANL ²⁶³
CVTp	CVT+	CVT with improved efficiency (NHTSA data)

5.3.5.3 TRANSMISSION – CVT Level 1

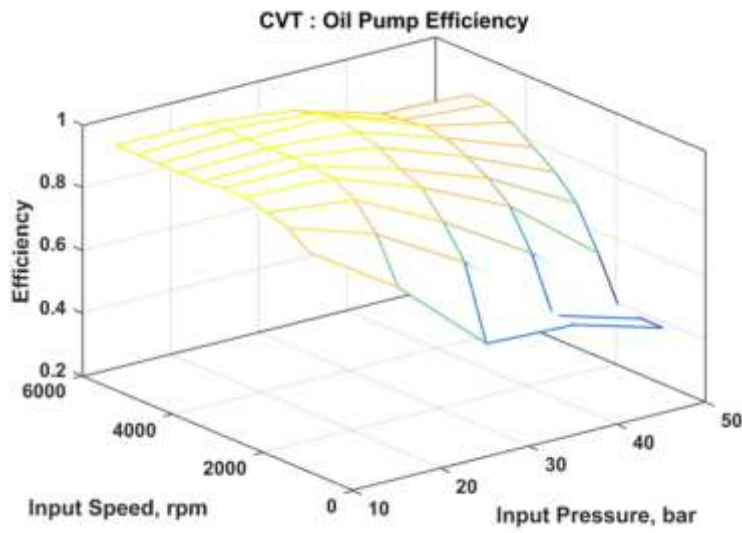

FIGURE 5-139 - OIL PUMP EFFICIENCY MAP OF CVT LEVEL 1

²⁶³ Hanho Son, N. K. (2015). Development of Performance Simulation for a HEV with CVT and Validation with Dynamometer Test Data. Presented at the 28th International Electric Vehicle Symposium (EVS28). Kintex, Korea.

*** EO 12866 Review – Draft – Do Not Cite, Quote or Release During Review ***

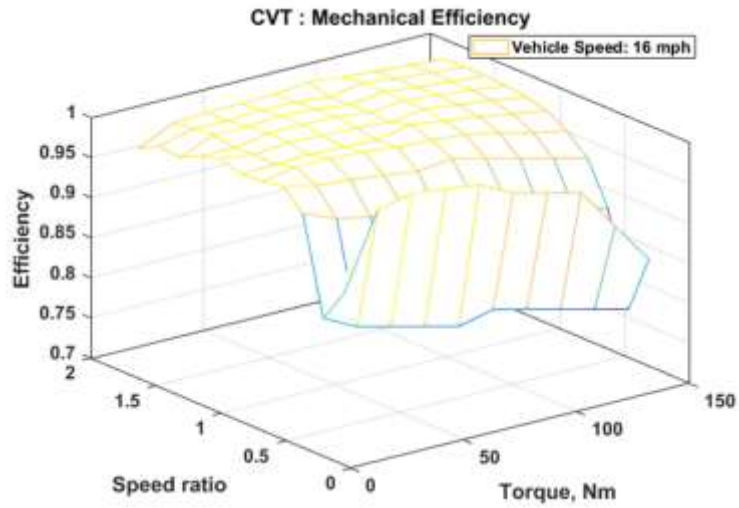
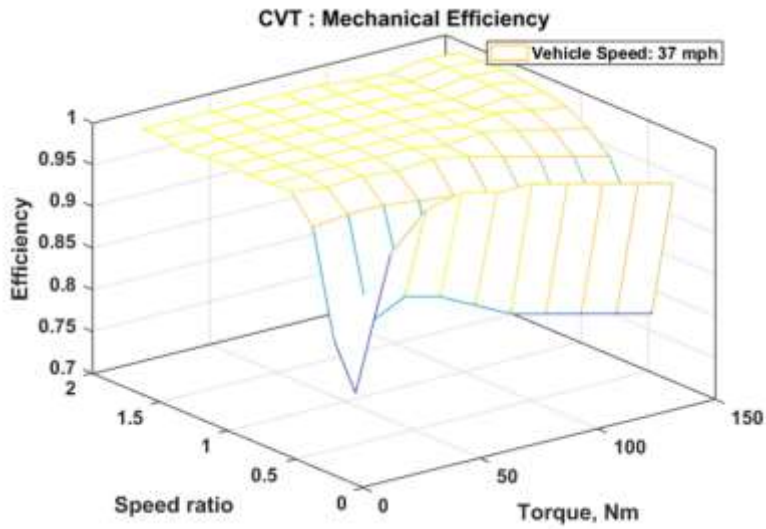

FIGURE 5-140 - MECHANICAL EFFICIENCY MAP OF CVT LEVEL 1 AT 16 MPH



*** EO 12866 Review – Draft – Do Not Cite, Quote or Release During Review ***

FIGURE 5-141 - MECHANICAL EFFICIENCY MAP OF CVT LEVEL 1 AT 37 MPH

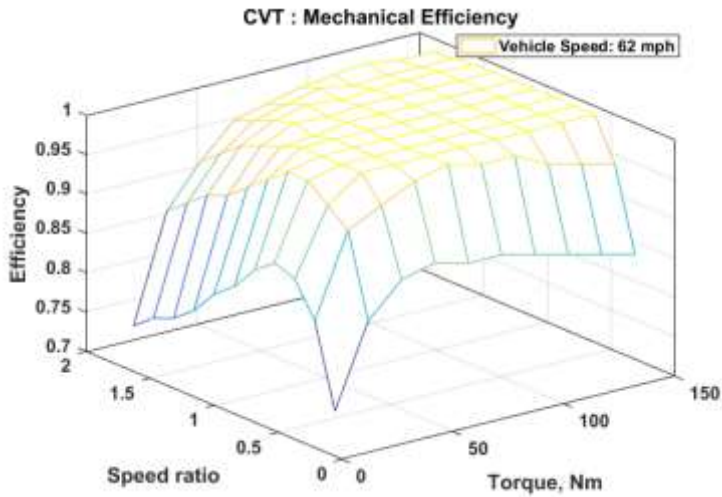
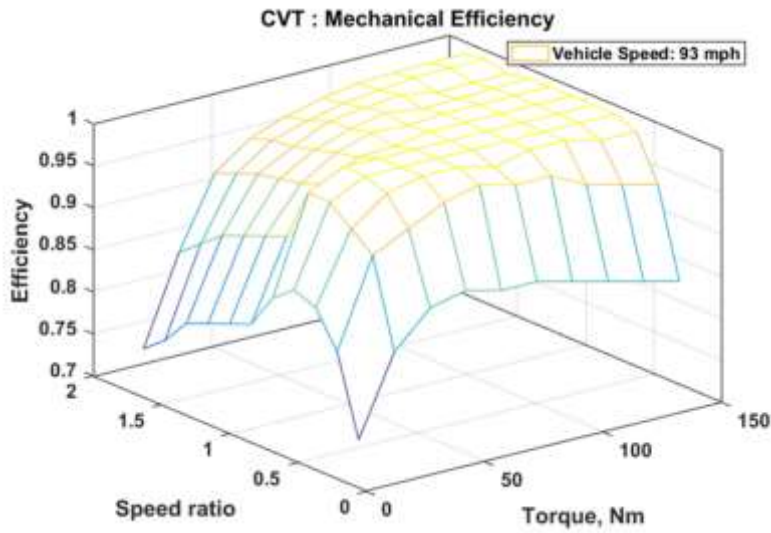

FIGURE 5-142 - MECHANICAL EFFICIENCY MAP OF CVT LEVEL 1 AT 62 MPH



*** EO 12866 Review – Draft – Do Not Cite, Quote or Release During Review ***

FIGURE 5-143 - MECHANICAL EFFICIENCY MAP OF CVT LEVEL 1 AT 93 MPH

In this NPRM analysis, CVT level 1 technology was carried over from the 2016 Draft TAR analysis. The details of the CVT map can be found in the Autonomie documentation report.

5.3.5.4 Transmission – CVT Level 2

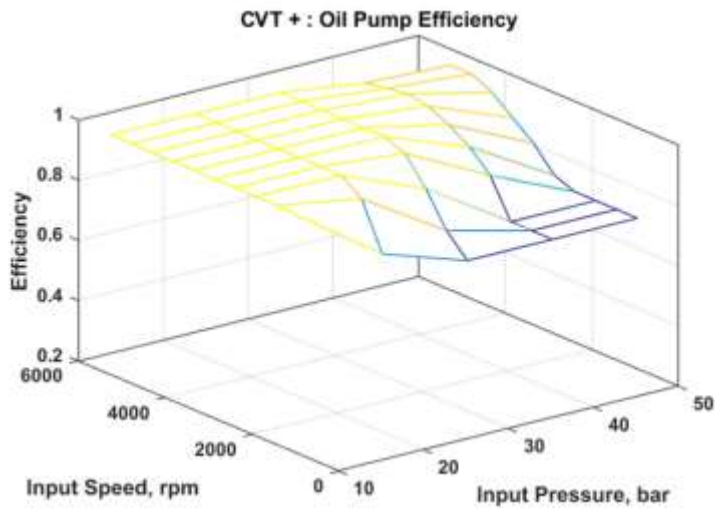

*** EO 12866 Review – Draft – Do Not Cite, Quote or Release During Review ***

FIGURE 5-144 - OIL PUMP EFFICIENCY MAP OF CVT LEVEL 2

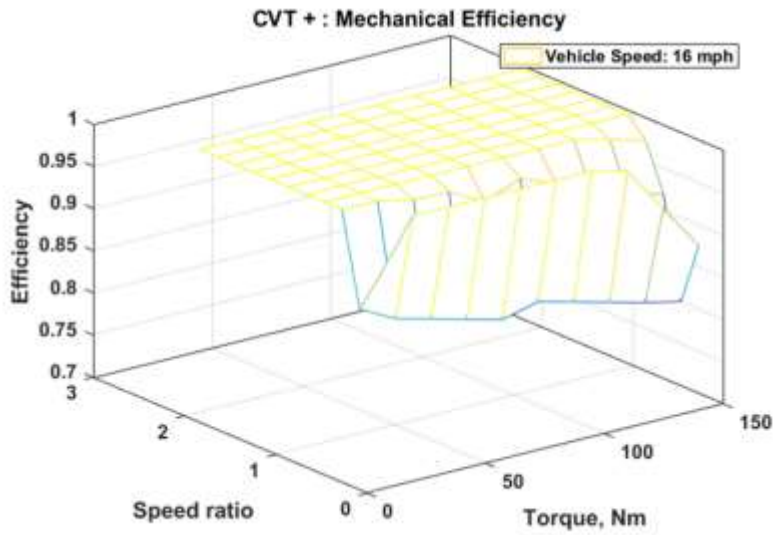
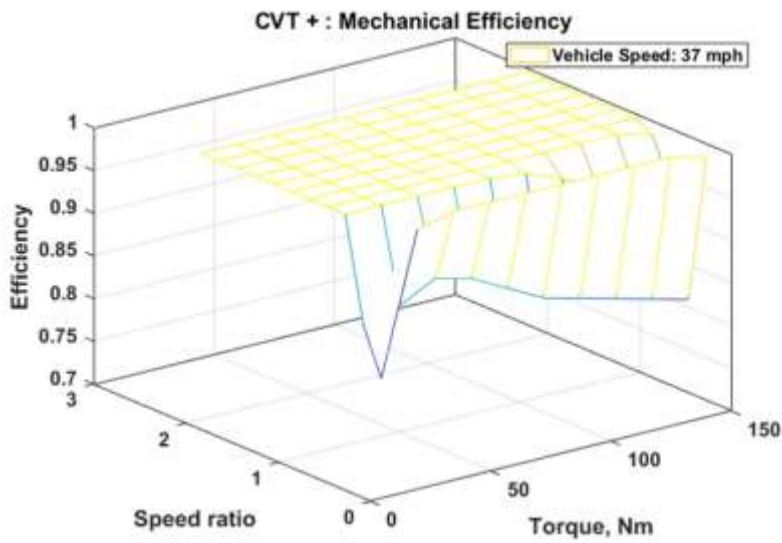

FIGURE 5-145 - MECHANICAL EFFICIENCY MAP OF CVT LEVEL 2 AT 16 MPH



*** EO 12866 Review – Draft – Do Not Cite, Quote or Release During Review ***

FIGURE 5-146 - MECHANICAL EFFICIENCY MAP OF CVT LEVEL 2 AT 37 MPH

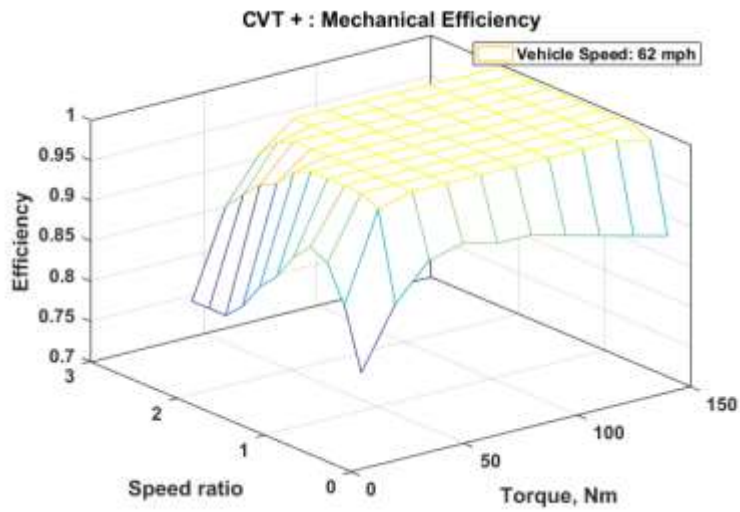

FIGURE 5-147 - MECHANICAL EFFICIENCY MAP OF CVT LEVEL 2 AT 62 MPH

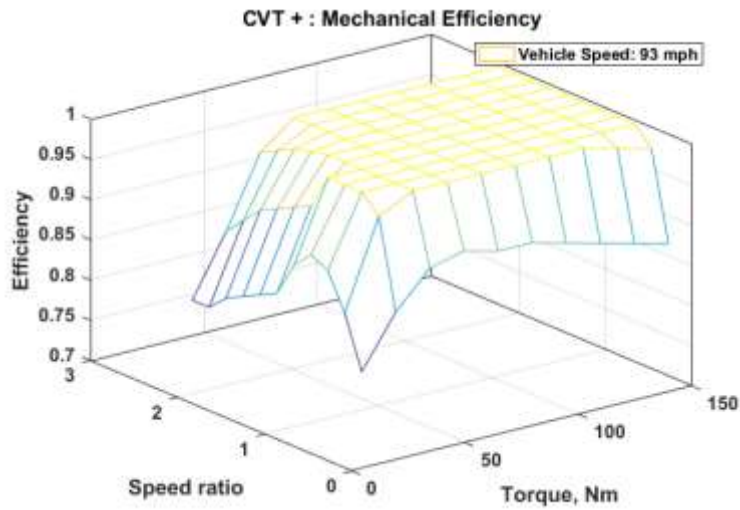

FIGURE 5-148 - MECHANICAL EFFICIENCY MAP OF CVT LEVEL 2 AT 93 MPH

CVT Level 2 technology is an upgrade from the CVT level 1 with increased efficiency, a larger ratio spread, and use of low friction parts. In the 2015 NAS study, the committee discussed that the major losses in CVT occur with the hydraulic pump and the belt, in approximately equal proportions. For this NPRM, the analysis applied improvements to improve pump efficiency and decrease mechanical losses in the belts.

5.3.6 Dual Clutch Transmissions (DCT)

Dual clutch transmissions are similar in their basic construction to manual transmissions, but use two coaxial input shafts with two clutches to shift between the two shafts. By simultaneously opening one clutch and closing the other, the DCT “hands off” power from one shaft to the other, and thus to sequential gears. Unlike the MT, the DCT selects the appropriate gear automatically (as in an AT). DCTs offer an efficiency advantage over a typical automatic because their parasitic losses are significantly lower. In addition, DCTs in general do not require a torque converter, as gradually engaging the clutch (much like with a manual transmission) provides the application of launch torque.

Multiple DCTs have been introduced into the marketplace, primarily in six- and seven-speed versions. Volkswagen has used multiple generations of DCTs in their products. Ford has used six-speed DCTs jointly developed with Getrag. Fiat has another version of a six-speed DCT, while both Honda and Hyundai have developed seven-speed versions. Honda introduced an eight-speed DCT with a torque converter on the 2015 Acura TLX.²⁶⁴

However, DCTs have encountered issues with customer acceptance-some so extreme as to prompt vehicle buyback campaigns, and, as the NAS stated in its 2015 report, “are not likely to reach the high penetration rates predicted by EPA/NHTSA ... primarily due to customer acceptance issues.”²⁶⁵ As noted by the NAS in their 2015 report, “This difference in drivability and consumer acceptance [between wet and dry clutch DCTs] can be seen in the comparison of two of Volkswagen’s MY 2015 vehicles, the VW Golf and the VW Polo. The Golf, with a wet-clutch DCT, has received many positive reviews and awards, while the Polo, with a dry-clutch DCT, has received poor reviews for transmission-related drivability.”²⁶⁶ The ICCT also commented that DCTs are more difficult to package in a vehicle and the dry clutch is limited by (high) temperature constraints.

Getrag announced the 7DCT300, which has a wet clutch with lubrication on demand, equaling the efficiency of a dry DCT. The wet clutch is also smaller and has a higher tolerance for engine

²⁶⁴ Carney, D. 2014. “Honda’s new 8-speed DCT uses a Torque Converter,” *SAE Automotive Engineering Magazine*, August 6.

²⁶⁵ NAS (2015), Prepublication Copy, p. 5-7.

²⁶⁶ NRC (2015), Prepublication Copy, p. 5-7.

irregularities.²⁶⁷ Wet clutch DCTs tend to have better consumer acceptance than dry clutch DCTs. The 7DCT300 is available in Europe on the 2015 Renault Espace.

As in ATs, it is expected that additional gears above the current maximum will not significantly decrease fuel consumption and resulting GHG emissions. A 2012 study by DCT manufacturer Getrag indicated that additional gears above seven and additional ratio spread above 8.5 provided minimal additional fuel economy benefits.²⁶⁸

Generally, DCTs are very cost effective technologies in simulation, but consumer acceptance issues currently limit their appeal in the American market. For these reasons, the agencies limit the application of additional DCT technology to vehicles that already use DCT technology.

5.3.6.1 Losses in DCTs

Advanced DCTs typically have lower losses than ATs, largely due to having an on-demand pump, splash lubrication, and fewer open clutches. The primary losses in DCTs are load-independent drag and splash losses. Unlike ATs, DCTs typically depend on splash lubrication for their internal components rather than forced lubrication. This eliminates the losses associated with oil supply pumps, but adds churning losses due to rotating components moving through the oil. Churning losses can be minimized by keeping oil levels low and warming up the lubrication oil.

A primary consideration in DCT losses is the use of wet or dry clutches.²⁶⁹ Dry clutches do not require oil cooling flow, and therefore do not contribute to oil churning losses that are incurred with wet clutch systems; this has traditionally meant that dry clutch reduced fuel consumption by an additional 0.5 to 1% over wet clutch DCTs. However, dry clutches have a limited maximum torque capacity, and have suffered from customer acceptance issues.

5.3.6.2 DCT Technology Definition in Autonomie

Table 5-20 below shows the assumptions used to develop the DCT technologies.

TABLE 5-20 - NPRM DCT SELECTION

Simulation Name	Transmission Type	Description/ Source
6DCT	6-speed DCT	Source - ANL ²⁷⁰
8DCT	8-speed DCT	1:1 ratio efficiency from 6DCT and use rule to

²⁶⁷ Eckl, B. “DCT in the American Market - Transferring Customer Perceptions into Product Refinements,” presented at the 2014 Car Training Institute Transmission Symposium, Rochester, MI.

²⁶⁸ Eckl, B. & Lexa., D. 2012. “How Many Gears do the Markets Need?” GETRAG. International Car Training Institute Transmission Symposium, Berlin, Germany, December.

²⁶⁹ NAS (2015), Prepublication Copy, p. 5-28.

²⁷⁰ Kim, N. L.-B. (2014). Development of a Model of the Dual Clutch Transmission in Autonomie and Validation with Dynamometer Test Data. International Journal of Automotive Technology, 15, 263-271.

		generate the efficiency for other ratios
--	--	--

5.3.6.2.1 Dual-clutch transmission efficiency rule

The efficiency of the DCT is broken down into a speed-dependent term (spin loss) and a load dependent term (gear train mechanical efficiency).

For the speed-dependent part, the turning torque (Nm) is given by the following equations through curve fit as a function of the overall gear ratio R:

- @ 93°C, 500 rpm
 - $T = 4.89 \times \left(\frac{1}{R}\right)^2 + 0.135 \times \left(\frac{1}{R}\right) + 0.21$ (1)
- @ 93°C, 5000 rpm
 - $T = 23.5 \times \left(\frac{1}{R}\right)^2 + 1.4 \times \left(\frac{1}{R}\right) + 1.7$ (2)

The turning torque is approximately linear between 500 rpm and 5000 rpm.

The gear mechanical efficiency is very high, and can be assumed to be in the range of 99% to 99.5% per gear mesh. The mesh efficiency is higher when the meshing gears are of similar size.

The efficiency data is generated by the following steps:

- The torque loss is subtracted from the input torque.
- The additional torque loss due to constant mechanical efficiency is calculated by multiplying the difference between the input torque and the torque loss by (1 - efficiency).
- The efficiency is calculated by taking the sum of the (spin) torque loss and the loss due to mechanical efficiency and dividing it by the input torque.

The data set is based on a DCT with a rated input torque of up to 250 Nm.

5.3.6.3 TRANSMISSION – DCT6

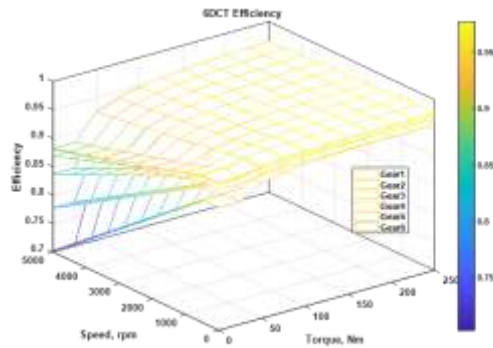

FIGURE 5-149 - EFFICIENCY MAP FOR THE 6-SPEED DUAL CLUTCH TRANSMISSION

For this NPRM analysis, the 6-speed dual clutch transmission was based on the 2016 Draft TAR technology.

5.3.6.4 TRANSMISSION – DCT8

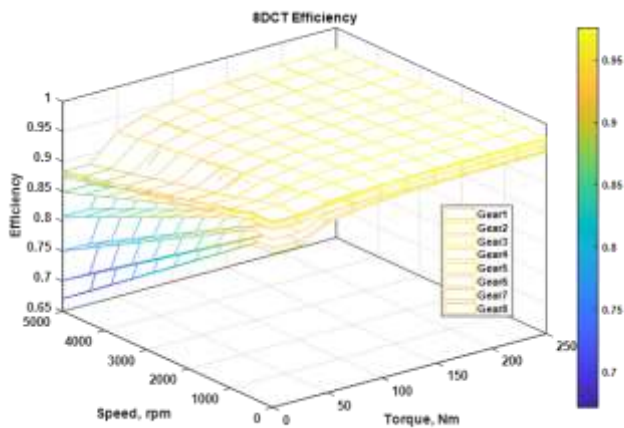

FIGURE 5-150 - EFFICIENCY MAP FOR THE 8-SPEED DUAL CLUTCH TRANSMISSION

For this NPRM analysis, the 8-speed DCT was based on the 2016 Draft TAR technology. This analysis concluded that the 7-speed DCT will have similar performance as the 8-speed DCTs, and vehicles that have initially started in the MY 2016 analysis fleet with 7-speed DCT will be

replaced with 8-speed DCT. More details of the MY 2016 analysis fleet are discussed in Section 5.4.3.

5.3.7 Manual Transmission

In a manual transmission, gear pairs along an output shaft and parallel layshaft are always engaged. Gears are selected via a shift lever, operated by the driver. The lever operates synchronizers, which speed match the output shaft and the selected gear before engaging the gear with the shaft. During shifting operations (and during idle), a clutch between the engine and transmission is disengaged to decouple engine output from the transmission.

Manual transmissions are in general lighter, cheaper to manufacture, and have lower parasitic losses than automatic transmissions. The 2015 NAS report found the overall energy loss in a manual transmission to be approximately 4%, as compared to a 13% loss in automatic transmissions.²⁷¹

As with ATs, the average number of gears in MTs has increased in the MY 2016 analysis fleet, albeit at a reduced rate compared to ATs. As in ATs, the higher number of gears and associated increase in ratio spread increases potential fuel savings.

However, manual transmissions have only a small market share, estimated at only 2.2% in MY 2016.²⁷² Automatic transmissions (ATs, CVTs, and DCTs) are more popular at least in part because customers prefer not to manually shift gears.

5.3.7.1 Manual Transmission technology for Autonomie modeling

Table shows definitions of manual transmission assumptions used for Autonomie modeling.

TABLE 5-21 - NPRM MANUAL TRANSMISSION SELECTION

Simulation Name	Transmission Type	Description/ Source
5DM	5-speed manual	1:1 ratio efficiency from 6DCT and use rule to generate the efficiency for other ratios
6DM	6-speed manual	1:1 ratio efficiency from 6DCT and use rule to generate the efficiency for other ratios
7DM	7-speed manual (premium class)	1:1 ratio efficiency from 6DCT and use rule to generate the efficiency for other ratios

²⁷¹ National Research Council. 2015. Cost, Effectiveness, and Deployment of Fuel Economy Technologies for Light-Duty Vehicles. Washington, DC - The National Academies Press. <https://doi.org/10.17226/21744>. p. 5-9.

²⁷² "Highlights of CO2 and Fuel Economy Trends," <https://www.epa.gov/fuel-economy-trends/download-report-co2-and-fuel-economy-trends>, Accessed Jan 12, 2017.

5.3.7.2 Effectiveness summary for transmissions

Figure 5-151, shows effectiveness ranges for all automatic transmissions in the CAFE model relative to a 5-speed automatic transmission, given a similar vehicle and on-vehicle equipment. Details of the how the vehicle adopts individual transmission technologies in the CAFE model are discussed in Section 5.4.3.

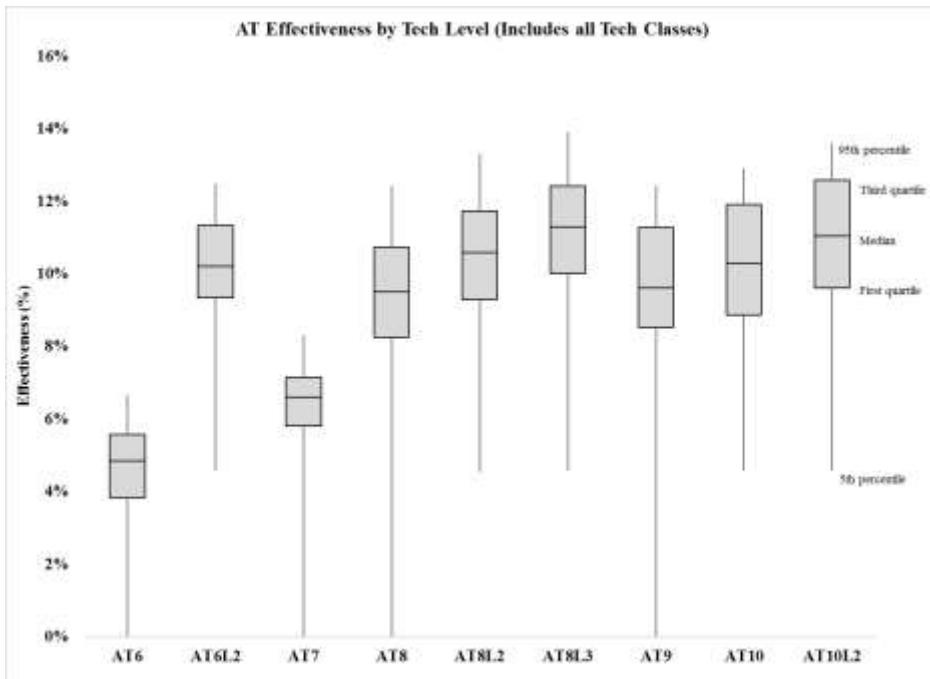

FIGURE 5-151 - RANGE OF EFFECTIVENESS FOR AUTOMATIC TRANSMISSIONS ACROSS ALL DIFFERENT TECHNOLOGIES AND VEHICLE CLASSES

Figure 5-152 shows effectiveness ranges for all CVT and DCT transmissions in the CAFE model relative to a 5-speed automatic transmission, given a similar vehicle and on-vehicle equipment.

*** EO 12866 Review – Draft – Do Not Cite, Quote or Release During Review ***

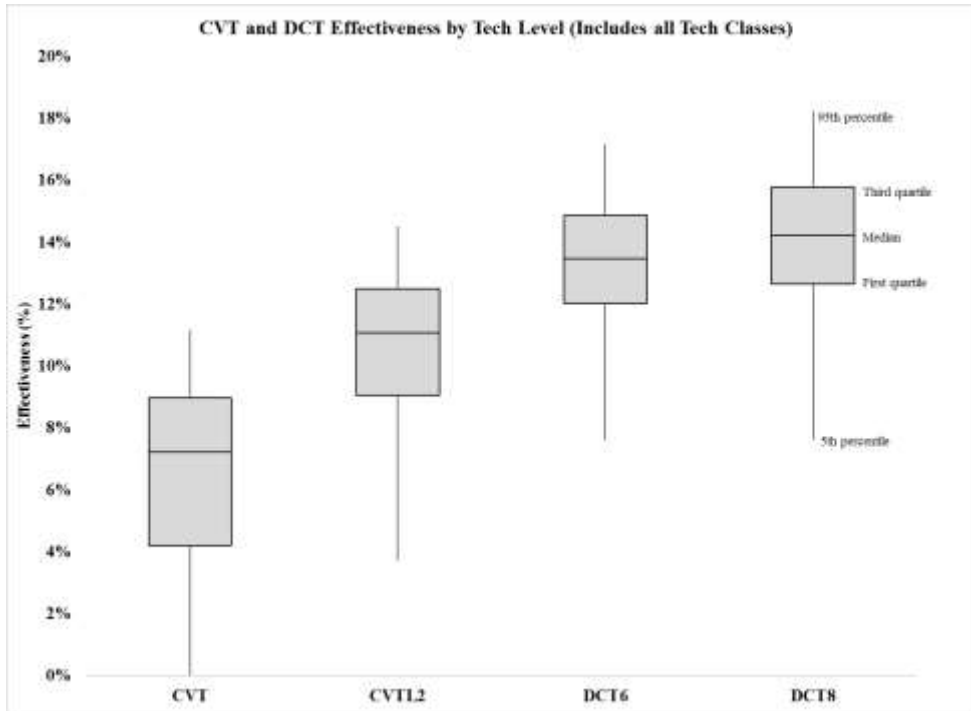

FIGURE 5-152 - RANGE OF EFFECTIVENESS FOR DCTs AND CVTs ACROSS ALL DIFFERENT TECHNOLOGIES AND VEHICLE CLASSES

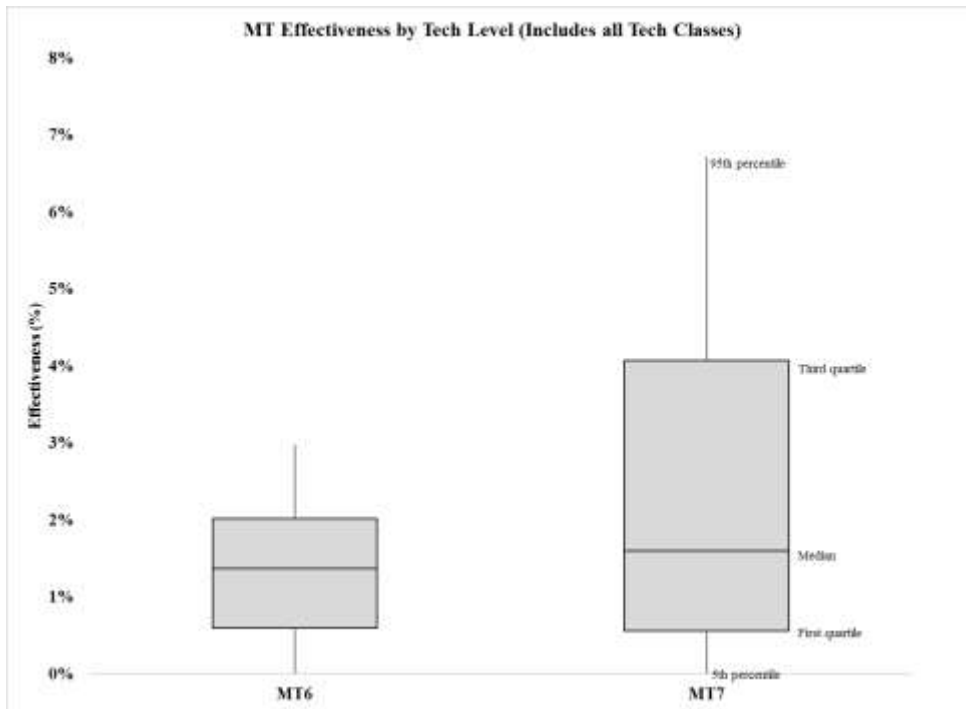

FIGURE 5-153 - RANGE OF EFFECTIVENESS FOR MANUAL TRANSMISSIONS ACROSS ALL DIFFERENT TECHNOLOGIES AND VEHICLE CLASSES

Figure 5-153 shows the range of effectiveness for all manual transmissions in the CAFE model relative to a 5-speed manual transmission, given a similar vehicle and on-vehicle equipment.

5.3.7.3 Cost summary for Transmissions

This section describes the cost analysis for transmission technologies conducted for this proposed rulemaking. The majority of transmission technology costs used by this analysis in this NPRM analysis are the same as those used in the 2016 Draft TAR, with exception of the new added transmission technologies. These costs have been updated to 2016 dollars as all costs in the analysis are in 2016 dollars. Based on new information, stakeholder feedback, and the 2015 NAS report, the analysis updated the direct manufacturing costs (DMC) for the technologies discussed below. As mentioned previously, the CAFE model applies a given technology to a given vehicle and estimates the incremental improvement in fuel consumption from the new combination of technologies on that vehicle – with the ultimate goal of applying the lowest cost technology combination that allows the vehicle to meet the CAFE or CO₂ standard. In this analysis the transmission technologies can obtain internal improvements without increasing

*** EO 12866 Review – Draft – Do Not Cite, Quote or Release During Review ***

number of gears. In the 2015 NAS study, the committee discussed these new improvements as High-Efficiency Gearbox – Level 1 (HEG1, Level 2 (HEG2), and Level 3 (HEG3).²⁷³

The 5-speed automatic transmission (AT5) is the reference base transmission for the CAFE model in this NPRM analysis. It was also the same reference baseline transmission assumed in the 2016 Draft TAR.

The 6-speed automatic transmission (AT6) is the same transmission from the 2016 Draft TAR with the updated cost to reflect the 2016\$ and is incremental to the AT5. The 6-speed automatic transmission level 2 (AT6L2) was updated for this NPRM analysis. The cost basis for AT6L2 in this NPRM analysis is the 2015 NAS HEG1 of \$120.00 in 2010\$ for the improvement over the AT6 transmission. The updated cost in 2016\$ is \$131.84.

The 7-speed automatic (AT7) is a new transmission in this analysis and the 2015 NAS study did not provide a cost estimate for this type of technology. In this NPRM, the cost basis for this transmission is based assessment advanced AT6 and advanced AT8 transmissions that are - \$73.08 in 2016\$ relative to the AT6 Level 2 transmission.

The 8-speed automatic (AT8) is from the 2016 Draft TAR and the DMC for this analysis is \$-46.18 in 2016\$ relative to AT6 level 2 transmission. The new Level 2 and Level 3 AT8 cost basis is from the 2015 NAS HEG1 and HEG2. In 2016\$, these new transmission DMCs are \$213.15 relative to AT8 and \$164.80 relative to AT8 Level 2.

The 9-speed automatic (AT9) is new for this NPRM analysis, and the cost basis for this new technology is based on 2015 NAS estimate for AT9s. The DMC in this NPRM analysis for AT9 is -\$295.55 relative to AT8L3 in 2016\$.

The two 10-speed automatics (AT10 and AT10 level 2) are new for this NPRM analysis and the cost basis for these new technologies is based on the 2015 NAS estimate for AT10s and HEG1. For this NPRM analysis, the AT10 DMC is -\$295.55 relative to AT8L3, and AT10L2 DMC is \$164.80 relative to AT10 in 2016\$.

For dual clutch transmissions (DCTs), the agencies, rely, y on the 2016 Draft TAR analysis for cost basis. The DCT6 DMC is \$19.83 from the 2016 Draft TAR analysis updated to the 2016\$. The agencies updated the DCT8 DMC from the Draft TAR to \$348.71, in 2016\$. The new cost considers the additional gears, synchronizer, shift rail and fork, actuator, and positions sensor. The agencies still adhere to the NAS committee's findings that the currently high costs of DCTs stem from the relatively low sales volumes, compounded by the fact that DCTs used by different vehicle manufactures have different components.

²⁷³ National Research Council. 2015. Cost, Effectiveness, and Deployment of Fuel Economy Technologies for Light-Duty Vehicles. Washington, DC - The National Academies Press. <https://doi.org/10.17226/21744>. page 191.

*** EO 12866 Review – Draft – Do Not Cite, Quote or Release During Review ***

DMC for the CVT technology was sourced from the 2016 Draft TAR. The DMC for this analysis is updated to \$182.79 to reflect 2016\$. CVT Level 2 is new for this analysis, and incorporates the HEG technologies discussed in the 2015 NAS report. The estimated NAS incremental DMC for CVT-HEG was \$125 in 2010\$. For this NPRM, the agencies used a DMC of \$137.33 in 2016\$.

DMC for 5-, 6- and 7-speed manual transmissions (MT5, MT6, and MT7) was sourced from the 2016 Draft TAR. The costs were updated to reflect 2016\$. Using MT5 as the base reference manual transmission, the cost for MT6 is \$257.91, and MT7 is \$249.24.

TABLE 5-22 SHOWS THE DMC USED FOR TRANSMISSIONS IN THIS NPRM ANALYSIS

Transmission Technologies - Direct Manufacturer Costs (2016\$)		
Transmission	Direct manufacturing Cost	Incremental to
AT5	\$0.00	BaseT
AT6	(\$14.31)	AT5
AT6L2	\$131.84	AT6
AT7	(\$73.08)	AT6L2
AT8	(\$46.18)	AT6L2
AT8L2	\$213.15	AT8
AT8L3	\$164.80	AT8L2
AT9	(\$295.55)	AT8L3
AT10	(\$295.55)	AT8L3
AT10.2	\$164.80	AT10
DCT6	\$19.83	AT5
DCT8	\$348.71	DCT6
CVT	\$182.79	AT5
CVTL2A/CVTL2B	\$137.33	CVT
MT5	\$0.00	BaseT
MT6	\$257.91	MT5
MT7	\$249.24	MT6

5.3.7.4 Transmission technology learning curves

Table 5-23 below shows the learning rates applied to the transmission technologies. For details of learning methodology see Chapter 7 of this PRIA.

*** EO 12866 Review – Draft – Do Not Cite, Quote or Release During Review ***

TABLE 5-23 SHOWS THE LEARNING RATES FOR TRANSMISSION TECHNOLOGIES

Technology	Model Year																	
	2016	2017	2018	2019	2020	2021	2022	2023	2024	2025	2026	2027	2028	2029	2030	2031	2032	
MT5	0.98	0.98	0.97	0.97	0.96	0.96	0.96	0.96	0.95	0.95	0.95	0.95	0.95	0.95	0.95	0.95	0.95	
MT6	0.95	0.94	0.93	0.92	0.91	0.9	0.9	0.89	0.89	0.88	0.88	0.87	0.87	0.87	0.86	0.86	0.86	
MT7	1.14	1.06	1	0.96	0.89	0.84	0.78	0.75	0.72	0.7	0.68	0.65	0.63	0.62	0.61	0.59	0.58	
AT5, AT6, AT8, DCT6, DCT8	0.99	0.99	0.99	0.99	0.99	0.99	0.99	0.99	0.99	0.99	0.99	0.98	0.98	0.98	0.98	0.98	0.98	
AT6L2, AT7, AT8L2, AT8L3, AT9, AT10, AT10L2	1	1	1	0.89	0.84	0.8	0.78	0.76	0.74	0.73	0.72	0.71	0.7	0.7	0.69	0.69	0.68	
CVT, CVTL2A, CVTL2B	0.93	0.91	0.9	0.89	0.87	0.87	0.86	0.85	0.84	0.84	0.83	0.82	0.82	0.81	0.81	0.8	0.8	

5.3.8 Electrification Technologies

5.3.8.1 Technology Overview

For this NPRM, the analysis of electrification technologies relies primarily on research published by the Department of Energy, Argonne National Laboratory (ANL).²⁷⁴ This analysis adopted ANL’s assumptions regarding all hybrid systems, including belt-integrated starter generators, strong parallel and series hybrids, plug-in hybrids, and battery electric vehicles, and most projected technology costs. In addition, this analysis rely on the most recent ANL BatPaC model to estimate battery costs.

This analysis did include one major structural update to the battery costing methodology used by NHTSA in on costs since the Draft TAR. Previously, NHTSA considered battery re-sizing for simulations, but used one cost value for the battery pack for each technology, and each technology class. For today’s analysis, battery pack costs is adjusted as the pack size changes in the ANL simulations. This results in some synergies between high levels of mass reduction technology and PHEV and BEVs, as the battery packs may be smaller if road loads are lower.

Because the analysis now consider battery costs separately from other electrification hardware, the presentation of costs is different from Draft TAR. The cost for each electrification technology (other than 12VSS) does *not* include battery costs. The costs only include other hardware, like wires, motors, controllers, and other essential non-battery systems. As a result, the costs of some technologies with large battery packs (like PHEV50, or BEV200) look very low in the cost tables. To estimate the total cost of advanced electrification technologies, this analysis added together the battery costs and other technology costs. The other technology costs consist of several components and these may include the following:

- *Body Modifications* required on HEVs and PHEVs include changes to sheet metal to accommodate electric drive components and the addition of fasteners to secure components such as electric cables.
- *Brake System* changes include the addition of a braking system that can control the vehicle’s regenerative braking system—a key enabler of electric drive vehicle efficiency.
- *Climate Control System* includes components such as an electric air conditioning compressor that enables operation while the engine is off for HEVs and PHEVs as well as for an EV which has no engine.

Commented [A8]: Since EPA and NHTSA methodologies differed in the Draft TAR, suggest adding the clarification about which methodology was revised: “This analysis did include one major structural update to the battery costing methodology used by NHTSA in the Draft TAR.”

²⁷⁴ ANL/ESD-15/28. Assessment of vehicle sizing, energy consumption, and cost through large-scale simulation of advanced engine technologies, Moawad, Kim, Shidore, Rousseau, Energy System Division, Argonne National Laboratory (March 2016).

*** EO 12866 Review – Draft – Do Not Cite, Quote or Release During Review ***

- *Conventional vehicle battery and alternator* are deleted in these vehicles, for a cost savings, replaced by the DC-DC converter which converts the high-voltage traction battery to a nominal 12V DC to operate the vehicle’s accessories.
- *DC-DC converter* converts the high-voltage battery voltage to a nominal 12V battery voltage to run vehicle accessories such as the radio, lights and wipers.
- *Power distribution and Control* consists of those components which route electricity to the motor, inverter and contains the controllers to operate and monitor the electric drive system.
- *On-Vehicle Charger* consists of the components necessary to charge a PHEV or EV from an outlet. It includes the charging port, wiring and electronics necessary to convert a 120V or 240V AC input to the high-voltage DC power necessary to charge the battery.
- *Supplemental heating* is required for passenger comfort on PHEVs and EVs which may operate for long periods with no engine heat available. The supplemental heater on the EV is assumed to be more costly than the PHEV because the entire cabin comfort is dependent on the supplemental heater.
- *High Voltage Wiring* is an item used on EVs only. It includes the high voltage cabling from the battery to the inverter and motor as well as control components. It is equivalent to the power distribution and control used on HEVs and PHEVs.
- *Battery Discharge System* for HEVs, PHEVs and EVs, it is expected that manufacturers will provide the means to safely discharge battery packs following a vehicle crash. The agencies have assumed that this would include dedicated DC terminals, an access panel for the terminals, and a diagnostics port.

In addition, the agency relied on the most recent Battery Performance and Cost model (BatPaC) to estimate battery costs.²⁷⁵ The BatPaC model is the product of long-term research and development at ANL. Over a period of years, ANL has developed methods to design Li-ion batteries for electric-drive vehicles based on modeling with Microsoft Office Excel spreadsheets. These design models provided all the data needed to estimate the annual materials requirements for manufacturing the batteries being designed. The BatPac’s assumptions can be adjusted to specific battery type, and for today’s analysis the agencies relied on DOE ANL’s battery experts to provide cost and battery size data for full vehicle simulation.²⁷⁶ ANL also extended the modeling to include estimates for battery manufacturing costs. The battery pack design and cost calculated in BatPaC represent projections for production in 2020 and a specified level of annual battery production of 20,000-500,000 units. As the goal is to predict the future cost of manufacturing batteries, a mature manufacturing process is assumed (this has some learning

Commented [A9]: From this statement, it sounds like this was done by ANL for NHTSA for this NPRM, when it has always been an integral part of the model.

²⁷⁵ “BatPaC - A Lithium-Ion Battery Performance and Cost Model for Electric-Drive Vehicles” <http://www.cse.anl.gov/batpac/index.html>, April 2018.

²⁷⁶ ANL vehicle component input file [Docket ID]

implications regarding right learning curves and cumulative volumes). The model designs a manufacturing plant with the sole purpose of producing the battery being modeled.

5.3.8.2 Infrastructure for Electric Vehicle

Over 190,000 electric vehicles (encompassing both plug-in hybrid electric vehicles, or PHEVs, and battery electric vehicles, or BEVs – collectively referred to here as EVs to encompass vehicles with batteries that require charging from the grid) were sold in 2017,²⁷⁷ accounting for 1.1 percent of the 2017 total vehicle sales. However, EVs are still only a small percentage of the total light-duty fleet – in 2016, EVs comprised 0.23% of the nearly 250 million light-duty vehicle registrations.²⁷⁸

Although total electricity use for light-duty vehicles currently only comprises a small percentage of total national electricity generation,²⁷⁹ some view potential additional EV charging electricity demand as beneficial to utilities. For example, EV charging could supplement reduced utility revenue due to flat or declining electricity demand.²⁸⁰ In addition, if implemented, vehicle-to-grid (V2G) technology has the potential to store surplus electricity during non-peak periods and feed power back to the grid when needed.²⁸¹

However, there are risks to the increased load that could be caused by EV charging, namely in the potential need for new generation capacity and upgrades to electrical equipment, in addition to the cost of developing a recharging infrastructure to support EVs. While large-scale deployment of EVs may not require additional electricity generation capacity if charging occurs at night-time when electrical demand is well below peak, uncontrolled charging can have significant negative impacts such as voltage stability control,²⁸² faster aging of transformers,²⁸³ and shortened insulation life,²⁸⁴ among other impacts to the electricity distribution grid.²⁸⁵

²⁷⁷ Argonne National Laboratory, Impacts of Electrification of Light-Duty Vehicles in the United States, 2010 – 2017 (January 2018), available at <http://www.ipd.anl.gov/anlpubs/2018/01/141595.pdf>.

²⁷⁸ *Id.* Through 2017, over 750,000 EVs have been sold.

²⁷⁹ *Id.* The total electricity use for light-duty vehicles in 2015 was 5.4 terawatt-hours, compared to 3,902 terawatt-hours of total national electricity generation.

²⁸⁰ U.S. Energy Information Administration, “In 2017, U.S. electricity sales fell by the greatest amount since the recession” (April 03, 2018), <https://www.eia.gov/todayinenergy/detail.php?id=35612>.

²⁸¹ U.S. Department of Energy National Renewable Energy Laboratory, Connecting Electric Vehicles to the Grid for Greater Infrastructure Resilience (April 20, 2017), <https://www.nrel.gov/news/program/2017/connecting-electric-vehicles-to-the-grid-for-greater-infrastructure-resilience.html>.

²⁸² Clement-Nyns et al., The impact of vehicle-to-grid on the distribution grid, *Electric Power Systems Research*, Volume 81, Issue 1, January 2011, Pages 185-192.

²⁸³ Q. Gong, S. Midlam-Mohler, V. Marano and G. Rizzoni, “Study of PEV Charging on Residential Distribution Transformer Life,” in *IEEE Transactions on Smart Grid*, vol. 3, no. 1, pp. 404-412, March 2012.

²⁸⁴ Burnham et al., Enabling fast charging – Infrastructure and economic considerations, *Journal of Power Sources* 367 (2017) 237-249.

²⁸⁵ P. Denholm and W. Short “An Evaluation of Utility System Impacts and Benefits of Optimally Dispatched Plug-In Hybrid Electric Vehicles” National Renewable Energy Laboratory, 2006.

*** EO 12866 Review – Draft – Do Not Cite, Quote or Release During Review ***

With regard to peak load increases, a recent analysis found the introduction of EVs – even considering the less powerful level 1 charging option (120 volt, 1.2 kW) – leads to a significant increase in peak demand at the distribution transformer.²⁸⁶ Level 2 (240 volt) charging was found to significantly exacerbate the impact of EVs on the residential distribution infrastructure, since charging events are shorter but at higher rates. This coupled with the fact that EV sales will likely be concentrated in geographic areas could significantly alter peak transformer loads and lead to decreased transformer life. With clustered charging, a study of one utility district in California found that 17 percent of transformers may need replacement due to EV overloads, costing approximately \$7,000 per transformer or \$84 million for the district alone.²⁸⁷

In addition to costs associated with existing electric grid system upgrades, developing an EV infrastructure requires significant investment. As shown in Table 5-24 below, EVs can be charged with different types of chargers; level 1 chargers (generally standard household outlet chargers) provide 2 to 5 miles of EV range per one hour of charging, level 2 chargers provide 10 to 20 miles of range per one hour of charging, and level 3/direct current fast chargers (DCFC) provide 60 to 80 miles of range per 20 minutes of charging. Charger installation and operating costs increase with the capacity of the charger. Survey data and simulation modeling indicate that currently, over 80 percent of energy for EVs comes from home charging.²⁸⁸ However, analysts expect that a public charging network will be needed to give EV owners the ability to drive longer distances in their vehicles and greater confidence that EVs can meet their travel needs.

Should EV sales increase, significant additional public charging infrastructure (with both public and private chargers) will be required. The National Renewable Energy Laboratory (NREL) conducted a study in 2017 to estimate national EV non-residential charging requirements within communities and along Interstate corridors.²⁸⁹ The study concluded that 8,000 level 3/DCFC stations are required to provide a minimum level of coverage nationwide. The study estimated that if the EV market expands to 15 million vehicles 25,000 level 3/DCFC plugs would be required, in addition to 600,000 non-residential level 2 plugs. It is anticipated that a nationwide system of level 3/DCFCs would be needed to support widespread electric vehicle adoption.

The cost associated with this additional infrastructure could be substantial - level 1 chargers with installation are estimated to cost between \$300 and \$1,500 per charger; level 2 chargers cost

²⁸⁶ Muratori, Matteo, Impact of uncoordinated plug-in electric vehicle charging on residential power demand. *Nature Energy* 3 (2018) 193-201.

²⁸⁷ Smart Electric Power Alliance, *Utilities and Electric Vehicles The Case for Managed Charging* (2017).

²⁸⁸ Idaho National Laboratory, *Plugged-In - How Americans Charge Their Electric Vehicles* (2015), available at <https://avt.inl.gov/sites/default/files/pdf/arra/PluggedInSummaryReport.pdf>.

²⁸⁹ U.S. Department of Energy Office of Energy Efficiency and Renewable Energy, *National Plug-In Electric Vehicle Infrastructure Analysis* (2017), available at <https://www.nrel.gov/docs/fy17osti/69031.pdf>.

between \$400 and \$6,500; and level 3/DCFC cost between \$10,000 and \$40,000 each.²⁹⁰ Level 3/DCFC costs include electric vehicle supply equipment (EVSE) unit hardware cost, installation, including connecting the EVSE to the electrical service (e.g. panel work, trenching/boring, and repaving), new electrical service or upgrades (e.g., transformers), and meeting Americans with Disabilities Act (ADA) specifications.

For higher power chargers, the cost of electricity is often greatly increased by demand charges. Demand charges are generally determined based on the highest measured use during the billing period. This highest rate of demand establishes the billing rate for as long as one year. With level 3/DCFCs, demand charges often result in a substantial cost to the system owner, since the spikes in energy usage that can occur with multiple vehicles charging simultaneously increase system power demand, which results in a long term increase in electricity costs. Thus, the development, operation, and deployment of a network of level 3/DCFC stations present a challenge due to lack of a sustainable business model. Moreover, two geographic challenges are associated with the development of a national network of level 3/DCFC stations - 1) availability of commercial land for siting level 3/DCFC stations, and 2) proximity of electric substations to the interstate corridor network.

TABLE 5-24. TYPES OF EV CHARGERS, ENERGY REQUIREMENTS, AND COSTS

Type	Description	Vehicle Range Added per Charging Time	Peak Load (kW)	Unit Cost Range (\$)
Level 1 J1772 ²⁹¹	Standard household outlet (110 Volts AC, 15 Amps)	2 to 10 miles of range per one hour of charging	1.2 kW	\$300 - \$1,500
Level 2 J1772	Dedicated 240 Volt AC line, 16-40 Amps	10 to 60 miles of range per one hour of charging	19 kW	\$400 - \$6,500
Level 3 (DCFC)	Dedicated 208/480V AC three-phase input	24 to 90 miles of range per 20 minutes of charging	50 kW	\$10,000 - \$40,000

²⁹⁰ U.S. Department of Energy Office of Energy Efficiency and Renewable Energy, Costs Associated with Non-Residential Electric Vehicle Supply Equipment (November 2015), available at https://www.afdc.energy.gov/uploads/publication/evse_cost_report_2015.pdf.

²⁹¹ SAE J1772 - SAE Electric Vehicle and Plug in Hybrid Electric Vehicle Conductive Charge Coupler. This SAE Standard covers the general physical, electrical, functional and performance requirements to facilitate conductive charging of EV/PHEV vehicles in North America. This document defines a common EV/PHEV and supply equipment vehicle conductive charging method including operational requirements and the functional and dimensional requirements for the vehicle inlet and mating connector.

5.3.9 HEV, PHEV and BEV battery pack design and cost analysis using the ANL BatPac model

Battery packs are the most expensive components in PHEVs and EVs, and a significant cost in HEVs. Therefore, it is important to design battery packs that are cost effective and provide the necessary functionality depending on the application. This analysis used ANL’s BatPac model to determine the size (power and energy rating) of the battery pack for different vehicle classes and for different types of vehicle electrification. EVs and PHEVs require bigger batteries as they provide propulsion only from stored electrical energy and therefore, the weight of the battery must be known in advance to determine the vehicle glider weight and to optimize the performance of the vehicle. Because the weight of the battery pack itself can change the energy required to move the vehicle, that extra weight can accordingly affect the vehicle range or per-mile energy consumption.

The BatPac model uses the bill of materials²⁹² (BOM) approach in addition to specific design criteria for the intended application of a battery pack for developing cost estimates. The BOM approach allows more granular battery pack design since the performance of the materials within the battery directly affects the end energy density and cost of the integrated battery pack. The ANL BatPac model has the distinct advantage of using the bottom-up cost and design model so that power and energy is balanced between performance and cost. The BatPac model also accounts for physical limitations of the electrochemical process so that unrealistic inputs to the model will penalize the energy density and cost. However, the BatPac model provides the flexibility to examine some new materials as long as bench test values are providing realistic energy density values, so the agencies may estimate future costs if there are rapid advancements in materials science. Also, the BatPac model assumes the existence of mature, high volume manufacturing of Li-ion batteries for transportation applications. If production volumes lags in real world, the estimated cost could be lower than real world cost for batteries. Subsequently, the BatPac model was updated to narrow the cost and performance differential by making adjustments in the following areas:

1. Battery pack cost is adjusted upward. This adjustment is based on the feedback from several peer-reviewers, and changes are related to limiting electrode thickness to 100 microns, changing allocation of overhead cost to more closely represent a Tier 1 auto supplier, increasing cost of tabs, changing capital cost of material preparation, etc.;
2. Battery management system (BMS) cost is increased to represent the complete monitoring and control needs for proper battery operation and safety, as shown in Table 5-25;

²⁹² Bill of material (BOM) is a list of the raw materials, sub-assemblies, parts and quantities needed to manufacture an end product.

Commented [A10]: Overall, battery costs included in this analysis are higher than what EPA has obtained from the most recent version of the BatPaC model. There is not enough detail provided for EPA to determine what is contributing to these higher costs, but two potential factors are notable. First, the text refers to both ANL/ESD-15/28 and the BatPac model, so there are potentially inconsistencies in the application of assumptions from one of these sources to the other. Second, the text frequently refers to the BatPaC model to lend authority to the battery cost estimates, without providing sufficient information on the much more significant issue of how battery sizing or other model inputs were determined, much less the battery sizings or cost estimates that resulted.

*** EO 12866 Review – Draft – Do Not Cite, Quote or Release During Review ***

3. Battery automatic and manual disconnect unit cost is added based on safety considerations as shown in Table 5-25; and
4. Liquid thermal management system is added. ANL stated in the report that the liquid-cooled closure design it uses in the model would not have sufficient surface area and cell spacing to be cooled by air effectively as shown in Table 5-25.

TABLE 5-25 - BMS DETAILS FROM BATPAC MODEL²⁹³

Battery Pack Integration System			
	Micro HEV	HEV	PHEV & HEV
Current and Voltage Sensing, \$	40	70	100
Module controls, \$/module	10	10	20
Auto battery disconnect, \$	50	70	200
Manual disconnect per pack, \$	15	15	15
Additional for parallel modules and packs, \$/string			100
Thermal Controls			
	Micro HEV	HEV	PHEV & HEV
Baseline thermal system*, \$	30	80	120
Additions to AC system**, \$/kw	40	40	40
Heating system**, \$/Kw/pack	20	20	20
Additional for multiple packs, \$/additional pack			100

*60 additional for each added pack

** No charge for cabin air cooling

The cost of the BMS will scale with magnitude of battery current and with the need to charge from the electrical grid. Therefore, the PHEV and EV batteries will have a higher burden from the BMS. BISGs and CISGs are assumed to have less complicated management and thus cost less than the HEV/PHEV/EV.

5.3.9.1 Start-Stop systems (12VSS) and cost estimates by vehicle class and vehicle size

The start-stop technology, also known as a micro-hybrid system, is the most basic hybrid system that facilitates idle start-stop capability. In this system, the integrated starter generator is coupled to the internal combustion (IC) engine. With this system, when the vehicle comes to an idle-stop the IC engine completely shuts off, and with the help of 12-volt battery, the engine cranks and

²⁹³ ANL/ESD-15/28. Assessment of vehicle sizing, energy consumption, and cost through large-scale simulation of advanced engine technologies, Moawad, Kim, Shidore, Rousseau, Energy System Division, Argonne National Laboratory (March 2016).

*** EO 12866 Review – Draft – Do Not Cite, Quote or Release During Review ***

starts again in response to throttle to move the vehicle. This technology is beneficial to reduce fuel consumption and emissions when the vehicle frequently stops such as in city driving conditions or in stop and go traffic. This technology can be applied to all classes of vehicles. The 12-volt battery used for the start-stop system is an improved unit capable of higher power, increased life cycle, and capable of minimizing voltage drop on restart.

Micro-hybrid systems may continue to use lead-acid batteries with capability to prevent steep discharge. The regular lead acid battery is traditionally used for starting, lighting and ignition. Deeply discharging the traditional batteries may greatly shorten its life span. The technology costs for 12VSS do include any incremental battery costs. For only this specific electrification technology, this analysis developed the battery cost estimate and as ANL did not provide costs for this battery configuration.

5.3.9.2 Mild Hybrid

Mild hybrid systems offer start-stop functionality, but use larger electric machines and higher capacity batteries, typically 42 volts and above, thus enabling a limited level of regeneration unavailable in the regular 12-volt start-stop system. In the mild hybrid system, the conventional alternator is replaced by either a belt driven starter/alternator (BISG) or by a crank integrated starter generator (CISG). In the BISG system, the 48-volt starter generator uses 3-phase alternating current (AC) electric machines with an integrated inverter. The inverter has two roles; convert the direct current (DC) from the battery to AC to power the electric machine when it is in motor mode, and convert the AC generated by the electric machine to DC when in generator mode so that energy can be stored in the battery.

For today's analysis, the costs assumed a higher voltage system would be needed for BISG and CISG on larger vehicles (MedSUV, MedSUVPerf, Pickup, PickupHT), but the agencies are evaluating the functionality of lower voltage systems on larger vehicles. The agencies seek comment on whether lower voltage systems should be considered on these larger vehicles for the final rule analysis, and why.

5.3.9.3 Strong hybrid vehicles, plug-in hybrid vehicles, battery electric vehicles and fuel cell vehicle technologies.

A hybrid vehicle is a vehicle that combines two or more sources of propulsion energy, where one uses a consumable fuel (like gasoline), and one is rechargeable (during operation, or by another energy source). Hybrids reduce fuel consumption through three major mechanisms, including - (1) potential engine downsizing, (2) optimizing the performance of the engine to operate at the most efficient operating point and under some conditions storing excess energy such as by charging the battery, and (3) capturing energy during braking and some decelerations that might otherwise be lost to the braking system and using the stored energy such as the battery to provide launch assist, coasting, and propulsion during stop and go traffic conditions. The effectiveness of the hybrid systems depends on how the above factors are balanced, taking into account

*** EO 12866 Review – Draft – Do Not Cite, Quote or Release During Review ***

complementary equipment and vehicle application. For some performance vehicles, the hybrid technologies are used for performance improvement without any engine downsizing. Depending on the location of electric machine (motor with or without inverter), the hybrid technologies are classified as P0 – motor located at the primary side of the engine, P1 – motor located at the flywheel side of the engine, P2 – motor located between engine and transmission, P3 – motor located at the transmission output, and P4 – motor located on the axle.

Any one of these configurations would provide start-stop or idle-stop functionality and all other configurations except P0 would provide either electric powered coasting and/or vehicle launch assist. This analysis evaluated the following technologies for cost and effectiveness in the CAFE model - SHEVP2 (P2 strong hybrid electric vehicle), SHEVPS (power split strong hybrid electric vehicle), PHEV30 (30-mile plug-in hybrid electric vehicle), PHEV50 (50-mile plug-in hybrid electric vehicle) and BEV200 (200-mile battery electric vehicle).

5.3.9.4 SHEVP2

A P2 hybrid is hybrid technology that uses a transmission-integrated electric motor placed between the engine and a gearbox or CVT, and coupled to the engine crankshaft via a clutch. The engine and the drive motor are mechanically independent of each other, allowing the engine or motor to power the vehicle separately or in combination. The P2 HEV system has an added clutch to engage or disengage the motor from the engine. Disengaging the engine clutch allows all-electric operation and more efficient brake-energy recovery. Examples of this include the MY 2016 Hyundai Sonata Hybrid and MY 2016 Chevrolet Malibu Hybrid, among others. The effectiveness of P2 systems varies and battery sizing depends on the vehicle class.

5.3.9.5 SHEVPS

Power-split hybrid (SHEVPS) is a hybrid electric drive system that replaces the traditional transmission with a single planetary gear set and two motors/generators. The smaller motor/generator uses the engine to either charge the battery or to supply additional power to the drive motor. The second, more powerful motor/generator is permanently connected to the vehicle's final drive and always turns with the wheels. The planetary gear splits engine power between the first motor/generator and the drive motor to either charge the battery or supply power to the wheels.

The SHEVPS system is inappropriate for larger load vehicles due to the higher power demand of those vehicles²⁹⁴.

5.3.9.6 PHEV

²⁹⁴ Kapadia, J., Kok, D., Jennings, M., Kuang, M. et al., "Powersplit or Parallel - Selecting the Right Hybrid Architecture," SAE Int. J. Alt. Power. 6(1):68-76, 2017, <https://doi.org/10.4271/2017-01-1154>.

Plug-in hybrid electric vehicles (PHEVs) allow all electric driving for a limited range. PHEV have three significant functionality differences versus strong hybrids. The first is the addition of a means to charge the battery pack from an outside source of electricity (e.g., the electric grid). Second, a PHEV would have a larger battery pack with more energy storage, and a greater capability to be discharged. Finally, a PHEV battery management system allows the battery pack to be significantly depleted during normal operation in contrast to strong hybrids. PHEVs generally derive propulsion energy from the electric grid.

For this NPRM, this analysis sized the battery energy to achieve the specified all-electric range (AER) on the combined cycle (UDDS + HWFET), on the basis of adjusted energy values.²⁹⁵ As mentioned above, the PHEV would provide propulsion energy for a limited range in addition to start-stop or idle-stop. This analysis have classified PHEV into two levels - (1) PHEV30 indicating a vehicle with an AER of 30 miles, and (2) PHEV50 indicating a vehicle with AER of 50 miles.

Unlike other alternative fuel systems that require specific infrastructure for refueling or recharging (e.g., hydrogen vehicles or rapidly charged battery electric vehicles), PHEV batteries can be charged using existing infrastructure, although widespread adoption may require upgrades to electrical power distribution systems.²⁹⁶ PHEVs are considerably more expensive than conventional vehicles and more expensive than SHEVPS technologies because of larger battery packs and charging systems capable of connecting to the electric grid. The effectiveness of the PHEV system depends on the battery pack size and the range, among other variables. The battery pack DMC is calculated using the ANL BatPac model.

5.3.9.7 Battery Electric Vehicles

Battery electric vehicles (BEVs) are vehicles with all-electric drive and with vehicle systems powered by energy-optimized batteries charged primarily from grid electricity. The range of the battery electric vehicles depends on the vehicle's class and the battery pack size. Today, BEVs are an expensive electrical alternative fuel vehicle due to large capacity batteries needed for energy storage and range. BEVs often require special infrastructure for charging, and there is sometimes an added expense to consumers to install 220 volt EV chargers in their homes.

5.3.9.8 Batteries for BISG, CISG, HEV, PHEV and BEVs

Battery packs for hybrid and electric vehicles are designed to meet the energy and power needs of the specific systems. These systems may be charged and managed in different ways. This section discusses attributes for different battery systems.

²⁹⁵ How this analysis size batteries and define combined cycle specific AERs are discussed in detail in ANL Autonomie Model Documentation.

²⁹⁶ See below for a discussion of electrical vehicle infrastructure.

When PHEV batteries are fully charged, the batteries operate in a charge-depleting mode, providing energy for propulsion until the battery reaches the low state of charge (SOC). At low SOC, it sustains some vehicle and accessory operations similar to HEVs. Some commercial examples of PHEV30 include the BMW i8, Ford Fusion Energi, Mercedes C 350e, and Hyundai Sonata Plug-in, among others. Some commercial examples of PHEV50 include the BMW i3 with Range Extender, Chevrolet Volt and Toyota Prius Prime, among others.

Early SHEVPS vehicles from Toyota, Ford, Honda and GM used nickel-metal hydride (NiMH) batteries, although lithium batteries are becoming common for strong hybrids. Many early strong hybrid batteries used cylindrical cells, although prismatic cells are becoming common. Lithium-ion batteries for PHEVs like those used by the GM Chevrolet Volt, Nissan Leaf, Mitsubishi iMiEV, and Toyota Prius Prime, among others, use large format, layered prismatic cells. The agencies anticipate more applications of large format lithium-ion batteries to replace NiMH batteries for all HEV applications over time with the advancements in cathode and anode chemistries.

EV battery packs tend to be optimized for high energy storage and are considerably larger and heavier than HEV batteries, due to the much larger energy capacity. EV battery cells tend to have thicker cathode and anode layers and fewer collectors and separators than HEV cells. This reduces the specific cost on a per-kWh basis for EV battery cells relative to HEV battery cells.

For this NPRM analysis, the batteries used for the BISG and CISG HEVs and PHEVs are lithium-ion. Table 5-26 provides a summary of the battery characteristics and technologies used by each powertrain.

TABLE 5-26 - REFERENCE BATTERY CHARACTERISTICS²⁹⁷

Powertrain Type	Technology	Reference Cell Capacity (Ah)
Micro-HEV	Lead acid	70
BISG	Li-ion	16
CISG	Li-ion	7
HEV	Li-ion	6.5
PHEVs	Li-ion	41
FCHEV	Li-ion	6.5
BEVs	Li-ion	41

Commented [A11]: Cell Capacity as output by the BatPaC model would be expected to vary when modeled over the range of pack capacities and voltages in different vehicle applications. Recommend showing the range of capacity values in this table.

The battery capacity was selected for each option to allow a battery nominal pack voltage between 200 V (full HEV case) and 350 V (BEV case). The energy storage cell weights for the PHEVs are based 100 Wh/kg for the PHEVs 30 and 50 AER; and 190 Wh/kg for the BEV 200

²⁹⁷ ANL vehicle component input file [Docket ID]

AER, based on battery total energy. The energy storage cell weights for micro-HEVs, BISGs, CISGs, and full HEVs are based on 2750 W/kg (1247 W/lb).

Commented [A12]: Suggest adding ranges here since presumably these are outputs (rather than inputs) to the BatPaC model, and would be expected to vary over the range of pack capacities in different vehicle applications.

This analysis assumed different useable SOC,²⁹⁸ depending on the powertrain configuration:

- 10% SOC range for micro and mild HEVs,
- 20% SOC range for full HEVs.
- 70% SOC range for PHEVs, and
- 90% SOC range for BEVs.

The table below, Table 5-27, show the cell chemistry used in the battery pack for different hybrid technology application(s). Pack energy is another input used in the BatPac model to calculate battery size and weight for a reference vehicle class.

TABLE 5-27 - ELECTRIFICATION USED IN THIS NPRM ANALYSIS²⁹⁹

Powertrain Type	Cell Chemistry	Battery Cooling System
Micro HEVs	LFP-Gr ³⁰⁰	CoolA
BISG HEVs	LFP-Gr	CoolA
CISG HEVs	LFP-Gr	CoolA
Full HEVs	LFP-Gr	CoolA
PHEVs	NMC3441 ³⁰¹ -Gr	EG-W
BEVs	NMC441-Gr	EG-W

5.3.9.9 Electric Machines

For this NPRM analysis, Oak Ridge National Laboratory provided electric machine performance data, which represents asynchronous permanent-magnet technologies.^{302, 303}

The main focus of BISG hybrid vehicles is to control engine operation at efficient load and speed combinations when possible; additionally, the system may provide modest regenerative braking

²⁹⁸ For small battery packs in some hybrid configurations, energy capacity is less of a constraining factor for battery size than peak charge or peak discharge of the battery pack.

²⁹⁹ Details of cell chemistry and battery cooling system are described in “*Modeling the Performance and Cost of Lithium-Ion Batteries for Electric-Drive Vehicles*” ANL-12/55 2nd edition. December 2012

³⁰⁰ Lithium Iron Phosphate (also called as LiFePo₄) Gr – Synthetic graphite anode

³⁰¹ Lithium-Nickel-Manganese-Cobalt-Oxide (also called as LiNiMnCo), Gr - Synthetic graphite anode

³⁰² Oak Ridge National Laboratory. (2008). Evaluation of the 2007 Toyota Camry Hybrid Synergy Drive System. Submitted to the U.S. Department of Energy.

³⁰³ Oak Ridge National Laboratory. (2011). Annual Progress Report for the Power Electronics and Electric Machinery Program.

and provide nominal assist to the engine during high-transient operating modes and low speed operation. Because the electric machine is linked to the engine through a belt, the peak power and peak torque are usually limited compared to other hybrid architectures. A nominal value of 10-kW peak power was assigned to the BISG for this study. CISG hybrid vehicles focus on the same areas of improvement as BISG vehicles. However, owing to its position, the electric machine can be larger; consequently, more benefits can be obtained from regenerative braking and assist in a CISG vehicle than in a BISG vehicle. An electric machine size of 15-kW peak power was selected for this study. The maps were developed assuming normal-temperature operating conditions. Electric machine inverter losses are included. The electric machine power, similarly to the engine, is sized for the reference-sized powertrains. Table 5-28 below shows the electric machine efficiency map sources for the different powertrain configurations.

TABLE 5-28 - ELECTRIC MACHINE EFFICIENCY MAP SOURCES FOR DIFFERENT POWERTRAIN CONFIGURATIONS

Powertrain Type	Source of Efficiency Map for Motor1 (Traction Motor) + Inverter	Source of Efficiency Map for Motor2 (Motor/Generator) + Inverter
Micro 12-V HEV, BISG	Camry EM1 data from ORNL	
CISG and Parallel HEV	Sonata HEV data from ORNL	
Split HEV and Blended PHEV	Camry EM1 data from ORNL	Camry EM2 Data from ORNL
EREV PHEV	Camry EM1 data from ORNL	Sonata HEV Data from ORNL
BEV and fuel-cell HEV	Nissan Leaf data from ORNL	

5.3.9.10 FCV

For this NPRM analysis, the fuel-cell system was modeled to represent hydrogen consumption as a function of the produced power. The system’s peak efficiency is 60%, including the balance of plant³⁰⁴, and represents normal-temperature operating conditions. The system’s specific power is 650 W/kg. The hydrogen storage technology selected is a high-pressure tank with a specific weight of 0.04 kg H₂/kg, sized to provide a 320-mile range on the combined cycle (UDDS + HWFET) on the basis of adjusted energy values.

Fuel Cell Vehicles (FCVs) are another potential technology option for implementing electrified drive to achieve zero tailpipe emissions. Like BEVs, FCVs use electricity to turn electric motors onboard the vehicle that provide the motive power for driving. However, unlike a BEV, the FCV also produces this power onboard. It achieves this by harnessing the energy produced in an

³⁰⁴ Power needed for supporting components and auxiliary systems.

*** EO 12866 Review – Draft – Do Not Cite, Quote or Release During Review ***

electrochemical reaction that combines hydrogen and oxygen to form water. This process occurs within the fuel cell itself, a device that shares a basic structure with batteries; namely, it consists primarily of an anode, a dividing electrolyte, and a cathode. Hydrogen from an onboard tank enters the fuel cell's anode and is separated into its constituent electron and proton. The electron is directed to an external circuit, where it ultimately provides power to the electric motors driving the wheels. The proton is transferred across the fuel cell's electrolyte membrane to the cathode, where it combines with oxygen from air entering the cathode and electrons returning from the external circuit to form water. Thus, the basic reaction in the fuel cell is $H_2 + \frac{1}{2}O_2 \rightarrow H_2O$, with usable electric power (and some amount of heat) produced in the process.

5.3.9.11 Summary of DOE Vehicle Technology Office's – Assessment of Vehicle Sizing, Energy Consumption, and Cost through Large-Scale Simulation Advanced Vehicle Technologies

The Department of Energy's Vehicle Technologies Office (VTO) evaluated the benefits of fuel-saving technologies for a wide range of vehicle applications, powertrain configurations, and component technologies for difference timeframes, and to quantify the potential future petroleum displacement up to 2045, as well as to evaluate costs. More than 5,000 light-duty vehicles were simulated with ANL's Autonomie full vehicle simulation model.

The assumptions were based on goals of the United States Driving Research and Innovation for Vehicle Efficiency and Energy Sustainability (U.S. DRIVE) Program. The other assumptions were developed through discussions with experts from companies, universities, and the national laboratories. To address performance and cost uncertainties, the report took into consideration three cases - low (10%), average (50%) and high (90%) uncertainty, as shown below.

- Low case (10% uncertainty) — aligned with original-equipment-manufacturer improvements based on regulations,
- Average case (50% uncertainty), and
- High case (90% uncertainty) — aligned with aggressive technology advancement based on DOE's VTO.

The report outlined several hundred assumptions that were used to define each reference vehicle. Some of the main assumptions are highlighted below:

- The difference in peak efficiency between gasoline and diesel engines is expected to narrow in the future because of the combination of advanced gasoline engine technologies and the impact of evermore stringent after-treatment for diesel.
- Coupling ultra-capacitors with batteries was not considered, owing to higher cost and expected increase in lithium ion battery life and cold-start performance in the short term.
- Because of the drive quality requirements in North America, automated manual transmissions were not included in the study.

The report concluded that technology improvements lead to significant reductions in energy consumption and possible cost reductions for fuel-saving technologies over time across light-duty vehicle applications. The study acknowledged that many technologies’ evolution and path towards commercialization remains uncertain, and that research should continue to be conducted in the different areas showing high potential. DOE VTO plans to update the research every two years to include the latest powertrain technologies and component technologies, as well as vehicle applications.

5.3.9.12 Cost of Electrification Technologies

As discussed in Section 5.3.8.1, the analysis is using battery pack costs that align with the updated battery pack sizes used in the ANL Autonomie simulation. Table 5-29 below shows some battery packs for different vehicle classes. The estimated size and cost of the battery is associated with vehicle size and vehicle class. In the example below, the sizing of the battery is based on a reference vehicle with zero mass reduction, zero aerodynamic reduction, and no rolling resistance reduction.

Commented [A13]: The BEV200 battery pack size (and potentially other electrified powertrain types) is larger than expected, when compared to current production vehicles achieving 200+ mile range with smaller batteries. Suggest docketing the BatPaC inputs and sizing assumptions used for generating these costs.

TABLE 5-29 - BATPAC RESULTS FOR REFERENCE VEHICLE CLASSES WITH MR0, AERO0 AND ROLL0.³⁰⁵

Specifications are for the highest demand configurations (MR0, AERO0 and ROLL0).						
Other demand configurations are sized differently.						
Technology Class	Vehicle Powertrain	Battery Power (Watts)	Battery Total Energy (Wh)	Motor Max Power (W)	Battery Nominal Voltage (V)	BatPaC DMC Cost (\$)
SmallCar	BISG	7692	806	10000	50.4	391.12
	CISG	18132	832	15000	118.8	588.44
	PHEV50	121391	22405	101674	173	4653.28
	SHEVP2	29670	1264	26143	194.4	1294.10
	SHEVPS	29670	1264	56121	194	1294.10
	PHEV30	51943	14439	61022	216	3264.05
	BEV200	132346	65718	92672	270	10838.69
SmallCarPerf	BISG	7692	806	10000	50	391.12
	CISG	18132	832	15000	119	588.44
	PHEV50	130459	24334	127800	184	4985.48
	SHEVP2	32967	1404	28326	216	1376.83
	SHEVPS	32967	1404	75950	216	1376.83
	PHEV30	57605	15561	82343	216	3410.47
	BEV200	181338	69481	114526	281	11266.92
MedCar	BISG	7692	806	10000	50.4	391.12

Commented [A14]: \$391 BattPac DMC Cost of 0.77 kW 48V BISG battery is about 11% higher than a typical 0.46kW 48V lithium-ion battery T1 supplier purchasing cost. EPA estimates the DMC cost should be around \$300. The same 0.77kW 48V lithium-ion battery was used for vehicle classes from small cars to pickup trucks. 0.43kW 48V lithium-ion battery is used in 2019 Dodge RAM 1500 48V BISG mild hybrid truck.

³⁰⁵ Some of these configurations may not be selected in the CAFE model.

*** EO 12866 Review – Draft – Do Not Cite, Quote or Release During Review ***

	CISG	18132	832	15000	118.8	588.44
	PHEV50	139848	24640	123688	184	5059.83
	SHEVP2	36264	1544	30937	237.6	1459.28
	SHEVPS	32967	1404	73009	216	1376.83
	PHEV30	60759	15893	78955	216	3456.97
	BEV200	169755	71457	113259	288	11474.23
MedCarPerf	BISG	7692	806	10000	50	391.12
	CISG	18132	832	15000	119	588.44
	PHEV50	158777	27726	204776	205	5570.80
	SHEVP2	39561	1685	33494	259	1540.45
	SHEVPS	39561	1685	122498	259	1540.45
	PHEV30	69761	17714	128276	216	3698.40
	BEV200	340694	76069	172350	299	12286.20
SmallSUV	BISG	7692	806	10000	50	391.12
	CISG	18132	832	15000	119	588.44
	PHEV50	146678	27696	123470	216	5612.47
	SHEVP2	32967	1404	30053	216	1376.83
	SHEVPS	36264	1544	82052	238	1459.28
	PHEV30	63848	18276	89905	216	3751.86
	BEV200	177563	81985	130543	266	12794.19
SmallSUVPerf	BISG	7692	806	10000	50	391.12
	CISG	18132	832	15000	119	588.44
	PHEV50	156724	30459	173298	227	5916.44
	SHEVP2	36264	1544	33147	238	1459.28
	SHEVPS	39561	1685	116450	259	1540.45
	PHEV30	74995	19616	124374	238	3964.03
	BEV200	244770	86657	167737	274	13263.54
MedSUV	BISG	7692	806	10000	50	391.12
	CISG	18132	832	15000	119	588.44
	PHEV50	151268	29668	127451	238	5869.67
	SHEVP2	36264	1544	32002	238	1459.28
	SHEVPS	36264	1544	77709	238	1459.28
	PHEV30	70206	19313	85888	238	3927.08
	BEV200	172321	88465	126753	295	13675.26
MedSUVPerf	BISG	7692	806	10000	50	391.12
	CISG	18132	832	15000	119	588.44
	PHEV50	173599	33948	193263	259	6498.32
	SHEVP2	42857	1825	37591	281	1619.27
	SHEVPS	42857	1825	133774	281	1619.27

*** EO 12866 Review – Draft – Do Not Cite, Quote or Release During Review ***

	PHEV30	82107	21779	140367	259	4264.11
	BEV200	273785	96893	190775	306	14548.64
Pickup	BISG	7692	806	10000	50	391.12
	CISG	18132	832	15000	119	588.44
	SHEVP2	39561	1685	34937	259	1540.45
PickupHT	BISG	7692	806	10000	50	391.12
	CISG	18132	832	15000	119	588.44
	SHEVP2	46154	1966	40842	302	1698.27

The direct manufacturing costs for this NPRM analysis are presented in the tables below. Costs have been updated to reflect 2016 dollars. Table 5-30 through Table 5-31 show the incremental costs that incorporates both the battery costs from BatPac and the individual components costs. Table 5-32 and

Commented [A15]: The BatPaC model inputs and sizing parameters are not included in the text. Suggest docketing the BatPaC inputs and sizing assumptions used for generating these costs.

*** EO 12866 Review – Draft – Do Not Cite, Quote or Release During Review ***

Table 5-33 show the absolute electrification cost without batteries relative to a baseline internal combustion engine, and including learning effects and retail price equivalent factor.

TABLE 5-30 - DMC FOR ELECTRIFICATION TECHNOLOGIES FOR THIS NPRM IN 2016\$

Electrification Technologies - Direct Manufacturing Cost (2016\$)						
	SmallCar	MedCar	SmallSUV	MedSUV	Pickup	Incremental to
EPS	\$93.59	\$93.59	\$93.59	\$93.59	\$93.59	BaseV
IACC	\$49.55	\$49.55	\$49.55	\$49.55	\$49.55	EPS
SS12V	\$259.51	\$284.94	\$306.04	\$313.55	\$354.51	IACC
BISG	\$1,055.94	\$1,055.94	\$1,055.94	\$1,212.01	\$1,212.01	SS12V
CISG	\$2,210.82	\$2,797.66	\$2,809.77	\$3,432.94	\$3,432.94	BISG

Commented [A16]: The combined costs here for BISG and SS12V of \$1460-\$1710 are too high. It's not clear from the write-up what is causing the high costs, but one possibility is the inclusion of SS12V is double-counting Start-Stop functionality inherent in BISG system.

TABLE 5-31 - HYBRID ELECTRIFICATION PATH - DIRECT MANUFACTURING (2016\$)

	SmallCar	MedCar	SmallSUV	MedSUV	Pickup	Incremental to
SHEVP2	\$1,977.82	\$2,614.50	\$2,128.50	\$2,437.05	\$2,572.18	CISG
SHEVPS	\$1,875.25	\$2,478.91	\$2,018.12	\$2,310.66	\$2,438.79	SHEVP2
PHEV30	\$3,076.60	\$5,573.14	\$3,564.29	\$5,573.14	\$5,573.14	SHEVPS
PHEV50	\$3,289.28	\$5,958.41	\$3,810.69	\$5,958.41	\$5,958.41	PHEV30
BEV200	\$452.85	\$2,467.70	\$147.29	\$2,467.70	\$2,467.70	PHEV50
FCV	\$15,174.68	\$15,174.68	\$15,174.68	\$15,174.68	\$15,174.68	BEV200

Commented [A17]: \$2210-\$2810 incremental small car to small SUV CISG cost from 48V BISG is too high. T1 supplier estimates have indicated about a \$600 cost from 48V BISG to 48V P2 inline mild hybrids. The 48V P2 inline mild hybrid cost and effectiveness are higher than the CISG mild hybrids by adding the k0 clutch between engine and motor.

Commented [A18]: About \$9232 powersplit hybrid cost is estimated from the base vehicle with EPS + IACC. It's hard to understand that \$3800 MSRP cost difference between 2018 Camry LE and 2018 Camry Hybrid LE with the high-level hybrid trims from \$9232 incremental powersplit cost.

:

*** EO 12866 Review – Draft – Do Not Cite, Quote or Release During Review ***

TABLE 5-32 - SUMMARY OF CAR AND SMALL SUV ABSOLUTE ELECTRIFICATION TECHNOLOGY COST WITHOUT BATTERIES VS. BASELINE INTERNAL COMBUSTION ENGINE, INCLUDING LEARNING EFFECTS AND RETAIL PRICE EQUIVALENT³⁰⁶

Name	Technology Pathway	CY-2017	CY-2021	CY-2025	CY-2029
EPS	Electric Improvements	\$127.78	\$119.33	\$112.48	\$107.39
IACC	Electric Improvements	\$188.36	\$156.72	\$140.67	\$131.35
CONV	Electrification	\$ -	\$ -	\$ -	\$ -
SS12V ³⁰⁷	Electrification	\$657.92	\$568.03	\$508.83	\$473.05
BISG	Electrification	\$1,137.19	\$829.75	\$714.98	\$655.86
CISG	Electrification	\$893.28	\$781.09	\$691.89	\$651.54
SHEVP2	Hybrid/Electric	\$2,206.07	\$1,942.13	\$1,732.29	\$1,637.38
SHEVPS	Hybrid/Electric	\$6,477.91	\$5,664.33	\$5,017.49	\$4,724.85
PHEV30	Advanced Hybrid/Electric	\$8,180.35	\$6,956.06	\$6,008.25	\$5,587.55
PHEV50	Advanced Hybrid/Electric	\$8,338.69	\$7,011.23	\$5,994.55	\$5,546.75
BEV200 ³⁰⁸	Advanced Hybrid/Electric	\$2,976.02	\$2,324.66	\$1,859.67	\$1,664.95
FCV	Advanced Hybrid/Electric	\$19,673.32	\$17,607.59	\$16,485.05	\$15,702.81

³⁰⁶ Costs do not include value loss for HEV's, PHEV's, and BEV's.

³⁰⁷ SS12V includes battery cost, whereas other electrification and hybrid/electric technologies do not.

³⁰⁸ BEVs do include cost of an internal combustion engine, multispeed transmission or internal combustion components, therefore non battery hardware is less expensive than PHEV.

*** EO 12866 Review – Draft – Do Not Cite, Quote or Release During Review ***

TABLE 5-33: SUMMARY OF TRUCK AND MEDIUM SUV ABSOLUTE ELECTRIFICATION TECHNOLOGY COST WITHOUT BATTERIES VS. BASELINE INTERNAL COMBUSTION ENGINE, INCLUDING LEARNING EFFECTS AND RETAIL PRICE EQUIVALENT³⁰⁹

Name	Technology Pathway	CY-2017	CY-2021	CY-2025	CY-2029
EPS	Electric Improvements	\$127.78	\$119.33	\$112.48	\$107.39
IACC	Electric Improvements	\$188.36	\$156.72	\$140.67	\$131.35
CONV	Electrification	\$ -	\$ -	\$ -	\$ -
SS12V ³¹⁰	Electrification	\$735.31	\$634.85	\$568.69	\$528.70
BISG	Electrification	\$524.86	\$382.96	\$329.99	\$302.70
CISG	Electrification	\$1,786.54	\$1,562.17	\$1,383.78	\$1,303.07
SHEVP2	Hybrid/Electric	\$1,924.68	\$1,696.08	\$1,514.34	\$1,432.14
SHEVPS	Hybrid/Electric	\$8,038.86	\$7,029.24	\$6,226.53	\$5,863.38
PHEV30	Advanced Hybrid/Electric	\$10,395.42	\$8,839.62	\$7,635.17	\$7,100.55
PHEV50	Advanced Hybrid/Electric	\$10,683.13	\$8,982.46	\$7,679.93	\$7,106.23
BEV200	Advanced Hybrid/Electric	\$4,351.27	\$3,398.92	\$2,719.04	\$2,434.34
FCV	Advanced Hybrid/Electric	\$25,969.16	\$23,242.36	\$21,760.59	\$20,728.01

5.3.9.13 Electrification Technologies Learning Rate

For this NPRM analysis, Table 5-34 below shows the learning rate for the basic and non-battery advanced electrification technologies. Learning rates were developed for electrification technologies using the 2015 NAS study, Wright-based learning curves,³¹¹ and ANL cost report.³¹²

³⁰⁹ Costs do not include value loss for HEV's, PHEV's, and BEV's.

³¹⁰ SS12V includes battery cost, whereas other electrification and hybrid/electric technologies do not.

³¹¹ Discussed further in PRIA Chapter 8.

³¹² ANL/ESD-15/28. Assessment of vehicle sizing, energy consumption, and cost through large-scale simulation of advanced engine technologies, Moawad, Kim, Shidore, Rousseau, Energy System Division, Argonne National Laboratory (March 2016).

*** EO 12866 Review – Draft – Do Not Cite, Quote or Release During Review ***

TABLE 5-34 - LEARNING RATE FOR ELECTRIFICATION TECHNOLOGIES FROM MY 2016 TO MY 2032

Technology	Model Year																
	2016	2017	2018	2019	2020	2021	2022	2023	2024	2025	2026	2027	2028	2029	2030	2031	2032
CONV	1	1	1	1	1	1	1	1	1	1	1	1	1	1	1	1	1
SS12V	0.86	0.81	0.77	0.74	0.71	0.69	0.67	0.65	0.63	0.61	0.6	0.59	0.57	0.56	0.56	0.55	0.54
BISG	0.98	0.93	0.87	0.81	0.73	0.68	0.64	0.61	0.59	0.57	0.55	0.54	0.52	0.51	0.5	0.5	0.49
CISG, SHEVPS	0.96	0.93	0.89	0.86	0.83	0.81	0.78	0.76	0.73	0.71	0.69	0.68	0.67	0.66	0.65	0.64	0.64
SHEVP2	0.87	0.84	0.81	0.78	0.76	0.73	0.71	0.69	0.66	0.64	0.63	0.62	0.61	0.6	0.59	0.58	0.58
PHEV30	0.95	0.91	0.87	0.84	0.8	0.77	0.74	0.71	0.69	0.66	0.64	0.63	0.61	0.6	0.6	0.59	0.58
PHEV50	0.95	0.9	0.86	0.83	0.79	0.76	0.73	0.7	0.67	0.64	0.62	0.61	0.59	0.58	0.57	0.57	0.56
BEV200	0.93	0.87	0.81	0.76	0.72	0.67	0.63	0.6	0.56	0.53	0.51	0.49	0.48	0.46	0.45	0.45	0.44

*** EO 12866 Review – Draft – Do Not Cite, Quote or Release During Review ***

Figure 5-154 shows the learning factor used for all electrification batteries except for 12VSS. This learning was derived from the ANL's BatPac battery model.

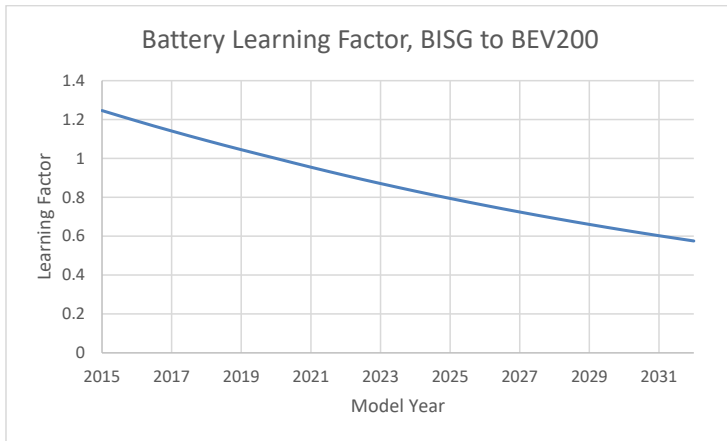
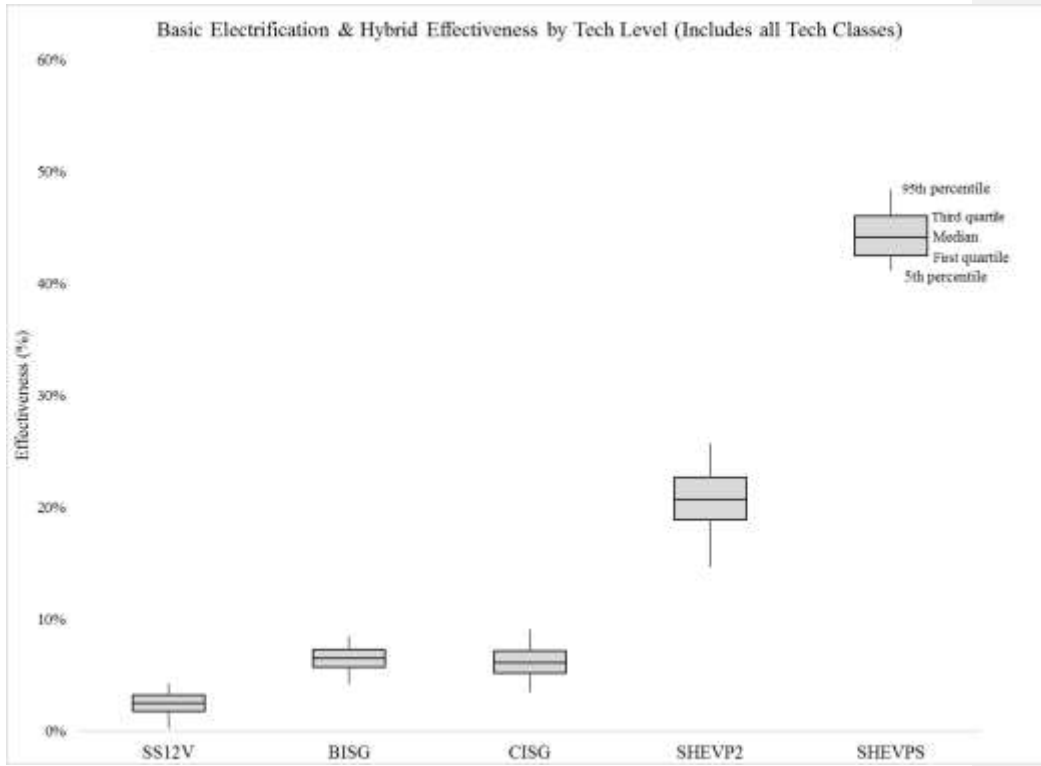

FIGURE 5-154 - BATTERY LEARNING FACTOR USED FOR ALL ELECTRIFICATION TECHNOLOGIES, BISG TO BEV200

5.3.9.14 Electrification Technologies Effectiveness

Figure 5-155 and Figure 5-156 below shows ranges of effectiveness for all electrification technologies in the CAFE model, relative to a similarly equipped vehicle with no electrification technologies.

*** EO 12866 Review – Draft – Do Not Cite, Quote or Release During Review ***



*** EO 12866 Review – Draft – Do Not Cite, Quote or Release During Review ***

FIGURE 5-155 - RANGE OF EFFECTIVENESS FOR BASE ELECTRIFICATION AND HYBRID TECHNOLOGIES ACROSS ALL VEHICLE CLASSES.

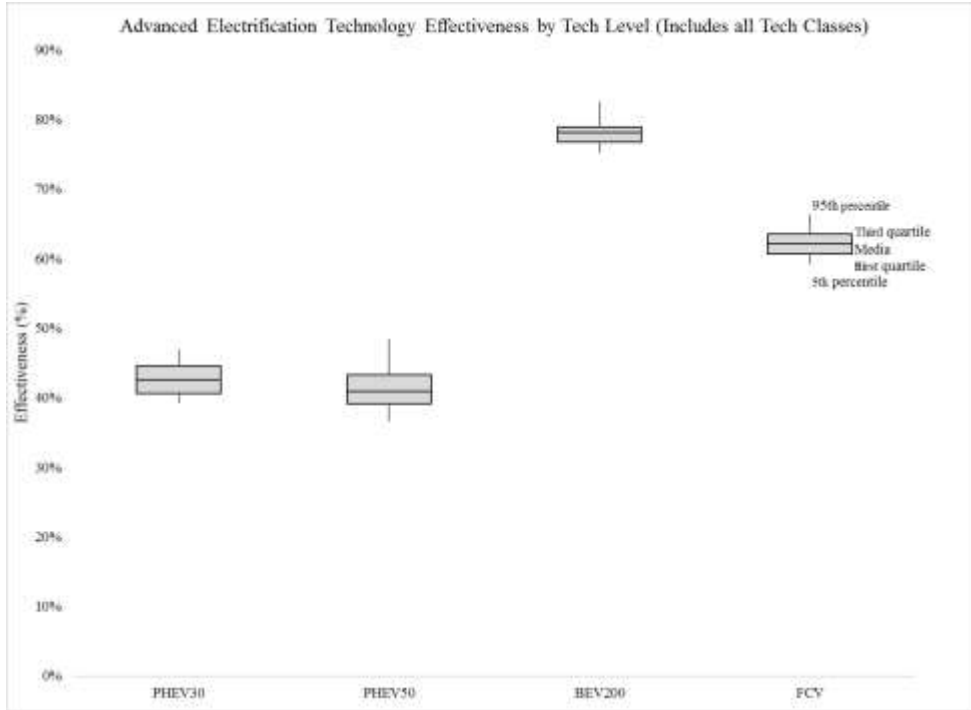

FIGURE 5-156 - RANGE OF EFFECTIVENESS FOR ADVANCED ELECTRIFICATION TECHNOLOGIES ACROSS ALL VEHICLE CLASSES

5.3.9.15 Summary of Road Load Technologies

5.3.9.15.1 Mass Reduction

Mass reduction remains a key technology that vehicle manufacturers are expected to continue to apply to meet light-duty fuel economy and CO₂ standards. Reducing vehicle mass can be accomplished through several different techniques, such as design optimization, part consolidation, and integrating light-weight and advanced materials (for example, advanced high strength steel, aluminum, magnesium, and plastics including carbon fiber reinforced plastics). The approach applied on each vehicle platform and vehicle model may be impacted by the materials and manufacturing methods a manufacturer has previously employed, the manufacturer's short term and long term mass reduction strategy including for design, materials, manufacturing and assembly.

In January 2018, EPA published a draft Trends report detailing light-duty vehicle fuel economy, GHG emissions, horsepower, and vehicle weight trends since 1975.³¹³

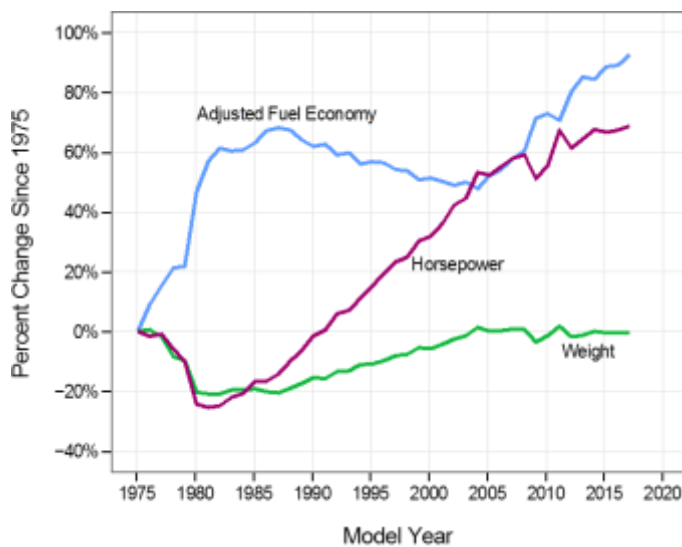

FIGURE 5-157 - CHANGE IN ADJUSTED FUEL ECONOMY, WEIGHT AND HORSEPOWER SINCE 1975

As mentioned in the Trends report, the trend lines in Figure 5-157 show that average vehicle weight and horsepower increased from the late 1990s to mid-2000s. Considerable technology

³¹³ U.S. EPA Light-Duty Automotive Technology, Carbon Dioxide Emissions, and Fuel Economy Trends - 1985 Through 2017 (January 2018), available at <https://nepis.epa.gov/Exe/ZyPDF.cgi?Dockey=P100TGLC.pdf>.

innovations from late MY 1990 to the mid-MY 2000s increased vehicle weight and power (and associated utility functions such as vehicle size, acceleration performance, safety features, and other features), but did not improve fuel economy. Additionally, an increased share of pickup trucks and sport utility vehicles (SUVs) entered the fleet. The Trends report also highlights that since model year 2005, new fuel saving technologies have improved fuel economy while keeping the vehicle weight relatively constant or slightly lower.

While the average vehicle curb weights may have stabilized, manufacturers often use additional mass reduction technologies to offset additional content (such as other fuel saving technologies, and sometimes other customer features like adjustable seats, infotainment systems, or larger wheels and tires).

5.3.9.15.1.1 Material Trends

Advanced high strength steel (AHSS) and aluminum (AL) have played a major role in recent years as materials used to reduce vehicle mass. The penetration rate of AHSS or AL depends on a number of factors such as vehicle redesign cycle timing, material availability, accompanying changes in manufacturing equipment, and changes in joining methods, among other things. A study conducted for the American Iron and Steel Institute shows the application of AHSS in vehicles has increased from 81 lbs. on average in 2006 to 254 lbs. in 2015.³¹⁴

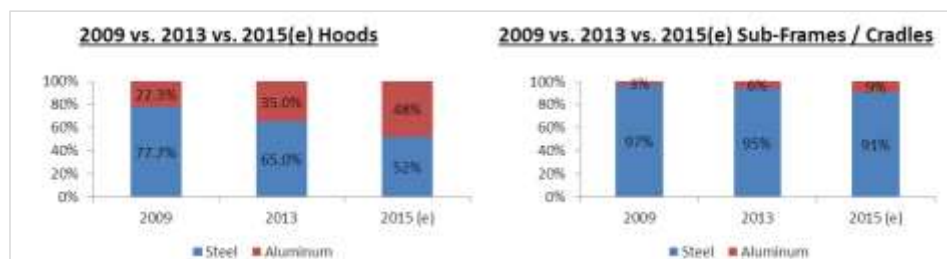

FIGURE 5-158 - PENETRATION OF AL IN HOODS AND ENGINE CRADLES FROM 2009 TO 2015

According to a study conducted for the Aluminum Association, aluminum content in vehicles has increased from nearly 300 lbs. in 2005, to 394 pounds in 2015, up from roughly 80 pounds in 1975, and a little more than 150 pounds in 1990.³¹⁵ Since the 1980s, many castings have migrated from steel to aluminum.³¹⁶ Figure 5-158 shows AL replacing steel in greater

³¹⁴ Abey Abraham, Metallic Material Trends in the North American Light Vehicle (May 2015), available online at - <http://www.steelsustainability.org/-/media/Files/Autosteel/Great%20Designs%20in%20Steel/GDIS%202015/Track%202%20-%20Abraham.pdf>

³¹⁵ Available online at - <http://www.autonews.com/assets/PDF/CA95065611.PDF>

³¹⁶ For instance, engine blocks and transmission cases are nearly universally aluminum in the MY 2016 fleet, but aluminum was rarely used in these applications prior to the 1990's.

percentages in vehicle hoods, and AL beginning to penetrate engine sub frames/cradles in small percentages.³¹⁷

Some manufacturers have also begun to experiment with advanced composites, such as carbon fiber, to achieve mass reduction. Currently, the cost of carbon fiber and production complexity limits wide-scale adoption in many high production automotive components. However, there are growing examples where carbon fiber is being strategically used, such as in roof bows, supporting pillars, door frames and in chassis in luxury vehicles. While many of these applications do decrease curb weight, many carbon fiber applications provide additional (or primary) benefits of lower center of gravity and improved weight distribution.

A 2017 report published by American Chemistry Council (ACC) shows that while the overall share of plastics and polymer composites in vehicles have decreased by 0.1% in the last 10 years,³¹⁸ the share of AL has increased by 2.3%.³¹⁹ The report also published data on material content in vehicles as shown in Table 5-35 and Table 5-36.

**TABLE 5-35 AVERAGE MATERIALS CONTENT OF US/CANADA LIGHT VEHICLES
(POUND/VEHICLE)**

	2006	2007	2008	2009	2010	2011	2012	2013	2014	2015	2016
Average Weight	4,081	4,103	4,046	3,953	3,960	4,007	3,896	3,900	3,928	3,991	4,026
Regular Steel	1,622	1,644	1,627	1,501	1,458	1,439	1,368	1,354	1,342	1,330	1,335
High- & Medium-	502	518	523	524	555	608	619	627	649	701	742
Stainless Steel	73	75	75	69	72	73	68	74	73	75	74
Other Steels	34	34	33	31	32	32	30	32	32	32	32
Iron Castings	331	322	253	206	242	261	270	271	278	268	249
Aluminum	323	319	316	324	338	344	349	355	368	395	410
Magnesium	10	10	11	11	11	12	10	10	10	10	11
Copper and Brass	67	66	71	71	74	73	71	70	68	67	66
Lead	39	41	44	42	41	39	35	35	36	35	35
Zinc Castings	10	9	9	9	9	9	8	8	8	8	8
Powder Metal	42	43	43	41	41	42	44	45	46	45	44
Other Metals ³²¹	5	5	5	5	5	5	5	5	4	5	5
Plastics/Polymer	342	339	348	384	359	353	332	328	329	334	332
Rubber	198	192	204	245	228	223	205	198	196	198	199

³¹⁷ *Id.*

³¹⁸ After rapidly increasing in the 1960's through the 1990's.

³¹⁹ American Chemistry Council Economics & Statistics Department, Plastics and Polymer Composites in Light Vehicles (November 2017), available at <https://plastics-car.com/lightvehiclereport> (last accessed May 2018).

³²⁰ Despite long lead times for material qualification of new metal alloys, medium and high strength steels have been and continue to be widely adopted in the automotive industry at a rapid pace. Advanced steel materials typically replace regular steel, and often compete with aluminum and composites in body systems.

³²¹ "Other Metals" are typically used sparingly in specialty applications in the auto industry, and these metals make up a small portion of total vehicle weight.

*** EO 12866 Review – Draft – Do Not Cite, Quote or Release During Review ***

Coatings	30	30	31	36	36	33	28	28	28	28	28
Textiles	47	46	48	58	56	50	49	50	49	45	44
Fluids and	211	215	214	217	219	221	219	222	224	225	226
Glass	105	103	99	88	92	98	95	96	96	95	93
Other	89	92	91	90	92	93	91	92	93	95	92

*** EO 12866 Review – Draft – Do Not Cite, Quote or Release During Review ***

TABLE 5-36 - AVERAGE MATERIALS CONTENT OF US/CANADA LIGHT VEHICLES (POUND/VEHICLE)

	2006	2007	2008	2009	2010	2011	2012	2013	2014	2015	2016
As a Percent of Total Weight	100%	100%	100%	100%	100%	100%	100%	100%	100%	100%	100%
Regular Steel	39.7%	40.1%	40.2%	38.0%	36.8%	35.9%	35.1%	34.7%	34.2%	33.3%	33.2%
High- & Stainless Steel	12.3%	12.6%	12.9%	13.3%	14.0%	15.2%	15.9%	16.1%	16.5%	17.6%	18.4%
Other Steels	1.8%	1.8%	1.9%	1.7%	1.8%	1.8%	1.7%	1.9%	1.9%	1.9%	1.8%
Iron Castings	0.8%	0.8%	0.8%	0.8%	0.8%	0.8%	0.8%	0.8%	0.8%	0.8%	0.8%
Aluminum	8.1%	7.8%	6.3%	5.2%	6.1%	6.5%	6.9%	6.9%	7.1%	6.7%	6.2%
Magnesium	7.9%	7.8%	7.8%	8.2%	8.5%	8.6%	9.0%	9.1%	9.4%	9.9%	10.2%
Copper and Lead	0.3%	0.3%	0.3%	0.3%	0.3%	0.3%	0.3%	0.3%	0.2%	0.2%	0.3%
Zinc Castings	1.6%	1.6%	1.7%	1.8%	1.9%	1.8%	1.8%	1.8%	1.7%	1.7%	1.6%
Powder Metal	1.0%	1.0%	1.1%	1.1%	1.0%	1.0%	0.9%	0.9%	0.9%	0.9%	0.9%
Other Metals	0.2%	0.2%	0.2%	0.2%	0.2%	0.2%	0.2%	0.2%	0.2%	0.2%	0.2%
Plastics/Polymer	1.0%	1.0%	1.1%	1.0%	1.0%	1.0%	1.1%	1.2%	1.2%	1.1%	1.1%
Rubber	0.1%	0.1%	0.1%	0.1%	0.1%	0.1%	0.1%	0.1%	0.1%	0.1%	0.1%
Coatings	8.4%	8.3%	8.6%	9.7%	9.1%	8.8%	8.5%	8.4%	8.4%	8.4%	8.3%
Textiles	4.8%	4.7%	5.1%	6.2%	5.8%	5.6%	5.3%	5.1%	5.0%	5.0%	4.9%
Fluids and Glass	0.7%	0.7%	0.8%	0.9%	0.9%	0.8%	0.7%	0.7%	0.7%	0.7%	0.7%
Other	1.2%	1.1%	1.2%	1.5%	1.4%	1.3%	1.3%	1.3%	1.2%	1.1%	1.1%
	5.2%	5.2%	5.3%	5.5%	5.5%	5.5%	5.6%	5.7%	5.7%	5.6%	5.6%
	2.6%	2.5%	2.4%	2.2%	2.3%	2.4%	2.4%	2.5%	2.4%	2.4%	2.3%
	2.2%	2.2%	2.2%	2.3%	2.3%	2.3%	2.3%	2.4%	2.4%	2.4%	2.3%

5.3.9.15.1.2 Development Since the 2012 Final Rule

In the 2012 final rule, NHTSA and EPA based their projections of cost and mass savings on literature review and from data provided by manufacturers. The agencies assumed the relationship between costs and the amount of mass reduction was linear, as shown in Figure 5-159 below. For example, on all MY 2008/2010 vehicles, a 10% mass reduction cost an estimated \$0.44/lb. on a 4,000-lb. vehicle, and a 15% mass reduction cost an estimated \$0.66/lb. This analysis has re-evaluated the assumptions from the 2012 final rule, and this analysis recognize that in most applications, costs exponentially rise for the highest levels of mass reduction.

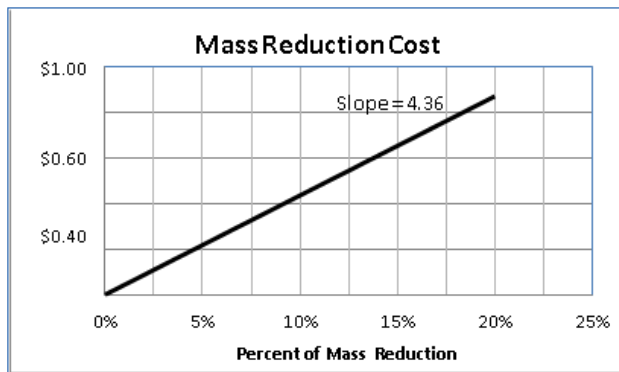

FIGURE 5-159 - COST CURVE USED IN 2012 FINAL RULE

Since the 2012 final rule, the agencies have conducted several light-weighting studies to assess the technological feasibility and cost of mass reduction in certain vehicles and component parts. The studies examined the cost of manufacturing and tooling to accommodate light-weight materials in automotive design. This analysis have updated their mass reduction cost estimates based on these studies.

In addition to agency studies, this analysis reviewed light-weighting studies performed by industry trade associations such as American Iron and Steel Institute (AISI), the Aluminum Association, and the American Chemistry Council. Many of these studies focused mostly on substituting existing material with advanced materials, such as advanced high strength steels, aluminum and composite materials and detailed cost estimates are not included in the study

5.3.9.15.1.3 Development of mass reduction costs for NPRM

Among the several light-weighting studies, ~~the agencies agreed to~~ this analysis uses NHTSA's passenger car light-weighting study and NHTSA's full size pickup truck light-weighting study to derive the cost estimates to achieve different levels of mass reduction. ~~The light-weighting~~

Commented [A19]: EPA did not agree to this approach. NHTSA made this decision independent of EPA.

~~studies initiated by other agencies and by industry often were limited to material substitution of the vehicle components, such as replacing steel with aluminum or replacing mild steel with AHSS or replacing mild steel with CFRP in selective components. The cost estimates for light weighting from other agencies varied due to incorrect or impractical assumptions such as aggressive secondary mass reduction which translated to cost savings for the initial 10% mass reduction.³²²~~

For today’s analysis, the agencies chose to use studies that evaluated materials, as well as material gauge and component geometry. Additionally, the agencies preferred to use studies that considered small overlap impact tests conducted by IIHS, and not all studies took that test into account. For pickup trucks, the NHTSA study accounted for vehicle functional performance for attributes including towing, noise and vibration and gradeability, in addition to considering platform sharing constraints.

Previously, in the Draft TAR, the agencies provided an incremental cost per pound for each stage of mass reduction. For today’s analysis, the agencies present an average cost per pound over the baseline (MR0) for the vehicle’s glider weight. While the definitions of glider may vary from study to study (or even simulation to simulation), the agencies referenced the same dollar per pound of curb weight to develop costs for different glider definitions. In translating these values, the agencies took care to track units (\$/kg vs. \$/lb.) and the reference for percentage improvements (glider vs. curb weight).

5.3.9.15.1.3.1 Passenger Cost Curve used in NPRM

NHTSA relied on a MY 2011 Honda Accord light-weighting study to develop the passenger cost curve used in this NPRM. The NHTSA-funded study, performed by Electricore, Inc., George Washington University, and EDAG, Inc, was completed in 2012 and the final report peer reviewed by industry experts and Honda Motor Company. EDAG and Electricore conducted further work to consider and make changes to the light-weighted model based on the feedback from Honda, and continued to make additional changes to the design concept to address the IIHS small overlap impact test. This study was completed in February 2016.³²³ Table 5-37 shows the list of components identified in the MY 2011 Honda Accord light-weighting study and the corresponding direct manufacturing cost (DMC) estimated to light weight those components. Cost estimates include consideration of advanced materials, redesign, tooling changes, and manufacturing setup changes. Figure 5-160 shows the cost curve derived from the list of components in Table 5-37. Figure 5-161 shows the DMC at different levels of mass reduction for the passenger car. The DMC shown in Table 5-38 is the average DMC and not the marginal cost for each additional mass reduction level. As the average cost per pound over baseline

Commented [A20]: Suggest removing this text, since it is not necessary when presenting NHTSA’s work, and does not apply to the EPA-contracted studies, which included not only material substitution, but also some level of design optimization (part consolidation, joining techniques, shape optimization, etc.)

³²² EPA-420-R-12-019, EPA-420-R-12-026, SAE Paper 2013-01-0656.

³²³ <https://www.nhtsa.gov/corporate-average-fuel-economy/light-duty-cape-midterm-evaluation>.

*** EO 12866 Review – Draft – Do Not Cite, Quote or Release During Review ***

increases, the marginal cost per pound may increase dramatically. (Table 5-37 units are in kg and \$/kg).

*** EO 12866 Review – Draft – Do Not Cite, Quote or Release During Review ***

TABLE 5-37 - LIST OF COMPONENTS LIGHT WEIGHTED IN THE LIGHT-WEIGHTED CONCEPT STUDY BASED ON THE MY 2011 HONDA ACCORD (\$/KG)

#	Vehicle Component/System	Baseline Mass	Substitution Material	Light-weighted Mass	Mass Saving	Δ Cost	Δ Cost	Cumulative Mass Saving	Cumulative MR	Cumulative Cost	Cumulative Cost
		(Kg)		(Kg)	(Kg)	(\$)	(\$/kg)	(Kg)	(%)	(\$)	(\$/kg)
1	Front Bumper	7.96	AHSS	4.37	3.59	-0.88	-0.25	3.59	0.31%	-0.88	-0.25
2	Front Door Trim	5.38	MuCell	4.04	1.34	0.00	0	4.93	0.42%	-0.88	-0.18
3	Front Door Wiring Harness	0.87	Al	0.57	0.3	0.00	0	5.23	0.45%	-0.88	-0.17
4	Head Lamps	6.86	MuCell	5.15	1.71	0.00	0	6.94	0.60%	-0.88	-0.13
5	HVAC	10.3	MuCell	7.7	2.6	0.00	0	9.54	0.82%	-0.88	-0.09
6	Insulation	9.35	Thinsulate & Quietblend	6.15	3.2	0.00	0	12.74	1.09%	-0.88	-0.07
7	Interior Trim	26.26	MuCell	23.23	3.03	0.00	0	15.77	1.35%	-0.88	-0.06
8	Parking Brake	3.31	Electronic	2.32	0.99	0.00	0	16.76	1.44%	-0.88	-0.05
9	Rear Door Trim	4.53	MuCell	3.4	1.13	0.00	0	17.89	1.54%	-0.88	-0.05
10	Rear Door Wiring Harness	0.33	Al	0.22	0.11	0.00	0	18	1.55%	-0.88	-0.05
11	Tail Lamps	2.54	MuCell	1.91	0.63	0.00	0	18.63	1.60%	-0.88	-0.05
12	Tires	37.1	Goodyear	32.65	4.45	0.00	0	23.08	1.98%	-0.88	-0.04
13	Wiring and Harness	21.7	Al	17.4	4.3	0.00	0	27.38	2.35%	-0.88	-0.03
14	Wheels	40.1	AHSS	38.66	1.44	0.00	0	28.82	2.47%	-0.88	-0.03
15	Rear Bumper	7.84	AHSS	4.33	3.51	2.10	0.6	32.33	2.78%	1.22	0.04
16	Instrument Panel	31.9	Mg	22.45	9.45	15.43	1.63	41.78	3.59%	16.65	0.40
17	Body Structure	328	AHSS	273.6	54.4	160.47	2.95	96.18	8.26%	177.12	1.84
18	Decklid	9.95	Al	4.74	5.21	17.04	3.27	101.39	8.70%	194.16	1.91
19	Hood	15.2	Al	7.73	7.47	24.61	3.29	108.86	9.34%	218.77	2.01
20	Front Door Frames	32.78	Al	17.38	15.4	56.30	3.66	124.26	10.67%	275.07	2.21
21	Fenders	7.35	Al	4.08	3.27	12.60	3.85	127.53	10.95%	287.67	2.26
22	Seats	66.77	Composite + Al + GFRP	46.74	20.03	96.84	4.83	147.56	12.67%	384.51	2.61
23	Rear Door Frames	26.8	Al	15.34	11.46	59.90	5.23	159.02	13.65%	444.41	2.79

The curb weight of MY 2011 Honda Accord used in the light-weighting study is approximately 1480kg. The glider weight^{324, 325} of the MY 2011 Honda Accord is approximately 1165kg. In this case, the glider represents 79% of curb weight. As shown in Table 5-37, approximately 4.67% of the glider mass is light weighted by substituting mild steel with AHSS in body-in-white (BIW) structure, and 3.39% of the glider mass is light weighted by substituting mild steel with AL in closures (closures include hood, front door, rear door and deck lid). Between BIW and closures, approximately 8.06% of glider mass is light weighted by substituting mild steel with AL. The additional light-weighting was achieved by using advanced plastics for door trims, switching copper wiring harness to aluminum wiring harness, using AHSS for seat frames, using AHSS and optimizing design for parking brakes, among other substitutions. As shown in Table 5-37, a total of 13.65% of glider mass was light weighted. This translates to 10.74% mass reduction at the curb weight level. The light-weighting report noted that follow-on mass reduction can be achieved by downsizing the engine and optimizing the powertrain components, while maintaining the same level of performance. The report shows powertrain downsizing translates to some cost savings as well (the cost savings comes from manufacturers selecting downsized engines from the inventory of engines used in other product lines through economies of scale and common parts).

The 2015 NAS report suggested an engine downsizing opportunity exists when the glider mass is light weighted by at least 10%.³²⁶ The 2015 NAS report also suggested that 10% light weighting of glider mass alone would boost the fuel economy by 3% and any engine downsizing following the 10% glider mass reduction would provide an additional 3% increase in fuel economy. This analysis uses the 2015 NAS recommendation and does downsize the engine at a 10% glider weight reduction, and the analysis rely on full vehicle simulations to estimate the effects of this action.

³²⁴ Glider weight is typically all components of the vehicle except the powertrain components such as engines, transmissions, radiator, fuel tank and exhaust systems.

³²⁵ Not all subsystems considered in the light-weighting study were considered in the ANL simulations and CAFE model.

³²⁶ National Research Council. 2015. Cost, Effectiveness, and Deployment of Fuel Economy Technologies for Light-Duty Vehicles. Washington, DC - The National Academies Press. <https://doi.org/10.17226/21744>.

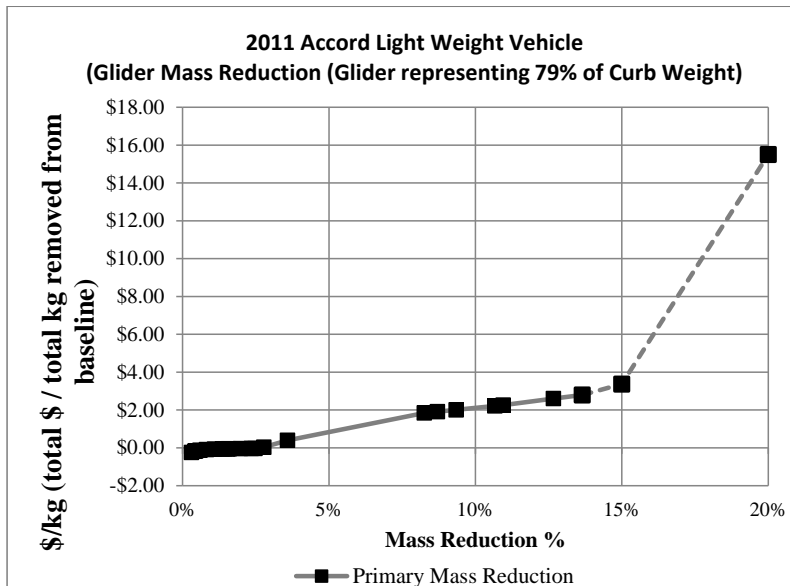

FIGURE 5-160 - PASSENGER CAR GLIDER COST CURVE BASED ON MY 2011 HONDA ACCORD (79% OF THE CURB WEIGHT)

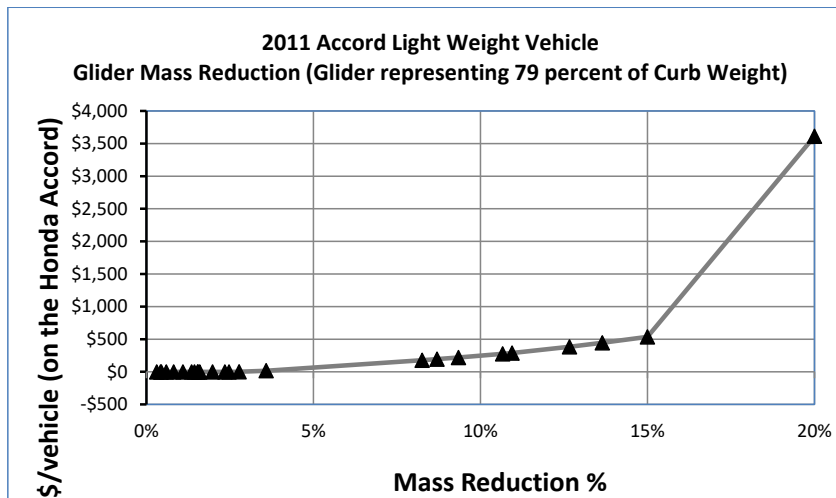

FIGURE 5-161 DMC FOR PASSENGER CAR GLIDER MASS REDUCTION (GLIDER - 79% OF CURB WEIGHT)

The Table 5-38 below shows the cost per kilogram (\$/kg) and estimated costs at discrete levels of mass reduction for a passenger car derived from light weighting the MY 2011 Honda Accord.

*** EO 12866 Review – Draft – Do Not Cite, Quote or Release During Review ***

Table 5-39 shows the cost numbers used in the CAFE model (Cost adjusted to reflect glider share of 50% of curb weight) (\$/lbs., including RPE market, MY 2016 cars).

TABLE 5-38 - COST NUMBERS DERIVED FROM PASSENGER CAR LIGHT-WEIGHTING STUDY

Curb Weight	1480 kg				
PC Glider (79% of Curb Weight)	1165 kg				
MR% (of glider in PC light-weighting study)	MR (kg)	\$/kg	Estimated DMC on MY 2011 Honda Accord	New Curb Weight after Glider Mass Reduction (kg)	Percentage Mass Reduction at Curb Weight Level
5.0%	58.25	\$0.84	\$48.93	1,421	4.0%
7.5%	87.38	\$1.61	\$140.67	1,392	5.9%
10.0%	116.50	\$2.12	\$246.98	1,363	7.9%
15.0%	174.75	\$3.37	\$535.90	1,320	10.8%
20.0%	233.00	\$5.50	\$3,611.50	1,247	15.7%

TABLE 5-39 - COST NUMBERS USED IN THE CAFE MODEL FOR PASSENGER CAR MASS REDUCTION

MR% (glider, 50% of curb weight)	MR Technology Level	\$/kg, including RPE markup	\$/lbs., including RPE markup, MY 2016 cars	New Curb Weight after Glider Mass Reduction (lbs.)	Approximate Percentage Mass Reduction at Curb Weight Level
0%	MR0	\$ -	\$ -	Depends on the vehicle as specified in the CAFE model	0.0%
5.0%	MR1	\$1.01	\$0.46		2.5%
7.5%	MR2	\$1.21	\$0.55		3.8%
10.0%	MR3	\$1.87	\$0.85		5.0%
15.0%	MR4	\$3.86	\$1.75		7.5%
20.0%	MR5	\$5.78	\$2.62		10.0%

5.3.9.15.1.3.2 Light Truck Cost Curve Used in NPRM

NHTSA’s cost curve for light trucks used in this NPRM was developed through an agency-funded light-weighting study on a MY 2014 Chevrolet Silverado 1500 full-size pickup truck.

*** EO 12866 Review – Draft – Do Not Cite, Quote or Release During Review ***

EDAG Inc. performed this light-weighting study along with other sub-contractors. This study considered lessons learned during the MY 2011 Honda Accord light weighting study, and included requirements that the vehicle meet the IIHS small overlap performance test. This project was completed in 2016 and the final report is available on NHTSA's website.³²⁷

Table 5-40 shows the list of components light-weighted in the MY 2014 Chevrolet Silverado 1500 full-size pickup truck. Figure 5-162 shows the cost curve generated from the list of the light weighted components, and Figure 5-163 shows the DMC at different levels of mass reduction.

³²⁷ <https://www.nhtsa.gov/corporate-average-fuel-economy/light-duty-cafe-midterm-evaluation>.

*** EO 12866 Review – Draft – Do Not Cite, Quote or Release During Review ***

TABLE 5-40 - LIST OF COMPONENTS LIGHT WEIGHTED IN THE MY 2014 CHEVROLET SILVERADO 1500

#	Vehicle Component/System	Baseline Mass	Substitution Material	Light-weighted Mass	Mass Saving	Δ Cost	Δ Cost	Cumulative Mass Saving	Cumulative MR	Cumulative Cost	Cumulative Cost
		(Kg)		(Kg)	(Kg)	(\$)	(\$/kg)	(Kg)	(%)	(\$)	(\$/kg)
1	Interior Electrical Wiring	6.9	Copper Clad Aluminum (CCA)	5.52	1.38	-28.07	20.34	1.38	0.08%	-28.07	-20.34
2	Headliner	3.63	Cellmould	3.45	0.18	-0.93	-5.17	1.56	0.09%	-29	-18.59
3	Trim - Plastic	20.68	Cellmould	19.65	1.03	-5.3	-5.15	2.59	0.14%	-34.3	-13.24
4	Trim - misc.	34.67	Cellmould	32.94	1.73	-8.89	-5.14	4.32	0.24%	-43.19	-10.00
5	Floor Covering	9.75	Cellmould	9.26	0.49	-2.5	-5.10	4.81	0.27%	-45.69	-9.50
6	Headlamps	7.68	Mucell Housings	6.14	1.54	0	0.00	6.35	0.35%	-45.69	-7.20
7	HVAC System	25.88	MuCell & Cellmould	24.17	1.71	0	0.00	8.06	0.45%	-45.69	-5.67
8	Tail Lamps	2	Mucell Housings	1.6	0.4	0	0.00	8.46	0.47%	-45.69	-5.40
9	Chassis Frame	243.97	AHSS	197.61	46.36	48.26	1.04	54.82	3.06%	2.57	0.05
10	Front Bumper	25.55	AHSS	20.44	5.11	5.32	1.04	59.93	3.35%	7.89	0.13
11	Rear Bumper	15.14	AHSS	12.11	3.03	3.15	1.04	62.96	3.52%	11.04	0.18
12	Towing Hitch	16.56	AHSS	13.59	2.97	3.09	1.04	65.93	3.68%	14.13	0.21
13	Rear Doors	38.1	AHSS + Al	27.03	11.07	13.96	1.26	77	4.30%	28.09	0.36
14	Wheels	158.96	eVOLVE	133.71	25.25	40.8	1.62	102.25	5.71%	68.89	0.67
15	Front Doors	45.46	AHSS + Al	31.05	14.41	23.64	1.64	116.66	6.52%	92.53	0.79
16	Fenders	25.91	Al	14.25	11.66	42.34	3.63	128.32	7.17%	134.87	1.05
17	Front/Rear Seat & Console	97.45	Composite + Al + GFRP	68.21	29.24	137.7	4.71	157.56	8.80%	272.57	1.73
18	Steering Column Assy	9.21	Mg	5.99	3.22	15.33	4.76	160.78	8.98%	287.9	1.79
19	Pickup Box	109.9	Al	65.94	43.96	210.45	4.79	204.74	11.44%	498.35	2.43
20	Tailgate	20.99	Al	12.59	8.4	40.2	4.79	213.14	11.91%	538.55	2.53
21	Instrument Panel	12.27	Mg	6.75	5.52	26.51	4.80	218.66	12.22%	565.06	2.58
22	Instrument Panel Skin, Cover, Plastic	17.36	Low Density Foam + MuCell + Cellmould	14.45	2.91	15.43	5.30	221.57	12.38%	580.49	2.62
23	Cab (+Insulation)	259.92	Al	176.52	83.4	466.86	5.60	304.97	17.04%	1047.35	3.43
24	Radiator Support	20	Al + Mg	14.1	5.9	47.99	8.13	310.87	17.37%	1095.34	3.52

*** EO 12866 Review – Draft – Do Not Cite, Quote or Release During Review ***

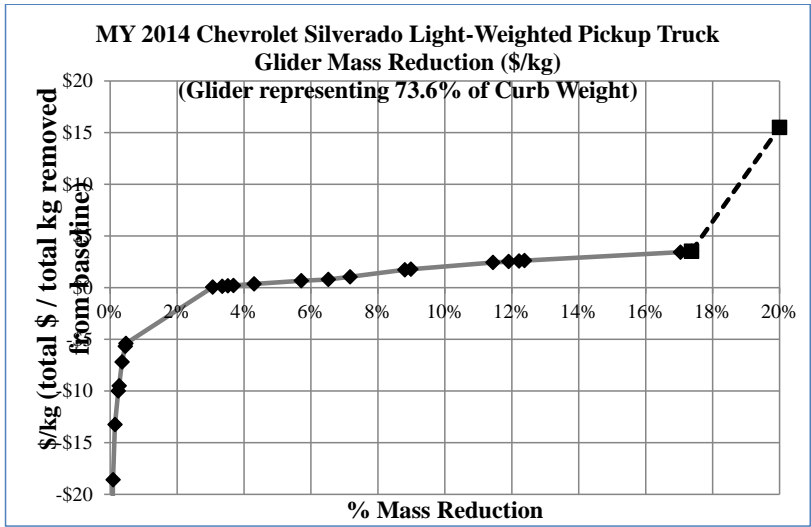
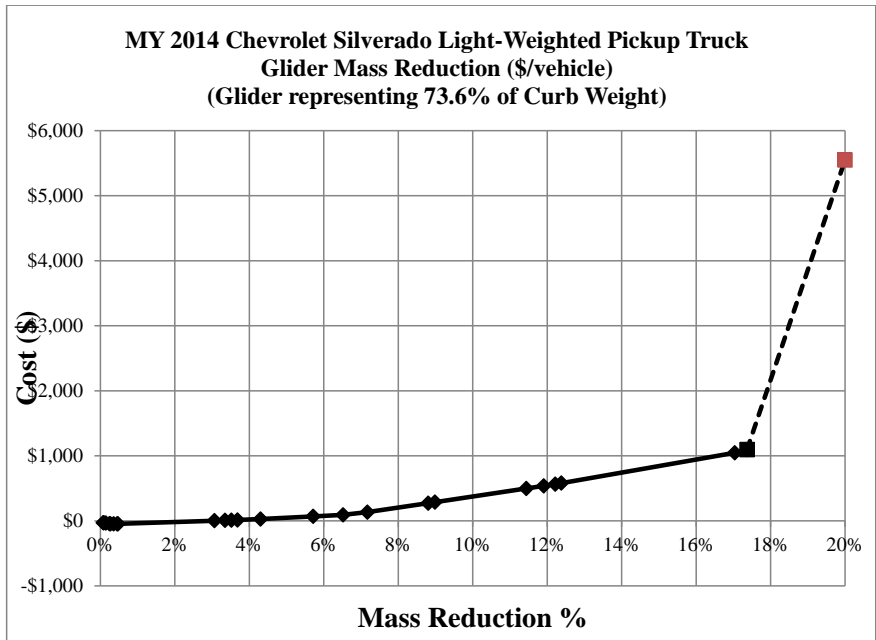

FIGURE 5-162 - COST CURVE FOR LIGHT WEIGHTED TRUCK BASED ON MY 2014 CHEVROLET SILVERADO 1500 FULL SIZE PICKUP (GLIDER REPRESENTING 73.6% OF CURB WEIGHT)



*** EO 12866 Review – Draft – Do Not Cite, Quote or Release During Review ***

FIGURE 5-163 - DMC FOR LIGHT TRUCK GLIDER MASS REDUCTION (GLIDER - 73.6% OF CURB WEIGHT)

Table 5-41 shows the \$/kg and cost associated at discrete mass reduction levels applicable to a light-weighted truck, per the MY 2014 Chevrolet Silverado study. Table 5-42 shows the cost numbers used in the CAFE model (cost adjusted to reflect glider share of 50% of curb weight). The numbers in the table include input values in the CAFE model for truck & sport utility vehicle mass reduction cost estimates (\$/lbs., including RPE markup, for 50% glider share).

TABLE 5-41 - COST NUMBERS DERIVED FROM LIGHT TRUCK LIGHT-WEIGHTING STUDY

Curb Weight	2432 kg				
Glider (73.60% of Curb Weight)	1790 kg				
MR% (of glider in LT light-weighting study)	MR (kg)	\$/kg	Estimated DMC on MY 2014 Chevrolet Silverado	New Curb Weight after Glider Mass Reduction (kg)	Percentage Mass Reduction at Curb Weight Level
5.0%	89.50	\$0.50	\$44.93	2,343	3.7%
7.5%	134.25	\$1.20	\$161.10	2,298	5.5%
10.0%	179.00	\$2.09	\$374.11	2,253	7.4%
15.0%	268.50	\$3.09	\$829.67	2,164	11.0%

TABLE 5-42 - COST NUMBERS USED IN THE CAFE MODEL FOR LIGHT TRUCK MASS REDUCTION

MR% (glider, 50% of curb weight)	MR Technology Level	\$/kg, including RPE markup	\$/lbs, including RPE markup, MY 2016 SUV's and Trucks	New Curb Weight after Glider Mass Reduction (lbs)	Approximate Percentage Mass Reduction at Curb Weight Level
0%	MR0	\$-	\$ -	Depends on the vehicle as specified in the CAFE model	0.0%
5.0%	MR1	\$0.62	\$0.28		2.5%
7.5%	MR2	\$0.82	\$0.37		3.8%
10.0%	MR3	\$1.41	\$0.64		5.0%
15.0%	MR4	\$3.68	\$1.67		7.5%
20.0%	MR5	\$5.38	\$2.44		10.0%

5.3.9.15.1.3.3 Cost of Carbon Fiber

Achieving the highest levels of mass reduction often necessitates extensive use of advanced materials like higher grades of aluminum, magnesium, or carbon fiber reinforced plastics

*** EO 12866 Review – Draft – Do Not Cite, Quote or Release During Review ***

(CFRP). CFRP is attractive in terms of strength to weight ratio, and CFRP is typically 30 to 50% lighter than conventional materials. Challenges to using CFRP include high cost of materials, failure mode predictability in crashes, longer lead time and cycle time to manufacture, and special tools required to assemble, and join components with other metallic components. Once limited to performance cars, CFRP is now strategically used in some automotive components in luxury vehicles. Manufacturers have used these expensive components strategically, not only to reduce mass, but also to change the vehicle's center of gravity and improve the vehicle's weight distribution. In the case of BMW i3, most of the cab structure is made of CFRP, including the bodysides. A teardown study by Munro & Associates showed the BMW i3 cab structure plus the CFRP cradle is 68 kg lighter than a comparable steel structure.³²⁸ This study also estimated the upfront investment and resulting part cost to manufacture CFRP components.

The IACMI Composites Institute also conducted a study to establish baseline metrics to determine the cost metric in terms of \$/kg for automotive components, among other composite parts.³²⁹ As part of the study, Oak Ridge National Laboratory (ORNL) provided cost estimates for carbon fiber in automotive applications. The ORNL cost estimates were higher than the NHTSA passenger car light-weighting study but in line with the cost estimates done for the NHTSA full size pickup truck light-weighting study. One reason for this difference could be that the NHTSA mass reduction study considered CFRP only for small components, whereas the ORNL study considered carbon fiber polymers for use in large automotive parts such as floor pan, door inner, tail gate closures etc.

During the Center for Automotive Research (CAR) annual management briefing seminar at Traverse City, Michigan, Ducker Worldwide presented on the cost and weight reduction estimates required to be implemented in the coming years to meet NHTSA's augural fuel economy standards.³³⁰ Ducker's cost estimates to achieve higher levels of mass reduction using CFRP match closely with the estimates from NHTSA's light-weighted truck study.

In the MY 2011 Honda Accord light-weighting study, the estimated cost of CFRP was \$5.37/kg and the cost of CFRP used in the MY 2014 Chevy Silverado light-weighting study was \$15.50/kg. The \$15.50 estimate closely matches the cost estimates from BMW i3 teardown analysis, the cost figures provided by Oak Ridge National Laboratory, and from the Ducker Worldwide presentation at the CAR management briefing seminar.

³²⁸ Singh, Harry, FSV Body Structure Comparison with 2014 BMW i3, Munro and Associates for World Auto Steel (June 3, 2015).

³²⁹ IACMI Baseline Cost and Energy Metrics (March 2017), available at <https://iacmi.org/wp-content/uploads/2017/12/IACMI-Baseline-Cost-and-Energy-Metrics-March-2017.pdf>.

³³⁰ Ducker Worldwide, The Road Ahead – Automotive Materials (2016), <https://societyofautomotiveanalysts.wildapricot.org/resources/Pictures/SAA%20Sumit%20slides%20for%20Abey%20Abraham%20of%20Ducker.pdf>.

The cost estimates for CFRP used in the MY 2011 Honda Accord light-weighting study were updated to reflect more realistic costs for higher levels of mass reduction (up to 20% mass reduction on the glider).

5.3.9.15.1.4 Overview of Different Studies

NHTSA relied on the results of the MY 2011 Honda Accord study and MY 2014 Chevrolet Silverado study because those studies considered materials, manufacturing, platform-sharing, functional attribute, performance, and NVH, among other constraints pertaining to cost, effectiveness, and safety considerations; these vehicles are also a reasonable representation of the baseline vehicle in the MY 2016 CAFE simulation. ~~Other agencies have performed additional light-weighting studies that were reviewed in developing light-weighting assumptions for the analysis, however those studies often did not consider many important factors, or those studies made unrealistic assumptions about key vehicle systems through secondary downsizing, resulting in unrealistically low costs.~~

Commented [A21]: Suggest removing this text, since it is not necessary when presenting NHTSA’s work, and does not apply to the EPA-contracted studies

These additional studies provide insight into the technological feasibility of light weighting a vehicle while attempting to keep “performance” constant. Performance considerations in studies may have included noise-vibration-harshness, handling, acceleration, ability to haul cargo, and many other performance factors. The objective of different light-weighting studies mentioned in the Table 5-43 was to demonstrate maximum light-weighting within a reasonable cost increase. These studies describe a breadth of approaches that may be used for light-weighting.

TABLE 5-43 - LIGHT-WEIGHTING STUDIES

Agency	Description	Completion Date	Reference
US EPA	Phase 2 Midsize CUV (2010 Toyota Venza) Low Development (HSS/AI focus)	2012	Final Report, Peer Review and SAE Paper EPA-420-R-12-019, EPA-420-R-12-026, SAE Paper 2013-01-0656
ARB	Phase 2 Midsize CUV (2010 Toyota Venza) High Development	2012	Final Report and Peer Review http://www.arb.ca.gov/msprog/levprog/leviii/final_arb_phase2_report-compressed.pdf http://www.arb.ca.gov/msprog/levprog/leviii/carb_version_lotus_project_peer_review.pdf

*** EO 12866 Review – Draft – Do Not Cite, Quote or Release During Review ***

NHTSA	Passenger Car (2011 Honda Accord)	2012	Final Report, Peer Review, OEM response, Revised Report ftp://ftp.nhtsa.dot.gov/CAFE/2017-25_Final/811666.pdf http://www.nhtsa.gov/Laws+&+Regulations/CAFE+-+Fuel+Economy/ci.NHTSA+Vehicle+Mass-Size-Safety+W_orkshop.print http://www.nhtsa.gov/staticfiles/rulemaking/pd
DOE/ Ford/ Magna	Passenger Car (2013 Ford Fusion) Mach 1 and Mach 2 projects -Cost Study for 40-45% Mass Reduction -Mass Reduction Spectrum Analysis And Process Cost Modeling Project	2015	http://energy.gov/sites/prod/files/2015/06/f24/lm072_skszek_2015_o.pdf http://energy.gov/sites/prod/files/2014/07/f17/lm072_skszek_2014_o.pdf http://energy.gov/sites/prod/files/2014/07/f17/lm088_skszek_2014_o.pdf http://avt.inl.gov/pdf/TechnicalCostModel40and45PercentWeightSavings.pdf http://energy.gov/sites/prod/files/2016/06/f33/lm090_mascarin_2016_o_web.pdf SAE papers include:2015-01-0405~0409,2015-01-1236~1240,2015-01-1613~1616
EPA	2011 Silverado 1500	2015	Final Report, Peer Review and SAE Paper EPA-420-R-15-006,SAE Paper 2015-01-0559
Transport Canada	IIHS small overlap mass add on LDT (EPA)	2015	Final Report and Peer Review https://www.tc.gc.ca/eng/programs/environment-etv-summary-eng-2982.html Peer Review (EPA docket)
NHTSA	2014 Silverado 1500	2016	DOT HS 812 487
NHTSA	Passenger Car small overlap mass add	2016	Final Report http://www.nhtsa.gov/staticfiles/rulemaking/pdf/cale/812237_LightWeightVehicleReport.pdf

5.3.9.15.1.5 Glider Weight in Autonomie Modeling

In the Autonomie simulations, mass reduction technologies remove a percentage of glider weight, which is a portion of average curb weight³³¹ for the technology class. Mass reduction levels range from MR0, MR1, MR2, MR3, MR4, and MR5, corresponding to reductions in glider weight of 0, 5, 7.5, 10, 15 and 20%. For today's analysis, the glider mass share in the ANL simulations was 50%. To maintain consistency with the Autonomie model, the CAFE model technology assignments and costs were calibrated to represent 50% of the vehicle curb mass as glider mass. As the analysis updated glider share assumptions, the agencies took care to maintain alignment with costs, and initial MR technology level assignments for MY 2016 vehicles. The agencies may change glider weight assumptions to increase the overall amount of mass reduction for the final rule analysis.

5.3.9.15.1.5.1 Test weight and inertia weight class determination.

In CAFE and CO₂ compliance testing, test procedures require adding 300 lbs. (136 kg) to the vehicle curb weight to determine the inertia weight class.³³² For the Draft TAR, the added weight was not included when performing Autonomie simulation. The industry commented that the test mass of 300 lbs. (136 kg) should be added to the vehicle curb mass for the ANL simulation modeling.

The agencies agreed with this comment and for this NPRM, the simulation included an added 300 lbs. (136 kg) mass to account for the compliance test procedure; however, this analysis does not simulate test weight class bins. For this NPRM, the mass reductions are applied to the glider system of the vehicle. Table 5-44 to

³³¹ Curb weight is the total weight of a vehicle with standard equipment (all necessary equipment for normal operation), while not loaded with passenger and cargo.

³³² See 40 CFR 86.129–80.

*** EO 12866 Review – Draft – Do Not Cite, Quote or Release During Review ***

Table 5-53 shows the initial vehicle curb mass, glider mass, mass reduction applied to the glider mass, resulting vehicle curb mass and the final vehicle test mass used in the Autonomie drive cycle simulations for different vehicle classes.³³³

TABLE 5-44 - MASS REDUCTION APPLIED TO GLIDER AND FINAL TEST MASS USED IN ANL SIMULATIONS FOR COMPACT BASE

Compact base							
A	B	C	D	E	F	G	H
Vehicle Curb mass	Glider Weight (52% of Curb Wt.)	% Mass Reduction to Total Glider Mass	New Glider Mass after Mass Reduction	Glider Mass Reduction (B - D)	New Curb Mass (A-E)	% Curb Mass Reduction	Final Vehicle Mass in ANL Simulation
(kg)	(kg)		(kg)	(kg)	(Kg)		(136kg added to Column F)
1330	685	5%	650.75	34	1296	2.58%	1432
1330	685	7.5%	633.625	51	1279	3.86%	1415
1330	685	10%	616.5	69	1262	5.15%	1398
1330	685	15%	582.25	103	1227	7.73%	1363
1330	685	20%	548	137	1193	10.30%	1329

TABLE 5-45 - MASS REDUCTION APPLIED TO GLIDER AND FINAL TEST MASS USED IN ANL SIMULATIONS FOR COMPACT PREMIUM

Compact Premium							
A	B	C	D	E	F	G	H
Vehicle Curb mass	Glider Weight (47% of Curb Wt.)	% Mass Reduction to Total Glider Mass	New Glider Mass after Mass Reduction	Glider Mass Reduction (B - D)	New Curb Mass (A-E)	% Curb Mass Reduction	Final Vehicle Mass in ANL Simulation (136kg + F)
(kg)	(Kg)		(kg)	(kg)	(kg)		(kg)
1450	685	5%	650.75	34	1416	2.36%	1552

³³³ Notably, the Autonomie simulations also consider the weights associated with additional fuel-saving technologies, like turbocharged engines, or transmissions with more gears. This analysis include these weights in the full-vehicle simulations as part of the effectiveness estimates, so final vehicle mass in the ANL simulations also depends on other fuel-saving technologies that may be equipped. “Final Vehicle Mass in ANL Simulation” is meant to be illustrative, as specific combinations of equipment may have slightly different values for curb weight in the Autonomie simulations. In some cases, like simulations for plug-in hybrids or electric vehicles, the final vehicle mass in ANL simulation may be materially different from what is presented in these tables.

*** EO 12866 Review – Draft – Do Not Cite, Quote or Release During Review ***

1450	685	7.5%	633.625	51	1399	3.54%	1535
1450	685	10%	616.5	69	1382	4.72%	1518
1450	685	15%	582.25	103	1347	7.09%	1483
1450	685	20%	548	137	1313	9.45%	1449

TABLE 5-46 - MASS REDUCTION APPLIED TO GLIDER AND FINAL TEST MASS USED IN ANL SIMULATIONS FOR MIDSIZE BASE

Midsize base							
A	B	C	D	E	F	G	H
Vehicle Curb mass	Glider Mass (53% of Curb Wt.)	% Mass Reduction to Total Glider Mass	New Glider Mass after Mass Reduction	Glider Mass Reduction (B - D)	New Curb Weight (A-E)	% Curb Weight Reduction	Final Vehicle Mass in ANL Simulation (136kg + F)
(kg)	(kg)		(kg)	(kg)	(Kg)		(kg)
1607	850	5%	807.5	43	1565	2.64%	1701
1607	850	7.5%	786.25	64	1543	3.97%	1679
1607	850	10%	765	85	1522	5.29%	1658
1607	850	15%	722.5	128	1480	7.93%	1616
1607	850	20%	680	170	1437	10.58%	1573

TABLE 5-47 - MASS REDUCTION APPLIED TO GLIDER AND FINAL TEST MASS USED IN ANL SIMULATIONS FOR MIDSIZE PREMIUM

Midsize Premium							
A	B	C	D	E	F	G	H
Vehicle Curb mass	Glider Mass (49% of Curb Wt.)	% Mass Reduction to Total Glider Mass	New Glider Mass after Mass Reduction	Glider Mass Reduction (B - D)	New Curb Weight (A-E)	% Curb Weight Reduction	Final Vehicle Mass in ANL Simulation (136kg + F)
(kg)	(kg)		(kg)	(kg)	(Kg)		(kg)
1735	850	5%	807.5	43	1693	2.45%	1829
1735	850	7.5%	786.25	64	1671	3.67%	1807
1735	850	10%	765	85	1650	4.90%	1786
1735	850	15%	722.5	128	1608	7.35%	1744
1735	850	20%	680	170	1565	9.80%	1701

*** EO 12866 Review – Draft – Do Not Cite, Quote or Release During Review ***

TABLE 5-48 - MASS REDUCTION APPLIED TO GLIDER AND FINAL TEST MASS USED IN ANL SIMULATIONS FOR SMALL SUV BASE

Small SUV Base							
A	B	C	D	E	F	G	H
Vehicle Curb mass	Glider Mass (52% of Curb Wt.)	% Mass Reduction to Total Glider Mass	New Glider Mass after Mass Reduction	Glider Mass Reduction (B - D)	New Curb Weight (A-E)	% Curb Weight Reduction	Final Vehicle Mass in ANL Simulation (136kg + F)
(kg)	(kg)		(kg)	(kg)	(Kg)		(kg)
1647	850	5%	807.5	43	1605	2.58%	1741
1647	850	7.5%	786.25	64	1583	3.87%	1719
1647	850	10%	765	85	1562	5.16%	1698
1647	850	15%	722.5	128	1520	7.74%	1656
1647	850	20%	680	170	1477	10.32%	1613

TABLE 5-49 - MASS REDUCTION APPLIED TO GLIDER AND FINAL TEST MASS USED IN ANL SIMULATIONS FOR SMALL SUV PREMIUM

Small SUV Premium							
A	B	C	D	E	F	G	H
Vehicle Curb mass	Glider Mass (47% of Curb Wt.)	% Mass Reduction to Total Glider Mass	New Glider Mass after Mass Reduction	Glider Mass Reduction (B - D)	New Curb Weight (A-E)	% Curb Weight Reduction	Final Vehicle Mass in ANL Simulation (136kg + F)
(kg)	(kg)		(kg)	(kg)	(Kg)		(kg)
1795	850	5%	807.5	43	1753	2.37%	1889
1795	850	7.5%	786.25	64	1731	3.55%	1867
1795	850	10%	765	85	1710	4.74%	1846
1795	850	15%	722.5	128	1668	7.10%	1804
1795	850	20%	680	170	1625	9.47%	1761

*** EO 12866 Review – Draft – Do Not Cite, Quote or Release During Review ***

TABLE 5-50 - MASS REDUCTION APPLIED TO GLIDER AND FINAL TEST MASS USED IN ANL SIMULATIONS FOR MIDSIZE SUV BASE

Midsize SUV Base							
A	B	C	D	E	F	G	H
Vehicle Curb mass	Glider Mass (50% of Curb Wt.)	% Mass Reduction to Total Glider Mass	New Glider Mass after Mass Reduction	Glider Mass Reduction (B - D)	New Curb Weight (A-E)	% Curb Weight Reduction	Final Vehicle Mass in ANL Simulation (136kg + F)
(kg)	(kg)		(kg)	(kg)	(kg)		(kg)
1705	850	5%	807.5	43	1663	2.49%	1799
1705	850	7.5%	786.25	64	1641	3.74%	1777
1705	850	10%	765	85	1620	4.99%	1756
1705	850	15%	722.5	128	1578	7.48%	1714
1705	850	20%	680	170	1535	9.97%	1671

*** EO 12866 Review – Draft – Do Not Cite, Quote or Release During Review ***

TABLE 5-51 - MASS REDUCTION APPLIED TO GLIDER AND FINAL TEST MASS USED IN ANL SIMULATIONS FOR MIDSIZE SUV PREMIUM

Midsize SUV Premium							
A	B	C	D	E	F	G	H
Vehicle Curb mass	Glider Mass (49% of Curb Wt.)	% Mass Reduction to Total Glider Mass	New Glider Mass after Mass Reduction	Glider Mass Reduction (B - D)	New Curb Weight (A-E)	% Curb Weight Reduction	Final Vehicle Mass in ANL Simulation (136kg + F)
(kg)	(kg)		(kg)	(kg)	(kg)		(kg)
2001	975	5%	926.25	49	1952	2.44%	2088
2001	975	7.5%	901.875	73	1928	3.65%	2064
2001	975	10%	877.5	98	1904	4.87%	2040
2001	975	15%	828.75	146	1855	7.31%	1991
2001	975	20%	780	195	1806	9.75%	1942

TABLE 5-52 - MASS REDUCTION APPLIED TO GLIDER AND FINAL TEST MASS USED IN ANL SIMULATIONS FOR PICKUP BASE

Pickup Base							
A	B	C	D	E	F	G	H
Vehicle Curb mass	Glider Mass (48% of Curb Wt.)	% Mass Reduction to Total Glider Mass	New Glider Mass after Mass Reduction	Glider Mass Reduction (B - D)	New Curb Weight (A-E)	% Curb Weight Reduction	Final Vehicle Mass in ANL Simulation (136kg + F)
(kg)	(kg)		(kg)	(kg)	(kg)		(kg)
1980	950	5%	902.5	48	1933	2.40%	2069
1980	950	7.5%	878.75	71	1909	3.60%	2045
1980	950	10%	855	95	1885	4.80%	2021
1980	950	15%	807.5	143	1838	7.20%	1974
1980	950	20%	760	190	1790	9.60%	1926

TABLE 5-53 - MASS REDUCTION APPLIED TO GLIDER AND FINAL TEST MASS USED IN ANL SIMULATIONS FOR PICKUP PREMIUM

Pickup Premium							
A	B	C	D	E	F	G	H
Vehicle Curb mass	Glider Mass (50% of Curb Wt.)	% Mass Reduction to Total Glider Mass	New Glider Mass after Mass Reduction	Glider Mass Reduction (B - D)	New Curb Weight (A-E)	% Curb Weight Reduction	Final Vehicle Mass in ANL Simulation (136kg + F)
(kg)	(kg)		(kg)	(kg)	(kg)		(kg)
2300	1150	5%	1092.5	58	2243	2.50%	2379
2300	1150	7.5%	1063.75	86	2214	3.75%	2350
2300	1150	10%	1035	115	2185	5.00%	2321
2300	1150	15%	977.5	173	2128	7.50%	2264
2300	1150	20%	920	230	2070	10.00%	2206

5.3.9.15.1.6 Development of Cost Curves for Different Class of Vehicles

Several mass reduction studies from the agencies or from the industry have used either a mid-size passenger car or a full-size pickup truck as an exemplar vehicle to demonstrate the technical and cost feasibility of mass reduction. While the finding of these studies may not apply directly to different vehicle classes, the cost estimates derived for the mass reduction technologies identified in these studies can be useful for formulating general guidance on costs. For this NPRM, this analysis compared weights of components from teardown studies with similar components from other vehicles in the other vehicle segments using the A2Mac1 database. The agencies applied the same mass reduction technologies identified in the NHTSA studies to estimate the level of mass reduction that may be achievable in other vehicles.

This analysis applied the cost estimates per pound derived from passenger cars to all passenger car segments, and the cost estimates per pound derived from full-size pickup trucks to all light-duty truck and SUV segments. The agencies are seeking comment on whether separate cost curves for each vehicle segment is necessary, or if the existing cost curves for PCs and LTs is sufficient to be applied for all vehicle segments.

5.3.9.15.1.7 Mass Addition from Safety-Related Technologies

Since the agencies completed the mass reduction studies mentioned above, there have been advancements in active and passive safety technologies. While vehicles have achieved some level of light weighting over a period of years, these safety technology advancements may add

Commented [A22]: Unibody CUVs/SUVs are more similar in construction to passenger cars than to body-on-frame pickup trucks. The cost-per-pound for LT CUVs/SUVs would be represented more accurately using the unibody passenger car costs.

mass back to the total weight of the vehicle. The following discussion describes potential safety technologies that could add mass to vehicles.

NHTSA began evaluating the cost of its Federal Motor Vehicle Safety Standards (FMVSS) in 1975 and periodically updates the cost and weight for each of the FMVSSs. In the latest report, NHTSA estimates that the total cost of safety technologies that are linked to the FMVSS (attributable to a specific standard or voluntarily added in advance of the standard) added an average of \$1,929 (in 2012 dollars) and 171 pounds to the average passenger car in MY 2012³³⁴. An average of \$1,808 (in 2012 dollars) and 136 pounds was added to the average LTV in MY 2012. Approximately 7.6% of the cost and 5.1% of the weight of a model year 2012 passenger car could be linked to the FMVSS, while 5.3% of the cost and 2.9% of the weight of a model year 2012 LTV could be linked to the FMVSS. Table 5-54 shows the mass add and cost from the FMVSS related to crash avoidance.

TABLE 5-54 - MASS ADDITION FROM CRASH AVOIDANCE SAFETY STANDARDS

FMVSS No.		Mass Addition for PC (lbs.)	Mass Addition for LT(lbs.)
105	Anti-Lock Brakes	10.1	10.1
111	Rear Visibility Camera	4.60	4.60
124	Accelerator Controls	0.02	0.02
126	Electronic Stability Control	1.82	1.82
	Total	16.54	16.64

Some crash avoidance features such as lane departure warning, lane keeping assistance, and automatic emergency braking, all of which use forward facing camera and sensors, are voluntarily installed by manufacturers and are gaining rapid market acceptance. The agencies discuss the mass addition from forward collision systems, automatic emergency braking systems, lane departure warning, and intelligent headlamps in Chapter 4 of this PRIA. The agencies seek comment on the mass addition from other voluntarily installed crash avoidance systems.

5.3.9.15.1.8 Mass reduction, baseline assignments and restrictions in the CAFE Model

This analysis developed cost curves for glider weight savings for each vehicle class in the CAFE model, based on the studies previously discussed. For cost curves to be used effectively in the CAFE model, vehicles in the analysis fleet must start at a position on the estimated cost curve reflecting the level of mass reduction technology currently used on the platform. Vehicles more advanced on the cost curve will face higher marginal costs for incremental mass reduction. This section describes the assignment process and summarizes the mass reduction assignment results.

³³⁴ DOT HS 812 354 Cost and Weight Added by the Federal Motor Vehicle Safety Standards for MY 1968-2012 Passenger Cars and LTVs.

In the Draft TAR, NHTSA developed regression models to estimate curb weights based on other observable attributes. With regression outputs in hand, NHTSA evaluated the distribution of vehicles in the analysis fleet. Additionally, the analysis evaluated vehicle platforms based on the sales-weighted residual of actual vehicle curb weights versus predicted vehicle curb weights. Based on the actual curb weights relative to predicted curb weights, it was assigned platforms (and the subsequent vehicles) a MY 2015 mass reduction level. This analysis followed a similar procedure for the MY 2016 fleet.

For the curb weight regressions, this analysis grouped vehicles into three separate body design categories for analysis - 3-Box, 2-Box, and Pick-up.

TABLE 5-55 - MASS REDUCTION BODY STYLES SETS

3-Box	2-Box	Pick-up
Coupe Sedan Convertible	Hatchback Wagon Sport Utility Minivan Van	Pick-up

For this NPRM analysis, the MY 2015 regressions for 3-Box and 2-Box vehicles presented by NHTSA in Draft TAR was retained.

This analysis substantially updated the Pick-up category regression in response to comments on Draft TAR. The analysis used a new trained regression with EPA MY 2014 data and added pick-up bed length as an independent variable. As a result of stepping back to MY 2014 data for the pick-up regression, the training data did not include the all-aluminum body Ford F-150 in the calculation of the baseline. The advanced F-150 in the MY 2015 pick-up regression meaningfully affected Draft TAR regression statistics because the F-150 accounted for a large portion of observations in the analysis fleet, and the F-150 included advanced weight savings technology.

The analysis leveraged many documented variables in the analysis fleet as independent variables in regressions. Continuous independent variables included footprint (wheelbase x track width) and powertrain peak power. Binary independent variables included strong HEV (yes or no), PHEV (yes or no), BEV or FCV (yes or no), all-wheel drive (yes or no), rear-wheel drive (yes or no), and convertible (yes or no). Additionally, for PHEV and BEV/FCV vehicles, the capacity of the battery pack was included in the regression as a continuous independent variable. In some body design categories, the analysis fleet did not cover the full spectrum of independent variables. For instance, in the pickup body style regression, there were no front-wheel drive vehicles in the analysis fleet, so the regression defaulted to all-wheel drive and left an independent variable for rear-wheel drive.

*** EO 12866 Review – Draft – Do Not Cite, Quote or Release During Review ***

Additionally, this analysis evaluated alternative regression variables in response to comments on the NHTSA/Volpe analysis in Draft TAR. Agency staff evaluated regressions including overall dimensions of vehicles, such as height, width, and length, instead of and in addition to just wheelbase and track width. The experimental regression variables only marginally changed predicted curb weight residuals as a percentage of predicted curb weight, at an industry level and for most manufacturers. The results were not significantly different, therefore, agencies opted not to add these variables to regressions, or replace independent variables presented in Draft TAR with new variables.

*** EO 12866 Review – Draft – Do Not Cite, Quote or Release During Review ***

TABLE 5-56 - REGRESSION STATISTICS FOR CURB WEIGHT (LBS.)³³⁵

	3-Box						2-Box						Pick-up					
Observations	822						584						312					
Adjusted R Square	0.865						0.883						0.844					
Standard Error	228.7						332.8						206.8					
REGRESSION STATISTICS	Coefficients	Standard Error	t Stat	P-value	Lower 95%	Upper 95%	Coefficients	Standard Error	t Stat	P-value	Lower 95%	Upper 95%	Coefficients	Standard Error	t Stat	P-value	Lower 95%	Upper 95%
Intercept	-1581.63	98.5	-16.06	0	-1775	1388.3	-1930.09	142.5	13.54	0	-2210	1650.2	1062.21	130.23	8.16	0	805.95	1318.48
Footprint (sqft)	100.5	2.2	44.79	0	69.1	104.9	104.72	3.6	28.69	0	97.5	111.9	58.31	2.37	24.96	0	53.72	62.91
Power (hp)	1.22	0.1	14.85	0	1.1	1.4	3.09	0.2	13.42	0	2.6	3.5	2.5	0.21	11.79	0	2.08	2.92
Bed length (inches)	-	-	-	-	-	-	-	-	-	-	-	-	-9.57	1.14	-8.4	0	-11.81	-7.32
Strong HEV (1,0)	200.36	46.3	4.33	0	109.5	291.2	358.97	80.3	4.47	0	201.3	516.6	-	-	-	-	-	-
PHEV (1,0)	259.28	96.8	2.68	0.0075	69.3	449.2	462.9	169.7	2.73	0.01	129.5	796.3	-	-	-	-	-	-
BEV or FCV (1,0)	602.33	215	2.8	0.0052	180.3	1024.3	374.24	152.1	2.46	0.01	75.5	673	-	-	-	-	-	-
Battery pack size (kWh)	-2.48	4.1	-0.6	0.5461	-10.6	5.6	-1.32	3.7	-0.36	0.72	-8.5	5.9	-	-	-	-	-	-
AWD (1,0)	294.51	24.5	12.03	0	246.4	342.6	353.91	33.4	10.59	0	288.3	419.5	260.91	23.62	11.05	0	214.43	307.38
RWD (1,0)	117.2	23.7	4.94	0	70.6	163.8	208.02	54.1	3.84	0	101.7	314.3	-	-	-	-	-	-
Convertible (1,0)	273.65	25.3	10.84	0	224.1	323.2	-	-	-	-	-	-	-	-	-	-	-	-

³³⁵ Data compiled based on the NHTSA 2015MY Draft TAR fleet, EPA 2014MY Draft TAR fleet.

*** EO 12866 Review – Draft – Do Not Cite, Quote or Release During Review ***

Each of the three regressions produced outputs effective for identifying vehicles with significant amounts of mass reduction technology in the MY 2016 analysis fleet. Many coefficients for independent variables provided clear insight into the average weight penalty for the utility feature. In some cases, like battery size, the relatively small sub-sample size and high collinearity with other variables confounded coefficients.

By design, no independent variable directly accounted for the degree of weight savings technology applied to the vehicle. Residuals of the regression captured weight reduction efforts and noise from other sources.

The agencies received many comments on the Draft TAR encouraging the use of observed technologies in each vehicle, and in each vehicle subsystem, to assign levels of mass reduction technology. As a practical matter, the agencies do not have means to conduct a tear down study and detailed cost assessment for every vehicle in every model year. However, upon review of many vehicles and their subsystems, the agencies recognized that a few vehicles with MRO or MRI assignments in NHTSA's analysis of the Draft TAR contained some advanced weight savings technologies, yet these vehicles and their platforms still produced ordinary residuals. Engineers from industry confirmed important factors other than glider weight savings and the independent variables considered in the regressions may factor into the use of lightweight technologies. Such factors included the desire to lower the center of gravity of a vehicle, improve the vehicle weight distribution for handling, optimize noise-vibration-and-harshness, increase torsional rigidity of the platform, offset increased vehicle content, and many other factors. Additionally, engineers highlighted the importance of sizing shared components for the most demanding applications on the vehicle platform; optimum weight savings for one platform application may not be suitable for all platform applications. For future analysis, the agencies will look for practical ways to improve the assessment of mass reduction content and the forecast of incremental mass reduction costs for each vehicle.

The Figure 5-164 below shows results from each of the three regressions on a predicted curb weight versus actual curb weight. Points above the solid regression line represent vehicles heavier than predicted; points below the solid regression line represent vehicles lighter than predicted. For points with actual curb weight below the predicted curb weight, agency staff used the residual as a percent of predicted weight to get a sense for the level of current mass reduction technology used in the vehicle. Notably, vehicles approaching -20% curb weight widely use advanced composites throughout major vehicle systems, and there are few examples in the 2016MY fleet.³³⁶

Generally, residuals of regressions as a percent of predicted weight appropriately stratified vehicles by mass reduction level. Most vehicles showed near zero residuals or had actual curb

³³⁶ This evidence suggests that achieving a 20% curb weight reduction for a production vehicle, with a baseline defined with this methodology is extremely challenging, and requires very advanced materials and disciplined design.

weights close to the predicted curb weight. Few vehicles in the analysis fleet were identified with the highest levels of mass reduction. Most vehicles with the largest negative residuals have demonstrably adopted advanced weight savings technologies at the most expensive end of the cost curve.

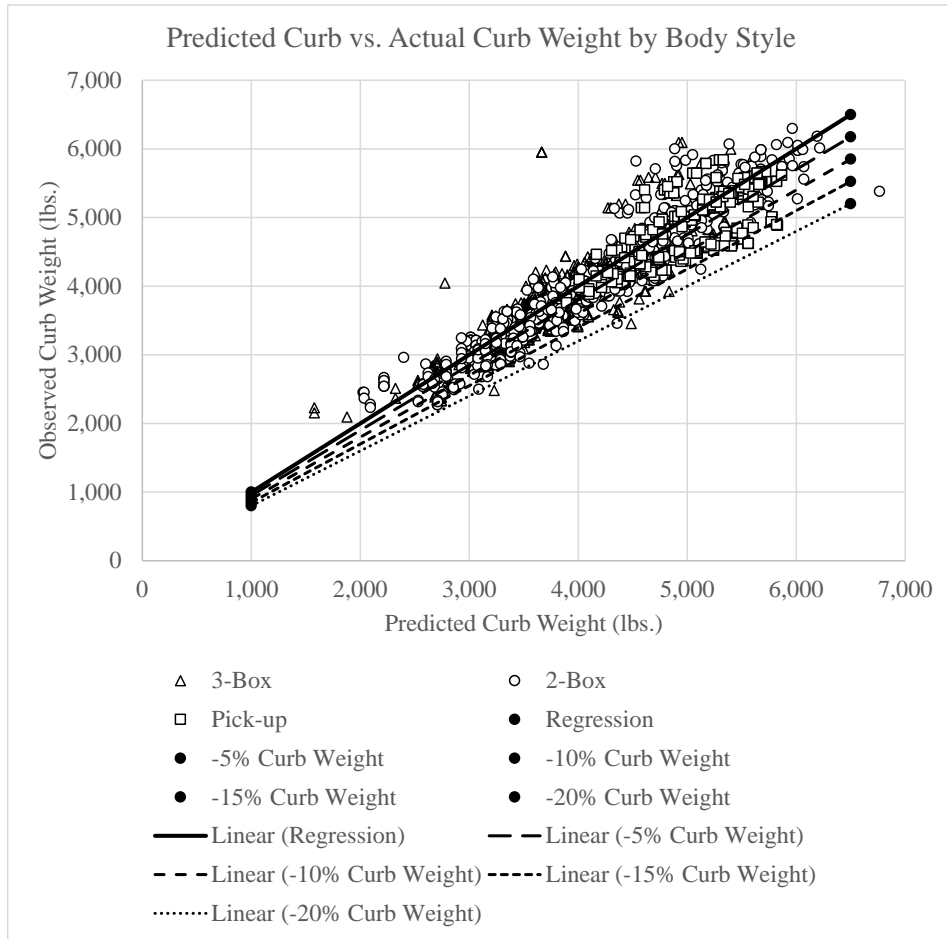

FIGURE 5-164 - MASS REDUCTION REGRESSION RESIDUAL PLOT BY BODY STYLE

For clarity, some discussion of curb weight and glider weight is important to understand the total analysis. When ANL produces simulations, they account for mass in each subsystem. These subsystems include engine, transmission, thermal, interior, body, chassis, electrical, and a few

others; the sum of these systems is curb weight in ANL simulations. The ANL simulations recognize many powertrain packages have different weights for each vehicle class; for instance, an eight-speed transmission may weigh more than a six-speed transmission, and a basic engine with variable valve timing may weigh more than a basic engine without variable valve timing. ANL varies weight of these powertrain systems inherently as part of their analysis, and these changes are done separately from “mass reduction” technology levels (MR0-MR5) in the simulations. When looking at “mass reduction” technology in the ANL simulations, ANL only removes a percentage of mass from the “glider”, as defined for that set of simulations. For the NHTSA analysis presented in the Draft TAR, the “glider” included everything on the vehicle except for engine, transmission, and thermal systems; for the assignment of technology level presented in Draft TAR, NHTSA assumed the “glider” to be approximately 75% of curb weight at MR0. For today’s analysis, the “glider” excludes engine, transmission, thermal systems, and some interior system components (because of safety considerations), or “glider” share is roughly 50% of curb weight at MR0. In the future, the analysis may present sensitivity cases, or reference simulations with glider share assumed to be between 65% and 75%, with costs and initial vehicle technology assignments, and matching with underlying ANL simulations. The mass reduction regression methodology remains the same, but the treatment of residuals and costs, so long as they are aligned, can correspond to different mass reduction technology levels in simulations.

TABLE 5-57 - MASS REDUCTION TECHNOLOGY LEVELS BY RESIDUAL ERROR, AND ASSUMED GLIDER SHARE

MR Technology Level	Percent glider weight reduction in ANL simulations	Percent curb weight reduction, 75% glider weight	Percent curb weight reduction, 66% glider weight	Percent curb weight reduction, 50% glider weight
MR0	0%	0%	0%	0%
MR1	5.0%	3.75%	3.3%	2.5%
MR2	7.5%	5.625%	4.95%	3.75%
MR3	10.0%	7.5%	6.6%	5%
MR4	15.0%	11.25%	9.9%	7.5%
MR5	20.0%	15%	13.2%	10%

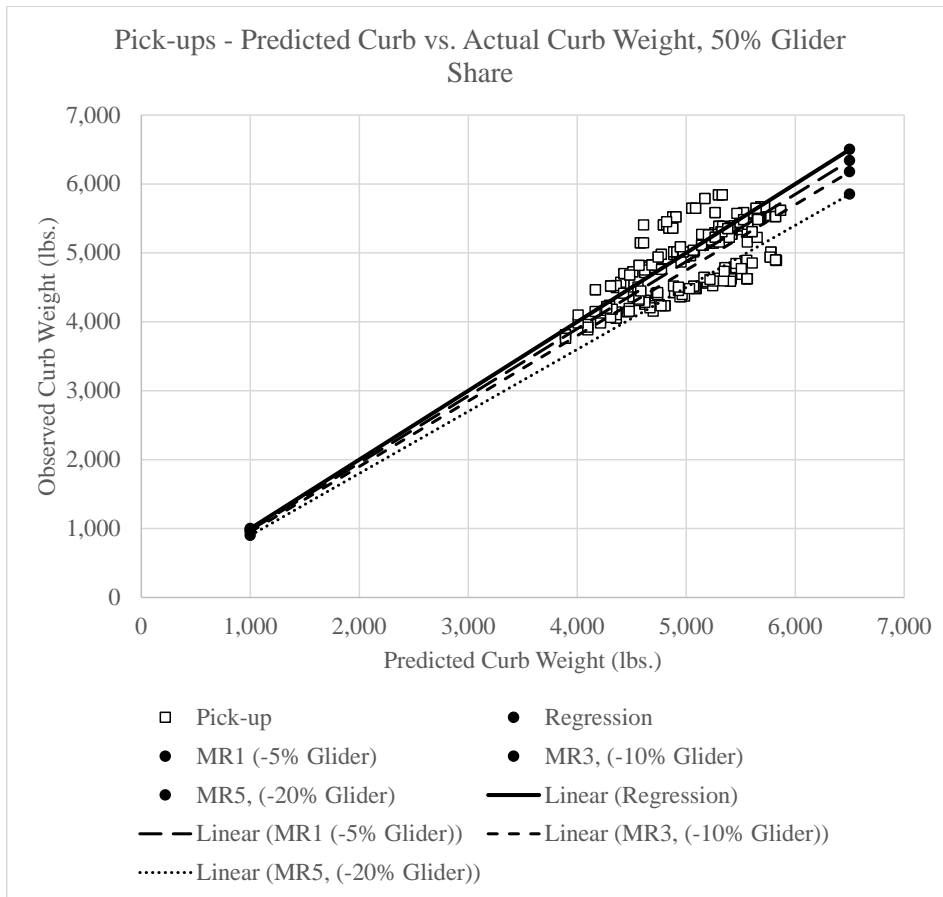

FIGURE 5-165 - MASS REDUCTION REGRESSION RESIDUAL PLOT - PICK-UPS WITH 50% GLIDER SHARE

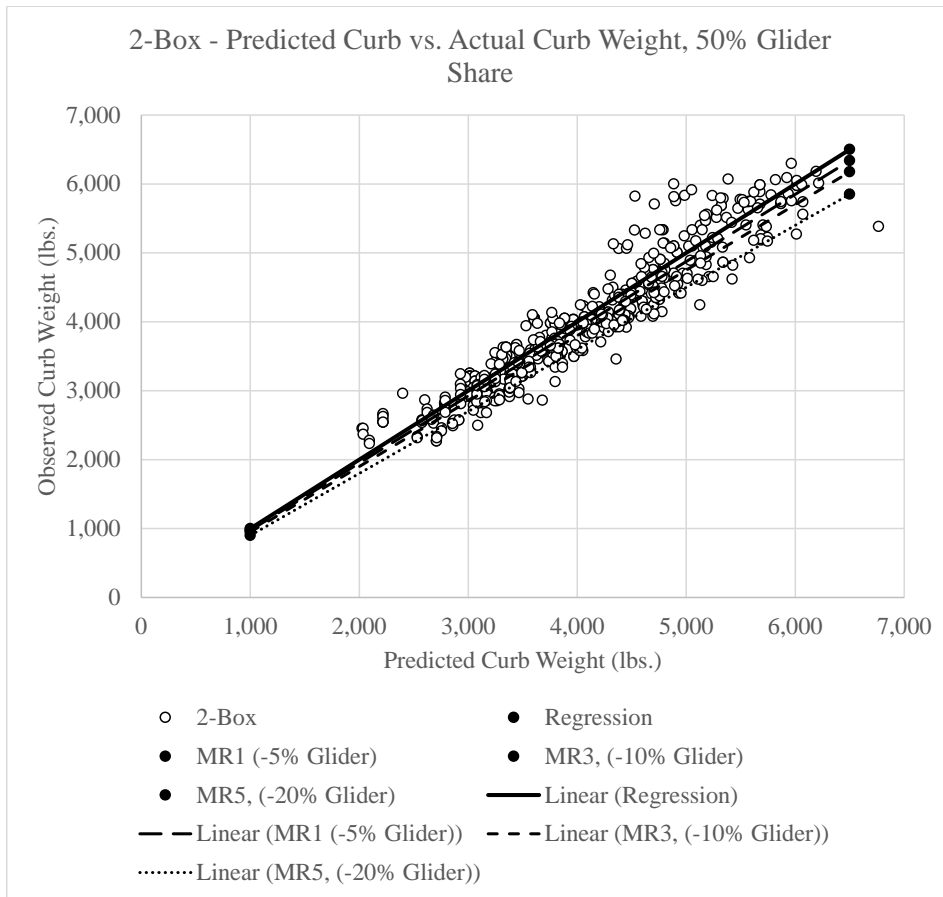

FIGURE 5-166 - MASS REDUCTION REGRESSION RESIDUAL PLOT - 2-BOX WITH 50% GLIDER SHARE

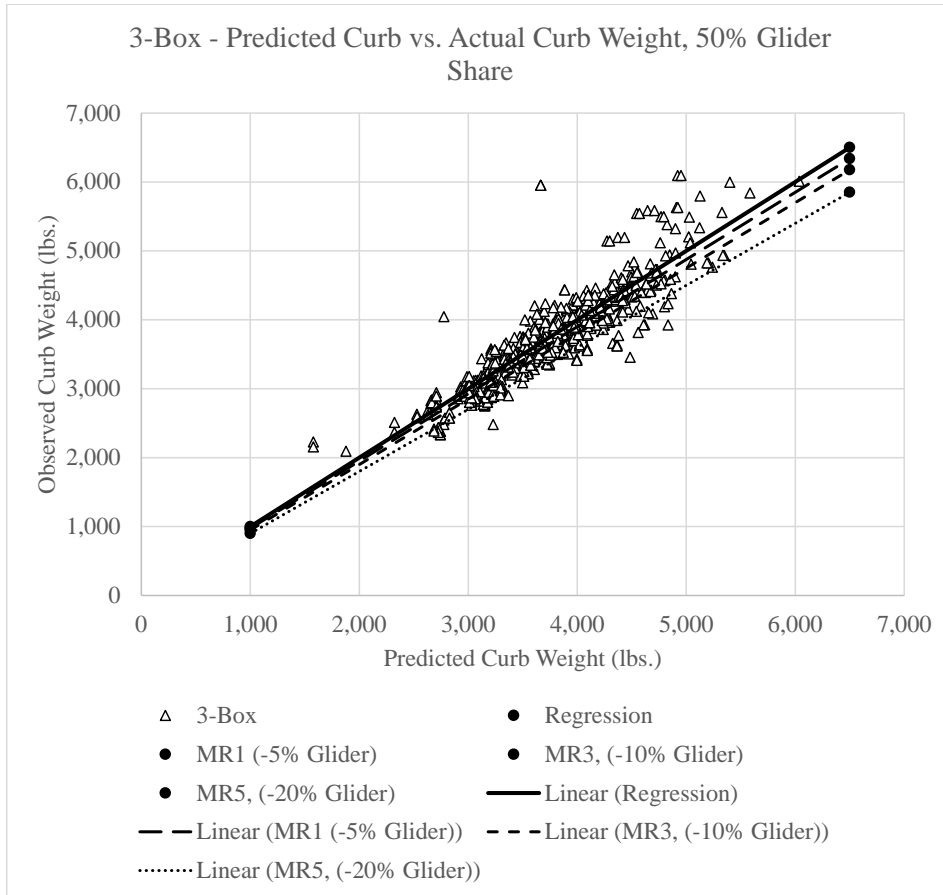

FIGURE 5-167 - MASS REDUCTION REGRESSION RESIDUAL PLOT - 3-BOX WITH 50% GLIDER SHARE

As part of the platform grouping process, this analysis took care to separate vehicles that traditionally operate on the same platform but had a mix of old and new platforms in production in MY 2016. For example, the Honda Civic and Honda CR-V traditionally share the same platform. In MY 2016, Honda redesigned the Civic and the updated platform, which included many mass reduction technologies. Also in MY 2016, Honda continued to build the CR-V on the previous generation platform – a platform that did not include many of the mass reduction technologies on the all new MY 2016 Civic. In MY 2017, Honda launched the new CR-V, and the Civic and CR-V again shared the same platform with common mass reduction technologies. If the analysis had lumped together the MY 2016 CR-V and MY 2016 Civic to estimate the sales weighted platform residual, the analysis would have underestimated the amount of mass

*** EO 12866 Review – Draft – Do Not Cite, Quote or Release During Review ***

reduction technology on the new platform launched with the MY 2016 Civic. In the NHTSA analysis presented in the Draft TAR, the analysis lumped old and new generation platforms together if they appeared in the same model year. For this NPRM, the analysis treat the old and new platforms separately to assign technology levels in the baseline, and the CAFE model brings vehicles on the old platform up to the level of mass reduction technology on the new shared platform at the first available redesign year.

TABLE 5-58 - VEHICLE PLATFORMS WITH HIGHEST ESTIMATED LEVELS OF MASS REDUCTION TECHNOLOGY

MR Groups with 66% Glider	MR Groups with 50% Glider	Volpe Platform Code	Example Model	MR Residual %
MR5, 66% Glider	MR5, 50% Glider	Alfa	Alfa Romeo 4C	-23.2%
		Li8	BMW i8	-23.0%
		Li	BMW i3	-18.4%
		Lamborghini-A	Aventador	-17.4%
		NBC(2)	Toyota Prius C	-15.5%
		Omega	Cadillac CT6	-14.4%
		SKYACTIV R	Mazda MX-5	-14.4%
MR4, 66% Glider		Y-CAR/Y1XX	Chevrolet Corvette	-12.5%
		T3	Ford F-150	-12.4%
		RamVan	Ram ProMaster	-12.0%
		Lamborghini-H	Huracan	-11.7%
		MR	Mitsubishi iMiev	-11.7%
		MODEL S	Tesla Model S	-11.3%
		Global Epsilon/E2XX	Chevrolet Malibu	-11.2%
	V	Nissan Versa	-10.8%	
	II	Honda Civic	-10.6%	
	Basic(K-Basic1)	Kia Soul	-10.0%	
MR3, 66% Glider	MR4, 50% Glider	SKYACTIV B	Mazda CX-3	-9.6%
		FCA-E2	Maserati Ghibli	-9.5%
		Mid-rear drive (C)	Hyundai Genesis	-9.1%
		Small(K-small)	Hyundai Accent	-9.0%
		FR	Subaru BRZ	-8.3%
		SPA	Volvo XC90	-7.8%
	MR3, 50% Glider	IV	Acura MDX	-7.1%
		R190	Mercedes GT	-6.8%
		Mid-Large RV 1st GEN (N-RV1)	Hyundai Santa Fe	-6.8%
	Mid-Large 2nd GEN (N-basic)	Hyundai Sonata	-6.7%	

*** EO 12866 Review – Draft – Do Not Cite, Quote or Release During Review ***

MR2, 66% Glider		L6	BMW 7-Series	-6.5%
		Mid-Large 2nd GEN (N-basic2)	Kia Optima	-6.4%
		GT-R	Nissan GT-R	-6.0%
		Viper	Dodge Viper	-5.9%
		X253	Mercedes GLC	-5.9%
		SKYACTIV C/D	Mazda CX-5	-5.8%
		31XX/32XX	Chevrolet Colorado	-5.4%
		Global Delta/D2XX	Chevrolet Volt	-5.3%
		PLA-D6a-b	Jaguar XJ	-5.0%
		I	Honda CR-Z	-5.0%
MR1, 66% Glider (not all MR1 shown in table)	MR2, 50% Glider	Nissan-D	Nissan Altima	-4.8%
		D2C	Ford Mustang	-4.8%
		CMF-C/D	Nissan Rogue	-4.7%
		970	Porsche Panamera	-4.7%
		Global Alpha/A2XX	Chevrolet Camaro	-4.5%
		Mid-Large RV 2nd GEN (N-RV2)	Kia Sedona	-4.5%
		SI(2)	Subaru Crosstrek	-4.4%
		X156	Mercedes GLA	-4.1%

Notably, the newest mainstream vehicles are likely to show mass efficiency improvements over their predecessors. The Ford F-150, Chevrolet Malibu, and Honda Civic scored highly with this methodology compared to the previous generation of vehicles.

TABLE 5-59 - AVERAGE MASS REDUCTION RESIDUAL BY ENGINEERING VINTAGE

Model Year of Last Redesign	2016MY Analysis Fleet Sales Weighted Average Mass Reduction Residual by Engineering Vintage
2006	1.4%
2007	1.5%
2008	-0.8%
2009	-0.2%
2010	1.4%
2011	-2.8%
2012	-2.6%
2013	-2.0%
2014	-3.1%
2015	-4.6%
2016	-6.1%

Since the Draft TAR, many platforms have not been redesigned, but in some cases the sales-weighted residuals for carryover platforms have moved. In the case of 2-Box and 3-Box vehicles, the analysis attribute such changes to differences in sales mix year-over-year and other updates to reported curb weights and platform designations. In the case of platforms with pick-up trucks, the analysis updated the pick-up regression since the Draft TAR, so that may be a contributing factor.

Unlike the NHTSA analysis presented in the Draft TAR that restricted high levels of mass reduction for cars to show a safety neutral pathway to compliance, today’s analysis does not artificially restrict mass reduction pathways simulated by ANL. The CAFE model considers MR0 through MR5 for all vehicles at redesign, as described in this section.

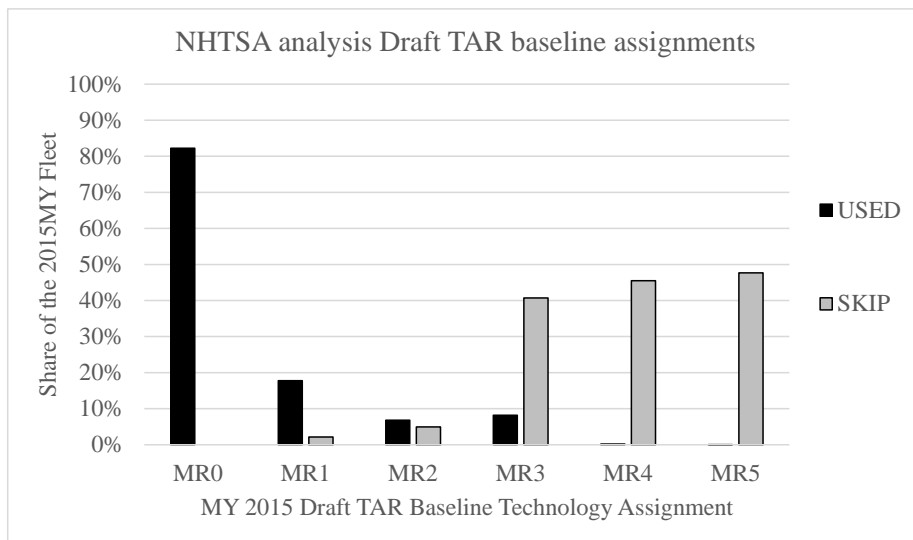

FIGURE 5-168 - MASS REDUCTION ASSIGNMENTS IN NHTSA DRAFT TAR BASELINE

*** EO 12866 Review – Draft – Do Not Cite, Quote or Release During Review ***

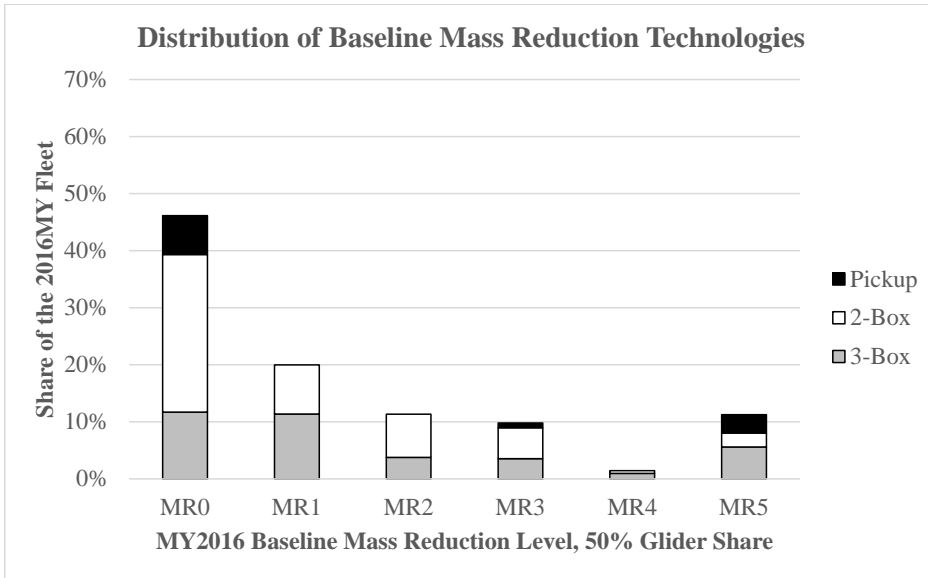

FIGURE 5-169 - DISTRIBUTION OF BASELINE MASS REDUCTION TECHNOLOGY, 50% GLIDER SHARE

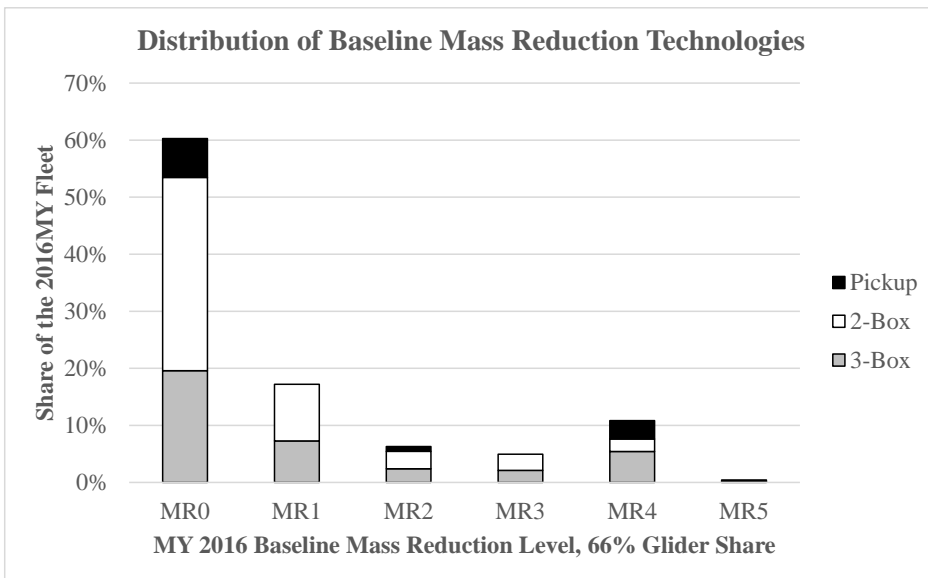

FIGURE 5-170 - DISTRIBUTION OF BASELINE MASS REDUCTION TECHNOLOGY, 66% GLIDER SHARE

5.3.9.15.1.8.1 Mass Reduction Technologies Costs

For this NPRM analysis, DMC for the mass reduction technologies are shown on Table 5-60 and Table 5-61 for passenger cars and light trucks, respectively. The basis for these costs have been discussed throughout Section 5.3.9.15.1.3.

TABLE 5-60 - DMC PER POUND FOR MASS REDUCTION TECHNOLOGIES FOR PASSENGER CARS

Vehicle Technologies for Passenger Cars Costs per lb. (2016\$)		
Technology	\$/lbs., including RPE	Incremental to
MR0	\$0.00	MR0 vehicle
MR1	\$0.38	MR0 vehicle
MR2	\$0.73	MR0 vehicle
MR3	\$0.96	MR0 vehicle
MR4	\$1.53	MR0 vehicle
MR5	\$2.44	MR0 vehicle

TABLE 5-61 - DMC PER POUND FOR MASS REDUCTION TECHNOLOGIES FOR LIGHT TRUCKS

Vehicle Technologies for Light Trucks Costs per lb (2016\$)		
Technology	\$/lbs., including RPE	Incremental to
MR0	\$0.00	MR0 vehicle
MR1	\$0.23	MR0 vehicle
MR2	\$0.54	MR0 vehicle
MR3	\$0.95	MR0 vehicle
MR4	\$1.40	MR0 vehicle
MR5	\$2.88	MR0 vehicle

5.3.9.15.1.8.2 Mass Reduction Technologies Learning Rates

For this NPRM analysis, Table 5-62 below shows the learning rates for mass reduction technologies.

*** EO 12866 Review – Draft – Do Not Cite, Quote or Release During Review ***

TABLE 5-62 - LEARNING RATES FOR MASS REDUCTION TECHNOLOGIES FROM MY 2016 TO MY 2032

Technology	Model Years																
	2016	2017	2018	2019	2020	2021	2022	2023	2024	2025	2026	2027	2028	2029	2030	2031	2032
MR0	1	1	1	1	1	1	1	1	1	1	1	1	1	1	1	1	1
MR1	0.81	0.77	0.74	0.71	0.68	0.66	0.65	0.63	0.62	0.61	0.6	0.59	0.58	0.57	0.56	0.56	0.55
MR2	0.73	0.69	0.67	0.64	0.63	0.61	0.59	0.58	0.57	0.56	0.55	0.54	0.53	0.53	0.52	0.51	0.51
MR3	0.76	0.73	0.7	0.68	0.67	0.65	0.64	0.63	0.61	0.6	0.59	0.58	0.57	0.56	0.56	0.55	0.55
MR4	1	0.87	0.82	0.79	0.75	0.7	0.67	0.64	0.63	0.61	0.59	0.57	0.56	0.55	0.54	0.53	0.53
MR5	1	1	1	0.93	0.88	0.84	0.8	0.78	0.76	0.73	0.71	0.69	0.67	0.66	0.65	0.64	0.63

5.3.9.15.1.9 Aerodynamic Drag

The energy required to overcome aerodynamic drag accounts for a significant portion of the energy consumed by a vehicle, and can become the dominant factor for a vehicle's energy consumption at high speeds. Reducing aerodynamic drag can therefore be an effective way to reduce fuel consumption and emissions.

Aerodynamic drag is proportional to the frontal area (A) of the vehicle and coefficient of drag (C_d), such that aerodynamic performance is often expressed as the product of the two values, C_dA , which is also known as the drag area of a vehicle. The coefficient of drag (C_d) is a dimensionless value that essentially represents the aerodynamic efficiency of the vehicle shape. The frontal area (A) is the cross-sectional area of the vehicle as viewed from the front. It acts with the coefficient of drag as a sort of scaling factor, representing the relative size of the vehicle shape that the coefficient of drag describes. The force imposed by aerodynamic drag increases with the square of vehicle velocity, accounting for the largest contribution to road loads' higher speeds.

C_d and A are most strongly influenced by the design of the vehicle. The greatest opportunity for improving aerodynamic performance is during a vehicle redesign cycle, when significant changes to the shape and size of the vehicle can be made. Incremental improvements may also be achieved during mid-cycle vehicle refresh using restyled exterior components and add-on devices. Some examples of potential technologies applied during mid-cycle refresh are restyled front and rear fascia, modified front air dams and rear valances, addition of rear deck lips and underbody panels, and low-drag exterior mirrors. While manufacturers may nudge the frontal area of the vehicle during redesigns, large changes in frontal area are typically not possible without impacting the utility and interior space of the vehicle. Similarly, manufacturers may improve C_d , but the form drag of certain body styles, and airflow needs for engine cooling often limit how much C_d may be improved.

During the vehicle development process, manufacturers use various tools such as Computational Fluid Dynamics (CFD), scaled clay models, and full size physical prototypes for wind tunnel testing and measurements, to determine aerodynamic drag values and to evaluate alternate vehicle designs to improve those values.

Aerodynamic technologies are divided into passive and active technologies. Passive aerodynamics refers to aerodynamic attributes that are inherent to the shape and size of the vehicle, including any components of a fixed nature. Active aerodynamics refers to technologies that variably deploy in response to driving conditions. These include technologies such as active grille shutters, active air dams and active ride height adjustment. It is important to note that manufacturers may employ both passive and active aerodynamic technologies to achieve aerodynamic drag values.

5.3.9.15.1.9.1 Aerodynamic Technologies in the 2012 Final Rule and Beyond

In the analysis supporting the 2012 final rule, the agencies relied on the 2011 Ricardo study³³⁷ and other publicly available technical literature to project a 10 to 20% reduction in aerodynamic drag across the fleet by 2025. The 2012 final rule considered two levels of aerodynamic improvements, which the agency labeled AERO1 and AERO2. The first level, AERO1, represents a 10% reduction in drag from the baseline. The agencies projected that AERO1 would be achieved mostly by means of passive aerodynamic technologies. The second level, AERO2, represents a 20% reduction from the baseline (nominally 10 percentage points incremental to AERO1), which the agencies projected manufacturers could achieve using a combination of passive and active aerodynamic drag reduction technologies.

This analysis took steps to evaluate the feasibility, cost and effectiveness assumptions for AERO1 and AERO2 (as defined in the 2012 final rule) by researching industry trends in the application of aerodynamic drag reduction technologies in light-duty vehicles. This analysis gathered information on aerodynamic drag reduction technologies from stakeholder meetings, conferences, and technical publications after the publication of the 2012 final rule.

Government and industry stakeholders initiated the following studies to evaluate the cost and effectiveness assumptions of aerodynamic drag reduction technologies.

5.3.9.15.1.9.1.1 Control Tec Study

The California Air Resources Board (CARB) contracted with Control-Tec, a company that specializes in automotive data analytics, to study vehicle load reduction technologies for future clean cars. The study, “Technical Analysis of Vehicle Load Reduction Potential for Advanced Clean Cars” provided information on aerodynamic drag reduction technology penetration in the MY 2014 fleet.³³⁸ The report also provided a distribution of manufacturer reported or estimated coefficient of drag values as a function of vehicle class,³³⁹ and used this data to identify the vehicles with best in class C_d values. This study highlights that the distribution of aerodynamic drag coefficients varies by body style; this analysis considered body style when assigning initial aerodynamic technology levels to vehicles.

5.3.9.15.1.9.1.2 National Research Council Canada and Transport Canada Study

In 2013, Transport Canada (TC), Environment and Climate Change Canada (ECCC), National Research Council (NRC) of Canada, and EPA initiated a Joint Aerodynamics Assessment Program. The objectives of this program were to quantify the aerodynamic drag impacts of

³³⁷ EPA-420-R-11-020 - Computer Simulation of Light-Duty Vehicle Technologies for Greenhouse Gas Emissions Reduction in the 2020-2025 Timeframe.

³³⁸ Technical Analysis of Vehicle Load Reduction Potential for Advanced Clean Cars (April 2015), available at <https://www.arb.ca.gov/research/apr/past/13-313.pdf>.

³³⁹ In many cases, the researchers estimated drag coefficient values based on road load forces and estimated frontal areas, as outlined in the paper.

various OEM aerodynamic technologies, and explore the improvement potential of these technologies by expanding the capability and/or improving the design of current state-of-the-art aerodynamic treatments.^{340, 341}

This project was carried out in four phases over a period of three years, using twenty-four different vehicles across different vehicle classes. Passive technologies evaluated included air dams (front bumper and wheels), underbody smoothing panels (both OEM and idealized prototypes), larger-than-baseline wheel/tire packages, wheel covers (i.e. solid hubcaps), miscellaneous improvements (including front license plates, decorative grille features and smoothing, tailgates (opened/closed/removed), and tonneau covers. Active technologies evaluated include active front bumper air dams (concepts/prototype), active grill shutters (AGS) and active ride height.

The main observations from the aerodynamic drag reduction technology evaluation in the study were -

- a. AGS, covering most or all the front surface of the radiator, provided the largest drag improvement of the individual technologies evaluated (experiments were conducted to study the effect of partial active grille shutters, and leakage of the completely closed grille shutters at different yaw angles),³⁴²
- b. Active ride height systems provided significant benefits. Active ride height reduces the clearance between the underbody and the ground at highway speeds while reducing the frontal area contributed by the tires, and changing underbody airflow. Such systems are currently only available only in a limited, typically more expensive vehicle. The study identified that there is potential for wider implementation of this technology.
- c. The largest potential drag improvement identified was a combination of two technologies - active ride height and bumper air dam extension. On the road, this would be achieved by an active air dam that would extend at highway speeds and active ride height adjustment that would reduce ride height at highway speeds. For example, the wind tunnel testing evaluated bumper air dam extension, lowering the ground clearance with ride height and active grill shutters 100% closed on a MY 2015 Nissan Murano improved

³⁴⁰ Larose, G., Belluz, L., Whittal, I., Belzile, M. et al., "Evaluation of the Aerodynamics of Drag Reduction Technologies for Light-duty Vehicles - a Comprehensive Wind Tunnel Study," SAE Int. J. Passeng. Cars - Mech. Syst. 9(2):772-784, 2016, <https://doi.org/10.4271/2016-01-1613>.

³⁴¹ Larose, Guy & Belluz, Leanna & Whittal, Ian & Belzile, Marc & Klomp, Ryan & Schmitt, Andreas. (2016). Evaluation of the Aerodynamics of Drag Reduction Technologies for Light-duty Vehicles - a Comprehensive Wind Tunnel Study. SAE International Journal of Passenger Cars - Mechanical Systems. 9. 10.4271/2016-01-1613.

³⁴² Engine cooling needs in extreme operating conditions may limit the opportunity to cover radiator openings in many cases.

*** EO 12866 Review – Draft – Do Not Cite, Quote or Release During Review ***

the C_d value from 0.37 to 0.31.³⁴³ Lowering the ride height from 6.9 to 5.3 inches (reduction of 1.6 inches or 40 mm) reduced the turbulent underbody air flow (for comparison, the ground clearance of Mercedes Benz ML 350 is 5.4 inches).

- d. Lowering the ride height while pitching the vehicle nose down (for example, 40mm in the front and 20mm in the rear) could provide significant drag reduction. In addition, it was shown that certain combinations of technologies (such as active grille shutters with air dams) often acted with positive synergy (i.e. more than additive) to result in greater reductions in overall drag than the individual technologies alone achieve.³⁴⁴
- e. The greatest reduction was observed for the “large car” classification. Additionally, full underbody panels extended to cover the entire surface area underneath the vehicle (full underbody cover) proved to be an efficient way to reduce drag.

Table 5-63 summarizes the aerodynamic drag improvements resulting from the use of different technologies. The results were observed during wind tunnel testing. Positive numbers indicate aerodynamic drag improvement and negative numbers indicate aerodynamic drag worsening.

³⁴³ Arai, M., Tone, K., Taniguchi, K., Murakami, M. et al., "Development of the Aerodynamics of the New Nissan Murano," SAE Technical Paper 2015-01-1542, 2015, <https://doi.org/10.4271/2015-01-1542>.

³⁴⁴ Such approaches could significantly compromise approach angles, break over angles, and ground clearance, all of which are important functional specifications for activities like traversing driveway berms on a daily basis, or off-roading in special circumstances.

*** EO 12866 Review – Draft – Do Not Cite, Quote or Release During Review ***

TABLE 5-63 - AERODYNAMIC DRAG IMPROVEMENTS RESULTING FROM INDIVIDUAL TECHNOLOGIES

Aero Feature (A-B Testing)		Aero Drag Reduction (%)	Comments
Fixed Air Dam-Bumper		1 - 6%	OEM stock components
Active Air Dam – Bumper (Conceptual)		4 - 9% (fixed air dam + 3%)	Fixed, prototype parts w/ lowest deployment height used
Fixed Air Dam-Wheels		1% (front)/4.5% (front & rear)	
Underbody Panels		1-7% (stock OEM)	Addtn'l 0.5%-4% w/ full body panels. Dodge Ram prototype: 8%
Increased Tire Size		-2.0 - 3.2%	17"/18" stock OEM rims vs. 22" optional OEM rims
Wheel Covers		1.5 - 3%	Solid wheel covers only; brake cooling affects not considered
Front License Plates		+/- 0.3%	Negligible impact
Decorative Grille Optimization		1.6%	Smoothing of grille features; function vs. styling trade-offs
Pick-up Tailgates	Open	-5.2%	
	Removed	-7.5%	Open tailgate + 2.3%
Pick-up Tonneau Cover		3.7%	

5.3.9.15.1.9.1.3 Industry trend observations

Since the 2012 final rule, many passive and some active aerodynamic drag reduction technologies (such as active grille shutters) have been introduced by the industry. Some active aerodynamic drag reduction technologies, such as active ride height and active air dams, are available for implementation but have not been widely offered by manufacturers, perhaps due to system complexity and the cost of extra parts.

In January 2015, EPA staff attended the 2015 North American International Auto Show (NAIAS) to gather information about the state of implementation of aerodynamic technologies in the vehicles represented at the show. A total of 76 vehicles that appeared to employ aerodynamic devices were viewed, across more than a dozen manufacturers. A memorandum describing this informal survey is available in EPA Docket EPA-HQ-OAR-2015-0827. Although the sample was casually collected and therefore not random or comprehensive, the information gathered informs the understanding of industry activity in the application of aerodynamic technology to production vehicles.

Figure 5-171 shows the distribution of aerodynamic technologies EPA observed in the 76 vehicles at the 2015 North American International Auto Show in Detroit. This limited sample shows that manufacturers have widely deployed both active and passive aerodynamic drag

reduction technologies. As manufacturers refresh or redesign vehicles, manufacturers may include more of these aerodynamic technologies in their products.

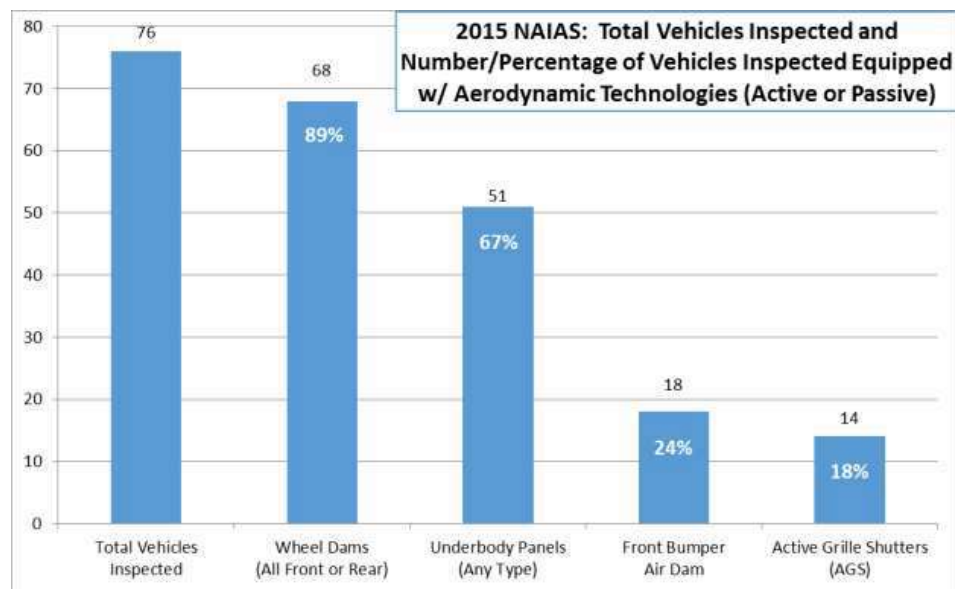

FIGURE 5-171 - DISTRIBUTION OF AERODYNAMIC TECHNOLOGIES OBSERVED DURING 2015 NAIAS BY EPA STAFF

The following commercial examples show how manufacturers of vehicles of different classes have improved aerodynamic drag reduction values relative to their previous generation model since 2012 final rule.

5.3.9.15.1.9.1.4 Toyota Prius

The Toyota Prius has achieved an exceptional aerodynamic drag value, with gradual improvements over two product generations. The MY 2008 Toyota Prius utilized aerodynamic kammback body styling, meaning the vehicle body was designed with smooth contours from front to the back, with the back abruptly cut off, to reduce aerodynamic drag. For the MY 2015 model, in addition to body styling changes, Toyota added several passive aero technologies such as bumper lip extension, front diffuser, rear diffuser, roof spoiler, engine undercover, center under body cover and rear under body cover, and incrementally improved aerodynamic drag. For the MY 2017 Prius, Toyota further improved the drag coefficient to a value of 0.24,345 with careful whole-body styling for aerodynamic optimization, reduced ground clearance and the addition of an active front grille. Vehicle styling considerations may impact the ability of other

³⁴⁵ 2017 Prius, <http://www.toyota.com/prius/ebrochure/>

manufacturers to achieve similar aerodynamic drag levels on their vehicles. Styling remains important in the marketplace and manufacturers’ unique styling themes for product identity may impact the level of improvement that can be incorporated.

5.3.9.15.1.9.1.5 Ford F150

Ford employed several passive and active aerodynamic technologies for aerodynamic improvements on their full size pickup truck, the F-150, as listed in Table 5-64, below.³⁴⁶ Among other aerodynamic improvements, the air curtain technology in the MY 2015 F-150 guides the air flow across the front wheels to reduce wind turbulence. NRC’s wind tunnel testing of one version of the MY 2015 Ford F-150 showed a drag coefficient value of 0.37.

TABLE 5-64 - AERO TECHNOLOGIES ON MY 2015 F-150

Aero Technologies	Active grill shutters
	Underbody Cover
	Front corners and head lamps canted back for smooth air flow
	Rear spoiler integrated with the Tail gate (Air from the roof lands on the spoiler before trailing off thereby reducing turbulence behind the truck
	Cargo box narrower than the cab and trim piece between the cab and pickup box
	Rear tail lamps shaped for smooth air flow tailing off and reducing turbulence
	Duct under head lamp channels air to the wheel house thereby reducing wake generated by the wheel, Cross sectional area slightly larger than previous gen which resulted in some loss of benefits.

5.3.9.15.1.9.1.6 Nissan Murano

The Nissan Murano is an example of a mid-size SUV with greater than fifteen (15) percent improvement in aerodynamic drag values compared to the previous generation.³⁴⁷ The exterior of this vehicle was completely redesigned from its MY 2013-2014 generation with the goal of minimizing aerodynamic drag by combining passive aerodynamic devices with an optimized vehicle shape. The primary passive devices employed include optimization of the rear end shape

³⁴⁶ Ford, How Air Curtains on F-150 Help Reduce Aerodynamic Drag and Aid Fuel Efficiency (July 2015), available at <https://media.ford.com/content/fordmedia/fna/us/en/news/2015/07/15/how-air-curtains-on-f-150-help-reduce-aerodynamic-drag.html>.

³⁴⁷ Arai, M., Tone, K., Taniguchi, K., Murakami, M. et al., "Development of the Aerodynamics of the New Nissan Murano," SAE Technical Paper 2015-01-1542, 2015, <https://doi.org/10.4271/2015-01-1542>.

*** EO 12866 Review – Draft – Do Not Cite, Quote or Release During Review ***

to reduce rear end drag, and addition of a large front spoiler to reduce underbody air flow and redirect it toward the roof of the vehicle, thus augmenting the rear end drag improvements. Other passive improvements include plastic fillet moldings at the wheel arches, raising the rear edge of the hood, shaping the windshield molding and front pillars, engine under-cover and floor cover, and air deflectors at the rear wheel wells. An active lower grille shutter also redirects air over the body when closed. Together, these measures resulted in a drag coefficient of 0.31 for the MY 2015 model, representing a 16 to 17% improvement over the 0.37 C_d of the previous model.

5.3.9.15.1.9.1.7 Industry Comments to Midterm Evaluation

The agencies received several comments regarding the aero technologies analyzed in the Draft TAR, including comments on aero technology effectiveness, cost estimates to achieve 10% and 20% coefficient of drag improvement, and confidential business information including manufacturer-submitted C_d values to further facilitate technical discussion. Each is discussed further, in turn, below.

5.3.9.15.1.9.1.8 Aero technology effectiveness

The Draft TAR outlined aerodynamic drag improvement values determined through NRCC wind tunnel testing for several technologies. The industry commented that some drag improvements observed in the wind tunnel testing occurred on vehicles with very poor baselines, and the same degree of effectiveness does not capture improvement values for vehicles that already have applied some aero technologies. Accordingly, for this NPRM, the analysis is using more conservative values for aero technologies for which there is an observed range of effectiveness.

5.3.9.15.1.9.1.9 Drag coefficient values

For the Draft TAR, the agencies received C_d values for the MY 2015 vehicles from manufacturers, or used estimated C_d values. This analysis evaluated the distribution of these C_d values, and paid particularly close attention to the lowest C_d value for a body style relative to a 10% and 20% aerodynamic drag coefficient reduction compared to the body style average, as shown in Table 5-65 below. In some cases, such as with pickup trucks, this analysis could point to no examples of vehicles with a C_d value 20% better than the body style average C_d .

TABLE 5-65 - AERODYNAMIC DRAG COEFFICIENTS BY BODY STYLE IN DRAFT TAR.

Body style	Sample Size	Body style Average Cd	Body style Lowest Cd	Body style Highest Cd	AERO10	AERO20
Sedan	437	0.302	0.240	0.370	0.271	0.241
Coupe	175	0.319	0.240	0.440	0.287	0.255
Minivan	23	0.326	0.290	0.360	0.293	0.261
Hatchback	88	0.333	0.250	0.370	0.300	0.266
Convertible	92	0.334	0.290	0.410	0.301	0.267
Wagon	32	0.342	0.290	0.380	0.308	0.274
Sport Utility	346	0.363	0.300	0.540	0.327	0.290
Van	21	0.389	0.337	0.415	0.350	0.311
Pickup	361	0.395	0.360	0.420	0.355	0.316

The industry commented that C_d values often varied by the measurement approach. For instance, aerodynamic drag coefficients for the same vehicle often vary significantly from wind-tunnel to wind-tunnel, complicating cross-comparison and cross-referencing. The industry commented that on average, the manufacturer reported C_d values are nine percent lower than the values reported by USCAR.³⁴⁸ For reference, USCAR follows the SAE J2881 test procedure. However, because C_d values are not required to be reported for compliance, manufacturers can and do choose different methods to estimate the C_d values. Therefore, to assess the potential for aerodynamic improvements, the industry commented that it is important to account for differences in the methodologies used to estimate C_d values, and it should not simply be comparing the lowest reported C_d value in a vehicle segment to other reported C_d values. The industry commented that such a comparison will not reflect the plausible amount of aerodynamic drag improvement that could be achieved. Accordingly, the industry suggested that the analysis should normalize manufacturer-reported C_d values using SAE J2881.

For this NPRM, the analysis took these comments under consideration and closely reviewed the MY 2016 C_d data submitted by manufacturers. This analysis observed that the C_d values reported by some of the manufacturers showed high levels of improvement relative to the previous model year or previous generation. In some cases, the agencies contacted the manufacturers to further discuss differences in C_d estimation methodologies. Where appropriate, the analysis adjusted MY 2016 fleet C_d values after consultation with the manufacturers, and used these values to assign baseline technology levels for each vehicle in the CAFE model simulation.

5.3.9.15.1.9.1.10 Cost estimates in the Draft TAR

For the Draft TAR, the agencies relied on the 2015 National Academy of Sciences (NAS) report to estimate the cost of AERO1 and AERO2 drag coefficient improvements. The Figure 5-172 shows the total cost³⁴⁹ assumptions used in the Draft TAR, and the associated learning curve.

³⁴⁸ FCA Draft TAR comments [Docket ID]

³⁴⁹ Total cost = Direct manufacturing cost + Incremental cost.

The total cost for AERO1 in 2013\$=\$51 and the total cost for AERO2 in 2013\$=\$172. The total cost of a 20% coefficient of drag improvement in 2013\$ = \$223 (AERO1 + AERO2).

The agencies received several comments related to the cost assumptions used in the Draft TAR, mainly that they were too low to meet AERO1 and AERO2 levels. The industry submitted an example of a passive aerodynamic technology needed to achieve AERO1 and showed a significantly higher cost estimate than analyzed in the Draft TAR. Similarly, the industry provided another example of active aerodynamic technology that can be very expensive to implement, but acknowledged the benefits in drag reduction. The industry also commented that some of these active aerodynamic technologies can only be implemented during vehicle redesigns and not during mid-cycle vehicle refresh.

This analysis considered these comments and revised the cost estimates for this NPRM. The updated costs can be found in tables 36 and 37, for passenger cars and light trucks, respectively.

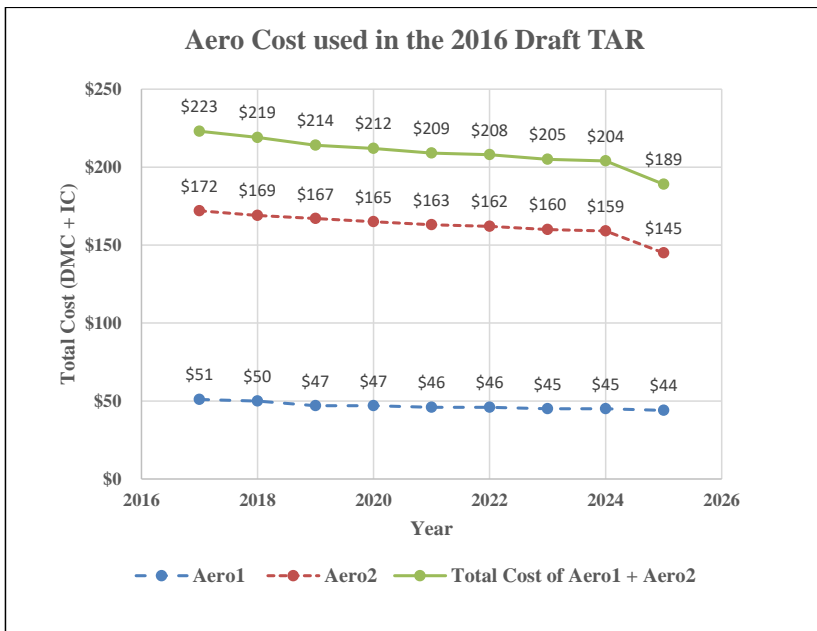

FIGURE 5-172 - DRAFT TAR AERO1 AND AERO2 TOTAL COST AND ASSOCIATED LEARNING CURVE

TABLE 5-66- AERO TECHNOLOGIES AND ESTIMATED COST FOR PASSENGER CARS AND SUVs

Aero Levels	Aero Improvements	\$DMC	\$Total Cost (\$DMC x 1.5)
AERO5	5%	45	67.5

*** EO 12866 Review – Draft – Do Not Cite, Quote or Release During Review ***

AERO10	10%	92	138
AERO15	15%	130	195
AERO20	20%	230	345

TABLE 5-67 - AERO TECHNOLOGIES AND ESTIMATED COST FOR PICKUPS

Aero Levels	Aero Improvements	\$DMC	\$Total Cost (\$DMC x 1.5)
AERO5	5%	45	67.5
AERO10	10%	92	138
AERO15	15%	230	345
AERO20	20%	667	1000

5.3.9.15.1.9.2 Aerodynamic Improvement Levels

As stated above, for the Draft TAR the drag improvement levels observed in the MY 2015 fleet were binned into two groups, AERO1 and AERO2. However, the agencies observed that many of the C_d improvement values in MY 2015 and MY 2016 vehicles were in between 0 to 10%, or in between 10 to 20%. To refine the resolution of the analysis of aero improvements in the MY 2016 fleet, this analysis introduced two additional bins for 5% and 15% C_d improvement. And now this analysis is using AERO5, AERO10, AERO15 and AERO20, representing 5, 10, 15 and 20% C_d improvement in this NPRM. Table 5-68 shows the labeling used in the Draft TAR and the new labeling system used in this NPRM.

TABLE 5-68 - DRAFT TAR, NPRM AERO IMPROVEMENT LEVELS LIMITING C_d IMPROVEMENT FOR CERTAIN BODY STYLES

Draft TAR Aero Improvement Levels	NPRM Aero Improvement Levels	Aero Improvements over simulated baseline C_d at AERO0
Baseline	AERO0	0%
	AERO5	5%
AERO1	AERO10	10%
	AERO15	15%
AERO2	AERO20	20%

The industry had also commented on the difficulty to achieve AERO20 improvements for certain body styles. This analysis considered the industry comments along with the observations made in the MY 2016 fleet, and hence limited the C_d improvement that could be achieved for pickup trucks to AERO15. Similarly, the analysis limited the C_d improvement that could be achieved for minivans to AERO10. The agencies seek comment(s) on limiting the C_d improvement for certain body styles.

*** EO 12866 Review – Draft – Do Not Cite, Quote or Release During Review ***

Table 5-69 below shows technologies that it can be utilized to achieve AERO5, AERO10, AERO15, and AERO20 improvements for all body styles except for pickups and minivans, based on NRC of Canada wind tunnel testing, extensive review of commercial vehicles utilizing those technologies, and industry comments. The table(s) shows that AERO5 could be achieved by styling changes and AERO10 could be achieved with the combination of body styling and with few passive aero technologies such as rear spoiler, wheel deflectors, bumper lips and rear diffuser. AERO15 and AERO20 could be achieved with the combination of body styling, passive and active aero technologies such active grill shutters or deployable air dams.

TABLE 5-69 - AERO TECHNOLOGIES FOR ALL BODY STYLES EXCEPT PICKUPS AND MINIVANS FOR ALL BODY STYLES EXCEPT PICKUP AND MINIVANS

Aero Improvements	Components	Effectiveness (%)
AERO5	Front Styling	2.0%
	Roof Line raised at forward of B -pillar	0.5%
	Faster A pillar rake angle	0.5%
	Shorter C pillar	1.0%
	Low drag wheels	1.0%
AERO10	Rear Spoiler	1.0%
	Wheel Deflector / Air outlet inside wheel housing	1.0%
	Bumper Lip	1.0%
	Rear Diffuser	2.0%
AERO15	Underbody Cover Incl. Rear axle cladding)	3.0%
	Lowering ride height by 10mm	2.0%
AERO20	Active Grill Shutters	3.0%
	Extend Air dam	2.0%

Considering the limitations for certain body styles as explained earlier, this analysis generated a separate list of technologies and their effectiveness for pickup trucks showing the pathway to achieve AERO5, AERO10 and AERO15 improvements. This analysis also adjusted the effectiveness for body styling due to design limitations associated with pickup utility functions. This analysis conclude that Tonneau covers for pickup truck beds is one example of passive aero technology that has an effectiveness of nearly 3.7%, as shown in the NRC of Canada wind tunnel testing Table 5-63. However, this technology was not considered as a pathway to achieve higher C_d improvements in pickups, as the use of the Tonneau covers is user-dependent. Table 5-70 shows the list of technologies and their effectiveness for pickup and minivan body styles.

TABLE 5-70 - AERO TECHNOLOGIES FOR PICKUP, MINIVAN BODY STYLES UPDATED COSTS FOR NPRM FOR PICKUPS, MINIVANS

Aero Improvements	Components	Effectiveness (%)
AERO5	Whole Body Styling (Shape Optimization)	1.5%
	Faster A pillar rake angle	0.5%
	Rear Spoiler	1.0%
	Wheel Deflector / Air outlet inside wheel housing	1.0%
	Bumper Lip	1.0%
AERO10	Rear Diffuser	2.0%
	Underbody Cover Incl. Rear axle cladding)	3.0%
AERO15	Active Grill Shutters	3.0%
	Extend Air dam	2.0%

AERO 20	Active Ride Height Adjustment	3% - 5%
---------	-------------------------------	---------

As discussed above, this analysis revised cost estimates for this NPRM based on new information available since the Draft TAR. To make updates, this analysis estimated the cost of manufacturing passive and active aero technologies for AERO5, AERO10, AERO15 and AERO20 based on industry feedback and CBI.

The cost to achieve AERO5 is relatively low, as most of the improvements can be made through body styling changes. The cost to achieve AERO10 is higher than AERO5, due to the addition of several passive aero technologies, and the cost to achieve AERO15 and AERO20 is higher than AERO10 due to use of both passive and active aero technologies.

Table 5-71 and Table 5-72 shows the DMC and total cost for passenger cars and light-duty trucks/SUVs at 5, 10, 15 and 20% aerodynamic improvements. This analysis uses 1.5 as the retail price equivalent (RPE) multiplier to estimate the total cost to achieve these improvements. Figure 5-173 and Figure 5-174 show the aero technology improvement cost curve for passenger cars and pickups.

TABLE 5-71 - AERO TECHNOLOGIES AND ESTIMATED COST FOR PASSENGER CARS AND SUVs

Aero Levels	Aero Improvements	\$DMC	\$Total Cost (\$DMC x 1.5)
AERO5	5%	45	67.5
AERO10	10%	92	138
AERO15	15%	130	195
AERO20	20%	230	345

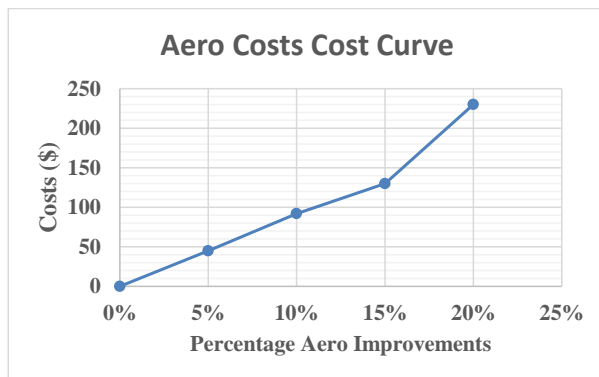

FIGURE 5-173 - AERO TECHNOLOGY COST CURVE FOR PASSENGER CARS AND SUV'S

TABLE 5-72 - AERO TECHNOLOGIES AND ESTIMATED COST FOR PICKUPS

Aero Levels	Aero Improvements	\$DMC	\$Total Cost (\$DMC x 1.5)
AERO5	5%	45	67.5
AERO10	10%	92	138
AERO15	15%	230	345
AERO20	20%	667	1000

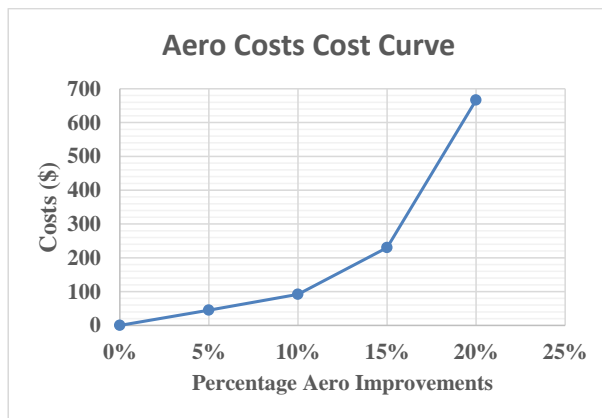

FIGURE 5-174 - AERO TECHNOLOGY COST CURVE FOR PICKUPS

5.3.9.15.1.9.3 Aerodynamic drag, baseline assignments and restrictions in the CAFE model

This analysis used a relative performance approach to assign the current aerodynamic technology level to a vehicle. Different body styles offer different utility and have varying levels of baseline form drag. Additionally, frontal area is a major factor in aerodynamic forces, and the frontal area varies by vehicle. This analysis considered both frontal area and body style as utility factors affecting aerodynamic forces; therefore, the analysis assumed all reduction in aerodynamic drag forces come from improvement in the aerodynamic coefficient of drag (C_d). Per the process outlined in NHTSA’s section of the Draft TAR, the analysis computed an average coefficient of drag for each body style segment in the MY 2015 analysis fleet from drag coefficients published by manufacturers. By comparing coefficients of drag among vehicles sharing body styles, this allowed to estimate the level of aerodynamic improvement present on specific vehicles.

This analysis assigned levels of aerodynamic technology to the MY 2016 fleet on a relative basis based on confidential business information submitted by manufacturers on aerodynamic drag coefficients and other information sources. In all cases, the analysis referenced manufacturer

Commented [A23]: Suggest providing an anonymized overview of the CBI aero data in the docketed materials (e.g. number of vehicles of each type, number of manufacturers submitting data, average and range values for each vehicle type) so that comments can be solicited, to the extent possible, based on the CBI data that was used.

*** EO 12866 Review – Draft – Do Not Cite, Quote or Release During Review ***

submitted data if that data was supplied. In the few cases that manufacturers did not submit C_d values via confidential business information, it was estimated the C_d based on other sources.

While some small differences exist between the aggregate MY 2015 and MY 2016 data, the analysis retained the NHTSA calculated MY 2015 average C_d as the baseline drag coefficient for nearly all body styles. For pickup trucks, this analysis assigned a baseline drag coefficient of 0.42, considering that a large portion of the pickups sold in MY 2015 already included aerodynamic features assumed for advanced levels of aero. This analysis was in conjunction with ANL to harmonize the simulation baselines with the assignment baselines to the fullest extent possible.³⁵⁰ The table below summarizes the best, worst, and average recorded C_d for each body style.

³⁵⁰ Often vehicles assigned to technology classes do not perfectly match up with simulated vehicles, but in most cases this analysis assumed the aerodynamic effects, and other specifications were comparable and appropriate for use as proxies.

*** EO 12866 Review – Draft – Do Not Cite, Quote or Release During Review ***

TABLE 5-73 - SUMMARY AERODYNAMIC DRAG COEFFICIENTS BY BODY STYLE

BODY STYLE	Year	AERODYNAMIC DRAG COEFFICIENT		
		High	Average	Low
Convertible	MY 2016	0.427	0.337	0.290
	MY 2015	0.410	0.334	0.290
Coupe	MY 2016	0.405	0.320	0.260
	MY 2015	0.440	0.319	0.240
Hatchback	MY 2016	0.384	0.324	0.270
	MY 2015	0.370	0.333	0.250
Minivan	MY 2016	0.365	0.324	0.286
	MY 2015	0.360	0.326	0.290
Pickup	MY 2016	0.448	0.398	0.360
	MY 2015	0.420	0.395	0.360
Sedan	MY 2016	0.379	0.292	0.240
	MY 2015	0.370	0.302	0.240
Sport Utility	MY 2016	0.540	0.366	0.290
	MY 2015	0.540	0.363	0.300
Van	MY 2016	0.454	0.369	0.310
	MY 2015	0.415	0.389	0.337
Wagon	MY 2016	0.360	0.316	0.286
	MY 2015	0.380	0.342	0.290

For a vehicle to achieve AERO10, the aerodynamic drag coefficient needs to be at least 10% below the baseline C_d for the body style. To achieve AERO20, the C_d needs to be at least 20% better than the baseline for the body style. The following table lists thresholds for AERO5, AERO10, AERO15, and AERO20 that the analysis used to assign an aerodynamic tech level for each vehicle.

TABLE 5-74 - BASELINE AERO TECHNOLOGIES, AND TECHNOLOGY STEPS BY BODY STYLE

BODY STYLE	AERO LEVEL & 2016MY VOLUME DISTRIBUTION						BODY STYLE SKIP LOGIC	
	Labels	AERO0	AERO5	AERO10	AERO15	AERO20	AERO15	AERO20
Convertible	Share	80.0%	6.0%	14.0%	0.0%	0.0%		SKIP
	C _d	0.334	0.317	0.301	0.284	0.267		
Coupe	Share	51.3%	31.9%	13.8%	3.0%	0.0%		
	C _d	0.319	0.303	0.287	0.271	0.255		
Hatchback	Share	39.3%	18.9%	15.1%	25.4%	1.3%		
	C _d	0.333	0.316	0.300	0.283	0.266		
Minivan	Share	53.3%	15.1%	31.6%	0.0%	0.0%	SKIP	SKIP
	C _d	0.326	0.310	0.293	0.277	0.261		
Pickup	Share	17.9%	67.2%	14.3%	0.6%	0.0%		SKIP
	C _d	0.420	0.399	0.378	0.357	0.336		
Sedan	Share	43.7%	26.3%	19.7%	7.9%	2.4%		
	C _d	0.302	0.287	0.272	0.257	0.242		
Sport Utility	Share	57.4%	28.1%	10.7%	3.5%	0.3%		
	C _d	0.363	0.345	0.327	0.309	0.290		
Van	Share	0.0%	4.3%	15.7%	57.2%	22.8%		
	C _d	0.389	0.370	0.350	0.331	0.311		
Wagon	Share	8.3%	78.6%	13.0%	0.2%	0.0%		SKIP
	C _d	0.342	0.325	0.308	0.291	0.274		

For some body styles, there were no commercial examples of drag coefficients demonstrating great improvement over baseline levels. In some of these cases, this analysis deemed the most advanced levels of aerodynamic drag simulated as not technically practicable given the form drag of the body style and costed technology. Because of form drag, the analysis did not consider highest levels of drag improvement for convertibles, minivans, pickups, and wagons as a potential pathway to compliance in response to regulatory alternatives.

Additionally, this analysis recognize many high performance vehicles already include advanced aerodynamic features despite middling aerodynamic drag coefficients. In these high performance vehicle cases, this analysis recognize manufacturers tune aerodynamic features to provide desirable downforce at high speeds and to provide sufficient cooling for the powertrain; therefore, manufacturers may have limited ability to improve aerodynamic drag coefficients for high performance vehicles with internal combustion engines. This analysis restrict application of AERO15 and AERO20 technology for all vehicles with more than 405 HP, excluding pickup trucks. Approximately 400,000 units of volume in the MY 2016 market data file include limited application of aerodynamic technologies because of vehicle performance.

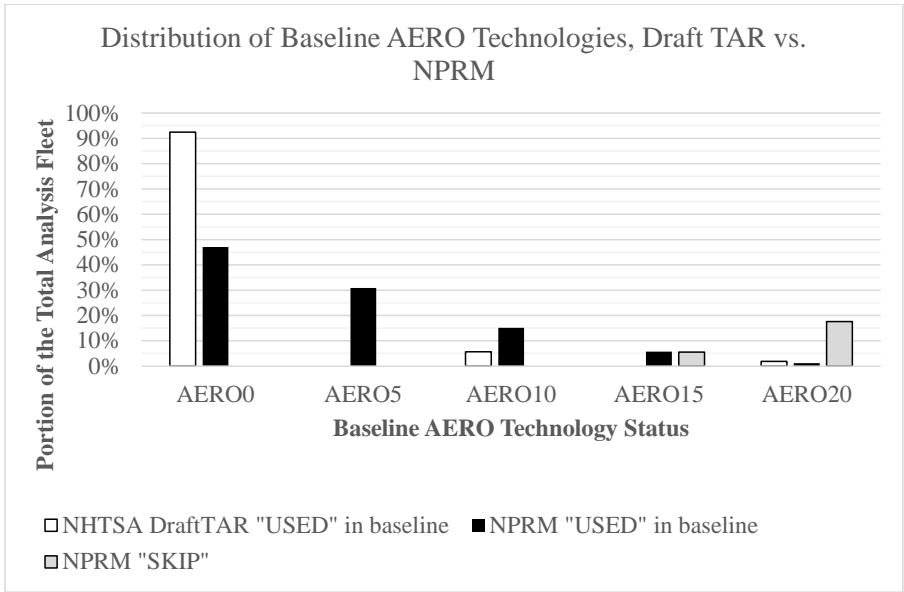

FIGURE 5-175 - DISTRIBUTION OF BASELINE AERO TECHNOLOGIES, DRAFT TAR VS. NPRM

5.3.9.15.1.9.4 Aerodynamic Drag reduction Technologies Learning Rates

For this NPRM analysis, Table 5-75 shows the learning rates used for aerodynamic technologies from MY 2016 to MY 2032.

*** EO 12866 Review – Draft – Do Not Cite, Quote or Release During Review ***

TABLE 5-75 - LEARNING RATES FOR AERODYNAMIC TECHNOLOGIES FROM MY 2016 TO MY 2032

Technology	Model Years																
	2016	2017	2018	2019	2020	2021	2022	2023	2024	2025	2026	2027	2028	2029	2030	2031	2032
AERO0	1	1	1	1	1	1	1	1	1	1	1	1	1	1	1	1	1
AERO5, AERO10, AERO15, AERO20	0.9	0.87	0.84	0.81	0.79	0.77	0.75	0.73	0.72	0.7	0.69	0.68	0.67	0.66	0.66	0.65	0.64

5.3.9.15.1.10 Tire Rolling Resistance

5.3.9.15.1.10.1 **Tire rolling resistance, baseline assignments and restrictions in the CAFE model**

Since Draft TAR, this analysis has reassessed rolling resistance values on modern tires through discussions with vehicle manufacturers, tire manufacturers, and independent bench testing. For the Draft TAR, ANL had simulated an optimistic baseline rolling resistance value in support of the NHTSA analysis. Based on a thorough review of experimental data, confidential business information submitted by industry, and a review of other literature, baseline rolling resistance values have been updated to 0.009. In the Draft TAR, the agencies used different rolling resistance values for different vehicles classes.³⁵¹ Using 0.009 is near the mode of the ControlTEC study on road loads, sponsored by the CARB. The updated baseline brings NPRM simulations into better alignment with current equipment in the MY 2016 fleet.

Commented [A24]: Suggest providing an anonymized overview of the CBI tire data in the docketed materials (e.g. number of vehicles of each type, number of manufacturers submitting data, average and range values for each vehicle type) so that comments can be solicited, to the extent possible, based on the CBI data that was used.

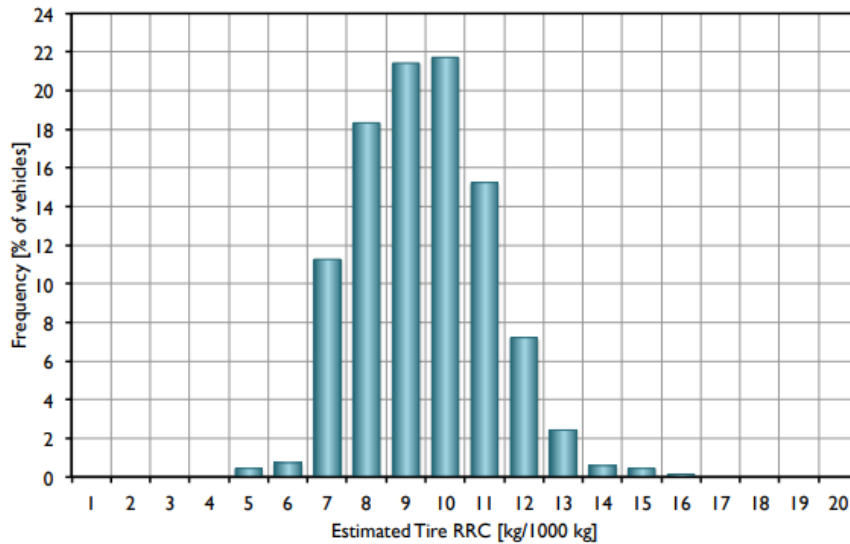

FIGURE 5-176 - CONTROLTEC DISTRIBUTION OF ESTIMATED TIRE RRC FOR ALL VEHICLES³⁵²

In the Draft TAR, the NHTSA analysis showed little rolling resistance technology in the baseline fleet. Reasons for this were threefold:

³⁵¹ Draft Tar RR values - compact Car = 0.0075, midsize car = 0.008, small suv = 0.0084, midsize suv = 0.0084, and pickup = 0.009

³⁵² "Technical Analysis of Vehicle Load Reduction Potential for Advanced Clean Cars," <https://www.arb.ca.gov/research/apr/past/13-313.pdf>, page 39.

*** EO 12866 Review – Draft – Do Not Cite, Quote or Release During Review ***

- Simulations used baseline values already reflecting best-in-class tire rolling resistance;
- Credible tire rolling resistance values for all vehicles from bench data were not available to the agencies at the time of Draft TAR; and
- Few manufacturers submitted rolling resistance values in support of the Draft TAR analysis.

For this analysis, to achieve ROLL10, the tire rolling resistance must be at least 10% better than baseline (.0081 or better). To achieve ROLL20, the tire rolling resistance must be at least 20% better than baseline (.0072 or better). This analysis used confidential business information provided by manufacturers to assign initial rolling resistance values for each vehicle.

Additionally, the agencies recognize some high performance vehicles will not sacrifice traction to improve rolling resistance. For this analysis, the analysis restrict the application of ROLL20 technology for non-pickup body styles with 405 HP or more. Furthermore, the analysis restrict the application of ROLL10 technology for non-pickup, non-SUV body styles with 500 HP or more. The analysis developed these cutoffs based on a review of confidential business information and the distribution of rolling resistance values in the fleet.

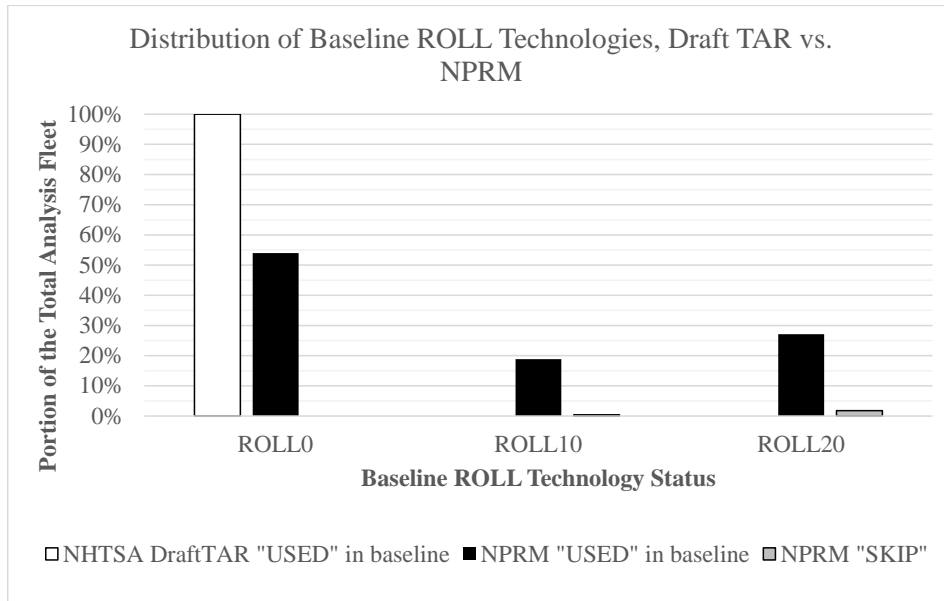

*** EO 12866 Review – Draft – Do Not Cite, Quote or Release During Review ***

FIGURE 5-177 - DISTRIBUTION OF BASELINE ROLL TECHNOLOGIES, DRAFT TAR VS. NPRM

5.3.9.15.1.10.2 Tire Rolling Resistance Technologies Costs

For this NPRM, the analysis used DMC from the 2016 Draft TAR and updated the values to reflect 2016\$. Table 5-76 below the different level of tire rolling resistance technology cost.

TABLE 5-76 - DMC FOR TIRE ROLLING RESISTANCE REDUCTION TECHNOLOGIES

Vehicle Technologies - Direct Manufacturer Costs (2016\$)		
Technology	Direct Manufacturing Cost	Incremental to
ROLL0	\$0.00	BaseV
ROLL10	\$5.88	ROLL0
ROLL20	\$44.58	ROLL10

5.3.9.15.1.10.3 Tire Rolling Resistance Technologies Learning Rate

For this NPRM analysis, Table 5-77 shows the learning rates applied to the tire rolling resistance technologies.

*** EO 12866 Review – Draft – Do Not Cite, Quote or Release During Review ***

TABLE 5-77 - LEARNING RATES FOR TIRE TECHNOLOGIES FROM MY 2016 TO MY 2032

Technology	Model Years																
	2016	2017	2018	2019	2020	2021	2022	2023	2024	2025	2026	2027	2028	2029	2030	2031	2032
ROLL0	1	1	1	1	1	1	1	1	1	1	1	1	1	1	1	1	1
ROLL10	0.91	0.88	0.85	0.82	0.8	0.78	0.76	0.74	0.73	0.72	0.71	0.7	0.69	0.68	0.68	0.67	0.66
ROLL20	1	0.85	0.77	0.72	0.68	0.65	0.62	0.6	0.58	0.57	0.56	0.55	0.54	0.53	0.52	0.52	0.51

5.3.9.15.1.11 Non-Modeled Technologies

5.3.9.15.1.11.1 Rationale for including limited technologies outside of Autonomie

The agencies considered some technologies in the CAFE model that were not modeled directly in Autonomie. For these few technologies, the CAFE model applies a fixed difference in fuel consumption if the technology is selected. While the agencies generally prefer not to employ fixed fuel consumption improvements, in these limited cases, the effectiveness of the technology does not vary much with combinations of complementary equipment, and the burden of the number of simulations conducted by ANL would be much higher if each of these technologies were included.

The “non-modeled” technologies are low drag brakes (LDB), electric power steering (EPS), improved accessory devices (IACC), and secondary axle disconnect (SAX), where the latter may only be applied to vehicles with all-wheel-drive or four-wheel-drive.

5.3.9.15.1.11.2 Electric Power Steering (EPS)

Electric power steering reduces fuel consumption and CO₂ emissions by reducing load on an engine. Specifically, it reduces or eliminates the parasitic losses associated with engine-driven power steering pumps that pump hydraulic fluid through steering actuation systems, even when no steering input is present. Power steering may be electrified on light duty vehicles with standard 12V electrical systems and is also an enabler for vehicle electrification because it provides power steering when the engine is off.

Power steering systems can be electrified in two ways. Manufacturers may choose to completely eliminate the hydraulic portion of the steering system and provide electric-only power steering (EPS) driven by an independent electric motor, or they may choose to move the hydraulic pump from a belt-driven configuration to a stand-alone electrically driven hydraulic pump. The latter system is commonly referred to as electro-hydraulic power steering (EHPS).

For this NPRM, the analysis is using NHTSA’s 2016 Draft TAR effectiveness and cost. The DMC in the Draft TAR analysis in 2013\$ was \$95.86 per vehicle, and the cost has been updated to 2016\$ to \$93.59 for this analysis.

5.3.9.15.1.11.3 Improved Accessories (IACC)

Engine accessories typically include the alternator, the coolant pump, and oil pump, and are traditionally mechanically-driven via belts, gears, or directly by other engine components such as camshafts or the crankshaft. Removing the drive of these items from the work performed by an engine will reduce fuel consumption, and when electrically driven, they can be driven only when needed (“on-demand”).

Electric coolant pumps and electric powertrain cooling fans provide better control of engine cooling. For example, flow from an electric coolant pump can be varied, and the radiator fan can

*** EO 12866 Review – Draft – Do Not Cite, Quote or Release During Review ***

be shut off during engine warm-up or cold ambient temperature conditions, reducing warm-up time, fuel enrichment requirements, and, ultimately reducing parasitic losses.

The agencies also include the benefits from a higher efficiency alternator in this category. Higher efficiency alternators improve overall accessory performance, and handle the increased electrical demands that result from electrifying formerly mechanically-driven components.

The agencies considered whether to include electric oil pump technology in the analysis supporting this rulemaking, but decided against it because electric engine oil pumps have insignificant impacts on reducing parasitic losses. However, the agencies request comment on this approach, and whether electric engine oil pumps should be included in future analyses. Please provide supporting data if applicable.

The agencies employed two levels of IACC in the Draft TAR analysis. For this NPRM, the analysis employ only one level of improved accessories technology, which corresponds to level 2 IACC in the Draft TAR analysis. Since the Draft TAR was published, the agencies have identified widespread application of the previously described IACC level 1 technologies, such as high efficiency alternators. This NPRM analysis considers *higher* efficiency alternators level 2 IACCs, which incorporate mild regeneration and further electrification of accessories, such as electric water pumps.

For this analysis, NHTSA is using the DMC from the 2012 final rule. The DMC for MY 2016 in 2010\$ adds another \$45.00 per vehicle, which is an additional \$49.55 per vehicle in 2016\$.

5.3.9.15.1.11.4 Low Drag Brakes (LDB)

Low or zero drag brakes reduce or eliminate the friction of disc brake pads coming into contact with brake rotors when the brakes are not being applied. By allowing brake pads to pull or be pushed away from the rotating disc, either by mechanical or electric methods, the drag on the vehicle is reduced or eliminated.

LDBs have historically employed a caliper and rotor system that allows the piston in the caliper to retract. However, if pads are allowed to move too far away from the rotor, the first pedal apply made by the vehicle operator can feel spongy and have excessive travel. This can lead to customer dissatisfaction regarding braking performance and pedal feel. For this reason, in conventional hydraulic-only brake systems, manufacturers are limited by how much they can allow pads to move away from the rotor.

Recent developments in braking systems have resulted in brakes with the potential for zero drag. In this system, the pad is allowed to move away from the rotor in much the same way as a conventional brake system, but in a zero drag brake system, the pedal feel is separated from hydraulics by a pedal simulator. This system is similar to the brake systems designed for hybrid and electric vehicles; in hybrid and electric vehicles, some of the primary braking is done through the recuperation of kinetic energy in the drive system. However, the pedal feel and the

deceleration the operator experiences is tuned to provide a braking experience equivalent to that of a conventional hydraulic brake system. These “brake-by-wire” systems have highly tuned pedal simulators feeling like typical hydraulic brakes and seamlessly transition to a conventional system as required by different braking conditions. The application of a pedal simulator and brake-by-wire system is new to non-electrified vehicle applications. By using this type of system, vehicle manufacturers can allow brake pads to move farther away from the rotor and still maintain the initial pedal feel and deceleration associated with a conventional brake system.

In addition to reducing brake drag, the zero drag brake system provides ancillary benefits. It allows for a faster brake apply and greater deceleration than is normally applied by the average vehicle operator. It also allows manufacturers to tune the braking for different customer preferences within the same vehicle. This means manufacturers can provide a “sport” mode, which provides greater deceleration with less pedal displacement and a “normal” mode, which might be more appropriate for day-to-day driving. These electrically driven systems also facilitate other brake features such as panic brake assist, automatic braking for crash avoidance, and possible future support for autonomous driving features.

The zero drag brake system also eliminates the need for a brake booster. This saves cost and weight in the system. Elimination of the conventional vacuum brake booster could also improve the effectiveness of stop-start systems. Typical stop-start systems need to restart the engine if the brake pedal is cycled because the action drains the booster of stored vacuum. Because the zero drag brake system provides braking assistance electrically, there is no need to supplement lost vacuum during an engine off event.

Finally, many engine technologies being considered to improve efficiency also reduce pumping losses through reduced throttle. The reduction in throttle could result in supplemental vacuum being required to operate a conventional brake system. This is the situation in many diesel-powered vehicles. Diesel engines run without a throttling and often require supplemental vacuum for brake boosting. By using a zero drag brake system, manufacturers may realize the elimination of brake drag as well as ancillary benefits described above, and avoid the need for a supplemental vacuum pump.

For this analysis, NHTSA is using DMC from the 2012 final rule. The DMC for MY 2017 in 2010\$ is \$59.00 per vehicle. In 2016\$ the cost becomes \$64.65 per vehicle.

5.3.9.15.1.11.5 Secondary Axle Disconnect (SAX)

All-wheel drive (AWD) and four-wheel drive (4WD) vehicles provide improved traction by delivering torque to the front and rear axles, rather than just one axle. Driving two axles rather than one tends to consume more energy because of additional friction and rotational inertia. Some of these losses may be reduced by providing a secondary axle disconnect function that disconnects one of the axles when driving conditions do not call for torque to be delivered to both.

The terms AWD and 4WD are often used interchangeably. The term AWD has come to be associated with light-duty passenger vehicles providing variable operation of one or both axles on ordinary roads. The term 4WD is often associated with larger truck-based vehicle platforms providing for a locked driveline configuration and/or a low range gearing meant primarily for off-road use.

Many 4WD vehicles provide for a single-axle (or two-wheel) drive mode that may be manually selected by the user. In this mode, a primary axle (perhaps the rear) will be powered, while the other axle (known as the secondary axle) is not. Even though the secondary axle is not contributing torque, energy may still be consumed by rotation of its driveline components because they are still connected to non-driven wheels. This energy loss directly results in increased fuel consumption and CO₂ emissions that could be avoided by disconnecting the secondary axle components under these conditions.

Further, many light-duty AWD systems are designed to variably divide torque between the front and rear axles in normal driving to optimize traction and handling in response to driving conditions. Even when the secondary axle is not delivering torque, it typically remains engaged with the driveline and continues to generate losses that could be avoided by a more advanced disconnect feature. For example, Chrysler has estimated the secondary axle disconnect in the Jeep Cherokee reduces friction and drag attributable to parasitics of the secondary axle by 80% when in disconnect mode.³⁵³ Some sources of secondary axle parasitics include lubricant churning, seal friction, bearing friction, and gear train losses.^{354,355}

Many part-time 4WD systems, such as those seen in light trucks, use some type of secondary axle disconnect to provide shift-on-the-fly capabilities. In many of these vehicles, particularly light trucks, the rear axle is permanently driven, and the front axle is secondary. The secondary axle disconnect is, therefore, part of the front differential assembly in these vehicles. Light-duty passenger cars employing AWD may instead permanently power the front wheels while making the rear axle secondary, as currently in production in the Jeep Cherokee 4WD system. As part of a shift-on-the-fly 4WD system, the secondary axle disconnect serves two basic purposes - first, in two-wheel drive mode, it disengages the secondary axle from the driveline so wheels do not turn the secondary driveline at road speed, reducing wear and parasitic energy losses; and second, when shifting from two- to four-wheel drive “on the fly” (while moving), the secondary axle disconnect couples the secondary axle to its differential side gear only after the synchronizing mechanism of the transfer case has spun the secondary driveshaft up to the same speed as the primary driveshaft.

³⁵³ Brooke, L. “Systems Engineering a new 4x4 benchmark,” *SAE Automotive Engineering*, June 2, 2014.

³⁵⁴ Phelps, P. “*EcoTrac Disconnecting AWD System*,” presented at 7th International CTI Symposium North America 2013, Rochester MI.

³⁵⁵ Pilot Systems, “AWD Component Analysis,” Project Report, performed for Transport Canada, Contract T8080-150132, May 31, 2016.

5.3.9.15.1.11.5.1 Developments in AWD Technology

As discussed in Draft TAR, EPA coordinated with Transport Canada and Environment and Climate Change Canada on a project to characterize AWD systems present in the market today. The primary objectives of this project were to gain an overview of AWD technology and to understand the potential effect of advances in these systems on GHG performance in comparison to their 2WD variants. A comprehensive technical characterization of 17 in-production AWD systems has been completed. It includes characterization of system architecture, operating modes, and current usage in the fleet. It also estimated and compared the mass and rotational inertia of AWD components and parts to those of 2WD variants to better understand the weight increase associated with AWD systems. Additionally, the all-wheel-drive components of three AWD vehicles (the 2015 Jeep Cherokee Limited 4x4, 2015 Ford Fusion AWD, and 2015 Volkswagen Tiguan Trendline 4motion) underwent a teardown to accurately characterize their mass and rotational inertia and estimate their approximate cost. One of the teardown vehicles, the Jeep Cherokee, includes a secondary axle disconnect, indicating this technology has begun to appear in light-duty vehicles since the 2012 final rule. In 2014, Chrysler Group LLC presented a positive outlook on advantages of this system for improving fuel efficiency while retaining a highly competitive off-road capability.³⁵⁶ This suggests the addition of secondary axle disconnect systems need not be accompanied by loss of traction and handling capability.

The study reinforced the perception that AWD is rapidly increasing in popularity in the vehicle fleet, with approximately one-third of all vehicles sold in North America in 2015 having AWD capability. However, the prevalence of AWD varies significantly between vehicle segments and trim levels; sedans have the lowest AWD availability, while AWD versions outnumber 2WD versions in the SUV and pickup segments, particularly among the higher trim levels in each segment.

The study identified several areas of potential efficiency improvement for AWD systems. These included system-level improvements such as - use of a single shaft Power Transfer Unit (PTU), which can save up to 10kg in mass compared to a two-shaft unit; careful integration into vehicle architecture; downsizing the driveline to further reduce mass while providing sufficient traction in adverse conditions; and use of electric rear axle drive (eRAD). Component-level improvements were also identified, including - use of fuel-efficient bearings, low drag seals, improved lubrication strategies, use of high-efficiency lubricants, advanced constant velocity (CV) joints, and dry clutch systems. Design improvements such as hypoid offset optimization, bearing preload optimization, use of single-shaft power transfer units (PTUs), and an optimized propshaft gear ratio were also suggested to have potential. Use of weight-reducing metals such as magnesium, and manufacturing improvements such as vacuum die casting and improved hypoid manufacturing were also cited as opportunities. The authors' judgement of the

³⁵⁶ Martin, B. et al. "The Innovative Driveline of the 9-Speed Jeep Cherokee," presented at 8th International CTINA Symposium, May 2014, Rochester, MI.

*** EO 12866 Review – Draft – Do Not Cite, Quote or Release During Review ***

relative potential for AWD efficiency improvements offered by each opportunity is depicted in Figure 5-178, below.

		cost / deterioration			savings / improvements		
		> 100	10 - 100	< 10	< 10	10 - 100	> 100
Cost	[\$]	> 100	10 - 100	< 10	< 10	10 - 100	> 100
Weight	[kg]	> 2.5	.5 - 2.5	< .5	< .5	.5 - 2.5	> 2.5
Fuel Consumption	[%]	> 2	.5 - 2	< .5	< .5	.5 - 2	> 2
Performance	[%]	> 10	1 - 10	< 1	< 1	1 - 10	> 10
Packaging		difficult		easy			improved

	Cost	Weight	Fuel Efficiency	Performance	Packaging	Do it	~	Don't
System Level								
Disconnect system FWD	Red	Red	Green	Yellow	Orange	Green		
Disconnect system RWD	Red	Red	Green	Yellow	Orange	Green		
downsizing	Green	Green	Green	Yellow	Green	Green		
eRAD (Hybrid)	Red	Red	Green	Green	Orange		Yellow	
Component Level								
FE bearings	Orange	Yellow	Light Green	Light Green	Yellow		Yellow	
Low drag seals	Yellow	Light Green	Light Green	Light Green	Light Green		Yellow	
Actuator technology	Light Green	Light Green	Light Green	Light Green	Light Green		Yellow	
Lubrication strategies	Light Green	Light Green	Light Green	Light Green	Light Green	Green		
Advanced CV-joints	Yellow	Light Green	Light Green	Light Green	Light Green		Yellow	
Dry clutch systems	Light Green	Light Green	Light Green	Light Green	Yellow			Red

FIGURE 5-178 - SUMMARY OF AWD EFFICIENCY IMPROVEMENT POTENTIALS

Various sources cited in the study suggested that AWD disconnect systems have the ability to lower fuel consumption of AWD vehicles between 2% and 7%, which is significantly higher than the estimates of 1.2% to 1.4% used in the 2012 final rule. However, it should be noted that a disconnect strategy must balance fuel efficiency with other concerns such as vehicle dynamics, traction, and safety requirements, which may act to reduce the fuel consumption improvements from the disconnect system. The study also identified three primary technological trends taking place in AWD systems design, including - actively controlled multi-plate clutches (MPCs), active disconnect systems (ADS), and electric rear axle drives (eRAD). While controlled MPCs appear to be the dominant technology in on-demand systems, ADS is a more recent trend and holds promise for reducing real world fuel consumption. eRAD is the most recent emerging technology with potential for even greater improvements (as seen in the Volvo XC90 Hybrid SUV).

The teardown analysis analyzed three power transfer units (PTUs) and rear drive modules (RDMs) from the Ford Fusion, Jeep Cherokee, and VW Tiguan. These were non-destructively disassembled and analyzed with respect to mass, rotational inertia, and the presence of specific design features. Figure 5-179 shows the contribution of individual AWD driveline components to the total additional mass of the AWD variant of each vehicle compared to the 2WD variant. Further analysis of rotational inertias of these parts suggested rotational inertias add little equivalent mass and, therefore, probably do not largely effect fuel consumption.

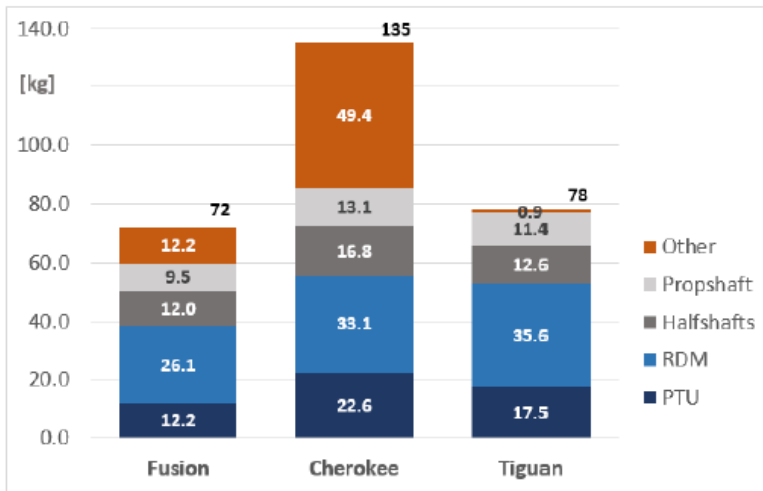

FIGURE 5-179 - CONTRIBUTION OF INDIVIDUAL AWD DRIVELINE COMPONENTS TO TOTAL ADDITIONAL VEHICLE MASS

The study included a high-level cost analysis for these parts, including the mechanical disconnect device and necessary modifications to the torque transfer device (TTD). The total cost of adding secondary axle disconnect to a vehicle was estimated at approximately \$90 to \$100. Although this cost estimate was informally derived based primarily on the experience and expertise of the authors, it compares well to the total cost (TC) figure attributed to MY 2017 in the 2012 final rule analysis, at \$98. The authors noted the cost for the Jeep Cherokee system would likely be higher because this system was designed to accommodate a planetary low gear, which adds mass and cost not related to the AWD disconnect function.

In addition to the in-production disconnect concepts described in the Transport Canada AWD report, activity continues in the development of innovative secondary axle disconnect concepts. For example, in 2015, Schaeffler presented a novel design for a clutch mechanism for use in

*** EO 12866 Review – Draft – Do Not Cite, Quote or Release During Review ***

AWD disconnect.³⁵⁷ Suppliers are also designing and marketing modular solutions for integration into existing OEM products. These developments and others suggest multiple potential paths will exist for disconnect technology to accompany the increasing growth and popularity of AWD in light-duty vehicles.

5.3.9.15.1.11.5.2 Values used for this NPRM

For this NPRM, this analysis carried forward the work conducted in the Draft TAR and EPA Proposed Determination on secondary axle disconnect systems. This work involved gathering information by monitoring press reports, holding meetings with suppliers and OEMS, and attending industry technical conferences. This analysis are using DMC from the 2012 final rule. The DMC for MY 2017 is \$82.00 per vehicle (in 2010 dollars). After adjusting for 2016 dollars, the cost becomes \$89.18 per vehicle.

5.3.9.15.1.11.6 Stage of commercialization and application highlights in the 2016MY fleet

All of the aforementioned “non-modeled” technologies have been commercialized, to some extent, in the MY 2016 fleet. However, many of the “non-modeled” technologies are difficult to observe and assign to analysis fleet vehicles without review of confidential business information. For the Draft TAR, the agencies assigned far too few of these technologies properly in the analysis fleet. After reviewing feedback from the Draft TAR, the agencies assigned electric power steering and improved accessory devices in higher rates for today’s analysis. Industry engagement and feedback is critical for the agencies to properly assign the use of difficult to observe technologies in the analysis fleet.

³⁵⁷ Lee, B. “A Novel Clutch Solution for AWD Disconnect,” presented at 9th International CTI Symposium North America 2015, Rochester, MI.

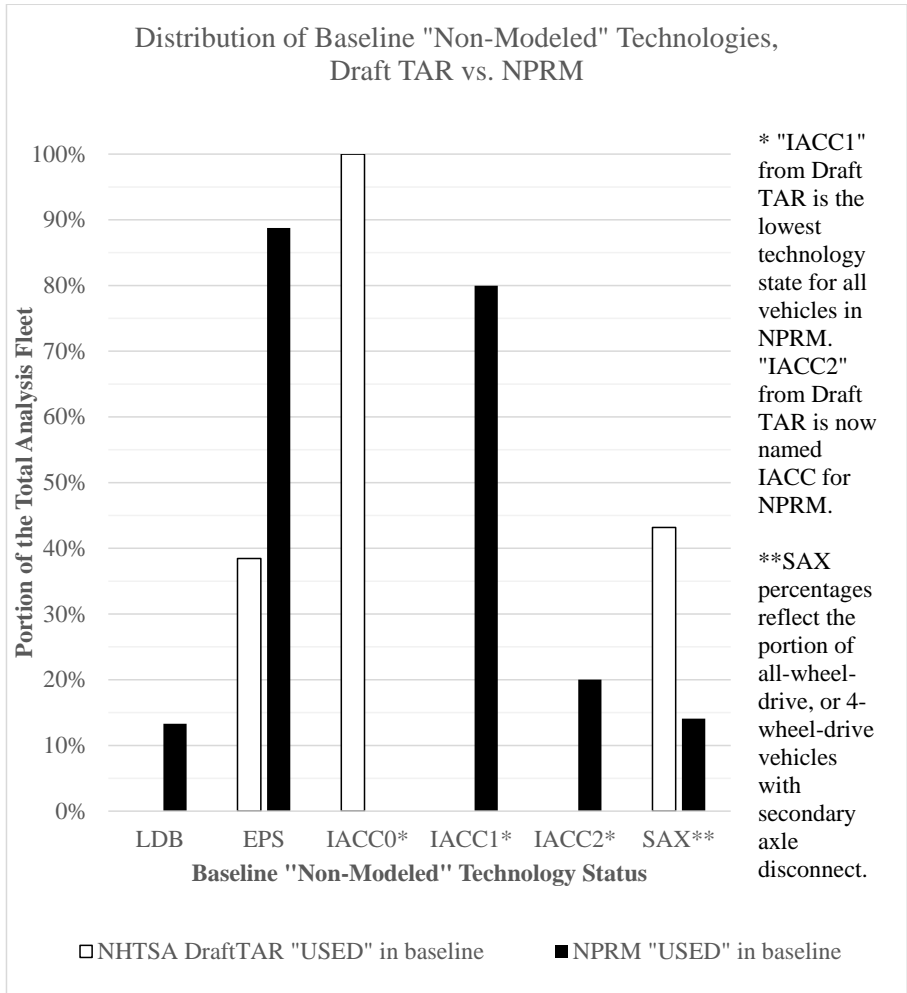

FIGURE 5-180 - DISTRIBUTION OF BASELINE "NON-MODELED" TECHNOLOGIES, DRAFT TAR VS. NPRM

5.3.9.15.1.11.7 Effectiveness estimates for non-modeled technologies

The effectiveness estimates for non-modeled technologies rely on previous work published as part of the rulemaking process. The percentages are applied as an increase to individual vehicle combined fuel economy figures.

TABLE 5-78 - FUEL CONSUMPTION IMPROVEMENT VALUES FOR TECHNOLOGIES NOT SIMULATED IN AUTONOMIE

NHTSA Draft TAR Fuel Consumption Improvements					
Tech Class	LDB	EPS	IACC1	IACC2	SAX
SmallCar	0.80%	1.50%	1.22%	1.85%	1.40%
MedCar	0.80%	1.30%	1.22%	2.36%	1.40%
SmallSUV	0.80%	1.20%	1.01%	1.74%	1.40%
MedSUV	0.80%	1.00%	0.91%	2.34%	1.30%
Pickup	0.80%	0.80%	1.61%	2.15%	1.60%

NHTSA NPRM Fuel Consumption Improvements					
Tech Class	LDB	EPS		IACC	SAX
SmallCar	0.80%	1.50%		1.85%	1.40%
SmallCarPerf					
MedCar	0.80%	1.30%		2.36%	1.40%
MedCarPerf					
SmallSUV	0.80%	1.20%		1.74%	1.40%
SmallSUVPerf					
MedSUV	0.80%	1.00%		2.34%	1.30%
MedSUVPerf					
Pickup	0.80%	0.80%		2.15%	1.60%
PickupHT					

*** EO 12866 Review – Draft – Do Not Cite, Quote or Release During Review ***

5.3.9.15.1.11.8 Cost estimates

The table below shows the DMC summary of the non-simulated technologies applied in this NPRM analysis. The costs have been updated to 2016\$, consistent with other costs in this analysis.

TABLE 5-79 - DMCs USED FOR VEHICLE TECHNOLOGIES IN THIS NPRM ANALYSIS

Vehicle Technologies - Direct Manufacturer Costs (2016\$)		
Technology	Direct Manufacturing Cost	Incremental to
EPS	\$93.59	BaseV
IACC	\$49.55	EPS
LDB	\$64.65	BaseV
SAX	\$89.18	BaseV

5.3.9.15.1.11.9 Non-Simulated Technologies Learning Rates

For this NPRM analysis, Table 5-80 below shows the learning rate for the non-simulation technologies.

*** EO 12866 Review – Draft – Do Not Cite, Quote or Release During Review ***

TABLE 5-80 - LEARNING RATES FOR NON-SIMULATED TECHNOLOGIES FOR MY 2016 TO MY 2032

Technology	Model Years																
	2016	2017	2018	2019	2020	2021	2022	2023	2024	2025	2026	2027	2028	2029	2030	2031	2032
EPS	0.94	0.93	0.91	0.89	0.88	0.86	0.85	0.84	0.82	0.81	0.8	0.79	0.78	0.77	0.77	0.76	0.75
IACC	1	0.93	0.88	0.83	0.79	0.76	0.73	0.71	0.69	0.67	0.66	0.64	0.63	0.62	0.61	0.6	0.6
LDB	0.94	0.93	0.91	0.89	0.87	0.85	0.84	0.82	0.8	0.79	0.77	0.76	0.75	0.74	0.73	0.72	0.72
SAX	0.77	0.73	0.7	0.67	0.65	0.64	0.62	0.61	0.6	0.59	0.58	0.57	0.56	0.55	0.54	0.54	0.53

5.3.9.15.1.11.10 How is Maintenance and Repair considered in this NPRM?

For this NPRM, this analysis, carried forward assumptions from the 2012 final rule for vehicle maintenance and repair. The costs for the maintenance and repair reflect 2016 dollars to appropriately account with other costs in the analysis.

The 2012 final rule noted areas where increases and decreases in maintenance costs were possible, but did not quantify these costs and requested comment on this topic. One example of an area of potential cost savings is the lack of need for oil changes in electric vehicles. Separately, increased use of low rolling resistance tires to improve fuel economy may result in an increase in maintenance costs, as low rolling resistance tires are more expensive to replace.

The National Automobile Dealers Association (NADA) offered comment on the issue of maintenance and other costs, stating that the 2012 final rule should evaluate the potential impact on a vehicle’s total cost of ownership, to include maintenance costs.³⁵⁸ In response, NHTSA identified a select list of technologies for which sufficient data on periodicity and cost exist to support quantification of changes in vehicle maintenance costs within the central analysis. This list includes costs associated with low rolling resistance tires, diesel fuel filters, and benefits resulting from electric vehicle characteristics that eliminate the need for oil changes as well as engine air filter changes.

To estimate maintenance costs in the 2012 final rule, NHTSA looked at vehicle models for which there exists a version with fuel-efficiency-improving technology and a version with the corresponding baseline technology. The difference between maintenance costs for the two models represent a cost which the agencies assumed to be attributable to this rulemaking. By comparing the manufacturer-recommended maintenance schedule of the items being compared, we estimated the differences in maintenance intervals for the two. With estimates of the costs per maintenance event, we could calculate the maintenance cost differences associated with the “new” technology.

³⁵⁸ [CITE TO DOCKET NUMBER OF COMMENT AND PAGE NUMBER].

TABLE 5-81 - MAINTENANCE EVENT COSTS AND INTERVALS (2016 DOLLARS)³⁵⁹

New Technology	Reference Case	Cost per Maintenance Event	Maintenance Interval (miles)
Low rolling resistance tires (level 1)	Standard tires	\$7.09	40,000
Low rolling resistance tires (level 2)	Standard tires	\$47.92	40,000
Diesel fuel filter replacement	Gasoline vehicle	\$54.22	20,000
EV oil change	Gasoline vehicle	-\$42.58	7,500
EV air filter replacement	Gasoline vehicle	-\$31.49	30,000
EV engine coolant replacement	Gasoline vehicle	-\$56.37	100,000
EV spark plug replacement	Gasoline vehicle	-\$91.38	105,000
EV battery coolant replacement	Gasoline vehicle	\$102.61	150,000
EV battery health check	Gasoline vehicle	\$42.58	15,000

The maintenance intervals are used along with yearly VMT tables to determine which year(s) maintenance events occur (note - the VMT schedule will vary depending on the vehicle class). The cost of maintenance events applied to a vehicle is also a function of the survival rate of that vehicle class. Once all of the maintenance event costs are tabulated, they are multiplied by the survival rate of that vehicle class to determine the average cost per vehicle in that class. Lastly, the net present value of the average costs is calculated based on the year they occurred and the discount rate chosen (e.g., 3% or 7%). The agencies seek comments on this methodology, in addition to these repair costs or additional maintenance events that have been introduced since the 2012 final rule.

5.3.9.16 Summary Air Conditioning efficiency and Off-cycle

A/C efficiency and off-cycle fuel consumption improvement values (FCIVs) are compliance flexibilities made available under NHTSA’s CAFE program through EPA’s EPCA authority to calculate fuel economy levels for individual vehicles and for fleets. NHTSA modified its regulations in the 2012 final rule for MYs 2017 and beyond to reflect the fact that certain flexibilities, including A/C efficiency improving technologies and off-cycle technology fuel

³⁵⁹ All maintenance interval, hours required, and part(s) cost differentials between reference and control cases were sourced from the ALLDATA subscription database (www.alldatapro.com) in January through February of 2012, unless noted otherwise in the text. Note - negative values represent savings resulting from forms of maintenance required by gasoline vehicles that are not required by EVs.

consumption improvement values (FCIVs), may be used as part of the determination of a manufacturers' CAFE level.³⁶⁰

“Off-cycle” technologies are those that reduce vehicle fuel consumption and CO₂ emissions, but for which the fuel consumption reduction benefits are not recognized under the 2-cycle test procedure used to determine compliance with the fleet average standards. The CAFE city and highway test cycles, also commonly referred to together as the 2-cycle laboratory compliance tests (or 2-cycle tests), were developed in the early 1970s when few vehicles were equipped with A/C systems. The city test simulates city driving in the Los Angeles area at that time. The highway test simulates driving on secondary roads (not expressways). The cycles are effective in measuring improvements in most fuel economy improving technologies; however, they are unable to measure or underrepresent some fuel economy improving technologies because of limitations in the test cycles.

5.3.9.16.1 Air Conditioning Efficiency Technologies

Air conditioning (A/C) is a virtually standard automotive accessory, with more than 95% of new cars and light trucks sold in the United States equipped with mobile air conditioning (MAC) systems. Most of the additional air conditioning related load on an engine is due to the compressor, which pumps the refrigerant around the system loop. The less the compressor operates, the less load the compressor places on the engine. The high penetration of A/C systems means improving the efficiency of those systems can significantly impact the total energy consumed by the light-duty vehicle fleet.

Vehicle manufacturers can generate credits for improved A/C systems under EPA's CO₂ program, and receive a fuel economy improvement equal to the value of the benefit not captured on the 2-cycle test under NHTSA's CAFE program.³⁶¹ A “menu” of fuel economy improvement values in grams per mile is available for qualifying A/C technologies, with the magnitude of each value estimated based on the expected reduction in CO₂ emissions from the technology.³⁶² NHTSA converts the improvement in grams per mile to a fuel economy improvement value for each vehicle for purposes of measuring CAFE compliance.

The 2012 final rule for MYs 2017 and later outlined two test procedures to determine eligibility for A/C efficiency menu credits, the idle test and the AC17 test. The idle test, performed while the vehicle is at idle, determined the additional CO₂ generated at idle when the A/C system is operated.³⁶³ The AC17 test is a four-part performance test that combines the existing SC03

³⁶⁰ 77 FR 63130-34 (October 15, 2012). Instead of manufacturers gaining credits as done under the GHG program, a direct adjustment is made to the manufacturer's fuel economy fleet performance value.

³⁶¹ See 77 FR 62720.

³⁶² See 40 CFR 86.1868-12.

³⁶³ See 75 FR 25431. The A/C CO₂ Idle Test is run with and without the A/C system cooling the interior cabin while the vehicle's engine is operating at idle and with the system under complete control of the engine and climate control system.

driving cycle, the fuel economy highway test cycle, and a pre-conditioning cycle and solar soak period.³⁶⁴ Manufacturers could use the idle test or AC17 test to determine improvement values for MYs 2014-2016, while for MYs 2017 and later, the AC17 test is the exclusive test that manufacturers can use to demonstrate eligibility for menu A/C improvement values.

In MYs 2020 and later, manufacturers will use the AC17 test to demonstrate eligibility for A/C credits, and also to partially quantify the amount of the credit earned. AC17 test results equal to or greater than the menu value will allow manufacturers to claim the full menu value for the credit. A test result less than the menu value will limit the amount of credit to that demonstrated on the AC17 test. In addition, in MYs 2017 and beyond, A/C fuel consumption improvement values are available for CAFE calculations, whereas efficiency credits were previously only available for GHG compliance. The agencies proposed these changes in the 2012 final rule largely as a result of new data collected, as well as the extensive technical comments submitted on the proposal.³⁶⁵

The pre-defined technology menu and associated car and light truck credit value is shown in Table 5-82 below. The regulations include a definition of each technology must met to be eligible for the menu credit.³⁶⁶ Manufacturers are not required to submit any other emissions data or information beyond meeting the definition and useful life requirements³⁶⁷ to use the pre-defined credit value. Manufacturers' use of menu-based credits for A/C efficiency is subject to a regulatory cap; 5.7 g/mi for cars and trucks through MY 2016 and separate caps of 5.0 g/mi for cars and 7.2g/mi for trucks for later MYs.³⁶⁸

In the 2012 final rule, the agencies estimated that manufacturers would employ significant advanced A/C technologies throughout their fleets to improve fuel economy, and this was reflected in the stringency of the standards.³⁶⁹ Many manufacturers have since incorporated A/C technology throughout their fleets, and the utilization of advanced A/C technologies has become significant contributor to industry compliance plans. As summarized in the EPA Manufacturer Performance Report for the 2016 model year,³⁷⁰ 15 auto manufacturers included A/C efficiency credits as part of their compliance demonstration in MY 2016. These amounted to more than 12 million Mg of fuel consumption improvement values of the total net fuel consumption improvement values reported. This is equivalent to approximately four grams per mile across the

³⁶⁴ See 77 FR 62723.

³⁶⁵ See 77 FR 62723.

³⁶⁶ See 77 FR 62725.

³⁶⁷ Lifetime vehicle miles travelled (VMT) for MY 2017-2025 are 195,264 miles and 225,865 miles for passenger cars and light trucks, respectively.

³⁶⁸ See 40 CFR 86.1868-12(b)(2).

³⁶⁹ See e.g. 77 FR at 62803-62806.

³⁷⁰ "Greenhouse Gas (GHG) Emission Standards for Light-Duty Vehicles - Manufacturer Performance Report," <https://www.epa.gov/regulations-emissions-vehicles-and-engines/greenhouse-gas-ghg-emission-standards-light-duty-vehicles> Accessed March 05, 2018.

*** EO 12866 Review – Draft – Do Not Cite, Quote or Release During Review ***

2016 fleet. Accordingly, a significant amount of new information about A/C technology and the efficacy of the test procedures has become available since the 2012 final rule.

The sections below provide a brief history of the AC17 test procedure for evaluating A/C efficiency improving technology and discuss stakeholder comments on the AC17 test procedure approach; discuss A/C efficiency technology valuation through the off-cycle program.

TABLE 5-82 - A/C EFFICIENCY CREDITS AND FUEL CONSUMPTION IMPROVEMENT VALUES

Technology Description	Estimated reduction in A/C CO2 emissions and fuel consumption (percent)	Car A/C efficiency credit (g/mi CO2)	Truck A/C efficiency credit (g/mi CO2)	Car A/C efficiency fuel consumption improvement (gallon/mi)	Truck A/C efficiency fuel consumption improvement (gallon/mi)
Reduced reheat, with externally-controlled, variable-displacement compressor	30	1.5	2.2	0.000169	0.000248
Reduced reheat, with externally-controlled, fixed-displacement or pneumatic variable displacement compressor	20	1	1.4	0.000113	0.000158
Default to recirculated air with closed-loop control of the air supply (sensor feedback to control interior air quality) whenever the outside ambient temperature is 75 °F or higher (although deviations from this temperature are allowed based on additional analysis)	30	1.5	2.2	0.000169	0.000248
Default to recirculated air with open-loop control of the air supply (no sensor feedback) whenever the outside ambient temperature is 75 °F or higher (although deviations from this temperature are	20	1	1.4	0.000113	0.000158

allowed if accompanied by an engineering analysis					
Blower motor controls that limit wasted electrical energy (e.g. pulse width modulated power controller)	15	0.8	1.1	0.00009	0.000124
Internal heat exchanger (or suction line heat exchanger)	20	1	1.4	0.000113	0.000158
Internal heat exchanger (or suction line heat exchanger)	20	1	1.4	0.000113	0.000158
Oil Separator (internal or external to compressor)	10	0.5	0.7	0.000056	0.000079

5.3.9.16.1.1 Evaluation of the AC17 Test Procedure Since the Draft TAR

In developing the AC17 test procedure, the agencies sought to develop a test procedure that could more reliably generate an appropriate fuel consumption improvement value based on an “A” to “B” comparison, that is, a comparison of substantially similar vehicles in which one has the technology and the other does not.³⁷¹ The agencies believe that the AC17 test procedure is more capable of detecting the effect of more efficient A/C components and controls strategies during a transient drive cycle, rather than during just idle (as measured in the old idle test procedure). As described above and in the 2012 final rule,³⁷² the AC17 test is a four-part performance test that combines the existing SC03 driving cycle, the fuel economy highway cycle, as well as a pre-conditioning cycle and a solar soak period.

In the 2016 Draft TAR, EPA discussed AC17 test developments since the 2012 final rule, including a discussion of USCAR members’ test program to assess the ability of the AC17 test procedure to properly quantify fuel economy improvements from A/C systems. At this time, the USCAR test program is not yet complete, and results are not yet conclusive. The details of the uncertainties are discussed further in the 2016 Draft TAR.³⁷³

The agencies received several comments in response to the Draft TAR evaluation of the AC17 test procedure. FCA commented generally that A/C efficiency technologies “are not showing

³⁷¹ For an explanation of how the agencies, in collaboration with stakeholders, developed the AC17 test procedure, see the 2017 and later final rule at 77 FR 62723.

³⁷² See 77 FR 62723; 2012 FRM TSD p. 5-40.

³⁷³ 2016 Draft TAR p. 5-211 to 5-216.

*** EO 12866 Review – Draft – Do Not Cite, Quote or Release During Review ***

their full effect on this AC17 test as most technologies provide benefit at different temperatures and humidity conditions in comparison to a standard test conditions. All of these technologies are effective at different levels at different conditions. So there is not one size fits all in this very complex testing approach. Selecting one test that captures benefits of all of these conditions has not been possible.”³⁷⁴

The agencies acknowledge that any single test procedure is unlikely to equally capture the real-world effect of every potential technology in every potential use case. Both the agencies and stakeholders understood this difficulty when developing the AC17 test procedure. While no test is perfect, the AC17 test procedure represents an industry best effort at identifying a test that would greatly improve upon the idle test by capturing a greater range of operating conditions.

FCA also noted that “[i]t is a major problem to find a baseline vehicle that is identical to the new vehicle but without the new A/C technology. This alone makes the test unworkable.”³⁷⁵ The agencies disagree this makes the test unworkable. The regulation describes the baseline vehicle as a “similar” vehicle, selected with good engineering judgment (such that the test comparison is not unduly affected by other differences). Also, OEMs expressed confidence in using A-to-B testing to qualify for fuel consumption improvement values for software-based A/C efficiency technologies. While hardware technologies may pose a greater challenge in locating a sufficiently similar “A” baseline vehicle, the engineering analysis provision under 40 CFR 86.1868-12(g)(2) provides an alternative to locating and performing an AC17 test on such a vehicle. Further, as the USCAR program in general and the GM with Denso SAS compressor application (discussed further below) specifically have shown, the test is able to resolve small differences in CO₂ effectiveness (1.3 grams in the latter case) when carefully conducted.

Commenters on the Draft TAR also expressed a desire for improvements in the process by which manufacturers without an “A” vehicle (for the A-to-B comparison) could apply under the engineering analysis provision, such as development of standardized engineering analysis and bench testing procedures that could support such applications. For example, Toyota requested that “EPA consider an optional method for validation via an engineering analysis, as is currently being developed by industry.”³⁷⁶ Similarly, the Alliance commented that, “[t]he future success of the MAC credit program in generating emissions reductions will depend to a large extent on the manner in which it is administered by EPA, especially with respect to making the AC17 A-to-B provisions function smoothly, without becoming a prohibitive obstacle to fully achieving the MAC indirect credits.”³⁷⁷

As described in the Draft TAR, in 2016, USCAR members initiated a Cooperative Research Program (CRP) through the Society of Automotive Engineers (SAE) to develop bench testing

³⁷⁴ FCA TAR comment at p.123-124.

³⁷⁵ FCA TAR comment at p.124.

³⁷⁶ Toyota TAR comment at p. 23.

³⁷⁷ Alliance TAR comment at p.160.

*** EO 12866 Review – Draft – Do Not Cite, Quote or Release During Review ***

standards for the four hardware technologies in the fuel consumption improvement value menu (blower motor control, internal heat exchanger, improved evaporators and condensers, and oil separator). The intent of the program is to streamline the process of conducting bench testing and engineering analysis in support of an application for A/C credits under 40 CFR Part 86.1868-12(g)(2), by creating uniform standards for bench testing and for establishing the expected GHG effect of the technology in a vehicle application. Continuing progress in this effort since the Draft TAR suggests the availability of these standards may soon resolve much of the uncertainty expressed by commenters.

An update to the list of SAE standards under development originally presented in the Draft TAR is listed in Table 5-83. Work has continued on these standards, which appear to be nearing completion.

TABLE 5-83 - HARDWARE BENCH TESTING STANDARDS UNDER DEVELOPMENT BY SAE COOPERATIVE RESEARCH PROGRAM

Number	Title	Status
J2765	Procedure for Measuring System COP of a Mobile Air Conditioning System on a Test Bench	Published
J3094	Internal Heat Exchanger (IHx) Measurement Standard	Work in Progress
J3109	HVAC PWM Blower Controller Efficiency Measurement	Published
J3112	A/C Compressor Oil Separator Effectiveness Test Standard	Published

5.3.9.16.1.2A/C Efficiency Technology Valuation through the Off-Cycle Program

The A/C technology menu, discussed at length above, includes several A/C efficiency-improving technologies that were well defined and had been quantified for effectiveness at the time of the 2012 final rule for MYs 2017 and beyond. Manufacturers claimed the vast majority of A/C efficiency credits to date by utilizing technologies on the menu; however, the agencies recognize that manufacturers will develop additional technologies that are not currently listed on the menu. These additional A/C efficiency-improving technologies are eligible for fuel consumption improvement values on a case-by-case basis under the off-cycle program. Approval under the off-cycle program also requires “A-to-B” comparison testing under the AC17 test, that is, testing substantially similar vehicles in which one has the technology and the other does not.

To date, the agencies have received one type off-cycle application for an A/C efficiency technology. In December 2014, General Motors submitted an off-cycle application for the Denso SAS A/C compressor with variable crankcase suction valve technology, requesting an off-cycle GHG credit of 1.1 grams CO₂ per mile. In December 2017, BMW of North America, Ford Motor Company, Hyundai Motor Company, and Toyota petitioned and received approval to receive the

*** EO 12866 Review – Draft – Do Not Cite, Quote or Release During Review ***

off-cycle improvement value for the same A/C efficiency technology.^{378, 379} EPA, in consultation with NHTSA, evaluated the applications and found methodologies described therein were sound and appropriate. Accordingly, the agencies approved the fuel economy improvement value applications.

The agencies received additional stakeholder comments on the off-cycle approval process as an alternate route to receiving A/C technology credit values. The Alliance requested that EPA “simplify and standardize the procedures for claiming off-cycle credits for the new MAC technologies that have been developed since the creation of the MAC indirect credit menu.”³⁸⁰ Other commenters noted the importance of continuing to incentivize further innovation in A/C efficiency technologies as new technologies emerge that are not listed on the menu, or when manufacturers begin to reach regulatory caps. The commenters suggested that EPA should consider adding new A/C efficiency technologies to the menu and/or update the fuel consumption improvement values for technology already listed on the menu, particularly in cases where manufacturers can show through an off-cycle application that the technology actually deserves more credit than that listed on the menu. For example, Toyota commented that “the incentive values for A/C efficiency should be updated along with including new technologies being deployed.”³⁸¹

The agencies note that some of these comments are directed towards the off-cycle technology approval process generally, which is described in more detail in section Preamble Section 8. Regarding the A/C technology menu specifically, the agencies do anticipate that new A/C technologies not currently on the menu will emerge over the time frame of the MY 2021-2026 standards. At the time of this proposal, the agencies are proposing to add one additional A/C technology to the menu – the A/C compressor with variable crankcase suction valve technology, discussed in section 5.5.13.3, below (and also one off-cycle technology, discussed in section 5.5.14, below). The agencies also request comment on whether to change any fuel economy improvement values currently assigned to technologies on the menu.

Next, as mentioned above, the menu-based improvement values for A/C efficiency established in the 2012 final rule for MYs 2017 and by end are subject to a regulatory cap. The rule set a cap of 5.7 g/mi for cars and trucks through MY 2016 and separate caps of 5.0 g/mi for cars and 7.2g/mi for trucks for later MYs.³⁸² Several commenters asked EPA to reconsider the applicability of the cap to non-menu A/C efficiency technologies claimed through the off-cycle process and questioned the applicability of this cap on several different grounds. These comments appear to

³⁷⁸ “EPA Decision Document - Off-Cycle Credits for BMW Group, Ford Motor Company, and Hyundai Motor Company,” <https://nepis.epa.gov/Exe/ZyPDF.cgi?Dockey=P100TF06.pdf> Access March 5, 2018.

³⁷⁹ “Alternative Method for Calculating Off-cycle Credits under the Light-duty Vehicle Greenhouse Gas Emissions Program - Applications from General Motors and Toyota Motor North America,” Federal Register ID# EPA-HQ-OAR-2017-0754-0001.

³⁸⁰ Alliance TAR comments at [page number].

³⁸¹ Toyota TAR comments at p. 23.

³⁸² See 40 CFR 86.1868-12(b)(2).

be in response to a Draft TAR passage that stated - “Applications for A/C efficiency credits made under the off-cycle credit program rather than the A/C credit program will continue to be subject to the A/C efficiency credit cap” (Draft TAR, p. 5-210). The agencies considered these comments and present clarification below.

As additional context, the 2012 TSD states - “...air conditioner efficiency is an off-cycle technology. It is thus appropriate [...] to employ the standard off-cycle credit approval process [to pursue a larger credit than the menu value]. Utilization of bench tests in combination with dynamometer tests and simulations [...] would be an appropriate alternate method of demonstrating and quantifying technology credits (*up to the maximum level of credits allowed for A/C efficiency*) [emphasis added].³⁸³ A manufacturer can choose this method even for technologies that are not currently included in the menu.” This suggests the concept of placing a limit on total A/C fuel consumption improvement values, even when some are granted under the off-cycle program, is not entirely new and that EPA considered the menu cap as being appropriate at the time.

Regulatory caps specified under 40 CFR 86.1868-12(b)(2) apply to menu-based improvement values and are not part of the off-cycle regulation (40 CFR 86.1869-12). However, it should be noted that off-cycle applications are decided individually on merits through a process involving public notice and opportunity for comment. In deciding whether to approve or deny a request, the agencies may take into account any factors deemed relevant, including such issues as the realization of claimed fuel consumption improvement value in real-world use. Such considerations could include synergies or interactions among applied technologies, which could potentially be addressed by application of some form of cap or other applicable limit, if warranted. Therefore, applying for A/C efficiency fuel consumption improvement values through the off-cycle provisions in 40 CFR Part 86.1869-12 should not be seen as a route to unlimited A/C fuel consumption improvement values.

Going forward, the agencies are not changing the cap for total A/C efficiency fuel consumption improvement values whether granted through 40 CFR Parts 86.1868-12 or 86.1869-12. That is, the agencies are likely to specify total A/C efficiency fuel consumption improvement values be capped in an appropriate manner. At this time, agencies believe that, unless information pertinent to a specific application causes a different conclusion, the caps specified in 40 CFR Part 86.1868-12 are appropriate for this purpose. Applicants can present, as part of the analysis supporting their application, evidence that a different conclusion should apply to the application in question.

5.3.9.16.1.3 Off-Cycle Technologies

“Off-cycle” emission reductions and fuel consumption improvements can be achieved by employing off-cycle technologies resulting in real-world benefits but where that benefit is not

³⁸³ See p. 5-58 2012 Final Rule TSD.

adequately captured on the test procedures used to demonstrate compliance with fuel economy emission standards. EPA initially included off-cycle technology credits in the MY 2012-2016 rule and revised the program in the MY 2017-2025 rule.³⁸⁴ NHTSA adopted equivalent off-cycle fuel consumption improvement value for MYs 2017 and later in the MY 2017-2025 rule.³⁸⁵

The intent of the off-cycle provisions is to allow manufacturers to use off-cycle technologies that improve real world fuel economy and CO₂ emissions, where the benefits of those technologies may not be captured with the standard 2-cycle test procedures. The 2012 final rule for MYs 2017 and beyond provided a detailed discussion of eligibility for off-cycle credits.³⁸⁶ Technologies that are integral or inherent to the basic vehicle design including engine, transmission, mass reduction, passive aerodynamics, and base tires that are accounted for in 2-cycle test procedures are not eligible. EPA established this approach believing the use of 2-cycle technologies would be driven by standards, and no additional improvement values would be necessary or appropriate.

Manufacturers can demonstrate the value of off-cycle technologies in three ways - first, they may select fuel economy improvement values and CO₂ credit values from a pre-defined “menu” for off-cycle technologies that meet certain regulatory specifications. As part of a manufacturer’s compliance data, manufacturers will provide information about which off-cycle technologies are present on which vehicles.

The pre-defined list of technologies and associated car and light truck credits and fuel economy improvement values is shown in Table 5-84 and Table 5-85 below.³⁸⁷ A definition of each technology equipment must meet to be eligible for the menu credit is included at 40 CFR 86.1869-12(b)(4). Manufacturers are not required to submit any other emissions data or information beyond meeting the definition and useful life requirements to use the pre-defined credit value. Credits based on the pre-defined list are subject to an annual manufacturer fleet-wide cap of 10 g/mile.

TABLE 5-84 - OFF-CYCLE FUEL CONSUMPTION IMPROVEMENT VALUE MENU TECHNOLOGIES FOR CARS AND LIGHT TRUCKS

Technology	CAFE Value for Cars	CAFE Value for Light Trucks
	g/mi (gallons/mi)	g/mi (gallons/mi)
High Efficiency Exterior Lighting (at 100W)	1.0 (0.000113)	1.0 (0.000113)

384 77 FR 62832, October 15, 2012.

385 77 FR 62839, October 15, 2012.

386 77 FR 62835-62837.

387 For a description of each technology and the derivation of the pre-defined credit levels see Chapter 5 of “Joint Technical Support Document - Final Rulemaking for 2017-2025 Light-duty Vehicle Greenhouse Gas Emission Standards and Corporate Average Fuel Economy,” EPA-420-R-12-901, August 2012.

*** EO 12866 Review – Draft – Do Not Cite, Quote or Release During Review ***

Waste Heat Recovery (at 100W; scalable)	0.7 (0.000079)	0.7 (0.000079)
Solar Roof Panels (for 75 W, battery charging only)	3.3 (0.000372)	3.3 (0.000372)
Solar Roof Panels (for 75 W, active cabin ventilation plus battery charging)	2.5 (0.000282)	2.5 (0.000282)
Active Aerodynamic Improvements (scalable)	0.6 (0.000068)	1.0 (0.000113)
Engine Idle Start-Stop w/ heater circulation system	2.5 (0.000282)	4.4 (0.000496)
Engine Idle Start-Stop without/ heater circulation system	1.5 (0.000169)	2.9 (0.000327)
Active Transmission Warm-Up	1.5 (0.000169)	3.2 (0.000361)
Active Engine Warm-Up	1.5 (0.000169)	3.2 (0.000361)
Solar/Thermal Control	Up to 3.0 (0.000338)	Up to 4.3 (0.000484)

TABLE 5-85 - OFF-CYCLE FUEL CONSUMPTION IMPROVEMENT VALUE MENU TECHNOLOGIES AND CREDITS FOR SOLAR/THERMAL CONTROL TECHNOLOGIES FOR CARS, LIGHT TRUCKS

Thermal Control Technology	CAFE Value (CO2 g/mi)	
	Car	Truck
Glass or Glazing	Up to 2.9 (0.000326)	Up to 3.9 (0.000439)
Active Seat Ventilation	1.0 (0.000113)	1.3 (0.000146)
Solar Reflective Paint	0.4 (0.00005)	0.5 (0.00006)
Passive Cabin Ventilation	1.7 (0.000191)	2.3 (0.000259)
Active Cabin Ventilation	2.1 (0.000236)	2.8 (0.000315)

Next, manufacturers can perform their own 5-cycle testing and submit results to the agencies with a request explaining the off-cycle technology. The three additional test cycles have different operating conditions, including high speeds, rapid accelerations, high temperatures with A/C operation and cold temperatures, which enables manufacturers to quantify technology benefits that do not impact operations on the 2-cycle tests. Credits or improvement values quantified according to this methodology do not undergo public review.

The third pathway allows manufacturers to seek EPA approval to use an alternative test methodology for determining the benefit of an off-cycle technology. This option is only available if the benefit of the technology cannot be adequately demonstrated using the 5-cycle methodology. Manufacturers may also use this option to demonstrate reductions that exceed

those available via use of the predetermined menu list. The manufacturer must also demonstrate that the off-cycle technology is effective for the full useful life of the vehicle; unless the manufacturer demonstrates that the technology is not subject to in-use deterioration, the manufacturer must account for the deterioration in their analysis.

Manufacturers must develop a methodology for demonstrating the benefit of the off-cycle technology, and EPA makes the methodology available for public comment prior to a joint agency determination of whether to allow the methodology to quantify off-cycle benefits. The data needed for this demonstration may be extensive.

Several manufacturers have requested and been granted use of an alternative test methodologies for measuring improvements and credits. In the fall of 2013, Mercedes-Benz requested off-cycle credits for the following off-cycle technologies in use or planned for implementation in the 2012-2016 model years - stop-start systems, high-efficiency lighting, infrared glass glazing, and active seat ventilation. EPA approved methodologies for Mercedes to determine these off-cycle credits in September 2014.³⁸⁸ Subsequently, FCA, Ford, and GM requested off-cycle credits under this pathway. FCA and Ford submitted applications for off-cycle credits from high efficiency exterior lighting, solar reflective glass/glazing, solar reflective paint, and active seat ventilation. Ford's application also demonstrated off-cycle benefits from active aerodynamic improvements (grill shutters), active transmission warm-up, active engine warm-up technologies, and engine idle stop-start. GM's application described real-world benefits of an air conditioning compressor with variable crankcase suction valve technology. EPA approved the credits for FCA, Ford, and GM in September 2015.³⁸⁹ Although EPA granted the use of alternative methodologies to determine credit values, manufacturers have yet to report credits to EPA based on those alternative methodologies.

5.3.9.16.1.3.1 Use of Off-Cycle Technologies to Date

Manufacturers used a wide array of off-cycle technologies in MY 2016 to generate off-cycle GHG credits using the pre-defined menu. Table 5-86 below shows the percent of each manufacturer's production volume in MY 2016 using each menu technology, by manufacturer. Table 5-87 shows the g/mile benefit each manufacturer reported across its fleet from each off-cycle technology. Like Table 25, Table 5-86 provides the mix of technologies used in MY 2016 by manufacturer and the extent to which each technology benefits each manufacturer's fleet. Fuel consumption improvement values for off-cycle technologies were not available in the CAFE

³⁸⁸ "EPA Decision Document - Mercedes-Benz Off-cycle Credits for MYs 2012-2016," U.S. EPA-420-R-14-025, Office of Transportation and Air Quality, September 2014. <https://www.epa.gov/vehicle-and-engine-certification/mercedes-benz-compliance-materials-light-duty-greenhouse-gas-ghg>.

³⁸⁹ "EPA Decision Document - Off-cycle Credits for Fiat Chrysler Automobiles, Ford Motor Company, and General Motors Corporation," U.S. EPA-420-R-15-014, Office of Transportation and Air Quality, September 2015. See <https://www.epa.gov/vehicle-and-engine-certification/ford-compliance-materials-light-duty-greenhouse-gas-ghg-standards>

*** EO 12866 Review – Draft – Do Not Cite, Quote or Release During Review ***

program until MY 2017, and therefore only GHG off-cycle credits have been generated by manufacturers thus far.

*** EO 12866 Review – Draft – Do Not Cite, Quote or Release During Review ***

TABLE 5-86 - PERCENT OF 2016 MODEL YEAR VEHICLE PRODUCTION VOLUME WITH CREDITS FROM THE MENU, BY MANUFACTURER & TECHNOLOGY (%)

Manufacturer	Active Aerodynamics		Thermal Control Technologies					Engine & Transmission Warmup		Other		
	Grille shutters	Ride height adjustment	Passive cabin ventilation	Active cabin ventilation	Active seat ventilation	Glass or glazing	Solar reflective surface coating	Active engine warmup	Active transmission warmup	Engine idle stop-start	High efficiency exterior lights	Solar panel(s)
BMW	2.9	0.0	0.0	93.9	8.3	0.3	0.0	70.8	0.0	2.8	97.3	0.0
Ford	73.7	0.0	0.0	0.0	0.0	0.0	0.0	30.4	20.7	11.0	58.8	0.0
GM	14.6	0.0	0.0	0.0	9.3	62.5	21.1	25.6	0.0	15.0	67.3	0.0
Honda	0.0	0.0	0.0	0.0	2.6	0.0	0.0	0.0	78.8	3.4	82.8	0.0
Hyundai	4.1	0.0	0.0	0.0	11.5	69.4	0.0	0.0	37.2	3.0	50.1	0.0
Jaguar Land Rover	38.4	0.0	0.0	0.0	57.9	100.0	0.0	0.0	0.0	100.0	100.0	0.0
Kia	0.8	0.0	0.0	0.0	10.6	99.1	0.0	0.0	37.1	1.0	50.3	0.0
Mercedes	0.0	0.0	0.0	0.0	17.2	4.6	0.0	0.0	0.0	81.1	81.5	0.0
Nissan	26.9	0.0	0.0	0.0	5.3	0.0	16.9	16.5	70.9	0.6	65.7	0.2
Subaru	33.6	0.0	0.0	0.0	0.0	0.0	0.0	0.0	0.0	0.0	48.1	0.0
Toyota	3.6	0.2	0.0	0.0	0.0	0.0	0.0	19.7	0.0	9.2	59.0	0.0
FCA	27.7	2.4	91.8	0.0	10.8	98.6	3.1	51.5	22.7	11.9	69.0	0.0
Fleet Total	14.6	0.4	23.5	2.3	12.2	51.9	13.2	20.7	28.2	5.8	49.1	0.0

*** EO 12866 Review – Draft – Do Not Cite, Quote or Release During Review ***

TABLE 5-87 - MODEL YEAR 2016 OFF-CYCLE TECHNOLOGY FUEL CONSUMPTION IMPROVEMENT VALUE FROM THE MENU, BY MANUFACTURER AND TECHNOLOGY (G/MILE)³⁹⁰

Manufacturer	Active Aerodynamics		Thermal Control Technologies					Engine & Transmission Warmup		Other			Total
	Grille shutters	Ride height	Passive cabin	Active cabin ventilation	Active seat ventilation	Glass or glazing	Solar reflective surfaces	Active engine warmup	Active transmission	Engine idle stop	High efficiency	Solar panel(s)	
BMW	0.0	-	-	2.0	0.1	0.0	-	1.4	-	0.1	0.7	-	6.4
Ford	1.1	-	-	-	-	-	-	0.8	0.6	0.5	0.2	-	3.2
GM	0.1	-	-	-	0.1	0.6	0.1	0.4	-	0.3	0.3	-	3.9
Honda	-	-	-	-	0.0	-	-	-	1.8	0.1	0.3	-	2.3
Hyundai	0.0	-	-	-	0.1	0.4	-	-	0.7	0.0	0.1	-	2.0
Jaguar Land Rover	0.4	-	-	-	1.2	2.8	-	-	-	6.0	1.2	-	15.7
Kia	0.0	-	-	-	0.1	0.9	-	-	0.9	0.0	0.1	-	3.0
Mercedes	-	-	-	-	0.2	0.1	-	-	-	2.2	0.8	-	3.5
Nissan	0.1	-	-	-	0.0	-	0.1	0.2	1.2	0.0	0.1	0.0	1.8
Subaru	0.1	-	-	-	-	-	-	-	-	-	0.1	-	0.2
Toyota	0.0	0.0	-	-	-	-	-	0.4	-	0.2	0.2	-	2.0
FCA	0.2	0.0	1.8	-	0.1	1.4	0.0	1.4	0.7	0.5	0.1	-	9.4
Fleet Total	0.2	0.0	0.2	0.1	0.1	0.4	0.0	0.5	0.5	0.3	0.2	0.0	2.5

³⁹⁰ Note - "0.0" indicates the manufacturer implemented that technology, but the overall penetration rate was not high enough to round to 0.1 g/mi whereas a dash indicates no use of a given technology by a manufacturer.

In 2016, manufacturers generated the vast majority of credits using the pre-defined menu.³⁹¹ Although MY 2014 was the first year that manufacturers could generate credits using pre-defined menu values, manufacturers have acted quickly to implement use of off-cycle technologies. FCA and Jaguar Land Rover generated the most off-cycle credits on a fleet-wide basis, reporting credits equivalent to approximately 6 g/mile and 5 g/mile, respectively.¹⁵ Several other manufacturers report fleet-wide credits in the range of approximately 1 to 4 g/mile. In MY 2016, the fleet total across manufacturers equaled approximately 2.5 g/mile. The agencies expect that as manufacturers continue expanding their use of off-cycle technologies, the fleet-wide effects will continue to grow with some manufacturers potentially approaching the 10 g/mile fleet-wide cap.

5.4 CAFE Model functionality

5.4.1 CAFE Model

5.4.1.1 Simulation of manufacturers' potential responses to each alternative

This analysis uses the CAFE model to estimate how manufacturers could comply with a given CAFE standard by adding technology to fleets that this analysis anticipates the manufacturers could produce in future model years. This exercise constitutes a simulation of manufacturers' decisions regarding compliance with CAFE or CO₂ standards.

This compliance simulation begins with the following inputs - (a) the analysis fleet of vehicles from model year 2016, (b) fuel economy improving technology estimates, (c) economic inputs, and (d) inputs defining baseline and potential new CAFE standards. For each manufacturer, the model applies technologies in both a logical sequence and a cost-minimizing strategy in order to identify a set of technologies the manufacturer could apply in response to CAFE or CO₂ standards. The model applies technologies to each of the projected individual vehicles in a manufacturer's fleet, considering the combined effect of regulatory and market incentives while attempting to account for manufacturers' production constraints. Depending on how the model is exercised, it will apply technology until one of the following occurs:

- (1) The manufacturer's fleet achieves compliance³⁹² with the applicable standard, and continuing to add technology in the current model year would be attractive neither

³⁹¹ Thus far, ~~the agencies~~EPA hasve only granted one manufacturer (GM) off-cycle "credits" for technology based on 5-cycle testing. These credits are for an off-cycle technology used on certain GM gasoline-electric hybrid vehicles, an auxiliary electric pump, which keeps engine coolant circulating in cold weather while the vehicle is stopped and the engine is off, thus allowing the engine stop-start system to be active more frequently in cold weather.

³⁹² When determining whether compliance has been achieved, existing over-compliance credits that may be carried over from prior model years or transferred between fleets are also used to determine compliance status. For purposes of determining the effect of maximum feasible CAFE standards, NHTSA cannot consider the availability of these

- in terms of stand-alone (*i.e.*, absent regulatory need) cost-effectiveness nor in terms of facilitating compliance in future model years;
- (2) The manufacturer “exhausts” available technologies³⁹³; or
 - (3) For purposes of the CAFE program, for manufacturers assumed to be willing to pay civil penalties, the manufacturer reaches the point at which doing so would be more cost-effective (from the manufacturer’s perspective) than adding further technology.

The model accounts explicitly for each model year, applying technologies when vehicles are scheduled to be redesigned or refreshed, and carrying forward technologies between model years once they are applied (until, if applicable, they are superseded by other technologies). The model then uses these simulated manufacturer fleets to generate both a representation of the U.S. auto industry, and to modify a representation of the entire light-duty registered vehicle population. From these fleets, the model estimates changes in physical quantities (gallons of fuel, pollutant emissions, traffic fatalities, etc.) and calculates the relative costs and benefits of regulatory alternatives under consideration.

The CAFE model accounts explicitly for each model year, in turn, because manufacturers actually “carry forward” most technologies between model years, tending to concentrate the application of new technology to vehicle redesigns or mid-cycle “freshenings,” and design cycles vary widely among manufacturers and specific products. Comments by manufacturers and model peer reviewers strongly support explicit year-by-year simulation. Year-by-year accounting also enables accounting for credit banking (*i.e.*, carry-forward), as discussed above, and at least four environmental organizations recently submitted comments urging the agencies to consider such credits, citing NHTSA’s 2016 results showing impacts of carried-forward credits.³⁹⁴ Moreover, EPCA/EISA requires that NHTSA make a year-by-year determination of the appropriate level of stringency and then set the standard at that level, while ensuring ratable increases in average fuel economy through MY 2020. The multi-year planning capability, (optional) simulation of “market-driven overcompliance,” and EPCA credit mechanisms (for purposes of the CAFE program, at least) increase the model’s ability to simulate manufacturers’ real-world behavior, accounting for the fact that manufacturers will seek out compliance paths for several model years at a time, while accommodating the year-by-year requirement. This same multi-year planning

mechanisms (though does so for model years that are already final, since those are not the subject of the maximum feasible determination) and exercises the CAFE model without enabling these options.

³⁹³ In a given model year, it is possible that production constraints cause a manufacturer to “run out” of available technology before achieving compliance with standards. This can occur when - (a) an insufficient volume of vehicles are expected to be redesigned, (b) vehicles have moved to the ends of each (relevant) technology pathway, after which no additional options exist, or (c) engineering aspects of available vehicles make available technology inapplicable (e.g., secondary axle disconnect cannot be applied to two-wheel drive vehicles).

³⁹⁴ Environmental Law & Policy Center, Natural Resources Defense Council (NRDC), Public Citizen, and Sierra Club, Docket No. EPA-HQ-OAR- 2015-0827, October 5, 2017, pp. 28-29.

*** EO 12866 Review – Draft – Do Not Cite, Quote or Release During Review ***

structure is used to simulate responses to standards defined in grams CO₂/mile, and utilizing the set of specific credit provisions defined under EPA’s program.

5.4.2 Representation of Manufacturers’ Production Constraints

After the 2012 final rule that finalized NHTSA’s standards through MY 2021, DOT staff began work on changes to the CAFE model with the intention of better reflecting constraints of product planning and cadence for which previous analyses did not account.

5.4.2.1 Product Cadence

Past comments on the CAFE model have stressed the importance of product cadence—i.e., the development and periodic redesign and freshening of vehicles—in terms of involving technical, financial, and other practical constraints on applying new technologies, and DOT has steadily made changes to both the CAFE model and its inputs with a view toward accounting for these considerations. For example, early versions of the model added explicit “carrying forward” of applied technologies between model years, subsequent versions applied assumptions that most technologies will be applied when vehicles are freshened or redesigned, and more recent versions applied assumptions that manufacturers would sometimes apply technology earlier than “necessary” in order to facilitate compliance with standards in ensuing model years. Thus, for example, if a manufacturer is expected to redesign many of its products in model years 2018 and 2023, and the standard’s stringency increases significantly in model year 2021 as compared to the prior year, the CAFE model will estimate the potential that the manufacturer will add more technology than necessary for compliance in MY 2018, in order to carry those product changes forward through the next redesign and contribute to compliance with the MY 2021 standard. This explicit simulation of multiyear planning plays an important role in determining year-by-year analytical results.

As in previous iterations of CAFE rulemaking analysis, the simulation of compliance actions that manufacturers might take is constrained by the pace at which new technologies can be applied in the new vehicle market. Operating at the make/model level (e.g., Toyota Camry) allows the CAFE model to explicitly account for the fact that individual vehicle models undergo significant redesigns relatively infrequently. Many popular models are only redesigned every six years or so, with some larger/legacy platforms (the old Ford Econoline Vans, for example) stretching more than a decade between significant redesigns. Engines, which are often shared among many different models and platforms for a single manufacturer, can last even longer – eight to ten years in most cases.

While these characterizations of product cadence are important to any evaluation of the impacts of CAFE or CO₂ standards, they are not known with certainty – even by the manufacturers themselves over time horizons as long as those covered by this analysis. However, lack of certainty about redesign schedules is not license to ignore them. Indeed, when DOT and EPA staff meet with manufacturers to discuss manufacturers’ plans vis-à-vis CAFE and CO₂ requirements, manufacturers typically present specific and detailed year-by-year information that explicitly accounts for anticipated redesigns. Such year-by-year analysis is also essential to

*** EO 12866 Review – Draft – Do Not Cite, Quote or Release During Review ***

manufacturers' plans to make use of provisions (for CAFE, statutory and specific) allowing credits to be carried forward to future model years, carried back from future model years, transferred between regulated fleets, and traded with other manufacturers. Manufacturers are never certain about future plans, but they spend considerable effort developing, continually adjusting, and implementing them.

For every vehicle model that appears in the MY 2016 analysis fleet, estimates were made regarding the model years in which future redesigns (and less significant "freshenings," which offer manufacturers the opportunity to make less significant changes to models) will occur. These appear in the market data file for each model variant. Mid-cycle freshenings provide additional opportunities to add some technologies in years where smaller shares of a manufacturer's portfolio is scheduled to be redesigned. In addition, this analysis accounts for multiyear planning – that is, the potential that manufacturers may apply "extra" technology in an early model year with many planned redesigns in order to carry technology forward to facilitate compliance in a later model year with fewer planned redesigns. Further, the analysis accounts for the potential that manufacturers could earn CAFE and/or CO₂ credits in some model years and use those credits in later model years, thereby providing another compliance option in years with few planned redesigns. Finally, it should be noted that today's analysis does not account for future new products (or discontinued products) – past trends suggest that some years in which an OEM had few redesigns may have been years when that OEM introduced significant new products. Such changes in product offerings can obviously be important to manufacturers' compliance positions, but cannot be systematically and transparently accounted for with a fleet forecast extrapolated forward ten or more years from a largely-known fleet. While manufacturers' actual plans reflect intentions to discontinue some products and introduce others, those plans are considered confidential business information (CBI). Further research would be required in order to determine whether and, if so, how it would be practicable to simulate such decisions, especially without relying on CBI.

Additionally, each technology considered for application by the CAFE model is assigned to either a "refresh" or "redesign" cadence that dictates when it can be applied to a vehicle. Technologies that are assigned to "refresh/redesign" can be applied at either a refresh or redesign, while technologies that are assigned to "redesign" can only be applied during a significant vehicle redesign. Table 5-88 and Table 5-89 below show the technologies available to manufacturers in the compliance simulation, the level at which they are applied (described in greater detail in the CAFE model documentation), whether they available outside of a vehicle redesign, and a short description of each. A brief examination of the tables shows that most technologies are only assumed to be available during a vehicle redesign – and nearly all engine improvements are assumed to be available only during redesign. In a departure from past CAFE analyses, all transmission improvements are assumed to be available during refresh as well as redesign. While there are past and recent examples of mid-cycle product changes, manufacturers are expected to attempt to keep engineering and other costs down by applying most major

changes mainly during vehicle redesigns, and some mostly modest changes during product freshenings. The NPRM seeks comment on the approach to accounting for product cadence.

In practice, manufacturers are limited in the number of engines and transmissions that they produce. Typically, a manufacturer produces a number of engines — perhaps six or eight engines for a large manufacturer — and tunes them for slight variants in output for a variety of car and truck applications. Manufacturers limit complexity in their engine portfolio for much the same reason as they limit complexity in vehicle variants - they face engineering manpower limitations, and supplier, production and service costs that scale with the number of parts produced.

In previous analyses that used the CAFE model (with the exception of the Draft TAR), engines and transmissions in individual vehicle models were allowed relative freedom in technology application, potentially leading to solutions that would, if followed, create many more unique engines and transmissions than exist in the analysis fleet (or in the market) for a given model year. This multiplicity likely failed to sufficiently account for costs associated with such increased complexity in the product portfolio, and may have represented an unrealistic diffusion of products for manufacturers that are consolidating global production to increasingly smaller numbers of shared engines and platforms.³⁹⁵ The lack of a constraint in this area allowed the CAFE model to apply different levels of technology to the engine in each vehicle in which it was present at the time that vehicle was redesigned or refreshed, independent of what was done to other vehicles using a previously identical engine.

One peer reviewer of the CAFE model commented, “The integration of inheritance and sharing of engines, transmissions, and platforms across a manufacturer’s light duty fleet and separately across its light duty truck fleet is standard practice within the industry.” In the current version of the CAFE model, engines and transmissions that are shared between vehicles must apply the same levels of technology, in all technologies, dictated by engine or transmission inheritance. This forced adoption is referred to as “engine inheritance” in the model documentation. In practice, the CAFE model first chooses an “engine leader” among vehicles sharing the same engine – the vehicle with the highest sales in MY 2016. If there is a tie, the vehicle with the highest average MSRP is chosen, representing the idea that manufacturers will choose to pilot the newest technology on premium vehicles if possible. The model applies the same logic with respect to the application of transmission changes. After the model modifies the engine on the “engine leader” (or “transmission leader”), the changes to that engine propagate through to the other vehicles that share that engine (or transmission) in subsequent years as those vehicles are redesigned. DOT staff have modified the CAFE model to provide additional flexibility vis-à-vis product cadence. In a recent public comment, NRDC noted that, “EPA and NHTSA currently constrain their model to apply significant fuel-efficient technologies mainly during a product-

395 National Research Council. 2015. *Cost, Effectiveness, and Deployment of Fuel Economy Technologies for Light-Duty Vehicles*. Washington, D.C. - The National Academies Press. <https://doi.org/10.17226/21744>, pp. 258-259.

*** EO 12866 Review – Draft – Do Not Cite, Quote or Release During Review ***

redesign as opposed to product-refresh (or mid-cycle). This was identified as one of the most sensitive assumptions affecting overall program costs by NHTSA in the TAR. By constraining the model, the agencies have likely under-estimated the ability of auto manufacturers to incorporate some technologies during their product refreshes. This is particularly true regarding the critical powertrain technologies which are undergoing continuous improvement. The agency should account for these trends and incorporate greater flexibility for automakers – within their models – to incorporate more mid-cycle enhancements.” While engine redesigns are only applied to the engine leader when it is redesigned in the model, followers may now inherit upgraded engines (that they share with the leader) at either refresh or redesign. All transmission changes, whether upgrades to the “leader” or inheritance to “followers” can occur at refresh as well as redesign. This provides additional opportunities for technology diffusion within manufacturers’ product portfolios.

While “follower” vehicles are awaiting redesign (or, for transmissions, refreshing as applicable), they carry a legacy version of the shared engine or transmission. As one peer reviewer stated, “Most of the time a manufacturer will convert only a single plant within a model year. Thus both the ‘old’ and ‘new’ variant of the engine (or transmission) will be produced for a finite number of years.”³⁹⁶ The CAFE model currently carries no additional cost associated with producing both earlier revisions of an engine and the updated version simultaneously. Further research would be needed to determine whether sufficient data is likely to be available to explicitly specify and apply additional costs involved with continuing to produce an existing engine or transmission for some vehicles that have not yet progressed to a newer version of that engine or transmission. The NPRM seeks comment on on possible data sources and approaches that could be used to represent any additional costs associated with phased introduction of new engines or transmissions.

There are some logical consequences of this approach, the first of which is that forcing engine and transmission changes to propagate through to other vehicles in this way effectively dictates the pace at which new technology can be applied and limits the total number of unique engines that the model simulates. In the past, NHTSA used “phase-in caps” (see discussion below) to limit the amount of technology that can be applied to any vehicle in a given year. However, by explicitly tying the engine changes to a specific vehicle’s product cadence, rather than letting the timing of changes vary across all the vehicles that share an engine, the CAFE model ensures that an engine is only changed when its leader is redesigned (at most). Given that most vehicle redesign cycles are 5-8 years, this approach still represents shorter average lives than most engines in the market (which tend to be in production for eight to ten years or more). It is also the case that vehicles which share an engine in the analysis fleet (MY 2016, for this analysis) are assumed to share that same engine throughout the analysis – unless one or both of them are converted to power-split hybrids (or farther) on the electrification path. In the market, this is not

³⁹⁶ [Report Number forthcoming - CAFE Model Peer Review, p. 19.].

true – because a manufacturer will choose an engine from among the engines it produces to fulfill the efficiency and power demands of a vehicle model upon redesign. That engine need not be from the same family of engines as the prior version of that vehicle. This is a deliberate simplifying assumption in the CAFE model. While the model already accommodates detailed inputs regarding redesign schedules for specific vehicles, and commercial information sources are available to inform these inputs, further research would be needed to determine whether design schedules for specific engines and transmissions can practicably be simulated.

The CAFE model has implemented a similar structure to address shared vehicle platforms. The term “platform” is used loosely in industry, but generally refers to a common structure shared by a group of vehicle variants. The degree of commonality varies, with some platform variants exhibiting traditional “badge engineering” where two products are differentiated by little more than insignias, while other platforms may be used to produce a broad suite of vehicles that bear little outer resemblance to one another.

Given the degree of commonality between variants of a single platform, manufacturers do not have complete freedom to apply technology to a vehicle - while some technologies (e.g. low rolling resistance tires) are very nearly “bolt-on” technologies, others involve substantial changes to the structure and design of the vehicle, and therefore necessarily are constant among vehicles that share a common platform. The CAFE model has therefore been modified such that all mass reduction technologies are forced to be constant among variants of a platform.

Within the analysis fleet, each vehicle is associated with a specific platform. Similar to the application of engine and transmission technologies, the CAFE model defines a platform “leader” as the vehicle variant of a given platform that has the highest level of observed mass reduction present in the analysis fleet. If there is a tie, the CAFE model begins mass reduction technology on the vehicle with the highest sales in model year 2016. If there remains a tie, the model begins by choosing the vehicle with the highest MSRP in MY 2016. As the model applies technologies, it effectively levels up all variants on a platform to the highest level of mass reduction technology on the platform. So, if the platform leader is already at MR3 in MY 2016, and a “follower” starts at MR0 in MY 2016, the follower will get MR3 at its next redesign (unless the leader is redesigned again before that time, and further increases the MR level associated with that platform, then the follower would receive the new MR level).

In the 2015 NPRM proposing new fuel consumption and GHG standards for heavy-duty pickups and vans, NHTSA specifically requested comment on the general use of shared engines, transmissions, and platforms within CAFE rulemakings.³⁹⁷ While the agency received no responses to this specific request, comments from some environmental organizations cited examples of technology sharing between light- and heavy-duty products. NHTSA has continued to refine its implementation of an approach accounting for shared engines, transmissions, and

³⁹⁷ 80 FR 40138 (July 13, 2015).

*** EO 12866 Review – Draft – Do Not Cite, Quote or Release During Review ***

platforms, and the NPRM now seeks comment on the approach, recommendations regarding any other approaches, and any information that would facilitate implementation of the current approach or any alternative approaches.

5.4.2.2 Phase-In Caps

The CAFE model retains the ability to use phase-in caps (specified in model inputs) as proxies for a variety of practical restrictions on technology application, including the improvements described above. Unlike vehicle-specific restrictions related to redesign, refreshes or platforms/engines, phase-in caps constrain technology application at the vehicle manufacturer level for a given model year. Introduced in the 2006 version of the CAFE model, they were intended to reflect a manufacturer's overall resource capacity available for implementing new technologies (such as engineering research and development personnel and financial resources), thereby ensuring that resource capacity is accounted for in the modeling process.

Compared to prior analyses of light-duty standards, these model changes result in some changes in the broad characteristics of the model's application of technology to manufacturers' fleets. Because the use of phase-in caps has been de-emphasized and manufacturer technology deployment remains tied strongly to estimated product redesign and freshening schedules, technology penetration rates may jump more quickly as manufacturers apply technology to high-volume products in their portfolio. As a result, the model will ignore a phase-in cap to apply inherited technology to vehicles on shared engines, transmissions, and platforms.

In previous CAFE rulemakings, redesign/refresh schedules and phase-in caps were the primary mechanisms to reflect an OEM's limited pool of available resources during the rulemaking time frame and the years preceding it, especially in years where many models may be scheduled for refresh or redesign. The newly-introduced representation of platform-, engine-, and transmission-related considerations discussed above augment the model's preexisting representation of redesign cycles, and eliminate the need to rely on phase-in caps. By design, restrictions that enforce commonality of mass reduction on variants of a platform, and those that enforce engine and transmission inheritance, will result in fewer vehicle-technology combinations in a manufacturer's future modeled fleet. The integration of shared components and product cadence as a mechanism to control the pace of technology application also more accurately represents each manufacturer's unique position in the market and its existing technology footprint, rather than a technology-specific phase-in cap that is uniformly applied to all manufacturers in a given year. The NPRM seeks comment regarding this shift away from relying on phase-in caps and, if greater reliance on phase-in caps is recommended, what approach and information can be used to define and apply these caps.

5.4.2.3 Interactions between Regulatory Classes

Like earlier versions, the current CAFE model provides the capability for integrated analysis spanning different regulatory classes, accounting both for standards that apply separately to different classes and for interactions between regulatory classes. Light vehicle CAFE and CO₂ standards are specified separately for passenger cars and light trucks. However, there is considerable technology sharing between these two regulatory classes – where a single engine, transmission, or platform can appear in both the passenger car and light truck regulatory class. For example, some sport-utility vehicles are offered in 2WD versions classified as passenger cars and 4WD versions classified as light trucks. Integrated analysis of manufacturers' passenger car and light truck fleets provides the ability to account for such sharing and reduces the likelihood of finding technology solutions that could involve introducing impractical levels of complexity in manufacturers' product lines. Additionally, integrated fleet analysis provides the ability to simulate the potential that manufacturers could earn credits by over complying with the standard in one fleet and use those credits toward compliance with the standard in another fleet (i.e., to simulate credit transfers between regulatory classes).

While previous versions of the CAFE model have represented manufacturers' fleets by drawing a distinction between passenger cars and light trucks, the current version of the CAFE model adds a further distinction, capturing the difference between passenger cars classified as domestic passenger cars and those classified as imports. The CAFE program regulates those passenger cars separately, and the current version of the CAFE model simulates all three CAFE regulatory classes separately - Domestic Passenger Cars (DC), Imported Passenger Cars (IC), and Light Trucks (LT). CAFE regulations state that standards, fuel economy levels, and compliance are all calculated separately for each class. These requirements are specified explicitly by the Energy Policy and Conservation Act (EPCA), with the 2007 Energy Independence and Security Act (EISA) having added the requirement to enforce minimum standards for domestic passenger cars. This update to the accounting imposes two additional constraints on manufacturers that sell vehicles in the U.S. - (1) the domestic minimum floor, and (2) limited transfers between cars classified as "domestic" versus those classified as "imported". The domestic minimum floor creates a threshold that every manufacturer's domestic car fleet must exceed without the application of CAFE credits. If a manufacturer's calculated standard is below the domestic minimum floor, then the domestic floor is the binding constraint (even for manufacturers that are assumed to be willing to pay fines for non-compliance). The second constraint poses challenges for manufacturers that sell cars from both the domestic and imported passenger car categories.

While previous versions of the CAFE model considered those fleets as a single fleet (i.e., passenger cars), the model now forces them to comply separately and limits the volume of credits that can be shifted between them for compliance. However, the CAA provides no direction regarding compliance by domestic and imported vehicles; EPA has not adopted provisions similar to the aforementioned EPCA/EISA requirements, and is not doing so today.

Therefore, consistent with current and proposed CO₂ regulations, the CAFE model determines compliance for manufacturers' overall passenger car fleets for that program.

5.4.2.4 Technology Application Algorithm

5.4.2.4.1 Technology representation and pathways

While some properties of the technologies included in the analysis are specified by the user (e.g., cost of the technology), the set of included technologies is part of the model itself, which contains the information about the relationships between technologies.³⁹⁸ In particular, the CAFE model contains the information about the sequence of technologies, the paths on which they reside, any prerequisites associated with a technology's application, and any exclusions that naturally follow once it is applied.

The "application level" describes the system of the vehicle to which the technology is applied, which in turn determines the extent to which that decision affects other vehicles in a manufacturer's fleet. For example, if a technology is applied at the "engine" level, it naturally affects all other vehicles that share that same engine (though not until they themselves are redesigned, if it happens to be in a future model year). Technologies applied at the "vehicle" level can be applied to a vehicle model without impacting the other models with which it shares components. Platform-level technologies affect all of the vehicles on a given platform, which can easily span technology classes, regulatory classes, and redesign cycles.

The "application schedule" identifies when manufacturers are assumed to be able to apply a given technology – with many available only during vehicle redesigns. The application schedule also accounts for which technologies the CAFE model tracks, but does not apply. These enter as part of the analysis fleet ("Baseline Only"), and while they are necessary for accounting related to cost and incremental fuel economy improvement, they do not represent a choice that manufacturers make in the model. As discussed in Section II.B of the NPRM, the analysis fleet contains the information about each vehicle model, engine, and transmission selected for simulation and defines the initial technology state of the fleet relative to the sets of technologies in Table 5-88 and Table 5-89.

³⁹⁸ Unlike the 2012 Final Rule, where each technology had a single effectiveness value, technology effectiveness in the current version of the CAFE model is based on the ANL simulation project and defined for each combination of technologies – resulting in more than 100,000 technology effectiveness values for each of ten technology classes. This large database is extracted locally the first time the model is run and can be modified by the user in that location to reflect alternative assumptions about technology effectiveness.

*** EO 12866 Review – Draft – Do Not Cite, Quote or Release During Review ***

TABLE 5-88 - CAFE MODEL TECHNOLOGIES

Technology	Application Level	Application Schedule	Description
SOHC	Engine	Baseline Only	Single Overhead Camshaft Engine
DOHC	Engine	Baseline Only	Double Overhead Camshaft Engine
OHV	Engine	Baseline Only	Overhead Valve Engine (maps to SOHC)
VVT	Engine	Baseline Only	Variable Valve Timing
VVL	Engine	Redesign Only	Variable Valve Lift
SGDI	Engine	Redesign Only	Stoichiometric Gasoline Direct Injection
DEAC	Engine	Redesign Only	Cylinder Deactivation
HCR	Engine	Redesign Only	High Compression Ratio Engine
HCR2	Engine	Redesign Only	High Compression Ratio Engine with DEAC and CEGR
TURBO1	Engine	Redesign Only	Turbocharging and Downsizing, Level 1 (18 bar)
TURBO2	Engine	Redesign Only	Turbocharging and Downsizing, Level 2 (24 bar)
CEGR1	Engine	Redesign Only	Cooled Exhaust Gas Recirculation, Level 1 (24 bar)
ADEAC	Engine	Redesign Only	Advanced Cylinder Deactivation
CNG	Engine	Baseline Only	Compressed Natural Gas Engine
ADSL	Engine	Redesign Only	Advanced Diesel Engine
DSLII	Engine	Redesign Only	Diesel engine improvements

TABLE 5-89 - CAFE MODEL TECHNOLOGIES

Technology	Application Level	Application Schedule	Description
MT5	Transmission	Refresh/Redesign	5-Speed Manual Transmission
MT6	Transmission	Refresh/Redesign	6-Speed Manual Transmission
MT7	Transmission	Refresh/Redesign	7-Speed Manual Transmission
AT5	Transmission	Refresh/Redesign	5-Speed Automatic Transmission
AT6	Transmission	Refresh/Redesign	6-Speed Automatic Transmission
AT6L2	Transmission	Refresh/Redesign	6-Speed Automatic Transmission level 2
AT6L3	Transmission	Refresh/Redesign	6-Speed Automatic Transmission level 3
AT8	Transmission	Refresh/Redesign	8-Speed Automatic Transmission
AT8L2	Transmission	Refresh/Redesign	8-Speed Automatic Transmission level 2
AT8L3	Transmission	Refresh/Redesign	8-Speed Automatic Transmission level 3
DCT6	Transmission	Refresh/Redesign	6-Speed Dual Clutch Transmission

*** EO 12866 Review – Draft – Do Not Cite, Quote or Release During Review ***

DCT8	Transmission	Refresh/Redesign	8-Speed Dual Clutch Transmission
CVT	Transmission	Refresh/Redesign	Continuously Variable Transmission
CVT2	Transmission	Refresh/Redesign	Continuously Variable Transmission level 2
EPS	Vehicle	Refresh/Redesign	Electric Power Steering
IACC	Vehicle	Refresh/Redesign	Improved Accessories (w/ Alternator Regen and 70% Efficient Alternator)
SS12V	Vehicle	Redesign Only	12V Micro-Hybrid (Stop-Start)
BISG	Vehicle	Redesign Only	Belt Mounted Integrated Starter/Generator
CISG	Vehicle	Redesign Only	Crank Mounted Integrated Starter/Generator
SHEVP2	Vehicle	Redesign Only	P2 Strong Hybrid/Electric Vehicle
SHEVPS	Vehicle	Redesign Only	Power Split Strong Hybrid/Electric Vehicle
PHEV30	Vehicle	Redesign Only	30-mile Plug-In Hybrid/Electric Vehicle
PHEV50	Vehicle	Redesign Only	50-mile Plug-In Hybrid/Electric Vehicle
BEV200	Vehicle	Redesign Only	200-mile Electric Vehicle
FCV	Vehicle	Redesign Only	Fuel Cell Vehicle
LDB	Vehicle	Refresh/Redesign	Low Drag Brakes
SAX	Vehicle	Refresh/Redesign	Secondary Axle Disconnect
ROLL10	Vehicle	Refresh/Redesign	Low Rolling Resistance Tires, Level 1 (10% Reduction)
ROLL20	Vehicle	Refresh/Redesign	Low Rolling Resistance Tires, Level 2 (20% Reduction)
MR1	Platform	Refresh/Redesign	Mass Reduction, Level 1 (5% Reduction in Glider Weight)
MR2	Platform	Redesign Only	Mass Reduction, Level 2 (7.5% Reduction in Glider Weight)
MR3	Platform	Redesign Only	Mass Reduction, Level 3 (10% Reduction in Glider Weight)
MR4	Platform	Redesign Only	Mass Reduction, Level 4 (15% Reduction in Glider Weight)
MR5	Platform	Redesign Only	Mass Reduction, Level 5 (20% Reduction in Glider Weight)
AERO5	Vehicle	Refresh/Redesign	Aero Drag Reduction, Level 1 (5% Reduction)
AERO10	Vehicle	Redesign Only	Aero Drag Reduction, Level 2 (10% Reduction)
AERO15	Vehicle	Redesign Only	Aero Drag Reduction, Level 3 (15% Reduction)
AERO20	Vehicle	Redesign Only	Aero Drag Reduction, Level 4 (20% Reduction)

As Table 5-88 and Table 5-89 show, all engine technologies may only be applied (for the first time) during redesign. New transmissions can be applied during either refresh or redesign, except

for manual transmissions, which can only be upgraded during redesign. Unlike previous versions of the model, which only allowed significant changes to vehicle powertrains at redesign, this version allows vehicles to inherit updates to shared components during refresh. For example, assume Vehicle A and Vehicle B share Engine 1, and engine 1 is redesigned as part of Vehicle A’s redesign in MY 2020. Vehicle B is not redesigned until 2025, but is refreshed in MY 2022. In the current version of the CAFE model, Vehicle B would inherit the updated version of Engine 1 when it is freshened in MY 2022. This change allows more rapid diffusion of powertrain updates (for example) throughout a manufacturer’s portfolio and reduces the number of years during which a manufacturer would build both new and legacy versions of the same engine. Despite increasing the rate of technology diffusion, this change still restricts the pace at which new engines (for example) can be designed and built (i.e., no faster than the redesign schedule of the “leader” vehicle to which they are tied). The only technology for which this does not hold is mass reduction improvements – these occur at the platform level, and each model on that platform must be redesigned (not merely refreshed) in order to receive the newest version of the platform that contains the most current mass reduction technology.

The CAFE model defines several “technology classes” and “technology pathways” for logically grouping all available technologies for application on a vehicle. Technology classes provide costs and improvement factors shared by all vehicles with similar body styles, curb weights, footprints, and engine types, while technology pathways establish a logical progression of technologies on a vehicle within a system or sub-system (e.g., engine technologies).

Technology classes, shown in Table-5-90, are a means for specifying common technology input assumptions for vehicles that share similar characteristics. Predominantly, these classes signify the degree of applicability of each of the available technologies to a specific class of vehicles, and represent a specific set of Autonomie simulations (conducted as part of the Argonne National Laboratory large-scale simulation study) that determine the effectiveness of each technology to improve fuel economy. The vehicle technology classes also define, for each technology, the additional cost associated with application.³⁹⁹ Like in NHTSA’s analysis for the 2016 Draft TAR, the CAFE model uses separate technology classes for compact cars, midsize cars, small SUVs, large SUVs, and pickup trucks. However, in this analysis, each of those distinctions also has a “performance” version, that represents another class with similar body style, but higher levels of performance attributes (for a total of ten technology classes). As the model simulates compliance, identifying technologies that can be applied to a given manufacturer’s product portfolio to improve fleet fuel economy, it relies on the vehicle class to provide relevant cost and effectiveness information for each vehicle model.

TABLE-5-90 - VEHICLE TECHNOLOGY CLASSES

Class	Description
-------	-------------

³⁹⁹ It is up to the user to assign each vehicle in the analysis fleet to one of these technology classes. The process for mapping the MY 2016 vehicle fleet onto the set of technologies is described below.

*** EO 12866 Review – Draft – Do Not Cite, Quote or Release During Review ***

SmallCar	<i>Small passenger cars</i>
MedCar	<i>Medium to large passenger cars</i>
SmallSUV	<i>Small sport utility vehicles and station wagons</i>
MedSUV	<i>Medium to large sport utility vehicles, minivans, and passenger vans</i>
Pickup	<i>Light duty pickups and other vehicles with ladder frame construction</i>

The CAFE model defines technology pathways for grouping and establishing a logical progression of technologies on a vehicle. Each pathway (or path) is evaluated independently and in parallel, with technologies on these paths being considered in sequential order. As the model traverses each path, the costs and fuel economy improvements are accumulated on an incremental basis with relation to the preceding technology. The system stops examining a given path once a combination of one or more technologies results in a “best” technology solution for that path. After evaluating all paths, the model selects the most cost-effective solution among all pathways. This parallel path approach allows the model to progress thorough technologies in any given pathway without being unnecessarily prevented from considering technologies in other paths.

Rather than rely on a specific set of technology combinations or packages, the CAFE model considers the universe of applicable technologies, dynamically identifying the most cost-effective combination of technologies for each manufacturer’s vehicle fleet based on each vehicle’s initial technology content and the assumptions about each technology’s effectiveness, cost, and interaction with all other technologies both present and available.

5.4.2.4.2 Technology Paths

The CAFE model incorporates sixteen technology pathways for evaluation, as shown in Table 5-91. Similar to individual technologies, each path carries an intrinsic application level that denotes the scope of applicability of all technologies present within that path, and whether the pathway is evaluated on one vehicle at a time, or on a collection of vehicles that share the same platform, engine, or transmission.

TABLE 5-91 - TECHNOLOGY PATHWAYS

Technology Pathway	Application Level
Basic Engine Path	Engine
Turbo Engine Path	Engine
HCR Engine Path	Engine
Advanced DEAC Path	Engine
Advanced Diesel Engine Path	Engine
Manual Transmission Path	Transmission
Automatic Transmission Path	Transmission
CVT path	Transmission
Dual Clutch Transmission Path	Transmission
Electrification Path	Vehicle
Hybrid/Electric Path	Vehicle
Advanced Hybrid/Electric Path	Vehicle
Dynamic Load Reduction Path	Vehicle
Low Rolling Resistance Tires Path	Vehicle
Aerodynamic Improvements Path	Vehicle
Mass Reduction Path	Platform

The technologies that comprise the five Engine-Level paths available within the model are presented in Figure 5-181. Note that the baseline-level technologies (SOHC, DOHC, OHV, and CNG) appear in gray boxes. These technologies are used to inform the modeling system of the initial engine’s configuration, and are not otherwise applicable during the analysis. Additionally, the VCR path (intended to house fuel economy improvements from variable compression ratio engines) was not used in this analysis, but is present within the model. Unlike earlier versions of the CAFE model, that enforced strictly sequential application of technologies like VVL and SGDI, this version of the CAFE model allows basic engine technologies to be applied in any order once an engine has VVT (the base state of all ANL simulations). Once the model progresses past the basic engine path, it considers all of the more advanced engine paths (Turbo, HCR, Diesel, and ADEAC) simultaneously. They are assumed to be mutually exclusive, to avoid situations where the model could be perceived to force manufacturers to radically change engine architecture with each redesign, incurring stranded capital costs and lost opportunities for learning. Thus, once one path is taken, it locks out the others.

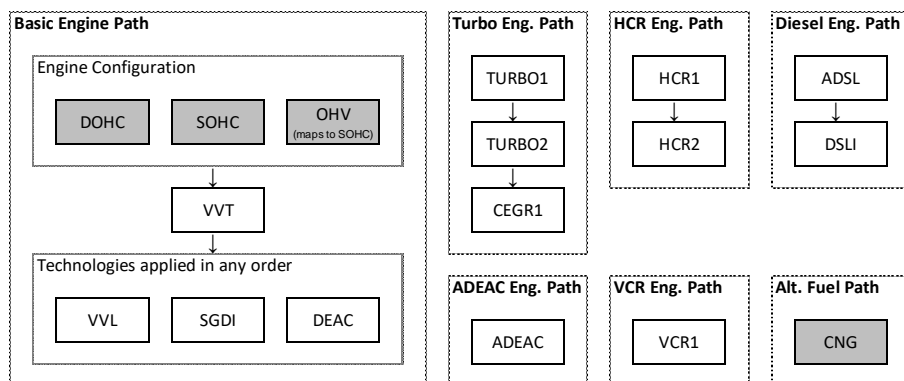

FIGURE 5-181 - ENGINE PATHS

For all pathways, the technologies are evaluated and applied to a vehicle in sequential order, as shown, from top to bottom. In some cases, however, if a technology is deemed ineffective, the system will bypass it and skip ahead to the next technology. If the modeling system applies a technology that resides later in the pathway, it will “backfill” anything that was previously skipped in order to fully account for costs and fuel economy improvements of the full technology combination.⁴⁰⁰ For any technology that is already present on a vehicle (either from the MY 2016 fleet or previously applied by the model), the system skips over those technologies as well and proceeds to the next. These skipped technologies, however, will not be applied again during backfill.

While costs are still purely incremental, technology effectiveness is no longer constructed that way. The non-sequential nature of the basic engine technologies has no obvious preceding technology except for VVT, the root of the engine path. It was a natural extension to carry this approach to the other branches as well. The technology effectiveness estimates are now an integrated part of the CAFE model, and represents a translation of the Argonne simulation database that compares the fuel consumption of any combination of technologies (across all paths) to the base vehicle (that has only VVT, 5-speed automatic transmission, no electrification, and no body-level improvements).⁴⁰¹

The Basic Engine path begins with SOHC, DOHC, and OHV technologies defining the initial configuration of the vehicle’s engine. Because these technologies are not available during modeling, the model evaluates this pathway starting with VVT. Whenever a technology pathway

⁴⁰⁰ More detail about how the Argonne simulation database was integrated into the CAFE model can be found in 5.1 and 5.2, above.

⁴⁰¹ This is true for all combinations other than those containing manual transmissions. Because the model does not convert automatic transmissions to manual transmissions, nor the inverse, technology combinations containing manual transmissions use a reference point identical to the base vehicle description, but containing a 5-speed manual rather than automatic transmission.

*** EO 12866 Review – Draft – Do Not Cite, Quote or Release During Review ***

forks into two or more branch points, as the engine path does at the end of the basic engine path, all of the branches are treated as mutually exclusive. The system evaluates all technologies forming the branch simultaneously, and selects the most cost-effective for the application, while disabling the remaining paths not chosen.

The technologies that make up the four Transmission-Level paths defined by the modeling system are shown in Figure 5-182. The baseline-level technologies (AT5, MT5 and CVT) appear in gray boxes and are only used to represent the initial configuration of a vehicle's transmission. For simplicity, all manual transmissions with five forward gears or fewer have been assigned the MT5 technology in the analysis fleet. Similarly, all automatic transmissions with five forward gears or fewer have been assigned the AT5 technology. The model preserves the initial configuration for as long as possible, and prohibits manual transmissions from becoming automatic transmissions at any point. Automatic transmissions may become CVT level 2 after progressing through the 6-speed automatic. While the structure of the model still allows automatic transmissions to consider the move to DCT, in practice they are restricted from doing so in the market data file. This allows vehicles that enter with a DCT to improve it (if opportunities to do so exist), but does not allow automatic transmissions to become DCTs, in recognition of low consumer enthusiasm for the earlier versions of the transmission that have been introduced over the last decade.

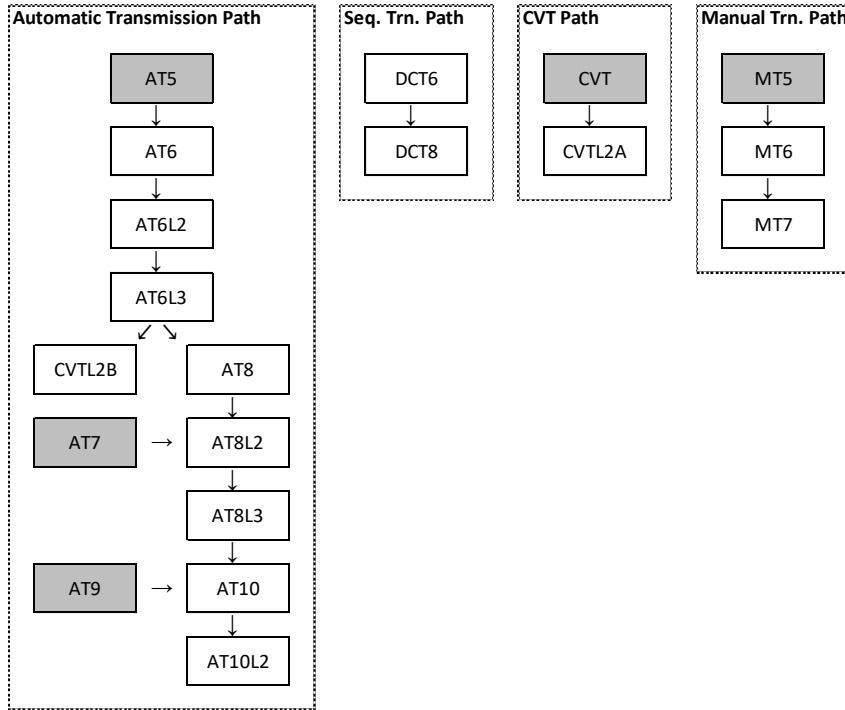

FIGURE 5-182 - TRANSMISSION PATHS

The root of the Electrification path, shown in Figure 5-183, is a conventional powertrain (CONV) with no electrification. The two strong hybrid technologies (SHEVP2 and SHEVPS) on the Hybrid/Electric path are defined as stand-alone and mutually exclusive. These technologies are not incremental over each other for cost or effectiveness and do not follow a traditional progression logic present on other paths. While the SHEVP2 represents a hybrid system paired with the existing engine on a given vehicle, the SHEVPS removes and replaces that engine, making it the larger architectural change of the two. In general, the electrification technologies are applied as vehicle-level technologies, meaning that the model applies them without affecting components that might be shared with other vehicles. In the case of the more advanced electrification technologies, where engines and transmissions are removed or replaced, the model will choose a new vehicle to be the leader on that component (if necessary) and will not force other vehicles sharing that engine or transmission to become hybrids (or EVs) as well. In addition to the electrification technologies, there are two electrical system improvements, electric power steering (EPS) and accessory improvements (IACC), which were not part of the ANL simulation project and are applied by the model as fixed percentage improvements to all

technology combinations in a particular technology class. Their improvements are superseded by technologies in the other electrification paths – BISG or CISG, in the case of EPS, and strong hybrids (and above) in the case of IACC – which are assumed to include those improvements already.

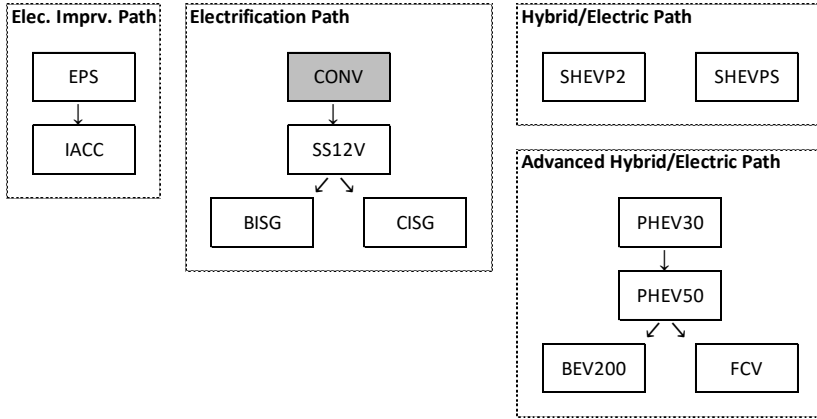

FIGURE 5-183 - ELECTRIFICATION TECHNOLOGY PATH

The technology paths related to load reduction of the vehicle are shown in Figure 5-184. Of these, only the Mass Reduction (MR) path is applied at the platform level, thus affecting all vehicles (across classes and body styles) on a given platform. The remaining technology paths are all applied at the vehicle level, and technologies within each path are considered purely sequential. For mass reduction, aerodynamic improvements, and reductions in rolling resistance, the base level of each path is the “zero state,” in which a vehicle has exhibited none of the improvements associated with the technology path. In addition to choosing among possible engine, transmission, and electrification improvements to improve a vehicle’s fuel economy, the CAFE model will consider technologies each of the possible load improvement paths simultaneously.

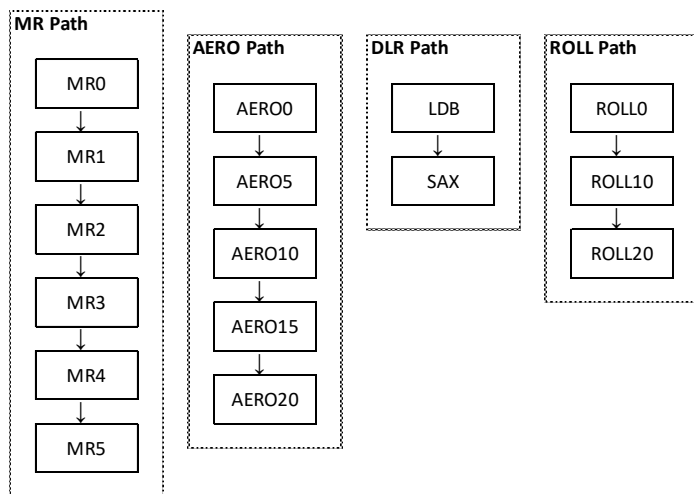

FIGURE 5-184 - LOAD REDUCTION TECHNOLOGY PATHS

Even though the model evaluates each technology path independently, some of the pathways are interconnected to allow for additional logical progression and incremental accounting of technologies. For example, the cost of SHEVPS (power-split strong hybrid/electric) on the Hybrid/Electric path is defined as incremental over the complete basic engine path (an engine that contains VVT, VVL, SGDI, and DEAC), the AT5 (5-speed automatic) technology on the Automatic Transmission path, and the CISG (crank mounted integrated starter/generator) technology on the Electrification path. For that reason, whenever the model evaluates the SHEVPS technology for application on a vehicle, it ensures that, at a minimum, all the aforementioned technologies (as well as their predecessors) have already been applied on that vehicle. However, if it becomes necessary for a vehicle to progress to the power-split hybrid, the model will virtually apply the technologies associated with the reference point in order to evaluate the attractiveness of transitioning to the strong hybrid.

Of the seventeen technology pathways present in the model, all Engine paths, the Automatic Transmission path, the Electrification path, and both Hybrid/Electric paths are logically linked for incremental technology progression. Some of the technology pathways, as defined in the CAFE model and shown in Figure 5-185, may not be compatible with a vehicle given its state at the time of evaluation. For example, a vehicle with a 6-speed automatic transmission will not be able to get improvements from a Manual Transmission path, because it is virtually certain that a manufacturer would not revert to a manual transmission for that vehicle in real life. For this reason, the model implements logic to explicitly disable certain paths whenever a constraining technology from another path is applied on a vehicle. On occasion, not all of the technologies

present within a pathway may produce compatibility constraints with another path. In such a case, the system will selectively disable a conflicting pathway (or part of the pathway) as required by the incompatible technology.

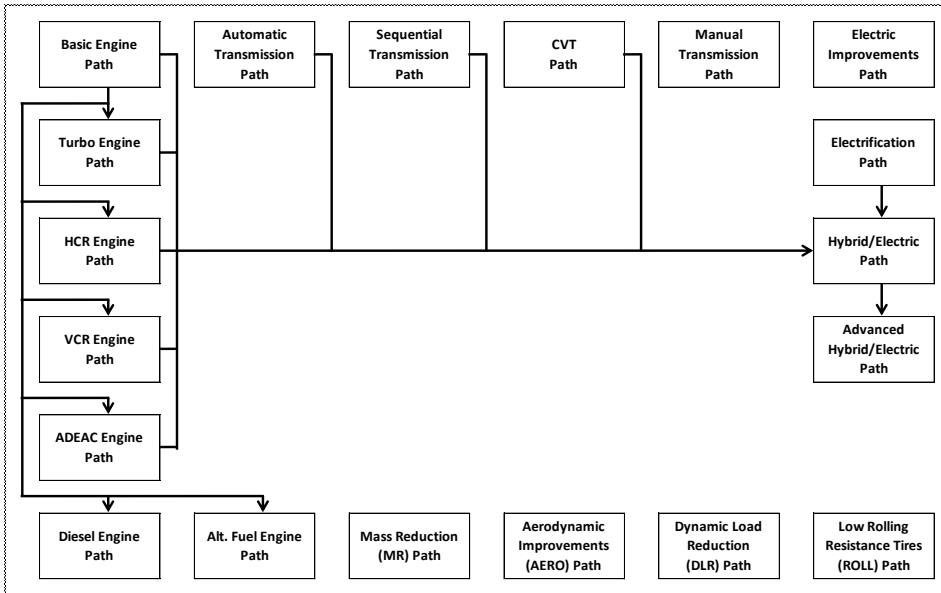

FIGURE 5-185 - ALL TECHNOLOGY PATHWAYS

For any interlinked technology pathways shown in Figure 5-185, the system also disables all preceding technology paths whenever a vehicle transitions to a succeeding pathway. For example, if the model applies SHEVPS technology on a vehicle, the system disables the Turbo, HCR, ADEAC, and Diesel Engine paths, as well as the Basic Engine, the Automatic Transmission, and the Electrification paths (all of which precede the Hybrid/Electric path).⁴⁰² This implicitly forces vehicles to always move in the direction of increasing technological sophistication each time they are reevaluated by the model.

5.4.2.5 Simulating manufacturer compliance with standards

⁴⁰² The only notable exception to this rule occurs whenever SHEVP2 technology is applied on a vehicle. This technology may be present in conjunction with any engine-level technology, and as such, the Basic Engine path is not disabled upon application of SHEVP2 technology, even though this pathway precedes the Hybrid/Electric path.

*** EO 12866 Review – Draft – Do Not Cite, Quote or Release During Review ***

As a starting point, the CAFE model needs enough information to represent each manufacturer covered by the program. As discussed in Section II.B of the NPRM, the MY 2016 analysis fleet contains information about each manufacturer's:

- Vehicle models offered for sale – their current (i.e., MY 2016) production volumes, manufacturer suggested retail prices (MSRPs), fuel saving technology content (relative to the set of technologies described in Table 5-88 and Table 5-89 and other attributes (curb weight, drive type, assignment to technology class and regulatory class),
- Production constraints – product cadence of vehicle models (i.e., schedule of model redesigns and “freshenings”), vehicle platform membership, degree of engine and/or transmission sharing (for each model variant) with other vehicles in the fleet, and
- Compliance constraints and flexibilities – historical preference for full compliance or fine payment/credit application, willingness to apply additional cost-effective fuel saving technology in excess of regulatory requirements, projected applicable flexible fuel credits, and current CAFE credit balance (by model year and regulatory class) in first model year of simulation.

Each manufacturer's regulatory requirement represents the production-weighted mean (for CAFE, the harmonic mean) of their vehicle's targets in each regulated fleet. This means that no individual vehicle has a “standard,” merely a target, and each manufacturer is free to identify a compliance strategy that makes the most sense given its unique combination of vehicle models, consumers, and competitive position in the various market segments. As the CAFE model takes regulatory standards (i.e., footprint curves) as an input, each manufacturer's requirement is dynamically defined based on the specification of the standards for any simulation and the distribution of footprints within each fleet.

Given this information, the model attempts to apply technology to each manufacturer's fleet in a manner that minimizes “effective costs.” The effective cost captures more than the incremental cost of a given technology – it represents the difference between their incremental cost and the value of fuel savings to a potential buyer over the first 30 months of ownership.⁴⁰³ In addition to the technology cost and fuel savings, the effective cost also includes the change in civil penalties (for the CAFE program) from applying a given technology and any estimated welfare losses associated with the technology (e.g., earlier versions of the CAFE model simulated low-range electric vehicles that produced a welfare loss to buyers who valued standard operating ranges between re-fueling events).

⁴⁰³ The length of time over which to value fuel savings in the effective cost calculation is a model input that can be modified by the user. This analysis uses 30 months' worth of fuel savings in the effective cost calculation, assuming the price of fuel at the time of purchase persists for at least the next 30 months. This implies new car buyers will behave as if the fuel price at the time of purchase reflects the fuel price he or she will face over the life of the vehicle.

This construction allows the model to choose technologies that both improve a manufacturer's compliance position and are most likely to be attractive to its consumers. This also means that different assumptions about future fuel prices will produce different rankings of technologies when the model evaluates available technologies for application. For example, in a high fuel price regime, an expensive but very efficient technology may look attractive to manufacturers because the value of the fuel savings is sufficiently high to both counteract the higher cost of the technology and, implicitly, satisfy consumer demand to balance price increases with reductions in operating cost. Similarly, technologies for which there exist consumer welfare losses (discussed in Section II.E of the NPRM) will be seen as less attractive to manufacturers who may be concerned about their ability to recover the full amount of the technology cost during the sale of the vehicle. The model continues to add technology until a manufacturer either - (a) reaches compliance with standards (possibly through the accumulation and application of overcompliance credits), (b) reaches a point at which it is more cost effective to pay civil penalties than to add more technology (for the CAFE program), or (c) reaches a point beyond compliance where the manufacturer assumes its consumers will be unwilling to pay for additional fuel saving technologies.

In general, the model adds technology for several reasons, but checks these sequentially. The model then applies any "forced" technologies. Currently, only VVT is forced to be applied to vehicles at redesign, since it is the root of the engine path and the reference point for all future engine technology applications.⁴⁰⁴ The model next applies any inherited technologies that were applied to a leader vehicle and carried forward into future model years where follower vehicles (on the shared system) are freshened or redesigned (and thus eligible to receive the updated version of the shared component). In practice, very few vehicle models enter without VVT, so inheritance is typically the first step in the compliance loop. Then the model evaluates the manufacturer's compliance status, applying all cost-effective technologies regardless of compliance status (essentially any technology for which the effective cost is negative). Then the model applies expiring overcompliance credits (if allowed to under the perspective of either the "unconstrained" or "standard setting" analysis, for CAFE purposes). At this point, the model checks the manufacturer's compliance status again. If the manufacturer is still not compliant (and is unwilling to pay civil penalties), the model will add technologies that are not cost-effective until the manufacturer reaches compliance. If the manufacturer exhausts opportunities to comply with the standard by improving fuel economy (typically due to a limited percentage of its fleet being redesigned in that year), the model will apply banked CAFE or CO₂ credits to offset the remaining deficit. If no credits exist to offset the remaining deficit, the model will reach back in time to alter technology solutions in earlier model years.

The CAFE model implements multi-year planning by looking back, rather than forward. When a manufacturer is unable to comply through cost-effective (i.e., producing effective cost values

⁴⁰⁴ As a practical matter, this affects very few vehicles. More than 95% of vehicles in the market file either already have VVT present, or have surpassed the basic engine path through the application of hybrids or electric vehicles.

*** EO 12866 Review – Draft – Do Not Cite, Quote or Release During Review ***

less than zero) technology improvements or credit application in a given year, the model will “reach back” to earlier years and apply the most cost-effective technologies that were not applied at that time, and then carry those technologies forward into the future and re-evaluate the manufacturer’s compliance position. The model repeats this process until compliance in the current year is achieved, dynamically rebuilding previous model year fleets and carrying them forward into the future – accumulating CAFE or CO₂ credits from over-compliance with the standard wherever appropriate.

In a given model year, the model determines applicability of each technology to each vehicle model, platform, engine, and transmission. The compliance simulation algorithm begins the process of applying technologies based on the CAFE or CO₂ standards specified during the current model year. This involves repeatedly evaluating the degree of noncompliance, identifying the next “best” technology (ranked by the effective cost discussed earlier) available on each of the parallel technology paths described above and applying the best of these. The algorithm combines some of the pathways, evaluating them sequentially instead of in parallel, in order to ensure appropriate incremental progression of technologies.

The algorithm first finds the best next applicable technology in each of the technology pathways, then selects the best among these. The model applies the technology to the affected vehicles if a manufacturer is either unwilling to pay penalties, or if applying the technology is more cost-effective than paying penalties. Afterwards, the algorithm reevaluates the manufacturer’s degree of noncompliance and continues application of technology. Once a manufacturer reaches compliance (i.e., the manufacturer would no longer need to pay CAFE civil penalties), the algorithm proceeds to apply any additional technology determined to be cost-effective (as discussed above). Conversely, if a manufacturer is assumed to prefer to pay CAFE civil penalties, the algorithm only applies technology up to the point where doing so is less costly than paying fines. The algorithm stops applying additional technology to this manufacturer’s products once no more cost-effective solutions are encountered. This process is repeated for each manufacturer present in the input fleet. It is then repeated again for each model year. Once all model years have been processed, the compliance simulation algorithm concludes. For purposes of CO₂ standards compliance analysis, the simulation is similar but does not include assumptions regarding payment of civil penalties or other EPCA/EISA statutory constraints.

5.4.2.6 Compliance Example

The following example will illustrate the features discussed above. While the example describes the actions that General Motors takes to modify the Chevrolet Equinox in order to comply with the CAFE “augural” standards (the baseline in this analysis), and the logical consequences of these actions, a similar example would develop if instead simulating compliance with the EPA standards for those years. The structure of GM’s fleet and the mechanisms at work in the CAFE model are identical in both cases, but different features of each program (unlimited credit

transfers between fleets, for example) would likely cause the model to choose different technology solutions.

At the start of the simulation in MY 2016, GM has 30 unique engines shared across more than 33 unique nameplates, 260 model variants, and three regulatory classes. As discussed earlier, the CAFE model will attempt to preserve that level of sharing across GM's fleets to avoid introducing additional production complexity for which costs are not estimated in this analysis. An even smaller number of transmissions (sixteen) and platforms (twelve) are shared across the same set of nameplates, model variants, and regulatory classes.

The Chevrolet Equinox is represented in the model inputs as a single nameplate, with five model variants – distinguished by the presence of all-wheel drive and four distinct powertrain configurations (two engines paired with two different transmissions). Across all five model variants, GM produced above 220,000 units of the Equinox nameplate. Approximately 150,000 units of that production volume is regulated as Domestic Passenger Car, with the remainder regulated as Light Trucks. The easiest way to describe the actions taken by the CAFE model is to focus on a single model variant of the Equinox (one row in the market data file). The model variant of the Equinox with the highest production volume, approximately 130,000 units in MY 2016, is vehicle code 110111.⁴⁰⁵ This unique model variant is the basis for the example. However, because it is only one of five variants on the Equinox nameplate, the modifications made to that model in the simulation will affect the rest of the Equinox variants, and other vehicles across all fleets.

The example Equinox variant is designated as an engine and platform leader. As discussed earlier, this implies that modifications to its engine (11031, a 2.4L I-4) are tied to the redesign cadence of this Equinox, as are modifications to its platform (Theta/TE). The engine is shared by the Buick LaCrosse, Regal, and Verano, and by the GMC Terrain (as well as appearing in two other variants of the Equinox). So those vehicles, if redesigned after this Equinox, will inherit changes to engine 11031 when they are redesigned, carrying the legacy version of the engine until then. Similarly, this Equinox shares its platform with the Cadillac SRX and GMC Terrain, which will inherit changes made to this platform when they are redesigned (if later than the Equinox, as is the case with the SRX).

This specific Equinox is a transmission “follower,” getting updates made to its transmission leader (the Chevrolet Malibu) when it is freshened or redesigned. Additionally, two other variants of the Equinox nameplate (the more powerful versions, containing a 3.6L V-6 engine) are not “leaders” on any of the primary components. Those variants are built on the same platform as the example Equinox variant, but share their engine with the Buick Enclave and

⁴⁰⁵ This numeric designation is not important to understand the example but will allow an interested reader to identify the vehicle in model outputs to either recreate the example or use it as a template to create similar examples for other manufacturers and vehicles.

*** EO 12866 Review – Draft – Do Not Cite, Quote or Release During Review ***

LaCrosse, the Cadillac SRX and XTS,⁴⁰⁶ the Chevrolet Colorado, Impala and Traverse (which is the designated “leader”), and the GMC Acadia, Canyon, and Terrain. This is an example of how shared and inherited components interact with product cadence - when the Equinox nameplate is redesigned, the CAFE model has more leverage over some variants than others and cannot make changes to the engines of the variants of the Equinox with V-6 unless that change is consistent with all of the other nameplates just listed. The transmissions on the other variants of the Equinox are similarly widely shared, and represent the same kind of production constraint just described with respect to the engine. When accounting for the full set of engines, transmissions, and platforms represented across the Equinox nameplate’s five variants, components are shared across all three regulatory classes.

This example uses a “standard setting” perspective to minimize the amount of credit generation and application, in order to focus on the mechanics of technology application and component sharing. The actions taken by the CAFE model when operating on the example Equinox during GM’s compliance simulation are shown in Table 5-92. In general, the example Equinox begins the compliance simulation with the technology observed in its MY 2016 incarnation – a 2.6L I-4 with VVT and SGDI, a 6-speed automatic transmission, low rolling resistance tires (ROLL20) and a 10% realized improvement in aerodynamic drag (AERO10). In MY 2018, the Equinox is redesigned, at which time the engine adds VVL and level-1 turbocharging. The transmission on the Malibu is upgraded to an 8-speed automatic in 2018, which the Equinox also gets. The platform, for which this Equinox is the designated leader, gets level-4 mass reduction. The CAFE model also applies a few vehicle-level technologies - low-drag brakes, electronic accessory improvements, and additional aerodynamic improvements (AERO20). Upon refresh in MY 2021, it acquires an upgraded 10-speed transmission (AT10) from the Malibu. Then in MY 2025 it is redesigned again and upgrades the engine to level-2 turbocharging, replaces the 10-speed automatic transmission with an 8-speed automatic transmission, adds a P2 strong hybrid, and further reduces the mass of the platform (MR5). Using an “unconstrained” perspective would possibly lead to additional actions taken after MY 2025, where GM may have been simulated to use credits earned in earlier model years to offset small, persistent CAFE deficits in one or more fleets. In the “standard setting” perspective, that forces compliance without the use of CAFE credits, this is not an issue.

⁴⁰⁶ It is worth noting that GM last produced the Cadillac SRX for MY 2016 – this is one example of the limitations of using an analysis fleet defined in terms of even a recent actual model year. Section II.B of the NPRM discusses these tradeoffs, and the tentative conclusion that, as a foundation for analysis presented here, it was better to develop the analysis fleet using the best information available for MY 2016 than to have used manufacturers’ CBI to construct an analysis fleet that, though more current, would have limited ability to make public all analytical inputs and outputs.

TABLE 5-92 - SUMMARY OF EXAMPLE EQUINOX TECHNOLOGY APPLICATION

Model Year	State	FE Target	MPG	Cost (\$)	Action
2016	Refresh	34.9	34.1	43	Starts with VVT; SGDI; AT6; ROLL20; AERO10
2017		36.9	34.1	37	
2018	Redesign	38.3	47.1	3,470	Applied - VVL, TURBO1, AT8, IACC, BISG, LDB, MR4, AERO20
2019		39.7	47.1	3,280	
2020		41.3	47.1	3,125	
2021	Refresh	43.0	47.6	3,070	Applied - AT10
2022		45.0	47.6	2,960	
2023		47.1	47.6	2,870	
2024		49.4	47.6	2,780	
2025	Redesign	51.7	52.3	5,020	Applied - TURBO2, AT8, SHEVP2, MR5
2026		51.7	52.3	4,870	
2027		51.7	52.3	4,735	
2028	Refresh	51.7	52.3	4,620	
2029		51.7	52.3	4,510	
2030		51.7	52.3	4,410	
2031		51.7	52.3	4,320	
2032	Redesign	51.7	52.3	4,260	

The technology applications described in Table 5-92 have consequences beyond the single variant of the Equinox shown in the table. In particular, two other variants of the Equinox (both of which are regulated as Light Trucks) get the upgraded engine, which they share with the

example, in MY 2018. Thus, this application of engine technology to a single variant of the Equinox in the Domestic Car fleet “spills over” into the Light Truck fleet, generating improvements in fuel economy and additional costs. Furthermore, the Buick LaCross and Regal, and the GMC Terrain also get the same engine, which they share with the example, in MY 2018. Those vehicles also span the Domestic Car and Light Truck fleets. However, the Buick Verano, which is not redesigned until MY 2019, continues with the legacy (i.e., MY 2016) version of the shared engine until it is redesigned. When it inherits the new engine in MY 2019, it does so without modification – the engine it inherits is the same one that was redesigned in MY 2018. This means that the Verano will improve its fuel economy in MY 2019 when the new engine is inherited, but only to the extent that the new version of the engine is an improvement over the legacy version in the context of the Verano’s other technology (which it is – the Verano moves from 32 MPG to 44 MPG when accounting for the other technologies added during the MY 2019 redesign).

This same story continues with the diffusion of platform improvements simulated by the CAFE model in MY 2018. The GMC Terrain is simulated to be redesigned in MY 2018, in conjunction with the Equinox. The performance variants of the Equinox, with a 3.5L V-6, also upgrade their engines in MY 2018 (in conjunction with the estimated Chevrolet Traverse redesign). However, when the Equinox is next redesigned in MY 2025, the engine shared with the Traverse is not upgraded again until MY 2026, so the performance versions of the Equinox continue with the 2018 version of the engine throughout the remainder of the simulation. While these inheritances and sharing dynamics are not a perfect representation of each manufacturer’s specific constraints, nor the flexibilities available to shift strategies in real-time as a response to changing market or regulatory conditions, they are a reasonable way to consider the resource constraints that prohibit fleet-wide technology diffusion over shorter windows than have been observed historically and for which this analysis has no way to impose additional costs.

Aside from the technology application and its consequences throughout the GM product portfolio, discussed above, there are other important conclusions to draw from the technology application example. The first of these is that product cadence matters, and only by taking a year-by-year perspective can this be seen. When the example Equinox is redesigned in MY 2018, the CAFE model takes actions that cause the redesigned Equinox to significantly exceed its fuel economy target. While, again, no single vehicle has a “standard,” having high volume vehicles significantly below their individual targets can present compliance challenges for manufacturers who must compensate by exceeding targets on other vehicles. While the example Equinox exceeds its MY 2018 target by almost 9 MPG, this version of the Equinox is not eligible to see significant technology changes again before MY 2025 (except for the transmission upgrade that occurs in MY 2021). Thus, the CAFE model is redesigning the Equinox in MY 2018 with respect to future targets and standards – this Equinox is nearly two MPG below its target in MY 2024 before being redesigned in MY 2025. This reflects a real challenge that manufacturers face in the context of continually increasing CAFE standards, and represents a clear example of why

*** EO 12866 Review – Draft – Do Not Cite, Quote or Release During Review ***

considering discrete model year snapshots where all vehicles are assumed to be redesigned is likely to be unrealistically simplistic. The MY 2018 version of the example Equinox persists (with little change) through six model years, and the standards present in those years. This is one reason why the CAFE model was used to examine the impacts of the proposed standards in this analysis.

Another feature of note in Table 5-92 is the cost of applying these technologies. The costs are all denominated in dollars, and represent incremental cost increases relative to the MY 2016 version of the Equinox. Aside from the cost increase of more than \$5,000 in MY 2025 when the vehicle is converted to a strong hybrid, the incremental technology costs display a consistent trend between application events – decreasing steadily over time as the cost associated with each given combination of technologies “learns down.” By MY 2032, even the most expensive version of the example Equinox costs nearly \$800 less to produce than it did in MY 2025.

The technology application in the example occurs in the context of GM’s attempt to comply with the augural standards. As some of the components on the Equinox nameplate are shared across all three regulated fleets,

Table-5-93 shows the compliance status of each fleet in MYs 2016 – 2025. In MY 2017, the CAFE model applies expiring credits to offset deficits in the DC and LT fleets. In MY 2028, when GM is simulated to aggressively apply technology to the example Equinox, the DC fleet exceeds its standard while the LT fleet still generates deficits. The CAFE model offset that deficit with expiring (and possibly transferred) credits. However, by MY 2020 the “standard setting” perspective removes the option of using CAFE credits to offset deficits and GM exceeds the standard in all three fleets, though by almost two MPG in DC and LT. As the Equinox example showed, many of the vehicles redesigned in MY 2020 will still be produced at the MY 2020 technology level in MY 2025, where GM is simulated to comply exactly across all three fleets. Under an “unconstrained” perspective, the CAFE model would use the CAFE credits earned through over-compliance with the standards in MYs 2020 – 2023 to offset deficits created by under-compliance as the standards continued to increase, pushing some technology application until later years when the standards stabilized and those credits expired. The CAFE model simulates compliance through MY 2032 to account for this behavior.

TABLE-5-93 - GM COMPLIANCE PATHWAY UNDER AUGURAL STANDARDS, “STANDARD SETTING” PERSPECTIVE

Model Year	Regulatory Class	Standard	CAFE
2016	DC	36.2	35.1
	IC	39.9	41.9
	LT	27.1	24.9
2017	DC	38.3	37.9
	IC	42.3	43.0
	LT	27.5	25.6
2018	DC	39.7	41.5
	IC	43.9	43.9
	LT	27.9	27.4
2019	DC	41.1	42.5
	IC	45.5	43.7
	LT	28.3	29.8
2020	DC	42.8	45.3
	IC	47.3	47.3
	LT	28.8	31.0
2021	DC	44.6	48.3
	IC	49.3	52.5
	LT	30.6	34.6
2022	DC	46.7	49.9
	IC	51.7	56.7
	LT	32.1	34.9
2023	DC	48.8	51.3
	IC	54.1	57.3
	LT	33.6	35.1
2024	DC	51.1	52.3
	IC	56.6	57.8
	LT	35.2	35.2
2025	DC	53.5	53.5
	IC	59.3	59.3
	LT	36.8	36.8

5.4.2.7 Representation of OEMs’ potential responsiveness to buyers’ willingness to pay for fuel economy improvements

The CAFE model simulates manufacturer responses to both fuel economy standards and technology availability. In order to do so, it requires assumptions about how the industry views consumer demand for additional fuel economy. In the 2012 Final Rule, the agencies analyzed

alternatives under the assumption that manufacturers would not improve the fuel economy of new vehicles at all, unless compelled to do so by the existence of increasingly stringent CAFE and GHG standards. This assumption led all of the fuel savings that occurred in the simulation after MY 2016 to be attributed to the proposed standards. However, this assumption contradicted much of the literature on this topic and the industry’s recent experience with CAFE compliance.

The industry has exceeded the required CAFE level for both passenger cars and light trucks in the past; by almost 5 MPG during the fuel price spikes of the 2000’s when CAFE standards for passenger cars were still frozen at levels established for the 1990 model year. In fact, a number of manufacturers that traditionally paid CAFE civil penalties even reached compliance during years with sufficiently high fuel prices. DOT attempts to account for this observed consumer preference for fuel economy, above and beyond that required by the CAFE standard, by allowing fuel price to influence the ranking of technologies that the model considers when modifying a manufacturer’s fleet in order to achieve compliance. In particular, the model ranks available technology not by cost, but by “effective cost.”

When the model chooses which technology to apply *next*, it calculates the effective cost of available technologies and chooses the technology with the lowest effective cost. The “effective cost” itself, is a combination of the technology cost, the fuel savings that would occur if that technology were applied to a given vehicle, the resulting change in CAFE penalties, any welfare losses associated with the technology, and the affected volumes. User inputs determine how much fuel savings manufacturers believe new car buyers will pay for (denominated in the number of years before a technology “pays back” its cost).

While described in greater detail in the CAFE model documentation, the effective cost contains an assumption not about consumers’ actual willingness to pay for additional fuel economy, but about what manufacturers believe consumers are willing to pay. The default assumption in the model is that manufacturers will treat all technologies that pay for themselves within the first 2 ½ years of ownership (through reduced expenditures on fuel) as if the cost of that technology were negative. In the current version of the model, this assumption holds whether or not a manufacturer has already achieved compliance. This means that the most cost-effective technologies are applied to new vehicles even in the absence of regulatory pressure. However, because the value of fuel savings depends upon the price of fuel, the model will add more technology without regulatory pressure when prices are high compared to simulations where fuel prices are assumed to be low. This assumption is consistent with observed historical compliance behavior.

One implication of this assumption is that futures with higher, or lower, fuel prices produce different sets of attractive technologies (and at different times). For example, if fuel prices were above \$7/gallon, many of the technologies in this analysis could pay for themselves within the first year or two and would be applied at high rates in all of the alternatives. Similarly, at the

other extreme (significantly reduced fuel prices), almost no additional fuel economy would be observed.

While these assumptions about desired payback period and consumer preferences for fuel economy may not affect the eventual level of achieved CAFE in the later years of the program, they will affect the amount of additional technology cost and fuel savings that are attributable to the standard. The approach currently only addresses the inherent trade-off between additional technology cost and the value of fuel savings, but other costs could be relevant as well. Further research would be required to support simulations that assume buyers behave as if they consider all ownership costs (e.g., additional excise taxes and insurance costs) at the time of purchase, and that manufacturers respond accordingly.

5.4.2.8 Representation of some OEMs' willingness to treat civil penalties as a program flexibility

When considering technology applications to improve fleet fuel economy, the model will add technology up to the point at which the effective cost of the technology (which includes technology cost, consumer fuel savings, consumer welfare changes, and the cost of fines for non-compliance with the standard) is less costly than paying civil penalties or purchasing credits. Unlike previous versions of the model, the current implementation further acknowledges that some manufacturers experience transitions between product lines where they rely heavily on credits (either carried forward from earlier model years or acquired from other manufacturers), or simply pay penalties in one or more fleets for some number of years. The model now allows the user to specify, on a year-by-year basis, whether each manufacturer should be considered as willing to pay penalties for non-compliance. This provides additional flexibility, particularly in the early years of the simulation. As discussed above, this assumption is best considered as a method to allow a manufacturer to under-comply with its standard in some model years – treating the civil penalty rate and payment option as a proxy for other actions it may take that are not represented in the CAFE model (e.g., purchasing credits from another manufacturer, carry-back from future model years, or negotiated settlements with NHTSA to resolve deficits).

In the current analysis, NHTSA has relied on past compliance behavior and certified transactions in the credit market to designate some manufacturers as being willing to pay penalties in some model years. The full set of assumptions regarding manufacturer behavior with respect to civil penalties is presented in Table-5-94, which shows all manufacturers are assumed to be willing to pay civil penalties prior to MY 2020. This is largely a reflection of either existing credit balances (which manufacturers will use to offset CAFE deficits until the credits reach their expiration dates), or assumed trades between manufacturers that are likely to happen in the near-future based on previous behavior. The manufacturers in the table whose names appear in bold all had at least one regulated fleet (of three) whose CAFE was below its standard in MY 2016. Because

*** EO 12866 Review – Draft – Do Not Cite, Quote or Release During Review ***

the analysis began with the MY 2016 fleet, and no technology can be added to vehicles that are already designed and built, all manufacturers can generate civil penalties in MY 2016. However, once a manufacturer is designated as unwilling to pay penalties, the CAFE model will attempt to add technology to the respective fleets to avoid shortfalls.

TABLE-5-94 - ASSUMED MANUFACTURER WILLING TO PAY CIVIL PENALTIES

Manufacturer	2017	2018	2019	2020	2021	2022	2023	2024	2025	2026
BMW	Y	Y	Y	Y	Y	Y	Y	Y	Y	Y
Daimler	Y	Y	Y	Y	Y	Y	Y	Y	Y	Y
FCA	Y	Y	Y	Y	Y	Y	Y	Y	Y	N
Ford	Y	Y	Y	N	N	N	N	N	N	N
General Motors	Y	Y	Y	N	N	N	N	N	N	N
Honda	Y	Y	Y	N	N	N	N	N	N	N
Hyundai Kia-H	Y	Y	Y	N	N	N	N	N	N	N
Hyundai Kia-K	Y	Y	Y	N	N	N	N	N	N	N
JLR	Y	Y	Y	Y	Y	Y	Y	Y	Y	Y
Mazda	Y	Y	Y	N	N	N	N	N	N	N
Nissan Mitsubishi	Y	Y	Y	N	N	N	N	N	N	N
Subaru	Y	Y	Y	N	N	N	N	N	N	N
Tesla	Y	Y	Y	N	N	N	N	N	N	N
Toyota	Y	Y	Y	N	N	N	N	N	N	N
Volvo	Y	Y	Y	Y	Y	Y	Y	Y	Y	Y
VWA	Y	Y	Y	N	N	N	N	N	N	N

Several of the manufacturers in Table-5-94 that are assumed to be willing to pay civil penalties in the early years of the program have no history of paying civil penalties. However, several of those manufacturers have either bought or sold credits – or transferred credits from one fleet to another to offset a shortfall in the underperforming fleet. As the CAFE model does not simulate credit trades between manufacturers, providing this additional flexibility in the modeling avoids the outcome where the CAFE model applies more technology than would be needed in the context of the full set of compliance flexibilities at the industry level. By statute, NHTSA cannot consider credit flexibilities when setting standards, so most manufacturers (those without a history of civil penalty payment) are assumed to comply with their standard through fuel economy improvements for the model years being considered in this analysis. The notable exception to this is FCA, who is expected to still satisfy the requirements of the program through a combination of credit application and civil penalties through MY 2025, before eventually complying exclusively through fuel economy improvements in MY 2026.

*** EO 12866 Review – Draft – Do Not Cite, Quote or Release During Review ***

As mentioned above, the CAA does not provide civil penalty provisions similar to those specified in EPCA/EISA, and the above-mentioned corresponding inputs apply only to simulation of compliance with CAFE standards.

5.4.2.9 Representation of CAFE and CO₂ credit provisions

The model's approach to simulating compliance decisions accounts for the potential to earn and use CAFE credits, as provided by EPCA/EISA. The model similarly accumulates and applies CO₂ credits when simulating compliance with EPA's standards. Like past versions, the current CAFE model can be used to simulate credit carry-forward (a.k.a. banking) between model years and transfers between the passenger car and light truck fleets, but not credit carry-back (a.k.a. borrowing) from future model years or trading between manufacturers. Some manufacturers have made occasional use of credit carry-back provisions, although it is logical not to assume use of carry-back as a compliance strategy because of the risk in relying on future improvements to offset earlier compliance deficits. Thus far, simulation of credit carry-back or trading has not been attempted in the CAFE model. Unlike past versions, the current CAFE model provides a basis to specify (in model inputs) CAFE credits available from model years earlier than those being simulated explicitly. For example, with this analysis representing model years 2016-2032 explicitly, credits earned in model year 2012 are made available for use through model year 2017 (given the current 5-year limit on carry-forward of credits). The banked credits are specific to both model year and fleet in which they were earned.

As discussed in the CAFE model documentation, the model's default logic attempts to maximize credit carry-forward—that is to “hold on” to credits for as long as possible. If a manufacturer needs to cover a shortfall that occurs when insufficient opportunities exist to add technology in order to achieve compliance with a standard, the model will apply credits. Otherwise it carries forward credits until they are about to expire, at which point it will use them before adding technology that is not considered cost-effective. The model attempts to use credits that will expire within the next three years as a means to smooth out technology application over time to avoid both compliance shortfalls and high levels of over-compliance that can result in a surplus of credits. As further discussed in the CAFE model documentation, model inputs can be used to adjust this logic to shift the use of credits ahead by one or more model years. In general, the logic used to generate credits and apply them to compensate for CAFE shortfalls, both in a given fleet and across regulatory fleets, is an area that requires more attention in the next phase of model development. While the current model correctly accounts for credits earned when a manufacturer exceeds its standard in a given year, the strategic decision of whether to earn additional credits to bank for future years (in the current fleet or to transfer into another regulatory fleet) and when to optimally apply them to deficits is challenging to simulate. This will be an area of focus moving forward.

*** EO 12866 Review – Draft – Do Not Cite, Quote or Release During Review ***

NHTSA introduced the CAFE Public Information Center⁴⁰⁷ to provide public access to a range of information regarding the CAFE program, including manufacturers' credit balances. However, there is a data lag in the information presented on the CAFE PIC that may not capture credit actions across the industry for as much as several months. Additionally, CAFE credits that are traded between manufacturers are adjusted to preserve the gallons saved that each credit represents.⁴⁰⁸ The adjustment occurs at the time of application rather than at the time the credits are traded. This means that a manufacturer who has acquired credits through trade, but has not yet applied them, may show a credit balance that is either considerably higher or lower than the real value of the credits when they are applied. For example, a manufacturer that buys 40 million credits from Tesla, may show a credit balance in excess of 40 million. However, when those credits are applied, they may be worth only 1/10 as much – making that manufacturer's true credit balance closer to 4 million than 40 million.

Having reviewed credit balances (as of October 23, 2017) and estimated the potential that some manufacturers could trade credits, NHTSA developed inputs that make carried-forward credits available as summarized in Table-5-95, Table-5-96, and Table-5-97, after subtracting credits assumed to be traded to other manufacturers, adding credits assumed to be acquired from other manufacturers through such trades, and adjusting any traded credits (up or down) to reflect their true value for the fleet and model year into which they were traded.⁴⁰⁹ While the CAFE model will transfer expiring credits into another fleet (e.g., moving expiring credits from the domestic car credit bank into the light truck fleet), some of these credits were moved in the initial banks to improve the efficiency of application and to better reflect both the projected shortfalls of each manufacturer's regulated fleets, and to represent observed behavior. For context, a manufacturer that produces 1 million vehicles in a given fleet, and experiences a shortfall of 2 MPG, would need 20 million credits to completely offset the shortfall.

⁴⁰⁷ Available at http://www.nhtsa.gov/CAFE_PIC/CAFE_PIC_Home.htm.

⁴⁰⁸ GHG credits for EPA's program are denominated in metric tons of CO₂, rather than gram/mile compliance credits and require no adjustment when traded between manufacturers or fleets.

⁴⁰⁹ The adjustments, which are based upon the standard, CAFE and year of both the party originally earning the credits and the party applying them, were implemented assuming the credits would be applied to the model year in which they were set to expire. For example, credits traded into a domestic passenger car fleet for MY 2014 were adjusted assuming they would be applied in the domestic passenger car fleet for MY 2019.

*** EO 12866 Review – Draft – Do Not Cite, Quote or Release During Review ***

TABLE-5-95 - ESTIMATED DOMESTIC CAR CAFE CREDIT BANKS, MY 2011 -2015

Manufacturer	Model Year				
	2011	2012	2013	2014	2015
BMW	-	-	-	-	-
Daimler	-	-	-	-	-
FCA	3,533,996	18,886,353	42,604,131	1,682,307	-
Ford	24,094,037	26,139,750	40,611,410	30,152,856	7,089,840
General Motors	7,682,752	7,246,220	24,976,993	7,338,835	-
Honda	99	1,379,203	813,612	39,580,944	52,537,420
Hyundai Kia-H	-	-	-	-	-
Hyundai Kia-K	-	-	-	-	-
JLR	-	-	-	-	-
Mazda	15,526	-	-	-	-
Nissan Mitsubishi	-	1,564,100	26,451,158	52,774,443	62,285,009
Subaru	-	-	-	589,594	2,880,250
Tesla	-	164,504	491,723	363,905	25,369,142
Toyota	31,937,216	29,691,134	17,474,425	12,181,000	4,828,440
Volvo	-	-	-	-	-
VWA	-	1,529,328	2,836,482	4,390,945	4,479,510

*** EO 12866 Review – Draft – Do Not Cite, Quote or Release During Review ***

TABLE-5-96 - ESTIMATED IMPORTED CAR CAFE CREDIT BANKS, MY 2011 - 2015

Manufacturer	Model Year				
	2011	2012	2013	2014	2015
BMW	-	-	-	4,163,432	6,329,325
Daimler	-	-	-	-	-
FCA	-	6,326,946	-	-	-
Ford	-	-	1,385,379	-	-
General Motors	1,576,672	251,275	2,780,629	3,646,294	1,304,196
Honda	101	99	5,431,859	2,142,966	1,356,300
Hyundai Kia-H	28,338,076	16,403,710	44,063,236	10,185,700	9,658,416
Hyundai Kia-K	15,078,920	12,759,767	11,603,509	-	-
JLR	-	-	-	1,270,772	293,436
Mazda	5,617,262	322,320	-	15,430,643	13,254,400
Nissan Mitsubishi	1,953,364	1,606,363	894,783	2,161,883	9,086,088
Subaru	-	6,804,584	1,894,165	22,616,350	1,867,661
Tesla	-	-	-	-	-
Toyota	39,697,080	62,935,487	66,791,277	47,709,001	50,293,119
Volvo	-	-	-	-	-
VWA	8,593,792	-	-	-	-

TABLE-5-97 - ESTIMATED LIGHT TRUCK CAFE CREDIT BANKS, MY 2011 - 2015

Manufacturer	Model Year				
	2011	2012	2013	2014	2015
BMW	-	-	-	235,952	1,132,000
Daimler	-	-	-	-	-
FCA	-	-	2,822,581	-	-
Ford	5,829,495	701,227	3,699,786	-	-
General Motors	4,181,275	-	-	10,481,490	-
Honda	-	100	373,308	9,823,076	12,807,872
Hyundai Kia-H	-	-	-	-	-
Hyundai Kia-K	2,314,000	2,285,440	1,618,398	-	-
JLR	-	-	-	66,174	-
Mazda	-	-	1,405,139	1,970,650	1,260,688
Nissan Mitsubishi	23,239	300,112	372,970	1,168,917	4,915,173
Subaru	369,021	3,441,060	-	-	9,158,682
Tesla	-	-	-	-	-
Toyota	14,507,492	9,082,704	17,975,353	6,810,262	-
Volvo	-	-	-	-	-
VWA	644,980	77,809	790,875	621,144	-

In addition to the inclusion of these existing credit banks, the CAFE model also updated its treatment of credits in the rulemaking analysis. Congress has declared that NHTSA set CAFE standards at maximum feasible levels for each model year under consideration, without consideration of the program’s credit mechanisms. However, as CAFE rulemakings have evaluated longer time periods in recent years, the early actions taken by manufacturers required more nuanced representation. Therefore, the CAFE model now allows a “last year to consider credits”, set at the last year for which new standards are not being considered (MY 2019 in this analysis). This allows the model to replicate the practical application of existing credits toward CAFE compliance in early years, but to examine the impact of proposed standards based solely on fuel economy improvements in all years for which new standards are being considered.

The CAFE model has also been modified to include a similar representation of existing credit banks in EPA’s CO₂ program. While the life of a CO₂ credit, denominated in metric tons CO₂, has a five-year life, matching the lifespan of CAFE credits, credits earned in the early years of the EPA program, ~~MY 2010-2014~~, may be used through MY 2021⁴¹⁰. The CAFE model was not modified to allow exceptions to the life-span of compliance credits, treating them all as if they may be carried forward for no more than five years, so the initial credit banks were modified to anticipate the years in which those credits might be needed. The fact that MY 2016 is simulated explicitly prohibited the inclusion of these banked credits in MY 2016 (which could be carried forward from MY 2016 to MY 2021), and thus underestimates the extent to which individual manufacturers, and the industry as a whole, may rely on these early credits to comply with EPA standards between MY 2016 and MY 2021. The credit banks with which the simulations in this analysis were conducted are presented in the following tables:

Commented [A25]: Extended credits are available for MYs 2010-2015.

⁴¹⁰ In response to comments, EPA placed limits on credits earned in MY 2009, causing them to expire prior to this rule. However, credits generated in MYs 2010 – 2011 may be carried forward, or traded, and applied to deficits generated through MY 2021.

*** EO 12866 Review – Draft – Do Not Cite, Quote or Release During Review ***

TABLE-5-98 - ESTIMATED PASSENGER CAR CO2CREDIT BANKS, MY 2011 - 2015

Manufacturer	Model Year				
	2011	2012	2013	2014	2015
BMW	790,137	1,213,000	1,558,000	1,833,000	2,089,000
Daimler	688,000	777,000	899,000	1,199,000	1,443,000
FCA	4,089,000	4,554,000	5,142,000	6,574,000	7,318,000
Ford	1,911,000	2,546,000	3,485,000	4,743,000	4,216,000
General Motors	2,040,000	3,804,000	3,487,000	4,882,000	4,588,000
Honda				600,000	2,000,000
Hyundai Kia-H					
Hyundai Kia-K	114,000	1,236,000	548,000	973,000	1,161,000
JLR	278,000	343,000	355,000	392,000	379,000
Mazda					600,000
Nissan Mitsubishi				765,000	1,863,000
Subaru	511,000	611,000	1,000,000	1,200,000	1,400,000
Tesla					
Toyota					450,000
Volvo	32,000	102,000	169,000	89,000	143,000
VWA	1,215,000	1,343,000	1,700,000	2,065,000	2,444,000

TABLE-5-99 - ESTIMATED LIGHT TRUCK CO₂CREDIT BANKS, MY 2011 - 2015

Manufacturer	Model Year				
	2011	2012	2013	2014	2015
BMW	112,314	-	-	-	-
Daimler	870,000	914,000	1,149,000	274,000	446,000
FCA	7,756,000	6,106,000	2,742,000	1,920,000	3,614,000
Ford	6,366,000	2,875,000	4,656,000	6,089,000	2,122,000
General Motors	11,318,000	11,216,000	9,164,000	6,049,000	4,829,000
Honda				945,000	1,400,000
Hyundai Kia-H	140,000	153,000	218,000	300,000	300,000
Hyundai Kia-K	556,000	591,000	981,000	973,000	1,219,000
JLR	1,715,000	1,635,000	1,973,000	1,940,000	2,168,000
Mazda			200,000	450,000	500,000
Nissan Mitsubishi					
Subaru					193,000
Tesla					
Toyota	8,701,000	8,710,000	8,545,000	9,045,000	8,000,000
Volvo			37,000	50,000	50,000
VWA	729,000	384,000	134,000	370,000	547,000

While the CAFE model does not simulate the ability to trade credits between manufacturers, it does simulate the strategic accumulation and application of CAFE credits, as well as the ability to transfer credits between fleets to improve the compliance position of a less efficient fleet by leveraging credits earned by a more efficient fleet. The model prefers to hold on to earned CAFE credits within a given fleet, carrying them forward into the future to offset potential future deficits. This assumption is consistent with observed strategic behavior dating back to 2009.

From 2009 to present, no manufacturer has transferred CAFE credits into a fleet to offset a deficit in the same year in which they were earned. This has occurred with credits acquired from other manufacturers via trade, but not with a manufacturer’s own credits. Therefore, the current representation of credit transfers between fleets – where the model prefers to transfer expiring, or soon-to-be-expiring credits rather than newly earned credits – is both appropriate and consistent with observed industry behavior.

This may not be the case for GHG standards, though it is difficult to be certain at this point. The GHG program seeded the industry with a large quantity of early compliance credits (earned in

*** EO 12866 Review – Draft – Do Not Cite, Quote or Release During Review ***

MYs 2009 – 2011⁴¹¹) prior to the official existence of the EPA program. Unlike credits earned under the regulations once in place, these early credits do not expire until 2021. So, for manufacturers looking to offset deficits, it is more sensible to use current-year credits that expire in the next 5 years, rather than draw down the bank of credits that can be used until MY2021. The first model year for which earned credits outlive the initial bank is MY2017, for which final compliance actions and deficit resolutions are still pending. Regardless, in order to accurately represent some of the observed behavior in the GHG credit system, the CAFE model allows (and encourages) within-year transfers between regulated fleets for the purpose of simulating compliance with the GHG standards.

In addition to more rigorous accounting of CAFE and CO₂ credits, the model now also accounts for air conditioning efficiency and off-cycle adjustments. NHTSA’s program considers those adjustments in a manufacturer’s compliance calculation starting in MY 2017, and the current model uses the adjustments claimed by each manufacturer in MY 2016 as the starting point for all future years. Because the air conditioning and off-cycle adjustments are not credits in NHTSA’s program, but rather adjustments to compliance fuel economy, they may be included under either a “standard setting” or “unconstrained” analysis perspective.

When the CAFE model simulates EPA’s program, the treatment of A/C efficiency and off-cycle credits is similar, but the model also accounts for A/C leakage (which is not part of NHTSA’s program). When determining the compliance status of a manufacturer’s fleet (in the case of EPA’s program, PC and LT are the only fleet distinctions), the CAFE model weighs future compliance actions against the presence of existing (and expiring) CO₂ credits resulting from over-compliance with earlier years’ standards, A/C efficiency credits, A/C leakage credits, and off-cycle credits.

5.4.2.10 Process flow from ANL Autonomie Full Vehicle Simulation Database to CAFE model database

For virtually all of the technologies analyzed within the CAFE model, the fuel economy improvements were derived from a database containing results of the ANL full vehicle simulation study described earlier in this chapter. In order to incorporate the results of the Argonne database, while still preserving the basic structure of the CAFE model’s technology subsystem, it was necessary to translate the points in the database into corresponding locations defined by the technology pathways described above. By recognizing that most of the pathways are unrelated, and are only logically linked to allow for incremental technology progression, it is possible to condense the paths into a smaller number of groups and branches based on the specific technology. Additionally, to allow for technologies present on the Basic Engine path to

⁴¹¹ In response to public comment, EPA eliminated the use of credits earned in MY2009 for future model years. However, credits earned in MY2010 and MY2011 remain.

be evaluated and applied in any order, as simulated in the Argonne database, a unique group was established for each of these technologies. As such, the following technology groups are defined - engine cam configuration (CONFIG), VVT engine technology (VVT), VVL engine technology (VVL), SGDI engine technology (SGDI), DEAC engine technology (DEAC), non-basic engine technologies (ADVENG),⁴¹² transmission technologies (TRANS), electrification and hybridization (ELEC), low rolling resistance tires (ROLL), mass reduction levels (MR), and aerodynamic improvements (AERO).⁴¹³ The combination of technologies along each of these groups forms a unique technology state vector and defines a unique technology combination that corresponds to a single point in the database for each technology class evaluated within the modeling system.

As an example, a technology state vector describing a vehicle with a SOHC engine, variable valve timing (only), a 6-speed automatic transmission, a belt-integrated starter generator, mass reduction (level 1), aerodynamic improvements (20%), and rolling resistance improvement (10%) would be specified as SOHC;VVT;;;;AT6;BISG;MR1;AERO20;ROLL10.⁴¹⁴ By assigning each unique technology combination a state vector such as the one in the example, the CAFE model can then assign each vehicle in the analysis fleet an initial state that corresponds to a point in the database. From there, it is relatively simple to obtain a fuel economy improvement factor for any new combination of technologies and apply that factor to the fuel economy of a vehicle in the analysis fleet.

Once a vehicle is assigned (or mapped) to an appropriate technology state vector (from one of approximately 150 thousand unique combinations in each technology class, which is defined in the Argonne simulation database as CONFIG;VVT;VVL;SGDI;DEAC;ADVENG;AT10;ELEC;ROLL;MR;AERO), adding a new technology to the vehicle simply represents progress from one state vector to another. Thus, the formula for calculating a vehicle's fuel economy for each technology represented within the Argonne database is defined as:

$$FE_{New} = FE_{Orig} \times \frac{F_{Prev}}{F_{New}} \quad (5-3)$$

Where:

FE_{Orig} : the original fuel economy for the vehicle in the analysis fleet, in mpg,
 F_{Prev} : the fuel economy improvement factor associated with the technology state vector before application of any new candidate technologies,

⁴¹² The ADVENG group includes all technologies found in the following pathways - Turbo, HCR, VCR, ADEAC, and Diesel path; however, this group does not include the Alt. Fuel path, because CNG technology is not present in the Argonne simulation database.

⁴¹³ Because none of the technologies within the Dynamic Load Reduction path were simulated by Argonne, this pathway is not represented by the technology group combination.

⁴¹⁴ In the example technology state vector, the series of semicolons between VVT and AT6 correspond to the engine technologies which are not included as part of the combination.

*** EO 12866 Review – Draft – Do Not Cite, Quote or Release During Review ***

F_{New} : the fuel economy improvement factor associated with the technology state vector after application of new candidate technologies, and
 FE_{New} : the resulting fuel economy for the same vehicle, in mpg.

The fuel economy improvement factor is defined in a way that captures the incremental improvement of moving between points in the database, where each point is defined uniquely as a combination of up to 11 distinct technologies describing, as mentioned above, the engine's cam configuration, multiple distinct combinations of engine technologies, transmission, electrification type, low rolling resistance tires, mass reduction level, and level of aerodynamic improvement. In the current implementation, each fuel economy improvement factor represents the improvement in fuel consumption for a given combination relative to the reference combination.⁴¹⁵ The improvement is defined as the ratio of each technology state combination to its appropriate reference point.

In addition to the technologies found in the Argonne simulation database, the modeling system also provides support for a handful of “*add-on*” technologies that were required for CAFE modeling, but were not explicitly simulated by Argonne. These technologies are - DSLI, EPS, IACC, LDB, and SAX. For calculating fuel economy improvements attributable to these technologies, the model uses the fuel consumption improvement factors, FC , as defined in the technologies input file.⁴¹⁶ Because VVT is defined as a prerequisite technology, it may also need to be applied by the model during analysis. However, because it is considered a reference point within the Argonne database, it would be impossible for the model to calculate the vehicle's fuel economy improvements using Equation (5-3) above. Instead, the model relies on the fuel consumption improvement factor when evaluation VVT technology as well. The model assumes that the improvements from these “*add-on*” technologies are constant across all technology combinations in the database and scale multiplicatively when applied together.

The FC factor is defined on a gallons-per-mile basis and represents a percent reduction in vehicle's fuel consumption value. The formula to find the resulting increase in fuel economy of a vehicle with fuel consumption reduction factors from one or more add-on technologies in the context of the technology combination from the database is defined as:

$$FE_{New} = FE_{Orig} \times \frac{F_{Prev}}{F_{New}} \times \prod_{i=0}^n \frac{1}{(1 - FC_i)} \quad (5-4)$$

Where:

FE_{Orig} : the original fuel economy for the vehicle in the analysis fleet, in mpg,

⁴¹⁵ There are two distinct reference combinations, that represent the lowest technology states in the database - DOHC;VVT;;;AT5;CONV;ROLL0;MR0;AERO0 for any combination without a manual transmission, and DOHC;VVT;;;MT5;CONV;ROLL0;MR0;AERO0 for any combination that includes a manual transmission.

⁴¹⁶ The technologies input file is further described in of CAFE Model Documentation.

*** EO 12866 Review – Draft – Do Not Cite, Quote or Release During Review ***

$F_{P_{rev}}$: the fuel economy improvement factor associated with the technology state vector before application of any new candidate technologies,
 F_{New} : the fuel economy improvement factor associated with the technology state vector after application of new candidate technologies,
 FC_i : the fuel consumption improvement factors attributed to the 0 -th to n -th candidate add-on technologies, and
 FE_{New} : the resulting fuel economy for the same vehicle, in mpg.

For some technologies, the modeling system may convert a vehicle or a vehicle’s engine from operating on one type of fuel to another. For example, application of Advanced Diesel (ADSL) technology converts a vehicle from gasoline operation to diesel operation. In such a case, the aforementioned Equations (5-3) and (5-4), still apply, however, in each case, the FE_{New} value is assigned to the vehicle’s new fuel type, while the fuel economy on the original fuel is discarded.

Moreover, whenever the modeling system converts a vehicle model to a 30-mile plug-in hybrid/electric vehicle (PHEV30), that vehicle is assumed to operate simultaneously on gasoline and electricity fuel types. In this case, the model obtains two sets of fuel economy improvement factors, F_{New} and $F2_{New}$, from the Argonne simulation database for estimating the FE_{New} values on gasoline and electricity, respectively. In the case of electricity, because no reference fuel economy exists prior to conversion to PHEV30, the $F2_{New}$ value is defined as an improvement over FE_{Orig} value on gasoline. That is, for calculating the fuel economy on electricity when upgrading a vehicle to PHEV30, Equation (5-3) becomes:

$$FE_{New,E} = FE_{Orig,G} \times \frac{F_{Orig}}{F2_{New}} \quad (5-5)$$

Where:

$FE_{Orig,G}$: the original fuel economy for the vehicle, in mpg, when operating on gasoline,
 F_{Orig} : the fuel economy improvement factor associated with the technology state vector before application of any new candidate technologies,
 $F2_{New}$: the fuel economy improvement factor associated with the technology state vector after application of new candidate technologies, and
 $FE_{New,E}$: the resulting fuel economy for the same vehicle, in mpg, when operating on electricity.

Just as no reference fuel economy on electricity exists on a vehicle prior to application of PHEV30 technology, a reference fuel economy improvement factor would not exist in the Argonne database either. For this reason, Equation (5-5) above uses F_{Orig} factor when calculating the new vehicle fuel economy on electricity. Because both $FE_{Orig,G}$ and F_{Orig} refer to the same reference state, Equation (5-5) mathematically applies and produces accurate results with regard to the Argonne simulation database.

Additionally, for PHEVs, the *Secondary FS* field, defined in the technologies input file, specifies the assumed amount of miles driven by the vehicle when operating on electricity. The vehicle's overall rated fuel economy is then defined as the average of the fuel economies on gasoline and electricity, weighted by the fuel shares.⁴¹⁷ As the system transitions to PHEV50, the same calculation applies, however, this time, the F_{2New} value is defined as a fuel economy improvement factor over FE_{Orig} on electricity.

When the system further improves the vehicle, converting it from a PHEV50 to a 200-mile electric vehicle (BEV200), the gasoline fuel component is removed, while the electric-operated portion remains. In this case, the F_{Orig} value, obtained from the simulation database, represents a fuel economy improvement factor over FE_{Orig} on PHEV50's electricity component. Similarly, when a vehicle is converted to a fuel cell vehicle (FCV) instead of BEV200, the same conversion logic applies, except the final fuel economy, FE_{New} , is defined on hydrogen fuel type.

5.4.3 CAFE market data file

5.4.3.1 Purpose of the developing and using an analysis fleet.

The fleet used for today's analysis is the set of vehicles offered for sale in MY 2016. The analysis fleet summarizes vehicle specifications, technology features, sales volumes, and other vehicles' statistics used in fleet modeling. In aggregate, the analysis fleet also includes information on fleet mix, technology penetration rates, and industry redesign cadence. Once the fleet is defined, the CAFE model estimates how each manufacturer could potentially deploy (not "should," "must," or "will" deploy) additional fuel-saving technology in response to a given series of attribute-based standards. The agencies track the application of technology that may benefit fuel economy and CO₂ emissions in the current fleet. A representative analysis fleet prevents the CAFE model from "double counting" benefits of a technology as the model does not allow technology to be added to a vehicle already equipped with that technology. For future years, the model uses current vehicle sales to help estimate future sales in response to vehicle price trends and fuel price changes. The analysis fleet grounds assumptions about vehicle sales, technology proliferation, and starting fuel economies and helps the model illustrate potential pathways to compliance for attribute-based standards. The cumulative sales volumes for specific technologies feed into cost reduction from learning.

The file for the analysis fleet includes a tremendous amount of data. The file includes vehicle models sold that year, listed by row. Each vehicle model is a unique combination of body style, powertrain configuration, footprint, technology, and vehicle specifications for each nameplate. It is common for a nameplate to be represented by multiple vehicle model configurations. For each

⁴¹⁷ The overall fuel economy for PHEVs is the rated value achieved by the vehicle assuming on-road operation specified by the *Secondary FS* field. For compliance purposes, the vehicle's overall fuel economy is determined by the *Multi-Fuel* and the *PHEV Share* parameters defined in the scenarios input file. The scenarios input file is further discussed in CAFE model documentation.

vehicle row, columns list observable and assignable attributes, including technology used, sales volumes, vehicle platform, and other inputs for the CAFE model. As discussed below, the basic data for vehicle configurations are provided by each manufacturer, either through final compliance data or by submission of business information. In many cases, manufacturers provide details about technologies, platforms, engines, transmissions, and other vehicle information. In some cases, the model requires information manufacturers did not provide. In these instances, the analysis fleet file was supplemented with information available from commercial and public sources.

5.4.3.2 How the MY 2016 Analysis Fleet was Developed

5.4.3.2.1 Background

Since 2001, CAFE rulemakings used either confidential, forward-estimating product plans from manufacturers or publicly available data on vehicles already sold. These two sources present a tradeoff. Confidential product plans provide a comprehensive representation of what vehicles a manufacturer expects to produce in coming years, accounting for plans to introduce new vehicles and fuel-saving technologies, and, for example, plans to discontinue other vehicles or even brands. However, for competitive reasons, most of this information is provided on a confidential basis and must be redacted prior to publication with rulemaking documentation. Since 2010, the agencies have based analysis fleets almost exclusively on information from commercial and public sources. Therefore, unlike an analysis fleet based primarily on confidential business information (CBI), an analysis fleet based primarily on public sources can be released to the public, allowing any interested parties to reproduce analysis. However, being “anchored” in an earlier model year, such an analysis fleet holds vehicle characteristics unchanged over time and may not reflect manufacturers’ actual plans to apply fuel-saving technologies (e.g., a manufacturer may apply turbocharging to improve not just fuel economy, but also to improve vehicle performance), or manufacturers’ plans to change product offerings by introducing some vehicles and brands and discontinuing other vehicles and brands. For example, in the 2012-2016 Final Rule, the MY 2008 fleet was used, while for the 2017-2025 Final Rule, both the 2008 and 2010 MY fleets were used. The general goal is to update analysis with the most recent analysis fleet data that is both available and appropriate to publish.

5.4.3.2.2 Decision to use MY 2016 Foundation for Analysis Fleet

For today’s analysis fleet, MY 2016 was chosen to be used because the data include the most recent possible mix of commercially available technologies and vehicle configurations, and the data may be made available to the public. If the analysis began with information from an earlier model year, the information could be disclosed, but the analysis fleet would neither include new vehicles recently introduced, nor would the data include the most recent estimated sales mix. If the analysis used MY 2017 data, then product planning information would have been needed that could not be made available to the public.

*** EO 12866 Review – Draft – Do Not Cite, Quote or Release During Review ***

Development of the MY 2016 fleet began prior to final compliance data becoming available for all manufacturers, so a concerted effort was made to align the analysis fleet data with final compliance data whenever possible. The analysis began with 2016 mid-model year compliance data, provided manufacturers the opportunity to review and comment on the characterization of their vehicles in the fleet, and then updated sales, footprint, and fuel economy values with final compliance data if the data was available. In some cases, final production and fuel economy values may be slightly different for specific MY 2016 vehicle models and configurations than are indicated in today's analysis; however, other vehicle characteristics (e.g., footprint, curb weight, technology content) which are vital to the analysis are generally considered current and accurate. Although final CAFE compliance data is available for earlier model years, that data can be subject to later revision (e.g., if errors in fuel economy tests are discovered).

Considering the range of important changes in MY 2016 (discussed below) to product offerings, the judgment is exercised used the best available data providing a realistic characterization of the 2016 market. Insofar as future product offerings are likely to be more similar to vehicles produced in 2016 than to vehicles produced in earlier model years, the agencies' judgment is further that using available data regarding the MY 2016 provides the most realistic, publicly releasable foundation for constructing a forecast of the future vehicle market.

The goal is to continue to consider ways to improve the analysis fleet used for subsequent modeling to evaluate potential new standards. The NPRM seeks comment on the option used today and any other options, and on tradeoffs between, on one hand, fidelity with manufacturers' actual plans and, on the other, the ability to make detailed analysis inputs and outputs publicly available.

5.4.3.2.3 Developments in 2016

Manufacturers launched many new or updated, technologically advanced models in MY 2016. Many manufacturers installed turbo-downsized engines, advanced transmissions, and additional mass reduction technology on new vehicles. Examples include the Honda Civic and Chevrolet Malibu. Also, many manufacturers retired nameplates between 2015MY and 2016MY. For example, FCA continued to shift volume away from passenger automobiles and towards other segments of the market.

5.4.3.2.3.1 Manufacturer-Provided Information for 2016MY

In 2016 and 2017, Volpe Center staff worked with the Alliance of Automobile Manufacturers and the Association of Global Automakers to invite individual manufacturers to provide information on the MY 2016 fleet, including a range of vehicle characteristics, as well as mid-model year estimates of 2016 production volumes. In December 2016, Volpe Center staff provided a template of the input file for the CAFE model, indicating relevant characteristics of vehicles, engines, and transmissions. By summer 2017, most manufacturers offered comments on the characterization of their vehicles in the analysis fleet. Many manufacturers provided

substantially more information about their vehicles, including aerodynamic drag coefficient, tire rolling resistance, transmission efficiency, and other information specific to the analysis. Volpe Center staff contacted manufacturers to clarify and correct some information and integrated the information into a single input file for use in the CAFE model. Information is sought that could be used to refine its representation of the MY 2016 analysis fleet or to develop a similarly-detailed representation of a more recent fleet.

5.4.3.2.4 Other Data

5.4.3.2.4.1 Redesign/Refresh Schedules

Redesign schedules play an important role in the application of new technologies. Many technologies that may improve fuel economy or reduce CO₂ emissions may be difficult to incorporate without a major product redesign. Therefore, the CAFE model includes redesign schedules as an input. The vehicle model limits the introduction of most technologies to major redesign years or refresh years. In addition to nameplate refresh and redesign schedules, the CAFE model also accounts for platform refresh and redesign schedules for advanced mass reduction technologies.

Manufacturers use diverse strategies with respect to when and how often they update vehicle designs. While most vehicles have been redesigned sometime in the last five years, many vehicles have not. In particular, vehicles with lower annual sales volumes tend to have extended product runs, perhaps giving manufacturers more time to amortize the investment needed to bring the product to market. In some cases, manufacturers continue to produce and sell vehicles designed more than a decade ago.

TABLE 5-100 - SALES DISTRIBUTION BY AGE OF VEHICLE ENGINEERING DESIGN

Most Recent Engineering Redesign Model Year of the Observed 2016MY Vehicle	% of 2016MY Fleet (Sales) by Engineering Design Age	Portion of Analysis Fleet Observations in 2016MY Fleet by Engineering Design Age	Age of Vehicle Engineering Design	Portion of total New Vehicle Sales with Engineering Designs as New or Newer than “Age of Vehicle Engineering Design”
2006	2.1%	1.7%	10	99.97%
2007	1.3%	2.0%	9	97.9%
2008	3.2%	2.3%	8	96.6%
2009	4.3%	9.8%	7	93.4%
2010	5.0%	7.2%	6	89.1%
2011	9.6%	7.9%	5	84.1%
2012	10.5%	13.0%	4	74.6%
2013	18.1%	10.6%	3	64.0%
2014	20.5%	21.8%	2	46.0%

*** EO 12866 Review – Draft – Do Not Cite, Quote or Release During Review ***

2015	12.6%	14.1%	1	25.4%
2016	12.9%	9.2%	New (0)	12.9%

Each manufacturer may use different strategies throughout their product portfolio, and a component of each strategy may include the timing of refresh and redesign cycles. The table below summarizes the average timing between redesigns, by manufacturer, by tech class. Dashes mean the manufacturer has no volume in that technology class in the MY 2016 analysis fleet. Across the industry, manufacturers average 6.5 years between product redesigns.

TABLE 5-101 - SUMMARY OF SALES WEIGHTED AVERAGE TIME BETWEEN ENGINEERING REDESIGNS, BY MANUFACTURER, BY VEHICLE CLASS

Manufacturer	SmallCar	SmallCarPerf	MedCar	MedCarPerf	SmallSUV	SmallSUVPerf	MedSUV	MedSUVPerf	Pickup	PickupHT	ALL CLASSES
BMW	6.0	6.1	6.7	6.5	5.5	6.4	6.3	6.1	-	-	6.3
Daimler	7.0	5.5	7.0	6.6	5.6	7.0	10.0	7.3	-	-	6.7
FCA	6.2	6.1	6.0	8.2	9.0	7.4	8.3	8.7	10.0	10.0	8.6
Ford	8.3	8.5	6.3	6.9	7.7	7.6	7.4	7.9	5.8	5.8	7.1
General Motors	5.7	5.2	5.0	6.2	5.7	7.3	7.4	6.1	6.5	7.9	6.3
Honda	4.4	4.8	4.8	4.9	5.5	5.8	-	6.0	-	-	5.3
Hyundai Kia-H	5.0	4.8	5.3	6.0	5.3	5.3	5.3	5.3	-	-	5.2
Hyundai Kia-K	5.7	6.0	5.5	5.0	4.7	5.5	5.5	7.1	-	-	5.4
JLR	-	-	-	7.5	-	6.3	-	6.4	-	-	6.5
Mazda	-	6.4	4.2	7.7	5.1	7.0	-	7.0	-	-	5.4
Nissan Mitsubishi	5.1	5.7	5.5	6.0	6.9	6.6	-	6.5	8.0	-	6.1
SUBARU	4.8	7.8	5.4	4.7	5.4	5.5	-	-	-	-	5.4
Tesla	-	-	-	10.0	-	-	-	10.0	-	-	10.0
TOYOTA	5.5	9.6	6.3	6.0	5.3	5.7	5.3	7.2	10.5	10.1	6.6
Volvo	-	8.3	-	8.6	-	8.0	-	7.2	-	-	7.8
VWA	-	5.9	7.3	6.0	7.7	7.1	-	7.6	-	-	6.6
TOTAL	5.5	6.0	5.6	6.7	6.2	6.6	7.2	7.1	8.1	7.8	6.5

There are a few notable observations from this table. Pick-up trucks have much longer redesign schedules (7.8 years on average) than small cars (5.5 years on average). Some manufacturers redesign vehicles often (every 5.2 years in the case of Hyundai), while other manufacturers redesign vehicles less often (FCA waits on average 8.6 years between vehicle redesigns).

*** EO 12866 Review – Draft – Do Not Cite, Quote or Release During Review ***

Even if two manufacturers deploy similar strategies on the time between redesigns, the actual timing of redesigns may still be different; in other words, the entire fleet is not redesigned in one calendar year.

The table below summarizes the average age of each manufacturers offering by technology class. A value of “0.0” means every vehicle for a manufacturer, in the technology class, represented in the MY 2016 analysis fleet was new in MY 2016. Across the industry, vehicle designs are an average of 3.2 years old.

TABLE 5-102 - SUMMARY OF SALES WEIGHTED AVERAGE AGE OF ENGINEERING DESIGN IN 2016MY BY MANUFACTURER, BY VEHICLE CLASS

Manufacturer	SmallCar	SmallCarPerf	MedCar	MedCarPerf	SmallSUV	SmallSUVPerf	MedSUV	MedSUVPerf	Pickup	PickupHT	ALL CLASSES
BMW	2.0	2.4	4.0	3.1	3.3	2.8	5.0	2.1	-	-	2.9
Daimler	2.0	2.3	6.0	2.8	0.5	0.0	4.0	3.7	-	-	2.8
FCA	4.3	4.8	5.0	5.5	4.1	5.0	4.8	7.8	7.0	7.0	6.0
Ford	4.9	4.0	3.0	2.7	3.0	1.5	2.6	3.2	1.0	1.0	2.5
General Motors	3.9	4.8	1.6	3.2	4.3	4.2	6.0	3.9	3.4	2.0	3.5
Honda	1.1	0.3	2.9	2.5	3.5	1.5	-	2.7	-	-	2.3
Hyundai Kia-H	4.0	4.0	0.9	2.6	0.6	3.0	3.0	3.0	-	-	2.5
Hyundai Kia-K	2.7	2.0	0.0	0.6	2.1	0.2	0.0	0.6	-	-	1.4
JLR	-	-	-	2.8	-	1.7	-	2.6	-	-	2.4
Mazda	-	1.7	2.0	2.0	2.7	0.0	-	0.0	-	-	2.2
Nissan Mitsubishi	2.5	0.3	3.0	1.7	2.7	0.9	-	2.6	2.0	-	2.6
SUBARU	4.0	3.3	2.9	0.3	1.9	1.3	-	-	-	-	2.0
Tesla	-	-	-	4.0	-	-	-	4.0	-	-	4.0
TOYOTA	1.6	2.8	4.9	2.9	3.0	1.2	3.1	4.2	0.0	8.0	3.2
Volvo	-	6.0	-	6.4	-	6.8	-	1.0	-	-	4.0
VWA	-	2.6	4.6	3.7	6.1	6.3	-	5.4	-	-	4.0
TOTAL	2.7	2.3	2.9	3.2	3.0	2.5	4.4	4.1	1.9	3.5	3.2

Based on historical observations and refresh/redesign schedule forecasts, careful consideration is given to redesign cycles for each manufacturer, and each vehicle is important. Simply assuming every vehicle is redesigned in 2021 and 2025 is not appropriate, as this would misrepresent both the likely timing of redesigns and the likely timing between redesigns in nearly all cases.

*** EO 12866 Review – Draft – Do Not Cite, Quote or Release During Review ***

To develop the refresh/redesign cycles used in the fleet, this analysis used information from Ward's Automotive and other sources to project redesign cycles through 2022. For years 2023-2035, Volpe Center staff extended redesign schedules based on Ward's projections, segment, and platform history, and anticipated competitive pressures. For this analysis, the staff did not request future product plans from manufacturers to define refresh and redesign cycles.

In some cases, Volpe Center staff judged the Ward's data to be incomplete or misleading. For instance, Ward's identified some newly imported vehicles as new platforms, but the international platform was midway through the product lifecycle. While new to the U.S. market, treating these vehicles as new entrants would have resulted in artificially short redesign cycles if carried forward, in some cases. Similarly, Ward's labeled some product refreshes as redesigns, and vice versa. In these limited cases, Volpe Center staff revised the Ward's forecast to reflect more realistic redesign and refresh schedules, for the purpose of the CAFE model.

5.4.3.2.4.2 Technologies

Manufacturers can add technology to a vehicle to improve fuel economy. Each technology may be more or less effective in reducing fuel consumption, depending on complementary equipment and vehicle attributes. As discussed above, Argonne National Laboratory supported the analysis by using Autonomie — Argonne's full vehicle simulation tool — to estimate the effect of a wide range of potential combinations of different technology, producing a database of results informing inputs to the CAFE model. The CAFE model uses these inputs to estimate the potential effectiveness benefits of applying specific combinations of technologies to specific vehicles in the analysis fleet.

The analysis fleet includes many technologies, such as vehicle technologies, engine technologies, and transmission types. Vehicle technologies include mass reduction, aerodynamic drag reduction, low rolling resistance tires, and others. Engine technologies cover core powertrain technologies, and engines attributes describe fuel type, engine aspiration, valvetrain configuration, compression ratio, number of cylinders, size of displacement, engine architecture, and others. Transmission technologies include arrangements like manual, 6-speed automatic, 8-speed automatic, continuously variable transmission, and dual-clutch transmissions. Hybrid and electric powertrains may complement traditional engine and transmission designs or replace them entirely. With a portfolio of descriptive technologies, the analysis fleet can be summarized and the CAFE model can project how vehicles in that fleet may improve over time via the application of advanced technology.

In many cases, technology is clearly observable, but in some cases, technology levels less discrete in nature. For the latter, like tiers of mass reduction, careful analysis was conducted to describe the level of technology already used in a given vehicle. Similarly, engineering judgment was used to determine if higher mass reduction tiers may be used practicably and safely in a given vehicle.

*** EO 12866 Review – Draft – Do Not Cite, Quote or Release During Review ***

Most manufacturers provided a summary of observable technology used in each of their vehicles. In some cases, Volpe Center staff supplemented supplied information with data available to the public, typically from manufacturer media sites. In limited cases, manufacturers did not supply adequate information, and Volpe Center staff used information from commercial and publicly available information.

5.4.3.2.4.3 Engine and Transmission Utilization

Manufacturers submitted many details about engines and transmissions for this analysis. These submissions were used to understand the current level of technology in the fleet and to estimate powertrain families.

Engine and transmission specifications were catalogued as part of the CAFE model input. For engines, the analysis recorded number of cylinders, displacement, valvetrain configuration, aspiration, fuel type, compression ratio, power output, and others. For transmissions, the number of forward gears, automatic or manual, driveline configuration (front-wheel drive, rear-wheel drive, all-wheel drive), and others were recorded. With an index of current equipment in the fleet, the CAFE model can project pathways for manufacturers to adapt and to adopt technologies and comply with regulations.

5.4.3.2.4.4 Estimated Technology Prevalence in the MY 2016 Fleet

The following tables show the estimated prevalence of major technologies, by sales volume weighting, in the MY 2016 analysis fleet. Numbers provided may differ from actual penetration rates based on projected sales and technology take rates. Separate tables cover conventional engine technologies, electrification technologies, and transmission technologies.

TABLE 5-103 - ENGINE TECHNOLOGIES BY MANUFACTURER AS A PERCENT OF SALES OF 2016MY VEHICLES WITHOUT ADVANCED ELECTRIFICATION TECHNOLOGIES

	VVT	VVL	SGDI	DEAC	ADEAC	TURBO1	TURBO2	CEGR1	CEGR2	HCR1	HCR2	ADSL	DSL1
BMW	98.4 %	97.8 %	97.4 %	0.0 %	0.0 %	97.4 %	0.0 %	0.0 %	0.0 %	0.0 %	0.0 %	1.6 %	0.0 %
Daimler	98.6 %	0.0 %	96.0 %	0.0 %	0.0 %	73.9 %	0.0 %	0.0 %	0.0 %	0.0 %	0.0 %	1.4 %	0.0 %
FCA	81.6 %	28.7 %	0.6 %	14.9 %	0.0 %	1.7 %	0.0 %	7.1 %	0.0 %	0.0 %	0.0 %	1.6 %	0.0 %
Ford	100 %	0.0 %	53.8 %	0.0 %	0.0 %	45.7 %	0.2 %	0.0 %	0.0 %	2.9 %	0.0 %	0.0 %	0.0 %
General Motors	98.8 %	4.3 %	87.1 %	33.6 %	0.0 %	22.1 %	0.0 %	0.0 %	0.0 %	0.3 %	0.0 %	0.7 %	0.0 %
Honda	63.1 %	100 %	65.1 %	30.2 %	0.0 %	6.2 %	0.0 %	0.0 %	0.0 %	0.0 %	0.0 %	0.0 %	0.0 %
Hyundai Kia-H	100 %	0.0 %	76.4 %	0.0 %	0.0 %	11.8 %	0.0 %	0.0 %	0.0 %	3.0 %	0.0 %	0.0 %	0.0 %
Hyundai Kia-K	100 %	0.0 %	88.6 %	0.0 %	0.0 %	5.4 %	0.0 %	0.0 %	0.0 %	0.0 %	0.0 %	0.0 %	0.0 %
JLR	88.8 %	0.0 %	88.8 %	0.0 %	0.0 %	88.8 %	0.0 %	0.0 %	0.0 %	0.0 %	0.0 %	11.2 %	0.0 %
Mazda	100 %	0.0 %	100 %	0.0 %	0.0 %	0.0 %	0.0 %	5.5 %	0.0 %	94.4 %	0.0 %	0.0 %	0.0 %
Nissan Mitsubishi	99.8 %	4.6 %	4.4 %	0.0 %	0.0 %	2.2 %	0.0 %	1.4 %	0.0 %	0.0 %	0.0 %	0.0 %	0.0 %
SUBARU	100 %	0.0 %	6.4 %	0.0 %	0.0 %	1.5 %	0.0 %	5.7 %	0.0 %	0.0 %	0.0 %	0.0 %	0.0 %
Tesla	-	-	-	-	-	-	-	-	-	-	-	-	-
TOYOTA	100 %	1.1 %	16.9 %	0.0 %	0.0 %	3.4 %	0.0 %	0.0 %	0.0 %	20.5 %	0.0 %	0.0 %	0.0 %
Volvo	100 %	0.0 %	72.6 %	0.0 %	0.0 %	100 %	0.0 %	0.0 %	0.0 %	0.0 %	0.0 %	0.0 %	0.0 %
VWA	98.2 %	40.5 %	97.9 %	1.7 %	0.0 %	91.7 %	0.0 %	0.0 %	0.0 %	0.0 %	0.0 %	1.8 %	0.0 %
TOTAL	93.1 %	19.6 %	50.4 %	10.5 %	0.0 %	20.7 %	0.02 %	1.4 %	0.0 %	6.2 %	0.0 %	0.6 %	0.0 %

Few manufacturers rely on diesel engines for a large portion of sales. All manufacturers have deployed DOHC and VVT across the majority of the light duty fleet. Adoption of VVL, SGDI, cylinder deactivation, and air intake charging vary widely across the fleet and across manufacturers.

*** EO 12866 Review – Draft – Do Not Cite, Quote or Release During Review ***

TABLE 5-104 - ELECTRIFICATION TECHNOLOGIES BY MANUFACTURER AS A PERCENT OF 2016MY SALES

	SS12V	BISG	CISG	SHEVP2	SHEVPS	PHEV30	PHEV50	BEV200	FCV	TOTAL
BMW	91.5%	0%	0%	0%	0%	1.9%	0%	1.2%	0%	94.5%
Daimler	82.8%	0%	0%	0%	0%	0.3%	0%	0.4%	0%	83.5%
FCA	12.4%	0%	0%	0%	0%	0%	0%	0.2%	0%	12.6%
Ford	8.0%	0%	0%	0%	1.9%	1.0%	0%	0.1%	0%	11.0%
General Motors	15.1%	0.3%	0%	0.3%	0%	0%	0.4%	0.1%	0%	16.2%
Honda	5.7%	0%	0.1%	0%	0%	0%	0%	0%	0%	5.8%
Hyundai Kia-H	0%	0%	0%	2.8%	0%	0.2%	0%	0%	0.01%	3.0%
Hyundai Kia-K	0.3%	0%	0%	0.7%	0%	0%	0%	0.4%	0%	1.4%
JLR	87.1%	0%	0%	0%	0%	0%	0%	0%	0%	87.1%
Mazda	0%	0%	0%	0%	0%	0%	0%	0%	0%	0.0%
Nissan Mitsubishi	1.5%	0%	0%	0.2%	0%	0%	0%	1.3%	0%	3.0%
SUBARU	0%	0%	0%	0.5%	0%	0%	0%	0%	0%	0.5%
Tesla	0%	0%	0%	0%	0%	0%	0%	100%	0%	100%
TOYOTA	0%	0%	0%	0%	9.2%	0%	0%	0%	0.03%	9.3%
Volvo	70.1%	0%	0%	0%	0%	2.4%	0%	0%	0%	72.6%
VWA	16.7%	0%	0%	0.1%	0%	1.1%	0%	1.2%	0%	19.1%
TOTAL	12.0%	0.1%	0.0%	0.2%	1.6%	0.2%	0.1%	0.5%	0.01%	13.3%

Many manufacturers have offered some type of alternative, electric powertrain to the market; however, electrification technologies currently have very modest market share. Few manufacturers have reported use of 12V start-stop systems, while few others report use of BISG or CISG systems in the MY 2016 fleet. Many manufacturers offer some combination of strong hybrids and plug-in hybrids, but only Toyota has sales in these categories approaching 10% of total sales volume. Most manufacturers have dabbled with commercializing electric vehicles, but only Tesla remains fully committed to pure battery electric vehicle technology. Vehicles with electrification technologies continue to form a small fraction of the total light duty fleet.

6 Manufacturer CAFE Capabilities

6.1 Overview

New CAFE and CO₂ standards will have a range of impacts. EPCA/EISA and NEPA require DOT to consider such impacts when making decisions about new CAFE standards, and the CAA requires EPA to do so when making decisions about new emissions standards. Like past rulemakings, today’s announcement is supported by the analysis of many potential impacts of new standards. Today’s announcement proposes new standards through model year 2026, explicitly estimates manufacturers’ responses to standards through model year 2030, and considers impacts through calendar year 2050. It is not known today what would actually come to pass decades from now under the proposed standards or under any of alternatives under consideration. The analysis is thus properly interpreted not as a forecast, but rather as an assessment—reflecting in some cases best judgments regarding different factors—of impacts that could occur.⁴¹⁸ As discussed below, the analysis explores the sensitivity of this assessment to a variety of potential changes in key analytical inputs (e.g., fuel prices).

This section summarizes various impacts of the preferred alternative (i.e., the proposed standards) defined above in Chapter 3.5.1. and Chapter 3.5.2. The no-action alternative defined in Chapter 3.5.3. provides the baseline relative to which all impacts are shown. Because the proposed standards (and other standards considered below), being of a “deregulatory” nature, are less stringent than the no-action alternative, all impacts are directionally opposite impacts reported in recent CAFE and CO₂ rulemakings. For example, while past rulemakings reported positive values for fuel consumption avoided under new standards, today’s announcement reports negative values, as fuel consumption will be somewhat greater under today’s proposed standards than under standards defining the baseline no-action alternative. Reported negative values for avoided fuel consumption could also be properly interpreted as simply “additional fuel consumption.” Similarly, reported negative values for costs could be properly interpreted as “avoided costs” or “benefits,” and reported negative values for benefits could be properly interpreted as “foregone benefits” or “costs.” However, today’s notice retains reporting conventions consistent with past rulemakings, anticipating that, compared to other options, doing so will facilitate review by most stakeholders.

Today’s analysis presents individual model year results two different ways. The first way is similar to past rulemakings and shows how manufacturers could respond in each model year under the proposed standards and each alternative covering MYs 2021/2-2026. The second, expanding on the information provided in past rulemakings, evaluates incremental impacts of new standards proposed for each model year, in turn. In past rulemaking analyses, NHTSA modeled year-by-year impacts under the aggregation of standards applied in all model years, and EPA modeled manufacturers’ hypothetical compliance with a single model years’ standards in that model year. Especially considering multiyear planning effects, neither approach provides a

⁴¹⁸ “Prediction is very difficult, especially if it’s about the future.” Attributed to Niels Bohr, Nobel laureate in Physics.

*** EO 12866 Review – Draft – Do Not Cite, Quote or Release During Review ***

clear basis to attribute impacts to specific standards first introduced in each of a series of model years. For example, of the technology manufacturers applied in MY 2016, some would have been applied even under the MY 2014 standards, and some was likely applied to position manufacturers toward compliance with (including credit banking to be used toward) MY 2018 standards. Therefore, of the impacts attributable to the model year 2016 fleet, only a portion can be properly attributed to the MY 2016 standards, and the impacts of the MY 2016 standards involve fleets leading up and extending well beyond MY 2016. Considering this, the proposed standards were examined on an incremental basis, modeling each new model year's standards over the entire span of included model years, using those results as a baseline relative to which to measure impacts attributable to the next model year's standards. For example, incremental costs attributable to the standards proposed today for MY 2023 are calculated as follows -

$$COST_{Proposed,MY\ 2023} = (COST_{Proposed_through_MY\ 2023} - COST_{No-Action_through_MY\ 2023}) - (COST_{Proposed_through_MY\ 2022} - COST_{No-Action_through_MY\ 2022})$$

where

$COST_{Proposed,MY\ 2023}$ - Incremental technology cost during MYs 2017-2030 and attributable to the standards proposed for MY 2023.

$COST_{Proposed_through_MY\ 2022}$ - Technology cost for MYs 2017-2030 under standards proposed through MY 2022.

$COST_{Proposed_through_MY\ 2023}$ - Technology cost for MYs 2017-2030 under standards proposed through MY 2023.

$COST_{No-Action_through_MY\ 2022}$ - Technology cost for MYs 2017-2030 under no-action alternative standards through MY 2022.

$COST_{No-Action_through_MY\ 2023}$ - Technology cost for MYs 2017-2030 under no-action alternative standards through MY 2023.

Additionally, today's analysis includes impacts on new vehicle sales volumes and the use (i.e., survival) of vehicles of all model years, such that standards introduced in a model year produce impacts attributable to vehicles having been in operation for some time. For example, as modeled here, standards for MY 2021 will impact the prices of new vehicles starting in MY 2017, and those price impacts will affect the survival of all vehicles still in operation in calendar years 2017 and beyond (e.g., MY 2021 standards impact the operation of MY 2007 vehicles in calendar year 2027). Therefore, while past rulemaking analyses focused largely on impacts over the useful lives of the explicitly modeled fleets, much of today's analysis considers all model years through 2029, as operated through calendar year 2050. For some impacts, such as on technology penetration rates, average vehicle prices, and average vehicle ownership costs, this analysis focused on the useful life of the MY 2030 fleet, as the simulation of manufacturers' technology

application and credit use (when included in the analysis) continues to evolve after model year 2026, stabilizing by model year 2030.

The analysis evaluated effects from four perspectives - the social perspective, the manufacturer perspective, the private perspective, and the physical perspective. The social perspective focuses on economic benefits and costs, setting aside economic transfers such as fuel taxes but including economic externalities such as the social cost of CO₂ emissions. The manufacturer perspective focuses on average requirements and levels of performance (i.e., average fuel economy level and CO₂ emission rates), compliance costs, and degrees of technology application. The private perspective focuses on costs of vehicle purchase and ownership, including outlays for fuel (and fuel taxes). The physical perspective focuses on national-scale highway travel, fuel consumption, highway fatalities, and greenhouse gas and criteria pollutant emissions. have evaluated effects from four perspectives - the social perspective, the manufacturer perspective, the private perspective, and the physical perspective. The social perspective focuses on economic benefits and costs, setting aside economic transfers such as fuel taxes but including economic externalities such as the social cost of CO₂ emissions. The manufacturer perspective focuses on average requirements and levels of performance (i.e., average fuel economy level and CO₂ emission rates), compliance costs, and degrees of technology application. The private perspective focuses on costs of vehicle purchase and ownership, including outlays for fuel (and fuel taxes). The physical perspective focuses on national-scale highway travel, fuel consumption, highway fatalities, and greenhouse gas and criteria pollutant emissions.

For the social perspective, the following effects are summarized for model years through 2029 as operated through calendar year 2050:

- Technology Costs - Incremental cost, as expected to be paid by vehicle purchasers, of fuel-saving technology beyond that added under the no-action alternative.
- Welfare Loss - Loss of value to vehicle owners resulting from incremental increases in the numbers of strong and plug-in hybrid electric vehicles (strong HEVs or SHEVs, and PHEVs) and/or battery electric vehicles (BEVs), beyond increases occurring under the no-action alternative. The loss of value is a function of the factors that lead to different valuations for conventional and electric versions of similar-size vehicles (e.g., differences in - travel range, recharging time versus refueling time, performance, and comfort).
- Pre-tax Fuel Savings - Incremental savings, beyond those achieved under the no-action alternative, in outlays for fuel purchases, setting aside fuel taxes.
- Mobility Benefit - Value of incremental travel, beyond that occurring under the no-action alternative.
- Refueling Benefit - Value of incremental reduction, compared to the no-action alternative, of time spent refueling vehicles.
- Non-Rebound Fatality Costs - Social value of additional fatalities, beyond those occurring under the no-action alternative, setting aside any additional travel attributable to the rebound effect.

*** EO 12866 Review – Draft – Do Not Cite, Quote or Release During Review ***

- Rebound Fatality Costs - Social value of additional fatalities attributable to the rebound effect, beyond those occurring under the no-action alternative.
- Benefits Offsetting Rebound Fatality Costs - Assumed further value, offsetting rebound fatality costs, of additional travel attributed to the rebound effect.
- Non-Rebound Non-Fatal Crash Costs - Social value of additional crash-related losses (other than fatalities), beyond those occurring under the no-action alternative, setting aside any additional travel attributable to the rebound effect.
- Rebound Non-Fatal Crash Costs - Social value of additional crash-related losses (other than fatalities) attributable to the rebound effect, beyond those occurring under the no-action alternative.
- Benefits Offsetting Rebound Non-Fatal Crash Costs - Assumed further value, offsetting rebound non-fatal crash costs, of additional travel attributed to the rebound effect.
- Additional Congestion and Noise (Costs) - Value of additional congestion and noise resulting from incremental travel, beyond that occurring under the no-action alternative.
- Energy Security Benefit - Value of avoided economic exposure to petroleum price “shocks,” the avoided exposure resulting from incremental reduction of fuel consumption beyond that occurring under the no-action alternative.
- Avoided CO₂ Damages (Benefits) - Social value of incremental reduction of CO₂ emissions, compared to emissions occurring under the no-action alternative.
- Other Avoided GHG Damages (Benefits) - Social value of incremental reduction of GHG emissions other than CO₂, compared to emissions occurring under the no-action alternative.
- Other Avoided Pollutant Damages (Benefits) - Social value of incremental reduction of criteria pollutant emissions, compared to emissions occurring under the no-action alternative.
- Total Costs - Sum of incremental technology costs, welfare loss, fatality costs, non-fatal crash costs, and additional congestion and noise costs.
- Total Benefits - Sum of pretax fuel savings, mobility benefits, refueling benefits, Benefits Offsetting Rebound Fatality Costs, Benefits Offsetting Rebound Non-Fatal Crash Costs, energy security benefits, and benefits from reducing emissions of CO₂, other GHGs, and criteria pollutants.
- Net Benefits - Total benefits minus total costs.

For the manufacturer perspective, the following effects are summarized for the aggregation of model years 2017-2029:

- Average Required Fuel Economy - Average of manufacturers’ CAFE requirements for indicated fleet(s) and model year(s).
- Percent Change in Stringency from Baseline - Percentage difference between averages of fuel economy requirements under no-action and indicated alternatives.
- Average Required Fuel Economy - Industry-wide average of fuel economy levels achieved by indicated fleet(s) in indicated model year(s).
- Percent Change in Stringency from Baseline - Percentage difference between averages of fuel economy levels achieved under no-action and indicated alternatives.

*** EO 12866 Review – Draft – Do Not Cite, Quote or Release During Review ***

- Total Technology Costs (\$b) - Cost of fuel-saving technology beyond that applied under no-action alternative.
- Total Civil Penalties (\$b) - Cost of civil penalties beyond those levied under no-action alternative.
- Total Regulatory Costs (\$b) - Sum of technology costs and civil penalties.
- Sales Change (millions) - Change in number of vehicles produced for sale in U.S., relative to the number estimated to be produced under the no-action alternative.
- Revenue Change (\$b) - Change in total revenues from vehicle sales, relative to total revenues occurring under the no-action alternative.
- Curb Weight Reduction - Reduction of average curb weight, relative to MY 2016.
- Technology Penetration Rates - MY 2030 average technology penetration rate for indicated ten technologies (3 engine technologies, advanced transmissions, and 6 degrees of electrification).
- Average Required CO₂ - Average of manufacturers' CO₂ requirements for indicated fleet(s) and model year(s).
- Percent Change in Stringency from Baseline - Percentage difference between averages of CO₂ requirements under no-action and indicated alternatives.
- Average Achieved CO₂ - Average of manufacturers' CO₂ emission rates for indicated fleet(s) and model year(s).

For the private perspective, the following effects are summarized for the MY 2030 fleet:

- Average Price Increase - Average increase in vehicle price, relative to the average occurring under the no-action alternative.
- Welfare Loss (Costs) - Average loss of value to vehicle owners resulting from incremental increases in the numbers of strong HEVs, PHEVs) and/or BEVs, beyond increases occurring under the no-action alternative. The loss of value is a function of the factors that lead to different valuations for conventional and electric versions of similar-size vehicles (e.g., differences in - travel range, recharging time versus refueling time, performance, and comfort).
- Ownership Costs - Average increase in some other costs of vehicle ownership (taxes, fees, financing), beyond increase occurring under no-action alternative.
- Fuel Savings - Average of fuel outlays (including taxes) avoided vehicles' useful lives, compared to outlays occurring under no-action alternative.
- Mobility Benefit - Average incremental value of additional travel over average vehicles' useful lives, compared to travel occurring under no-action alternative.
- Refueling Benefit - Average incremental value of avoided time spent refueling over average vehicles' useful lives, compared to time spent refueling under no-action alternative.
- Total Costs - Sum of average price increase, welfare loss, and ownership costs.
- Total Benefits - Sum of fuel savings, mobility benefit, and refueling benefit.
- Net Benefits - Total benefits minus total costs.

For the physical perspective, the following effects are summarized for model years through 2029 as operated through calendar year 2050:

*** EO 12866 Review – Draft – Do Not Cite, Quote or Release During Review ***

- Greenhouse gases include carbon dioxide (CO₂), methane (CH₄), and nitrous oxide (N₂O), and values are reported separately for vehicles (tailpipe) and upstream processes (combining fuel production, distribution, and delivery) and shown as reductions relative to the no-action alternative.
- Criteria pollutants include carbon monoxide (CO), volatile organic compounds (VOC), nitrogen oxides (NO_x), sulfur dioxide (SO₂) and particulate matter (PM), and values are shown as reductions relative to the no-action alternative.
- Fuel consumption aggregates all fuels, with electricity, hydrogen, and compressed natural gas (CNG) included on a gasoline-equivalent-gallon (GEG) basis, and values are shown as reductions relative to the no-action alternative.
- VMT, with rebound (billion miles) - Increase in highway travel (as vehicle miles traveled), relative to the no-action alternative, and including the rebound effect.
- VMT, without rebound (billion miles) - Increase in highway travel (as vehicle miles traveled), relative to the no-action alternative, and excluding the rebound effect.
- Fatalities, with rebound - Increase in highway fatalities, relative to the no-action alternative, and including the rebound effect.
- Fatalities, without rebound - Increase in highway fatalities, relative to the no-action alternative, and excluding the rebound effect.
- Fuel Consumption, with rebound (billion gallons) - Reduction of fuel consumption, relative to the no-action alternative, and including the rebound effect.
- Fuel Consumption, without rebound (billion gallons) - Reduction of fuel consumption, relative to the no-action alternative, and excluding the rebound effect.

Below, this chapter tabulates results for each of these four perspectives and does so separately for the proposed CAFE and CO₂ standards. More detailed results are presented in the Preliminary Regulatory Impact Analysis (PRIA) accompanying today's notice, and additional and more detailed analysis of environmental impacts is provided for CAFE regulatory alternatives in the corresponding Draft Environmental Impact Statement (DEIS). Underlying CAFE model output files are available (along with input files, model, source code, and documentation) on NHTSA's web site.⁴¹⁹ Summarizing and tabulating results for presentation here involved considerable "off model" calculations (e.g., to combine results for selected model years and calendar years, and to combine various components of social and private costs and benefits); tools Volpe Center staff used to perform these calculations are also available on NHTSA's web site.⁴²⁰

While the National Environmental Policy Act (NEPA) requires NHTSA to prepare an EIS documenting estimating environmental impacts of the regulatory alternatives under consideration in CAFE rulemakings, NEPA does not require EPA to do so for EPA rulemakings. CO₂ standards for each regulatory alternative being harmonized as practical with corresponding CAFE standards, environmental impacts of CO₂ standards should be directionally identical and

⁴¹⁹ <https://www.nhtsa.gov/corporate-average-fuel-economy/compliance-and-effects-modeling-system>.

⁴²⁰ These tools, available at the same location, are scripts executed using R, a free software environment for statistical computing. R is available through <https://www.r-project.org/>.

*** EO 12866 Review – Draft – Do Not Cite, Quote or Release During Review ***

similar in magnitude to those of CAFE standards. Nevertheless, in this chapter, following the series of tables below, today’s announcement provides a more detailed analysis of estimated impacts of the proposed CAFE and CO₂ standards. Results presented herein for the CAFE standards differ slightly from those presented in the DEIS; while, as discussed above, EPCA/EISA requires that the Secretary determine the maximum feasible levels of CAFE standards in manner that, as presented here, sets aside the potential use of CAFE credits or application of alternative fuels toward compliance with new standards, NEPA does not impose such constraints on analysis presented corresponding DEISs, and the DEIS presents results of an “unconstrained” analysis that considers manufacturers’ potential application of alternative fuels and use of CAFE credits.

Similarly, results presented herein for the CO₂ standards differ slightly from those presented for CAFE standards in the DEIS, because CAFE and CO₂ regulatory provisions produce some differences in estimated impacts. For example, EPA has not adopted the EPCA/EISA caps on credit transfers between regulated fleets, or EPCA/EISA’s approach to penalizing noncompliance.

As mentioned above, this analysis was conducted to examine the sensitivity of results to changes in key inputs. Following the detailed consideration of potential environmental impacts, this chapter concludes with a tabular summary of results of this sensitivity analysis.

6.2 Impacts of Proposed Standards on Requirements, Performance, and Costs to Manufacturers in Specific Model Years

As mentioned above, this analysis presents impacts from two different perspectives for today’s proposal. From either perspective, overall impacts are the same. The first perspective, following the approach taken by NHTSA in past CAFE rulemakings, examines impacts of the overall proposal — i.e., the entire series of year-by-year standards — on each model year. This perspective is especially relevant to understanding how the overall proposal may impact manufacturers in terms of year-by-year compliance, technology pathways, and costs. The second, presented below provides a clearer characterization of the incremental impacts attributable to standards introduced in each successive model year.

Part 1 below reviews estimates from the CAFE model. Table -1 and

*** EO 12866 Review – Draft – Do Not Cite, Quote or Release During Review ***

Table 6-2 present estimated required and achieved fuel economy by manufacturer and model year under the baseline (no-action) and preferred alternatives. Table 6-3 and 6-4 present regulatory costs and average vehicle price increases, respectively, by manufacturer and model year. Table 6-5 provides summary estimates of impacts on technology costs, average vehicle prices, sales, and labor utilization.

Table 6-6 through Table 6-21 provide estimated technology penetration, with a focus on estimates by manufacturer. In Part 2, the analysis from Part 1 is repeated under EPA's CO₂ Program rather than the CAFE Model.

*** EO 12866 Review – Draft – Do Not Cite, Quote or Release During Review ***

6.2.1 CAFE Standards

TABLE 6-1 - REQUIRED AND ACHIEVED CAFE LEVELS IN MYS 2016-2029 UNDER BASELINE CAFE STANDARDS (NO-ACTION ALTERNATIVE)

Manufacturer		2016	2017	2018	2019	2020	2021	2022	2023	2024	2025	2026	2027	2028	2029
BMW	Required	34.3	36.0	37.2	38.3	39.7	41.7	43.6	45.7	47.8	50.1	50.0	50.0	50.0	50.0
BMW	Achieved	32.4	34.3	35.3	36.5	37.0	37.0	37.5	37.8	37.9	37.9	38.1	38.1	38.1	38.1
Daimler	Required	33.4	34.8	35.8	36.9	38.2	40.2	42.1	44.0	46.1	48.2	48.2	48.2	48.1	48.1
Daimler	Achieved	31.2	32.9	32.9	35.3	35.4	35.9	36.4	36.7	36.8	36.8	36.9	36.9	36.9	36.9
Fiat Chrysler	Required	30.9	31.9	32.7	33.3	34.3	36.4	38.1	39.9	41.7	43.7	43.7	43.6	43.6	43.6
Fiat Chrysler	Achieved	27.9	30.0	33.5	35.5	35.9	38.1	38.8	39.8	39.7	40.5	43.7	43.7	43.9	44.1
Ford	Required	30.9	31.9	32.5	33.2	34.0	35.9	37.6	39.4	41.2	43.1	43.0	43.0	42.9	42.9
Ford	Achieved	29.7	31.3	31.6	32.0	36.9	40.5	42.2	42.3	43.0	43.1	43.1	43.3	43.2	43.2
General Motors	Required	30.8	31.7	32.3	33.1	34.0	35.8	37.5	39.2	41.1	43.0	43.0	42.9	42.9	42.9
General Motors	Achieved	28.9	30.2	32.4	34.5	36.3	39.9	40.6	41.1	41.4	42.9	43.1	43.1	43.1	43.1
Honda	Required	34.3	35.8	36.8	38.0	39.2	41.3	43.3	45.3	47.4	49.6	49.6	49.6	49.6	49.6
Honda	Achieved	36.7	39.0	40.8	41.5	41.7	44.0	47.2	49.2	49.5	49.6	49.7	49.9	50.1	50.1
Hyundai	Required	36.7	38.7	40.1	41.6	43.2	45.1	47.2	49.4	51.7	54.2	54.2	54.2	54.2	54.2
Hyundai	Achieved	39.0	41.8	43.0	44.9	45.8	49.5	52.4	53.0	54.1	54.2	54.4	54.4	54.3	54.3
Kia	Required	35.3	37.1	38.3	39.6	41.0	43.0	45.0	47.1	49.3	51.7	51.6	51.6	51.6	51.6
Kia	Achieved	35.1	36.8	38.9	40.1	41.8	47.4	48.7	50.2	52.2	52.4	52.4	52.7	52.7	52.7
Jaguar/Land Rover	Required	30.2	30.9	31.6	32.3	33.2	35.4	37.0	38.8	40.6	42.5	42.5	42.5	42.5	42.5
Jaguar/Land Rover	Achieved	26.0	27.3	27.9	28.8	29.3	30.7	30.9	31.3	31.3	31.6	31.6	31.6	31.6	31.7
Mazda	Required	35.1	36.8	37.9	39.1	40.4	42.6	44.6	46.7	48.9	51.1	51.1	51.1	51.1	51.1

*** EO 12866 Review – Draft – Do Not Cite, Quote or Release During Review ***

Mazda	Achieved	38.8	39.4	42.9	43.4	44.7	44.9	45.8	52.3	52.5	52.6	52.6	52.6	52.6	52.6
Nissan Mitsubishi	Required	34.9	36.5	37.6	38.9	40.2	42.3	44.3	46.3	48.5	50.8	50.8	50.7	50.6	50.6
Nissan Mitsubishi	Achieved	37.0	38.2	38.7	41.2	43.7	47.6	49.1	49.9	51.1	52.3	52.4	52.4	52.4	52.4
Subaru	Required	33.9	35.3	36.3	37.3	38.4	40.7	42.7	44.6	46.8	49.0	49.0	49.0	48.9	48.9
Subaru	Achieved	36.5	40.0	40.0	40.3	41.7	47.5	48.8	49.1	49.1	49.1	49.3	49.5	49.5	49.5
Tesla	Required	31.5	32.6	33.4	34.4	35.4	37.1	38.8	40.6	42.5	44.5	44.5	44.5	44.4	44.4
Tesla	Achieved	228.5	260.2	259.6	259.8	260.6	260.5	260.4	260.3	260.2	260.1	260.1	259.8	259.6	259.6
Toyota	Required	33.4	34.7	35.6	36.6	37.7	39.8	41.6	43.6	45.6	47.7	47.7	47.7	47.6	47.6
Toyota	Achieved	33.0	33.9	36.7	38.4	42.0	46.0	46.5	46.6	47.6	47.9	48.4	48.4	48.4	48.5
Volvo	Required	31.6	32.6	33.4	34.3	35.4	37.5	39.2	41.0	43.0	45.0	45.0	45.0	44.9	44.9
Volvo	Achieved	31.4	32.3	32.3	34.9	34.9	34.9	35.0	35.9	36.1	36.1	36.1	36.4	36.4	36.4
VWA	Required	36.0	37.7	39.0	40.3	41.7	43.8	45.8	47.9	50.2	52.5	52.5	52.5	52.5	52.5
VWA	Achieved	34.7	38.8	42.3	43.5	45.7	46.4	48.5	49.8	53.3	54.8	55.0	55.1	55.2	55.2
Ave./Total	Required	32.8	34.0	34.9	35.8	36.9	39.0	40.8	42.7	44.7	46.8	46.7	46.7	46.7	46.6
Ave./Total	Achieved	32.2	33.9	35.8	37.3	39.4	42.4	43.7	44.5	45.1	45.7	46.3	46.3	46.4	46.4

*** EO 12866 Review – Draft – Do Not Cite, Quote or Release During Review ***

**TABLE 6-2 - REQUIRED AND ACHIEVED FUEL ECONOMY LEVELS IN MYS 2016-2029 UNDER PROPOSED CAFE STANDARDS
(PREFERRED ALTERNATIVE)**

Manufacturer		2016	2017	2018	2019	2020	2021	2022	2023	2024	2025	2026	2027	2028	2029
BMW	Required	34.3	36.0	37.2	38.3	39.7	39.7	39.7	39.7	39.7	39.7	39.8	39.8	39.7	39.8
BMW	Achieved	32.4	34.3	35.2	36.4	36.9	36.9	37.3	37.6	37.8	37.8	38.0	38.0	38.1	38.1
Daimler	Required	33.4	34.8	35.8	36.9	38.2	38.2	38.2	38.2	38.2	38.2	38.2	38.2	38.2	38.2
Daimler	Achieved	31.2	32.9	32.9	35.3	35.4	35.9	36.3	36.6	36.7	36.7	36.9	36.9	36.9	36.9
Fiat Chrysler	Required	30.9	31.9	32.7	33.3	34.3	34.3	34.3	34.3	34.3	34.3	34.3	34.3	34.3	34.3
Fiat Chrysler	Achieved	27.9	29.8	32.0	32.5	32.8	33.8	34.1	34.4	34.4	34.6	35.6	35.6	35.7	35.8
Ford	Required	30.9	31.9	32.5	33.2	34.0	33.9	34.0	34.0	34.0	34.0	34.0	34.0	34.0	34.0
Ford	Achieved	29.7	31.3	31.4	31.6	34.2	34.8	35.0	35.1	35.2	35.2	35.3	35.4	35.4	35.4
General Motors	Required	30.8	31.7	32.3	33.1	34.0	33.9	34.0	34.0	34.0	34.0	34.0	34.0	34.0	34.0
General Motors	Achieved	28.9	30.1	31.5	32.7	34.0	35.5	35.6	35.6	35.7	36.1	36.3	36.3	36.3	36.3
Honda	Required	34.3	35.8	36.8	38.0	39.2	39.2	39.2	39.2	39.2	39.2	39.3	39.3	39.2	39.3
Honda	Achieved	36.7	37.9	38.8	39.3	39.4	39.6	41.3	42.1	42.1	42.2	42.2	42.6	42.6	42.6
Hyundai	Required	36.7	38.7	40.1	41.6	43.2	43.2	43.2	43.2	43.2	43.2	43.2	43.2	43.2	43.2
Hyundai	Achieved	39.0	41.8	43.0	44.6	45.4	47.8	48.3	48.4	48.5	48.5	48.8	48.8	48.8	48.8
Kia	Required	35.3	37.1	38.3	39.6	41.0	41.0	41.0	41.0	41.0	41.0	41.0	41.0	41.0	41.0
Kia	Achieved	35.1	36.8	38.8	40.0	41.0	44.4	44.5	45.3	46.2	46.2	46.3	46.5	46.5	46.5
Jaguar/Land Rover	Required	30.2	30.9	31.6	32.3	33.2	33.2	33.2	33.2	33.2	33.2	33.2	33.2	33.2	33.2
Jaguar/Land Rover	Achieved	26.0	27.3	27.9	28.8	29.3	30.7	30.9	31.3	31.3	31.6	31.6	31.6	31.6	31.7
Mazda	Required	35.1	36.8	37.9	39.1	40.4	40.4	40.4	40.4	40.5	40.5	40.5	40.5	40.5	40.5
Mazda	Achieved	38.8	39.4	42.1	42.6	43.0	43.1	43.2	43.6	43.6	43.7	43.7	43.7	44.0	44.0
Nissan Mitsubishi	Required	34.9	36.5	37.6	38.9	40.2	40.2	40.2	40.2	40.2	40.2	40.3	40.3	40.3	40.3
Nissan Mitsubishi	Achieved	37.0	38.2	38.7	40.1	42.1	43.1	43.8	44.0	44.1	44.2	44.3	44.3	44.3	44.3
Subaru	Required	33.9	35.3	36.3	37.3	38.4	38.4	38.4	38.4	38.4	38.4	38.4	38.4	38.4	38.4

*** EO 12866 Review – Draft – Do Not Cite, Quote or Release During Review ***

Subaru	Achieved	36.5	39.9	39.9	40.2	40.6	42.4	42.6	42.7	42.7	42.7	43.2	43.3	43.3	43.3
Tesla	Required	31.5	32.6	33.4	34.4	35.4	35.1	35.1	35.1	35.1	35.2	35.2	35.2	35.2	35.2
Tesla	Achieved	228.5	260.2	259.6	259.8	260.6	260.5	260.6	260.6	260.6	260.8	261.0	260.9	260.9	260.9
Toyota	Required	33.4	34.7	35.6	36.6	37.7	37.7	37.7	37.7	37.7	37.8	37.8	37.8	37.8	37.8
Toyota	Achieved	33.0	33.9	36.2	37.6	39.5	41.0	41.4	41.4	41.6	41.7	42.2	42.2	42.2	42.2
Volvo	Required	31.6	32.6	33.4	34.3	35.4	35.3	35.4	35.4	35.4	35.4	35.4	35.4	35.4	35.4
Volvo	Achieved	31.4	32.3	32.3	34.9	34.9	34.9	34.9	35.8	35.9	35.9	35.9	36.3	36.3	36.3
VWA	Required	36.0	37.7	39.0	40.3	41.7	41.7	41.7	41.7	41.7	41.7	41.8	41.8	41.8	41.8
VWA	Achieved	34.7	37.9	40.1	40.9	42.2	42.3	42.9	43.0	43.0	43.1	43.2	43.2	43.2	43.3
Ave./Total	Required	32.8	34.0	34.9	35.8	36.9	36.9	36.9	36.9	37.0	37.0	37.0	37.0	37.0	37.0
Ave./Total	Achieved	32.2	33.7	35.0	36.0	37.2	38.3	38.7	39.0	39.1	39.2	39.5	39.6	39.6	39.7

*** EO 12866 Review – Draft – Do Not Cite, Quote or Release During Review ***

TABLE 6-3 - UNDISCOUNTED REGULATORY COSTS (\$B) IN MYS 2017-2029 UNDER BASELINE AND PROPOSED CAFE STANDARDS

Manufacturer		2017	2018	2019	2020	2021	2022	2023	2024	2025	2026	2027	2028	2029	Sum
BMW	Costs under Baseline	0.0	0.1	0.1	0.2	0.2	0.3	0.3	0.3	0.4	0.4	0.4	0.4	0.4	3.4
BMW	Chg. under Proposal	-	0.0	0.0	0.0	0.0	-0.1	-0.1	-0.2	-0.2	-0.2	-0.2	-0.2	-0.2	-1.5
Daimler	Costs under Baseline	0.1	0.1	0.2	0.2	0.2	0.3	0.3	0.3	0.4	0.4	0.4	0.4	0.4	3.4
Daimler	Chg. under Proposal	-	-	-	-	0.0	-0.1	-0.1	-0.1	-0.2	-0.2	-0.2	-0.2	-0.2	-1.2
Fiat Chrysler	Costs under Baseline	1.1	3.3	5.1	5.1	6.2	6.6	7.2	7.1	7.7	9.5	9.3	9.4	9.3	86.8
Fiat Chrysler	Chg. under Proposal	-0.6	-2.3	-3.7	-3.6	-4.5	-4.7	-5.2	-5.2	-5.7	-6.9	-6.8	-6.8	-6.7	-62.6
Ford	Costs under Baseline	0.2	0.5	1.2	5.4	7.9	8.7	8.5	8.7	8.4	8.2	8.1	7.9	7.8	81.6
Ford	Chg. under Proposal	0.0	-0.2	-0.7	-3.7	-6.2	-6.9	-6.7	-6.9	-6.7	-6.5	-6.4	-6.2	-6.1	-63.2
General Motors	Costs under Baseline	0.7	2.7	4.2	5.0	7.5	8.2	8.5	8.5	9.9	9.7	9.6	9.5	9.3	93.2
General Motors	Chg. under Proposal	-0.3	-1.5	-2.7	-3.1	-5.3	-6.0	-6.3	-6.4	-7.6	-7.4	-7.3	-7.2	-7.0	-68.0
Honda	Costs under Baseline	0.3	0.6	0.7	0.8	1.7	2.8	3.8	3.9	3.9	3.8	3.9	3.9	3.8	33.9
Honda	Chg. under Proposal	-0.2	-0.4	-0.4	-0.4	-1.4	-2.3	-3.2	-3.3	-3.2	-3.2	-3.2	-3.2	-3.2	-27.6
Hyundai	Costs under Baseline	0.1	0.1	0.2	0.3	0.5	0.7	0.8	0.9	0.9	1.0	1.0	0.9	0.9	8.2
Hyundai	Chg. under Proposal	-	-	0.0	-0.1	-0.2	-0.4	-0.5	-0.7	-0.7	-0.7	-0.7	-0.7	-0.7	-5.2
Kia	Costs under Baseline	0.3	0.4	0.4	0.7	1.4	1.7	1.8	2.0	2.0	1.9	2.0	2.0	1.9	18.3

*** EO 12866 Review – Draft – Do Not Cite, Quote or Release During Review ***

Kia	Chg. under Proposal	0.0	0.0	0.0	-0.3	-0.8	-1.2	-1.3	-1.4	-1.4	-1.4	-1.4	-1.4	-1.4	-11.9
JLR	Costs under Baseline	0.1	0.1	0.1	0.1	0.2	0.2	0.2	0.3	0.3	0.3	0.3	0.3	0.3	2.8
JLR	Chg. under Proposal	-	-	-	-	0.0	-0.1	-0.1	-0.1	-0.1	-0.1	-0.1	-0.1	-0.1	-1.0
Mazda	Costs under Baseline	0.0	0.1	0.1	0.4	0.4	0.6	1.4	1.3	1.3	1.3	1.2	1.2	1.2	10.6
Mazda	Chg. under Proposal	-	-0.1	-0.1	-0.3	-0.3	-0.5	-1.3	-1.2	-1.2	-1.2	-1.1	-1.1	-1.1	-9.3
Nissan/Mitsubishi	Costs under Baseline	0.2	0.2	0.5	1.0	1.5	1.6	1.7	1.9	2.1	2.1	2.0	2.0	2.0	18.9
Nissan/Mitsubishi	Chg. under Proposal	-	0.0	-0.2	-0.3	-0.7	-0.8	-0.8	-1.0	-1.2	-1.2	-1.2	-1.2	-1.2	-9.9
Subaru	Costs under Baseline	0.3	0.3	0.3	0.6	1.0	1.1	1.1	1.1	1.0	1.0	1.0	1.0	1.0	11.0
Subaru	Chg. under Proposal	0.0	0.0	0.0	-0.2	-0.5	-0.7	-0.7	-0.7	-0.6	-0.6	-0.6	-0.6	-0.6	-5.9
Tesla	Costs under Baseline	0.0	0.0	0.0	0.0	0.0	0.0	0.0	0.0	0.0	0.0	0.0	0.0	0.0	0.0
Tesla	Chg. under Proposal	-	-	-	-	-	0.0	0.0	0.0	0.0	0.0	0.0	0.0	0.0	0.0
Toyota	Costs under Baseline	0.0	1.4	2.0	3.7	5.4	5.4	5.3	5.8	5.9	5.9	5.8	5.8	5.9	58.4
Toyota	Chg. under Proposal	0.0	-0.4	-0.7	-1.8	-3.2	-3.2	-3.2	-3.6	-3.7	-3.7	-3.6	-3.6	-3.6	-34.2
Volvo	Costs under Baseline	0.0	0.0	0.0	0.0	0.0	0.0	0.1	0.1	0.1	0.1	0.1	0.1	0.1	0.6
Volvo	Chg. under Proposal	-	-	0.0	0.0	0.0	0.0	0.0	0.0	0.0	0.0	0.0	0.0	0.0	-0.3
VWA	Costs under Baseline	0.9	1.5	1.6	2.0	2.0	2.3	2.5	2.9	3.0	2.9	2.8	2.8	2.7	29.9
VWA	Chg. under Proposal	-0.5	-0.9	-1.0	-1.1	-1.2	-1.4	-1.7	-2.1	-2.2	-2.1	-2.1	-2.0	-2.0	-20.2

*** EO 12866 Review – Draft – Do Not Cite, Quote or Release During Review ***

Ave./Total	Costs under Baseline	4.3	11.4	16.8	25.3	36.1	40.3	43.5	45.3	47.2	48.5	48.0	47.6	47.0	461.3	
Ave./Total	Chg. under Proposal	-1.6	-5.8	-9.4	-14.8	-24.3	-28.2	-31.1	-32.9	-34.8	-35.5	-35.0	-34.6	-34.1	-	322.2

TABLE 6-4 - AVERAGE PRICE INCREASES (\$) IN MYS 2017-2029 UNDER BASELINE AND PROPOSED CAFE STANDARDS

Manufacturer		2017	2018	2019	2020	2021	2022	2023	2024	2025	2026	2027	2028	2029
BMW	Costs under Baseline	57	211	342	405	489	615	722	826	931	932	922	912	902
BMW	Chg. under Proposal	-	-12	-12	-11	-100	-211	-319	-417	-527	-520	-510	-501	-495
Daimler	Costs under Baseline	187	256	433	506	613	732	832	935	1,034	1,035	1,024	1,013	1,006
Daimler	Chg. under Proposal	-	-	-	-	-101	-211	-312	-414	-520	-515	-509	-504	-500
Fiat Chrysler	Costs under Baseline	540	1,534	2,325	2,305	2,776	2,946	3,213	3,203	3,438	4,251	4,164	4,161	4,097
Fiat Chrysler	Chg. under Proposal	-296	-1,045	-1,690	-1,618	-2,010	-2,115	-2,314	-2,320	-2,538	-3,112	-3,029	-3,003	-2,938
Ford	Costs under Baseline	98	231	550	2,349	3,463	3,796	3,703	3,790	3,681	3,587	3,527	3,440	3,360
Ford	Chg. under Proposal	-1	-87	-314	-1,620	-2,690	-3,017	-2,939	-3,028	-2,931	-2,849	-2,779	-2,702	-2,631
General Motors	Costs under Baseline	270	1,000	1,542	1,837	2,730	2,977	3,086	3,115	3,594	3,547	3,501	3,437	3,358
General Motors	Chg. under Proposal	-97	-567	-1,004	-1,138	-1,920	-2,182	-2,296	-2,325	-2,777	-2,698	-2,662	-2,604	-2,534
Honda	Costs under Baseline	162	332	383	393	892	1,443	1,948	2,008	1,976	1,943	1,981	1,977	1,942
Honda	Chg. under Proposal	-127	-207	-208	-217	-697	-1,180	-1,633	-1,695	-1,666	-1,636	-1,647	-1,646	-1,614

*** EO 12866 Review – Draft – Do Not Cite, Quote or Release During Review ***

Hyundai	Costs under Baseline	87	152	257	330	628	911	991	1,223	1,237	1,286	1,271	1,258	1,246
Hyundai	Chg. under Proposal	-	-	-47	-93	-289	-555	-634	-865	-881	-919	-905	-893	-883
Kia	Costs under Baseline	342	470	511	875	1,741	2,145	2,319	2,567	2,535	2,480	2,539	2,483	2,433
Kia	Chg. under Proposal	-7	-7	-7	-330	-1,054	-1,474	-1,616	-1,836	-1,815	-1,769	-1,820	-1,772	-1,729
JLR	Costs under Baseline	182	252	333	372	621	705	811	893	1,006	993	981	970	970
JLR	Chg. under Proposal	-	-	-	-	-113	-196	-287	-377	-470	-465	-460	-455	-450
Mazda	Costs under Baseline	29	267	282	789	759	1,115	2,759	2,710	2,632	2,573	2,504	2,440	2,379
Mazda	Chg. under Proposal	-	-106	-102	-585	-556	-916	-2,530	-2,485	-2,410	-2,354	-2,287	-2,204	-2,145
Nissan/Mitsubishi	Costs under Baseline	113	153	356	703	1,016	1,107	1,166	1,293	1,422	1,403	1,391	1,384	1,371
Nissan/Mitsubishi	Chg. under Proposal	-	-2	-123	-175	-451	-520	-575	-716	-854	-846	-843	-846	-840
Subaru	Costs under Baseline	596	576	585	1,006	1,597	1,770	1,796	1,747	1,704	1,707	1,681	1,646	1,617
Subaru	Chg. under Proposal	-63	-58	-57	-381	-890	-1,074	-1,111	-1,077	-1,047	-1,022	-997	-972	-953
Tesla	Costs under Baseline	3	3	3	4	4	4	4	4	4	4	4	4	4
Tesla	Chg. under Proposal	-	-	-	-	-	0	0	0	0	0	0	0	0
Toyota	Costs under Baseline	18	555	774	1,443	2,086	2,090	2,076	2,267	2,315	2,316	2,280	2,270	2,277
Toyota	Chg. under Proposal	-2	-173	-259	-695	-1,247	-1,235	-1,232	-1,403	-1,464	-1,444	-1,418	-1,414	-1,427
Volvo	Costs under Baseline	45	75	194	231	330	415	566	666	759	749	763	754	746

*** EO 12866 Review – Draft – Do Not Cite, Quote or Release During Review ***

Volvo	Chg. under Proposal	-	-	-6	-6	-106	-195	-264	-364	-462	-456	-438	-431	-426
VWA	Costs under Baseline	1,537	2,618	2,742	3,275	3,342	3,776	4,211	4,839	4,954	4,838	4,755	4,672	4,552
VWA	Chg. under Proposal	-802	-1,564	-1,619	-1,897	-1,983	-2,383	-2,821	-3,490	-3,644	-3,561	-3,506	-3,444	-3,347
Ave./Total	Costs under Baseline	253	665	963	1,435	2,032	2,272	2,449	2,555	2,665	2,737	2,706	2,674	2,630
Ave./Total	Chg. under Proposal	-96	-337	-540	-839	-1,370	-1,591	-1,755	-1,862	-1,973	-2,011	-1,980	-1,950	-1,912

*** EO 12866 Review – Draft – Do Not Cite, Quote or Release During Review ***

TABLE 6-5 - TECHNOLOGY COSTS, AVERAGE PRICES, SALES, AND LABOR UTILIZATION UNDER BASELINE AND PROPOSED CAFE STANDARDS

MY	Costs (\$b) for Tech. (beyond MY 2016)				Average Vehicle Prices (\$)				Annual Sales (million units)				Labor (1000s of Job-Years)			
	Standards		Change		Standards		Change		Standards		Change		Standards		Change	
	Baseline	Proposed	Abs.	%	Baseline	Proposed	Abs.	%	Baseline	Proposed	Abs.	%	Baseline	Proposed	Abs.	%
2017	4	2	-2	-41%	32,322	32,226	-96	0%	16.83	16.83	-	0.00%	1,169	1,166	-3	0%
2018	11	5	-6	-53%	32,795	32,458	-337	-1%	17.19	17.19	-	0.00%	1,208	1,198	-10	-1%
2019	16	7	-10	-58%	33,067	32,527	-540	-2%	17.48	17.48	-	0.00%	1,237	1,220	-17	-1%
2020	25	10	-15	-60%	33,531	32,691	-839	-3%	17.66	17.66	-	0.00%	1,263	1,236	-27	-2%
2021	36	11	-24	-68%	34,138	32,767	-1,370	-4%	17.75	17.75	-	0.00%	1,293	1,244	-48	-4%
2022	40	12	-28	-70%	34,382	32,776	-1,606	-5%	17.76	17.79	0.03	0.20%	1,301	1,248	-53	-4%
2023	43	12	-31	-72%	34,575	32,785	-1,790	-5%	17.74	17.8	0.06	0.30%	1,306	1,249	-57	-4%
2024	44	12	-32	-73%	34,693	32,780	-1,913	-6%	17.73	17.83	0.11	0.60%	1,306	1,251	-55	-4%
2025	46	12	-34	-74%	34,809	32,765	-2,044	-6%	17.71	17.87	0.16	0.90%	1,309	1,253	-56	-4%
2026	48	13	-35	-73%	34,886	32,782	-2,104	-6%	17.7	17.9	0.2	1.10%	1,312	1,257	-56	-4%
2027	47	13	-34	-73%	34,880	32,784	-2,096	-6%	17.74	17.94	0.2	1.20%	1,315	1,260	-55	-4%
2028	47	13	-34	-73%	34,866	32,785	-2,081	-6%	17.81	17.97	0.16	0.90%	1,320	1,261	-58	-4%
2029	46	13	-34	-72%	34,829	32,774	-2,055	-6%	17.87	18.01	0.14	0.80%	1,323	1,264	-59	-4%
2030	46	13	-33	-72%	34,778	32,756	-2,021	-6%	17.92	18.03	0.11	0.60%	1,325	1,265	-60	-5%

*** EO 12866 Review – Draft – Do Not Cite, Quote or Release During Review ***

TABLE 6-6 - TECHNOLOGY PENETRATION UNDER BASELINE AND PROPOSED CAFE STANDARDS – INDUSTRY AVERAGE

Technology		2017	2018	2019	2020	2021	2022	2023	2024	2025	2026	2027	2028	2029
Curb Weight (lb.)	Baseline	3815	3792	3759	3725	3686	3667	3656	3647	3636	3622	3618	3613	3611
Curb Weight (lb.)	Proposal	3815	3798	3771	3741	3718	3706	3701	3693	3688	3675	3671	3669	3668
High CR NA Engines	Baseline	6%	10%	14%	18%	23%	25%	25%	26%	26%	26%	26%	26%	26%
High CR NA Engines	Proposal	6%	10%	12%	14%	16%	17%	17%	17%	17%	17%	17%	17%	17%
Turbo SI Engines	Baseline	27%	38%	41%	46%	54%	57%	59%	59%	59%	63%	63%	64%	64%
Turbo SI Engines	Proposal	25%	31%	32%	36%	39%	44%	46%	47%	48%	51%	51%	51%	51%
Dynamic Deac,	Baseline	0%	0%	3%	4%	5%	5%	5%	6%	6%	6%	6%	6%	6%
Dynamic Deac,	Proposal	0%	0%	0%	0%	0%	0%	0%	0%	0%	0%	0%	0%	0%
Adv. Transmission	Baseline	48%	65%	73%	82%	83%	81%	79%	77%	73%	71%	71%	72%	72%
Adv. Transmission	Proposal	48%	66%	75%	86%	92%	92%	93%	93%	93%	93%	93%	93%	93%
12V SS Systems	Baseline	12%	12%	13%	13%	12%	13%	15%	15%	14%	13%	13%	13%	13%
12V SS Systems	Proposal	13%	13%	13%	13%	13%	13%	13%	13%	14%	14%	14%	14%	14%
Mild HEVs	Baseline	2%	9%	14%	22%	30%	33%	35%	35%	33%	34%	34%	34%	34%
Mild HEVs	Proposal	0%	0%	0%	0%	0%	0%	0%	0%	0%	0%	0%	0%	0%
Strong HEVs	Baseline	3%	3%	4%	7%	11%	13%	16%	18%	22%	24%	24%	24%	24%
Strong HEVs	Proposal	2%	2%	2%	2%	2%	2%	2%	2%	2%	2%	2%	2%	2%
Plug-In HEVs	Baseline	0%	0%	0%	1%	1%	1%	1%	1%	1%	1%	1%	1%	1%
Plug-In HEVs	Proposal	0%	0%	0%	0%	0%	0%	0%	0%	0%	0%	0%	0%	0%
Dedicated EVs	Baseline	1%	1%	1%	1%	1%	1%	1%	1%	1%	1%	1%	1%	1%
Dedicated EVs	Proposal	1%	1%	1%	1%	1%	1%	1%	1%	1%	1%	1%	1%	1%
Fuel Cell Vehicles	Baseline	0%	0%	0%	0%	0%	0%	0%	0%	0%	0%	0%	0%	0%
Fuel Cell Vehicles	Proposal	0%	0%	0%	0%	0%	0%	0%	0%	0%	0%	0%	0%	0%

*** EO 12866 Review – Draft – Do Not Cite, Quote or Release During Review ***

TABLE 6-7 - TECHNOLOGY PENETRATION UNDER BASELINE AND PROPOSED CAFE STANDARDS – BMW

Technology		2017	2018	2019	2020	2021	2022	2023	2024	2025	2026	2027	2028	2029
Curb Weight (lb.)	Baseline	3835	3819	3749	3735	3735	3710	3686	3686	3686	3686	3689	3683	3683
Curb Weight (lb.)	Proposal	3835	3819	3749	3735	3735	3708	3683	3681	3680	3678	3679	3671	3670
High CR NA Engines	Baseline	0%	0%	0%	0%	0%	0%	0%	0%	0%	0%	0%	0%	0%
High CR NA Engines	Proposal	0%	0%	0%	0%	0%	0%	0%	0%	0%	0%	0%	0%	0%
Turbo SI Engines	Baseline	96%	96%	96%	96%	96%	96%	96%	96%	96%	96%	96%	96%	96%
Turbo SI Engines	Proposal	96%	96%	96%	96%	96%	96%	96%	96%	96%	96%	96%	96%	96%
Dynamic Deac,	Baseline	0%	0%	0%	0%	0%	0%	0%	0%	0%	0%	0%	0%	0%
Dynamic Deac,	Proposal	0%	0%	0%	0%	0%	0%	0%	0%	0%	0%	0%	0%	0%
Adv. Transmission	Baseline	80%	82%	82%	90%	90%	90%	90%	91%	91%	91%	91%	91%	91%
Adv. Transmission	Proposal	80%	82%	82%	90%	90%	90%	90%	91%	91%	91%	91%	91%	91%
12V SS Systems	Baseline	91%	91%	91%	91%	91%	91%	91%	91%	91%	91%	91%	91%	91%
12V SS Systems	Proposal	91%	91%	91%	91%	91%	91%	91%	91%	91%	91%	91%	91%	91%
Mild HEVs	Baseline	0%	0%	0%	0%	0%	0%	0%	0%	0%	0%	0%	0%	0%
Mild HEVs	Proposal	0%	0%	0%	0%	0%	0%	0%	0%	0%	0%	0%	0%	0%
Strong HEVs	Baseline	0%	0%	0%	0%	0%	0%	0%	0%	0%	0%	0%	0%	0%
Strong HEVs	Proposal	0%	0%	0%	0%	0%	0%	0%	0%	0%	0%	0%	0%	0%
Plug-In HEVs	Baseline	2%	2%	2%	2%	2%	2%	2%	2%	2%	2%	2%	2%	2%
Plug-In HEVs	Proposal	2%	2%	2%	2%	2%	2%	2%	2%	2%	2%	2%	2%	2%
Dedicated EVs	Baseline	1%	1%	1%	1%	1%	1%	1%	1%	1%	1%	1%	1%	1%
Dedicated EVs	Proposal	1%	1%	1%	1%	1%	1%	1%	1%	1%	1%	1%	1%	1%
Fuel Cell Vehicles	Baseline	0%	0%	0%	0%	0%	0%	0%	0%	0%	0%	0%	0%	0%
Fuel Cell Vehicles	Proposal	0%	0%	0%	0%	0%	0%	0%	0%	0%	0%	0%	0%	0%

*** EO 12866 Review – Draft – Do Not Cite, Quote or Release During Review ***

TABLE 6-8 - TECHNOLOGY PENETRATION UNDER BASELINE AND PROPOSED CAFE STANDARDS – DAIMLER

Technology		2017	2018	2019	2020	2021	2022	2023	2024	2025	2026	2027	2028	2029
Curb Weight (lb.)	Baseline	4129	4134	4058	4057	4037	3994	3976	3977	3978	3973	3976	3979	3980
Curb Weight (lb.)	Proposal	4129	4134	4058	4057	4037	3992	3971	3970	3968	3960	3960	3961	3960
High CR NA Engines	Baseline	0%	0%	0%	0%	0%	0%	0%	0%	0%	0%	0%	0%	0%
High CR NA Engines	Proposal	0%	0%	0%	0%	0%	0%	0%	0%	0%	0%	0%	0%	0%
Turbo SI Engines	Baseline	85%	85%	98%	98%	98%	98%	98%	98%	98%	98%	98%	98%	98%
Turbo SI Engines	Proposal	85%	85%	98%	98%	98%	98%	98%	98%	98%	98%	98%	98%	98%
Dynamic Deac,	Baseline	0%	0%	0%	0%	0%	0%	0%	0%	0%	0%	0%	0%	0%
Dynamic Deac,	Proposal	0%	0%	0%	0%	0%	0%	0%	0%	0%	0%	0%	0%	0%
Adv. Transmission	Baseline	13%	13%	59%	74%	83%	84%	85%	85%	85%	85%	85%	85%	85%
Adv. Transmission	Proposal	13%	13%	59%	74%	83%	84%	85%	85%	85%	85%	85%	85%	85%
12V SS Systems	Baseline	83%	82%	83%	83%	83%	83%	82%	82%	82%	82%	82%	82%	82%
12V SS Systems	Proposal	83%	82%	83%	83%	83%	83%	83%	83%	83%	83%	83%	83%	83%
Mild HEVs	Baseline	0%	0%	0%	0%	0%	0%	0%	0%	0%	0%	0%	0%	0%
Mild HEVs	Proposal	0%	0%	0%	0%	0%	0%	0%	0%	0%	0%	0%	0%	0%
Strong HEVs	Baseline	0%	0%	0%	0%	0%	0%	0%	0%	0%	0%	0%	0%	0%
Strong HEVs	Proposal	0%	0%	0%	0%	0%	0%	0%	0%	0%	0%	0%	0%	0%
Plug-In HEVs	Baseline	0%	0%	0%	0%	0%	0%	0%	0%	0%	0%	0%	0%	0%
Plug-In HEVs	Proposal	0%	0%	0%	0%	0%	0%	0%	0%	0%	0%	0%	0%	0%
Dedicated EVs	Baseline	0%	0%	0%	0%	0%	0%	0%	0%	0%	0%	0%	0%	0%
Dedicated EVs	Proposal	0%	0%	0%	0%	0%	0%	0%	0%	0%	0%	0%	0%	0%
Fuel Cell Vehicles	Baseline	0%	0%	0%	0%	0%	0%	0%	0%	0%	0%	0%	0%	0%
Fuel Cell Vehicles	Proposal	0%	0%	0%	0%	0%	0%	0%	0%	0%	0%	0%	0%	0%

*** EO 12866 Review – Draft – Do Not Cite, Quote or Release During Review ***

TABLE 6-9 - TECHNOLOGY PENETRATION UNDER BASELINE AND PROPOSED CAFE STANDARDS – FIAT CHRYSLER

Technology		2017	2018	2019	2020	2021	2022	2023	2024	2025	2026	2027	2028	2029
Curb Weight (lb.)	Baseline	4169	4118	4033	4011	3992	3975	3964	3964	3950	3906	3907	3868	3862
Curb Weight (lb.)	Proposal	4169	4137	4073	4051	4033	4015	4009	4008	4007	3984	3984	3965	3965
High CR NA Engines	Baseline	0%	0%	0%	0%	0%	0%	0%	0%	0%	0%	0%	0%	0%
High CR NA Engines	Proposal	0%	0%	0%	0%	0%	0%	0%	0%	0%	0%	0%	0%	0%
Turbo SI Engines	Baseline	16%	40%	43%	42%	48%	48%	52%	52%	52%	80%	81%	82%	82%
Turbo SI Engines	Proposal	16%	32%	32%	32%	36%	36%	40%	40%	40%	59%	60%	61%	61%
Dynamic Deac,	Baseline	0%	0%	13%	13%	15%	15%	15%	15%	15%	15%	15%	15%	15%
Dynamic Deac,	Proposal	0%	0%	0%	0%	0%	0%	0%	0%	0%	0%	0%	0%	0%
Adv. Transmission	Baseline	62%	82%	78%	84%	79%	73%	66%	66%	59%	43%	43%	44%	44%
Adv. Transmission	Proposal	64%	85%	85%	91%	95%	94%	95%	95%	95%	95%	95%	95%	95%
12V SS Systems	Baseline	12%	13%	11%	11%	11%	11%	10%	10%	5%	0%	0%	0%	0%
12V SS Systems	Proposal	12%	13%	12%	12%	12%	12%	12%	12%	14%	14%	14%	14%	14%
Mild HEVs	Baseline	3%	23%	37%	37%	37%	37%	37%	37%	39%	43%	43%	44%	44%
Mild HEVs	Proposal	0%	0%	0%	0%	1%	1%	1%	1%	1%	1%	1%	1%	1%
Strong HEVs	Baseline	4%	4%	8%	8%	17%	23%	30%	29%	37%	53%	53%	52%	52%
Strong HEVs	Proposal	0%	0%	0%	0%	1%	2%	2%	2%	2%	2%	2%	2%	2%
Plug-In HEVs	Baseline	0%	0%	0%	0%	1%	1%	1%	1%	1%	1%	1%	1%	1%
Plug-In HEVs	Proposal	0%	0%	0%	0%	0%	0%	0%	0%	0%	0%	0%	0%	0%
Dedicated EVs	Baseline	0%	0%	0%	0%	0%	0%	0%	0%	0%	0%	0%	0%	0%
Dedicated EVs	Proposal	0%	0%	0%	0%	0%	0%	0%	0%	0%	0%	0%	0%	0%
Fuel Cell Vehicles	Baseline	0%	0%	0%	0%	0%	0%	0%	0%	0%	0%	0%	0%	0%
Fuel Cell Vehicles	Proposal	0%	0%	0%	0%	0%	0%	0%	0%	0%	0%	0%	0%	0%

*** EO 12866 Review – Draft – Do Not Cite, Quote or Release During Review ***

TABLE 6-10 - TECHNOLOGY PENETRATION UNDER BASELINE AND PROPOSED CAFE STANDARDS – FORD

Technology		2017	2018	2019	2020	2021	2022	2023	2024	2025	2026	2027	2028	2029
Curb Weight (lb.)	Baseline	4038	4039	4035	3923	3913	3890	3892	3886	3884	3884	3866	3869	3870
Curb Weight (lb.)	Proposal	4038	4039	4035	3937	3927	3911	3911	3901	3896	3893	3870	3870	3869
High CR NA Engines	Baseline	3%	3%	3%	3%	3%	3%	3%	3%	3%	3%	3%	3%	3%
High CR NA Engines	Proposal	3%	3%	3%	3%	3%	3%	3%	3%	3%	3%	3%	3%	3%
Turbo SI Engines	Baseline	46%	48%	55%	76%	89%	94%	95%	96%	97%	97%	97%	97%	97%
Turbo SI Engines	Proposal	46%	46%	54%	67%	68%	68%	68%	68%	68%	68%	68%	68%	68%
Dynamic Deac,	Baseline	0%	0%	0%	0%	0%	0%	0%	0%	0%	0%	0%	0%	0%
Dynamic Deac,	Proposal	0%	0%	0%	0%	0%	0%	0%	0%	0%	0%	0%	0%	0%
Adv. Transmission	Baseline	41%	47%	47%	70%	63%	58%	59%	56%	56%	56%	57%	57%	57%
Adv. Transmission	Proposal	41%	47%	47%	81%	85%	85%	86%	86%	86%	86%	86%	86%	86%
12V SS Systems	Baseline	8%	10%	10%	9%	2%	2%	2%	0%	0%	0%	0%	0%	0%
12V SS Systems	Proposal	8%	8%	8%	8%	8%	8%	8%	8%	8%	8%	8%	8%	8%
Mild HEVs	Baseline	0%	3%	11%	41%	59%	63%	63%	64%	64%	64%	64%	64%	64%
Mild HEVs	Proposal	0%	0%	0%	0%	0%	0%	0%	0%	0%	0%	0%	0%	0%
Strong HEVs	Baseline	2%	2%	2%	13%	24%	29%	29%	32%	32%	32%	32%	32%	32%
Strong HEVs	Proposal	2%	2%	2%	2%	2%	2%	2%	2%	2%	2%	2%	2%	2%
Plug-In HEVs	Baseline	1%	1%	1%	1%	1%	1%	1%	1%	1%	1%	1%	1%	1%
Plug-In HEVs	Proposal	1%	1%	1%	1%	1%	1%	1%	1%	1%	1%	1%	1%	1%
Dedicated EVs	Baseline	0%	0%	0%	0%	0%	0%	0%	0%	0%	0%	0%	0%	0%
Dedicated EVs	Proposal	0%	0%	0%	0%	0%	0%	0%	0%	0%	0%	0%	0%	0%
Fuel Cell Vehicles	Baseline	0%	0%	0%	0%	0%	0%	0%	0%	0%	0%	0%	0%	0%
Fuel Cell Vehicles	Proposal	0%	0%	0%	0%	0%	0%	0%	0%	0%	0%	0%	0%	0%

*** EO 12866 Review – Draft – Do Not Cite, Quote or Release During Review ***

TABLE 6-11 - TECHNOLOGY PENETRATION UNDER BASELINE AND PROPOSED CAFE STANDARDS – GENERAL MOTORS

Technology		2017	2018	2019	2020	2021	2022	2023	2024	2025	2026	2027	2028	2029
Curb Weight (lb.)	Baseline	4293	4244	4169	4151	4070	4061	4057	4045	4018	3996	4000	4001	4003
Curb Weight (lb.)	Proposal	4293	4253	4200	4187	4133	4128	4123	4110	4099	4071	4072	4072	4071
High CR NA Engines	Baseline	0%	0%	0%	0%	0%	0%	0%	0%	0%	0%	0%	0%	0%
High CR NA Engines	Proposal	0%	0%	0%	0%	0%	0%	0%	0%	0%	0%	0%	0%	0%
Turbo SI Engines	Baseline	27%	47%	52%	58%	67%	69%	69%	69%	70%	70%	70%	70%	70%
Turbo SI Engines	Proposal	27%	36%	36%	41%	49%	49%	50%	50%	61%	62%	62%	62%	62%
Dynamic Deac,	Baseline	0%	0%	12%	13%	22%	22%	22%	24%	27%	28%	28%	28%	28%
Dynamic Deac,	Proposal	0%	0%	0%	0%	0%	0%	0%	0%	0%	0%	0%	0%	0%
Adv. Transmission	Baseline	14%	45%	66%	82%	91%	86%	84%	82%	64%	64%	64%	66%	66%
Adv. Transmission	Proposal	14%	45%	66%	83%	95%	95%	95%	95%	95%	95%	95%	97%	97%
12V SS Systems	Baseline	16%	17%	18%	16%	10%	6%	5%	2%	0%	0%	0%	0%	0%
12V SS Systems	Proposal	15%	15%	15%	15%	15%	15%	15%	15%	15%	15%	15%	15%	15%
Mild HEVs	Baseline	6%	25%	38%	45%	72%	76%	81%	81%	66%	66%	66%	66%	66%
Mild HEVs	Proposal	0%	0%	0%	0%	0%	0%	0%	0%	0%	0%	0%	0%	0%
Strong HEVs	Baseline	0%	0%	0%	2%	6%	11%	13%	15%	33%	33%	33%	33%	33%
Strong HEVs	Proposal	0%	0%	0%	1%	1%	1%	1%	1%	1%	1%	1%	1%	1%
Plug-In HEVs	Baseline	0%	0%	0%	0%	0%	0%	0%	0%	0%	0%	0%	0%	0%
Plug-In HEVs	Proposal	0%	0%	0%	0%	0%	0%	0%	0%	0%	0%	0%	0%	0%
Dedicated EVs	Baseline	0%	0%	0%	0%	0%	0%	0%	0%	0%	0%	0%	0%	0%
Dedicated EVs	Proposal	0%	0%	0%	0%	0%	0%	0%	0%	0%	0%	0%	0%	0%
Fuel Cell Vehicles	Baseline	0%	0%	0%	0%	0%	0%	0%	0%	0%	0%	0%	0%	0%
Fuel Cell Vehicles	Proposal	0%	0%	0%	0%	0%	0%	0%	0%	0%	0%	0%	0%	0%

*** EO 12866 Review – Draft – Do Not Cite, Quote or Release During Review ***

TABLE 6-12 - TECHNOLOGY PENETRATION UNDER BASELINE AND PROPOSED CAFE STANDARDS – HONDA

Technology		2017	2018	2019	2020	2021	2022	2023	2024	2025	2026	2027	2028	2029
Curb Weight (lb.)	Baseline	3452	3421	3412	3411	3403	3361	3312	3306	3306	3303	3279	3271	3272
Curb Weight (lb.)	Proposal	3452	3432	3423	3422	3420	3416	3405	3404	3402	3400	3400	3401	3400
High CR NA Engines	Baseline	0%	0%	0%	0%	0%	0%	0%	0%	0%	0%	0%	0%	0%
High CR NA Engines	Proposal	0%	0%	0%	0%	0%	0%	0%	0%	0%	0%	0%	0%	0%
Turbo SI Engines	Baseline	29%	55%	58%	62%	83%	99%	100%	100%	100%	100%	100%	100%	100%
Turbo SI Engines	Proposal	6%	18%	21%	21%	21%	60%	76%	76%	76%	76%	76%	76%	76%
Dynamic Deac,	Baseline	0%	0%	0%	0%	0%	0%	0%	0%	0%	0%	0%	0%	0%
Dynamic Deac,	Proposal	0%	0%	0%	0%	0%	0%	0%	0%	0%	0%	0%	0%	0%
Adv. Transmission	Baseline	75%	87%	97%	97%	97%	97%	97%	97%	97%	97%	97%	97%	97%
Adv. Transmission	Proposal	75%	87%	97%	97%	97%	97%	97%	97%	97%	97%	97%	97%	97%
12V SS Systems	Baseline	6%	6%	6%	6%	12%	32%	49%	55%	55%	55%	55%	55%	55%
12V SS Systems	Proposal	6%	6%	6%	6%	6%	6%	6%	6%	6%	6%	6%	6%	6%
Mild HEVs	Baseline	0%	0%	0%	0%	0%	3%	13%	13%	13%	13%	13%	13%	13%
Mild HEVs	Proposal	0%	0%	0%	0%	0%	0%	0%	0%	0%	0%	0%	0%	0%
Strong HEVs	Baseline	0%	0%	0%	0%	0%	0%	0%	0%	0%	0%	0%	0%	0%
Strong HEVs	Proposal	0%	0%	0%	0%	0%	0%	0%	0%	0%	0%	0%	0%	0%
Plug-In HEVs	Baseline	0%	0%	0%	0%	0%	0%	0%	0%	0%	0%	0%	0%	0%
Plug-In HEVs	Proposal	0%	0%	0%	0%	0%	0%	0%	0%	0%	0%	0%	0%	0%
Dedicated EVs	Baseline	0%	0%	0%	0%	0%	0%	0%	0%	0%	0%	0%	0%	0%
Dedicated EVs	Proposal	0%	0%	0%	0%	0%	0%	0%	0%	0%	0%	0%	0%	0%
Fuel Cell Vehicles	Baseline	0%	0%	0%	0%	0%	0%	0%	0%	0%	0%	0%	0%	0%
Fuel Cell Vehicles	Proposal	0%	0%	0%	0%	0%	0%	0%	0%	0%	0%	0%	0%	0%

*** EO 12866 Review – Draft – Do Not Cite, Quote or Release During Review ***

TABLE 6-13 - TECHNOLOGY PENETRATION UNDER BASELINE AND PROPOSED CAFE STANDARDS – HYUNDAI

Technology		2017	2018	2019	2020	2021	2022	2023	2024	2025	2026	2027	2028	2029
Curb Weight (lb.)	Baseline	3157	3161	3148	3141	3099	3097	3089	3078	3077	3078	3079	3080	3081
Curb Weight (lb.)	Proposal	3157	3161	3159	3159	3159	3159	3158	3158	3156	3144	3144	3144	3144
High CR NA Engines	Baseline	7%	18%	25%	25%	55%	82%	82%	82%	82%	82%	81%	81%	81%
High CR NA Engines	Proposal	7%	18%	25%	25%	55%	58%	58%	58%	58%	59%	59%	59%	59%
Turbo SI Engines	Baseline	12%	12%	15%	18%	18%	18%	18%	18%	18%	18%	19%	19%	19%
Turbo SI Engines	Proposal	12%	12%	15%	18%	18%	18%	18%	18%	18%	18%	18%	18%	18%
Dynamic Deac,	Baseline	0%	0%	0%	0%	0%	0%	0%	0%	0%	0%	0%	0%	0%
Dynamic Deac,	Proposal	0%	0%	0%	0%	0%	0%	0%	0%	0%	0%	0%	0%	0%
Adv. Transmission	Baseline	53%	68%	79%	79%	82%	82%	82%	82%	82%	82%	82%	82%	82%
Adv. Transmission	Proposal	53%	68%	79%	79%	82%	82%	82%	82%	82%	82%	82%	82%	82%
12V SS Systems	Baseline	0%	0%	0%	1%	4%	13%	15%	22%	23%	23%	23%	23%	23%
12V SS Systems	Proposal	0%	0%	0%	0%	0%	0%	0%	0%	0%	0%	0%	0%	0%
Mild HEVs	Baseline	0%	0%	0%	0%	0%	0%	0%	0%	0%	0%	0%	0%	0%
Mild HEVs	Proposal	0%	0%	0%	0%	0%	0%	0%	0%	0%	0%	0%	0%	0%
Strong HEVs	Baseline	3%	3%	3%	3%	3%	3%	3%	3%	3%	3%	3%	3%	3%
Strong HEVs	Proposal	3%	3%	3%	3%	3%	3%	3%	3%	3%	3%	3%	3%	3%
Plug-In HEVs	Baseline	0%	0%	0%	0%	0%	0%	0%	0%	0%	0%	0%	0%	0%
Plug-In HEVs	Proposal	0%	0%	0%	0%	0%	0%	0%	0%	0%	0%	0%	0%	0%
Dedicated EVs	Baseline	0%	0%	0%	0%	0%	0%	0%	0%	0%	0%	0%	0%	0%
Dedicated EVs	Proposal	0%	0%	0%	0%	0%	0%	0%	0%	0%	0%	0%	0%	0%
Fuel Cell Vehicles	Baseline	0%	0%	0%	0%	0%	0%	0%	0%	0%	0%	0%	0%	0%
Fuel Cell Vehicles	Proposal	0%	0%	0%	0%	0%	0%	0%	0%	0%	0%	0%	0%	0%

*** EO 12866 Review – Draft – Do Not Cite, Quote or Release During Review ***

TABLE 6-14 - TECHNOLOGY PENETRATION UNDER BASELINE AND PROPOSED CAFE STANDARDS – KIA

Technology		2017	2018	2019	2020	2021	2022	2023	2024	2025	2026	2027	2028	2029
Curb Weight (lb.)	Baseline	3292	3296	3295	3294	3241	3242	3225	3220	3220	3221	3205	3207	3207
Curb Weight (lb.)	Proposal	3292	3296	3295	3294	3281	3281	3276	3276	3275	3274	3274	3274	3274
High CR NA Engines	Baseline	0%	31%	31%	45%	76%	76%	76%	76%	76%	76%	75%	75%	75%
High CR NA Engines	Proposal	0%	31%	31%	37%	67%	67%	67%	67%	67%	67%	67%	67%	67%
Turbo SI Engines	Baseline	5%	5%	5%	5%	5%	5%	13%	23%	23%	23%	23%	23%	23%
Turbo SI Engines	Proposal	5%	5%	5%	5%	5%	5%	13%	22%	22%	22%	22%	22%	22%
Dynamic Deac,	Baseline	0%	0%	0%	0%	0%	0%	0%	0%	0%	0%	0%	0%	0%
Dynamic Deac,	Proposal	0%	0%	0%	0%	0%	0%	0%	0%	0%	0%	0%	0%	0%
Adv. Transmission	Baseline	0%	29%	53%	67%	93%	93%	93%	92%	92%	92%	92%	92%	92%
Adv. Transmission	Proposal	0%	29%	53%	67%	93%	93%	93%	93%	93%	93%	93%	93%	93%
12V SS Systems	Baseline	0%	0%	0%	0%	0%	0%	0%	0%	0%	0%	0%	0%	0%
12V SS Systems	Proposal	0%	0%	0%	0%	0%	0%	0%	0%	0%	0%	0%	0%	0%
Mild HEVs	Baseline	0%	0%	0%	14%	44%	68%	73%	76%	76%	76%	76%	76%	76%
Mild HEVs	Proposal	0%	0%	0%	0%	0%	0%	0%	0%	0%	0%	0%	0%	0%
Strong HEVs	Baseline	2%	2%	2%	2%	2%	2%	2%	3%	3%	3%	3%	3%	3%
Strong HEVs	Proposal	2%	2%	2%	2%	2%	2%	2%	2%	2%	2%	2%	2%	2%
Plug-In HEVs	Baseline	1%	1%	1%	1%	1%	1%	1%	1%	1%	1%	1%	1%	1%
Plug-In HEVs	Proposal	1%	1%	1%	1%	1%	1%	1%	1%	1%	1%	1%	1%	1%
Dedicated EVs	Baseline	0%	0%	0%	0%	0%	0%	0%	0%	0%	0%	0%	0%	0%
Dedicated EVs	Proposal	0%	0%	0%	0%	0%	0%	0%	0%	0%	0%	0%	0%	0%
Fuel Cell Vehicles	Baseline	0%	0%	0%	0%	0%	0%	0%	0%	0%	0%	0%	0%	0%
Fuel Cell Vehicles	Proposal	0%	0%	0%	0%	0%	0%	0%	0%	0%	0%	0%	0%	0%

*** EO 12866 Review – Draft – Do Not Cite, Quote or Release During Review ***

TABLE 6-15 - TECHNOLOGY PENETRATION UNDER BASELINE AND PROPOSED CAFE STANDARDS – JAGUAR / LAND ROVER

Technology		2017	2018	2019	2020	2021	2022	2023	2024	2025	2026	2027	2028	2029
Curb Weight (lb.)	Baseline	4829	4832	4800	4793	4662	4651	4615	4615	4591	4591	4592	4593	4593
Curb Weight (lb.)	Proposal	4829	4832	4800	4793	4662	4650	4613	4613	4587	4587	4587	4587	4587
High CR NA Engines	Baseline	0%	0%	0%	0%	0%	0%	0%	0%	0%	0%	0%	0%	0%
High CR NA Engines	Proposal	0%	0%	0%	0%	0%	0%	0%	0%	0%	0%	0%	0%	0%
Turbo SI Engines	Baseline	89%	89%	89%	89%	89%	89%	89%	89%	89%	89%	89%	89%	89%
Turbo SI Engines	Proposal	89%	89%	89%	89%	89%	89%	89%	89%	89%	89%	89%	89%	89%
Dynamic Deac,	Baseline	0%	0%	0%	0%	0%	0%	0%	0%	0%	0%	0%	0%	0%
Dynamic Deac,	Proposal	0%	0%	0%	0%	0%	0%	0%	0%	0%	0%	0%	0%	0%
Adv. Transmission	Baseline	100%	100%	100%	100%	100%	100%	100%	100%	100%	100%	100%	100%	100%
Adv. Transmission	Proposal	100%	100%	100%	100%	100%	100%	100%	100%	100%	100%	100%	100%	100%
12V SS Systems	Baseline	87%	87%	87%	87%	87%	87%	87%	87%	87%	87%	87%	87%	87%
12V SS Systems	Proposal	87%	87%	87%	87%	87%	87%	87%	87%	87%	87%	87%	87%	87%
Mild HEVs	Baseline	0%	0%	0%	0%	0%	0%	0%	0%	0%	0%	0%	0%	0%
Mild HEVs	Proposal	0%	0%	0%	0%	0%	0%	0%	0%	0%	0%	0%	0%	0%
Strong HEVs	Baseline	0%	0%	0%	0%	0%	0%	0%	0%	0%	0%	0%	0%	0%
Strong HEVs	Proposal	0%	0%	0%	0%	0%	0%	0%	0%	0%	0%	0%	0%	0%
Plug-In HEVs	Baseline	0%	0%	0%	0%	0%	0%	0%	0%	0%	0%	0%	0%	0%
Plug-In HEVs	Proposal	0%	0%	0%	0%	0%	0%	0%	0%	0%	0%	0%	0%	0%
Dedicated EVs	Baseline	0%	0%	0%	0%	0%	0%	0%	0%	0%	0%	0%	0%	0%
Dedicated EVs	Proposal	0%	0%	0%	0%	0%	0%	0%	0%	0%	0%	0%	0%	0%
Fuel Cell Vehicles	Baseline	0%	0%	0%	0%	0%	0%	0%	0%	0%	0%	0%	0%	0%
Fuel Cell Vehicles	Proposal	0%	0%	0%	0%	0%	0%	0%	0%	0%	0%	0%	0%	0%

*** EO 12866 Review – Draft – Do Not Cite, Quote or Release During Review ***

TABLE 6-16 - TECHNOLOGY PENETRATION UNDER BASELINE AND PROPOSED CAFE STANDARDS – MAZDA

Technology		2017	2018	2019	2020	2021	2022	2023	2024	2025	2026	2027	2028	2029
Curb Weight (lb.)	Baseline	3305	3311	3308	3288	3289	3273	3220	3222	3222	3223	3225	3227	3227
Curb Weight (lb.)	Proposal	3305	3311	3308	3307	3308	3307	3307	3306	3305	3303	3304	3304	3303
High CR NA Engines	Baseline	94%	94%	94%	94%	94%	94%	94%	94%	94%	94%	94%	94%	94%
High CR NA Engines	Proposal	94%	94%	94%	94%	94%	94%	94%	94%	94%	95%	95%	95%	95%
Turbo SI Engines	Baseline	6%	6%	6%	6%	6%	6%	6%	6%	6%	6%	6%	6%	6%
Turbo SI Engines	Proposal	6%	6%	6%	6%	6%	6%	6%	6%	6%	5%	5%	5%	5%
Dynamic Deac,	Baseline	0%	0%	0%	0%	0%	0%	0%	0%	0%	0%	0%	0%	0%
Dynamic Deac,	Proposal	0%	0%	0%	0%	0%	0%	0%	0%	0%	0%	0%	0%	0%
Adv. Transmission	Baseline	22%	82%	93%	93%	94%	94%	60%	58%	58%	58%	58%	58%	58%
Adv. Transmission	Proposal	22%	82%	93%	93%	94%	94%	94%	94%	94%	94%	94%	94%	94%
12V SS Systems	Baseline	0%	0%	0%	0%	0%	0%	0%	0%	0%	0%	0%	0%	0%
12V SS Systems	Proposal	0%	0%	0%	0%	0%	0%	0%	0%	0%	0%	0%	0%	0%
Mild HEVs	Baseline	0%	0%	0%	21%	21%	39%	58%	58%	58%	58%	58%	58%	58%
Mild HEVs	Proposal	0%	0%	0%	0%	0%	0%	0%	0%	0%	0%	0%	0%	0%
Strong HEVs	Baseline	0%	0%	0%	0%	0%	0%	34%	36%	36%	36%	36%	36%	36%
Strong HEVs	Proposal	0%	0%	0%	0%	0%	0%	0%	0%	0%	0%	0%	0%	0%
Plug-In HEVs	Baseline	0%	0%	0%	0%	0%	0%	0%	0%	0%	0%	0%	0%	0%
Plug-In HEVs	Proposal	0%	0%	0%	0%	0%	0%	0%	0%	0%	0%	0%	0%	0%
Dedicated EVs	Baseline	0%	0%	0%	0%	0%	0%	0%	0%	0%	0%	0%	0%	0%
Dedicated EVs	Proposal	0%	0%	0%	0%	0%	0%	0%	0%	0%	0%	0%	0%	0%
Fuel Cell Vehicles	Baseline	0%	0%	0%	0%	0%	0%	0%	0%	0%	0%	0%	0%	0%
Fuel Cell Vehicles	Proposal	0%	0%	0%	0%	0%	0%	0%	0%	0%	0%	0%	0%	0%

*** EO 12866 Review – Draft – Do Not Cite, Quote or Release During Review ***

TABLE 6-17 - TECHNOLOGY PENETRATION UNDER BASELINE AND PROPOSED CAFE STANDARDS – NISSAN / MITSUBISHI

Technology		2017	2018	2019	2020	2021	2022	2023	2024	2025	2026	2027	2028	2029
Curb Weight (lb.)	Baseline	3400	3408	3390	3344	3308	3289	3286	3269	3247	3248	3247	3244	3244
Curb Weight (lb.)	Proposal	3400	3408	3390	3351	3348	3333	3330	3329	3322	3320	3321	3321	3320
High CR NA Engines	Baseline	0%	0%	19%	35%	63%	70%	76%	81%	86%	86%	86%	86%	86%
High CR NA Engines	Proposal	0%	0%	1%	16%	16%	18%	18%	18%	18%	18%	18%	18%	18%
Turbo SI Engines	Baseline	4%	4%	5%	5%	5%	5%	6%	6%	6%	6%	6%	6%	6%
Turbo SI Engines	Proposal	4%	4%	5%	5%	5%	5%	6%	6%	6%	6%	6%	6%	6%
Dynamic Deac,	Baseline	0%	0%	0%	0%	0%	0%	0%	0%	0%	0%	0%	0%	0%
Dynamic Deac,	Proposal	0%	0%	0%	0%	0%	0%	0%	0%	0%	0%	0%	0%	0%
Adv. Transmission	Baseline	86%	92%	92%	91%	91%	94%	95%	95%	96%	96%	96%	96%	96%
Adv. Transmission	Proposal	86%	92%	92%	91%	91%	94%	95%	95%	96%	96%	96%	96%	96%
12V SS Systems	Baseline	2%	1%	2%	2%	2%	1%	1%	1%	1%	1%	1%	1%	1%
12V SS Systems	Proposal	2%	1%	2%	2%	2%	2%	2%	2%	2%	2%	2%	2%	2%
Mild HEVs	Baseline	0%	0%	0%	0%	0%	0%	0%	0%	0%	0%	0%	0%	0%
Mild HEVs	Proposal	0%	0%	0%	0%	0%	0%	0%	0%	0%	0%	0%	0%	0%
Strong HEVs	Baseline	0%	0%	0%	0%	0%	0%	0%	0%	0%	0%	0%	0%	0%
Strong HEVs	Proposal	0%	0%	0%	0%	0%	0%	0%	0%	0%	0%	0%	0%	0%
Plug-In HEVs	Baseline	1%	1%	1%	2%	2%	2%	2%	2%	2%	2%	2%	2%	2%
Plug-In HEVs	Proposal	1%	1%	1%	2%	2%	2%	2%	2%	2%	2%	2%	2%	2%
Dedicated EVs	Baseline	1%	1%	1%	1%	1%	1%	1%	1%	1%	1%	1%	1%	1%
Dedicated EVs	Proposal	1%	1%	1%	1%	1%	1%	1%	1%	1%	1%	1%	1%	1%
Fuel Cell Vehicles	Baseline	0%	0%	0%	0%	0%	0%	0%	0%	0%	0%	0%	0%	0%
Fuel Cell Vehicles	Proposal	0%	0%	0%	0%	0%	0%	0%	0%	0%	0%	0%	0%	0%

*** EO 12866 Review – Draft – Do Not Cite, Quote or Release During Review ***

TABLE 6-18 - TECHNOLOGY PENETRATION UNDER BASELINE AND PROPOSED CAFE STANDARDS – SUBARU

Technology		2017	2018	2019	2020	2021	2022	2023	2024	2025	2026	2027	2028	2029
Curb Weight (lb.)	Baseline	3443	3444	3444	3443	3280	3214	3214	3214	3214	3187	3188	3188	3188
Curb Weight (lb.)	Proposal	3443	3444	3444	3443	3389	3367	3367	3367	3367	3357	3334	3334	3334
High CR NA Engines	Baseline	0%	0%	0%	0%	0%	0%	0%	0%	0%	0%	0%	0%	0%
High CR NA Engines	Proposal	0%	0%	0%	0%	0%	0%	0%	0%	0%	0%	0%	0%	0%
Turbo SI Engines	Baseline	35%	35%	35%	35%	59%	59%	59%	59%	59%	69%	69%	68%	68%
Turbo SI Engines	Proposal	35%	35%	35%	35%	35%	35%	35%	35%	35%	35%	35%	35%	35%
Dynamic Deac,	Baseline	0%	0%	0%	0%	0%	0%	0%	0%	0%	0%	0%	0%	0%
Dynamic Deac,	Proposal	0%	0%	0%	0%	0%	0%	0%	0%	0%	0%	0%	0%	0%
Adv. Transmission	Baseline	91%	92%	91%	81%	81%	81%	81%	81%	81%	81%	81%	81%	81%
Adv. Transmission	Proposal	91%	92%	91%	92%	92%	92%	92%	92%	92%	92%	92%	92%	92%
12V SS Systems	Baseline	10%	9%	9%	9%	9%	0%	0%	0%	0%	0%	0%	0%	0%
12V SS Systems	Proposal	0%	0%	0%	10%	10%	10%	10%	10%	11%	11%	11%	11%	11%
Mild HEVs	Baseline	0%	0%	0%	0%	0%	9%	9%	9%	9%	9%	9%	9%	9%
Mild HEVs	Proposal	0%	0%	0%	0%	0%	0%	0%	0%	0%	0%	0%	0%	0%
Strong HEVs	Baseline	1%	1%	1%	11%	12%	12%	12%	11%	11%	11%	11%	11%	11%
Strong HEVs	Proposal	1%	1%	1%	1%	1%	1%	1%	1%	1%	0%	1%	1%	0%
Plug-In HEVs	Baseline	0%	0%	0%	0%	0%	0%	0%	0%	0%	0%	0%	0%	0%
Plug-In HEVs	Proposal	0%	0%	0%	0%	0%	0%	0%	0%	0%	0%	0%	0%	0%
Dedicated EVs	Baseline	0%	0%	0%	0%	0%	0%	0%	0%	0%	0%	0%	0%	0%
Dedicated EVs	Proposal	0%	0%	0%	0%	0%	0%	0%	0%	0%	0%	0%	0%	0%
Fuel Cell Vehicles	Baseline	0%	0%	0%	0%	0%	0%	0%	0%	0%	0%	0%	0%	0%
Fuel Cell Vehicles	Proposal	0%	0%	0%	0%	0%	0%	0%	0%	0%	0%	0%	0%	0%

*** EO 12866 Review – Draft – Do Not Cite, Quote or Release During Review ***

TABLE 6-19 - TECHNOLOGY PENETRATION UNDER BASELINE AND PROPOSED CAFE STANDARDS – TOYOTA

Technology		2017	2018	2019	2020	2021	2022	2023	2024	2025	2026	2027	2028	2029
Curb Weight (lb.)	Baseline	3739	3699	3685	3635	3590	3585	3589	3566	3551	3524	3529	3529	3516
Curb Weight (lb.)	Proposal	3739	3699	3685	3635	3600	3591	3591	3565	3561	3533	3534	3532	3530
High CR NA Engines	Baseline	21%	34%	45%	62%	62%	63%	64%	64%	64%	65%	65%	65%	65%
High CR NA Engines	Proposal	21%	34%	45%	46%	46%	47%	47%	47%	47%	48%	48%	48%	48%
Turbo SI Engines	Baseline	3%	10%	11%	19%	29%	31%	31%	31%	32%	32%	32%	33%	33%
Turbo SI Engines	Proposal	3%	10%	10%	18%	23%	24%	24%	24%	24%	24%	24%	24%	24%
Dynamic Deac,	Baseline	0%	0%	0%	0%	0%	0%	0%	0%	0%	0%	0%	0%	0%
Dynamic Deac,	Proposal	0%	0%	0%	0%	0%	0%	0%	0%	0%	0%	0%	0%	0%
Adv. Transmission	Baseline	38%	61%	74%	84%	85%	86%	87%	80%	80%	80%	79%	79%	79%
Adv. Transmission	Proposal	38%	62%	75%	87%	97%	98%	99%	99%	99%	99%	99%	99%	99%
12V SS Systems	Baseline	0%	0%	6%	6%	6%	6%	6%	0%	0%	0%	0%	0%	0%
12V SS Systems	Proposal	0%	0%	0%	0%	0%	0%	0%	0%	0%	0%	0%	0%	0%
Mild HEVs	Baseline	0%	7%	8%	14%	16%	17%	17%	17%	16%	16%	16%	16%	16%
Mild HEVs	Proposal	0%	0%	0%	0%	0%	0%	0%	0%	0%	0%	0%	0%	0%
Strong HEVs	Baseline	9%	10%	10%	13%	21%	21%	21%	28%	28%	28%	29%	29%	29%
Strong HEVs	Proposal	9%	9%	9%	9%	9%	9%	9%	9%	9%	9%	9%	9%	9%
Plug-In HEVs	Baseline	0%	0%	0%	0%	0%	0%	0%	0%	0%	0%	0%	0%	0%
Plug-In HEVs	Proposal	0%	0%	0%	0%	0%	0%	0%	0%	0%	0%	0%	0%	0%
Dedicated EVs	Baseline	0%	0%	0%	0%	0%	0%	0%	0%	0%	0%	0%	0%	0%
Dedicated EVs	Proposal	0%	0%	0%	0%	0%	0%	0%	0%	0%	0%	0%	0%	0%
Fuel Cell Vehicles	Baseline	0%	0%	0%	0%	0%	0%	0%	0%	0%	0%	0%	0%	0%
Fuel Cell Vehicles	Proposal	0%	0%	0%	0%	0%	0%	0%	0%	0%	0%	0%	0%	0%

*** EO 12866 Review – Draft – Do Not Cite, Quote or Release During Review ***

TABLE 6-20 - TECHNOLOGY PENETRATION UNDER BASELINE AND PROPOSED CAFE STANDARDS – VOLVO

Technology		2017	2018	2019	2020	2021	2022	2023	2024	2025	2026	2027	2028	2029
Curb Weight (lb.)	Baseline	4165	4172	4071	4070	4071	4072	4074	4059	4060	4061	4064	4063	4064
Curb Weight (lb.)	Proposal	4165	4172	4071	4070	4071	4070	4069	4053	4051	4049	4049	4046	4046
High CR NA Engines	Baseline	0%	0%	0%	0%	0%	0%	0%	0%	0%	0%	0%	0%	0%
High CR NA Engines	Proposal	0%	0%	0%	0%	0%	0%	0%	0%	0%	0%	0%	0%	0%
Turbo SI Engines	Baseline	100%	100%	100%	100%	100%	100%	100%	100%	100%	100%	100%	100%	100%
Turbo SI Engines	Proposal	100%	100%	100%	100%	100%	100%	100%	100%	100%	100%	100%	100%	100%
Dynamic Deac,	Baseline	0%	0%	0%	0%	0%	0%	0%	0%	0%	0%	0%	0%	0%
Dynamic Deac,	Proposal	0%	0%	0%	0%	0%	0%	0%	0%	0%	0%	0%	0%	0%
Adv. Transmission	Baseline	70%	71%	91%	98%	98%	98%	98%	97%	97%	97%	97%	97%	97%
Adv. Transmission	Proposal	70%	71%	91%	98%	98%	98%	98%	98%	98%	98%	98%	98%	98%
12V SS Systems	Baseline	70%	71%	70%	70%	70%	70%	70%	71%	71%	71%	71%	71%	71%
12V SS Systems	Proposal	70%	71%	70%	70%	70%	70%	70%	70%	70%	70%	70%	70%	70%
Mild HEVs	Baseline	0%	0%	0%	0%	0%	0%	0%	0%	0%	0%	0%	0%	0%
Mild HEVs	Proposal	0%	0%	0%	0%	0%	0%	0%	0%	0%	0%	0%	0%	0%
Strong HEVs	Baseline	0%	0%	0%	0%	0%	0%	0%	0%	0%	0%	0%	0%	0%
Strong HEVs	Proposal	0%	0%	0%	0%	0%	0%	0%	0%	0%	0%	0%	0%	0%
Plug-In HEVs	Baseline	2%	2%	2%	2%	2%	2%	2%	3%	3%	3%	3%	3%	3%
Plug-In HEVs	Proposal	2%	2%	2%	2%	2%	2%	2%	2%	2%	2%	2%	2%	2%
Dedicated EVs	Baseline	0%	0%	0%	0%	0%	0%	0%	0%	0%	0%	0%	0%	0%
Dedicated EVs	Proposal	0%	0%	0%	0%	0%	0%	0%	0%	0%	0%	0%	0%	0%
Fuel Cell Vehicles	Baseline	0%	0%	0%	0%	0%	0%	0%	0%	0%	0%	0%	0%	0%
Fuel Cell Vehicles	Proposal	0%	0%	0%	0%	0%	0%	0%	0%	0%	0%	0%	0%	0%

*** EO 12866 Review – Draft – Do Not Cite, Quote or Release During Review ***

TABLE 6-21 - TECHNOLOGY PENETRATION UNDER BASELINE AND PROPOSED CAFE STANDARDS – VW

Technology		2017	2018	2019	2020	2021	2022	2023	2024	2025	2026	2027	2028	2029
Curb Weight (lb.)	Baseline	3484	3416	3402	3362	3361	3326	3299	3286	3280	3267	3256	3242	3243
Curb Weight (lb.)	Proposal	3484	3423	3409	3369	3368	3333	3324	3323	3322	3320	3321	3319	3318
High CR NA Engines	Baseline	0%	0%	0%	0%	0%	0%	0%	0%	0%	0%	0%	0%	0%
High CR NA Engines	Proposal	0%	0%	0%	0%	0%	0%	0%	0%	0%	0%	0%	0%	0%
Turbo SI Engines	Baseline	91%	94%	94%	94%	94%	94%	94%	85%	82%	82%	82%	82%	82%
Turbo SI Engines	Proposal	91%	95%	95%	95%	95%	96%	96%	96%	97%	97%	97%	97%	97%
Dynamic Deac,	Baseline	0%	0%	0%	0%	0%	0%	0%	0%	0%	0%	0%	0%	0%
Dynamic Deac,	Proposal	0%	0%	0%	0%	0%	0%	0%	0%	0%	0%	0%	0%	0%
Adv. Transmission	Baseline	36%	32%	38%	48%	48%	40%	20%	14%	14%	14%	14%	14%	14%
Adv. Transmission	Proposal	45%	54%	64%	74%	74%	74%	74%	74%	74%	73%	74%	74%	73%
12V SS Systems	Baseline	15%	3%	3%	3%	2%	0%	0%	0%	0%	0%	0%	0%	0%
12V SS Systems	Proposal	41%	47%	51%	51%	51%	51%	51%	51%	51%	51%	51%	51%	51%
Mild HEVs	Baseline	24%	34%	34%	46%	46%	44%	27%	22%	22%	22%	21%	21%	21%
Mild HEVs	Proposal	0%	0%	0%	6%	6%	6%	6%	6%	6%	6%	6%	6%	6%
Strong HEVs	Baseline	10%	24%	27%	31%	32%	43%	63%	59%	56%	56%	56%	56%	56%
Strong HEVs	Proposal	0%	0%	0%	0%	0%	0%	0%	0%	0%	0%	0%	0%	0%
Plug-In HEVs	Baseline	1%	1%	1%	1%	1%	2%	2%	11%	15%	15%	15%	15%	15%
Plug-In HEVs	Proposal	1%	1%	1%	1%	1%	1%	1%	1%	1%	1%	1%	1%	1%
Dedicated EVs	Baseline	1%	1%	1%	1%	1%	1%	1%	1%	1%	1%	1%	1%	1%
Dedicated EVs	Proposal	1%	1%	1%	1%	1%	1%	1%	1%	1%	1%	1%	1%	1%
Fuel Cell Vehicles	Baseline	0%	0%	0%	0%	0%	0%	0%	0%	0%	0%	0%	0%	0%
Fuel Cell Vehicles	Proposal	0%	0%	0%	0%	0%	0%	0%	0%	0%	0%	0%	0%	0%

*** EO 12866 Review – Draft – Do Not Cite, Quote or Release During Review ***

6.2.2 CO2 Standards

TABLE 6-22 - REQUIRED AND ACHIEVED AVE. CO₂ LEVELS IN MYS 2016-2029 UNDER BASELINE CO₂ STANDARDS (NO-ACTION ALTERNATIVE)

Manufacturer		2017	2018	2019	2020	2021	2022	2023	2024	2025	2026	2027	2028	2029	Sum
BMW	Required	248	240	229	221	213	202	192	183	175	166	166	166	167	167
BMW	Achieved	250	236	225	206	203	201	190	183	176	168	167	167	166	166
Daimler	Required	256	248	239	229	221	209	199	190	181	172	172	173	173	173
Daimler	Achieved	269	251	248	215	215	204	188	181	179	180	172	172	172	172
Fiat Chrysler	Required	277	272	262	254	247	232	221	211	201	191	191	191	191	191
Fiat Chrysler	Achieved	302	284	254	237	229	212	208	206	206	204	198	196	192	191
Ford	Required	277	272	263	256	249	235	224	214	204	194	194	194	195	195
Ford	Achieved	286	273	269	264	230	214	207	206	203	203	201	195	195	195
General Motors	Required	278	273	265	257	249	236	225	214	204	195	195	195	195	195
General Motors	Achieved	293	286	266	248	236	215	212	210	208	204	201	200	198	196
Honda	Required	248	241	231	222	215	203	193	184	176	167	168	168	168	168
Honda	Achieved	222	220	216	214	213	201	182	173	170	170	170	168	167	167
Hyundai	Required	232	222	212	203	195	186	177	169	161	153	153	153	153	153
Hyundai	Achieved	209	198	192	185	181	170	167	167	165	165	161	153	152	152
Kia	Required	241	232	222	213	205	196	186	178	169	161	161	161	161	161
Kia	Achieved	234	231	218	211	203	178	176	170	163	163	162	159	159	159
Jaguar/Land Rover	Required	283	282	270	262	255	238	226	216	206	196	196	196	196	196
Jaguar/Land Rover	Achieved	316	313	304	280	266	225	223	190	189	188	188	188	188	188
Mazda	Required	242	234	224	216	208	197	188	179	170	162	162	162	162	162
Mazda	Achieved	214	210	196	194	189	189	186	174	173	170	166	166	161	161
Nissan Mitsubishi	Required	244	236	226	217	210	199	189	180	172	164	164	164	164	164

*** EO 12866 Review – Draft – Do Not Cite, Quote or Release During Review ***

Nissan Mitsubishi	Achieved	220	216	213	205	200	193	190	187	172	165	165	162	159	158
Subaru	Required	251	245	234	225	219	205	196	186	178	168	168	169	169	169
Subaru	Achieved	224	217	217	215	208	190	175	175	171	171	169	169	169	169
Tesla	Required	282	275	265	256	248	234	223	213	203	193	193	193	193	193
Tesla	Achieved	-19	-19	-19	-19	-19	-19	-19	-19	-19	-19	-19	-19	-19	-19
Toyota	Required	256	249	239	231	223	211	201	192	183	175	175	175	175	175
Toyota	Achieved	254	252	233	221	208	195	192	192	190	183	176	176	174	173
Volvo	Required	270	266	255	246	239	225	214	204	194	185	185	185	185	185
Volvo	Achieved	260	254	255	212	214	214	214	194	190	190	190	184	184	184
VWA	Required	236	228	218	209	202	191	183	174	166	158	158	158	158	158
VWA	Achieved	244	222	206	200	189	185	178	172	166	165	161	160	158	158
Ave./Total	Required	260	254	244	236	229	216	206	196	187	178	178	178	179	179
Ave./Total	Achieved	259	251	238	227	216	201	195	191	187	185	181	179	177	177

*** EO 12866 Review – Draft – Do Not Cite, Quote or Release During Review ***

TABLE 6-23 - REQUIRED AND ACHIEVED AVE. CO₂ LEVELS IN MYS 2016-2029 UNDER PROPOSED CO₂ STANDARDS (PREFERRED ALTERNATIVE)

Manufacturer		2017	2018	2019	2020	2021	2022	2023	2024	2025	2026	2027	2028	2029	Sum
BMW	Required	248	240	229	221	213	224	224	224	224	224	223	223	223	223
BMW	Achieved	250	236	226	211	208	221	218	217	216	216	216	216	216	215
Daimler	Required	256	248	239	229	221	232	232	232	232	232	232	232	232	232
Daimler	Achieved	269	255	253	226	225	230	228	226	226	226	225	225	225	225
Fiat Chrysler	Required	277	272	262	254	247	259	259	259	259	259	259	259	259	259
Fiat Chrysler	Achieved	302	285	256	247	240	243	241	240	240	240	237	237	236	236
Ford	Required	277	272	263	256	249	261	261	261	261	261	261	261	261	261
Ford	Achieved	286	273	271	266	247	259	257	257	256	256	256	255	255	255
General Motors	Required	278	273	265	257	249	261	261	261	261	261	261	261	261	261
General Motors	Achieved	293	288	274	261	251	254	254	254	253	253	252	252	251	251
Honda	Required	248	241	231	222	215	227	227	227	227	227	226	226	226	226
Honda	Achieved	222	221	218	216	215	227	216	211	211	211	211	209	209	208
Hyundai	Required	232	222	212	203	195	206	206	206	206	206	206	206	206	206
Hyundai	Achieved	209	198	192	185	182	186	184	184	183	183	182	182	182	182
Kia	Required	241	232	222	213	205	217	217	217	217	217	217	217	217	217
Kia	Achieved	234	232	219	212	207	203	204	200	196	196	196	195	195	195
Jaguar/Land Rover	Required	283	282	270	262	255	268	268	268	268	268	268	268	268	268
Jaguar/Land Rover	Achieved	316	313	304	288	276	263	262	259	259	258	258	258	258	257
Mazda	Required	242	234	224	216	208	219	219	219	219	219	219	219	219	219
Mazda	Achieved	214	210	196	194	192	206	206	203	203	203	203	203	202	202
Nissan Mitsubishi	Required	244	236	226	217	210	221	221	221	221	221	221	221	221	221
Nissan Mitsubishi	Achieved	220	216	213	206	202	213	211	210	210	209	208	208	208	208
Subaru	Required	251	245	234	225	219	231	231	231	231	231	231	231	231	231

*** EO 12866 Review – Draft – Do Not Cite, Quote or Release During Review ***

Subaru	Achieved	224	217	217	215	215	221	220	219	219	219	218	218	218	218
Tesla	Required	282	275	265	256	248	260	260	260	260	259	259	259	259	259
Tesla	Achieved	-19	-19	-19	-19	-19	-4	-4	-4	-4	-4	-4	-4	-4	-4
Toyota	Required	256	249	239	231	223	236	236	236	236	235	235	235	235	235
Toyota	Achieved	254	252	240	234	226	235	234	233	232	231	228	228	228	227
Volvo	Required	270	266	255	246	239	252	252	252	252	252	251	251	251	251
Volvo	Achieved	260	256	256	233	234	251	251	245	244	244	244	243	243	243
VWA	Required	236	228	218	209	202	213	213	213	213	213	213	213	213	213
VWA	Achieved	244	224	211	206	199	211	210	209	209	208	208	208	207	207
Ave./Total	Required	260	254	244	236	229	241	241	241	241	240	240	240	240	240
Ave./Total	Achieved	259	251	241	233	226	233	231	230	229	229	227	227	226	226

*** EO 12866 Review – Draft – Do Not Cite, Quote or Release During Review ***

TABLE 6-24 - UNDISCOUNTED REGULATORY COSTS (\$B) IN MYS 2017-2029 UNDER BASELINE AND PROPOSED CO₂ STANDARDS

Manufacturer		2017	2018	2019	2020	2021	2022	2023	2024	2025	2026	2027	2028	2029	Sum
BMW	Costs under Baseline	0.2	0.3	0.7	0.8	0.8	1.1	1.3	1.5	1.6	1.6	1.5	1.5	1.5	14.5
BMW	Chg. under Proposal	0	0	-0.2	-0.2	-0.2	-0.4	-0.6	-0.8	-1	-1	-0.9	-0.9	-0.9	-7.1
Daimler	Costs under Baseline	0.2	0.3	0.6	0.6	0.8	1.2	1.3	1.3	1.3	1.4	1.4	1.4	1.4	13.1
Daimler	Chg. under Proposal	-0.1	-0.1	-0.3	-0.3	-0.3	-0.6	-0.7	-0.8	-0.8	-1	-0.9	-0.9	-0.9	-7.6
Fiat Chrysler	Costs under Baseline	1.3	2.9	4.3	5	6.4	6.6	6.9	6.7	6.8	7.6	7.8	8.4	8.5	79.3
Fiat Chrysler	Chg. under Proposal	-0.4	-0.8	-2	-2	-2.7	-2.9	-3.1	-3	-3.2	-3.9	-4.2	-4.7	-4.8	-37.7
Ford	Costs under Baseline	0.2	0.5	0.9	3.7	5.2	5.8	5.7	5.9	5.8	6.2	7.1	7	6.9	60.8
Ford	Chg. under Proposal	0	-0.2	-0.4	-2.5	-3.9	-4.5	-4.5	-4.7	-4.5	-4.9	-5.8	-5.7	-5.6	-47.3
General Motors	Costs under Baseline	0.4	1.8	2.8	3.3	5.1	5.6	5.9	6.1	7	7.4	7.6	8.2	8.7	69.9
General Motors	Chg. under Proposal	-0.2	-1.2	-1.9	-2.1	-3.5	-4	-4.3	-4.5	-5.4	-5.7	-5.9	-6.6	-7.1	-52.3
Honda	Costs under Baseline	0.1	0.2	0.3	0.3	1	2	2.7	3	2.9	2.9	3	3.2	3.2	24.8
Honda	Chg. under Proposal	0	-0.1	-0.1	-0.1	-0.7	-1.5	-2.1	-2.3	-2.3	-2.3	-2.4	-2.5	-2.5	-18.9
Hyundai	Costs under Baseline	0.1	0.1	0.2	0.2	0.3	0.3	0.3	0.4	0.4	0.5	0.7	0.8	0.8	5.1
Hyundai	Chg. under Proposal	-	-	0	0	0	0	0	-0.1	-0.1	-0.2	-0.5	-0.5	-0.5	-2
Kia	Costs under Baseline	0	0.1	0.2	0.3	0.7	0.9	1	1.2	1.2	1.2	1.5	1.4	1.4	11.1

*** EO 12866 Review – Draft – Do Not Cite, Quote or Release During Review ***

Kia	Chg. under Proposal	0	0	0	-0.1	-0.4	-0.5	-0.6	-0.8	-0.8	-0.8	-1.1	-1	-1	-7.2
JLR	Costs under Baseline	0	0	0.4	0.5	1.1	1.1	1.7	1.6	1.6	1.5	1.5	1.5	1.4	13.8
JLR	Chg. under Proposal	-	-	-0.2	-0.2	-0.5	-0.5	-1.1	-1.1	-1.1	-1	-1	-1	-1	-8.7
Mazda	Costs under Baseline	0	0.1	0.1	0.2	0.2	0.2	0.7	0.7	0.7	1	1	1.1	1.1	7
Mazda	Chg. under Proposal	-	-	-	-0.1	-0.1	-0.1	-0.6	-0.6	-0.6	-0.9	-0.9	-1	-1	-5.8
Nissan/Mitsubishi	Costs under Baseline	0	0	0.2	0.3	0.5	0.6	0.7	1.1	1.4	1.4	1.5	1.6	1.7	11.1
Nissan/Mitsubishi	Chg. under Proposal	-	0	0	-0.1	-0.2	-0.3	-0.3	-0.8	-1	-1	-1.2	-1.3	-1.3	-7.7
Subaru	Costs under Baseline	0	0	0	0.3	0.5	0.9	0.9	1	0.9	0.9	0.9	0.9	0.9	8.3
Subaru	Chg. under Proposal	-	-	-	-0.3	-0.4	-0.8	-0.8	-0.8	-0.8	-0.8	-0.8	-0.8	-0.8	-7.2
Tesla	Costs under Baseline	0	0	0	0	0	0	0	0	0	0	0	0	0	0
Tesla	Chg. under Proposal	-	-	-	-	-	0	0	0	0	0	0	0	0	0
Toyota	Costs under Baseline	0	1	1.5	2.3	3.2	3.2	3.2	3.6	4	5.1	5.1	5.3	5.4	42.9
Toyota	Chg. under Proposal	-	-0.7	-1	-1.7	-2.4	-2.5	-2.4	-2.7	-3.2	-4.1	-4.2	-4.3	-4.4	-33.7
Volvo	Costs under Baseline	0	0	0.2	0.2	0.2	0.2	0.3	0.3	0.3	0.3	0.3	0.3	0.3	2.9
Volvo	Chg. under Proposal	0	0	-0.2	-0.2	-0.2	-0.2	-0.2	-0.3	-0.3	-0.2	-0.3	-0.3	-0.3	-2.5
VWA	Costs under Baseline	0.4	0.8	0.9	1.4	1.4	1.7	2.2	2.4	2.4	2.5	2.5	2.5	2.4	23.4
VWA	Chg. under Proposal	-0.2	-0.4	-0.5	-0.8	-0.8	-1.1	-1.5	-1.8	-1.8	-1.9	-1.9	-1.9	-1.9	-16.5

*** EO 12866 Review – Draft – Do Not Cite, Quote or Release During Review ***

Ave./Total	Costs under Baseline	3	8.1	13.2	19.3	27.3	31.5	34.7	36.7	38.2	41.7	43.6	45.1	45.6	388	
Ave./Total	Chg. under Proposal	-1	-3.5	-6.7	-10.5	-16.3	-20	-23	-25	-26.8	-29.9	-31.9	-33.5	-34	-	262.1

*** EO 12866 Review – Draft – Do Not Cite, Quote or Release During Review ***

TABLE 6-25 - AVERAGE PRICE INCREASES (\$) IN MYs 2017-2029 UNDER BASELINE AND PROPOSED CO₂ STANDARDS

Manufacturer		2017	2018	2019	2020	2021	2022	2023	2024	2025	2026	2027	2028	2029
BMW	Costs under Baseline	386	802	1,801	1,928	1,952	2,667	3,054	3,507	3,847	3,842	3,725	3,695	3,610
BMW	Chg. under Proposal	-35	-66	-408	-412	-402	-1,010	-1,428	-1,939	-2,334	-2,379	-2,307	-2,305	-2,255
Daimler	Costs under Baseline	704	770	1,807	1,733	2,259	3,236	3,554	3,668	3,536	4,051	3,981	3,938	3,834
Daimler	Chg. under Proposal	-226	-289	-760	-709	-785	-1,775	-2,122	-2,258	-2,172	-2,719	-2,687	-2,679	-2,605
Fiat Chrysler	Costs under Baseline	629	1,332	1,986	2,250	2,878	2,989	3,114	3,023	3,049	3,408	3,479	3,698	3,721
Fiat Chrysler	Chg. under Proposal	-208	-381	-907	-911	-1,232	-1,286	-1,396	-1,342	-1,402	-1,724	-1,821	-2,048	-2,082
Ford	Costs under Baseline	98	210	380	1,624	2,247	2,532	2,498	2,584	2,524	2,688	3,069	3,015	2,977
Ford	Chg. under Proposal	-1	-79	-177	-1,112	-1,702	-1,972	-1,948	-2,029	-1,976	-2,149	-2,516	-2,469	-2,436
General Motors	Costs under Baseline	167	679	1,045	1,201	1,844	2,038	2,144	2,219	2,538	2,701	2,742	2,969	3,143
General Motors	Chg. under Proposal	-90	-437	-694	-765	-1,272	-1,462	-1,566	-1,638	-1,960	-2,087	-2,135	-2,364	-2,535
Honda	Costs under Baseline	35	104	139	156	512	1,022	1,406	1,510	1,498	1,479	1,554	1,624	1,606
Honda	Chg. under Proposal	-19	-29	-30	-30	-341	-763	-1,094	-1,202	-1,194	-1,177	-1,215	-1,288	-1,272
Hyundai	Costs under Baseline	83	147	212	244	361	413	413	511	509	660	991	1,076	1,068
Hyundai	Chg. under Proposal	-	-	-2	-7	-23	-58	-57	-153	-153	-293	-625	-712	-704
Kia	Costs under Baseline	40	172	230	390	910	1,087	1,232	1,507	1,521	1,559	1,849	1,823	1,801
Kia	Chg. under Proposal	-25	-25	-23	-138	-494	-676	-779	-1,011	-1,028	-1,067	-1,344	-1,320	-1,300

*** EO 12866 Review – Draft – Do Not Cite, Quote or Release During Review ***

JLR	Costs under Baseline	23	71	1,212	1,577	3,587	3,565	5,374	5,177	5,126	4,951	4,804	4,662	4,532
JLR	Chg. under Proposal	-	-	-703	-708	-1,726	-1,725	-3,560	-3,432	-3,431	-3,314	-3,219	-3,125	-3,034
Mazda	Costs under Baseline	29	162	180	319	313	475	1,355	1,344	1,449	2,027	1,972	2,256	2,206
Mazda	Chg. under Proposal	-	-	-	-115	-111	-276	-1,126	-1,119	-1,227	-1,808	-1,756	-2,020	-1,972
Nissan/Mitsubishi	Costs under Baseline	7	27	119	218	354	411	470	774	942	953	1,038	1,111	1,130
Nissan/Mitsubishi	Chg. under Proposal	-	-2	-18	-78	-159	-192	-238	-545	-702	-716	-803	-879	-899
Subaru	Costs under Baseline	55	51	68	498	823	1,554	1,519	1,573	1,529	1,548	1,510	1,476	1,445
Subaru	Chg. under Proposal	-	-	-	-432	-650	-1,373	-1,335	-1,393	-1,352	-1,359	-1,322	-1,290	-1,261
Tesla	Costs under Baseline	3	3	3	4	4	4	4	4	4	4	4	4	4
Tesla	Chg. under Proposal	-	-	-	-	-	0	0	0	0	0	0	0	0
Toyota	Costs under Baseline	16	396	573	895	1,233	1,257	1,238	1,388	1,575	1,982	1,988	2,044	2,101
Toyota	Chg. under Proposal	-	-281	-404	-647	-938	-958	-941	-1,067	-1,256	-1,609	-1,620	-1,676	-1,731
Volvo	Costs under Baseline	93	85	2,048	1,964	1,881	1,819	2,881	3,100	2,990	2,886	3,287	3,224	3,136
Volvo	Chg. under Proposal	-79	-72	-1,750	-1,668	-1,594	-1,537	-2,512	-2,722	-2,619	-2,522	-2,910	-2,850	-2,766
VWA	Costs under Baseline	715	1,366	1,480	2,262	2,368	2,858	3,601	3,955	3,942	4,169	4,141	4,167	4,068
VWA	Chg. under Proposal	-342	-743	-798	-1,359	-1,377	-1,829	-2,568	-2,945	-2,961	-3,212	-3,204	-3,243	-3,159
Ave./Total	Costs under Baseline	180	473	756	1,091	1,536	1,774	1,955	2,066	2,156	2,346	2,446	2,530	2,550
Ave./Total	Chg. under Proposal	-61	-204	-382	-595	-916	-1,128	-1,300	-1,414	-1,514	-1,691	-1,793	-1,882	-1,906

*** EO 12866 Review – Draft – Do Not Cite, Quote or Release During Review ***

TABLE 6-26 - TECHNOLOGY COSTS, AVERAGE PRICES, SALES, AND LABOR UTILIZATION UNDER BASELINE AND PROPOSED CO₂ STANDARDS

MY	Costs (\$b) for Tech. (beyond MY 2016)				Average Vehicle Prices (\$)				Annual Sales (million units)				Labor (1000s of Job-Years)			
	Standards		Change		Standards		Change		Standards		Change		Standards		Change	
	Baseline	Proposed	Abs.	%	Baseline	Proposed	Abs.	%	Baseline	Proposed	Abs.	%	Baseline	Proposed	Abs.	%
2017	3	2	(1)	-34%	32,250	32,189	(61)	0%	16.84	16.84	-	0.0%	1,169	1,167	(2)	0%
2018	8	5	(4)	-43%	32,602	32,399	(204)	-1%	17.19	17.19	-	0.0%	1,204	1,198	(6)	-1%
2019	13	7	(7)	-51%	32,859	32,477	(382)	-1%	17.49	17.49	-	0.0%	1,231	1,220	(11)	-1%
2020	19	9	(11)	-55%	33,186	32,590	(595)	-2%	17.66	17.66	-	0.0%	1,254	1,236	(18)	-1%
2021	27	11	(16)	-60%	33,615	32,699	(916)	-3%	17.79	17.79	-	0.0%	1,278	1,247	(31)	-2%
2022	31	11	(20)	-64%	33,867	32,729	(1,139)	-3%	17.74	17.77	0.03	0.2%	1,281	1,247	(34)	-3%
2023	35	12	(23)	-66%	34,075	32,735	(1,339)	-4%	17.73	17.80	0.07	0.4%	1,285	1,249	(37)	-3%
2024	37	12	(25)	-68%	34,203	32,729	(1,474)	-4%	17.75	17.83	0.08	0.4%	1,289	1,251	(39)	-3%
2025	38	11	(27)	-70%	34,305	32,705	(1,600)	-5%	17.73	17.87	0.13	0.7%	1,291	1,253	(39)	-3%
2026	42	12	(30)	-72%	34,508	32,700	(1,808)	-5%	17.76	17.90	0.14	0.8%	1,300	1,255	(45)	-3%
2027	44	12	(32)	-73%	34,624	32,696	(1,928)	-6%	17.82	17.95	0.13	0.7%	1,309	1,259	(51)	-4%
2028	45	12	(33)	-74%	34,727	32,693	(2,034)	-6%	17.84	17.97	0.13	0.7%	1,314	1,260	(54)	-4%
2029	46	12	(34)	-75%	34,765	32,681	(2,083)	-6%	17.87	18.01	0.14	0.8%	1,318	1,263	(56)	-4%
2030	45	12	(34)	-74%	34,746	32,663	(2,083)	-6%	17.90	18.04	0.14	0.8%	1,320	1,264	(56)	-4%

*** EO 12866 Review – Draft – Do Not Cite, Quote or Release During Review ***

TABLE 6-27 - TECHNOLOGY PENETRATION UNDER BASELINE AND PROPOSED CO₂ STANDARDS – INDUSTRY AVERAGE

Technology		2017	2018	2019	2020	2021	2022	2023	2024	2025	2026	2027	2028	2029
Curb Weight (lb.)	Baseline	3814	3792	3756	3722	3681	3662	3651	3639	3629	3604	3587	3573	3568
Curb Weight (lb.)	Proposal	3817	3805	3779	3752	3724	3715	3710	3705	3699	3688	3683	3681	3679
High CR NA Engines	Baseline	6%	10%	12%	13%	16%	16%	17%	20%	24%	24%	25%	26%	26%
High CR NA Engines	Proposal	6%	8%	9%	9%	12%	12%	12%	12%	12%	12%	12%	12%	12%
Turbo SI Engines	Baseline	24%	33%	36%	42%	50%	57%	60%	61%	61%	62%	62%	62%	62%
Turbo SI Engines	Proposal	24%	30%	32%	35%	37%	43%	45%	46%	46%	46%	46%	46%	46%
Dynamic Deac,	Baseline	0%	0%	2%	2%	2%	2%	2%	2%	2%	2%	2%	5%	7%
Dynamic Deac,	Proposal	0%	0%	0%	0%	0%	0%	0%	0%	0%	0%	0%	0%	0%
Adv. Transmission	Baseline	48%	64%	72%	83%	87%	88%	86%	85%	84%	83%	82%	83%	82%
Adv. Transmission	Proposal	48%	64%	73%	85%	91%	92%	93%	93%	93%	93%	93%	93%	93%
12V SS Systems	Baseline	12%	13%	13%	16%	16%	16%	15%	16%	14%	11%	11%	10%	10%
12V SS Systems	Proposal	13%	13%	12%	13%	13%	13%	13%	13%	13%	13%	13%	13%	13%
Mild HEVs	Baseline	2%	4%	9%	12%	19%	22%	24%	25%	27%	34%	38%	41%	41%
Mild HEVs	Proposal	1%	1%	2%	2%	2%	2%	2%	2%	2%	2%	2%	2%	2%
Strong HEVs	Baseline	2%	2%	3%	4%	6%	8%	10%	11%	12%	13%	13%	14%	14%
Strong HEVs	Proposal	2%	2%	2%	2%	2%	2%	2%	2%	2%	2%	2%	2%	2%
Plug-In HEVs	Baseline	0%	0%	0%	0%	0%	0%	1%	1%	1%	1%	1%	1%	1%
Plug-In HEVs	Proposal	0%	0%	0%	0%	0%	0%	0%	0%	0%	0%	0%	0%	0%
Dedicated EVs	Baseline	1%	1%	1%	1%	1%	1%	1%	1%	1%	1%	1%	1%	0%
Dedicated EVs	Proposal	1%	1%	1%	1%	1%	1%	1%	1%	1%	1%	1%	1%	1%
Fuel Cell Vehicles	Baseline	0%	0%	0%	0%	0%	0%	0%	0%	0%	0%	0%	0%	0%
Fuel Cell Vehicles	Proposal	0%	0%	0%	0%	0%	0%	0%	0%	0%	0%	0%	0%	0%

*** EO 12866 Review – Draft – Do Not Cite, Quote or Release During Review ***

TABLE 6-28 - TECHNOLOGY PENETRATION UNDER BASELINE AND PROPOSED CO₂ STANDARDS – BMW

Technology		2017	2018	2019	2020	2021	2022	2023	2024	2025	2026	2027	2028	2029
Curb Weight (lb.)	Baseline	3823	3797	3708	3690	3687	3650	3602	3578	3540	3522	3522	3497	3494
Curb Weight (lb.)	Proposal	3823	3797	3708	3690	3687	3649	3620	3618	3617	3615	3615	3607	3606
High CR NA Engines	Baseline	0%	0%	0%	0%	0%	0%	0%	0%	0%	0%	0%	0%	0%
High CR NA Engines	Proposal	0%	0%	0%	0%	0%	0%	0%	0%	0%	0%	0%	0%	0%
Turbo SI Engines	Baseline	96%	97%	97%	97%	97%	97%	97%	97%	97%	96%	96%	96%	96%
Turbo SI Engines	Proposal	96%	97%	97%	97%	97%	97%	97%	97%	97%	97%	97%	97%	97%
Dynamic Deac,	Baseline	0%	0%	0%	0%	0%	0%	0%	0%	0%	0%	0%	0%	0%
Dynamic Deac,	Proposal	0%	0%	0%	0%	0%	0%	0%	0%	0%	0%	0%	0%	0%
Adv. Transmission	Baseline	80%	79%	61%	64%	64%	48%	38%	18%	13%	13%	13%	13%	13%
Adv. Transmission	Proposal	80%	80%	79%	84%	83%	84%	84%	85%	85%	85%	85%	85%	85%
12V SS Systems	Baseline	79%	76%	57%	53%	53%	34%	25%	16%	0%	0%	0%	0%	0%
12V SS Systems	Proposal	79%	76%	57%	53%	53%	53%	53%	53%	53%	53%	53%	53%	53%
Mild HEVs	Baseline	11%	13%	14%	14%	14%	14%	13%	3%	13%	13%	13%	13%	13%
Mild HEVs	Proposal	13%	16%	33%	34%	34%	34%	34%	34%	34%	34%	34%	34%	34%
Strong HEVs	Baseline	2%	6%	25%	29%	29%	48%	58%	78%	83%	82%	82%	82%	82%
Strong HEVs	Proposal	0%	3%	6%	9%	9%	9%	9%	9%	9%	9%	9%	9%	9%
Plug-In HEVs	Baseline	2%	2%	2%	2%	2%	2%	2%	2%	2%	3%	3%	3%	3%
Plug-In HEVs	Proposal	2%	2%	2%	2%	2%	2%	2%	2%	2%	2%	2%	2%	2%
Dedicated EVs	Baseline	1%	1%	1%	1%	1%	1%	1%	1%	1%	1%	1%	1%	1%
Dedicated EVs	Proposal	1%	1%	1%	1%	1%	1%	1%	1%	1%	1%	1%	1%	1%
Fuel Cell Vehicles	Baseline	0%	0%	0%	0%	0%	0%	0%	0%	0%	0%	0%	0%	0%
Fuel Cell Vehicles	Proposal	0%	0%	0%	0%	0%	0%	0%	0%	0%	0%	0%	0%	0%

*** EO 12866 Review – Draft – Do Not Cite, Quote or Release During Review ***

TABLE 6-29 - TECHNOLOGY PENETRATION UNDER BASELINE AND PROPOSED CO₂ STANDARDS – DAIMLER

Technology		2017	2018	2019	2020	2021	2022	2023	2024	2025	2026	2027	2028	2029
Curb Weight (lb.)	Baseline	4113	4115	4003	4002	3965	3878	3840	3819	3821	3781	3778	3781	3783
Curb Weight (lb.)	Proposal	4113	4117	4034	4033	3995	3951	3931	3930	3928	3920	3919	3920	3919
High CR NA Engines	Baseline	0%	0%	0%	0%	0%	0%	0%	0%	0%	0%	0%	0%	0%
High CR NA Engines	Proposal	0%	0%	0%	0%	0%	0%	0%	0%	0%	0%	0%	0%	0%
Turbo SI Engines	Baseline	85%	85%	98%	98%	98%	98%	98%	98%	98%	98%	98%	98%	98%
Turbo SI Engines	Proposal	85%	85%	98%	98%	98%	98%	98%	98%	98%	98%	98%	98%	98%
Dynamic Deac,	Baseline	0%	0%	0%	0%	0%	0%	0%	0%	0%	0%	0%	0%	0%
Dynamic Deac,	Proposal	0%	0%	0%	0%	0%	0%	0%	0%	0%	0%	0%	0%	0%
Adv. Transmission	Baseline	13%	13%	57%	63%	64%	41%	31%	26%	26%	2%	2%	2%	2%
Adv. Transmission	Proposal	13%	13%	59%	74%	76%	78%	79%	79%	79%	79%	79%	79%	79%
12V SS Systems	Baseline	67%	66%	50%	50%	37%	13%	3%	3%	3%	0%	0%	0%	0%
12V SS Systems	Proposal	67%	67%	59%	59%	49%	49%	49%	49%	49%	49%	49%	49%	49%
Mild HEVs	Baseline	6%	6%	28%	28%	30%	30%	30%	25%	25%	4%	4%	4%	4%
Mild HEVs	Proposal	15%	15%	24%	24%	27%	27%	27%	27%	27%	27%	27%	27%	27%
Strong HEVs	Baseline	9%	11%	20%	20%	32%	56%	66%	71%	71%	95%	95%	95%	95%
Strong HEVs	Proposal	0%	0%	0%	0%	9%	9%	9%	9%	9%	9%	9%	9%	9%
Plug-In HEVs	Baseline	0%	0%	0%	0%	0%	0%	0%	0%	0%	0%	0%	0%	0%
Plug-In HEVs	Proposal	0%	0%	0%	0%	0%	0%	0%	0%	0%	0%	0%	0%	0%
Dedicated EVs	Baseline	0%	0%	0%	0%	0%	0%	0%	0%	0%	0%	0%	0%	0%
Dedicated EVs	Proposal	0%	0%	0%	0%	0%	0%	0%	0%	0%	0%	0%	0%	0%
Fuel Cell Vehicles	Baseline	0%	0%	0%	0%	0%	0%	0%	0%	0%	0%	0%	0%	0%
Fuel Cell Vehicles	Proposal	0%	0%	0%	0%	0%	0%	0%	0%	0%	0%	0%	0%	0%

*** EO 12866 Review – Draft – Do Not Cite, Quote or Release During Review ***

TABLE 6-30 - TECHNOLOGY PENETRATION UNDER BASELINE AND PROPOSED CO₂ STANDARDS – FIAT CHRYSLER

Technology		2017	2018	2019	2020	2021	2022	2023	2024	2025	2026	2027	2028	2029
Curb Weight (lb.)	Baseline	4158	4104	4009	3976	3947	3931	3926	3927	3920	3893	3882	3837	3813
Curb Weight (lb.)	Proposal	4158	4123	4059	4026	3997	3989	3989	3989	3988	3974	3974	3957	3957
High CR NA Engines	Baseline	0%	0%	0%	0%	0%	0%	0%	0%	0%	0%	0%	0%	0%
High CR NA Engines	Proposal	0%	0%	0%	0%	0%	0%	0%	0%	0%	0%	0%	0%	0%
Turbo SI Engines	Baseline	20%	44%	47%	57%	70%	75%	79%	79%	79%	83%	83%	83%	83%
Turbo SI Engines	Proposal	20%	44%	47%	57%	68%	74%	77%	77%	77%	82%	82%	82%	82%
Dynamic Deac,	Baseline	0%	0%	13%	13%	15%	15%	15%	15%	15%	15%	15%	15%	15%
Dynamic Deac,	Proposal	0%	0%	0%	0%	0%	0%	0%	0%	0%	0%	0%	0%	0%
Adv. Transmission	Baseline	64%	85%	85%	91%	87%	86%	80%	80%	77%	72%	72%	72%	72%
Adv. Transmission	Proposal	64%	85%	85%	91%	96%	96%	97%	97%	97%	97%	97%	97%	97%
12V SS Systems	Baseline	12%	13%	11%	10%	10%	13%	13%	13%	8%	4%	4%	4%	4%
12V SS Systems	Proposal	23%	26%	26%	29%	38%	38%	38%	38%	38%	38%	38%	38%	38%
Mild HEVs	Baseline	11%	13%	30%	34%	35%	35%	28%	28%	31%	39%	47%	62%	63%
Mild HEVs	Proposal	0%	0%	0%	0%	0%	0%	0%	0%	0%	0%	0%	0%	0%
Strong HEVs	Baseline	0%	0%	0%	0%	9%	10%	17%	17%	19%	25%	25%	25%	25%
Strong HEVs	Proposal	0%	0%	0%	0%	0%	0%	0%	0%	0%	0%	0%	0%	0%
Plug-In HEVs	Baseline	0%	0%	0%	0%	0%	0%	0%	0%	0%	0%	0%	0%	0%
Plug-In HEVs	Proposal	0%	0%	0%	0%	0%	0%	0%	0%	0%	0%	0%	0%	0%
Dedicated EVs	Baseline	0%	0%	0%	0%	0%	0%	0%	0%	0%	0%	0%	0%	0%
Dedicated EVs	Proposal	0%	0%	0%	0%	0%	0%	0%	0%	0%	0%	0%	0%	0%
Fuel Cell Vehicles	Baseline	0%	0%	0%	0%	0%	0%	0%	0%	0%	0%	0%	0%	0%
Fuel Cell Vehicles	Proposal	0%	0%	0%	0%	0%	0%	0%	0%	0%	0%	0%	0%	0%

*** EO 12866 Review – Draft – Do Not Cite, Quote or Release During Review ***

TABLE 6-31 - TECHNOLOGY PENETRATION UNDER BASELINE AND PROPOSED CO₂ STANDARDS – FORD

Technology		2017	2018	2019	2020	2021	2022	2023	2024	2025	2026	2027	2028	2029
Curb Weight (lb.)	Baseline	4038	4039	4035	3923	3909	3887	3891	3886	3885	3847	3776	3777	3780
Curb Weight (lb.)	Proposal	4038	4039	4035	3936	3922	3909	3909	3899	3894	3891	3867	3867	3866
High CR NA Engines	Baseline	3%	3%	3%	3%	3%	3%	3%	3%	3%	3%	3%	3%	3%
High CR NA Engines	Proposal	3%	3%	3%	3%	3%	3%	3%	3%	3%	3%	3%	3%	3%
Turbo SI Engines	Baseline	46%	48%	55%	76%	89%	94%	95%	96%	97%	97%	97%	97%	97%
Turbo SI Engines	Proposal	46%	46%	54%	54%	54%	54%	54%	54%	54%	54%	54%	54%	54%
Dynamic Deac,	Baseline	0%	0%	0%	0%	0%	0%	0%	0%	0%	0%	0%	0%	0%
Dynamic Deac,	Proposal	0%	0%	0%	0%	0%	0%	0%	0%	0%	0%	0%	0%	0%
Adv. Transmission	Baseline	41%	47%	47%	81%	85%	85%	86%	86%	86%	86%	86%	87%	87%
Adv. Transmission	Proposal	41%	47%	47%	81%	85%	85%	86%	86%	86%	86%	86%	86%	86%
12V SS Systems	Baseline	8%	8%	16%	41%	35%	36%	36%	35%	35%	30%	22%	21%	21%
12V SS Systems	Proposal	8%	8%	8%	8%	8%	8%	8%	8%	8%	8%	8%	8%	8%
Mild HEVs	Baseline	0%	3%	3%	18%	44%	52%	52%	56%	56%	62%	70%	71%	71%
Mild HEVs	Proposal	0%	0%	0%	0%	0%	0%	0%	0%	0%	0%	0%	0%	0%
Strong HEVs	Baseline	2%	2%	2%	2%	2%	2%	2%	2%	2%	2%	2%	2%	2%
Strong HEVs	Proposal	2%	2%	2%	2%	2%	2%	2%	2%	2%	2%	2%	2%	2%
Plug-In HEVs	Baseline	1%	1%	1%	1%	1%	1%	1%	1%	1%	1%	1%	1%	1%
Plug-In HEVs	Proposal	1%	1%	1%	1%	1%	1%	1%	1%	1%	1%	1%	1%	1%
Dedicated EVs	Baseline	0%	0%	0%	0%	0%	0%	0%	0%	0%	0%	0%	0%	0%
Dedicated EVs	Proposal	0%	0%	0%	0%	0%	0%	0%	0%	0%	0%	0%	0%	0%
Fuel Cell Vehicles	Baseline	0%	0%	0%	0%	0%	0%	0%	0%	0%	0%	0%	0%	0%
Fuel Cell Vehicles	Proposal	0%	0%	0%	0%	0%	0%	0%	0%	0%	0%	0%	0%	0%

*** EO 12866 Review – Draft – Do Not Cite, Quote or Release During Review ***

TABLE 6-32 - TECHNOLOGY PENETRATION UNDER BASELINE AND PROPOSED CO₂ STANDARDS – GENERAL MOTORS

Technology		2017	2018	2019	2020	2021	2022	2023	2024	2025	2026	2027	2028	2029
Curb Weight (lb.)	Baseline	4300	4250	4176	4159	4073	4059	4057	4045	4020	3993	3986	3965	3955
Curb Weight (lb.)	Proposal	4301	4273	4221	4209	4150	4149	4143	4133	4122	4094	4094	4094	4093
High CR NA Engines	Baseline	0%	0%	0%	0%	0%	0%	0%	0%	0%	0%	0%	0%	0%
High CR NA Engines	Proposal	0%	0%	0%	0%	0%	0%	0%	0%	0%	0%	0%	0%	0%
Turbo SI Engines	Baseline	27%	47%	48%	53%	63%	65%	65%	65%	66%	66%	66%	66%	66%
Turbo SI Engines	Proposal	27%	36%	36%	41%	50%	50%	50%	50%	50%	50%	50%	50%	50%
Dynamic Deac,	Baseline	0%	0%	0%	0%	0%	0%	0%	0%	0%	0%	0%	18%	33%
Dynamic Deac,	Proposal	0%	0%	0%	0%	0%	0%	0%	0%	0%	0%	0%	0%	0%
Adv. Transmission	Baseline	14%	45%	66%	84%	96%	97%	97%	97%	96%	96%	96%	98%	97%
Adv. Transmission	Proposal	14%	45%	66%	84%	96%	96%	96%	96%	96%	96%	96%	98%	98%
12V SS Systems	Baseline	15%	23%	23%	26%	31%	31%	31%	31%	22%	7%	4%	2%	0%
12V SS Systems	Proposal	15%	15%	15%	15%	15%	15%	15%	15%	15%	15%	15%	15%	15%
Mild HEVs	Baseline	4%	6%	19%	21%	39%	45%	52%	58%	70%	88%	94%	96%	96%
Mild HEVs	Proposal	0%	0%	0%	0%	0%	0%	0%	0%	0%	0%	0%	0%	0%
Strong HEVs	Baseline	0%	0%	0%	0%	0%	0%	0%	0%	0%	1%	1%	1%	2%
Strong HEVs	Proposal	0%	0%	0%	0%	0%	0%	0%	0%	0%	0%	0%	0%	0%
Plug-In HEVs	Baseline	0%	0%	0%	0%	0%	0%	0%	0%	0%	0%	0%	0%	0%
Plug-In HEVs	Proposal	0%	0%	0%	0%	0%	0%	0%	0%	0%	0%	0%	0%	0%
Dedicated EVs	Baseline	0%	0%	0%	0%	0%	0%	0%	0%	0%	0%	0%	0%	0%
Dedicated EVs	Proposal	0%	0%	0%	0%	0%	0%	0%	0%	0%	0%	0%	0%	0%
Fuel Cell Vehicles	Baseline	0%	0%	0%	0%	0%	0%	0%	0%	0%	0%	0%	0%	0%
Fuel Cell Vehicles	Proposal	0%	0%	0%	0%	0%	0%	0%	0%	0%	0%	0%	0%	0%

*** EO 12866 Review – Draft – Do Not Cite, Quote or Release During Review ***

TABLE 6-33 - TECHNOLOGY PENETRATION UNDER BASELINE AND PROPOSED CO₂ STANDARDS – HONDA

Technology		2017	2018	2019	2020	2021	2022	2023	2024	2025	2026	2027	2028	2029
Curb Weight (lb.)	Baseline	3452	3435	3426	3425	3415	3376	3326	3320	3321	3318	3304	3284	3286
Curb Weight (lb.)	Proposal	3472	3466	3460	3459	3455	3444	3433	3431	3429	3427	3417	3417	3415
High CR NA Engines	Baseline	0%	0%	0%	0%	0%	0%	0%	0%	0%	0%	0%	0%	0%
High CR NA Engines	Proposal	0%	0%	0%	0%	0%	0%	0%	0%	0%	0%	0%	0%	0%
Turbo SI Engines	Baseline	6%	18%	21%	21%	41%	80%	96%	100%	100%	100%	100%	100%	100%
Turbo SI Engines	Proposal	6%	18%	21%	21%	21%	60%	76%	76%	76%	76%	76%	76%	76%
Dynamic Deac,	Baseline	0%	0%	0%	0%	0%	0%	0%	0%	0%	0%	0%	0%	0%
Dynamic Deac,	Proposal	0%	0%	0%	0%	0%	0%	0%	0%	0%	0%	0%	0%	0%
Adv. Transmission	Baseline	75%	75%	75%	85%	87%	97%	97%	97%	97%	97%	97%	97%	97%
Adv. Transmission	Proposal	75%	75%	75%	85%	87%	97%	97%	97%	97%	97%	97%	97%	97%
12V SS Systems	Baseline	6%	6%	6%	6%	6%	3%	3%	3%	3%	3%	10%	11%	13%
12V SS Systems	Proposal	6%	6%	6%	6%	6%	6%	6%	6%	6%	6%	6%	6%	6%
Mild HEVs	Baseline	0%	0%	0%	0%	0%	3%	3%	3%	3%	3%	3%	3%	3%
Mild HEVs	Proposal	0%	0%	0%	0%	0%	0%	0%	0%	0%	0%	0%	0%	0%
Strong HEVs	Baseline	0%	0%	0%	0%	0%	0%	0%	0%	0%	0%	0%	0%	0%
Strong HEVs	Proposal	0%	0%	0%	0%	0%	0%	0%	0%	0%	0%	0%	0%	0%
Plug-In HEVs	Baseline	0%	0%	0%	0%	0%	0%	0%	0%	0%	0%	0%	0%	0%
Plug-In HEVs	Proposal	0%	0%	0%	0%	0%	0%	0%	0%	0%	0%	0%	0%	0%
Dedicated EVs	Baseline	0%	0%	0%	0%	0%	0%	0%	0%	0%	0%	0%	0%	0%
Dedicated EVs	Proposal	0%	0%	0%	0%	0%	0%	0%	0%	0%	0%	0%	0%	0%
Fuel Cell Vehicles	Baseline	0%	0%	0%	0%	0%	0%	0%	0%	0%	0%	0%	0%	0%
Fuel Cell Vehicles	Proposal	0%	0%	0%	0%	0%	0%	0%	0%	0%	0%	0%	0%	0%

*** EO 12866 Review – Draft – Do Not Cite, Quote or Release During Review ***

TABLE 6-34 - TECHNOLOGY PENETRATION UNDER BASELINE AND PROPOSED CO₂ STANDARDS – HYUNDAI

Technology		2017	2018	2019	2020	2021	2022	2023	2024	2025	2026	2027	2028	2029
Curb Weight (lb.)	Baseline	3157	3161	3159	3154	3145	3147	3148	3127	3127	3091	3090	3091	3092
Curb Weight (lb.)	Proposal	3157	3161	3159	3159	3157	3158	3157	3157	3156	3143	3143	3143	3142
High CR NA Engines	Baseline	7%	18%	25%	25%	55%	58%	58%	58%	58%	58%	81%	81%	81%
High CR NA Engines	Proposal	7%	18%	25%	25%	55%	58%	58%	58%	59%	59%	59%	59%	59%
Turbo SI Engines	Baseline	12%	12%	15%	18%	18%	18%	18%	18%	18%	19%	19%	19%	19%
Turbo SI Engines	Proposal	12%	12%	15%	18%	18%	18%	18%	18%	18%	18%	18%	18%	18%
Dynamic Deac,	Baseline	0%	0%	0%	0%	0%	0%	0%	0%	0%	0%	0%	0%	0%
Dynamic Deac,	Proposal	0%	0%	0%	0%	0%	0%	0%	0%	0%	0%	0%	0%	0%
Adv. Transmission	Baseline	53%	68%	79%	79%	82%	82%	82%	82%	82%	82%	82%	82%	81%
Adv. Transmission	Proposal	53%	68%	79%	79%	82%	82%	82%	82%	82%	82%	82%	82%	82%
12V SS Systems	Baseline	0%	0%	0%	0%	0%	0%	0%	0%	0%	0%	0%	0%	0%
12V SS Systems	Proposal	0%	0%	0%	0%	0%	0%	0%	0%	0%	0%	0%	0%	0%
Mild HEVs	Baseline	0%	0%	0%	0%	0%	0%	0%	0%	0%	0%	0%	0%	0%
Mild HEVs	Proposal	0%	0%	0%	0%	0%	0%	0%	0%	0%	0%	0%	0%	0%
Strong HEVs	Baseline	3%	3%	3%	3%	3%	3%	3%	3%	3%	3%	3%	3%	3%
Strong HEVs	Proposal	3%	3%	3%	3%	3%	3%	3%	3%	3%	3%	3%	3%	3%
Plug-In HEVs	Baseline	0%	0%	0%	0%	0%	0%	0%	0%	0%	0%	0%	0%	0%
Plug-In HEVs	Proposal	0%	0%	0%	0%	0%	0%	0%	0%	0%	0%	0%	0%	0%
Dedicated EVs	Baseline	0%	0%	0%	0%	0%	0%	0%	0%	0%	0%	0%	0%	0%
Dedicated EVs	Proposal	0%	0%	0%	0%	0%	0%	0%	0%	0%	0%	0%	0%	0%
Fuel Cell Vehicles	Baseline	0%	0%	0%	0%	0%	0%	0%	0%	0%	0%	0%	0%	0%
Fuel Cell Vehicles	Proposal	0%	0%	0%	0%	0%	0%	0%	0%	0%	0%	0%	0%	0%

*** EO 12866 Review – Draft – Do Not Cite, Quote or Release During Review ***

TABLE 6-35 - TECHNOLOGY PENETRATION UNDER BASELINE AND PROPOSED CO₂ STANDARDS – KIA

Technology		2017	2018	2019	2020	2021	2022	2023	2024	2025	2026	2027	2028	2029
Curb Weight (lb.)	Baseline	3292	3296	3295	3294	3240	3241	3225	3220	3221	3221	3181	3182	3184
Curb Weight (lb.)	Proposal	3298	3302	3300	3300	3285	3286	3281	3281	3280	3279	3279	3279	3279
High CR NA Engines	Baseline	0%	31%	31%	45%	77%	77%	77%	77%	77%	77%	77%	77%	77%
High CR NA Engines	Proposal	0%	31%	31%	34%	66%	66%	66%	66%	66%	66%	66%	66%	66%
Turbo SI Engines	Baseline	5%	5%	5%	5%	5%	5%	13%	23%	23%	23%	23%	23%	23%
Turbo SI Engines	Proposal	5%	5%	5%	5%	5%	5%	13%	22%	22%	22%	22%	22%	22%
Dynamic Deac,	Baseline	0%	0%	0%	0%	0%	0%	0%	0%	0%	0%	0%	0%	0%
Dynamic Deac,	Proposal	0%	0%	0%	0%	0%	0%	0%	0%	0%	0%	0%	0%	0%
Adv. Transmission	Baseline	0%	29%	53%	67%	96%	96%	96%	96%	96%	96%	96%	96%	96%
Adv. Transmission	Proposal	0%	29%	53%	67%	96%	96%	96%	96%	96%	96%	96%	96%	96%
12V SS Systems	Baseline	0%	0%	0%	4%	21%	45%	51%	54%	54%	64%	78%	77%	77%
12V SS Systems	Proposal	0%	0%	0%	0%	0%	0%	0%	0%	0%	0%	0%	0%	0%
Mild HEVs	Baseline	0%	0%	0%	0%	2%	2%	2%	2%	2%	2%	5%	5%	5%
Mild HEVs	Proposal	0%	0%	0%	0%	0%	0%	0%	0%	0%	0%	0%	0%	0%
Strong HEVs	Baseline	1%	1%	1%	1%	1%	1%	1%	1%	1%	1%	1%	1%	1%
Strong HEVs	Proposal	1%	1%	1%	1%	1%	1%	1%	1%	1%	1%	1%	1%	1%
Plug-In HEVs	Baseline	0%	0%	0%	0%	0%	0%	0%	0%	0%	0%	0%	0%	0%
Plug-In HEVs	Proposal	0%	0%	0%	0%	0%	0%	0%	0%	0%	0%	0%	0%	0%
Dedicated EVs	Baseline	0%	0%	0%	0%	0%	0%	0%	0%	0%	0%	0%	0%	0%
Dedicated EVs	Proposal	0%	0%	0%	0%	0%	0%	0%	0%	0%	0%	0%	0%	0%
Fuel Cell Vehicles	Baseline	0%	0%	0%	0%	0%	0%	0%	0%	0%	0%	0%	0%	0%
Fuel Cell Vehicles	Proposal	0%	0%	0%	0%	0%	0%	0%	0%	0%	0%	0%	0%	0%

*** EO 12866 Review – Draft – Do Not Cite, Quote or Release During Review ***

TABLE 6-36 - TECHNOLOGY PENETRATION UNDER BASELINE AND PROPOSED CO₂ STANDARDS – JAGUAR / LAND ROVER

Technology		2017	2018	2019	2020	2021	2022	2023	2024	2025	2026	2027	2028	2029
Curb Weight (lb.)	Baseline	4829	4832	4785	4775	4577	4554	4482	4483	4434	4435	4435	4436	4437
Curb Weight (lb.)	Proposal	4829	4832	4785	4775	4577	4565	4528	4528	4503	4502	4502	4502	4502
High CR NA Engines	Baseline	0%	0%	0%	0%	0%	0%	0%	0%	0%	0%	0%	0%	0%
High CR NA Engines	Proposal	0%	0%	0%	0%	0%	0%	0%	0%	0%	0%	0%	0%	0%
Turbo SI Engines	Baseline	89%	89%	89%	86%	86%	86%	69%	69%	69%	69%	69%	69%	69%
Turbo SI Engines	Proposal	89%	89%	89%	87%	87%	87%	87%	87%	87%	87%	87%	87%	87%
Dynamic Deac,	Baseline	0%	0%	0%	0%	0%	0%	0%	0%	0%	0%	0%	0%	0%
Dynamic Deac,	Proposal	0%	0%	0%	0%	0%	0%	0%	0%	0%	0%	0%	0%	0%
Adv. Transmission	Baseline	100%	100%	76%	73%	34%	35%	17%	17%	17%	17%	17%	17%	17%
Adv. Transmission	Proposal	100%	100%	100%	97%	97%	97%	97%	97%	97%	97%	97%	97%	97%
12V SS Systems	Baseline	87%	87%	76%	73%	23%	23%	6%	6%	6%	6%	6%	5%	5%
12V SS Systems	Proposal	87%	87%	89%	86%	36%	36%	36%	36%	36%	36%	36%	36%	36%
Mild HEVs	Baseline	0%	0%	0%	0%	11%	11%	11%	11%	11%	11%	11%	11%	11%
Mild HEVs	Proposal	0%	0%	11%	11%	61%	61%	61%	61%	61%	61%	61%	61%	60%
Strong HEVs	Baseline	0%	0%	24%	24%	63%	63%	63%	63%	63%	63%	63%	63%	63%
Strong HEVs	Proposal	0%	0%	0%	1%	1%	1%	1%	1%	1%	1%	1%	1%	1%
Plug-In HEVs	Baseline	0%	0%	0%	3%	3%	3%	20%	20%	20%	20%	20%	20%	20%
Plug-In HEVs	Proposal	0%	0%	0%	2%	2%	2%	2%	2%	2%	2%	2%	2%	2%
Dedicated EVs	Baseline	0%	0%	0%	0%	0%	0%	0%	0%	0%	0%	0%	0%	0%
Dedicated EVs	Proposal	0%	0%	0%	0%	0%	0%	0%	0%	0%	0%	0%	0%	0%
Fuel Cell Vehicles	Baseline	0%	0%	0%	0%	0%	0%	0%	0%	0%	0%	0%	0%	0%
Fuel Cell Vehicles	Proposal	0%	0%	0%	0%	0%	0%	0%	0%	0%	0%	0%	0%	0%

*** EO 12866 Review – Draft – Do Not Cite, Quote or Release During Review ***

TABLE 6-37 - TECHNOLOGY PENETRATION UNDER BASELINE AND PROPOSED CO₂ STANDARDS – MAZDA

Technology		2017	2018	2019	2020	2021	2022	2023	2024	2025	2026	2027	2028	2029
Curb Weight (lb.)	Baseline	3305	3311	3308	3288	3286	3271	3220	3221	3222	3193	3194	3148	3150
Curb Weight (lb.)	Proposal	3305	3311	3308	3307	3306	3306	3306	3305	3304	3302	3302	3302	3302
High CR NA Engines	Baseline	94%	94%	94%	94%	94%	94%	94%	94%	94%	94%	94%	94%	94%
High CR NA Engines	Proposal	94%	94%	94%	94%	94%	94%	94%	94%	95%	95%	95%	95%	95%
Turbo SI Engines	Baseline	6%	6%	6%	6%	6%	6%	6%	6%	6%	6%	6%	6%	6%
Turbo SI Engines	Proposal	6%	6%	6%	6%	6%	6%	6%	6%	5%	5%	5%	5%	5%
Dynamic Deac,	Baseline	0%	0%	0%	0%	0%	0%	0%	0%	0%	0%	0%	0%	0%
Dynamic Deac,	Proposal	0%	0%	0%	0%	0%	0%	0%	0%	0%	0%	0%	0%	0%
Adv. Transmission	Baseline	22%	82%	93%	93%	94%	94%	94%	94%	94%	94%	94%	87%	87%
Adv. Transmission	Proposal	22%	82%	93%	93%	94%	94%	94%	94%	94%	94%	94%	94%	94%
12V SS Systems	Baseline	0%	0%	0%	0%	0%	13%	27%	27%	27%	19%	19%	14%	14%
12V SS Systems	Proposal	0%	0%	0%	0%	0%	0%	0%	0%	0%	0%	0%	0%	0%
Mild HEVs	Baseline	0%	0%	0%	0%	0%	0%	40%	41%	42%	75%	75%	73%	73%
Mild HEVs	Proposal	0%	0%	0%	0%	0%	0%	0%	0%	0%	0%	0%	0%	0%
Strong HEVs	Baseline	0%	0%	0%	0%	0%	0%	0%	0%	0%	0%	0%	7%	7%
Strong HEVs	Proposal	0%	0%	0%	0%	0%	0%	0%	0%	0%	0%	0%	0%	0%
Plug-In HEVs	Baseline	0%	0%	0%	0%	0%	0%	0%	0%	0%	0%	0%	0%	0%
Plug-In HEVs	Proposal	0%	0%	0%	0%	0%	0%	0%	0%	0%	0%	0%	0%	0%
Dedicated EVs	Baseline	0%	0%	0%	0%	0%	0%	0%	0%	0%	0%	0%	0%	0%
Dedicated EVs	Proposal	0%	0%	0%	0%	0%	0%	0%	0%	0%	0%	0%	0%	0%
Fuel Cell Vehicles	Baseline	0%	0%	0%	0%	0%	0%	0%	0%	0%	0%	0%	0%	0%
Fuel Cell Vehicles	Proposal	0%	0%	0%	0%	0%	0%	0%	0%	0%	0%	0%	0%	0%

*** EO 12866 Review – Draft – Do Not Cite, Quote or Release During Review ***

TABLE 6-38 - TECHNOLOGY PENETRATION UNDER BASELINE AND PROPOSED CO₂ STANDARDS – NISSAN / MITSUBISHI

Technology		2017	2018	2019	2020	2021	2022	2023	2024	2025	2026	2027	2028	2029
Curb Weight (lb.)	Baseline	3400	3408	3389	3355	3339	3326	3325	3309	3289	3291	3266	3263	3265
Curb Weight (lb.)	Proposal	3400	3408	3391	3375	3371	3362	3358	3358	3342	3339	3339	3339	3339
High CR NA Engines	Baseline	0%	0%	1%	3%	3%	5%	10%	55%	69%	70%	75%	84%	87%
High CR NA Engines	Proposal	0%	0%	1%	3%	3%	4%	4%	4%	4%	4%	4%	4%	4%
Turbo SI Engines	Baseline	4%	5%	5%	5%	5%	5%	7%	7%	7%	7%	7%	7%	7%
Turbo SI Engines	Proposal	4%	5%	5%	5%	5%	5%	6%	6%	7%	7%	7%	7%	7%
Dynamic Deac,	Baseline	0%	0%	0%	0%	0%	0%	0%	0%	0%	0%	0%	0%	0%
Dynamic Deac,	Proposal	0%	0%	0%	0%	0%	0%	0%	0%	0%	0%	0%	0%	0%
Adv. Transmission	Baseline	86%	92%	92%	92%	92%	95%	96%	96%	97%	97%	97%	97%	97%
Adv. Transmission	Proposal	86%	92%	92%	92%	92%	95%	96%	96%	97%	97%	97%	97%	97%
12V SS Systems	Baseline	2%	1%	2%	2%	2%	2%	1%	1%	1%	1%	1%	1%	1%
12V SS Systems	Proposal	2%	1%	2%	2%	2%	2%	2%	2%	2%	2%	2%	2%	2%
Mild HEVs	Baseline	0%	0%	0%	0%	0%	0%	0%	0%	0%	0%	0%	0%	0%
Mild HEVs	Proposal	0%	0%	0%	0%	0%	0%	0%	0%	0%	0%	0%	0%	0%
Strong HEVs	Baseline	0%	0%	0%	0%	0%	0%	0%	0%	0%	0%	0%	0%	0%
Strong HEVs	Proposal	0%	0%	0%	0%	0%	0%	0%	0%	0%	0%	0%	0%	0%
Plug-In HEVs	Baseline	0%	0%	0%	0%	0%	0%	0%	0%	0%	0%	0%	0%	0%
Plug-In HEVs	Proposal	0%	0%	0%	0%	0%	0%	0%	0%	0%	0%	0%	0%	0%
Dedicated EVs	Baseline	1%	1%	1%	1%	1%	1%	1%	1%	1%	1%	1%	1%	1%
Dedicated EVs	Proposal	1%	1%	1%	1%	1%	1%	1%	1%	1%	1%	1%	1%	1%
Fuel Cell Vehicles	Baseline	0%	0%	0%	0%	0%	0%	0%	0%	0%	0%	0%	0%	0%
Fuel Cell Vehicles	Proposal	0%	0%	0%	0%	0%	0%	0%	0%	0%	0%	0%	0%	0%

*** EO 12866 Review – Draft – Do Not Cite, Quote or Release During Review ***

TABLE 6-39 - TECHNOLOGY PENETRATION UNDER BASELINE AND PROPOSED CO₂ STANDARDS – SUBARU

Technology		2017	2018	2019	2020	2021	2022	2023	2024	2025	2026	2027	2028	2029
Curb Weight (lb.)	Baseline	3443	3444	3444	3443	3280	3214	3214	3214	3214	3187	3188	3188	3188
Curb Weight (lb.)	Proposal	3443	3444	3444	3443	3362	3329	3328	3328	3328	3314	3314	3314	3314
High CR NA Engines	Baseline	0%	0%	0%	0%	0%	0%	0%	0%	0%	0%	0%	0%	0%
High CR NA Engines	Proposal	0%	0%	0%	0%	0%	0%	0%	0%	0%	0%	0%	0%	0%
Turbo SI Engines	Baseline	7%	7%	7%	7%	7%	35%	35%	35%	35%	35%	35%	35%	35%
Turbo SI Engines	Proposal	7%	7%	7%	7%	7%	7%	8%	8%	8%	8%	8%	8%	8%
Dynamic Deac,	Baseline	0%	0%	0%	0%	0%	0%	0%	0%	0%	0%	0%	0%	0%
Dynamic Deac,	Proposal	0%	0%	0%	0%	0%	0%	0%	0%	0%	0%	0%	0%	0%
Adv. Transmission	Baseline	91%	92%	91%	81%	81%	81%	81%	82%	82%	82%	82%	82%	82%
Adv. Transmission	Proposal	91%	92%	91%	92%	92%	92%	92%	92%	92%	91%	91%	91%	91%
12V SS Systems	Baseline	0%	0%	0%	0%	0%	0%	0%	0%	0%	0%	0%	0%	0%
12V SS Systems	Proposal	0%	0%	0%	0%	0%	0%	0%	0%	0%	0%	0%	0%	0%
Mild HEVs	Baseline	0%	0%	0%	0%	1%	10%	10%	10%	10%	10%	10%	10%	10%
Mild HEVs	Proposal	0%	0%	0%	0%	0%	0%	0%	0%	0%	0%	0%	0%	0%
Strong HEVs	Baseline	1%	1%	1%	11%	11%	11%	11%	11%	11%	11%	10%	10%	10%
Strong HEVs	Proposal	1%	1%	1%	1%	1%	1%	1%	1%	1%	0%	0%	0%	0%
Plug-In HEVs	Baseline	0%	0%	0%	0%	0%	0%	0%	0%	0%	0%	0%	0%	0%
Plug-In HEVs	Proposal	0%	0%	0%	0%	0%	0%	0%	0%	0%	0%	0%	0%	0%
Dedicated EVs	Baseline	0%	0%	0%	0%	0%	0%	0%	0%	0%	0%	0%	0%	0%
Dedicated EVs	Proposal	0%	0%	0%	0%	0%	0%	0%	0%	0%	0%	0%	0%	0%
Fuel Cell Vehicles	Baseline	0%	0%	0%	0%	0%	0%	0%	0%	0%	0%	0%	0%	0%
Fuel Cell Vehicles	Proposal	0%	0%	0%	0%	0%	0%	0%	0%	0%	0%	0%	0%	0%

*** EO 12866 Review – Draft – Do Not Cite, Quote or Release During Review ***

TABLE 6-40 - TECHNOLOGY PENETRATION UNDER BASELINE AND PROPOSED CO₂ STANDARDS – TOYOTA

Technology		2017	2018	2019	2020	2021	2022	2023	2024	2025	2026	2027	2028	2029
Curb Weight (lb.)	Baseline	3739	3699	3685	3635	3587	3584	3589	3556	3541	3488	3488	3482	3470
Curb Weight (lb.)	Proposal	3739	3722	3711	3685	3654	3651	3651	3638	3634	3614	3613	3611	3609
High CR NA Engines	Baseline	21%	34%	45%	46%	46%	47%	47%	47%	63%	64%	64%	64%	64%
High CR NA Engines	Proposal	21%	21%	21%	21%	21%	22%	22%	22%	22%	23%	23%	23%	23%
Turbo SI Engines	Baseline	3%	10%	11%	19%	28%	30%	31%	31%	31%	32%	32%	33%	33%
Turbo SI Engines	Proposal	3%	3%	3%	3%	4%	4%	4%	4%	4%	4%	4%	4%	4%
Dynamic Deac,	Baseline	0%	0%	0%	0%	0%	0%	0%	0%	0%	0%	0%	0%	0%
Dynamic Deac,	Proposal	0%	0%	0%	0%	0%	0%	0%	0%	0%	0%	0%	0%	0%
Adv. Transmission	Baseline	38%	62%	75%	87%	97%	98%	99%	99%	99%	99%	99%	99%	99%
Adv. Transmission	Proposal	38%	62%	75%	87%	97%	98%	99%	99%	99%	99%	99%	99%	99%
12V SS Systems	Baseline	0%	0%	0%	0%	0%	0%	0%	6%	7%	10%	10%	10%	10%
12V SS Systems	Proposal	0%	0%	0%	0%	0%	0%	0%	0%	0%	0%	0%	0%	0%
Mild HEVs	Baseline	0%	1%	2%	2%	7%	7%	7%	7%	7%	27%	30%	33%	34%
Mild HEVs	Proposal	0%	0%	0%	0%	0%	0%	0%	0%	0%	0%	0%	0%	0%
Strong HEVs	Baseline	9%	9%	9%	9%	9%	9%	9%	9%	9%	9%	9%	9%	9%
Strong HEVs	Proposal	9%	9%	9%	9%	9%	9%	9%	9%	9%	9%	9%	9%	9%
Plug-In HEVs	Baseline	0%	0%	0%	0%	0%	0%	0%	0%	0%	0%	0%	0%	0%
Plug-In HEVs	Proposal	0%	0%	0%	0%	0%	0%	0%	0%	0%	0%	0%	0%	0%
Dedicated EVs	Baseline	0%	0%	0%	0%	0%	0%	0%	0%	0%	0%	0%	0%	0%
Dedicated EVs	Proposal	0%	0%	0%	0%	0%	0%	0%	0%	0%	0%	0%	0%	0%
Fuel Cell Vehicles	Baseline	0%	0%	0%	0%	0%	0%	0%	0%	0%	0%	0%	0%	0%
Fuel Cell Vehicles	Proposal	0%	0%	0%	0%	0%	0%	0%	0%	0%	0%	0%	0%	0%

*** EO 12866 Review – Draft – Do Not Cite, Quote or Release During Review ***

TABLE 6-41 - TECHNOLOGY PENETRATION UNDER BASELINE AND PROPOSED CO₂ STANDARDS – VOLVO

Technology		2017	2018	2019	2020	2021	2022	2023	2024	2025	2026	2027	2028	2029
Curb Weight (lb.)	Baseline	4165	4172	4022	4021	4019	4021	3970	3948	3950	3951	3904	3901	3903
Curb Weight (lb.)	Proposal	4165	4172	4071	4070	4068	4068	4068	4051	4050	4047	4047	4044	4043
High CR NA Engines	Baseline	0%	0%	0%	0%	0%	0%	0%	0%	0%	0%	0%	0%	0%
High CR NA Engines	Proposal	0%	0%	0%	0%	0%	0%	0%	0%	0%	0%	0%	0%	0%
Turbo SI Engines	Baseline	100%	100%	100%	100%	100%	100%	100%	100%	100%	100%	100%	100%	100%
Turbo SI Engines	Proposal	100%	100%	100%	100%	100%	100%	100%	100%	100%	100%	100%	100%	100%
Dynamic Deac,	Baseline	0%	0%	0%	0%	0%	0%	0%	0%	0%	0%	0%	0%	0%
Dynamic Deac,	Proposal	0%	0%	0%	0%	0%	0%	0%	0%	0%	0%	0%	0%	0%
Adv. Transmission	Baseline	70%	71%	77%	84%	84%	84%	84%	76%	76%	76%	52%	51%	51%
Adv. Transmission	Proposal	70%	71%	91%	98%	98%	98%	98%	98%	98%	98%	98%	98%	98%
12V SS Systems	Baseline	67%	68%	37%	37%	36%	37%	0%	0%	0%	0%	0%	0%	0%
12V SS Systems	Proposal	70%	71%	70%	70%	70%	70%	70%	70%	70%	70%	70%	70%	70%
Mild HEVs	Baseline	3%	3%	40%	41%	41%	41%	77%	76%	76%	76%	52%	51%	51%
Mild HEVs	Proposal	0%	0%	0%	0%	0%	0%	0%	0%	0%	0%	0%	0%	0%
Strong HEVs	Baseline	0%	0%	14%	14%	14%	14%	14%	22%	22%	21%	45%	47%	46%
Strong HEVs	Proposal	0%	0%	0%	0%	0%	0%	0%	0%	0%	0%	0%	0%	0%
Plug-In HEVs	Baseline	2%	2%	2%	2%	2%	2%	2%	3%	3%	3%	3%	3%	3%
Plug-In HEVs	Proposal	2%	2%	2%	2%	2%	2%	2%	2%	2%	2%	2%	2%	2%
Dedicated EVs	Baseline	0%	0%	0%	0%	0%	0%	0%	0%	0%	0%	0%	0%	0%
Dedicated EVs	Proposal	0%	0%	0%	0%	0%	0%	0%	0%	0%	0%	0%	0%	0%
Fuel Cell Vehicles	Baseline	0%	0%	0%	0%	0%	0%	0%	0%	0%	0%	0%	0%	0%
Fuel Cell Vehicles	Proposal	0%	0%	0%	0%	0%	0%	0%	0%	0%	0%	0%	0%	0%

*** EO 12866 Review – Draft – Do Not Cite, Quote or Release During Review ***

TABLE 6-42 - TECHNOLOGY PENETRATION UNDER BASELINE AND PROPOSED CO₂ STANDARDS – VW

Technology		2017	2018	2019	2020	2021	2022	2023	2024	2025	2026	2027	2028	2029
Curb Weight (lb.)	Baseline	3484	3416	3402	3362	3358	3324	3299	3286	3280	3263	3251	3237	3239
Curb Weight (lb.)	Proposal	3484	3423	3409	3369	3365	3332	3323	3322	3321	3319	3319	3317	3316
High CR NA Engines	Baseline	0%	0%	0%	0%	0%	0%	0%	0%	0%	0%	0%	0%	0%
High CR NA Engines	Proposal	0%	0%	0%	0%	0%	0%	0%	0%	0%	0%	0%	0%	0%
Turbo SI Engines	Baseline	91%	95%	95%	95%	95%	96%	96%	96%	97%	96%	96%	95%	95%
Turbo SI Engines	Proposal	91%	95%	95%	95%	95%	96%	96%	96%	97%	97%	97%	97%	97%
Dynamic Deac,	Baseline	0%	0%	0%	0%	0%	0%	0%	0%	0%	0%	0%	0%	0%
Dynamic Deac,	Proposal	0%	0%	0%	0%	0%	0%	0%	0%	0%	0%	0%	0%	0%
Adv. Transmission	Baseline	45%	54%	64%	64%	63%	57%	35%	21%	16%	2%	2%	2%	2%
Adv. Transmission	Proposal	45%	54%	64%	74%	74%	74%	74%	74%	74%	73%	73%	73%	73%
12V SS Systems	Baseline	37%	33%	34%	34%	33%	25%	4%	0%	0%	0%	0%	0%	0%
12V SS Systems	Proposal	17%	18%	18%	19%	20%	20%	20%	20%	19%	19%	19%	19%	19%
Mild HEVs	Baseline	4%	17%	21%	21%	21%	24%	26%	25%	19%	4%	4%	4%	4%
Mild HEVs	Proposal	0%	0%	0%	0%	0%	0%	0%	0%	0%	0%	0%	0%	0%
Strong HEVs	Baseline	0%	1%	1%	16%	18%	29%	52%	67%	73%	86%	86%	86%	86%
Strong HEVs	Proposal	0%	0%	0%	0%	0%	0%	0%	0%	0%	0%	0%	0%	0%
Plug-In HEVs	Baseline	1%	1%	1%	1%	1%	1%	1%	1%	1%	2%	2%	3%	3%
Plug-In HEVs	Proposal	1%	1%	1%	1%	1%	1%	1%	1%	1%	1%	1%	1%	1%
Dedicated EVs	Baseline	1%	1%	1%	1%	1%	1%	1%	1%	1%	1%	1%	1%	1%
Dedicated EVs	Proposal	1%	1%	1%	1%	1%	1%	1%	1%	1%	1%	1%	1%	1%
Fuel Cell Vehicles	Baseline	0%	0%	0%	0%	0%	0%	0%	0%	0%	0%	0%	0%	0%
Fuel Cell Vehicles	Proposal	0%	0%	0%	0%	0%	0%	0%	0%	0%	0%	0%	0%	0%

6.3 Impacts on Producers of New Vehicles

Part 1 below presents estimates from the CAFE Model. CAFE Standards

Table 6-43, Table 6-47, and Table 6-51 present estimated compliance impacts and cumulative industry costs under the preferred alternative, including changes in stringency, achieved fuel economy, technology costs, civil penalties, sales impacts and revenue impacts.

Table 6-44, Table 6-48, and Table 6-52 present estimated required fuel economy across fuel economy standards; Table 6-45, Table 6-49, and Table 6-53 present corresponding estimates of achieved fuel economy. Table 6-46, Table 6-50, and Table 6-54 present estimated technology penetration rates for MY 2030 vehicles under the preferred alternative. Table 6-54 through Table 6-58 detail impacts on the passenger car fleet, including separate estimates for domestic and imported vehicles.

*** EO 12866 Review – Draft – Do Not Cite, Quote or Release During Review ***

Table 6-109 present impacts on fuel economy, regulatory cost, average vehicle price, and technology use by manufacturer. In Part 2, the analysis from Part 1 is repeated under EPA’s CO₂ Program rather than the CAFE Model.

6.3.1 CAFE Standards

TABLE 6-43 - COMBINED LIGHT-DUTY CAFE COMPLIANCE IMPACTS, CUMULATIVE INDUSTRY COSTS THROUGH MY 2029

Model Year Standards through	MY 2021	MY 2022	MY 2023	MY 2024	MY 2025	MY 2026	TOTAL
Fuel Economy							
Average Required Fuel Economy - MY 2026+ (mpg)	37.0	37.0	37.0	37.0	37.0	37.0	N/A
Percent Change in Stringency from Baseline	-5.4%	-10.2%	-15.3%	-20.6%	-26.0%	-26.0%	N/A
Average Achieved Fuel Economy - MY 2030 (mpg)	39.7	39.7	39.7	39.7	39.7	39.7	N/A
Average Achieved Fuel Economy - MY 2020 (mpg)	37.2	37.2	37.2	37.2	37.2	37.2	N/A
Total Regulatory Costs through MY 2029 Vehicles (7% discount rate)							
Total Technology Costs (\$b)	-23.9	-31.0	-42.8	-54.5	-42.0	0.0	-194.2
Total Civil Penalties (\$b)	-0.7	-0.6	-0.5	-0.3	0.0	0.0	-2.1
Total Regulatory Costs (\$b)	-24.5	-31.6	-43.3	-54.7	-42.0	0.0	-196.2
Sales and Revenue Impacts through MY 2029 Vehicles (7% discount rate for Revenue Change)							
Sales Change (millions)	0.1	0.2	0.2	0.3	0.2	0.0	1.1
Revenue Change (\$b)	-23.9	-30.2	-40.3	-50.8	-38.9	0.0	-184.1

*** EO 12866 Review – Draft – Do Not Cite, Quote or Release During Review ***

TABLE 6-44 - ESTIMATED REQUIRED AVERAGE FOR THE COMBINED LIGHT-DUTY FLEET, IN MPG

Passenger Cars and Light Trucks	MY 2017	MY 2018	MY 2019	MY 2020	MY 2021	MY 2022	MY 2023	MY 2024	MY 2025	MY 2026	MY 2027	MY 2028	MY 2029
0.00%/Y Pc and 0.00%/Y Lt During 2021-2026	34.0	34.9	35.8	36.9	36.9	36.9	36.9	37.0	37.0	37.0	37.0	37.0	37.0
0.50%/Y Pc and 0.50%/Y Lt During 2021-2026	34.0	34.9	35.8	36.9	37.1	37.3	37.5	37.7	37.9	38.1	38.1	38.1	38.1
0.50%/Y Pc and 0.50%/Y Lt During 2021-2026 with AC and Off-Cycle Adj. Phaseout but No Target Offset	34.0	34.9	35.8	36.9	37.1	37.3	37.5	37.7	37.9	38.1	38.1	38.1	38.1
1.00%/Y Pc and 2.00%/Y Lt During 2021-2026	34.0	34.9	35.8	36.9	37.5	38.1	38.7	39.3	39.9	40.6	40.5	40.5	40.5
1.00%/Y Pc and 2.00%/Y Lt During 2022-2026	34.0	34.9	35.8	36.9	39.0	39.5	40.2	40.8	41.4	42.1	42.1	42.1	42.1
2.00%/Y Pc and 3.00%/Y Lt During 2021-2026	34.0	34.9	35.8	36.9	37.9	38.9	39.9	40.9	42.0	43.1	43.0	43.0	43.0
2.00%/Y Pc and 3.00%/Y Lt During 2021-2026 with AC and Off-Cycle Adj. Phaseout but No Target Offset	34.0	34.9	35.8	36.9	37.9	38.9	39.9	40.9	42.0	43.1	43.0	43.0	42.9
2.00%/Y Pc and 3.00%/Y Lt During 2022-2026	34.0	34.9	35.8	36.9	39.0	40.0	41.0	42.1	43.2	44.3	44.2	44.2	44.2

*** EO 12866 Review – Draft – Do Not Cite, Quote or Release During Review ***

TABLE 6-45 - ESTIMATED ACHIEVED HARMONIC AVERAGE FOR THE COMBINED LIGHT-DUTY FLEET, IN MPG

Passenger Cars and Light Trucks	MY 2017	MY 2018	MY 2019	MY 2020	MY 2021	MY 2022	MY 2023	MY 2024	MY 2025	MY 2026	MY 2027	MY 2028	MY 2029
0.00%/Y Pc and 0.00%/Y Lt During 21-2026	33.7	35.0	36.0	37.2	38.3	38.7	39.0	39.1	39.2	39.5	39.6	39.6	39.7
0.50%/Y Pc and 0.50%/Y Lt During 21-2026	33.7	35.2	36.1	37.4	38.5	39.0	39.2	39.3	39.5	39.9	40.0	40.0	40.0
0.50%/Y Pc and 0.50%/Y Lt During 21-2026 with AC and Off-Cycle Phaseout but No Target Offset	33.7	35.2	36.2	37.5	38.7	39.1	39.4	39.4	39.2	39	39.1	39.2	39.2
0.00%/Y Pc and 2.00%/Y Lt During 21-2026	33.7	35.3	36.4	37.7	39.1	39.7	40	40.2	40.4	41.1	41.1	41.2	41.2
0.00%/Y Pc and 2.00%/Y Lt During 22-2026	33.9	35.5	36.7	38.2	40.1	40.6	40.9	41.2	41.5	42.2	42.2	42.3	42.3
0.00%/Y Pc and 3.00%/Y Lt During 21-2026	33.8	35.4	36.6	38.0	39.9	40.7	41.2	41.8	42.1	43.0	43.0	43.1	43.2
0.00%/Y Pc and 3.00%/Y Lt During 21-2026 with AC and Off-Cycle Phaseout but No Target Offset	33.8	35.4	36.8	38.3	40.4	41.4	41.9	42.2	42.3	42.7	42.7	42.8	42.8
0.00%/Y Pc and 3.00%/Y Lt During 22-2026	33.9	35.6	37.0	38.6	41	41.8	42.3	42.6	43.0	43.9	44.0	44.1	44.1

*** EO 12866 Review – Draft – Do Not Cite, Quote or Release During Review ***

TABLE 6-46 - COMBINED LIGHT-DUTY FLEET PENETRATION FOR MY 2030, CAFE PROGRAM

Model Year Standards through	MY 2021	MY 2022	MY 2023	MY 2024	MY 2025	MY 2026
Technology Use Under CAFE Alternative in MY 2030 (total fleet penetration)						
Curb Weight Reduction (percent change from MY 2016)	4.3%	4.3%	4.3%	4.3%	4.3%	4.3%
High Compression Ratio Non-Turbo Engines	17.2%	17.2%	17.2%	17.2%	17.2%	17.2%
Turbocharged Gasoline Engines	51.1%	51.1%	51.1%	51.1%	51.1%	51.1%
Dynamic Cylinder Deactivation	0.0%	0.0%	0.0%	0.0%	0.0%	0.0%
Advanced Transmissions	92.9%	92.9%	92.9%	92.9%	92.9%	92.9%
Stop-Start 12V (Non-Hybrid)	13.7%	13.7%	13.7%	13.7%	13.7%	13.7%
Mild Hybrid Electric Systems (48v)	0.4%	0.4%	0.4%	0.4%	0.4%	0.4%
Strong Hybrid Electric Systems	2.3%	2.3%	2.3%	2.3%	2.3%	2.3%
Plug-In Hybrid Electric Vehicles (PHEVs)	0.5%	0.5%	0.5%	0.5%	0.5%	0.5%
Dedicated Electric Vehicles (EVs)	0.5%	0.5%	0.5%	0.5%	0.5%	0.5%
Fuel Cell Vehicles (FCVs)	0.0%	0.0%	0.0%	0.0%	0.0%	0.0%

*** EO 12866 Review – Draft – Do Not Cite, Quote or Release During Review ***

TABLE 6-47 - LIGHT TRUCK CAFE COMPLIANCE IMPACTS AND CUMULATIVE INDUSTRY COSTS THROUGH MY 2029

Model Year Standards through	MY 2021	MY 2022	MY 2023	MY 2024	MY 2025	MY 2026	TOTAL
Fuel Economy							
Average Required Fuel Economy - MY 2026+ (mpg)	31.3	31.3	31.3	31.3	31.3	31.3	N/A
Percent Change in Stringency from Baseline	-6.6%	-11.7%	-17.0%	-22.6%	-28.3%	-28.3%	N/A
Average Achieved Fuel Economy - MY 2030 (mpg)	33.6	33.6	33.6	33.6	33.6	33.6	N/A
Average Achieved Fuel Economy - MY 2020 (mpg)	31.6	31.6	31.6	31.6	31.6	31.6	N/A
Total Regulatory Costs through MY 2029 Vehicles (7% discount rate)							
Total Technology Costs (\$b)	-13.1	-20.1	-22.1	-32.9	-20.1	0.0	-108.3
Total Civil Penalties (\$b)	-0.3	-0.3	-0.3	-0.1	-0.1	0.0	-1.0
Total Regulatory Costs (\$b)	-13.4	-20.4	-22.3	-33.0	-20.1	0.0	-109.1
Sales and Revenue Impacts through MY 2029 Vehicles (7% discount rate for Revenue Change)							
Sales Change (millions)	-0.4	-0.4	-0.2	-0.1	-0.1	0.0	-1.1
Revenue Change (\$b)	-20.6	-27.1	-26.1	-34.2	-21.5	0.0	-129.4

*** EO 12866 Review – Draft – Do Not Cite, Quote or Release During Review ***

TABLE 6-48 - ESTIMATED REQUIRED AVERAGE FOR THE LIGHT TRUCK FLEET, IN MPG

Light Trucks	MY 2017	MY 2018	MY 2019	MY 2020	MY 2021	MY 2022	MY 2023	MY 2024	MY 2025	MY 2026	MY 2027	MY 2028	MY 2029
0.00%/Y Pc and 0.00%/Y Lt During 2021-2026	29.5	30.1	30.6	31.3	31.3	31.3	31.3	31.3	31.3	31.3	31.3	31.3	31.3
0.50%/Y Pc and 0.50%/Y Lt During 2021-2026	29.5	30.1	30.6	31.3	31.4	31.6	31.7	31.9	32.0	32.2	32.2	32.2	32.2
0.50%/Y Pc and 0.50%/Y Lt During 2021-2026 with AC and Off-Cycle Adj. Phaseout but No Target Offset	29.5	30.1	30.6	31.3	31.4	31.6	31.7	31.9	32.0	32.2	32.2	32.2	32.2
1.00%/Y Pc and 2.00%/Y Lt During 2021-2026	29.5	30.1	30.6	31.3	31.9	32.6	33.2	33.9	34.6	35.3	35.3	35.3	35.3
1.00%/Y Pc and 2.00%/Y Lt During 2022-2026	29.5	30.1	30.6	31.3	33.3	34.0	34.7	35.4	36.1	36.9	36.9	36.9	36.9
2.00%/Y Pc and 3.00%/Y Lt During 2021-2026	29.5	30.1	30.6	31.3	32.2	33.2	34.3	35.3	36.4	37.5	37.5	37.5	37.5
2.00%/Y Pc and 3.00%/Y Lt During 2021-2026 with AC and Off-Cycle Adj. Phaseout but No Target Offset	29.5	30.1	30.6	31.3	32.2	33.2	34.3	35.3	36.4	37.5	37.5	37.5	37.5
2.00%/Y Pc and 3.00%/Y Lt During 2022-2026	29.5	30.1	30.6	31.3	33.3	34.4	35.4	36.5	37.6	38.8	38.8	38.8	38.8

*** EO 12866 Review – Draft – Do Not Cite, Quote or Release During Review ***

TABLE 6-49 - ESTIMATED ACHIEVED HARMONIC AVERAGE FOR THE LIGHT TRUCK FLEET, IN MPG

Light Trucks	MY 2017	MY 2018	MY 2019	MY 2020	MY 2021	MY 2022	MY 2023	MY 2024	MY 2025	MY 2026	MY 2027	MY 2028	MY 2029
0.00%/Y Pc and 0.00%/Y Lt During 21-2026	28.6	29.8	30.7	31.6	32.6	32.9	33.1	33.2	33.2	33.5	33.6	33.6	33.6
0.50%/Y Pc and 0.50%/Y Lt During 21-2026	28.6	30.0	30.9	31.8	32.9	33.2	33.3	33.4	33.5	34.0	34.0	34.1	34.1
0.50%/Y Pc and 0.50%/Y Lt During 21-2026 with AC and Off-Cycle Phaseout but No Target Offset	28.6	30.0	31.1	32.0	33.1	33.4	33.5	33.5	33.3	33.3	33.3	33.4	33.4
1.00%/Y Pc and 2.00%/Y Lt During 21-2026	28.6	30.1	31.2	32.3	33.8	34.2	34.4	34.6	34.8	35.4	35.5	35.6	35.7
1.00%/Y Pc and 2.00%/Y Lt During 22-2026	28.7	30.3	31.5	32.7	34.6	35.0	35.3	35.6	35.9	36.6	36.7	36.8	36.9
1.00%/Y Pc and 3.00%/Y Lt During 21-2026	28.6	30.3	31.6	32.7	34.7	35.3	35.7	36.1	36.4	37.3	37.4	37.5	37.6
1.00%/Y Pc and 3.00%/Y Lt During 21-2026 with AC and Off-Cycle Phaseout but No Target Offset	28.6	30.4	31.8	33.1	35.3	36.1	36.3	36.5	36.6	37.1	37.2	37.3	37.3
1.00%/Y Pc and 3.00%/Y Lt During 22-2026	28.7	30.5	31.9	33.3	35.7	36.3	36.7	37.1	37.4	38.3	38.4	38.5	38.6

*** EO 12866 Review – Draft – Do Not Cite, Quote or Release During Review ***

TABLE 6-50 - LIGHT TRUCK FLEET PENETRATION FOR MY 2030, CAFE PROGRAM

Model Year Standards through	MY 2021	MY 2022	MY 2023	MY 2024	MY 2025	MY 2026
Technology Use Under CAFE Alternative in MY 2030 (total fleet penetration)						
Curb Weight Reduction (percent change from MY 2016)	4.4%	4.4%	4.4%	4.4%	4.4%	4.4%
High Compression Ratio Non-Turbo Engines	8.1%	8.1%	8.1%	8.1%	8.1%	8.1%
Turbocharged Gasoline Engines	53.1%	53.1%	53.1%	53.1%	53.1%	53.1%
Dynamic Cylinder Deactivation	0.0%	0.0%	0.0%	0.0%	0.0%	0.0%
Advanced Transmissions	98.3%	98.3%	98.3%	98.3%	98.3%	98.3%
Stop-Start 12V (Non-Hybrid)	12.3%	12.3%	12.3%	12.3%	12.3%	12.3%
Mild Hybrid Electric Systems (48v)	0.0%	0.0%	0.0%	0.0%	0.0%	0.0%
Strong Hybrid Electric Systems	0.9%	0.9%	0.9%	0.9%	0.9%	0.9%
Plug-In Hybrid Electric Vehicles (PHEVs)	0.3%	0.3%	0.3%	0.3%	0.3%	0.3%
Dedicated Electric Vehicles (EVs)	0.3%	0.3%	0.3%	0.3%	0.3%	0.3%
Fuel Cell Vehicles (FCVs)	0.0%	0.0%	0.0%	0.0%	0.0%	0.0%

*** EO 12866 Review – Draft – Do Not Cite, Quote or Release During Review ***

TABLE 6-51 - PASSENGER CAR CAFE COMPLIANCE IMPACTS AND CUMULATIVE INDUSTRY COSTS THROUGH MY 2029

Model Year Standards through	MY 2021	MY 2022	MY 2023	MY 2024	MY 2025	MY 2026	TOTAL
Fuel Economy							
Average Required Fuel Economy - MY 2026+ (mpg)	43.7	43.7	43.7	43.7	43.7	43.7	N/A
Percent Change in Stringency from Baseline	-4.3%	-9.2%	-14.3%	-19.6%	-25.2%	-25.2%	N/A
Average Achieved Fuel Economy - MY 2030 (mpg)	46.7	46.7	46.7	46.7	46.7	46.7	N/A
Average Achieved Fuel Economy - MY 2020 (mpg)	43.9	43.9	43.9	43.9	43.9	43.9	N/A
Total Regulatory Costs through MY 2029 Vehicles (7% discount rate)							
Total Technology Costs (\$b)	-10.8	-10.9	-20.7	-21.6	-21.9	0.0	-85.9
Total Civil Penalties (\$b)	-0.4	-0.4	-0.2	-0.2	0.0	0.0	-1.0
Total Regulatory Costs (\$b)	-11.2	-11.3	-21.0	-21.7	-21.9	0.0	-87.1
Sales and Revenue Impacts through MY 2029 Vehicles (7% discount rate for Revenue Change)							
Sales Change (millions)	0.5	0.5	0.4	0.3	0.3	0.0	2.1
Revenue Change (\$b)	-3.3	-3.1	-14.2	-16.6	-17.5	0.0	-54.7

*** EO 12866 Review – Draft – Do Not Cite, Quote or Release During Review ***

TABLE 6-52 - ESTIMATED REQUIRED AVERAGE FOR THE PASSENGER CAR FLEET, IN MPG

Passenger Cars	MY 2017	MY 2018	MY 2019	MY 2020	MY 2021	MY 2022	MY 2023	MY 2024	MY 2025	MY 2026	MY 2027	MY 2028	MY 2029
0.00%/Y Pc and 0.00%/Y Lt During 2021-2026	39.1	40.5	42.0	43.7	43.7	43.7	43.7	43.7	43.7	43.7	43.7	43.7	43.7
0.50%/Y Pc and 0.50%/Y Lt During 2021-2026	39.1	40.5	42.0	43.7	43.9	44.1	44.3	44.5	44.8	45.0	45.0	45.0	45.0
0.50%/Y Pc and 0.50%/Y Lt During 2021-2026 with AC and Off-Cycle Adj. Phaseout but No Target Offset	39.1	40.5	42.0	43.7	43.9	44.1	44.3	44.5	44.8	45.0	45.0	45.0	45.0
1.00%/Y Pc and 2.00%/Y Lt During 2021-2026	39.1	40.5	42.0	43.7	44.1	44.5	45	45.5	45.9	46.4	46.4	46.4	46.4
1.00%/Y Pc and 2.00%/Y Lt During 2022-2026	39.1	40.5	42.0	43.7	45.5	46.0	46.4	46.9	47.4	47.9	47.9	47.9	47.9
2.00%/Y Pc and 3.00%/Y Lt During 2021-2026	39.1	40.5	42.0	43.7	44.5	45.5	46.4	47.3	48.3	49.3	49.3	49.3	49.3
2.00%/Y Pc and 3.00%/Y Lt During 2021-2026 with AC and Off-Cycle Adj. Phaseout but No Target Offset	39.1	40.5	42.0	43.7	44.5	45.5	46.4	47.3	48.3	49.3	49.3	49.3	49.3
2.00%/Y Pc and 3.00%/Y Lt During 2022-2026	39.1	40.5	42.0	43.7	45.5	46.4	47.4	48.4	49.4	50.4	50.4	50.4	50.4

*** EO 12866 Review – Draft – Do Not Cite, Quote or Release During Review ***

**TABLE 6-53 - ESTIMATED ACHIEVED HARMONIC AVERAGE FOR THE PASSENGER CAR FLEET,
IN MPG**

Passenger Cars	MY 2017	MY 2018	MY 2019	MY 2020	MY 2021	MY 2022	MY 2023	MY 2024	MY 2025	MY 2026	MY 2027	MY 2028	MY 2029
0.00%/Y Pc and 0.00%/Y Lt During 2021-2026	39.7	41.3	42.2	43.9	45.0	45.5	46.0	46.1	46.2	46.5	46.6	46.6	46.7
0.50%/Y Pc and 0.50%/Y Lt During 2021-2026	39.7	41.3	42.2	43.9	45.1	45.7	46.1	46.2	46.4	46.7	46.8	46.8	46.9
0.50%/Y Pc and 0.50%/Y Lt During 2021-2026 with AC and Off-Cycle Adj. Phaseout but No Target Offset	39.7	41.3	42.2	43.9	45.2	45.8	46.2	46.2	46.0	45.6	45.7	45.8	45.8
1.00%/Y Pc and 2.00%/Y Lt During 2021-2026	39.7	41.3	42.3	44.0	45.3	46.0	46.5	46.6	46.8	47.3	47.5	47.6	47.6
1.00%/Y Pc and 2.00%/Y Lt During 2022-2026	39.8	41.7	42.8	44.6	46.3	47.1	47.5	47.7	47.9	48.4	48.5	48.6	48.6
2.00%/Y Pc and 3.00%/Y Lt During 2021-2026	39.7	41.4	42.4	44.1	45.8	46.8	47.6	48.2	48.5	49.4	49.5	49.6	49.6
2.00%/Y Pc and 3.00%/Y Lt During 2021-2026 with AC and Off-Cycle Adj. Phaseout but No Target Offset	39.8	41.4	42.4	44.2	46.1	47.3	48.2	48.8	48.8	49.0	49.1	49.2	49.2
2.00%/Y Pc and 3.00%/Y Lt During 2022-2026	39.8	41.7	42.9	44.7	46.8	47.9	48.6	49.0	49.4	50.3	50.4	50.5	50.6

*** EO 12866 Review – Draft – Do Not Cite, Quote or Release During Review ***

TABLE 6-54 - PASSENGER CAR FLEET PENETRATION FOR MY 2030, CAFE PROGRAM

Model Year Standards through	MY 2021	MY 2022	MY 2023	MY 2024	MY 2025	MY 2026
Technology Use Under CAFE Alternative in MY 2030 (total fleet penetration)						
Curb Weight Reduction (percent change from MY 2016)	4.1%	4.1%	4.1%	4.1%	4.1%	4.1%
High Compression Ratio Non-Turbo Engines	24.7%	24.7%	24.7%	24.7%	24.7%	24.7%
Turbocharged Gasoline Engines	49.5%	49.5%	49.5%	49.5%	49.5%	49.5%
Dynamic Cylinder Deactivation	0.0%	0.0%	0.0%	0.0%	0.0%	0.0%
Advanced Transmissions	88.5%	88.5%	88.5%	88.5%	88.5%	88.5%
Stop-Start 12V (Non-Hybrid)	15.0%	15.0%	15.0%	15.0%	15.0%	15.0%
Mild Hybrid Electric Systems (48v)	0.7%	0.7%	0.7%	0.7%	0.7%	0.7%
Strong Hybrid Electric Systems	3.5%	3.5%	3.5%	3.5%	3.5%	3.5%
Plug-In Hybrid Electric Vehicles (PHEVs)	0.7%	0.7%	0.7%	0.7%	0.7%	0.7%
Dedicated Electric Vehicles (EVs)	0.7%	0.7%	0.7%	0.7%	0.7%	0.7%
Fuel Cell Vehicles (FCVs)	0.0%	0.0%	0.0%	0.0%	0.0%	0.0%

*** EO 12866 Review – Draft – Do Not Cite, Quote or Release During Review ***

TABLE 6-55 - DOMESTIC CAR CAFE COMPLIANCE IMPACTS AND CUMULATIVE INDUSTRY COSTS THROUGH MY 2029

Model Year Standards through	MY 2021	MY 2022	MY 2023	MY 2024	MY 2025	MY 2026	TOTAL
Fuel Economy							
Average Required Fuel Economy - MY 2026+ (mpg)	43.2	43.2	43.2	43.2	43.2	43.2	N/A
Percent Change in Stringency from Baseline	-4.3%	-9.1%	-14.2%	-19.6%	-25.2%	-25.2%	N/A
Average Achieved Fuel Economy - MY 2030 (mpg)	46.5	46.5	46.5	46.5	46.5	46.5	N/A
Average Achieved Fuel Economy - MY 2020 (mpg)	43.6	43.6	43.6	43.6	43.6	43.6	N/A
Total Regulatory Costs through MY 2029 Vehicles (7% discount rate)							
Total Technology Costs (\$b)	-6.1	-9.1	-14.3	-12.9	-14.2	0.0	-56.7
Total Civil Penalties (\$b)	-0.1	-0.1	0.0	0.0	0.2	0.0	0.0
Total Regulatory Costs (\$b)	-6.2	-9.2	-14.4	-12.8	-14.1	0.0	-56.8
Sales and Revenue Impacts through MY 2029 Vehicles (7% discount rate for Revenue Change)							
Sales Change (millions)	0.3	0.3	0.3	0.2	0.2	0.0	1.3
Revenue Change (\$b)	-1.8	-4.7	-10.7	-10.1	-11.7	0.0	-38.9

*** EO 12866 Review – Draft – Do Not Cite, Quote or Release During Review ***

TABLE 6-56 - DOMESTIC CAR FLEET PENETRATION FOR MY 2030, CAFE PROGRAM

Model Year Standards through	MY 2021	MY 2022	MY 2023	MY 2024	MY 2025	MY 2026
Technology Use Under CAFE Alternative in MY 2030 (total fleet penetration)						
Curb Weight Reduction (percent change from MY 2016)	4.8%	4.8%	4.8%	4.8%	4.8%	4.8%
High Compression Ratio Non-Turbo Engines	12.7%	12.7%	12.7%	12.7%	12.7%	12.7%
Turbocharged Gasoline Engines	61.9%	61.9%	61.9%	61.9%	61.9%	61.9%
Dynamic Cylinder Deactivation	0.0%	0.0%	0.0%	0.0%	0.0%	0.0%
Advanced Transmissions	91.1%	91.1%	91.1%	91.1%	91.1%	91.1%
Stop-Start 12V (Non-Hybrid)	11.5%	11.5%	11.5%	11.5%	11.5%	11.5%
Mild Hybrid Electric Systems (48v)	0.1%	0.1%	0.1%	0.1%	0.1%	0.1%
Strong Hybrid Electric Systems	1.0%	1.0%	1.0%	1.0%	1.0%	1.0%
Plug-In Hybrid Electric Vehicles (PHEVs)	0.6%	0.6%	0.6%	0.6%	0.6%	0.6%
Dedicated Electric Vehicles (EVs)	0.6%	0.6%	0.6%	0.6%	0.6%	0.6%
Fuel Cell Vehicles (FCVs)	0.0%	0.0%	0.0%	0.0%	0.0%	0.0%

*** EO 12866 Review – Draft – Do Not Cite, Quote or Release During Review ***

TABLE 6-57 - IMPORTED CAR CAFE COMPLIANCE IMPACTS AND CUMULATIVE INDUSTRY COSTS THROUGH MY 2029

Model Year Standards through	MY 2021	MY 2022	MY 2023	MY 2024	MY 2025	MY 2026	TOTAL
Fuel Economy							
Average Required Fuel Economy - MY 2026+ (mpg)	44.2	44.2	44.2	44.2	44.2	44.2	N/A
Percent Change in Stringency from Baseline	-4.3%	-9.2%	-14.3%	-19.6%	-25.3%	-25.3%	N/A
Average Achieved Fuel Economy - MY 2030 (mpg)	47.0	47.0	47.0	47.0	47.0	47.0	N/A
Average Achieved Fuel Economy - MY 2020 (mpg)	44.1	44.1	44.1	44.1	44.1	44.1	N/A
Total Regulatory Costs through MY 2029 Vehicles (7% discount rate)							
Total Technology Costs (\$b)	-4.7	-1.8	-6.4	-8.7	-7.7	0.0	-29.2
Total Civil Penalties (\$b)	-0.2	-0.3	-0.2	-0.2	-0.1	0.0	-1.0
Total Regulatory Costs (\$b)	-4.9	-2.0	-6.6	-8.9	-7.8	0.0	-30.3
Sales and Revenue Impacts through MY 2029 Vehicles (7% discount rate for Revenue Change)							
Sales Change (millions)	0.2	0.2	0.2	0.1	0.1	0.0	0.9
Revenue Change (\$b)	-1.5	1.6	-3.6	-6.6	-5.8	0.0	-15.8

*** EO 12866 Review – Draft – Do Not Cite, Quote or Release During Review ***

TABLE 6-58 - IMPORTED CAR FLEET PENETRATION FOR MY 2030, CAFE PROGRAM

Model Year Standards through	MY 2021	MY 2022	MY 2023	MY 2024	MY 2025	MY 2026
Technology Use Under CAFE Alternative in MY 2030 (total fleet penetration)						
Curb Weight Reduction (percent change from MY 2016)	3.2%	3.2%	3.2%	3.2%	3.2%	3.2%
High Compression Ratio Non-Turbo Engines	39.0%	39.0%	39.0%	39.0%	39.0%	39.0%
Turbocharged Gasoline Engines	34.7%	34.7%	34.7%	34.7%	34.7%	34.7%
Dynamic Cylinder Deactivation	0.0%	0.0%	0.0%	0.0%	0.0%	0.0%
Advanced Transmissions	85.4%	85.4%	85.4%	85.4%	85.4%	85.4%
Stop-Start 12V (Non-Hybrid)	19.1%	19.1%	19.1%	19.1%	19.1%	19.1%
Mild Hybrid Electric Systems (48v)	1.3%	1.3%	1.3%	1.3%	1.3%	1.3%
Strong Hybrid Electric Systems	6.5%	6.5%	6.5%	6.5%	6.5%	6.5%
Plug-In Hybrid Electric Vehicles (PHEVs)	0.8%	0.8%	0.8%	0.8%	0.8%	0.8%
Dedicated Electric Vehicles (EVs)	0.9%	0.9%	0.9%	0.9%	0.9%	0.9%
Fuel Cell Vehicles (FCVs)	0.0%	0.0%	0.0%	0.0%	0.0%	0.0%

*** EO 12866 Review – Draft – Do Not Cite, Quote or Release During Review ***

TABLE 6-59 - IMPACTS ON FUEL ECONOMY, REGULATORY COST, AVERAGE PRICE, AND TECHNOLOGY USE FOR PASSENGER CAR FLEET, CAFE PROGRAM

	Alternative								
	No Action	1	2	3	4	5	6	7	8
Years	2021-2025	2021-2026	2021-2026	2021-2026	2021-2026	2022-2026	2021-2026	2021-2026	2022-2026
Rate of Stringency	MY 2017-2021 Final MY 2022-2025 Augural	0.0%/Year PC 0.0%/Year LT	0.5%/Year PC 0.5%/Year LT	0.5%/Year PC 0.5%/Year LT	1.0%/Year PC 2.0%/Year LT	1.0%/Year PC 2.0%/Year LT	2.0%/Year PC 3.0%/Year LT	2.0%/Year PC 3.0%/Year LT	2.0%/Year PC 3.0%/Year LT
Phaseout Procedures	No Change	No Change	No Change	Phaseout 2022-2026	No Change	No Change	No Change	Phaseout 2022-2026	No Change
Fuel Economy									
Required Fuel Economy - 2026+ (mpg)	54.7	43.7	45.0	45.0	46.4	47.9	49.3	49.3	50.4
Change in Stringency from 2016	0.0%	-25.2%	-21.5%	-21.6%	-17.9%	-14.2%	-10.9%	-10.9%	-8.6%
Achieved Fuel Economy - 2026 (mpg)	54.2	46.7	46.9	45.9	47.7	48.7	49.7	49.3	50.6
Regulatory Costs through 2029 Vehicles									
Technology Costs (\$b)	237.7	-157.5	-153.4	-145.5	-141.1	-119.6	-109.9	-82.7	-87.7
Compliance Penalties (\$b)	4.5	-2.3	-2.0	-1.9	-1.8	-1.2	-1.2	-1.2	-0.9
Regulatory Costs (\$b)	242.2	-160.0	-155.6	-147.5	-143.0	-120.9	-111.2	-83.9	-88.6
Average Price Increase for MY 2030 Vehicles									
Price Increase due to New CAFE Standards (\$)	2355	-1648	-1601	-1492	-1404	-1201	-1011	-658	-796
Technology Use under CAFE Program in MY 2030 (total penetration)									
Weight Reduction (percent from MY 2016)	5.9%	4.1%	4.2%	4.4%	4.7%	5.0%	5.5%	5.8%	5.9%
Compression Ratio Non-Engines	39.0%	24.7%	24.7%	24.7%	24.7%	29.7%	29.8%	29.8%	29.8%
Large Gasoline Engines	57.8%	49.5%	49.9%	49.9%	50.4%	51.5%	56.1%	57.3%	58.0%
Cylinder Deactivation	0.5%	0.0%	0.0%	0.0%	0.0%	0.0%	0.5%	0.5%	0.5%
Start 12V (Non-Hybrid)	14.1%	15.0%	15.0%	17.8%	17.5%	15.2%	13.1%	17.7%	21.5%
Hybrid Electric Systems	22.9%	0.7%	0.5%	2.6%	0.9%	6.5%	9.2%	13.5%	8.3%
Hybrid Electric Systems	23.6%	3.5%	3.6%	3.7%	3.7%	3.8%	4.6%	10.3%	6.7%
Hybrid Electric Vehicles (HEVs)	1.3%	0.7%	0.7%	0.7%	0.7%	0.7%	0.7%	0.9%	0.8%
Plug-in Electric Vehicles (EVs)	0.7%	0.7%	0.7%	0.7%	0.7%	0.7%	0.7%	0.7%	0.7%
Fuel Cell Vehicles (FCVs)	0.0%	0.0%	0.0%	0.0%	0.0%	0.0%	0.0%	0.0%	0.0%

*** EO 12866 Review – Draft – Do Not Cite, Quote or Release During Review ***

TABLE 6-60 - IMPACTS ON FUEL ECONOMY, REGULATORY COST, AVERAGE PRICE, AND TECHNOLOGY USE FOR LIGHT TRUCK FLEET, CAFE PROGRAM

	Alternative								
	No Action	1	2	3	4	5	6	7	8
Time Period	2021-2025	2021-2026	2021-2026	2021-2026	2021-2026	2022-2026	2021-2026	2021-2026	2022-2026
Annual Rate of Stringency Increase	MY 2017-2021 Final MY 2022-2025 Augural	0.0%/Year PC 0.0%/Year LT	0.5%/Year PC 0.5%/Year LT	0.5%/Year PC 0.5%/Year LT	1.0%/Year PC 2.0%/Year LT	1.0%/Year PC 2.0%/Year LT	2.0%/Year PC 3.0%/Year LT	2.0%/Year PC 3.0%/Year LT	2.0%/Year PC 3.0%/Year LT
Off-Cycle Procedures	No Change	No Change	No Change	Phaseout 2022-2026	No Change	No Change	No Change	Phaseout 2022-2026	No Change
Fuel Economy									
Average Required Fuel Economy - MY 2026+ (mpg)	40.1	31.3	32.2	32.2	35.3	36.9	37.5	37.5	38.8
Percent Change in Stringency from Baseline	0.0%	-28.3%	-24.5%	-24.5%	-13.7%	-8.7%	-6.8%	-6.8%	-3.4%
Average Achieved Fuel Economy - MY 2030 (mpg)	40.0	33.6	34.1	33.4	35.7	36.9	37.6	37.4	38.6
Regulatory Costs through MY 2029 Vehicles									
Technology Costs (\$b)	262.1	-193.7	-184.1	-171.0	-148.4	-114.5	-91.6	-40.3	-44.2
Civil Penalties (\$b)	3.2	-2.2	-2.1	-1.9	-1.5	-0.8	-1.0	-0.8	-0.5
Regulatory Costs (\$b)	265.4	-195.7	-186.0	-172.8	-149.7	-115.1	-92.5	-41.1	-44.6
Average Price Increase for MY 2030 Vehicles									
Price Increase due to New Standards (\$)	2835	-2114	-1997	-1851	-1527	-1124	-857	-246	-402
Technology Use under Alternative in MY (total fleet penetration)									
Weight Reduction Percent change from MY	6.6%	4.4%	4.5%	4.9%	5.8%	6.3%	6.7%	6.8%	6.8%
Compression Ratio Non-Engines	11.9%	8.1%	8.1%	8.1%	8.1%	10.8%	10.8%	10.8%	10.8%
Charged Gasoline Engines	69.9%	53.1%	58.4%	58.4%	62.8%	66.9%	67.3%	69.1%	67.3%
Electric Cylinder Ignition	12.7%	0.0%	0.0%	0.0%	0.0%	0.0%	3.4%	14.1%	14.1%
Start 12V (Non-Hybrid)	11.4%	12.3%	12.4%	13.2%	14.0%	17.7%	19.1%	7.6%	9.9%
Hybrid Electric Systems	46.1%	0.0%	0.0%	1.8%	5.2%	19.8%	34.9%	55.4%	61.6%

*** EO 12866 Review – Draft – Do Not Cite, Quote or Release During Review ***

Hybrid Electric ns	23.5%	0.9%	0.9%	0.9%	0.9%	0.9%	1.7%	12.6%	2.5%
n Hybrid Electric es (PHEVs)	0.8%	0.3%	0.3%	0.3%	0.3%	0.3%	0.3%	0.3%	0.3%
ated Electric Vehicles	0.3%	0.3%	0.3%	0.3%	0.3%	0.3%	0.3%	0.3%	0.3%
Cell Vehicles (FCVs)	0.0%	0.0%	0.0%	0.0%	0.0%	0.0%	0.0%	0.0%	0.0%

*** EO 12866 Review – Draft – Do Not Cite, Quote or Release During Review ***

TABLE 6-61 - IMPACTS ON FUEL ECONOMY, REGULATORY COST, AVERAGE PRICE, AND TECHNOLOGY USE FOR COMBINED LIGHT-DUTY FLEET, CAFE PROGRAM

	Alternative								
	No Action	1	2	3	4	5	6	7	8
Years	2021-2025	2021-2026	2021-2026	2021-2026	2021-2026	2022-2026	2021-2026	2021-2026	2022-2026
Rate of Stringency	MY 2017-2021 Final	0.0%/Year	0.5%/Year	0.5%/Year	1.0%/Year	1.0%/Year	2.0%/Year	2.0%/Year	2.0%/Year
	MY 2022-2025	PC	PC	PC	PC	PC	PC	PC	PC
	Augural	0.0%/Year	0.5%/Year	0.5%/Year	2.0%/Year	2.0%/Year	3.0%/Year	3.0%/Year	3.0%/Year
LT	LT	LT	LT	LT	LT	LT	LT	LT	LT
Phaseout	No Change	No Change	No Change	Phaseout 2022-2026	No Change	No Change	No Change	Phaseout 2022-2026	No Change
Fuel Economy									
Required Fuel Economy 2026+ (mpg)	46.7	37.0	38.1	38.1	40.5	42.1	43.0	43.0	44.2
Change in Stringency Baseline	0.0%	-26.0%	-22.4%	-22.5%	-15.2%	-10.9%	-8.5%	-8.6%	-5.6%
Achieved Fuel Economy 2030 (mpg)	46.4	39.7	40.1	39.2	41.3	42.4	43.2	42.8	44.1
Regulatory Costs through 2029 Vehicles									
Technology Costs (\$b)	499.9	-351.2	-337.5	-316.5	-289.5	-234.0	-201.6	-123.0	-131.9
Civil Penalties (\$b)	7.7	-4.5	-4.1	-3.7	-3.2	-2.0	-2.2	-2.0	-1.4
Regulatory Costs (\$b)	507.6	-355.7	-341.6	-320.2	-292.8	-236.0	-203.7	-124.9	-133.3
Price Increase for MY Vehicles									
Increase due to New CAFE Standards (\$)	2582	-1869	-1790	-1663	-1467	-1168	-941	-465	-612
Technology Use under CAFE Alternative in MY 2030 (total penetration)									
Weight Change (percent MY 2016)	5.7%	4.3%	4.4%	4.6%	5.1%	5.4%	5.7%	5.8%	5.9%
Compression Ratio Non-Engines	26.2%	17.2%	17.2%	17.1%	17.1%	20.9%	20.9%	20.9%	20.9%
Charged Gasoline Engines	63.6%	51.1%	53.7%	53.8%	56.1%	58.7%	61.3%	62.9%	62.4%
Cylinder Deactivation	6.3%	0.0%	0.0%	0.0%	0.0%	0.0%	1.9%	6.9%	6.9%
Start 12V (Non-Hybrid)	12.9%	13.7%	13.8%	15.7%	15.9%	16.3%	15.9%	12.9%	16.0%
Hybrid Electric Systems	33.9%	0.4%	0.3%	2.3%	2.9%	12.7%	21.3%	33.2%	33.4%
Hybrid Electric Systems	23.5%	2.3%	2.4%	2.4%	2.4%	2.4%	3.2%	11.4%	4.7%
Hybrid Electric Vehicles (s)	1.1%	0.5%	0.5%	0.5%	0.5%	0.5%	0.5%	0.6%	0.5%

*** EO 12866 Review – Draft – Do Not Cite, Quote or Release During Review ***

ted Electric Vehicles	0.5%	0.5%	0.5%	0.5%	0.5%	0.5%	0.5%	0.5%	0.5%
ell Vehicles (FCVs)	0.0%	0.0%	0.0%	0.0%	0.0%	0.0%	0.0%	0.0%	0.0%

*** EO 12866 Review – Draft – Do Not Cite, Quote or Release During Review ***

TABLE 6-62 - IMPACTS ON FUEL ECONOMY, REGULATORY COST, AVERAGE PRICE, AND TECHNOLOGY USE FOR PASSENGER CARS PRODUCED BY BMW, CAFE PROGRAM

	Alternative								
	No Action	1	2	3	4	5	6	7	8
Model Years	2021-2025	2021-2026	2021-2026	2021-2026	2021-2026	2022-2026	2021-2026	2021-2026	2022-2026
Annual Rate of Stringency Increase	MY 2017-2021 Final MY 2022-2025 Augural	0.0%/Year PC 0.0%/Year LT	0.5%/Year PC 0.5%/Year LT	0.5%/Year PC 0.5%/Year LT	1.0%/Year PC 2.0%/Year LT	1.0%/Year PC 2.0%/Year LT	2.0%/Year PC 3.0%/Year LT	2.0%/Year PC 3.0%/Year LT	2.0%/Year PC 3.0%/Year LT
Off-Cycle Procedures	No Change	No Change	No Change	Phaseout 2022-2026	No Change	No Change	No Change	Phaseout 2022-2026	No Change
Fuel Economy									
Weighted Average Required Fuel Economy - MY 2026+ (mpg)	53.7	42.8	44.2	44.2	45.5	47.0	48.4	48.4	49.5
Percent Change in Stringency from Baseline	0.0%	-25.5%	-21.5%	-21.5%	-18.0%	-14.3%	-11.0%	-11.0%	-8.5%
Weighted Average Achieved Fuel Economy - MY 2030 (mpg)	40.0	40.0	40.0	38.6	40.0	40.0	40.0	38.6	40.0
Regulatory Costs through MY 2029 Vehicles									
Advanced Technology Costs (\$b)	1.1	0.0	0.0	0.0	0.0	0.0	0.0	0.0	0.0
Civil Penalties (\$b)	1.9	-1.2	-1.1	-1.0	-1.0	-0.7	-0.7	-0.5	-0.5
Regulatory Costs (\$b)	3.0	-1.3	-1.2	-1.0	-1.0	-0.7	-0.6	-0.5	-0.5
Average Price Increase for MY 2030 Vehicles									
Increase due to New Stringency Standards (\$)	966	-536	-474	-395	-393	-319	-254	-184	-199
Technology Use under Alternative in MY (total fleet penetration)									
Weight Reduction Percent change from MY	4.9%	4.8%	4.8%	4.8%	4.8%	4.8%	4.8%	4.8%	4.8%
Compression Ratio Non-Combustion Engines	0.0%	0.0%	0.0%	0.0%	0.0%	0.0%	0.0%	0.0%	0.0%
Recharged Gasoline Vehicles	96.0%	96.1%	96.1%	96.1%	96.1%	96.1%	96.1%	96.1%	96.1%
Electric Cylinder Activation	0.0%	0.0%	0.0%	0.0%	0.0%	0.0%	0.0%	0.0%	0.0%
Start 12V (Non-Hybrid)	89.9%	90.5%	90.4%	90.4%	90.3%	90.1%	90.1%	90.0%	90.0%
Hybrid Electric Systems	0.0%	0.0%	0.0%	0.0%	0.0%	0.0%	0.0%	0.0%	0.0%

*** EO 12866 Review – Draft – Do Not Cite, Quote or Release During Review ***

g Hybrid Electric ms	0.0%	0.0%	0.0%	0.0%	0.0%	0.0%	0.0%	0.0%	0.0%
In Hybrid Electric les (PHEVs)	0.6%	0.6%	0.6%	0.6%	0.6%	0.6%	0.6%	0.6%	0.6%
ated Electric Vehicles	1.5%	1.6%	1.6%	1.6%	1.6%	1.6%	1.6%	1.5%	1.5%
Cell Vehicles (FCVs)	0.0%	0.0%	0.0%	0.0%	0.0%	0.0%	0.0%	0.0%	0.0%

*** EO 12866 Review – Draft – Do Not Cite, Quote or Release During Review ***

TABLE 6-63 - IMPACTS ON FUEL ECONOMY, REGULATORY COST, AVERAGE PRICE, AND TECHNOLOGY USE FOR LIGHT TRUCKS PRODUCED BY BMW, CAFE PROGRAM

	Alternative								
	No Action	1	2	3	4	5	6	7	8
Model Years	2021-2025	2021-2026	2021-2026	2021-2026	2021-2026	2022-2026	2021-2026	2021-2026	2022-2026
Annual Rate of Stringency Increase	MY 2017-2021 Final MY 2022-2025 Augural	0.0%/Year PC 0.0%/Year LT	0.5%/Year PC 0.5%/Year LT	0.5%/Year PC 0.5%/Year LT	1.0%/Year PC 2.0%/Year LT	1.0%/Year PC 2.0%/Year LT	2.0%/Year PC 3.0%/Year LT	2.0%/Year PC 3.0%/Year LT	2.0%/Year PC 3.0%/Year LT
Off-Cycle Procedures	No Change	No Change	No Change	Phaseout 2022-2026	No Change	No Change	No Change	Phaseout 2022-2026	No Change
Fuel Economy									
Average Required Fuel Economy - MY 2026+ (mpg)	42.2	32.8	33.8	33.8	37.0	38.8	39.4	39.4	40.8
Percent Change in Stringency from Baseline	0.0%	-28.7%	-24.9%	-24.9%	-14.1%	-8.8%	-7.1%	-7.1%	-3.4%
Average Achieved Fuel Economy - MY 2030 (mpg)	33.9	33.7	33.8	32.5	33.9	33.9	33.9	32.5	33.9
Regulatory Costs through MY 2029 Vehicles									
Technology Costs (\$b)	0.4	-0.1	0.0	0.0	0.0	0.0	0.0	0.0	0.0
Civil Penalties (\$b)	0.4	-0.4	-0.4	-0.3	-0.2	-0.2	-0.2	-0.1	-0.1
Regulatory Costs (\$b)	0.9	-0.4	-0.4	-0.3	-0.2	-0.2	-0.1	-0.1	-0.1
Average Price Increase for MY 2030 Vehicles									
Price Increase due to New Standards (\$)	720	-409	-365	-315	-243	-163	-132	-80	-70
Technology Use under Alternative in MY 2030 (total fleet penetration)									
Weight Reduction Percent change from MY 2017	5.0%	5.0%	5.0%	5.0%	5.0%	5.0%	5.0%	5.0%	5.0%
Compression Ratio Non-Engines	0.0%	0.0%	0.0%	0.0%	0.0%	0.0%	0.0%	0.0%	0.0%
Charged Gasoline Engines	96.6%	96.6%	96.6%	96.6%	96.6%	96.6%	96.6%	96.6%	96.6%
Electric Cylinder Ignition	0.0%	0.0%	0.0%	0.0%	0.0%	0.0%	0.0%	0.0%	0.0%
Start 12V (Non-Hybrid)	94.5%	94.5%	94.5%	94.5%	94.5%	94.5%	94.5%	94.5%	94.5%
Hybrid Electric Systems	0.0%	0.0%	0.0%	0.0%	0.0%	0.0%	0.0%	0.0%	0.0%

*** EO 12866 Review – Draft – Do Not Cite, Quote or Release During Review ***

Hybrid Electric ns	0.0%	0.0%	0.0%	0.0%	0.0%	0.0%	0.0%	0.0%	0.0%
n Hybrid Electric es (PHEVs)	5.5%	5.5%	5.5%	5.5%	5.5%	5.5%	5.5%	5.5%	5.5%
ated Electric Vehicles	0.0%	0.0%	0.0%	0.0%	0.0%	0.0%	0.0%	0.0%	0.0%
Cell Vehicles (FCVs)	0.0%	0.0%	0.0%	0.0%	0.0%	0.0%	0.0%	0.0%	0.0%

*** EO 12866 Review – Draft – Do Not Cite, Quote or Release During Review ***

TABLE 6-64 - IMPACTS ON FUEL ECONOMY, REGULATORY COST, AVERAGE PRICE, TECHNOLOGY USE FOR LIGHT-DUTY VEHICLES PRODUCED BY BMW, CAFE PROGRAM

	Alternative								
	No Action	1	2	3	4	5	6	7	8
Model Years	2021-2025	2021-2026	2021-2026	2021-2026	2021-2026	2022-2026	2021-2026	2021-2026	2022-2026
Average Annual Rate of Stringency Increase	MY 2017-2021 Final MY 2022-2025 Augural	0.0%/Year PC 0.0%/Year LT	0.5%/Year PC 0.5%/Year LT	0.5%/Year PC 0.5%/Year LT	1.0%/Year PC 2.0%/Year LT	1.0%/Year PC 2.0%/Year LT	2.0%/Year PC 3.0%/Year LT	2.0%/Year PC 3.0%/Year LT	2.0%/Year PC 3.0%/Year LT
Off-Cycle Procedures	No Change	No Change	No Change	Phaseout 2022-2026	No Change	No Change	No Change	Phaseout 2022-2026	No Change
Fuel Economy									
Volume Required Fuel Economy - MY 2026+ (mpg)	50.0	39.7	41.0	40.9	42.9	44.5	45.6	45.6	46.8
Percent Change in Stringency Baseline	0.0%	-25.9%	-22.0%	-22.1%	-16.5%	-12.3%	-9.6%	-9.7%	-6.8%
Volume Achieved Fuel Economy - MY 2030 (mpg)	38.2	38.2	38.2	36.9	38.2	38.2	38.2	36.8	38.2
Regulatory Costs through MY 2029 Vehicles									
Technology Costs (\$b)	1.5	-0.1	-0.1	0.0	0.0	0.0	0.0	0.0	0.0
Civil Penalties (\$b)	2.3	-1.6	-1.5	-1.3	-1.2	-0.9	-0.8	-0.6	-0.6
Regulatory Costs (\$b)	3.8	-1.7	-1.5	-1.3	-1.2	-0.9	-0.8	-0.6	-0.6
Average Price Increase for MY 2030 Vehicles									
Increase due to New Stringency Standards (\$)	899	-499	-442	-371	-351	-276	-220	-155	-164
Technology Use under Alternative in MY 2030 (total fleet penetration)									
Weight Change (percent MY 2016)	4.5%	4.9%	4.8%	4.8%	4.7%	4.6%	4.6%	4.5%	4.6%
Compression Ratio Non-Hybrid Engines	0.0%	0.0%	0.0%	0.0%	0.0%	0.0%	0.0%	0.0%	0.0%
Uncharged Gasoline Engines	96.2%	96.3%	96.3%	96.3%	96.2%	96.2%	96.2%	96.2%	96.2%
Electric Cylinder Ignition	0.0%	0.0%	0.0%	0.0%	0.0%	0.0%	0.0%	0.0%	0.0%
Start 12V (Non-Hybrid)	91.2%	91.5%	91.5%	91.4%	91.4%	91.3%	91.3%	91.2%	91.2%
Hybrid Electric Systems	0.0%	0.0%	0.0%	0.0%	0.0%	0.0%	0.0%	0.0%	0.0%
Plug Hybrid Electric Systems	0.0%	0.0%	0.0%	0.0%	0.0%	0.0%	0.0%	0.0%	0.0%

*** EO 12866 Review – Draft – Do Not Cite, Quote or Release During Review ***

In Hybrid Electric Vehicles (PHEVs)	1.9%	1.9%	1.9%	1.9%	1.9%	1.9%	1.9%	1.9%	1.9%
Plugged Electric Vehicles	1.1%	1.2%	1.2%	1.2%	1.2%	1.1%	1.1%	1.1%	1.1%
Fuel Cell Vehicles (FCVs)	0.0%	0.0%	0.0%	0.0%	0.0%	0.0%	0.0%	0.0%	0.0%

TABLE 6-65 - IMPACTS ON FUEL ECONOMY, REGULATORY COST, AVERAGE PRICE, AND TECHNOLOGY USE FOR PASSENGER CARS PRODUCED BY DAIMLER, CAFE PROGRAM

	Alternative								
	No Action	1	2	3	4	5	6	7	8
Model Years	2021-2025	2021-2026	2021-2026	2021-2026	2021-2026	2022-2026	2021-2026	2021-2026	2022-2026
Average Annual Rate of Stringency Increase	MY 2017-2021 Final MY 2022-2025 Augural	0.0%/Year PC 0.0%/Year LT	0.5%/Year PC 0.5%/Year LT	0.5%/Year PC 0.5%/Year LT	1.0%/Year PC 2.0%/Year LT	1.0%/Year PC 2.0%/Year LT	2.0%/Year PC 3.0%/Year LT	2.0%/Year PC 3.0%/Year LT	2.0%/Year PC 3.0%/Year LT
Off-Cycle Procedures	No Change	No Change	No Change	Phaseout 2022-2026	No Change	No Change	No Change	Phaseout 2022-2026	No Change
Fuel Economy									
Weighted Average Required Fuel Economy - MY 2026+ (mpg)	52.8	42.2	43.5	43.5	44.8	46.3	47.6	47.6	48.7
Percent Change in Stringency from Baseline	0.0%	-25.2%	-21.5%	-21.5%	-17.9%	-14.1%	-10.9%	-10.9%	-8.5%
Weighted Average Achieved Fuel Economy - MY 2030 (mpg)	40.1	39.9	40.1	38.6	40.1	40.1	40.1	38.5	40.1
Regulatory Costs through MY 2029 Vehicles									
Advanced Technology Costs (\$b)	1.1	0.0	0.0	0.0	0.0	0.0	0.0	0.0	0.0
Civil Penalties (\$b)	1.3	-0.9	-0.8	-0.7	-0.7	-0.6	-0.5	-0.4	-0.4
Regulatory Costs (\$b)	2.5	-1.0	-0.8	-0.7	-0.7	-0.5	-0.5	-0.4	-0.4
Average Price Increase for MY 2030 Vehicles									
Increase due to New Stringency Standards (\$)	1007	-547	-460	-383	-379	-306	-244	-177	-193
Technology Use under Alternative in MY 2030 (total fleet penetration)									
Weight Reduction Percent change from MY 2017	4.8%	4.8%	4.8%	4.8%	4.8%	4.8%	4.8%	4.8%	4.8%
Compression Ratio Non-Hybrid Engines	0.0%	0.0%	0.0%	0.0%	0.0%	0.0%	0.0%	0.0%	0.0%
Recharged Gasoline Engines	98.9%	98.9%	98.9%	98.9%	98.9%	98.9%	98.9%	98.9%	98.9%
Electric Cylinder Ignition	0.0%	0.0%	0.0%	0.0%	0.0%	0.0%	0.0%	0.0%	0.0%
Start 12V (Non-Hybrid)	95.9%	95.8%	95.8%	95.8%	95.8%	95.9%	95.9%	95.9%	95.9%
Hybrid Electric Systems	0.0%	0.0%	0.0%	0.0%	0.0%	0.0%	0.0%	0.0%	0.0%

*** EO 12866 Review – Draft – Do Not Cite, Quote or Release During Review ***

g Hybrid Electric ms	0.0%	0.0%	0.0%	0.0%	0.0%	0.0%	0.0%	0.0%	0.0%
In Hybrid Electric les (PHEVs)	0.4%	0.4%	0.4%	0.4%	0.4%	0.4%	0.4%	0.4%	0.4%
ated Electric Vehicles	0.6%	0.6%	0.6%	0.6%	0.6%	0.6%	0.6%	0.6%	0.6%
Cell Vehicles (FCVs)	0.0%	0.0%	0.0%	0.0%	0.0%	0.0%	0.0%	0.0%	0.0%

*** EO 12866 Review – Draft – Do Not Cite, Quote or Release During Review ***

TABLE 6-66 - IMPACTS ON FUEL ECONOMY, REGULATORY COST, AVERAGE PRICE, AND TECHNOLOGY USE FOR LIGHT TRUCKS PRODUCED BY DAIMLER, CAFE PROGRAM

	Alternative								
	No Action	1	2	3	4	5	6	7	8
Model Years	2021-2025	2021-2026	2021-2026	2021-2026	2021-2026	2022-2026	2021-2026	2021-2026	2022-2026
Annual Rate of Stringency Increase	MY 2017-2021 Final MY 2022-2025 Augural	0.0%/Year PC 0.0%/Year LT	0.5%/Year PC 0.5%/Year LT	0.5%/Year PC 0.5%/Year LT	1.0%/Year PC 2.0%/Year LT	1.0%/Year PC 2.0%/Year LT	2.0%/Year PC 3.0%/Year LT	2.0%/Year PC 3.0%/Year LT	2.0%/Year PC 3.0%/Year LT
Off-Cycle Procedures	No Change	No Change	No Change	Phaseout 2022-2026	No Change	No Change	No Change	Phaseout 2022-2026	No Change
Fuel Economy									
Engine Required Fuel Economy - MY 2026+ (mpg)	41.4	32.2	33.2	33.2	36.4	38.1	38.7	38.7	40.1
Percent Change in Stringency Baseline	0.0%	-28.6%	-24.7%	-24.7%	-13.7%	-8.7%	-7.0%	-7.0%	-3.2%
Engine Achieved Fuel Economy - MY 2030 (mpg)	32.2	32.2	32.2	31.3	32.2	32.2	32.2	31.3	32.2
Regulatory Costs through MY 2029 Vehicles									
Technology Costs (\$b)	0.8	0.0	0.0	0.0	0.0	0.0	0.0	0.0	0.0
Civil Penalties (\$b)	0.5	-0.5	-0.4	-0.4	-0.3	-0.2	-0.2	-0.1	-0.1
Regulatory Costs (\$b)	1.3	-0.4	-0.4	-0.4	-0.3	-0.2	-0.2	-0.1	-0.1
Average Price Increase for 2030 Vehicles									
Increase due to New E Standards (\$)	980	-392	-362	-331	-248	-168	-136	-86	-70
Technology Use under Alternative in MY (total fleet penetration)									
Weight Reduction Percent change from MY	4.8%	4.8%	4.8%	4.8%	4.8%	4.8%	4.8%	4.8%	4.8%
Compression Ratio Non-Engines	0.0%	0.0%	0.0%	0.0%	0.0%	0.0%	0.0%	0.0%	0.0%
Recharged Gasoline Engines	96.9%	96.9%	96.9%	96.9%	96.9%	96.9%	96.9%	96.9%	96.9%
Electric Cylinder Activation	0.0%	0.0%	0.0%	0.0%	0.0%	0.0%	0.0%	0.0%	0.0%
Start 12V (Non-Hybrid)	56.8%	56.8%	56.8%	56.8%	56.8%	56.8%	56.8%	56.8%	56.8%
Hybrid Electric Systems	0.0%	0.0%	0.0%	0.0%	0.0%	0.0%	0.0%	0.0%	0.0%

*** EO 12866 Review – Draft – Do Not Cite, Quote or Release During Review ***

g Hybrid Electric ms	0.0%	0.0%	0.0%	0.0%	0.0%	0.0%	0.0%	0.0%	0.0%
In Hybrid Electric les (PHEVs)	0.2%	0.2%	0.2%	0.2%	0.2%	0.2%	0.2%	0.2%	0.2%
ated Electric Vehicles	0.0%	0.0%	0.0%	0.0%	0.0%	0.0%	0.0%	0.0%	0.0%
Cell Vehicles (FCVs)	0.0%	0.0%	0.0%	0.0%	0.0%	0.0%	0.0%	0.0%	0.0%

*** EO 12866 Review – Draft – Do Not Cite, Quote or Release During Review ***

TABLE 6-67 - IMPACTS ON FUEL ECONOMY, REGULATORY COST, AVERAGE PRICE, TECHNOLOGY USE FOR LIGHT-DUTY VEHICLES PRODUCED BY DAIMLER, CAFE PROGRAM

	Alternative								
	No Action	1	2	3	4	5	6	7	8
Model Years	2021-2025	2021-2026	2021-2026	2021-2026	2021-2026	2022-2026	2021-2026	2021-2026	2022-2026
Average Rate of Stringency Increase	MY 2017-2021 Final MY 2022-2025 Augural	0.0%/Year PC 0.0%/Year LT	0.5%/Year PC 0.5%/Year LT	0.5%/Year PC 0.5%/Year LT	1.0%/Year PC 2.0%/Year LT	1.0%/Year PC 2.0%/Year LT	2.0%/Year PC 3.0%/Year LT	2.0%/Year PC 3.0%/Year LT	2.0%/Year PC 3.0%/Year LT
Phaseout Cycle Procedures	No Change	No Change	No Change	Phaseout 2022-2026	No Change	No Change	No Change	Phaseout 2022-2026	No Change
Fuel Economy									
Average Required Fuel Economy - MY 2026+ (mpg)	48.1	38.3	39.4	39.4	41.5	43.1	44.1	44.1	45.3
Percent Change in Stringency Baseline	0.0%	-25.8%	-22.1%	-22.2%	-15.9%	-11.7%	-9.2%	-9.2%	-6.3%
Average Achieved Fuel Economy - MY 2030 (mpg)	36.9	37.0	37.1	35.8	37.0	37.0	36.9	35.6	36.9
Regulatory Costs through MY 2029 Vehicles									
Technology Costs (\$b)	1.9	0.0	0.0	0.0	0.0	0.0	0.0	0.0	0.0
Civil Penalties (\$b)	1.9	-1.4	-1.2	-1.1	-1.0	-0.7	-0.6	-0.5	-0.4
Regulatory Costs (\$b)	3.7	-1.4	-1.2	-1.1	-1.0	-0.7	-0.6	-0.5	-0.4
Average Price Increase for MY 2030 Vehicles									
Price Increase due to New Standards (\$)	997	-495	-427	-365	-334	-258	-206	-145	-150
Technology Use under Alternative in MY 2030 (total fleet penetration)									
Weight Change (percent MY 2016)	4.3%	4.8%	4.8%	4.7%	4.6%	4.5%	4.4%	4.4%	4.4%
Compression Ratio Non-Engines	0.0%	0.0%	0.0%	0.0%	0.0%	0.0%	0.0%	0.0%	0.0%
Charged Gasoline Engines	98.2%	98.2%	98.2%	98.2%	98.2%	98.2%	98.2%	98.2%	98.2%
Electric Cylinder Ignition	0.0%	0.0%	0.0%	0.0%	0.0%	0.0%	0.0%	0.0%	0.0%
Start 12V (Non-Hybrid)	82.0%	82.9%	82.8%	82.7%	82.5%	82.3%	82.2%	82.1%	82.1%
Hybrid Electric Systems	0.0%	0.0%	0.0%	0.0%	0.0%	0.0%	0.0%	0.0%	0.0%
Plug-in Hybrid Electric Systems	0.0%	0.0%	0.0%	0.0%	0.0%	0.0%	0.0%	0.0%	0.0%

*** EO 12866 Review – Draft – Do Not Cite, Quote or Release During Review ***

Plug-in Hybrid Electric Vehicles (PHEVs)	0.3%	0.3%	0.3%	0.3%	0.3%	0.3%	0.3%	0.3%	0.3%
Plug-in Electric Vehicles	0.4%	0.4%	0.4%	0.4%	0.4%	0.4%	0.4%	0.4%	0.4%
Fuel Cell Vehicles (FCVs)	0.0%	0.0%	0.0%	0.0%	0.0%	0.0%	0.0%	0.0%	0.0%

TABLE 6-68 - IMPACTS ON FUEL ECONOMY, REGULATORY COST, AVERAGE PRICE, TECHNOLOGY USE FOR PASSENGER CARS PRODUCED BY FIAT CHRYSLER, CAFE PROGRAM

	Alternative								
	No Action	1	2	3	4	5	6	7	8
Model Years	2021-2025	2021-2026	2021-2026	2021-2026	2021-2026	2022-2026	2021-2026	2021-2026	2022-2026
Annual Rate of Stringency Increase	MY 2017-2021 Final MY 2022-2025 Augural	0.0%/Year PC 0.0%/Year LT	0.5%/Year PC 0.5%/Year LT	0.5%/Year PC 0.5%/Year LT	1.0%/Year PC 2.0%/Year LT	1.0%/Year PC 2.0%/Year LT	2.0%/Year PC 3.0%/Year LT	2.0%/Year PC 3.0%/Year LT	2.0%/Year PC 3.0%/Year LT
Off-Cycle Procedures	No Change	No Change	No Change	Phaseout 2022-2026	No Change	No Change	No Change	Phaseout 2022-2026	No Change
Fuel Economy									
Weighted Average Required Fuel Economy - MY 2026+ (mpg)	53.2	42.3	43.6	43.6	45.0	46.5	47.9	47.9	48.9
Percent Change in Stringency from Baseline	0.0%	-25.7%	-21.9%	-21.9%	-18.1%	-14.3%	-10.9%	-10.9%	-8.6%
Weighted Average Achieved Fuel Economy - MY 2030 (mpg)	54.0	42.8	44.3	43.8	45.2	47.0	48.6	48.5	49.7
Regulatory Costs through MY 2029 Vehicles									
Advanced Technology Costs (\$b)	33.7	-22.3	-20.3	-15.0	-16.8	-13.0	-8.8	-5.3	-7.8
Civil Penalties (\$b)	0.8	0.1	0.1	0.0	0.1	0.3	0.1	-0.1	0.1
Total Regulatory Costs (\$b)	34.4	-22.4	-20.4	-15.1	-16.9	-12.9	-8.9	-5.4	-7.8
Average Price Increase for MY 2030 Vehicles									
Increase due to New Stringency Standards (\$)	4892	-3226	-2909	-2088	-2325	-1665	-1199	-585	-1067
Technology Use under Alternative in MY (total fleet penetration)									
Weight Reduction Percent change from MY 2017	9.2%	6.5%	8.1%	8.2%	8.3%	9.1%	9.2%	9.2%	9.2%
Compression Ratio Non-Hybrid Engines	0.0%	0.0%	0.0%	0.0%	0.0%	0.0%	0.0%	0.0%	0.0%
Recharged Gasoline Engines	89.5%	83.5%	87.9%	88.1%	88.6%	88.3%	90.5%	91.2%	91.8%
Electric Cylinder Ignition	6.4%	0.0%	0.0%	0.0%	0.0%	0.0%	6.4%	6.4%	6.4%
Start 12V (Non-Hybrid)	0.0%	10.3%	10.3%	44.5%	52.1%	41.0%	0.0%	0.0%	0.0%
Hybrid Electric Systems	0.2%	2.5%	0.9%	27.8%	0.1%	45.0%	86.0%	36.9%	79.6%

*** EO 12866 Review – Draft – Do Not Cite, Quote or Release During Review ***

g Hybrid Electric ms	91.6%	6.5%	8.1%	8.5%	9.0%	8.7%	8.4%	56.7%	14.6%
In Hybrid Electric les (PHEVs)	3.5%	0.0%	0.0%	0.4%	0.1%	0.4%	0.7%	1.7%	1.1%
ated Electric Vehicles	0.7%	0.7%	0.7%	0.7%	0.7%	0.7%	0.7%	0.7%	0.7%
Cell Vehicles (FCVs)	0.0%	0.0%	0.0%	0.0%	0.0%	0.0%	0.0%	0.0%	0.0%

*** EO 12866 Review – Draft – Do Not Cite, Quote or Release During Review ***

TABLE 6-69 - IMPACTS ON FUEL ECONOMY, REGULATORY COST, AVERAGE PRICE, TECHNOLOGY USE FOR LIGHT TRUCKS PRODUCED BY FIAT CHRYSLER, CAFE PROGRAM

	Alternative								
	No Action	1	2	3	4	5	6	7	8
Model Years	2021-2025	2021-2026	2021-2026	2021-2026	2021-2026	2022-2026	2021-2026	2021-2026	2022-2026
Annual Rate of Stringency Increase	MY 2017-2021 Final MY 2022-2025 Augural	0.0%/Year PC 0.0%/Year LT	0.5%/Year PC 0.5%/Year LT	0.5%/Year PC 0.5%/Year LT	1.0%/Year PC 2.0%/Year LT	1.0%/Year PC 2.0%/Year LT	2.0%/Year PC 3.0%/Year LT	2.0%/Year PC 3.0%/Year LT	2.0%/Year PC 3.0%/Year LT
Off-Cycle Procedures	No Change	No Change	No Change	Phaseout 2022-2026	No Change	No Change	No Change	Phaseout 2022-2026	No Change
Fuel Economy									
Weighted Average Required Fuel Economy - MY 2026+ (mpg)	40.4	31.5	32.4	32.4	35.5	37.2	37.8	37.8	39.1
Percent Change in Stringency from Baseline	0.0%	-28.3%	-24.7%	-24.7%	-13.8%	-8.6%	-6.9%	-6.9%	-3.3%
Weighted Average Achieved Fuel Economy - MY 2030 (mpg)	40.8	33.2	35.9	35.1	37.4	37.6	38.8	38.2	39.5
Regulatory Costs for Light MY 2029 Vehicles									
Advanced Technology Costs (\$b)	61.0	-46.7	-37.6	-27.5	-27.6	-25.1	-13.3	-2.3	-6.6
Civil Penalties (\$b)	0.5	-0.4	-0.4	-0.4	-0.4	-0.1	-0.3	-0.3	-0.2
Total Regulatory Costs (\$b)	61.6	-46.8	-37.7	-27.7	-27.7	-25.0	-13.5	-2.6	-6.7
Average Price Increase for MY 2030 Vehicles									
Price Increase due to New Standards (\$)	3622	-2720	-2116	-1575	-1534	-1371	-825	-112	-484
Technology Use under Alternative in MY 2030 (total fleet penetration)									
Weight Reduction Percent change from MY 2021	8.2%	5.5%	6.4%	7.7%	7.7%	8.2%	8.2%	8.2%	8.2%
Compression Ratio Non-Engines	0.0%	0.0%	0.0%	0.0%	0.0%	0.0%	0.0%	0.0%	0.0%
Charged Gasoline Engines	79.2%	50.4%	79.0%	79.0%	79.0%	79.0%	79.2%	79.2%	79.2%
Electric Cylinder Ignition	18.5%	0.0%	0.0%	0.0%	0.0%	0.0%	18.5%	18.5%	18.5%
Start 12V (Non-Hybrid)	0.0%	16.4%	16.9%	21.1%	25.6%	23.4%	24.5%	0.0%	0.0%
Hybrid Electric Systems	62.9%	0.0%	0.0%	9.4%	16.2%	18.5%	53.2%	64.9%	97.8%

*** EO 12866 Review – Draft – Do Not Cite, Quote or Release During Review ***

Hybrid Electric ns	34.9%	0.0%	0.0%	0.0%	0.0%	0.0%	0.0%	32.8%	0.0%
n Hybrid Electric es (PHEVs)	0.0%	0.0%	0.0%	0.0%	0.0%	0.0%	0.0%	0.0%	0.0%
ated Electric Vehicles	0.0%	0.0%	0.0%	0.0%	0.0%	0.0%	0.0%	0.0%	0.0%
Cell Vehicles (FCVs)	0.0%	0.0%	0.0%	0.0%	0.0%	0.0%	0.0%	0.0%	0.0%

*** EO 12866 Review – Draft – Do Not Cite, Quote or Release During Review ***

TABLE 6-70 - IMPACTS ON FUEL ECONOMY, REGULATORY COST, AVERAGE PRICE, TECHNOLOGY USE FOR ALL LIGHT-DUTY VEHICLES PRODUCED BY FIAT CHRYSLER, CAFE PROGRAM

	Alternative								
	No Action	1	2	3	4	5	6	7	8
Model Years	2021-2025	2021-2026	2021-2026	2021-2026	2021-2026	2022-2026	2021-2026	2021-2026	2022-2026
Annual Rate of Stringency Increase	MY 2017-2021 Final MY 2022-2025 Augural	0.0%/Year PC 0.0%/Year LT	0.5%/Year PC 0.5%/Year LT	0.5%/Year PC 0.5%/Year LT	1.0%/Year PC 2.0%/Year LT	1.0%/Year PC 2.0%/Year LT	2.0%/Year PC 3.0%/Year LT	2.0%/Year PC 3.0%/Year LT	2.0%/Year PC 3.0%/Year LT
Off-Cycle Procedures	No Change	No Change	No Change	Phaseout 2022-2026	No Change	No Change	No Change	Phaseout 2022-2026	No Change
Fuel Economy									
Change Required Fuel Economy - MY 2026+ (mpg)	43.6	34.3	35.3	35.3	38.0	39.7	40.5	40.4	41.7
Percent Change in Stringency Baseline	0.0%	-27.1%	-23.5%	-23.6%	-14.7%	-9.9%	-7.8%	-7.9%	-4.6%
Change Achieved Fuel Economy - MY 2030 (mpg)	44.1	35.8	38.2	37.5	39.6	40.1	41.4	40.8	42.2
Regulatory Costs through MY 2029 Vehicles									
Technology Costs (\$b)	94.7	-68.9	-57.9	-42.5	-44.4	-38.1	-22.1	-7.6	-14.4
Civil Penalties (\$b)	1.2	-0.2	-0.3	-0.3	-0.2	0.1	-0.3	-0.4	-0.1
Regulatory Costs (\$b)	96.0	-69.1	-58.2	-42.8	-44.6	-37.9	-22.4	-8.1	-14.5
Average Price Increase for MY 2030 Vehicles									
Increase due to New E Standards (\$)	4014	-2865	-2354	-1724	-1774	-1456	-938	-256	-663
Technology Use under Alternative in MY (total fleet penetration)									
Weight Change (percent MY 2016)	8.2%	5.8%	6.9%	7.8%	7.8%	8.3%	8.3%	8.2%	8.3%
Compression Ratio Non-Charged Gasoline Engines	0.0%	0.0%	0.0%	0.0%	0.0%	0.0%	0.0%	0.0%	0.0%
Electric Cylinder Ignition	14.8%	0.0%	0.0%	0.0%	0.0%	0.0%	14.7%	14.8%	14.8%
Start 12V (Non-Hybrid)	0.0%	14.4%	14.7%	28.6%	34.0%	28.9%	16.9%	0.0%	0.0%
Hybrid Electric Systems	43.5%	0.8%	0.3%	15.3%	11.1%	26.8%	63.4%	56.3%	92.2%

*** EO 12866 Review – Draft – Do Not Cite, Quote or Release During Review ***

g Hybrid Electric ms	52.4%	2.1%	2.6%	2.7%	2.8%	2.7%	2.6%	40.2%	4.5%
In Hybrid Electric les (PHEVs)	1.1%	0.0%	0.0%	0.1%	0.0%	0.1%	0.2%	0.5%	0.3%
ated Electric Vehicles	0.2%	0.2%	0.2%	0.2%	0.2%	0.2%	0.2%	0.2%	0.2%
Cell Vehicles (FCVs)	0.0%	0.0%	0.0%	0.0%	0.0%	0.0%	0.0%	0.0%	0.0%

*** EO 12866 Review – Draft – Do Not Cite, Quote or Release During Review ***

TABLE 6-71 - IMPACTS ON FUEL ECONOMY, REGULATORY COST, AVERAGE PRICE, AND TECHNOLOGY USE FOR PASSENGER CARS PRODUCED BY FORD, CAFE PROGRAM

	Alternative								
	No Action	1	2	3	4	5	6	7	8
Model Years	2021-2025	2021-2026	2021-2026	2021-2026	2021-2026	2022-2026	2021-2026	2021-2026	2022-2026
Annual Rate of Stringency Increase	MY 2017-2021 Final MY 2022-2025 Augural	0.0%/Year PC 0.0%/Year LT	0.5%/Year PC 0.5%/Year LT	0.5%/Year PC 0.5%/Year LT	1.0%/Year PC 2.0%/Year LT	1.0%/Year PC 2.0%/Year LT	2.0%/Year PC 3.0%/Year LT	2.0%/Year PC 3.0%/Year LT	2.0%/Year PC 3.0%/Year LT
AC/Off-Cycle Procedures	No Change	No Change	No Change	Phaseout 2022-2026	No Change	No Change	No Change	Phaseout 2022-2026	No Change
Fuel Economy									
Average Required Fuel Economy - MY 2026+ (mpg)	54.0	43.1	44.4	44.4	45.8	47.3	48.7	48.7	49.7
Percent Change in Stringency from Baseline	0.0%	-25.3%	-21.6%	-21.6%	-17.9%	-14.2%	-10.9%	-10.9%	-8.7%
Average Achieved Fuel Economy - MY 2030 (mpg)	54.7	45.8	45.8	44.8	47.3	48.2	49.5	49.5	50.6
Total Regulatory Costs through MY 2029 Vehicles									
Total Technology Costs (\$b)	40.4	-27.6	-27.6	-27.3	-25.5	-23.0	-21.3	-15.4	-18.3
Total Civil Penalties (\$b)	0.0	0.0	0.0	0.0	0.0	0.0	0.0	0.0	0.0
Total Regulatory Costs (\$b)	40.4	-27.6	-27.6	-27.3	-25.5	-23.0	-21.3	-15.4	-18.3
Average Price Increase for MY 2030 Vehicles									
Price Increase due to New CAFE Standards (\$)	3278	-2266	-2266	-2230	-1912	-1725	-1402	-766	-1133
Technology Use under CAFE Alternative in MY 2030 (total fleet penetration)									
Curb Weight Reduction (percent change from MY 2016)	6.2%	5.7%	5.7%	5.7%	6.5%	6.8%	8.2%	8.2%	8.2%
High Compression Ratio Non-Turbo Engines	6.1%	6.3%	6.3%	6.3%	6.2%	6.2%	6.2%	6.2%	6.2%
Turbocharged Gasoline Engines	93.7%	79.4%	79.4%	79.3%	83.4%	86.7%	90.0%	93.6%	93.6%
Dynamic Cylinder Deactivation	0.0%	0.0%	0.0%	0.0%	0.0%	0.0%	0.0%	0.0%	0.0%
Stop-Start 12V (Non-Hybrid)	0.0%	1.9%	1.9%	1.9%	1.9%	3.2%	12.1%	71.7%	45.8%
Mild Hybrid Electric Systems (48v)	58.4%	0.0%	0.0%	0.0%	0.0%	0.0%	0.0%	16.2%	0.4%

*** EO 12866 Review – Draft – Do Not Cite, Quote or Release During Review ***

Strong Hybrid Electric Systems	33.6%	4.3%	4.3%	4.2%	4.2%	4.2%	4.2%	4.2%	4.2%
Plug-In Hybrid Electric Vehicles (PHEVs)	2.1%	2.1%	2.1%	2.2%	2.2%	2.1%	2.1%	2.1%	2.1%
Dedicated Electric Vehicles (EVs)	0.1%	0.2%	0.2%	0.2%	0.2%	0.2%	0.1%	0.1%	0.1%
Fuel Cell Vehicles (FCVs)	0.0%	0.0%	0.0%	0.0%	0.0%	0.0%	0.0%	0.0%	0.0%

*** EO 12866 Review – Draft – Do Not Cite, Quote or Release During Review ***

TABLE 6-72 - IMPACTS ON FUEL ECONOMY, REGULATORY COST, AVERAGE PRICE, AND TECHNOLOGY USE FOR LIGHT TRUCKS PRODUCED BY FORD, CAFE PROGRAM

	Alternative								
	No Action	1	2	3	4	5	6	7	8
Years	2021-2025	2021-2026	2021-2026	2021-2026	2021-2026	2022-2026	2021-2026	2021-2026	2022-2026
Annual Rate of Stringency Increase	MY 2017-2021 Final MY 2022-2025 Augural	0.0%/Year PC 0.0%/Year LT	0.5%/Year PC 0.5%/Year LT	0.5%/Year PC 0.5%/Year LT	1.0%/Year PC 2.0%/Year LT	1.0%/Year PC 2.0%/Year LT	2.0%/Year PC 3.0%/Year LT	2.0%/Year PC 3.0%/Year LT	2.0%/Year PC 3.0%/Year LT
Phaseout Cycle Procedures	No Change	No Change	No Change	Phaseout 2022-2026	No Change	No Change	No Change	Phaseout 2022-2026	No Change
Fuel Economy									
Weighted Average Required Fuel Economy - MY 2026+ (mpg)	36.9	28.8	29.7	29.7	32.5	34.0	34.6	34.6	35.7
Percent Change in Stringency from Baseline	0.0%	-28.1%	-24.2%	-24.2%	-13.5%	-8.5%	-6.6%	-6.6%	-3.4%
Weighted Average Achieved Fuel Economy - MY 2030 (mpg)	37.0	29.6	29.7	29.7	32.7	34.1	34.8	34.8	35.9
Regulatory Costs for MY 2029 Vehicles									
Technology Costs (\$b)	48.8	-41.6	-41.5	-39.2	-31.0	-22.7	-20.0	-8.5	-10.6
Civil Penalties (\$b)	0.1	0.0	0.0	0.0	0.0	0.0	0.0	0.0	0.0
Regulatory Costs (\$b)	48.8	-41.6	-41.5	-39.2	-31.0	-22.7	-20.0	-8.5	-10.6
Average Price Increase for MY 2030 Vehicles									
Price Increase due to New Standards (\$)	3295	-2826	-2815	-2612	-1828	-1242	-967	-182	-449
Technology Use under Alternative in MY 2030 (total fleet penetration)									
Weight Reduction Percent change from MY 2017	3.7%	3.1%	3.1%	3.1%	4.6%	4.6%	4.7%	4.7%	4.7%
Compression Ratio Non-Engines	0.0%	0.0%	0.0%	0.0%	0.0%	0.0%	0.0%	0.0%	0.0%
Charged Gasoline Systems	100.0%	59.0%	59.0%	59.0%	86.1%	100.0%	100.0%	100.0%	100.0%
Electric Cylinder Ignition	0.0%	0.0%	0.0%	0.0%	0.0%	0.0%	0.0%	0.0%	0.0%
Start 12V (Non-Hybrid)	0.0%	13.4%	13.4%	13.4%	4.6%	11.6%	20.5%	0.0%	7.3%
Hybrid Electric Systems	69.2%	0.0%	0.0%	0.0%	8.9%	32.9%	58.2%	93.1%	89.0%

*** EO 12866 Review – Draft – Do Not Cite, Quote or Release During Review ***

Hybrid Electric s	30.2%	0.0%	0.0%	0.0%	0.0%	0.0%	0.0%	6.2%	0.0%
h Hybrid Electric es (PHEVs)	0.0%	0.0%	0.0%	0.0%	0.0%	0.0%	0.0%	0.0%	0.0%
ted Electric Vehicles	0.0%	0.0%	0.0%	0.0%	0.0%	0.0%	0.0%	0.0%	0.0%
ell Vehicles (FCVs)	0.0%	0.0%	0.0%	0.0%	0.0%	0.0%	0.0%	0.0%	0.0%

*** EO 12866 Review – Draft – Do Not Cite, Quote or Release During Review ***

TABLE 6-73 - IMPACTS ON FUEL ECONOMY, REGULATORY COST, AVERAGE PRICE, TECHNOLOGY USE FOR ALL LIGHT-DUTY VEHICLES PRODUCED BY FORD, CAFE PROGRAM

	Alternative								
	No Action	1	2	3	4	5	6	7	8
Model Years	2021-2025	2021-2026	2021-2026	2021-2026	2021-2026	2022-2026	2021-2026	2021-2026	2022-2026
Average Rate of Stringency Increase	MY 2017-2021 Final MY 2022-2025 Augural	0.0%/Year PC 0.0%/Year LT	0.5%/Year PC 0.5%/Year LT	0.5%/Year PC 0.5%/Year LT	1.0%/Year PC 2.0%/Year LT	1.0%/Year PC 2.0%/Year LT	2.0%/Year PC 3.0%/Year LT	2.0%/Year PC 3.0%/Year LT	2.0%/Year PC 3.0%/Year LT
Off-Cycle Procedures	No Change	No Change	No Change	Phaseout 2022-2026	No Change	No Change	No Change	Phaseout 2022-2026	No Change
Fuel Economy									
Volume Required Fuel Economy - MY 2026+ (mpg)	42.9	34.1	35.1	35.1	37.5	38.9	39.8	39.7	40.8
Percent Change in Stringency Baseline	0.0%	-26.1%	-22.4%	-22.5%	-14.6%	-10.2%	-8.0%	-8.1%	-5.1%
Volume Achieved Fuel Economy - MY 2030 (mpg)	43.2	35.5	35.5	35.2	38.1	39.3	40.2	40.2	41.3
Regulatory Costs through MY 2029 Vehicles									
Technology Costs (\$b)	89.2	-69.2	-69.2	-66.5	-56.5	-45.7	-41.3	-24.0	-28.9
Civil Penalties (\$b)	0.1	0.0	0.0	0.0	0.0	0.0	0.0	0.0	0.0
Regulatory Costs (\$b)	89.2	-69.2	-69.1	-66.5	-56.5	-45.7	-41.3	-24.0	-28.9
Average Price Increase for MY 2030 Vehicles									
Increase due to New Stringency Standards (\$)	3288	-2566	-2560	-2436	-1867	-1460	-1162	-443	-755
Technology Use under Alternative in MY 2030 (total fleet penetration)									
Weight Change (percent MY 2016)	4.1%	4.1%	4.1%	4.0%	5.1%	5.1%	5.7%	5.6%	5.6%
Compression Ratio Non-Hybrid Engines	2.7%	2.9%	2.9%	2.9%	2.8%	2.8%	2.8%	2.8%	2.8%
Uncharged Gasoline Engines	97.2%	68.5%	68.4%	68.4%	84.9%	94.0%	95.5%	97.2%	97.2%
Electric Cylinder Ignition	0.0%	0.0%	0.0%	0.0%	0.0%	0.0%	0.0%	0.0%	0.0%
Start 12V (Non-Hybrid)	0.0%	8.0%	8.0%	8.1%	3.3%	7.8%	16.7%	32.0%	24.5%
Hybrid Electric Systems	64.4%	0.0%	0.0%	0.0%	4.8%	18.0%	32.1%	58.8%	49.4%
Plug Hybrid Electric Systems	31.7%	2.0%	2.0%	2.0%	1.9%	1.9%	1.9%	5.3%	1.9%

*** EO 12866 Review – Draft – Do Not Cite, Quote or Release During Review ***

Plug-In Hybrid Electric Vehicles (PHEVs)	0.9%	1.0%	1.0%	1.0%	1.0%	1.0%	1.0%	1.0%	1.0%
Plug-in Hybrid Electric Vehicles	0.1%	0.1%	0.1%	0.1%	0.1%	0.1%	0.1%	0.1%	0.1%
Fuel Cell Vehicles (FCVs)	0.0%	0.0%	0.0%	0.0%	0.0%	0.0%	0.0%	0.0%	0.0%

*** EO 12866 Review – Draft – Do Not Cite, Quote or Release During Review ***

TABLE 6-74 - IMPACTS ON FUEL ECONOMY, REGULATORY COST, AVERAGE PRICE, TECHNOLOGY USE FOR PASSENGER CARS PRODUCED BY GENERAL MOTORS, CAFE PROGRAM

	Alternative								
	No Action	1	2	3	4	5	6	7	8
Model Years	2021-2025	2021-2026	2021-2026	2021-2026	2021-2026	2022-2026	2021-2026	2021-2026	2022-2026
Annual Rate of Stringency Increase	MY 2017-2021 Final MY 2022-2025 Augural	0.0%/Year PC 0.0%/Year LT	0.5%/Year PC 0.5%/Year LT	0.5%/Year PC 0.5%/Year LT	1.0%/Year PC 2.0%/Year LT	1.0%/Year PC 2.0%/Year LT	2.0%/Year PC 3.0%/Year LT	2.0%/Year PC 3.0%/Year LT	2.0%/Year PC 3.0%/Year LT
Off-Cycle Procedures	No Change	No Change	No Change	Phaseout 2022-2026	No Change	No Change	No Change	Phaseout 2022-2026	No Change
Fuel Economy									
Weighted Average Required Fuel Economy - MY 2026+ (mpg)	54.1	43.2	44.5	44.5	45.9	47.4	48.7	48.7	49.8
Percent Change in Stringency Baseline	0.0%	-25.1%	-21.4%	-21.4%	-17.9%	-14.1%	-11.0%	-11.0%	-8.5%
Weighted Average Achieved Fuel Economy - MY 2030 (mpg)	54.6	45.6	45.6	44.8	47.5	48.1	49.2	49.2	49.9
Regulatory Costs through MY 2029 Vehicles									
Technology Costs (\$b)	46.4	-32.9	-32.9	-32.3	-30.4	-26.3	-25.4	-16.6	-20.1
Civil Penalties (\$b)	0.0	0.0	0.0	0.0	0.0	0.0	0.0	0.0	0.0
Regulatory Costs (\$b)	46.5	-32.9	-32.9	-32.3	-30.4	-26.2	-25.4	-16.6	-20.1
Average Price Increase for MY 2030 Vehicles									
Increase due to New Emission Standards (\$)	3470	-2580	-2579	-2489	-2256	-1969	-1823	-909	-1370
Technology Use under Alternative in MY 2030 (total fleet penetration)									
Weight Reduction Percent change from MY 2017	7.8%	6.2%	6.2%	6.2%	6.6%	7.6%	7.8%	7.8%	7.8%
Compression Ratio Non-Diesel Engines	0.5%	0.6%	0.6%	0.5%	0.5%	0.5%	0.5%	0.5%	0.5%
Rechargeable Gasoline Engines	97.7%	89.1%	89.1%	89.1%	89.5%	89.6%	94.8%	96.8%	94.8%
Electric Cylinder Ignition	0.6%	0.0%	0.0%	0.0%	0.0%	0.0%	0.0%	0.6%	0.6%
Start 12V (Non-Hybrid)	0.0%	31.6%	31.5%	31.4%	31.2%	30.9%	32.5%	19.4%	63.1%
Hybrid Electric Systems	48.1%	0.5%	0.5%	0.5%	0.5%	0.5%	0.5%	62.6%	1.5%

*** EO 12866 Review – Draft – Do Not Cite, Quote or Release During Review ***

g Hybrid Electric ms	48.9%	2.8%	2.8%	2.8%	2.9%	2.9%	2.9%	2.9%	2.9%
In Hybrid Electric les (PHEVs)	1.0%	1.0%	1.0%	1.0%	1.0%	1.0%	1.0%	1.0%	1.0%
ated Electric Vehicles	0.2%	0.3%	0.3%	0.3%	0.3%	0.3%	0.3%	0.3%	0.3%
Cell Vehicles (FCVs)	0.0%	0.0%	0.0%	0.0%	0.0%	0.0%	0.0%	0.0%	0.0%

*** EO 12866 Review – Draft – Do Not Cite, Quote or Release During Review ***

TABLE 6-75 - IMPACTS ON FUEL ECONOMY, REGULATORY COST, AVERAGE PRICE, TECHNOLOGY USE FOR LIGHT TRUCKS PRODUCED BY GENERAL MOTORS, CAFE PROGRAM

	Alternative								
	No Action	1	2	3	4	5	6	7	8
Model Years	2021-2025	2021-2026	2021-2026	2021-2026	2021-2026	2022-2026	2021-2026	2021-2026	2022-2026
Annual Rate of Stringency Increase	MY 2017-2021 Final MY 2022-2025 Augural	0.0%/Year PC 0.0%/Year LT	0.5%/Year PC 0.5%/Year LT	0.5%/Year PC 0.5%/Year LT	1.0%/Year PC 2.0%/Year LT	1.0%/Year PC 2.0%/Year LT	2.0%/Year PC 3.0%/Year LT	2.0%/Year PC 3.0%/Year LT	2.0%/Year PC 3.0%/Year LT
Off-Cycle Procedures	No Change	No Change	No Change	Phaseout 2022-2026	No Change	No Change	No Change	Phaseout 2022-2026	No Change
Fuel Economy									
Weighted Average Required Fuel Economy - MY 2026+ (mpg)	36.8	28.8	29.7	29.7	32.5	33.9	34.6	34.6	35.6
Percent Change in Stringency from Baseline	0.0%	-27.8%	-23.9%	-23.9%	-13.2%	-8.6%	-6.4%	-6.4%	-3.4%
Weighted Average Achieved Fuel Economy - MY 2030 (mpg)	36.9	31.0	31.0	30.1	32.8	34.0	34.8	34.8	35.8
Regulatory Costs through MY 2029 Vehicles									
Advanced Technology Costs (\$b)	55.9	-42.1	-42.1	-42.0	-33.4	-26.5	-22.8	-8.0	-7.2
Civil Penalties (\$b)	0.1	0.1	0.1	0.1	0.0	0.0	0.0	0.0	0.0
Regulatory Costs (\$b)	55.9	-42.0	-42.0	-42.0	-33.4	-26.5	-22.8	-8.0	-7.2
Average Price Increase for MY 2030 Vehicles									
Increase due to New Stringency Standards (\$)	3150	-2387	-2387	-2380	-1742	-1235	-1099	-128	-248
Technology Use under Alternative in MY 2030 (total fleet penetration)									
Weight Reduction Percent change from MY 2017	7.7%	5.2%	5.2%	5.2%	7.6%	8.0%	8.0%	8.0%	8.0%
Compression Ratio Non-Hybrid Engines	0.0%	0.0%	0.0%	0.0%	0.0%	0.0%	0.0%	0.0%	0.0%
Recharged Gasoline Engines	48.1%	38.6%	38.6%	38.6%	40.3%	40.3%	40.3%	40.3%	40.3%
Electric Cylinder Ignition	50.6%	0.0%	0.0%	0.0%	0.0%	0.0%	0.0%	58.4%	58.4%
Start 12V (Non-Hybrid)	0.0%	0.9%	0.9%	0.9%	2.1%	1.8%	4.9%	0.0%	0.0%
Hybrid Electric Systems	79.7%	0.2%	0.2%	0.2%	1.8%	40.5%	66.7%	85.7%	98.9%

*** EO 12866 Review – Draft – Do Not Cite, Quote or Release During Review ***

g Hybrid Electric ms	20.1%	0.0%	0.0%	0.0%	0.0%	0.0%	0.0%	14.1%	0.0%
In Hybrid Electric les (PHEVs)	0.0%	0.0%	0.0%	0.0%	0.0%	0.0%	0.0%	0.0%	0.0%
ated Electric Vehicles	0.0%	0.0%	0.0%	0.0%	0.0%	0.0%	0.0%	0.0%	0.0%
Cell Vehicles (FCVs)	0.0%	0.0%	0.0%	0.0%	0.0%	0.0%	0.0%	0.0%	0.0%

*** EO 12866 Review – Draft – Do Not Cite, Quote or Release During Review ***

TABLE 6-76 - IMPACTS ON FUEL ECONOMY, REGULATORY COST, AVERAGE PRICE, AND TECHNOLOGY USE FOR ALL LIGHT-DUTY VEHICLES PRODUCED BY GENERAL MOTORS, CAFE PROGRAM

	Alternative								
	No Action	1	2	3	4	5	6	7	8
Years	2021-2025	2021-2026	2021-2026	2021-2026	2021-2026	2022-2026	2021-2026	2021-2026	2022-2026
Annual Rate of Stringency Increase	MY 2017-2021 Final MY 2022-2025 Augural	0.0%/Year PC 0.0%/Year LT	0.5%/Year PC 0.5%/Year LT	0.5%/Year PC 0.5%/Year LT	1.0%/Year PC 2.0%/Year LT	1.0%/Year PC 2.0%/Year LT	2.0%/Year PC 3.0%/Year LT	2.0%/Year PC 3.0%/Year LT	2.0%/Year PC 3.0%/Year LT
Off-Cycle Procedures	No Change	No Change	No Change	Phaseout 2022-2026	No Change	No Change	No Change	Phaseout 2022-2026	No Change
Fuel Economy									
Average Required Fuel Economy - MY 2026+ (mpg)	42.9	34.0	35.1	35.1	37.5	38.9	39.7	39.7	40.8
Percent Change in Stringency Baseline	0.0%	-25.9%	-22.2%	-22.2%	-14.4%	-10.3%	-7.8%	-7.9%	-5.1%
Average Achieved Fuel Economy - MY 2030 (mpg)	43.1	36.4	36.3	35.5	38.2	39.2	40.0	40.0	41.0
Regulatory Costs for MY 2029 Vehicles									
Technology Costs (\$b)	102.3	-75.0	-75.0	-74.3	-63.8	-52.8	-48.3	-24.6	-27.3
Civil Penalties (\$b)	0.1	0.1	0.1	0.1	0.0	0.0	0.0	0.0	0.0
Regulatory Costs (\$b)	102.4	-74.9	-74.9	-74.3	-63.8	-52.7	-48.2	-24.5	-27.3
Average Price Increase for MY 2030 Vehicles									
Price Increase due to New Standards (\$)	3292	-2470	-2470	-2424	-1972	-1563	-1421	-474	-746
Technology Use under MY 2026 Alternative in MY 2030 total fleet penetration									
Weight Change (percent MY 2016)	7.1%	5.6%	5.5%	5.4%	7.0%	7.5%	7.5%	7.4%	7.4%
Compression Ratio Non-Engines	0.2%	0.3%	0.3%	0.3%	0.2%	0.2%	0.2%	0.2%	0.2%
Recharged Gasoline Engines	70.1%	61.9%	61.9%	61.8%	62.6%	62.5%	64.6%	65.4%	64.5%
Electric Cylinder Ignition	28.4%	0.0%	0.0%	0.0%	0.0%	0.0%	0.0%	32.7%	32.7%
Start 12V (Non-Hybrid)	0.0%	15.1%	15.0%	14.9%	15.3%	14.9%	17.2%	8.6%	28.1%
Hybrid Electric Systems	65.7%	0.3%	0.3%	0.3%	1.2%	22.5%	37.1%	75.4%	55.5%

*** EO 12866 Review – Draft – Do Not Cite, Quote or Release During Review ***

Hybrid Electric ns	32.9%	1.3%	1.3%	1.3%	1.3%	1.3%	1.3%	9.1%	1.3%
n Hybrid Electric es (PHEVs)	0.4%	0.4%	0.4%	0.4%	0.4%	0.4%	0.4%	0.4%	0.4%
ated Electric Vehicles	0.1%	0.1%	0.1%	0.1%	0.1%	0.1%	0.1%	0.1%	0.1%
Cell Vehicles (FCVs)	0.0%	0.0%	0.0%	0.0%	0.0%	0.0%	0.0%	0.0%	0.0%

*** EO 12866 Review – Draft – Do Not Cite, Quote or Release During Review ***

TABLE 6-77 - IMPACTS ON FUEL ECONOMY, REGULATORY COST, AVERAGE PRICE, AND TECHNOLOGY USE FOR PASSENGER CARS PRODUCED BY HONDA, CAFE PROGRAM

	Alternative								
	No Action	1	2	3	4	5	6	7	8
Model Years	2021-2025	2021-2026	2021-2026	2021-2026	2021-2026	2022-2026	2021-2026	2021-2026	2022-2026
Annual Rate of Stringency Increase	MY 2017-2021 Final MY 2022-2025 Augural	0.0%/Year PC 0.0%/Year LT	0.5%/Year PC 0.5%/Year LT	0.5%/Year PC 0.5%/Year LT	1.0%/Year PC 2.0%/Year LT	1.0%/Year PC 2.0%/Year LT	2.0%/Year PC 3.0%/Year LT	2.0%/Year PC 3.0%/Year LT	2.0%/Year PC 3.0%/Year LT
Off-Cycle Procedures	No Change	No Change	No Change	Phaseout 2022-2026	No Change	No Change	No Change	Phaseout 2022-2026	No Change
Fuel Economy									
Average Required Fuel Economy - MY 2026+ (mpg)	55.8	44.5	45.8	45.8	47.2	48.8	50.2	50.2	51.3
Percent Change in Stringency from Baseline	0.0%	-25.3%	-21.7%	-21.7%	-18.1%	-14.2%	-11.0%	-11.0%	-8.6%
Average Achieved Fuel Economy - MY 2030 (mpg)	56.0	47.1	47.5	46.2	47.6	49.3	51.5	51.7	53.6
Regulatory Costs through MY 2029 Vehicles									
Technology Costs (\$b)	20.3	-17.2	-16.8	-16.8	-16.7	-13.7	-13.1	-9.6	-8.3
Civil Penalties (\$b)	0.0	0.0	0.0	0.0	0.0	0.0	0.0	0.0	0.0
Regulatory Costs (\$b)	20.3	-17.2	-16.8	-16.8	-16.7	-13.7	-13.1	-9.6	-8.3
Average Price Increase for MY 2030 Vehicles									
Price Increase due to New Standards (\$)	1729	-1464	-1427	-1427	-1411	-1239	-1022	-674	-681
Technology Use under Alternative in MY (total fleet penetration)									
Weight Reduction Percent change from MY	5.7%	2.7%	2.7%	2.7%	2.6%	3.0%	3.0%	4.8%	4.8%
Compression Ratio Non-Engines	0.0%	0.0%	0.0%	0.0%	0.0%	0.0%	0.0%	0.0%	0.0%
Charged Gasoline Engines	100.0%	59.3%	59.3%	59.3%	59.3%	65.5%	87.8%	87.7%	99.8%
Electric Cylinder Activation	0.0%	0.0%	0.0%	0.0%	0.0%	0.0%	0.0%	0.0%	0.0%
Start 12V (Non-Hybrid)	52.6%	3.2%	3.1%	3.1%	3.1%	3.1%	3.1%	3.1%	3.1%
Hybrid Electric Systems	0.2%	0.2%	0.2%	0.2%	0.2%	0.2%	0.2%	0.2%	0.2%

*** EO 12866 Review – Draft – Do Not Cite, Quote or Release During Review ***

Hybrid Electric ns	0.0%	0.0%	0.0%	0.0%	0.0%	0.0%	0.0%	0.0%	0.0%
n Hybrid Electric es (PHEVs)	0.0%	0.0%	0.0%	0.0%	0.0%	0.0%	0.0%	0.0%	0.0%
ated Electric Vehicles	0.0%	0.0%	0.0%	0.0%	0.0%	0.0%	0.0%	0.0%	0.0%
Cell Vehicles (FCVs)	0.0%	0.0%	0.0%	0.0%	0.0%	0.0%	0.0%	0.0%	0.0%

*** EO 12866 Review – Draft – Do Not Cite, Quote or Release During Review ***

TABLE 6-78 - IMPACTS ON FUEL ECONOMY, REGULATORY COST, AVERAGE PRICE, AND TECHNOLOGY USE FOR LIGHT TRUCKS PRODUCED BY HONDA, CAFE PROGRAM

	Alternative								
	No Action	1	2	3	4	5	6	7	8
Model Years	2021-2025	2021-2026	2021-2026	2021-2026	2021-2026	2022-2026	2021-2026	2021-2026	2022-2026
Annual Rate of Stringency Increase	MY 2017-2021 Final MY 2022-2025 Augural	0.0%/Year PC 0.0%/Year LT	0.5%/Year PC 0.5%/Year LT	0.5%/Year PC 0.5%/Year LT	1.0%/Year PC 2.0%/Year LT	1.0%/Year PC 2.0%/Year LT	2.0%/Year PC 3.0%/Year LT	2.0%/Year PC 3.0%/Year LT	2.0%/Year PC 3.0%/Year LT
Off-Cycle Procedures	No Change	No Change	No Change	Phaseout 2022-2026	No Change	No Change	No Change	Phaseout 2022-2026	No Change
Fuel Economy									
Weighted Average Required Fuel Economy - MY 2026+ (mpg)	43.1	33.5	34.5	34.5	37.8	39.6	40.2	40.2	41.7
Percent Change in Stringency from Baseline	0.0%	-28.7%	-24.9%	-24.9%	-14.0%	-8.8%	-7.2%	-7.2%	-3.4%
Weighted Average Achieved Fuel Economy - MY 2030 (mpg)	43.8	37.4	37.4	36.6	37.8	40.1	40.8	40.5	42.3
Regulatory Costs through MY 2029 Vehicles									
Advanced Technology Costs (\$b)	17.4	-13.6	-13.6	-13.6	-13.0	-8.8	-8.3	-5.9	-3.3
Civil Penalties (\$b)	0.0	0.0	0.0	0.0	0.0	0.0	0.0	0.0	0.0
Total Regulatory Costs (\$b)	17.4	-13.6	-13.6	-13.6	-13.0	-8.8	-8.3	-5.9	-3.3
Average Price Increase for MY 2030 Vehicles									
Increase due to New Stringency Standards (\$)	2158	-1743	-1743	-1743	-1689	-1154	-1018	-729	-403
Technology Use under Alternative in MY 2030 (total fleet penetration)									
Weight Reduction Percent change from MY 2017	7.8%	2.5%	2.5%	2.5%	2.5%	5.1%	5.1%	6.1%	7.8%
Compression Ratio Non-Hybrid Engines	0.0%	0.0%	0.0%	0.0%	0.0%	0.0%	0.0%	0.0%	0.0%
Recharged Gasoline Engines	100.0%	100.0%	100.0%	100.0%	100.0%	100.0%	100.0%	100.0%	100.0%
Electric Cylinder Ignition	0.0%	0.0%	0.0%	0.0%	0.0%	0.0%	0.0%	0.0%	0.0%
Start 12V (Non-Hybrid)	58.2%	9.4%	9.4%	9.4%	9.4%	9.4%	9.4%	2.0%	12.4%
Hybrid Electric Systems	30.4%	0.0%	0.0%	0.0%	0.0%	0.0%	0.0%	7.4%	7.4%

*** EO 12866 Review – Draft – Do Not Cite, Quote or Release During Review ***

g Hybrid Electric ms	0.0%	0.0%	0.0%	0.0%	0.0%	0.0%	0.0%	0.0%	0.0%
In Hybrid Electric les (PHEVs)	0.0%	0.0%	0.0%	0.0%	0.0%	0.0%	0.0%	0.0%	0.0%
ated Electric Vehicles	0.0%	0.0%	0.0%	0.0%	0.0%	0.0%	0.0%	0.0%	0.0%
Cell Vehicles (FCVs)	0.0%	0.0%	0.0%	0.0%	0.0%	0.0%	0.0%	0.0%	0.0%

*** EO 12866 Review – Draft – Do Not Cite, Quote or Release During Review ***

TABLE 6-79. IMPACTS ON FUEL ECONOMY, REGULATORY COST, AVERAGE PRICE, TECHNOLOGY USE FOR ALL LIGHT-DUTY VEHICLES PRODUCED BY HONDA, CAFE PROGRAM

	Alternative								
	No Action	1	2	3	4	5	6	7	8
Model Years	2021-2025	2021-2026	2021-2026	2021-2026	2021-2026	2022-2026	2021-2026	2021-2026	2022-2026
Average Rate of Stringency Increase	MY 2017-2021 Final MY 2022-2025 Augural	0.0%/Year PC 0.0%/Year LT	0.5%/Year PC 0.5%/Year LT	0.5%/Year PC 0.5%/Year LT	1.0%/Year PC 2.0%/Year LT	1.0%/Year PC 2.0%/Year LT	2.0%/Year PC 3.0%/Year LT	2.0%/Year PC 3.0%/Year LT	2.0%/Year PC 3.0%/Year LT
Off-Cycle Procedures	No Change	No Change	No Change	Phaseout 2022-2026	No Change	No Change	No Change	Phaseout 2022-2026	No Change
Fuel Economy									
Weighted Average Required Fuel Economy - MY 2026+ (mpg)	49.6	39.3	40.4	40.4	42.8	44.5	45.5	45.4	46.8
Percent Change in Stringency from Baseline	0.0%	-26.2%	-22.6%	-22.7%	-15.8%	-11.4%	-9.0%	-9.1%	-6.0%
Weighted Average Achieved Fuel Economy - MY 2030 (mpg)	50.1	42.6	42.8	41.8	43.0	45.0	46.4	46.3	48.2
Regulatory Costs through MY 2029 Vehicles									
Advanced Technology Costs (\$b)	37.7	-30.8	-30.4	-30.4	-29.7	-22.5	-21.4	-15.4	-11.6
Civil Penalties (\$b)	0.0	0.0	0.0	0.0	0.0	0.0	0.0	0.0	0.0
Regulatory Costs (\$b)	37.7	-30.8	-30.4	-30.4	-29.7	-22.5	-21.4	-15.4	-11.6
Average Price Increase for MY 2030 Vehicles									
Increase due to New Stringency Standards (\$)	1911	-1585	-1563	-1563	-1531	-1206	-1022	-698	-564
Technology Use under Alternative in MY 2030 (total fleet penetration)									
Weight Change (percent MY 2016)	6.3%	2.6%	2.6%	2.5%	2.4%	3.7%	3.7%	5.0%	5.8%
Compression Ratio Non-Hybrid Engines	0.0%	0.0%	0.0%	0.0%	0.0%	0.0%	0.0%	0.0%	0.0%
Recharged Gasoline Vehicles	100.0%	75.8%	75.8%	75.9%	76.1%	79.9%	92.9%	92.9%	99.9%
Electric Cylinder Ignition	0.0%	0.0%	0.0%	0.0%	0.0%	0.0%	0.0%	0.0%	0.0%
Start 12V (Non-Hybrid)	55.0%	5.7%	5.7%	5.7%	5.7%	5.7%	5.7%	2.6%	7.0%
Hybrid Electric Systems	13.0%	0.1%	0.1%	0.1%	0.1%	0.1%	0.1%	3.2%	3.2%
Plug-in Hybrid Electric Vehicles	0.0%	0.0%	0.0%	0.0%	0.0%	0.0%	0.0%	0.0%	0.0%

*** EO 12866 Review – Draft – Do Not Cite, Quote or Release During Review ***

In Hybrid Electric Vehicles (PHEVs)	0.0%	0.0%	0.0%	0.0%	0.0%	0.0%	0.0%	0.0%	0.0%
Plugged Electric Vehicles	0.0%	0.0%	0.0%	0.0%	0.0%	0.0%	0.0%	0.0%	0.0%
Fuel Cell Vehicles (FCVs)	0.0%	0.0%	0.0%	0.0%	0.0%	0.0%	0.0%	0.0%	0.0%

*** EO 12866 Review – Draft – Do Not Cite, Quote or Release During Review ***

TABLE 6-80 - IMPACTS ON FUEL ECONOMY, REGULATORY COST, AVERAGE PRICE, AND TECHNOLOGY USE FOR PASSENGER CARS PRODUCED BY HYUNDAI, CAFE PROGRAM

	Alternative								
	No Action	1	2	3	4	5	6	7	8
Model Years	2021-2025	2021-2026	2021-2026	2021-2026	2021-2026	2022-2026	2021-2026	2021-2026	2022-2026
Annual Rate of Stringency Increase	MY 2017-2021 Final MY 2022-2025 Augural	0.0%/Year PC 0.0%/Year LT	0.5%/Year PC 0.5%/Year LT	0.5%/Year PC 0.5%/Year LT	1.0%/Year PC 2.0%/Year LT	1.0%/Year PC 2.0%/Year LT	2.0%/Year PC 3.0%/Year LT	2.0%/Year PC 3.0%/Year LT	2.0%/Year PC 3.0%/Year LT
Off-Cycle Procedures	No Change	No Change	No Change	Phaseout 2022-2026	No Change	No Change	No Change	Phaseout 2022-2026	No Change
Fuel Economy									
Weighted Average Required Fuel Economy - MY 2026+ (mpg)	54.6	43.6	44.9	44.9	46.3	47.8	49.2	49.2	50.3
Percent Change in Stringency from Baseline	0.0%	-25.2%	-21.6%	-21.6%	-17.9%	-14.2%	-11.0%	-11.0%	-8.5%
Weighted Average Achieved Fuel Economy - MY 2030 (mpg)	54.7	49.3	49.3	47.9	49.5	49.6	49.6	49.2	50.3
Regulatory Costs through MY 2029 Vehicles									
Advanced Technology Costs (\$b)	8.6	-5.5	-5.5	-5.5	-5.3	-5.2	-5.2	-4.7	-4.8
Civil Penalties (\$b)	0.0	0.0	0.0	0.0	0.0	0.0	0.0	0.0	0.0
Total Regulatory Costs (\$b)	8.6	-5.5	-5.5	-5.5	-5.3	-5.2	-5.2	-4.7	-4.8
Average Price Increase for MY 2030 Vehicles									
Increase due to New Stringency Standards (\$)	1202	-846	-846	-846	-807	-789	-776	-667	-689
Technology Use under Alternative in MY (total fleet penetration)									
Weight Reduction Percent change from MY 2017	2.3%	0.4%	0.4%	0.4%	0.3%	0.5%	0.5%	0.7%	0.7%
Compression Ratio Non-Hybrid Engines	83.8%	60.2%	60.2%	60.2%	60.2%	60.2%	60.2%	60.2%	60.2%
Recharged Gasoline Engines	16.2%	15.3%	15.3%	15.4%	15.5%	15.7%	15.8%	16.1%	16.1%
Electric Cylinder Ignition	0.0%	0.0%	0.0%	0.0%	0.0%	0.0%	0.0%	0.0%	0.0%
Start 12V (Non-Hybrid)	21.8%	0.0%	0.0%	0.0%	0.0%	0.0%	0.0%	0.0%	0.0%
Hybrid Electric Systems	0.0%	0.0%	0.0%	0.0%	0.0%	0.0%	0.0%	0.0%	0.0%

*** EO 12866 Review – Draft – Do Not Cite, Quote or Release During Review ***

g Hybrid Electric ms	2.8%	2.9%	2.9%	2.9%	2.9%	2.9%	2.9%	2.8%	2.8%
In Hybrid Electric les (PHEVs)	0.2%	0.2%	0.2%	0.2%	0.2%	0.2%	0.2%	0.2%	0.2%
ated Electric Vehicles	0.0%	0.0%	0.0%	0.0%	0.0%	0.0%	0.0%	0.0%	0.0%
Cell Vehicles (FCVs)	0.0%	0.0%	0.0%	0.0%	0.0%	0.0%	0.0%	0.0%	0.0%

*** EO 12866 Review – Draft – Do Not Cite, Quote or Release During Review ***

TABLE 6-81 - IMPACTS ON FUEL ECONOMY, REGULATORY COST, AVERAGE PRICE, AND TECHNOLOGY USE FOR LIGHT TRUCKS PRODUCED BY HYUNDAI, CAFE PROGRAM

	Alternative								
	No Action	1	2	3	4	5	6	7	8
Model Years	2021-2025	2021-2026	2021-2026	2021-2026	2021-2026	2022-2026	2021-2026	2021-2026	2022-2026
Annual Rate of Stringency Increase	MY 2017-2021 Final MY 2022-2025 Augural	0.0%/Year PC 0.0%/Year LT	0.5%/Year PC 0.5%/Year LT	0.5%/Year PC 0.5%/Year LT	1.0%/Year PC 2.0%/Year LT	1.0%/Year PC 2.0%/Year LT	2.0%/Year PC 3.0%/Year LT	2.0%/Year PC 3.0%/Year LT	2.0%/Year PC 3.0%/Year LT
Off-Cycle Procedures	No Change	No Change	No Change	Phaseout 2022-2026	No Change	No Change	No Change	Phaseout 2022-2026	No Change
Fuel Economy									
Weighted Average Required Fuel Economy - MY 2026+ (mpg)	43.2	33.6	34.6	34.6	37.9	39.7	40.3	40.3	41.8
Percent Change in Stringency from Baseline	0.0%	-28.6%	-24.9%	-24.9%	-14.0%	-8.8%	-7.2%	-7.2%	-3.3%
Weighted Average Achieved Fuel Economy - MY 2030 (mpg)	43.5	37.7	37.7	36.3	37.9	39.9	41.6	40.6	42.5
Regulatory Costs through MY 2029 Vehicles									
Advanced Technology Costs (\$b)	0.5	-0.3	-0.3	-0.3	-0.3	-0.3	-0.2	-0.1	-0.1
Civil Penalties (\$b)	0.0	0.0	0.0	0.0	0.0	0.0	0.0	0.0	0.0
Regulatory Costs (\$b)	0.5	-0.3	-0.3	-0.3	-0.3	-0.3	-0.2	-0.1	-0.1
Average Price Increase for MY 2030 Vehicles									
Increase due to New Stringency Standards (\$)	2331	-1625	-1625	-1625	-1572	-1173	-708	-314	-314
Technology Use under Alternative in MY 2030 (total fleet penetration)									
Weight Reduction Percent change from MY 2017	5.6%	0.0%	0.0%	0.0%	0.0%	2.8%	2.8%	5.6%	5.6%
Compression Ratio Non-Combustion Engines	0.0%	0.0%	0.0%	0.0%	0.0%	0.0%	0.0%	0.0%	0.0%
Recharged Gasoline Engines	100.0%	100.0%	100.0%	100.0%	100.0%	100.0%	100.0%	100.0%	100.0%
Electric Cylinder Ignition	0.0%	0.0%	0.0%	0.0%	0.0%	0.0%	0.0%	0.0%	0.0%
Start 12V (Non-Hybrid)	49.4%	0.0%	0.0%	0.0%	0.0%	0.0%	0.0%	0.0%	0.0%
Hybrid Electric Systems	0.0%	0.0%	0.0%	0.0%	0.0%	0.0%	0.0%	0.0%	0.0%

*** EO 12866 Review – Draft – Do Not Cite, Quote or Release During Review ***

g Hybrid Electric ms	0.0%	0.0%	0.0%	0.0%	0.0%	0.0%	0.0%	0.0%	0.0%
In Hybrid Electric les (PHEVs)	0.0%	0.0%	0.0%	0.0%	0.0%	0.0%	0.0%	0.0%	0.0%
ated Electric Vehicles	0.0%	0.0%	0.0%	0.0%	0.0%	0.0%	0.0%	0.0%	0.0%
Cell Vehicles (FCVs)	0.0%	0.0%	0.0%	0.0%	0.0%	0.0%	0.0%	0.0%	0.0%

*** EO 12866 Review – Draft – Do Not Cite, Quote or Release During Review ***

TABLE 6-82 - IMPACTS ON FUEL ECONOMY, REGULATORY COST, AVERAGE PRICE, AND TECHNOLOGY USE FOR ALL LIGHT-DUTY VEHICLES PRODUCED BY HYUNDAI, CAFE PROGRAM

	Alternative								
	No Action	1	2	3	4	5	6	7	8
Years	2021-2025	2021-2026	2021-2026	2021-2026	2021-2026	2022-2026	2021-2026	2021-2026	2022-2026
Annual Rate of Stringency Increase	MY 2017-2021 Final MY 2022-2025 Augural	0.0%/Year PC 0.0%/Year LT	0.5%/Year PC 0.5%/Year LT	0.5%/Year PC 0.5%/Year LT	1.0%/Year PC 2.0%/Year LT	1.0%/Year PC 2.0%/Year LT	2.0%/Year PC 3.0%/Year LT	2.0%/Year PC 3.0%/Year LT	2.0%/Year PC 3.0%/Year LT
Off-Cycle Procedures	No Change	No Change	No Change	Phaseout 2022-2026	No Change	No Change	No Change	Phaseout 2022-2026	No Change
Fuel Economy									
Average Required Fuel Economy - MY 2026+ (mpg)	54.2	43.2	44.5	44.5	46.0	47.5	48.9	48.9	50.0
Percent Change in Stringency Baseline	0.0%	-25.3%	-21.6%	-21.7%	-17.7%	-14.0%	-10.8%	-10.8%	-8.3%
Average Achieved Fuel Economy - MY 2030 (mpg)	54.3	48.9	48.8	47.5	49.1	49.2	49.3	48.9	50.0
Regulatory Costs for MY 2029 Vehicles									
Technology Costs (\$b)	9.2	-5.9	-5.9	-5.9	-5.6	-5.5	-5.4	-4.8	-4.9
Civil Penalties (\$b)	0.0	0.0	0.0	0.0	0.0	0.0	0.0	0.0	0.0
Regulatory Costs (\$b)	9.2	-5.9	-5.9	-5.9	-5.6	-5.5	-5.4	-4.8	-4.9
Average Price Increase for MY 2030 Vehicles									
Price Increase due to New Standards (\$)	1236	-870	-870	-870	-830	-801	-775	-657	-679
Technology Use under Alternative in MY (total fleet penetration)									
Weight Change (percent MY 2016)	2.4%	0.4%	0.4%	0.4%	0.3%	0.5%	0.5%	0.8%	0.8%
Compression Ratio Non-Engines	81.3%	58.5%	58.5%	58.5%	58.5%	58.4%	58.4%	58.4%	58.4%
Charged Gasoline Engines	18.7%	17.6%	17.7%	17.7%	18.0%	18.1%	18.2%	18.6%	18.6%
Electric Cylinder Ignition	0.0%	0.0%	0.0%	0.0%	0.0%	0.0%	0.0%	0.0%	0.0%
Start 12V (Non-Hybrid)	22.7%	0.0%	0.0%	0.0%	0.0%	0.0%	0.0%	0.0%	0.0%
Hybrid Electric Systems	0.0%	0.0%	0.0%	0.0%	0.0%	0.0%	0.0%	0.0%	0.0%

*** EO 12866 Review – Draft – Do Not Cite, Quote or Release During Review ***

Hybrid Electric ns	2.8%	2.8%	2.8%	2.8%	2.8%	2.8%	2.8%	2.8%	2.8%
n Hybrid Electric es (PHEVs)	0.2%	0.2%	0.2%	0.2%	0.2%	0.2%	0.2%	0.2%	0.2%
ated Electric Vehicles	0.0%	0.0%	0.0%	0.0%	0.0%	0.0%	0.0%	0.0%	0.0%
Cell Vehicles (FCVs)	0.0%	0.0%	0.0%	0.0%	0.0%	0.0%	0.0%	0.0%	0.0%

*** EO 12866 Review – Draft – Do Not Cite, Quote or Release During Review ***

TABLE 6-83 - IMPACTS ON FUEL ECONOMY, REGULATORY COST, AVERAGE PRICE, AND TECHNOLOGY USE FOR PASSENGER CARS PRODUCED BY KIA, CAFE PROGRAM

	Alternative								
	No Action	1	2	3	4	5	6	7	8
Model Years	2021-2025	2021-2026	2021-2026	2021-2026	2021-2026	2022-2026	2021-2026	2021-2026	2022-2026
Annual Rate of Stringency Increase	MY 2017-2021 Final MY 2022-2025 Augural	0.0%/Year PC 0.0%/Year LT	0.5%/Year PC 0.5%/Year LT	0.5%/Year PC 0.5%/Year LT	1.0%/Year PC 2.0%/Year LT	1.0%/Year PC 2.0%/Year LT	2.0%/Year PC 3.0%/Year LT	2.0%/Year PC 3.0%/Year LT	2.0%/Year PC 3.0%/Year LT
Off-Cycle Procedures	No Change	No Change	No Change	Phaseout 2022-2026	No Change	No Change	No Change	Phaseout 2022-2026	No Change
Fuel Economy									
Weighted Average Required Fuel Economy - MY 2026+ (mpg)	54.9	43.8	45.2	45.2	46.6	48.1	49.5	49.5	50.6
Percent Change in Stringency from Baseline	0.0%	-25.3%	-21.5%	-21.5%	-17.8%	-14.1%	-10.9%	-10.9%	-8.5%
Weighted Average Achieved Fuel Economy - MY 2030 (mpg)	55.1	48.5	48.5	47.5	48.5	49.0	49.5	49.6	50.6
Regulatory Costs through MY 2029 Vehicles									
Advanced Technology Costs (\$b)	15.3	-11.9	-11.9	-11.9	-11.9	-11.7	-11.2	-10.0	-10.3
Civil Penalties (\$b)	0.0	0.0	0.0	0.0	0.0	0.0	0.0	0.0	0.0
Total Regulatory Costs (\$b)	15.3	-11.9	-11.9	-11.9	-11.9	-11.7	-11.2	-10.0	-10.3
Average Price Increase for MY 2030 Vehicles									
Increase due to New Stringency Standards (\$)	2289	-1791	-1790	-1790	-1788	-1736	-1688	-1449	-1499
Technology Use under Alternative in MY (total fleet penetration)									
Weight Reduction Percent change from MY 2017	2.6%	0.5%	0.5%	0.5%	0.5%	0.5%	0.4%	1.1%	0.5%
Compression Ratio Non-Hybrid Engines	92.3%	81.5%	81.5%	81.6%	81.8%	91.3%	91.4%	91.4%	91.4%
Recharged Gasoline Engines	7.2%	7.3%	7.3%	7.3%	7.3%	7.3%	7.3%	7.2%	7.2%
Electric Cylinder Ignition	0.0%	0.0%	0.0%	0.0%	0.0%	0.0%	0.0%	0.0%	0.0%
Start 12V (Non-Hybrid)	0.0%	0.4%	0.4%	0.4%	0.4%	0.4%	0.4%	0.4%	0.4%
Hybrid Electric Systems	94.6%	0.0%	0.0%	0.0%	0.0%	0.0%	0.0%	0.0%	0.0%

*** EO 12866 Review – Draft – Do Not Cite, Quote or Release During Review ***

g Hybrid Electric ms	1.7%	0.9%	0.9%	0.9%	0.9%	0.9%	0.9%	0.9%	0.9%
In Hybrid Electric les (PHEVs)	0.0%	0.0%	0.0%	0.0%	0.0%	0.0%	0.0%	0.0%	0.0%
ated Electric Vehicles	0.5%	0.5%	0.5%	0.5%	0.5%	0.5%	0.5%	0.5%	0.5%
Cell Vehicles (FCVs)	0.0%	0.0%	0.0%	0.0%	0.0%	0.0%	0.0%	0.0%	0.0%

*** EO 12866 Review – Draft – Do Not Cite, Quote or Release During Review ***

TABLE 6-84 - IMPACTS ON FUEL ECONOMY, REGULATORY COST, AVERAGE PRICE, AND TECHNOLOGY USE FOR LIGHT TRUCKS PRODUCED BY KIA, CAFE PROGRAM

	Alternative								
	No Action	1	2	3	4	5	6	7	8
Model Years	2021-2025	2021-2026	2021-2026	2021-2026	2021-2026	2022-2026	2021-2026	2021-2026	2022-2026
Average Annual Rate of Stringency Increase	MY 2017-2021 Final MY 2022-2025 Augural	0.0%/Year PC 0.0%/Year LT	0.5%/Year PC 0.5%/Year LT	0.5%/Year PC 0.5%/Year LT	1.0%/Year PC 2.0%/Year LT	1.0%/Year PC 2.0%/Year LT	2.0%/Year PC 3.0%/Year LT	2.0%/Year PC 3.0%/Year LT	2.0%/Year PC 3.0%/Year LT
Off-Cycle Procedures	No Change	No Change	No Change	Phaseout 2022-2026	No Change	No Change	No Change	Phaseout 2022-2026	No Change
Fuel Economy									
Weighted Average Required Fuel Economy - MY 2026+ (mpg)	41.5	32.2	33.2	33.2	36.4	38.1	38.7	38.7	40.1
Percent Change in Stringency from Baseline	0.0%	-28.9%	-25.0%	-25.0%	-14.0%	-8.9%	-7.2%	-7.2%	-3.5%
Weighted Average Achieved Fuel Economy - MY 2030 (mpg)	44.8	41.3	41.3	40.0	41.3	41.3	41.3	40.1	41.7
Regulatory Costs through MY 2029 Vehicles									
Advanced Technology Costs (\$b)	4.9	-1.4	-1.4	-1.4	-1.3	-1.3	-1.3	-1.3	-1.2
Civil Penalties (\$b)	0.0	0.0	0.0	0.0	0.0	0.0	0.0	0.0	0.0
Regulatory Costs (\$b)	4.9	-1.4	-1.4	-1.4	-1.3	-1.3	-1.3	-1.3	-1.2
Average Price Increase for MY 2030 Vehicles									
Price Increase due to New Stringency Standards (\$)	2788	-1079	-1079	-1079	-1079	-1079	-1079	-1034	-980
Technology Use under Alternative in MY 2030 (total fleet penetration)									
Weight Reduction Percent change from MY 2017	4.2%	1.5%	1.5%	1.5%	1.5%	1.5%	1.5%	1.5%	1.5%
Compression Ratio Non-Hybrid Engines	6.8%	6.8%	6.8%	6.8%	6.8%	6.8%	6.8%	6.8%	6.8%
Recharged Gasoline Engines	85.9%	85.9%	85.9%	85.9%	85.9%	85.9%	85.9%	85.9%	85.9%
Electric Cylinder Ignition	0.0%	0.0%	0.0%	0.0%	0.0%	0.0%	0.0%	0.0%	0.0%
Start 12V (Non-Hybrid)	0.0%	0.0%	0.0%	0.0%	0.0%	0.0%	0.0%	0.0%	0.0%
Hybrid Electric Systems	0.0%	0.0%	0.0%	0.0%	0.0%	0.0%	0.0%	0.0%	0.0%

*** EO 12866 Review – Draft – Do Not Cite, Quote or Release During Review ***

g Hybrid Electric ms	6.8%	6.8%	6.8%	6.8%	6.8%	6.8%	6.8%	6.8%	6.8%
In Hybrid Electric les (PHEVs)	7.3%	7.3%	7.3%	7.3%	7.3%	7.3%	7.3%	7.3%	7.3%
ated Electric Vehicles	0.0%	0.0%	0.0%	0.0%	0.0%	0.0%	0.0%	0.0%	0.0%
Cell Vehicles (FCVs)	0.0%	0.0%	0.0%	0.0%	0.0%	0.0%	0.0%	0.0%	0.0%

*** EO 12866 Review – Draft – Do Not Cite, Quote or Release During Review ***

TABLE 6-85 - IMPACTS ON FUEL ECONOMY, REGULATORY COST, AVERAGE PRICE, TECHNOLOGY USE FOR ALL LIGHT-DUTY VEHICLES PRODUCED BY KIA, CAFE PROGRAM

	Alternative								
	No Action	1	2	3	4	5	6	7	8
Model Years	2021-2025	2021-2026	2021-2026	2021-2026	2021-2026	2022-2026	2021-2026	2021-2026	2022-2026
Annual Rate of Stringency Increase	MY 2017-2021 Final MY 2022-2025 Augural	0.0%/Year PC 0.0%/Year LT	0.5%/Year PC 0.5%/Year LT	0.5%/Year PC 0.5%/Year LT	1.0%/Year PC 2.0%/Year LT	1.0%/Year PC 2.0%/Year LT	2.0%/Year PC 3.0%/Year LT	2.0%/Year PC 3.0%/Year LT	2.0%/Year PC 3.0%/Year LT
Off-Cycle Procedures	No Change	No Change	No Change	Phaseout 2022-2026	No Change	No Change	No Change	Phaseout 2022-2026	No Change
Fuel Economy									
Change Required Fuel Economy - MY 2026+ (mpg)	51.6	41.0	42.3	42.3	44.2	45.8	46.9	46.9	48.1
Percent Change in Stringency Baseline	0.0%	-25.9%	-22.0%	-22.0%	-16.7%	-12.8%	-10.0%	-10.0%	-7.2%
Change Achieved Fuel Economy - MY 2030 (mpg)	52.7	47.0	47.0	45.8	46.9	47.2	47.6	47.4	48.5
Regulatory Costs through MY 2029 Vehicles									
Technology Costs (\$b)	20.2	-13.2	-13.2	-13.2	-13.2	-13.0	-12.6	-11.3	-11.4
Civil Penalties (\$b)	0.0	0.0	0.0	0.0	0.0	0.0	0.0	0.0	0.0
Regulatory Costs (\$b)	20.2	-13.2	-13.2	-13.2	-13.2	-13.0	-12.6	-11.3	-11.4
Average Price Increase for MY 2030 Vehicles									
Price Increase due to New Standards (\$)	2387	-1660	-1659	-1658	-1654	-1610	-1569	-1367	-1398
Technology Use under Alternative in MY 2030 (total fleet penetration)									
Weight Change (percent MY 2016)	2.8%	0.7%	0.7%	0.7%	0.6%	0.6%	0.5%	1.0%	0.5%
Compression Ratio Non-Engines	75.4%	67.3%	67.3%	67.3%	67.3%	74.9%	74.8%	74.8%	74.8%
Charged Gasoline Engines	22.8%	22.2%	22.2%	22.3%	22.4%	22.6%	22.6%	22.7%	22.7%
Electric Cylinder Ignition	0.0%	0.0%	0.0%	0.0%	0.0%	0.0%	0.0%	0.0%	0.0%
Start 12V (Non-Hybrid)	0.0%	0.3%	0.3%	0.3%	0.3%	0.3%	0.3%	0.3%	0.3%
Hybrid Electric Systems	76.0%	0.0%	0.0%	0.0%	0.0%	0.0%	0.0%	0.0%	0.0%
Plug-in Hybrid Electric Systems	2.7%	2.0%	2.0%	2.0%	2.1%	2.1%	2.1%	2.1%	2.1%

*** EO 12866 Review – Draft – Do Not Cite, Quote or Release During Review ***

Plug-in Hybrid Electric Vehicles (PHEVs)	1.4%	1.4%	1.4%	1.4%	1.4%	1.4%	1.4%	1.4%	1.4%
Plug-in Electric Vehicles	0.4%	0.4%	0.4%	0.4%	0.4%	0.4%	0.4%	0.4%	0.4%
Fuel Cell Vehicles (FCVs)	0.0%	0.0%	0.0%	0.0%	0.0%	0.0%	0.0%	0.0%	0.0%

*** EO 12866 Review – Draft – Do Not Cite, Quote or Release During Review ***

TABLE 6-86 - IMPACTS ON FUEL ECONOMY, REGULATORY COST, AVERAGE PRICE, TECHNOLOGY USE FOR PASSENGER CARS PRODUCED BY JAGUAR LAND ROVER, CAFE PROGRAM

	Alternative								
	No Action	1	2	3	4	5	6	7	8
Model Years	2021-2025	2021-2026	2021-2026	2021-2026	2021-2026	2022-2026	2021-2026	2021-2026	2022-2026
Annual Rate of Stringency Increase	MY 2017-2021 Final MY 2022-2025 Augural	0.0%/Year PC 0.0%/Year LT	0.5%/Year PC 0.5%/Year LT	0.5%/Year PC 0.5%/Year LT	1.0%/Year PC 2.0%/Year LT	1.0%/Year PC 2.0%/Year LT	2.0%/Year PC 3.0%/Year LT	2.0%/Year PC 3.0%/Year LT	2.0%/Year PC 3.0%/Year LT
Off-Cycle Procedures	No Change	No Change	No Change	Phaseout 2022-2026	No Change	No Change	No Change	Phaseout 2022-2026	No Change
Fuel Economy									
Weighted Average Required Fuel Economy - MY 2026+ (mpg)	50.9	40.7	41.9	41.9	43.2	44.6	45.9	45.9	46.9
Percent Change in Stringency Baseline	0.0%	-25.1%	-21.5%	-21.5%	-17.8%	-14.1%	-10.9%	-10.9%	-8.5%
Weighted Average Achieved Fuel Economy - MY 2030 (mpg)	32.0	32.0	32.0	31.0	32.0	32.0	32.0	31.0	32.0
Regulatory Costs for MY 2029 Vehicles									
Technology Costs (\$b)	0.1	0.0	0.0	0.0	0.0	0.0	0.0	0.0	0.0
Civil Penalties (\$b)	0.3	-0.1	-0.1	-0.1	-0.1	-0.1	-0.1	0.0	0.0
Regulatory Costs (\$b)	0.4	-0.1	-0.1	-0.1	-0.1	-0.1	-0.1	0.0	0.0
Average Price Increase for MY 2030 Vehicles									
Increase due to New CAFE Standards (\$)	1250	-706	-596	-419	-418	-328	-262	-140	-199
Technology Use under Alternative in MY 2030 (total fleet penetration)									
Weight Reduction Percent change from MY 2017	5.0%	5.0%	5.0%	5.0%	5.0%	5.0%	5.0%	5.0%	5.0%
Compression Ratio Non-Hybrid Engines	0.0%	0.0%	0.0%	0.0%	0.0%	0.0%	0.0%	0.0%	0.0%
Rechargeable Gasoline Engines	100.0%	100.0%	100.0%	100.0%	100.0%	100.0%	100.0%	100.0%	100.0%
Electric Cylinder Ignition	0.0%	0.0%	0.0%	0.0%	0.0%	0.0%	0.0%	0.0%	0.0%
Start 12V (Non-Hybrid)	100.0%	100.0%	100.0%	100.0%	100.0%	100.0%	100.0%	100.0%	100.0%
Hybrid Electric Systems	0.0%	0.0%	0.0%	0.0%	0.0%	0.0%	0.0%	0.0%	0.0%

*** EO 12866 Review – Draft – Do Not Cite, Quote or Release During Review ***

g Hybrid Electric ms	0.0%	0.0%	0.0%	0.0%	0.0%	0.0%	0.0%	0.0%	0.0%
In Hybrid Electric les (PHEVs)	0.0%	0.0%	0.0%	0.0%	0.0%	0.0%	0.0%	0.0%	0.0%
ated Electric Vehicles	0.0%	0.0%	0.0%	0.0%	0.0%	0.0%	0.0%	0.0%	0.0%
Cell Vehicles (FCVs)	0.0%	0.0%	0.0%	0.0%	0.0%	0.0%	0.0%	0.0%	0.0%

*** EO 12866 Review – Draft – Do Not Cite, Quote or Release During Review ***

TABLE 6-87 - IMPACTS ON FUEL ECONOMY, REGULATORY COST, AVERAGE PRICE, TECHNOLOGY USE FOR LIGHT TRUCKS PRODUCED BY JAGUAR LAND ROVER, CAFE PROGRAM

	Alternative								
	No Action	1	2	3	4	5	6	7	8
Model Years	2021-2025	2021-2026	2021-2026	2021-2026	2021-2026	2022-2026	2021-2026	2021-2026	2022-2026
Annual Rate of Stringency Increase	MY 2017-2021 Final MY 2022-2025 Augural	0.0%/Year PC 0.0%/Year LT	0.5%/Year PC 0.5%/Year LT	0.5%/Year PC 0.5%/Year LT	1.0%/Year PC 2.0%/Year LT	1.0%/Year PC 2.0%/Year LT	2.0%/Year PC 3.0%/Year LT	2.0%/Year PC 3.0%/Year LT	2.0%/Year PC 3.0%/Year LT
Off-Cycle Procedures	No Change	No Change	No Change	Phaseout 2022-2026	No Change	No Change	No Change	Phaseout 2022-2026	No Change
Fuel Economy									
Weighted Average Required Fuel Economy - MY 2026+ (mpg)	41.9	32.6	33.6	33.6	36.8	38.5	39.1	39.1	40.5
Percent Change in Stringency from Baseline	0.0%	-28.5%	-24.7%	-24.7%	-13.9%	-8.8%	-7.2%	-7.2%	-3.5%
Weighted Average Achieved Fuel Economy - MY 2030 (mpg)	31.8	31.8	31.8	30.1	31.8	31.8	31.8	30.1	31.8
Regulatory Costs for Light MY 2029 Vehicles									
Technology Costs (\$b)	1.3	0.0	0.0	0.0	0.0	0.0	0.0	0.0	0.0
Civil Penalties (\$b)	1.4	-1.1	-1.0	-0.8	-0.6	-0.4	-0.4	-0.2	-0.2
Regulatory Costs (\$b)	2.8	-1.0	-0.9	-0.8	-0.6	-0.4	-0.4	-0.3	-0.2
Average Price Increase for MY 2030 Vehicles									
Increase due to New CAFE Standards (\$)	953	-422	-380	-338	-239	-160	-132	-83	-66
Technology Use under Alternative in MY 2030 (total fleet penetration)									
Weight Reduction Percent change from MY 2017	5.0%	5.0%	5.0%	5.0%	5.0%	5.0%	5.0%	5.0%	5.0%
Compression Ratio Non-Hybrid Engines	0.0%	0.0%	0.0%	0.0%	0.0%	0.0%	0.0%	0.0%	0.0%
Recharged Gasoline Vehicles	87.7%	87.7%	87.7%	87.7%	87.7%	87.7%	87.7%	87.7%	87.7%
Electric Cylinder Activation	0.0%	0.0%	0.0%	0.0%	0.0%	0.0%	0.0%	0.0%	0.0%
Start 12V (Non-Hybrid)	85.8%	85.8%	85.8%	85.8%	85.8%	85.8%	85.8%	85.8%	85.8%
Hybrid Electric Systems	0.0%	0.0%	0.0%	0.0%	0.0%	0.0%	0.0%	0.0%	0.0%

*** EO 12866 Review – Draft – Do Not Cite, Quote or Release During Review ***

g Hybrid Electric ms	0.0%	0.0%	0.0%	0.0%	0.0%	0.0%	0.0%	0.0%	0.0%
In Hybrid Electric les (PHEVs)	0.0%	0.0%	0.0%	0.0%	0.0%	0.0%	0.0%	0.0%	0.0%
ated Electric Vehicles	0.0%	0.0%	0.0%	0.0%	0.0%	0.0%	0.0%	0.0%	0.0%
Cell Vehicles (FCVs)	0.0%	0.0%	0.0%	0.0%	0.0%	0.0%	0.0%	0.0%	0.0%

*** EO 12866 Review – Draft – Do Not Cite, Quote or Release During Review ***

TABLE 6-88 - IMPACTS ON FUEL ECONOMY, REGULATORY COST, AVERAGE PRICE, TECHNOLOGY USE FOR ALL LIGHT-DUTY VEHICLES PRODUCED BY JAGUAR LAND ROVER, CAFE PROGRAM

	Alternative								
	No Action	1	2	3	4	5	6	7	8
Model Years	2021-2025	2021-2026	2021-2026	2021-2026	2021-2026	2022-2026	2021-2026	2021-2026	2022-2026
Annual Rate of Stringency Increase	MY 2017-2021 Final MY 2022-2025 Augural	0.0%/Year PC 0.0%/Year LT	0.5%/Year PC 0.5%/Year LT	0.5%/Year PC 0.5%/Year LT	1.0%/Year PC 2.0%/Year LT	1.0%/Year PC 2.0%/Year LT	2.0%/Year PC 3.0%/Year LT	2.0%/Year PC 3.0%/Year LT	2.0%/Year PC 3.0%/Year LT
Off-Cycle Procedures	No Change	No Change	No Change	Phaseout 2022-2026	No Change	No Change	No Change	Phaseout 2022-2026	No Change
Fuel Economy									
Weighted Average Required Fuel Economy - MY 2026+ (mpg)	42.5	33.2	34.2	34.2	37.3	39.0	39.6	39.6	41.0
Percent Change in Stringency Baseline	0.0%	-28.1%	-24.3%	-24.3%	-14.0%	-9.1%	-7.4%	-7.4%	-3.8%
Weighted Average Achieved Fuel Economy - MY 2030 (mpg)	31.8	31.8	31.8	30.2	31.8	31.8	31.8	30.2	31.8
Regulatory Costs for Light MY 2029 Vehicles									
Technology Costs (\$b)	1.4	0.0	0.0	0.0	0.0	0.0	0.0	0.0	0.0
Civil Penalties (\$b)	1.7	-1.2	-1.0	-0.9	-0.7	-0.4	-0.4	-0.3	-0.2
Regulatory Costs (\$b)	3.1	-1.2	-1.1	-0.9	-0.7	-0.5	-0.4	-0.3	-0.2
Average Price Increase for MY 2030 Vehicles									
Increase due to New Emission Standards (\$)	978	-446	-397	-343	-253	-173	-142	-88	-77
Technology Use under Alternative in MY 2026 (total fleet penetration)									
Weight Change (percent MY 2016)	4.9%	5.0%	5.0%	5.0%	4.9%	4.9%	4.9%	4.9%	4.9%
Compression Ratio Non-Hybrid Engines	0.0%	0.0%	0.0%	0.0%	0.0%	0.0%	0.0%	0.0%	0.0%
Recharged Gasoline Engines	88.7%	88.8%	88.8%	88.8%	88.8%	88.8%	88.8%	88.7%	88.7%
Dynamic Cylinder Deactivation	0.0%	0.0%	0.0%	0.0%	0.0%	0.0%	0.0%	0.0%	0.0%
Start 12V (Non-Hybrid)	87.0%	87.1%	87.1%	87.1%	87.0%	87.0%	87.0%	87.0%	87.0%
Hybrid Electric Systems	0.0%	0.0%	0.0%	0.0%	0.0%	0.0%	0.0%	0.0%	0.0%

*** EO 12866 Review – Draft – Do Not Cite, Quote or Release During Review ***

g Hybrid Electric ms	0.0%	0.0%	0.0%	0.0%	0.0%	0.0%	0.0%	0.0%	0.0%
In Hybrid Electric les (PHEVs)	0.0%	0.0%	0.0%	0.0%	0.0%	0.0%	0.0%	0.0%	0.0%
ated Electric Vehicles	0.0%	0.0%	0.0%	0.0%	0.0%	0.0%	0.0%	0.0%	0.0%
Cell Vehicles (FCVs)	0.0%	0.0%	0.0%	0.0%	0.0%	0.0%	0.0%	0.0%	0.0%

*** EO 12866 Review – Draft – Do Not Cite, Quote or Release During Review ***

TABLE 6-89 - IMPACTS ON FUEL ECONOMY, REGULATORY COST, AVERAGE PRICE, AND TECHNOLOGY USE FOR PASSENGER CARS PRODUCED BY MAZDA, CAFE PROGRAM

	Alternative								
	No Action	1	2	3	4	5	6	7	8
Model Years	2021-2025	2021-2026	2021-2026	2021-2026	2021-2026	2022-2026	2021-2026	2021-2026	2022-2026
Annual Rate of Stringency Increase	MY 2017-2021 Final MY 2022-2025 Augural	0.0%/Year PC 0.0%/Year LT	0.5%/Year PC 0.5%/Year LT	0.5%/Year PC 0.5%/Year LT	1.0%/Year PC 2.0%/Year LT	1.0%/Year PC 2.0%/Year LT	2.0%/Year PC 3.0%/Year LT	2.0%/Year PC 3.0%/Year LT	2.0%/Year PC 3.0%/Year LT
Off-Cycle Procedures	No Change	No Change	No Change	Phaseout 2022-2026	No Change	No Change	No Change	Phaseout 2022-2026	No Change
Fuel Economy									
Average Required Fuel Economy - MY 2026+ (mpg)	55.2	44.1	45.5	45.5	46.9	48.4	49.8	49.8	50.9
Percent Change in Stringency Baseline	0.0%	-25.2%	-21.3%	-21.3%	-17.7%	-14.0%	-10.8%	-10.8%	-8.4%
Average Achieved Fuel Economy - MY 2030 (mpg)	55.5	47.1	47.1	47.1	47.3	48.7	50.5	50.3	51.3
Regulatory Costs through MY 2029 Vehicles									
Technology Costs (\$b)	7.5	-6.7	-6.7	-6.7	-6.6	-5.9	-4.8	-4.8	-4.2
Civil Penalties (\$b)	0.0	0.0	0.0	0.0	0.0	0.0	0.0	0.0	0.0
Regulatory Costs (\$b)	7.5	-6.7	-6.7	-6.7	-6.6	-5.9	-4.8	-4.8	-4.2
Average Price Increase for MY 2030 Vehicles									
Price Increase due to New Standards (\$)	2198	-1989	-1989	-1989	-1943	-1622	-1178	-1177	-918
Technology Use under Alternative in MY 2030 (total fleet penetration)									
Weight Reduction Percent change from MY 2017	2.4%	0.0%	0.0%	0.0%	-0.1%	-0.2%	4.7%	4.7%	4.9%
Compression Ratio Non-Engines	100.0%	100.0%	100.0%	100.0%	100.0%	100.0%	100.0%	100.0%	100.0%
Charged Gasoline Engines	0.0%	0.0%	0.0%	0.0%	0.0%	0.0%	0.0%	0.0%	0.0%
Electric Cylinder Ignition	0.0%	0.0%	0.0%	0.0%	0.0%	0.0%	0.0%	0.0%	0.0%
Start 12V (Non-Hybrid)	0.0%	0.0%	0.0%	0.0%	0.0%	0.0%	0.0%	0.0%	50.7%
Hybrid Electric Systems	58.4%	0.0%	0.0%	0.0%	0.0%	0.0%	0.0%	0.0%	0.0%

*** EO 12866 Review – Draft – Do Not Cite, Quote or Release During Review ***

Hybrid Electric ns	32.7%	0.0%	0.0%	0.0%	0.0%	0.0%	0.0%	0.0%	0.0%
n Hybrid Electric es (PHEVs)	0.0%	0.0%	0.0%	0.0%	0.0%	0.0%	0.0%	0.0%	0.0%
ated Electric Vehicles	0.0%	0.0%	0.0%	0.0%	0.0%	0.0%	0.0%	0.0%	0.0%
Cell Vehicles (FCVs)	0.0%	0.0%	0.0%	0.0%	0.0%	0.0%	0.0%	0.0%	0.0%

*** EO 12866 Review – Draft – Do Not Cite, Quote or Release During Review ***

TABLE 6-90 - IMPACTS ON FUEL ECONOMY, REGULATORY COST, AVERAGE PRICE, AND TECHNOLOGY USE FOR LIGHT TRUCKS PRODUCED BY MAZDA, CAFE PROGRAM

	Alternative								
	No Action	1	2	3	4	5	6	7	8
Model Years	2021-2025	2021-2026	2021-2026	2021-2026	2021-2026	2022-2026	2021-2026	2021-2026	2022-2026
Annual Rate of Stringency Increase	MY 2017-2021 Final MY 2022-2025 Augural	0.0%/Year PC 0.0%/Year LT	0.5%/Year PC 0.5%/Year LT	0.5%/Year PC 0.5%/Year LT	1.0%/Year PC 2.0%/Year LT	1.0%/Year PC 2.0%/Year LT	2.0%/Year PC 3.0%/Year LT	2.0%/Year PC 3.0%/Year LT	2.0%/Year PC 3.0%/Year LT
Off-Cycle Procedures	No Change	No Change	No Change	Phaseout 2022-2026	No Change	No Change	No Change	Phaseout 2022-2026	No Change
Fuel Economy									
Weighted Average Required Fuel Economy - MY 2026+ (mpg)	44.8	34.8	35.9	35.9	39.3	41.2	41.8	41.8	43.3
Percent Change in Stringency from Baseline	0.0%	-28.7%	-24.8%	-24.8%	-14.0%	-8.7%	-7.2%	-7.2%	-3.5%
Weighted Average Achieved Fuel Economy - MY 2030 (mpg)	48.0	38.9	38.9	38.9	39.3	41.6	43.2	42.8	44.1
Regulatory Costs through MY 2029 Vehicles									
Advanced Technology Costs (\$b)	4.2	-3.6	-3.6	-3.6	-3.6	-2.7	-2.3	-2.0	-1.8
Civil Penalties (\$b)	0.0	0.0	0.0	0.0	0.0	0.0	0.0	0.0	0.0
Total Regulatory Costs (\$b)	4.2	-3.6	-3.6	-3.6	-3.6	-2.7	-2.3	-2.0	-1.8
Average Price Increase for MY 2030 Vehicles									
Increase due to New Stringency Standards (\$)	2550	-2271	-2271	-2271	-2208	-1584	-1041	-852	-786
Technology Use under Alternative in MY (total fleet penetration)									
Weight Reduction Percent change from MY 2017	2.8%	0.0%	0.0%	0.0%	0.0%	0.0%	5.6%	5.6%	5.6%
Compression Ratio Non-Hybrid Engines	83.6%	83.6%	83.6%	83.6%	83.6%	83.6%	83.6%	83.6%	83.6%
Recharged Gasoline Engines	16.4%	16.4%	16.4%	16.4%	16.4%	16.4%	16.4%	16.4%	16.4%
Electric Cylinder Ignition	0.0%	0.0%	0.0%	0.0%	0.0%	0.0%	0.0%	0.0%	0.0%
Start 12V (Non-Hybrid)	0.0%	0.0%	0.0%	0.0%	0.0%	48.9%	48.9%	89.5%	96.2%
Hybrid Electric Systems	57.0%	0.0%	0.0%	0.0%	0.0%	0.0%	0.0%	0.0%	3.8%

*** EO 12866 Review – Draft – Do Not Cite, Quote or Release During Review ***

g Hybrid Electric ms	43.0%	0.0%	0.0%	0.0%	0.0%	0.0%	0.0%	0.0%	0.0%
In Hybrid Electric les (PHEVs)	0.0%	0.0%	0.0%	0.0%	0.0%	0.0%	0.0%	0.0%	0.0%
ated Electric Vehicles	0.0%	0.0%	0.0%	0.0%	0.0%	0.0%	0.0%	0.0%	0.0%
Cell Vehicles (FCVs)	0.0%	0.0%	0.0%	0.0%	0.0%	0.0%	0.0%	0.0%	0.0%

*** EO 12866 Review – Draft – Do Not Cite, Quote or Release During Review ***

TABLE 6-91 - IMPACTS ON FUEL ECONOMY, REGULATORY COST, AVERAGE PRICE, TECHNOLOGY USE FOR ALL LIGHT-DUTY VEHICLES PRODUCED BY MAZDA, CAFE PROGRAM

	Alternative								
	No Action	1	2	3	4	5	6	7	8
Years	2021-2025	2021-2026	2021-2026	2021-2026	2021-2026	2022-2026	2021-2026	2021-2026	2022-2026
Annual Rate of Stringency Increase	MY 2017-2021 Final MY 2022-2025 Augural	0.0%/Year PC 0.0%/Year LT	0.5%/Year PC 0.5%/Year LT	0.5%/Year PC 0.5%/Year LT	1.0%/Year PC 2.0%/Year LT	1.0%/Year PC 2.0%/Year LT	2.0%/Year PC 3.0%/Year LT	2.0%/Year PC 3.0%/Year LT	2.0%/Year PC 3.0%/Year LT
Phaseout Cycle Procedures	No Change	No Change	No Change	Phaseout 2022-2026	No Change	No Change	No Change	Phaseout 2022-2026	No Change
Fuel Economy									
Stringency Required Fuel Economy - MY 2026+ (mpg)	51.1	40.5	41.8	41.8	44.0	45.7	46.7	46.7	48.0
Percent Change in Stringency Baseline	0.0%	-26.1%	-22.3%	-22.3%	-16.0%	-11.8%	-9.3%	-9.4%	-6.4%
Stringency Achieved Fuel Economy - MY 2030 (mpg)	52.6	44.0	44.0	44.0	44.2	46.0	47.7	47.4	48.6
Regulatory Costs for MY 2029 Vehicles									
Technology Costs (\$b)	11.7	-10.3	-10.3	-10.3	-10.2	-8.5	-7.0	-6.8	-6.0
Civil Penalties (\$b)	0.0	0.0	0.0	0.0	0.0	0.0	0.0	0.0	0.0
Regulatory Costs (\$b)	11.7	-10.3	-10.3	-10.3	-10.2	-8.5	-7.0	-6.8	-6.0
Average Price Increase for MY 2030 Vehicles									
Increase due to New Standards (\$)	2321	-2088	-2088	-2088	-2036	-1611	-1132	-1065	-873
Technology Use under Alternative in MY 2030 (total fleet penetration)									
Weight Change (percent MY 2016)	2.3%	0.0%	0.0%	-0.1%	-0.2%	-0.3%	4.9%	4.8%	4.9%
Compression Ratio Non-Engines	94.3%	94.5%	94.5%	94.5%	94.4%	94.4%	94.3%	94.3%	94.3%
Charged Gasoline Engines	5.7%	5.5%	5.5%	5.5%	5.6%	5.6%	5.7%	5.7%	5.7%
Mechanical Cylinder Variation	0.0%	0.0%	0.0%	0.0%	0.0%	0.0%	0.0%	0.0%	0.0%
Start 12V (Non-Hybrid)	0.0%	0.0%	0.0%	0.0%	0.0%	16.8%	16.9%	31.1%	66.5%
Hybrid Electric Systems	57.9%	0.0%	0.0%	0.0%	0.0%	0.0%	0.0%	0.0%	1.3%
Hybrid Electric Systems	36.3%	0.0%	0.0%	0.0%	0.0%	0.0%	0.0%	0.0%	0.0%

*** EO 12866 Review – Draft – Do Not Cite, Quote or Release During Review ***

Hybrid Electric Vehicles (PHEVs)	0.0%	0.0%	0.0%	0.0%	0.0%	0.0%	0.0%	0.0%	0.0%
Plug-in Electric Vehicles	0.0%	0.0%	0.0%	0.0%	0.0%	0.0%	0.0%	0.0%	0.0%
Fuel Cell Vehicles (FCVs)	0.0%	0.0%	0.0%	0.0%	0.0%	0.0%	0.0%	0.0%	0.0%

*** EO 12866 Review – Draft – Do Not Cite, Quote or Release During Review ***

TABLE 6-92 - IMPACTS ON FUEL ECONOMY, REGULATORY COST, AVERAGE PRICE, TECHNOLOGY USE FOR PASSENGER CARS PRODUCED BY NISSAN MITSUBISHI, CAFE PROGRAM

	Alternative								
	No Action	1	2	3	4	5	6	7	8
Model Years	2021-2025	2021-2026	2021-2026	2021-2026	2021-2026	2022-2026	2021-2026	2021-2026	2022-2026
Annual Rate of Stringency Increase	MY 2017-2021 Final MY 2022-2025 Augural	0.0%/Year PC 0.0%/Year LT	0.5%/Year PC 0.5%/Year LT	0.5%/Year PC 0.5%/Year LT	1.0%/Year PC 2.0%/Year LT	1.0%/Year PC 2.0%/Year LT	2.0%/Year PC 3.0%/Year LT	2.0%/Year PC 3.0%/Year LT	2.0%/Year PC 3.0%/Year LT
Off-Cycle Procedures	No Change	No Change	No Change	Phaseout 2022-2026	No Change	No Change	No Change	Phaseout 2022-2026	No Change
Fuel Economy									
Average Required Fuel Economy - MY 2026+ (mpg)	55.0	44.0	45.3	45.3	46.7	48.2	49.6	49.6	50.7
Percent Change in Stringency Baseline	0.0%	-25.0%	-21.4%	-21.4%	-17.8%	-14.1%	-10.8%	-10.8%	-8.5%
Average Achieved Fuel Economy - MY 2030 (mpg)	57.4	48.3	48.2	46.9	48.3	51.7	51.5	50.1	52.2
Regulatory Costs through MY 2029 Vehicles									
Technology Costs (\$b)	15.1	-7.3	-7.3	-7.3	-7.2	-4.5	-5.7	-5.7	-4.0
Civil Penalties (\$b)	0.0	0.0	0.0	0.0	0.0	0.0	0.0	0.0	0.0
Regulatory Costs (\$b)	15.1	-7.3	-7.3	-7.3	-7.2	-4.5	-5.7	-5.7	-4.0
Average Price Increase for 2030 Vehicles									
Increase due to New Emission Standards (\$)	1406	-830	-830	-829	-821	-577	-603	-593	-507
Technology Use under Alternative in MY (total fleet penetration)									
Weight Reduction Percent change from MY	4.8%	2.4%	2.3%	2.3%	2.4%	2.4%	2.3%	2.5%	3.6%
Compression Ratio Non-Hybrid Engines	88.7%	22.2%	22.2%	22.1%	22.0%	61.7%	61.8%	61.8%	61.6%
Uncharged Gasoline Engines	7.3%	7.1%	7.1%	7.1%	7.2%	7.2%	7.2%	7.3%	7.3%
Electric Cylinder Activation	0.0%	0.0%	0.0%	0.0%	0.0%	0.0%	0.0%	0.0%	0.0%
Start 12V (Non-Hybrid)	2.1%	2.2%	2.2%	2.2%	2.1%	2.1%	2.1%	2.1%	2.1%
Hybrid Electric Systems	0.0%	0.0%	0.0%	0.0%	0.0%	0.0%	0.0%	0.0%	0.0%

*** EO 12866 Review – Draft – Do Not Cite, Quote or Release During Review ***

g Hybrid Electric ms	0.2%	0.2%	0.2%	0.2%	0.2%	0.2%	0.2%	0.2%	0.2%
In Hybrid Electric les (PHEVs)	2.3%	2.2%	2.2%	2.2%	2.2%	2.2%	2.2%	2.2%	2.2%
ated Electric Vehicles	1.8%	1.8%	1.8%	1.8%	1.8%	1.8%	1.8%	1.8%	1.8%
Cell Vehicles (FCVs)	0.0%	0.0%	0.0%	0.0%	0.0%	0.0%	0.0%	0.0%	0.0%

*** EO 12866 Review – Draft – Do Not Cite, Quote or Release During Review ***

TABLE 6-93 - IMPACTS ON FUEL ECONOMY, REGULATORY COST, AVERAGE PRICE, TECHNOLOGY USE FOR LIGHT TRUCKS PRODUCED BY NISSAN MITSUBISHI, CAFE PROGRAM

	Alternative								
	No Action	1	2	3	4	5	6	7	8
Years	2021-2025	2021-2026	2021-2026	2021-2026	2021-2026	2022-2026	2021-2026	2021-2026	2022-2026
Rate of Stringency Increase	MY 2017-2021 Final MY 2022-2025 Augural	0.0%/Year PC 0.0%/Year LT	0.5%/Year PC 0.5%/Year LT	0.5%/Year PC 0.5%/Year LT	1.0%/Year PC 2.0%/Year LT	1.0%/Year PC 2.0%/Year LT	2.0%/Year PC 3.0%/Year LT	2.0%/Year PC 3.0%/Year LT	2.0%/Year PC 3.0%/Year LT
Off-Cycle Procedures	No Change	No Change	No Change	Phaseout 2022-2026	No Change	No Change	No Change	Phaseout 2022-2026	No Change
Fuel Economy									
Weighted Average Required Fuel Economy - MY 2026+ (mpg)	43.0	33.4	34.4	34.4	37.7	39.5	40.1	40.1	41.6
Percent Change in Stringency from Baseline	0.0%	-28.7%	-25.0%	-25.0%	-14.1%	-8.9%	-7.2%	-7.2%	-3.4%
Weighted Average Achieved Fuel Economy - MY 2030 (mpg)	43.9	37.0	37.0	36.1	37.7	39.9	40.3	40.3	41.7
Regulatory Costs through MY 2029 Vehicles									
Technology Costs (\$b)	5.8	-3.8	-3.8	-3.8	-3.4	-2.5	-2.7	-1.7	-1.2
Civil Penalties (\$b)	0.0	0.0	0.0	0.0	0.0	0.0	0.0	0.0	0.0
Regulatory Costs (\$b)	5.8	-3.8	-3.8	-3.8	-3.4	-2.5	-2.7	-1.7	-1.2
Average Price Increase for MY 2030 Vehicles									
Price Increase due to New Standards (\$)	1283	-887	-887	-887	-791	-596	-554	-348	-305
Technology Use under Alternative in MY 2030 (total fleet penetration)									
Weight Reduction (percent change from MY 2017)	5.3%	2.2%	2.2%	2.2%	2.8%	2.8%	2.8%	2.8%	3.4%
Compression Ratio Non-Engines	79.5%	9.4%	9.4%	9.4%	9.4%	58.9%	58.9%	58.9%	58.9%
Charged Gasoline Engines	4.4%	4.4%	4.4%	4.4%	4.4%	4.4%	4.4%	4.4%	4.4%
Electric Cylinder Ignition	0.0%	0.0%	0.0%	0.0%	0.0%	0.0%	0.0%	0.0%	0.0%
Start 12V (Non-Hybrid)	0.0%	0.0%	0.0%	0.0%	0.0%	0.0%	0.0%	0.0%	0.0%
Hybrid Electric Systems	0.0%	0.0%	0.0%	0.0%	0.0%	0.0%	0.0%	0.0%	0.0%

*** EO 12866 Review – Draft – Do Not Cite, Quote or Release During Review ***

Hybrid Electric s	0.0%	0.0%	0.0%	0.0%	0.0%	0.0%	0.0%	0.0%	0.0%
h Hybrid Electric es (PHEVs)	0.0%	0.0%	0.0%	0.0%	0.0%	0.0%	0.0%	0.0%	0.0%
ted Electric Vehicles	0.0%	0.0%	0.0%	0.0%	0.0%	0.0%	0.0%	0.0%	0.0%
ell Vehicles (FCVs)	0.0%	0.0%	0.0%	0.0%	0.0%	0.0%	0.0%	0.0%	0.0%

*** EO 12866 Review – Draft – Do Not Cite, Quote or Release During Review ***

TABLE 6-94 - IMPACTS ON FUEL ECONOMY, REGULATORY COST, AVERAGE PRICE, AND TECHNOLOGY USE FOR ALL LIGHT-DUTY VEHICLES PRODUCED BY NISSAN MITSUBISHI, CAFE PROGRAM

	Alternative								
	No Action	1	2	3	4	5	6	7	8
Model Years	2021-2025	2021-2026	2021-2026	2021-2026	2021-2026	2022-2026	2021-2026	2021-2026	2022-2026
Annual Rate of Stringency Increase	MY 2017-2021 Final MY 2022-2025 Augural	0.0%/Year PC 0.0%/Year LT	0.5%/Year PC 0.5%/Year LT	0.5%/Year PC 0.5%/Year LT	1.0%/Year PC 2.0%/Year LT	1.0%/Year PC 2.0%/Year LT	2.0%/Year PC 3.0%/Year LT	2.0%/Year PC 3.0%/Year LT	2.0%/Year PC 3.0%/Year LT
Off-Cycle Procedures	No Change	No Change	No Change	Phaseout 2022-2026	No Change	No Change	No Change	Phaseout 2022-2026	No Change
Fuel Economy									
Weighted Average Required Fuel Economy - MY 2026+ (mpg)	50.6	40.3	41.5	41.4	43.6	45.2	46.3	46.3	47.5
Percent Change in Stringency from Baseline	0.0%	-25.7%	-22.1%	-22.2%	-16.2%	-12.0%	-9.4%	-9.5%	-6.6%
Weighted Average Achieved Fuel Economy - MY 2030 (mpg)	52.4	44.3	44.3	43.1	44.5	47.5	47.5	46.6	48.5
Regulatory Costs through MY 2029 Vehicles									
Technology Costs (\$b)	20.9	-11.1	-11.1	-11.1	-10.7	-6.9	-8.4	-7.4	-5.3
Civil Penalties (\$b)	0.0	0.0	0.0	0.0	0.0	0.0	0.0	0.0	0.0
Regulatory Costs (\$b)	20.9	-11.1	-11.1	-11.1	-10.7	-6.9	-8.4	-7.4	-5.3
Average Price Increase for MY 2030 Vehicles									
Increase due to New Emission Standards (\$)	1368	-845	-845	-845	-811	-582	-587	-517	-445
Technology Use under Alternative in MY 2026 (total fleet penetration)									
Weight Change (percent MY 2016)	4.6%	2.3%	2.3%	2.2%	2.4%	2.3%	2.2%	2.3%	3.2%
Compression Ratio Non-Diesel Engines	85.9%	18.5%	18.4%	18.4%	18.2%	60.8%	60.9%	60.9%	60.8%
Recharged Gasoline Engines	6.4%	6.3%	6.3%	6.3%	6.3%	6.3%	6.4%	6.4%	6.4%
Electric Cylinder Ignition	0.0%	0.0%	0.0%	0.0%	0.0%	0.0%	0.0%	0.0%	0.0%
Start 12V (Non-Hybrid)	1.5%	1.5%	1.5%	1.5%	1.5%	1.5%	1.5%	1.5%	1.5%
Hybrid Electric Systems	0.0%	0.0%	0.0%	0.0%	0.0%	0.0%	0.0%	0.0%	0.0%

*** EO 12866 Review – Draft – Do Not Cite, Quote or Release During Review ***

g Hybrid Electric ms	0.2%	0.2%	0.2%	0.2%	0.2%	0.2%	0.2%	0.2%	0.2%
In Hybrid Electric les (PHEVs)	1.6%	1.5%	1.5%	1.5%	1.5%	1.6%	1.6%	1.6%	1.6%
ated Electric Vehicles	1.2%	1.3%	1.3%	1.3%	1.2%	1.2%	1.2%	1.2%	1.2%
Cell Vehicles (FCVs)	0.0%	0.0%	0.0%	0.0%	0.0%	0.0%	0.0%	0.0%	0.0%

*** EO 12866 Review – Draft – Do Not Cite, Quote or Release During Review ***

TABLE 6-95 - IMPACTS ON FUEL ECONOMY, REGULATORY COST, AVERAGE PRICE, AND TECHNOLOGY USE FOR PASSENGER CARS PRODUCED BY SUBARU, CAFE PROGRAM

	Alternative								
	No Action	1	2	3	4	5	6	7	8
Years	2021-2025	2021-2026	2021-2026	2021-2026	2021-2026	2022-2026	2021-2026	2021-2026	2022-2026
Annual Rate of Stringency Increase	MY 2017-2021 Final MY 2022-2025 Augural	0.0%/Year PC 0.0%/Year LT	0.5%/Year PC 0.5%/Year LT	0.5%/Year PC 0.5%/Year LT	1.0%/Year PC 2.0%/Year LT	1.0%/Year PC 2.0%/Year LT	2.0%/Year PC 3.0%/Year LT	2.0%/Year PC 3.0%/Year LT	2.0%/Year PC 3.0%/Year LT
Test-Cycle Procedures	No Change	No Change	No Change	Phaseout 2022-2026	No Change	No Change	No Change	Phaseout 2022-2026	No Change
Fuel Economy									
Weighted Average Required Fuel Economy - MY 2026+ (mpg)	56.4	45.0	46.4	46.4	47.8	49.4	50.8	50.8	51.9
Percentage Change in Stringency from Baseline	0.0%	-25.3%	-21.6%	-21.6%	-18.0%	-14.2%	-11.0%	-11.0%	-8.7%
Weighted Average Achieved Fuel Economy - MY 2030 (mpg)	58.2	46.3	46.6	46.5	48.9	51.2	51.2	52.4	53.0
Regulatory Costs for MY 2029 Vehicles									
Technology Costs (\$b)	5.9	-3.5	-3.4	-3.3	-3.2	-2.4	-2.3	-1.9	-1.4
Civil Penalties (\$b)	0.0	0.0	0.0	0.0	0.0	0.0	0.0	0.0	0.0
Regulatory Costs (\$b)	5.9	-3.5	-3.4	-3.3	-3.2	-2.4	-2.3	-1.9	-1.4
Average Price Increase for MY 2030 Vehicles									
Price Increase due to New Standards (\$)	2969	-1892	-1868	-1816	-1669	-1245	-1117	-725	-793
Technology Use under Alternative in MY 2030 (total fleet penetration)									
Weight Reduction Percentage Change from MY 2017	7.4%	3.2%	3.7%	4.9%	4.9%	7.4%	7.4%	7.4%	7.4%
Compression Ratio Non-Engines	0.0%	0.0%	0.0%	0.0%	0.0%	0.0%	0.0%	0.0%	0.0%
Charged Gasoline Engines	96.8%	58.8%	61.4%	61.4%	61.4%	61.4%	61.4%	96.8%	61.4%
Electric Cylinder Ignition	0.0%	0.0%	0.0%	0.0%	0.0%	0.0%	0.0%	0.0%	0.0%
Start 12V (Non-Hybrid)	0.0%	38.6%	38.6%	38.6%	38.6%	65.6%	65.6%	54.7%	3.2%
Hybrid Electric Systems	35.4%	0.0%	0.0%	0.0%	0.0%	11.2%	11.2%	22.1%	73.6%

*** EO 12866 Review – Draft – Do Not Cite, Quote or Release During Review ***

Hybrid Electric Vs	41.4%	0.0%	0.0%	0.0%	0.0%	0.0%	0.0%	0.0%	0.0%
Hybrid Electric Vs (PHEVs)	0.0%	0.0%	0.0%	0.0%	0.0%	0.0%	0.0%	0.0%	0.0%
Plug-in Hybrid Electric Vehicles	0.0%	0.0%	0.0%	0.0%	0.0%	0.0%	0.0%	0.0%	0.0%
Fuel Cell Vehicles (FCVs)	0.0%	0.0%	0.0%	0.0%	0.0%	0.0%	0.0%	0.0%	0.0%

*** EO 12866 Review – Draft – Do Not Cite, Quote or Release During Review ***

TABLE 6-96 - IMPACTS ON FUEL ECONOMY, REGULATORY COST, AVERAGE PRICE, AND TECHNOLOGY USE FOR LIGHT TRUCKS PRODUCED BY SUBARU, CAFE PROGRAM

	Alternative								
	No Action	1	2	3	4	5	6	7	8
Time Period	2021-2025	2021-2026	2021-2026	2021-2026	2021-2026	2022-2026	2021-2026	2021-2026	2022-2026
Annual Rate of Stringency Increase	MY 2017-2021 Final MY 2022-2025 Augural	0.0%/Year PC 0.0%/Year LT	0.5%/Year PC 0.5%/Year LT	0.5%/Year PC 0.5%/Year LT	1.0%/Year PC 2.0%/Year LT	1.0%/Year PC 2.0%/Year LT	2.0%/Year PC 3.0%/Year LT	2.0%/Year PC 3.0%/Year LT	2.0%/Year PC 3.0%/Year LT
Off-Cycle Procedures	No Change	No Change	No Change	Phaseout 2022-2026	No Change	No Change	No Change	Phaseout 2022-2026	No Change
Fuel Economy									
Average Required Fuel Economy - MY 2026+ (mpg)	46.8	36.4	37.5	37.5	41.0	43.0	43.6	43.6	45.2
Percent Change in Stringency from Baseline	0.0%	-28.6%	-24.8%	-24.8%	-14.1%	-8.8%	-7.3%	-7.3%	-3.5%
Average Achieved Fuel Economy - MY 2030 (mpg)	47.1	42.3	41.9	42.0	44.1	44.9	44.9	46.3	45.6
Regulatory Costs through MY 2029 Vehicles									
Technology Costs (\$b)	6.0	-3.0	-3.1	-2.8	-2.4	-1.7	-1.1	-0.4	-1.3
Civil Penalties (\$b)	0.0	0.0	0.0	0.0	0.0	0.0	0.0	0.0	0.0
Regulatory Costs (\$b)	6.0	-3.0	-3.1	-2.8	-2.4	-1.7	-1.1	-0.4	-1.3
Average Price Increase for MY 2030 Vehicles									
Price Increase due to New Standards (\$)	1121	-623	-658	-597	-448	-296	-217	79	-241
Technology Use under Alternative in MY 2030 (total fleet penetration)									
Weight Reduction Percent change from MY 2017	7.5%	3.3%	3.7%	5.0%	5.0%	7.5%	7.5%	7.5%	7.5%
Compression Ratio Non-Engines	0.0%	0.0%	0.0%	0.0%	0.0%	0.0%	0.0%	0.0%	0.0%
Charged Gasoline Engines	58.7%	25.8%	25.8%	25.8%	25.8%	25.8%	25.8%	58.7%	25.8%
Electric Cylinder Ignition	0.0%	0.0%	0.0%	0.0%	0.0%	0.0%	0.0%	0.0%	0.0%
Start 12V (Non-Hybrid)	0.0%	0.0%	0.0%	0.0%	0.0%	0.0%	0.0%	0.0%	0.0%
Hybrid Electric Systems	0.0%	0.0%	0.0%	0.0%	0.0%	0.0%	0.0%	0.0%	0.0%

*** EO 12866 Review – Draft – Do Not Cite, Quote or Release During Review ***

Hybrid Electric ns	0.7%	0.7%	0.7%	0.7%	0.7%	0.7%	0.7%	0.7%	0.7%
n Hybrid Electric es (PHEVs)	0.0%	0.0%	0.0%	0.0%	0.0%	0.0%	0.0%	0.0%	0.0%
ated Electric Vehicles	0.0%	0.0%	0.0%	0.0%	0.0%	0.0%	0.0%	0.0%	0.0%
Cell Vehicles (FCVs)	0.0%	0.0%	0.0%	0.0%	0.0%	0.0%	0.0%	0.0%	0.0%

*** EO 12866 Review – Draft – Do Not Cite, Quote or Release During Review ***

TABLE 6-97 - IMPACTS ON FUEL ECONOMY, REGULATORY COST, AVERAGE PRICE, TECHNOLOGY USE FOR ALL LIGHT-DUTY VEHICLES PRODUCED BY SUBARU, CAFE PROGRAM

	Alternative								
	No Action	1	2	3	4	5	6	7	8
Model Years	2021-2025	2021-2026	2021-2026	2021-2026	2021-2026	2022-2026	2021-2026	2021-2026	2022-2026
Annual Rate of Stringency Increase	MY 2017-2021 Final MY 2022-2025 Augural	0.0%/Year PC 0.0%/Year LT	0.5%/Year PC 0.5%/Year LT	0.5%/Year PC 0.5%/Year LT	1.0%/Year PC 2.0%/Year LT	1.0%/Year PC 2.0%/Year LT	2.0%/Year PC 3.0%/Year LT	2.0%/Year PC 3.0%/Year LT	2.0%/Year PC 3.0%/Year LT
Off-Cycle Procedures	No Change	No Change	No Change	Phaseout 2022-2026	No Change	No Change	No Change	Phaseout 2022-2026	No Change
Fuel Economy									
Change Required Fuel Economy - MY 2026+ (mpg)	48.9	38.4	39.6	39.6	42.6	44.5	45.3	45.3	46.8
Percent Change in Stringency Baseline	0.0%	-27.3%	-23.6%	-23.6%	-14.8%	-9.9%	-8.1%	-8.1%	-4.6%
Change Achieved Fuel Economy - MY 2030 (mpg)	49.5	43.4	43.1	43.1	45.3	46.4	46.4	47.8	47.3
Regulatory Costs through MY 2029 Vehicles									
Technology Costs (\$b)	11.9	-6.5	-6.5	-6.2	-5.6	-4.0	-3.4	-2.3	-2.7
Civil Penalties (\$b)	0.0	0.0	0.0	0.0	0.0	0.0	0.0	0.0	0.0
Regulatory Costs (\$b)	11.9	-6.5	-6.5	-6.2	-5.6	-4.0	-3.4	-2.3	-2.7
Average Price Increase for MY 2030 Vehicles									
Increase due to New E Standards (\$)	1594	-935	-955	-897	-753	-532	-443	-124	-379
Technology Use under Alternative in MY (total fleet penetration)									
Weight Change (percent MY 2016)	7.4%	3.2%	3.7%	5.0%	4.9%	7.4%	7.4%	7.4%	7.4%
Compression Ratio Non-Charged Gasoline Engines	0.0%	0.0%	0.0%	0.0%	0.0%	0.0%	0.0%	0.0%	0.0%
Electric Cylinder Ignition	0.0%	0.0%	0.0%	0.0%	0.0%	0.0%	0.0%	0.0%	0.0%
Start 12V (Non-Hybrid)	0.0%	10.7%	10.6%	10.6%	10.4%	17.3%	17.1%	14.1%	0.8%
Hybrid Electric Systems	9.1%	0.0%	0.0%	0.0%	0.0%	3.0%	2.9%	5.7%	19.0%

*** EO 12866 Review – Draft – Do Not Cite, Quote or Release During Review ***

g Hybrid Electric ms	11.1%	0.5%	0.5%	0.5%	0.5%	0.5%	0.5%	0.5%	0.5%
In Hybrid Electric les (PHEVs)	0.0%	0.0%	0.0%	0.0%	0.0%	0.0%	0.0%	0.0%	0.0%
ated Electric Vehicles	0.0%	0.0%	0.0%	0.0%	0.0%	0.0%	0.0%	0.0%	0.0%
Cell Vehicles (FCVs)	0.0%	0.0%	0.0%	0.0%	0.0%	0.0%	0.0%	0.0%	0.0%

*** EO 12866 Review – Draft – Do Not Cite, Quote or Release During Review ***

TABLE 6-98 - IMPACTS ON FUEL ECONOMY, REGULATORY COST, AVERAGE PRICE, AND TECHNOLOGY USE FOR PASSENGER CARS PRODUCED BY TESLA, CAFE PROGRAM

	Alternative								
	No Action	1	2	3	4	5	6	7	8
Model Years	2021-2025	2021-2026	2021-2026	2021-2026	2021-2026	2022-2026	2021-2026	2021-2026	2022-2026
Annual Rate of Stringency Increase	MY 2017-2021 Final MY 2022-2025 Augural	0.0%/Year PC 0.0%/Year LT	0.5%/Year PC 0.5%/Year LT	0.5%/Year PC 0.5%/Year LT	1.0%/Year PC 2.0%/Year LT	1.0%/Year PC 2.0%/Year LT	2.0%/Year PC 3.0%/Year LT	2.0%/Year PC 3.0%/Year LT	2.0%/Year PC 3.0%/Year LT
Off-Cycle Procedures	No Change	No Change	No Change	Phaseout 2022-2026	No Change	No Change	No Change	Phaseout 2022-2026	No Change
Fuel Economy									
Average Required Fuel Economy - MY 2026+ (mpg)	50.3	40.2	41.4	41.4	42.7	44.0	45.3	45.3	46.3
Percent Change in Stringency from Baseline	0.0%	-25.1%	-21.5%	-21.5%	-17.8%	-14.3%	-11.0%	-11.0%	-8.6%
Average Achieved Fuel Economy - MY 2030 (mpg)	287.9	287.9	287.9	237.2	287.9	287.9	287.9	237.2	287.9
Regulatory Costs through MY 2029 Vehicles									
Technology Costs (\$b)	0.0	0.0	0.0	0.0	0.0	0.0	0.0	0.0	0.0
Civil Penalties (\$b)	0.0	0.0	0.0	0.0	0.0	0.0	0.0	0.0	0.0
Regulatory Costs (\$b)	0.0	0.0	0.0	0.0	0.0	0.0	0.0	0.0	0.0
Average Price Increase for MY 2030 Vehicles									
Price Increase due to New Standards (\$)	2	0	0	0	0	0	0	0	0
Technology Use under Alternative in MY 2030 (total fleet penetration)									
Weight Reduction Percent change from MY 2017	0.0%	0.0%	0.0%	0.0%	0.0%	0.0%	0.0%	0.0%	0.0%
Compression Ratio Non-Engines	0.0%	0.0%	0.0%	0.0%	0.0%	0.0%	0.0%	0.0%	0.0%
Charged Gasoline Engines	0.0%	0.0%	0.0%	0.0%	0.0%	0.0%	0.0%	0.0%	0.0%
Electric Cylinder Ignition	0.0%	0.0%	0.0%	0.0%	0.0%	0.0%	0.0%	0.0%	0.0%
Start 12V (Non-Hybrid)	0.0%	0.0%	0.0%	0.0%	0.0%	0.0%	0.0%	0.0%	0.0%
Hybrid Electric Systems	0.0%	0.0%	0.0%	0.0%	0.0%	0.0%	0.0%	0.0%	0.0%

*** EO 12866 Review – Draft – Do Not Cite, Quote or Release During Review ***

Hybrid Electric ns	0.0%	0.0%	0.0%	0.0%	0.0%	0.0%	0.0%	0.0%	0.0%
n Hybrid Electric les (PHEVs)	0.0%	0.0%	0.0%	0.0%	0.0%	0.0%	0.0%	0.0%	0.0%
ated Electric Vehicles	100.0%	100.0%	100.0%	100.0%	100.0%	100.0%	100.0%	100.0%	100.0%
Cell Vehicles (FCVs)	0.0%	0.0%	0.0%	0.0%	0.0%	0.0%	0.0%	0.0%	0.0%

*** EO 12866 Review – Draft – Do Not Cite, Quote or Release During Review ***

TABLE 6-99 - IMPACTS ON FUEL ECONOMY, REGULATORY COST, AVERAGE PRICE, AND TECHNOLOGY USE FOR LIGHT TRUCKS PRODUCED BY TESLA, CAFE PROGRAM

	Alternative								
	No Action	1	2	3	4	5	6	7	8
Model Years	2021-2025	2021-2026	2021-2026	2021-2026	2021-2026	2022-2026	2021-2026	2021-2026	2022-2026
Annual Rate of Stringency Increase	MY 2017-2021 Final MY 2022-2025 Augural	0.0%/Year PC 0.0%/Year LT	0.5%/Year PC 0.5%/Year LT	0.5%/Year PC 0.5%/Year LT	1.0%/Year PC 2.0%/Year LT	1.0%/Year PC 2.0%/Year LT	2.0%/Year PC 3.0%/Year LT	2.0%/Year PC 3.0%/Year LT	2.0%/Year PC 3.0%/Year LT
Off-Cycle Procedures	No Change	No Change	No Change	Phaseout 2022-2026	No Change	No Change	No Change	Phaseout 2022-2026	No Change
Fuel Economy									
Weighted Average Required Fuel Economy - MY 2026+ (mpg)	39.4	30.6	31.6	31.6	34.6	36.2	36.8	36.8	38.1
Percent Change in Stringency from Baseline	0.0%	-28.8%	-24.7%	-24.7%	-13.9%	-8.8%	-7.1%	-7.1%	-3.4%
Weighted Average Achieved Fuel Economy - MY 2030 (mpg)	234.5	234.5	234.5	228.4	234.5	234.5	234.5	228.4	234.5
Regulatory Costs through MY 2029 Vehicles									
Advanced Technology Costs (\$b)	0.0	0.0	0.0	0.0	0.0	0.0	0.0	0.0	0.0
Civil Penalties (\$b)	0.0	0.0	0.0	0.0	0.0	0.0	0.0	0.0	0.0
Regulatory Costs (\$b)	0.0	0.0	0.0	0.0	0.0	0.0	0.0	0.0	0.0
Average Price Increase for MY 2030 Vehicles									
Increase due to New Stringency Standards (\$)	6	0	0	0	0	0	0	0	0
Technology Use under Alternative in MY 2030 (total fleet penetration)									
Weight Reduction Percent change from MY 2021	0.0%	0.0%	0.0%	0.0%	0.0%	0.0%	0.0%	0.0%	0.0%
Compression Ratio Non-Hybrid Engines	0.0%	0.0%	0.0%	0.0%	0.0%	0.0%	0.0%	0.0%	0.0%
Recharged Gasoline Engines	0.0%	0.0%	0.0%	0.0%	0.0%	0.0%	0.0%	0.0%	0.0%
Electric Cylinder Ignition	0.0%	0.0%	0.0%	0.0%	0.0%	0.0%	0.0%	0.0%	0.0%
Start 12V (Non-Hybrid)	0.0%	0.0%	0.0%	0.0%	0.0%	0.0%	0.0%	0.0%	0.0%
Hybrid Electric Systems	0.0%	0.0%	0.0%	0.0%	0.0%	0.0%	0.0%	0.0%	0.0%

*** EO 12866 Review – Draft – Do Not Cite, Quote or Release During Review ***

g Hybrid Electric ms	0.0%	0.0%	0.0%	0.0%	0.0%	0.0%	0.0%	0.0%	0.0%
In Hybrid Electric les (PHEVs)	0.0%	0.0%	0.0%	0.0%	0.0%	0.0%	0.0%	0.0%	0.0%
ated Electric Vehicles	100.0%	100.0%	100.0%	100.0%	100.0%	100.0%	100.0%	100.0%	100.0%
Cell Vehicles (FCVs)	0.0%	0.0%	0.0%	0.0%	0.0%	0.0%	0.0%	0.0%	0.0%

*** EO 12866 Review – Draft – Do Not Cite, Quote or Release During Review ***

TABLE 6-100 - IMPACTS ON FUEL ECONOMY, REGULATORY COST, AVERAGE PRICE, TECHNOLOGY USE FOR ALL LIGHT-DUTY VEHICLES PRODUCED BY TESLA, CAFE PROGRAM

	Alternative								
	No Action	1	2	3	4	5	6	7	8
Model Years	2021-2025	2021-2026	2021-2026	2021-2026	2021-2026	2022-2026	2021-2026	2021-2026	2022-2026
Annual Rate of Stringency Increase	MY 2017-2021 Final MY 2022-2025 Augural	0.0%/Year PC 0.0%/Year LT	0.5%/Year PC 0.5%/Year LT	0.5%/Year PC 0.5%/Year LT	1.0%/Year PC 2.0%/Year LT	1.0%/Year PC 2.0%/Year LT	2.0%/Year PC 3.0%/Year LT	2.0%/Year PC 3.0%/Year LT	2.0%/Year PC 3.0%/Year LT
Off-Cycle Procedures	No Change	No Change	No Change	Phaseout 2022-2026	No Change	No Change	No Change	Phaseout 2022-2026	No Change
Fuel Economy									
Average Required Fuel Economy - MY 2026+ (mpg)	44.4	35.2	36.3	36.3	38.5	40.0	40.8	40.8	42.0
Percent Change in Stringency Baseline	0.0%	-26.1%	-22.4%	-22.4%	-15.3%	-11.1%	-8.8%	-8.8%	-5.8%
Average Achieved Fuel Economy - MY 2030 (mpg)	259.6	261.1	261.0	233.1	260.5	260.1	259.9	232.9	259.8
Regulatory Costs through MY 2029 Vehicles									
Technology Costs (\$b)	0.0	0.0	0.0	0.0	0.0	0.0	0.0	0.0	0.0
Civil Penalties (\$b)	0.0	0.0	0.0	0.0	0.0	0.0	0.0	0.0	0.0
Regulatory Costs (\$b)	0.0	0.0	0.0	0.0	0.0	0.0	0.0	0.0	0.0
Average Price Increase for MY 2030 Vehicles									
Price Increase due to New Standards (\$)	4	0	0	0	0	0	0	0	0
Technology Use under Alternative in MY 2030 (total fleet penetration)									
Weight Change (percent MY 2016)	-0.2%	0.0%	0.0%	0.0%	-0.1%	-0.1%	-0.2%	-0.2%	-0.2%
Compression Ratio Non-Engines	0.0%	0.0%	0.0%	0.0%	0.0%	0.0%	0.0%	0.0%	0.0%
Recharged Gasoline Engines	0.0%	0.0%	0.0%	0.0%	0.0%	0.0%	0.0%	0.0%	0.0%
Electric Cylinder Ignition	0.0%	0.0%	0.0%	0.0%	0.0%	0.0%	0.0%	0.0%	0.0%
Start 12V (Non-Hybrid)	0.0%	0.0%	0.0%	0.0%	0.0%	0.0%	0.0%	0.0%	0.0%
Hybrid Electric Systems	0.0%	0.0%	0.0%	0.0%	0.0%	0.0%	0.0%	0.0%	0.0%
Plug-in Hybrid Electric Systems	0.0%	0.0%	0.0%	0.0%	0.0%	0.0%	0.0%	0.0%	0.0%

*** EO 12866 Review – Draft – Do Not Cite, Quote or Release During Review ***

Plug-in Hybrid Electric Vehicles (PHEVs)	0.0%	0.0%	0.0%	0.0%	0.0%	0.0%	0.0%	0.0%	0.0%
Plug-in Electric Vehicles	100.0%	100.0%	100.0%	100.0%	100.0%	100.0%	100.0%	100.0%	100.0%
Fuel Cell Vehicles (FCVs)	0.0%	0.0%	0.0%	0.0%	0.0%	0.0%	0.0%	0.0%	0.0%

*** EO 12866 Review – Draft – Do Not Cite, Quote or Release During Review ***

TABLE 6-101 - IMPACTS ON FUEL ECONOMY, REGULATORY COST, AVERAGE PRICE, AND TECHNOLOGY USE FOR PASSENGER CARS PRODUCED BY TOYOTA, CAFE PROGRAM

	Alternative								
	No Action	1	2	3	4	5	6	7	8
Model Years	2021-2025	2021-2026	2021-2026	2021-2026	2021-2026	2022-2026	2021-2026	2021-2026	2022-2026
Annual Rate of Stringency Increase	MY 2017-2021 Final MY 2022-2025 Augural	0.0%/Year PC 0.0%/Year LT	0.5%/Year PC 0.5%/Year LT	0.5%/Year PC 0.5%/Year LT	1.0%/Year PC 2.0%/Year LT	1.0%/Year PC 2.0%/Year LT	2.0%/Year PC 3.0%/Year LT	2.0%/Year PC 3.0%/Year LT	2.0%/Year PC 3.0%/Year LT
Off-Cycle Procedures	No Change	No Change	No Change	Phaseout 2022-2026	No Change	No Change	No Change	Phaseout 2022-2026	No Change
Fuel Economy									
Average Required Fuel Economy - MY 2026+ (mpg)	55.4	44.2	45.6	45.5	47.0	48.5	49.9	49.9	51.0
Percent Change in Stringency from Baseline	0.0%	-25.2%	-21.5%	-21.7%	-17.8%	-14.3%	-11.1%	-11.0%	-8.7%
Average Achieved Fuel Economy - MY 2030 (mpg)	55.9	50.4	50.4	48.7	50.9	50.9	52.1	51.4	52.8
Regulatory Costs through MY 2029 Vehicles									
Technology Costs (\$b)	18.9	-8.4	-8.4	-8.4	-7.0	-6.8	-4.5	-3.6	-4.0
Civil Penalties (\$b)	0.0	0.0	0.0	0.0	0.0	0.0	0.0	0.0	0.0
Regulatory Costs (\$b)	18.9	-8.3	-8.3	-8.4	-6.9	-6.8	-4.5	-3.6	-4.0
Average Price Increase for MY 2030 Vehicles									
Price Increase due to New Standards (\$)	1266	-686	-686	-685	-496	-481	-227	-124	-177
Technology Use under Alternative in MY 2030 (total fleet penetration)									
Weight Reduction Percent change from MY 2017	6.3%	5.0%	5.0%	5.0%	6.2%	6.2%	7.2%	7.2%	7.2%
Compression Ratio Non-Engines	84.8%	54.2%	54.2%	54.2%	54.3%	54.4%	54.8%	54.9%	54.9%
Charged Gasoline Engines	11.0%	10.3%	10.3%	10.3%	10.4%	10.4%	14.8%	14.8%	14.8%
Electric Cylinder Activation	0.0%	0.0%	0.0%	0.0%	0.0%	0.0%	0.0%	0.0%	0.0%
Start 12V (Non-Hybrid)	0.8%	0.0%	0.0%	0.0%	0.0%	0.0%	0.0%	0.0%	0.0%
Hybrid Electric Systems	0.0%	0.0%	0.0%	0.0%	0.0%	0.0%	0.0%	0.0%	0.0%

*** EO 12866 Review – Draft – Do Not Cite, Quote or Release During Review ***

Hybrid Electric ns	12.4%	12.6%	12.6%	12.6%	12.5%	12.5%	12.4%	12.4%	12.4%
n Hybrid Electric les (PHEVs)	0.0%	0.0%	0.0%	0.0%	0.0%	0.0%	0.0%	0.0%	0.0%
ated Electric Vehicles	0.0%	0.0%	0.0%	0.0%	0.0%	0.0%	0.0%	0.0%	0.0%
ell Vehicles (FCVs)	0.1%	0.1%	0.1%	0.1%	0.1%	0.1%	0.1%	0.1%	0.1%

*** EO 12866 Review – Draft – Do Not Cite, Quote or Release During Review ***

TABLE 6-102 - IMPACTS ON FUEL ECONOMY, REGULATORY COST, AVERAGE PRICE, AND TECHNOLOGY USE FOR LIGHT TRUCKS PRODUCED BY TOYOTA, CAFE PROGRAM

	Alternative								
	No Action	1	2	3	4	5	6	7	8
Model Years	2021-2025	2021-2026	2021-2026	2021-2026	2021-2026	2022-2026	2021-2026	2021-2026	2022-2026
Annual Rate of Stringency Increase	MY 2017-2021 Final MY 2022-2025 Augural	0.0%/Year PC 0.0%/Year LT	0.5%/Year PC 0.5%/Year LT	0.5%/Year PC 0.5%/Year LT	1.0%/Year PC 2.0%/Year LT	1.0%/Year PC 2.0%/Year LT	2.0%/Year PC 3.0%/Year LT	2.0%/Year PC 3.0%/Year LT	2.0%/Year PC 3.0%/Year LT
Off-Cycle Procedures	No Change	No Change	No Change	Phaseout 2022-2026	No Change	No Change	No Change	Phaseout 2022-2026	No Change
Fuel Economy									
Weighted Average Required Fuel Economy - MY 2026+ (mpg)	40.9	31.9	32.8	32.8	36.0	37.6	38.3	38.3	39.6
Percent Change in Stringency from Baseline	0.0%	-28.2%	-24.7%	-24.7%	-13.6%	-8.8%	-6.8%	-6.8%	-3.3%
Weighted Average Achieved Fuel Economy - MY 2030 (mpg)	42.0	35.0	35.0	34.0	36.1	37.9	38.8	38.8	40.1
Regulatory Costs through MY 2029 Vehicles									
Advanced Technology Costs (\$b)	45.3	-29.6	-29.5	-29.5	-26.0	-18.1	-15.5	-6.2	-7.4
Civil Penalties (\$b)	0.0	0.1	0.1	0.1	0.1	0.1	0.1	0.0	0.0
Regulatory Costs (\$b)	45.3	-29.5	-29.5	-29.5	-25.9	-18.0	-15.4	-6.2	-7.4
Average Price Increase for MY 2030 Vehicles									
Price Increase due to New Standards (\$)	3379	-2199	-2199	-2199	-1877	-1265	-881	-105	-400
Technology Use under Alternative in MY 2030 (total fleet penetration)									
Weight Reduction Percent change from MY 2017	6.9%	6.0%	6.0%	6.0%	6.9%	6.9%	8.6%	8.6%	7.7%
Compression Ratio Non-Engines	40.9%	40.9%	40.9%	40.9%	40.9%	40.9%	40.9%	40.9%	40.9%
Charged Gasoline Engines	58.5%	41.9%	41.9%	41.9%	41.9%	56.1%	58.5%	58.5%	58.5%
Electric Cylinder Ignition	0.0%	0.0%	0.0%	0.0%	0.0%	0.0%	0.0%	0.0%	0.0%
Start 12V (Non-Hybrid)	0.0%	0.0%	0.0%	0.0%	11.8%	26.6%	21.7%	0.0%	0.0%
Hybrid Electric Systems	35.3%	0.0%	0.0%	0.0%	0.0%	16.6%	22.9%	88.5%	73.8%

*** EO 12866 Review – Draft – Do Not Cite, Quote or Release During Review ***

Hybrid Electric ns	47.7%	5.0%	5.0%	5.0%	5.0%	5.0%	5.0%	10.8%	9.2%
n Hybrid Electric les (PHEVs)	0.0%	0.0%	0.0%	0.0%	0.0%	0.0%	0.0%	0.0%	0.0%
ated Electric Vehicles	0.0%	0.0%	0.0%	0.0%	0.0%	0.0%	0.0%	0.0%	0.0%
Cell Vehicles (FCVs)	0.0%	0.0%	0.0%	0.0%	0.0%	0.0%	0.0%	0.0%	0.0%

*** EO 12866 Review – Draft – Do Not Cite, Quote or Release During Review ***

TABLE 6-103 - IMPACTS ON FUEL ECONOMY, REGULATORY COST, AVERAGE PRICE, TECHNOLOGY USE FOR ALL LIGHT-DUTY VEHICLES PRODUCED BY TOYOTA, CAFE PROGRAM

	Alternative								
	No Action	1	2	3	4	5	6	7	8
Years	2021-2025	2021-2026	2021-2026	2021-2026	2021-2026	2022-2026	2021-2026	2021-2026	2022-2026
Rate of Stringency	MY 2017-2021 Final MY 2022-2025 Augural	0.0%/Year PC 0.0%/Year LT	0.5%/Year PC 0.5%/Year LT	0.5%/Year PC 0.5%/Year LT	1.0%/Year PC 2.0%/Year LT	1.0%/Year PC 2.0%/Year LT	2.0%/Year PC 3.0%/Year LT	2.0%/Year PC 3.0%/Year LT	2.0%/Year PC 3.0%/Year LT
Life-Cycle Procedures	No Change	No Change	No Change	Phaseout 2022-2026	No Change	No Change	No Change	Phaseout 2022-2026	No Change
Fuel Economy									
Required Fuel Economy - MY 2026+ (mpg)	47.6	37.8	38.9	38.9	41.3	42.9	43.8	43.8	45.0
Change in Stringency Baseline	0.0%	-25.9%	-22.3%	-22.5%	-15.1%	-11.1%	-8.6%	-8.7%	-5.7%
Achieved Fuel Economy - MY 2030 (mpg)	48.5	42.2	42.2	40.9	43.0	44.1	45.0	44.8	46.1
Regulatory Costs for MY 2029 Vehicles									
Technology Costs (\$b)	64.2	-37.9	-37.9	-37.9	-33.0	-24.8	-20.0	-9.8	-11.4
Civil Penalties (\$b)	0.0	0.1	0.1	0.1	0.1	0.1	0.1	0.0	0.0
Regulatory Costs (\$b)	64.2	-37.8	-37.8	-37.8	-32.9	-24.8	-19.9	-9.7	-11.4
Average Price Increase for 2030 Vehicles									
Increase due to New Standards (\$)	2240	-1397	-1396	-1394	-1142	-854	-536	-120	-285
Technology Use under Alternative in MY (total fleet penetration)									
Weight Change (percent MY 2016)	5.9%	5.5%	5.5%	5.4%	6.3%	6.1%	7.4%	7.3%	6.8%
Compression Ratio Non-Engines	64.6%	48.4%	48.4%	48.4%	48.3%	48.3%	48.5%	48.5%	48.5%
Charged Gasoline Engines	32.9%	24.1%	24.2%	24.2%	24.4%	31.0%	34.7%	34.8%	34.8%
Electric Cylinder Penetration	0.0%	0.0%	0.0%	0.0%	0.0%	0.0%	0.0%	0.0%	0.0%
Start 12V (Non-Hybrid)	0.4%	0.0%	0.0%	0.0%	5.3%	12.0%	9.9%	0.0%	0.0%
Hybrid Electric Systems	16.2%	0.0%	0.0%	0.0%	0.0%	7.5%	10.4%	40.5%	33.8%

*** EO 12866 Review – Draft – Do Not Cite, Quote or Release During Review ***

Hybrid Electric s	28.7%	9.3%	9.2%	9.2%	9.1%	9.1%	9.0%	11.7%	10.9%
Hybrid Electric s (PHEVs)	0.0%	0.0%	0.0%	0.0%	0.0%	0.0%	0.0%	0.0%	0.0%
ed Electric Vehicles	0.0%	0.0%	0.0%	0.0%	0.0%	0.0%	0.0%	0.0%	0.0%
ell Vehicles (FCVs)	0.0%	0.0%	0.0%	0.0%	0.0%	0.0%	0.0%	0.0%	0.0%

*** EO 12866 Review – Draft – Do Not Cite, Quote or Release During Review ***

TABLE 6-104 - IMPACTS ON FUEL ECONOMY, REGULATORY COST, AVERAGE PRICE, AND TECHNOLOGY USE FOR PASSENGER CARS PRODUCED BY VOLVO, CAFE PROGRAM

	Alternative								
	No Action	1	2	3	4	5	6	7	8
Model Years	2021-2025	2021-2026	2021-2026	2021-2026	2021-2026	2022-2026	2021-2026	2021-2026	2022-2026
Annual Rate of Stringency Increase	MY 2017-2021 Final MY 2022-2025 Augural	0.0%/Year PC 0.0%/Year LT	0.5%/Year PC 0.5%/Year LT	0.5%/Year PC 0.5%/Year LT	1.0%/Year PC 2.0%/Year LT	1.0%/Year PC 2.0%/Year LT	2.0%/Year PC 3.0%/Year LT	2.0%/Year PC 3.0%/Year LT	2.0%/Year PC 3.0%/Year LT
Off-Cycle Procedures	No Change	No Change	No Change	Phaseout 2022-2026	No Change	No Change	No Change	Phaseout 2022-2026	No Change
Fuel Economy									
Weighted Average Required Fuel Economy - MY 2026+ (mpg)	53.0	42.4	43.7	43.7	45.0	46.5	47.8	47.8	48.9
Percent Change in Stringency from Baseline	0.0%	-25.0%	-21.3%	-21.3%	-17.8%	-14.0%	-10.9%	-10.9%	-8.4%
Weighted Average Achieved Fuel Economy - MY 2030 (mpg)	41.5	41.6	41.6	40.6	41.5	41.5	41.5	40.5	41.5
Regulatory Costs through MY 2029 Vehicles									
Advanced Technology Costs (\$b)	0.1	0.0	0.0	0.0	0.0	0.0	0.0	0.0	0.0
Civil Penalties (\$b)	0.2	-0.1	-0.1	-0.1	-0.1	-0.1	-0.1	-0.1	-0.1
Regulatory Costs (\$b)	0.3	-0.1	-0.1	-0.1	-0.1	-0.1	-0.1	-0.1	-0.1
Average Price Increase for MY 2030 Vehicles									
Price Increase due to New Standards (\$)	912	-496	-463	-416	-384	-307	-247	-194	-191
Technology Use under Alternative in MY 2030 (total fleet penetration)									
Weight Reduction Percent change from MY 2017	4.8%	5.0%	5.0%	5.0%	4.9%	4.9%	4.8%	4.8%	4.8%
Compression Ratio Non-Engines	0.0%	0.0%	0.0%	0.0%	0.0%	0.0%	0.0%	0.0%	0.0%
Charged Gasoline Engines	100.0%	100.0%	100.0%	100.0%	100.0%	100.0%	100.0%	100.0%	100.0%
At Least One Electric Cylinder Ignition	0.0%	0.0%	0.0%	0.0%	0.0%	0.0%	0.0%	0.0%	0.0%
Start 12V (Non-Hybrid)	84.0%	83.4%	83.4%	83.5%	83.6%	83.8%	83.9%	83.9%	83.9%
Hybrid Electric Systems	0.0%	0.0%	0.0%	0.0%	0.0%	0.0%	0.0%	0.0%	0.0%

*** EO 12866 Review – Draft – Do Not Cite, Quote or Release During Review ***

Hybrid Electric ns	0.0%	0.0%	0.0%	0.0%	0.0%	0.0%	0.0%	0.0%	0.0%
n Hybrid Electric les (PHEVs)	0.0%	0.0%	0.0%	0.0%	0.0%	0.0%	0.0%	0.0%	0.0%
ated Electric Vehicles	0.0%	0.0%	0.0%	0.0%	0.0%	0.0%	0.0%	0.0%	0.0%
Cell Vehicles (FCVs)	0.0%	0.0%	0.0%	0.0%	0.0%	0.0%	0.0%	0.0%	0.0%

*** EO 12866 Review – Draft – Do Not Cite, Quote or Release During Review ***

TABLE 6-105 - IMPACTS ON FUEL ECONOMY, REGULATORY COST, AVERAGE PRICE, AND TECHNOLOGY USE FOR LIGHT TRUCKS PRODUCED BY VOLVO, CAFE PROGRAM

	Alternative								
	No Action	1	2	3	4	5	6	7	8
Model Years	2021-2025	2021-2026	2021-2026	2021-2026	2021-2026	2022-2026	2021-2026	2021-2026	2022-2026
Annual Rate of Stringency Increase	MY 2017-2021 Final MY 2022-2025 Augural	0.0%/Year PC 0.0%/Year LT	0.5%/Year PC 0.5%/Year LT	0.5%/Year PC 0.5%/Year LT	1.0%/Year PC 2.0%/Year LT	1.0%/Year PC 2.0%/Year LT	2.0%/Year PC 3.0%/Year LT	2.0%/Year PC 3.0%/Year LT	2.0%/Year PC 3.0%/Year LT
Off-Cycle Procedures	No Change	No Change	No Change	Phaseout 2022-2026	No Change	No Change	No Change	Phaseout 2022-2026	No Change
Fuel Economy									
Weighted Average Required Fuel Economy - MY 2026+ (mpg)	41.6	32.4	33.4	33.4	36.5	38.2	38.8	38.8	40.2
Percent Change in Stringency from Baseline	0.0%	-28.4%	-24.6%	-24.6%	-14.0%	-8.9%	-7.2%	-7.2%	-3.5%
Weighted Average Achieved Fuel Economy - MY 2030 (mpg)	34.2	33.9	33.9	33.2	34.2	34.2	34.2	33.2	34.2
Regulatory Costs through MY 2029 Vehicles									
Advanced Technology Costs (\$b)	0.2	0.0	0.0	0.0	0.0	0.0	0.0	0.0	0.0
Civil Penalties (\$b)	0.2	-0.2	-0.2	-0.2	-0.1	-0.1	-0.1	-0.1	0.0
Regulatory Costs (\$b)	0.4	-0.2	-0.2	-0.2	-0.1	-0.1	-0.1	-0.1	0.0
Average Price Increase for MY 2030 Vehicles									
Price Increase due to New Standards (\$)	647	-388	-372	-341	-241	-163	-134	-97	-69
Technology Use under Alternative in MY 2030 (total fleet penetration)									
Weight Reduction Percent change from MY 2017	1.6%	1.9%	1.8%	1.8%	1.8%	1.7%	1.7%	1.7%	1.7%
Compression Ratio Non-Engines	0.0%	0.0%	0.0%	0.0%	0.0%	0.0%	0.0%	0.0%	0.0%
Charged Gasoline Engines	100.0%	100.0%	100.0%	100.0%	100.0%	100.0%	100.0%	100.0%	100.0%
Electric Cylinder Ignition	0.0%	0.0%	0.0%	0.0%	0.0%	0.0%	0.0%	0.0%	0.0%
Start 12V (Non-Hybrid)	63.8%	62.7%	62.8%	62.9%	63.2%	63.4%	63.6%	63.7%	63.7%
Hybrid Electric Systems	0.0%	0.0%	0.0%	0.0%	0.0%	0.0%	0.0%	0.0%	0.0%

*** EO 12866 Review – Draft – Do Not Cite, Quote or Release During Review ***

Hybrid Electric ns	0.0%	0.0%	0.0%	0.0%	0.0%	0.0%	0.0%	0.0%	0.0%
n Hybrid Electric les (PHEVs)	3.9%	3.8%	3.8%	3.8%	3.8%	3.9%	3.9%	3.9%	3.9%
ated Electric Vehicles	0.0%	0.0%	0.0%	0.0%	0.0%	0.0%	0.0%	0.0%	0.0%
Cell Vehicles (FCVs)	0.0%	0.0%	0.0%	0.0%	0.0%	0.0%	0.0%	0.0%	0.0%

*** EO 12866 Review – Draft – Do Not Cite, Quote or Release During Review ***

TABLE 6-106 - IMPACTS ON FUEL ECONOMY, REGULATORY COST, AVERAGE PRICE, AND TECHNOLOGY USE FOR ALL LIGHT-DUTY VEHICLES PRODUCED BY VOLVO, CAFE PROGRAM

	Alternative								
	No Action	1	2	3	4	5	6	7	8
Model Years	2021-2025	2021-2026	2021-2026	2021-2026	2021-2026	2022-2026	2021-2026	2021-2026	2022-2026
Annual Rate of Stringency Increase	MY 2017-2021 Final MY 2022-2025 Augural	0.0%/Year PC 0.0%/Year LT	0.5%/Year PC 0.5%/Year LT	0.5%/Year PC 0.5%/Year LT	1.0%/Year PC 2.0%/Year LT	1.0%/Year PC 2.0%/Year LT	2.0%/Year PC 3.0%/Year LT	2.0%/Year PC 3.0%/Year LT	2.0%/Year PC 3.0%/Year LT
Off-Cycle Procedures	No Change	No Change	No Change	Phaseout 2022-2026	No Change	No Change	No Change	Phaseout 2022-2026	No Change
Fuel Economy									
Average Required Fuel Economy - MY 2026+ (mpg)	44.9	35.4	36.5	36.5	39.1	40.7	41.5	41.5	42.8
Percent Change in Stringency Baseline	0.0%	-27.0%	-23.2%	-23.3%	-14.9%	-10.3%	-8.2%	-8.3%	-4.9%
Average Achieved Fuel Economy - MY 2030 (mpg)	36.4	36.3	36.3	35.5	36.4	36.4	36.4	35.4	36.4
Regulatory Costs through MY 2029 Vehicles									
Technology Costs (\$b)	0.3	0.0	0.0	0.0	0.0	0.0	0.0	0.0	0.0
Civil Penalties (\$b)	0.4	-0.3	-0.3	-0.3	-0.2	-0.2	-0.2	-0.1	-0.1
Regulatory Costs (\$b)	0.7	-0.4	-0.3	-0.3	-0.2	-0.2	-0.2	-0.1	-0.1
Average Price Increase for MY 2030 Vehicles									
Price Increase due to New Standards (\$)	738	-423	-401	-365	-289	-212	-172	-130	-111
Technology Use under Alternative in MY 2030 (total fleet penetration)									
Weight Change (percent MY 2016)	2.4%	2.9%	2.8%	2.8%	2.7%	2.6%	2.5%	2.4%	2.4%
Compression Ratio Non-Engines	0.0%	0.0%	0.0%	0.0%	0.0%	0.0%	0.0%	0.0%	0.0%
Charged Gasoline Engines	100.0%	100.0%	100.0%	100.0%	100.0%	100.0%	100.0%	100.0%	100.0%
Electric Cylinder Ignition	0.0%	0.0%	0.0%	0.0%	0.0%	0.0%	0.0%	0.0%	0.0%
Start 12V (Non-Hybrid)	70.8%	70.1%	70.2%	70.2%	70.4%	70.6%	70.6%	70.7%	70.7%
Hybrid Electric Systems	0.0%	0.0%	0.0%	0.0%	0.0%	0.0%	0.0%	0.0%	0.0%
Plug-In Hybrid Electric Systems	0.0%	0.0%	0.0%	0.0%	0.0%	0.0%	0.0%	0.0%	0.0%

*** EO 12866 Review – Draft – Do Not Cite, Quote or Release During Review ***

Plug-in Hybrid Electric Vehicles (PHEVs)	2.5%	2.4%	2.5%	2.5%	2.5%	2.5%	2.5%	2.5%	2.5%
Plug-in Electric Vehicles	0.0%	0.0%	0.0%	0.0%	0.0%	0.0%	0.0%	0.0%	0.0%
Fuel Cell Vehicles (FCVs)	0.0%	0.0%	0.0%	0.0%	0.0%	0.0%	0.0%	0.0%	0.0%

*** EO 12866 Review – Draft – Do Not Cite, Quote or Release During Review ***

TABLE 6-107 - IMPACTS ON FUEL ECONOMY, REGULATORY COST, AVERAGE PRICE, AND TECHNOLOGY USE FOR PASSENGER CARS PRODUCED BY VOLKSWAGEN GROUP, CAFE PROGRAM

	Alternative								
	No Action	1	2	3	4	5	6	7	8
Time Period	2021-2025	2021-2026	2021-2026	2021-2026	2021-2026	2022-2026	2021-2026	2021-2026	2022-2026
Annual Rate of Stringency Increase	MY 2017-2021 Final MY 2022-2025 Augural	0.0%/Year PC 0.0%/Year LT	0.5%/Year PC 0.5%/Year LT	0.5%/Year PC 0.5%/Year LT	1.0%/Year PC 2.0%/Year LT	1.0%/Year PC 2.0%/Year LT	2.0%/Year PC 3.0%/Year LT	2.0%/Year PC 3.0%/Year LT	2.0%/Year PC 3.0%/Year LT
Phaseout Cycle Procedures	No Change	No Change	No Change	Phaseout 2022-2026	No Change	No Change	No Change	Phaseout 2022-2026	No Change
Fuel Economy									
Average Required Fuel Economy - MY 2026+ (mpg)	55.9	44.6	46.0	46.0	47.4	49.0	50.4	50.4	51.5
Percent Change in Stringency from Baseline	0.0%	-25.2%	-21.5%	-21.5%	-17.9%	-14.1%	-10.9%	-10.9%	-8.5%
Average Achieved Fuel Economy - MY 2030 (mpg)	56.5	46.1	46.6	46.9	48.2	49.5	50.8	50.7	51.9
Regulatory Costs for MY 2029 Vehicles									
Technology Costs (\$b)	23.1	-14.3	-12.6	-10.9	-10.5	-7.2	-7.5	-5.2	-4.5
Civil Penalties (\$b)	0.0	0.0	0.0	0.0	0.0	0.0	0.0	0.0	0.0
Regulatory Costs (\$b)	23.1	-14.3	-12.6	-10.9	-10.5	-7.2	-7.5	-5.2	-4.5
Average Price Increase for MY 2030 Vehicles									
Price Increase due to New Standards (\$)	4083	-2808	-2522	-1975	-1945	-1537	-1248	-722	-832
Technology Use under Alternative in MY (total fleet penetration)									
Weight Reduction Percent change from MY	9.9%	7.4%	7.4%	10.0%	9.9%	9.9%	9.9%	9.9%	9.9%
Compression Ratio Non-Engines	0.0%	0.0%	0.0%	0.0%	0.0%	0.0%	0.0%	0.0%	0.0%
Charged Gasoline Engines	89.1%	97.9%	98.1%	98.1%	98.1%	98.1%	98.1%	97.2%	98.1%
Electric Cylinder Penetration	0.0%	0.0%	0.0%	0.0%	0.0%	0.0%	0.0%	0.0%	0.0%
Start 12V (Non-Hybrid)	0.0%	54.8%	55.2%	62.2%	46.9%	4.1%	0.0%	0.0%	0.0%
Hybrid Electric Systems	25.7%	7.9%	7.9%	10.6%	16.4%	59.9%	53.1%	9.4%	19.3%

*** EO 12866 Review – Draft – Do Not Cite, Quote or Release During Review ***

Hybrid Electric ns	55.6%	0.2%	0.2%	0.2%	0.2%	3.5%	20.1%	62.9%	53.9%
n Hybrid Electric les (PHEVs)	9.0%	0.9%	0.9%	0.9%	0.9%	0.9%	0.9%	1.8%	0.9%
ated Electric Vehicles	1.5%	1.5%	1.5%	1.5%	1.5%	1.5%	1.5%	1.5%	1.5%
Cell Vehicles (FCVs)	0.0%	0.0%	0.0%	0.0%	0.0%	0.0%	0.0%	0.0%	0.0%

*** EO 12866 Review – Draft – Do Not Cite, Quote or Release During Review ***

TABLE 6-108 - IMPACTS ON FUEL ECONOMY, REGULATORY COST, AVERAGE PRICE, TECHNOLOGY USE FOR LIGHT TRUCKS PRODUCED BY VOLKSWAGEN GROUP, CAFE PROGRAM

	Alternative								
	No Action	1	2	3	4	5	6	7	8
Time Period	2021-2025	2021-2026	2021-2026	2021-2026	2021-2026	2022-2026	2021-2026	2021-2026	2022-2026
Annual Rate of Stringency Increase	MY 2017-2021 Final MY 2022-2025 Augural	0.0%/Year PC 0.0%/Year LT	0.5%/Year PC 0.5%/Year LT	0.5%/Year PC 0.5%/Year LT	1.0%/Year PC 2.0%/Year LT	1.0%/Year PC 2.0%/Year LT	2.0%/Year PC 3.0%/Year LT	2.0%/Year PC 3.0%/Year LT	2.0%/Year PC 3.0%/Year LT
Phaseout Cycle Procedures	No Change	No Change	No Change	Phaseout 2022-2026	No Change	No Change	No Change	Phaseout 2022-2026	No Change
Fuel Economy									
Average Required Fuel Economy - MY 2026+ (mpg)	43.5	33.8	34.8	34.8	38.1	39.9	40.5	40.5	42.0
Percent Change in Stringency Baseline	0.0%	-28.7%	-25.0%	-25.0%	-14.2%	-9.0%	-7.4%	-7.4%	-3.6%
Average Achieved Fuel Economy - MY 2030 (mpg)	51.4	35.2	35.3	35.5	38.2	40.2	41.7	40.7	42.1
Regulatory Costs for Light MY 2029 Vehicles									
Technology Costs (\$b)	9.5	-7.8	-7.4	-7.1	-6.3	-4.9	-4.2	-3.8	-3.5
Civil Penalties (\$b)	0.0	0.0	0.0	0.0	0.0	0.0	0.0	0.0	0.0
Regulatory Costs (\$b)	9.5	-7.8	-7.4	-7.1	-6.3	-4.9	-4.2	-3.8	-3.5
Average Price Increase for MY 2030 Vehicles									
Price Increase due to New Standards (\$)	5678	-4826	-4647	-4186	-3708	-2846	-2250	-1817	-2026
Technology Use under Alternative in MY (total fleet penetration)									
Weight Reduction Percent change from MY	9.3%	6.8%	6.8%	8.5%	10.0%	10.0%	10.0%	10.0%	10.0%
Compression Ratio Non-Engines	0.0%	0.0%	0.0%	0.0%	0.0%	0.0%	0.0%	0.0%	0.0%
Charged Gasoline Engines	58.6%	93.2%	93.2%	93.2%	93.2%	93.2%	93.2%	93.2%	93.2%
Electric Cylinder Activation	0.0%	0.0%	0.0%	0.0%	0.0%	0.0%	0.0%	0.0%	0.0%
Start 12V (Non-Hybrid)	0.0%	35.0%	35.0%	35.0%	0.0%	0.0%	0.0%	0.0%	0.0%
Hybrid Electric Systems	6.8%	0.0%	0.0%	0.0%	35.0%	98.2%	47.2%	18.1%	33.9%

*** EO 12866 Review – Draft – Do Not Cite, Quote or Release During Review ***

Hybrid Electric ns	58.6%	0.0%	0.0%	0.0%	0.0%	0.0%	51.0%	80.1%	64.3%
n Hybrid Electric les (PHEVs)	34.6%	1.8%	1.8%	1.8%	1.8%	1.8%	1.8%	1.8%	1.8%
ated Electric Vehicles	0.0%	0.0%	0.0%	0.0%	0.0%	0.0%	0.0%	0.0%	0.0%
ell Vehicles (FCVs)	0.0%	0.0%	0.0%	0.0%	0.0%	0.0%	0.0%	0.0%	0.0%

*** EO 12866 Review – Draft – Do Not Cite, Quote or Release During Review ***

TABLE 6-109 - IMPACTS ON FUEL ECONOMY, REGULATORY COST, AVERAGE PRICE, AND TECHNOLOGY USE FOR ALL LIGHT-DUTY VEHICLES PRODUCED BY VOLKSWAGEN GROUP, CAFE PROGRAM

	Alternative								
	No Action	1	2	3	4	5	6	7	8
Years	2021-2025	2021-2026	2021-2026	2021-2026	2021-2026	2022-2026	2021-2026	2021-2026	2022-2026
Annual Rate of Stringency Increase	MY 2017-2021 Final MY 2022-2025 Augural	0.0%/Year PC 0.0%/Year LT	0.5%/Year PC 0.5%/Year LT	0.5%/Year PC 0.5%/Year LT	1.0%/Year PC 2.0%/Year LT	1.0%/Year PC 2.0%/Year LT	2.0%/Year PC 3.0%/Year LT	2.0%/Year PC 3.0%/Year LT	2.0%/Year PC 3.0%/Year LT
Off-Cycle Procedures	No Change	No Change	No Change	Phaseout 2022-2026	No Change	No Change	No Change	Phaseout 2022-2026	No Change
Fuel Economy									
Weighted Average Required Fuel Economy - MY 2026+ (mpg)	52.5	41.8	43.1	43.0	45.0	46.6	47.8	47.7	49.0
Percent Change in Stringency from Baseline	0.0%	-25.5%	-21.8%	-21.9%	-16.6%	-12.5%	-9.8%	-9.9%	-7.1%
Weighted Average Achieved Fuel Economy - MY 2030 (mpg)	55.3	43.3	43.6	43.9	45.6	47.1	48.4	48.0	49.3
Regulatory Costs for Light MY 2029 Vehicles									
Advanced Technology Costs (\$b)	32.6	-22.1	-20.0	-18.0	-16.8	-12.1	-11.7	-9.0	-8.0
Civil Penalties (\$b)	0.0	0.0	0.0	0.0	0.0	0.0	0.0	0.0	0.0
Regulatory Costs (\$b)	32.6	-22.1	-20.0	-18.0	-16.8	-12.1	-11.7	-9.0	-8.0
Average Price Increase for MY 2030 Vehicles									
Price Increase due to New Standards (\$)	4447	-3261	-2999	-2471	-2346	-1837	-1479	-973	-1106
Technology Use under Alternative in MY (total fleet penetration)									
Weight Reduction Percent change from MY	9.4%	7.3%	7.2%	9.6%	9.8%	9.7%	9.7%	9.6%	9.6%
Compression Ratio Non-Engines	0.0%	0.0%	0.0%	0.0%	0.0%	0.0%	0.0%	0.0%	0.0%
Charged Gasoline Engines	82.1%	96.9%	97.0%	97.0%	97.0%	97.0%	97.0%	96.3%	97.0%
Electric Cylinder Activation	0.0%	0.0%	0.0%	0.0%	0.0%	0.0%	0.0%	0.0%	0.0%
Start 12V (Non-Hybrid)	0.0%	50.6%	50.9%	56.4%	36.6%	3.2%	0.0%	0.0%	0.0%
Hybrid Electric Systems	21.4%	6.2%	6.2%	8.3%	20.5%	68.4%	51.7%	11.4%	22.6%

*** EO 12866 Review – Draft – Do Not Cite, Quote or Release During Review ***

Hybrid Electric ns	56.3%	0.1%	0.1%	0.1%	0.1%	2.7%	27.0%	66.8%	56.3%
n Hybrid Electric es (PHEVs)	14.9%	1.1%	1.1%	1.1%	1.1%	1.1%	1.1%	1.8%	1.1%
ated Electric Vehicles	1.1%	1.2%	1.2%	1.2%	1.2%	1.2%	1.2%	1.2%	1.2%
Cell Vehicles (FCVs)	0.0%	0.0%	0.0%	0.0%	0.0%	0.0%	0.0%	0.0%	0.0%

*** EO 12866 Review – Draft – Do Not Cite, Quote or Release During Review ***

6.3.2 CO₂ Standards

TABLE 6-110:- COMBINED LIGHT-DUTY CO₂ COMPLIANCE IMPACTS AND CUMULATIVE INDUSTRY COSTS THROUGH MY 2029

Model Year Standards through	MY 2021	MY 2022	MY 2023	MY 2024	MY 2025	MY 2026	TOTAL
Average CO ₂ Emission Rate							
Average Required CO ₂ - MY 2026+ (g/mi)	240.0	240.0	240.0	240.0	240.0	240.0	N/A
Percent Change in Stringency from Baseline	-11.2%	-16.5%	-22.2%	-28.2%	-34.3%	-34.3%	N/A
Average Achieved CO ₂ - MY 2030 (g/mi)	225.8	225.8	225.8	225.8	225.8	225.8	N/A
Total Regulatory Costs through MY 2029 Vehicles (7% discount rate)							
Total Technology Costs (\$b)	-24.2	-29.5	-26.6	-41.6	-33.5	0.0	-155.4
Total Civil Penalties (\$b)	N/A	N/A	N/A	N/A	N/A	N/A	N/A
Total Regulatory Costs (\$b)	-24.2	-29.5	-26.6	-41.6	-33.5	0.0	-155.4
Sales and Revenue Impacts through MY 2029 Vehicles (7% discount rate for Revenue Change)							
Sales Change (millions)	0.1	0.2	0.2	0.2	0.2	0.0	0.8
Revenue Change (\$b)	-23.3	-29.4	-24.5	-38.7	-31.9	0.0	-147.9

TABLE 6-111 - COMBINED LIGHT-DUTY FLEET PENETRATION FOR MY 2030, CO₂ PROGRAM

Model Year Standards through	MY 2021	MY 2022	MY 2023	MY 2024	MY 2025	MY 2026
Technology Use Under CAFE Alternative in MY 2030 (total fleet penetration)						
Curb Weight Reduction (percent change from MY 2016)	4.0%	4.0%	4.0%	4.0%	4.0%	4.0%
High Compression Ratio Non-Turbo Engines	12.4%	12.4%	12.4%	12.4%	12.4%	12.4%
Turbocharged Gasoline Engines	46.2%	46.2%	46.2%	46.2%	46.2%	46.2%
Dynamic Cylinder Deactivation	0.0%	0.0%	0.0%	0.0%	0.0%	0.0%
Advanced Transmissions	93.2%	93.2%	93.2%	93.2%	93.2%	93.2%
Stop-Start 12V (Non-Hybrid)	12.8%	12.8%	12.8%	12.8%	12.8%	12.8%
Mild Hybrid Electric Systems (48v)	2.5%	2.5%	2.5%	2.5%	2.5%	2.5%
Strong Hybrid Electric Systems	2.2%	2.2%	2.2%	2.2%	2.2%	2.2%
Plug-In Hybrid Electric Vehicles (PHEVs)	0.3%	0.3%	0.3%	0.3%	0.3%	0.3%
Dedicated Electric Vehicles (EVs)	0.5%	0.5%	0.5%	0.5%	0.5%	0.5%
Fuel Cell Vehicles (FCVs)	0.0%	0.0%	0.0%	0.0%	0.0%	0.0%

*** EO 12866 Review – Draft – Do Not Cite, Quote or Release During Review ***

TABLE 6-112 - LIGHT TRUCK CO₂ COMPLIANCE IMPACTS AND CUMULATIVE INDUSTRY COSTS THROUGH MY 2029

Model Year Standards through	MY 2021	MY 2022	MY 2023	MY 2024	MY 2025	MY 2026	TOTAL
Average CO ₂ Emission Rate							
Average Required CO ₂ - MY 2026+ (g/mi)	284.0	284.0	284.0	284.0	284.0	284.0	N/A
Percent Change in Stringency from Baseline	-12.3%	-17.8%	-23.5%	-29.7%	-36.5%	-36.5%	N/A
Average Achieved CO ₂ - MY 2030 (g/mi)	266.0	266.0	266.0	266.0	266.0	266.0	N/A
Total Regulatory Costs through MY 2029 Vehicles (7% discount rate)							
Total Technology Costs (\$b)	-12.3	-18.7	-14.2	-22.0	-15.0	0.0	-82.2
Total Civil Penalties (\$b)	N/A	N/A	N/A	N/A	N/A	N/A	N/A
Total Regulatory Costs (\$b)	-12.3	-18.7	-14.2	-22.0	-15.0	0.0	-82.2
Sales and Revenue Impacts through MY 2029 Vehicles (7% discount rate for Revenue Change)							
Sales Change (millions)	-0.3	-0.7	-0.2	-0.1	-0.2	0.0	-1.5
Revenue Change (\$b)	-18.9	-32.3	-17.2	-23.9	-17.8	0.0	-110.0

TABLE 6-113 - LIGHT TRUCK FLEET PENETRATION FOR MY 2030, CO₂ PROGRAM

Model Year Standards through	MY 2021	MY 2022	MY 2023	MY 2024	MY 2025	MY 2026
Technology Use Under CAFE Alternative in MY 2030 (total fleet penetration)						
Curb Weight Reduction (percent change from MY 2016)	4.1%	4.1%	4.1%	4.1%	4.1%	4.1%
High Compression Ratio Non-Turbo Engines	6.3%	6.3%	6.3%	6.3%	6.3%	6.3%
Turbocharged Gasoline Engines	49.6%	49.6%	49.6%	49.6%	49.6%	49.6%
Dynamic Cylinder Deactivation	0.0%	0.0%	0.0%	0.0%	0.0%	0.0%
Advanced Transmissions	98.6%	98.6%	98.6%	98.6%	98.6%	98.6%
Stop-Start 12V (Non-Hybrid)	10.5%	10.5%	10.5%	10.5%	10.5%	10.5%
Mild Hybrid Electric Systems (48v)	2.3%	2.3%	2.3%	2.3%	2.3%	2.3%
Strong Hybrid Electric Systems	0.7%	0.7%	0.7%	0.7%	0.7%	0.7%
Plug-In Hybrid Electric Vehicles (PHEVs)	0.1%	0.1%	0.1%	0.1%	0.1%	0.1%
Dedicated Electric Vehicles (EVs)	0.3%	0.3%	0.3%	0.3%	0.3%	0.3%
Fuel Cell Vehicles (FCVs)	0.0%	0.0%	0.0%	0.0%	0.0%	0.0%

*** EO 12866 Review – Draft – Do Not Cite, Quote or Release During Review ***

TABLE 6-114 - PASSENGER CAR CO₂ COMPLIANCE IMPACTS AND CUMULATIVE INDUSTRY COSTS THROUGH MY 2029

Model Year Standards through	MY 2021	MY 2022	MY 2023	MY 2024	MY 2025	MY 2026	TOTAL
Average CO₂ Emission Rate							
Average Required CO ₂ - MY 2026+ (g/mi)	204.0	204.0	204.0	204.0	204.0	204.0	N/A
Percent Change in Stringency from Baseline	-10.3%	-15.9%	-22.2%	-28.3%	-34.2%	-34.2%	N/A
Average Achieved CO ₂ - MY 2030 (g/mi)	193.0	193.0	193.0	193.0	193.0	193.0	N/A
Total Regulatory Costs through MY 2029 Vehicles (7% discount rate)							
Total Technology Costs (\$b)	-11.9	-10.8	-12.4	-19.6	-18.5	0.0	-73.2
Total Civil Penalties (\$b)	N/A	N/A	N/A	N/A	N/A	N/A	N/A
Total Regulatory Costs (\$b)	-11.9	-10.8	-12.4	-19.6	-18.5	0.0	-73.2
Sales and Revenue Impacts through MY 2029 Vehicles (7% discount rate for Revenue Change)							
Sales Change (millions)	0.5	0.9	0.3	0.3	0.3	0.0	2.3
Revenue Change (\$b)	-4.3	2.8	-7.4	-14.9	-14.1	0.0	-37.9

TABLE 6-115 - PASSENGER CAR FLEET PENETRATION FOR MY 2030, CO₂ PROGRAM

Model Year Standards through	MY 2021	MY 2022	MY 2023	MY 2024	MY 2025	MY 2026
Technology Use Under CAFE Alternative in MY 2030 (total fleet penetration)						
Curb Weight Reduction (percent change from MY 2016)	3.6%	3.6%	3.6%	3.6%	3.6%	3.6%
High Compression Ratio Non-Turbo Engines	17.4%	17.4%	17.4%	17.4%	17.4%	17.4%
Turbocharged Gasoline Engines	43.4%	43.4%	43.4%	43.4%	43.4%	43.4%
Dynamic Cylinder Deactivation	0.0%	0.0%	0.0%	0.0%	0.0%	0.0%
Advanced Transmissions	88.9%	88.9%	88.9%	88.9%	88.9%	88.9%
Stop-Start 12V (Non-Hybrid)	14.7%	14.7%	14.7%	14.7%	14.7%	14.7%
Mild Hybrid Electric Systems (48v)	2.6%	2.6%	2.6%	2.6%	2.6%	2.6%
Strong Hybrid Electric Systems	3.5%	3.5%	3.5%	3.5%	3.5%	3.5%
Plug-In Hybrid Electric Vehicles (PHEVs)	0.5%	0.5%	0.5%	0.5%	0.5%	0.5%
Dedicated Electric Vehicles (EVs)	0.7%	0.7%	0.7%	0.7%	0.7%	0.7%
Fuel Cell Vehicles (FCVs)	0.0%	0.0%	0.0%	0.0%	0.0%	0.0%

*** EO 12866 Review – Draft – Do Not Cite, Quote or Release During Review ***

TABLE 6-116 - IMPACTS ON CARBON DIOXIDE EMISSIONS, REGULATORY COST, AVERAGE PRICE, AND TECHNOLOGY USE FOR PASSENGER CAR FLEET, CO2 PROGRAM

	Alternative								
	No Action	1	2	3	4	5	6	7	8
Model Years	2021-2025	2021-2026	2021-2026	2021-2026	2021-2026	2022-2026	2021-2026	2021-2026	2022-2026
Annual Rate of Stringency Increase	MY 2017-2021 Final MY 2022-2025 Augural	0.0%/Year PC 0.0%/Year LT	0.5%/Year PC 0.5%/Year LT	0.5%/Year PC 0.5%/Year LT	1.0%/Year PC 2.0%/Year LT	1.0%/Year PC 2.0%/Year LT	2.0%/Year PC 3.0%/Year LT	2.0%/Year PC 3.0%/Year LT	2.0%/Year PC 3.0%/Year LT
AC/Off-Cycle Procedures	No Change	No Change	No Change	Phaseout 2022-2026	No Change	No Change	No Change	Phaseout 2022-2026	No Change
Average CO₂ Emission Rate									
Average Required CO ₂ - MY 2026+ (g/mi)	152.0	204.0	198.0	198.0	192.0	186.0	180.0	180.0	176.0
Percent Change in Stringency from Baseline	0.0%	-34.2%	-30.3%	-30.3%	-26.3%	-22.4%	-18.4%	-18.4%	-15.8%
Average Achieved CO ₂ - MY 2030 (g/mi)	150.0	193.0	192.0	194.0	186.0	181.0	178.0	179.0	174.0
Total Regulatory Costs through MY 2029 Vehicles									
Total Technology Costs (\$b)	209.8	-138.7	-133.4	-124.7	-116.3	-87.9	-82.2	-55.8	-56.9
Total Civil Penalties (\$b)	0.0	0.0	0.0	0.0	0.0	0.0	0.0	0.0	0.0
Total Regulatory Costs (\$b)	209.8	-138.7	-133.4	-124.7	-116.3	-87.9	-82.2	-55.8	-56.9
Average Price Increase for MY 2030 Vehicles									
Price Increase due to New CAFE Standards (\$)	2237	-1633	-1586	-1455	-1325	-1094	-887	-528	-641
Technology Use under CAFE Alternative in MY 2030 (total fleet penetration)									

*** EO 12866 Review – Draft – Do Not Cite, Quote or Release During Review ***

Curb Weight Reduction (percent change from MY 2016)	6.7%	3.6%	3.6%	4.3%	4.5%	5.1%	5.9%	6.1%	6.3%
High Compression Ratio Non-Turbo Engines	38.9%	17.4%	17.4%	23.8%	23.9%	28.3%	28.3%	29.2%	28.3%
Turbocharged Gasoline Engines	57.8%	43.4%	45.8%	46.0%	49.8%	52.4%	53.6%	56.8%	58.5%
Dynamic Cylinder Deactivation	0.5%	0.0%	0.0%	0.0%	0.0%	0.0%	0.0%	0.7%	0.0%
Stop-Start 12V (Non-Hybrid)	10.4%	14.7%	14.1%	14.1%	14.7%	10.4%	7.0%	7.1%	13.2%
Mild Hybrid Electric Systems (48v)	23.4%	2.6%	3.1%	3.1%	3.6%	8.4%	13.5%	15.1%	11.0%
Strong Hybrid Electric Systems	19.9%	3.5%	3.8%	3.8%	4.1%	5.5%	4.8%	12.0%	8.1%
Plug-In Hybrid Electric Vehicles (PHEVs)	0.6%	0.5%	0.5%	0.5%	0.5%	0.5%	0.5%	0.5%	0.5%
Dedicated Electric Vehicles (EVs)	0.7%	0.7%	0.7%	0.7%	0.7%	0.7%	0.7%	0.7%	0.7%
Fuel Cell Vehicles (FCVs)	0.0%	0.0%	0.0%	0.0%	0.0%	0.0%	0.0%	0.0%	0.0%

*** EO 12866 Review – Draft – Do Not Cite, Quote or Release During Review ***

TABLE 6-117 - IMPACTS ON CARBON DIOXIDE EMISSIONS, REGULATORY COST, AVERAGE PRICE, AND TECHNOLOGY USE FOR LIGHT TRUCK FLEET, CO₂ PROGRAM

	Alternative								
	No Action	1	2	3	4	5	6	7	8
Model Years	2021-2025	2021-2026	2021-2026	2021-2026	2021-2026	2022-2026	2021-2026	2021-2026	2022-2026
Annual Rate of Stringency Increase	MY 2017-2021 Final MY 2022-2025 Augural	0.0%/Year PC 0.0%/Year LT	0.5%/Year PC 0.5%/Year LT	0.5%/Year PC 0.5%/Year LT	1.0%/Year PC 2.0%/Year LT	1.0%/Year PC 2.0%/Year LT	2.0%/Year PC 3.0%/Year LT	2.0%/Year PC 3.0%/Year LT	2.0%/Year PC 3.0%/Year LT
AC/Off-Cycle Procedures	No Change	No Change	No Change	Phaseout 2022-2026	No Change	No Change	No Change	Phaseout 2022-2026	No Change
Average CO₂ Emission Rate									
Average Required CO ₂ - MY 2026+ (g/mi)	208.0	284.0	276.0	276.0	252.0	241.0	237.0	237.0	229.0
Percent Change in Stringency from Baseline	0.0%	-36.5%	-32.7%	-32.7%	-21.2%	-15.9%	-13.9%	-13.9%	-10.1%
Average Achieved CO ₂ - MY 2030 (g/mi)	206.0	266.0	264.0	268.0	248.0	238.0	234.0	235.0	227.0
Total Regulatory Costs through MY 2029 Vehicles									
Total Technology Costs (\$b)	223.3	-156.9	-151.8	-145.5	-115.5	-72.8	-71.4	-29.0	-23.9
Total Civil Penalties (\$b)	0.0	0.0	0.0	0.0	0.0	0.0	0.0	0.0	0.0
Total Regulatory Costs (\$b)	223.3	-156.9	-151.8	-145.5	-115.5	-72.8	-71.4	-29.0	-23.9
Average Price Increase for MY 2030 Vehicles									
Price Increase due to New CAFE Standards (\$)	2827	-2144	-2083	-1955	-1526	-1024	-774	-105	-263
Technology Use under CAFE Alternative in MY 2030 (total fleet penetration)									

*** EO 12866 Review – Draft – Do Not Cite, Quote or Release During Review ***

Curb Weight Reduction (percent change from MY 2016)	8.2%	4.1%	4.1%	4.5%	5.6%	6.9%	7.5%	8.2%	8.2%
High Compression Ratio Non-Turbo Engines	12.0%	6.3%	6.3%	8.2%	8.2%	10.9%	10.9%	10.9%	10.9%
Turbocharged Gasoline Engines	66.6%	49.6%	52.2%	55.3%	63.3%	66.8%	68.7%	69.0%	71.7%
Dynamic Cylinder Deactivation	14.1%	0.0%	0.0%	0.0%	0.0%	0.0%	0.0%	13.9%	0.0%
Stop-Start 12V (Non-Hybrid)	9.7%	10.5%	10.5%	10.5%	6.8%	13.4%	4.4%	7.0%	10.1%
Mild Hybrid Electric Systems (48v)	60.3%	2.3%	2.3%	2.3%	5.9%	21.5%	29.1%	58.3%	45.6%
Strong Hybrid Electric Systems	6.9%	0.7%	0.7%	0.7%	1.6%	3.5%	4.5%	6.7%	6.1%
Plug-In Hybrid Electric Vehicles (PHEVs)	0.8%	0.1%	0.1%	0.1%	0.1%	0.1%	0.1%	0.2%	0.4%
Dedicated Electric Vehicles (EVs)	0.3%	0.3%	0.3%	0.3%	0.3%	0.3%	0.3%	0.3%	0.3%
Fuel Cell Vehicles (FCVs)	0.0%	0.0%	0.0%	0.0%	0.0%	0.0%	0.0%	0.2%	0.0%

*** EO 12866 Review – Draft – Do Not Cite, Quote or Release During Review ***

TABLE 6-118 - IMPACTS ON CARBON DIOXIDE EMISSIONS, REGULATORY COST, AVERAGE PRICE, TECHNOLOGY USE FOR COMBINED LIGHT-DUTY FLEET, CO₂ PROGRAM

	Alternative								
	No Action	1	2	3	4	5	6	7	8
Model Years	2021-2025	2021-2026	2021-2026	2021-2026	2021-2026	2022-2026	2021-2026	2021-2026	2022-2026
Annual Rate of Stringency Increase	MY 2017-2021 Final MY 2022-2025 Augural	0.0%/Year PC 0.0%/Year LT	0.5%/Year PC 0.5%/Year LT	0.5%/Year PC 0.5%/Year LT	1.0%/Year PC 2.0%/Year LT	1.0%/Year PC 2.0%/Year LT	2.0%/Year PC 3.0%/Year LT	2.0%/Year PC 3.0%/Year LT	2.0%/Year PC 3.0%/Year LT
AC/Off-Cycle Procedures	No Change	No Change	No Change	Phaseout 2022-2026	No Change	No Change	No Change	Phaseout 2022-2026	No Change
Average CO₂ Emission Rate									
Average Required CO ₂ - MY 2026+ (g/mi)	178.7	240.0	233.1	233.3	219.5	211.7	206.8	207.1	201.2
Percent Change in Stringency from Baseline	0.0%	-34.3%	-30.4%	-30.6%	-22.9%	-18.5%	-15.7%	-15.9%	-12.6%
Average Achieved CO ₂ - MY 2030 (g/mi)	176.7	225.8	224.4	227.5	214.5	207.6	204.3	205.6	199.2
Total Regulatory Costs through MY 2029 Vehicles									
Total Technology Costs (\$b)	433.1	-295.6	-285.2	-270.2	-231.8	-160.7	-153.6	-84.8	-80.8
Total Civil Penalties (\$b)	0.0	0.0	0.0	0.0	0.0	0.0	0.0	0.0	0.0
Total Regulatory Costs (\$b)	433.1	-295.6	-285.2	-270.2	-231.8	-160.7	-153.6	-84.8	-80.8
Average Price Increase for MY 2030 Vehicles									
Price Increase due to New CAFE Standards (\$)	2518	-1879	-1825	-1696	-1428	-1067	-838	-329	-462
Technology Use under CAFE Alternative in MY 2030 (total fleet penetration)									

*** EO 12866 Review – Draft – Do Not Cite, Quote or Release During Review ***

Curb Weight Reduction (percent change from MY 2016)	6.8%	4.0%	4.0%	4.4%	4.9%	5.6%	6.3%	6.6%	6.7%
High Compression Ratio Non-Turbo Engines	26.1%	12.4%	12.4%	16.8%	16.7%	20.2%	20.1%	20.5%	20.1%
Turbocharged Gasoline Engines	62.0%	46.2%	48.7%	50.2%	56.0%	59.1%	60.7%	62.6%	64.7%
Dynamic Cylinder Deactivation	7.0%	0.0%	0.0%	0.0%	0.0%	0.0%	0.0%	7.0%	0.0%
Stop-Start 12V (Non-Hybrid)	10.1%	12.8%	12.5%	12.5%	11.1%	11.8%	5.8%	7.0%	11.7%
Mild Hybrid Electric Systems (48v)	41.0%	2.5%	2.7%	2.7%	4.7%	14.5%	20.8%	35.6%	27.4%
Strong Hybrid Electric Systems	13.7%	2.2%	2.4%	2.4%	2.9%	4.6%	4.6%	9.5%	7.2%
Plug-In Hybrid Electric Vehicles (PHEVs)	0.7%	0.3%	0.3%	0.3%	0.3%	0.3%	0.3%	0.3%	0.4%
Dedicated Electric Vehicles (EVs)	0.5%	0.5%	0.5%	0.5%	0.5%	0.5%	0.5%	0.5%	0.5%
Fuel Cell Vehicles (FCVs)	0.0%	0.0%	0.0%	0.0%	0.0%	0.0%	0.0%	0.1%	0.0%

*** EO 12866 Review – Draft – Do Not Cite, Quote or Release During Review ***

TABLE 6-119 - IMPACTS ON CARBON DIOXIDE EMISSIONS, REGULATORY COST, AVERAGE PRICE, TECHNOLOGY USE FOR PASSENGER CARS PRODUCED BY BMW, CO₂ PROGRAM

	Alternative								
	No Action	1	2	3	4	5	6	7	8
Model Years	2021-2025	2021-2026	2021-2026	2021-2026	2021-2026	2022-2026	2021-2026	2021-2026	2022-2026
Annual Rate of Stringency Increase	MY 2017-2021 Final MY 2022-2025 Augural	0.0%/Year PC 0.0%/Year LT	0.5%/Year PC 0.5%/Year LT	0.5%/Year PC 0.5%/Year LT	1.0%/Year PC 2.0%/Year LT	1.0%/Year PC 2.0%/Year LT	2.0%/Year PC 3.0%/Year LT	2.0%/Year PC 3.0%/Year LT	2.0%/Year PC 3.0%/Year LT
AC/Off-Cycle Procedures	No Change	No Change	No Change	Phaseout 2022-2026	No Change	No Change	No Change	Phaseout 2022-2026	No Change
Average CO₂ Emission Rate									
Average Required CO ₂ - MY 2026+ (g/mi)	155.0	207.0	201.0	201.0	195.0	189.0	184.0	184.0	180.0
Percent Change in Stringency from Baseline	0.0%	-33.5%	-29.7%	-29.7%	-25.8%	-21.9%	-18.7%	-18.7%	-16.1%
Average Achieved CO ₂ - MY 2030 (g/mi)	153.9	201.2	199.7	199.9	194.6	186.9	181.2	182.4	177.5
Total Regulatory Costs through MY 2029 Vehicles									
Total Technology Costs (\$b)	12.9	-6.1	-5.7	-4.8	-5.2	-3.0	-2.7	-1.4	-1.4
Total Civil Penalties (\$b)	0.0	0.0	0.0	0.0	0.0	0.0	0.0	0.0	0.0
Total Regulatory Costs (\$b)	12.9	-6.1	-5.7	-4.8	-5.2	-3.0	-2.7	-1.4	-1.4
Average Price Increase for MY 2030 Vehicles									
Price Increase due to New CAFE Standards (\$)	3703	-2179	-2077	-1592	-1903	-1340	-876	-398	-665
Technology Use under CAFE Alternative in MY 2030 (total fleet penetration)									

*** EO 12866 Review – Draft – Do Not Cite, Quote or Release During Review ***

Curb Weight Reduction (percent change from MY 2016)	9.8%	6.7%	6.7%	9.0%	7.3%	7.9%	9.7%	9.8%	9.8%
High Compression Ratio Non-Turbo Engines	0.0%	0.0%	0.0%	0.0%	0.0%	0.0%	0.0%	0.0%	0.0%
Turbocharged Gasoline Engines	96.0%	97.4%	97.4%	97.4%	97.4%	97.4%	97.4%	97.4%	97.4%
Dynamic Cylinder Deactivation	0.0%	0.0%	0.0%	0.0%	0.0%	0.0%	0.0%	0.0%	0.0%
Stop-Start 12V (Non-Hybrid)	0.0%	38.5%	38.5%	38.5%	38.6%	38.7%	0.0%	0.0%	0.0%
Mild Hybrid Electric Systems (48v)	1.0%	46.3%	38.9%	38.9%	35.9%	6.2%	60.3%	21.3%	41.9%
Strong Hybrid Electric Systems	94.6%	12.0%	19.4%	19.4%	22.3%	51.9%	36.6%	75.6%	55.0%
Plug-In Hybrid Electric Vehicles (PHEVs)	1.8%	0.6%	0.6%	0.6%	0.6%	0.6%	0.6%	0.6%	0.6%
Dedicated Electric Vehicles (EVs)	1.5%	1.6%	1.6%	1.6%	1.6%	1.6%	1.5%	1.5%	1.5%
Fuel Cell Vehicles (FCVs)	0.1%	0.0%	0.0%	0.0%	0.0%	0.0%	0.0%	0.0%	0.0%

*** EO 12866 Review – Draft – Do Not Cite, Quote or Release During Review ***

TABLE 6-120 - IMPACTS ON CARBON DIOXIDE EMISSIONS, REGULATORY COST, AVERAGE PRICE, TECHNOLOGY USE FOR LIGHT TRUCKS PRODUCED BY BMW, CO₂ PROGRAM

	Alternative								
	No Action	1	2	3	4	5	6	7	8
Model Years	2021-2025	2021-2026	2021-2026	2021-2026	2021-2026	2022-2026	2021-2026	2021-2026	2022-2026
Annual Rate of Stringency Increase	MY 2017-2021 Final MY 2022-2025 Augural	0.0%/Year PC 0.0%/Year LT	0.5%/Year PC 0.5%/Year LT	0.5%/Year PC 0.5%/Year LT	1.0%/Year PC 2.0%/Year LT	1.0%/Year PC 2.0%/Year LT	2.0%/Year PC 3.0%/Year LT	2.0%/Year PC 3.0%/Year LT	2.0%/Year PC 3.0%/Year LT
AC/Off-Cycle Procedures	No Change	No Change	No Change	Phaseout 2022-2026	No Change	No Change	No Change	Phaseout 2022-2026	No Change
Average CO₂ Emission Rate									
Average Required CO ₂ - MY 2026+ (g/mi)	197.0	271.0	263.0	263.0	240.0	229.0	226.0	226.0	218.0
Percent Change in Stringency from Baseline	0.0%	-37.6%	-33.5%	-33.5%	-21.8%	-16.2%	-14.7%	-14.7%	-10.7%
Average Achieved CO ₂ - MY 2030 (g/mi)	197.5	256.5	256.5	262.0	243.2	226.5	225.8	228.2	217.6
Total Regulatory Costs through MY 2029 Vehicles									
Total Technology Costs (\$b)	3.0	-1.8	-1.8	-1.6	-1.6	-0.8	-0.8	-0.2	-0.2
Total Civil Penalties (\$b)	0.0	0.0	0.0	0.0	0.0	0.0	0.0	0.0	0.0
Total Regulatory Costs (\$b)	3.0	-1.8	-1.8	-1.6	-1.6	-0.8	-0.8	-0.2	-0.2
Average Price Increase for MY 2030 Vehicles									
Price Increase due to New CAFE Standards (\$)	3036	-2302	-2302	-1954	-1942	-985	-952	-214	-297
Technology Use under CAFE Alternative in MY 2030 (total fleet penetration)									

*** EO 12866 Review – Draft – Do Not Cite, Quote or Release During Review ***

Curb Weight Reduction (percent change from MY 2016)	10.0%	6.0%	6.0%	6.9%	7.5%	10.0%	10.0%	10.0%	10.0%
High Compression Ratio Non-Turbo Engines	0.0%	0.0%	0.0%	0.0%	0.0%	0.0%	0.0%	0.0%	0.0%
Turbocharged Gasoline Engines	96.6%	96.6%	96.6%	96.6%	96.6%	96.6%	96.6%	96.6%	96.6%
Dynamic Cylinder Deactivation	0.0%	0.0%	0.0%	0.0%	0.0%	0.0%	0.0%	0.0%	0.0%
Stop-Start 12V (Non-Hybrid)	0.0%	94.5%	94.5%	94.5%	93.8%	33.9%	33.9%	0.0%	0.0%
Mild Hybrid Electric Systems (48v)	45.1%	0.0%	0.0%	0.0%	0.7%	60.7%	60.7%	54.5%	60.7%
Strong Hybrid Electric Systems	49.4%	0.0%	0.0%	0.0%	0.0%	0.0%	0.0%	40.0%	33.9%
Plug-In Hybrid Electric Vehicles (PHEVs)	5.5%	5.5%	5.5%	5.5%	5.5%	5.5%	5.5%	5.5%	5.5%
Dedicated Electric Vehicles (EVs)	0.0%	0.0%	0.0%	0.0%	0.0%	0.0%	0.0%	0.0%	0.0%
Fuel Cell Vehicles (FCVs)	0.0%	0.0%	0.0%	0.0%	0.0%	0.0%	0.0%	0.0%	0.0%

*** EO 12866 Review – Draft – Do Not Cite, Quote or Release During Review ***

TABLE 6-121 - IMPACTS ON CARBON DIOXIDE EMISSIONS, REGULATORY COST, AVERAGE PRICE, AND TECHNOLOGY USE FOR ALL LIGHT-DUTY VEHICLES PRODUCED BY BMW, CO₂ PROGRAM

	Alternative								
	No Action	1	2	3	4	5	6	7	8
Model Years	2021-2025	2021-2026	2021-2026	2021-2026	2021-2026	2022-2026	2021-2026	2021-2026	2022-2026
Annual Rate of Stringency Increase	MY 2017-2021 Final MY 2022-2025 Augural	0.0%/Year PC 0.0%/Year LT	0.5%/Year PC 0.5%/Year LT	0.5%/Year PC 0.5%/Year LT	1.0%/Year PC 2.0%/Year LT	1.0%/Year PC 2.0%/Year LT	2.0%/Year PC 3.0%/Year LT	2.0%/Year PC 3.0%/Year LT	2.0%/Year PC 3.0%/Year LT
AC/Off-Cycle Procedures	No Change	No Change	No Change	Phaseout 2022-2026	No Change	No Change	No Change	Phaseout 2022-2026	No Change
Average CO₂ Emission Rate									
Average Required CO ₂ - MY 2026+ (g/mi)	166.6	223.2	216.7	216.9	206.8	199.8	195.4	195.6	190.5
Percent Change in Stringency from Baseline	0.0%	-33.9%	-30.1%	-30.1%	-24.1%	-19.9%	-17.2%	-17.4%	-14.3%
Average Achieved CO ₂ - MY 2030 (g/mi)	166.0	215.2	214.1	215.8	207.3	197.6	193.3	195.0	188.6
Total Regulatory Costs through MY 2029 Vehicles									
Total Technology Costs (\$b)	15.9	-8.0	-7.5	-6.3	-6.7	-3.8	-3.5	-1.6	-1.5
Total Civil Penalties (\$b)	0.0	0.0	0.0	0.0	0.0	0.0	0.0	0.0	0.0
Total Regulatory Costs (\$b)	15.9	-8.0	-7.5	-6.3	-6.7	-3.8	-3.5	-1.6	-1.5
Average Price Increase for MY 2030 Vehicles									
Price Increase due to New CAFE Standards (\$)	3518	-2194	-2119	-1670	-1903	-1239	-892	-346	-562
Technology Use under CAFE Alternative in MY 2030 (total fleet penetration)									

*** EO 12866 Review – Draft – Do Not Cite, Quote or Release During Review ***

Curb Weight Reduction (percent change from MY 2016)	9.4%	6.5%	6.5%	8.4%	7.2%	8.3%	9.5%	9.4%	9.4%
High Compression Ratio Non-Turbo Engines	0.0%	0.0%	0.0%	0.0%	0.0%	0.0%	0.0%	0.0%	0.0%
Turbocharged Gasoline Engines	96.2%	97.2%	97.2%	97.2%	97.2%	97.2%	97.2%	97.2%	97.2%
Dynamic Cylinder Deactivation	0.0%	0.0%	0.0%	0.0%	0.0%	0.0%	0.0%	0.0%	0.0%
Stop-Start 12V (Non-Hybrid)	0.0%	52.7%	52.7%	52.8%	53.1%	37.4%	9.2%	0.0%	0.0%
Mild Hybrid Electric Systems (48v)	13.2%	34.6%	29.1%	29.0%	26.7%	20.8%	60.4%	30.5%	47.1%
Strong Hybrid Electric Systems	82.1%	9.0%	14.5%	14.4%	16.5%	37.9%	26.7%	65.8%	49.2%
Plug-In Hybrid Electric Vehicles (PHEVs)	2.8%	1.8%	1.8%	1.9%	1.9%	1.9%	1.9%	1.9%	1.9%
Dedicated Electric Vehicles (EVs)	1.1%	1.2%	1.2%	1.2%	1.2%	1.1%	1.1%	1.1%	1.1%
Fuel Cell Vehicles (FCVs)	0.1%	0.0%	0.0%	0.0%	0.0%	0.0%	0.0%	0.0%	0.0%

*** EO 12866 Review – Draft – Do Not Cite, Quote or Release During Review ***

TABLE 6-122 - IMPACTS ON CARBON DIOXIDE EMISSIONS, REGULATORY COST, AVERAGE PRICE, AND TECHNOLOGY USE FOR PASSENGER CARS PRODUCED BY DAIMLER, CO₂ PROGRAM

	Alternative								
	No Action	1	2	3	4	5	6	7	8
Model Years	2021-2025	2021-2026	2021-2026	2021-2026	2021-2026	2022-2026	2021-2026	2021-2026	2022-2026
Annual Rate of Stringency Increase	MY 2017-2021 Final MY 2022-2025 Augural	0.0%/Year PC 0.0%/Year LT	0.5%/Year PC 0.5%/Year LT	0.5%/Year PC 0.5%/Year LT	1.0%/Year PC 2.0%/Year LT	1.0%/Year PC 2.0%/Year LT	2.0%/Year PC 3.0%/Year LT	2.0%/Year PC 3.0%/Year LT	2.0%/Year PC 3.0%/Year LT
AC/Off-Cycle Procedures	No Change	No Change	No Change	Phaseout 2022-2026	No Change	No Change	No Change	Phaseout 2022-2026	No Change
Average CO₂ Emission Rate									
Average Required CO ₂ - MY 2026+ (g/mi)	157.0	210.0	204.0	204.0	198.0	192.0	186.0	186.0	182.0
Percent Change in Stringency from Baseline	0.0%	-33.8%	-29.9%	-29.9%	-26.1%	-22.3%	-18.5%	-18.5%	-15.9%
Average Achieved CO ₂ - MY 2030 (g/mi)	156.9	205.1	204.0	202.1	193.7	186.2	185.9	185.1	181.9
Total Regulatory Costs through MY 2029 Vehicles									
Total Technology Costs (\$b)	9.7	-5.3	-5.2	-4.2	-4.2	-2.7	-2.7	-1.0	-1.7
Total Civil Penalties (\$b)	0.0	0.0	0.0	0.0	0.0	0.0	0.0	0.0	0.0
Total Regulatory Costs (\$b)	9.7	-5.3	-5.2	-4.2	-4.2	-2.7	-2.7	-1.0	-1.7
Average Price Increase for MY 2030 Vehicles									
Price Increase due to New CAFE Standards (\$)	3621	-2325	-2272	-1873	-1888	-1471	-1082	-297	-799
Technology Use under CAFE Alternative in MY 2030 (total fleet penetration)									

*** EO 12866 Review – Draft – Do Not Cite, Quote or Release During Review ***

Curb Weight Reduction (percent change from MY 2016)	9.5%	6.2%	6.2%	7.6%	6.5%	7.5%	9.5%	9.5%	9.5%
High Compression Ratio Non-Turbo Engines	0.0%	0.0%	0.0%	0.0%	0.0%	0.0%	0.0%	0.0%	0.0%
Turbocharged Gasoline Engines	98.9%	98.9%	98.9%	98.9%	98.9%	98.9%	98.9%	98.9%	98.9%
Dynamic Cylinder Deactivation	0.0%	0.0%	0.0%	0.0%	0.0%	0.0%	0.0%	0.0%	0.0%
Stop-Start 12V (Non-Hybrid)	0.0%	44.9%	44.9%	44.9%	45.0%	45.1%	36.0%	0.0%	33.0%
Mild Hybrid Electric Systems (48v)	4.4%	40.9%	36.4%	36.3%	28.0%	4.5%	31.3%	29.4%	16.6%
Strong Hybrid Electric Systems	94.3%	12.9%	17.4%	17.4%	25.6%	49.1%	31.4%	69.3%	49.0%
Plug-In Hybrid Electric Vehicles (PHEVs)	0.4%	0.4%	0.4%	0.4%	0.4%	0.4%	0.4%	0.4%	0.4%
Dedicated Electric Vehicles (EVs)	0.6%	0.6%	0.6%	0.6%	0.6%	0.6%	0.6%	0.6%	0.6%
Fuel Cell Vehicles (FCVs)	0.0%	0.0%	0.0%	0.0%	0.0%	0.0%	0.0%	0.0%	0.0%

*** EO 12866 Review – Draft – Do Not Cite, Quote or Release During Review ***

TABLE 6-123 - IMPACTS ON CARBON DIOXIDE EMISSIONS, REGULATORY COST, AVERAGE PRICE, AND TECHNOLOGY USE FOR LIGHT TRUCKS PRODUCED BY DAIMLER, CO₂ PROGRAM

	Alternative								
	No Action	1	2	3	4	5	6	7	8
Model Years	2021-2025	2021-2026	2021-2026	2021-2026	2021-2026	2022-2026	2021-2026	2021-2026	2022-2026
Annual Rate of Stringency Increase	MY 2017-2021 Final MY 2022-2025 Augural	0.0%/Year PC 0.0%/Year LT	0.5%/Year PC 0.5%/Year LT	0.5%/Year PC 0.5%/Year LT	1.0%/Year PC 2.0%/Year LT	1.0%/Year PC 2.0%/Year LT	2.0%/Year PC 3.0%/Year LT	2.0%/Year PC 3.0%/Year LT	2.0%/Year PC 3.0%/Year LT
AC/Off-Cycle Procedures	No Change	No Change	No Change	Phaseout 2022-2026	No Change	No Change	No Change	Phaseout 2022-2026	No Change
Average CO₂ Emission Rate									
Average Required CO ₂ - MY 2026+ (g/mi)	201.0	276.0	268.0	268.0	244.0	233.0	230.0	230.0	222.0
Percent Change in Stringency from Baseline	0.0%	-37.3%	-33.3%	-33.3%	-21.4%	-15.9%	-14.4%	-14.4%	-10.4%
Average Achieved CO ₂ - MY 2030 (g/mi)	200.3	263.8	262.7	268.3	249.4	235.5	232.2	240.0	226.1
Total Regulatory Costs through MY 2029 Vehicles									
Total Technology Costs (\$b)	4.8	-3.2	-3.2	-3.0	-2.6	-1.3	-1.6	-1.0	-0.8
Total Civil Penalties (\$b)	0.0	0.0	0.0	0.0	0.0	0.0	0.0	0.0	0.0
Total Regulatory Costs (\$b)	4.8	-3.2	-3.2	-3.0	-2.6	-1.3	-1.6	-1.0	-0.8
Average Price Increase for MY 2030 Vehicles									
Price Increase due to New CAFE Standards (\$)	4037	-3027	-3004	-2860	-2483	-1637	-1193	-948	-722
Technology Use under CAFE Alternative in MY 2030 (total fleet penetration)									

*** EO 12866 Review – Draft – Do Not Cite, Quote or Release During Review ***

Curb Weight Reduction (percent change from MY 2016)	9.7%	4.9%	4.9%	5.2%	7.5%	9.5%	9.7%	9.7%	9.7%
High Compression Ratio Non-Turbo Engines	0.0%	0.0%	0.0%	0.0%	0.0%	0.0%	0.0%	0.0%	0.0%
Turbocharged Gasoline Engines	96.9%	96.9%	96.9%	96.9%	96.9%	96.9%	96.9%	96.9%	96.9%
Dynamic Cylinder Deactivation	0.0%	0.0%	0.0%	0.0%	0.0%	0.0%	0.0%	0.0%	0.0%
Stop-Start 12V (Non-Hybrid)	0.0%	56.8%	56.8%	56.8%	8.4%	0.0%	0.0%	0.0%	0.0%
Mild Hybrid Electric Systems (48v)	3.1%	0.0%	0.0%	0.0%	48.4%	91.5%	71.1%	64.0%	45.0%
Strong Hybrid Electric Systems	96.7%	0.0%	0.0%	0.0%	0.0%	8.4%	28.8%	35.8%	54.9%
Plug-In Hybrid Electric Vehicles (PHEVs)	0.2%	0.2%	0.2%	0.2%	0.2%	0.2%	0.2%	0.2%	0.2%
Dedicated Electric Vehicles (EVs)	0.0%	0.0%	0.0%	0.0%	0.0%	0.0%	0.0%	0.0%	0.0%
Fuel Cell Vehicles (FCVs)	0.0%	0.0%	0.0%	0.0%	0.0%	0.0%	0.0%	0.0%	0.0%

*** EO 12866 Review – Draft – Do Not Cite, Quote or Release During Review ***

TABLE 6-124 - IMPACTS ON CARBON DIOXIDE EMISSIONS, REGULATORY COST, AVERAGE PRICE, AND TECHNOLOGY USE FOR ALL LIGHT-DUTY VEHICLES PRODUCED BY DAIMLER, CO₂ PROGRAM

	Alternative								
	No Action	1	2	3	4	5	6	7	8
Model Years	2021-2025	2021-2026	2021-2026	2021-2026	2021-2026	2022-2026	2021-2026	2021-2026	2022-2026
Annual Rate of Stringency Increase	MY 2017-2021 Final MY 2022-2025 Augural	0.0%/Year PC 0.0%/Year LT	0.5%/Year PC 0.5%/Year LT	0.5%/Year PC 0.5%/Year LT	1.0%/Year PC 2.0%/Year LT	1.0%/Year PC 2.0%/Year LT	2.0%/Year PC 3.0%/Year LT	2.0%/Year PC 3.0%/Year LT	2.0%/Year PC 3.0%/Year LT
AC/Off-Cycle Procedures	No Change	No Change	No Change	Phaseout 2022-2026	No Change	No Change	No Change	Phaseout 2022-2026	No Change
Average CO₂ Emission Rate									
Average Required CO ₂ - MY 2026+ (g/mi)	172.8	231.7	225.1	225.3	213.6	206.3	201.4	201.7	196.3
Percent Change in Stringency from Baseline	0.0%	-34.1%	-30.3%	-30.4%	-23.6%	-19.4%	-16.6%	-16.7%	-13.6%
Average Achieved CO ₂ - MY 2030 (g/mi)	172.5	224.5	223.4	224.1	212.7	203.4	202.2	204.6	197.7
Total Regulatory Costs through MY 2029 Vehicles									
Total Technology Costs (\$b)	14.4	-8.5	-8.3	-7.3	-6.8	-4.0	-4.3	-1.9	-2.5
Total Civil Penalties (\$b)	0.0	0.0	0.0	0.0	0.0	0.0	0.0	0.0	0.0
Total Regulatory Costs (\$b)	14.4	-8.5	-8.3	-7.3	-6.8	-4.0	-4.3	-1.9	-2.5
Average Price Increase for MY 2030 Vehicles									
Price Increase due to New CAFE Standards (\$)	3770	-2569	-2525	-2212	-2098	-1533	-1124	-530	-773
Technology Use under CAFE Alternative in MY 2030 (total fleet penetration)									

*** EO 12866 Review – Draft – Do Not Cite, Quote or Release During Review ***

Curb Weight Reduction (percent change from MY 2016)	9.0%	5.8%	5.8%	6.7%	6.7%	8.0%	9.2%	9.0%	9.0%
High Compression Ratio Non-Turbo Engines	0.0%	0.0%	0.0%	0.0%	0.0%	0.0%	0.0%	0.0%	0.0%
Turbocharged Gasoline Engines	98.2%	98.2%	98.2%	98.2%	98.2%	98.2%	98.2%	98.2%	98.2%
Dynamic Cylinder Deactivation	0.0%	0.0%	0.0%	0.0%	0.0%	0.0%	0.0%	0.0%	0.0%
Stop-Start 12V (Non-Hybrid)	0.0%	48.8%	48.8%	48.9%	32.6%	29.4%	23.3%	0.0%	21.3%
Mild Hybrid Electric Systems (48v)	4.0%	27.4%	24.4%	24.3%	35.0%	34.8%	45.3%	41.8%	26.7%
Strong Hybrid Electric Systems	95.1%	8.7%	11.6%	11.6%	16.9%	34.9%	30.5%	57.4%	51.1%
Plug-In Hybrid Electric Vehicles (PHEVs)	0.3%	0.3%	0.3%	0.3%	0.3%	0.3%	0.3%	0.3%	0.3%
Dedicated Electric Vehicles (EVs)	0.4%	0.4%	0.4%	0.4%	0.4%	0.4%	0.4%	0.4%	0.4%
Fuel Cell Vehicles (FCVs)	0.0%	0.0%	0.0%	0.0%	0.0%	0.0%	0.0%	0.0%	0.0%

*** EO 12866 Review – Draft – Do Not Cite, Quote or Release During Review ***

TABLE 6-125 - IMPACTS ON CARBON DIOXIDE EMISSIONS, REGULATORY COST, AVERAGE PRICE, AND TECHNOLOGY USE FOR PASSENGER CARS PRODUCED BY FIAT CHRYSLER, CO₂ PROGRAM

	Alternative								
	No Action	1	2	3	4	5	6	7	8
Model Years	2021-2025	2021-2026	2021-2026	2021-2026	2021-2026	2022-2026	2021-2026	2021-2026	2022-2026
Annual Rate of Stringency Increase	MY 2017-2021 Final MY 2022-2025 Augural	0.0%/Year PC 0.0%/Year LT	0.5%/Year PC 0.5%/Year LT	0.5%/Year PC 0.5%/Year LT	1.0%/Year PC 2.0%/Year LT	1.0%/Year PC 2.0%/Year LT	2.0%/Year PC 3.0%/Year LT	2.0%/Year PC 3.0%/Year LT	2.0%/Year PC 3.0%/Year LT
AC/Off-Cycle Procedures	No Change	No Change	No Change	Phaseout 2022-2026	No Change	No Change	No Change	Phaseout 2022-2026	No Change
Average CO₂ Emission Rate									
Average Required CO ₂ - MY 2026+ (g/mi)	156.0	210.0	204.0	204.0	198.0	191.0	186.0	185.0	181.0
Percent Change in Stringency from Baseline	0.0%	-34.6%	-30.8%	-30.8%	-26.9%	-22.4%	-19.2%	-18.6%	-16.0%
Average Achieved CO ₂ - MY 2030 (g/mi)	155.6	201.2	200.0	210.4	197.1	190.3	185.3	185.3	179.2
Total Regulatory Costs through MY 2029 Vehicles									
Total Technology Costs (\$b)	36.3	-17.7	-16.5	-16.6	-15.5	-9.3	-10.3	-5.4	-5.7
Total Civil Penalties (\$b)	0.0	0.0	0.0	0.0	0.0	0.0	0.0	0.0	0.0
Total Regulatory Costs (\$b)	36.3	-17.7	-16.5	-16.6	-15.5	-9.3	-10.3	-5.4	-5.7
Average Price Increase for MY 2030 Vehicles									
Price Increase due to New CAFE Standards (\$)	4552	-2467	-2344	-2343	-2189	-1638	-1163	-477	-708
Technology Use under CAFE Alternative in MY 2030 (total fleet penetration)									

*** EO 12866 Review – Draft – Do Not Cite, Quote or Release During Review ***

Curb Weight Reduction (percent change from MY 2016)	9.8%	7.2%	7.2%	7.2%	7.6%	7.4%	9.7%	9.8%	9.8%
High Compression Ratio Non-Turbo Engines	0.0%	0.0%	0.0%	0.0%	0.0%	0.0%	0.0%	0.0%	0.0%
Turbocharged Gasoline Engines	93.0%	88.4%	88.4%	88.4%	88.6%	99.2%	89.5%	90.5%	99.3%
Dynamic Cylinder Deactivation	6.3%	0.0%	0.0%	0.0%	0.0%	0.0%	0.0%	8.8%	0.0%
Stop-Start 12V (Non-Hybrid)	0.0%	83.9%	72.9%	72.9%	61.8%	0.4%	9.7%	0.0%	0.0%
Mild Hybrid Electric Systems (48v)	13.4%	0.0%	11.6%	11.6%	22.5%	83.6%	85.5%	53.9%	78.8%
Strong Hybrid Electric Systems	81.9%	0.0%	0.0%	0.0%	0.0%	0.0%	0.0%	41.4%	16.5%
Plug-In Hybrid Electric Vehicles (PHEVs)	0.0%	0.0%	0.0%	0.0%	0.0%	0.0%	0.0%	0.0%	0.0%
Dedicated Electric Vehicles (EVs)	0.7%	0.7%	0.7%	0.7%	0.7%	0.7%	0.7%	0.7%	0.7%
Fuel Cell Vehicles (FCVs)	0.0%	0.0%	0.0%	0.0%	0.0%	0.0%	0.0%	0.0%	0.0%

*** EO 12866 Review – Draft – Do Not Cite, Quote or Release During Review ***

TABLE 6-126 - IMPACTS ON CARBON DIOXIDE EMISSIONS, REGULATORY COST, AVERAGE PRICE, AND TECHNOLOGY USE FOR LIGHT TRUCKS PRODUCED BY FIAT CHRYSLER, CO₂ PROGRAM

	Alternative								
	No Action	1	2	3	4	5	6	7	8
Model Years	2021-2025	2021-2026	2021-2026	2021-2026	2021-2026	2022-2026	2021-2026	2021-2026	2022-2026
Annual Rate of Stringency Increase	MY 2017-2021 Final MY 2022-2025 Augural	0.0%/Year PC 0.0%/Year LT	0.5%/Year PC 0.5%/Year LT	0.5%/Year PC 0.5%/Year LT	1.0%/Year PC 2.0%/Year LT	1.0%/Year PC 2.0%/Year LT	2.0%/Year PC 3.0%/Year LT	2.0%/Year PC 3.0%/Year LT	2.0%/Year PC 3.0%/Year LT
AC/Off-Cycle Procedures	No Change	No Change	No Change	Phaseout 2022-2026	No Change	No Change	No Change	Phaseout 2022-2026	No Change
Average CO₂ Emission Rate									
Average Required CO ₂ - MY 2026+ (g/mi)	206.0	282.0	274.0	274.0	250.0	239.0	235.0	235.0	227.0
Percent Change in Stringency from Baseline	0.0%	-36.9%	-33.0%	-33.0%	-21.4%	-16.0%	-14.1%	-14.1%	-10.2%
Average Achieved CO ₂ - MY 2030 (g/mi)	206.2	251.8	250.8	263.2	244.8	239.5	235.1	235.1	227.1
Total Regulatory Costs through MY 2029 Vehicles									
Total Technology Costs (\$b)	51.4	-24.7	-22.7	-22.7	-17.4	-10.4	-13.9	-0.5	-2.9
Total Civil Penalties (\$b)	0.0	0.0	0.0	0.0	0.0	0.0	0.0	0.0	0.0
Total Regulatory Costs (\$b)	51.4	-24.7	-22.7	-22.7	-17.4	-10.4	-13.9	-0.5	-2.9
Average Price Increase for MY 2030 Vehicles									
Price Increase due to New CAFE Standards (\$)	3271	-1871	-1771	-1771	-1507	-1171	-884	129	-304
Technology Use under CAFE Alternative in MY 2030 (total fleet penetration)									

*** EO 12866 Review – Draft – Do Not Cite, Quote or Release During Review ***

Curb Weight Reduction (percent change from MY 2016)	9.6%	5.4%	5.4%	5.4%	6.6%	7.1%	8.0%	9.6%	9.6%
High Compression Ratio Non-Turbo Engines	0.0%	0.0%	0.0%	0.0%	0.0%	0.0%	0.0%	0.0%	0.0%
Turbocharged Gasoline Engines	79.2%	79.0%	79.0%	79.0%	79.0%	97.7%	79.0%	79.0%	97.7%
Dynamic Cylinder Deactivation	18.5%	0.0%	0.0%	0.0%	0.0%	0.0%	0.0%	18.6%	0.0%
Stop-Start 12V (Non-Hybrid)	5.4%	16.4%	16.4%	16.4%	16.4%	33.8%	6.4%	0.0%	10.3%
Mild Hybrid Electric Systems (48v)	84.4%	0.0%	0.0%	0.0%	0.0%	1.0%	24.7%	96.0%	30.8%
Strong Hybrid Electric Systems	0.0%	0.0%	0.0%	0.0%	0.0%	0.0%	0.0%	1.8%	0.0%
Plug-In Hybrid Electric Vehicles (PHEVs)	0.0%	0.0%	0.0%	0.0%	0.0%	0.0%	0.0%	0.0%	0.0%
Dedicated Electric Vehicles (EVs)	0.0%	0.0%	0.0%	0.0%	0.0%	0.0%	0.0%	0.0%	0.0%
Fuel Cell Vehicles (FCVs)	0.0%	0.0%	0.0%	0.0%	0.0%	0.0%	0.0%	0.0%	0.0%

*** EO 12866 Review – Draft – Do Not Cite, Quote or Release During Review ***

TABLE 6-127 - IMPACTS ON CARBON DIOXIDE EMISSIONS, REGULATORY COST, AVERAGE PRICE, AND TECHNOLOGY USE FOR ALL LIGHT-DUTY VEHICLES PRODUCED BY FIAT CHRYSLER, CO₂ PROGRAM

	Alternative								
	No Action	1	2	3	4	5	6	7	8
Model Years	2021-2025	2021-2026	2021-2026	2021-2026	2021-2026	2022-2026	2021-2026	2021-2026	2022-2026
Annual Rate of Stringency Increase	MY 2017-2021 Final MY 2022-2025 Augural	0.0%/Year PC 0.0%/Year LT	0.5%/Year PC 0.5%/Year LT	0.5%/Year PC 0.5%/Year LT	1.0%/Year PC 2.0%/Year LT	1.0%/Year PC 2.0%/Year LT	2.0%/Year PC 3.0%/Year LT	2.0%/Year PC 3.0%/Year LT	2.0%/Year PC 3.0%/Year LT
AC/Off-Cycle Procedures	No Change	No Change	No Change	Phaseout 2022-2026	No Change	No Change	No Change	Phaseout 2022-2026	No Change
Average CO₂ Emission Rate									
Average Required CO ₂ - MY 2026+ (g/mi)	190.7	258.6	251.3	251.4	233.5	224.0	219.8	219.6	212.9
Percent Change in Stringency from Baseline	0.0%	-35.6%	-31.7%	-31.8%	-22.4%	-17.5%	-15.2%	-15.2%	-11.6%
Average Achieved CO ₂ - MY 2030 (g/mi)	190.7	235.4	234.3	246.2	229.7	224.1	219.7	219.8	212.4
Total Regulatory Costs through MY 2029 Vehicles									
Total Technology Costs (\$b)	87.7	-42.4	-39.2	-39.2	-32.8	-19.7	-24.2	-5.8	-8.6
Total Civil Penalties (\$b)	0.0	0.0	0.0	0.0	0.0	0.0	0.0	0.0	0.0
Total Regulatory Costs (\$b)	87.7	-42.4	-39.2	-39.2	-32.8	-19.7	-24.2	-5.8	-8.6
Average Price Increase for MY 2030 Vehicles									
Price Increase due to New CAFE Standards (\$)	3662	-2040	-1932	-1933	-1708	-1309	-964	-55	-427
Technology Use under CAFE Alternative in MY 2030 (total fleet penetration)									

*** EO 12866 Review – Draft – Do Not Cite, Quote or Release During Review ***

Curb Weight Reduction (percent change from MY 2016)	9.4%	6.0%	6.0%	5.9%	6.8%	7.0%	8.2%	9.4%	9.4%
High Compression Ratio Non-Turbo Engines	0.0%	0.0%	0.0%	0.0%	0.0%	0.0%	0.0%	0.0%	0.0%
Turbocharged Gasoline Engines	83.4%	82.1%	82.1%	82.1%	82.1%	98.2%	82.3%	82.6%	98.2%
Dynamic Cylinder Deactivation	14.8%	0.0%	0.0%	0.0%	0.0%	0.0%	0.0%	15.6%	0.0%
Stop-Start 12V (Non-Hybrid)	3.7%	38.3%	34.7%	34.6%	30.8%	23.4%	7.5%	0.0%	7.1%
Mild Hybrid Electric Systems (48v)	62.7%	0.0%	3.8%	3.7%	7.2%	26.8%	43.5%	83.1%	45.5%
Strong Hybrid Electric Systems	25.0%	0.0%	0.0%	0.0%	0.0%	0.0%	0.0%	13.9%	5.0%
Plug-In Hybrid Electric Vehicles (PHEVs)	0.0%	0.0%	0.0%	0.0%	0.0%	0.0%	0.0%	0.0%	0.0%
Dedicated Electric Vehicles (EVs)	0.2%	0.2%	0.2%	0.2%	0.2%	0.2%	0.2%	0.2%	0.2%
Fuel Cell Vehicles (FCVs)	0.0%	0.0%	0.0%	0.0%	0.0%	0.0%	0.0%	0.0%	0.0%

*** EO 12866 Review – Draft – Do Not Cite, Quote or Release During Review ***

TABLE 6-128 - IMPACTS ON CARBON DIOXIDE EMISSIONS, REGULATORY COST, AVERAGE PRICE, AND TECHNOLOGY USE FOR PASSENGER CARS PRODUCED BY FORD, CO₂ PROGRAM

	Alternative								
	No Action	1	2	3	4	5	6	7	8
Model Years	2021-2025	2021-2026	2021-2026	2021-2026	2021-2026	2022-2026	2021-2026	2021-2026	2022-2026
Annual Rate of Stringency Increase	MY 2017-2021 Final MY 2022-2025 Augural	0.0%/Year PC 0.0%/Year LT	0.5%/Year PC 0.5%/Year LT	0.5%/Year PC 0.5%/Year LT	1.0%/Year PC 2.0%/Year LT	1.0%/Year PC 2.0%/Year LT	2.0%/Year PC 3.0%/Year LT	2.0%/Year PC 3.0%/Year LT	2.0%/Year PC 3.0%/Year LT
AC/Off-Cycle Procedures	No Change	No Change	No Change	Phaseout 2022-2026	No Change	No Change	No Change	Phaseout 2022-2026	No Change
Average CO₂ Emission Rate									
Average Required CO ₂ - MY 2026+ (g/mi)	154.0	206.0	200.0	200.0	194.0	188.0	183.0	183.0	179.0
Percent Change in Stringency from Baseline	0.0%	-33.8%	-29.9%	-29.9%	-26.0%	-22.1%	-18.8%	-18.8%	-16.2%
Average Achieved CO ₂ - MY 2030 (g/mi)	153.7	200.5	195.6	200.2	191.3	184.4	181.6	182.4	179.1
Total Regulatory Costs through MY 2029 Vehicles									
Total Technology Costs (\$b)	29.7	-20.8	-19.5	-19.0	-18.0	-15.1	-14.0	-10.2	-9.7
Total Civil Penalties (\$b)	0.0	0.0	0.0	0.0	0.0	0.0	0.0	0.0	0.0
Total Regulatory Costs (\$b)	29.7	-20.8	-19.5	-19.0	-18.0	-15.1	-14.0	-10.2	-9.7
Average Price Increase for MY 2030 Vehicles									
Price Increase due to New CAFE Standards (\$)	2821	-2113	-1966	-1944	-1748	-1384	-1179	-819	-868
Technology Use under CAFE Alternative in MY 2030 (total fleet penetration)									

*** EO 12866 Review – Draft – Do Not Cite, Quote or Release During Review ***

Curb Weight Reduction (percent change from MY 2016)	8.3%	5.7%	5.7%	5.7%	5.7%	6.8%	7.9%	8.2%	8.3%
High Compression Ratio Non-Turbo Engines	6.1%	6.3%	6.3%	6.3%	6.3%	6.2%	6.2%	6.1%	6.1%
Turbocharged Gasoline Engines	93.7%	51.3%	73.1%	74.6%	77.3%	86.8%	89.5%	93.7%	90.1%
Dynamic Cylinder Deactivation	0.0%	0.0%	0.0%	0.0%	0.0%	0.0%	0.0%	0.0%	0.0%
Stop-Start 12V (Non-Hybrid)	31.5%	1.8%	1.8%	1.9%	1.9%	1.9%	1.9%	26.2%	4.0%
Mild Hybrid Electric Systems (48v)	56.6%	0.0%	0.0%	0.0%	0.0%	0.0%	0.0%	0.0%	0.0%
Strong Hybrid Electric Systems	4.0%	4.2%	4.2%	4.2%	4.1%	4.1%	4.1%	4.1%	4.1%
Plug-In Hybrid Electric Vehicles (PHEVs)	2.1%	2.1%	2.1%	2.1%	2.1%	2.1%	2.1%	2.1%	2.1%
Dedicated Electric Vehicles (EVs)	0.1%	0.2%	0.2%	0.2%	0.2%	0.2%	0.1%	0.1%	0.1%
Fuel Cell Vehicles (FCVs)	0.0%	0.0%	0.0%	0.0%	0.0%	0.0%	0.0%	0.0%	0.0%

*** EO 12866 Review – Draft – Do Not Cite, Quote or Release During Review ***

TABLE 6-129 - IMPACTS ON CARBON DIOXIDE EMISSIONS, REGULATORY COST, AVERAGE PRICE, AND TECHNOLOGY USE FOR LIGHT TRUCKS PRODUCED BY FORD, CO₂ PROGRAM

	Alternative								
	No Action	1	2	3	4	5	6	7	8
Model Years	2021-2025	2021-2026	2021-2026	2021-2026	2021-2026	2022-2026	2021-2026	2021-2026	2022-2026
Annual Rate of Stringency Increase	MY 2017-2021 Final MY 2022-2025 Augural	0.0%/Year PC 0.0%/Year LT	0.5%/Year PC 0.5%/Year LT	0.5%/Year PC 0.5%/Year LT	1.0%/Year PC 2.0%/Year LT	1.0%/Year PC 2.0%/Year LT	2.0%/Year PC 3.0%/Year LT	2.0%/Year PC 3.0%/Year LT	2.0%/Year PC 3.0%/Year LT
AC/Off-Cycle Procedures	No Change	No Change	No Change	Phaseout 2022-2026	No Change	No Change	No Change	Phaseout 2022-2026	No Change
Average CO₂ Emission Rate									
Average Required CO ₂ - MY 2026+ (g/mi)	227.0	308.0	299.0	299.0	273.0	262.0	257.0	257.0	249.0
Percent Change in Stringency from Baseline	0.0%	-35.7%	-31.7%	-31.7%	-20.3%	-15.4%	-13.2%	-13.2%	-9.7%
Average Achieved CO ₂ - MY 2030 (g/mi)	226.3	301.5	299.0	299.4	273.1	262.0	256.5	257.5	248.3
Total Regulatory Costs through MY 2029 Vehicles									
Total Technology Costs (\$b)	38.0	-32.1	-31.7	-30.6	-22.8	-16.0	-14.5	-9.6	-6.3
Total Civil Penalties (\$b)	0.0	0.0	0.0	0.0	0.0	0.0	0.0	0.0	0.0
Total Regulatory Costs (\$b)	38.0	-32.1	-31.7	-30.6	-22.8	-16.0	-14.5	-9.6	-6.3
Average Price Increase for MY 2030 Vehicles									
Price Increase due to New CAFE Standards (\$)	3076	-2691	-2635	-2477	-1801	-1094	-758	-138	-144
Technology Use under CAFE Alternative in MY 2030 (total fleet penetration)									

*** EO 12866 Review – Draft – Do Not Cite, Quote or Release During Review ***

Curb Weight Reduction (percent change from MY 2016)	6.3%	3.1%	3.1%	3.1%	3.7%	6.2%	6.3%	6.4%	6.3%
High Compression Ratio Non-Turbo Engines	0.0%	0.0%	0.0%	0.0%	0.0%	0.0%	0.0%	0.0%	0.0%
Turbocharged Gasoline Engines	100.0%	55.8%	59.1%	77.2%	86.1%	86.1%	100.0%	100.0%	100.0%
Dynamic Cylinder Deactivation	0.0%	0.0%	0.0%	0.0%	0.0%	0.0%	0.0%	0.0%	0.0%
Stop-Start 12V (Non-Hybrid)	12.8%	13.4%	13.4%	13.4%	0.0%	0.3%	6.1%	13.7%	7.3%
Mild Hybrid Electric Systems (48v)	82.2%	0.0%	0.0%	0.0%	13.4%	30.0%	30.9%	57.3%	53.7%
Strong Hybrid Electric Systems	0.0%	0.0%	0.0%	0.0%	0.0%	0.0%	0.0%	0.0%	0.0%
Plug-In Hybrid Electric Vehicles (PHEVs)	0.0%	0.0%	0.0%	0.0%	0.0%	0.0%	0.0%	0.0%	0.0%
Dedicated Electric Vehicles (EVs)	0.0%	0.0%	0.0%	0.0%	0.0%	0.0%	0.0%	0.0%	0.0%
Fuel Cell Vehicles (FCVs)	0.0%	0.0%	0.0%	0.0%	0.0%	0.0%	0.0%	0.0%	0.0%

*** EO 12866 Review – Draft – Do Not Cite, Quote or Release During Review ***

TABLE 6-130 - IMPACTS ON CARBON DIOXIDE EMISSIONS, REGULATORY COST, AVERAGE PRICE, AND TECHNOLOGY USE FOR ALL LIGHT-DUTY VEHICLES PRODUCED BY FORD, CO₂ PROGRAM

	Alternative								
	No Action	1	2	3	4	5	6	7	8
Model Years	2021-2025	2021-2026	2021-2026	2021-2026	2021-2026	2022-2026	2021-2026	2021-2026	2022-2026
Annual Rate of Stringency Increase	MY 2017-2021 Final MY 2022-2025 Augural	0.0%/Year PC LT	0.5%/Year PC LT	0.5%/Year PC LT	1.0%/Year PC LT	1.0%/Year PC LT	2.0%/Year PC LT	2.0%/Year PC LT	2.0%/Year PC LT
AC/Off-Cycle Procedures	No Change	No Change	No Change	Phaseout 2022-2026	No Change	No Change	No Change	Phaseout 2022-2026	No Change
Average CO₂ Emission Rate									
Average Required CO ₂ - MY 2026+ (g/mi)	194.9	260.3	252.7	253.0	236.8	228.7	223.9	224.3	218.1
Percent Change in Stringency from Baseline	0.0%	-33.5%	-29.7%	-29.8%	-21.5%	-17.4%	-14.9%	-15.1%	-11.9%
Average Achieved CO ₂ - MY 2030 (g/mi)	194.4	254.2	250.7	253.3	235.6	227.1	223.0	224.3	217.7
Total Regulatory Costs through MY 2029 Vehicles									
Total Technology Costs (\$b)	67.7	-52.9	-51.1	-49.6	-40.7	-31.1	-28.5	-19.8	-16.0
Total Civil Penalties (\$b)	0.0	0.0	0.0	0.0	0.0	0.0	0.0	0.0	0.0
Total Regulatory Costs (\$b)	67.7	-52.9	-51.1	-49.6	-40.7	-31.1	-28.5	-19.8	-16.0
Average Price Increase for MY 2030 Vehicles									
Price Increase due to New CAFE Standards (\$)	2964	-2428	-2329	-2236	-1782	-1227	-948	-440	-464
Technology Use under CAFE Alternative in MY 2030 (total fleet penetration)									

*** EO 12866 Review – Draft – Do Not Cite, Quote or Release During Review ***

Curb Weight Reduction (percent change from MY 2016)	6.4%	4.2%	4.2%	4.1%	4.3%	6.0%	6.5%	6.5%	6.5%
High Compression Ratio Non-Turbo Engines	2.7%	3.0%	3.0%	2.9%	2.9%	2.8%	2.8%	2.7%	2.7%
Turbocharged Gasoline Engines	97.2%	53.7%	65.6%	76.0%	82.1%	86.4%	95.3%	97.2%	95.6%
Dynamic Cylinder Deactivation	0.0%	0.0%	0.0%	0.0%	0.0%	0.0%	0.0%	0.0%	0.0%
Stop-Start 12V (Non-Hybrid)	21.0%	8.0%	8.0%	8.0%	0.9%	1.0%	4.2%	19.3%	5.9%
Mild Hybrid Electric Systems (48v)	70.9%	0.0%	0.0%	0.0%	7.3%	16.5%	17.1%	32.0%	30.0%
Strong Hybrid Electric Systems	1.8%	2.0%	2.0%	1.9%	1.9%	1.8%	1.8%	1.8%	1.8%
Plug-In Hybrid Electric Vehicles (PHEVs)	0.9%	1.0%	1.0%	1.0%	1.0%	0.9%	0.9%	0.9%	0.9%
Dedicated Electric Vehicles (EVs)	0.1%	0.1%	0.1%	0.1%	0.1%	0.1%	0.1%	0.1%	0.1%
Fuel Cell Vehicles (FCVs)	0.0%	0.0%	0.0%	0.0%	0.0%	0.0%	0.0%	0.0%	0.0%

*** EO 12866 Review – Draft – Do Not Cite, Quote or Release During Review ***

TABLE 6-131 - IMPACTS ON CARBON DIOXIDE EMISSIONS, REGULATORY COST, AVERAGE PRICE, AND TECHNOLOGY USE FOR PASSENGER CARS PRODUCED BY GENERAL MOTORS, CO₂ PROGRAM

	Alternative								
	No Action	1	2	3	4	5	6	7	8
Model Years	2021-2025	2021-2026	2021-2026	2021-2026	2021-2026	2022-2026	2021-2026	2021-2026	2022-2026
Annual Rate of Stringency Increase	MY 2017-2021 Final MY 2022-2025 Augural	0.0%/Year PC 0.0%/Year LT	0.5%/Year PC 0.5%/Year LT	0.5%/Year PC 0.5%/Year LT	1.0%/Year PC 2.0%/Year LT	1.0%/Year PC 2.0%/Year LT	2.0%/Year PC 3.0%/Year LT	2.0%/Year PC 3.0%/Year LT	2.0%/Year PC 3.0%/Year LT
AC/Off-Cycle Procedures	No Change	No Change	No Change	Phaseout 2022-2026	No Change	No Change	No Change	Phaseout 2022-2026	No Change
Average CO₂ Emission Rate									
Average Required CO ₂ - MY 2026+ (g/mi)	154.0	206.0	200.0	200.0	194.0	188.0	182.0	182.0	178.0
Percent Change in Stringency from Baseline	0.0%	-33.8%	-29.9%	-29.9%	-26.0%	-22.1%	-18.2%	-18.2%	-15.6%
Average Achieved CO ₂ - MY 2030 (g/mi)	154.2	201.8	199.1	201.4	187.7	186.1	181.2	181.8	177.9
Total Regulatory Costs through MY 2029 Vehicles									
Total Technology Costs (\$b)	34.2	-26.0	-25.0	-22.9	-21.5	-17.4	-16.5	-10.2	-11.3
Total Civil Penalties (\$b)	0.0	0.0	0.0	0.0	0.0	0.0	0.0	0.0	0.0
Total Regulatory Costs (\$b)	34.2	-26.0	-25.0	-22.9	-21.5	-17.4	-16.5	-10.2	-11.3
Average Price Increase for MY 2030 Vehicles									
Price Increase due to New CAFE Standards (\$)	2975	-2395	-2309	-2117	-1870	-1719	-1368	-594	-966
Technology Use under CAFE Alternative in MY 2030 (total fleet penetration)									

*** EO 12866 Review – Draft – Do Not Cite, Quote or Release During Review ***

Curb Weight Reduction (percent change from MY 2016)	7.8%	4.9%	5.0%	6.4%	6.3%	7.0%	7.6%	7.8%	7.8%
High Compression Ratio Non-Turbo Engines	0.5%	0.6%	0.6%	0.6%	0.5%	0.5%	0.5%	0.5%	0.5%
Turbocharged Gasoline Engines	97.9%	71.5%	71.5%	71.7%	89.7%	89.8%	97.0%	97.0%	97.0%
Dynamic Cylinder Deactivation	0.6%	0.0%	0.0%	0.0%	0.0%	0.0%	0.0%	0.6%	0.0%
Stop-Start 12V (Non-Hybrid)	0.0%	31.9%	31.9%	31.7%	31.4%	31.0%	31.7%	26.1%	70.5%
Mild Hybrid Electric Systems (48v)	93.0%	0.5%	0.5%	0.5%	0.5%	0.5%	0.5%	54.4%	0.5%
Strong Hybrid Electric Systems	4.2%	0.6%	0.6%	0.6%	0.5%	0.5%	0.5%	0.5%	0.5%
Plug-In Hybrid Electric Vehicles (PHEVs)	0.8%	0.8%	0.8%	0.8%	0.8%	0.8%	0.8%	0.8%	0.8%
Dedicated Electric Vehicles (EVs)	0.2%	0.3%	0.3%	0.3%	0.3%	0.3%	0.3%	0.2%	0.2%
Fuel Cell Vehicles (FCVs)	0.0%	0.0%	0.0%	0.0%	0.0%	0.0%	0.0%	0.0%	0.0%

*** EO 12866 Review – Draft – Do Not Cite, Quote or Release During Review ***

TABLE 6-132 - IMPACTS ON CARBON DIOXIDE EMISSIONS, REGULATORY COST, AVERAGE PRICE, AND TECHNOLOGY USE FOR LIGHT TRUCKS PRODUCED BY GENERAL MOTORS, CO₂ PROGRAM

	Alternative								
	No Action	1	2	3	4	5	6	7	8
Model Years	2021-2025	2021-2026	2021-2026	2021-2026	2021-2026	2022-2026	2021-2026	2021-2026	2022-2026
Annual Rate of Stringency Increase	MY 2017-2021 Final MY 2022-2025 Augural	0.0%/Year PC 0.0%/Year LT	0.5%/Year PC 0.5%/Year LT	0.5%/Year PC 0.5%/Year LT	1.0%/Year PC 2.0%/Year LT	1.0%/Year PC 2.0%/Year LT	2.0%/Year PC 3.0%/Year LT	2.0%/Year PC 3.0%/Year LT	2.0%/Year PC 3.0%/Year LT
AC/Off-Cycle Procedures	No Change	No Change	No Change	Phaseout 2022-2026	No Change	No Change	No Change	Phaseout 2022-2026	No Change
Average CO₂ Emission Rate									
Average Required CO ₂ - MY 2026+ (g/mi)	228.0	308.0	299.0	299.0	273.0	262.0	257.0	257.0	249.0
Percent Change in Stringency from Baseline	0.0%	-35.1%	-31.1%	-31.1%	-19.7%	-14.9%	-12.7%	-12.7%	-9.2%
Average Achieved CO ₂ - MY 2030 (g/mi)	228.4	292.3	292.3	297.6	272.8	262.1	254.9	257.2	249.4
Total Regulatory Costs through MY 2029 Vehicles									
Total Technology Costs (\$b)	44.3	-33.2	-33.1	-32.4	-26.5	-18.5	-16.3	-7.5	-7.7
Total Civil Penalties (\$b)	0.0	0.0	0.0	0.0	0.0	0.0	0.0	0.0	0.0
Total Regulatory Costs (\$b)	44.3	-33.2	-33.1	-32.4	-26.5	-18.5	-16.3	-7.5	-7.7
Average Price Increase for MY 2030 Vehicles									
Price Increase due to New CAFE Standards (\$)	3183	-2549	-2548	-2470	-1867	-1434	-914	-87	-560
Technology Use under CAFE Alternative in MY 2030 (total fleet penetration)									

*** EO 12866 Review – Draft – Do Not Cite, Quote or Release During Review ***

Curb Weight Reduction (percent change from MY 2016)	9.5%	5.0%	5.0%	5.2%	7.0%	7.6%	9.5%	9.5%	9.5%
High Compression Ratio Non-Turbo Engines	0.0%	0.0%	0.0%	0.0%	0.0%	0.0%	0.0%	0.0%	0.0%
Turbocharged Gasoline Engines	40.3%	31.5%	31.5%	33.1%	40.3%	40.3%	40.3%	40.3%	40.3%
Dynamic Cylinder Deactivation	58.4%	0.0%	0.0%	0.0%	0.0%	0.0%	0.0%	56.8%	0.0%
Stop-Start 12V (Non-Hybrid)	0.0%	0.9%	0.9%	0.9%	0.9%	5.0%	1.7%	0.0%	1.0%
Mild Hybrid Electric Systems (48v)	98.9%	0.2%	0.2%	0.2%	0.2%	40.7%	58.4%	97.1%	90.3%
Strong Hybrid Electric Systems	0.0%	0.0%	0.0%	0.0%	0.0%	0.0%	0.0%	2.6%	0.0%
Plug-In Hybrid Electric Vehicles (PHEVs)	0.0%	0.0%	0.0%	0.0%	0.0%	0.0%	0.0%	0.0%	0.0%
Dedicated Electric Vehicles (EVs)	0.0%	0.0%	0.0%	0.0%	0.0%	0.0%	0.0%	0.0%	0.0%
Fuel Cell Vehicles (FCVs)	0.0%	0.0%	0.0%	0.0%	0.0%	0.0%	0.0%	0.0%	0.0%

*** EO 12866 Review – Draft – Do Not Cite, Quote or Release During Review ***

TABLE 6-133 - IMPACTS ON CARBON DIOXIDE EMISSIONS, REGULATORY COST, AVERAGE PRICE, AND TECHNOLOGY USE FOR ALL LIGHT-DUTY VEHICLES PRODUCED BY GENERAL MOTORS, CO₂ PROGRAM

	Alternative								
	No Action	1	2	3	4	5	6	7	8
Model Years	2021-2025	2021-2026	2021-2026	2021-2026	2021-2026	2022-2026	2021-2026	2021-2026	2022-2026
Annual Rate of Stringency Increase	MY 2017-2021 Final MY 2022-2025 Augural	0.0%/Year PC 0.0%/Year LT	0.5%/Year PC 0.5%/Year LT	0.5%/Year PC 0.5%/Year LT	1.0%/Year PC 2.0%/Year LT	1.0%/Year PC 2.0%/Year LT	2.0%/Year PC 3.0%/Year LT	2.0%/Year PC 3.0%/Year LT	2.0%/Year PC 3.0%/Year LT
AC/Off-Cycle Procedures	No Change	No Change	No Change	Phaseout 2022-2026	No Change	No Change	No Change	Phaseout 2022-2026	No Change
Average CO₂ Emission Rate									
Average Required CO ₂ - MY 2026+ (g/mi)	195.5	260.6	253.1	253.3	237.0	228.9	223.6	223.9	217.7
Percent Change in Stringency from Baseline	0.0%	-33.3%	-29.4%	-29.6%	-21.2%	-17.1%	-14.4%	-14.5%	-11.4%
Average Achieved CO ₂ - MY 2030 (g/mi)	195.8	250.3	249.0	253.2	234.1	228.1	222.1	224.0	217.9
Total Regulatory Costs through MY 2029 Vehicles									
Total Technology Costs (\$b)	78.5	-59.2	-58.1	-55.4	-48.0	-35.9	-32.7	-17.7	-19.0
Total Civil Penalties (\$b)	0.0	0.0	0.0	0.0	0.0	0.0	0.0	0.0	0.0
Total Regulatory Costs (\$b)	78.5	-59.2	-58.1	-55.4	-48.0	-35.9	-32.7	-17.7	-19.0
Average Price Increase for MY 2030 Vehicles									
Price Increase due to New CAFE Standards (\$)	3092	-2483	-2442	-2312	-1872	-1563	-1118	-311	-739
Technology Use under CAFE Alternative in MY 2030 (total fleet penetration)									

*** EO 12866 Review – Draft – Do Not Cite, Quote or Release During Review ***

Curb Weight Reduction (percent change from MY 2016)	8.2%	5.1%	5.1%	5.6%	6.6%	6.9%	8.3%	8.2%	8.2%
High Compression Ratio Non-Turbo Engines	0.2%	0.3%	0.3%	0.3%	0.2%	0.2%	0.2%	0.2%	0.2%
Turbocharged Gasoline Engines	65.6%	50.1%	50.0%	51.0%	62.8%	62.4%	65.5%	65.3%	65.3%
Dynamic Cylinder Deactivation	33.0%	0.0%	0.0%	0.0%	0.0%	0.0%	0.0%	32.0%	0.0%
Stop-Start 12V (Non-Hybrid)	0.0%	15.3%	15.3%	15.2%	14.8%	16.7%	15.1%	11.5%	31.7%
Mild Hybrid Electric Systems (48v)	96.3%	0.3%	0.3%	0.3%	0.3%	22.7%	32.6%	78.3%	50.7%
Strong Hybrid Electric Systems	1.8%	0.3%	0.3%	0.3%	0.2%	0.2%	0.2%	1.7%	0.2%
Plug-In Hybrid Electric Vehicles (PHEVs)	0.3%	0.4%	0.4%	0.4%	0.4%	0.3%	0.3%	0.3%	0.3%
Dedicated Electric Vehicles (EVs)	0.1%	0.1%	0.1%	0.1%	0.1%	0.1%	0.1%	0.1%	0.1%
Fuel Cell Vehicles (FCVs)	0.0%	0.0%	0.0%	0.0%	0.0%	0.0%	0.0%	0.0%	0.0%

*** EO 12866 Review – Draft – Do Not Cite, Quote or Release During Review ***

TABLE 6-134 - IMPACTS ON CARBON DIOXIDE EMISSIONS, REGULATORY COST, AVERAGE PRICE, AND TECHNOLOGY USE FOR PASSENGER CARS PRODUCED BY HONDA, CO₂ PROGRAM

	Alternative								
	No Action	1	2	3	4	5	6	7	8
Model Years	2021-2025	2021-2026	2021-2026	2021-2026	2021-2026	2022-2026	2021-2026	2021-2026	2022-2026
Annual Rate of Stringency Increase	MY 2017-2021 Final MY 2022-2025 Augural	0.0%/Year PC 0.0%/Year LT	0.5%/Year PC 0.5%/Year LT	0.5%/Year PC 0.5%/Year LT	1.0%/Year PC 2.0%/Year LT	1.0%/Year PC 2.0%/Year LT	2.0%/Year PC 3.0%/Year LT	2.0%/Year PC 3.0%/Year LT	2.0%/Year PC 3.0%/Year LT
AC/Off-Cycle Procedures	No Change	No Change	No Change	Phaseout 2022-2026	No Change	No Change	No Change	Phaseout 2022-2026	No Change
Average CO₂ Emission Rate									
Average Required CO ₂ - MY 2026+ (g/mi)	149.0	200.0	194.0	194.0	188.0	182.0	177.0	177.0	173.0
Percent Change in Stringency from Baseline	0.0%	-34.2%	-30.2%	-30.2%	-26.2%	-22.1%	-18.8%	-18.8%	-16.1%
Average Achieved CO ₂ - MY 2030 (g/mi)	147.8	188.4	188.4	193.0	187.4	180.7	175.9	173.0	165.8
Total Regulatory Costs through MY 2029 Vehicles									
Total Technology Costs (\$b)	14.7	-11.7	-11.6	-11.5	-11.4	-9.7	-8.0	-4.2	-3.8
Total Civil Penalties (\$b)	0.0	0.0	0.0	0.0	0.0	0.0	0.0	0.0	0.0
Total Regulatory Costs (\$b)	14.7	-11.7	-11.6	-11.5	-11.4	-9.7	-8.0	-4.2	-3.8
Average Price Increase for MY 2030 Vehicles									
Price Increase due to New CAFE Standards (\$)	1353	-1082	-1082	-1073	-1057	-880	-706	-313	-273
Technology Use under CAFE Alternative in MY 2030 (total fleet penetration)									

*** EO 12866 Review – Draft – Do Not Cite, Quote or Release During Review ***

Curb Weight Reduction (percent change from MY 2016)	5.7%	1.8%	1.8%	1.7%	1.7%	3.0%	4.4%	4.8%	4.8%
High Compression Ratio Non-Turbo Engines	0.0%	0.0%	0.0%	0.0%	0.0%	0.0%	0.0%	0.0%	0.0%
Turbocharged Gasoline Engines	100.0%	59.3%	59.3%	59.3%	59.3%	65.5%	65.4%	87.5%	99.8%
Dynamic Cylinder Deactivation	0.0%	0.0%	0.0%	0.0%	0.0%	0.0%	0.0%	0.0%	0.0%
Stop-Start 12V (Non-Hybrid)	3.0%	3.2%	3.2%	3.2%	3.1%	3.1%	3.1%	3.1%	3.0%
Mild Hybrid Electric Systems (48v)	0.2%	0.2%	0.2%	0.2%	0.2%	0.2%	0.2%	0.2%	0.2%
Strong Hybrid Electric Systems	0.0%	0.0%	0.0%	0.0%	0.0%	0.0%	0.0%	0.0%	0.0%
Plug-In Hybrid Electric Vehicles (PHEVs)	0.0%	0.0%	0.0%	0.0%	0.0%	0.0%	0.0%	0.0%	0.0%
Dedicated Electric Vehicles (EVs)	0.0%	0.0%	0.0%	0.0%	0.0%	0.0%	0.0%	0.0%	0.0%
Fuel Cell Vehicles (FCVs)	0.0%	0.0%	0.0%	0.0%	0.0%	0.0%	0.0%	0.0%	0.0%

*** EO 12866 Review – Draft – Do Not Cite, Quote or Release During Review ***

TABLE 6-135 - IMPACTS ON CARBON DIOXIDE EMISSIONS, REGULATORY COST, AVERAGE PRICE, AND TECHNOLOGY USE FOR LIGHT TRUCKS PRODUCED BY HONDA, CO₂ PROGRAM

	Alternative								
	No Action	1	2	3	4	5	6	7	8
Model Years	2021-2025	2021-2026	2021-2026	2021-2026	2021-2026	2022-2026	2021-2026	2021-2026	2022-2026
Annual Rate of Stringency Increase	MY 2017-2021 Final MY 2022-2025 Augural	0.0%/Year PC 0.0%/Year LT	0.5%/Year PC 0.5%/Year LT	0.5%/Year PC 0.5%/Year LT	1.0%/Year PC 2.0%/Year LT	1.0%/Year PC 2.0%/Year LT	2.0%/Year PC 3.0%/Year LT	2.0%/Year PC 3.0%/Year LT	2.0%/Year PC 3.0%/Year LT
AC/Off-Cycle Procedures	No Change	No Change	No Change	Phaseout 2022-2026	No Change	No Change	No Change	Phaseout 2022-2026	No Change
Average CO₂ Emission Rate									
Average Required CO ₂ - MY 2026+ (g/mi)	193.0	265.0	257.0	257.0	235.0	224.0	221.0	221.0	213.0
Percent Change in Stringency from Baseline	0.0%	-37.3%	-33.2%	-33.2%	-21.8%	-16.1%	-14.5%	-14.5%	-10.4%
Average Achieved CO ₂ - MY 2030 (g/mi)	193.3	237.7	237.7	242.7	235.5	221.7	217.6	217.1	209.5
Total Regulatory Costs through MY 2029 Vehicles									
Total Technology Costs (\$b)	13.2	-9.7	-9.4	-9.4	-8.8	-5.3	-4.0	0.2	1.0
Total Civil Penalties (\$b)	0.0	0.0	0.0	0.0	0.0	0.0	0.0	0.0	0.0
Total Regulatory Costs (\$b)	13.2	-9.7	-9.4	-9.4	-8.8	-5.3	-4.0	0.2	1.0
Average Price Increase for MY 2030 Vehicles									
Price Increase due to New CAFE Standards (\$)	1908	-1486	-1486	-1486	-1438	-931	-774	-138	-33
Technology Use under CAFE Alternative in MY 2030 (total fleet penetration)									

*** EO 12866 Review – Draft – Do Not Cite, Quote or Release During Review ***

Curb Weight Reduction (percent change from MY 2016)	7.1%	2.5%	2.5%	2.5%	2.5%	5.1%	5.1%	7.8%	7.8%
High Compression Ratio Non-Turbo Engines	0.0%	0.0%	0.0%	0.0%	0.0%	0.0%	0.0%	0.0%	0.0%
Turbocharged Gasoline Engines	100.0%	100.0%	100.0%	100.0%	100.0%	100.0%	100.0%	100.0%	100.0%
Dynamic Cylinder Deactivation	0.0%	0.0%	0.0%	0.0%	0.0%	0.0%	0.0%	0.0%	0.0%
Stop-Start 12V (Non-Hybrid)	25.2%	9.4%	9.4%	9.4%	9.4%	9.4%	2.0%	8.5%	25.2%
Mild Hybrid Electric Systems (48v)	7.4%	0.0%	0.0%	0.0%	0.0%	0.0%	7.4%	7.4%	7.4%
Strong Hybrid Electric Systems	0.0%	0.0%	0.0%	0.0%	0.0%	0.0%	0.0%	0.0%	0.0%
Plug-In Hybrid Electric Vehicles (PHEVs)	0.0%	0.0%	0.0%	0.0%	0.0%	0.0%	0.0%	0.0%	0.0%
Dedicated Electric Vehicles (EVs)	0.0%	0.0%	0.0%	0.0%	0.0%	0.0%	0.0%	0.0%	0.0%
Fuel Cell Vehicles (FCVs)	0.0%	0.0%	0.0%	0.0%	0.0%	0.0%	0.0%	0.0%	0.0%

*** EO 12866 Review – Draft – Do Not Cite, Quote or Release During Review ***

TABLE 6-136 - IMPACTS ON CARBON DIOXIDE EMISSIONS, REGULATORY COST, AVERAGE PRICE, AND TECHNOLOGY USE FOR ALL LIGHT-DUTY VEHICLES PRODUCED BY HONDA, CO₂ PROGRAM

	Alternative								
	No Action	1	2	3	4	5	6	7	8
Model Years	2021-2025	2021-2026	2021-2026	2021-2026	2021-2026	2022-2026	2021-2026	2021-2026	2022-2026
Annual Rate of Stringency Increase	MY 2017-2021 Final MY 2022-2025 Augural	0.0%/Year PC 0.0%/Year LT	0.5%/Year PC 0.5%/Year LT	0.5%/Year PC 0.5%/Year LT	1.0%/Year PC 2.0%/Year LT	1.0%/Year PC 2.0%/Year LT	2.0%/Year PC 3.0%/Year LT	2.0%/Year PC 3.0%/Year LT	2.0%/Year PC 3.0%/Year LT
AC/Off-Cycle Procedures	No Change	No Change	No Change	Phaseout 2022-2026	No Change	No Change	No Change	Phaseout 2022-2026	No Change
Average CO₂ Emission Rate									
Average Required CO ₂ - MY 2026+ (g/mi)	167.9	226.2	219.4	219.5	207.4	199.6	195.6	195.8	190.1
Percent Change in Stringency from Baseline	0.0%	-34.7%	-30.7%	-30.8%	-23.5%	-18.9%	-16.5%	-16.6%	-13.2%
Average Achieved CO ₂ - MY 2030 (g/mi)	167.3	208.3	208.3	213.2	207.2	197.9	193.5	191.8	184.4
Total Regulatory Costs through MY 2029 Vehicles									
Total Technology Costs (\$b)	27.9	-21.3	-21.0	-21.0	-20.2	-15.0	-11.9	-4.0	-2.9
Total Civil Penalties (\$b)	0.0	0.0	0.0	0.0	0.0	0.0	0.0	0.0	0.0
Total Regulatory Costs (\$b)	27.9	-21.3	-21.0	-21.0	-20.2	-15.0	-11.9	-4.0	-2.9
Average Price Increase for MY 2030 Vehicles									
Price Increase due to New CAFE Standards (\$)	1591	-1259	-1259	-1254	-1224	-906	-738	-239	-172
Technology Use under CAFE Alternative in MY 2030 (total fleet penetration)									

*** EO 12866 Review – Draft – Do Not Cite, Quote or Release During Review ***

Curb Weight Reduction (percent change from MY 2016)	5.8%	2.2%	2.2%	2.1%	1.9%	3.7%	4.3%	5.7%	5.7%
High Compression Ratio Non-Turbo Engines	0.0%	0.0%	0.0%	0.0%	0.0%	0.0%	0.0%	0.0%	0.0%
Turbocharged Gasoline Engines	100.0%	75.7%	75.7%	75.8%	76.1%	80.0%	80.0%	92.8%	99.9%
Dynamic Cylinder Deactivation	0.0%	0.0%	0.0%	0.0%	0.0%	0.0%	0.0%	0.0%	0.0%
Stop-Start 12V (Non-Hybrid)	12.6%	5.7%	5.7%	5.7%	5.7%	5.7%	2.6%	5.4%	12.5%
Mild Hybrid Electric Systems (48v)	3.3%	0.1%	0.1%	0.1%	0.1%	0.1%	3.2%	3.2%	3.2%
Strong Hybrid Electric Systems	0.0%	0.0%	0.0%	0.0%	0.0%	0.0%	0.0%	0.0%	0.0%
Plug-In Hybrid Electric Vehicles (PHEVs)	0.0%	0.0%	0.0%	0.0%	0.0%	0.0%	0.0%	0.0%	0.0%
Dedicated Electric Vehicles (EVs)	0.0%	0.0%	0.0%	0.0%	0.0%	0.0%	0.0%	0.0%	0.0%
Fuel Cell Vehicles (FCVs)	0.0%	0.0%	0.0%	0.0%	0.0%	0.0%	0.0%	0.0%	0.0%

*** EO 12866 Review – Draft – Do Not Cite, Quote or Release During Review ***

TABLE 6-137 - IMPACTS ON CARBON DIOXIDE EMISSIONS, REGULATORY COST, AVERAGE PRICE, AND TECHNOLOGY USE FOR PASSENGER CARS PRODUCED BY HYUNDAI, CO₂ PROGRAM

	Alternative								
	No Action	1	2	3	4	5	6	7	8
Model Years	2021-2025	2021-2026	2021-2026	2021-2026	2021-2026	2022-2026	2021-2026	2021-2026	2022-2026
Annual Rate of Stringency Increase	MY 2017-2021 Final MY 2022-2025 Augural	0.0%/Year PC 0.0%/Year LT	0.5%/Year PC 0.5%/Year LT	0.5%/Year PC 0.5%/Year LT	1.0%/Year PC 2.0%/Year LT	1.0%/Year PC 2.0%/Year LT	2.0%/Year PC 3.0%/Year LT	2.0%/Year PC 3.0%/Year LT	2.0%/Year PC 3.0%/Year LT
AC/Off-Cycle Procedures	No Change	No Change	No Change	Phaseout 2022-2026	No Change	No Change	No Change	Phaseout 2022-2026	No Change
Average CO₂ Emission Rate									
Average Required CO ₂ - MY 2026+ (g/mi)	152.0	204.0	198.0	198.0	192.0	186.0	181.0	181.0	177.0
Percent Change in Stringency from Baseline	0.0%	-34.2%	-30.3%	-30.3%	-26.3%	-22.4%	-19.1%	-19.1%	-16.4%
Average Achieved CO ₂ - MY 2030 (g/mi)	150.5	180.4	180.4	185.5	180.8	181.2	179.1	179.9	177.5
Total Regulatory Costs through MY 2029 Vehicles									
Total Technology Costs (\$b)	5.4	-2.3	-2.3	-2.3	-2.3	-2.4	-2.0	-1.7	-2.0
Total Civil Penalties (\$b)	0.0	0.0	0.0	0.0	0.0	0.0	0.0	0.0	0.0
Total Regulatory Costs (\$b)	5.4	-2.3	-2.3	-2.3	-2.3	-2.4	-2.0	-1.7	-2.0
Average Price Increase for MY 2030 Vehicles									
Price Increase due to New CAFE Standards (\$)	1029	-673	-673	-673	-672	-672	-553	-419	-508
Technology Use under CAFE Alternative in MY 2030 (total fleet penetration)									

*** EO 12866 Review – Draft – Do Not Cite, Quote or Release During Review ***

Curb Weight Reduction (percent change from MY 2016)	2.0%	0.5%	0.4%	0.4%	0.3%	0.2%	0.4%	0.6%	0.4%
High Compression Ratio Non-Turbo Engines	83.7%	60.2%	60.2%	60.2%	60.2%	60.2%	60.2%	60.2%	60.2%
Turbocharged Gasoline Engines	16.3%	15.2%	15.2%	15.3%	15.5%	15.7%	15.8%	16.0%	16.0%
Dynamic Cylinder Deactivation	0.0%	0.0%	0.0%	0.0%	0.0%	0.0%	0.0%	0.0%	0.0%
Stop-Start 12V (Non-Hybrid)	0.0%	0.0%	0.0%	0.0%	0.0%	0.0%	0.0%	0.0%	0.0%
Mild Hybrid Electric Systems (48v)	0.0%	0.0%	0.0%	0.0%	0.0%	0.0%	0.0%	0.0%	0.0%
Strong Hybrid Electric Systems	2.8%	2.9%	2.9%	2.9%	2.9%	2.9%	2.8%	2.8%	2.8%
Plug-In Hybrid Electric Vehicles (PHEVs)	0.2%	0.2%	0.2%	0.2%	0.2%	0.2%	0.2%	0.2%	0.2%
Dedicated Electric Vehicles (EVs)	0.0%	0.0%	0.0%	0.0%	0.0%	0.0%	0.0%	0.0%	0.0%
Fuel Cell Vehicles (FCVs)	0.0%	0.0%	0.0%	0.0%	0.0%	0.0%	0.0%	0.0%	0.0%

*** EO 12866 Review – Draft – Do Not Cite, Quote or Release During Review ***

TABLE 6-138 - IMPACTS ON CARBON DIOXIDE EMISSIONS, REGULATORY COST, AVERAGE PRICE, AND TECHNOLOGY USE FOR LIGHT TRUCKS PRODUCED BY HYUNDAI, CO₂ PROGRAM

	Alternative								
	No Action	1	2	3	4	5	6	7	8
Model Years	2021-2025	2021-2026	2021-2026	2021-2026	2021-2026	2022-2026	2021-2026	2021-2026	2022-2026
Annual Rate of Stringency Increase	MY 2017-2021 Final PC MY 2022-2025 Augural LT	0.0%/Year PC 0.0%/Year LT	0.5%/Year PC 0.5%/Year LT	0.5%/Year PC 0.5%/Year LT	1.0%/Year PC 2.0%/Year LT	1.0%/Year PC 2.0%/Year LT	2.0%/Year PC 3.0%/Year LT	2.0%/Year PC 3.0%/Year LT	2.0%/Year PC 3.0%/Year LT
AC/Off-Cycle Procedures	No Change	No Change	No Change	Phaseout 2022-2026	No Change	No Change	No Change	Phaseout 2022-2026	No Change
Average CO₂ Emission Rate									
Average Required CO ₂ - MY 2026+ (g/mi)	192.0	265.0	257.0	257.0	234.0	224.0	220.0	220.0	213.0
Percent Change in Stringency from Baseline	0.0%	-38.0%	-33.9%	-33.9%	-21.9%	-16.7%	-14.6%	-14.6%	-10.9%
Average Achieved CO ₂ - MY 2030 (g/mi)	191.4	236.0	236.0	245.0	236.0	236.0	219.9	218.4	212.4
Total Regulatory Costs through MY 2029 Vehicles									
Total Technology Costs (\$b)	0.4	-0.2	-0.2	-0.2	-0.2	-0.2	-0.2	-0.2	-0.2
Total Civil Penalties (\$b)	0.0	0.0	0.0	0.0	0.0	0.0	0.0	0.0	0.0
Total Regulatory Costs (\$b)	0.4	-0.2	-0.2	-0.2	-0.2	-0.2	-0.2	-0.2	-0.2
Average Price Increase for MY 2030 Vehicles									
Price Increase due to New CAFE Standards (\$)	2101	-1394	-1394	-1394	-1394	-1394	-614	0	-394
Technology Use under CAFE Alternative in MY 2030 (total fleet penetration)									

*** EO 12866 Review – Draft – Do Not Cite, Quote or Release During Review ***

Curb Weight Reduction (percent change from MY 2016)	5.6%	0.0%	0.0%	0.0%	0.0%	0.0%	2.8%	5.6%	2.8%
High Compression Ratio Non-Turbo Engines	0.0%	0.0%	0.0%	0.0%	0.0%	0.0%	0.0%	0.0%	0.0%
Turbocharged Gasoline Engines	100.0%	100.0%	100.0%	100.0%	100.0%	100.0%	100.0%	100.0%	100.0%
Dynamic Cylinder Deactivation	0.0%	0.0%	0.0%	0.0%	0.0%	0.0%	0.0%	0.0%	0.0%
Stop-Start 12V (Non-Hybrid)	0.0%	0.0%	0.0%	0.0%	0.0%	0.0%	0.0%	0.0%	0.0%
Mild Hybrid Electric Systems (48v)	0.0%	0.0%	0.0%	0.0%	0.0%	0.0%	0.0%	0.0%	0.0%
Strong Hybrid Electric Systems	0.0%	0.0%	0.0%	0.0%	0.0%	0.0%	0.0%	0.0%	0.0%
Plug-In Hybrid Electric Vehicles (PHEVs)	0.0%	0.0%	0.0%	0.0%	0.0%	0.0%	0.0%	0.0%	0.0%
Dedicated Electric Vehicles (EVs)	0.0%	0.0%	0.0%	0.0%	0.0%	0.0%	0.0%	0.0%	0.0%
Fuel Cell Vehicles (FCVs)	0.0%	0.0%	0.0%	0.0%	0.0%	0.0%	0.0%	0.0%	0.0%

*** EO 12866 Review – Draft – Do Not Cite, Quote or Release During Review ***

TABLE 6-139 - IMPACTS ON CARBON DIOXIDE EMISSIONS, REGULATORY COST, AVERAGE PRICE, AND TECHNOLOGY USE FOR ALL LIGHT-DUTY VEHICLES PRODUCED BY HYUNDAI, CO₂ PROGRAM

	Alternative								
	No Action	1	2	3	4	5	6	7	8
Model Years	2021-2025	2021-2026	2021-2026	2021-2026	2021-2026	2022-2026	2021-2026	2021-2026	2022-2026
Annual Rate of Stringency Increase	MY 2017-2021 Final MY 2022-2025 Augural	0.0%/Year PC 0.0%/Year LT	0.5%/Year PC 0.5%/Year LT	0.5%/Year PC 0.5%/Year LT	1.0%/Year PC 2.0%/Year LT	1.0%/Year PC 2.0%/Year LT	2.0%/Year PC 3.0%/Year LT	2.0%/Year PC 3.0%/Year LT	2.0%/Year PC 3.0%/Year LT
AC/Off-Cycle Procedures	No Change	No Change	No Change	Phaseout 2022-2026	No Change	No Change	No Change	Phaseout 2022-2026	No Change
Average CO₂ Emission Rate									
Average Required CO ₂ - MY 2026+ (g/mi)	153.2	205.7	199.6	199.6	193.2	187.1	182.2	182.2	178.1
Percent Change in Stringency from Baseline	0.0%	-34.2%	-30.3%	-30.3%	-26.1%	-22.1%	-18.9%	-18.9%	-16.2%
Average Achieved CO ₂ - MY 2030 (g/mi)	151.8	181.9	181.9	187.1	182.4	182.8	180.3	181.1	178.6
Total Regulatory Costs through MY 2029 Vehicles									
Total Technology Costs (\$b)	5.9	-2.5	-2.5	-2.6	-2.6	-2.6	-2.2	-1.9	-2.2
Total Civil Penalties (\$b)	0.0	0.0	0.0	0.0	0.0	0.0	0.0	0.0	0.0
Total Regulatory Costs (\$b)	5.9	-2.5	-2.5	-2.6	-2.6	-2.6	-2.2	-1.9	-2.2
Average Price Increase for MY 2030 Vehicles									
Price Increase due to New CAFE Standards (\$)	1062	-696	-696	-696	-695	-694	-555	-407	-505
Technology Use under CAFE Alternative in MY 2030 (total fleet penetration)									

*** EO 12866 Review – Draft – Do Not Cite, Quote or Release During Review ***

Curb Weight Reduction (percent change from MY 2016)	2.0%	0.4%	0.4%	0.4%	0.3%	0.1%	0.5%	0.8%	0.4%
High Compression Ratio Non-Turbo Engines	81.1%	58.5%	58.5%	58.5%	58.5%	58.4%	58.4%	58.4%	58.4%
Turbocharged Gasoline Engines	18.9%	17.5%	17.5%	17.6%	17.9%	18.2%	18.3%	18.5%	18.5%
Dynamic Cylinder Deactivation	0.0%	0.0%	0.0%	0.0%	0.0%	0.0%	0.0%	0.0%	0.0%
Stop-Start 12V (Non-Hybrid)	0.0%	0.0%	0.0%	0.0%	0.0%	0.0%	0.0%	0.0%	0.0%
Mild Hybrid Electric Systems (48v)	0.0%	0.0%	0.0%	0.0%	0.0%	0.0%	0.0%	0.0%	0.0%
Strong Hybrid Electric Systems	2.7%	2.8%	2.8%	2.8%	2.8%	2.8%	2.8%	2.7%	2.7%
Plug-In Hybrid Electric Vehicles (PHEVs)	0.2%	0.2%	0.2%	0.2%	0.2%	0.2%	0.2%	0.2%	0.2%
Dedicated Electric Vehicles (EVs)	0.0%	0.0%	0.0%	0.0%	0.0%	0.0%	0.0%	0.0%	0.0%
Fuel Cell Vehicles (FCVs)	0.0%	0.0%	0.0%	0.0%	0.0%	0.0%	0.0%	0.0%	0.0%

*** EO 12866 Review – Draft – Do Not Cite, Quote or Release During Review ***

TABLE 6-140 - IMPACTS ON CARBON DIOXIDE EMISSIONS, REGULATORY COST, AVERAGE PRICE, TECHNOLOGY USE FOR PASSENGER CARS PRODUCED BY KIA, CO₂ PROGRAM

	Alternative								
	No Action	1	2	3	4	5	6	7	8
Model Years	2021-2025	2021-2026	2021-2026	2021-2026	2021-2026	2022-2026	2021-2026	2021-2026	2022-2026
Annual Rate of Stringency Increase	MY 2017-2021 Final MY 2022-2025 Augural	0.0%/Year PC 0.0%/Year LT	0.5%/Year PC 0.5%/Year LT	0.5%/Year PC 0.5%/Year LT	1.0%/Year PC 2.0%/Year LT	1.0%/Year PC 2.0%/Year LT	2.0%/Year PC 3.0%/Year LT	2.0%/Year PC 3.0%/Year LT	2.0%/Year PC 3.0%/Year LT
AC/Off-Cycle Procedures	No Change	No Change	No Change	Phaseout 2022-2026	No Change	No Change	No Change	Phaseout 2022-2026	No Change
Average CO₂ Emission Rate									
Average Required CO ₂ - MY 2026+ (g/mi)	151.0	203.0	197.0	197.0	191.0	185.0	180.0	180.0	176.0
Percent Change in Stringency from Baseline	0.0%	-34.4%	-30.5%	-30.5%	-26.5%	-22.5%	-19.2%	-19.2%	-16.6%
Average Achieved CO ₂ - MY 2030 (g/mi)	151.3	184.2	184.2	188.3	184.5	183.8	180.7	178.8	177.5
Total Regulatory Costs through MY 2029 Vehicles									
Total Technology Costs (\$b)	9.8	-6.6	-6.6	-6.6	-6.6	-6.2	-6.1	-5.3	-5.1
Total Civil Penalties (\$b)	0.0	0.0	0.0	0.0	0.0	0.0	0.0	0.0	0.0
Total Regulatory Costs (\$b)	9.8	-6.6	-6.6	-6.6	-6.6	-6.2	-6.1	-5.3	-5.1
Average Price Increase for MY 2030 Vehicles									
Price Increase due to New CAFE Standards (\$)	1709	-1241	-1240	-1240	-1238	-1190	-1107	-783	-959
Technology Use under CAFE Alternative in MY 2030 (total fleet penetration)									

*** EO 12866 Review – Draft – Do Not Cite, Quote or Release During Review ***

Curb Weight Reduction (percent change from MY 2016)	3.1%	0.4%	0.4%	0.4%	0.3%	1.0%	0.3%	1.6%	1.6%
High Compression Ratio Non-Turbo Engines	92.3%	78.0%	78.0%	78.1%	78.4%	78.8%	78.9%	91.4%	79.1%
Turbocharged Gasoline Engines	7.2%	7.3%	7.4%	7.4%	7.3%	7.3%	7.2%	7.2%	7.2%
Dynamic Cylinder Deactivation	0.0%	0.0%	0.0%	0.0%	0.0%	0.0%	0.0%	0.0%	0.0%
Stop-Start 12V (Non-Hybrid)	91.1%	0.4%	0.4%	0.4%	0.4%	0.4%	0.4%	0.4%	0.4%
Mild Hybrid Electric Systems (48v)	4.3%	0.0%	0.0%	0.0%	0.0%	0.0%	0.0%	0.0%	0.0%
Strong Hybrid Electric Systems	0.9%	0.9%	0.9%	0.9%	0.9%	0.9%	0.9%	0.9%	0.9%
Plug-In Hybrid Electric Vehicles (PHEVs)	0.0%	0.0%	0.0%	0.0%	0.0%	0.0%	0.0%	0.0%	0.0%
Dedicated Electric Vehicles (EVs)	0.5%	0.5%	0.5%	0.5%	0.5%	0.5%	0.5%	0.5%	0.5%
Fuel Cell Vehicles (FCVs)	0.0%	0.0%	0.0%	0.0%	0.0%	0.0%	0.0%	0.0%	0.0%

*** EO 12866 Review – Draft – Do Not Cite, Quote or Release During Review ***

TABLE 6-141 - IMPACTS ON CARBON DIOXIDE EMISSIONS, REGULATORY COST, AVERAGE PRICE, AND TECHNOLOGY USE FOR LIGHT TRUCKS PRODUCED BY KIA, CO₂ PROGRAM

	Alternative								
	No Action	1	2	3	4	5	6	7	8
Model Years	2021-2025	2021-2026	2021-2026	2021-2026	2021-2026	2022-2026	2021-2026	2021-2026	2022-2026
Annual Rate of Stringency Increase	MY 2017-2021 Final MY 2022-2025 Augural	0.0%/Year PC 0.0%/Year LT	0.5%/Year PC 0.5%/Year LT	0.5%/Year PC 0.5%/Year LT	1.0%/Year PC 2.0%/Year LT	1.0%/Year PC 2.0%/Year LT	2.0%/Year PC 3.0%/Year LT	2.0%/Year PC 3.0%/Year LT	2.0%/Year PC 3.0%/Year LT
AC/Off-Cycle Procedures	No Change	No Change	No Change	Phaseout 2022-2026	No Change	No Change	No Change	Phaseout 2022-2026	No Change
Average CO₂ Emission Rate									
Average Required CO ₂ - MY 2026+ (g/mi)	201.0	276.0	268.0	268.0	244.0	233.0	230.0	230.0	222.0
Percent Change in Stringency from Baseline	0.0%	-37.3%	-33.3%	-33.3%	-21.4%	-15.9%	-14.4%	-14.4%	-10.4%
Average Achieved CO ₂ - MY 2030 (g/mi)	189.4	230.9	230.9	236.9	230.9	219.5	228.3	230.2	218.1
Total Regulatory Costs through MY 2029 Vehicles									
Total Technology Costs (\$b)	2.7	-1.6	-1.6	-1.6	-1.6	-0.8	-1.5	-1.3	-0.7
Total Civil Penalties (\$b)	0.0	0.0	0.0	0.0	0.0	0.0	0.0	0.0	0.0
Total Regulatory Costs (\$b)	2.7	-1.6	-1.6	-1.6	-1.6	-0.8	-1.5	-1.3	-0.7
Average Price Increase for MY 2030 Vehicles									
Price Increase due to New CAFE Standards (\$)	2074	-1279	-1279	-1279	-1279	-825	-1206	-978	-751
Technology Use under CAFE Alternative in MY 2030 (total fleet penetration)									

*** EO 12866 Review – Draft – Do Not Cite, Quote or Release During Review ***

Curb Weight Reduction (percent change from MY 2016)	5.5%	1.2%	1.2%	1.2%	1.2%	3.9%	1.2%	2.8%	3.9%
High Compression Ratio Non-Turbo Engines	13.6%	13.6%	13.6%	13.6%	13.6%	13.6%	13.6%	13.6%	13.6%
Turbocharged Gasoline Engines	86.4%	86.4%	86.4%	86.4%	86.4%	86.4%	86.4%	86.4%	86.4%
Dynamic Cylinder Deactivation	0.0%	0.0%	0.0%	0.0%	0.0%	0.0%	0.0%	0.0%	0.0%
Stop-Start 12V (Non-Hybrid)	21.7%	0.0%	0.0%	0.0%	0.0%	21.7%	0.0%	0.0%	21.7%
Mild Hybrid Electric Systems (48v)	9.1%	0.0%	0.0%	0.0%	0.0%	0.0%	0.0%	0.0%	9.1%
Strong Hybrid Electric Systems	0.0%	0.0%	0.0%	0.0%	0.0%	0.0%	0.0%	0.0%	0.0%
Plug-In Hybrid Electric Vehicles (PHEVs)	0.0%	0.0%	0.0%	0.0%	0.0%	0.0%	0.0%	0.0%	0.0%
Dedicated Electric Vehicles (EVs)	0.0%	0.0%	0.0%	0.0%	0.0%	0.0%	0.0%	0.0%	0.0%
Fuel Cell Vehicles (FCVs)	0.0%	0.0%	0.0%	0.0%	0.0%	0.0%	0.0%	0.0%	0.0%

*** EO 12866 Review – Draft – Do Not Cite, Quote or Release During Review ***

TABLE 6-142 - IMPACTS ON CARBON DIOXIDE EMISSIONS, REGULATORY COST, AVERAGE PRICE, AND TECHNOLOGY USE FOR ALL LIGHT-DUTY VEHICLES PRODUCED BY KIA, CO₂ PROGRAM

	Alternative								
	No Action	1	2	3	4	5	6	7	8
Model Years	2021-2025	2021-2026	2021-2026	2021-2026	2021-2026	2022-2026	2021-2026	2021-2026	2022-2026
Annual Rate of Stringency Increase	MY 2017-2021 Final MY 2022-2025 Augural	0.0%/Year PC 0.0%/Year LT	0.5%/Year PC 0.5%/Year LT	0.5%/Year PC 0.5%/Year LT	1.0%/Year PC 2.0%/Year LT	1.0%/Year PC 2.0%/Year LT	2.0%/Year PC 3.0%/Year LT	2.0%/Year PC 3.0%/Year LT	2.0%/Year PC 3.0%/Year LT
AC/Off-Cycle Procedures	No Change	No Change	No Change	Phaseout 2022-2026	No Change	No Change	No Change	Phaseout 2022-2026	No Change
Average CO₂ Emission Rate									
Average Required CO ₂ - MY 2026+ (g/mi)	161.0	216.8	210.4	210.5	201.2	194.4	189.8	189.9	185.1
Percent Change in Stringency from Baseline	0.0%	-34.7%	-30.7%	-30.8%	-25.0%	-20.8%	-17.9%	-18.0%	-15.0%
Average Achieved CO ₂ - MY 2030 (g/mi)	158.9	193.0	193.0	197.5	193.4	190.8	190.1	189.0	185.5
Total Regulatory Costs through MY 2029 Vehicles									
Total Technology Costs (\$b)	12.5	-8.2	-8.2	-8.2	-8.2	-7.0	-7.5	-6.7	-5.8
Total Civil Penalties (\$b)	0.0	0.0	0.0	0.0	0.0	0.0	0.0	0.0	0.0
Total Regulatory Costs (\$b)	12.5	-8.2	-8.2	-8.2	-8.2	-7.0	-7.5	-6.7	-5.8
Average Price Increase for MY 2030 Vehicles									
Price Increase due to New CAFE Standards (\$)	1781	-1252	-1251	-1251	-1248	-1120	-1127	-822	-918

*** EO 12866 Review – Draft – Do Not Cite, Quote or Release During Review ***

Technology Use under CAFE Alternative in MY 2030 (total fleet penetration)									
Curb Weight Reduction (percent change from MY 2016)	3.4%	0.6%	0.6%	0.6%	0.5%	1.5%	0.3%	1.7%	1.9%
High Compression Ratio Non-Turbo Engines	76.6%	65.8%	65.8%	65.9%	65.9%	66.0%	66.0%	76.0%	66.1%
Turbocharged Gasoline Engines	23.0%	22.2%	22.3%	22.3%	22.5%	22.7%	22.8%	22.9%	22.9%
Dynamic Cylinder Deactivation	0.0%	0.0%	0.0%	0.0%	0.0%	0.0%	0.0%	0.0%	0.0%
Stop-Start 12V (Non-Hybrid)	77.3%	0.3%	0.3%	0.3%	0.3%	4.5%	0.3%	0.3%	4.6%
Mild Hybrid Electric Systems (48v)	5.3%	0.0%	0.0%	0.0%	0.0%	0.0%	0.0%	0.0%	1.8%
Strong Hybrid Electric Systems	0.7%	0.8%	0.8%	0.8%	0.7%	0.7%	0.7%	0.7%	0.7%
Plug-In Hybrid Electric Vehicles (PHEVs)	0.0%	0.0%	0.0%	0.0%	0.0%	0.0%	0.0%	0.0%	0.0%
Dedicated Electric Vehicles (EVs)	0.4%	0.4%	0.4%	0.4%	0.4%	0.4%	0.4%	0.4%	0.4%
Fuel Cell Vehicles (FCVs)	0.0%	0.0%	0.0%	0.0%	0.0%	0.0%	0.0%	0.0%	0.0%

*** EO 12866 Review – Draft – Do Not Cite, Quote or Release During Review ***

TABLE 6-143 - IMPACTS ON CARBON DIOXIDE EMISSIONS, REGULATORY COST, AVERAGE PRICE, AND TECHNOLOGY USE FOR PASSENGER CARS PRODUCED BY JAGUAR LAND ROVER, CO₂ PROGRAM

	Alternative								
	No Action	1	2	3	4	5	6	7	8
Model Years	2021-2025	2021-2026	2021-2026	2021-2026	2021-2026	2022-2026	2021-2026	2021-2026	2022-2026
Annual Rate of Stringency Increase	MY 2017-2021 Final MY 2022-2025 Augural	0.0%/Year PC 0.0%/Year LT	0.5%/Year PC 0.5%/Year LT	0.5%/Year PC 0.5%/Year LT	1.0%/Year PC 2.0%/Year LT	1.0%/Year PC 2.0%/Year LT	2.0%/Year PC 3.0%/Year LT	2.0%/Year PC 3.0%/Year LT	2.0%/Year PC 3.0%/Year LT
AC/Off-Cycle Procedures	No Change	No Change	No Change	Phaseout 2022-2026	No Change	No Change	No Change	Phaseout 2022-2026	No Change
Average CO₂ Emission Rate									
Average Required CO ₂ - MY 2026+ (g/mi)	164.0	219.0	212.0	212.0	206.0	199.0	194.0	194.0	189.0
Percent Change in Stringency from Baseline	0.0%	-33.5%	-29.3%	-29.3%	-25.6%	-21.3%	-18.3%	-18.3%	-15.2%
Average Achieved CO ₂ - MY 2030 (g/mi)	171.7	207.0	197.8	206.4	198.4	198.2	194.5	194.3	189.9
Total Regulatory Costs through MY 2029 Vehicles									
Total Technology Costs (\$b)	1.4	-0.2	-0.1	-0.1	-0.1	-0.1	-0.1	-0.1	-0.1
Total Civil Penalties (\$b)	0.0	0.0	0.0	0.0	0.0	0.0	0.0	0.0	0.0
Total Regulatory Costs (\$b)	1.4	-0.2	-0.1	-0.1	-0.1	-0.1	-0.1	-0.1	-0.1
Average Price Increase for MY 2030 Vehicles									
Price Increase due to New CAFE Standards (\$)	4188	-915	-566	-492	-512	-509	-434	65	-285
Technology Use under CAFE Alternative in MY 2030 (total fleet penetration)									

*** EO 12866 Review – Draft – Do Not Cite, Quote or Release During Review ***

Curb Weight Reduction (percent change from MY 2016)	9.1%	5.9%	5.9%	5.9%	5.9%	5.9%	5.9%	9.1%	7.5%
High Compression Ratio Non-Turbo Engines	0.0%	0.0%	0.0%	0.0%	0.0%	0.0%	0.0%	0.0%	0.0%
Turbocharged Gasoline Engines	68.5%	75.2%	68.5%	68.5%	68.5%	68.5%	68.5%	68.5%	68.5%
Dynamic Cylinder Deactivation	0.0%	0.0%	0.0%	0.0%	0.0%	0.0%	0.0%	0.0%	0.0%
Stop-Start 12V (Non-Hybrid)	66.2%	66.2%	66.2%	66.2%	66.2%	66.2%	66.2%	66.2%	66.2%
Mild Hybrid Electric Systems (48v)	0.0%	0.0%	0.0%	0.0%	0.0%	0.0%	0.0%	0.0%	0.0%
Strong Hybrid Electric Systems	2.3%	9.0%	2.3%	2.3%	2.3%	2.3%	2.3%	2.3%	2.3%
Plug-In Hybrid Electric Vehicles (PHEVs)	31.5%	24.8%	31.5%	31.5%	31.5%	31.5%	31.5%	31.5%	31.5%
Dedicated Electric Vehicles (EVs)	0.0%	0.0%	0.0%	0.0%	0.0%	0.0%	0.0%	0.0%	0.0%
Fuel Cell Vehicles (FCVs)	0.0%	0.0%	0.0%	0.0%	0.0%	0.0%	0.0%	0.0%	0.0%

*** EO 12866 Review – Draft – Do Not Cite, Quote or Release During Review ***

TABLE 6-144 - IMPACTS ON CARBON DIOXIDE EMISSIONS, REGULATORY COST, AVERAGE PRICE, AND TECHNOLOGY USE FOR LIGHT TRUCKS PRODUCED BY JAGUAR LAND ROVER, CO₂ PROGRAM

	Alternative								
	No Action	1	2	3	4	5	6	7	8
Model Years	2021-2025	2021-2026	2021-2026	2021-2026	2021-2026	2022-2026	2021-2026	2021-2026	2022-2026
Annual Rate of Stringency Increase	MY 2017-2021 Final MY 2022-2025 Augural	0.0%/Year PC 0.0%/Year LT	0.5%/Year PC 0.5%/Year LT	0.5%/Year PC 0.5%/Year LT	1.0%/Year PC 2.0%/Year LT	1.0%/Year PC 2.0%/Year LT	2.0%/Year PC 3.0%/Year LT	2.0%/Year PC 3.0%/Year LT	2.0%/Year PC 3.0%/Year LT
AC/Off-Cycle Procedures	No Change	No Change	No Change	Phaseout 2022-2026	No Change	No Change	No Change	Phaseout 2022-2026	No Change
Average CO₂ Emission Rate									
Average Required CO ₂ - MY 2026+ (g/mi)	199.0	273.0	265.0	265.0	242.0	231.0	227.0	227.0	219.0
Percent Change in Stringency from Baseline	0.0%	-37.2%	-33.2%	-33.2%	-21.6%	-16.1%	-14.1%	-14.1%	-10.1%
Average Achieved CO ₂ - MY 2030 (g/mi)	189.2	262.3	260.5	263.0	239.3	230.5	226.1	227.1	218.7
Total Regulatory Costs through MY 2029 Vehicles									
Total Technology Costs (\$b)	13.9	-9.5	-9.2	-8.0	-6.4	-3.5	-3.6	-0.5	-1.5
Total Civil Penalties (\$b)	0.0	0.0	0.0	0.0	0.0	0.0	0.0	0.0	0.0
Total Regulatory Costs (\$b)	13.9	-9.5	-9.2	-8.0	-6.4	-3.5	-3.6	-0.5	-1.5
Average Price Increase for MY 2030 Vehicles									
Price Increase due to New CAFE Standards (\$)	4431	-3157	-3080	-2257	-1659	-1017	-727	275	-342
Technology Use under CAFE Alternative in MY 2030 (total fleet penetration)									

*** EO 12866 Review – Draft – Do Not Cite, Quote or Release During Review ***

Curb Weight Reduction (percent change from MY 2016)	8.2%	6.8%	6.8%	10.0%	10.0%	10.0%	10.0%	10.0%	10.0%
High Compression Ratio Non-Turbo Engines	0.0%	0.0%	0.0%	0.0%	0.0%	0.0%	0.0%	0.0%	0.0%
Turbocharged Gasoline Engines	68.5%	87.7%	87.7%	87.7%	87.7%	87.7%	87.7%	80.1%	80.6%
Dynamic Cylinder Deactivation	0.0%	0.0%	0.0%	0.0%	0.0%	0.0%	0.0%	0.0%	0.0%
Stop-Start 12V (Non-Hybrid)	0.0%	33.4%	33.4%	33.4%	0.0%	0.0%	0.0%	0.0%	0.0%
Mild Hybrid Electric Systems (48v)	12.3%	66.6%	66.6%	66.6%	73.7%	30.9%	12.3%	12.3%	12.3%
Strong Hybrid Electric Systems	68.5%	0.0%	0.0%	0.0%	26.3%	69.1%	87.7%	80.1%	80.6%
Plug-In Hybrid Electric Vehicles (PHEVs)	19.2%	0.0%	0.0%	0.0%	0.0%	0.0%	0.0%	0.6%	7.1%
Dedicated Electric Vehicles (EVs)	0.0%	0.0%	0.0%	0.0%	0.0%	0.0%	0.0%	0.0%	0.0%
Fuel Cell Vehicles (FCVs)	0.0%	0.0%	0.0%	0.0%	0.0%	0.0%	0.0%	7.1%	0.0%

*** EO 12866 Review – Draft – Do Not Cite, Quote or Release During Review ***

TABLE 6-145 - IMPACTS ON CARBON DIOXIDE EMISSIONS, REGULATORY COST, AVERAGE PRICE, AND TECHNOLOGY USE FOR ALL LIGHT-DUTY VEHICLES PRODUCED BY JAGUAR LAND ROVER, CO₂ PROGRAM

	Alternative								
	No Action	1	2	3	4	5	6	7	8
Model Years	2021-2025	2021-2026	2021-2026	2021-2026	2021-2026	2022-2026	2021-2026	2021-2026	2022-2026
Annual Rate of Stringency Increase	MY 2017-2021 Final MY 2022-2025 Augural	0.0%/Year PC 0.0%/Year LT	0.5%/Year PC 0.5%/Year LT	0.5%/Year PC 0.5%/Year LT	1.0%/Year PC 2.0%/Year LT	1.0%/Year PC 2.0%/Year LT	2.0%/Year PC 3.0%/Year LT	2.0%/Year PC 3.0%/Year LT	2.0%/Year PC 3.0%/Year LT
AC/Off-Cycle Procedures	No Change	No Change	No Change	Phaseout 2022-2026	No Change	No Change	No Change	Phaseout 2022-2026	No Change
Average CO₂ Emission Rate									
Average Required CO ₂ - MY 2026+ (g/mi)	196.2	268.0	260.1	260.2	238.8	228.3	224.2	224.3	216.5
Percent Change in Stringency from Baseline	0.0%	-36.6%	-32.6%	-32.6%	-21.7%	-16.4%	-14.3%	-14.3%	-10.4%
Average Achieved CO ₂ - MY 2030 (g/mi)	187.8	257.2	254.7	257.8	235.7	227.7	223.5	224.4	216.3
Total Regulatory Costs through MY 2029 Vehicles									
Total Technology Costs (\$b)	15.2	-9.7	-9.3	-8.1	-6.5	-3.6	-3.7	-0.6	-1.6
Total Civil Penalties (\$b)	0.0	0.0	0.0	0.0	0.0	0.0	0.0	0.0	0.0
Total Regulatory Costs (\$b)	15.2	-9.7	-9.3	-8.1	-6.5	-3.6	-3.7	-0.6	-1.6
Average Price Increase for MY 2030 Vehicles									
Price Increase due to New CAFE Standards (\$)	4411	-2952	-2850	-2098	-1559	-975	-703	258	-337
Technology Use under CAFE Alternative in MY 2030 (total fleet penetration)									

*** EO 12866 Review – Draft – Do Not Cite, Quote or Release During Review ***

Curb Weight Reduction (percent change from MY 2016)	8.1%	6.8%	6.8%	9.7%	9.7%	9.6%	9.6%	9.8%	9.7%
High Compression Ratio Non-Turbo Engines	0.0%	0.0%	0.0%	0.0%	0.0%	0.0%	0.0%	0.0%	0.0%
Turbocharged Gasoline Engines	68.5%	86.6%	85.9%	86.0%	86.0%	86.1%	86.1%	79.1%	79.6%
Dynamic Cylinder Deactivation	0.0%	0.0%	0.0%	0.0%	0.0%	0.0%	0.0%	0.0%	0.0%
Stop-Start 12V (Non-Hybrid)	5.4%	36.4%	36.4%	36.4%	5.9%	5.6%	5.5%	5.4%	5.4%
Mild Hybrid Electric Systems (48v)	11.3%	60.4%	60.5%	60.5%	67.2%	28.2%	11.3%	11.3%	11.3%
Strong Hybrid Electric Systems	63.2%	0.8%	0.2%	0.2%	24.2%	63.5%	80.6%	73.7%	74.2%
Plug-In Hybrid Electric Vehicles (PHEVs)	20.2%	2.3%	2.9%	2.9%	2.8%	2.7%	2.6%	3.1%	9.1%
Dedicated Electric Vehicles (EVs)	0.0%	0.0%	0.0%	0.0%	0.0%	0.0%	0.0%	0.0%	0.0%
Fuel Cell Vehicles (FCVs)	0.0%	0.0%	0.0%	0.0%	0.0%	0.0%	0.0%	6.5%	0.0%

*** EO 12866 Review – Draft – Do Not Cite, Quote or Release During Review ***

TABLE 6-146 - IMPACTS ON CARBON DIOXIDE EMISSIONS, REGULATORY COST, AVERAGE PRICE, TECHNOLOGY USE FOR PASSENGER CARS PRODUCED BY MAZDA, CO₂ PROGRAM

	Alternative								
	No Action	1	2	3	4	5	6	7	8
Model Years	2021-2025	2021-2026	2021-2026	2021-2026	2021-2026	2022-2026	2021-2026	2021-2026	2022-2026
Annual Rate of Stringency Increase	MY 2017-2021 Final MY 2022-2025 Augural	0.0%/Year PC 0.0%/Year LT	0.5%/Year PC 0.5%/Year LT	0.5%/Year PC 0.5%/Year LT	1.0%/Year PC 2.0%/Year LT	1.0%/Year PC 2.0%/Year LT	2.0%/Year PC 3.0%/Year LT	2.0%/Year PC 3.0%/Year LT	2.0%/Year PC 3.0%/Year LT
AC/Off-Cycle Procedures	No Change	No Change	No Change	Phaseout 2022-2026	No Change	No Change	No Change	Phaseout 2022-2026	No Change
Average CO₂ Emission Rate									
Average Required CO ₂ - MY 2026+ (g/mi)	150.0	201.0	196.0	195.0	190.0	184.0	178.0	178.0	175.0
Percent Change in Stringency from Baseline	0.0%	-34.0%	-30.7%	-30.0%	-26.7%	-22.7%	-18.7%	-18.7%	-16.7%
Average Achieved CO ₂ - MY 2030 (g/mi)	150.1	188.6	188.6	188.7	187.9	184.3	175.8	176.4	173.2
Total Regulatory Costs through MY 2029 Vehicles									
Total Technology Costs (\$b)	5.3	-4.5	-4.5	-4.5	-4.4	-4.0	-3.1	-3.1	-2.6
Total Civil Penalties (\$b)	0.0	0.0	0.0	0.0	0.0	0.0	0.0	0.0	0.0
Total Regulatory Costs (\$b)	5.3	-4.5	-4.5	-4.5	-4.4	-4.0	-3.1	-3.1	-2.6
Average Price Increase for MY 2030 Vehicles									
Price Increase due to New CAFE Standards (\$)	2220	-2011	-2011	-2011	-1963	-1820	-1175	-1174	-929
Technology Use under CAFE Alternative in MY 2030 (total fleet penetration)									

*** EO 12866 Review – Draft – Do Not Cite, Quote or Release During Review ***

Curb Weight Reduction (percent change from MY 2016)	4.8%	0.1%	0.0%	0.0%	-0.1%	-0.2%	4.9%	4.9%	4.8%
High Compression Ratio Non-Turbo Engines	100.0%	100.0%	100.0%	100.0%	100.0%	100.0%	100.0%	100.0%	100.0%
Turbocharged Gasoline Engines	0.0%	0.0%	0.0%	0.0%	0.0%	0.0%	0.0%	0.0%	0.0%
Dynamic Cylinder Deactivation	0.0%	0.0%	0.0%	0.0%	0.0%	0.0%	0.0%	0.0%	0.0%
Stop-Start 12V (Non-Hybrid)	0.0%	0.0%	0.0%	0.0%	0.0%	0.0%	0.0%	0.0%	52.4%
Mild Hybrid Electric Systems (48v)	80.6%	0.0%	0.0%	0.0%	0.0%	0.0%	0.0%	0.0%	0.0%
Strong Hybrid Electric Systems	10.6%	0.0%	0.0%	0.0%	0.0%	0.0%	0.0%	0.0%	0.0%
Plug-In Hybrid Electric Vehicles (PHEVs)	0.0%	0.0%	0.0%	0.0%	0.0%	0.0%	0.0%	0.0%	0.0%
Dedicated Electric Vehicles (EVs)	0.0%	0.0%	0.0%	0.0%	0.0%	0.0%	0.0%	0.0%	0.0%
Fuel Cell Vehicles (FCVs)	0.0%	0.0%	0.0%	0.0%	0.0%	0.0%	0.0%	0.0%	0.0%

*** EO 12866 Review – Draft – Do Not Cite, Quote or Release During Review ***

TABLE 6-147 - IMPACTS ON CARBON DIOXIDE EMISSIONS, REGULATORY COST, AVERAGE PRICE, TECHNOLOGY USE FOR LIGHT TRUCKS PRODUCED BY MAZDA, CO₂ PROGRAM

	Alternative								
	No Action	1	2	3	4	5	6	7	8
Model Years	2021-2025	2021-2026	2021-2026	2021-2026	2021-2026	2022-2026	2021-2026	2021-2026	2022-2026
Annual Rate of Stringency Increase	MY 2017-2021 Final MY 2022-2025 Augural	0.0%/Year PC 0.0%/Year LT	0.5%/Year PC 0.5%/Year LT	0.5%/Year PC 0.5%/Year LT	1.0%/Year PC 2.0%/Year LT	1.0%/Year PC 2.0%/Year LT	2.0%/Year PC 3.0%/Year LT	2.0%/Year PC 3.0%/Year LT	2.0%/Year PC 3.0%/Year LT
AC/Off-Cycle Procedures	No Change	No Change	No Change	Phaseout 2022-2026	No Change	No Change	No Change	Phaseout 2022-2026	No Change
Average CO₂ Emission Rate									
Average Required CO ₂ - MY 2026+ (g/mi)	185.0	255.0	248.0	248.0	226.0	216.0	213.0	213.0	205.0
Percent Change in Stringency from Baseline	0.0%	-37.8%	-34.1%	-34.1%	-22.2%	-16.8%	-15.1%	-15.1%	-10.8%
Average Achieved CO ₂ - MY 2030 (g/mi)	181.6	228.5	228.5	228.5	225.9	213.9	209.3	209.2	196.6
Total Regulatory Costs through MY 2029 Vehicles									
Total Technology Costs (\$b)	2.8	-2.3	-2.3	-2.3	-2.2	-1.3	-1.3	-1.0	0.4
Total Civil Penalties (\$b)	0.0	0.0	0.0	0.0	0.0	0.0	0.0	0.0	0.0
Total Regulatory Costs (\$b)	2.8	-2.3	-2.3	-2.3	-2.2	-1.3	-1.3	-1.0	0.4
Average Price Increase for MY 2030 Vehicles									
Price Increase due to New CAFE Standards (\$)	2119	-1840	-1840	-1840	-1772	-1163	-811	-611	279
Technology Use under CAFE Alternative in MY 2030 (total fleet penetration)									

*** EO 12866 Review – Draft – Do Not Cite, Quote or Release During Review ***

Curb Weight Reduction (percent change from MY 2016)	5.6%	0.0%	0.0%	0.0%	0.0%	0.0%	5.6%	5.6%	5.6%
High Compression Ratio Non-Turbo Engines	83.6%	83.6%	83.6%	83.6%	83.6%	83.6%	83.6%	83.6%	83.6%
Turbocharged Gasoline Engines	16.4%	16.4%	16.4%	16.4%	16.4%	16.4%	16.4%	16.4%	16.4%
Dynamic Cylinder Deactivation	0.0%	0.0%	0.0%	0.0%	0.0%	0.0%	0.0%	0.0%	0.0%
Stop-Start 12V (Non-Hybrid)	40.6%	0.0%	0.0%	0.0%	0.0%	48.9%	5.9%	48.9%	0.0%
Mild Hybrid Electric Systems (48v)	59.4%	0.0%	0.0%	0.0%	0.0%	0.0%	0.0%	0.0%	100.0%
Strong Hybrid Electric Systems	0.0%	0.0%	0.0%	0.0%	0.0%	0.0%	0.0%	0.0%	0.0%
Plug-In Hybrid Electric Vehicles (PHEVs)	0.0%	0.0%	0.0%	0.0%	0.0%	0.0%	0.0%	0.0%	0.0%
Dedicated Electric Vehicles (EVs)	0.0%	0.0%	0.0%	0.0%	0.0%	0.0%	0.0%	0.0%	0.0%
Fuel Cell Vehicles (FCVs)	0.0%	0.0%	0.0%	0.0%	0.0%	0.0%	0.0%	0.0%	0.0%

*** EO 12866 Review – Draft – Do Not Cite, Quote or Release During Review ***

TABLE 6-148 - IMPACTS ON CARBON DIOXIDE EMISSIONS, REGULATORY COST, AVERAGE PRICE, AND TECHNOLOGY USE FOR ALL LIGHT-DUTY VEHICLES PRODUCED BY MAZDA, CO₂ PROGRAM

	Alternative								
	No Action	1	2	3	4	5	6	7	8
Model Years	2021-2025	2021-2026	2021-2026	2021-2026	2021-2026	2022-2026	2021-2026	2021-2026	2022-2026
Annual Rate of Stringency Increase	MY 2017-2021 Final MY 2022-2025 Augural	0.0%/Year PC 0.0%/Year LT	0.5%/Year PC 0.5%/Year LT	0.5%/Year PC 0.5%/Year LT	1.0%/Year PC 2.0%/Year LT	1.0%/Year PC 2.0%/Year LT	2.0%/Year PC 3.0%/Year LT	2.0%/Year PC 3.0%/Year LT	2.0%/Year PC 3.0%/Year LT
AC/Off-Cycle Procedures	No Change	No Change	No Change	Phaseout 2022-2026	No Change	No Change	No Change	Phaseout 2022-2026	No Change
Average CO₂ Emission Rate									
Average Required CO ₂ - MY 2026+ (g/mi)	162.3	218.9	213.3	212.7	202.2	195.0	190.1	190.3	185.5
Percent Change in Stringency from Baseline	0.0%	-34.9%	-31.4%	-31.0%	-24.6%	-20.2%	-17.1%	-17.2%	-14.3%
Average Achieved CO ₂ - MY 2030 (g/mi)	161.2	201.8	201.8	201.9	200.8	194.5	187.4	187.9	181.4
Total Regulatory Costs through MY 2029 Vehicles									
Total Technology Costs (\$b)	8.1	-6.7	-6.7	-6.7	-6.6	-5.3	-4.4	-4.1	-2.2
Total Civil Penalties (\$b)	0.0	0.0	0.0	0.0	0.0	0.0	0.0	0.0	0.0
Total Regulatory Costs (\$b)	8.1	-6.7	-6.7	-6.7	-6.6	-5.3	-4.4	-4.1	-2.2
Average Price Increase for MY 2030 Vehicles									
Price Increase due to New CAFE Standards (\$)	2184	-1952	-1952	-1952	-1897	-1593	-1048	-976	-505
Technology Use under CAFE Alternative in MY 2030 (total fleet penetration)									

*** EO 12866 Review – Draft – Do Not Cite, Quote or Release During Review ***

Curb Weight Reduction (percent change from MY 2016)	4.8%	0.1%	0.1%	0.0%	-0.1%	-0.3%	4.9%	4.9%	4.8%
High Compression Ratio Non-Turbo Engines	94.2%	94.6%	94.6%	94.5%	94.4%	94.3%	94.3%	94.3%	94.2%
Turbocharged Gasoline Engines	5.8%	5.4%	5.4%	5.5%	5.6%	5.7%	5.7%	5.7%	5.8%
Dynamic Cylinder Deactivation	0.0%	0.0%	0.0%	0.0%	0.0%	0.0%	0.0%	0.0%	0.0%
Stop-Start 12V (Non-Hybrid)	14.3%	0.0%	0.0%	0.0%	0.0%	16.9%	2.0%	17.1%	34.0%
Mild Hybrid Electric Systems (48v)	73.2%	0.0%	0.0%	0.0%	0.0%	0.0%	0.0%	0.0%	35.1%
Strong Hybrid Electric Systems	6.9%	0.0%	0.0%	0.0%	0.0%	0.0%	0.0%	0.0%	0.0%
Plug-In Hybrid Electric Vehicles (PHEVs)	0.0%	0.0%	0.0%	0.0%	0.0%	0.0%	0.0%	0.0%	0.0%
Dedicated Electric Vehicles (EVs)	0.0%	0.0%	0.0%	0.0%	0.0%	0.0%	0.0%	0.0%	0.0%
Fuel Cell Vehicles (FCVs)	0.0%	0.0%	0.0%	0.0%	0.0%	0.0%	0.0%	0.0%	0.0%

*** EO 12866 Review – Draft – Do Not Cite, Quote or Release During Review ***

TABLE 6-149 - IMPACTS ON CARBON DIOXIDE EMISSIONS, REGULATORY COST, AVERAGE PRICE, AND TECHNOLOGY USE FOR PASSENGER CARS PRODUCED BY NISSAN MITSUBISHI, CO₂ PROGRAM

	Alternative								
	No Action	1	2	3	4	5	6	7	8
Model Years	2021-2025	2021-2026	2021-2026	2021-2026	2021-2026	2022-2026	2021-2026	2021-2026	2022-2026
Annual Rate of Stringency Increase	MY 2017-2021 Final MY 2022-2025 Augural	0.0%/Year PC 0.0%/Year LT	0.5%/Year PC 0.5%/Year LT	0.5%/Year PC 0.5%/Year LT	1.0%/Year PC 2.0%/Year LT	1.0%/Year PC 2.0%/Year LT	2.0%/Year PC 3.0%/Year LT	2.0%/Year PC 3.0%/Year LT	2.0%/Year PC 3.0%/Year LT
AC/Off-Cycle Procedures	No Change	No Change	No Change	Phaseout 2022-2026	No Change	No Change	No Change	Phaseout 2022-2026	No Change
Average CO₂ Emission Rate									
Average Required CO ₂ - MY 2026+ (g/mi)	151.0	202.0	196.0	196.0	190.0	184.0	179.0	179.0	175.0
Percent Change in Stringency from Baseline	0.0%	-33.8%	-29.8%	-29.8%	-25.8%	-21.9%	-18.5%	-18.5%	-15.9%
Average Achieved CO ₂ - MY 2030 (g/mi)	144.7	193.5	193.6	195.1	189.7	178.6	178.7	179.4	174.0
Total Regulatory Costs through MY 2029 Vehicles									
Total Technology Costs (\$b)	8.2	-6.0	-6.0	-5.7	-5.6	-3.8	-3.8	-2.8	-2.8
Total Civil Penalties (\$b)	0.0	0.0	0.0	0.0	0.0	0.0	0.0	0.0	0.0
Total Regulatory Costs (\$b)	8.2	-6.0	-6.0	-5.7	-5.6	-3.8	-3.8	-2.8	-2.8
Average Price Increase for MY 2030 Vehicles									
Price Increase due to New CAFE Standards (\$)	1080	-889	-889	-812	-797	-588	-587	-450	-446
Technology Use under CAFE Alternative in MY 2030 (total fleet penetration)									

*** EO 12866 Review – Draft – Do Not Cite, Quote or Release During Review ***

Curb Weight Reduction (percent change from MY 2016)	3.9%	1.7%	1.7%	1.7%	1.8%	1.7%	1.6%	1.5%	2.8%
High Compression Ratio Non-Turbo Engines	90.0%	3.4%	3.4%	16.4%	16.4%	56.1%	56.1%	56.2%	56.2%
Turbocharged Gasoline Engines	8.3%	8.1%	8.1%	8.1%	8.1%	8.2%	8.2%	8.2%	8.2%
Dynamic Cylinder Deactivation	0.0%	0.0%	0.0%	0.0%	0.0%	0.0%	0.0%	0.0%	0.0%
Stop-Start 12V (Non-Hybrid)	2.1%	2.2%	2.2%	2.2%	2.1%	2.1%	2.1%	2.1%	2.1%
Mild Hybrid Electric Systems (48v)	0.0%	0.0%	0.0%	0.0%	0.0%	0.0%	0.0%	0.0%	0.0%
Strong Hybrid Electric Systems	0.2%	0.2%	0.2%	0.2%	0.2%	0.2%	0.2%	0.2%	0.2%
Plug-In Hybrid Electric Vehicles (PHEVs)	0.0%	0.0%	0.0%	0.0%	0.0%	0.0%	0.0%	0.0%	0.0%
Dedicated Electric Vehicles (EVs)	1.7%	1.8%	1.8%	1.8%	1.8%	1.8%	1.8%	1.7%	1.7%
Fuel Cell Vehicles (FCVs)	0.0%	0.0%	0.0%	0.0%	0.0%	0.0%	0.0%	0.0%	0.0%

*** EO 12866 Review – Draft – Do Not Cite, Quote or Release During Review ***

TABLE 6-150 - IMPACTS ON CARBON DIOXIDE EMISSIONS, REGULATORY COST, AVERAGE PRICE, AND TECHNOLOGY USE FOR LIGHT TRUCKS PRODUCED BY NISSAN MITSUBISHI, CO₂ PROGRAM

	Alternative								
	No Action	1	2	3	4	5	6	7	8
Model Years	2021-2025	2021-2026	2021-2026	2021-2026	2021-2026	2022-2026	2021-2026	2021-2026	2022-2026
Annual Rate of Stringency Increase	MY 2017-2021 Final MY 2022-2025 Augural	0.0%/Year PC 0.0%/Year LT	0.5%/Year PC 0.5%/Year LT	0.5%/Year PC 0.5%/Year LT	1.0%/Year PC 2.0%/Year LT	1.0%/Year PC 2.0%/Year LT	2.0%/Year PC 3.0%/Year LT	2.0%/Year PC 3.0%/Year LT	2.0%/Year PC 3.0%/Year LT
AC/Off-Cycle Procedures	No Change	No Change	No Change	Phaseout 2022-2026	No Change	No Change	No Change	Phaseout 2022-2026	No Change
Average CO₂ Emission Rate									
Average Required CO ₂ - MY 2026+ (g/mi)	193.0	266.0	258.0	258.0	236.0	225.0	222.0	222.0	214.0
Percent Change in Stringency from Baseline	0.0%	-37.8%	-33.7%	-33.7%	-22.3%	-16.6%	-15.0%	-15.0%	-10.9%
Average Achieved CO ₂ - MY 2030 (g/mi)	185.9	241.3	241.3	247.3	235.9	222.4	221.9	222.4	213.9
Total Regulatory Costs through MY 2029 Vehicles									
Total Technology Costs (\$b)	4.6	-3.0	-3.0	-3.0	-2.7	-1.9	-1.9	-1.4	-0.7
Total Civil Penalties (\$b)	0.0	0.0	0.0	0.0	0.0	0.0	0.0	0.0	0.0
Total Regulatory Costs (\$b)	4.6	-3.0	-3.0	-3.0	-2.7	-1.9	-1.9	-1.4	-0.7
Average Price Increase for MY 2030 Vehicles									
Price Increase due to New CAFE Standards (\$)	1236	-887	-887	-887	-762	-579	-570	-369	-302
Technology Use under CAFE Alternative in MY 2030 (total fleet penetration)									

*** EO 12866 Review – Draft – Do Not Cite, Quote or Release During Review ***

Curb Weight Reduction (percent change from MY 2016)	5.2%	2.0%	2.0%	2.0%	2.6%	2.6%	2.6%	2.6%	3.2%
High Compression Ratio Non-Turbo Engines	79.5%	9.4%	9.4%	9.4%	9.4%	58.9%	58.9%	58.9%	58.9%
Turbocharged Gasoline Engines	4.4%	4.4%	4.4%	4.4%	4.4%	4.4%	4.4%	4.4%	4.4%
Dynamic Cylinder Deactivation	0.0%	0.0%	0.0%	0.0%	0.0%	0.0%	0.0%	0.0%	0.0%
Stop-Start 12V (Non-Hybrid)	0.0%	0.0%	0.0%	0.0%	0.0%	0.0%	0.0%	0.0%	0.0%
Mild Hybrid Electric Systems (48v)	0.0%	0.0%	0.0%	0.0%	0.0%	0.0%	0.0%	0.0%	0.0%
Strong Hybrid Electric Systems	0.0%	0.0%	0.0%	0.0%	0.0%	0.0%	0.0%	0.0%	0.0%
Plug-In Hybrid Electric Vehicles (PHEVs)	0.0%	0.0%	0.0%	0.0%	0.0%	0.0%	0.0%	0.0%	0.0%
Dedicated Electric Vehicles (EVs)	0.0%	0.0%	0.0%	0.0%	0.0%	0.0%	0.0%	0.0%	0.0%
Fuel Cell Vehicles (FCVs)	0.0%	0.0%	0.0%	0.0%	0.0%	0.0%	0.0%	0.0%	0.0%

*** EO 12866 Review – Draft – Do Not Cite, Quote or Release During Review ***

TABLE 6-151 - IMPACTS ON CARBON DIOXIDE EMISSIONS, REGULATORY COST, AVERAGE PRICE, AND TECHNOLOGY USE FOR ALL LIGHT-DUTY VEHICLES PRODUCED BY NISSAN MITSUBISHI, CO₂ PROGRAM

	Alternative								
	No Action	1	2	3	4	5	6	7	8
Model Years	2021-2025	2021-2026	2021-2026	2021-2026	2021-2026	2022-2026	2021-2026	2021-2026	2022-2026
Annual Rate of Stringency Increase	MY 2017-2021 Final MY 2022-2025 Augural	0.0%/Year PC 0.0%/Year LT	0.5%/Year PC 0.5%/Year LT	0.5%/Year PC 0.5%/Year LT	1.0%/Year PC 2.0%/Year LT	1.0%/Year PC 2.0%/Year LT	2.0%/Year PC 3.0%/Year LT	2.0%/Year PC 3.0%/Year LT	2.0%/Year PC 3.0%/Year LT
AC/Off-Cycle Procedures	No Change	No Change	No Change	Phaseout 2022-2026	No Change	No Change	No Change	Phaseout 2022-2026	No Change
Average CO₂ Emission Rate									
Average Required CO ₂ - MY 2026+ (g/mi)	164.1	220.6	214.0	214.1	203.7	196.5	192.2	192.4	187.1
Percent Change in Stringency from Baseline	0.0%	-34.4%	-30.4%	-30.5%	-24.1%	-19.7%	-17.1%	-17.2%	-14.0%
Average Achieved CO ₂ - MY 2030 (g/mi)	157.6	207.4	207.4	210.4	203.5	192.0	192.0	192.8	186.4
Total Regulatory Costs through MY 2029 Vehicles									
Total Technology Costs (\$b)	12.8	-9.0	-9.0	-8.7	-8.3	-5.7	-5.7	-4.2	-3.4
Total Civil Penalties (\$b)	0.0	0.0	0.0	0.0	0.0	0.0	0.0	0.0	0.0
Total Regulatory Costs (\$b)	12.8	-9.0	-9.0	-8.7	-8.3	-5.7	-5.7	-4.2	-3.4
Average Price Increase for MY 2030 Vehicles									
Price Increase due to New CAFE Standards (\$)	1129	-892	-892	-837	-789	-586	-583	-426	-401
Technology Use under CAFE Alternative in MY 2030 (total fleet penetration)									

*** EO 12866 Review – Draft – Do Not Cite, Quote or Release During Review ***

Curb Weight Reduction (percent change from MY 2016)	4.0%	1.9%	1.9%	1.8%	1.9%	1.7%	1.6%	1.5%	2.6%
High Compression Ratio Non-Turbo Engines	86.7%	5.1%	5.1%	14.4%	14.3%	56.9%	57.0%	57.0%	57.0%
Turbocharged Gasoline Engines	7.0%	7.0%	7.0%	7.0%	7.0%	7.0%	7.0%	7.0%	7.0%
Dynamic Cylinder Deactivation	0.0%	0.0%	0.0%	0.0%	0.0%	0.0%	0.0%	0.0%	0.0%
Stop-Start 12V (Non-Hybrid)	1.4%	1.5%	1.5%	1.5%	1.5%	1.5%	1.5%	1.4%	1.4%
Mild Hybrid Electric Systems (48v)	0.0%	0.0%	0.0%	0.0%	0.0%	0.0%	0.0%	0.0%	0.0%
Strong Hybrid Electric Systems	0.2%	0.2%	0.2%	0.2%	0.2%	0.2%	0.2%	0.2%	0.2%
Plug-In Hybrid Electric Vehicles (PHEVs)	0.0%	0.0%	0.0%	0.0%	0.0%	0.0%	0.0%	0.0%	0.0%
Dedicated Electric Vehicles (EVs)	1.2%	1.3%	1.3%	1.3%	1.3%	1.2%	1.2%	1.2%	1.2%
Fuel Cell Vehicles (FCVs)	0.0%	0.0%	0.0%	0.0%	0.0%	0.0%	0.0%	0.0%	0.0%

*** EO 12866 Review – Draft – Do Not Cite, Quote or Release During Review ***

TABLE 6-152 - IMPACTS ON CARBON DIOXIDE EMISSIONS, REGULATORY COST, AVERAGE PRICE, AND TECHNOLOGY USE FOR PASSENGER CARS PRODUCED BY SUBARU, CO₂ PROGRAM

	Alternative								
	No Action	1	2	3	4	5	6	7	8
Model Years	2021-2025	2021-2026	2021-2026	2021-2026	2021-2026	2022-2026	2021-2026	2021-2026	2022-2026
Annual Rate of Stringency Increase	MY 2017-2021 Final MY 2022-2025 Augural	0.0%/Year PC 0.0%/Year LT	0.5%/Year PC 0.5%/Year LT	0.5%/Year PC 0.5%/Year LT	1.0%/Year PC 2.0%/Year LT	1.0%/Year PC 2.0%/Year LT	2.0%/Year PC 3.0%/Year LT	2.0%/Year PC 3.0%/Year LT	2.0%/Year PC 3.0%/Year LT
AC/Off-Cycle Procedures	No Change	No Change	No Change	Phaseout 2022-2026	No Change	No Change	No Change	Phaseout 2022-2026	No Change
Average CO₂ Emission Rate									
Average Required CO ₂ - MY 2026+ (g/mi)	147.0	197.0	192.0	192.0	186.0	180.0	175.0	175.0	171.0
Percent Change in Stringency from Baseline	0.0%	-34.0%	-30.6%	-30.6%	-26.5%	-22.4%	-19.0%	-19.0%	-16.3%
Average Achieved CO ₂ - MY 2030 (g/mi)	142.9	213.8	213.8	207.7	183.5	180.2	171.3	174.8	170.4
Total Regulatory Costs through MY 2029 Vehicles									
Total Technology Costs (\$b)	4.9	-4.5	-4.5	-4.4	-4.0	-3.5	-3.4	-3.3	-2.9
Total Civil Penalties (\$b)	0.0	0.0	0.0	0.0	0.0	0.0	0.0	0.0	0.0
Total Regulatory Costs (\$b)	4.9	-4.5	-4.5	-4.4	-4.0	-3.5	-3.4	-3.3	-2.9
Average Price Increase for MY 2030 Vehicles									
Price Increase due to New CAFE Standards (\$)	2760	-2532	-2532	-2373	-1733	-1549	-1301	-1301	-1136
Technology Use under CAFE Alternative in MY 2030 (total fleet penetration)									

*** EO 12866 Review – Draft – Do Not Cite, Quote or Release During Review ***

Curb Weight Reduction (percent change from MY 2016)	7.4%	3.7%	3.7%	4.4%	5.8%	7.3%	7.3%	7.3%	8.8%
High Compression Ratio Non-Turbo Engines	0.0%	0.0%	0.0%	0.0%	0.0%	0.0%	0.0%	0.0%	0.0%
Turbocharged Gasoline Engines	61.4%	23.1%	23.1%	23.1%	58.5%	58.5%	100.0%	100.0%	96.8%
Dynamic Cylinder Deactivation	0.0%	0.0%	0.0%	0.0%	0.0%	0.0%	0.0%	0.0%	0.0%
Stop-Start 12V (Non-Hybrid)	0.0%	0.0%	0.0%	0.0%	0.0%	0.0%	0.0%	0.0%	0.0%
Mild Hybrid Electric Systems (48v)	38.2%	0.0%	0.0%	0.0%	0.0%	0.0%	0.0%	0.0%	0.0%
Strong Hybrid Electric Systems	38.6%	0.0%	0.0%	0.0%	0.0%	0.0%	0.0%	0.0%	0.0%
Plug-In Hybrid Electric Vehicles (PHEVs)	0.0%	0.0%	0.0%	0.0%	0.0%	0.0%	0.0%	0.0%	0.0%
Dedicated Electric Vehicles (EVs)	0.0%	0.0%	0.0%	0.0%	0.0%	0.0%	0.0%	0.0%	0.0%
Fuel Cell Vehicles (FCVs)	0.0%	0.0%	0.0%	0.0%	0.0%	0.0%	0.0%	0.0%	0.0%

*** EO 12866 Review – Draft – Do Not Cite, Quote or Release During Review ***

TABLE 6-153 - IMPACTS ON CARBON DIOXIDE EMISSIONS, REGULATORY COST, AVERAGE PRICE, AND TECHNOLOGY USE FOR LIGHT TRUCKS PRODUCED BY SUBARU, CO₂ PROGRAM

	Alternative								
	No Action	1	2	3	4	5	6	7	8
Model Years	2021-2025	2021-2026	2021-2026	2021-2026	2021-2026	2022-2026	2021-2026	2021-2026	2022-2026
Annual Rate of Stringency Increase	MY 2017-2021 Final MY 2022-2025 Augural	0.0%/Year PC 0.0%/Year LT	0.5%/Year PC 0.5%/Year LT	0.5%/Year PC 0.5%/Year LT	1.0%/Year PC 2.0%/Year LT	1.0%/Year PC 2.0%/Year LT	2.0%/Year PC 3.0%/Year LT	2.0%/Year PC 3.0%/Year LT	2.0%/Year PC 3.0%/Year LT
AC/Off-Cycle Procedures	No Change	No Change	No Change	Phaseout 2022-2026	No Change	No Change	No Change	Phaseout 2022-2026	No Change
Average CO2 Emission Rate									
Average Required CO2 - MY 2026+ (g/mi)	176.0	244.0	237.0	237.0	217.0	207.0	204.0	204.0	196.0
Percent Change in Stringency from Baseline	0.0%	-38.6%	-34.7%	-34.7%	-23.3%	-17.6%	-15.9%	-15.9%	-11.4%
Average Achieved CO2 - MY 2030 (g/mi)	176.3	219.7	219.7	214.9	195.7	192.1	187.1	190.2	185.7
Total Regulatory Costs through MY 2029 Vehicles									
Total Technology Costs (\$b)	4.3	-3.4	-3.4	-3.2	-2.2	-0.9	-0.8	-0.6	0.1
Total Civil Penalties (\$b)	0.0	0.0	0.0	0.0	0.0	0.0	0.0	0.0	0.0
Total Regulatory Costs (\$b)	4.3	-3.4	-3.4	-3.2	-2.2	-0.9	-0.8	-0.6	0.1
Average Price Increase for MY 2030 Vehicles									
Price Increase due to New CAFE Standards (\$)	1019	-853	-853	-703	-233	-86	63	63	235
Technology Use under CAFE Alternative in MY 2030 (total fleet penetration)									

*** EO 12866 Review – Draft – Do Not Cite, Quote or Release During Review ***

Curb Weight Reduction (percent change from MY 2016)	7.5%	3.7%	3.7%	4.5%	6.0%	7.5%	7.5%	7.5%	9.0%
High Compression Ratio Non-Turbo Engines	0.0%	0.0%	0.0%	0.0%	0.0%	0.0%	0.0%	0.0%	0.0%
Turbocharged Gasoline Engines	25.8%	2.1%	2.1%	2.1%	35.1%	35.1%	63.4%	63.4%	58.7%
Dynamic Cylinder Deactivation	0.0%	0.0%	0.0%	0.0%	0.0%	0.0%	0.0%	0.0%	0.0%
Stop-Start 12V (Non-Hybrid)	0.0%	0.0%	0.0%	0.0%	0.0%	0.0%	0.0%	0.0%	0.0%
Mild Hybrid Electric Systems (48v)	0.0%	0.0%	0.0%	0.0%	0.0%	0.0%	0.0%	0.0%	0.0%
Strong Hybrid Electric Systems	0.7%	0.7%	0.7%	0.7%	0.7%	0.7%	0.7%	0.7%	0.7%
Plug-In Hybrid Electric Vehicles (PHEVs)	0.0%	0.0%	0.0%	0.0%	0.0%	0.0%	0.0%	0.0%	0.0%
Dedicated Electric Vehicles (EVs)	0.0%	0.0%	0.0%	0.0%	0.0%	0.0%	0.0%	0.0%	0.0%
Fuel Cell Vehicles (FCVs)	0.0%	0.0%	0.0%	0.0%	0.0%	0.0%	0.0%	0.0%	0.0%

TABLE 6-154 - IMPACTS ON CARBON DIOXIDE EMISSIONS, REGULATORY COST, AVERAGE PRICE, AND TECHNOLOGY USE FOR ALL LIGHT-DUTY VEHICLES PRODUCED BY SUBARU, CO₂ PROGRAM

	Alternative								
	No Action	1	2	3	4	5	6	7	8
Model Years	2021-2025	2021-2026	2021-2026	2021-2026	2021-2026	2022-2026	2021-2026	2021-2026	2022-2026
Annual Rate of Stringency Increase	MY 2017-2021 Final MY 2022-2025 Augural	0.0%/Year PC 0.0%/Year LT	0.5%/Year PC 0.5%/Year LT	0.5%/Year PC 0.5%/Year LT	1.0%/Year PC 2.0%/Year LT	1.0%/Year PC 2.0%/Year LT	2.0%/Year PC 3.0%/Year LT	2.0%/Year PC 3.0%/Year LT	2.0%/Year PC 3.0%/Year LT

*** EO 12866 Review – Draft – Do Not Cite, Quote or Release During Review ***

AC/Off-Cycle Procedures	No Change	No Change	No Change	Phaseout 2022-2026	No Change	No Change	No Change	Phaseout 2022-2026	No Change
Average CO₂ Emission Rate									
Average Required CO ₂ - MY 2026+ (g/mi)	168.7	230.8	224.4	224.5	208.6	199.9	196.5	196.6	189.7
Percent Change in Stringency from Baseline	0.0%	-36.8%	-33.0%	-33.1%	-23.7%	-18.5%	-16.5%	-16.6%	-12.4%
Average Achieved CO ₂ - MY 2030 (g/mi)	167.9	218.0	218.0	212.9	192.4	189.0	183.0	186.2	181.8
Total Regulatory Costs through MY 2029 Vehicles									
Total Technology Costs (\$b)	9.2	-8.0	-8.0	-7.6	-6.2	-4.4	-4.2	-3.9	-2.8
Total Civil Penalties (\$b)	0.0	0.0	0.0	0.0	0.0	0.0	0.0	0.0	0.0
Total Regulatory Costs (\$b)	9.2	-8.0	-8.0	-7.6	-6.2	-4.4	-4.2	-3.9	-2.8
Average Price Increase for MY 2030 Vehicles									
Price Increase due to New CAFE Standards (\$)	1457	-1273	-1273	-1122	-605	-452	-277	-279	-109
Technology Use under CAFE Alternative in MY 2030 (total fleet penetration)									
Curb Weight Reduction (percent change from MY 2016)	7.4%	3.7%	3.7%	4.5%	5.9%	7.4%	7.4%	7.4%	8.9%
High Compression Ratio Non-Turbo Engines	0.0%	0.0%	0.0%	0.0%	0.0%	0.0%	0.0%	0.0%	0.0%
Turbocharged Gasoline Engines	34.7%	8.0%	8.0%	7.9%	41.4%	41.2%	72.9%	72.7%	68.4%
Dynamic Cylinder Deactivation	0.0%	0.0%	0.0%	0.0%	0.0%	0.0%	0.0%	0.0%	0.0%
Stop-Start 12V (Non-Hybrid)	0.0%	0.0%	0.0%	0.0%	0.0%	0.0%	0.0%	0.0%	0.0%

*** EO 12866 Review – Draft – Do Not Cite, Quote or Release During Review ***

Mild Hybrid Electric Systems (48v)	9.6%	0.0%	0.0%	0.0%	0.0%	0.0%	0.0%	0.0%	0.0%
Strong Hybrid Electric Systems	10.2%	0.5%	0.5%	0.5%	0.5%	0.5%	0.5%	0.5%	0.5%
Plug-In Hybrid Electric Vehicles (PHEVs)	0.0%	0.0%	0.0%	0.0%	0.0%	0.0%	0.0%	0.0%	0.0%
Dedicated Electric Vehicles (EVs)	0.0%	0.0%	0.0%	0.0%	0.0%	0.0%	0.0%	0.0%	0.0%
Fuel Cell Vehicles (FCVs)	0.0%	0.0%	0.0%	0.0%	0.0%	0.0%	0.0%	0.0%	0.0%

*** EO 12866 Review – Draft – Do Not Cite, Quote or Release During Review ***

TABLE 6-155 - IMPACTS ON CARBON DIOXIDE EMISSIONS, REGULATORY COST, AVERAGE PRICE, AND TECHNOLOGY USE FOR PASSENGER CARS PRODUCED BY TESLA, CO₂ PROGRAM

	Alternative								
	No Action	1	2	3	4	5	6	7	8
Model Years	2021-2025	2021-2026	2021-2026	2021-2026	2021-2026	2022-2026	2021-2026	2021-2026	2022-2026
Annual Rate of Stringency Increase	MY 2017-2021 Final MY 2022-2025 Augural	0.0%/Year PC 0.0%/Year LT	0.5%/Year PC 0.5%/Year LT	0.5%/Year PC 0.5%/Year LT	1.0%/Year PC 2.0%/Year LT	1.0%/Year PC 2.0%/Year LT	2.0%/Year PC 3.0%/Year LT	2.0%/Year PC 3.0%/Year LT	2.0%/Year PC 3.0%/Year LT
AC/Off-Cycle Procedures	No Change	No Change	No Change	Phaseout 2022-2026	No Change	No Change	No Change	Phaseout 2022-2026	No Change
Average CO₂ Emission Rate									
Average Required CO ₂ - MY 2026+ (g/mi)	176.0	234.0	227.0	227.0	220.0	213.0	207.0	207.0	202.0
Percent Change in Stringency from Baseline	0.0%	-33.0%	-29.0%	-29.0%	-25.0%	-21.0%	-17.6%	-17.6%	-14.8%
Average Achieved CO ₂ - MY 2030 (g/mi)	-20.6	-6.6	-6.6	0.0	-6.6	-6.6	-6.6	0.0	-6.6
Total Regulatory Costs through MY 2029 Vehicles									
Total Technology Costs (\$b)	0.0	0.0	0.0	0.0	0.0	0.0	0.0	0.0	0.0
Total Civil Penalties (\$b)	0.0	0.0	0.0	0.0	0.0	0.0	0.0	0.0	0.0
Total Regulatory Costs (\$b)	0.0	0.0	0.0	0.0	0.0	0.0	0.0	0.0	0.0
Average Price Increase for MY 2030 Vehicles									
Price Increase due to New CAFE Standards (\$)	2	0	0	0	0	0	0	0	0
Technology Use under CAFE Alternative in MY 2030 (total fleet penetration)									

*** EO 12866 Review – Draft – Do Not Cite, Quote or Release During Review ***

Curb Weight Reduction (percent change from MY 2016)	0.0%	0.0%	0.0%	0.0%	0.0%	0.0%	0.0%	0.0%	0.0%
High Compression Ratio Non-Turbo Engines	0.0%	0.0%	0.0%	0.0%	0.0%	0.0%	0.0%	0.0%	0.0%
Turbocharged Gasoline Engines	0.0%	0.0%	0.0%	0.0%	0.0%	0.0%	0.0%	0.0%	0.0%
Dynamic Cylinder Deactivation	0.0%	0.0%	0.0%	0.0%	0.0%	0.0%	0.0%	0.0%	0.0%
Stop-Start 12V (Non-Hybrid)	0.0%	0.0%	0.0%	0.0%	0.0%	0.0%	0.0%	0.0%	0.0%
Mild Hybrid Electric Systems (48v)	0.0%	0.0%	0.0%	0.0%	0.0%	0.0%	0.0%	0.0%	0.0%
Strong Hybrid Electric Systems	0.0%	0.0%	0.0%	0.0%	0.0%	0.0%	0.0%	0.0%	0.0%
Plug-In Hybrid Electric Vehicles (PHEVs)	0.0%	0.0%	0.0%	0.0%	0.0%	0.0%	0.0%	0.0%	0.0%
Dedicated Electric Vehicles (EVs)	100.0%	100.0%	100.0%	100.0%	100.0%	100.0%	100.0%	100.0%	100.0%
Fuel Cell Vehicles (FCVs)	0.0%	0.0%	0.0%	0.0%	0.0%	0.0%	0.0%	0.0%	0.0%

*** EO 12866 Review – Draft – Do Not Cite, Quote or Release During Review ***

TABLE 6-156 - IMPACTS ON CARBON DIOXIDE EMISSIONS, REGULATORY COST, AVERAGE PRICE, AND TECHNOLOGY USE FOR LIGHT TRUCKS PRODUCED BY TESLA, CO₂ PROGRAM

	Alternative								
	No Action	1	2	3	4	5	6	7	8
Model Years	2021-2025	2021-2026	2021-2026	2021-2026	2021-2026	2022-2026	2021-2026	2021-2026	2022-2026
Annual Rate of Stringency Increase	MY 2017-2021 Final MY 2022-2025 Augural	0.0%/Year PC 0.0%/Year LT	0.5%/Year PC 0.5%/Year LT	0.5%/Year PC 0.5%/Year LT	1.0%/Year PC 2.0%/Year LT	1.0%/Year PC 2.0%/Year LT	2.0%/Year PC 3.0%/Year LT	2.0%/Year PC 3.0%/Year LT	2.0%/Year PC 3.0%/Year LT
AC/Off-Cycle Procedures	No Change	No Change	No Change	Phaseout 2022-2026	No Change	No Change	No Change	Phaseout 2022-2026	No Change
Average CO₂ Emission Rate									
Average Required CO ₂ - MY 2026+ (g/mi)	212.0	290.0	281.0	281.0	257.0	245.0	242.0	242.0	233.0
Percent Change in Stringency from Baseline	0.0%	-36.8%	-32.5%	-32.5%	-21.2%	-15.6%	-14.2%	-14.2%	-9.9%
Average Achieved CO ₂ - MY 2030 (g/mi)	-18.0	-1.0	-1.0	0.0	-1.0	-1.0	-1.0	0.0	-1.0
Total Regulatory Costs through MY 2029 Vehicles									
Total Technology Costs (\$b)	0.0	0.0	0.0	0.0	0.0	0.0	0.0	0.0	0.0
Total Civil Penalties (\$b)	0.0	0.0	0.0	0.0	0.0	0.0	0.0	0.0	0.0
Total Regulatory Costs (\$b)	0.0	0.0	0.0	0.0	0.0	0.0	0.0	0.0	0.0
Average Price Increase for MY 2030 Vehicles									
Price Increase due to New CAFE Standards (\$)	6	0	0	0	0	0	0	0	0
Technology Use under CAFE Alternative in MY 2030 (total fleet penetration)									

*** EO 12866 Review – Draft – Do Not Cite, Quote or Release During Review ***

Curb Weight Reduction (percent change from MY 2016)	0.0%	0.0%	0.0%	0.0%	0.0%	0.0%	0.0%	0.0%	0.0%
High Compression Ratio Non-Turbo Engines	0.0%	0.0%	0.0%	0.0%	0.0%	0.0%	0.0%	0.0%	0.0%
Turbocharged Gasoline Engines	0.0%	0.0%	0.0%	0.0%	0.0%	0.0%	0.0%	0.0%	0.0%
Dynamic Cylinder Deactivation	0.0%	0.0%	0.0%	0.0%	0.0%	0.0%	0.0%	0.0%	0.0%
Stop-Start 12V (Non-Hybrid)	0.0%	0.0%	0.0%	0.0%	0.0%	0.0%	0.0%	0.0%	0.0%
Mild Hybrid Electric Systems (48v)	0.0%	0.0%	0.0%	0.0%	0.0%	0.0%	0.0%	0.0%	0.0%
Strong Hybrid Electric Systems	0.0%	0.0%	0.0%	0.0%	0.0%	0.0%	0.0%	0.0%	0.0%
Plug-In Hybrid Electric Vehicles (PHEVs)	0.0%	0.0%	0.0%	0.0%	0.0%	0.0%	0.0%	0.0%	0.0%
Dedicated Electric Vehicles (EVs)	100.0%	100.0%	100.0%	100.0%	100.0%	100.0%	100.0%	100.0%	100.0%
Fuel Cell Vehicles (FCVs)	0.0%	0.0%	0.0%	0.0%	0.0%	0.0%	0.0%	0.0%	0.0%

*** EO 12866 Review – Draft – Do Not Cite, Quote or Release During Review ***

TABLE 6-157 - IMPACTS ON CARBON DIOXIDE EMISSIONS, REGULATORY COST, AVERAGE PRICE, AND TECHNOLOGY USE FOR ALL LIGHT-DUTY VEHICLES PRODUCED BY TESLA, CO₂ PROGRAM

	Alternative								
	No Action	1	2	3	4	5	6	7	8
Model Years	2021-2025	2021-2026	2021-2026	2021-2026	2021-2026	2022-2026	2021-2026	2021-2026	2022-2026
Annual Rate of Stringency Increase	MY 2017-2021 Final MY 2022-2025 Augural	0.0%/Year PC 0.0%/Year LT	0.5%/Year PC 0.5%/Year LT	0.5%/Year PC 0.5%/Year LT	1.0%/Year PC 2.0%/Year LT	1.0%/Year PC 2.0%/Year LT	2.0%/Year PC 3.0%/Year LT	2.0%/Year PC 3.0%/Year LT	2.0%/Year PC 3.0%/Year LT
AC/Off-Cycle Procedures	No Change	No Change	No Change	Phaseout 2022-2026	No Change	No Change	No Change	Phaseout 2022-2026	No Change
Average CO₂ Emission Rate									
Average Required CO ₂ - MY 2026+ (g/mi)	193.4	259.1	251.2	251.4	237.0	228.1	223.6	223.8	216.9
Percent Change in Stringency from Baseline	0.0%	-33.9%	-29.9%	-30.0%	-22.5%	-17.9%	-15.6%	-15.7%	-12.1%
Average Achieved CO ₂ - MY 2030 (g/mi)	-19.3	-4.1	-4.1	0.0	-4.0	-4.0	-3.9	0.0	-3.9
Total Regulatory Costs through MY 2029 Vehicles									
Total Technology Costs (\$b)	0.0	0.0	0.0	0.0	0.0	0.0	0.0	0.0	0.0
Total Civil Penalties (\$b)	0.0	0.0	0.0	0.0	0.0	0.0	0.0	0.0	0.0
Total Regulatory Costs (\$b)	0.0	0.0	0.0	0.0	0.0	0.0	0.0	0.0	0.0
Average Price Increase for MY 2030 Vehicles									
Price Increase due to New CAFE Standards (\$)	4	0	0	0	0	0	0	0	0
Technology Use under CAFE Alternative in MY 2030 (total fleet penetration)									

*** EO 12866 Review – Draft – Do Not Cite, Quote or Release During Review ***

Curb Weight Reduction (percent change from MY 2016)	-0.3%	0.0%	0.0%	0.0%	-0.1%	-0.2%	-0.2%	-0.3%	-0.3%
High Compression Ratio Non-Turbo Engines	0.0%	0.0%	0.0%	0.0%	0.0%	0.0%	0.0%	0.0%	0.0%
Turbocharged Gasoline Engines	0.0%	0.0%	0.0%	0.0%	0.0%	0.0%	0.0%	0.0%	0.0%
Dynamic Cylinder Deactivation	0.0%	0.0%	0.0%	0.0%	0.0%	0.0%	0.0%	0.0%	0.0%
Stop-Start 12V (Non-Hybrid)	0.0%	0.0%	0.0%	0.0%	0.0%	0.0%	0.0%	0.0%	0.0%
Mild Hybrid Electric Systems (48v)	0.0%	0.0%	0.0%	0.0%	0.0%	0.0%	0.0%	0.0%	0.0%
Strong Hybrid Electric Systems	0.0%	0.0%	0.0%	0.0%	0.0%	0.0%	0.0%	0.0%	0.0%
Plug-In Hybrid Electric Vehicles (PHEVs)	0.0%	0.0%	0.0%	0.0%	0.0%	0.0%	0.0%	0.0%	0.0%
Dedicated Electric Vehicles (EVs)	100.0%	100.0%	100.0%	100.0%	100.0%	100.0%	100.0%	100.0%	100.0%
Fuel Cell Vehicles (FCVs)	0.0%	0.0%	0.0%	0.0%	0.0%	0.0%	0.0%	0.0%	0.0%

*** EO 12866 Review – Draft – Do Not Cite, Quote or Release During Review ***

TABLE 6-158 - IMPACTS ON CARBON DIOXIDE EMISSIONS, REGULATORY COST, AVERAGE PRICE, AND TECHNOLOGY USE FOR PASSENGER CARS PRODUCED BY TOYOTA, CO₂ PROGRAM

	Alternative								
	No Action	1	2	3	4	5	6	7	8
Model Years	2021-2025	2021-2026	2021-2026	2021-2026	2021-2026	2022-2026	2021-2026	2021-2026	2022-2026
Annual Rate of Stringency Increase	MY 2017-2021 Final MY 2022-2025 Augural	0.0%/Year PC 0.0%/Year LT	0.5%/Year PC 0.5%/Year LT	0.5%/Year PC 0.5%/Year LT	1.0%/Year PC 2.0%/Year LT	1.0%/Year PC 2.0%/Year LT	2.0%/Year PC 3.0%/Year LT	2.0%/Year PC 3.0%/Year LT	2.0%/Year PC 3.0%/Year LT
AC/Off-Cycle Procedures	No Change	No Change	No Change	Phaseout 2022-2026	No Change	No Change	No Change	Phaseout 2022-2026	No Change
Average CO₂ Emission Rate									
Average Required CO ₂ - MY 2026+ (g/mi)	150.0	201.0	195.0	195.0	189.0	183.0	178.0	178.0	174.0
Percent Change in Stringency from Baseline	0.0%	-34.0%	-30.0%	-30.0%	-26.0%	-22.0%	-18.7%	-18.7%	-16.0%
Average Achieved CO ₂ - MY 2030 (g/mi)	148.1	187.7	187.7	184.8	173.2	172.4	172.5	175.3	172.0
Total Regulatory Costs through MY 2029 Vehicles									
Total Technology Costs (\$b)	15.8	-11.5	-11.5	-9.3	-5.6	-2.4	-2.4	-1.7	-2.3
Total Civil Penalties (\$b)	0.0	0.0	0.0	0.0	0.0	0.0	0.0	0.0	0.0
Total Regulatory Costs (\$b)	15.8	-11.5	-11.5	-9.3	-5.6	-2.4	-2.4	-1.7	-2.3
Average Price Increase for MY 2030 Vehicles									
Price Increase due to New CAFE Standards (\$)	1222	-966	-966	-727	-383	-252	-251	-175	-235
Technology Use under CAFE Alternative in MY 2030 (total fleet penetration)									

*** EO 12866 Review – Draft – Do Not Cite, Quote or Release During Review ***

Curb Weight Reduction (percent change from MY 2016)	7.1%	2.7%	2.7%	4.0%	6.2%	7.2%	7.2%	7.1%	7.1%
High Compression Ratio Non-Turbo Engines	83.3%	20.8%	20.8%	54.2%	54.3%	54.5%	54.5%	54.6%	54.6%
Turbocharged Gasoline Engines	10.6%	6.5%	6.5%	6.6%	10.4%	10.4%	10.4%	10.6%	10.4%
Dynamic Cylinder Deactivation	0.0%	0.0%	0.0%	0.0%	0.0%	0.0%	0.0%	0.0%	0.0%
Stop-Start 12V (Non-Hybrid)	0.0%	0.0%	0.0%	0.0%	0.0%	0.0%	0.0%	0.0%	0.0%
Mild Hybrid Electric Systems (48v)	0.0%	0.0%	0.0%	0.0%	0.0%	0.0%	0.0%	0.0%	0.0%
Strong Hybrid Electric Systems	12.4%	12.6%	12.6%	12.6%	12.5%	12.4%	12.4%	12.4%	12.4%
Plug-In Hybrid Electric Vehicles (PHEVs)	0.0%	0.0%	0.0%	0.0%	0.0%	0.0%	0.0%	0.0%	0.0%
Dedicated Electric Vehicles (EVs)	0.0%	0.0%	0.0%	0.0%	0.0%	0.0%	0.0%	0.0%	0.0%
Fuel Cell Vehicles (FCVs)	0.1%	0.1%	0.1%	0.1%	0.1%	0.1%	0.1%	0.1%	0.1%

*** EO 12866 Review – Draft – Do Not Cite, Quote or Release During Review ***

TABLE 6-159 - IMPACTS ON CARBON DIOXIDE EMISSIONS, REGULATORY COST, AVERAGE PRICE, AND TECHNOLOGY USE FOR LIGHT TRUCKS PRODUCED BY TOYOTA, CO₂ PROGRAM

	Alternative								
	No Action	1	2	3	4	5	6	7	8
Model Years	2021-2025	2021-2026	2021-2026	2021-2026	2021-2026	2022-2026	2021-2026	2021-2026	2022-2026
Annual Rate of Stringency Increase	MY 2017-2021 Final MY 2022-2025 Augural	0.0%/Year PC 0.0%/Year LT	0.5%/Year PC 0.5%/Year LT	0.5%/Year PC 0.5%/Year LT	1.0%/Year PC 2.0%/Year LT	1.0%/Year PC 2.0%/Year LT	2.0%/Year PC 3.0%/Year LT	2.0%/Year PC 3.0%/Year LT	2.0%/Year PC 3.0%/Year LT
AC/Off-Cycle Procedures	No Change	No Change	No Change	Phaseout 2022-2026	No Change	No Change	No Change	Phaseout 2022-2026	No Change
Average CO₂ Emission Rate									
Average Required CO ₂ - MY 2026+ (g/mi)	204.0	279.0	271.0	271.0	247.0	236.0	232.0	232.0	224.0
Percent Change in Stringency from Baseline	0.0%	-36.8%	-32.8%	-32.8%	-21.1%	-15.7%	-13.7%	-13.7%	-9.8%
Average Achieved CO ₂ - MY 2030 (g/mi)	202.3	278.6	270.3	269.8	244.7	233.1	230.8	232.0	222.6
Total Regulatory Costs through MY 2029 Vehicles									
Total Technology Costs (\$b)	32.4	-26.6	-24.6	-22.6	-16.5	-9.6	-8.4	-4.2	-3.5
Total Civil Penalties (\$b)	0.0	0.0	0.0	0.0	0.0	0.0	0.0	0.0	0.0
Total Regulatory Costs (\$b)	32.4	-26.6	-24.6	-22.6	-16.5	-9.6	-8.4	-4.2	-3.5
Average Price Increase for MY 2030 Vehicles									
Price Increase due to New CAFE Standards (\$)	3060	-2550	-2339	-2089	-1442	-749	-721	-116	-229
Technology Use under CAFE Alternative in MY 2030 (total fleet penetration)									

*** EO 12866 Review – Draft – Do Not Cite, Quote or Release During Review ***

Curb Weight Reduction (percent change from MY 2016)	8.6%	3.9%	3.9%	5.2%	6.9%	8.6%	8.6%	8.9%	8.6%
High Compression Ratio Non-Turbo Engines	40.9%	26.9%	26.9%	40.9%	40.9%	40.9%	40.9%	40.9%	40.9%
Turbocharged Gasoline Engines	58.5%	1.7%	16.6%	16.6%	41.9%	41.9%	54.2%	58.5%	54.2%
Dynamic Cylinder Deactivation	0.0%	0.0%	0.0%	0.0%	0.0%	0.0%	0.0%	0.0%	0.0%
Stop-Start 12V (Non-Hybrid)	21.7%	0.0%	0.0%	0.0%	2.2%	23.2%	7.7%	21.7%	28.1%
Mild Hybrid Electric Systems (48v)	72.5%	0.0%	0.0%	0.0%	0.4%	30.8%	30.3%	72.0%	65.6%
Strong Hybrid Electric Systems	5.0%	5.0%	5.0%	5.0%	5.0%	5.0%	5.0%	5.0%	5.0%
Plug-In Hybrid Electric Vehicles (PHEVs)	0.0%	0.0%	0.0%	0.0%	0.0%	0.0%	0.0%	0.0%	0.0%
Dedicated Electric Vehicles (EVs)	0.0%	0.0%	0.0%	0.0%	0.0%	0.0%	0.0%	0.0%	0.0%
Fuel Cell Vehicles (FCVs)	0.0%	0.0%	0.0%	0.0%	0.0%	0.0%	0.0%	0.0%	0.0%

*** EO 12866 Review – Draft – Do Not Cite, Quote or Release During Review ***

TABLE 6-160 - IMPACTS ON CARBON DIOXIDE EMISSIONS, REGULATORY COST, AVERAGE PRICE, AND TECHNOLOGY USE FOR ALL LIGHT-DUTY VEHICLES PRODUCED BY TOYOTA, CO₂ PROGRAM

	Alternative								
	No Action	1	2	3	4	5	6	7	8
Model Years	2021-2025	2021-2026	2021-2026	2021-2026	2021-2026	2022-2026	2021-2026	2021-2026	2022-2026
Annual Rate of Stringency Increase	MY 2017-2021 Final MY 2022-2025 Augural	0.0%/Year PC 0.0%/Year LT	0.5%/Year PC 0.5%/Year LT	0.5%/Year PC 0.5%/Year LT	1.0%/Year PC 2.0%/Year LT	1.0%/Year PC 2.0%/Year LT	2.0%/Year PC 3.0%/Year LT	2.0%/Year PC 3.0%/Year LT	2.0%/Year PC 3.0%/Year LT
AC/Off-Cycle Procedures	No Change	No Change	No Change	Phaseout 2022-2026	No Change	No Change	No Change	Phaseout 2022-2026	No Change
Average CO₂ Emission Rate									
Average Required CO ₂ - MY 2026+ (g/mi)	175.1	234.9	228.0	228.3	214.8	207.1	202.7	203.0	197.2
Percent Change in Stringency from Baseline	0.0%	-34.1%	-30.2%	-30.3%	-22.7%	-18.2%	-15.7%	-15.9%	-12.6%
Average Achieved CO ₂ - MY 2030 (g/mi)	173.3	227.2	223.6	222.0	205.0	200.0	199.1	201.5	195.4
Total Regulatory Costs through MY 2029 Vehicles									
Total Technology Costs (\$b)	48.2	-38.1	-36.1	-31.8	-22.0	-12.0	-10.8	-5.9	-5.8
Total Civil Penalties (\$b)	0.0	0.0	0.0	0.0	0.0	0.0	0.0	0.0	0.0
Total Regulatory Costs (\$b)	48.2	-38.1	-36.1	-31.8	-22.0	-12.0	-10.8	-5.9	-5.8
Average Price Increase for MY 2030 Vehicles									
Price Increase due to New CAFE Standards (\$)	2078	-1711	-1620	-1374	-892	-498	-481	-153	-236
Technology Use under CAFE Alternative in MY 2030 (total fleet penetration)									

*** EO 12866 Review – Draft – Do Not Cite, Quote or Release During Review ***

Curb Weight Reduction (percent change from MY 2016)	7.0%	3.4%	3.4%	4.6%	6.3%	7.4%	7.3%	7.3%	7.1%
High Compression Ratio Non-Turbo Engines	63.5%	23.4%	23.4%	48.4%	48.3%	48.3%	48.3%	48.3%	48.3%
Turbocharged Gasoline Engines	32.9%	4.4%	10.9%	10.9%	24.4%	24.7%	30.5%	32.8%	30.7%
Dynamic Cylinder Deactivation	0.0%	0.0%	0.0%	0.0%	0.0%	0.0%	0.0%	0.0%	0.0%
Stop-Start 12V (Non-Hybrid)	10.1%	0.0%	0.0%	0.0%	1.0%	10.5%	3.5%	10.1%	13.0%
Mild Hybrid Electric Systems (48v)	33.8%	0.0%	0.0%	0.0%	0.2%	14.0%	13.9%	33.3%	30.4%
Strong Hybrid Electric Systems	8.9%	9.3%	9.3%	9.2%	9.2%	9.0%	9.0%	8.9%	8.9%
Plug-In Hybrid Electric Vehicles (PHEVs)	0.0%	0.0%	0.0%	0.0%	0.0%	0.0%	0.0%	0.0%	0.0%
Dedicated Electric Vehicles (EVs)	0.0%	0.0%	0.0%	0.0%	0.0%	0.0%	0.0%	0.0%	0.0%
Fuel Cell Vehicles (FCVs)	0.0%	0.0%	0.0%	0.0%	0.0%	0.0%	0.0%	0.0%	0.0%

*** EO 12866 Review – Draft – Do Not Cite, Quote or Release During Review ***

TABLE 6-161 - IMPACTS ON CARBON DIOXIDE EMISSIONS, REGULATORY COST, AVERAGE PRICE, AND TECHNOLOGY USE FOR PASSENGER CARS PRODUCED BY VOLVO, CO₂ PROGRAM

	Alternative								
	No Action	1	2	3	4	5	6	7	8
Model Years	2021-2025	2021-2026	2021-2026	2021-2026	2021-2026	2022-2026	2021-2026	2021-2026	2022-2026
Annual Rate of Stringency Increase	MY 2017-2021 Final MY 2022-2025 Augural	0.0%/Year PC 0.0%/Year LT	0.5%/Year PC 0.5%/Year LT	0.5%/Year PC 0.5%/Year LT	1.0%/Year PC 2.0%/Year LT	1.0%/Year PC 2.0%/Year LT	2.0%/Year PC 3.0%/Year LT	2.0%/Year PC 3.0%/Year LT	2.0%/Year PC 3.0%/Year LT
AC/Off-Cycle Procedures	No Change	No Change	No Change	Phaseout 2022-2026	No Change	No Change	No Change	Phaseout 2022-2026	No Change
Average CO₂ Emission Rate									
Average Required CO ₂ - MY 2026+ (g/mi)	157.0	210.0	204.0	204.0	197.0	191.0	186.0	186.0	182.0
Percent Change in Stringency from Baseline	0.0%	-33.8%	-29.9%	-29.9%	-25.5%	-21.7%	-18.5%	-18.5%	-15.9%
Average Achieved CO ₂ - MY 2030 (g/mi)	153.7	209.7	202.8	202.8	196.1	190.3	190.3	186.5	184.6
Total Regulatory Costs through MY 2029 Vehicles									
Total Technology Costs (\$b)	1.4	-1.1	-1.0	-0.8	-0.7	-0.5	-0.6	-0.3	-0.3
Total Civil Penalties (\$b)	0.0	0.0	0.0	0.0	0.0	0.0	0.0	0.0	0.0
Total Regulatory Costs (\$b)	1.4	-1.1	-1.0	-0.8	-0.7	-0.5	-0.6	-0.3	-0.3
Average Price Increase for MY 2030 Vehicles									
Price Increase due to New CAFE Standards (\$)	3686	-3169	-2926	-2601	-2288	-1818	-2028	-1124	-1240
Technology Use under CAFE Alternative in MY 2030 (total fleet penetration)									

*** EO 12866 Review – Draft – Do Not Cite, Quote or Release During Review ***

Curb Weight Reduction (percent change from MY 2016)	9.6%	5.0%	7.5%	7.5%	7.4%	7.3%	7.3%	9.6%	9.6%
High Compression Ratio Non-Turbo Engines	0.0%	0.0%	0.0%	0.0%	0.0%	0.0%	0.0%	0.0%	0.0%
Turbocharged Gasoline Engines	100.0%	100.0%	100.0%	100.0%	100.0%	100.0%	100.0%	100.0%	100.0%
Dynamic Cylinder Deactivation	0.0%	0.0%	0.0%	0.0%	0.0%	0.0%	0.0%	0.0%	0.0%
Stop-Start 12V (Non-Hybrid)	0.0%	83.3%	83.3%	83.4%	91.7%	64.5%	64.2%	0.0%	33.7%
Mild Hybrid Electric Systems (48v)	16.0%	0.0%	0.0%	0.0%	0.0%	35.5%	35.8%	89.7%	66.3%
Strong Hybrid Electric Systems	84.0%	0.0%	0.0%	0.0%	0.0%	0.0%	0.0%	10.3%	0.0%
Plug-In Hybrid Electric Vehicles (PHEVs)	0.0%	0.0%	0.0%	0.0%	0.0%	0.0%	0.0%	0.0%	0.0%
Dedicated Electric Vehicles (EVs)	0.0%	0.0%	0.0%	0.0%	0.0%	0.0%	0.0%	0.0%	0.0%
Fuel Cell Vehicles (FCVs)	0.0%	0.0%	0.0%	0.0%	0.0%	0.0%	0.0%	0.0%	0.0%

*** EO 12866 Review – Draft – Do Not Cite, Quote or Release During Review ***

TABLE 6-162 - IMPACTS ON CARBON DIOXIDE EMISSIONS, REGULATORY COST, AVERAGE PRICE, AND TECHNOLOGY USE FOR LIGHT TRUCKS PRODUCED BY VOLVO, CO₂ PROGRAM

	Alternative								
	No Action	1	2	3	4	5	6	7	8
Model Years	2021-2025	2021-2026	2021-2026	2021-2026	2021-2026	2022-2026	2021-2026	2021-2026	2022-2026
Annual Rate of Stringency Increase	MY 2017-2021 Final MY 2022-2025 Augural	0.0%/Year PC 0.0%/Year LT	0.5%/Year PC 0.5%/Year LT	0.5%/Year PC 0.5%/Year LT	1.0%/Year PC 2.0%/Year LT	1.0%/Year PC 2.0%/Year LT	2.0%/Year PC 3.0%/Year LT	2.0%/Year PC 3.0%/Year LT	2.0%/Year PC 3.0%/Year LT
AC/Off-Cycle Procedures	No Change	No Change	No Change	Phaseout 2022-2026	No Change	No Change	No Change	Phaseout 2022-2026	No Change
Average CO₂ Emission Rate									
Average Required CO ₂ - MY 2026+ (g/mi)	200.0	274.0	266.0	266.0	243.0	232.0	229.0	229.0	221.0
Percent Change in Stringency from Baseline	0.0%	-37.0%	-33.0%	-33.0%	-21.5%	-16.0%	-14.5%	-14.5%	-10.5%
Average Achieved CO ₂ - MY 2030 (g/mi)	199.3	261.2	257.5	261.4	243.1	231.1	226.8	228.3	219.1
Total Regulatory Costs through MY 2029 Vehicles									
Total Technology Costs (\$b)	1.9	-1.7	-1.5	-1.4	-1.2	-0.9	-0.6	-0.2	-0.2
Total Civil Penalties (\$b)	0.0	0.0	0.0	0.0	0.0	0.0	0.0	0.0	0.0
Total Regulatory Costs (\$b)	1.9	-1.7	-1.5	-1.4	-1.2	-0.9	-0.6	-0.2	-0.2
Average Price Increase for MY 2030 Vehicles									
Price Increase due to New CAFE Standards (\$)	2726	-2446	-2283	-2125	-1725	-1298	-744	-190	-199
Technology Use under CAFE Alternative in MY 2030 (total fleet penetration)									

*** EO 12866 Review – Draft – Do Not Cite, Quote or Release During Review ***

Curb Weight Reduction (percent change from MY 2016)	5.1%	1.9%	2.8%	2.8%	2.7%	2.6%	4.5%	5.1%	5.1%
High Compression Ratio Non-Turbo Engines	0.0%	0.0%	0.0%	0.0%	0.0%	0.0%	0.0%	0.0%	0.0%
Turbocharged Gasoline Engines	100.0%	100.0%	100.0%	100.0%	100.0%	100.0%	100.0%	100.0%	100.0%
Dynamic Cylinder Deactivation	0.0%	0.0%	0.0%	0.0%	0.0%	0.0%	0.0%	0.0%	0.0%
Stop-Start 12V (Non-Hybrid)	0.0%	62.6%	62.6%	62.7%	63.1%	6.6%	9.7%	0.0%	0.0%
Mild Hybrid Electric Systems (48v)	69.6%	0.0%	0.0%	0.0%	0.0%	57.0%	63.7%	86.6%	86.7%
Strong Hybrid Electric Systems	26.5%	0.0%	0.0%	0.0%	0.0%	0.0%	0.0%	9.5%	9.5%
Plug-In Hybrid Electric Vehicles (PHEVs)	3.9%	3.8%	3.8%	3.8%	3.8%	3.9%	3.9%	3.9%	3.9%
Dedicated Electric Vehicles (EVs)	0.0%	0.0%	0.0%	0.0%	0.0%	0.0%	0.0%	0.0%	0.0%
Fuel Cell Vehicles (FCVs)	0.0%	0.0%	0.0%	0.0%	0.0%	0.0%	0.0%	0.0%	0.0%

*** EO 12866 Review – Draft – Do Not Cite, Quote or Release During Review ***

TABLE 6-163 - IMPACTS ON CARBON DIOXIDE EMISSIONS, REGULATORY COST, AVERAGE PRICE, AND TECHNOLOGY USE FOR ALL LIGHT-DUTY VEHICLES PRODUCED BY VOLVO, CO₂ PROGRAM

	Alternative								
	No Action	1	2	3	4	5	6	7	8
Model Years	2021-2025	2021-2026	2021-2026	2021-2026	2021-2026	2022-2026	2021-2026	2021-2026	2022-2026
Annual Rate of Stringency Increase	MY 2017-2021 Final MY 2022-2025 Augural	0.0%/Year PC 0.0%/Year LT	0.5%/Year PC 0.5%/Year LT	0.5%/Year PC 0.5%/Year LT	1.0%/Year PC 2.0%/Year LT	1.0%/Year PC 2.0%/Year LT	2.0%/Year PC 3.0%/Year LT	2.0%/Year PC 3.0%/Year LT	2.0%/Year PC 3.0%/Year LT
AC/Off-Cycle Procedures	No Change	No Change	No Change	Phaseout 2022-2026	No Change	No Change	No Change	Phaseout 2022-2026	No Change
Average CO₂ Emission Rate									
Average Required CO ₂ - MY 2026+ (g/mi)	185.2	251.0	243.7	243.8	226.7	217.7	214.1	214.2	207.6
Percent Change in Stringency from Baseline	0.0%	-35.5%	-31.6%	-31.6%	-22.4%	-17.5%	-15.6%	-15.6%	-12.1%
Average Achieved CO ₂ - MY 2030 (g/mi)	183.7	242.7	237.8	240.4	226.4	216.8	214.1	213.9	207.2
Total Regulatory Costs through MY 2029 Vehicles									
Total Technology Costs (\$b)	3.2	-2.8	-2.5	-2.3	-1.9	-1.4	-1.2	-0.5	-0.6
Total Civil Penalties (\$b)	0.0	0.0	0.0	0.0	0.0	0.0	0.0	0.0	0.0
Total Regulatory Costs (\$b)	3.2	-2.8	-2.5	-2.3	-1.9	-1.4	-1.2	-0.5	-0.6
Average Price Increase for MY 2030 Vehicles									
Price Increase due to New CAFE Standards (\$)	3056	-2690	-2498	-2281	-1914	-1474	-1186	-511	-556
Technology Use under CAFE Alternative in MY 2030 (total fleet penetration)									

*** EO 12866 Review – Draft – Do Not Cite, Quote or Release During Review ***

Curb Weight Reduction (percent change from MY 2016)	6.2%	2.9%	4.3%	4.3%	4.1%	3.9%	5.2%	6.3%	6.2%
High Compression Ratio Non-Turbo Engines	0.0%	0.0%	0.0%	0.0%	0.0%	0.0%	0.0%	0.0%	0.0%
Turbocharged Gasoline Engines	100.0%	100.0%	100.0%	100.0%	100.0%	100.0%	100.0%	100.0%	100.0%
Dynamic Cylinder Deactivation	0.0%	0.0%	0.0%	0.0%	0.0%	0.0%	0.0%	0.0%	0.0%
Stop-Start 12V (Non-Hybrid)	0.0%	70.0%	70.0%	70.1%	73.2%	26.8%	28.6%	0.0%	11.6%
Mild Hybrid Electric Systems (48v)	51.2%	0.0%	0.0%	0.0%	0.0%	49.5%	54.0%	87.7%	79.7%
Strong Hybrid Electric Systems	46.3%	0.0%	0.0%	0.0%	0.0%	0.0%	0.0%	9.7%	6.2%
Plug-In Hybrid Electric Vehicles (PHEVs)	2.6%	2.4%	2.4%	2.4%	2.5%	2.5%	2.5%	2.5%	2.5%
Dedicated Electric Vehicles (EVs)	0.0%	0.0%	0.0%	0.0%	0.0%	0.0%	0.0%	0.0%	0.0%
Fuel Cell Vehicles (FCVs)	0.0%	0.0%	0.0%	0.0%	0.0%	0.0%	0.0%	0.0%	0.0%

*** EO 12866 Review – Draft – Do Not Cite, Quote or Release During Review ***

TABLE 6-164 - IMPACTS ON CARBON DIOXIDE EMISSIONS, REGULATORY COST, AVERAGE PRICE, AND TECHNOLOGY USE FOR PASSENGER CARS PRODUCED BY VOLKSWAGEN GROUP, CO₂ PROGRAM

	Alternative								
	No Action	1	2	3	4	5	6	7	8
Model Years	2021-2025	2021-2026	2021-2026	2021-2026	2021-2026	2022-2026	2021-2026	2021-2026	2022-2026
Annual Rate of Stringency Increase	MY 2017-2021 Final MY 2022-2025 Augural	0.0%/Year PC 0.0%/Year LT	0.5%/Year PC 0.5%/Year LT	0.5%/Year PC 0.5%/Year LT	1.0%/Year PC 2.0%/Year LT	1.0%/Year PC 2.0%/Year LT	2.0%/Year PC 3.0%/Year LT	2.0%/Year PC 3.0%/Year LT	2.0%/Year PC 3.0%/Year LT
AC/Off-Cycle Procedures	No Change	No Change	No Change	Phaseout 2022-2026	No Change	No Change	No Change	Phaseout 2022-2026	No Change
Average CO₂ Emission Rate									
Average Required CO ₂ - MY 2026+ (g/mi)	148.0	199.0	193.0	193.0	187.0	182.0	176.0	176.0	173.0
Percent Change in Stringency from Baseline	0.0%	-34.5%	-30.4%	-30.4%	-26.4%	-23.0%	-18.9%	-18.9%	-16.9%
Average Achieved CO ₂ - MY 2030 (g/mi)	148.3	195.1	193.5	190.3	184.9	179.7	174.3	175.6	171.3
Total Regulatory Costs through MY 2029 Vehicles									
Total Technology Costs (\$b)	20.2	-14.3	-13.6	-12.0	-11.3	-7.8	-6.6	-5.0	-5.2
Total Civil Penalties (\$b)	0.0	0.0	0.0	0.0	0.0	0.0	0.0	0.0	0.0
Total Regulatory Costs (\$b)	20.2	-14.3	-13.6	-12.0	-11.3	-7.8	-6.6	-5.0	-5.2
Average Price Increase for MY 2030 Vehicles									
Price Increase due to New CAFE Standards (\$)	3971	-3062	-2969	-2397	-2245	-1700	-1340	-853	-1026
Technology Use under CAFE Alternative in MY 2030 (total fleet penetration)									

*** EO 12866 Review – Draft – Do Not Cite, Quote or Release During Review ***

Curb Weight Reduction (percent change from MY 2016)	9.9%	7.4%	7.4%	10.0%	10.0%	9.9%	9.9%	9.9%	9.9%
High Compression Ratio Non-Turbo Engines	0.0%	0.0%	0.0%	0.0%	0.0%	0.0%	0.0%	0.0%	0.0%
Turbocharged Gasoline Engines	95.3%	97.9%	98.0%	98.0%	98.1%	98.1%	98.1%	98.1%	98.1%
Dynamic Cylinder Deactivation	0.0%	0.0%	0.0%	0.0%	0.0%	0.0%	0.0%	0.0%	0.0%
Stop-Start 12V (Non-Hybrid)	0.0%	15.3%	19.5%	19.7%	48.0%	55.2%	0.0%	0.0%	0.0%
Mild Hybrid Electric Systems (48v)	3.7%	0.0%	0.0%	0.0%	0.0%	34.1%	86.0%	46.3%	62.7%
Strong Hybrid Electric Systems	83.8%	0.2%	0.2%	0.2%	0.2%	0.2%	3.4%	43.2%	26.8%
Plug-In Hybrid Electric Vehicles (PHEVs)	2.8%	0.9%	0.9%	0.9%	0.9%	0.9%	0.9%	0.9%	0.9%
Dedicated Electric Vehicles (EVs)	1.5%	1.5%	1.5%	1.5%	1.5%	1.5%	1.5%	1.5%	1.5%
Fuel Cell Vehicles (FCVs)	0.1%	0.0%	0.0%	0.0%	0.0%	0.0%	0.0%	0.0%	0.0%

*** EO 12866 Review – Draft – Do Not Cite, Quote or Release During Review ***

TABLE 6-165. IMPACTS ON CARBON DIOXIDE EMISSIONS, REGULATORY COST, AVERAGE PRICE, AND TECHNOLOGY USE FOR LIGHT TRUCKS PRODUCED BY VOLKSWAGEN GROUP, CO₂ PROGRAM

	Alternative								
	No Action	1	2	3	4	5	6	7	8
Model Years	2021-2025	2021-2026	2021-2026	2021-2026	2021-2026	2022-2026	2021-2026	2021-2026	2022-2026
Annual Rate of Stringency Increase	MY 2017-2021 Final MY 2022-2025 Augural	0.0%/Year PC 0.0%/Year LT	0.5%/Year PC 0.5%/Year LT	0.5%/Year PC 0.5%/Year LT	1.0%/Year PC 2.0%/Year LT	1.0%/Year PC 2.0%/Year LT	2.0%/Year PC 3.0%/Year LT	2.0%/Year PC 3.0%/Year LT	2.0%/Year PC 3.0%/Year LT
AC/Off-Cycle Procedures	No Change	No Change	No Change	Phaseout 2022-2026	No Change	No Change	No Change	Phaseout 2022-2026	No Change
Average CO₂ Emission Rate									
Average Required CO ₂ - MY 2026+ (g/mi)	191.0	263.0	255.0	255.0	233.0	223.0	219.0	219.0	211.0
Percent Change in Stringency from Baseline	0.0%	-37.7%	-33.5%	-33.5%	-22.0%	-16.8%	-14.7%	-14.7%	-10.5%
Average Achieved CO ₂ - MY 2030 (g/mi)	190.7	253.2	252.7	250.3	231.4	220.5	220.5	220.3	210.6
Total Regulatory Costs through MY 2029 Vehicles									
Total Technology Costs (\$b)	5.6	-4.0	-3.9	-3.5	-2.9	-1.4	-2.0	-1.0	-0.6
Total Civil Penalties (\$b)	0.0	0.0	0.0	0.0	0.0	0.0	0.0	0.0	0.0
Total Regulatory Costs (\$b)	5.6	-4.0	-3.9	-3.5	-2.9	-1.4	-2.0	-1.0	-0.6
Average Price Increase for MY 2030 Vehicles									
Price Increase due to New CAFE Standards (\$)	4036	-3193	-3182	-2599	-2096	-1138	-1248	-376	-365
Technology Use under CAFE Alternative in MY 2030 (total fleet penetration)									

*** EO 12866 Review – Draft – Do Not Cite, Quote or Release During Review ***

Curb Weight Reduction (percent change from MY 2016)	10.0%	6.8%	6.8%	8.5%	10.0%	10.0%	10.0%	10.0%	10.0%
High Compression Ratio Non-Turbo Engines	0.0%	0.0%	0.0%	0.0%	0.0%	0.0%	0.0%	0.0%	0.0%
Turbocharged Gasoline Engines	93.2%	93.2%	93.2%	93.2%	93.2%	93.2%	93.2%	93.2%	93.2%
Dynamic Cylinder Deactivation	0.0%	0.0%	0.0%	0.0%	0.0%	0.0%	0.0%	0.0%	0.0%
Stop-Start 12V (Non-Hybrid)	0.0%	35.0%	35.0%	35.0%	32.8%	0.0%	0.0%	0.0%	0.0%
Mild Hybrid Electric Systems (48v)	6.8%	0.0%	0.0%	0.0%	35.0%	80.1%	80.1%	17.9%	21.5%
Strong Hybrid Electric Systems	91.4%	0.0%	0.0%	0.0%	0.0%	18.2%	18.2%	80.4%	76.7%
Plug-In Hybrid Electric Vehicles (PHEVs)	1.8%	1.8%	1.8%	1.8%	1.8%	1.8%	1.8%	1.8%	1.8%
Dedicated Electric Vehicles (EVs)	0.0%	0.0%	0.0%	0.0%	0.0%	0.0%	0.0%	0.0%	0.0%
Fuel Cell Vehicles (FCVs)	0.0%	0.0%	0.0%	0.0%	0.0%	0.0%	0.0%	0.0%	0.0%

*** EO 12866 Review – Draft – Do Not Cite, Quote or Release During Review ***

TABLE 6-166 - IMPACTS ON CARBON DIOXIDE EMISSIONS, REGULATORY COST, AVERAGE PRICE, AND TECHNOLOGY USE FOR ALL LIGHT-DUTY VEHICLES PRODUCED BY VOLKSWAGEN GROUP, CO₂ PROGRAM

	Alternative								
	No Action	1	2	3	4	5	6	7	8
Model Years	2021-2025	2021-2026	2021-2026	2021-2026	2021-2026	2022-2026	2021-2026	2021-2026	2022-2026
Annual Rate of Stringency Increase	MY 2017-2021 Final MY 2022-2025 Augural	0.0%/Year PC 0.0%/Year LT	0.5%/Year PC 0.5%/Year LT	0.5%/Year PC 0.5%/Year LT	1.0%/Year PC 2.0%/Year LT	1.0%/Year PC 2.0%/Year LT	2.0%/Year PC 3.0%/Year LT	2.0%/Year PC 3.0%/Year LT	2.0%/Year PC 3.0%/Year LT
AC/Off-Cycle Procedures	No Change	No Change	No Change	Phaseout 2022-2026	No Change	No Change	No Change	Phaseout 2022-2026	No Change
Average CO₂ Emission Rate									
Average Required CO ₂ - MY 2026+ (g/mi)	158.0	212.4	206.0	206.1	197.0	191.2	185.7	185.9	181.8
Percent Change in Stringency from Baseline	0.0%	-34.4%	-30.4%	-30.5%	-24.7%	-21.0%	-17.6%	-17.7%	-15.1%
Average Achieved CO ₂ - MY 2030 (g/mi)	158.2	207.2	205.9	203.0	195.0	188.8	184.7	185.9	180.4
Total Regulatory Costs through MY 2029 Vehicles									
Total Technology Costs (\$b)	25.8	-18.3	-17.6	-15.5	-14.2	-9.2	-8.6	-6.0	-5.8
Total Civil Penalties (\$b)	0.0	0.0	0.0	0.0	0.0	0.0	0.0	0.0	0.0
Total Regulatory Costs (\$b)	25.8	-18.3	-17.6	-15.5	-14.2	-9.2	-8.6	-6.0	-5.8
Average Price Increase for MY 2030 Vehicles									
Price Increase due to New CAFE Standards (\$)	3986	-3091	-3015	-2441	-2214	-1575	-1320	-743	-874
Technology Use under CAFE Alternative in MY 2030 (total fleet penetration)									

*** EO 12866 Review – Draft – Do Not Cite, Quote or Release During Review ***

Curb Weight Reduction (percent change from MY 2016)	9.5%	7.3%	7.3%	9.6%	9.9%	9.7%	9.7%	9.6%	9.6%
High Compression Ratio Non-Turbo Engines	0.0%	0.0%	0.0%	0.0%	0.0%	0.0%	0.0%	0.0%	0.0%
Turbocharged Gasoline Engines	94.8%	96.9%	97.0%	97.0%	97.0%	97.0%	97.0%	97.0%	97.0%
Dynamic Cylinder Deactivation	0.0%	0.0%	0.0%	0.0%	0.0%	0.0%	0.0%	0.0%	0.0%
Stop-Start 12V (Non-Hybrid)	0.0%	19.5%	22.7%	22.9%	44.7%	42.8%	0.0%	0.0%	0.0%
Mild Hybrid Electric Systems (48v)	4.4%	0.0%	0.0%	0.0%	7.6%	44.4%	84.7%	39.7%	53.2%
Strong Hybrid Electric Systems	85.6%	0.1%	0.1%	0.1%	0.1%	4.2%	6.8%	51.8%	38.3%
Plug-In Hybrid Electric Vehicles (PHEVs)	2.6%	1.1%	1.1%	1.1%	1.1%	1.1%	1.1%	1.1%	1.1%
Dedicated Electric Vehicles (EVs)	1.1%	1.2%	1.2%	1.2%	1.2%	1.2%	1.2%	1.1%	1.1%
Fuel Cell Vehicles (FCVs)	0.1%	0.0%	0.0%	0.0%	0.0%	0.0%	0.0%	0.0%	0.0%

7 Economic Analysis of Regulatory Alternatives

This chapter describes the approach for measuring the various economic costs and benefits that are likely to result from adopting different regulatory alternatives. It also reports the values of the economic parameters used to calculate each category of costs and benefits, describes the sources relied on for estimates of the values of these parameters, and highlights the uncertainty surrounding those values.

These are important considerations, because as Office of Management and Budget Circular A-4 states, benefits and costs reported in regulatory analyses must be defined and measured consistently with economic theory, and should also reflect how alternative regulations are anticipated to change the behavior of producers and consumers from a baseline scenario.⁴²¹ In this analysis, those include vehicle manufacturers, buyers of new cars and light trucks, and owners of used vehicles, all of whose behavior is likely to be affected in complex ways by the proposed action to adopt less strict CAFE and CO₂ emission standards for future years.

The values of economic parameters used in this analysis are equally important, because they directly affect the estimated dollar values of each regulatory alternative's benefits and costs. These values were chosen based on extensive review of careful empirical research, rather than chosen selectively from individual studies, extrapolated using uncertain assumptions, or derived from speculative assessments of future trends.

7.1 Overview of Economic Consequences from Changing Fuel Economy and CO₂ Emission Standards

Figure 7-1 illustrates how changes in fuel economy and emissions standards generate benefits and costs in various markets and throughout the U.S. economy. As it shows, vehicle manufacturers respond to changes in standards by accelerating – or decelerating, if standards are reduced – the pace at which they apply new technology to improve the energy efficiency of the models they offer. At the same time, they may also modify how it is incorporated into those vehicles' power trains to produce accompanying changes in other features that affect their utility and value to potential buyers. These attributes can include performance, seating or carrying capacity, passenger comfort, occupant safety, or towing capability. Because new technology is costly to produce and to integrate into a vehicle's design, changes in manufacturers' decisions to incorporate additional technology will affect their costs to produce the models they redesign, and they will attempt to recover these additional costs by raising selling prices for those or other models they offer.

⁴²¹ White House Office of Management and Budget, *Circular A-4 - Regulatory Analysis*, September 17, 2003 (https://obamawhitehouse.archives.gov/omb/circulars_a004_a-4/), Section E.

FIGURE 7-1 - OVERVIEW OF ECONOMIC EFFECTS OF CHANGING FUEL ECONOMY AND CO2 STANDARDS

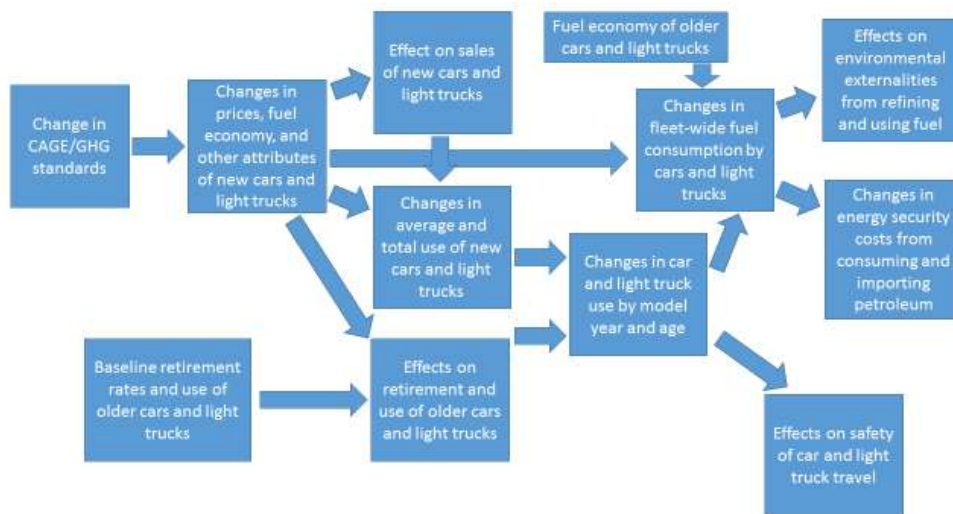

As the figure indicates, the resulting changes in the fuel economy, other features, and prices of new vehicles will affect their sales, although the direction in which they do so is difficult to anticipate. This is because the change depends on how potential buyers value the future savings or increase in fuel costs that result from changing vehicles' fuel economy, as well as how they value any accompanying changes in other attributes that affect their utility. Modifying vehicles' fuel economy also changes their operating costs (by changing the amount of fuel consumed in driving each mile), which as the figure also shows, affects how much they are likely to be driven each year and throughout their lifetimes.

At the same time, changes in the prices, fuel economy, and other features of new cars and light trucks will alter some potential buyers' choices between new and used models because used vehicles often represent a close substitute for new models. The direction of this effect again depends on the magnitude of changes in new vehicles' prices and on how buyers value the changes in new vehicles' fuel economy relative to any accompanying changes in their other features. If on balance fewer buyers elect to purchase new cars or light trucks, some who would otherwise have purchased a new model may decide to buy a used model instead, while others will continue to drive a vehicle they already own. Conversely, if buyers find the combination of changes in new vehicles' prices, fuel economy, and other attributes attractive, some will respond by purchasing new vehicles instead of buying used models or by replacing one on they already own.

*** EO 12866 Review – Draft – Do Not Cite, Quote or Release During Review ***

This effect is shown in Figure 7-1 as a change in the demand for used vehicles. If demand for used cars and light trucks increases in response to the same factors that reduce new car sales, the value of used cars will rise, because their supply is limited (although it is not fixed, as will be discussed in detail later). As a consequence, some that would otherwise have been retired will instead be kept in service. But if changes in prices and characteristics of new vehicles cause their sales to rise, demand for used cars and light trucks will decline, causing their value to decline and increasing the number of them that are retired. This will in effect result in a transfer of some travel (VMT) between new and used vehicles - in the first case more of total VMT will be driven in used cars and light trucks than under the baseline scenario, while in the latter case some will be shifted from used models to the newly-purchased ones that replace them.

As Figure 7-1 shows, this process will have several economic consequences, but whether these represent costs or benefits will again depend on how changing the fuel economy levels that new cars and light trucks are required to achieve affects the sales and use of new versus used models. First, total fuel use by new vehicles will decline if fuel economy standards rise and increase if they are reduced, but in either case fuel consumption by used vehicles will change in the opposite direction and offset some fraction of the anticipated effect of raising or lowering standards for new cars and light trucks.

Raising standards will produce economic benefits to new vehicle buyers from savings in future fuel use that offset costs for increased fuel consumption by used vehicles, while reducing them will produce net costs to light-duty vehicle users as higher fuel use by new models offsets any decline in driving and fuel consumption by older vehicles. Additional economic benefits – including savings in time spent refueling and the value of increased travel, as vehicle use responds to higher fuel economy – will accompany those savings in fuel costs if standards are raised from their levels under the baseline, while if standards are reduced, drivers will spend more time refueling and travel less, in response to higher fuel costs for driving each mile.

In turn, changes in the volume of fuel refined (or imported), distributed, and consumed throughout the U.S. will affect emissions of CO₂ and criteria air pollutants, generating economic benefits by reducing the costs these externalities impose if total fuel supplied and consumed declines, but increasing those costs if fuel production and use increase. Changing the volume of fuel refined or imported will also affect the magnitude and costs of economic externalities that result from U.S. petroleum consumption and imports, which include transfers from consumers of petroleum products to petroleum suppliers and increases in the potential costs to businesses and households for adapting to interruptions in the supply of petroleum or sudden, large increases in its price. Again, reducing U.S. fuel consumption and petroleum demand by raising required fuel economy levels for new cars and light trucks will reduce the costs resulting from these externalities, while reducing those standards from the baseline scenario will increase the costs these externalities impose on the U.S. economy.

*** EO 12866 Review – Draft – Do Not Cite, Quote or Release During Review ***

Finally, Figure 7-1 also shows that changes in the mix of new and used cars and light trucks in use and accompanying shifts in total VMT between them – again, measured relative to the composition of the vehicle fleet and the mix of driving by new and used vehicles under the baseline scenario – will affect the safety of drivers and their passengers. This effect occurs primarily because new vehicles have become progressively safer over time, and this trend is anticipated to continue. Thus if changing CAFE and CO₂ standards leads to an increase in sales of new cars and light trucks, the accompanying shift of some travel to new vehicles will reduce fatalities, other injuries, and property damage caused by motor vehicle crashes, producing significant economic benefits.

Conversely, if buyers' reaction to the changes in prices and attributes of new vehicles that manufacturers make in response to higher or lower fuel economy standards causes a decline in their sales, some travel that would otherwise have taken place in newer, safer cars and light trucks will instead be sifted to older models. As a consequence, the safety consequences and economic costs of motor vehicle crashes will rise.

7.2 New Issues Addressed in this Regulatory Analysis

This regulatory analysis addresses two important issues that have not been recognized in the analyses supporting previous CAFE/GHG rules. First, this RIA recognizes the effects of changing fuel economy and CO₂ standards for new light-duty vehicles on the number, age distribution, and retirement rates of vehicles that were produced during previous model years and make up the current used vehicle fleet. It estimates the effects of changes in fuel economy, prices, and other attributes of new vehicles produced during future model years on the usage and fuel consumption of used vehicles, and their consequences for fuel savings, emissions reductions, associated externalities, and safety impacts resulting from the proposed changes in CAFE and CO₂ emissions standards.

7.2.1 Effects on the Used Vehicle Fleet

The potential for regulations affecting new cars and light trucks to change their prices and other attributes in ways that influence the usage, energy consumption, and emissions of used vehicles produced during previous years has been recognized in analyses of the impacts of fuel economy and emission standards for nearly 40 years. This effect has long been recognized by academic and government researchers, and other regulatory agencies have acknowledged it as a significant concern.⁴²² Limitations on data and analytic resources – rather than reservations about its realism or empirical significance – have prevented a quantitative incorporation of this effect in previous regulatory analyses, but this analysis corrects that previous omission.

⁴²² Gruenspecht (1981), Greenspan & Cohen (1999), California Air Resources Board (2004), Jacobsen & van Benthem (2015).

The core of this analysis is a detailed econometric model of the annual retirement (or “scrappage”) rates of vehicles from previous model years that make up the used vehicle fleet during each future calendar year. It estimates changes in their retirement rates that result from changes in the fuel economy, prices, and other attributes of new cars and light trucks produced during future model years, as well as from other variables that affect owners’ decisions about when to retire used vehicles. These other influences include maintenance and repair costs, fuel prices, the fuel economy of vehicles produced during earlier model years, and macroeconomic conditions such as the rates of economic growth and unemployment. Changes in the values of these factors affect the number of used vehicles of different ages that are kept in service rather than being retired, and their continued usage contributes to fuel consumption, emissions, and safety concerns in ways that offset some of the direct effects of changes in CAFE and CO₂ standards.

7.2.2 Changes in Vehicle Features Other than Fuel Economy

Second, this analysis recognizes that manufacturers’ changes in the fuel economy and emissions levels of new vehicles in response to raising or lowering federal standards may also entail changes in other attributes that affect their energy consumption, and that potential buyers also value. These other attributes may include carrying capacity for passengers and cargo, comfort and ride quality, performance, and occupant safety. Any sacrifices or gains in the levels of these desired attributes that vehicle manufacturers implement in the process of responding to changes in the fuel economy and emissions levels required by federal standards represent opportunity costs or benefits that should be included among the more widely-recognized economic effects of changing those standards. Although detailed estimates of the economic benefits or costs of changes in these other vehicle attributes have not yet been developed, this regulatory analysis explicitly recognizes the potential significance of these benefits or costs, and reports a rough estimate of their likely empirical significance.

Instead, the analysis holds most other attributes of new cars and light trucks produced in future model years fixed at their levels during the model year (2016) used to represent its base year fleet. Where this is not the case, the analysis imputes some loss in vehicles’ value (as with range limitations from PHEVs and BEVs), or (as with engine downsizing and mass reduction) includes any additional technology costs that are necessary to maintain performance, utility, or safety at base year (2016) values. Because the improvements in energy conversion efficiency that result from most technologies cannot effectively be deployed exclusively to improve fuel economy, some fraction of their energy efficiency benefits remains available to improve other vehicle attributes as a by-product of using them to increase fuel economy, and the estimates of their effectiveness in increasing fuel economy developed in Argonne’s simulations reflect this.⁴²³ The short payback period used to calculate the effective cost estimates used in the CAFE model’s technology selection algorithm also reflects an implicit assumption that manufacturers will

⁴²³ For further discussion of Argonne National Laboratory’s physics-based simulation modeling, see RIA Chapter V.

*** EO 12866 Review – Draft – Do Not Cite, Quote or Release During Review ***

continue to apply some of the energy efficiency improvements from most technologies to improve other desirable attributes of vehicles, as they have historically done.

It is important to realize, however, that this approach is *not* equivalent to including the value of changes in the attributes of future model years' vehicles from those that manufacturers would offer if today's prevailing CAFE and CO₂ standards were left unchanged but extended to apply to future model years. In general, the opportunity costs or benefits of potential changes to future vehicle attributes as they are traded off against improved fuel economy are likely to exceed the costs or benefits of maintaining those attributes at the levels featured by today's (or a recent model year's) new cars and light trucks.

7.3 Baseline for Measuring Benefits and Costs

The Office of Management and Budget's guidance on regulatory analysis directs agencies to measure the benefits and costs of their proposed actions against a baseline alternative that represents "...the best assessment of the way the world would look absent the proposed action." Where that future world includes existing government regulations, OMB's guidance further advises that a baseline should reflect "...changes in regulations promulgated by the agency or other government entities, and the degree of compliance by regulated entities with other regulations," and that "[f]or review of an existing regulation, a baseline assuming no change in the regulatory program generally provides an appropriate basis for evaluating regulatory alternatives."⁴²⁴

Executive Order 13771 (issued January 30, 2017) directs federal agencies to take various actions that reduce the burden of regulations and control the costs regulations impose on businesses and households. The proposed revision of CO₂ emissions and CAFE standards for light-duty vehicles produced in MY 2021, and establishment and revision of CAFE and CO₂ standards for MYs 2022-2026, represent a prominent example of such a "deregulatory" action. Guidance from OMB interpreting Executive Order 13771 clarifies that analyses of such actions should measure the resulting savings in regulatory costs by applying in reverse the same accounting conventions normally used to define and measure benefits and costs of regulations, as prescribed in Circular A-4. Thus savings in future costs that regulations would otherwise have imposed represent the benefits of such actions, while sacrifices in future benefits that would have resulted from previously adopted regulations represent the costs of deregulatory actions.⁴²⁵

7.3.1 Regulatory Baseline Used in this Analysis

NHTSA and EPA interpret OMB's guidance as indicating that EPA's CO₂ emission standards for MYs years 2022-25 should represent the baseline alternative for this regulatory analysis,

⁴²⁴ OMB Circular A-4, p. 15.

⁴²⁵ Office of Management and Budget, "Guidance Implementing Executive Order 13771, Titled 'Reducing Regulation and Controlling Regulatory Costs,'" April 5, 2017, pp. 9-11.

*** EO 12866 Review – Draft – Do Not Cite, Quote or Release During Review ***

against which alternative changes to those standards should be evaluated. Because EPA's standards were adopted previously and thus have the force of law, the operative interpretation is that they represent the correct baseline for measuring benefits and costs of proposed alternative standards for the EPA CO₂ program. Similarly, the operative interpretation for this analysis is that the augural CAFE standards NHTSA announced previously for MYs 2022-2025 represent the correct baseline for assessing the effects of alternative CAFE standards for those model years. Where this analysis considers alternative fuel economy and CO₂ emissions standards for model years beyond 2026, it evaluates them against a baseline that assumes the standards previously established for model year 2026 would be extended to apply to subsequent model years.

This perspective has important implications for the definition of those benefits and costs, because each of the regulatory alternatives considered in this analysis would allow vehicles across the footprint spectrum to meet higher CO₂ emission targets, which correspond to lower fuel economy targets. As a consequence, each alternative reduces manufacturers' compliance costs from their levels under the baseline, while also reducing other resulting private and social costs of compliance with EPA's adopted standards, and these cost reductions represent benefits of that alternative. Conversely, sacrifices in private and economy-wide benefits of the reductions in fuel consumption and CO₂ emissions that were projected to result from EPA's standards for future model years represent costs of each regulatory alternative considered in this analysis.

7.3.2 Other Assumptions Used in Measuring Benefits and Costs

This analysis also incorporates other economic assumptions and forecasts, and while these do not vary between the baseline scenario and those that would change CAFE and CO₂ standards, they do affect the benefits and costs of the various regulatory alternatives the agencies consider. Forecasts of U.S. economic activity, personal income, and other macroeconomic aggregates, which affect the projections of retirement rates of used vehicles through U.S. fuel prices, are taken from the U.S. Energy Information Administration's *Annual Energy Outlook 2017* (AEO 2017).⁴²⁶ This is also the source for the forecasts of global petroleum supply and prices, as well as U.S. consumption and imports of crude petroleum and refined fuel.⁴²⁷

7.4 Effects of Reducing CAFE Standards on Vehicle Prices, Fuel Economy, and Other Features

Changing fuel economy and CO₂ emissions standards will directly affect the design and production cost of light-duty vehicles, and these direct impacts are the initial source of all resulting costs and benefits. Changing CAFE standards is likely to affect not only the fuel

⁴²⁶ U.S. Energy Information Administration, Annual Energy Outlook 2017, Reference Case Table 20 (https://www.eia.gov/outlooks/aeo/tables_ref.php).

⁴²⁷ U.S. Energy Information Administration, Annual Energy Outlook 2017, Reference Case Tables 11 and 12 (https://www.eia.gov/outlooks/aeo/tables_ref.php).

*** EO 12866 Review – Draft – Do Not Cite, Quote or Release During Review ***

economy of cars and light trucks, but also other features that buyers value, including seating and cargo-carrying capacity, ride comfort, occupant protection, and performance. These other features are likely to be affected because they also influence vehicles' energy consumption, so changing fuel economy may enable manufacturers to make improvements – or alternatively, require them to make tradeoffs – in these other attributes. By doing so, changing CAFE standards will also affect vehicles' production costs and selling prices, as manufacturers attempt to pass changes in their production costs on to buyers.

Without fuel economy regulation (or where CAFE standards require low fuel economy levels), manufacturers will offer levels of fuel economy and other features that provides the highest utility to buyers, and in combination with prices manufacturers charge to recover their production costs, result in maximum sales or profits. This combination will be affected by the fuel prices that potential buyers of different vehicle models expect to prevail over those vehicles' lifetimes (or over the periods they expect to own them), as well as by their income levels, household demographics, and travel demands. When CAFE standards require higher fuel economy than manufacturers would otherwise provide, they are likely to use a combination of use two strategies to comply. First, they will add technology to some models to improve their fuel economy, which increases those models' production costs and selling prices. Second, manufacturers will sacrifice potential improvements to those models, in effect substituting additional fuel economy for some of the improvement in other desirable features they would have made if the CAFE standard had not increased.

Manufacturers' responses to the higher CAFE standard will balance these two strategies to preserve their profitability, but both strategies impose economic costs on potential buyers of redesigned car and light truck models. Manufacturers' increased production costs will be translated into higher selling prices for those (or other) models, while sacrificing potential improvements in vehicles' other desirable features reduces their appeal to potential buyers. Even if manufacturers are able to preserve vehicles' other desirable features at *today's* levels, some features of the models whose fuel economy they improve will be inferior – from the perspective of potential buyers – to those that manufacturers *could have offered* without the higher CAFE standard in effect.

The proposed rule would reduce CAFE standards for future model years from the levels that the augural standards would have required. This will have exactly the opposite of the two effects described previously - first, manufacturers' costs to produce some vehicles in future model years will be reduced by the amount they would otherwise have been required to invest to improve their fuel economy. Second, reducing standards will enable manufacturers to improve vehicles' other attributes, and thus to offer combinations of fuel economy, other desirable features, and lower prices that will make new cars and light trucks more desirable to buyers.

Limited data from the vehicle simulations performed for this rulemaking (or from other sources) is available to estimate specific improvements in attributes other than fuel economy that could be

*** EO 12866 Review – Draft – Do Not Cite, Quote or Release During Review ***

made using the same technologies that are available to improve fuel economy. Thus the analysis cannot accurately quantify the sacrifices in these other attributes that would have resulted from requiring manufacturers to meet the augural CAFE standards, or the benefits from reducing those standards and enabling manufacturers to improve other desirable attributes instead. In addition, by using a reference fleet from a previous model year (2016), the analysis does not incorporate the normal gradual improvements in vehicle technology that enable slow but steady increases in fuel economy and other features that buyers value.

As a consequence, the estimates of the cost to improve the fuel economy of the reference fleet to meet higher CAFE standards during future model years may overstate the incremental cost of the additional technology that would be required. At the same time, however, it omits the opportunity costs to buyers from requiring manufacturers to use additional technology exclusively to improve fuel economy, rather than other features that buyers also value. Although it is difficult to anticipate the net effect of these over- and under-estimates, without the need to meet constantly increasing CAFE standards manufacturers are likely to improve other attributes of vehicles, as they have done during past periods when standards remained unchanged. This suggests that, on balance, the estimates presented in this analysis probably understate the true economic costs of meeting stricter standards.

For this same reason, the analysis supporting this proposed rule is likely to understate the benefits from reducing fuel economy and CO₂ emission standards for future model years, because those benefits take the form of avoided costs to meet the higher augural standards. Again, however, the likely extent of any resulting underestimation of benefits from the proposed action is difficult to anticipate. An illustrative estimate of the economic effects of including opportunity costs from sacrificing potential improvements in selected features of future cars and light trucks is provided at the conclusion of this chapter. These estimated losses exceed the value of improvements in fuel economy that the baseline standards would have required, which implies that reducing CAFE standards to the levels proposed here would enable improvements in other features that buyers value more than enough to offset the fuel savings they forego when manufacturers are required to meet less stringent standards.

7.5 Effects of Changes in Vehicle Prices and Attributes on Sales

The changes in selling prices, fuel economy, and other features of cars and light trucks produced during future model years that result from manufacturers' responses to lower CAFE and CO₂ emission standards are likely to affect both sales of individual models and the total number of new vehicles sold. Because the values of changes in fuel economy and other features to potential buyers are not completely understood, the magnitude – and possibly even the direction – of their effect on sales of new vehicles is difficult to anticipate. On balance, the changes in prices, fuel economy, and other attributes expected to result from their proposed action to reduce fuel economy and CO₂ emission standards are likely to increase total sales of new cars and light trucks slightly during future model years.

7.5.1 Anticipated Effects of Changes in Prices and Other Attributes on Sales

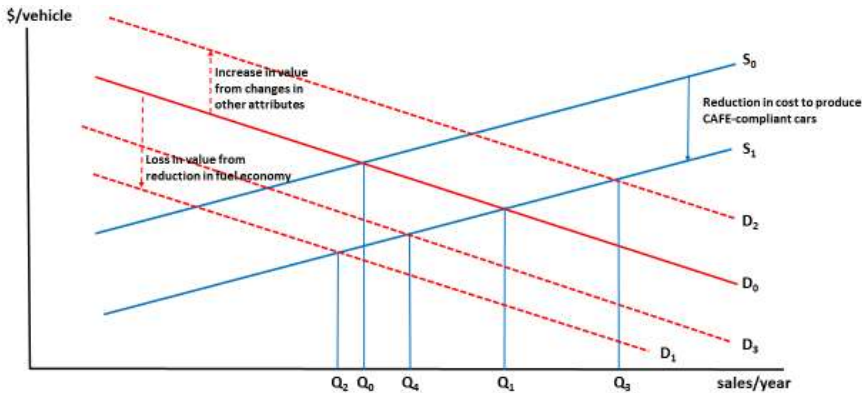

Figure 7-2 illustrates the analysis of this proposed rule’s likely effect on sales of new vehicles. Under the baseline scenario, total demand for new cars and light trucks is shown by the demand curve D_0 , which shows the number that will be purchased at each (average) price. The industry-wide supply curve – which depicts the number produced and offered for sale at each price – is shown by S_0 in the figure; in the baseline, demand and supply interact to result in total sales of Q_0 vehicles. By reducing the amount of fuel economy-improving technology that manufacturers must employ, reducing CAFE and CO_2 standards reduces the costs to produce new vehicles, and this effect is shown as a downward shift in the industry-wide supply curve to S_1 . If there were no accompanying change in demand, annual sales would increase to the level corresponding to Q_1 .

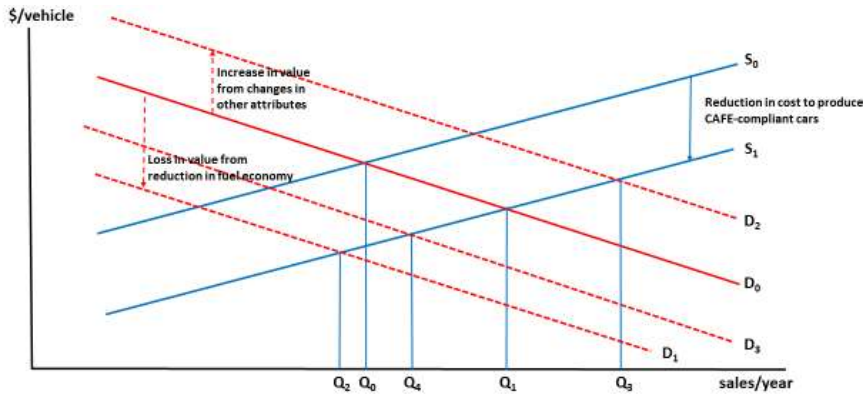

FIGURE 7-2 - EFFECT OF CHANGES IN VEHICLE PRICES, FUEL ECONOMY, AND OTHER ATTRIBUTES ON SALES

As indicated in the previous section, however, the combinations of fuel economy and other features offered on many new car and light truck models will also change, as their manufacturers employ less technology and redeploy some of its energy-efficiency benefits from increasing fuel economy to improving other features that potential buyers seek. Both of these changes will affect demand for new vehicles, but they are likely to do so in opposite directions. On one hand, reducing vehicles' fuel economy increases their operating costs, which reduces their desirability to buyers; by itself, this would shift demand for new vehicles downward – for example, to the level shown by the lower demand curve D_1 . In conjunction with lower prices, this decline in the value of new vehicles would reduce their sales to Q_2 if no other changes in their attributes occurred. At the same time, however, the accompanying improvements in new vehicles' other attributes will increase new models' desirability and value to their potential buyers, which by itself would increase demand to D_2 . In conjunction with their lower prices, this would increase their sales to Q_3 if it were not accompanied by a reduction in their fuel economy.

The net effect of these two changes on demand for new cars and light trucks is difficult to anticipate, because it depends on the magnitude of changes in fuel economy and vehicles' other features, as well as on the values that buyers attach to fuel economy and those other attributes. As the previous section indicated, one consequence of reducing fuel economy and CO₂ standards for future model years is that manufacturers may offer combinations of fuel economy and other features that buyers view as more desirable than those that would have been available with the higher baseline standards in effect. Thus on balance, demand for new cars and light trucks is likely to increase in response to the changes in their fuel economy and other features likely to result from this proposed action. Together with the lower production costs and vehicle prices permitted by less demanding CAFE and CO₂ standards, this is likely to increase sales of cars and light trucks in future model years for which this proposed action would reduce those requirements.

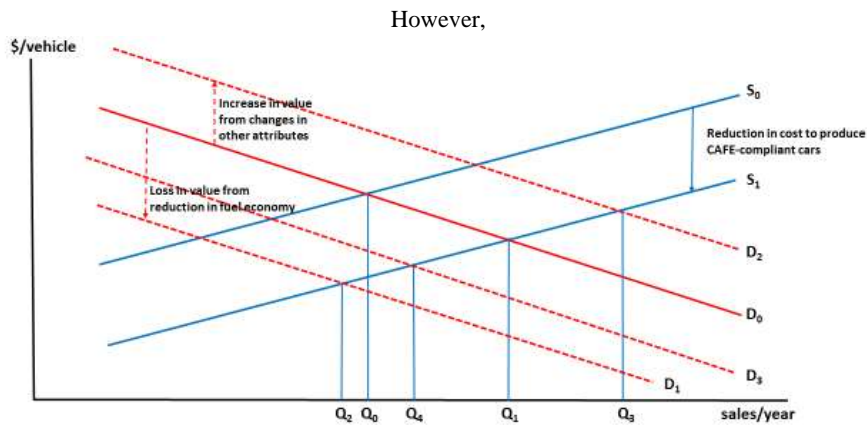

Figure 7-2 shows that even if buyers view the resulting combination of lower fuel economy and improvements to other attributes as making future models *less* desirable than those manufacturers would offer with the baseline standards in effect, and demand for new vehicles declines to a position such as D_3 , sales will *still* rise (to Q_4 in the figure) because the effect of lower prices will outweigh that of the net decline in demand. Viewed another way, sales will increase as long as potential buyers view the combination of lower prices and improvements to vehicles' other attributes as increasing their desirability by more than the accompanying reduction in their fuel economy reduces it, which is the most likely response to this proposed action.

The likely increase in future sales of new cars and light trucks produces two sources of economic benefits to their buyers. Figure 7-3 illustrates these benefits for a simplified case where demand for new cars and light trucks declines (from D_0 to D_1) as their manufacturers provide lower levels of fuel economy in response to reduced standards, but make no accompanying improvements in their other attributes. This example provides a conservative estimate of benefits, because the resulting decline in their attractiveness to potential buyers would by itself reduce their sales (to Q_1), and the only source of increased appeal is their lower price (which declines from P_0 to P_1). On balance, sales of new cars and light trucks still increase (to Q_2) in this example, and if manufacturers make accompanying improvements in new vehicles' other features, the increase in sales and resulting benefits will be larger than Figure 8-4 shows.

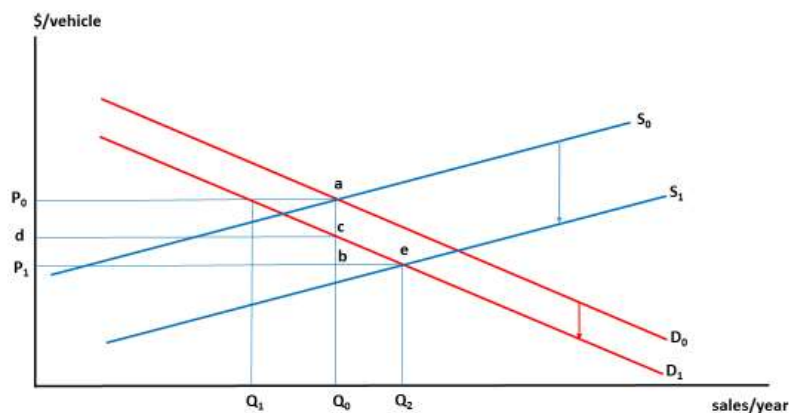

FIGURE 7-3 - BENEFITS FROM LOWER IN CAR AND LIGHT TRUCK PRICES AND INCREASED

First, those who would have purchased new models even with the baseline standards for future model years in effect will on balance experience improved welfare from the combination of lower prices and lower fuel economy. Collective benefits to these buyers are measured by their savings from lower prices for the models they purchase, shown as rectangle P_0abP_1 in the figure, minus the loss in vehicles' value that stems from the additional fuel costs their owners incur over those vehicles' lifetimes. This loss in their value is the rectangle P_0acd , which leaves net benefits to buyers equal to rectangle $dc bP_1$. As the previous section indicated, sufficient information is not available to quantify the changes in other attributes that are likely to accompany the reduction in new vehicles' fuel economy, so the value of any such improvements is not reflected in this estimate. Including it would increase benefits to buyers, and a tentative estimate of how much it might do so is included as a sensitivity analysis.

Second, buyers who would *not* have purchased new models with the baseline standards in effect but decide to do so in response to the changes in new vehicles' prices and features that result with less demanding standards in place will also experience increased welfare. Collective benefits to these "new" buyers are measured by the consumer surplus they receive from their increased purchases, which is shown as the triangular area labeled cbe in Figure 8-4. When expressed on a per-vehicle or per-buyer basis, this benefit averages approximately half of that experienced by those who would have bought new vehicles even with the baseline standards in effect. Because it is not entirely certain that sales of new cars and light trucks will increase in response to this proposed action, however, this analysis does *not* estimate the value of these likely additional economic benefits.

7.5.2 Estimating Changes in New Vehicle Sales

This analysis estimates the change in total sales of new cars and light trucks during future model years using an econometric model that captures the historical relationship of sales to their

*** EO 12866 Review – Draft – Do Not Cite, Quote or Release During Review ***

average price, potential buyers' disposable income, and other macroeconomic conditions. The shares of future sales of new vehicles accounted for by cars and light trucks is estimated using a model developed by the U.S. Energy Information Administration as part of its National Energy Modeling System (NEMS), which relates those shares to fuel prices, the relative fuel economy levels of new cars and light trucks, other attributes that differ between the two, and their recent historical shares of total sales.

Developing a procedure to predict the effects of changes in prices and attributes of new vehicles is complicated by the fact that their sales are highly pro-cyclical – that is, they are very sensitive to changes in macroeconomic conditions – and also statistically “noisy,” because they reflect the transient effects of other factors such as consumers' confidence in the future, which can be difficult to observe and measure accurately. At the same time, their average sales price tends to move in parallel with changes in economic growth; that is, average new vehicle prices tend to be higher when the total number of new vehicles sold is increasing and lower when the total number of new sales decreases (typically during periods of low economic growth or recessions). Finally, counts of the total number of new cars and light trucks that are sold do not capture shifts in demand among vehicle size classes or body styles (“market segments”); nor do they measure changes in the durability, safety, fuel economy, carrying capacity, comfort, or other aspects of vehicles' quality.

The historical series of new light-duty vehicle sales exhibits cyclic behavior over time that is most responsive to larger cycles in the macro economy – but has not increased over time in the same way the population, for example, has. While U.S. population has grown more than 35% since 1980, the registered vehicle population has grown at an even faster pace – nearly doubling between 1980 and 2015. But annual vehicle sales did not grow at a similar pace – even accounting for the cyclical nature of the industry. Total new light-duty sales prior to the 2008 recession climbed as high as 16 million, though similarly high sales years occurred in the 1980's and 1990's as well. In fact, when considering a 10-year moving average to smooth out the effect of cycles, most 10-year averages between 1992 and 2015 are within a few percent of the 10-year average in 1992. And although average transaction prices for new vehicles have been rising steadily since the recession ended, prices are not yet at historical highs when adjusted for inflation. The period of highest inflation-adjusted transaction prices occurred from 1996-2006, when the average transaction price for a new light-duty vehicle was consistently higher than the price in 2015⁴²⁸.

The analysis explored various approaches to predict the response of new vehicle sales to the changes in prices, fuel economy, and other features in an attempt to overcome these analytic challenges. This included treating new vehicle demand as a product of changes in total demand for vehicle ownership and demand necessary to replace used vehicles that are retired, analyzing

⁴²⁸ While 2015 is the last year for which data informed the estimated sales response, the average new vehicle price continued its increase in 2016 and 2017.

*** EO 12866 Review – Draft – Do Not Cite, Quote or Release During Review ***

total expenditures to purchase new cars and light trucks in conjunction with the total number sold, and other approaches. However, none of these methods offered a significant improvement over estimating the total number of vehicles sold directly from its historical relationship to directly measurable factors such as their average sales price, macroeconomic variables such as GDP or Personal Disposable Income, and regularly published surveys of consumer sentiment or confidence.

Quarterly rather than annual data on total sales of new cars and light trucks, their average selling price, and macroeconomic variables were used to develop an econometric model of sales, in order to increase the number of observations and more accurately capture the causal effects of individual explanatory variables. Applying conventional data diagnostics for time-series economic data revealed that most variables were non-stationary (i.e., they reflected strong underlying time trends) and displayed unit roots, and statistical tests revealed cointegration between the total vehicle sales – the model’s dependent variable – and most candidate explanatory variables.

An autoregressive distributed-lag (ARDL) model that employs a combination of lagged values of its dependent variable – in this case, last year’s and the prior year’s vehicle sales – and the change in average vehicle price, quarterly changes in the U.S. GDP growth rate, as well as current and lagged values of quarterly estimates of U.S. labor force participation, was estimated in order to address complications in time series data. The number of lagged values of each explanatory variable to include was determined by examining how different combinations of their lagged values affected the model’s ability to “explain” (or reproduce) historical variation in car and light truck sales.

The results of this approach are encouraging - as Figure 7-4 shows, the model’s predictions fit the historical data on sales well, each of its explanatory variables displayed the expected effect on sales, and analysis of its unexplained residual terms revealed little evidence of autocorrelation or other indications of statistical problems. The model coefficients suggest that positive GDP growth rates and increases in labor force participation are both indicators of increases in new vehicle sales, while positive changes in average new vehicle price reduce new sales. However, the magnitude of the coefficient on change in average price is not as determinative of total sales as the other variables.

Based on the model, a \$1,000 increase in the average new vehicle price causes approximately 170,000 lost units in the first year, followed by a reduction of another 600,000 units over the next ten years as the initial sales decrease propagates over time through the lagged variables and their coefficients. The price elasticity of new car and light truck sales implied by alternative estimates of the model’s coefficients ranged from -0.2 to -0.3 – meaning that changes in their prices have moderate effects on total sales – which contrasts with estimates of higher sensitivity to prices implied by some model. The model did not incorporate any measure of new car and light truck fuel economy that added to its ability to explain historical variation in sales, even after

experimenting with alternative measures of such as the unweighted and sales-weighted averages fuel economy of models sold in each quarter, the level of fuel economy they were required to achieve, and the change in their fuel economy from previous periods.

TRUCKS

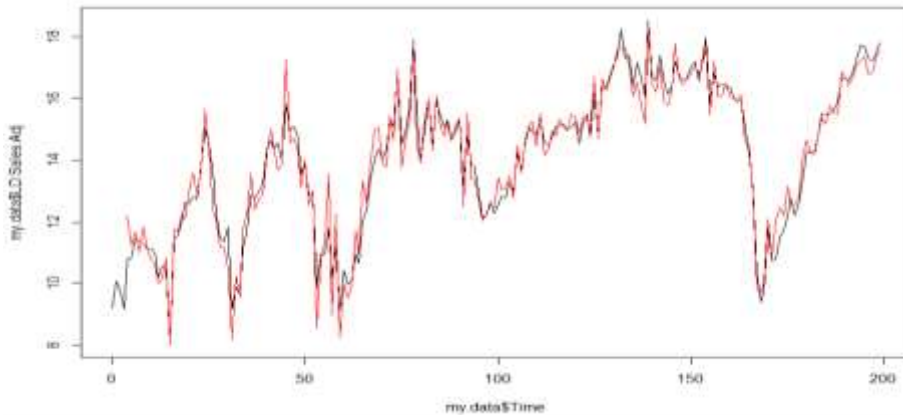

FIGURE 7-4 - ACTUAL VERSUS PREDICTED QUARTERLY SALES OF NEW CARS AND LIGHT

The model's predictions of quarterly sales were aggregated to obtain estimates of annual sales, which still produced a reasonable fit to their actual historical values. Figure 7-5 compares two versions of the model's estimates of annual car and light truck sales to their actual values - the first (shown in blue in the figure) is constructed using the actual values of previous quarters' sales and the model's other explanatory variables, while the second (shown in yellow) uses the model's *predicted* values of sales for past quarters in conjunction with actual past values of its other explanatory variables. This latter estimate represents a more demanding test of the model's predictive performance, and is also more consistent with the way it is applied to obtain forecasts of new car and light truck sales during future years with different CAFE and CO₂ standards (which affect vehicle prices) in effect.

Estimating the sales response at the level of total new vehicle sales likely fails to address valid concerns about changes to the quality or attributes of new vehicles sold – both over time and in response to price increases resulting from CAFE standards. However, attempts to address such concerns would require significant additional data, new statistical approaches, and structural changes to the CAFE model over several years. It is also the case that using absolute changes in the average price may be more limited than another characterization of price that relies on distributions of household income over time or percentage change in the new vehicle price. The former would require forecasting a deeply uncertain quantity many years into the future, and the latter only become relevant once the simulation moves beyond the magnitude of observed price changes in the historical series. Future versions of this model may use a different

characterization of cost that accounts for some of these factors if their inclusion improves the model estimation and corresponding forecast projections are available.

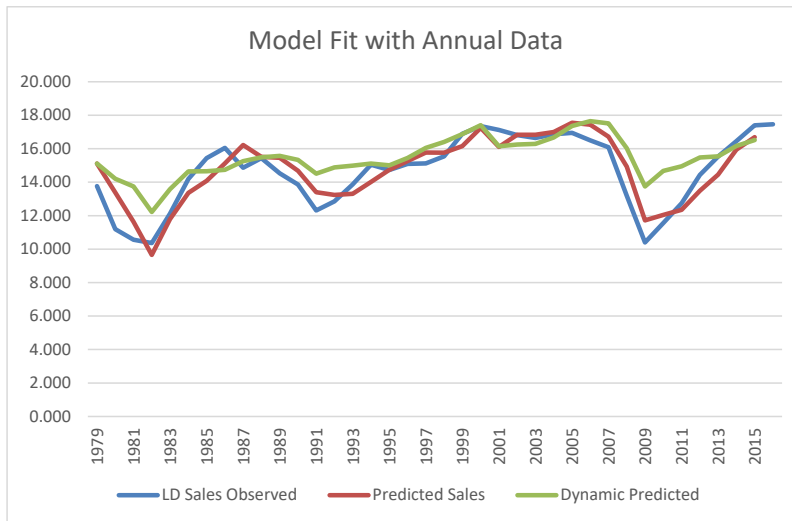

FIGURE 7-5 - ACTUAL VERSUS PREDICTED ANNUAL SALES OF NEW CARS AND LIGHT TRUCKS

The changes in selling prices, fuel economy, and other features of cars and light trucks produced during future model years that result from manufacturers' responses to lower CAFE and CO₂ emission standards are likely to affect both sales of individual models and the total number of new vehicles sold. Because the values of changes in fuel economy and other features to potential buyers are not completely understood, however, the magnitude – and possibly even the direction – of their effect on sales of new vehicles is difficult to anticipate. On balance, the changes in prices, fuel economy, and other attributes expected to result from this proposed action to amend and establish fuel economy and CO₂ emission standards are likely to increase total sales of new cars and light trucks during future model years.

The purpose of the sales response model is to allow the CAFE model to simulate new vehicle sales in a given future model year, accounting for the impact of a regulatory alternative's stringency on new vehicle prices (in a macro-economic context that is identical across alternatives). In order to accomplish this, it is important that the model of sales response be dynamically stable – meaning that it responds to shocks not by “exploding”, increasing or decreasing in a way that is unbounded, but rather returns to a stable path, allowing the shock to dissipate. The CAFE model uses the sales model described above to dynamically project future sales; after the first year of the simulation, lagged values of new vehicle sales are those that were produced by the model itself, rather than observed. The sales response model constructed here uses two lagged dependent variables, and simple econometric conditions determine if the model

*** EO 12866 Review – Draft – Do Not Cite, Quote or Release During Review ***

is dynamically stable. The coefficients of the one-year lag and the 2-year lag, β_1 and β_2 , respectively must satisfy three conditions. Their sum must be less than one, $\beta_2 - \beta_1 < 1$, and the absolute value of β_2 must be less than 1. The coefficients of this model satisfy all three conditions.

Using the augural CAFE standards as the baseline, it is possible to produce a series of future total sales as shown in Table-7-1. For comparison, the table includes the calculated total light-duty sales of a proprietary forecast purchased to support the 2016 Draft TAR analysis, the total new light-duty sales in EIA’s 2017 Annual Energy Outlook, and a (short) forecast published in the Center for Automotive Research’s Q4 2017 Automotive Outlook. All of the forecasts in Table-7-1 assume the augural standards are in place through MY 2025, though assumptions about the costs required to comply with them likely differ. As the table shows, despite differences among them, the dynamically produced sales projection from the CAFE model is not qualitatively different from the others.

TABLE-7-1 - COMPARISON OF FORECASTS, 2016-2029

Year	CAFE model ⁴²⁹	IHS/Polk	AEO 2017	CAR Outlook	Actual Sales ⁴³⁰
2016	16.34	17.78	16.43	17.5	17.55
2017	16.83	18.20	17.05	17.5	17.25
2018	17.19	18.08	16.91	17.4	
2019	17.48	17.68	16.32	17.3	
2020	17.66	17.23	16.27	17	
2021	17.75	17.12	16.54	17.5	
2022	17.76	17.02	16.40	17.6	
2023	17.74	17.08	16.28		
2024	17.73	17.16	16.71		
2025	17.71	17.30	16.70		
2026	17.70	17.33	16.45		
2027	17.74	17.41	16.57		
2028	17.81	17.21	16.58		
2029	17.87	17.08	16.88		

In addition to the statistical model that estimates the response of total new vehicle sales to changes in the average new vehicle price, the CAFE model incorporates a dynamic fleet share model that modifies the light truck (and, symmetrically, passenger car) share of the new vehicle market. A version of this model first appeared in the 2012 final rule, when this fleet share

⁴²⁹ Out of necessity, the analysis in today’s rule conflates production year (or “model year”) and calendar year. The volumes cited in the CAFE model forecast represent forecasted production volumes for those model years, while the other represent calendar year sales (rather than production) – during which two, or possibly three, different model year vehicles are sold. In the long run, the difference is not important. In the early years, there are likely to be discrepancies.

⁴³⁰ [CITE] Automotive News

*** EO 12866 Review – Draft – Do Not Cite, Quote or Release During Review ***

component was introduced to ensure greater internal consistency within inputs in the uncertainty analysis. For today’s analysis, this dynamic fleet share is enabled throughout the analysis of alternatives.

The dynamic fleet share model is a series of difference equations that determine the relative share of light trucks (and passenger cars) based on the average fuel economy of each, the fuel price, and average vehicle attributes like horsepower and vehicle mass (the latter of which explicitly evolves as a result of the compliance simulation). While this model was taken from EIA’s National Energy Modeling System (NEMS), it is applied at a different level. Rather than apply the shares based on the regulatory class distinction, the CAFE model applies the shares to body-style. This is done to account for the large-scale shift in recent years to crossover utility vehicles that have model variants in both the passenger car and light truck regulatory fleets. Static forecasts of new vehicle sales have been modified for this analysis to reflect the PC/LT split present in the Annual Energy Outlook, and this integration continues that approach in a way that ensures greater internal consistency when simulating multiple regulatory alternatives (and conducting sensitivity analysis on any of the factors that influence fleet share).

7.6 Employment Impacts

Higher vehicle prices resulting from CAFE technologies will reduce new vehicle sales, which will in turn affect employment associated with those sales. Conversely, production of new technologies used to improve fuel economy will create new demand for production. Note that employment impacts represent a net effect of labor years associated with changes in new vehicle sales and changes in labor years required to produce new technologies that improve CAFE. Relative to the baseline augural standards, the proposal would produce small increases in sales and small net decreases in labor requirements for MYs 2017-2030.

7.6.1 Industry employment baseline (including multiplier effect) and data description

In the first two joint CAFE/CO₂ rulemakings, the agencies considered an analysis of industry employment impacts in some form in setting both CAFE and emissions standards; NHTSA conducted an industry employment analysis in part to determine whether the standards the agency set were economically practicable, that is, whether the standards were “within the financial capability of the industry, but not so stringent as to” lead to “adverse economic consequences, such as a significant loss of jobs or unreasonable elimination of consumer choice.”⁴³¹ EPA similarly conducted an industry employment analysis under the broad authority granted to the agency under the Clean Air Act.⁴³² Both agencies recognized the uncertainties inherent in estimating industry employment impacts; in fact, both agencies dedicated a

⁴³¹ 67 FR 77015, 77021 (December 16, 2002).

⁴³² See *George E. Warren Corp. v. EPA*, 159 F.3d 616, 623-624 (D.C. Cir. 1998) (ordinarily permissible for EPA to consider factors not specifically enumerated in the Act).

*** EO 12866 Review – Draft – Do Not Cite, Quote or Release During Review ***

substantial amount of discussion to uncertainty in industry employment analyses in the 2012 final rule for MYs 2017 and beyond.⁴³³ Notwithstanding these uncertainties, CAFE and CO₂ standards do impact industry labor hours, and providing the best analysis practicable better informs stakeholders and the public about the standards' impact than would omitting any estimates of potential labor impacts.

The framework for today's analysis is similar to frameworks presented in the past, but today, many of the effects that were qualitatively identified but previously not considered were quantified. For instance, in the PRIA for the 2017-2025 rule, EPA identified "demand effects," "cost effects," and "factor shift effects" as important considerations for industry labor, but the analysis did not attempt to quantify either the demand effect or the factor shift effect.⁴³⁴ Today's industry labor analysis quantifies direct labor changes that had previously been discussed qualitatively.

Today's analysis both improved on previous analyses and developed new methodologies to consider direct labor effects on the automotive sector in the United States. The analysis evaluated potential changes to (1) dealership labor related to new light duty vehicle unit sales; (2) changes in assembly labor for vehicles, for engines and for transmissions related to new vehicle unit sales; and (3) changes in industry labor related to additional fuel savings technologies, accounting for new vehicle unit sales. All automotive labor effects were estimated and reported at a national level,⁴³⁵ in labor-years, assuming 2,000 hours of labor per labor-year.

The analysis estimated labor effects from the forecasted CAFE model technology costs and from review of automotive labor for the MY 2016 fleet. For each vehicle in the CAFE model analysis, the locations for vehicle assembly, engine assembly, transmission assembly, and estimated labor in MY 2016 were recorded. Percent U.S. content for each vehicle was also recorded. Not all parts are made in the United States, so the analysis also took into account the percent U.S. content for each vehicle as manufacturers add fuel-savings technologies. As manufacturers added fuel-economy technologies in the CAFE model simulations, it was assumed that percent U.S. content would remain constant in the future, and that the U.S. labor added would be proportional to U.S. content. From this foundation, the analysis forecasted automotive labor effects as the CAFE model added fuel economy technology and adjusted future sales for each vehicle.

The analysis also accounts for sales projections in response to the different regulatory alternatives; the labor analysis considers changes in new vehicle prices and new vehicle sales. As vehicle prices rise, it is expected that consumers will purchase fewer vehicles than they would have at lower prices. As manufacturers sell fewer vehicles, the manufacturers may need less

⁴³³ See 77 FR 62952, 63102 (October 15, 2012).

⁴³⁴ Pages 8-24 to 8-32 of August 2012 "Regulatory Impact Analysis - Final Rulemaking for 2017-2025 Light-Duty Vehicle Greenhouse Gas Emission Standards and Corporate Average Fuel Economy Standards."

⁴³⁵ This analysis recognizes a few local production facilities may contribute meaningfully to local economies, but the analysis reported only on national effects.

*** EO 12866 Review – Draft – Do Not Cite, Quote or Release During Review ***

labor to produce the vehicles, and less labor to sell the vehicles. However, as manufacturers add equipment to each new vehicle, the manufacturers will require human resources to develop, sell, and produce additional fuel-saving technologies. The analysis also accounts for the potential that new standards could shift the relative shares of passenger cars and lig

ht trucks in the overall fleet; insofar as different vehicles involved different amounts of labor, this shifting impacts the quantity of estimated labor. The CAFE model automotive labor analysis takes into account reduction in vehicle sales, shifts in the mix of passenger cars and light trucks, and addition of fuel-savings technologies.

Today's analysis assumes that some observations about the production of MY 2016 vehicles would carry forward, unchanged into the future. For instance, the analysis assumed assembly plants would remain the same as MY 2016 for all products now, and in the future. The analysis also assumed percent U.S. content would remain constant, even as manufacturers updated vehicles and introduced new fuel-saving technologies. It was also assumed that assembly labor hours per unit would remain at estimated MY 2016 levels for vehicles, engines, and transmissions, and the factor between direct assembly labor and parts production jobs would remain the same. When considering shifts from one technology to another, the analysis assumed revenue per employee at suppliers and original equipment manufacturers would remain in line with MY 2016 levels, even as manufacturers added fuel-saving technologies and realized cost reductions from learning.

The analysis focused on automotive labor because adjacent employment factors and consumer spending factors for other goods and services are uncertain and difficult to predict. The analysis did not consider how direct labor changes may affect the macro economy and possibly change employment in adjacent industries. For instance, the analysis did not consider possible labor changes in vehicle maintenance and repair, nor did the analysis consider changes in labor at retail gas stations. The analysis did not consider possible labor changes due to raw material production, such as production of aluminum, steel, copper and lithium, nor did the analysis consider possible labor impacts due to changes in production of oil and gas, ethanol, and electricity. The analysis did not consider effects of how consumers could spend money saved due to improved fuel economy, nor did the analysis consider effects of how consumers would pay for more expensive fuel savings technologies at the time of purchase; either could affect consumption of other goods and services, and hence affect labor in other industries. The analysis did not consider the effects of increased usage of car-sharing, ride-sharing, and automated vehicles. The analysis did not estimate how changes in labor from any industry could affect gross domestic product and possibly affect other industries as a result.

Finally, the analysis made no assumptions about full-employment or not full-employment and the availability of human resources to fill positions. When the economy is at full employment, a fuel economy regulation is unlikely to have much impact on net U.S. employment; instead, labor would primarily be shifted from one sector to another. These shifts in employment impose an

opportunity cost on society, approximated by the wages of the employees, as regulation diverts workers from other activities in the economy. In this situation, any effects on net employment are likely to be transitory as workers change jobs (e.g., some workers may need to be retrained or require time to search for new jobs, while shortages in some sectors or regions could bid up wages to attract workers). On the other hand, if a regulation comes into effect during a period of high unemployment, a change in labor demand due to regulation may affect net U.S. employment because the labor market is not in equilibrium. Schmalensee & Stavins point out that net positive employment effects are possible in the near term when the economy is at less than full employment due to the potential hiring of idle labor resources by the regulated sector to meet new requirements (e.g., to install new equipment) and new economic activity in sectors related to the regulated sector. Longer run, the net effect on employment is more difficult to predict and will depend on the way in which the related industries respond to the regulatory requirements. For that reason, this analysis does not include multiplier effects, but instead focuses on labor impacts in the most directly affected industries. Those sectors are likely to face the most concentrated labor impacts.

Please provide comments on these assumptions and approaches in the labor analysis.

7.6.2 Estimating labor for fuel economy technologies, vehicle components, final assembly, and retailers

The following sections discuss the approaches to estimating factors related to dealership labor, final assembly labor and parts production, and fuel economy technology labor.

7.6.2.1 Dealership labor

The analysis evaluated dealership labor related to new light-duty vehicle sales, and estimated the labor hours per new vehicle sold at dealerships, including labor from sales, finance, insurance, and management. The effect of new car sales on the maintenance, repair, and parts department labor is expected to be limited, as this need is based on the vehicle miles traveled of the total fleet. To estimate the labor hours at dealerships per new vehicle sold, the analysis referenced the National Automobile Dealers Association 2016 Annual Report, which provides franchise dealer employment by department and function.⁴³⁶ It was estimated that slightly less than 20% of dealership employees' work relates to new car sales (versus approximately 80% in service, parts, and used car sales), and that on average dealership employees working on new vehicle sales labor for 27.8 hours per new vehicle sold.

⁴³⁶ National Automobile Dealers Association, 2016 Annual Report (2017).

7.6.2.2 Final assembly labor and parts production

The analysis also estimated how the quantity of assembly labor and parts production labor for MY 2016 vehicles would increase or decrease in the future as new vehicle unit sales increased or decreased.

Specific assembly locations for final vehicle assembly, engine assembly, and transmission assembly for each MY 2016 vehicle were identified. In some cases, manufacturers assembled products in more than one location, and such products and parallel production were considered in the labor analysis.

Industry average direct assembly labor per vehicle (30 hours), per engine (4 hours), and per transmission (5 hours) were estimated based on a sample of U.S. assembly plant employment and production statistics and other publicly available information. Some plants may have used less labor than the analysis estimates to produce the vehicle, the engine, or the transmission, and other plants may have used more labor. The assembly locations and industry averages for labor per unit were used to estimate U.S. assembly labor hours for each vehicle. U.S. assembly labor hours per vehicle ranged from as high as 39 hours if the manufacturer assembled the vehicle, engine, and transmission at U.S. plants, to as low as 0 hours if the manufacturer imported the vehicle, engine, and transmission.

Labor for parts production in addition to labor for final assembly was also considered. Motor vehicle and equipment manufacturing labor statistics from the U.S. Census Bureau, the Bureau of Labor Statistics,⁴³⁷ and other publicly available sources was also surveyed. Based on these sources, it is apparent that the historical average ratio of vehicle assembly manufacturing employment to employment for total motor vehicle and equipment manufacturing for new vehicles remained roughly constant over the period from 2001 through 2013, at a ratio of 5.26. Observations from 2001-2013 spanned many years, many combinations of technologies and technology trends, and many economic conditions, yet the ratio remained about the same. Accordingly, the analysis scaled up estimated U.S. assembly labor hours by a factor of 5.26 to consider U.S. parts production labor in addition to assembly labor for each vehicle.

The industry estimates for vehicle assembly labor and parts production labor for each vehicle scaled up or down as unit sales scaled up or down over time in the CAFE model.

7.6.2.3 Fuel economy technology labor

As manufacturers spend additional dollars on fuel-saving technologies, parts suppliers and manufacturers require human resources to bring those technologies to market. Manufacturers may add, shift, or replace employees in ways that are difficult for the agencies to predict in response to adding fuel-savings technologies; however, it is expected that the revenue per labor

⁴³⁷ NAICS Code 3361, 3363.

*** EO 12866 Review – Draft – Do Not Cite, Quote or Release During Review ***

hour at original equipment manufacturers (OEMs) and suppliers will remain about the same as in MY 2016, even as industry includes additional fuel-saving technology.

To estimate the average revenue per labor hour at OEMs and suppliers, financial reports from publicly traded automotive businesses were analyzed.⁴³⁸ Based on recent figures, it was estimated that OEMs would add one labor year per \$633,066 revenue,⁴³⁹ and that suppliers would add one labor year per \$247,648 in revenue.⁴⁴⁰ These global estimates are applied to all revenues, and U.S. content is applied as a later adjustment. Today’s analysis assumed these ratios would remain constant for all technologies, rather than that the increased labor costs would be shifted toward foreign countries. Please provide comments on the realism of this assumption.

7.6.2.4 Labor Calculations

The analysis estimated the total labor as the sum of three components - dealership hours, final assembly and parts production, and labor for fuel-economy technologies (at OEM’s and suppliers). The CAFE model calculated additional labor hours for each vehicle, based on current vehicle manufacturing locations and simulation outputs for additional technologies, and sales changes. Some constants were applied to all vehicles,⁴⁴¹ but other constants were vehicle specific,⁴⁴² or year specific for a vehicle.⁴⁴³

While the analysis presented today did not consider a multiplier effect of all U.S. automotive related jobs on non-auto related U.S. jobs, the model does include a “global multiplier” that can be used to scale up or scale down the total labor hours. This multiplier exists in the parameters file, and today’s analysis uses a value set at 1.00.

⁴³⁸ The analysis surveyed suppliers who won the Automotive News “PACE Award” from 2013-2017, covering more than 40 suppliers, more than 30 of which are publicly traded companies. Automotive News gives “PACE Awards” to innovative manufacturers, with most recent winners earning awards for new fuel-savings technologies.

⁴³⁹ The analysis assumed incremental OEM revenue as the retail price equivalent for technologies, adjusting for changes in sales volume.

⁴⁴⁰ The analysis assumed incremental supplier revenue as the technology cost for technologies before retail price equivalent mark-up, adjusting for changes in sales volume.

⁴⁴¹ The analysis applied the same assumptions to all manufacturers for annual labor hours per employee, dealership hours per unit sold, OEM revenue per employee, supplier revenue per employee, and factor for the jobs multiplier.

⁴⁴² The analysis included vehicle specific assumptions about percent U.S. content and U.S. assembly employment hours.

⁴⁴³ The technology cost for each vehicle, for each year was estimated based on the technology content applied in the CAFE model, year-by-year.

EQUATION 7-1 - TOTAL LABOR HOURS EQUATION

$$\begin{aligned}
 &= \sum_{vehicle=1}^N \left(Unit_sales_{vehicle} \times \frac{Dealership_Hours_{vehicle}}{Unit_sale} \right) \\
 &+ \sum_{vehicle=1}^N \left(Unit_sales_{vehicle} \times \frac{US_Assembly_Employment_Hours_{vehicle} \times Factor_{jobs_multiplier}}{Unit_sale} \right) \\
 &+ \sum_{vehicle=1}^N \left(Unit_sales_{vehicle} \times Percent_US_Content_{vehicle} \times \frac{Technology_Cost_{vehicle}}{Unit_sale} \times \frac{Annual_Labor_Hours}{OEM_Revenue_per_Employee} \right) \\
 &+ \sum_{vehicle=1}^N \left(Unit_sales_{vehicle} \times Percent_US_Content_{vehicle} \times \frac{Technology_Cost_{vehicle}}{Unit_sale \times Retail_Price_Equivalent_{Markup}} \times \frac{Annual_Labor_Hours}{Supplier_Revenue_per_Employee} \right)
 \end{aligned}$$

EQUATION 7-2 - TOTAL LABOR HOURS EQUATION WITH GLOBAL CONSTANTS

$$\begin{aligned}
 &\sum_{vehicle=1}^N \left(Unit_sales_{vehicle} \times \frac{US_Assembly_Employment_Hours_{vehicle} \times 5.26}{Unit_sale} \right) \\
 &+ \sum_{vehicle=1}^N \left(Unit_sales_{vehicle} \times Percent_US_Content_{vehicle} \times \frac{Technology_Cost_{vehicle}}{Unit_sale} \times \frac{2,000 \text{ hours}}{\$633,066} \right) \\
 &+ \sum_{vehicle=1}^N \left(Unit_sales_{vehicle} \times Percent_US_Content_{vehicle} \times \frac{Technology_Cost_{vehicle}}{Unit_sale \times 1.5} \times \frac{2,000 \text{ hours}}{\$247,648} \right)
 \end{aligned}$$

EQUATION 7-3 - EQUATION FOR JOB-YEARS TO TOTAL LABOR HOURS

$$Job_years = \frac{Total_Labor_Hours}{Annual_Labor_Hours} = \frac{Total_Labor_Hours}{2,000 \text{ hours}}$$

7.6.2.5 Assumptions and Limitations

As discussed in Section II.E of the preamble, the analysis includes estimates of impacts on U.S. auto industry labor, considering the combined impact of changes in sales volumes and changes in outlays for additional fuel-saving technology. Note that this analysis does not consider the possibility that potential new jobs and plants attributable to increased stringency will not be located in the United States, or that increased stringency will not lead to the relocation of current jobs or plants to foreign countries. Compared to the no-action alternative (i.e., the baseline

*** EO 12866 Review – Draft – Do Not Cite, Quote or Release During Review ***

standards), the proposed standards (alternative 1) and other regulatory alternatives under consideration all involve reduced regulatory costs expected to lead to reduced average vehicle prices and, in turn, increased sales.

While the increased sales slightly increase estimated U.S. auto sector labor, because producing and selling more vehicles uses additional U.S. labor, the reduced outlays for fuel-saving technology slightly reduce estimated U.S. auto sector labor, because manufacturing, integrating, and selling less technology means using less labor to do so. Of course, this is technology that may not otherwise be produced or deployed were it not for regulatory mandate, and the additional costs of this technology would be borne by a reduced number of consumers given reduction in sales in response to increased prices.

Today's analysis shows the negative impact of reduced mandatory technology outlays outweighing the positive impact of increased sales. However, both of these underlying factors are subject to uncertainty. For example, if fuel-saving technology that would have been applied under the baseline standards is more likely to have come from foreign suppliers than estimated here, less of the foregone labor to manufacture that technology would have been U.S. labor. Also, if sales would be more positively impacted by reduced vehicle prices than estimated here, correspondingly positive impacts on U.S. auto sector labor could be magnified. Alternatively, if manufacturers are able to deploy technology to improve vehicle attributes that new car buyers prefer to fuel economy improvements, both technology spending and vehicle sales would correspondingly increase.

The sales and employment analysis may be updated for the final rule, and incremental changes opposite in sign from those presented below may result. Please provide comments, in particular, on the potential for changes in stringency to result in new jobs and plants being created in foreign countries, or for current United States jobs and plants to be moved outside of the United States.

7.7 Effect of the Proposed Action on New Car Use

The fuel economy rebound effect – a specific example of the well-documented energy efficiency rebound effect for energy-consuming capital goods – refers to the tendency of motor vehicles' use to increase when their fuel economy is improved and the cost of driving each mile declines as a result. Reducing fuel economy and CO₂ standards for future model years will lead to lower fuel economy for new cars and light trucks, thus increasing the amount of fuel they consume and the cost of traveling each mile. The resulting increase in their per-mile fuel and total driving costs will lead to a reduction in the number of miles they are driven each year over their lifetimes, an example of the fuel economy rebound effect working in reverse.

7.7.1 Vehicle Usage and Mileage Accumulation

*** EO 12866 Review – Draft – Do Not Cite, Quote or Release During Review ***

The MY 2017-2021 final rule built estimates of average lifetime mileage accumulation by body style and age using the 2009 National Household Travel Survey (NHTS), which surveys odometer readings of the vehicles present from the approximately 113,000 households sampled. Approximately 210,000 vehicles were in the sample readings collected between April 2008 and April 2009. This represents a sample size of less than one percent of the more than 250 million light-duty vehicles registered in 2008 and 2009. The NHTS sample is now 10 years old and taken during the Great Recession. The 2017 NHTS was not available at the time of this rulemaking. Because of the age of the last available NHTS and the unusual economic conditions under which it was collected, the new schedule was built using a similar method from a proprietary dataset collected in the fall of 2015.

In order to develop new mileage accumulation schedules for vehicles regulated under the CAFE program (classes 1-3), NHTSA purchased a data set of vehicle odometer readings from IHS/Polk (Polk). Polk collects odometer readings from registered vehicles when they encounter maintenance facilities, state inspection programs, or interactions with dealerships and OEMs. The average odometer readings in the data set NHTSA purchased are based on more than 74 million unique odometer readings across 16 model years (2000-2015) and vehicle classes present in the data purchase (all registered vehicles less than 14,000 lbs. GVW). This sample represents approximately 28% of the light-duty vehicles registered in 2015, and thus has the benefit of not only being a newer, but also, a larger, sample.

Comparably to the NHTS, the Polk data provide a measure of the cumulative lifetime vehicle miles traveled (VMT) for vehicles, at the time of measurement, aggregated by the following parameters - make, model, model year, fuel type, drive type, door count, and ownership type (commercial or personal). Within each of these subcategories they provide the average odometer reading, the number of odometer readings in the sample from which Polk calculated the averages, and the total number of that subcategory of vehicles in operation.

7.7.1.1 Updated Schedules

Figure 7-6 shows the predicted total VMT by age for the sample of passenger cars. It also shows the old and new schedules together. The new schedule predicts lower annual VMT for all ages—except the first year—but the discrepancy increases for vehicles older than 8 years. The resulting difference in VMT over a 30-year life of a passenger car is a decrease of 96,882 miles under the new schedule, a 32% decrease from the old schedule. A notable trend in the new passenger car schedule is a higher annual VMT for the first year, followed by a relatively constant annual VMT until age 6 (MY 2014 to MY 2008, for this sample). This trend is likely a byproduct of the patterns of commercial and personal vehicle ownership over the age of vehicles.

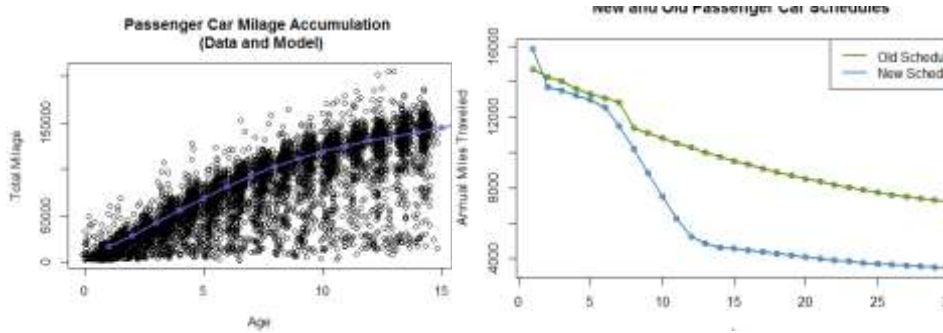

FIGURE 7-6 - A COMPARISON OF THE NEW AND OLD PASSENGER CAR SCHEDULES

Figure 7-6 shows the share of passenger cars registered between commercial and personal fleets, and the population-weighted average odometer reading by ownership type. Commercial vehicles are driven more than personally-owned vehicles, and make up the largest share of one-year-old vehicles, relative to other ages. Because a model year of vehicles is sold starting in the fall of the previous calendar year, throughout the matching calendar year, and into the succeeding one, this initial proportion suggests that (in proportion to fleet share) more commercially-owned vehicles are bought early. Another partial explanation is likely that commercial vehicles are sold into the personal fleet after a short time. Regardless of the cause, this pattern of ownership likely explains why the first year annual VMT is higher than other years - the share of more heavily-driven commercial vehicles is highest for age one vehicles, and we weight the models by the proportion each makes up of the total population of registered vehicles. The SUV/van and light-duty truck class fleets show similar patterns of more-heavily driven commercial vehicles, and the highest share of commercial vehicles occurring for one-year-old vehicles. Unsurprisingly, the initial peak of annual VMT occurs for these classes as well.

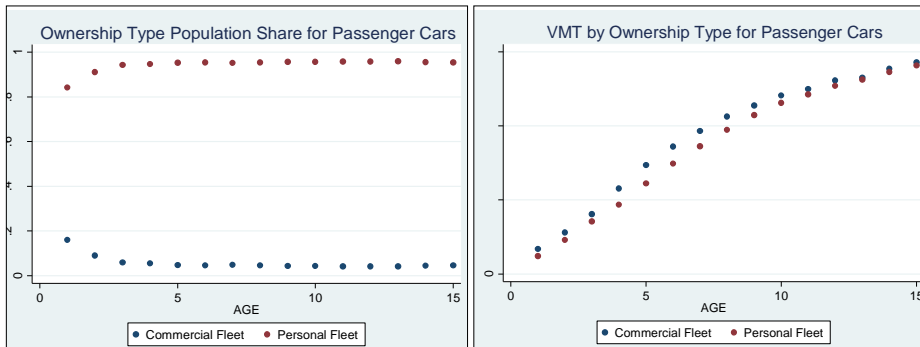

FIGURE 7-7 - TOTAL VMT AND SHARE OF POPULATION BY OWNERSHIP TYPE FOR PASSENGER

The old SUV and van schedules are very similar (Figure 7-8). Because the Polk data is already aggregated to the model-level, there are 38 categories of vans in 2014. For all other classes there are at least 3 times as many model-level classifications. For these reasons, it was determined that vans and SUVs were sufficiently similar, and so they were merged into a single class for VMT purposes. The new SUV/van schedule shows a peak average annual VMT (16,035) occurring at age one. It predicts lower annual VMT for all ages (except the first year, which is slightly higher than the old SUV schedule, though still predicts lower annual VMT than the old van schedule). The new schedule predicts a total of 89,529 (29%) fewer miles driven over a 30-year lifespan than the old SUV schedule, and a total of 99,445 (32%) fewer miles driven over a 30-year lifespan than the old van schedule.

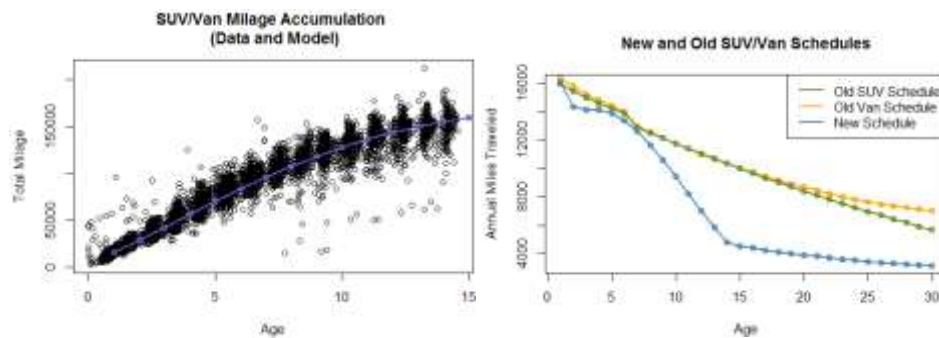

FIGURE 7-8 - A COMPARISON OF THE NEW AND OLD SUV/VAN SCHEDULES

The new light-duty pickup schedule predicts a peak annual VMT of 17,436 miles at age one. Figure 7-9 shows that the new light-duty pickup VMT schedule predicts higher annual VMT for ages one through five, and lower annual VMT for all other ages. Even considering this, the new schedule for light pickups predicts a total 30-year lifetime decrease of 74,385 (24%) from the old schedule for light trucks.

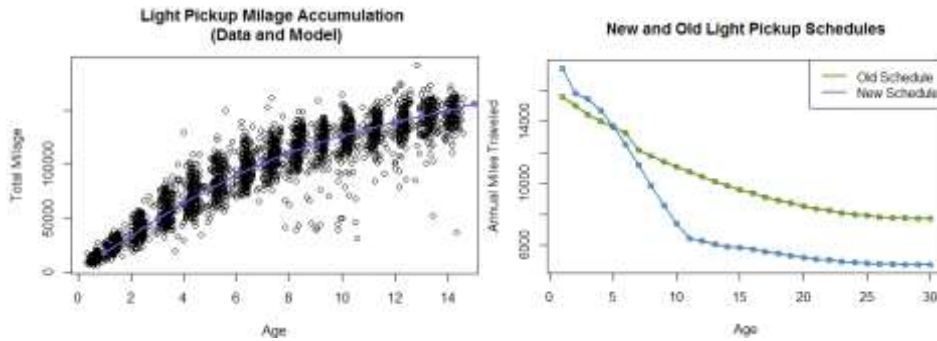

FIGURE 7-9 - A COMPARISON OF THE NEW AND OLD LIGHT PICKUP SCHEDULES

Table 7-2 offers a summary of the comparison of lifetime VMT (by class) under the new schedule, compared with lifetime VMT under the old schedule. In addition to the total lifetime VMT expected under each schedule for vehicles that survive to their full useful life, Figure 8 also shows the survival-weighted lifetime VMT for both schedules. This represents the average lifetime VMT for all vehicles, not only those that survive to their full useful life. The percentage difference between the two schedules is not as stark for the survival-weighted schedules - the percentage decrease of survival-weighted lifetime VMT under the new schedules range from 16.2% (for pickups) to 21.2% (for passenger vans).

TABLE 7-2 - SUMMARY COMPARISON OF LIFETIME VMT OF THE NEW AND OLD SCHEDULES

	Maximum Lifetime VMT			Survival-Weighted ("Expected") Lifetime VMT		
	New	Old	% difference	New	Old	% difference
	Car	204,233	301,115	32.2%	142,119	179,399
Van	237,623	362,482	34.4%	155,115	196,725	21.2%
SUV	237,623	338,646	29.8%	155,115	193,115	19.7%
Pickup	265,849	360,982	26.4%	157,991	188,634	16.2%

7.7.1.2 Data Description

While the Polk data set contains model-level average odometer readings, the CAFE model assigns lifetime VMT schedules at a lower resolution based on vehicle body style. For the purposes of VMT accounting, the CAFE model classifies every vehicle in the analysis fleet as being one of the following - passenger car, SUV, pickup truck, or passenger van. In order to use the Polk data to develop VMT schedules for each of the (VMT) classes in the CAFE model, a map was constructed between the classification of each model in the Polk data and the classes in the CAFE model. The only difference between the mapping for the VMT schedules and the rest of the CAFE model is that SUV and van body styles were merged into one class (for reasons described in the discussion of the SUV/van schedule above). This mapping allowed the analysis

to predict the lifetime miles traveled, by the age of a vehicle, for the categories in the CAFE model.

In estimating the VMT models, each data point (make/model classification) was weighted by the share of each make/model in the total population of the corresponding CAFE class. This weighting ensures that the predicted odometer readings, by class and model year, represent each of vehicle classification among observed vehicles (i.e., the vehicles for which Polk has odometer readings), based on each vehicles' representation in the registered vehicle population of its class. Implicit in this weighting scheme, is the assumption that the samples used to calculate each average odometer reading by make, model, and model year are representative of the total population of vehicles of that type. Several indicators suggest that this is a reasonable assumption.

First, the majority of each vehicle make/model is well-represented in the sample. Histograms and empirical cumulative distribution functions (CDFs) of the ratio of the number of odometer readings to the total population of those makes/models by each class (Figure 7-10, below), show that for more than 85% of make/model combinations, the average odometer readings are collected for 20% or more of the total population. Most make/model observations have sufficient sample sizes, relative to their representation in the vehicle population, to produce meaningful average odometer totals at that level.⁴⁴⁴

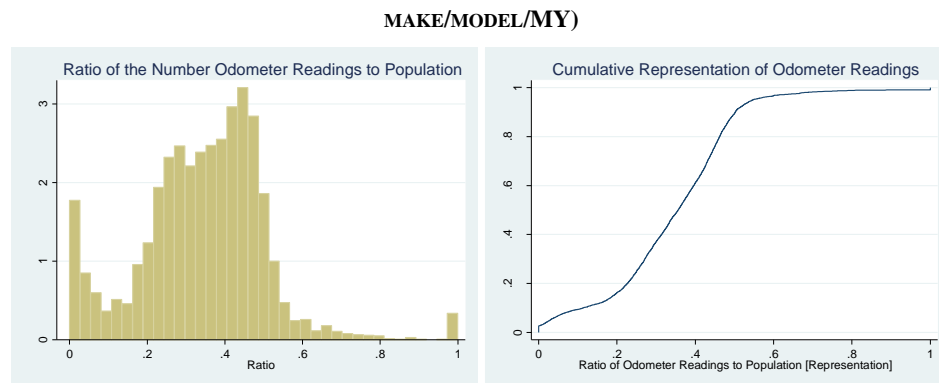

FIGURE 7-10 - DISTRIBUTION OF THE RATIO OF THE SAMPLE SIZE TO THE POPULATION SIZE (BY

The analysis also considered whether the representativeness of the odometer sample varies by vehicle age, since VMT schedules in the CAFE model are specific to each age. To investigate, the percentage of vehicle types (by make, model, and model year) that did not have odometer readings were calculated. Figure 7-11 shows that all model years, apart from 2015, have odometer readings for 96% or more of the total types of vehicles observed in the fleet.

⁴⁴⁴ Similar figures were developed that were stratified by each vehicle class, but these were no more revealing than the figures for all vehicles.

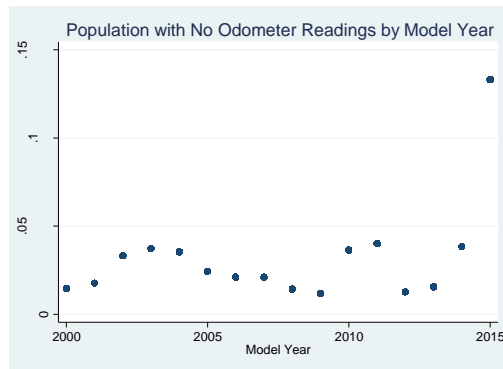

FIGURE 7-11 - THE PERCENTAGE OF THE TOTAL VEHICLE POPULATION WITH NO ODOMETER READINGS ACROSS MODEL YEAR

While the preceding discussion supports the *coverage* of the odometer sample across makes/models by each model year, it is possible that, for some of those models, an insufficient number of odometer readings is recorded to create an average that is likely to be representative of all of those models in operation for a given year. Figure 7-12, below, shows the percentage of all vehicle types for which the number of odometer readings is less than 5% of the total population (for that model). Again, for all model years other than 2015, approximately 95% or more of vehicles types are represented by at least 5% of their population. For this reason, observations from all model years other than 2015 were included, in the estimation of the new VMT schedules.

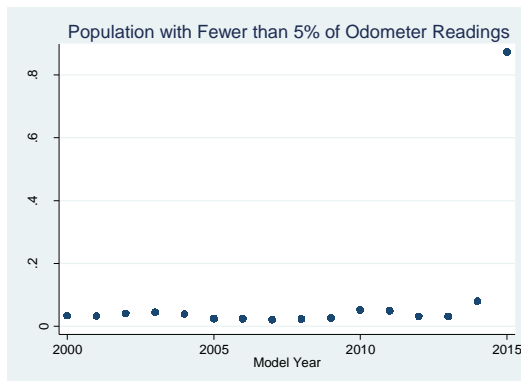

FIGURE 7-12 - PERCENTAGE OF VEHICLES WITH FEWER THAN 5% OF THE POPULATION IN ODOMETER READINGS (BY CLASS)

It is possible that the odometer sample is biased. If certain vehicles are over-represented in the sample of odometer readings relative to the registered vehicle population, a simple average, or even one weighted by the number of odometer observations will be biased. However, while

weighting by the share of each vehicle in the population will account for this bias, it would not correct for a sample that entirely omits a large number of makes/models within a model year. This assumption was tested by computing the proportion of the count of odometer readings for each individual vehicle type — within a class and model year — to the total count of readings for that class and model year. The population of each make/model — within each class and model year — was also compared to the population of the corresponding class and model year. The difference of these two ratios shows the difference of the representation of a vehicle type — in its respective class and model year — in the sample versus the population. All vehicle types are represented in the sample within 10% of their representation in the population, and the variance between the two representations is normally distributed. This suggests that, on average, the likelihood that a vehicle is in the sample is comparable to its proportion in the relevant population, and that there is little under or over sampling of certain vehicle makes/models.⁴⁴⁵

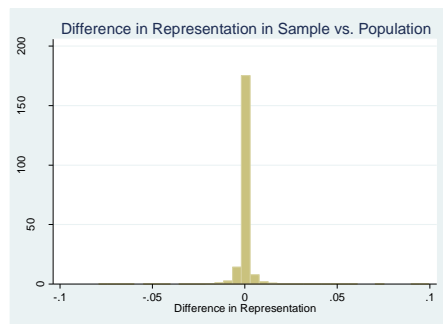

FIGURE 7-13 - DIFFERENCE IN THE SHARE OF EACH VEHICLE IN THE POPULATION VERSUS THE SAMPLE (BY CLASS)

7.7.1.3 Estimation

Because model years are sold in in the fall of the previous calendar year, throughout the same calendar year, and even into the following calendar year — not all registered vehicles of a make/model/model year will have been registered for at least a year (or more) until age 3. The result is that some MY 2014 vehicles may have been driven for longer than one year, and some less, at the time the odometer was observed. In order to consider this in the definition of age, the age of a vehicle was assigned to be the difference between the average reading date of a make/model and the average first registration date of that make/model. The result is that the continuous age variable reflects the amount of time that a car has been registered at the time of odometer reading, and presumably the time span that the car has accumulated the miles.

⁴⁴⁵ We produced similar figures, stratified by class, but these were no more revealing; the only difference being that cars are represented in the sample within 5% of their representation in the population (with a distribution range of .05 on either side).

After creating the “Age” variable, the make/model lifetime VMT data points were fit to a weighted quartic polynomial regression of the age of the vehicle (stratified by class).⁴⁴⁶ The predicted values of the quartic regressions are used to calculate the marginal annual VMT by age for each class by calculating differences in estimated lifetime mileage accumulation by age. However, the Polk data acquired by NHTSA only contains observations for vehicles newer than 16 years of age. In order to estimate the schedule for vehicles older than the age 15 vehicles in the Polk data, that information was combined with the portion of the schedule from the VMT schedules used in the 2017-2021 Final Light Duty Rule. The light-duty schedules were derived from the survey data contained in the 2009 National Household Travel Survey (NHTS).

Based on the vehicle ages for which data is available (from the Polk purchase), the newly estimated annual schedules differ from the previous version in important ways. Perhaps most significantly, the annual mileage associated with ages beyond age 8 begin to, and continue to, trend much lower. The approach taken here attempts to preserve the results obtained through estimation on the Polk observations, while leveraging the existing (NHTS-based) schedules to support estimation of the higher ages (age 16 and beyond). Because the two schedules are so far apart, simply splicing them together would have created not only a discontinuity, but also precluded the possibility of a monotonically decreasing scale with age (which is consistent with previous schedules, the data acquired from Polk, and common sense).

From the old schedules, annual VMT is expected to be decreasing for all ages. Towards the end of the sample, the predictions for annual VMT increase. In order to force the expected monotonicity, a triangular smoothing algorithm was performed until the schedule became monotonic. This performs a weighted average which weights the observations close to the observation more than those farther from it. The result is a monotonic function, which predicts similar lifetime VMT for the sample span as the original function. Because data beyond 15 years of age is not available, it is impossible to correctly capture that part of the annual VMT curve using only the new dataset. For this reason, trends in the old data are used to extrapolate the new schedule for ages beyond the sample range.

In order to use the VMT information from the newer data source for ages outside of the sample, the final in-sample age (15 years) is used as a seed and then applied to the proportional trend from the old schedules to extrapolate the new schedules out to age 30. To do this, the annual percentage difference in VMT of the old schedule for ages 15-30 is calculated. The same annual percentage difference in VMT is applied to the new schedule to extend beyond the final in-sample value. This assumes the proportional trend in the outer years is correctly modeled in the old VMT schedule, and imposes this same trend for the outer years of the new schedule. The extrapolated schedules are the final input for the VMT schedules in the CAFE model.

7.7.1.4 Comparison to Previous Schedules

As can be seen from all of the schedules, the new VMT data suggests that the VMT schedule used in the last light-duty CAFE final rule likely does not represent current annual VMT rates. Across all classes, the previous VMT schedules overestimate the average annual VMT. The previous schedules are based on data that is outdated and self-reported, while the observations from Polk are between 5 and 7 years newer than those in the NHTS and represent valid odometer readings (rather than self-reported information).

Additionally, while the NHTS may be a representative sample of *households*, it is less likely to be a representative sample of *vehicles*. However, by properly accounting for vehicle population weights in the new averages and models, this issue is corrected for in the derivation of the new schedules.

While these changes will influence total benefits and fatalities associated with the CAFE program, they are an improvement on the previous iterations and will be used until the next available update.

7.7.2 The Fuel Economy Rebound Effect on Vehicle Use

Figure 7-14 illustrates the effect of new vehicles’ lower sales prices and fuel economy on the number of miles they are driven annually, using the average values of both variables for new cars and light trucks produced during a future model year where this proposed rule would reduce fuel economy and CO₂ emission standards from their levels under the baseline alternative. As it shows, vehicles’ per-mile operating costs include the cost of fuel they consume, the expected cost associated with potential crashes, maintenance and repair outlays, operating costs other than fuel (oil, tire wear, etc.), depreciation associated with vehicle use, and the value of their drivers’ and other occupants’ travel time.

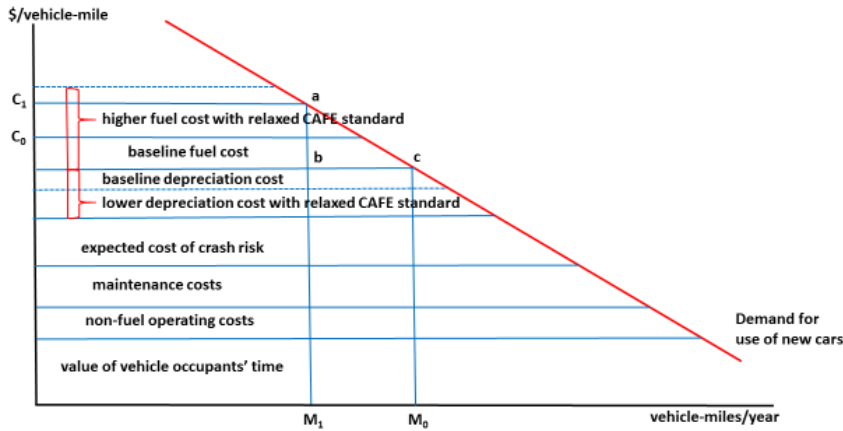

FIGURE 7-14 - EFFECT OF REDUCING CAFE/CO₂ STANDARDS ON NEW CAR AND LIGHT TRUCK USE

Reducing fuel economy and CO₂ standards will lead to both lower fuel economy and lower sales prices for cars and light trucks produced during future model years. Lower fuel economy will increase the amount of fuel vehicles consume each mile they are driven, thus increasing their per-mile driving cost. By itself, this effect will reduce the number of miles vehicles are driven each year during their lifetimes. At the same time, new models' lower sales prices may reduce their per-mile depreciation costs slightly, as their lower initial value gradually depreciates over their lifetimes; whether their per-mile depreciation also declines depend on whether their initial selling prices (which measure their market value when new) fall proportionally less than does their cumulative lifetime mileage.

For illustrative purposes, Figure 7-14 shows the situation where new vehicles' fuel costs increase but their per-mile depreciation costs decline, and on balance these changes raise their total cost for driving each mile slightly, from C_0 to C_1 . This increase in driving costs leads to an upward movement along the demand curve for vehicle use, reducing the average number of miles they are driven annually from M_0 to M_1 . Two direct economic costs, as well as a variety of indirect economic costs and benefits, which are discussed in subsequent sections, will result from the decline in new vehicles' use caused by this "reverse rebound effect."

First, new car and light truck buyers' annual outlays for fuel increase throughout the lifetimes of the models they purchase, as reducing future CAFE and CO₂ standards leads to lower fuel economy levels (on average) and increased fuel consumption. The magnitude of this cost depends on how much new vehicles' average fuel economy declines when future standards are lowered and how much they continue to be driven each year, as well as on future retail prices for fuel; graphically, it is equal to the shaded rectangular area C_1abC_0 in Figure 7-14. The analysis estimates this cost using the reductions in the fuel economy of individual cars and light truck models expected to be offered in future model years that are simulated by DOT's CAFE compliance model, together with forecasts of fuel prices from the U.S. Energy Information Administration's *Annual Energy Outlook 2017*.

Second, some travel or mobility-related benefits are sacrificed when driving declines in response to higher fuel costs. At the same time, however, drivers save costs this driving would have entailed, and this saving offsets much of the loss in benefits the additional driving would have brought them. On balance, the net loss in welfare is measured by the consumer surplus they would have gained from the driving they no longer do when their per-mile fuel costs rise, which is shown as the triangular area abc in Figure 7-14. The analysis estimates this loss by assuming the demand curve for vehicle use is linear over the relevant range, so its annual value can be calculated as one-half of the product of the increase in driving costs ($C_1 - C_0$) and the reduction in vehicle use ($M_0 - M_1$).

Even if new vehicles' per-mile depreciation costs decline by enough to offset the increase in their fuel costs and thus cause a decline in the total cost of driving each mile, the reduction in their fuel economy that occurs in response to reducing future standards would *by itself* cause an increase in their per-mile driving cost and a decline in their annual use. This separate effect – or more commonly, the reverse of this effect – is what empirical estimates of the fuel economy rebound effect measure, so they cannot instead be applied to the change in vehicles' per-mile driving cost (including fuel, depreciation, and its other components) to estimate the resulting change in their use. Thus incorporating depreciation costs would not change the estimates of the reduction in vehicle use stemming from lower fuel economy levels permitted by less stringent CAFE standards or its associated economic costs.

7.7.3 Externalities from Increased Rebound-Effect Driving

Vehicle use also generates external costs via adverse health effects from its contribution to air pollution, emissions of GHGs and their role in climate-related economic damages, and increased traffic congestion and noise in the vicinity of roadways. While these external costs are small for new cars and light trucks –except possibly for their contribution to congestion – the reduction in their use that results from permitting them to meet lower fuel economy standards nevertheless produces some economic benefits by reducing the magnitude of these costs.

Figure 7-15 illustrates the nature of these benefits. Like the preceding figure, it shows the demand for travel in new cars and light trucks, and illustrates the effect of the rise in their per-mile driving costs that occurs with lower fuel economy. Figure 7-15 omits the detailed breakdown of total driving costs shown in the previous figure, and instead shows the combined external costs imposed by new vehicles' contributions to air pollution, climate-related damages, traffic congestion, and road noise. At the level of new car and light truck use that would occur with the baseline standards in effect, these external costs are equal to the product of their per-mile value ($SC_0 - C_0$) and initial vehicle use M_0 , or the rectangular area SC_0fcC_0 .

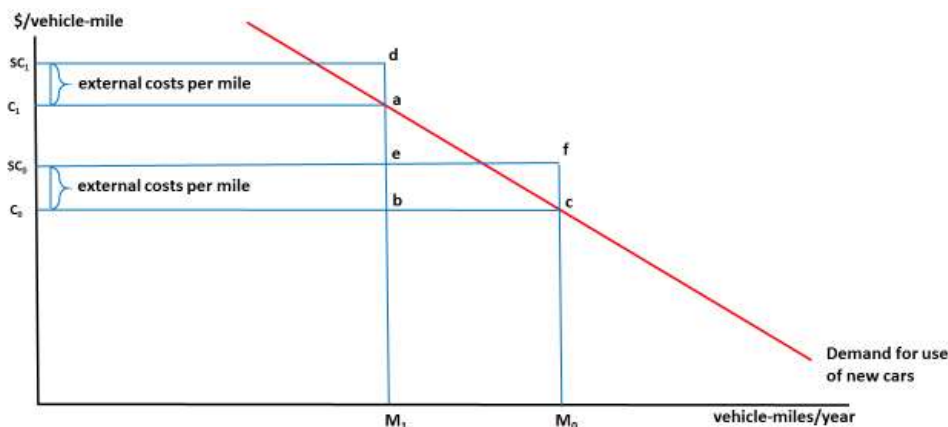

FIGURE 7-15 - EXTERNALITIES RESULTING FROM CHANGES IN NEW CAR AND LIGHT TRUCK USE

At the lower level of driving by new cars and light trucks that results when their fuel economy declines (M_1 in Figure 7-15), the total cost of these externalities is again the product of their per-mile value ($SC_1 - C_1$) and this lower level of use M_1 , or the rectangular area SC_1daC_1 . If the per-mile value of these externalities is unaffected by the change in new vehicles' use from M_0 to M_1 , as shown in Figure 7-15, total external costs will decline by the area of the rectangle $ebcf$, which is $(M_0 - M_1) * (SC_0 - C_0)$. More generally, the value of this additional economic benefit is the difference between the total cost of driving-related externalities caused by use of new cars and light trucks with the baseline CAGE and CO₂ standards in effect, or $M_0 * (SC_0 - C_0)$, and their presumably lower value under the lower proposed standards, $M_1 * (SC_1 - C_1)$.⁴⁴⁷

The analysis calculates changes in each of these external costs resulting from less intensive use of new cars and light trucks separately. The reduction in GHG emissions from their lower use is already reflected in the net change in total GHG emissions, because this is based on the increase in fuel production and consumption with the proposed rather than the baseline standards in effect. Reductions in emissions of criteria air pollutants are calculated from the estimated decline in new vehicles' use and per-mile emission factors for future model year vehicles derived from EPA's MOVES model, which incorporate future changes in emission standards for light-duty vehicles. Finally, reductions in external costs from congestion delays and road noise caused by

⁴⁴⁷ It is possible the per-mile cost of these externalities could increase sufficiently with the decline in new vehicles' use to cause their total value to rise, but this seems extremely unlikely because all except congestion are approximately constant on a per-mile basis, and congestion is likely to decline with lower vehicle use.

new cars and light trucks are estimated using estimates of their per-mile marginal or incremental contributions to these costs reported by the Federal Highway Administration.⁴⁴⁸

7.7.4 Measuring the Fuel Economy Rebound Effect

Together with the change in new vehicles' fuel economy that results from reducing CAFE standards, the rebound effect determines how much their use is likely to decline, so its magnitude is an important parameter in this analysis. Formally, the fuel economy rebound effect is equal to the elasticity of average or total vehicle use per time period with respect to fuel economy (or its reciprocal, fuel efficiency), usually expressed as a positive percentage rather than as a negative decimal number. Most research on the rebound effect has relied on econometric analysis of one of three sources of data -

- Time-series data on total annual vehicle use, average fuel cost per mile, macroeconomic conditions, road supply measures, and other variables thought to affect vehicle use.
- “Panel” data combining vehicle use, average fuel cost, and other measures thought to affect vehicle travel for individual states over a succession of years, to capture their variation among states and over time.
- Survey data on use of individual vehicles that also includes their fuel economy and other attributes, as well as demographic and location characteristics of the households that own them.

Some research has estimated the fuel economy rebound effect using econometric analysis of the relationship between vehicle use and fuel economy, controlling for other factors likely to affect vehicle use such as fuel prices, measures of economic activity or income, and road supply (as a proxy for travel speed and congestion). Other analyses measure the rebound effect using the elasticity of vehicle use with respect to fuel cost per mile – equal to fuel price per gallon divided by fuel economy (in miles per gallon) – under the assumption that drivers respond identically to changes in fuel cost per mile that resulting from either varying fuel prices or changes in fuel economy.

Analysts often resort to this second approach because variation in fuel economy is typically limited in aggregate time-series data on large vehicle fleets, such as those for states or nations, which makes it difficult to isolate the response of vehicle use to changing fuel economy from the effects of other factors. The second strategy is also common because data on vehicle use that reflect independent (or “exogenous”) variation in fuel economy are difficult to obtain, whereas variation in fuel prices is less likely to be influenced by vehicle use.

⁴⁴⁸ Federal Highway Administration, 1997 Highway Cost Allocation Study, Chapter V (<https://www.fhwa.dot.gov/policy/hcas/final/five.cfm>), Tables V-22 and V-23. These values were updated to 2016 dollars using the change in the Implicit Price Deflator for U.S. Gross Domestic Product, reported in U.S. Bureau of Economic Analysis, National Income and Product Accounts, Table 1.1.9 (<https://www.bea.gov/iTable/iTable.cfm?reqid=19&step=2#reqid=19&step=3&isuri=1&1921=survey&1903=13>).

A related complication in most analyses of national and state data is that they measure fuel economy by dividing total vehicle use by fuel sales (to obtain average miles per gallon), thus creating a “definitional” connection between the two variables that makes it difficult to identify whether they have a true cause-and-effect relationship. A similar concern arises with survey data on individual vehicles – which typically contain much wider variation in fuel economy and vehicle use – because households who anticipate using vehicles more intensively may purchase models with higher fuel economy. Insofar as they do, this again makes it challenging for analysts to be confident that they are measuring the influence of fuel economy on vehicle use independently from any reverse effect.

State-level data on vehicle use and fuel consumption are also hampered by a geographic “mismatch” between where fuel is purchased and where vehicles consuming it are driven, because of through travel by trucks and some drivers’ purchases of fuel in neighboring states. Thus, there is likely to be extensive measurement error in the fuel economy measures used in studies relying on state data, reducing confidence that they actually measure the rebound effect rather than other influences on vehicle use that also differs among neighboring states.

Some research tries to avoid these complications by inferring the magnitude of the rebound effect from econometric estimates of the elasticity of vehicle use with respect to the price of fuel itself, rather than fuel economy or fuel cost per mile. The main advantage of this approach is that vehicle use may be less likely to affect fuel prices than it is to affect fuel economy (at either the fleet-wide aggregate level or for individual vehicles), thus increasing confidence that any statistical association between vehicle use and fuel prices actually reflects a behavioral relationship, although this depends on the assumption that the supply of fuel is highly elastic with respect to its price. Despite this advantage, the elasticity of vehicle use with respect to fuel price does not capture the effect of fuel economy itself on vehicle use and thus does not measure the rebound effect, so the estimates of this effect are generally regarded as less informative.

7.7.5 Early Empirical Estimates of the Rebound Effect

Table 7-3 summarizes estimates of the fuel economy rebound effect for light-duty vehicles from studies conducted through 2008, when research on this subject was first surveyed for the light-duty CAFE and GHG rulemaking.⁴⁴⁹ It summarizes estimates reported in published and other publicly-available research available at that time, and also distinguishes among estimates based on the type of data used to develop them. As the table reports, estimates of the rebound effect ranged from 6% to as high as 75%, and the range spanned by published estimates was nearly as wide (7-75%). Most studies reported more than one empirical estimate, and the authors of published studies typically identified the single estimate in which they were most confident; these preferred estimates spanned only a slightly narrower range (9-75%).

⁴⁴⁹ [Need reference and docket citation to RIA for MY 2012-26 CAFE rule.]

TABLE 7-3 - SUMMARY OF RESEARCH ON THE FUEL ECONOMY REBOUND EFFECT THROUGH 2008

Category of Estimates	Number of Studies	Number of Estimates	Range		Distribution		
			Low	High	Median	Mean	Std. Dev.
All Estimates	27	87	6%	75%	19%	22%	13%
Published Estimates	20	68	7%	75%	19%	23%	13%
Authors' Preferred Estimates	20	20	9%	75%	22%	22%	15%
U.S. Time-Series Estimates	7	34	7%	45%	14%	18%	9%
Household Survey Estimates	17	38	6%	75%	22%	25%	15%
Pooled U.S. State Estimates	3	15	8%	58%	22%	23%	12%

Despite their wide range, these estimates displayed a strong central tendency, as Table 7-3 also shows. The average values of all estimates, those that were published, and authors' preferred estimates from published studies were 22-23%, and the median estimates in each category were close to these values, indicating nearly symmetric distributions. Estimates in each category also clustered fairly tightly around their respective average values, as shown by their standard deviations in the table's last column. Research based on U.S. aggregate time-series data produced slightly smaller values (averaging 18%) than did panel-type data for individual states (23%) or household survey data (25%). In each category, the median estimate was again quite close to the average reported value, and comparing the standard deviations of estimates based on each type of data again suggests a fairly tight scatter around their respective means.

Of these studies, the agencies singled out a then recently-published analysis by Small & Van Dender (2007) which reported that the rebound effect appeared to be declining over time in response to increasing income of drivers. These authors theorized that rising income increased the opportunity cost of drivers' time, leading them to be less responsive over time to reductions in the fuel cost of driving each mile. Small and Van Dender reported that while the rebound effect averaged 22% over the entire time period they analyzed (1967-2001), its value declined by half – or to 11% – during the last five years they studied (1997-2001). The agencies also took particular note of recent EPA-funded research by Greene (2009), which replicated the finding that the rebound effect appeared to be declining over time as U.S. income levels increased using time-series data for the U.S., and projected that it could decline to 10% by the year 2020 with continued income growth.

Relying primarily on these studies' projections that sustained income growth would continue to reduce the rebound effect over time, the agencies reduced the 20% estimate that NHTSA had used to analyze the effects of CAFE standards for light trucks produced during model years 2005-07 and 2008-11 to 10% for their analysis of CAFE and GHG standards for model year 2012-16 passenger cars and light trucks. The agencies continued to use the 10% estimate of the rebound effect in their subsequent analyses of CAFE and GHG standards for model years 2017-21 and beyond, although the income growth that had been anticipated to erode the value of the rebound effect had not materialized.

7.7.6 More Recent Research on the Rebound Effect

Table 7-4 summarizes estimates of the rebound effect reported in research that has become available since the agencies' original survey, which extended through 2008, and the following discussion briefly summarizes the approaches used by these more recent studies. As in all previous analyses, this analysis focuses on estimates of the long-run rebound effect – that is, the effect of fuel economy on vehicle use after sufficient time has elapsed for drivers to adapt to the effect of changes in fuel economy on driving costs. As the table shows, several recent studies of the rebound effect utilize data on the characteristics and use of household vehicles from the 2009 U.S. National household Travel Survey, which was conducted over a period (March 2008-April 2009) when fuel prices and the performance of the U.S. economy varied widely. These circumstances offered an unusual opportunity to isolate the effect of fuel economy on vehicle use by U.S. households from those of fuel prices and household income levels, while the large number of U.S. households owning multiple vehicles increased the range of fuel economy levels and enabled analysts to examine households' substitution among them.

TABLE 7-4 - RECENT ESTIMATES OF THE FUEL ECONOMY REBOUND EFFECT

Authors (Date)	Nation	Time Period	Data	Estimate of Long-Run Effect	Source of Variation in Estimates
Barla <i>et al.</i> (2009)	Canada	1990-2004	10 Canadian provinces	20%	Overall estimate
Bento (2009)	U.S.	2001	~150,000 household vehicles	21-38%	Vehicle type, size, age
Waddud (2009)	U.S.	1984-2003	U.S income quintiles	1-25%	Household income
West and Pickrell (2011)	U.S.	2009	120,000 household vehicles	9-34%	Vehicle ownership
Anjovic and Haas (2012)	E.U.	1970-2007	6 E.U. nations	44%	Time, nation
Su (2012)	U.S.	2009	45,000 households	11-19%	Vehicle use
Greene (2012)	U.S.	1967-2006	U.S. aggregate data	8-12%	Model specification
Linn (2013)	U.S.	2009	230,000 household vehicles	20-40%	Model specification

Frondel and Vance (2013)	Germany	1997-2009	2,165 households	46-70%	Definition of rebound effect, household driving
Liu (2014)	U.S.	2009	1,420 households	39-40%	Household characteristics
Gillingham (2014)	California	2001-09	5 million vehicles	22-23%	Model specification
Weber and Farsi (2014)	Switzerland	2010	8,000 household vehicles	19-81%	Annual vs. daily driving; estimation procedure
Hymel & Small (2015)	U.S.	2003-09	50 U.S. states	18%	Overall estimate
West <i>et al.</i> (2015)	U.S.	2009	166,000 new vehicles	0%	Overall estimate
DeBorger (2016)	Denmark	2001-11	23,000 households	8-10%	Model specification
Stapleton et al. (2016,2017)	Great Britain	1970-2012	average annual values	14-30%	Time period

Bento et al. (2009) combined demographic characteristics of more than 20,000 U.S. households, the manufacturer and model of each vehicle they owned, and their annual usage of each vehicle from the 2001 National Household Travel Survey with detailed data on fuel economy and other attributes for each vehicle model obtained from commercial publications. The authors aggregated vehicle models into 350 categories representing combinations of manufacturer, vehicle type, and age, and use the resulting data to estimate the parameters of a complex model of households' joint choices of the number and types of vehicles to own, and their annual use of each vehicle.

Bento et al. estimated the effect of vehicles' operating cost per mile, including fuel costs – which depend in part on each vehicle's fuel economy – as well as maintenance and insurance expenses, on households' annual use of each vehicle they own. Combining the authors' estimates of the elasticity of vehicle use with respect to per-mile operating costs with the reported fraction of total operating costs accounted for by fuel (slightly less than one-half) yielded estimates of the rebound effect. The resulting values varied by household composition, vehicle size and type, and

vehicle age, ranging from 21 to 38%, with a composite estimate of 34% for all households, vehicle models, and ages. The smallest values applied to new luxury cars, while the largest estimates are for light trucks and households with children, but the implied rebound effects differed little by vehicle age.

Barla *et al.* (2009) analyzed the responses of car and light truck ownership, vehicle travel, and average fuel efficiency to variation in fuel prices and aggregate economic activity (measured by gross product) using panel-type data for the 10 Canadian provinces over the period from 1990 through 2004. The authors estimated a system of equations for these three variables using statistical procedures appropriate for models where the variables of interest are simultaneously determined (that is, where each variable is one of the factors explaining variation in the others).⁴⁵⁰ This procedure enabled them to control for the potential “reverse influence” of households’ demand for vehicle travel on their choices of how many vehicles to own and their fuel efficiency levels when estimating the effect of variation in fuel efficiency on vehicle use.

Their analysis found that provincial-level aggregate economic activity had moderately strong effects on car and light truck ownership and use, but that fuel prices had only modest effects on driving and the average fuel efficiency of the light-duty vehicle fleet. Each of these effects became considerably stronger over the long term than in the year when changes in economic activity and fuel prices initially occurred, with 3-5 years typically required for behavioral adjustments to stabilize. After controlling for the joint relationship among vehicle ownership, driving demand, and the fuel efficiency of cars and light trucks, Barla *et al.* estimated elasticities of average vehicle use with respect to fuel efficiency that corresponded to a rebound effect of 8% in the short run, rising to nearly 20% within 5 years. A notable feature of their analysis was that variation in average fuel efficiency among the individual Canadian provinces and over the time period they studied was adequate to identify its effect on vehicle use, without the need to combine it with variation in fuel prices in order to identify its effect.

Wadud *et al.* (2009) combined data on U.S. households’ demographic characteristics and expenditures on gasoline over the period 1984-2003 from the Consumer Expenditure Survey with data on gasoline prices and an estimate of the average fuel economy of vehicles owned by individual households (constructed from a variety of sources). They employed these data to explore variation in the sensitivity of individual households’ gasoline consumption to differences in income, gasoline prices, number of vehicles owned by each household, and their average fuel economy. Using an estimation procedure intended to account for correlation among unmeasured characteristics of households and among estimation errors for successive years, the authors explored variation in the response of fuel consumption to fuel economy and other variables

⁴⁵⁰ Barla *et al.*’s model specification and estimation procedure closely resembled that used by Small and Van Dender (2007) in their analysis of the fuel economy rebound effect for the U.S.

among households in different income categories, and between those residing in urban and rural areas.

Dividing U. S. households into five equally-sized income categories, Wadud et al. (2009) estimated rebound effects ranging from 1-25%, with the smallest estimates (8% and 1%) for the two lowest income categories, and significantly larger estimates for the middle (18%) and two highest income groups (18 and 25%). In a separate analysis, the authors estimated rebound effects of 7% for households of all income levels residing in U.S. urban areas and 21% for rural households.

West & Pickrell (2011) analyzed data on more than 100,000 households and 300,000 vehicles from the 2009 Nationwide Household Transportation Survey to explore how households owning multiple vehicles chose which vehicles to use and how much to drive each one on the day the household was surveyed. Their study focused on how the type and fuel economy of each vehicle a household owned, as well as its demographic characteristics and location, influenced household members' decisions about whether and how much to drive each vehicle. They also investigated whether fuel economy and fuel prices exerted similar influences on vehicle use and whether households owning more than one vehicle tended to substitute use of one for another – or vary their use of all of them similarly – in response to fluctuations in fuel prices and differences in their vehicles' fuel economy.

Their estimates of the fuel economy rebound effect ranged from as low as 9% to as high as 34%, with their lowest estimates typically applying to single-vehicle households and their highest values to households owning three or more vehicles. They generally found differences in fuel prices faced by households who were surveyed on different dates or who lived in different regions of the U.S. explained more of the observed variation in daily vehicle use than did differences in vehicles' fuel economy. West and Pickrell also found that while the rebound effect for households' use of passenger cars appeared to be quite large – ranging from 17% to nearly twice that value – detecting a consistent rebound effect for SUVs was difficult.

Anjovic & Haas (2012) examined variation in vehicle use and fuel efficiency among 6 European nations over an extended period (1970-2006), using an elaborate model and estimation procedure intended to account for the existence of common underlying trends among the variables analyzed and thus avoid identifying spurious or misleading relationships among them. The six nations included in their analysis were Austria, Germany, Denmark, France, Italy, and Sweden; the authors also conducted similar analyses for the six nations combined. The authors focused on the effects of average income levels, fuel prices, and the fuel efficiency of each nation's fleet of cars on the total distance they were driven each year and their total fuel energy consumption. They also tested whether the responses of energy consumption to rising and falling fuel prices appeared to be symmetric in the different nations.

Anjovic & Haas report a long-run aggregate rebound effect of 44% for the six nations their study included, with corresponding values for individual nations ranging from a low of 19% (for Austria) to as high as 56% (Italy). These estimates are based on the estimated response of vehicle use to variation in average fuel cost per kilometer driven in each of the six nations and for their combined total. Other information reported in their study, however, suggests lower rebound effects - their estimates of the response of total fuel energy consumption to fuel efficiency appear to imply an aggregate rebound effect of 24% for the six nations, with values ranging from as low as 0-3% (for Austria and Denmark) to as high as 70% (Sweden), although the latter is very uncertain.⁴⁵¹ These results suggest that vehicle use in European nations may be somewhat less sensitive to variation in driving costs caused by changes in fuel efficiency than to changes in driving costs arising from variation in fuel prices, but they find no evidence of asymmetric responses of total fuel consumption to rising and falling prices.

Using data on household characteristics and vehicle use from the 2009 Nationwide Household Transportation Survey (NHTS), Su (2012) analyzed effects of locational and demographic factors on household vehicle use and investigated how the magnitude of the rebound effect varies with vehicles' annual use. Using variation in the fuel economy and per-mile cost of and detailed controls for the demographic, economic, and locational characteristics of the households that owned them (e.g., road and population density) and each vehicle's main driver (as identified by survey respondents), the author employed specialized regression methods to capture the variation in the rebound effect across 10 different categories of vehicle use.

Su (2012) estimated the rebound effect for vehicles in the sample averaged 13%, and that its magnitude varied from 11-19% among 10 different categories of annual vehicle use. The smallest rebound effects were estimated for vehicles at the two extremes of the distribution of annual use – those driven comparatively little and those used most intensively — while the largest estimated effects applied to vehicles that were driven slightly more than average. Controlling for the possibility that high-mileage drivers respond to the increased importance of fuel costs by choosing vehicles offering higher fuel economy narrowed the range of Su's estimated rebound effects slightly (to 11-17%) but did not alter the finding that rebound effects were smallest for lightly- and heavily-driven vehicles, and largest for those with slightly above average use.

Linn (2013) also used the 2009 NHTS to develop a linear regression approach to estimate the relationship between the VMT of vehicles belonging to each household and a variety of different factors - fuel costs, vehicle characteristics other than fuel economy (e.g., horsepower, the "quality" of the vehicle), and household characteristics (e.g., age, income). Linn (2013) reported a fuel economy rebound effect with respect to VMT of between 20–40%. One interesting result of Linn's study is that when the fuel efficiency of all vehicles increased, which would be the

⁴⁵¹ These estimates were derived from Anjovic & Haas (2012), Table 4A, p. 42, line 4 ("long term fuel intensity elasticity" of total fuel energy consumption).

long-run effect of rising fuel efficiency standards, two factors had opposing effects on the VMT of a particular vehicle. First, VMT increased when vehicle's fuel efficiency increased. But the increase in the fuel efficiency of the household's other vehicles caused the vehicle's own VMT to decrease. Because the effect of a vehicle's own fuel efficiency was larger than other vehicles' fuel efficiency, VMT increased if the fuel efficiency of all vehicles increased proportionately. Linn (2013) also found VMT responded much more strongly to vehicle fuel economy than to gasoline prices.

A study of the rebound effect by Frondel et al. (2012) used data from travel diaries recorded by more than 2,000 German households from 1997 through 2009 to estimate alternative measures of the rebound effect, and to explore variation in their magnitude among households. Each household participating in the survey recorded its automobile travel and fuel purchases over a period of one to three years, and also supplied information on its composition and personal characteristics of its members. The authors converted households' travel and fuel consumption to a monthly basis, and used specialized estimation procedures (quantile and random-effects panel regression) to analyze monthly variation in their travel and fuel use in relation to differences in fuel prices, the fuel efficiency of each vehicle a household owned, and the fuel cost per mile of driving each vehicle.

Frondel et al. (2012) estimate four separate measures of the rebound effect, three of which capture the response of vehicle use to variation in fuel efficiency, fuel price, and fuel cost per mile traveled, and a fourth capturing the response of fuel consumption to changes in fuel price. Their first three estimates range from 42% to 57%, while their fourth estimate corresponds to a rebound effect of 90%. Although their analysis finds no significant variation of the rebound effect with household income, vehicle ownership, or urban versus rural location, it does conclude the rebound effect is substantially larger for households that drive less (90%) than for those who use their vehicles most intensively (56%).

Like Su (2012) and Linn (2013), Liu et al. (2014) employed the 2009 NHTS to develop an elaborate model of an individual household's choices about how many vehicles to own, what types and ages of vehicles to purchase, and how much combined driving they do. Their analysis used a complex mathematical formulation and statistical methods to represent and measure the interdependence among households' choices of the number, types, and ages of vehicles to purchase, as well as how intensively to use them.

Liu et al. (2014) employed their model to simulate variation in households' total vehicle use to changes in their income levels, neighborhood characteristics, and the per-mile fuel cost of driving averaged over all vehicles each household owns. The complexity of relationships among the number of vehicles owned, their specific types and ages, fuel economy levels, and use incorporated in their model required the researchers to measure these effects by introducing variation in income, neighborhood attributes, and fuel costs, and observing the response of households' annual driving. Their results imply a rebound effect of approximately 40% in

*** EO 12866 Review – Draft – Do Not Cite, Quote or Release During Review ***

response to significant (25-50%) variation in fuel costs with almost exactly symmetrical responses to increases and declines.

Gillingham (2014) analyzed variation in the use of approximately 5 million new vehicles sold in California from 2001 to 2003 during the first several years after their purchase, focusing particularly on how their use responded to geographic and temporal variation in fuel prices. His sample consisted primarily of personal or household vehicles (87%), but also included some that were purchased by businesses, rental car companies, and government agencies. Using county-level data, he analyzed the effect of differences in the monthly average fuel price paid by their drivers on variation in their monthly use, and explored how that effect varied with drivers' demographic characteristics and household incomes.

Gillingham's analysis did not include a measure of vehicles' fuel economy or fuel cost per mile driven, so he could not measure the rebound effect directly. However, his estimates of the effect of fuel prices on vehicle use correspond to rebound effects of 22-23%, depending on whether he controlled for the potential effect of gasoline demand on its retail price. His estimation procedure and results imply that vehicle use requires nearly two years to adjust fully to changes in fuel prices. He found little variation in the sensitivity of vehicle use to fuel prices among car buyers with different demographic characteristics, although his results suggested that it increases with their income levels.

Weber & Farsi (2014) analyzed variation in the use of more than 70,000 individual cars owned by Swiss households who were included in a 2010 survey of travel behavior. Their analysis focuses on the simultaneous relationships among households' choices of the fuel efficiency and size (weight) of the vehicles they own, and how much they drive each one, although they recognize that fuel efficiency cannot be chosen independently of vehicle weight.⁴⁵² The authors employ a model specification and statistical estimation procedures that account for the likelihood that households intending to drive more will purchase more fuel-efficient cars, but may also choose more spacious and comfortable – and thus heavier – models, which affects their fuel efficiency indirectly, because heavier vehicles are generally less fuel-efficient. The survey data they rely on includes both owners' estimates of their annual use of each car and the distance it was actually driven on a specific day; because they are not closely correlated, the authors employ them as alternative measures of vehicle use to estimate the rebound effect, but this restricts their sample to the roughly 8,100 cars for which both measures are available.

Weber & Farsi's estimates of the rebound effect are extremely large - 75% using estimated annual driving, and 81% when they measure vehicle use by actual daily driving. Excluding vehicle size (weight) and limiting the choices that households are assumed to consider simultaneously to just vehicles' fuel efficiency and how much to drive approximately reverses

⁴⁵² In fact, their measure of fuel efficiency – which they refer to as fuel “intensity” — is derived from a calibrated relationship between its value and a vehicle's weight; see Weber and Farsi (2015), footnote 8, p. 10.

these estimates, but both are still very large. Using a simpler procedure that does not account for the potential effect of driving demand on households' choices among vehicle models of different size and fuel efficiency produces much smaller values for the rebound effect - 37% using annual driving and 19% using daily travel. The authors interpret these latter estimates as likely to be too low, because actual on-road fuel efficiency has not improved as rapidly as suggested by the manufacturer-reported measure they employ. This introduces an error in their measure that may be related to a vehicle's age, and their more complex estimation procedure may reduce its effect on their estimates.⁴⁵³ Nevertheless, even their lower estimates exceed those from many other studies of the rebound effect, as Table 7-4 shows.

Hymel, Small & Van Dender (2010) – and more recently, Hymel & Small (2015) – extended the simultaneous equations analysis of time-series and state-level variation in vehicle use originally reported in Small & Van Dender (2007) to test the effect of including more recent data. As in the original 2007 study, both subsequent extensions found that the fuel economy rebound effect declined over time in response to increasing personal income and urbanization, but rose during periods when fuel prices increased. Because they relied on the response of vehicle use to fuel cost per mile to estimate the rebound effect, however, none of these three studies was able to detect whether its apparent decline in response to rising income levels over time truly reflects its changing effect on drivers' response improving fuel economy – the rebound effect itself – or simply captured the effect of rising income on their sensitivity to fuel prices.⁴⁵⁴ These updated studies each revised Small & Van Dender's original estimate of an 11% rebound effect for 1997-2011 upward when they included more recent experience - to 13% for the period 2001-04, and subsequently to 18% for 2000–2009.

In their 2015 update, Hymel & Small hypothesized that the recent increase in the rebound effect could be traced to a combination of expanded media coverage of changing fuel prices, increased price volatility, and an asymmetric response by drivers to variation in fuel costs. The authors estimated that approximately half of the apparent increase in the rebound effect for recent years could be attributed to greater volatility in fuel prices and more media coverage of sudden price changes. Their results also suggest that households curtail their vehicle use within the first year following an increase in fuel prices and driving costs, while the increase in driving that occurs in response to declining fuel prices – and by implication, to improvements in fuel economy – occurs more slowly.

West *et al.* (2015) attempted to infer the fuel economy rebound effect using data from Texas households who replaced their vehicles with more fuel-efficient models under the 2009 “Cash

⁴⁵³ See Weber and Farsi (2015), p. 13.

⁴⁵⁴ DeBorger *et al.* (2016) analyze the separate effects of variation in household income on the sensitivity of their vehicle use to fuel prices and the fuel economy of vehicles they own. Their results imply that the decline in the fuel economy rebound effect with income reported in Small and Van Dender (2007) and its subsequent extensions appears to result entirely from a reduction in drivers' sensitivity to fuel prices as their incomes rise, rather than from any effect of rising income on the sensitivity of vehicle use to improving fuel economy; i.e., on the fuel economy rebound effect itself.

for Clunkers” program, which offered sizeable financial incentives to do so. Under the program, households that retired older vehicles with fuel economy levels of 18 miles per gallon (MPG) or less were eligible for cash incentives ranging from \$3,500-4,000, while those retiring vehicles with higher fuel economy were ineligible for such rebates. The authors examined the fuel economy, other features, and subsequent use of new vehicles that Texas households purchased to replace older models that narrowly qualified for the program’s financial incentives (because their fuel economy was only slightly below the 18 MPG threshold). They then compared these to the fuel economy, features, and use of new vehicles that demographically similar households bought to replace older models whose slightly higher fuel economy – 19 MPG or above – made them barely *ineligible* for the program.

The authors reported that the higher fuel economy of new models that eligible households purchased in response to the generous financial incentives offered under the “Cash for Clunkers” program did not prompt their buyers to use them more than the older, low-MPG vehicles they replaced. They attributed this apparent absence of a fuel economy rebound effect – which they described as an “attribute-adjusted” measure of its magnitude – to the fact that eligible households chose to buy less expensive, smaller, and lower-performing models to replace those they retired. Because these replacements offered lower-quality transportation service, their buyers did not drive them more than the vehicles they replaced.

The applicability of this result to this analysis is doubtful, because previous regulatory analyses have stressed that manufacturers could achieve required improvements in fuel economy without compromising the performance, carrying and towing capacity, comfort, or safety of cars and light trucks from recent model years.⁴⁵⁵ If this argument was correct, then reducing future standards from their previously-adopted levels should not lead to changes in new vehicles’ other features that offset the reduction in their use stemming from lower fuel economy.

De Borger et al. (2016) analyzed the response of vehicle use to changes in fuel economy among a sample of nearly 350,000 Danish households owning a single vehicle, of which almost one-third replaced it with a different model sometime during the period from 2001 to 2011. By comparing changes in households’ driving from the early years of this period to its later years among those who replaced their vehicles during the intervening period to changes in driving among households who kept their original vehicles, the authors attempted to isolate the effect of changes in fuel economy on vehicle use from those of other factors. They measured the rebound effect as the change in households’ vehicle use in response to differences in the fuel economy between vehicles they owned previously and new models they purchased to replace them, over and above any change in vehicle use among households who did not buy new cars (and thus saw no change in fuel economy).

⁴⁵⁵ As discussed previously, this does not mean attributes of future cars and light trucks will be identical to those manufacturers could have offered if lower standards had remained in effect. Instead, features other than fuel economy could be maintained at levels offered in recent model years.

These authors' data enabled them to control for the effects of changes over time in household characteristics and vehicle features other than fuel economy that were likely to have contributed to observed changes in vehicle use. They also employed complex statistical methods to account for the fact that some households replacing their vehicles may have done so in anticipation of changes in their driving demands (rather than the reverse), as well as for the possibility that some households who replaced their cars may have done so because their driving behavior was more sensitive to fuel prices than other households. Their estimates ranged from 8-10%, varying only minimally among alternative model specifications and statistical estimation procedures, or in response to whether their sample was restricted to households that replaced their vehicles or also included households that kept their original vehicles throughout the period.⁴⁵⁶ Finally, De Borger *et al.* found no evidence that the rebound effect is smaller among lower-income households than among their higher-income counterparts.

Most recently, Stapleton *et al.* (2016) and Stapleton *et al.* (2017) analyzed long-term (1970-2011) trends in vehicle use in Great Britain, arriving at varying conclusions about the magnitude of the fuel economy rebound effect there. The earlier study employs time-series econometric analysis of alternative measures of light-duty vehicle use (vehicle- and passenger-kilometers per person, per adult, and per licensed driver), and their relationship to retail fuel prices, vehicles' average fuel efficiency, and fuel cost per unit of distance driven (the product of fuel price and fuel efficiency). While their analysis controls for changes in income levels over time, it is not clear whether it also controls for other factors that might also affect vehicle use and passenger travel. After experimenting with alternative model specifications, statistical estimation procedures, and diagnostic checks on their results, the authors conclude that there is little evidence of a fuel efficiency rebound effect *per se*.⁴⁵⁷ However, they estimate its magnitude at 14-23% when using fuel cost per mile driven, which supplements the limited variation in fuel efficiency in their data with variation in fuel prices to assist in identifying the former's effect on vehicle use.⁴⁵⁸

The more recently-published study by Stapleton *et al.* (2017) uses similar data and econometric methods, but adds controls for the increasing urbanization, driver licensing, and use of electronic information and communications technology in Great Britain over the time period they analyze (extended from the previous study to include 2012). Measuring vehicle use by annual kilometers driven per adult and measuring the effect of improvements over time in fuel efficiency indirectly

⁴⁵⁶ This latter result suggests that their estimates were not biased by any tendency for households whose demographic characteristics, economic circumstances, or driving demands changed over the period in ways that prompted them to replace their vehicles with models offering different fuel economy.

⁴⁵⁷ It is important to note that this does not represent an estimate that the magnitude of the fuel efficiency or fuel economy rebound effect is zero. Instead, it simply means that the authors are unable to identify a (statistically) significant effect of fuel efficiency on vehicle use or passenger travel in the data they analyze.

⁴⁵⁸ Figure 4, p. 321 of Stapleton *et al.* (2016) shows historical variation in fuel prices, fuel efficiency, and fuel cost per kilometer driven in Great Britain over the time period the authors study. Tables 9 and 10, p. 323 summarize their estimates of the rebound effect using fuel cost per kilometer driven.

through their effect on fuel cost per kilometer, this newer analysis finds rebound effects of 22-30% using slightly different model specifications and statistical estimation procedures. Some of the model variations the study tests also suggest that the rebound effect appears to be increasing over time, and may have reached values well above 30% by the end of the period studied. However, the authors report that they were again unable to identify any significant effect of improvements over time in fuel efficiency itself on vehicle use.⁴⁵⁹

The apparently conflicting results reported in these two studies may indicate that vehicle use responds differently to changes in fuel prices and fuel efficiency, and perhaps not significantly to the latter. However, they could also arise because of their failure to control for the possibility that drivers' anticipated use of the vehicles they purchase influences the fuel economy of the models they choose, or because the limited variation in fuel efficiency measured at the national average level makes it difficult to detect its effect on vehicle use. Finally, they could also arise if fuel efficiency is correlated with other attributes of vehicles in ways that make more fuel-efficient models otherwise less desirable to drive, as West *et al.* (2015) concluded. However, these authors' inability to identify an effect of fuel efficiency on vehicle use does not represent an estimate that the magnitude of the rebound effect associated with improving fuel efficiency is actually zero; instead, it simply means that such an effect cannot be detected using their data and analytic approach.

7.7.7 Selecting a Rebound Effect for this Analysis

On the basis of all of the evidence summarized here, the analysis presented today uses a fuel economy rebound effect of 20%. This is a departure from the 10% value used in previous regulatory analyses of CAFE and GHG standards for MYs 2012-2016 and MYs 2017-2025, and represents a return to the value of the rebound effect originally employed in NHTSA's regulatory analysis for MY 2005-07 and MY 2008-2011 CAFE standards. There are several reasons that the estimate of the fuel economy rebound effect is being increased for this analysis. Most important, a 20% value better reflects the universe of research on the magnitude of the rebound effect, as Table 7-3 and Table 7-4 indicated.

In contrast, the previous 10% estimate was based almost exclusively on informed by the finding of the 2007 study by Small and Van Dender that the rebound effect had been declining over time in response to drivers' rising incomes, and on extending that decline through future years using an assumption of steady income growth. As indicated above, however, subsequent extensions of Small and Van Dender's original research have produced larger estimates of the rebound effect for recent years - while their original study estimated the rebound effect at 11% for 1997-2001, the 2010 update by Hymel, Small, and Van Dender reported a value of 13% for 2004, and Hymel and Small's 2015 update estimated the rebound effect at 18% for 2003-09. Further, the issues

Commented [A26]: Suggest revising the text from “was based almost exclusively on” to “was informed by”, since the 10% estimate was also informed by Greene and previous NHTSA forecasts (see NHTSA 2011 FRIA: “other recent research - particularly that conducted by Small and Van Dender and by Greene - reports persuasive evidence that the magnitude of the rebound effect is likely to be declining over time, and the forecasts developed by NHTSA and reported here also suggest that this is likely to be the case.”)

⁴⁵⁹ See Stapleton et al. (2017), p. 220.

*** EO 12866 Review – Draft – Do Not Cite, Quote or Release During Review ***

with state-level measures of vehicle use, fuel consumption, and fuel economy identified previously raise some doubt about the reliability of these studies' estimates of the rebound effect.

At the same time, the continued increases in income that were anticipated to produce a continued decline in the rebound effect have not materialized, and are not anticipated to do so over the foreseeable future. In contrast to the 2-3% annual growth assumed by the agencies when developing earlier forecasts of the future rebound effect, the income measure (real personal income per capita) used in these analyses has grown approximately 1% annually over the past two decades, and is projected to grow at approximately 1.5% for the next 30 years. Moreover, the recent study by DeBorger et al. (2016) separated the effects of variation in household income on the sensitivity of vehicle use to fuel prices and fuel economy, and found that the decline in the rebound effect with rising income reported in Small & Van Dender (2007) and subsequent research resulted entirely from a reduction in drivers' sensitivity to fuel *prices* as their incomes rose, rather than from any effect of rising income on the sensitivity of vehicle use to fuel economy itself. This latter measure – which DeBorger *et al.* found had not changed significantly as incomes rose over time – is the correct measure of the fuel economy rebound effect, so their analysis calls into question its assumed sensitivity to income.

Some studies of households' use of individual vehicles also find that the fuel economy rebound effect increases with the number of vehicles they own. Because vehicle ownership is strongly associated with household income, this common finding suggests that the rebound effect is unlikely to decline with rising incomes as the agencies had previously assumed. In addition, buyers of new cars and light trucks belong disproportionately to higher-income households that already own multiple vehicles, which further suggests that the higher values of the rebound effect estimated by many studies for such households are more relevant for analyzing use of newly-purchased cars and light trucks.

Finally, research on the rebound effect conducted since the agencies' original 2008 review of evidence almost universally reports estimates in the 10-40% (and larger) range, as Table 7-4 shows. Thus the 20% rebound effect used in this analysis more accurately represents the findings from both studies considered in the 2008 research review and more recent analyses.

7.8 Effects of Revising CAFE and GHG Standards on Ownership and Use of Older Cars and Light Trucks

The effects of the proposed action on the fuel economy, prices, and other features of new cars and light trucks will affect not only their sales, but also the demand for used vehicles. This is because used cars and light trucks – especially those produced during recent model years – are a close substitute for new models, so changes in prices and other attributes of new cars and light trucks will affect demand for used models. In turn, this will affect their market value and selling prices, as well as the number that remain in service and how much they are driven. Changes in the number of used vehicles in service and how much they are driven have important

consequences for fuel consumption, emissions of GHGs and criteria air pollutants, and safety, so it is important that this effect on the existing vehicle fleet is considered. This section traces each of those effects in detail, and explains how the likely magnitude of this effect is estimated for the proposed action.

7.8.1 Anticipating the Rule’s Effects on Prices and Retirement Rates of Used Cars and Light Trucks

Figure 7-16 illustrates the likely effect of proposed changes in CAFE and CO₂ standards on the market for used cars and light trucks. Some households and businesses will respond to the lower prices and changes in features of new cars and light trucks resulting from the agencies’ proposed action by purchasing new models, because a new vehicle will become a more attractive alternative to those they now own. This will reduce demand for used cars and light trucks, shifting the demand curve for used vehicles in the figure from its original position at D_0 inward to D_1 . The supply curve for used vehicles is likely to be “inelastic” – that is, relatively insensitive – to changes in their price, but it is not fixed, because their supply can be changed by accelerating or slowing the rate at which they are normally retired from service (or “scrapped”).

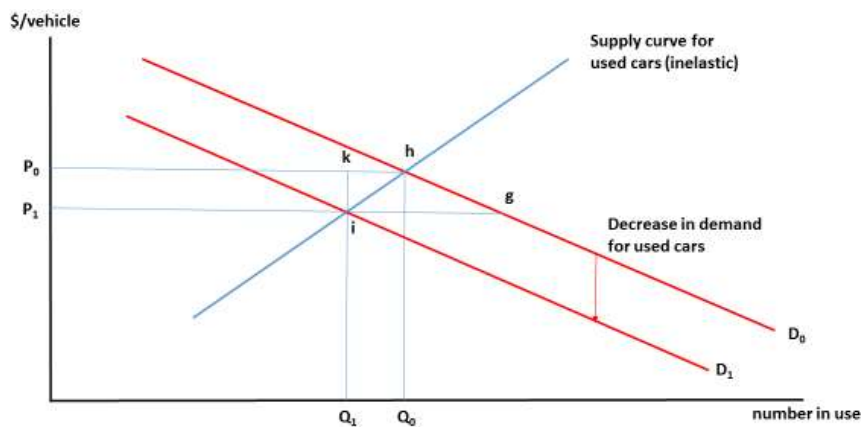

FIGURE 7-16 - EFFECT OF PROPOSED ACTION ON MARKET FOR USED CARS AND LIGHT TRUCKS

The interaction of reduced demand for used car and light truck models and their inelastic supply will cause their average price to fall; in Figure 7-16, their price declines from P_0 to P_1 . Some owners will retire used vehicles when their market value drops below the cost of maintenance and repairs necessary to keep them in service longer, so the decline in their price (which measures their market value) will reduce the number in service, shown in the figure as a reduction from Q_0 to Q_1 . Because the market for used vehicles is very active – nearly 250 million light-duty vehicles were in use throughout the U.S. in 2016, and there were almost 40 million sales of used cars and light trucks – these changes are likely to occur fairly rapidly.

The effects of this process on prices and the number of vehicles in use are likely to vary significantly among those of different ages and accumulated mileage (a measure of their cumulative lifetime use). Figure 7-17 through -Figure 7-18 illustrate the likely differences. As Figure 7-17 and Figure 7-17 show, the supply of both nearly-new vehicles (say, those less than five years old) and very old vehicles (more than 15 years) is likely to be very unresponsive to changes in their price. In the case of nearly-new vehicles, this is because only those few that are driven extremely intensively would have been likely candidates for retirement at that age, so variation in their price is likely to lead to only a minimal change in the number of them kept in use.

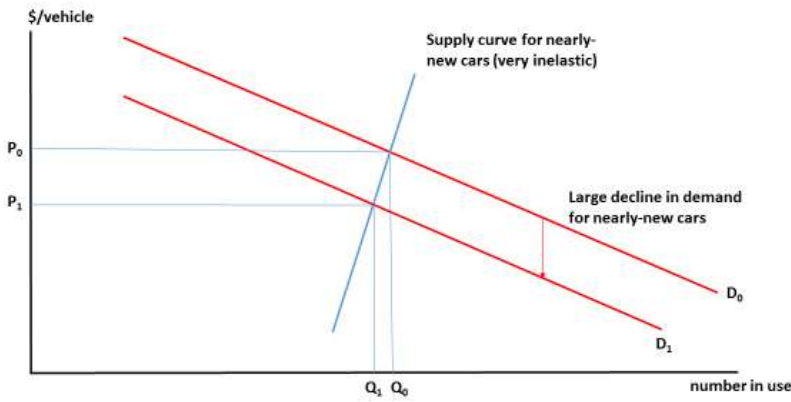

FIGURE 7-17 - EFFECT ON MARKET FOR “NEARLY NEW” CARS AND LIGHT TRUCKS

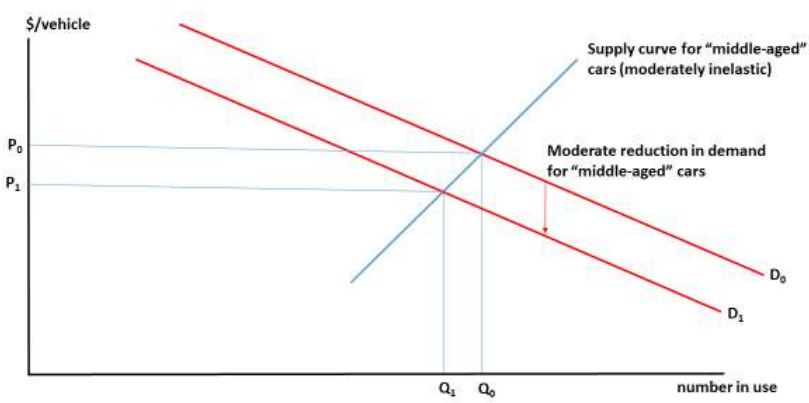

FIGURE 7-18 - EFFECT ON MARKET FOR “MIDDLE-AGE” CARS AND LIGHT TRUCKS

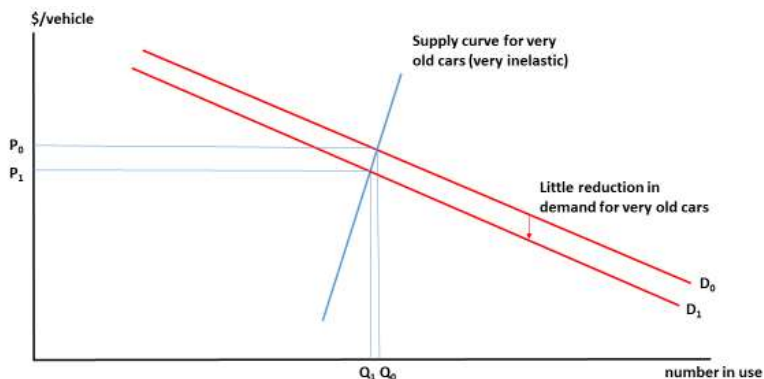

FIGURE 7-19 - EFFECT ON MARKET FOR “VERY OLD” CARS AND LIGHT TRUCKS

For very old models, mechanical failures due to accumulated use become a more frequent cause of retirements, and the maintenance and repairs necessary to keep them in service become progressively costlier. Thus variation in their market value is unlikely to lead to major changes in the number of owners that elect to incur those costs and keep them in service. In contrast Figure 7-17 shows that the supply of “middle-age” used vehicles (those from roughly 5 to about 15 years old) is likely to be more responsive to changes in their market value, because they typically become costlier to maintain and repair, so changes in their market value can affect the willingness of a significant number of owners to incur the costs necessary to keep them in working order.

Shifts in demand for used cars and light trucks of different ages in response to changes in the prices and attributes of new models are likely to mirror how closely they substitute for their new counterparts. Nearly-new vehicles offer the closest substitutes for new ones, so their demand is likely to be most responsive to changes in prices and other characteristics of new ones, while the outdated features and accumulated usage of older vehicles make them less satisfactory substitutes. Thus Figure 7-17 shows that demand for nearly-new used cars and light trucks is likely to decline significantly when prices for new models fall (and their fuel economy and other attributes change in the ways anticipated to result from this action), while Figure 7-17 and Figure 7-18 and show that changes in the demand for older vehicles are likely to be progressively smaller.

7.8.2 Aggregate Effects on the Composition and Use of the Used Vehicle Fleet

The combined effects of these complex interactions are likely to include only modest reductions from the baseline scenario in the numbers of nearly-new (1-5 year-old) and very old (15 or more years) vehicles that are in use as a result of the agencies’ proposed action, and a slightly larger reduction in the number of middle-age cars and light trucks. These reductions will continue through all future model years for which this action will reduce the stringency of CAFE and CO₂

emission standards that would otherwise be in effect under the baseline scenario. In effect, this process will accelerate the “turnover” of the nation’s light-duty vehicle fleet from its pace under the baseline, by increasing the rate at which new cars and light trucks produced during future model years enter the fleet to replace the growing number of used vehicles that are retired from service each year. Because the fleet of used vehicles is so large in relation to the number of new cars and light trucks sold in any model year and the number of older models that are retired, however, all of these effects are likely to be quite small in their *absolute* size.

Coupled with the increase in sales of new cars and light trucks anticipated to result from this proposed action, the resulting decline in the number of used models in service will also in effect “transfer” some of the travel that would have been done in used vehicles under the baseline scenario to newly-purchased models. As discussed in various places throughout this regulatory analysis, this shift of light-duty vehicle travel toward newer cars and light trucks will have important implications for fuel consumption, the environmental and energy security externalities associated with petroleum consumption and refining, and transportation safety.

Figure 7-20 illustrates the effect of changes in the composition of the car and light truck fleet by their original model year and current age on fuel production and use, the externalities they create, and travelers’ safety. The subsequent section describes in detail how the magnitude these effects are estimated.

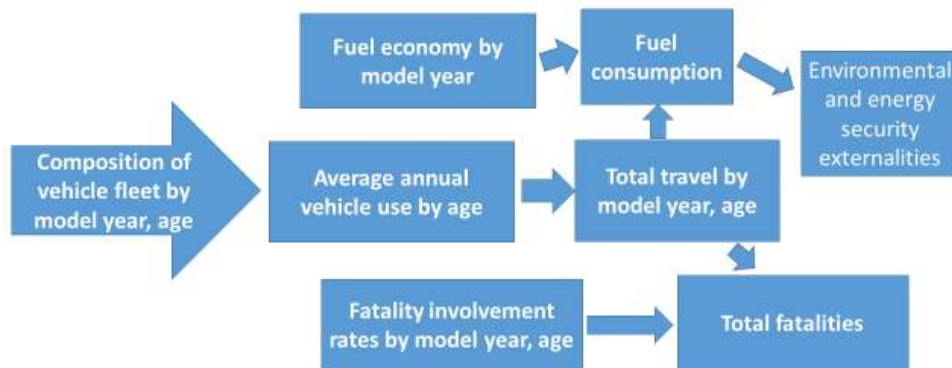

FIGURE 7-20 - EFFECT OF CHANGES IN FLEET COMPOSITION ON FUEL USE, EXTERNALITIES, AND SAFETY

7.8.3 Estimating the Proposed Rule’s Effect on Used Cars and Light Trucks

As noted, the increase in the price of new vehicles will result in increased demand for used vehicles as substitutes, extending the expected age and lifetime vehicle miles travelled of less efficient, and generally, less safe vehicles. The additional usage of older vehicles will result in fewer gallons saved and more total on road fatalities under more stringent regulatory alternatives.

*** EO 12866 Review – Draft – Do Not Cite, Quote or Release During Review ***

For more on the topic of safety, the relative safety of specific model year vehicles is discussed in Chapter 10.4.4 of this RIA. Both the erosion of fuel savings and the increase in incremental fatalities will decrease the societal net benefits of increasing new vehicle fuel economy standards.

Previous estimates of vehicle scrappage used in prior CAFE and GHG rulemaking did not incorporate a quantitative response to changes in new vehicle prices, but recent research has continued to illustrate that the consequences of this likely effect could rival the rebound effect in importance.⁴⁶⁰ For this reason, an econometric survival model that captures the effect of increasing the price of new vehicles on the survival rate of used vehicles was developed for this analysis. An overview of the literature on vehicle scrappage rates is provided and discussed below. A brief explanation of why unique models were developed for this analysis, and the data sources and econometric estimations used to do so, follows. The discussion concludes with a summary of the results, a description of how those results are used in the CAFE model, and finally, how the updated schedules compare with the previous static scrappage schedules.

7.8.4 Previous Research on Vehicle Scrappage Behavior

7.8.4.1 Fuel Economy Standards and Vehicle Scrappage

The effects of differentiated regulation⁴⁶¹ in the context of fuel economy (particularly, emission standards only affecting new vehicles) was discussed in detail in Gruenspecht (1981)⁴⁶² and (1982),⁴⁶³ and has since been coined the ‘Gruenspecht effect.’ Gruenspecht recognized because fuel economy standards affect only new vehicles, any increase in price (net of the portion of reduced fuel savings valued by consumers) will increase the expected life of used vehicles and reduce the number of new vehicles entering the fleet. In this way, increased fuel economy standards slow the turnover of the fleet and the entrance of any regulated attributes tied only to new vehicles. Although Gruenspecht acknowledges that a structural model which allows new vehicle prices to affect used vehicle scrappage only through their effect on used vehicle prices would be preferable, the data available on used vehicle prices was (and still is) limited. Instead he tested his hypothesis in his 1981 dissertation using new vehicle price and other determinants of used car prices as a reduced form to approximate used car scrappage in response to increasing fuel economy standards.

⁴⁶⁰ Jacobsen, M. R. & Van Benthem, A. A. “Vehicle Scrappage and Gasoline Policy.” *American Economic Review*, vol. 105, no. 3, 2015, pp. 1312–1338., doi:10.1257/aer.20130935.

⁴⁶¹ Differentiated regulations are regulations which affect segments of the market differently; here it references the fact that emission and fuel economy standards have largely only applied to new and not used vehicles.

⁴⁶² Gruenspecht, H. K. “Differentiated Social Regulation in Theory and Practice.” Yale University, 1981.econpapers.repec.org/RePEc:aea:aecrev:v:72:y:1982:i:2:p:328-31.

⁴⁶³ Gruenspecht, H. K. “Differentiated Regulation - The Case of Auto Emissions Standards.” *American Economic Review*, American Economic Association, 1 Jan. 1982, econpapers.repec.org/RePEc:aea:aecrev:v:72:y:1982:i:2:p:328-31.

Greenspan and Cohen’s work offers additional foundations from which to think about vehicle stock and scrappage.⁴⁶⁴ Their work identifies two types of scrappage - engineering scrappage and cyclical scrappage. Engineering scrappage represents the physical wear on vehicles which results in their being scrapped. Cyclical scrappage represents the effects of macroeconomic conditions on the relative value of new and used vehicles—under economic growth the demand for new vehicles increases and the value of used vehicles declines, resulting in increased scrappage. In addition to allowing new vehicle prices to affect cyclical vehicle scrappage à la the Gruenspecht effect, Greenspan & Cohen also note that engineering scrappage seems to increase where EPA emission standards also increase; as more costs goes towards compliance technologies, it becomes more expensive to maintain and repair more complicated parts, and scrappage increases. In this way, Greenspan and Cohen identify two ways that fuel economy standards could affect vehicle scrappage - 1) through increasing new vehicle prices, thereby increasing used vehicle prices, and finally, reducing on-road vehicle scrappage, and 2) by shifting resources towards fuel-saving technologies — potentially reducing the durability of new vehicles by making them more complex.

7.8.4.2 Aggregate vs. Atomic Data Sources in the Literature

One important distinction between the literatures on vehicles scrappage is between those that use atomic vehicle data, data following specific individual vehicles, and those that use some level of aggregated data, data that counts the total number of vehicles of a given type. The decision to scrap a vehicle is an atomic one—that is, made on an individual vehicle basis. The decision relates to the cost of maintaining a vehicle, and the value of the vehicle both on the used car market, and as scrap metal. Generally, a used car owner will decide to scrap a vehicle where the value of the vehicle is less than the value of the vehicle as scrap metal, plus the cost to maintain or repair the vehicle. In other words, the owner gets more value from scrapping the vehicle than continuing to drive it, or from selling it.

Recent work is able to model scrappage at the level of individual vehicles because of the availability of a large database of used vehicle transactions. Following previous research by other authors, including Busse, Knittel & Zettelmeyer (2013), Sallee, West & Fan (2010), Alcott & Wozny (2013), Li, Timmins, & von Haefen (2009) consider the impact of changes in gasoline prices on used vehicle values and scrappage rates.^{465, 466, 467, 468} They find increases in gasoline

⁴⁶⁴ Greenspan, A. & Cohen, D. “Motor Vehicle Stocks, Scrappage, and Sales.” *Review of Economics and Statistics*, vol. 81, no. 3, 1999, pp. 369–383., doi:10.1162/003465399558300.

⁴⁶⁵ Busse, M. R., et al. “Are Consumers Myopic? Evidence from New and Used Car Purchases.” *American Economic Review*, vol. 103, no. 1, 2013, pp. 220–256., doi:10.1257/aer.103.1.220.

⁴⁶⁶ Sallee, J. M., et al. “Do Consumers Recognize the Value of Fuel Economy? Evidence from Used Car Prices and Gasoline Price Fluctuations.” *Journal of Public Economics*, vol. 135, 2016, pp. 61–73., doi:10.1016/j.jpubeco.2016.01.003.

⁴⁶⁷ Alcott, H. & Wozny, N. “Gasoline Prices, Fuel Economy, and the Energy Paradox.” *Review of Economics and Statistics*, vol. 96, no. 5, 2014, pp. 779–795., doi:10.1162/rest_a_00419.

⁴⁶⁸ Li, S., et al. “How Do Gasoline Prices Affect Fleet Fuel Economy?” *American Economic Journal - Economic Policy*, vol. 1, no. 2, 2009, pp. 113–137., doi:10.1257/pol.1.2.113.

prices reduce scrappage rates of the most fuel efficient vehicles, and increase scrappage rates for the least fuel efficient vehicles. This has important implications for the validity of the average fuel economy values linked to model years, and assumed to be constant over the life of that model year fleet within this study. Future iterations of this study could further investigate the relationship between fuel economy, vehicle usage, and scrappage, as noted in other places in this discussion.

While the decision to scrap a vehicle is made atomically, the data available for this analysis on scrappage rates and variables that influence these scrappage rates are aggregate measures. This influences the best available methods to measure the impacts of new vehicle prices on existing vehicle scrappage. The result is that this study models aggregate trends in vehicle scrappage, and not the atomic decisions that make up these trends. Many other works within the literature use the same data source and general scrappage construct, such as - Walker (1968), Parks (1977), Greene & Chen (1981), Gruenspecht (1981), Gruenspecht (1982), Feeney & Cardebring (1988), Greenspan & Cohen (1996), Jacobsen & van Bentham (2015), and Bento, Roth & Zhuo (2016); all use the same aggregate vehicle registration data as the source to compute vehicle scrappage.^{469, 470, 471, 472, 473, 474, 475, 476, 477}

Walker (1968) and Bento, Roth & Zhuo (2016) use aggregate data to directly compute the elasticity of scrappage from measures of used vehicle prices.^{478, 479} Walker uses the ratio of used vehicle Consumer Price Index (CPI) to repair and maintenance CPI. Bento, Roth & Zhuo use used vehicle prices directly. While the direct measurement of the elasticity of scrappage is preferable in a theoretical sense, the CAFE model does not predict future values of used vehicles,

⁴⁶⁹ Walker, F. V. "Determinants of Auto Scrappage." *The Review of Economics and Statistics*, vol. 50, no. 4, Nov. 1968, pp. 503–506.

⁴⁷⁰ Parks, R. W. "Determinants of Scrapping Rates for Postwar Vintage Automobiles." *Econometrica*, vol. 45, no. 5, 1977, p. 1099., doi:10.2307/1914061.

⁴⁷¹ Greene, D. L., & C.k.eric Chen. "Scrappage and Survival Rates of Passenger Cars and Light Trucks in the U.S., 1966-1977." *Transportation Research Part A - General*, vol. 15, no. 5, 1981, pp. 383–389., doi:10.1016/0191-2607(81)90144-8.

⁴⁷² Gruenspecht, H. K. "Differentiated Social Regulation in Theory and Practice." Yale University, 1981.

⁴⁷³ Gruenspecht, H. K. "Differentiated Regulation - The Case of Auto Emissions Standards." *American Economic Review*, American Economic Association, 1 Jan. 1982, econpapers.repec.org/RePEc:aea:aecrev:v:72:y:1982:i:2:p:328-31.

⁴⁷⁴ Feeney, B. P., and Cardebring, P. "Car Longevity in Sweden - A Revised Estimate." *Transportation Research Part A - General*, vol. 22, no. 6, 1988, pp. 455–465., doi:10.1016/0191-2607(88)90049-0.

⁴⁷⁵ Greenspan, A.& Cohen, D. "Motor Vehicle Stocks, Scrappage, and Sales." *Review of Economics and Statistics*, vol. 81, no. 3, 1999, pp. 369–383., doi:10.1162/003465399558300.

⁴⁷⁶ Jacobsen, M. R. & Van Bentham. A. A. "Vehicle Scrappage and Gasoline Policy." *American Economic Review*, vol. 105, no. 3, 2015, pp. 1312–1338., doi:10.1257/aer.20130935.

⁴⁷⁷ Bento, A, et al. "Vehicle Lifetime Trends and Scrappage Behavior in the U.S. Used Car Market." *The Energy Journal*, vol. 39, no. 1, Jan. 2018, doi:10.5547/01956574.39.1.aben.

⁴⁷⁸ Walker, F. V. "Determinants of Auto Scrappage." *The Review of Economics and Statistics*, vol. 50, no. 4, Nov. 1968, pp. 503–506.

⁴⁷⁹ Bento, A, et al. "Vehicle Lifetime Trends and Scrappage Behavior in the U.S. Used Car Market." *The Energy Journal*, vol. 39, no. 1, Jan. 2018, doi:10.5547/01956574.39.1.aben.

only future prices of new vehicles. For this reason, any model compatible with the current CAFE model must estimate a reduced form similar to Parks (1977), Gruenspecht (1981), Greenspan & Cohen (1996), who use some form of new vehicle prices or the ratio of new vehicle prices to maintenance and repair prices to impute some measure of the effect of new vehicle prices on vehicle scrappage.^{480, 481, 482}

7.8.4.3 Historical Trends in Vehicle Durability

Waker (1968), Parks (1977), Feeney & Cardebring (1988), Hamilton & Macauley (1999), and Bento, Ruth & Zhuo (2016) all note vehicles change in durability over time.^{483, 484, 485, 486, 487} Walker simply notes a significant distinction in expected vehicle lifetimes pre- and post- World War I. Park discusses a ‘durability factor’ set by the producer for each year, so that different vintages and makes will have varying expected lifecycles. Feeney and Cardebring show that durability of vehicles appears to have generally increased over time both in the U.S. and Swedish fleets using registration data from each country. They also note that the changes in median lifetime between the Swedish and U.S. fleet track well, with a 1.5-year lag in the U.S. fleet. This lag is likely due to variation in how the data is collected—the Swedish vehicle registry requires a title to de-register a vehicle, and therefore gets immediate responses, where the U.S. vehicle registry requires re-registration, which creates a lag in reporting that is discussed further in the data section below.

Hamilton & Macauley (1999) argue for a clear distinction between embodied versus disembodied impacts on vehicle longevity.⁴⁸⁸ They define embodied impacts as inherent durability similar to Park’s producer supplied ‘durability factor’ and Greenspan’s ‘engineering scrappage’ and disembodied effects those which are environmental, not unlike Greenspan and

⁴⁸⁰ Parks, R. W. “Determinants of Scrapping Rates for Postwar Vintage Automobiles.” *Econometrica*, vol. 45, no. 5, 1977, p. 1099., doi:10.2307/1914061.

⁴⁸¹ Gruenspecht, H. K. “Differentiated Social Regulation in Theory and Practice.” Yale University, 1981.

⁴⁸² Greenspan, A & Cohen, D. “Motor Vehicle Stocks, Scrappage, and Sales.” *Review of Economics and Statistics*, vol. 81, no. 3, 1999, pp. 369–383., doi:10.1162/003465399558300.

⁴⁸³ Walker, F. V. “Determinants of Auto Scrappage.” *The Review of Economics and Statistics*, vol. 50, no. 4, Nov. 1968, pp. 503–506.

⁴⁸⁴ Parks, R. W. “Determinants of Scrapping Rates for Postwar Vintage Automobiles.” *Econometrica*, vol. 45, no. 5, 1977, p. 1099., doi:10.2307/1914061.

⁴⁸⁵ Feeney, B. P., & Cardebring, P. “Car Longevity in Sweden - A Revised Estimate.” *Transportation Research Part A - General*, vol. 22, no. 6, 1988, pp. 455–465., doi:10.1016/0191-2607(88)90049-0.

⁴⁸⁶ Hamilton, B. W. & Macauley, M. K. “Hereditry or Environment - Why Is Automobile Longevity Increasing?” *The Journal of Industrial Economics*, vol. 47, no. 3, 2003, pp. 251–261., doi:10.1111/1467-6451.00100.

⁴⁸⁷ Bento, A., et al. “Vehicle Lifetime Trends and Scrappage Behavior in the U.S. Used Car Market.” *The Energy Journal*, vol. 39, no. 1, Jan. 2018, doi:10.5547/01956574.39.1.aben.

⁴⁸⁸ Hamilton, B. W. & Macauley, M. K. “Hereditry or Environment - Why Is Automobile Longevity Increasing?” *The Journal of Industrial Economics*, vol. 47, no. 3, 2003, pp. 251–261., doi:10.1111/1467-6451.00100.

Cohen’s ‘cyclical scrappage.’^{489, 490} They use calendar year and vintage dummy variables to isolate the effects — concluding that the environmental factors are greater than any pre-defined ‘durability factor.’ Some of their results could be due to some inflexibility of assuming model year coefficients are constant over the life of a vehicle, and also some correlation between the observed life of the later model years of their sample and the ‘stagflation’⁴⁹¹ of the 1970’s. Bento, Ruth & Zhuo (2016) find that the average vehicle lifetime has increased 27% from 1969 to 2014 by sub-setting their data into three model year cohorts.⁴⁹² To implement these findings in the scrappage model incorporated into the CAFE model, this study takes pains to estimate the effect of durability changes in such a way that the historical durability trend can be projected into the future; for this reason, a continuous ‘durability’ factor as a function of model year vintage is included.

7.8.5 Use of the Gruenspecht Effect to Analyze Related Policies

This is not the first estimation of the ‘Gruenspecht Effect’ for policy considerations. In their Technical Support Document (TSD) for the 2004 proposal to reduce greenhouse gas emissions from motor vehicles, California Air Resources Board (CARB) outlines how they utilized the CARBITS vehicle transaction choice model in an attempt to capture the effect of increasing new vehicle prices on vehicle replacement rates.⁴⁹³ They consider data from the National Personal Transportation Survey (NPTS) as a source of revealed preferences and a University of California (UC) study as a source of stated preferences for the purchase and sale of household fleets under different prices and attributes (including fuel economy) of new vehicles.

The transaction choice model represents the addition and deletion of a vehicle from a household fleet within a short period of time as a “replacement” of a vehicle, rather than as two separate actions. Their final data set consists of 790 vehicle replacements, 292 additions, and 213 deletions; they do not include the deletions, but assume any vehicle more than 19 years old that is sold is scrapped. This allows them to capture a slowing of vehicle replacement under higher new vehicle prices, but because their model does not include deletions, does not explicitly model vehicle scrappage, but assumes all vehicles aged 20 and older are scrapped rather than resold. They calibrate the model so the overall fleet size is benchmarked to Emissions Factors (EMFAC) fleet predictions for the starting year; the simulation then produces estimates that match the EMFAC predictions without further calibration.

⁴⁸⁹ Parks, R. W. “Determinants of Scrapping Rates for Postwar Vintage Automobiles.” *Econometrica*, vol. 45, no. 5, 1977, p. 1099., doi:10.2307/1914061.

⁴⁹⁰ Greenspan, A., & Cohen, D. “Motor Vehicle Stocks, Scrappage, and Sales.” *Review of Economics and Statistics*, vol. 81, no. 3, 1999, pp. 369–383., doi:10.1162/003465399558300.

⁴⁹¹ Continued high inflation combined with high unemployment and slow economic growth.

⁴⁹² Bento, A., et al. “Vehicle Lifetime Trends and Scrappage Behavior in the U.S. Used Car Market.” *The Energy Journal*, vol. 39, no. 1, Jan. 2018, doi:10.5547/01956574.39.1.aben.

⁴⁹³ California Air Resources Board. “Technical Support Document for Staff Proposal Regarding Reduction of Greenhouse Gas Emissions from Motor Vehicles.” 6 Aug. 2004. www.arb.ca.gov/cc/ccms/documents/drafts/support_other.pdf.

The CARB study captures the effect on new vehicle prices on the fleet replacement rates, and offers some precedence for including some estimate of the Gruenspecht Effect. One important thing to note is that because vehicles that exited the fleet without replacement were excluded, the effect of new vehicle prices on scrappage rates where the scrapped vehicle is not replaced is not available. Because new and used vehicles are substitutes, it is expected that used vehicle prices will increase with new vehicle prices. Because higher used vehicle prices will lower the number of vehicles whose cost of maintenance is higher than their value, it is expected that not only will replacements of used vehicles slow, but also, that some vehicles that would have been scrapped without replacement under lower new vehicle prices will now remain on the road because their value will have increased. Aggregate measures of the Gruenspecht effect in this analysis will include changes to scrappage rates both from slower replacement rates, and slower non-replacement scrappage rates.

7.8.6 Car Allowance Rebate System

On June 14, 2009, former President Barack Obama signed the Car Allowance Rebate System (CARS), with the intent to jumpstart the economy through automobile sales during the Great Recession, and also to accelerate the retirement of older, less fuel efficient and less safe vehicles. The program offered a \$3,500 to \$4,500 rebate for vehicles traded-in for the purchase of a new vehicle. A vehicle must have met several criteria to be eligible for the program - first, the vehicle must be drivable and continuously registered and insured by the same owner for at least one year; second, it must be newer than 25 years; third, the MSRP must be smaller than \$45,000; and finally, the new vehicle purchased must be some fixed miles per gallon more efficient than the trade-in vehicle. The fuel economy improvement requirements by body style for specific rebates are presented in Table 7-5.

TABLE 7-5 - CARS FUEL ECONOMY IMPROVEMENT REQUIRED FOR REBATES BY REGULATORY CLASS

	\$3,500 Rebate Eligibility	\$4,500 Rebate Eligibility
Passenger Car	4-9 MPG Improvement	10+ MPG Improvement
Light Truck	2-5 MPG Improvement	5+ MPG Improvement

The program was originally budgeted for \$1 billion dollars and to end on November 1, 2009, but it only ran from July 27 to August 25, 2009 and \$2.85 billion was spent on the 678,359 eligible transactions. To ensure that the vehicles did not remain on the road, they were scrapped at the point of trade-in. While the program traded in more vehicles and at a faster rate than expected,

critics have argued that many of the trade-ins would have happened even if the program were not in place, so that any economic stimulus to the automobile industry during the crisis cannot be attributable to the CARS program. Further, forcing the scrappage of vehicles that could still remain on the road has negative environmental impacts, which potentially outweigh any environmental benefits of the reduced fuel consumption from the accelerated retirement of these less efficient vehicles.

Li, Linn & Spiller (2010) use Canada as a counterfactual example to identify the portion of CARS trade-ins attributable to the policy, i.e., trade-ins that would not have happened anywhere if the program were not in place.⁴⁹⁴ They argue the Canadian market is largely similar to the U.S. market, and note that 13-14% of households purchased a new vehicle one-year pre-recession in both countries. They also note that the economic crisis affected the Canadian economy similarly as it affected the U.S. economy. They do note that Canada offered a small rebate of \$300 to vehicles traded in during January, 2009, but that only 60,000 vehicles were traded in under the program. Making all of these assumptions, Li et al. are able to use a difference-in-difference methodology to isolate the effect of the CARS program on the scrappage of eligible vehicles—they find a significant increase in the scrappage only for eligible U.S. vehicles, suggesting that they have isolated the effect of the policy. They conclude that of the 678,359 trade-ins made under the program, 370,000 of those would not have happened during July and August 2009. They conclude the CARS program reduced gasoline consumption by .9-2.9 billion gallons, at \$.89-\$2.80 per gallon saved.

While the debate over the effectiveness of the program at reducing environmental emissions is not in the purview of this analysis, the evidence from Li, Linn and Spiller is convincing of the importance of including a control for the CARS program during calendar year 2009.⁴⁹⁵ The importance is discussed further in both Section 7.8.7, which provides provide more evidence for the effect of the CARS program, and in Section 7.8.7.9, which describes the controls used for the effect of the program. This ensures that the measurements of other determining factors are not biased by the exceptional scrappage observed in calendar year 2009.

7.8.7 Data - Source, Aggregation and Cleaning

There are several key characteristics important in a scrappage model that both could be implemented within the CAFE model and consider the relevant concerns in the literature. First, the model should consider recent data so as to more closely resemble the future vehicles modeled in the analysis. Second, because the analysis does not explicitly model used vehicle prices, the model must be modified to relate average new vehicle prices and fuel costs directly to scrappage rates for used vehicles, in effect assuming that changes in new vehicle prices will ultimately be reflected in those for used vehicles. Third, the level of aggregation should align either with

⁴⁹⁴ Li, S. et al. "Evaluating Cash-for-Clunkers - Program Effects on Auto Sales and the Environment." *Journal of Environmental Economics and Management*, vol. 65, no. 2, 2013, pp. 175-193., doi:10.1016/j.jeem.2012.07.004.

⁴⁹⁵ Id.

*** EO 12866 Review – Draft – Do Not Cite, Quote or Release During Review ***

NHTSA’s regulatory classes or body style classes that are already implemented in the model. And finally, the model should capture the increases in vehicle durability over time as this is important in the calculation of costs and benefits of future vehicles. Much of the literature met some of these considerations, but no existing work met all of them. For this reason, econometric models were built for vehicle body style classes compatible with their VMT schedules using data from calendar years 1975-2015. The models include a response to new vehicle prices, fuel costs per mile of travel for used and new vehicles, and the increase in vehicle durability over time.

7.8.7.1 Scrappage Data Source - IHS/Polk Registered Vehicle Population Data

NHTSA purchases proprietary data on the registered vehicle population from IHS/Polk for safety analyses. IHS/Polk has annual snapshots of registered vehicles counts beginning in calendar year (CY) 1975 and continuing until calendar year 2015. Notably, the data collection procedure changed in CY 2010, which requires some special consideration (discussed below). The data includes the following regulatory classes as defined by NHTSA - passenger cars, light trucks (classes 1 and 2a), and medium and heavy-duty trucks (classes 2b and 3). Polk separates these vehicles into another classification scheme - cars and trucks. Under their schema, pickups, vans, and SUVs are treated as trucks, and all other body styles are included as cars. In order to build scrappage models to support the model year (MY) 2021-2026 light duty vehicle (LDV) standards, it was important to separate these vehicle types in a way compatible with the existing CAFE model.

7.8.7.2 Choice of Aggregation Level - Body style

There were two compatible choices to aggregate scrappage rates - 1) by regulatory class or 2) by body style. Since for the purposes of this analysis, vans/SUVs are sometimes classified as passenger cars and sometimes as light trucks, and there was no quick way to reclassify some SUVs as passenger cars within the Polk dataset, survival schedules were aggregated by body style. This approach is also preferable because body style specific lifetime VMT schedules are used in the analysis. Vehicles experience increased wear with use; many maintenance and repair events are closely tied to the number of miles on a vehicle. The current version of the CAFE model considers separate lifetime VMT schedules for cars, vans/SUVs, pickups and classes 2b and 3 vehicles. These vehicles are assumed to serve different purposes and as a result are modelled to have different average lifetime VMT patterns. These different uses likely also result in different lifetime scrappage patterns.

Once stratified into body style level buckets, the data can be aggregated into population counts by vintage and age. These counts represent the population of vehicles of a given body style and vintage in a given calendar year. The difference between the counts of a given vintage and vehicle type from one calendar year to the next is assumed to represent the number of vehicles of that vintage and type scrapped in a given year. As noted above, Polk changed their data collection in CY 2009, which further complicates the imputation of annual scrappage.

7.8.7.3 Polk Data Collection Changes

Prior to calendar year 2009, Polk vehicle registration data was collected as a single snapshot on July 1st of every calendar year. All vehicles that are in the registration database at that date are included in the dataset. For these years the majority of vehicles where MY=CY should be in the dataset; only late model year sales will not yet be registered in the fleet (those vehicles sold and registered after July 1st). For calendar years after 2009, Polk changed the timing of the data collection process to October 1st and for calendar years 2010 and later, to December 31st of the calendar year. In addition to changing the timing of the data collection, Polk updated the process to a rolling sample. That is, any vehicle that was on the road at any point in that calendar year will appear in the database, not only vehicles that are currently registered on December 31st of that year.

In order to ensure a consistent data set for the newest calendar years—including newer model years more likely to resemble the model years analyzed in this rulemaking—NHTSA requested Polk build older calendar year snapshots using the same rolling methodology used from CY's 2010-2015. The final dataset includes July 1st snapshots for calendar years 1975-2004, and December 31st rolling snapshots for calendar years 2005-2015. The implications of and the solution to the discontinuity in data collection methodologies is discussed further in the following section.

7.8.7.4 Greenspan and Cohen Correction

One issue with the way the Polk data is collected is that it includes vehicles that were registered in a given calendar year but may have been scrapped sometime during that calendar year. To correct for the scrappage that occurs during a calendar year, a similar correction as that in Greenspan & Cohen (1996) is applied.⁴⁹⁶ It is assumed that the real on-road count of vehicles of a given MY registered in a given CY is best represented by the Polk count of the vehicles of that model year in the succeeding calendar year ($Polk_{CY+1}$). For example, the vehicles scrapped between CY 2000 and CY 2001 will still remain in the Polk snapshot from CY 2000 ($Polk_{CY2000}$), as they will have been registered at some point in that calendar year, and therefore exist in the database. Assuming that all states have annual re-registration requirements,⁴⁹⁷ vehicles scrapped between July 1, 2000, and July 1, 2001, will not be re-registered between July 1, 2001, and July 1, 2002, and will not show up in $Polk_{CY2002}$. The vehicles scrapped during CY 2000 is therefore represented by the difference in count from the CY 2001 and CY 2002 Polk datasets - $Polk_{CY2001} - Polk_{CY2002}$.

⁴⁹⁶ Greenspan, A. & Cohen, D. "Motor Vehicle Stocks, Scrappage, and Sales." Review of Economics and Statistics, vol. 81, no. 3, 1999, pp. 369–383., doi:10.1162/003465399558300.

⁴⁹⁷ In future analysis, it may be possible to work with state-level information and incorporate state-specific re-registration requirements in the calculation of scrappage, but this correction is beyond the initial scope of this study as it would also require estimates of the interstate migration of registered vehicles.

For new vehicles (vehicles where MY is greater than or equal to CY), the count of vehicles will be smaller than the count in the following year — not all of the model year cohort will have been sold and registered. For these new model years, Greenspan and Cohen assume that the Polk counts will capture all vehicles which were present in the given calendar year and that approximately one percent of those vehicles will be scrapped during the year. Importantly, this analysis begins modeling the scrappage of a given model year cohort in $CY = MY + 2$, so that the adjustment to new vehicles is not relevant in the modeling because it only considers scrappage after the point where the on-road count of a given MY vintage has reached its maximum.⁴⁹⁸

The Greenspan and Cohen adjustment does not change for Polk’s new collection procedures.⁴⁹⁹ Vehicles scrapped during a given calendar year will appear in the registration database at some point in that calendar year. They will not appear the succeeding year, so for example vehicles scrapped between December 31, 2005, and December 31, 2006 — in other words, during CY 2005 — will appear in - $Polk_{CY2005}$, but not in - $Polk_{CY2006}$. The Polk count from CY 2006 represents the on road fleet as of December 31, 2005. Thus $Polk_{CY2006} - Polk_{CY2007}$ represents those vehicles actually scrapped during CY 2005. As indicated in, Figure 7-21 the scrappage counts computed from the old Polk snapshot series represent vehicles scrapped between July 1st of a given calendar year and the succeeding July 1st, and is computed for CY 1976-2003. The new Polk snapshot series represents vehicles scrapped between December 31st of a given calendar year and the succeeding calendar year, and is computed for CY 2005-2014.

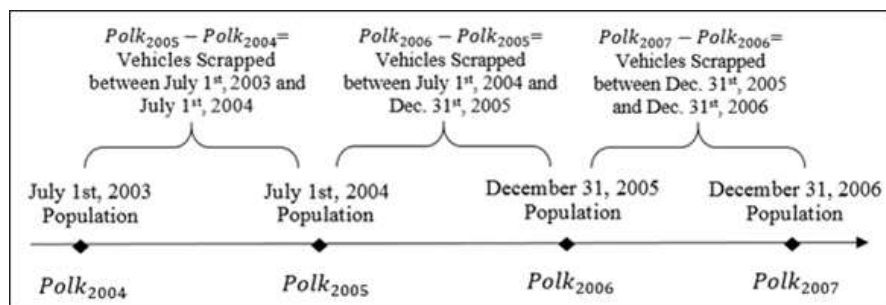

FIGURE 7-21 - VISUALIZATION OF GREENSPAN AND COHEN ADJUSTMENT AND POLK DATA COLLECTION CHANGE

There is a discontinuity between the old and new methods so that the computed scrappage for calendar year 2004 represents the difference between the vehicle count reported in $Polk_{CY2006}$ and $Polk_{CY2005}$. $Polk_{CY2005}$ represents all vehicles on the road as of July 1, 2004, and

⁴⁹⁸ Calculating scrappage could begin at $CY=MY+1$, as for most model year the entirety of the fleet will have been sold by July 1st of the succeeding CY, but for some exceptional model years, the maximum count of vehicles for a vintage in the Polk data set occurs at age 2.

⁴⁹⁹ Greenspan, A. & Cohen, D. “Motor Vehicle Stocks, Scrappage, and Sales.” Review of Economics and Statistics, vol. 81, no. 3, 1999, pp. 369–383., doi:10.1162/003465399558300.

*** EO 12866 Review – Draft – Do Not Cite, Quote or Release During Review ***

*Polk*_{CY2006} represents all vehicles on the road as of December 31, 2005. For this one timespan the scrappage will represent vehicles scrapped over a 17-month time period, rather than a year. For this reason, the CY 2004 scrappage data point is dropped, and because of the difference in the time period of vehicles scrapped under the old and new collection schemes, an indicator for scrappage measured before and after CY 2004 is considered; this indicator is not statistically significant, and is dropped from the preferred model.

7.8.7.5 Historical Sources for Variables that CAFE and CO₂ Standards Will Affect

The CAFE model outputs both expected changes in manufacturing costs and changes in the cost per mile (CPM) of vehicles. These are expected to be the primary factors that drive any changes in vehicle retirement from changes to fuel economy, and accordingly CO₂ standards. While ideal data would represent individual vehicles, unfortunately the data is only available in aggregate for historical model years. The models are thus unable to be trained on model-specific data and must rely on average measures. This decision is further justified by the fact that the CAFE model does not capture any cross subsidization of technology costs that occurs between vehicles in an OEM's fleet. Because it is likely manufacturers will cross-subsidize costs, the aggregate measure of average new vehicle price may be the best measure of the general price trend of the new vehicle market under different fuel economy standards, even if disaggregated data were available.

For historical data on vehicle transaction prices, the models use data from the National Automobile Dealers Association (NADA), which records the average transaction price of all light-duty vehicles. These transaction prices represent the prices consumers paid for new vehicles, but do not include any value of vehicles that may have been traded in to dealers. Importantly, these transaction prices were not available by vehicle body styles, thus the models will miss any unique trends that may have occurred for a particular vehicle body style. This may be particularly relevant for pickup trucks, which observed considerable average price increases as luxury and high option pickups entered the market. Future models will further consider incorporating price series that consider the price trends for cars, SUVs and vans, and pickups separately.⁵⁰⁰

The models use the NADA price series rather than the Bureau of Labor Statistics (BLS) New Vehicle Consumer Price Index (CPI), used by Parks (1977) and Greenspan & Cohen (1997),

⁵⁰⁰ Note - Using historical data aggregated by body styles to capture differences in price trends by body style does not require the assertion that technology costs are or are not born by the body style to which they are applied. If the body-style level average price change is used, then the assumption is that manufacturers do not cross-subsidize across body styles, whereas if the average price change is used then the assumption is that they would proportion costs equally for each vehicle. These are implementation questions to be worked out once the agencies have a historical data source which separates price series by body styles, but do not matter in the current model which only considers the average price of all light-duty vehicles.

because the BLS New Vehicle CPI makes quality adjustments to the new vehicle prices.^{501,502} BLS assumes that additions of safety and fuel economy equipment are a quality adjustment to a vehicle model, which changes the good and should not be represented as an increase in its price. While this is good for some purposes, it presumes consumers fully value technologies that improve fuel economy. Because it is the purpose of this study to measure whether this is true, it is important that vehicle prices adjusted to fully value fuel economy improving technologies, which would obscure the ability to measure the preference for more fuel efficient and expensive new vehicles, are not used. As further justification for using the NADA price series over the BLS New Vehicle CPI, Park (1977) cites a discontinuity found in the amount of quality adjustments made to the series so that more adjustments are made over time. This could further limit the ability for the BLS New Vehicle CPI to predict changes in vehicle scrappage.

Other influencers for calculating vehicle scrappage rates include fuel economy and fuel prices. Historical data on the fuel economy by vehicle style from model years 1979-2016 was obtained from the 2016 EPA Fuel Economy Trends Report.⁵⁰³ The van/SUV fuel economy values represent a sales-weighted harmonic average of the individual body styles. Fuel prices were obtained from Department of Energy (DOE) historical values, and future fuel prices within the CAFE model use the Annual Energy Outlook (AEO 2017) future oil price projections.⁵⁰⁴ From these values the average cost per 100 miles of travel for the cohort of new vehicles in a given calendar year and the average cost per 100 miles of travel for each used model year cohort in that same calendar year are computed.⁵⁰⁵ It is expected that as the new vehicle fleet becomes more efficient (holding all other attributes constant) that it will be more desirable, and the demand for used vehicles should decrease (increasing their scrappage). As a given model year cohort becomes more expensive to operate due to increases in fuel prices, it is expected the scrappage of that model year will increase. It is perhaps worth noting that more efficient model year vintages will be less susceptible to changes in fuel prices, as absolute changes in their cost per mile will

⁵⁰¹ Parks, R. W. “Determinants of Scrapping Rates for Postwar Vintage Automobiles.” *Econometrica*, vol. 45, no. 5, 1977, p. 1099., doi:10.2307/1914061.

⁵⁰² Greenspan, A. & Cohen, D. “Motor Vehicle Stocks, Scrappage, and Sales.” *Review of Economics and Statistics*, vol. 81, no. 3, 1999, pp. 369–383., doi:10.1162/003465399558300.

⁵⁰³ Environmental Protection Agency, Light-Duty Automotive Technology, Carbon Dioxide Emissions, and Fuel Economy Trends - 1975 through 2016, EPA-420-R-16-010, November 2016.

⁵⁰⁴ Note - The central analysis uses the AEO reference fuel price case, but sensitivity analysis also considers the possibility of AEO’s low and high fuel price cases.

⁵⁰⁵ Work by Jacobsen & van Benthem suggests that these initial average fuel economy values may not represent the average fuel economy of a model year cohort as it ages — mainly, they find that the least fuel efficient vehicles scrap earlier than the most fuel efficient models in a given cohort. This may be an important consideration in future endeavors that work to link fuel economy, vehicle miles travelled (VMT), and scrappage. Studies on “the rebound effect” suggest that lowering the fuel cost per driven mile increases the demand for VMT. With more miles, a vehicle will be worth less as its perceived remaining useful life will be shorter; this will result in the vehicle being more likely to be scrapped. A rebound effect is included in the CAFE model, but because reliable data on how average VMT by age has varied over calendar year and model year vintage is not available, expected lifetime VMT is not included within the current dynamic scrappage model.

be smaller. The functional forms of the cost per mile measures are further discussed in the model specification section below.

7.8.7.6 Data Sources for Other Variables Affecting Cyclical Scrappage

Other aggregate measures that cyclically affect the value of used vehicles include macroeconomic factors like the real interest rate, the GDP growth rate, and unemployment rates. These values were all sourced from the 2017 OASDI Trustees Report, in large part because it offers consistent projections beyond 2032 of all three data series. Because the purpose of building this scrappage model is to project vehicle survival rates under different fuel economy alternatives, and the current fuel economy projections go as far forward as calendar year 2032, using a data set that encompasses projections at least through 2032 is an essential characteristic of any source used for this analysis.

The interest rate series used is the average real interest rate on social security trust public-debt obligations. While this is not a perfect measure of auto loan interest rates, the two are correlated so that most of the effect of auto loan rates should be captured by using the interest rate facing the federal government. Further, no reliable auto loan interest rate projections have been identified for this analysis. As the real interest rate increases so does the cost of borrowing and the opportunity cost of not investing. For this reason, it is expected that as real interest rates increase that vehicle scrappage should decline. Consumers delay purchasing new vehicles because the cost of financing increases. Models that included interest rates were considered, but were not selected as the preferred model for reasons discussed in the following section.

The Trustees Report also provides historical and projected real GDP growth rates and the average annual unemployment rate. As GDP increases this is generally correlated with lowered unemployment,⁵⁰⁶ and potentially increased average wages. Generally economic growth will result in a higher demand for new vehicles—cars in aggregate are normal goods—and a reduction in the value of used vehicles. The result should be an increase in the scrappage rate of existing vehicles. Note further that travel to employment is a major source of the demand for transportation—where this does not result in new vehicle sales it will result in delayed scrappage. Given the nature of the collinearity of GDP and unemployment, both unemployment rate and GDP growth rate are considered in alternate specifications. For brevity's sake, The GDP growth rate is the better predictor and is used in the preferred specification—alternatives specifying unemployment rate are not shown in the model specification section.

Another component of vehicle scrappage is the cost of maintenance, which includes both repairs and the relative cost of travel. For maintenance costs, no model considered for this analysis showed the expected signs on that variable, as shown in the following section. For this reason, the preferred model excludes the variable. There is likely some issue with simultaneity; where

⁵⁰⁶ Colloquial wisdom from *Okun's Law* suggests that for every one percent increase in unemployment, GDP will be two percent lower; the main conclusion being that the two are co-integrated of order one (and therefore collinear).

the complexity of new vehicles increases so does the cost of maintenance. The BLS maintenance and repair series does not measure the cost of maintenance for individual model year cohorts, but instead measures by calendar year. Note that examples from the literature use the ratio of used vehicle prices to maintenance costs as a way of capturing the relative movement of repair and used vehicle prices, but this does not solve the problem of isolating overall changes in maintenance costs for the same maintenance event versus the increase in the number of, or complexity of, these events. Further, a reliable source of projections for either used vehicle prices, or future maintenance and repair costs, was identified for this analysis. If model year specific repair costs become available, future models could include this variable.

A final component of vehicle scrappage is the value of a vehicle at the time of scrappage. As noted by Parks (1977), the value of a scrapped vehicle can be derived either from the value of recoverable scrap metal or from the value of sellable used parts.⁵⁰⁷ There are several issues with using the BLS scrap steel CPI. First, as in Park’s work, the coefficient on scrap steel is statistically insignificant—model results including the CPI of scrap steel are not shown, as there were other theoretical problems with the measure. The material composition and mass of vehicles has changed over time so that the absolute amount of recoverable scrap steel is not constant over the series. The average weight of recoverable steel by vintage would have to be known, and this measure would still be missing any other recoverable metals and other materials. Further, projecting the future value of the recoverable scrap metal would involve computing the amount of recoverable steel under all scenarios of fuel economy standards, where mass and material composition are assumed to vary across all alternatives. This value is not calculated explicitly in the current model, which is another reason some estimate of the value of recoverable metal is not included in the preferred model specification.

7.8.7.7 Model Specifications

The final model specification considering all the above sources of scrappage is as follows:

$$\ln\left(\frac{s}{1-s}\right) = \beta_0 * Age + \beta_1 * Age^2 + \beta_2 * Age^3 +$$

$$\ln(MY - 1959) * (\beta_3 + \beta_4 * Age + \beta_5 * Age^2)$$

$$New Price * (\beta_6 + \beta_7 * Age + \beta_8 * Age^2 + \beta_9 * Age^3) +$$

$$Lag New Price * (\beta_{10} + \beta_{11} * Age + \beta_{12} * Age^2 + \beta_{13} * Age^3) +$$

$$Lag2 New Price * (\beta_{14} + \beta_{15} * Age + \beta_{16} * Age^2 + \beta_{17} * Age^3) +$$

$$Lag3 New Price * (\beta_{18} + \beta_{19} * Age + \beta_{20} * Age^2 + \beta_{21} * Age^3) +$$

$$\beta_{22} * CP100M + \beta_{23} * Lag CP100M +$$

$$\beta_{24} * New CP100M + \beta_{25} * Lag New CP100M +$$

$$\beta_{26} * GDP Growth + \beta_{27} * Lag GDP Growth + \beta_{28} * Lag2 GDP Growth +$$

$$\beta_{29} * Lag \ln\left(\frac{s}{1-s}\right) + \beta_{30} * Lag2 \ln\left(\frac{s}{1-s}\right) + \beta_{31} * Lag3 \ln\left(\frac{s}{1-s}\right) + \beta_{32} * CY2009 + \beta_{33}$$

⁵⁰⁷ Parks, R. W. “Determinants of Scrapping Rates for Postwar Vintage Automobiles.” *Econometrica*, vol. 45, no. 5, 1977, p. 1099., doi:10.2307/1914061.

Here, “s” is the instantaneous scrappage rate, so that $\ln(s/1-s)$ is the logit formulation of scrappage. Logit models ensure that predicted values are bounded—in this case between zero and one. More than 100% of remaining vehicles cannot be scrapped, nor fewer than 0%. For a visual, see the graph below:

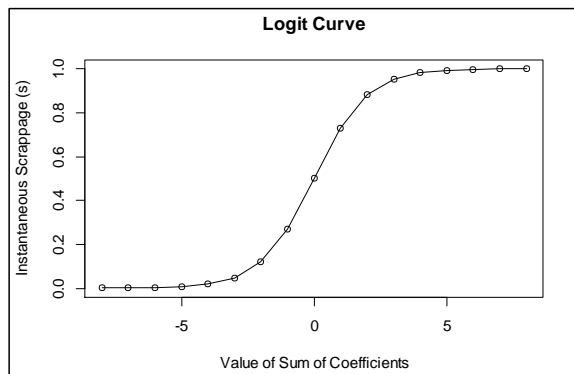

FIGURE 7-22 - EXAMPLE LOGISTIC CURVE

Solving for instantaneous scrappage gives the following:

EQUATION 7-4 - INSTANTANEOUS VEHICLE SCRAPPAGE

$$s = \frac{e^{\sum \beta_i X_i}}{1 + e^{\sum \beta_i X_i}}$$

Here $\sum \beta_i X_i$ represents the right-hand side of the model specification above. The instantaneous scrappage can be calculated directly from “s” above. This gives the share of remaining vehicles in a given calendar year which are scrapped in the next year. The population of vehicles in the next calendar year is calculated as follows:

EQUATION 7-5 - VEHICLE POPULATION

$$Population_{MY,CY+1} = Population_{MY,CY} * (1 - s_{MY,CY}).$$

7.8.7.8 Form of Engineering Scrappage

The most predictive element of vehicle scrappage is what Greenspan & Cohen deem ‘engineering scrappage.’ This source of scrappage is largely determined by the age of a vehicle and the durability of a specific model year vintage. Vehicle scrappage typically follows a roughly logistic function with age — that is, instantaneous scrappage increases to some peak, and then declines, with age as noted in Walker (1968), Parks (1977), Greene & Chen (1981), Gruenspecht (1981), Feeney & Cardebring (1988), Greenspan & Cohen (1996), Hamilton &

Macauley (1999), and Bento, Roth & Zhuo (2016).^{508, 509, 510, 511, 512, 513, 514, 515} Thus, this analysis also uses a logistic function to capture this trend of vehicle scrappage with age, but allows non-linear terms to capture any skew to the logistic relationship. Comparing the instantaneous scrappage rates by body style in 5 year vintage increments in Figure 7-23, Figure 7-24, and Figure 7-25, the three body style groups have different general patterns for instantaneous scrappage with age. The car instantaneous scrappage has the least skew peaking between ages 15 and 20 for all model years. Vans/SUVs have a more skewed scrappage pattern — increasing steadily until age 15, remaining high until ages 20 to 25 before tailing off. Finally, the pickup scrappage pattern is the least symmetrical; it increases more gradually until ages 15 or 20 and remaining high until around age 30. Including non-linear terms for the age variable will capture any parametric skew to the scrappage patterns of the three body style groups.

Variations in the scrappage rates are observable also by model year vintage — as noted in the literature, this is in part due to changes in the durability of vehicles. For cars the durability seems to be increasing at a diminishing rate with vintage (see Figure 7-23). This effect seems to be diminishing and also to be related to the age of a vehicle. For this reason, the natural log of MY (inherently a diminishing function) is used, and interacted with the age functional form.

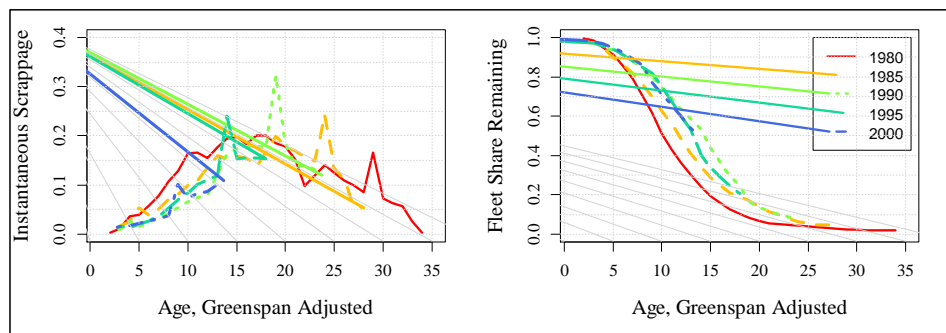

⁵⁰⁸ Walker, F. V. "Determinants of Auto Scrappage." *The Review of Economics and Statistics*, vol. 50, no. 4, Nov. 1968, pp. 503–506.

⁵⁰⁹ Parks, R. W. "Determinants of Scrapping Rates for Postwar Vintage Automobiles." *Econometrica*, vol. 45, no. 5, 1977, p. 1099., doi:10.2307/1914061.

⁵¹⁰ Greene, D. L., and C.k.eric Chen. "Scrappage and Survival Rates of Passenger Cars and Light Trucks in the U.S., 1966-1977." *Transportation Research Part A - General*, vol. 15, no. 5, 1981, pp. 383–389., doi:10.1016/0191-2607(81)90144-8.

⁵¹¹ Gruenspecht, H. K. "Differentiated Social Regulation in Theory and Practice." Yale University, 1981.

⁵¹² Feeney, B. P. & Cardebring, P. "Car Longevity in Sweden - A Revised Estimate." *Transportation Research Part A - General*, vol. 22, no. 6, 1988, pp. 455–465., doi:10.1016/0191-2607(88)90049-0.

⁵¹³ Greenspan, A. & Cohen, D. "Motor Vehicle Stocks, Scrappage, and Sales." *Review of Economics and Statistics*, vol. 81, no. 3, 1999, pp. 369–383., doi:10.1162/003465399558300.

⁵¹⁴ Hamilton, B. W. & Macauley, M. K. "Heredity or Environment - Why Is Automobile Longevity Increasing?" *The Journal of Industrial Economics*, vol. 47, no. 3, 2003, pp. 251–261., doi:10.1111/1467-6451.00100.

⁵¹⁵ Bento, A. et al. "Vehicle Lifetime Trends and Scrappage Behavior in the U.S. Used Car Market." *The Energy Journal*, vol. 39, no. 1, Jan. 2018, doi:10.5547/01956574.39.1.aben.

*** EO 12866 Review – Draft – Do Not Cite, Quote or Release During Review ***

FIGURE 7-23 - CAR SCRAPPAGE BY MODEL YEAR

As shown in Table 7-6, the best fit in terms of minimizing the root mean squared error (RMSE), Bayesian Information Criterion (BIC) and Akaike Information Criterion (AIC) is “Eng. Alt. 1” (engineering scrappage alternative 1), which includes linear, squared and cubic terms both for age and age interacted with the natural log of model year. However, for projections forward, the model predicts precipitous scrappage for future model years beyond age 10 — so that less than 1% of the fleet remains by age 13 for MY 2015, assuming both new vehicle prices and CPM remains constant at current levels. Compare this with the predicted results for MY 2015 survival rates for the preferred model, and note that the preferred model projects future model year scrappage rates more comparable to observed historical rates. For this reason, a linear, squared and cubic term of age are used to capture the trend of scrappage with age, and only a linear and squared term of age interacted with the log of model year to capture how this trend changes with successive model years, which is the second best fit model using RMSE, BIC, and AIC as measures.

*** EO 12866 Review – Draft – Do Not Cite, Quote or Release During Review ***

TABLE 7-6 - ALTERNATIVE CAR ENGINEERING SCRAPPAGE SPECIFICATIONS

Variable	Preferred	Eng. Alt. 1	Eng. Alt. 2	Eng. Alt. 3
<i>Age</i>	0.61604705*	1.68096703***	0.76506903**	-0.29030721**
<i>Age</i> ²	-0.05740675**	-0.12323758***	-0.06055253**	0.01426796***
<i>Age</i> ³	0.00158213***	0.00280985***	0.00137653**	0
<i>log</i> (<i>MY</i> – 1959)	-1.60888589***	0.19023048	-0.47547264**	-1.48861814***
<i>log</i> (<i>MY</i> – 1959) * <i>Age</i>	0.21358227***	-0.18776621**	0.02174726**	0.20222460***
<i>log</i> (<i>MY</i> – 1959) * <i>Age</i> ²	-0.00671599***	0.01963573***	0	-0.00650722***
<i>log</i> (<i>MY</i> – 1959) * <i>Age</i> ³	0	-0.00052822***	0	0
<i>New.Price</i>	-0.00016128	-0.00018581*	-0.00014144	-0.00023914**
<i>New.Price</i> * <i>Age</i>	0.00000784	0.00001188	0.00000519	0.00002706
<i>New.Price</i> * <i>Age</i> ²	0.0000001	-0.00000016	0.00000027	-0.0000014
<i>New.Price</i> * <i>Age</i> ³	-0.00000001	-0.00000001	-0.00000002	0.00000002
<i>lag</i> (<i>New.Price</i>)	0.00009476	0.00006951	0.00008414	0.000095
<i>lag</i> (<i>New.Price</i>) * <i>Age</i>	-0.00000234	0.00000024	-0.000001	-0.00000108
<i>lag</i> (<i>New.Price</i>) * <i>Age</i> ²	-0.00000074	-0.00000098	-0.00000069	-0.00000087
<i>lag</i> (<i>New.Price</i>) * <i>Age</i> ³	0.00000003	0.00000003	0.00000002	0.00000003
<i>lag</i> ₂ (<i>New.Price</i>)	-0.00033559**	-0.00037744***	-0.00027530*	-0.00033896**
<i>lag</i> ₂ (<i>New.Price</i>) * <i>Age</i>	0.00005203*	0.00006103**	0.00004141	0.00005479*
<i>lag</i> ₂ (<i>New.Price</i>) * <i>Age</i> ²	-0.00000222	-0.00000272	-0.00000158	-0.00000247
<i>lag</i> ₂ (<i>New.Price</i>) * <i>Age</i> ³	0.00000002	0.00000003	0.00000001	0.00000002
<i>lag</i> ₃ (<i>New.Price</i>)	0.00049373***	0.00050779***	0.00033894***	0.00046852***
<i>lag</i> ₃ (<i>New.Price</i>) * <i>Age</i>	-0.00009124***	-0.00009610***	-0.00006169***	-0.00008580***
<i>lag</i> ₃ (<i>New.Price</i>) * <i>Age</i> ²	0.00000512***	0.00000545***	0.00000347***	0.00000479***
<i>lag</i> ₃ (<i>New.Price</i>) * <i>Age</i> ³	-0.00000008***	-0.00000009***	-0.00000005**	-0.00000008***
<i>CPM.Car_{MY}</i>	-0.08588378*	-0.09866687**	-0.04162492	-0.12118495***
<i>lag</i> (<i>CPM.Car_{MY}</i>)	0.08546280*	0.07463071*	0.07604193	0.12746590***
<i>New.CPM.Car_{CY}</i>	0.08029769	0.11143204**	0.03452148	0.11451806**
<i>lag</i> (<i>New.CPM.Car_{CY}</i>)	-0.10117160*	-0.11240287**	-0.10036028*	-0.15073963***

*** EO 12866 Review – Draft – Do Not Cite, Quote or Release During Review ***

<i>GDP.growth.rate</i>	0.04791870***	0.04275665***	0.04260164***	0.04866929***
<i>lag(GDP.growth.rate)</i>	0.02476165***	0.02378924***	0.02163104***	0.02532817***
<i>lag₂(GDP.growth.rate)</i>	0.01101399	0.01393572**	0.00596884	0.00971095
<i>lag(Dependent Var.)</i>	0.20296197***	0.13232060***	0.23841382***	0.21092713***
<i>lag₂(Dependent Var.)</i>	0.15087160***	0.08004249***	0.17093763***	0.16429722***
<i>lag₃(Dependent Var.)</i>	0.03576158	-0.0050022	0.02422192	0.03605243
<i>CARS(CY2009)</i>	0.94774531***	0.95338930***	0.98085046***	0.93195627***
Degrees of Freedom	425	424	426	426
R-squared	0.9636	0.9662	0.9609	0.963
RSME	0.1486	0.1434	0.1539	0.1498
AIC	-412.8	-444.6	-381.6	-406.7
BIC	-268.3	-296	-241.2	-266.3

The trend of durability for successive vintages is less pronounced for the van/SUV fleet, as shown in Figure 7-24. Earlier model year vintages appear to be more durable; this is likely due to the fact that SUVs were built on truck chassis which tend to have longer expected lifetimes. Over time most manufacturers migrated their SUVs to be built on car platforms. For MY 1990 vehicles the durability of SUVs and vans is significantly lower. After MY 1990 the durability of SUVs increases over time. Note - The series for SUVs and van scrappage rates is noisier than that of cars. This is likely due to inconsistencies for how SUVs and vans were coded for different Polk datasets. In the future, further data cleaning could ensure that given nameplates are consistently coded as specific body styles. Comparing the general trend of instantaneous scrappage rates, it remains the case that the scrappage rates for MY's 1990, 1995, and 2000 are progressively lower, implying a trend of increasing durability within recent model years.

FIGURE 7-24 - SUV/VAN SCRAPPAGE BY MODEL YEAR

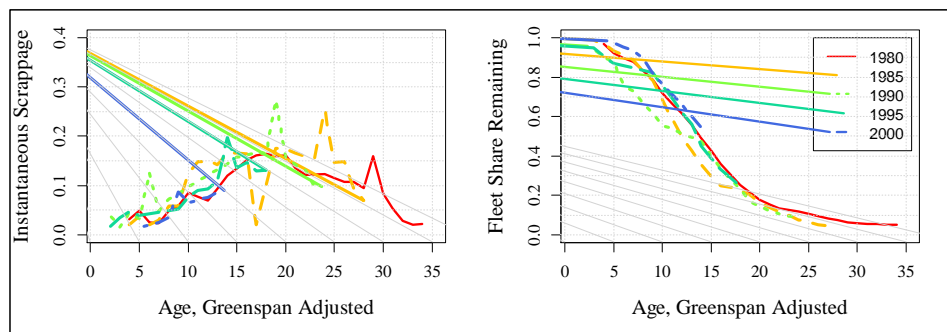

*** EO 12866 Review – Draft – Do Not Cite, Quote or Release During Review ***

Table 7-7 shows that the best fit engineering scrappage specification for SUVs in terms of minimizing RMSE, BIC, and AIC is also the preferred model. This specification, like cars, includes a linear, squared and cubic term for the relationship between scrappage and age, and a linear and squared term for how successive model year ‘durability’ improvements change with age. Predictions of this preferred model are shown below.

TABLE 7-7 - ALTERNATIVE SUV ENGINEERING SCRAPPAGE SPECIFICATIONS

Variable	Preferred	Eng. Alt. 1	Eng. Alt. 2	Eng. Alt. 3
<i>Age</i>	-0.47344112**	-0.52246743	0.20360275	-0.05978781
<i>Age</i> ²	0.03232415***	0.03556608*	-0.00505831	0.00588905
<i>Age</i> ³	-0.00030189***	-0.00036303	0.00007863***	0
<i>log</i> (<i>MY</i> – 1959)	-3.94661636***	-4.01905364***	-0.407509	-1.86967280***
<i>log</i> (<i>MY</i> – 1959) * <i>Age</i>	0.50480338***	0.52192184***	0.01632231	0.21606859***
<i>log</i> (<i>MY</i> – 1959) * <i>Age</i> ²	-0.01515964***	-0.01623873***	0	-0.00613015***
<i>log</i> (<i>MY</i> – 1959) * <i>Age</i> ³	0	0.00001948	0	0
<i>New.Price</i>	0.00037159***	0.00037088***	0.00027168***	0.00028113***
<i>New.Price</i> * <i>Age</i>	-0.00002887**	-0.00002886**	-0.00001562	-0.00001596
<i>New.Price</i> * <i>Age</i> ²	0.00000059*	0.00000059*	0.00000016	0.0000002
<i>lag</i> (<i>New.Price</i>)	-0.00018534	-0.00018505	-0.00025742**	-0.00021576*
<i>lag</i> (<i>New.Price</i>) * <i>Age</i>	0.00000109	0.00000097	0.0000109	0.00000509
<i>lag</i> (<i>New.Price</i>) * <i>Age</i> ²	0.00000001	0.00000001	-0.00000029	-0.00000012
<i>lag</i> ₂ (<i>New.Price</i>)	-0.00003482	-0.00003507	-0.00000012	-0.0000088
<i>lag</i> ₂ (<i>New.Price</i>) * <i>Age</i>	0.00001745	0.00001748	0.00001398	0.00001387
<i>lag</i> ₂ (<i>New.Price</i>) * <i>Age</i> ²	-0.00000067*	-0.00000067*	-0.00000056	-0.00000053
<i>lag</i> ₃ (<i>New.Price</i>)	0.00013793*	0.00013915*	-0.00001032	0.00004383
<i>lag</i> ₃ (<i>New.Price</i>) * <i>Age</i>	-0.00002503***	-0.00002515***	-0.00000799	-0.0000149
<i>lag</i> ₃ (<i>New.Price</i>) * <i>Age</i> ²	0.00000088***	0.00000088***	0.00000054**	0.00000069***
<i>CPM.SUV_{MY}</i>	-0.13815102**	-0.14001302**	-0.04532974	-0.0711635
<i>lag</i> (<i>CPM.SUV_{MY}</i>)	0.04460368	0.04580178	0.00711892	-0.01143975
<i>New.CPM.SUV_{CY}</i>	0.27307243***	0.27517518***	0.16684354**	0.20156668***
<i>lag</i> (<i>New.CPM.SUV_{CY}</i>)	-0.13534695*	-0.13668080*	-0.10535438	-0.07765391
<i>GDP.growth.rate</i>	0.06054021***	0.06055095***	0.05807211***	0.05957340***
<i>lag</i> (<i>GDP.growth.rate</i>)	0.07254451***	0.07275413***	0.07780086***	0.07278210***
<i>lag</i> (<i>Dependent Var.</i>)	0.18961627***	0.19017211***	0.27927398***	0.23652226***
<i>lag</i> ₂ (<i>Dependent Var.</i>)	0.00502922	0.00589676	0.04087536	0.02683385
<i>lag</i> ₃ (<i>Dependent Var.</i>)	-0.06628044**	-0.06518710*	-0.03747507	-0.04804536
<i>CARS</i> (<i>CY</i> 2009)	1.46662812***	1.46502129***	1.51673329***	1.54705934***
Degrees of Freedom	414	413	415	415
R-squared	0.8885	0.8885	0.8708	0.8802
RSME	0.2646	0.2649	0.2845	0.274
AIC	109.1	111	172.5	139.2
BIC	231.9	237.9	291.2	257.9

There is still less of a pronounced durability trend for the pickup fleet as shown in Figure 7-25. However, in looking at the instantaneous scrappage through age 15, it can be seen that with increases in vintages, there does appear to be a reduction in the instantaneous scrappage rate. The trend is less observable when looking at the share of the fleet remaining at each age. In general, the scrappage pattern for pickup trucks has remained more constant over time than that of vans/SUVs and cars.

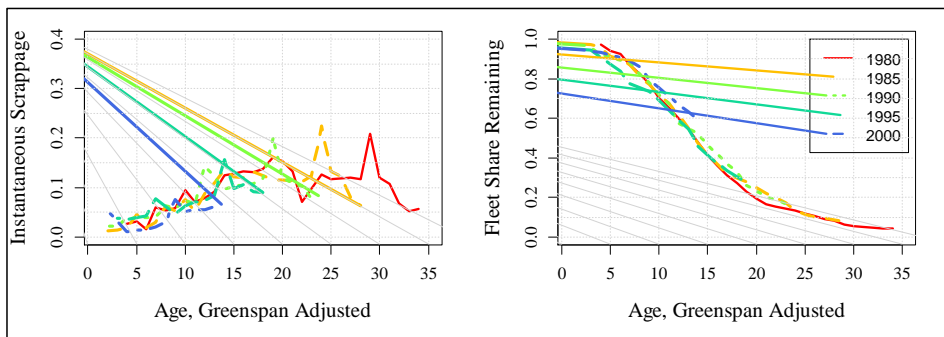

FIGURE 7-25 - PICKUP SCRAPPAGE BY MODEL YEAR

The final form used to capture the engineering scrappage of the truck fleet includes linear and squared terms of age and their interactions with the log of model year to capture how durability changes depending on the age of the pickup. Note that the preferred engineering alternative has the lowest BIC, but that engineering alternatives 1 and 3 have slightly lower AICs and RMSEs. No model is a definitively better fit, so predictions of future model year scrappage were used as the determining criterion. The preferred and alternative 3 are nearly coincident until after age 30, where alternative 3 predicts 1-2% more of the fleet remains than the preferred alternative, predicting the fleet converges to retain approximately 9% of pickups. Because both of these final shares are higher than historically observed values, the preferred alternative was chosen, which was slightly more in line with the historical share of the fleet that remains after age 20. Alternative 1 is coincident until around age 15, and then scraps pickups more aggressively, with only 16% of MY 2015 pickups predicted to remain by age 20, as compared to 26% under the preferred and third alternative. The analysis shows that historically more than 20% of the pickup fleet has remained for most model years at age 20, which makes the preferred specification more closely predict historical trends than alternatives 1 and 3.

*** EO 12866 Review – Draft – Do Not Cite, Quote or Release During Review ***

TABLE 7-8 - ALTERNATIVE TRUCK ENGINEERING SCRAPPAGE SPECIFICATIONS

Variable	Preferred	Eng. Alt. 1	Eng. Alt. 2	Eng. Alt. 3	Eng. Alt. 4
<i>Age</i>	-0.86677928***	-0.91499283***	-0.48161158***	-0.99407214***	-0.0902835
<i>Age</i> ²	0.03112533***	0.03351499***	0.02177193***	0.03858927***	0
<i>Age</i> ³	0	0	0	-0.00008332**	0
<i>log(MY – 1959)</i>	-2.56039652***	-2.95500403***	-0.72808606*	-3.16254200***	-2.80233581***
<i>log(MY – 1959) * Age</i>	0.27307916***	0.31837948***	0.05913970***	0.35457968***	0.26419074***
<i>log(MY – 1959) * Age</i> ²	-0.00646007***	-0.00733243***	0	-0.00903734***	-0.00559967***
<i>log(MY – 1959) * Age</i> ³	0	-0.00002047	0	0	0
<i>New. Price</i>	-0.00031900***	-0.00029597***	-0.00029427***	-0.00029007***	-0.00021361***
<i>New. Price * Age</i>	0.00002526***	0.00002210**	0.00001830*	0.00002111**	0.00000991
<i>New. Price * Age</i> ²	-0.00000080***	-0.00000070***	-0.00000068**	-0.00000067**	-0.00000026
<i>lag(New. Price)</i>	0.00040797***	0.00041147***	0.00036109***	0.00041350***	0.00042332***
<i>lag(New. Price) * Age</i>	-0.00002120*	-0.00002126*	-0.00001429	-0.00002138*	-0.00002166*
<i>lag(New. Price) * Age</i> ²	0.00000035	0.00000035	0.00000016	0.00000035	0.00000039
<i>lag₂(New. Price)</i>	-0.00043049***	-0.00043459***	-0.00041485***	-0.00043611***	-0.00040207***
<i>lag₂(New. Price) * Age</i>	0.00003337***	0.00003342***	0.00003198**	0.00003344***	0.00002707**
<i>lag₂(New. Price) * Age</i> ²	-0.00000081**	-0.00000081**	-0.00000081**	-0.00000080**	-0.00000057*
<i>lag₃(New. Price)</i>	0.00038428***	0.00040019***	0.00032484***	0.00040639***	0.00039199***
<i>lag₃(New. Price) * Age</i>	-0.00003353***	-0.00003503***	-0.00002423***	-0.00003559***	-0.00003549***
<i>lag₃(New. Price) * Age</i> ²	0.00000084***	0.00000086***	0.00000061***	0.00000087***	0.00000092***
<i>CPM.Truck_{MY}</i>	0.07367069*	0.06739084*	0.08509962**	0.06517770*	0.06962458*
<i>lag(CPM.Truck_{MY})</i>	-0.09157160**	-0.08772070**	-0.07179030*	-0.08600923**	-0.08694554**
<i>New. CPM.Truck_{CY}</i>	-0.13230543**	-0.12519757**	-0.17738920***	-0.12314286**	-0.11479711**
<i>lag(New. CPM.Truck_{CY})</i>	0.09496014*	0.09226479*	0.07725083	0.09095026*	0.08847701
<i>GDP.growth.rate</i>	0.03480447**	0.03445514**	0.04108243***	0.03468920**	0.03333400**
<i>lag(GDP.growth.rate)</i>	0.0149701	0.01445633	0.03404562***	0.0146604	0.00537557
<i>lag(Dependent Var.)</i>	0.14683419***	0.13890061***	0.21342174***	0.13738067***	0.18734982***
<i>lag₂(Dependent Var.)</i>	0.04812011	0.03873806	0.11893794***	0.03731351	0.04711231
<i>lag₃(Dependent Var.)</i>	0.10184713***	0.09744648***	0.14994151***	0.09707212***	0.09776487***
<i>CARS(CY2009)</i>	0.91228345***	0.90504128***	0.77657775***	0.90162042***	1.02730964***

*** EO 12866 Review – Draft – Do Not Cite, Quote or Release During Review ***

MY95_00	3.31543806	2.78142374	-1.05049141	2.73442239	1.39352084
MY95_00 * log(MY – 1959)	-0.77125504	-0.63153754	0.37426983	-0.62173734	-0.29355154
MY95_00 * log(MY – 1959) * Age	-0.00852493***	-0.00806900***	-0.00274877	-0.00793508***	-0.0047196
Degrees of Freedom	394	393	395	393	395
R-squared	0.9271	0.9275	0.9155	0.9278	0.922
RSME	0.2013	0.2009	0.2164	0.2006	0.208
AIC	-124.5	-125.2	-64.1	-126.8	-97.7
BIC	5.2	8.5	61.5	6.9	27.9

*** EO 12866 Review – Draft – Do Not Cite, Quote or Release During Review ***

Note - The preferred pickup specification includes a separate durability trend for model years 1995-2000. Pickup durability in these model years was lower, so they were modelled to have their own durability trend.

Table 7-9 specifies different forms of this trend that were considered. As noted, the preferred specification is the best fit model by RMSE, BIC and AIC. When not included, the projections forward for a MY 2015 vehicle do look very similar, as do the coefficients on the variables more stringent CAFE standards would impact (new vehicle price and future model years' average CPM). Controlling for the lower durability for model years 1995-2000 does not greatly impact predictions.

*** EO 12866 Review – Draft – Do Not Cite, Quote or Release During Review ***

TABLE 7-9 - ALTERNATIVE TRUCK ENGINEERING SCRAPPAGE SPECIFICATIONS FOR MY'S 1995-2000

Variable	Preferred	MY95-00, Alt. 1	MY95-00, Alt. 2	MY95-00, Alt. 3
<i>Age</i>	-0.86677928***	-0.87824330***	-0.73394577***	-0.71149679***
<i>Age</i> ²	0.03112533***	0.03148633***	0.02671112***	0.02515804***
<i>log</i> (<i>MY</i> – 1959)	-2.56039652***	-2.59270529***	-2.70178720***	-2.75987499***
<i>log</i> (<i>MY</i> – 1959) * <i>Age</i>	0.27307916***	0.27722914***	0.26007885***	0.27885087***
<i>log</i> (<i>MY</i> – 1959) * <i>Age</i> ²	-0.00646007***	-0.00662114***	-0.00584372***	-0.00640788***
<i>New.Price</i>	-0.00031900***	-0.00031856***	-0.00029728***	-0.00032590***
<i>New.Price</i> * <i>Age</i>	0.00002526***	0.00002521***	0.00002276**	0.00002459***
<i>New.Price</i> * <i>Age</i> ²	-0.00000080***	-0.00000079***	-0.00000073***	-0.00000075***
<i>lag</i> (<i>New.Price</i>)	0.00040797***	0.00040809***	0.00042045***	0.00044507***
<i>lag</i> (<i>New.Price</i>) * <i>Age</i>	-0.00002120*	-0.00002141*	-0.00002160*	-0.00002321*
<i>lag</i> (<i>New.Price</i>) * <i>Age</i> ²	0.00000035	.00000035	.00000036	.0000004
<i>lag</i> ₂ (<i>New.Price</i>)	-0.00043049***	-0.00043267***	-0.00042460***	-0.00042904***
<i>lag</i> ₂ (<i>New.Price</i>) * <i>Age</i>	0.00003337***	0.00003374***	0.00003175***	0.00003053**
<i>lag</i> ₂ (<i>New.Price</i>) * <i>Age</i> ²	-0.00000081**	-0.00000081**	-0.00000077**	-0.00000073**
<i>lag</i> ₃ (<i>New.Price</i>)	0.00038428***	0.00038465***	0.00038837***	0.00041272***
<i>lag</i> ₃ (<i>New.Price</i>) * <i>Age</i>	-0.00003353***	-0.00003358***	-0.00003264***	-0.00003461***
<i>lag</i> ₃ (<i>New.Price</i>) * <i>Age</i> ²	0.00000084***	0.00000084***	0.00000081***	0.00000086***
<i>CPM.Truck</i> _{MY}	0.07367069*	0.07226879*	0.07287254*	0.07746187**
<i>lag</i> (<i>CPM.Truck</i> _{MY})	-0.09157160**	-0.09129960**	-0.09096347**	-0.09473755**
<i>New.CPM.Truck</i> _{CY}	-0.13230543**	-0.12802869**	-0.12723171**	-0.13649662**
<i>lag</i> (<i>New.CPM.Truck</i> _{CY})	0.09496014*	0.09262072*	0.09730340*	0.10972351**
<i>GDP.growth.rate</i>	0.03480447**	0.03446958**	0.03472851**	0.03973632***
<i>lag</i> (<i>GDP.growth.rate</i>)	0.0149701	0.014169	0.011488	0.012834
<i>lag</i> (<i>Dependent Var.</i>)	0.14683419***	0.14391990***	0.16146453***	0.18934305***
<i>lag</i> ₂ (<i>Dependent Var.</i>)	0.04812011	0.044543	0.051436	0.06834612**
<i>lag</i> ₃ (<i>Dependent Var.</i>)	0.10184713***	0.09967444***	0.10633280***	0.11453081***
<i>CARS</i> (<i>CY</i> 2009)	0.91228345***	0.92464329***	0.94014024***	0.95334262***
<i>MY</i> 95_00	3.31543806	2.508064	0.663523	0
<i>MY</i> 95_00 * <i>log</i> (<i>MY</i> – 1959)	-0.77125504	-0.48796	-0.14609	0
<i>MY</i> 95_00 * <i>log</i> (<i>MY</i> – 1959) * <i>Age</i>	-0.00852493***	-0.02027	0	0
<i>MY</i> 95_00 * <i>log</i> (<i>MY</i> – 1959) * <i>Age</i> ²	0	0.000503	0	0
Degrees of Freedom	394	393	395	397
R-squared	0.9271	0.9272	0.9254	0.9232
RSME	0.2013	0.2014	0.2033	0.2058
AIC	-124.5	-123.1	-117.1	-108.6
BIC	5.2	10.6	8.5	9

7.8.7.9 Effect of 2009 CARS Program

There is one other trend observable across all body styles and vintages shown in Figure 7-23, Figure 7-24, and Figure 7-25—a spike in the scrappage rate associated with calendar year 2009—occurring at ages 29, 24, 19, 14, and 9 for MYs 1980, 1985, 1990, 1995, and 2000, respectively. This is easily explained by the Car Allowance Rebate System (CARS) active in July and August of 2009 (discussed above). CARS aimed to accelerate the scrappage of older, less efficient and less safe vehicles as discussed in the literature review. Figure 7-26, below, shows the impact of the program from another perspective. It shows the observed instantaneous scrappage rate of MYs 1977-2015 by age for CYs 1980-2015. The black stars represent observed scrappage rates for calendar years where the CARS program was not in effect, the red stars represent CY 2009 when the CARS program was in effect, and the blue dots represent the mean value of the scrappage when CARS was not in effect.

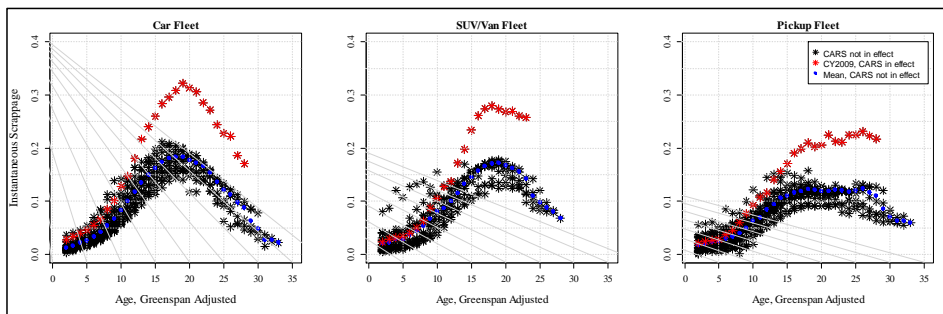

FIGURE 7-26 - IMPACTS OF THE 2009 CARS BY BODY STYLE

Notable from Figure 7-26 is that the effect of CARS on instantaneous scrappage is largest around the point that the average scrappage peaks for all other calendar years for each body style. For cars the effect of the program increases until around age 20 and then decreases, for vans/SUVs the effect increases until just after age 15 and then decreases at a much slower rate, and finally, for trucks the effect increases steadily until around age 17 and then nearly levels off for all observed ages. For this reason, a dummy variable for CY 2009 was interacted with linear and non-linear age variables to represent the effect of the CARS program.

Table 7-10, Table 7-11, and Table 7-12 in the section immediately following give the specification including a linear age effect for cars, vans/SUVs and pickups, respectively. For all body types the best fit model either includes only a constant CY 2009 effect, or a constant CY 2009 effect and an interaction with age, which allows a disproportionate scaling of the effect of CARS on scrappage with age. The age interaction is insignificant for cars, and the model is a worse fit than the preferred model by RSME, BIC and AIC. For vans/SUVs the model including the age interaction is a slightly better fit by all measures and the interaction is statistically

significant. However, the inclusion slightly changes the estimates of other coefficients, and results in a higher predicted share of vans/SUVs remaining for a MY 2015 van or SUV. Because the implications are small and the measures of fitness are close, only the constant CY 2009 term is included. For pickups, the model including an interaction is better only using the RMSE and AIC as criteria, and the interaction is also statistically significant. However, including the interaction has almost no impact on the predictions for MY 2015 vehicles, with average pickup CPM and new vehicle price held at MY 2015 levels; nor does it greatly change the estimates of other coefficients, so for simplicity's sake only the constant CY 2009 effect is included. The analysis confirmed that modeling as a constant dummy variable is sufficient to capture the nonlinear effect and accurately predict the spikes in scrappage under the CARS program.

7.8.7.10 Form of Cyclical Scrappage

As previously discussed, because the two leading measures of economic activity are collinear, the preferred model includes only one of GDP growth rate or unemployment rate; when both were included, the GDP growth rate was more predictive, so the GDP growth rate is included in the final model. The GDP growth rate is not a single-period effect; both the current and previous GDP growth rates will affect vehicle scrappage rates. A single year increase will affect scrappage differently than a multi-period trend. For this reason, an optimal number of lagged terms are included - the within-period GDP growth rate, the previous period GDP growth rate, and the growth rate from two prior years for the car model, while for vans/SUVs, and pickups, the current and previous period GDP growth rate are sufficient.

Table 7-10, Table 7-11, and Table 7-12 show the preferred model specifications for GDP growth rate for cars, vans/SUVs, and pickups, respectively. Summing the coefficients captures the overall effect of a constant positive GDP growth rate — for all body styles a constant positive GDP growth rate increases scrappage. For both cars and vans/SUVs, if all periods of GDP growth rate are positive, then scrappage increases. For trucks, however, the previous GDP growth rate is inversely related with scrappage — so that a positive GDP growth rate will increase scrappage in the current year, but decrease scrappage in the next year — that is, increased demand for new trucks in this period will take away from demand for new trucks in the next period. Another way of considering this effect is by taking the ratio of the two coefficients to predict under what changes in GDP growth rate the scrappage of trucks will decline — from this it is possible to conclude that if the GDP growth rate for this period is less than 42% of the GDP growth rate of the previous period, the scrappage of trucks will decline. This could be because trucks are purchased more often as a part of a non-personal fleet; commercial truck owners likely require a fairly constant supply of trucks for their businesses — they tend to purchase vehicles new, and more economic growth may result in faster commercial fleet turnover, but likely will not result in increased demand for new trucks from this source generally. Private fleets are more likely to substitute used vehicle purchases with new purchases under increased economic growth.

*** EO 12866 Review – Draft – Do Not Cite, Quote or Release During Review ***

Similarly, the considered model allows that one-period changes in new vehicle prices will affect the used vehicle market differently than a consistent trend in new vehicle prices. The optimal number of lags is three, so that the price trend from the current year and the three prior years influences the demand for and scrappage of used vehicles. Note that the average lease length is three years, so that the price of an average vehicle coming off lease is estimated to affect the scrappage rate of used vehicles — this is a major source of the newest used vehicles that enter the used car fleet.⁵¹⁶ Table 7-10, Table 7-11, and Table 7-12 show an alternative where the third lagged value of new vehicle prices is dropped for cars, vans/SUVs and pickups, respectively. For all body styles the better fit model is the one that includes all three lags by all measures (RMSE, BIC, and AIC).

Because increases in new vehicle prices due to increased stringency of CAFE standards is the primary mechanism through which CAFE standards influence vehicle scrappage, and the CAFE model assumes that usage, efficiency, and safety vary with the age of the vehicle, particular attention is paid to the form of this effect. It is important to know the likelihood of scrappage by the age of the vehicle to correctly account for the additional costs of additional fatalities and increased fuel consumption from deferred scrappage. Thus, the influence of increasing new vehicle prices is allowed to influence the demand for used vehicles (and reduce their scrappage) differently for different ages of vehicles in the scrappage model. For cars the best fit for the effect includes a linear, squared, and cubed terms, while for vans/SUVs and pickups, a linear and squared term suffice.

Table 7-10 shows a specification for cars which does not include a cubic term — this model has a higher RMSE, BIC, and AIC, suggesting that it is a worse fit. Table 7-11 and Table 7-12 show specifications of vans/SUVs and pickups, respectively, which both include a cubic term, and include only a linear term for new vehicle price interacted with the age of a vehicle. For both body styles the models not including a cubic term have lower AICs and RMSEs, but higher BICs and predict scrappage that is more aggressive than historically observed for older ages. The models with only a linear term are a worse fit by all measures. For these reasons, only a linear and squared term for new vehicle price interacted with age are included for these body styles.

There are at least two reasons the effect of increases in the likelihood of scrappage may not be constant over the age of vehicles. First, newer used vehicles are a closer substitute for new vehicles, so that when an individual opts to defer purchase of a new vehicle they are likely holding onto a relatively new used vehicle, or opting instead to buy a newer used vehicle. However, increasing the demand and prices of lightly used vehicles will result in a similar substitution effect for more worn vehicles, and so on, so that the value of all used vehicles should increase. This leads to the second factor that may explain the non-constant increase in the risk of scrappage—the decision to scrap a vehicle occurs where the value of the vehicle is less than the

⁵¹⁶ Edmunds Lease Market Report, January 2017, <https://dealers.edmunds.com/static/assets/articles/lease-report-jan-2017.pdf>

value of the vehicle as scrap and used parts less any maintenance costs. Any marginal maintenance event that scraps a more valuable vehicle will be a more expensive and less probabilistic event, while marginal maintenance events that scrap an older vehicle are likely to be less expensive and more probabilistic. Thus, a small variation in the price of older vehicles is more likely to change the decision of whether or not the vehicle is scrapped, and this altered decision criterion will affect more vehicles.

The final cyclical factor affecting vehicle scrappage in the preferred model is the cost per 100 miles of travel both of new vehicles and of the vehicle which is the subject of the decision to scrap or not to scrap. The new vehicle cost per 100 miles is defined as the ratio of the average fuel price faced by new vehicles in a given calendar year and the average new vehicle fuel economy for 100 miles in the same calendar year, and varies only with calendar year:

EQUATION 7-6 - VEHICLE POPULATION

$$New\ CPM100 = \frac{Per\ Gallon\ Avg.\ Fuel\ Price}{New\ Vehicle\ Avg.\ Fuel\ Economy} * 100$$

The cost per 100 miles of the potentially scrapped vehicle is described as the ratio of the average fuel price faced by that model year vintage in a given calendar year and the average fuel economy for 100 miles of travel for that model year when it was new, and varies both with calendar year and model year:

EQUATION 7-7 - VEHICLE POPULATION

$$CPM100 = \frac{Per\ Gallon\ Avg.\ Fuel\ Price}{MY\ Vintage\ Avg.\ Fuel\ Economy} * 100$$

The average per-gallon fuel price faced by a model year vintage in a given calendar year is the annual average fuel price of all fuel types present in that model year fleet for the given calendar year, weighted by the share of each fuel type in that model year fleet. Or the following, where FT represents the set of fuel types present in a given model year vintage:

EQUATION 7-8 - VEHICLE POPULATION

$$Per\ Gallon\ Avg.\ Fuel\ Price_{MY,CY} = \sum_{FT} Fuel\ Share_{MY,FT} * Avg.\ Fuel\ Price_{CY,FT}$$

For these variables, the best fit model includes the cost per mile of both new and the used vehicle for the current and prior year. This is congruent with research that suggests consumers respond to current fuel prices and fuel price changes.⁵¹⁷ Remember that the combination of the current and lagged cost per mile result in an estimate of the level and first period difference effect of cost of travel on vehicle scrappage. If the signs of the current and lagged values are opposite, the effect

⁵¹⁷ [citation forthcoming]

*** EO 12866 Review – Draft – Do Not Cite, Quote or Release During Review ***

of the change in the cost per mile changes sign at some identifiable value. Taking the negative ratio of the coefficients will identify the threshold where the sign change occurs.

By summing the current and lagged period new vehicle cost per mile coefficients, the overall level effect of the cost of travel can be computed by body style. As expected, the cost of travel for new vehicles is inversely related to the scrappage of cars and pickups—as new vehicles are more efficient there is an increase in the demand for new vehicles, and a decrease in the demand for used vehicles, holding new vehicle price constant. The van/SUV curve suggests that the level of the cost of travel for new vans/SUVs is positively correlated with the scrappage of used vehicles—that is, as the cost per mile of new vans/SUVs increases, new vans/SUVs become more attractive. It may be either that cost per mile is negatively correlated with van/SUV attributes consumers value more than fuel economy and/or that increases in the cost of travel result in a shift away from pickups and towards vans/SUVs which may be slightly more fuel efficient.

The differing signs between the current and lagged value of the cost per mile of new vehicles for all body styles implies that the impact of the change in the cost of travel changes sign depending on the magnitude of the change in the cost of travel. As noted above, taking the negative ratio of the coefficients tells us the threshold point for this change in sign. For cars, a new car CPM of 126% or greater than the that of the previous period will result in an increase in scrappage, while for vans and SUVs a current CPM at least 50% of the previous period's will result in an increase in scrappage. The difference in these threshold points is likely a result of the fact that the CPM for most cars of the same vintage is lower than the CPM of most vans/SUVs of the same vintage. A portion of the CPM change is driven by a change in fuel prices — as fuel prices increase only a substitution towards more fuel efficient new vehicles, but also a substitution towards more fuel efficient body styles is expected within the used fleet.

The effect of the change in CPM for pickups tells a slightly different story; taking the negative ratio, again, a CPM of new pickups this period of at least 82% of last period's will result in a reduction (rather than an increase) in scrappage. This is probably explained by the fact that pickups and cars serve different purposes, and often households have vehicles of both body styles in their fleet. The different purpose pickups serve within a household fleet could result in a greater opportunity cost of increasing fuel economy for pickups at the expense of features like torque or carrying capacity, which would result in decreased demand for new, more fuel efficient pickups. Another part of the explanation is that high fuel prices result in higher demand for more fuel efficient body styles; because pickups are often a part of a household fleet, higher fuel prices result in a reduction for the demand of pickups, and households delay trading in their pickup for newer, more fuel efficient versions and instead update another household vehicle of a different body style.

Changes in the cost of travel within a model year vintage as modelled only has variance from the change in fuel prices.⁵¹⁸ Taking the ratio of the coefficients of the current and previous cost per mile as with the new cost per mile, the effect of the change in fuel prices on the scrappage of a given model year vintage can be computed. For cars, a current fuel price 99% or higher than the last period will result in an increase in the scrappage of cars — as fuel prices increase, so does the scrappage of on-road cars. For vans/SUVs, a current fuel price 32% or higher than the last period will result in an increase in scrappage. For pickups, a current fuel price 255% or higher than the last period will result in a decrease (not an increase) in scrappage. Note that for most observed fuel price increases, there is a projected increase in pickup scrappage — it is only under high fuel price increases (again, a 255% or higher increase over the previous period) that scrappage for pickups decreases. This could likely be due to the fact that high increases in fuel price will shift demand towards other body styles and away from less efficient pickups. The combined implications of both the price and cost of travel estimates in the context of further fuel economy standards is discussed further in the following section.

Table 7-10, Table 7-11, and Table 7-12 include interest rates and maintenance and repair CPI for cars, vans/SUVs, and pickups, respectively. For cars, as shown in Table 8-8, real interest rate is of the opposite sign than expected; as real interest rates increase, so does the scrappage rate — this model is also a worse fit by measures of AIC and BIC relative to the preferred model. The car model including the maintenance and repair CPI shows a sign on maintenance and repair as expected; as maintenance and repair costs increase, so does scrappage; however, it is statistically insignificant, and the overall model is a worse fit than the otherwise identical model excluding the variable; for these reasons (and the theoretical concerns about maintenance and repair mentioned in the data section), the preferred model for cars excludes maintenance and repair costs.

⁵¹⁸ Note again the Jacobsen paper, which suggests that the average fuel economy of a model year fleet will change as the vintage ages because the most fuel efficient vehicles scrap first.

*** EO 12866 Review – Draft – Do Not Cite, Quote or Release During Review ***

TABLE 7-10 - ALTERNATIVE CAR CYCLICAL AND CARS SCRAPPAGE SPECIFICATIONS

Variable	Price, Alt. 1	Price, Alt. 2	Interest Rate	Maint./Repair	CY 2009*Age
<i>Age</i>	0.67265955*	-0.08612656	0.59365281*	0.52855844	0.60621477*
<i>Age</i> ²	-0.05409594*	0.00521654	-0.05555994**	-0.05076388*	-0.05702798**
<i>Age</i> ³	0.00148933**	0.00002441	0.00154174***	0.00144932**	0.00159217***
<i>log</i> (<i>MY</i> – 1959)	-1.47188184***	-1.27036097***	-1.49938591***	-1.83079387***	-1.61812991***
<i>log</i> (<i>MY</i> – 1959) * <i>Age</i>	0.19033212***	0.14844147***	0.21001265***	0.22354143***	0.21539630***
<i>log</i> (<i>MY</i> – 1959) * <i>Age</i> ²	-0.00638644***	-0.00447643***	-0.00662407***	-0.00705482***	-0.00679389***
<i>New.Price</i>	-0.00005696	-0.00017036***	-0.00016883	-0.00016056	-0.00016036
<i>New.Price</i> * <i>Age</i>	-0.00000695	0.00001273*	0.00000849	0.00000771	0.00000755
<i>New.Price</i> * <i>Age</i> ²	0.00000073	-0.00000039**	0.00000006	0.00000008	0.00000012
<i>New.Price</i> * <i>Age</i> ³	-0.00000002	0	-0.00000001	-0.00000001	-0.00000001
<i>lag</i> (<i>New.Price</i>)	-0.00016753	0.00021814***	0.0000916	0.00008747	0.00009006
<i>lag</i> (<i>New.Price</i>) * <i>Age</i>	0.00004618	-0.00002811***	-0.00000145	-0.0000008	-0.00000075
<i>lag</i> (<i>New.Price</i>) * <i>Age</i> ²	-0.00000340*	0.00000080***	-0.00000079	-0.00000084	-0.00000086
<i>lag</i> (<i>New.Price</i>) * <i>Age</i> ³	0.00000007*	0	0.00000003	0.00000003	0.00000003
<i>lag</i> ₂ (<i>New.Price</i>)	0.00030835***	-0.00024691***	-0.00033782**	-0.00033391**	-0.00033073**
<i>lag</i> ₂ (<i>New.Price</i>) * <i>Age</i>	-0.00007086***	0.00003320***	0.00005241*	0.00005238*	0.00005050*
<i>lag</i> ₂ (<i>New.Price</i>) * <i>Age</i> ²	0.00000475***	-0.00000112***	-0.00000224	-0.00000225	-0.0000021
<i>lag</i> ₂ (<i>New.Price</i>) * <i>Age</i> ³	-0.00000009***	0	0.00000002	0.00000002	0.00000002
<i>lag</i> ₃ (<i>New.Price</i>)	0	0.00019210***	0.00049795***	0.00049766***	0.00049247***
<i>lag</i> ₃ (<i>New.Price</i>) * <i>Age</i>	0	-0.00002292**	-0.00009208***	-0.00009143***	-0.00009094***
<i>lag</i> ₃ (<i>New.Price</i>) * <i>Age</i> ²	0	0.00000078***	0.00000517***	0.00000511***	0.00000510***
<i>lag</i> ₃ (<i>New.Price</i>) * <i>Age</i> ³	0	0	-0.00000008***	-0.00000008***	-0.00000008***
<i>CPM.Car</i> _{MY}	-0.08072916*	-0.08885701**	-0.08258189*	-0.08986721**	-0.09466128*
<i>lag</i> (<i>CPM.Car</i> _{MY})	0.07056412	0.08945285**	0.08501118*	0.08138707*	0.09423355*
<i>New.CPM.Car</i> _{CY}	0.08551972	0.08158892	0.08145106	0.08137274	0.08981588
<i>lag</i> (<i>New.CPM.Car</i> _{CY})	-0.09080758	-0.09711815*	-0.10969024*	-0.09625982*	-0.11130146*
<i>GDP.growth.rate</i>	0.02732897***	0.04845146***	0.04708064***	0.04755521***	0.04793574***
<i>lag</i> (<i>GDP.growth.rate</i>)	0.01615282**	0.02375206***	0.02585502***	0.02831877***	0.02486136***
<i>lag</i> ₂ (<i>GDP.growth.rate</i>)	0.00653671	0.01012622	0.01160593	0.01157896	0.01059526
<i>Real.Interest.Rate</i>	0	0	0.00745646	0	0

*** EO 12866 Review – Draft – Do Not Cite, Quote or Release During Review ***

<i>Maint. Repair. CPI</i>	0	0	0	0.00406616	0
<i>lag</i> (Dependent Var.)	0.23989055***	0.24165485***	0.20039085***	0.19118863***	0.20248739***
<i>lag</i> ₂ (Dependent Var.)	0.11363811***	0.16864597***	0.15139107***	0.14838911***	0.15217290***
<i>lag</i> ₃ (Dependent Var.)	-0.01976982	0.03476564	0.04207924	0.04040274	0.03490939
<i>CARS</i> (CY2009)	0.85190319***	0.95604673***	0.94220655***	0.90483718***	0.97623209***
<i>CARS</i> (CY2009) * <i>Age</i>	0	0	0	0	-0.00204325
Degrees of Freedom	429	429	424	424	424
R-squared	0.9568	0.9608	0.9637	0.9637	0.9637
RSME	0.1612	0.1535	0.1487	0.1486	0.1488
AIC	-341.8	-386.6	-411.2	-412.1	-411
BIC	-213.8	-258.6	-262.5	-263.4	-262.3

Table 7-11 shows the alternate cyclical specifications for vans/SUVs. The model including real interest rate predicts a counter-intuitive and statistically insignificant sign for real interest rates; it suggests as real interest rates increase, so does the scrappage rate. The model is a worse fit than the model excluding it, and for this reason, real interest rate is not included in the preferred specification. The model including the maintenance and repair CPI is a better fit than the model without it. However, the statistically significant estimate for maintenance and repair CPI is opposite than expected; as maintenance and repair costs increase, the scrappage rate decreases. Given this and the theoretical concerns about maintenance and repair mentioned in the data section, this variable is excluded in the final preferred model.

*** EO 12866 Review – Draft – Do Not Cite, Quote or Release During Review ***

TABLE 7-11 - ALTERNATIVE SUV CYCLICAL AND CARS SCRAPPAGE SPECIFICATIONS

Variable	Price, Alt. 1	Price, Alt. 2	Price, Alt. 3	Interest Rate	Maint./Repair	CY 2009*Age
<i>Age</i>	-3.26970936***	-2.75791105***	-0.72832869***	-0.45222568**	-0.49355331**	-0.70098169***
<i>Age</i> ²	0.24553617***	0.20775827***	0.04182791***	0.03194094***	0.03251389***	0.04598950***
<i>Age</i> ³	-0.00465692***	-0.00403403***	-0.00020784***	-0.00030275***	-0.00029112***	-0.00034740***
<i>log(MY – 1959)</i>	-3.62880725***	-3.56606234***	-2.86380333***	-3.85329770***	-1.25040567*	-4.02184829***
<i>log(MY – 1959) * Age</i>	0.47336863***	0.45251633***	0.37303346***	0.50461238***	0.39414519***	0.52918132***
<i>log(MY – 1959) * Age</i> ²	-0.01502987***	-0.01398425***	-0.01164361***	-0.01518298***	-0.01240910***	-0.01633480***
<i>New. Price</i>	0.00030200*	0.00045013**	0.00024963***	0.00036711***	0.00035256***	0.00036550***
<i>New. Price * Age</i>	0.00000112	-0.00003888	-0.00001040***	-0.00002900**	-0.00002429**	-0.00002631**
<i>New. Price * Age</i> ²	-0.00000262	0.00000056	0	0.00000060*	0.00000058*	0.00000044
<i>New. Price * Age</i> ³	0.00000008**	0.00000001	0	0	0	0
<i>lag(New. Price)</i>	-0.00038909	-0.00041166*	-0.00018529***	-0.00017373	-0.00022374*	-0.00012056
<i>lag(New. Price) * Age</i>	0.00003853	0.00004824	0.00000045	0.00000031	0.00000051	-0.00000846
<i>lag(New. Price) * Age</i> ²	-0.00000166	-0.00000288	0	0.00000002	-0.00000002	0.00000023
<i>lag(New. Price) * Age</i> ³	0.00000002	0.00000005	0	0	0	0
<i>lag₂(New. Price)</i>	0.0000381	-0.00015623	0.00017401***	-0.00004333	-0.00006922	-0.00011633
<i>lag₂(New. Price) * Age</i>	0.00001303	0.00004818	-0.00001007***	0.00001834	0.00002042	0.00002934*
<i>lag₂(New. Price) * Age</i> ²	-0.00000137	-0.00000274	0	-0.00000068*	-0.00000080**	-0.00000101**
<i>lag₂(New. Price) * Age</i> ³	0.00000003	0.00000004	0	0	0	0
<i>lag₃(New. Price)</i>	0	0.00010833	-0.00010420***	0.00013961*	0.00007648	0.00014130*
<i>lag₃(New. Price) * Age</i>	0	-0.00001747	0.00000853***	-0.00002548***	-0.00001851**	-0.00002602***
<i>lag₃(New. Price) * Age</i> ²	0	0.00000037	0	0.00000089***	0.00000074***	0.00000090***

*** EO 12866 Review – Draft – Do Not Cite, Quote or Release During Review ***

$lag_3(New.Price) * Age^3$	0	0.00000001	0	0	0	0
$CPM.SUV_{MY}$	-0.11221428**	-0.13736113**	-0.11976707**	-0.13533990**	-0.10871745**	-0.24774627***
$lag(CPM.SUV_{MY})$	0.04969991	0.06151321	0.03969436	0.04316947	0.11210435**	0.15160222**
$New.CPM.SUV$	0.22514716***	0.26714162***	0.24057616***	0.27353521***	0.29183649***	0.40880736***
$lag(New.CPM.SUV)$	-0.14352088*	-0.15680329**	-0.12435770*	-0.14047347*	-0.24990264***	-0.27297839***
$GDP.growth.rate$	0.05185019***	0.05501193***	0.05719946***	0.05891639***	0.06776626***	0.05986268***
$lag(GDP.g.r.)$	0.07963177***	0.07608427***	0.08305604***	0.07270305***	0.03891725***	0.07600393***
$Real.Interest.Rate$	0	0	0	0.01021969	0	0
$Maint.Repair.CPI$	0	0	0	0	-0.04542069***	0
$lag(Dep.Var.)$	0.21967465***	0.20120563***	0.21652778***	0.18446614***	0.18343753***	0.17575656***
$lag_2(Dep.Var.)$	0.01410376	0.03017646	0.00062824	0.00185897	0.01854784	0.01758024
$lag_3(Dep.Var.)$	-0.10646839***	-0.06902920**	-0.06918297**	-0.06572978*	-0.00962556	-0.07407809**
$CARS(CY2009)$	1.33764602***	1.40222890***	1.38618394***	1.44618397***	1.99024997***	1.85682519***
$CARS(CY2009) * Age$	0	0	0	0	0	-0.02699908**
Degrees of Freedom	414	410	418	413	413	413
R-squared	0.8853	0.8927	0.882	0.8886	0.8992	0.8902
RSME	0.2683	0.2608	0.2709	0.2648	0.2519	0.2628
AIC	121.6	100	126.2	110.9	66.5	104.2
BIC	244.4	239.1	232.7	237.8	193.4	231.1

Table 7-12 shows similar cyclical scrappage alternatives for pickup trucks. The model including real interest rate is a worse fit model by all reported metrics, and the sign on real interest rate is statistically insignificant and of a counter-intuitive sign; for these reasons, this variable is excluded. The model including maintenance and repair CPI is a slightly better fit than the model without it. The sign on maintenance and repair costs is of the expected sign, and statistically significant. However, because of the theoretical concerns with maintenance and repair costs described previously, and the fact that the model is not able to predict relative maintenance and repair costs for all vehicles into the future with much fidelity, maintenance and repair costs are not included in the final model.

*** EO 12866 Review – Draft – Do Not Cite, Quote or Release During Review ***

TABLE 7-12 - ALTERNATIVE PICKUP CYCLICAL AND CARS SCRAPPAGE SPECIFICATIONS

Variable	Price, Alt. 1	Price, Alt. 2	Price, Alt. 3	Interest Rate	Maint./Repair	CY 2009*Age
<i>Age</i>	-0.86293421***	-0.94516756***	-0.42466482***	-0.86660776***	-0.90448563***	-0.97182461***
<i>Age</i> ²	0.03182109***	0.03480834***	0.01647568***	0.03112470***	0.03231390***	0.03672184***
<i>log</i> (<i>MY</i> – 1959)	-2.43834939***	-3.10053590***	-2.75950777***	-2.55455298***	-3.19050784***	-2.49265788***
<i>log</i> (<i>MY</i> – 1959) * <i>Age</i>	0.26688474***	0.35429909***	0.26254521***	0.27296884***	0.29092998***	0.26654808***
<i>log</i> (<i>MY</i> – 1959) * <i>Age</i> ²	-0.00636506***	-0.00907888***	-0.00616535***	-0.00645816***	-0.00699053***	-0.00632925***
<i>New.Price</i>	-0.000096	-0.0002	-0.00011783***	-0.00031916***	-0.00033608***	-0.00032979***
<i>New.Price</i> * <i>Age</i>	.00000313	.0000017	-.0000012	0.00002525***	0.00002606***	0.00002744***
<i>New.Price</i> * <i>Age</i> ²	-.00000022	.00000053	0	-0.00000080***	-0.00000085***	-0.00000090***
<i>New.Price</i> * <i>Age</i> ³	0	-.00000002	0	0	0	0
<i>lag</i> (<i>New.Price</i>)	0.000126	0.00018	0.00032825***	0.00040777***	0.00040475***	0.00043890***
<i>lag</i> (<i>New.Price</i>) * <i>Age</i>	.00000618	.0000299	-0.00000877***	-0.00002116*	-.00002	-0.00002358*
<i>lag</i> (<i>New.Price</i>) * <i>Age</i> ²	-.00000036	-.0000028	0	.00000035	.00000034	.00000034
<i>lag</i> (<i>New.Price</i>) * <i>Age</i> ³	0	.00000006	0	0	0	0
<i>lag</i> ₂ (<i>New.Price</i>)	.00000083	-0.00028623**	-0.00023226***	-0.00043036***	-0.00042572***	-0.00047198***
<i>lag</i> ₂ (<i>New.Price</i>) * <i>Age</i>	-.0000032	.00000025	0.00000411*	0.00003334***	0.00003382***	0.00003766***
<i>lag</i> ₂ (<i>New.Price</i>) * <i>Age</i> ²	.0000001	.00000126	0	-0.00000081**	-0.00000082***	-0.00000088***
<i>lag</i> ₂ (<i>New.Price</i>) * <i>Age</i> ³	0	-0.00000004	0	0	0	0
<i>lag</i> ₃ (<i>New.Price</i>)	0	0.00040541***	0.00016275***	0.00038422***	0.00041744***	0.00038516***
<i>lag</i> ₃ (<i>New.Price</i>) * <i>Age</i>	0	-0.00003568***	-0.00000280*	-0.00003352***	-0.00003697***	-0.00003358***
<i>lag</i> ₃ (<i>New.Price</i>) * <i>Age</i> ²	0	0.00000087***	0	0.00000084***	0.00000093***	0.00000084***
<i>CPM.Truck</i> _{MY}	0.07769667*	0.046962	0.06601023*	0.07382682*	0.07173813*	0.06792421*

*** EO 12866 Review – Draft – Do Not Cite, Quote or Release During Review ***

<i>lag(CPM.Truck_{MY})</i>	-0.08834450**	-0.06753144*	-0.08465369**	-0.09169171**	-0.10119167***	-0.08433284**
<i>New.CPM.Truck</i>	-0.12127200**	-0.10058931*	-0.11506474**	-0.13227482**	-0.14431363***	-0.12624446**
<i>lag(New.CPM.Trk)</i>	0.057622	0.065229	0.09301920*	0.09486840*	0.11389617**	0.084165
<i>GDP.growth.rate</i>	-0.00708	0.03356596**	0.03276145**	0.03478365**	0.03463956**	0.03402064**
<i>lag(GDP.g.r.)</i>	-0.00282	0.015621	0.011053	0.015056	0.02969903**	0.016681
<i>Real.Interest.Rate</i>	0	0	0	0.000609	0	0
<i>Maint.Repair.CPI</i>	0	0	0	0	0.01451398***	0
<i>lag(Dep.Var.)</i>	0.09295185**	0.13578716***	0.16873440***	0.14696119***	0.13999182***	0.14138107***
<i>lag₂(Dep.Var.)</i>	0.021262	0.040308	0.030183	0.048028	0.054592	0.05071
<i>lag₃(Dep.Var.)</i>	0.040384	0.09832306***	0.08184131***	0.10183017***	0.10146581***	0.10079950***
<i>CARS(CY2009)</i>	0.80319969***	0.88180854***	0.97222593***	0.91140183***	0.74957548***	1.15104287***
<i>CARS(CY2009) * Age</i>	0	0	0	0	0	-0.01543554**
<i>MY95_00</i>	4.317663	2.86575	1.722766	3.314202	3.569883	3.508921
<i>MY95_00 * log(MY – 1959)</i>	-0.99669	-0.65333	-0.36241	-0.77098	-0.84359	-0.81947
<i>MY95_00 * log(MY – 1959) * Age</i>	-0.01140047***	-0.00822357***	-0.00610444**	-0.00851962***	-0.00848145***	-0.00881550***
Degrees of Freedom	397	391	398	393	393	393
R-squared	0.9139	0.9283	0.9213	0.9271	0.9284	0.9281
RSME	0.218	0.2004	0.2081	0.2016	0.1997	0.2002
AIC	-59.8	-125.5	-100.3	-122.5	-130.5	-128.5
BIC	57.7	16.3	13.2	11.2	3.2	5.2

7.8.8 Autocorrelation

As noted in Bento, Roth & Zhuo (2016), a potential problem for these scrappage panel models is serial correlation within the times component of each individual model year cohort.⁵¹⁹ Serial correlation was tested for using the Breusch-Godfrey/Woolridge test and the Durbin Watson test for panel models both implemented in the plm package of R.⁵²⁰ The test statistics and significance for all tests using the preferred model, only with a different number of lagged dependent variables, are presented in Table 7-13, Table 7-14, and

⁵¹⁹ Bento, A., et al. "Vehicle Lifetime Trends and Scrappage Behavior in the U.S. Used Car Market." *The Energy Journal*, vol. 39, no. 1, Jan. 2018, doi:10.5547/01956574.39.1.aben.

⁵²⁰ R is an open-source statistical programming software. The plm package is an add-on which enables the ability to model panel data.

*** EO 12866 Review – Draft – Do Not Cite, Quote or Release During Review ***

Table 7-15 for cars, vans/SUVs, and pickups, respectively. The null hypothesis of no serial correlation of at least one of the tests is rejected when no lags of the dependent variable are included (because the p-value is less than 0.1). For all body styles the test resulted in a failure to reject the null hypothesis that there is no serial correlation when three lags of the dependent variables were included. For cars, there seems to be no signs of serial correlation after the inclusion of one lagged dependent variable. However, as shown in the succeeding alternative specifications section, up to three included lags of the dependent variable remain statistically significant. Also, the models that include further lagged dependent variables are better fitting models from the RMSEs, BICs, and AICs. For these reasons, three lags of the car dependent variable were included, even though one seems to be sufficient to correct for serial correlation.

*** EO 12866 Review – Draft – Do Not Cite, Quote or Release During Review ***

TABLE 7-13 - ALTERNATIVE CAR AUTOCORRELATION CORRECTIONS

Variable	Preferred, 3 lags	Dep., 2 lags	Dep., 1 lag	Dep., No lag
<i>Age</i>	0.61604705*	0.349776	1.34182502***	1.31491092***
<i>Age</i> ²	-0.05740675**	-0.02779	-0.08920458***	-0.08079116***
<i>Age</i> ³	0.00158213***	0.00085427*	0.00195727***	0.00173634***
<i>log(MY – 1959)</i>	-1.60888589***	-1.07487831***	-0.83140443***	-0.05872
<i>log(MY – 1959) * Age</i>	0.21358227***	0.15922394***	0.11974438***	0.021546
<i>log(MY – 1959) * Age</i> ²	-0.00671599***	-0.00555129***	-0.00468093***	-0.00199
<i>New.Price</i>	-0.00016128	-0.00013	-2.6E-05	-0.00011742*
<i>New.Price * Age</i>	0.00000784	-3.6E-06	-2.4E-05	-9.6E-06
<i>New.Price * Age</i> ²	0.0000001	6.3E-07	0.00000203*	1.2E-06
<i>New.Price * Age</i> ³	-0.00000001	-2E-08	-0.00000005*	-3E-08
<i>lag(New.Price)</i>	0.00009476	1.49E-05	7.81E-05	7.58E-05
<i>lag(New.Price) * Age</i>	-0.00000234	1.96E-05	-3.8E-07	-7.6E-07
<i>lag(New.Price) * Age</i> ²	-0.00000074	-2.1E-06	-7.6E-07	-6.1E-07
<i>lag(New.Price) * Age</i> ³	0.00000003	5E-08	3E-08	2E-08
<i>lag</i> ₂ <i>(New.Price)</i>	-0.00033559**	-0.00011	-0.00017	-7.6E-05
<i>lag</i> ₂ <i>(New.Price) * Age</i>	0.00005203*	6.43E-06	2.12E-05	2.76E-06
<i>lag</i> ₂ <i>(New.Price) * Age</i> ²	-0.00000222	3.8E-07	-3.5E-07	6.2E-07
<i>lag</i> ₂ <i>(New.Price) * Age</i> ³	0.00000002	-3E-08	-1E-08	-3E-08
<i>lag</i> ₃ <i>(New.Price)</i>	0.00049373***	0.00025160***	0.00022065***	0.00012332**
<i>lag</i> ₃ <i>(New.Price) * Age</i>	-0.00009124***	-0.00004300***	-0.00004064***	-2.2E-05
<i>lag</i> ₃ <i>(New.Price) * Age</i> ²	0.00000512***	0.00000233**	0.00000206**	1.12E-06
<i>lag</i> ₃ <i>(New.Price) * Age</i> ³	-0.00000008***	-3E-08	-3E-08	-1E-08
<i>CPM.Car_{MY}</i>	-0.08588378*	-0.10324391**	-0.08025	-0.06545
<i>lag(CPM.Car_{MY})</i>	0.08546280*	0.08800963*	0.036714	0.029349
<i>New.CPM.Car_{CY}</i>	0.08029769	0.078675	0.099257	0.102975
<i>lag(New.CPM.Car_{CY})</i>	-0.10117160*	-0.08098	-0.05577	-0.09801
<i>GDP.growth.rate</i>	0.04791870***	0.06641936***	0.06254757***	0.06529784***
<i>lag(GDP.growth.rate)</i>	0.02476165***	0.02183242***	0.01326438*	0.002756
<i>lag</i> ₂ <i>(GDP.growth.rate)</i>	0.01101399	0.008892	0.011219	0.012214
<i>lag(Dependent Var.)</i>	0.20296197***	0.24595244***	0.22394817***	0
<i>lag</i> ₂ <i>(Dependent Var.)</i>	0.15087160***	0.16464818***	0	0
<i>lag</i> ₃ <i>(Dependent Var.)</i>	0.03576158	0	0	0
<i>CARS(CY2009)</i>	0.94774531***	0.93143897***	1.06401945***	1.13421254***
Degrees of Freedom	425	487	551	614
R-squared	0.9636	0.9608	0.9549	0.9458
RSME	0.1486	0.1672	0.199	0.2367
AIC	-412.8	-350.3	-194.7	3.8
BIC	-268.3	-205.6	-50.6	146.8
Breusch-Godfrey Chi-sqr.	0.01	.32	.1	18.1***
Durbin-Watson Statistic	2	2	2	1.7***

*** EO 12866 Review – Draft – Do Not Cite, Quote or Release During Review ***

TABLE 7-14 - ALTERNATIVE SUV AUTOCORRELATION CORRECTIONS

Variable	Preferred, 3 lags	Dep., 2 lags	Dep., 1 lag	Dep., No lag
<i>Age</i>	-0.47344112**	-0.29578083	-0.17309695	-0.39542341**
<i>Age</i> ²	0.03232415***	0.02591121***	0.02093263***	0.03350263***
<i>Age</i> ³	-0.00030189***	-0.00027212***	-0.00025095***	-0.00031707***
<i>log(MY – 1959)</i>	-3.94661636***	-3.09257807***	-2.64446184***	-2.94321591***
<i>log(MY – 1959) * Age</i>	0.50480338***	0.43452561***	0.38959889***	0.44027855***
<i>log(MY – 1959) * Age</i> ²	-0.01515964***	-0.01343924***	-0.01216213***	-0.01388001***
<i>New.Price</i>	0.00037159***	0.00032394***	0.00034022***	0.00047858***
<i>New.Price * Age</i>	-0.00002887**	-0.00002603**	-0.00003186***	-0.00004659***
<i>New.Price * Age</i> ²	0.00000059*	0.00000054*	0.00000069**	0.00000102***
<i>lag(New.Price)</i>	-0.00018534	-0.00020144*	-0.00025587***	-0.00039192***
<i>lag(New.Price) * Age</i>	0.00000109	-0.0000002	0.0000112	0.00002923**
<i>lag(New.Price) * Age</i> ²	0.00000001	0.00000006	-0.00000024	-0.00000074*
<i>lag₂(New.Price)</i>	-0.00003482	-0.00004632	-0.00002409	0.00000768
<i>lag₂(New.Price) * Age</i>	0.00001745	0.00002067	0.00001423	0.00001122
<i>lag₂(New.Price) * Age</i> ²	-0.00000067*	-0.00000077**	-0.00000056	-0.00000049
<i>lag₃(New.Price)</i>	0.00013793*	0.00015994**	0.00014971**	0.00011899**
<i>lag₃(New.Price) * Age</i>	-0.00002503***	-0.00002816***	-0.00002604***	-0.00002337***
<i>lag₃(New.Price) * Age</i> ²	0.00000088***	0.00000097***	0.00000090***	0.00000083***
<i>CPM.SUV_{MY}</i>	-0.13815102**	-0.15995632***	-0.12826469**	-0.06871637
<i>lag(CPM.SUV_{MY})</i>	0.04460368	0.06817261	0.04182079	-0.02322427
<i>New.CPM.SUV_{CY}</i>	0.27307243***	0.29587822***	0.24288277***	0.16088568**
<i>lag(New.CPM.SUV_{CY})</i>	-0.13534695*	-0.18573498**	-0.14857369**	-0.08776628
<i>GDP.growth.rate</i>	0.06054021***	0.05126592***	0.05638390***	0.04705645***
<i>lag(GDP.growth.rate)</i>	0.07254451***	0.08444594***	0.08231005***	0.07618521***
<i>lag(Dependent Var.)</i>	0.18961627***	0.19121841***	0.25341776***	0
<i>lag₂(Dependent Var.)</i>	0.00502922	0.04170485	0	0
<i>lag₃(Dependent Var.)</i>	-0.06628044**	0	0	0
<i>CARS(CY2009)</i>	1.46662812***	1.42924286***	1.45228763***	1.45910383***
Degrees of Freedom	414	470	530	594
R-squared	0.8885	0.8906	0.8987	0.8832
RSME	0.2646	0.2775	0.2883	0.3351
AIC	109.1	165.7	223.5	431.4
BIC	231.9	287.8	344.5	551
Breusch-Godfrey Chi-sqr.	4	8.3*	2.7*	13.2***
Durbin-Watson Statistic	2.1	2.1	2.1	1.7***

*** EO 12866 Review – Draft – Do Not Cite, Quote or Release During Review ***

TABLE 7-15 - ALTERNATIVE TRUCK AUTOCORRELATION CORRECTIONS

Variable	Preferred, 3 lags	Dep., 2 lags	Dep., 1 lag	Dep., No lag
<i>Age</i>	-0.86677928***	-0.98442349***	-0.47859285***	-0.71259846***
<i>Age</i> ²	0.03112533***	0.03070412***	0.01503673***	0.02176385***
<i>log</i> (<i>MY</i> – 1959)	-2.56039652***	-2.99703714***	-2.77722972***	-2.44261811***
<i>log</i> (<i>MY</i> – 1959) * <i>Age</i>	0.27307916***	0.28740448***	0.24225912***	0.21559927***
<i>log</i> (<i>MY</i> – 1959) * <i>Age</i> ²	-0.00646007***	-0.00624998***	-0.00491011***	-0.00381027***
<i>New.Price</i>	-0.00031900***	-0.00026850***	-4.7E-05	-4.8E-05
<i>New.Price</i> * <i>Age</i>	0.00002526***	0.00002236**	-5E-06	9E-08
<i>New.Price</i> * <i>Age</i> ²	-0.00000080***	-0.00000071***	2E-08	-1.7E-07
<i>lag</i> (<i>New.Price</i>)	0.00040797***	0.00024558**	0.000151	2.64E-05
<i>lag</i> (<i>New.Price</i>) * <i>Age</i>	-0.00002120*	-1.8E-06	1.13E-05	1.55E-05
<i>lag</i> (<i>New.Price</i>) * <i>Age</i> ²	0.00000035	-1.6E-07	-4.6E-07	-5.3E-07
<i>lag</i> ₂ (<i>New.Price</i>)	-0.00043049***	-0.00024522***	-0.00026110***	-0.00017865**
<i>lag</i> ₂ (<i>New.Price</i>) * <i>Age</i>	0.00003337***	1.53E-05	1.36E-05	1.42E-05
<i>lag</i> ₂ (<i>New.Price</i>) * <i>Age</i> ²	-0.00000081**	-3E-07	-2.3E-07	-2.9E-07
<i>lag</i> ₃ (<i>New.Price</i>)	0.00038428***	0.00030888***	0.00027874***	0.00023616***
<i>lag</i> ₃ (<i>New.Price</i>) * <i>Age</i>	-0.00003353***	-0.00002941***	-0.00002464***	-0.00002340***
<i>lag</i> ₃ (<i>New.Price</i>) * <i>Age</i> ²	0.00000084***	0.00000074***	0.00000060***	0.00000058***
<i>CPM.Truck</i> _{MY}	0.07367069*	0.17348423***	0.16078021***	0.19764086***
<i>lag</i> (<i>CPM.Truck</i> _{MY})	-0.09157160**	-0.18974323***	-0.17727692***	-0.20015230***
<i>New.CPM.Truck</i> _{CY}	-0.13230543**	-0.24051628***	-0.23076493***	-0.27195152***
<i>lag</i> (<i>New.CPM.Truck</i> _{CY})	0.09496014*	0.20461999***	0.19818251***	0.19150483***
<i>GDP.growth.rate</i>	0.03480447**	0.017603	0.013937	-0.00903
<i>lag</i> (<i>GDP.growth.rate</i>)	0.0149701	-0.00518	-0.00373	-0.00168
<i>lag</i> (<i>Dependent Var.</i>)	0.14683419***	0.11048006***	0.14775573***	0
<i>lag</i> ₂ (<i>Dependent Var.</i>)	0.04812011	0.045045	0	0
<i>lag</i> ₃ (<i>Dependent Var.</i>)	0.10184713***	0	0	0
<i>CARS</i> (<i>CY</i> 2009)	0.91228345***	0.98122041***	0.99760991***	0.93453406***
<i>MY</i> 95_00	3.31543806	7.04904262***	6.54838283**	6.77638925**
<i>MY</i> 95_00 * <i>log</i> (<i>MY</i> – 1959)	-0.77125504	-1.78190244**	-1.67650733**	-1.68084767**
<i>MY</i> 95_00 * <i>log</i> (<i>MY</i> – 1959) * <i>Age</i>	-0.00852493***	-0.00934939***	-0.00661393**	-0.01068555***
Degrees of Freedom	394	453	515	578
R-squared	0.9271	0.9074	0.8989	0.8759
RSME	0.2013	0.2416	0.2692	0.3144
AIC	-124.5	29.5	146	346.6
BIC	5.2	159.1	275	474.4
Breusch-Godfrey Chi-sqr.	4.1	12.2***	20.1***	8.1
Durbin-Watson Statistic	2.2	2.3	2.2	1.9*

7.8.9 Predictions and Use in the CAFE Model

Figure 7-27, Figure 7-28 and Figure 7-29 show predicted versus observed instantaneous scrappage rates for selected model years; the dotted lines show predicted values, and the solid lines show the observed values. Figure 7-27 shows the instantaneous scrappage for cars, and as shown below, the model captures the general trends of scrappage for given model years. Note that the constant CY 2009 effect captures the peaks very well, but that some of the other peaks are not captured as effectively. This is likely due to the inclusion of lagged dependent variables that build in trends, but does not allow for the capturing of some of the more peaked variation.

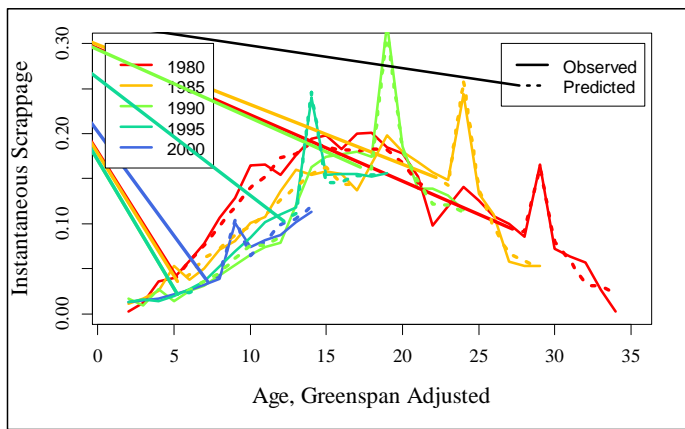

FIGURE 7-27 - CAR PREDICTED AND OBSERVED INSTANTANEOUS SCRAPPAGE

Figure 7-28 shows the observed and predicted instantaneous scrappage rates for vans and SUVs. The constant increase assigned to calendar year 2009 captures the peaks for all model years. The van and SUV data is noisier than the car data, but the model for vans and SUVs captures most of the obvious peaks within the data. The model does not capture the peak for model year 1990 around age 6, which is likely an outlier. The model also under-predicts the instantaneous scrappage rates for ages 15 through 20 for model year 1980. This is likely due to the lower scrappage rate for 1980 vehicles before ages 15, and the persistence of the lagged dependent variables into later ages. As mentioned above, early vans and SUVs were built on pickup truck platforms, and therefore MY 1980 results more closely resemble the skewed instantaneous scrappage pattern of the pickups in Figure 7-29. The durability trend observed towards the end of the sample period for vans/SUVs, which is captured well, represents the trends for vehicles built on car platforms; there is no current data to suggest that future vans/SUVs will not continue to be built on similar platforms. Thus, the durability trend predicted towards the end of the period is projected forward for model years 2016-2032, the model years simulated by the CAFE Model.

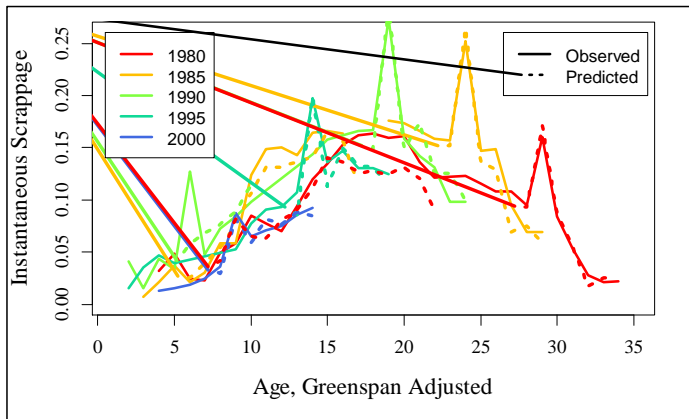

FIGURE 7-28 - VAN AND SUV OBSERVED AND PREDICTED INSTANTANEOUS SCRAPPAGE

Figure 7-29, below, shows the observed and predicted instantaneous scrappage rates for pickups. Again, the constant calendar year 2009 dummy variable captures the peaks in scrappage from CARS. The model is able to capture many of the peaks within the data, and also the general trend of durability across the model years. Remember, the truck model years had inconsistent durability trends — durability was lower for model years 1995 through 2000. A separate trend in durability for these model years is specified, which as shown below allows the model to predict the scrappage rates well.

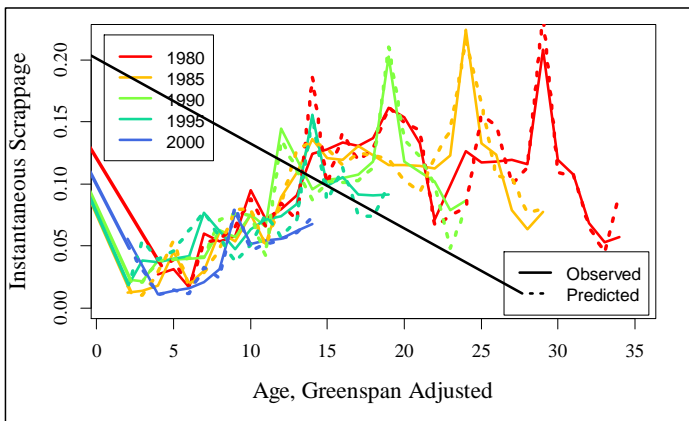

FIGURE 7-29 - TRUCK OBSERVED AND PREDICTED INSTANTANEOUS SCRAPPAGE

The projected share of the fleet remaining for model years 2015 and 2030 are shown below in Figure 7-30 and

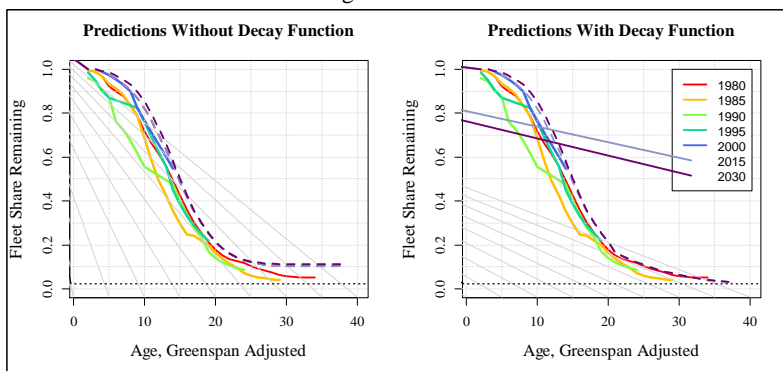

Figure 7-31.

All models predict some increase in durability for model year 2015 vehicles, and a smaller increase in durability for model year 2030 — this aligns with historical data and the reality that it is only practical for durability to increase so much. The logit models described above fit the historical data of car and truck scrappage well, but when used to project the scrappage of future model years, all models over-predict the point of convergence for the final remaining share of the fleet. The dotted black lines represent the observed convergences for the final fleet share for each body class.

In the model implementation, an exponential decay function is used beginning at the age when the projected pattern deviates from the observed historical data to ensure that the predicted final fleet share matches the final fleet share observed in the Polk data. For all body styles the projected and historical trends appear to deviate after age 20 — this is likely because there are fewer model years on which to predict the increasing durability trend for older ages — for example, for 30-year-old vehicles the data set only includes 10 data points, and for 40-year-old vehicles, only one.

The decay function can be implemented in the model using the following conditions:

EQUATION 7-9 - EXPONENTIAL DECAY FUNCTION

If ($Age < decay\ starts$):

$$s = \frac{e^{\sum \beta_i X_i}}{1 + e^{\sum \beta_i X_i}}$$

And:

$$Population_{MY, Age+1} = Population_{MY, Age} * (1 - s_{MY, Age}).$$

If ($Age \geq decay\ starts$):

$$Population_{MY, Age+1} = Population_{MY, Age=decay\ starts} * exp^{rate*t}$$

Where:

$$t = (Age + 1 - decay\ starts)$$

And:

$$rate = \frac{\ln\left(\frac{(Final\ Survival\ Rate)}{Population_{MY, Age=decay\ starts}}\right)}{40 - decay\ starts}$$

Here the instantaneous scrappage for ages beyond 20 depends on the share of the fleet remaining at age 20, and the decay rate necessary to ensure that the final fleet share at age 20 matches the final survival rate assumed for that class. The predicted fleet shares remaining when the decay function is added is also shown in Figure 7-29 and

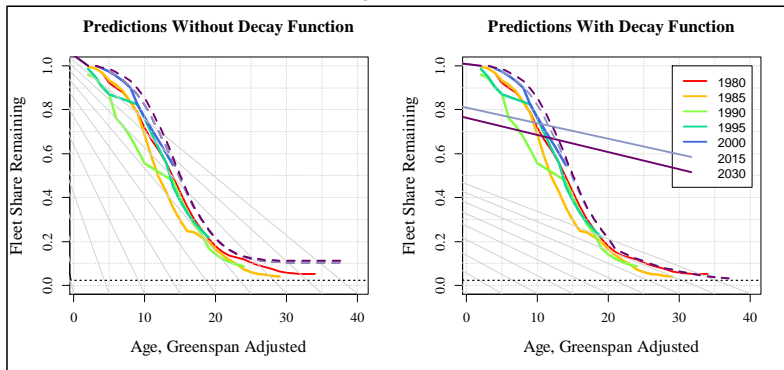

Figure 7-31.

Figure 7-30 shows the share of the fleet remaining at ages 0 through 40 for cars — model year 2015 and 2030 have nearly identical patterns, suggesting that most improvements in durability have already been realized for cars. The final fleet share is predicted to be around 8%, while the observed historical final fleet share is around 1%. Once the decay function is added the projected curves follow a similar pattern as that observed in the data — increasing durability until around age 15 and then a gradual convergence so that only 1% of the fleet is projected to remain at age 39 (the final age modeled within the CAFE model).

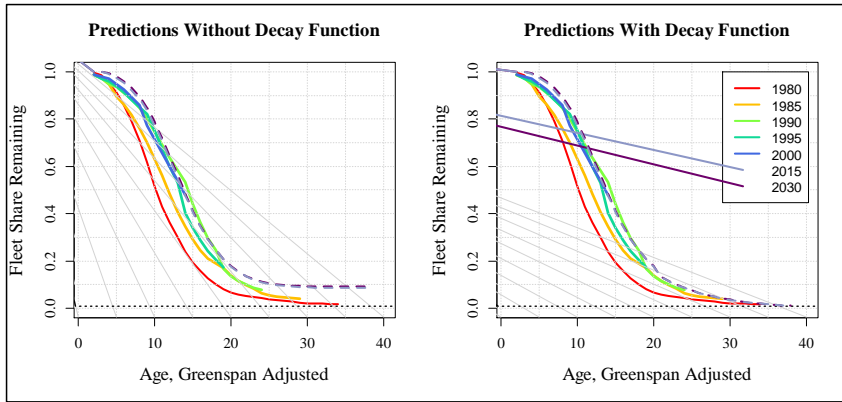

FIGURE 7-30 MY 2015 AND MY 2030 PASSENGER CAR PREDICTIONS WITH AND WITHOUT DECAY FUNCTIONS

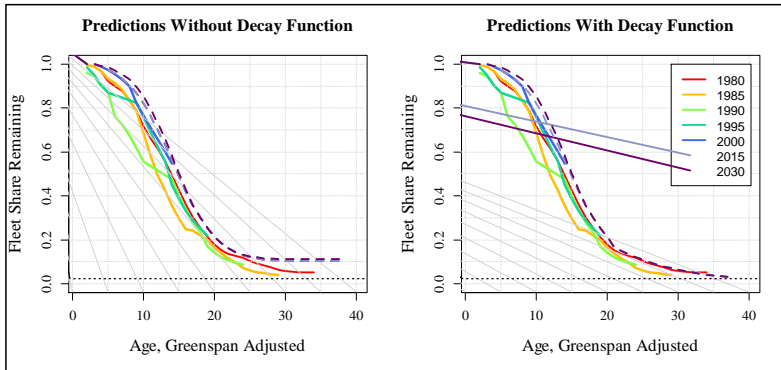

Figure 7-31 shows the predicted scrappage pattern for vans and SUVs. This model predicts that durability will increase until around age 15, and then that the fleet converges to a final fleet share of approximately 11%. The observed final fleet share is around 2.5%. Once the decay function is added to the right tail, the scrappage pattern follows the trends for durability in the data, and converges to a constant final fleet share for all model years.

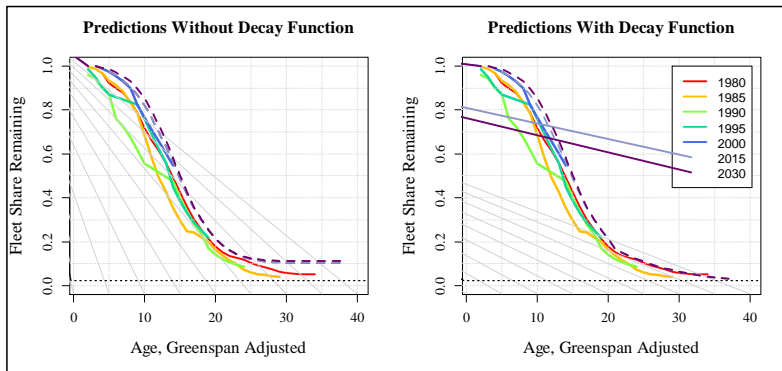

FIGURE 7-31 - MY 2015 AND MY 2030 VAN AND SUV PREDICTIONS WITH AND WITHOUT DECAY FUNCTIONS

Figure 7-32 shows the predicted scrappage pattern for pickup trucks. The model predicts sizeable increases in the durability of pickup trucks through model year 2015, and only a small increase in durability from model years 2015 to 2030. Note - This curve shows the survival rate of model year 2001, rather than 2000. There was a reduction in the durability for model years 1995 to 2000, followed by increases in durability for the observed ages for model years after 2000. The projected improvements in durability track the observed increases in the ages available for the latest model years. The final fleet share is predicted to converge to approximately 12%, which is significantly higher than the observed 2.5%. Once the decay function is spliced to the predicted logistic curve, the pattern tracks the observed historical data.

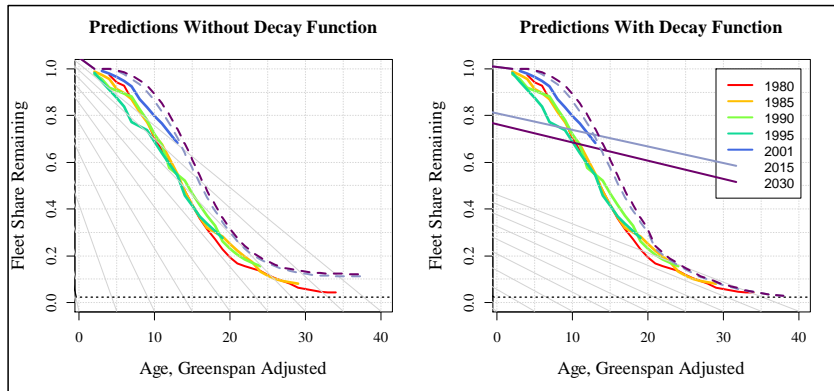

FIGURE 7-32 - MY 2015 AND MY 2030 PICKUP PREDICTIONS WITH AND WITHOUT DECAY FUNCTIONS

The logistic parameters, the age at which the decay starts, and the final fleet share are all specified by body style as inputs to the model. Table 7-16 shows the inputs as they are structured

*** EO 12866 Review – Draft – Do Not Cite, Quote or Release During Review ***

in the parameter file. Note that the model also allows the user to turn off the dynamic scrappage model and return to the prior static scrappage schedule. Zero values suggest that that parameter is not used in the final scrappage model for that body style.

TABLE 7-16 - COEFFICIENT VALUES AND OTHER INPUTS

Parameter	Cars	Vans/SUVs	Pickups
Estimate Scrappage	TRUE	TRUE	TRUE
Beta Coefs			
Age	0.616047051	-0.473441117	-1.119398279
Age^2	-0.057406753	0.032324147	0.037890057
Age^3	0.001582126	-0.000301894	0
ln(MY-1959)	-1.608885894	-3.946616362	-3.364968508
ln(MY-1959)*Age	0.213582275	0.504803381	0.34204715
ln(MY-1959)*Age^2	-0.006715995	-0.015159639	-0.008384946
New Price	-0.000161276	0.000371589	-0.000303124
New Price*Age	7.84025E-06	-2.88675E-05	2.83304E-05
New Price*Age^2	1.00488E-07	5.91183E-07	-9.62014E-07
New Price*Age^3	-1.212E-08	0	0
Lag New Price	9.47558E-05	-0.000185344	0.000460661
Lag New Price*Age	-2.34041E-06	1.08866E-06	-2.76789E-05
Lag New Price*Age^2	-7.40388E-07	6.36025E-09	6.4343E-07
Lag New Price*Age^3	2.60286E-08	0	0
Lag2 New Price	-0.000335592	-3.4816E-05	-0.000514968
Lag2 New Price*Age	5.20348E-05	1.745E-05	4.61463E-05
Lag2 New Price*Age^2	-2.21832E-06	-6.69202E-07	-1.27972E-06
Lag2 New Price*Age^3	1.84799E-08	0	0
Lag3 New Price	0.000493728	0.00013793	0.000430244
Lag3 New Price*Age	-9.12445E-05	-2.50298E-05	-4.29461E-05
Lag3 New Price*Age^2	5.12464E-06	8.77884E-07	1.18069E-06
Lag3 New Price*Age^3	-8.16078E-08	0	0
CPM	-0.085883784	-0.138151017	0.015197004
Lag CPM	0.085462805	0.044603678	-0.038813225
New CPM	0.080297688	0.273072429	-0.05654879
Lag New CPM	-0.1011716	-0.135346955	0.046611305
GDP Growth Rate	0.047918699	0.06054021	0.029019379
Lag GDP Growth Rate	0.024761655	0.072544513	-0.012424423
Lag2 GDP Growth Rate	0.011013988	0	0
Lag Scrappage	0.202961972	0.189616269	0.146198548
Lag2 Scrappage	0.150871596	0.005029224	0.056999227
Lag3 Scrappage	0.03576158	-0.066280435	0.112202637
Intercept	-0.691368454	-0.233821851	6.459967525
Decay Age	21	21	21
Final Survival Rate	0.01	0.025	0.025

To calculate the simulated outputs, the CAFE model adds the average absolute total regulatory costs for all manufacturers and regulatory classes to the average transaction price for a vehicle in model year 2025 (\$33,883, in \$2016) as the stream of new vehicle prices faced by future model years — because model years past MY 2032 are not projected, constant prices are used for ages occurring beyond CY 2032. AEO gasoline prices serve as the predictions of future fuel costs, and the Social Security Trustees Report serves as the source of projections for the GDP growth rate. Body-style specific simulated industry CAFE levels are used to compute the cost per mile of the model year 2025 vehicles and of new vehicles throughout the life of the model year 2025 fleet.

Although the CAFE model calculates scrappage rates by body style internally, it does not output fleet size by body style, but rather by regulatory class. Some SUVs are classified as passenger cars and some as light trucks, so that the outputted scrappage rates by regulatory class do not represent only one of the body style level models described above — the projected passenger car curves will be made up of the projected share of cars and the projected share of vans and SUVs within the passenger car fleet, and the light truck curves will be made up of the projected share of pickups and the projected share of vans and SUVs making up the light truck fleet. Figure 7-33 and Figure 7-34 show the absolute number and share of produced MY 2020 passenger cars and light trucks, respectively, simulated to remain on the road at each age under the considered regulatory alternatives.

Figure 7-33 shows the predicted scrappage of a MY 2025 passenger car under different stringencies of CAFE standards. The legend orders the alternatives in order of least to most stringent. The share of initial passenger cars remaining is spans less than 0.5% through age 11, and continues to spread out until age 20 when the decay function begins. At age 20, 31.8% of initial passenger cars are projected to remain under the augural scenario vs. 26.4% under the preferred scenario which does not increase standards past MY 2020 levels. Once the decay function kicks in the survival curves converge until they reach the final fleet share of 1.4%. Considering the absolute volumes remaining at each age makes it clear that the sales, dynamic fleet share, and scrappage models are linked. Under higher regulatory alternatives, fewer new passenger cars are sold, but because future prices remain higher the scrappage rate is lower. Around ages 12 to 13 the absolute number of passenger cars remaining for all alternatives is roughly the same and thereafter the ranking of most absolute vehicles remaining by regulatory alternative changes. After age 13 more MY 2025 passenger cars remaining on the road in the most stringent scenarios than the least stringent scenarios.

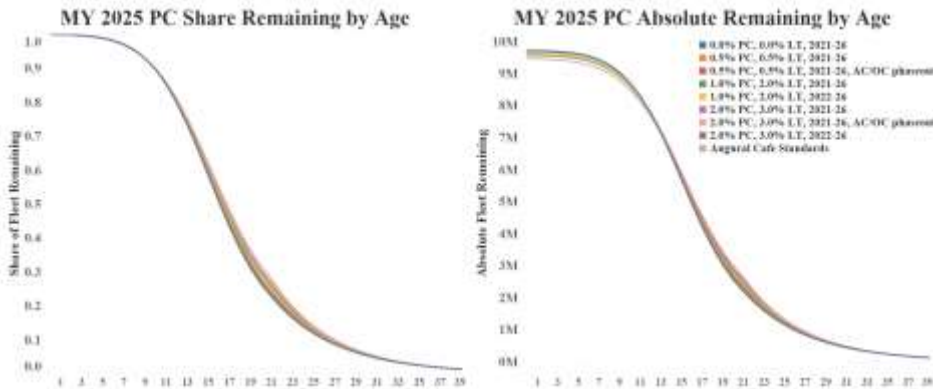

FIGURE 7-33 - ESTIMATED PASSENGER CAR SCRAPPAGE UNDER KEY REGULATORY ALTERNATIVES

Figure 7-34 shows the predicted scrappage rate of model year 2025 light trucks under the same CAFE regulatory alternatives. Under the augural standards, a slightly smaller share of light trucks is expected to remain through age 13, as more efficient trucks are more favorable. Around age 14, a similar share of initial light trucks remains for all scenarios, and for ages 14 to 20 the scrappage rate is slowest for the augural scenario and most aggressive for the alternative which keeps MY 2020 standards through MY 2026 (the preferred alternative). By age 20, 22.4% of the light truck fleet remains in the preferred alternative versus the 25% in the augural scenario. The decay function begins at age 20 and forces the remaining fleet to be 2.5% for age 39 as observed in historical the data. Considering the absolute number of light trucks by age, shows that although overall vehicle demand declines in the most stringent scenario, the dynamic fleet share model predicts that more of those vehicles will be light trucks as the difference in the cost of travel for trucks and cars converge. The joint effect is that a slightly larger number of trucks are sold in the augural scenario than the preferred scenario, as shown below.

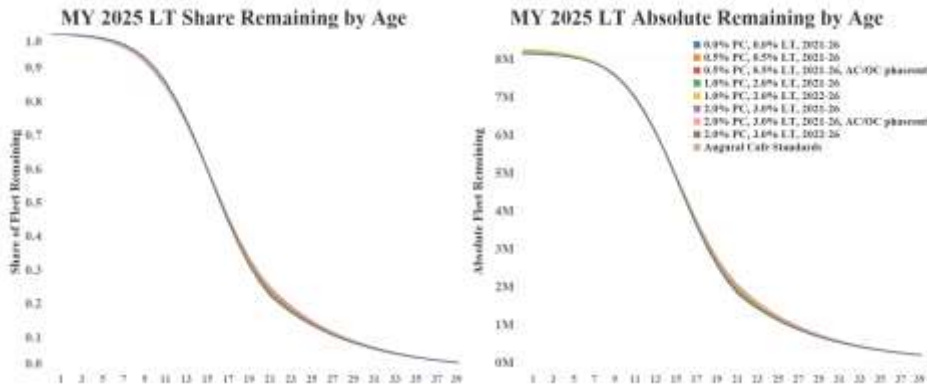

FIGURE 7-34. ESTIMATED LIGHT TRUCK SCRAPPAGE UNDER KEY REGULATORY ALTERNATIVES

7.8.10 Implications for Total Vehicle Use

It is important to note that the current analysis, to the extent that it accurately represents changes in the used vehicle fleet and usage, represents an improvement over the previous static scrappage models used for analyzing the impacts of CAFE or GHG standards. The previous schedules did not model increasing durability over time, responses to cyclical factors, nor the effect of further regulation that shifts the supply curve for new vehicle upwards and supplies more fuel economy than consumers would otherwise demand. Figure 7-35, Figure 7-36, and Figure 7-37 compare NHTSA’s previous static scrappage schedule, the current scrappage schedule for model year 2016 vehicles under no future changes to new vehicle price or fuel economy, but using the reference case for future fuel prices and GDP growth rates, and scrappage predictions for MY’s 1987-2014 from Bento, Roth and Zhuo (2016), who argue the importance of including increasing expected lifetimes of later model year vintages.⁵²¹

Figure 7-35 compares the scrappage models for cars; the dynamic scrappage model predicts more cars survive for the first nine years than the static model. The dynamic scrappage model predicts fewer cars survive for ages 10 to 22. The dynamic scrappage model prediction and the Bento et al. model align until around age 8, when the dynamic scrappage model falls below the Bento et al. model. The GDP growth rate used for the dynamic scrappage model ranges between 2.1 and 3%, an optimistic projection. Another useful measure to compare the previous and current scrappage model is the expected lifetime vehicle miles travelled—the static model predicts an expected lifetime VMT of a car of 153,000 miles; the dynamic scrappage model predicts an expected lifetime VMT of 148,000 miles. Under an assumption of zero GDP growth,

Commented [A27]: Suggest adding clarification “It is important to note that the current analysis, to the extent that it accurately represents changes in the used vehicle fleet, represents and improvement.....”, since the improvement will only be realized with a model that better captures the actual dynamics of the market.

⁵²¹ Bento, Antonio, et al. “Vehicle Lifetime Trends and Scrappage Behavior in the U.S. Used Car Market.” *The Energy Journal*, vol. 39, no. 1, Jan. 2018, doi:10.5547/01956574.39.1.aben.

the expected VMT of the dynamic scrappage model under no future change to new vehicle prices or future fuel economy is 153,000 miles.

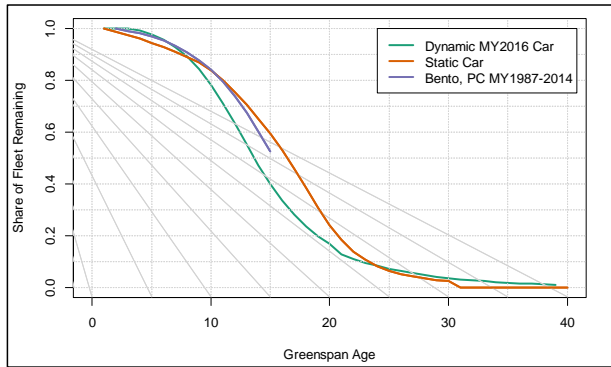

FIGURE 7-35 - COMPARING DIFFERENT CAR SCRAPPAGE MODELS

Figure 7-36 shows the scrappage models for vans and SUVs. The dynamic scrappage model predicts a higher share of vans and SUVs surviving through age 13 than the static scrappage model, but a lower share for the remainder of the life of a van or SUV (besides age 39). The dynamic scrappage model predicts a similar share remaining as model year 1987-2014 passenger cars in Bento et al., 2016. The expected lifetime VMT under the static scrappage model is 167,000; the estimated lifetime VMT for the dynamic scrappage model under input GDP assumptions, under no change to future fuel economy or new vehicle prices is also 167,000. Finally, the expected VMT for no GDP growth is 175,000 miles.

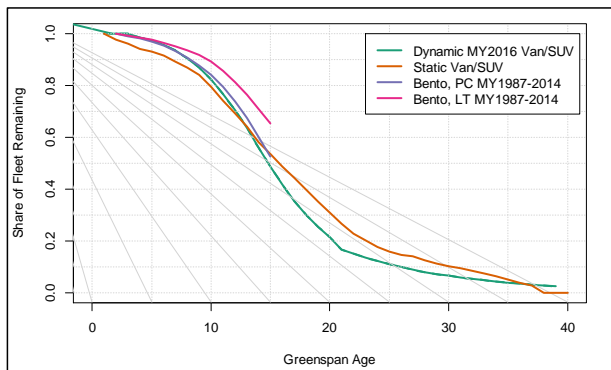

FIGURE 7-36 - COMPARING DIFFERENT VAN/SUV SCRAPPAGE MODELS

Figure 7-37 shows the fleet share remaining for pickups under different scrappage models. The dynamic scrappage model predicts a larger remaining fleet share for no regulatory alternatives

for pickups ages 0 to 17, and nearly identical remaining fleet share for ages older than 17. The expected lifetime VMT of pickups for the dynamic model is 166,000 miles, while the expected lifetime VMT for the static model is 160,000. The dynamic scrapped model for no GDP growth predicts expected lifetime VMT for pickups of 167,000 miles.

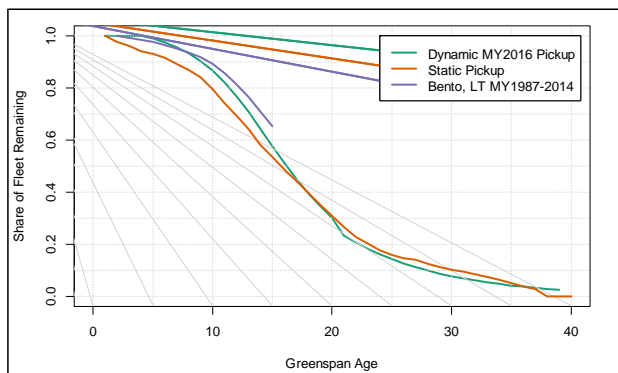

FIGURE 7-37 - COMPARING DIFFERENT PICKUP SCRAPPAGE MODELS

Impacts of the dynamic scrappage model on the expected lifetime VMT is small relative both to the previous static scrappage model and relative to changes in the regulatory stringency. This is another check on the plausibility of the scrappage patterns predicted by the dynamic scrappage models. It has already been discussed that the final models predict historical values of scrappage well, and also predict reasonable parameterized improvements of durability over time. In summary, this analysis includes the effect of differentiated fuel economy regulations that only affect new and not used vehicles—and to our knowledge is the first dynamic vehicle scrappage model implemented in a larger framework. Work will continue to further enhance these models.

7.8.11 Sensitivity Case which Excludes the Gruenspecht Effect

In addition to the central case, which includes the new vehicle price effect, a sensitivity case was considered that uses the same model, but excludes the effect of changing prices from MY 2016 levels across the regulatory alternatives. This allows a point of comparison to measure the impact of the price effect under the same model, one that includes the observed trend of increasing durability over time, and allows for macroeconomic conditions to influence scrappage rates. Since these other factors influence scrappage rate, this is the proper comparison to isolate the magnitude of the Gruenspecht effect, rather than returning to the static scrappage rate schedules used in the 2012 final rule. Creating this sensitivity case requires altering the scrappage model intercept and coefficients related to new vehicle price. The process and resulting coefficients are described below. The results of the sensitivity case are reported in Section 07.h.1 of the preamble and in Chapter 12 of this document.

Because of the form of the dependent variable (a logistic specification), removing the price effect of the scrappage model is not as simple as setting the coefficient values of all variables related to new vehicle price to zero. However, by fixing new vehicle prices to the average prices for MY 2016, the same effect as zeroing out the price coefficients in a linear model (removing the measure of the Gruenspecht effect on simulated future vehicle scrappage for all regulatory alternatives) can be achieved. To do so, the value of the portion of the scrappage equation which varies with new vehicle prices at MY 2016 new vehicle price levels is calculated, that is:

$$\begin{aligned}
 \text{Price Component} = & \text{New Price} * (\beta_6 + \beta_7 * \text{Age} + \beta_8 * \text{Age}^2 + \beta_9 * \text{Age}^3) + \\
 & \text{Lag New Price} * (\beta_{10} + \beta_{11} * \text{Age} + \beta_{12} * \text{Age}^2 + \beta_{13} * \\
 & \text{Age}^3) + \\
 & \text{Lag2 New Price} * (\beta_{14} + \beta_{15} * \text{Age} + \beta_{16} * \text{Age}^2 + \beta_{17} * \text{Age}^3
 \end{aligned}$$

Where the average new vehicle price, previous calendar year average new vehicle price, and average new vehicle price from two previous calendar years, all equal the average new vehicle price for calendar year 2016, or \$33,883, as defined below:

$$\text{New Price} = \text{Lag New Price} = \text{Lag2 New Price} = 33,883,$$

The calculated price component was then added to the intercept value, and the coefficients which contain any new vehicle price values were all set to zero. Doing so sets the entire new vehicle price stream equal to the levels at the beginning of the analysis simulates a case where future prices do not change, so that there is no Gruenspecht effect. Table 7-17 shows the resulting coefficients used for the scrappage sensitivity cases with the price effect disabled.

TABLE 7-17 - COEFFICIENTS FOR SCRAPPAGE SENSITIVITY CASES WITH PRICE EFFECT DISABLED

Parameter	Cars	Vans/SUVs	Pickups
Estimate Scrappage	TRUE	TRUE	TRUE
Beta Coefs			
Age	-0.5261416	-1.6714953	-0.9888897
Age^2	0.01938623	0.05964151	0.0237401
Age^3	-8.557E-05	-0.0003019	0
ln(MY-1959)	-1.6088859	-3.9466164	-3.3649685
ln(MY-1959)*Age	0.21358227	0.50480338	0.34204715
ln(MY-1959)*Age^2	-0.006716	-0.0151596	-0.0083849
ln(MY-1959)*Age^3	0	0	0
New Price	0	0	0
New Price*Age	0	0	0
New Price*Age^2	0	0	0
New Price*Age^3	0	0	0
Lag New Price	0	0	0
Lag New Price*Age	0	0	0
Lag New Price*Age^2	0	0	0
Lag New Price*Age^3	0	0	0

*** EO 12866 Review – Draft – Do Not Cite, Quote or Release During Review ***

Lag2 New Price	0	0	0
Lag2 New Price*Age	0	0	0
Lag2 New Price*Age^2	0	0	0
Lag2 New Price*Age^3	0	0	0
Lag3 New Price	0	0	0
Lag3 New Price*Age	0	0	0
Lag3 New Price*Age^2	0	0	0
Lag3 New Price*Age^3	0	0	0
CPM	-0.0858838	-0.138151	0.015197
Lag CPM	0.0854628	0.04460368	-0.0388132
New CPM	0.08029769	0.27307243	-0.0565488
Lag New CPM	-0.1011716	-0.135347	0.0466113
GDP Growth Rate	0.0479187	0.06054021	0.02901938
Lag GDP Growth Rate	0.02476165	0.07254451	-0.0124244
Lag2 GDP Growth Rate	0.01101399	0	0
Lag Scrappage	0.20296197	0.18961627	0.14619855
Lag2 Scrappage	0.1508716	0.00502922	0.05699923
Lag3 Scrappage	0.03576158	-0.0662804	0.11220264
Intercept	2.412819	9.57052624	8.92708963
Decay Age	21	21	21
Final Survival Rate	0.01	0.025	0.025

7.8.12 Simulating the Future Car and Light Truck Fleet

Figure 7-38 shows how the various effects of the proposed action are combined to simulate the size and composition of each future year's total fleet of cars and light trucks. This process begins with a detailed profile of the previous year's fleet. As an example, for the first future year included in the analysis, the previous year's fleet would be described by total registrations of cars and light trucks produced during each previous model year and remaining in use during the base year of 2016. As the figure shows, this is combined with the estimated effects of the previously-adopted CAFE and GHG standards on average prices and fuel economy levels of model year 2017 cars and light trucks to estimate changes in their total sales, as well as changes in the retirement rates of used cars and light trucks produced during past model years that remained in the previous year's fleet.

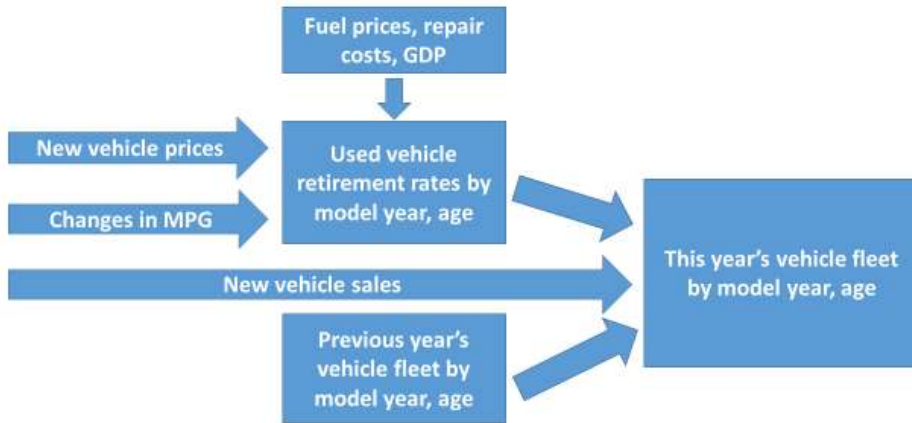

FIGURE 7-38 - SIMULATING THE CAR AND LIGHT TRUCK FLEET FOR FUTURE YEARS

The outcome of this process is a profile of the 2017 car and light truck fleet. The process is repeated for each year included in the analysis. In this way, future car and light truck fleets can be constructed under both the baseline scenario – with EPA’s previously-adopted GHG emission standards in effect through model year 2025 and astringent CAFE standards – and with the proposed action to reduce their stringency for model years 2021 through 2026. Differences in the composition of the baseline fleet and the fleet under each alternative are the source of many of the proposed action’s benefits and costs, as illustrated previously by other occupants’ travel time.

7.9 Effects of Revising CAFE and GHG Standards on Fuel Use and Environmental Externalities

Today’s proposed action will increase demand for transportation fuels relative to a baseline. Because gasoline and diesel – which account for the vast bulk of energy consumed to power light-duty vehicles – are refined from petroleum, this will in turn increase U.S. demand for petroleum, and some of this increased demand may be met by additional U.S. imports of crude oil (or fuel that has been refined overseas). Increased fuel purchases by drivers of cars and light trucks will contribute additional tax revenues at both federal and state levels, which will be available to fund increased spending on highways or other transportation infrastructure. This effect represents an economy-wide benefit, which will offset some of the increase in fuel costs to new car and light truck buyers.

7.9.1 Impact on Fuel Use and Total Fuel Costs

As indicated above, the proposed action will increase U.S. demand for transportation fuels, which are primarily refined from petroleum.⁵²² In Figure 7-39, this is shown as an upward shift in the demand for fuel. The supply of refined transportation fuels is expected to be moderately sensitive (or “elastic”) to increases in its price – that is, increasing fuel production will exert some upward pressure on petroleum prices, refining costs, and ultimately on fuel prices – so increased demand is expected to raise fuel prices modestly, as the figure indicates.

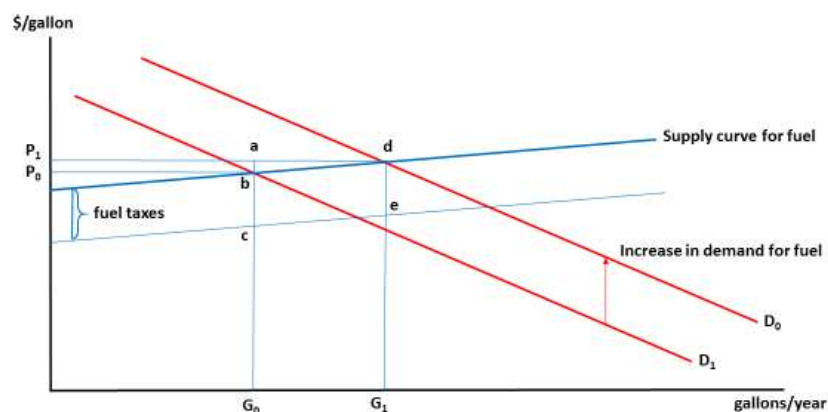

FIGURE 7-39 - EFFECT OF THE PROPOSED ACTION ON FUEL CONSUMPTION AND EXPENDITURES

As a consequence of increased demand, total fuel consumption will increase from G_0 to G_1 in Figure 7-39, and the retail price of fuel will increase from P_0 to P_1 . As a consequence, drivers’ total outlays for fuel will increase from $P_0 \cdot G_0$ to $P_1 \cdot G_1$, or by the sum of area P_1abP_0 (the increase in spending on fuel that results from its higher price) plus area G_0adG_1 (the increased spending to purchase additional fuel). Buyers of new cars and light trucks will incur higher costs for fuel throughout those vehicles’ lifetimes because they will have lower fuel economy with the proposed action in place than they would have had with the baseline standards in effect.

The annual increase in fuel costs to buyers of new cars and light trucks produced during future model years was shown previously as the increase in their per-mile fuel costs that occurs with less demanding standards in effect, multiplied by the number of miles they drive those vehicles each year throughout their lifetimes. The increase in total spending on fuel – the area G_0adG_1 in Figure 7-39 – represents the difference between this increase in fuel costs to buyers of new vehicles and any reduction in the cost of fuel consumed by used vehicles as they are retired from

⁵²² Petroleum-based fuels currently account for more than 99% of total energy used by light-duty vehicles, and this figure is projected to remain well above 90% for the foreseeable future; see U.S. Energy Information Administration, Annual Energy Outlook 2017 (https://www.eia.gov/outlooks/aeo/tables_ref.php), Table 38.

use more rapidly than would have occurred under the baseline scenario, and some of the travel they would have served under the baseline scenario shifts to newer cars and light trucks.

Of the increase in total fuel costs, some fraction – shown as the area bced in Figure 7-39 – represents increased payments of fuel taxes, which become available to fund new investments or improved maintenance of roads and other transportation infrastructure. The value corresponding to area bced is the product of average fuel taxes per gallon – federal, state, and some local governments impose taxes on gasoline and diesel that together average nearly \$0.50 per gallon – and the increase in the number of gallons consumed annually with the proposed standards in effect. The spending funded by increased fuel tax revenue produces economic benefits to infrastructure users, and so it is assumed that the value of these benefits is at least as large as the increase in tax revenue, so it offsets the tax component of the higher fuel costs incurred by new car and light truck buyers.

7.9.2 Increases in Externalities from Refining and Consuming More Fuel

Extracting and transporting crude petroleum, refining it to produce transportation fuels, and distributing fuel all generate emissions of GHGs and criteria air pollutants, as does its actual use by cars and light trucks. By increasing the volume of petroleum-based fuel produced and consumed, the proposed reduction of CAFE and CO₂ emission standards will thus increase potential future climate-related economic damages caused by accumulation of GHGs, as well as the more immediate and localized health damages caused by exposure to criteria pollutants. The increases in these external costs caused by producing and consuming more fuel – so called because they are borne only partly (if at all) by producers and users of fuel, and fall mainly on the broader population and economy – represent additional economic costs of the today’s proposed action.

Increases in GHG emissions are calculated directly from the increased volume of fuel refined and consumed, using typical chemical properties of gasoline and diesel together with emission rates per unit of fuel energy obtained from Argonne National Laboratories’ GREET model.⁵²³ The resulting increases include emissions that result from both fuel combustion itself and the production and distribution of fuel (often called “upstream” emissions). The unit values (or social costs) of emissions of GHGs that are used to convert these increased emissions to economic costs were estimated by EPA for use in its recent regulatory analysis of that agency’s proposed review of its Clean Power Plan.⁵²⁴ These values are sharply lower than those used previously by the agencies to estimate benefits from the reductions in emissions of GHGs anticipated to result from previous increases to CAFE and GHG standards, primarily because the

⁵²³ Need reference to current version of GREET and specifically upstream emission factors.

⁵²⁴ See U.S. Environmental Protection Agency, Regulatory Impact Analysis for the Review of the Clean Power Plan: *Proposal*, October 2017, https://www.epa.gov/sites/production/files/2017-10/documents/ria_proposed-cpp-repeal_2017-10.pdf, Table 3-7, p. 44, and Appendix C.

*** EO 12866 Review – Draft – Do Not Cite, Quote or Release During Review ***

new values reflect only reductions in potential climate-related economic damages to the U.S., rather than to the entire world economy.

The revised estimates of climate damage costs from GHG emissions were developed by EPA in response to Executive Order 13783. That order withdrew previous guidance providing estimates of such costs and directed federal agencies to ensure that estimates used in future regulatory analyses were consistent with guidance in OMB’s earlier Circular A-4, particularly regarding their inclusion of domestic versus overseas economic impacts of regulations and the use of appropriate discount rates.⁵²⁵ Specifically, Circular A-4 states that analysis of economically significant regulations “should focus on benefits and costs that accrue to citizens and residents of the United States.” EPA’s revised estimates of the costs imposed by GHG emissions follows Circular A-4’s guidance by including only domestic climate damages in their central values, and by providing values that reflect both 3% and 7% discount rates.⁵²⁶

Increases in emissions of criteria air pollutants are estimated using projected changes in the total number of miles driven by cars and light trucks that were produced during each model year and remain in use during future calendar years. Emission rates for cars and light trucks were obtained from EPA’s Motor Vehicle Emission Simulator (MOVES), and these vary depending on both the model year in which they were produced and the ages they will have reached in future calendar years. By reducing prices for new cars and light trucks from those that would have prevailed under the baseline standards, the proposed action is anticipated to increase sales of new models and hasten retirement of older vehicles slightly. In effect, this acceleration in the turnover of the light-duty vehicle fleet will transfer some fraction of travel from older cars and light trucks to newly-purchased models. Because new cars and light trucks emit criteria pollutants at dramatically lower rates per mile driven than the older vehicles they will replace, this substitution of new vehicle use for some driving in older vehicles will significantly reduce total emissions of criteria air pollutants.

Emissions of criteria pollutants during fuel refining and distribution are also accounted for, using emission rates per unit energy content of different fuels obtained from Argonne’s GREET model. Health damage costs resulting from increased population exposure to harmful accumulations of these pollutants were also obtained from recent EPA analyses; these costs are expressed per ton of emissions of each pollutant (or chemical precursor), and reflect specific assumptions about their geographic dispersal, chemical behavior in the atmosphere, and accumulation in populated areas.

⁵²⁵ President of the United States, Executive Order 13783, *Promoting Energy Independence and Economic Growth*, Federal Register, March 28, 2017, pp. 16093-16097, Section 5(c).

⁵²⁶ EPA provides a detailed description of how it developed these estimates in *Regulatory Impact Analysis For the Review of the Clean Power Plan - Proposal*, October 2017, Appendix C.

7.10 Effects on Petroleum Consumption and U.S. Energy Security

Higher U.S. fuel consumption will produce a corresponding increase in the nation’s demand for crude petroleum, which is traded actively in a worldwide market. The U.S. accounts for a large enough share of global oil consumption that the resulting boost in global demand will raise its worldwide price.⁵²⁷ The increase in global petroleum prices that results from higher U.S. demand causes a transfer of revenue to oil producers worldwide from not only buyers of new cars and light trucks, but also other consumers of petroleum products in the U.S. and throughout the world, all of whom pay the higher price that results.

Growing U.S. petroleum consumption will also increase potential costs to all U.S. petroleum users from possible interruptions in the global supply of petroleum or rapid increases in global oil prices, not all of which are borne by the households or businesses who increase their petroleum consumption (that is, they are partly “external” to petroleum users). If U.S. demand for imported petroleum increases, it is also possible that increased military spending to secure larger oil supplies from unstable regions of the globe will be necessary.

These three effects are often referred to collectively as “energy security externalities” resulting from U.S. petroleum consumption, and increases in their magnitude are sometimes cited as potential social costs of increased U.S. demand for oil. To the extent that they represent real economic costs that would rise incrementally with increases in U.S. petroleum consumption of the magnitude likely to result from reducing CAFE and CO₂ standards, these effects represent potential additional costs of today’s proposed action. This section describes how the extent to which each cost will actually occur as a direct result of this action is assessed, whether it represents a real economic cost, and where appropriate to include it, how that cost can be measured.

7.10.1 U.S. Petroleum Demand and its Effect on Global Prices

⁵²⁷ This contrasts with the usual situation, where no participant in the market for a product accounts for a large enough share of total purchases that changes in that buyer’s demand for the product will cause a change in its market price.

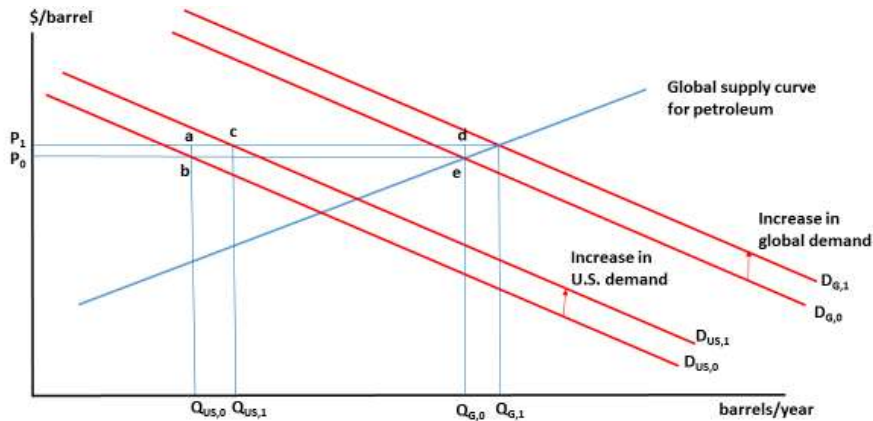

Figure 7-40 illustrates the effect of the increase in U.S. fuel and petroleum demand anticipated to result from reducing CAFE and CO₂ standards on global demand for petroleum and its market price. The increase in domestic demand means that the U.S. will purchase more petroleum at any price, and this is shown as an outward shift in the U.S. demand curve for petroleum from its position at $D_{US,0}$ with the baseline standards for future model years remaining in effect, to $D_{US,1}$ with the proposed standards replacing them. As the figure illustrates, the U.S. accounts for a major share of global petroleum demand; because global demand is simply the sum of what each nation would purchase at different prices, the outward shift in U.S. demand causes an identical shift in the global demand schedule.

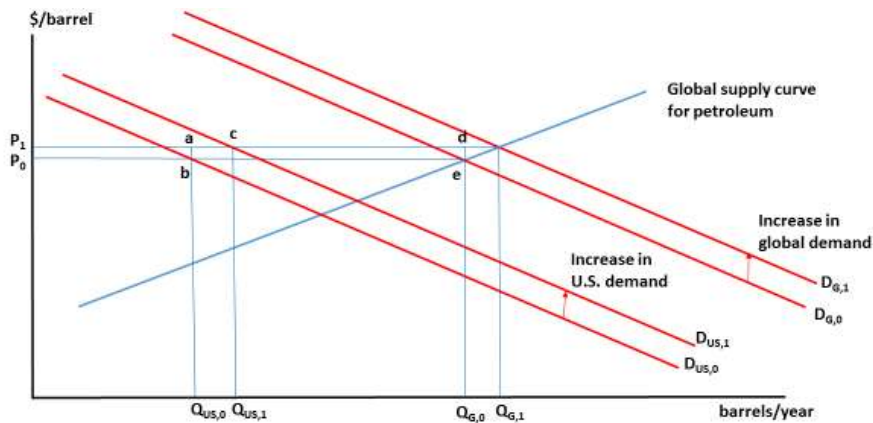

FIGURE 7-40 - EFFECT OF U.S. PETROLEUM DEMAND ON GLOBAL PRICES AND PURCHASES

At the global level, the supply curve for petroleum slopes upward, reflecting the fact that it is progressively costlier to explore for, extract, and deliver additional supplies of oil to the world

*** EO 12866 Review – Draft – Do Not Cite, Quote or Release During Review ***

market. Thus the upward shifts in the U.S. and world demand schedules cause an increase in the global price for oil, from P_0 to P_1 in the figure. U.S. purchases of petroleum increase from $Q_{US,0}$ to $Q_{US,1}$, and if no other nation's demand changes, the increase in global consumption from $Q_{G,0}$ to $Q_{G,1}$ will be identical to the increase in U.S. purchases. The increase in U.S. petroleum purchases will increase spending by U.S. buyers who purchase additional oil by the area $Q_{US,0} \times (P_1 - P_0)$, the dollar value of which is the product of the new, higher price P_1 and the increase in U.S. consumption, $Q_{US,1} - Q_{US,0}$.

At the same time, however, the increase in its price from P_0 to P_1 will mean that global consumers who previously purchased the quantity of oil $Q_{G,0}$ at its lower price will now pay more for that same amount. Specifically, previous purchasers will pay the additional area $P_1 \times Q_{G,0} - P_0 \times Q_{G,0}$, whose value is the increase in price $P_1 - P_0$ multiplied by the volume they originally bought, $Q_{G,0}$. Of this windfall increase in revenue to oil producers, the rectangular area $P_1 \times (Q_{US,1} - Q_{US,0})$, the value of which is the product of the increase in price $P_1 - P_0$ times original U.S. purchases $Q_{US,0}$, is a transfer from U.S. consumers to global oil suppliers. The remaining fraction of increased payments to producers, the rectangular area $(P_1 - P_0) \times (Q_{G,0} - Q_{US,0})$ – whose value is the product of the price increase $P_1 - P_0$ and previous purchases by other nations (which were $Q_{G,0} - Q_{US,0}$) – is a transfer from consumers outside the U.S. to global oil producers.

At the global scale, the entire global increase in spending on the amount of oil that was previously purchased is simply a transfer of revenue from global consumers of petroleum products to oil producers. It has no effects on global use of resources, so it produces no economic costs or benefits. Thus to the extent that it is an incidental consequence of U.S. car and light truck buyers' increased demand for petroleum-based fuel, it is a purely "pecuniary" externality – one that only changes prices, and not production or consumption. However, some of the increased payments by U.S. consumers for the petroleum products they originally consumed flows out of the U.S. economy to foreign oil producers. Although this transfer does not affect resource use, it is a financial drain on the U.S. economy, so from a domestic perspective it may be reasonable to view it as an additional cost to the U.S. economy from permitting new cars and light trucks to meet the lower proposed standards.

To an increasing extent, however, the additional payments by U.S. consumers that result from upward pressure on the world oil price are a transfer entirely within the nation's economy, because a growing fraction of domestic petroleum consumption is being supplied by U.S. producers. The U.S. is projected to become a net *exporter* of petroleum by 2025, and as the nation moves toward that status, an increasing share of the higher costs paid by U.S. consumers of petroleum products becomes a gain to U.S. oil producers.⁵²⁸ Domestic oil production is

⁵²⁸ The U.S. Energy Information Administration projects that net U.S. imports of crude petroleum and similar liquid fuels will decline to less than 5% of total domestic supply by 2024, and to less than 1% by 2028, and then to remain at approximately 0% through 2050. See *Annual Energy Outlook 2017* (https://www.eia.gov/outlooks/aeo/tables_ref.php), Reference Case, Table 11, Petroleum and Other Liquids Supply and Disposition.

*** EO 12866 Review – Draft – Do Not Cite, Quote or Release During Review ***

increasing rapidly, and as it does, a growing fraction of the higher costs to U.S. petroleum consumers that result from increased domestic fuel consumption becomes additional revenue to domestic oil suppliers. When the U.S. becomes self-sufficient in petroleum supply – which is now anticipated to occur within a decade – the *entire* value of increased payments by U.S. petroleum users that results from relaxing CAFE and CO₂ standards will become a transfer within the U.S. economy.

Thus over almost the entire time period spanned by the analysis of this proposed action, any increase in domestic spending for petroleum caused by the effect of higher U.S. fuel consumption and petroleum use on world oil prices will in effect be a transfer within the U.S. economy. For this reason – and because in any case such transfers do not create real economic costs or benefits – increased U.S. spending on petroleum products that results from increased U.S. fuel demand and upward pressure on petroleum prices stemming from this proposed action is not included among the economic costs accounted for in this proposal.

7.10.2 Macroeconomic Costs of U.S. Petroleum Consumption

In addition to influencing global demand and prices, U.S. petroleum consumption – and the fraction of it supplied by imports – may impose costs on the domestic economy that are not fully reflected in the market price for petroleum, or in the prices paid by consumers of refined products such as gasoline.⁵²⁹ Petroleum consumption can impose external economic costs because it exposes the U.S. economy to the risk of rapid increases in prices triggered by global political events that may also disrupt the supply of imported oil, and U.S. consumers of petroleum products are unlikely to recognize that their purchases contribute to these risks.

Sudden interruptions in oil supply and rapid increases in its price can impose significant economic costs, because they temporarily reduce the level of output that the U.S. economy can produce. The reduction in potential output depends on the extent and duration of the increases in prices for petroleum products prices that result from a disruption in global oil supplies, as well as on whether and how rapidly prices return to their pre-disruption levels. Even if prices for imported oil return completely to their original levels, however, economic output will be at least temporarily reduced from the level that would have been possible with uninterrupted oil supplies and stable prices.

Because supply disruptions and price increases caused by global political events tend to occur suddenly and unexpectedly, they force businesses and households to adjust their use of

⁵²⁹ See, e.g., Bohi, D. R. & W. David Montgomery (1982), *Oil Prices, Energy Security, and Import Policy* Washington, D.C. - Resources for the Future, Johns Hopkins University Press; Bohi, D. R., & M. A. Toman (1993), “Energy and Security - Externalities and Policies,” *Energy Policy* 21:1093-1109; and Toman, M. A. (1993). “The Economics of Energy Security - Theory, Evidence, Policy,” in A. V. Kneese and J. L. Sweeney, eds. (1993), *Handbook of Natural Resource and Energy Economics, Vol. III*, Amsterdam - North-Holland, pp. 1167-1218.

*** EO 12866 Review – Draft – Do Not Cite, Quote or Release During Review ***

petroleum products more rapidly than if the same price increase occurred gradually. Rapid substitutions between energy and other inputs, changes in their production levels, and adjustments to prices are costly and disruptive for businesses to make, while sudden changes in energy prices and use are also difficult for households to adapt to quickly or smoothly. The need to make rapid adjustments in petroleum use can also temporarily reduce economic output below the level that will ultimately be reached once the U.S. economy adapts completely to higher prices for petroleum products.

Because interruptions in oil supplies and sudden increases in petroleum prices are both uncertain prospects, the costs of the disruptions they can cause must be weighted or adjusted by the probability that they will occur and their potential duration. The “expected value” of these disruption costs, which combines the probabilities that price increases of different magnitudes and durations will occur during some future period with the costs of reduced U.S. economic output and abrupt adjustments to sharply higher petroleum prices, is the appropriate measure of their value. Any *change* in their expected value that can be traced to higher U.S. fuel consumption and petroleum demand stemming from this proposed action to establish less demanding fuel economy standards should be counted among its external or social costs.

Businesses and households can use a variety of mechanisms, including making purchases or sales in oil futures markets, adopting energy conservation measures, and installing technologies that permit rapid fuel switching to “insure” against higher petroleum prices and reduce their costs for adjusting to sudden price increases. Coupled with continued improvements in the efficiency of energy use throughout the economy, growing reliance on such measures has probably reduced the potential costs of oil price shocks to the U.S. economy, making them a significantly less important economic threat than estimated by studies conducted in the wake of oil supply disruptions that occurred during the 1970s.

There is considerable debate about the magnitude and continued relevance of potential economic damages from sudden increases in petroleum prices in the current situation, where the petroleum intensity of the U.S. economy has declined considerably and global oil prices are dramatically lower than when analysis first identified them, and the nation has become nearly self-sufficient in petroleum supply. Some recent analysis asserts that potential macroeconomic costs of sudden increases in oil prices are now likely to be small; for example, the National Research Council (2009) argued that non-environmental externalities associated with dependence on foreign oil are small, and perhaps trivial.⁵³⁰ Recent research by Nordhaus and by Blanchard & Gali also questioned how harmful to the economy recent oil price shocks have been, noting that the U.S.

⁵³⁰ National Research Council, *Hidden Costs of Energy - Unpriced Consequences of Energy Production and Use*, National Academy of Sciences, Washington, D.C., 2009.

economy actually expanded immediately after the most recent oil price shocks and that there was little evidence of higher energy prices being passed through to higher wages or prices.⁵³¹

At the same time, the implications of the U.S. shale oil revolution are now being felt in the international markets, with current prices at their lowest levels in nearly a decade. Many analysts attribute this situation partly to the significant increase in global supply resulting from expanded U.S. production, which has put its petroleum output on par with that of Saudi Arabia. It may also owe partly to sustained reductions in U.S. consumption and global demand resulting from energy efficiency measures and previously high oil prices. The resulting decline in U.S. petroleum imports – to approximately 20% of domestic consumption in 2017 – permits U.S. supply to act as a buffer against artificial or natural restrictions on global petroleum supplies (the latter due to military conflicts or natural disasters, for example). In addition, the speed and relatively low incremental cost with which U.S. oil production has increased suggests that both the magnitude and (especially) the duration of future oil price shocks may be capped, because U.S. production offers the potential for a large and relatively swift supply response.

Other research, however, emphasizes the continued threat to the U.S. economy posed by the potential for sudden increases in global petroleum prices.⁵³² For example, Ramey and Vine (2010) note “...remarkable stability in the response of aggregate real variables to oil shocks once we account for the extra costs imposed on the economy in the 1970s by price controls and a complex system of entitlements that led to some rationing and shortages.”⁵³³ Another recent

⁵³¹ Nordhaus argues that one reason for this is that monetary policy has become more accommodating to the price impacts of oil shocks, while another is that U.S. consumers may simply have decided that such movements are temporary and do not appear to be passed on as inflationary price increases in other parts of the economy. He also notes that changes in productivity in response to recent oil price increases have been extremely modest, observing that “... energy-price changes have no effect on multifactor productivity and very little effect on labor productivity.” (p. 19) Blanchard and Gali (2010) contend that improvements in monetary policy, more flexible labor markets, and the declining energy intensity of the U.S. economy (combined with an absence of concurrent shocks to the economy from other sources) lessened the impact of oil price shocks after 1980. They find that “... the effects of oil price shocks have changed over time, with steadily smaller effects on prices and wages, as well as on output and employment...The message...is thus optimistic in that it suggests a transformation in U.S. institutions has inoculated the economy against the responses that we saw in the past.” (p. 414) See William Nordhaus, “Who’s Afraid of a Big Bad Oil Shock?” http://aida.econ.yale.edu/~nordhaus/homepage/Big_Bad_Oil_Shock_Meeting.pdf, and Blanchard, Olivier and Jordi Gali, J., “The Macroeconomic Effects of Oil price Shocks - Why are the 2000s so Different from the 1970s?,” in Gali, Jordi and Mark Gertler, M., eds., *The International Dimensions of Monetary Policy*, University of Chicago Press, February 2010, pp. 373-421 (<http://www.nber.org/chapters/c0517.pdf>).

⁵³² Hamilton (2012) reviewed the empirical literature on oil shocks and concluded that its findings are mixed, noting that some recent research (e.g., Rasmussen and Roitman, 2011) finds either less evidence for significant economic effects of oil price shocks or declining effects (Blanchard and Gali 2010), while other research finds evidence of their continuing economic importance. See Hamilton, J. D., “Oil Prices, Exhaustible Resources, and Economic Growth,” in *Handbook of Energy and Climate Change* (http://econweb.ucsd.edu/~jhamilto/handbook_climate.pdf).

⁵³³ Ramey, V. A., & Vine, D. J. “Oil, Automobiles, and the U.S. Economy - How Much have Things Really Changed?” National Bureau of Economic Research Working Paper 16067, June 2010. (<http://www.nber.org/papers/w16067.pdf>).

study found that while the effects of sudden oil price increases have become smaller over time, the declining sensitivity of petroleum demand to prices means that any future disruptions to oil supplies will have larger effects on petroleum prices, so that on balance their economic impact is likely to remain significant.⁵³⁴ Other recent research has concluded that rising petroleum prices continue to have adverse effects on economic activity and growth in countries other than the U.S.⁵³⁵

Some recent research on oil price shocks has emphasized that their macroeconomic impacts can differ depending on whether they are caused by sudden interruptions in supply or by surges in petroleum demand. Most recent analyses have confirmed that increases in oil prices driven by surges in demand tend to have positive effects on an economy while those caused by interruptions in supply still have negative economic impacts, and that the impacts of either can differ between nations that import oil and those that are exporters.⁵³⁶ Another recent study noted that rapid price increases extending beyond the range of recent experience appear to have larger macroeconomic effects than do price spikes that remain within the range of experience.⁵³⁷

Despite this considerable uncertainty about the likely magnitude and importance of sudden future increases in oil prices, their occurrence could still impose significant costs on the U.S. economy. Thus, in this analysis, any increase in the expected value of these economic costs that results from higher U.S. fuel and petroleum demand represents an additional cost of this proposed action to reduce CAFE and CO₂ standards, *beyond* the direct cost for increased purchases of petroleum products. Consumers of petroleum products are unlikely to consider their contributions to these costs when deciding how much energy to consume, however, because they will be distributed widely throughout the economy and fall partly on other businesses and households. Thus they represent an external (or “social”) cost that users of petroleum energy such as transportation fuel are unlikely to recognize, and the analysis includes the estimated increase in these costs among of the social costs stemming from their proposed action.

Although the vulnerability of the U.S. economy to oil price shocks is widely believed to depend on *total* petroleum consumption rather than on the level of oil imports, variation in U.S. oil imports may itself have some effect on the frequency, size, or duration of sudden oil price increases. If so, the expected value of the resulting economic costs will also depend partly on the fraction of U.S. petroleum use that is supplied by imports. While total U.S. petroleum consumption is the primary determinant of potential economic costs to the nation from rapid increases in oil prices, the estimate of these costs that have been relied upon on in past regulatory analyses – and in this analysis – is expressed per unit (barrel) of *imported* oil.

⁵³⁴ Baumeister & Peersman (2011). NEED FULL CITATION.

⁵³⁵ He notes “...a negative effect of oil prices on real output has also been reported for a number of other countries, particularly when nonlinear functional forms have been employed,” citing Kim (2012), Engemann, Kliesen, & Owyang (2011) and Daniel, et al. (2011). NEED COMPLETE CITATIONS.

⁵³⁶ (Baumeister, Peersman & Robays (2010)), and Cashin et al. (2014). NEED COMPLETE CITATIONS.

⁵³⁷ Kilian & Vigfusson (2014). [Reference Forthcoming]

Table 7-18 reports the per-gallon estimates of external costs from potential oil price shocks used in this analysis to estimate the increase in the total value of these costs that is likely to result from this proposed action. These values are identical to those used in the recent Draft TAR and in the previous analysis of CAFE and GHG standards for model years 2017-2025, except that they have been updated to reflect 2016 prices for this analysis. They depend in part on projected future oil prices, U.S. petroleum consumption and imports, and the total value of petroleum purchases in relation to U.S. economic output (as measured by Gross Domestic Product). Since values were last updated by the agencies for the prior actions mentioned above, all of these factors have evolved in directions that would reduce them, so the figures in Table 8-16 are likely to overestimate the increase in expected costs to the U.S. economy from potential oil price shocks calculated in this analysis, perhaps significantly.^{538,539}

TABLE 7-18 - CHANGE IN EXPECTED COST OF PETROLEUM PRICE SHOCKS FROM INCREASED FUEL CONSUMPTION (2016\$ PER GALLON)

Year	Low	Middle	High
2021	\$0.065	\$0.142	\$0.232
2025	\$0.074	\$0.159	\$0.258
2030	\$0.086	\$0.183	\$0.296
2035	\$0.101	\$0.214	\$0.343
2040	\$0.115	\$0.243	\$0.389
2050	\$0.115	\$0.243	\$0.389

Applying these estimates requires an estimation of any increase in U.S. oil imports that is likely to result from the higher level of fuel consumption anticipated to occur as a result of this proposed action. This is done by using the Energy Information Administration’s National Energy Modeling System (NEMS) to simulate the incremental effects on U.S. petroleum consumption and imports of imposing the previously adopted CAFE standards for model years 2012-2021, and expressing the resulting change in imports as a percentage of the change in total U.S. petroleum consumption. This percentage ranges from 53% to 92% over the period from 2018 through 2050 – the same period spanned by this analysis, and averages 75% over that period.

⁵³⁸ Specifically, the global petroleum prices projected in EIA’s Annual Energy Outlook 2018 Reference Case range from 33-57% below those used to develop the estimates reported in Table 8-16. U.S. petroleum consumption and imports are now projected to be 3-8% and 20-27% lower than the forecast values used to construct the estimates in the table. Finally, total petroleum expenditures are now projected to average 1.5-2.4% of U.S. GDP, in contrast to the 3.8-4.0% shares reflected in the values reported in Table 7-16. Each of these differences suggests that the values in Table 8-16 overstate the current magnitude of potential costs to the U.S. economy from the risk of petroleum price shocks, and together they suggest that this overstatement may be significant.

⁵³⁹ The costs reported in Table 8-16 also depend on the probabilities or expected frequencies of supply interruptions or sudden price shocks of different sizes and durations. A recent (2016) reassessment of the probabilities on which these estimates are based (which were developed in 2005) concluded that they had not changed significantly 2005, so the values in the table would not have changed for this reason; see Beccue, Phillip C. and Hillard G. Huntington, An Updated Assessment of Oil Market Disruption Risks - Final Report EMF SR 10, Stanford University Energy Modeling Forum, February 5, 2016 (<https://emf.stanford.edu/publications/emf-sr-10-updated-assessment-oil-market-disruption-risks>).

*** EO 12866 Review – Draft – Do Not Cite, Quote or Release During Review ***

Hence it is assumed that 75% of the increase in fuel consumption resulting from lower CAFE and CO₂ emissions standards will be reflected in increased U.S. imports.

7.10.3 Potential Effects of Fuel Consumption and Petroleum Imports on U.S. Military Spending

A third potential effect of increasing U.S. demand for petroleum is an increase in U.S. military spending to secure the supply of oil imports from potentially unstable regions of the world and protect against their interruption. If the increase in fuel consumption that results from reducing CAFE and CO₂ standards leads to higher military spending to protect oil supplies, this might represent an additional external or social cost of the agencies' proposal. Some analysts also argue that increased costs to maintain the U.S. Strategic Petroleum Reserve (SPR) are another external cost of increased U.S. petroleum use, because it is intended to cushion the U.S. economy against disruptions in the supply of imported oil or sudden increases in the global price of oil.

Eliminating petroleum imports entirely might permit the nation to scale back its military presence in oil-supplying regions of the globe, but there is little evidence that U.S. military activity and spending in those regions have varied over history in response to fluctuations in the nation's oil imports, or are likely to do so over the future period spanned by this analysis.

Figure 7-41 shows that military spending as a share of total U.S. economic activity has gradually declined over the past several decades, and that any temporary – although occasionally major – reversals of this longer-term decline have been closely associated with U.S. foreign policy initiatives or overseas wars.

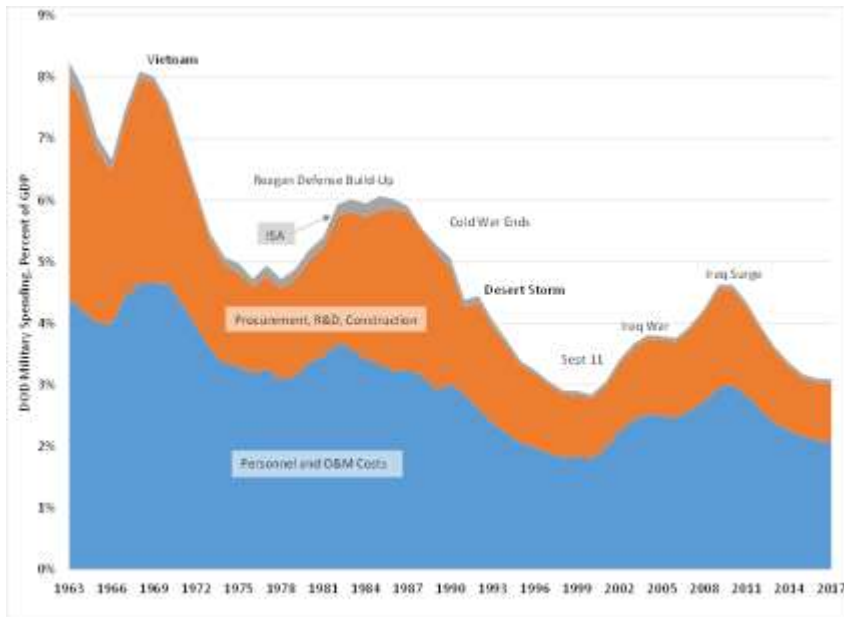

FIGURE 7-41 - HISTORICAL VARIATION IN U.S. MILITARY SPENDING (% OF U.S. GROSS DOMESTIC PRODUCT)

Figure 7-42 superimposes U.S. petroleum consumption and imports on the history of military spending shown in the previous figure. Doing so shows that the value of both the nation's total petroleum purchases and its imports of foreign oil – again measured relative total economic output – actually *rose* throughout most of this period, even as military spending declined. This history suggests that U.S. military activities – even in regions of the world that have historically represented vital sources of oil imports – serve a broader range of security and foreign policy objectives than protecting oil supplies.

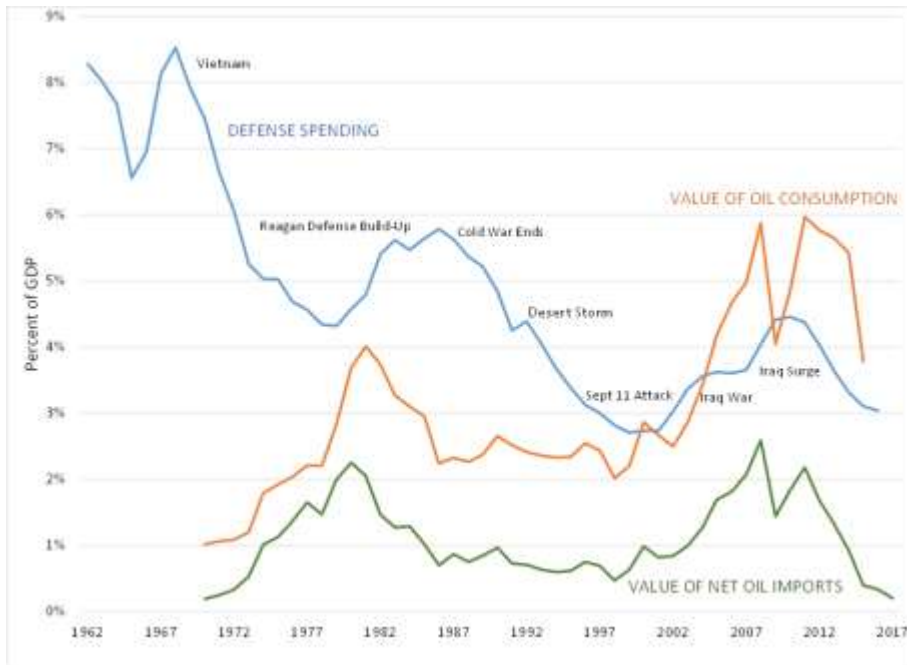

FIGURE 7-42 - HISTORICAL VARIATION IN U.S. MILITARY SPENDING IN RELATION TO U.S. PETROLEUM CONSUMPTION AND IMPORTS (% OF U.S. GROSS DOMESTIC PRODUCT)

Further, no record could be found of the U.S. government attempting to calibrate U.S. military expenditures, force levels, or deployments to any measure of the nation’s petroleum use and the fraction supplied by imports, or to an assessment of the potential economic consequences of hostilities in oil-supplying regions of the world that could disrupt the global market.⁵⁴⁰ Instead, changes in U.S. force levels, deployments, and spending in such regions appear to have been

⁵⁴⁰ Crane et al. (2009) analyzed reductions in U.S. forces and associated cost savings that could be achieved if oil security were no longer a consideration in military planning, and disagree with this assessment. After reviewing recent allocations of budget resources they concluded that “...the United States *does* include the security of oil supplies and global transit of oil as a prominent element in its force planning.” (p. ??; emphasis added) Nevertheless, their detailed analysis of individual budget categories estimated that even eliminating the protection of foreign oil supplies *completely* as a military mission would reduce the current U.S. defense budget by approximately 12-15%. See Crane, K., A. Goldthau, M. Toman, T. Light, S. E. Johnson, A. Nader, A. Rabasa, & H. Dogo, *Imported Oil and U.S. National Security*, Santa Monica, CA, The RAND Corporation, 2009 (<https://www.rand.org/pubs/monographs/MG838.html>).

governed by purposeful foreign policy initiatives, unforeseen political events, and emerging security threats, rather than by shifts in U.S. oil consumption or imports.⁵⁴¹

In short, total U.S. military spending has not varied in any pattern that would imply protecting U.S. oil imports is an important motivation, so it is reasonable to conclude that U.S. military activity and expenditures are unlikely to be affected by even relatively large changes in consumption of petroleum-derived fuels by light duty vehicles. Certainly, the historical record offers no suggestion that U.S. military spending is likely to adjust significantly in response to the increase in domestic petroleum use that would result from reducing CAFE and CO₂ standards.

Nevertheless, it is possible that more detailed analysis of military spending might identify some relationship to historical variation in U.S. petroleum consumption or imports. A number of recent studies have attempted to isolate the fraction of total U.S. military spending that is attributable to protecting overseas oil supplies.⁵⁴² Their extensive efforts to isolate components of military spending that can be reliably attributed to this objective have produced varying estimates of how much it might be reduced if the U.S. no longer had *any* strategic interest in protecting global oil supplies. However, none has identified an estimate of spending that is likely to vary incrementally in response to changes in U.S. petroleum consumption or imports.

Nor has any of these studies tracked changes in spending that can be attributed to protecting U.S. interests in foreign oil supplies over a prolonged period, so they have been unable to examine whether their estimates of such spending vary in response to fluctuations in domestic

⁵⁴¹ Crane et al. (2009) also acknowledge the difficulty of reliably allocating U.S. military spending by specific mission or objective, such as protecting foreign oil supplies. Moore et al. (1997) conclude that protecting oil supplies cannot be distinguished reliably from other strategic objectives of U.S. military activity, so that no clearly separable component of military spending to protect oil flows can be identified, and its value is likely to be near zero. Similarly, the U.S. Council on Foreign Relations (2015) takes the view that significant foreign policy missions will remain over the foreseeable future even without any imperative to secure petroleum imports. A dissenting view is that of Stern (2010), who argues that other policy concerns in the Persian Gulf derive from U.S. interests in securing oil supplies, or from other nations' reactions to U.S. policies that attempt to protect its oil supplies. See Crane, K., A. Goldthau, M. Toman, T. Light, S.E. Johnson, A. Nader, A. Rabasa, and H. Dogo, *Imported Oil and U.S. National Security*, Santa Monica, CA, The RAND Corporation, 2009 (<https://www.rand.org/pubs/monographs/MG838.html>); Moore, John L., E.J. Carl, C. Behrens, and John E. Blodgett, "Oil Imports - An Overview and Update of Economic and Security Effects," Congressional Research Service, Environment and Natural Resources Policy Division, Report 98, No. 1 (1997), pp. 1-14; Council on Foreign Relations, "Automobile Fuel Economy Standards in a Lower-Oil-Price World", November 2015; and Stern, Roger J. "United States cost of military force projection in the Persian Gulf, 1976-2007," *Energy Policy* 38, no. 6 (June 2010), pp. 2816-2825 (<https://www.sciencedirect.com/science/article/pii/S0301421510000194?via%3DIihub>).
⁵⁴² These include Copulos, M R. "America's Achilles Heel - The Hidden Costs of Imported Oil," Alexandria VA - The National Defense Council Foundation, September 2003 - 1-153 (http://ndcf.dyndns.org/ndcf/energy/NDCFHiddenCostsofImported_Oil.pdf); Copulos, M R. "The Hidden Cost of Imported Oil--An Update." The National Defense Council Foundation, 2007 (http://ndcf.dyndns.org/ndcf/energy/NDCF_Hidden_Cost_2006_summary_paper.pdf); Delucchi, Mark A. & James J. Murphy. "US military expenditures to protect the use of Persian Gulf oil for motor vehicles," *Energy Policy* 36, no. 6 (June 2008), pp. 2253-2264; and National Research Council Committee on Transitions to Alternative Vehicles and Fuels, *Transitions to Alternative Vehicles and Fuels*, 2013.

petroleum consumption or imports. A more plausible interpretation of this research is probably that U.S. military commitments in the Persian Gulf and other oil-producing regions of the world are a contribution to worldwide economic and political stability, and insofar as the costs of these commitments are attributable to petroleum use it is to oil consumption throughout the world, rather than simply U.S. oil consumption or imports.

In addition, as discussed previously, the U.S. is rapidly approaching self-sufficiency in petroleum supply, as domestic production is projected to overtake U.S. consumption of fuel and other products refined from petroleum within the next decade.⁵⁴³ Once it reaches that situation, attributing any fraction of remaining military spending to protecting foreign sources of petroleum supply will be logically as well as analytically challenging. Any argument that military spending might vary in response to increases in U.S. petroleum demand resulting from this proposed action is also likely to become less persuasive.

Thus it seems unlikely *either* that U.S. petroleum imports will increase as a consequence of reducing CAFE and CO₂ standards for light-duty vehicles, or that military spending would rise in response to any increase in U.S. imports that did result from this proposed action. As a consequence, the analysis of alternative CAFE and CO₂ emission standards for future model years applies no increase in government spending to support U.S. military activities as a potential cost of allowing new cars and light trucks to achieve lower fuel economy and thus increasing domestic petroleum use.

Similarly, while the ideal size of the Strategic Petroleum Reserve from the standpoint of its potential stabilizing influence on global oil prices may be related to the level of U.S. petroleum consumption or imports, its actual size has not appeared to vary in response to either of those measures. While the budgetary costs for maintaining the SPR are thus similar to U.S. military spending in that they are not reflected in the market price for oil (and thus do not enter consumers' decisions about how much to use), they do not appear to have varied in response to changes in domestic petroleum consumption or imports.

As a consequence, the analysis does not include any potential increase in the cost to maintain a larger SPR among the external or social costs of the increase in gasoline and petroleum consumption likely to result from reducing future CAFE and CO₂ standards. This view concurs with the conclusions of most recent studies of military-related costs to protect U.S. oil imports, which generally conclude that savings in military spending are unlikely to result from incremental reductions in U.S. consumption of petroleum products on the scale of those that would result from adopting higher CAFE or CO₂ standards.

⁵⁴³ U.S. Energy Information Administration, Annual Energy Outlook 2017 Reference Case (https://www.eia.gov/outlooks/aeo/tables_ref.php), Table 11.

7.11 Discounting Future Costs and Benefits

Reductions in costs for producing new cars and light trucks enabled by the proposed action will initially be experienced by vehicle manufacturers. These cost savings may enable them to take advantage of opportunities to invest in improving vehicle designs, building more efficient production facilities, or other initiatives. Alternatively, competitive pressures in the market for new vehicles may lead manufacturers to pass some these cost savings through to buyers in the form of lower selling prices for cars and light trucks. To the extent that this occurs, their buyers will have expanded opportunities for other consumption.

OMB Circular A-4 directs federal agencies to discount future benefits and costs of proposed regulatory actions that affect opportunities for business investment using a 7% rate; in contrast, it advises agencies to discount the economic effects of regulations that will primarily affect households' future consumption opportunities at a 3% rate. As the previous analysis indicates, most or all of the cost savings resulting from their proposed action to revise CAFE and CO₂ emission standards will likely ultimately be reflected in lower prices for new cars and light trucks. This implies that future cost savings (benefits) and foregone benefits (costs) anticipated to result from their action should be discounted using a 3% rate.

Because there is some uncertainty about whether and how completely cost savings will be passed through to buyers rather than redeployed by manufacturers to other investment opportunities, however, a 7% rate may be more appropriate for discounting some future economic consequences of this action. To acknowledge this uncertainty, the results of discounting the anticipated future costs and benefits of this action are reported using both 3% and 7% rates. Benefits and costs are discounted using both rates to their present values as of 2017, and are expressed in constant dollars reflecting the economy-wide price level of 2016.

7.12 Reporting Benefits and Costs

It is important to report the benefits and costs of this proposed action in a format that conveys useful information about how these impacts are generated, and also in a way that distinguishes its economic consequences for private businesses and households from its effects on the remainder of the U.S. economy. A reporting format will accomplish the first objective to the extent that it clarifies the benefits and costs of the proposed action's impacts on car and light truck producers, illustrates how these are transmitted to buyers of new vehicles, shows the action's collateral economic effects on owners of used cars and light trucks, and identifies how these impacts create costs and benefits for the remainder of the U.S. economy. It will achieve the second objective by showing clearly how the economy-wide or "social" benefits and costs of the agencies' proposed action are composed of its direct effects on vehicle producers, buyers, and users, plus the indirect or "external" benefits and costs it creates for the general public.

*** EO 12866 Review – Draft – Do Not Cite, Quote or Release During Review ***

Table 7-19 presents the economic benefits and costs of the proposed action to reduce CAFE and CO₂ emissions standards for model years 2021-26 in a format that is intended to meet these objectives. As it indicates, the proposed action first reduces costs to manufacturers for adding technology necessary to enable new cars and light trucks to comply with fuel economy and emission regulations (line 1). It may also reduce fine payments by manufacturers who would have failed to comply with the more demanding baseline standards. Manufacturers are assumed to pass these cost savings to buyers by charging lower prices; although this reduces their revenues (line 3), on balance, the reduction in compliance costs and lower sales revenue leaves them financially unaffected (line 4).

**TABLE 7-19 - BENEFITS AND COSTS RESULTING FROM THE AGENCIES' PROPOSED ACTION
(PRESENT VALUES DISCOUNTED AT 7%)**

Line	Affected Party	Source	Private Benefits and (Costs)	Amount
1	Vehicle Manufacturers	CAFE model	Savings in technology costs to increase fuel economy	\$194.2
2			Reduced fine payments for CAFE non-compliance	\$1.8
3		assumed = -(1+2)	Loss in revenue from lower vehicle prices	(\$196.0)
4		net = 1+2+3	Net benefits to manufacturers	\$0.0
5	New Vehicle Buyers	assumed = 3	Lower purchase prices for new vehicles	\$196.0
6			Reduced injuries and fatalities from higher vehicle weight	\$1.3
7			Avoided losses in utility of hybrid and electric vehicles	\$26.4
8		CAFE model	Higher fuel costs from lower fuel economy (at retail prices)*	(\$97.1)
9			Inconvenience from more frequent refueling	(\$5.5)
10			Lost mobility benefits from reduced driving	(\$37.1)
11		net = 5+6+7+8+9+10	Net benefits to new vehicle buyers	\$84.0
12	Used Vehicle Owners	CAFE model	Reduced costs for injuries and property damage costs from driving in used vehicles	\$46.0
13	All Private Parties	net = 4+11+12	Net private benefits	\$130.0
Line	Affected Party	Source	External Benefits and (Costs)	Amount
14	Rest of U.S. Economy	CAFE Model	Increase in climate damages from added GHG Emissions**	(\$2.7)
15			Increase in health damages from added emissions of air pollutants**	(\$1.2)
16			Increase in economic externalities from added petroleum use**	(\$6.9)
17			Reduction in civil penalty revenue	(\$1.8)
18			Reduction in external costs from lower vehicle use***	\$29.7
19			Increase in Fuel Tax Revenues	\$12.7
20		net = 14+15+16+17+18+19	Net external benefits	\$29.7
Entry	Affected Party	Source	Economy-Wide Benefits and (Costs)	Amount
21	Entire U.S. Economy	total = 1+2+5+6+7+12+18+19	Total benefits	\$508.0
22		total = 3+8+9+10+14+15+16+17	Total costs	(\$348.2)
23		net = 21+22 (also =13+20)	Net Benefits	\$159.7

As the table shows, most impacts of the proposed action will fall on private businesses and individuals, including manufacturers of cars and light trucks, buyers and subsequent owners of the new models they produce and sell, and owners of used cars and light trucks – that is, vehicles produced during model years prior to those covered by this action. Buyers of new cars and light trucks benefit from their lower purchase prices (line 5), and will also avoid the increased risks of being injured in crashes that would have resulted from manufacturers' efforts to reduce the weight of new models to comply with the baseline standards (line 6). Finally, some buyers will

also avoid the sacrifices in performance, capacity, or driving range they would otherwise have made when purchasing the advanced-technology models such as hybrids, PHEVs, and BEVs that manufacturers would have produced to comply with the more demanding baseline standards (line 7).

At the same time, new cars and light trucks will offer lower fuel economy with more lenient standards in place, and this imposes various costs on their buyers and users. Drivers will experience higher costs as a consequence of new vehicles' increased fuel consumption (line 8), and from the added inconvenience of more frequent refueling stops required by their reduced driving range (line 9). They will also forego some mobility benefits as they use newly-purchased cars and light trucks less in response to their higher fuel costs, although much of this loss will be offset by savings in fuel and other costs as they drive less (the net loss is shown in line 10). On balance, buyers of new cars and light trucks produced during the model years for which this proposed action establishes less demanding fuel economy and GHG emission standards will experience significant economic benefits (line 11).

By lowering prices for new cars and light trucks, this proposed action will cause some owners of used vehicles to retire them from service earlier than they would otherwise have done, and to replace them with new models. In effect, it will transfer some driving that would have been done in used cars and light trucks under the baseline scenario to newer and safer models, thus reducing costs for injuries (both fatal and less severe) and property damages sustained in motor vehicle crashes. This improvement in safety results from the fact that cars and light trucks have become progressively more protective in crashes over time (and also slightly less prone to certain types of crashes, such as rollovers). Thus shifting some travel from older to newer models reduces injuries and damages sustained by drivers and passengers because they are traveling in inherently safer vehicles, rather than because it changes the risk profiles of drivers themselves. This reduction in injury risks and other damage costs produces benefits to owners and drivers of older cars and light trucks (line 12).

Table 7-19 also shows that the changes in fuel consumption and vehicle use resulting from the proposed action will in turn generate both benefits and costs to the remainder of the U.S. economy. These impacts are "external," in the sense that they are by-products of decisions by private firms and individuals that alter vehicle use and fuel consumption, but are experienced broadly throughout the U.S. economy rather than by the firms and individuals who indirectly cause them. Increased refining and consumption of petroleum-based fuel will increase emissions of carbon dioxide and other greenhouse gases that contribute to climate change, and some of the resulting increase in economic damages from future changes in the global climate will be borne throughout the U.S. economy (line 14). Similarly, added fuel production and use will increase emissions of more localized air pollutants (or their chemical precursors), and the resulting increase in the U.S. population's exposure to harmful levels of these pollutants will lead to higher costs from its adverse effects on health (line 15).

*** EO 12866 Review – Draft – Do Not Cite, Quote or Release During Review ***

As discussed in Chapter 7.10, increased consumption and imports of crude petroleum for refining higher volumes of gasoline and diesel will also impose external costs throughout the U.S. economy, in the form of potential losses in production and costs for businesses and households to adjust rapidly to sudden changes in energy prices (line 16 of the table). Reductions in driving by buyers of new cars and light trucks in response to their higher operating costs will also reduce the external costs associated with their contributions to traffic delays and noise levels in urban areas, and these additional benefits will be experienced throughout much of the U.S. economy (line 17). Finally, some of the higher fuel costs to buyers of new cars and light trucks will consist of increased fuel taxes; this increase in revenue will enable federal and state government agencies to provide higher levels of road capacity or maintenance, producing benefits for road users (line 19).

On balance Table 7-19, shows that the proposal to establish less stringent CAFE and CO₂ emission standards will produce significant economic benefits to the remainder of the U.S. economy, as the reduction in external costs imposed by vehicle use combines with higher fuel tax revenue to more than offset the increase in environmental and energy security externalities (line 20). Finally, the table also shows that combined benefits to vehicle manufacturers, buyers and users of cars and light trucks, and the general public (line 21) will significantly outweigh the combined economic costs they experience as a consequence of the agencies' proposed action (line 22). As a consequence, the U.S. economy as a whole will experience large net economic benefits from the proposed action (line 23).

The finding that this action to reduce the stringency of previously-established standards will create significant net economic benefits – when the agencies initially claimed that establishing those standards would also generate large economic benefits to vehicle buyers and others throughout the economy – is notable. Its contrast with that earlier finding is explained by the availability of updated information on the costs and effectiveness of technologies that will remain available to improve fuel economy in model years 2021 and beyond, the fleet-wide consequences for vehicle use, fuel consumption, and safety from requiring higher fuel economy (that is, considering these consequences for used cars and light trucks as well as new ones), and new estimates of some external costs of fuel and petroleum use.

7.13 How Widespread Would Benefits from Lower Standards Be?

The estimates of benefits and costs from the proposed action are based on the expected lifetimes and average annual usage of cars and light trucks, but both the actual lifetimes and annual use number of individual vehicles vary widely around these expected or average values. This means that not all buyers of new cars and light trucks will benefit on balance from the combination of the expected reduction in new vehicles' sales prices and the increase in their lifetime fuel costs due to their lower fuel economy, even if buyers do so *on average*.

Few buyers (and subsequent owners) drive their cars or light trucks enough that the fuel savings from higher fuel economy levels required by the baseline standards would have repaid the higher purchase prices they initially paid. These buyers will be worse off under the proposed alternative standards, because the savings from their lower purchase prices will not be enough to offset the higher fuel costs they will pay over their vehicles’ lifetimes. In contrast, buyers who do not drive enough for the savings in fuel costs with the baseline standards in effect to repay the higher purchase prices for new cars and light trucks under those standards will be better off financially under the reduced standards the agencies are proposing to adopt.

Table 7-20 uses the estimates of price reductions and changes in fuel economy for new cars and light trucks from replacing the baseline standards with the preferred alternative standards to calculate the number of miles new cars and light trucks would need to be driven for their higher lifetime fuel costs to offset buyers’ savings in their initial purchase prices. These mileage estimates differ between cars and light trucks because the changes in their purchase prices and fuel economy levels differ, and they also vary slightly among model years because of the differing fuel prices vehicles from each model year will face over their lifetimes.

TABLE 7-20 - MILEAGE REQUIRED FOR HIGHER FUEL COSTS TO OFFSET SAVINGS IN PURCHASE PRICES OF NEW CARS AND LIGHT TRUCKS

Model Year	Cars						
	Price Reduction	Baseline MPG	Preferred Alternative MPG	MPG Reduction	Average Fuel Price	Increase in Fuel Cost per Mile	Breakeven Miles
2021	\$801	46.4	43.6	2.7	\$3.13	\$0.005	153,000
2022	\$1,034	47.7	44.2	3.5	\$3.16	\$0.007	156,000
2023	\$1,236	48.7	44.5	4.2	\$3.18	\$0.008	161,000
2024	\$1,323	49.2	44.6	4.6	\$3.20	\$0.008	158,000
2025	\$1,474	50.0	44.8	5.2	\$3.22	\$0.009	156,000
2026	\$1,572	50.7	45.1	5.7	\$3.25	\$0.010	156,000
2027	\$1,605	51.1	45.2	6.0	\$3.26	\$0.011	152,000
2028	\$1,633	51.4	45.2	6.2	\$3.28	\$0.011	149,000
Model Year	Light Trucks						
	Price Reduction	Baseline MPG	Preferred Alternative MPG	MPG Reduction	Average Fuel Price	Increase in Fuel Cost per Mile	Breakeven Miles
2021	\$1,402	34.6	31.7	2.9	\$3.13	\$0.010	136,000
2022	\$1,547	35.2	32.0	3.2	\$3.16	\$0.011	137,000
2023	\$1,645	35.6	32.1	3.5	\$3.18	\$0.012	135,000
2024	\$1,750	36.0	32.2	3.8	\$3.20	\$0.013	133,000
2025	\$1,807	36.3	32.3	4.0	\$3.22	\$0.014	131,000
2026	\$2,002	37.0	32.5	4.6	\$3.25	\$0.015	130,000
2027	\$2,062	37.3	32.6	4.7	\$3.26	\$0.016	130,000
2028	\$2,133	37.6	32.6	5.0	\$3.28	\$0.017	128,000

As the table shows, cars would need to be driven 150-160,000 miles for higher fuel costs to offset buyers' savings in their initial purchase prices, while light trucks would need to be driven somewhat less (128-130,000 miles). Because buyers discount future fuel savings, the *discounted* mileage they expect to accumulate over future years would need to exceed these thresholds for the present value of higher lifetime fuel costs to offset the savings in purchase prices. Conversely, buyers of new cars and light trucks who expect to drive less than these thresholds – again, discounting miles that will be driven in future years – will save more on their initial purchases than they will pay in higher lifetime fuel costs.

There is some uncertainty in converting the lifetime mileage thresholds derived in Table 7-20 to average yearly miles over vehicles' lifetimes, it is unknown whether vehicles are driven a constant number of miles each year or their use declines gradually throughout their lifetimes; presumably, each of these patterns occurs to some extent.⁵⁴⁴ Because the pattern of a vehicle's use as it ages affects the discounted value of the total mileage and fuel costs it accumulates over its lifetime, different assumptions about the pattern of use produce slightly different estimates of average annual mileage and discounted fuel costs. The assumption that annual use of cars and light trucks declines gradually with increasing age produces slightly lower estimates of the annual mileage they must be driven for their higher fuel costs to offset the savings in their purchase prices, while assuming that they are driven the same number of miles each year throughout their lifetimes produces slightly higher estimates of their annual "breakeven" mileage.⁵⁴⁵

Figure 7-43 and Figure 7-44 display the distributions of average annual use of cars and light trucks of all ages owned and leased by U.S. households during 2017.⁵⁴⁶ As these figures show, the median number of miles cars are driven is approximately 9,100, while median annual use of light trucks is slightly higher – approximately 9,900 miles. Figure 7-43 also displays the range of estimates of average annual mileage for cars corresponding to the "breakeven" mileage estimates derived in Table 7-20 and shows how these compare to cars' median actual use. Figure 7-44 shows the same comparison for household-owned light-duty trucks.

⁵⁴⁴ Either of these (or any combination of them) would produce the observed fleet-wide distribution of annual car and light truck use by age, which shows average use for new vehicles in the range of 15-17,000 miles and annual use declining in an S-shaped pattern with increasing age.

⁵⁴⁵ These estimates assume that buyers (and subsequent owners) of new cars and light trucks discount future fuel costs using the average interest rate on 60-month new car loans from Finance Companies during 2017, reported in Federal Reserve Bank of The United States, Consumer Credit – G.19, April 6, 2018 (<https://www.federalreserve.gov/Releases/G19/Current/default.htm>).

⁵⁴⁶ These distributions were tabulated from the vehicle file of the 2017 National Household Travel Survey conducted by the Federal Highway Administration; see <https://nhts.ornl.gov/>. Annual use is calculated from each vehicle's odometer reading on the day the household was surveyed, divided by its age in years.

*** EO 12866 Review – Draft – Do Not Cite, Quote or Release During Review ***

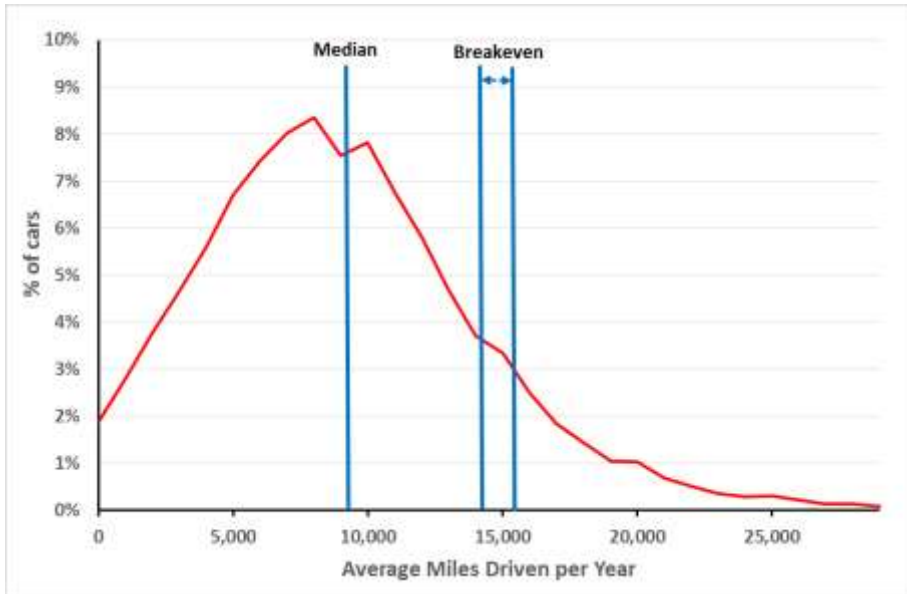

FIGURE 7-43 - DISTRIBUTION OF AVERAGE ANNUAL USE OF HOUSEHOLD AUTOMOBILES

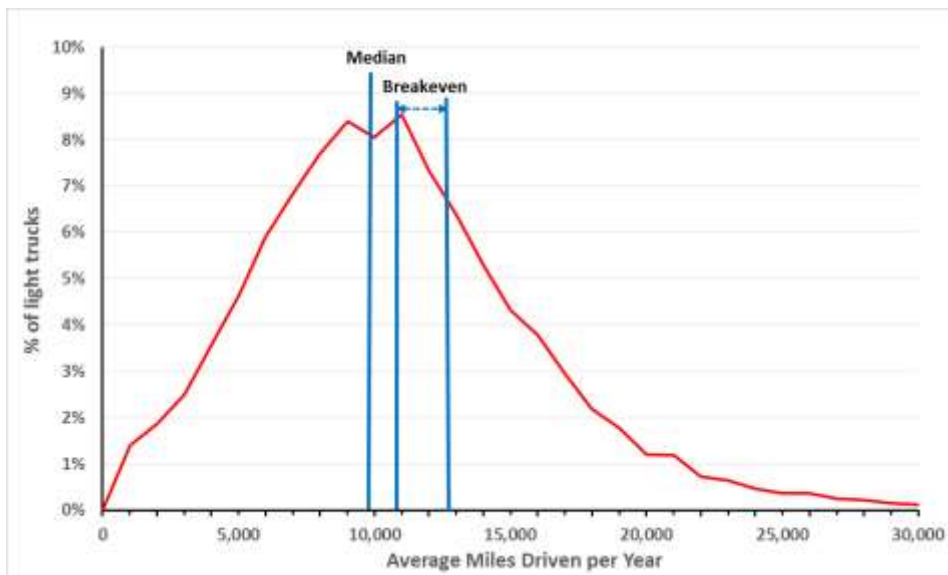

FIGURE 7-44 - DISTRIBUTION OF AVERAGE ANNUAL USE OF HOUSEHOLD LIGHT TRUCKS

As these comparisons illustrate, the annual mileage above which the higher fuel costs resulting from the proposed action would offset new car buyers' savings from lower purchase prices (estimated to be 14,200-15,400 miles per year) is well above cars' median annual use. This means that most new-car buyers will be financially better off under the proposed more lenient standards than they would have been with the baseline standards remaining in effect, because they will save more from lower prices to purchase new cars than they will pay in additional fuel costs (with future fuel costs discounted to their present value). Specifically, about 85% of household-owned cars were driven less during 2017 than the average annual use necessary for higher fuel costs to offset purchase price savings, resulting in net financial savings for their owners.

For light trucks, the level of annual use necessary for higher fuel costs to offset lower purchase prices is lower (10,800-12,800 miles) and much closer to median annual use of household-owned light trucks in 2017, although still above the latter. As a consequence, more than 70% of light truck owners would on balance experience cost savings from the combination of lower purchase prices and higher fuel costs anticipated to result from this action.

Of course, a significant fraction – typically 15-20% of new vehicles are purchased by businesses for the use of their employees, rental car firms, taxi operators, and government agencies. Statistics on the use of these vehicles are difficult to obtain, but annual use of corporate-owned cars and light trucks is reported to average 26-27,000 miles, while annual use of rental cars and light trucks appears to be only slightly lower.⁵⁴⁷ Cars and minivans used in taxi service appear to be driven well more than 100,000 miles annually, while use of government-owned cars and light trucks appears to average 8-11,000 miles annually.⁵⁴⁸ Thus the owners and users of most of these vehicles are likely to experience cost increases on balance, as their higher fuel costs exceed savings in their purchase prices – significantly so, in the case of corporate fleet, rental, and taxi vehicles.

⁵⁴⁷ See Automotive Fleet, U.S. Fleet Statistics by Industry Segment, http://www.automotive-fleet.com/statistics/statsviewer.aspx?file=http%3a%2f%2fwww.automotive-fleet.com%2ffc_resources%2fstats%2faffb12-9-fleetstats.pdf&channel= Use of rental cars was estimated from information reported on vehicles' average odometer readings and ages when they are sold by rental car companies, reported in <http://online.wsj.com/news/articles/SB10001424127887324463604579040870991145200>

⁵⁴⁸ Use of taxis was estimated from Automotive Fleet, U.S. Fleet Statistics by Industry Segment, http://www.automotive-fleet.com/statistics/statsviewer.aspx?file=http%3a%2f%2fwww.automotive-fleet.com%2ffc_resources%2fstats%2faffb12-9-fleetstats.pdf&channel= Use of cars and light trucks owned by government agencies was estimated from Government Fleet Fact Book 2012 (<http://www.government-fleet.com/fileviewer/1556.aspx>), "Fleet Size by Unit Type," p. 28, and "State, County, and Municipal Vehicle Totals," p. 30; and 2012 Federal Fleet Report (<http://www.gsa.gov/portal/category/102859>), Tables 2-5, 2-6, and 4-2.

7.14 Potential Benefits from Improving Vehicles’ Other Attributes

As Section 7.5 indicated, sufficiently detailed information on the potential improvements in car and light truck attributes such as comfort, safety, carrying and towing capacity, or performance manufacturers could also make using the various technologies available to improve fuel economy is not currently available. Thus the analysis does not estimate the specific improvements in those other attributes that producers are instead likely to make on individual car and light truck models when they face less demanding fuel economy standards. To some extent, they are likely to react to less demanding standards by employing less technology – thus reducing their costs for producing many models and the selling prices they establish for them – but another response is likely to be redeploying the energy efficiency benefits of technologies they retain to improve other features that potential buyers value highly. This section estimates the potential improvements in selected attributes manufacturers could make instead of improving fuel economy, and estimates the additional benefits buyers would receive from those improvements.

Table 7-21 summarizes empirical estimates of the tradeoffs among fuel economy, horsepower (for cars) or torque (for light trucks), and weight – which is related to features such as a vehicle’s passenger- and cargo-carrying capacity, interior volume, comfort, and safety – derived from different authors’ econometric estimates of the “curvature” of the energy efficiency frontiers for cars and light trucks described in Chapter 7.5. The entries in the table show different authors’ estimates of the percent increases in horsepower, torque, and weight that car and light truck manufacturers could instead achieve if they reduced fuel economy by one percent. These tradeoffs apply to overall average values of each attribute for all cars or light trucks (as labeled in the table) produced during recent model years, rather than to the features of individual models.

TABLE 7-21 - ESTIMATED TRADEOFFS AMONG FUEL ECONOMY AND OTHER ATTRIBUTES OF CARS AND LIGHT TRUCKS

Source	Vehicle Class	% Increase in Fuel Economy per 1% Reduction in Other Attributes		
		Horsepower	Torque	Weight
Klier and Linn	Cars	0.24%	--	0.34%
	Light Trucks	--	0.16%	0.36%
Knittel	Cars	0.26%	0.08%	0.39%
	Light Trucks	0.06%	0.31%	0.36%
Mackenzie	Cars			
	Light Trucks			
Estimates Used for this Analysis	Cars	0.25%	--	0.36%
	Light Trucks	--	0.24%	0.36%

Table 7-21 shows that, for example, Klier & Linn estimate reducing the average fuel economy of cars by 1% would enable producers to increase their average horsepower by 0.24%, and Knittel’s estimate of that tradeoff is very similar (0.26%). Similarly, those two studies estimate that reducing the average fuel economy of cars and light trucks would enable their weight to be

increased by 0.34-0.39%, which would in turn permit manufacturers to make modest improvements in their passenger- and cargo-carrying capacity, interior volume, comfort, or safety. (Reducing average fuel economy by 1% would permit either power *or* weight to increase as indicated, but not both at the same time.)

The historical evolution of car and light truck characteristics under CAFE standards suggests that producers are not likely to use all improvements in energy efficiency to improve features other than fuel economy under the constant CAFE and CO₂ emission standards the agencies' proposed action would establish. Figure 7-45 and Figure 7-46 shows that during historical periods when CAFE standards remained essentially unchanged – approximately 1985-2010 for cars, and 1984-2004 for light trucks – manufacturers gradually improved cars' and light trucks' average fuel economy as well as their power (or torque) and weight, and also gradually increased the average interior volume of cars.

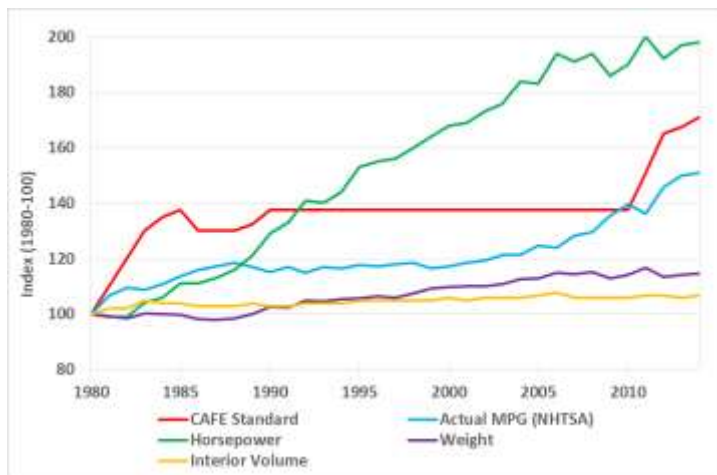

FIGURE 7-45 - HISTORICAL EVOLUTION OF CAR ATTRIBUTES WITH CAFE STANDARDS IN EFFECT

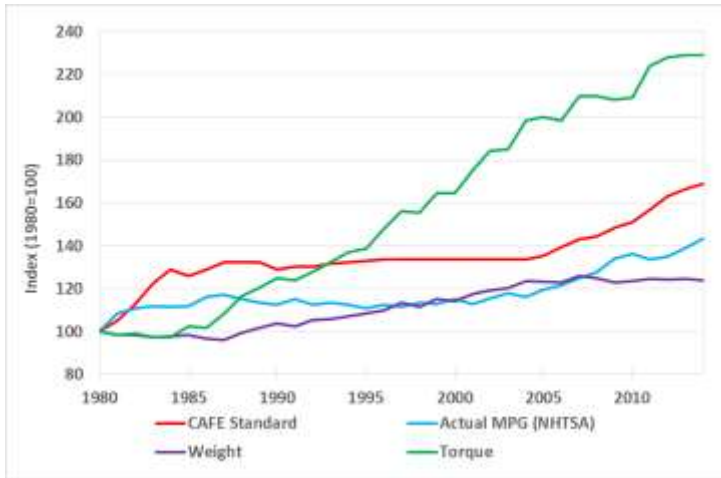

FIGURE 7-46 - HISTORICAL EVOLUTION OF LIGHT TRUCK ATTRIBUTES WITH CAFE STANDARDS IN EFFECT

Table 7-22 summarizes the rates of change in this limited set of car and light truck attributes over those periods; as it shows, most of the improvements in cars’ energy efficiency were used to increase their power, fuel economy, and weight, while most of light trucks’ improved energy efficiency was used to increase their torque and weight, with relatively little used to improve fuel economy.

TABLE 7-22 - ANNUAL RATES OF CHANGE IN CAR AND LIGHT TRUCK ATTRIBUTES WITH CAFE STANDARDS IN EFFECT

Vehicle Class	Period of Approximately Flat Standards	Annual Percent Increases				
		Actual MPG (NHTSA)	Horse-power	Torque	Weight	Interior Volume
Passenger Cars	1985-2010	0.83%	2.17%	--	0.53%	0.07%
Light Trucks	1984-2004	0.20%	--	3.54%	1.21%	--

Table 7-23 shows the estimated average values of fuel economy and other characteristics that cars and light trucks produced during model years 2021-2025 would have if the baseline standards remained in effect. These estimates reflect the average achieved CAFE ratings for cars and light trucks, together with the assumption (discussed previously in Section 7.2.2) that features other than their fuel economy would be held constant at their base year (model year 2020) values.⁵⁴⁹

⁵⁴⁹ Tables 8-21 through 8-25 consider only model years through 2025, because there are no baseline CAFE standards for 2026 that can be compared to those the agencies are proposing to establish.

*** EO 12866 Review – Draft – Do Not Cite, Quote or Release During Review ***

TABLE 7-23 - ESTIMATED FUEL ECONOMY AND OTHER CHARACTERISTICS OF BASELINE CAR AND LIGHT TRUCK FLEETS

Model Year	Passenger Car Attributes				Light Truck Attributes		
	Fuel Economy (mpg)	Horse-power	Weight (lbs.)	Interior Volume (cu. ft.)	Fuel Economy (mpg)	Torque (ft.-lbs.)	Weight (lbs.)
2020	43.9	201	3,231	112.0	32.3	301	4,308
2021	46.4	201	3,208	112.0	34.6	301	4,252
2022	47.7	201	3,187	112.0	35.2	301	4,235
2023	48.7	201	3,172	112.0	35.6	301	4,224
2024	49.2	201	3,159	112.0	36.0	301	4,216
2025	50.0	201	3,150	112.0	36.3	301	4,205
2026	50.7	201	3,127	112.0	37.0	301	4,176

Using the estimates of tradeoffs among fuel economy and vehicles’ other features reported in the bottom row of Table 7-21 above (those labeled “Estimates Used for this Analysis”), Table 7-24 projects the potential changes in fuel economy and other features car and light truck producers could make instead of the increases in fuel economy that the baseline standards would have required. The estimates reported in Table 7-24 assume that manufacturers would still choose to increase fuel economy at the rates observed during historical periods when CAFE standards remained unchanged – 0.83% per year for cars and 0.20% annually for light trucks, as reported in Table 7-22 – rather than channeling all efficiency improvements into improving other attributes.

The remaining increase in vehicles’ energy efficiency that would otherwise have been used to achieve the required increases in fuel economy shown in Table 7-23 will instead be used to increase the average power, weight, and interior volume of cars, or the average torque and weight of light trucks. Improvements in these other attributes are assumed to occur in the same combination – that is, at the same relative rates – during future model years as was the case during the extended periods when car and light truck CAFE standards remained unchanged.

TABLE 7-24 - ESTIMATED FUEL ECONOMY AND OTHER CHARACTERISTICS OF CAR AND LIGHT TRUCK FLEETS UNDER PROPOSED STANDARDS

Model Year	Passenger Car Attributes				Light Truck Attributes		
	Fuel Economy (mpg)	Horsepower	Weight (lbs.)	Interior Volume (cu. ft.)	Fuel Economy (mpg)	Torque (ft.-lbs.)	Weight (lbs.)
2020	42.6	202	3,267	112.0	30.7	304	4,362
2021	43.6	204	3,278	112.1	31.7	308	4,397
2022	44.2	206	3,292	112.1	32.0	313	4,436
2023	44.5	209	3,309	112.2	32.1	319	4,479
2024	44.6	212	3,327	112.3	32.2	326	4,525
2025	44.8	216	3,348	112.4	32.3	332	4,575
2026	45.1	220	3,370	112.5	32.5	340	4,631

As Table 7-24 indicates, the proposed action to freeze CAFE and GHG standards at their previously established levels for model year 2021 (cars) and 2020 (light trucks) would enable producers to make modest improvements features that buyers appear to value highly, while also continuing to improve fuel economy gradually. Comparing the values in Table 7-24 to the corresponding entries in Table 7-23 shows that by model year 2026, the average car would have 19 additional horsepower, weigh approximately 240 pounds more, and have a slightly larger interior volume than if the baseline standards remained in effect. At the same time, cars' average CAFE rating would reach 45.1 miles per gallon by 2026, in contrast to the 50.7 miles per gallon they were estimated to achieve in 2026 under the baseline standards. Similarly, the average torque and weight of model year 2026 light trucks would be significantly higher with the agencies' proposed action than if the baseline standards remained in effect, although their fuel economy would be 4.6 miles per gallon lower.

Table 7-25 summarizes published estimates of the dollar values that buyers of new cars and light trucks appear to attach to these various attributes. There are few empirical estimates of these values, and the range of estimates for the values of individual attributes reported in each study is very wide. Where the two studies included in the table report comparable measures, their estimates also differ widely. The Trimmed Mean estimates reported by Greene at al. (2015) represent the average values of estimates those authors reviewed, with extreme outlying values excluded to limit their influence; comparing the mean and Trimmed Mean estimates shows that excluding outliers significantly reduces the calculated mean values of the included estimates, which suggests that the most extreme outlying estimates were at the high end of the range.

TABLE 7-25 - ESTIMATED VALUES OF SELECTED ATTRIBUTES TO BUYERS OF NEW CARS AND LIGHT TRUCKS

Attribute	Measure	Greene et al. (2015\$)			Whitefoot and Skerlos (2008\$)		
		Mean	Trimmed Mean	Median	Low	Mid	High
Fuel Economy	Miles per Gallon	\$375	\$164	\$64	--	--	--
Power	Horsepower	\$54	\$13	\$10	--	--	--
Weight	Curb Weight (lbs.)	\$10	\$6	\$1	--	--	--
Horsepower/weight	0.01 HP/pound	\$1,861	\$1,334	\$346	\$160	\$2,830	\$5,500
Footprint	sq. ft.	--	--	--	\$340	\$1,170	\$2,000

Though recognizing that values of individual attributes are not well estimated, Table 7-26 applies the Trimmed Mean values of individual attributes from the study by Greene et al. (2015) to the differences in average car and light truck attributes between the baseline scenario from Table 7-23, and the proposed action to freeze standards at levels previously established for model years 2020 (light trucks) and 2021 (cars), from Table 7-24. As it shows, if the values used here are considered reliable, the improvements in features other than fuel economy this proposal would enable manufacturers to make – in addition to increasing fuel economy, although at slower rates than the baseline standards would have required – would provide substantial value to car and light truck buyers.⁵⁵⁰ Most of this would come from increasing vehicles’ weight, although this does not necessarily mean that buyers value added weight itself; instead, they presumably value the increases in ride quality, comfort, cargo-carrying capacity (for light trucks), and safety that are associated with higher vehicle weight.

Commented [A28]: Suggest adding a stipulation that acknowledges the wide range of distributions in the Greene et al. study:
“Though recognizing that values of individual attributes are not well estimated, Table 7-26 applies the Trimmed Mean values of individual attributes from the study by Greene et al. (2015) to the differences in average car and light truck attributes...”

Commented [A29]: Similar to above, change the text from “As it shows” to “If the values used here are considered reliable” acknowledges the wide range of results in the Greene study.

TABLE 7-26 - VALUE OF IMPROVEMENTS IN OTHER CAR AND LIGHT TRUCK ATTRIBUTES UNDER PROPOSED STANDARDS

Model Year	Cars				Light Trucks		
	Horsepower	Weight	Interior Volume	Total	Torque	Weight	Total
2020	\$12	\$218	\$0	\$230	\$34	\$326	\$360
2021	\$36	\$417	\$0	\$453	\$95	\$873	\$968
2022	\$68	\$629	\$0	\$697	\$163	\$1,208	\$1,371
2023	\$105	\$820	\$0	\$925	\$238	\$1,526	\$1,764
2024	\$147	\$1,008	\$0	\$1,155	\$321	\$1,856	\$2,177
2025	\$195	\$1,188	\$0	\$1,383	\$410	\$2,220	\$2,630
2026	\$248	\$1,462	\$1	\$1,711	\$512	\$2,727	\$3,239

Finally, Table 7-27 summarizes the projected reductions in new car and light truck purchase prices, increases in their lifetime fuel costs due to their lower fuel economy (discounted at 7%), and the value of improvements in their other attributes shown in Table 7-26. The sum of these

⁵⁵⁰ The value of increased interior volume of cars – which improves passengers’ comfort and may permit an additional passenger or parcels to be carried in some models – cannot be estimated, but it would probably be small, because the increase in interior volume is itself small.

figures provides a measure of the extent to which the average buyer of a new car or light trucks is better off as a consequence of the proposed action, although this calculation omits some minor benefits and costs that buyers will also experience (such as increased time and inconvenience from more frequent refueling, savings in maintenance costs, etc.).

As Table 7-27 shows, new car and light truck buyers will be financially better off even without considering the value of improvements in attributes other than fuel economy of the models they purchase, because the reduction in their purchase prices will more than compensate for their higher lifetime fuel costs.⁵⁵¹ It also shows that when the estimated values of improvements in those other attributes are included, buyers will be substantially better off under the agencies’ proposed action than if the baseline standards remained in force, and their financial gain will increase gradually over successive model years through 2026.

TABLE 7-27 - NET FINANCIAL IMPACT ON NEW CAR AND LIGHT TRUCK BUYERS

Model Year	Passenger Cars				Light Trucks			
	Reduction in Purchase Price	Higher Lifetime Fuel Costs	Improvements in Other Features	Net Gain or Loss	Reduction in Purchase Price	Higher Lifetime Fuel Costs	Improvements in Other Features	Net Gain or Loss
2020	\$472	\$145	\$230	\$557	\$923	\$551	\$360	\$733
2021	\$801	\$371	\$453	\$883	\$1,402	\$940	\$968	\$1,430
2022	\$1,034	\$497	\$697	\$1,233	\$1,547	\$1,044	\$1,371	\$1,874
2023	\$1,236	\$590	\$925	\$1,571	\$1,645	\$1,133	\$1,764	\$2,276
2024	\$1,323	\$657	\$1,155	\$1,821	\$1,750	\$1,238	\$2,177	\$2,689
2025	\$1,474	\$749	\$1,383	\$2,107	\$1,807	\$1,297	\$2,630	\$3,140
2026	\$1,572	\$807	\$1,711	\$2,476	\$2,002	\$1,450	\$3,239	\$3,791

As indicated previously, these results should be considered illustrative, because the specific improvements in attributes other than fuel economy that producers are likely to make to their individual car and light truck models when they face less demanding fuel economy standards cannot be estimated. The estimates of the extent of those improvements and their value apply to typical or representative new cars and light trucks, but they were not developed at the same level of detail and precision as the simulations of changes in fuel economy and production costs for individual models. Nevertheless, they indicate the rough magnitude of the sacrifices in vehicles’ features and overall value that manufacturers would have made to meet the more demanding baseline CAFE and CO₂ emission standards, and the economic benefits to buyers that are likely to result from reducing those standards as the agencies are now proposing.

⁵⁵¹ The same will be true even if buyers discount future fuel costs at 3%, instead of the 7% rate used to calculate the increases in fuel costs reported in Table 8-25.

8 Cost Impacts

8.1 CAFE Model Results

The technology application algorithm implemented with the CAFE model was used as the basis for estimating costs for the fleet. Here, costs refer to costs or civil penalties to manufacturers relative to NHTSA's MY 2022-2025 augural standards and the MY 2022-2025 EPA standards finalized in 2012. In each of these tables, costs are shown incremental to a technology baseline that represents the technology that the CAFE model assumes would proceed the new technology application.

Table 8-1 through Table 8-9 show the direct unit costs of the various CAFE technologies that are examined in the CAFE model lumped by general technology category. These direct costs were marked up to retail level using the Retail Price Equivalent (RPE) multiplier and adjusted for learning effects to produce the aggregate cost impacts that are illustrated in Table 8-10 through Table 8-81. A full discussion of the indirect cost and learning curve impacts is provided in later sections of this chapter.

Monetized aggregate cost impacts are presented for Passenger Cars, Light Trucks, and Combined Light-Duty. Also, 3% and 7% discounts rates are shown; undiscounted values are also presented where applicable. Lastly, results have been produced for both CAFE and CO₂ standards. The following is a brief description of the tables presenting aggregate cost impacts:

Table 8-10 through Table 8-27 show lifetime societal costs, by model year, under the preferred alternative. Table 8-28 through Table 8-39 show incremental lifetime societal costs for MYs 1975-2029 for each alternative. Costs are included for advanced vehicle technologies, consumer surplus/loss, and costs due to increased crashes, fatalities, congestion, and noise.

Table 8-40 through Table 8-51 show incremental total costs by societal perspective under each alternative, by vehicle model year.

Table 8-52 through Table 8-57 show average incremental technology cost and civil penalties per vehicle by model year. Average costs are presented for each alternative and without a discount rate.

Table 8-58 through Table 8-69 show per-vehicle net present value of ownership costs, by model year, under the preferred alternative. Table 8-70 through Table 8-81 show MY 2030 per-vehicle net present value of ownership costs under each alternative. Owner costs include vehicle price increase, welfare loss, and additional ownership costs.

Section 8.2 discusses indirect costs to manufacturers, which are estimated as a mark-up to direct manufacturing costs for the various technologies manufacturers are expected to use to meet future CAFE and CO₂ standards. Section 8.2.1 discusses retail price equivalent (RPE), which is a method of estimating indirect costs based on an examination of historical financial data contained in 10-K

*** EO 12866 Review – Draft – Do Not Cite, Quote or Release During Review ***

reports filed by manufacturers with the Securities and Exchange Commission (SEC). In Section 8.2.2, the indirect cost multiplier (ICM) is discussed as another method for estimating indirect costs, which is more specific to technology in terms of level of complexity.

Cost impacts due to learning in manufacturing are discussed in Section 8.3. Learning curves reflect the effect of experience and volume on the cost of production, which generally results in better utilization of resources, leading to higher and more efficient production.

TABLE 8-1 - GASOLINE ENGINE TECHNOLOGIES - DIRECT MANUFACTURER COSTS (2016\$)

Tech	Basis	Unit DMC	Direct Manufacturing Cost (DMC)					Incremental to
			4-Cylinder	4-Cylinder	6-Cylinder	6-Cylinder	8-Cylinder	
			1-Bank Engine	2-Bank Engine	1-Bank Engine	2-Bank Engine	2-Bank Engine	
LUBEFR1	cylinder	\$13.93	\$55.71	\$55.71	\$83.57	\$83.57	\$111.42	BaseE
LUBEFR2	cylinder	\$0.84	\$3.36	\$3.36	\$5.04	\$5.04	\$6.72	LUBEFR1
LUBEFR3	cylinder	\$0.76	\$3.02	\$3.02	\$4.54	\$4.54	\$6.05	LUBEFR2
VVT	bank	\$78.38	\$78.38	\$156.75	\$78.38	\$156.75	\$156.75	BaseE
VVL	cylinder	\$53.48	\$213.92	\$213.92	\$320.89	\$320.89	\$427.85	VVT
SGDI	cylinder	\$59.16	\$236.64	\$236.64	\$354.95	\$354.95	\$473.27	VVT
DEAC	none	\$29.39	\$29.39	\$29.39	\$29.39	\$29.39	\$29.39	VVT
ADEAC	cylinder	\$188.93 -206.17	\$835.52	\$835.52	\$1,253.29	\$1,253.29	\$1,671.05	VVT
HCR	none	-	\$550.15	\$550.15	\$811.46	\$811.46	\$1,108.01	VVT
TURBO1	none	-	\$838.99	\$838.99	\$845.09	\$845.09	\$1,384.75	VVT
TURBO2	none	-	\$231.28	\$231.28	\$231.28	\$231.28	\$389.85	TURBO1
CEGR1	none	-	\$277.02	\$277.02	\$277.02	\$277.02	\$277.02	TURBO2
ADSL	none	-	\$3,328.34	\$3,328.34	\$3,925.09	\$3,925.09	\$4,178.32	VVT
DSL1	none	-	\$367.74	\$367.74	\$478.94	\$478.94	\$478.94	ADSL

TABLE 8-2 - TRANSMISSION TECHNOLOGIES - DIRECT MANUFACTURER COSTS (2016\$)

Transmission	Direct manufacturing Cost	Incremental to
AT5	\$0.00	BaseT
AT6	(\$14.31)	AT5
AT6L2	\$131.84	AT6
AT7	(\$73.08)	AT6L2
AT8	(\$46.18)	AT6L2
AT8L2	\$213.15	AT8

*** EO 12866 Review – Draft – Do Not Cite, Quote or Release During Review ***

AT8L3	\$164.80	AT8L2
AT9	(\$295.55)	AT8L3
AT10	(\$295.55)	AT8L3
AT10.2	\$164.80	AT10
DCT6	\$19.83	AT5
DCT8	\$348.71	DCT6
CVT	\$182.79	AT5
CVTL2A	\$137.33	CVT
MT5	\$0.00	BaseT
MT6	\$257.91	MT5
MT7	\$249.24	MT6

TABLE 8-3 - ELECTRIFICATION TECHNOLOGIES - DIRECT MANUFACTURING (2016\$)

	SmallCar	MedCar	SmallSUV	MedSUV	Pickup	Incremental to
EPS	\$93.59	\$93.59	\$93.59	\$93.59	\$93.59	BaseV
IACC	\$49.55	\$49.55	\$49.55	\$49.55	\$49.55	EPS
SS12V	\$259.51	\$284.94	\$306.04	\$313.55	\$354.51	IACC
BISG	\$1,055.94	\$1,055.94	\$1,055.94	\$1,212.01	\$1,212.01	SS12V
CISG	\$2,210.82	\$2,797.66	\$2,809.77	\$3,432.94	\$3,432.94	BISG

TABLE 8-4 - HYBRID ELECTRIFICATION PATH - DIRECT MANUFACTURING (2016\$)

	SmallCar	MedCar	SmallSUV	MedSUV	Pickup	Incremental to
SHEVP2	\$1,977.82	\$2,614.50	\$2,128.50	\$2,437.05	\$2,572.18	CISG
SHEVPS	\$1,875.25	\$2,478.91	\$2,018.12	\$2,310.66	\$2,438.79	SHEVP2
PHEV30	\$3,076.60	\$5,573.14	\$3,564.29	\$5,573.14	\$5,573.14	SHEVPS
PHEV50	\$3,289.28	\$5,958.41	\$3,810.69	\$5,958.41	\$5,958.41	PHEV30
BEV200	\$452.85	\$2,467.70	\$147.29	\$2,467.70	\$2,467.70	PHEV50
FCV	\$15,174.68	\$15,174.68	\$15,174.68	\$15,174.68	\$15,174.68	BEV200

TABLE 8-5 - VEHICLE TECHNOLOGIES - DIRECT MANUFACTURER COSTS (2016\$)

Technology	Direct Manufacturing Cost	Incremental to
LDB	\$64.65	BaseV
SAX	\$89.18	BaseV

*** EO 12866 Review – Draft – Do Not Cite, Quote or Release During Review ***

TABLE 8-6 - ROLLING RESISTANCE VEHICLE TECHNOLOGIES - DIRECT MANUFACTURER COSTS (2016\$)

Technology	Direct Manufacturing Cost	Incremental to
ROLL0	\$0.00	BaseV
ROLL1	\$5.88	ROLL0
ROLL2	\$44.58	ROLL1

TABLE 8-7 - AERODYNAMIC VEHICLE TECHNOLOGIES - DIRECT MANUFACTURER COSTS (2016\$)

Technology	Direct Manufacturing Cost	Incremental to
AERO0	\$0	BaseV
AERO5	\$45	AERO0
AERO10	\$92	AERO5
AERO15	\$228	AERO10
AERO20	\$1,000	AERO15

TABLE 8-8 - MASS REDUCTION VEHICLE TECHNOLOGIES FOR PASSENGER CARS DIRECT MANUFACTURER COSTS PER LB (2016\$)

Technology	Direct Manufacturing Cost	Incremental to
MR0	\$0.00	BaseV
MR1	\$0.38	BaseV
MR2	\$0.73	BaseV
MR3	\$0.96	BaseV
MR4	\$1.53	BaseV
MR5	\$2.44	BaseV

TABLE 8-9 - MASS REDUCTION VEHICLE TECHNOLOGIES FOR LIGHT TRUCKS DIRECT MANUFACTURER COSTS PER LB (2016\$)

Technology	Direct Manufacturing Cost	Incremental to
MR0	\$0.00	BaseV
MR1	\$0.23	BaseV
MR2	\$0.54	BaseV
MR3	\$0.95	BaseV
MR4	\$1.40	BaseV
MR5	\$2.88	BaseV

*** EO 12866 Review – Draft – Do Not Cite, Quote or Release During Review ***

**TABLE 8-10 - LIFETIME SOCIETAL COSTS FOR PREFERRED ALTERNATIVE BY MODEL YEAR, PASSENGER CAR
3% DISCOUNT RATE, CAFE (BILLIONS OF 2016\$)**

	MY 1977- 2016	MY 2017	MY 2018	MY 2019	MY 2020	MY 2021	MY 2022	MY 2023	MY 2024	MY 2025	MY 2026	MY 2027	MY 2028	MY 2029	TOTAL
Technology Costs	0.0	-0.9	-1.9	-2.6	-5.3	-8.8	-10.8	-12.2	-12.4	-12.7	-12.4	-11.8	-11.2	-10.7	-113.7
Advanced Technology Value Loss	0.0	-0.1	-0.2	-0.2	-0.5	-1.0	-1.4	-1.9	-2.1	-2.5	-2.5	-2.4	-2.4	-2.3	-19.6
Congestion Costs	-12.2	-1.3	-1.4	-1.5	-1.7	-2.1	-1.9	-1.5	-1.1	-0.6	-0.2	0.2	0.2	0.3	-24.9
Noise Costs	-0.2	0.0	0.0	0.0	0.0	0.0	0.0	0.0	0.0	0.0	0.0	0.0	0.0	0.0	-0.3
Non-Rebound Fatality Costs	-18.8	-1.8	-1.7	-1.6	-1.5	-1.3	-0.7	-0.1	0.5	1.2	1.8	2.2	2.2	2.2	-17.3
Non-Rebound Non-Fatal Crash Costs	-29.3	-2.8	-2.6	-2.5	-2.3	-2.1	-1.1	-0.2	0.8	1.8	2.8	3.4	3.4	3.5	-27.1
Rebound Fatality Costs	0.6 ¹	-0.1	-0.3	-0.5	-0.9	-1.6	-2.0	-2.2	-2.3	-2.3	-2.3	-2.2	-2.1	-2.1	-20.2
Non-Fatal Crash Costs	0.9 ¹	-0.1	-0.5	-0.8	-1.4	-2.5	-3.1	-3.4	-3.6	-3.6	-3.6	-3.4	-3.3	-3.2	-31.6
Total Societal Costs	-58.9	-7.3	-8.6	-9.6	-13.6	-19.4	-21.1	-21.5	-20.2	-18.6	-16.3	-14.0	-13.2	-12.4	-254.8

¹Note that MY's 1977-2016 have fixed fuel economy values across regulatory alternatives, but that the 2017 AEO fuel price projections generally increase over time. This results in a reduction of driving when the rebound effect is included. However, fewer MY 1977-2016 vehicle remain on the road in the preferred scenario than the baseline standards, making the increment of fatal/non-fatal crash costs due to rebound miles positive. This is true for the fatal/non-fatal crash costs for MY's 1977-2016 reported in all tables.

*** EO 12866 Review – Draft – Do Not Cite, Quote or Release During Review ***

**TABLE 8-11 - LIFETIME SOCIETAL COSTS FOR PREFERRED ALTERNATIVE BY MODEL YEAR, PASSENGER CAR
3% DISCOUNT RATE, CO₂ (BILLIONS OF 2016\$)**

	MY 1977- 2016	MY 2017	MY 2018	MY 2019	MY 2020	MY 2021	MY 2022	MY 2023	MY 2024	MY 2025	MY 2026	MY 2027	MY 2028	MY 2029	TOTAL
Technology Costs	0.0	-0.7	-1.7	-2.3	-4.2	-6.0	-8.1	-9.4	-10.1	-10.7	-11.3	-11.4	-11.2	-10.7	-97.9
Advanced Technology Value Loss	0.0	-0.1	-0.1	-0.2	-0.4	-0.6	-0.9	-1.3	-1.3	-1.4	-1.6	-1.5	-1.6	-1.6	-12.4
Congestion Costs	-10.1	-1.3	-1.4	-1.5	-1.6	-1.8	-1.7	-1.2	-1.0	-0.6	-0.1	0.0	0.2	0.6	-21.6
Noise Costs	-0.1	0.0	0.0	0.0	0.0	0.0	0.0	0.0	0.0	0.0	0.0	0.0	0.0	0.0	-0.3
Non-Rebound Fatality Costs	-15.5	-1.7	-1.7	-1.7	-1.6	-1.5	-1.1	-0.2	0.3	1.1	1.7	2.0	2.2	2.6	-15.0
Non-Rebound Non-Fatal Crash Costs	-24.3	-2.7	-2.7	-2.6	-2.5	-2.4	-1.6	-0.3	0.5	1.7	2.7	3.1	3.5	4.1	-23.5
Rebound Fatality Costs	0.5	-0.1	-0.3	-0.4	-0.7	-1.1	-1.6	-1.8	-2.0	-2.3	-2.4	-2.4	-2.4	-2.3	-19.3
Non-Fatal Crash Costs	0.8	-0.1	-0.5	-0.7	-1.1	-1.8	-2.4	-2.8	-3.2	-3.5	-3.7	-3.8	-3.7	-3.7	-30.1
Total Societal Costs	-48.8	-6.7	-8.4	-9.3	-12.2	-15.4	-17.4	-17.0	-16.8	-15.6	-14.6	-14.0	-12.9	-10.9	-220.0

*** EO 12866 Review – Draft – Do Not Cite, Quote or Release During Review ***

**TABLE 8-12 - LIFETIME SOCIETAL COSTS FOR PREFERRED ALTERNATIVE BY MODEL YEAR, PASSENGER CAR
7% DISCOUNT RATE, CAFE (BILLIONS OF 2016\$)**

	MY 1977- 2016	MY 2017	MY 2018	MY 2019	MY 2020	MY 2021	MY 2022	MY 2023	MY 2024	MY 2025	MY 2026	MY 2027	MY 2028	MY 2029	TOTAL
Technology Costs	0.0	-0.9	-1.8	-2.4	-4.7	-7.5	-8.9	-9.7	-9.5	-9.3	-8.8	-8.0	-7.4	-6.8	-85.9
Advanced Technology Value Loss	0.0	-0.1	-0.2	-0.2	-0.4	-0.9	-1.2	-1.5	-1.6	-1.8	-1.8	-1.7	-1.6	-1.5	-14.4
Congestion Costs	-7.6	-0.7	-0.8	-0.8	-1.0	-1.2	-1.1	-0.8	-0.5	-0.2	0.0	0.2	0.3	0.3	-13.9
Noise Costs	-0.1	0.0	0.0	0.0	0.0	0.0	0.0	0.0	0.0	0.0	0.0	0.0	0.0	0.0	-0.2
Non-Rebound Fatality Costs	-11.8	-0.9	-0.8	-0.8	-0.7	-0.6	-0.2	0.2	0.6	0.9	1.2	1.4	1.3	1.3	-8.7
Non-Rebound Non-Fatal Crash Costs	-18.5	-1.5	-1.3	-1.2	-1.0	-0.9	-0.3	0.3	0.9	1.5	1.9	2.2	2.1	2.0	-13.7
Rebound Fatality Costs	0.4	-0.1	-0.3	-0.4	-0.7	-1.1	-1.3	-1.4	-1.4	-1.4	-1.3	-1.2	-1.2	-1.1	-12.5
Non-Fatal Crash Costs	0.6	-0.1	-0.4	-0.6	-1.0	-1.8	-2.1	-2.2	-2.2	-2.2	-2.1	-1.9	-1.8	-1.7	-19.6
Total Societal Costs	-37.0	-4.4	-5.5	-6.3	-9.5	-14.0	-15.1	-15.2	-13.9	-12.6	-10.8	-9.0	-8.2	-7.4	-168.9

*** EO 12866 Review – Draft – Do Not Cite, Quote or Release During Review ***

**TABLE 8-13 - LIFETIME SOCIETAL COSTS FOR PREFERRED ALTERNATIVE BY MODEL YEAR, PASSENGER CAR
7% DISCOUNT RATE, CO₂ (BILLIONS OF 2016\$)**

	MY 1977- 2016	MY 2017	MY 2018	MY 2019	MY 2020	MY 2021	MY 2022	MY 2023	MY 2024	MY 2025	MY 2026	MY 2027	MY 2028	MY 2029	TOTAL
Technology Costs	0.0	-0.7	-1.7	-2.1	-3.7	-5.1	-6.7	-7.5	-7.7	-7.9	-8.0	-7.8	-7.4	-6.8	-73.2
Advanced Technology Value Loss	0.0	-0.1	-0.1	-0.2	-0.3	-0.5	-0.7	-1.0	-1.0	-1.0	-1.1	-1.0	-1.0	-1.0	-9.1
Congestion Costs	-6.2	-0.7	-0.8	-0.8	-0.9	-1.0	-0.9	-0.6	-0.4	-0.2	0.1	0.1	0.2	0.4	-11.6
Noise Costs	-0.1	0.0	0.0	0.0	0.0	0.0	0.0	0.0	0.0	0.0	0.0	0.0	0.0	0.0	-0.2
Non-Rebound Fatality Costs	-9.6	-0.9	-0.9	-0.8	-0.8	-0.7	-0.4	0.2	0.5	0.9	1.2	1.3	1.4	1.5	-7.1
Non-Rebound Non-Fatal Crash Costs	-15.0	-1.4	-1.3	-1.3	-1.2	-1.1	-0.6	0.2	0.7	1.4	1.9	2.0	2.2	2.4	-11.0
Rebound Fatality Costs	0.3	-0.1	-0.2	-0.3	-0.5	-0.8	-1.1	-1.2	-1.3	-1.4	-1.4	-1.4	-1.3	-1.2	-11.8
Non-Fatal Crash Costs	0.5	-0.1	-0.4	-0.5	-0.8	-1.3	-1.6	-1.8	-2.0	-2.2	-2.2	-2.1	-2.0	-1.9	-18.4
Total Societal Costs	-30.1	-3.9	-5.3	-6.0	-8.3	-10.6	-12.1	-11.7	-11.3	-10.3	-9.5	-8.8	-7.9	-6.6	-142.3

*** EO 12866 Review – Draft – Do Not Cite, Quote or Release During Review ***

**TABLE 8-14 - LIFETIME SOCIETAL COSTS FOR PREFERRED ALTERNATIVE BY MODEL YEAR, PASSENGER CAR
UNDISCOUNTED, CAFE (BILLIONS OF 2016\$)**

	MY 1977- 2016	MY 2017	MY 2018	MY 2019	MY 2020	MY 2021	MY 2022	MY 2023	MY 2024	MY 2025	MY 2026	MY 2027	MY 2028	MY 2029	TOTAL
Technology Costs	0.0	-0.9	-2.0	-2.8	-5.8	-9.9	-12.5	-14.6	-15.3	-16.0	-16.2	-15.8	-15.5	-15.3	-142.5
Advanced Technology Value Loss	0.0	-0.1	-0.2	-0.3	-0.5	-1.2	-1.6	-2.3	-2.6	-3.1	-3.3	-3.3	-3.3	-3.3	-25.0
Congestion Costs	-18.0	-2.2	-2.3	-2.5	-2.8	-3.4	-3.2	-2.7	-2.2	-1.5	-0.7	-0.2	-0.1	0.0	-41.8
Noise Costs	-0.2	0.0	0.0	0.0	0.0	0.0	0.0	0.0	0.0	0.0	0.0	0.0	0.0	0.0	-0.6
Non-Rebound Fatality Costs	-27.6	-3.1	-2.9	-2.9	-2.7	-2.5	-1.7	-0.9	0.1	1.1	2.2	2.9	3.0	3.2	-31.9
Non-Rebound Non-Fatal Crash Costs	-43.2	-4.8	-4.6	-4.5	-4.3	-4.0	-2.7	-1.4	0.1	1.8	3.4	4.5	4.7	5.0	-50.0
Rebound Fatality Costs	0.9	-0.1	-0.4	-0.6	-1.2	-2.2	-2.8	-3.1	-3.3	-3.5	-3.5	-3.5	-3.5	-3.5	-30.4
Non-Fatal Crash Costs	1.4	-0.2	-0.6	-1.0	-1.9	-3.4	-4.3	-4.8	-5.2	-5.4	-5.5	-5.5	-5.5	-5.5	-47.5
Total Societal Costs	-86.8	-11.4	-13.0	-14.5	-19.3	-26.6	-28.9	-29.8	-28.4	-26.7	-23.8	-20.9	-20.3	-19.5	-369.7

*** EO 12866 Review – Draft – Do Not Cite, Quote or Release During Review ***

**TABLE 8-15 - LIFETIME SOCIETAL COSTS FOR PREFERRED ALTERNATIVE BY MODEL YEAR, PASSENGER CAR
UNDISCOUNTED, CO₂ (BILLIONS OF 2016\$)**

	MY 1977- 2016	MY 2017	MY 2018	MY 2019	MY 2020	MY 2021	MY 2022	MY 2023	MY 2024	MY 2025	MY 2026	MY 2027	MY 2028	MY 2029	TOTAL
Technology Costs	0.0	-0.7	-1.8	-2.4	-4.5	-6.7	-9.4	-11.2	-12.4	-13.6	-14.8	-15.3	-15.5	-15.3	-123.7
Advanced Technology Value Loss	0.0	-0.1	-0.1	-0.2	-0.4	-0.7	-1.0	-1.5	-1.6	-1.8	-2.0	-2.1	-2.2	-2.2	-15.9
Congestion Costs	-15.2	-2.1	-2.3	-2.5	-2.7	-3.1	-3.0	-2.3	-2.0	-1.4	-0.7	-0.5	-0.1	0.5	-37.5
Noise Costs	-0.2	0.0	0.0	0.0	0.0	0.0	0.0	0.0	0.0	0.0	0.0	0.0	0.0	0.0	-0.5
Non-Rebound Fatality Costs	-23.2	-3.0	-3.0	-3.0	-3.0	-2.9	-2.2	-1.1	-0.3	1.0	2.0	2.5	3.1	3.9	-29.0
Non-Rebound Non-Fatal Crash Costs	-36.2	-4.6	-4.7	-4.7	-4.7	-4.5	-3.5	-1.7	-0.4	1.5	3.2	3.9	4.8	6.1	-45.4
Rebound Fatality Costs	0.7	0.0	-0.4	-0.5	-1.0	-1.5	-2.2	-2.5	-3.0	-3.4	-3.7	-3.9	-4.0	-4.0	-29.2
Non-Fatal Crash Costs	1.1	-0.1	-0.6	-0.8	-1.5	-2.4	-3.4	-3.9	-4.6	-5.4	-5.7	-6.0	-6.2	-6.2	-45.7
Total Societal Costs	-72.9	-10.7	-12.8	-14.2	-17.8	-22.0	-24.8	-24.3	-24.4	-23.0	-21.7	-21.3	-20.0	-17.2	-327.0

*** EO 12866 Review – Draft – Do Not Cite, Quote or Release During Review ***

**TABLE 8-16 - LIFETIME SOCIETAL COSTS FOR PREFERRED ALTERNATIVE BY MODEL YEAR, LIGHT TRUCK
3% DISCOUNT RATE, CAFE (BILLIONS OF 2016\$)**

	MY 1977- 2016	MY 2017	MY 2018	MY 2019	MY 2020	MY 2021	MY 2022	MY 2023	MY 2024	MY 2025	MY 2026	MY 2027	MY 2028	MY 2029	TOTAL
Technology Costs	0.0	-0.7	-3.8	-6.4	-8.3	-12.9	-13.4	-13.6	-13.8	-14.1	-14.3	-13.8	-13.4	-12.8	-141.5
Advanced Technology Value Loss	0.0	-0.1	-0.2	-0.3	-0.5	-1.0	-1.1	-1.2	-1.6	-2.0	-2.1	-2.1	-2.1	-2.0	-16.3
Congestion Costs	-5.2	-0.5	-0.6	-0.8	-0.9	-1.2	-1.4	-1.6	-1.8	-2.0	-2.2	-2.5	-2.8	-3.0	-26.4
Noise Costs	-0.1	0.0	0.0	0.0	0.0	0.0	0.0	0.0	0.0	0.0	0.0	0.0	0.0	0.0	-0.4
Non-Rebound Fatality Costs	-9.3	-0.7	-0.5	-0.3	-0.2	0.1	0.0	-0.3	-0.4	-0.6	-0.9	-1.3	-1.7	-2.0	-18.1
Non-Rebound Non-Fatal Crash Costs	-14.5	-1.1	-0.8	-0.5	-0.3	0.2	0.0	-0.5	-0.7	-0.9	-1.3	-2.0	-2.7	-3.2	-28.3
Rebound Fatality Costs	0.3	-0.1	-0.5	-0.9	-1.1	-1.9	-2.0	-2.1	-2.1	-2.3	-2.3	-2.2	-2.2	-2.1	-21.5
Non-Fatal Crash Costs	0.5	-0.2	-0.8	-1.3	-1.8	-3.0	-3.1	-3.2	-3.3	-3.5	-3.6	-3.5	-3.4	-3.3	-33.7
Total Societal Costs	-28.3	-3.4	-7.3	-10.6	-13.2	-19.7	-21.1	-22.5	-23.7	-25.4	-26.8	-27.5	-28.3	-28.5	-286.1

*** EO 12866 Review – Draft – Do Not Cite, Quote or Release During Review ***

**TABLE 8-17 - LIFETIME SOCIETAL COSTS FOR PREFERRED ALTERNATIVE BY MODEL YEAR, LIGHT TRUCK
3% DISCOUNT RATE, CO₂ (BILLIONS OF 2016\$)**

	MY 1977- 2016	MY 2017	MY 2018	MY 2019	MY 2020	MY 2021	MY 2022	MY 2023	MY 2024	MY 2025	MY 2026	MY 2027	MY 2028	MY 2029	TOTAL
Technology Costs	0.0	-0.3	-1.7	-4.0	-5.5	-8.5	-9.1	-9.9	-10.2	-10.4	-11.6	-12.3	-13.0	-13.1	-109.6
Advanced Technology Value Loss	0.0	0.0	0.0	-0.1	-0.1	-0.3	-0.3	-0.6	-0.7	-0.7	-0.8	-0.8	-0.8	-0.8	-5.8
Congestion Costs	-5.0	-0.6	-0.7	-0.8	-0.9	-1.1	-1.3	-1.7	-1.9	-2.2	-2.6	-2.9	-3.2	-3.5	-28.4
Noise Costs	-0.1	0.0	0.0	0.0	0.0	0.0	0.0	0.0	0.0	0.0	0.0	0.0	0.0	-0.1	-0.4
Non-Rebound Fatality Costs	-8.7	-0.9	-0.8	-0.6	-0.5	-0.2	-0.2	-0.7	-1.0	-1.2	-1.8	-2.2	-2.4	-2.7	-24.0
Non-Rebound Non-Fatal Crash Costs	-13.7	-1.4	-1.2	-1.0	-0.7	-0.4	-0.3	-1.1	-1.5	-1.9	-2.8	-3.4	-3.7	-4.3	-37.5
Rebound Fatality Costs	0.3	0.0	-0.3	-0.6	-0.9	-1.5	-1.7	-1.7	-1.9	-1.9	-2.0	-2.1	-2.2	-2.2	-18.6
Non-Fatal Crash Costs	0.5	-0.1	-0.4	-0.9	-1.4	-2.3	-2.6	-2.7	-2.9	-3.0	-3.2	-3.3	-3.4	-3.4	-29.0
Total Societal Costs	-26.7	-3.3	-5.1	-8.1	-10.1	-14.3	-15.5	-18.3	-20.1	-21.4	-24.9	-26.9	-28.6	-30.0	-253.3

*** EO 12866 Review – Draft – Do Not Cite, Quote or Release During Review ***

**TABLE 8-18 - LIFETIME SOCIETAL COSTS FOR PREFERRED ALTERNATIVE BY MODEL YEAR, LIGHT TRUCK
7% DISCOUNT RATE, CAFE (BILLIONS OF 2016\$)**

	MY 1977- 2016	MY 2017	MY 2018	MY 2019	MY 2020	MY 2021	MY 2022	MY 2023	MY 2024	MY 2025	MY 2026	MY 2027	MY 2028	MY 2029	TOTAL
Technology Costs	0.0	-0.7	-3.7	-5.9	-7.4	-11.0	-11.1	-10.8	-10.6	-10.4	-10.2	-9.5	-8.8	-8.1	-108.3
Advanced Technology Value Loss	0.0	-0.1	-0.2	-0.3	-0.5	-0.9	-0.9	-0.9	-1.2	-1.5	-1.5	-1.4	-1.4	-1.3	-12.0
Congestion Costs	-3.2	-0.2	-0.4	-0.5	-0.5	-0.8	-0.9	-1.0	-1.1	-1.2	-1.3	-1.4	-1.5	-1.5	-15.3
Noise Costs	0.0	0.0	0.0	0.0	0.0	0.0	0.0	0.0	0.0	0.0	0.0	0.0	0.0	0.0	-0.2
Non-Rebound Fatality Costs	-5.7	-0.3	-0.2	-0.1	0.0	0.2	0.1	-0.2	-0.2	-0.3	-0.5	-0.7	-0.9	-1.0	-9.7
Non-Rebound Non-Fatal Crash Costs	-8.9	-0.4	-0.2	-0.1	0.0	0.3	0.1	-0.2	-0.3	-0.5	-0.7	-1.1	-1.4	-1.6	-15.2
Rebound Fatality Costs	0.2	-0.1	-0.4	-0.6	-0.8	-1.3	-1.4	-1.3	-1.3	-1.4	-1.3	-1.3	-1.2	-1.1	-13.3
Non-Fatal Crash Costs	0.3	-0.2	-0.6	-1.0	-1.3	-2.1	-2.1	-2.1	-2.1	-2.1	-2.1	-2.0	-1.8	-1.7	-20.9
Total Societal Costs	-17.2	-2.0	-5.7	-8.5	-10.5	-15.7	-16.2	-16.6	-16.9	-17.4	-17.6	-17.3	-17.0	-16.4	-194.9

*** EO 12866 Review – Draft – Do Not Cite, Quote or Release During Review ***

**TABLE 8-19 – LIFETIME SOCIETAL COSTS FOR PREFERRED ALTERNATIVE BY MODEL YEAR, LIGHT TRUCK
7% DISCOUNT RATE, CO₂ (BILLIONS OF 2016\$)**

	MY 1977- 2016	MY 2017	MY 2018	MY 2019	MY 2020	MY 2021	MY 2022	MY 2023	MY 2024	MY 2025	MY 2026	MY 2027	MY 2028	MY 2029	TOTAL
Technology Costs	0.0	-0.3	-1.6	-3.7	-4.9	-7.3	-7.6	-7.8	-7.8	-7.7	-8.2	-8.4	-8.6	-8.3	-82.2
Advanced Technology Value Loss	0.0	0.0	0.0	-0.1	-0.1	-0.2	-0.2	-0.5	-0.5	-0.5	-0.6	-0.5	-0.5	-0.5	-4.2
Congestion Costs	-3.0	-0.3	-0.3	-0.4	-0.5	-0.7	-0.8	-1.0	-1.2	-1.3	-1.5	-1.6	-1.7	-1.8	-16.1
Noise Costs	0.0	0.0	0.0	0.0	0.0	0.0	0.0	0.0	0.0	0.0	0.0	0.0	0.0	0.0	-0.2
Non-Rebound Fatality Costs	-5.2	-0.4	-0.3	-0.2	-0.1	0.0	0.0	-0.3	-0.5	-0.7	-1.0	-1.2	-1.2	-1.4	-12.7
Non-Rebound Non-Fatal Crash Costs	-8.2	-0.6	-0.5	-0.4	-0.2	0.0	0.0	-0.5	-0.8	-1.1	-1.6	-1.8	-1.9	-2.2	-19.9
Rebound Fatality Costs	0.2	0.0	-0.2	-0.5	-0.7	-1.0	-1.1	-1.1	-1.2	-1.1	-1.2	-1.2	-1.2	-1.1	-11.3
Non-Fatal Crash Costs	0.3	-0.1	-0.3	-0.7	-1.0	-1.6	-1.7	-1.8	-1.8	-1.8	-1.8	-1.8	-1.8	-1.8	-17.8
Total Societal Costs	-15.9	-1.7	-3.3	-6.0	-7.6	-10.9	-11.5	-13.1	-13.9	-14.2	-15.9	-16.5	-16.9	-17.0	-164.5

*** EO 12866 Review – Draft – Do Not Cite, Quote or Release During Review ***

**TABLE 8-20 - LIFETIME SOCIETAL COSTS FOR PREFERRED ALTERNATIVE BY MODEL YEAR, LIGHT TRUCK
UNDISCOUNTED, CAFE (BILLIONS OF 2016\$)**

	MY 1977- 2016	MY 2017	MY 2018	MY 2019	MY 2020	MY 2021	MY 2022	MY 2023	MY 2024	MY 2025	MY 2026	MY 2027	MY 2028	MY 2029	TOTAL
Technology Costs	0.0	-0.7	-4.0	-6.8	-9.1	-14.5	-15.5	-16.2	-17.0	-17.9	-18.7	-18.6	-18.5	-18.3	-175.8
Advanced Technology Value Loss	0.0	-0.1	-0.2	-0.3	-0.6	-1.2	-1.3	-1.4	-1.9	-2.5	-2.8	-2.8	-2.9	-2.9	-20.8
Congestion Costs	-8.0	-0.9	-1.1	-1.3	-1.4	-1.8	-2.1	-2.5	-2.7	-3.1	-3.5	-4.1	-4.7	-5.2	-42.4
Noise Costs	-0.1	0.0	0.0	0.0	0.0	0.0	0.0	0.0	0.0	0.0	-0.1	-0.1	-0.1	-0.1	-0.6
Non-Rebound Fatality Costs	-14.1	-1.3	-1.1	-0.9	-0.6	-0.1	-0.2	-0.7	-0.8	-1.0	-1.5	-2.2	-3.0	-3.6	-31.0
Non-Rebound Non-Fatal Crash Costs	-22.0	-2.1	-1.7	-1.3	-1.0	-0.2	-0.4	-1.0	-1.2	-1.6	-2.3	-3.4	-4.7	-5.6	-48.5
Rebound Fatality Costs	0.5	-0.2	-0.7	-1.1	-1.5	-2.6	-2.8	-3.0	-3.2	-3.4	-3.6	-3.6	-3.7	-3.7	-32.4
Non-Fatal Crash Costs	0.8	-0.2	-1.0	-1.7	-2.4	-4.0	-4.4	-4.6	-5.0	-5.4	-5.6	-5.7	-5.7	-5.7	-50.7
Total Societal Costs	-42.9	-5.5	-9.6	-13.4	-16.6	-24.3	-26.8	-29.5	-31.9	-35.0	-38.1	-40.5	-43.2	-45.1	-402.3

*** EO 12866 Review – Draft – Do Not Cite, Quote or Release During Review ***

**TABLE 8-21 - LIFETIME SOCIETAL COSTS FOR PREFERRED ALTERNATIVE BY MODEL YEAR, LIGHT TRUCK
UNDISCOUNTED, CO₂ (BILLIONS OF 2016\$)**

	MY 1977- 2016	MY 2017	MY 2018	MY 2019	MY 2020	MY 2021	MY 2022	MY 2023	MY 2024	MY 2025	MY 2026	MY 2027	MY 2028	MY 2029	TOTAL
Technology Costs	0.0	-0.3	-1.7	-4.2	-6.0	-9.6	-10.6	-11.8	-12.6	-13.2	-15.1	-16.5	-18.0	-18.7	-138.3
Advanced Technology Value Loss	0.0	0.0	0.0	-0.1	-0.1	-0.3	-0.3	-0.7	-0.8	-0.9	-1.1	-1.1	-1.1	-1.1	-7.5
Congestion Costs	-7.7	-1.1	-1.2	-1.4	-1.5	-1.8	-2.0	-2.6	-3.1	-3.5	-4.3	-4.9	-5.4	-6.1	-46.5
Noise Costs	-0.1	0.0	0.0	0.0	0.0	0.0	0.0	0.0	0.0	-0.1	-0.1	-0.1	-0.1	-0.1	-0.7
Non-Rebound Fatality Costs	-13.4	-1.7	-1.6	-1.3	-1.1	-0.7	-0.6	-1.3	-1.7	-2.1	-3.0	-3.7	-4.1	-4.9	-41.2
Non-Rebound Non-Fatal Crash Costs	-21.0	-2.6	-2.4	-2.1	-1.7	-1.1	-1.0	-2.0	-2.7	-3.3	-4.7	-5.8	-6.4	-7.6	-64.5
Rebound Fatality Costs	0.5	0.0	-0.3	-0.8	-1.2	-2.0	-2.3	-2.5	-2.7	-2.9	-3.2	-3.4	-3.6	-3.7	-28.3
Non-Fatal Crash Costs	0.7	-0.1	-0.5	-1.2	-1.9	-3.1	-3.6	-3.9	-4.3	-4.5	-5.0	-5.3	-5.6	-5.8	-44.2
Total Societal Costs	-41.0	-5.8	-7.8	-11.2	-13.5	-18.6	-20.5	-24.8	-28.0	-30.5	-36.5	-40.6	-44.4	-47.9	-371.1

*** EO 12866 Review – Draft – Do Not Cite, Quote or Release During Review ***

TABLE 8-22 - LIFETIME SOCIETAL COSTS FOR PREFERRED ALTERNATIVE BY MODEL YEAR, COMBINED LIGHT-DUTY, 3% DISCOUNT RATE, CAFE (BILLIONS OF 2016\$)

	MY 1977- 2016	MY 2017	MY 2018	MY 2019	MY 2020	MY 2021	MY 2022	MY 2023	MY 2024	MY 2025	MY 2026	MY 2027	MY 2028	MY 2029	TOTAL
Technology Costs	0.0	-1.6	-5.7	-9.0	-13.6	-21.6	-24.2	-25.8	-26.3	-26.8	-26.7	-25.6	-24.6	-23.5	-255.1
Advanced Technology Value Loss	0.0	-0.2	-0.3	-0.5	-1.0	-2.1	-2.5	-3.1	-3.7	-4.4	-4.7	-4.5	-4.4	-4.3	-35.9
Congestion Costs	-17.4	-1.9	-2.0	-2.3	-2.6	-3.3	-3.3	-3.2	-2.9	-2.6	-2.4	-2.3	-2.5	-2.7	-51.3
Noise Costs	-0.2	0.0	0.0	0.0	0.0	0.0	0.0	0.0	0.0	0.0	0.0	0.0	0.0	0.0	-0.7
Non-Rebound Fatality Costs	-28.1	-2.5	-2.1	-1.9	-1.7	-1.2	-0.7	-0.4	0.1	0.6	0.9	0.9	0.5	0.2	-35.4
Non-Rebound Non-Fatal Crash Costs	-43.9	-3.9	-3.4	-3.0	-2.6	-1.9	-1.1	-0.7	0.2	0.9	1.5	1.4	0.7	0.3	-55.4
Rebound Fatality Costs	0.9	-0.2	-0.8	-1.4	-2.1	-3.5	-4.0	-4.2	-4.4	-4.5	-4.6	-4.4	-4.3	-4.2	-41.7
Non-Fatal Crash Costs	1.5	-0.3	-1.3	-2.1	-3.2	-5.5	-6.2	-6.6	-6.9	-7.1	-7.1	-6.9	-6.8	-6.6	-65.3
Total Societal Costs	-87.2	-10.6	-15.8	-20.2	-26.7	-39.1	-42.2	-44.1	-43.9	-44.0	-43.1	-41.5	-41.5	-40.9	-540.9

*** EO 12866 Review – Draft – Do Not Cite, Quote or Release During Review ***

TABLE 8-23 - LIFETIME SOCIETAL COSTS FOR PREFERRED ALTERNATIVE BY MODEL YEAR, COMBINED LIGHT-DUTY, 3% DISCOUNT RATE, CO₂ (BILLIONS OF 2016\$)

	MY 1977- 2016	MY 2017	MY 2018	MY 2019	MY 2020	MY 2021	MY 2022	MY 2023	MY 2024	MY 2025	MY 2026	MY 2027	MY 2028	MY 2029	TOTAL
Technology Costs	0.0	-1.0	-3.4	-6.3	-9.6	-14.5	-17.2	-19.3	-20.4	-21.1	-22.9	-23.7	-24.2	-23.8	-207.5
Advanced Technology Value Loss	0.0	-0.1	-0.1	-0.3	-0.5	-0.9	-1.2	-1.9	-2.0	-2.1	-2.4	-2.3	-2.3	-2.3	-18.2
Congestion Costs	-15.1	-1.9	-2.1	-2.3	-2.5	-3.0	-3.0	-2.9	-2.9	-2.7	-2.8	-2.9	-3.0	-2.9	-50.0
Noise Costs	-0.2	0.0	0.0	0.0	0.0	0.0	0.0	0.0	0.0	0.0	0.0	0.0	0.0	0.0	-0.7
Non-Rebound Fatality Costs	-24.2	-2.6	-2.5	-2.3	-2.1	-1.8	-1.3	-0.9	-0.7	-0.1	-0.1	-0.2	-0.1	-0.1	-39.0
Non-Rebound Non-Fatal Crash Costs	-37.9	-4.1	-3.9	-3.6	-3.3	-2.8	-2.0	-1.4	-1.0	-0.2	-0.1	-0.3	-0.2	-0.1	-61.0
Rebound Fatality Costs	0.8	-0.1	-0.6	-1.0	-1.6	-2.6	-3.2	-3.5	-3.9	-4.2	-4.4	-4.5	-4.6	-4.5	-37.8
Non-Fatal Crash Costs	1.3	-0.1	-0.9	-1.6	-2.6	-4.1	-5.0	-5.5	-6.1	-6.5	-6.8	-7.0	-7.1	-7.1	-59.1
Total Societal Costs	-75.4	-10.0	-13.4	-17.4	-22.3	-29.6	-32.9	-35.3	-37.0	-37.0	-39.5	-41.0	-41.6	-40.9	-473.3

*** EO 12866 Review – Draft – Do Not Cite, Quote or Release During Review ***

TABLE 8-24 - LIFETIME SOCIETAL COSTS FOR PREFERRED ALTERNATIVE BY MODEL YEAR, COMBINED LIGHT-DUTY, 7% DISCOUNT RATE, CAFE (BILLIONS OF 2016\$)

	MY 1977- 2016	MY 2017	MY 2018	MY 2019	MY 2020	MY 2021	MY 2022	MY 2023	MY 2024	MY 2025	MY 2026	MY 2027	MY 2028	MY 2029	TOTAL
Technology Costs	0.0	-1.6	-5.5	-8.4	-12.1	-18.6	-20.0	-20.5	-20.1	-19.8	-19.0	-17.5	-16.2	-14.9	-194.2
Advanced Technology Value Loss	0.0	-0.2	-0.3	-0.5	-0.9	-1.8	-2.1	-2.5	-2.8	-3.3	-3.3	-3.1	-2.9	-2.7	-26.4
Congestion Costs	-10.8	-1.0	-1.1	-1.3	-1.5	-2.0	-2.0	-1.8	-1.6	-1.4	-1.2	-1.1	-1.2	-1.2	-29.2
Noise Costs	-0.1	0.0	0.0	0.0	0.0	0.0	0.0	0.0	0.0	0.0	0.0	0.0	0.0	0.0	-0.4
Non-Rebound Fatality Costs	-17.5	-1.2	-1.0	-0.8	-0.7	-0.4	-0.1	0.0	0.4	0.6	0.8	0.7	0.4	0.3	-18.5
Non-Rebound Non-Fatal Crash Costs	-27.3	-1.9	-1.5	-1.3	-1.0	-0.6	-0.2	0.1	0.6	1.0	1.2	1.1	0.7	0.4	-28.9
Rebound Fatality Costs	0.6	-0.2	-0.7	-1.0	-1.5	-2.5	-2.7	-2.8	-2.8	-2.8	-2.7	-2.5	-2.3	-2.2	-25.9
Non-Fatal Crash Costs	0.9	-0.3	-1.0	-1.6	-2.3	-3.8	-4.2	-4.3	-4.3	-4.3	-4.2	-3.9	-3.6	-3.4	-40.4
Total Societal Costs	-54.2	-6.4	-11.2	-14.8	-20.1	-29.7	-31.3	-31.8	-30.7	-29.9	-28.4	-26.3	-25.2	-23.8	-363.9

*** EO 12866 Review – Draft – Do Not Cite, Quote or Release During Review ***

TABLE 8-25 - LIFETIME SOCIETAL COSTS FOR PREFERRED ALTERNATIVE BY MODEL YEAR, COMBINED LIGHT-DUTY, 7% DISCOUNT RATE, CO₂ (BILLIONS OF 2016\$)

	MY 1977- 2016	MY 2017	MY 2018	MY 2019	MY 2020	MY 2021	MY 2022	MY 2023	MY 2024	MY 2025	MY 2026	MY 2027	MY 2028	MY 2029	TOTAL
Technology Costs	0.0	-1.0	-3.3	-5.8	-8.6	-12.4	-14.3	-15.3	-15.6	-15.6	-16.3	-16.2	-15.9	-15.1	-155.4
Advanced Technology Value Loss	0.0	-0.1	-0.1	-0.3	-0.4	-0.8	-1.0	-1.5	-1.5	-1.5	-1.7	-1.6	-1.5	-1.5	-13.4
Congestion Costs	-9.2	-1.0	-1.1	-1.2	-1.4	-1.7	-1.7	-1.6	-1.6	-1.4	-1.4	-1.5	-1.4	-1.4	-27.7
Noise Costs	-0.1	0.0	0.0	0.0	0.0	0.0	0.0	0.0	0.0	0.0	0.0	0.0	0.0	0.0	-0.4
Non-Rebound Fatality Costs	-14.8	-1.3	-1.2	-1.0	-0.9	-0.7	-0.4	-0.2	-0.1	0.2	0.2	0.1	0.1	0.1	-19.8
Non-Rebound Non-Fatal Crash Costs	-23.2	-2.0	-1.9	-1.6	-1.4	-1.1	-0.6	-0.3	-0.1	0.4	0.4	0.2	0.2	0.2	-30.9
Rebound Fatality Costs	0.5	-0.1	-0.4	-0.8	-1.2	-1.8	-2.2	-2.3	-2.4	-2.5	-2.5	-2.5	-2.5	-2.3	-23.1
Non-Fatal Crash Costs	0.8	-0.1	-0.7	-1.2	-1.9	-2.9	-3.4	-3.6	-3.8	-3.9	-4.0	-3.9	-3.9	-3.7	-36.1
Total Societal Costs	-46.0	-5.6	-8.7	-12.0	-15.9	-21.5	-23.6	-24.8	-25.2	-24.5	-25.3	-25.4	-24.9	-23.6	-306.8

*** EO 12866 Review – Draft – Do Not Cite, Quote or Release During Review ***

TABLE 8-26 - LIFETIME SOCIETAL COSTS FOR PREFERRED ALTERNATIVE BY MODEL YEAR, COMBINED LIGHT-DUTY, UNDISCOUNTED, CAFE (BILLIONS OF 2016\$)

	MY 1977- 2016	MY 2017	MY 2018	MY 2019	MY 2020	MY 2021	MY 2022	MY 2023	MY 2024	MY 2025	MY 2026	MY 2027	MY 2028	MY 2029	TOTAL
Technology Costs	0.0	-1.6	-5.9	-9.6	-14.9	-24.3	-28.0	-30.8	-32.3	-34.0	-34.9	-34.4	-34.1	-33.5	-318.3
Advanced Technology Value Loss	0.0	-0.2	-0.3	-0.5	-1.1	-2.3	-2.9	-3.7	-4.5	-5.6	-6.1	-6.1	-6.1	-6.2	-45.8
Congestion Costs	-26.0	-3.2	-3.4	-3.8	-4.2	-5.2	-5.3	-5.2	-4.9	-4.6	-4.3	-4.3	-4.8	-5.1	-84.2
Noise Costs	-0.4	0.0	0.0	-0.1	-0.1	-0.1	-0.1	-0.1	-0.1	-0.1	-0.1	-0.1	-0.1	-0.1	-1.2
Non-Rebound Fatality Costs	-41.7	-4.4	-4.0	-3.7	-3.4	-2.6	-2.0	-1.5	-0.7	0.1	0.7	0.7	0.0	-0.4	-63.0
Non-Rebound Non-Fatal Crash Costs	-65.2	-6.9	-6.2	-5.8	-5.3	-4.1	-3.1	-2.4	-1.1	0.2	1.1	1.1	0.0	-0.7	-98.5
Rebound Fatality Costs	1.4	-0.3	-1.1	-1.7	-2.7	-4.8	-5.6	-6.1	-6.5	-6.9	-7.1	-7.1	-7.2	-7.2	-62.8
Non-Fatal Crash Costs	2.2	-0.4	-1.6	-2.7	-4.2	-7.4	-8.7	-9.5	-10.2	-10.8	-11.2	-11.2	-11.2	-11.3	-98.2
Total Societal Costs	-129.7	-16.9	-22.6	-27.9	-35.8	-50.9	-55.7	-59.3	-60.3	-61.7	-61.9	-61.4	-63.5	-64.5	-772.1

*** EO 12866 Review – Draft – Do Not Cite, Quote or Release During Review ***

TABLE 8-27 - LIFETIME SOCIETAL COSTS FOR PREFERRED ALTERNATIVE BY MODEL YEAR, COMBINED LIGHT-DUTY, UNDISCOUNTED, CO₂ (BILLIONS OF 2016\$)

	MY 1977- 2016	MY 2017	MY 2018	MY 2019	MY 2020	MY 2021	MY 2022	MY 2023	MY 2024	MY 2025	MY 2026	MY 2027	MY 2028	MY 2029	TOTAL
Technology Costs	0.0	-1.0	-3.5	-6.7	-10.5	-16.3	-20.0	-23.0	-25.0	-26.8	-29.9	-31.9	-33.5	-34.0	-262.1
Advanced Technology Value Loss	0.0	-0.1	-0.1	-0.3	-0.5	-1.0	-1.4	-2.2	-2.5	-2.6	-3.1	-3.1	-3.2	-3.3	-23.4
Congestion Costs	-22.9	-3.2	-3.5	-3.9	-4.2	-4.9	-5.0	-4.9	-5.1	-4.9	-5.0	-5.4	-5.5	-5.6	-83.9
Noise Costs	-0.3	0.0	0.0	-0.1	-0.1	-0.1	-0.1	-0.1	-0.1	-0.1	-0.1	-0.1	-0.1	-0.1	-1.2
Non-Rebound Fatality Costs	-36.6	-4.6	-4.5	-4.3	-4.1	-3.6	-2.9	-2.4	-2.0	-1.1	-1.0	-1.2	-1.0	-1.0	-70.2
Non-Rebound Non-Fatal Crash Costs	-57.2	-7.3	-7.1	-6.8	-6.4	-5.6	-4.5	-3.7	-3.1	-1.8	-1.5	-1.8	-1.6	-1.5	-109.9
Rebound Fatality Costs	1.2	-0.1	-0.7	-1.3	-2.2	-3.6	-4.5	-5.0	-5.7	-6.3	-6.8	-7.2	-7.6	-7.7	-57.5
Non-Fatal Crash Costs	1.9	-0.1	-1.1	-2.1	-3.4	-5.6	-7.0	-7.9	-8.9	-9.9	-10.7	-11.3	-11.8	-12.0	-89.9
Total Societal Costs	-113.9	-16.5	-20.6	-25.4	-31.4	-40.6	-45.2	-49.1	-52.4	-53.5	-58.1	-62.0	-64.4	-65.1	-698.1

*** EO 12866 Review – Draft – Do Not Cite, Quote or Release During Review ***

TABLE 8-28 - INCREMENTAL LIFETIME SOCIETAL COSTS FOR MY'S 1975-2029, BY ALTERNATIVE, PASSENGER CAR, 3% DISCOUNT RATE, CAFE (BILLIONS OF 2016\$)

	Alternative							
	1	2	3	4	5	6	7	8
Model Years	2021-2026	2021-2026	2021-2026	2021-2026	2022-2026	2021-2026	2021-2026	2022-2026
Annual Rate of Stringency Increase	0.0%/Year PC 0.0%/Year LT	0.5%/Year PC 0.5%/Year LT	0.5%/Year PC 0.5%/Year LT	1.0%/Year PC 2.0%/Year LT	1.0%/Year PC 2.0%/Year LT	2.0%/Year PC 3.0%/Year LT	2.0%/Year PC 3.0%/Year LT	2.0%/Year PC 3.0%/Year LT
AC/Off-Cycle Procedures	No Change	No Change	Phaseout 2022- 2026	No Change	No Change	No Change	Phaseout 2022- 2026	No Change
Technology Costs	-113.7	-110.7	-105.3	-102.6	-86.6	-80.9	-62.3	-64.5
Advanced Technology Value Loss	-19.6	-19.5	-19.3	-19.4	-19.1	-18.6	-14.5	-16.9
Congestion Costs	-24.9	-23.9	-22.4	-21.1	-17.6	-15.4	-9.2	-10.8
Noise Costs	-0.3	-0.3	-0.3	-0.3	-0.2	-0.2	-0.1	-0.1
Non-Rebound Fatality Costs	-17.3	-16.3	-14.8	-13.5	-12.4	-9.3	-2.9	-5.7
Non-Rebound Non-Fatal Crash Costs	-27.1	-25.5	-23.1	-21.1	-19.4	-14.5	-4.5	-8.9
Rebound Fatality Costs	-20.2	-19.6	-18.9	-17.9	-13.8	-13.3	-10.5	-9.7
Non-Fatal Crash Costs	-31.6	-30.7	-29.5	-28.0	-21.5	-20.7	-16.5	-15.2
Total Societal Costs	-254.8	-246.5	-233.5	-223.9	-190.7	-173.0	-120.5	-131.8

*** EO 12866 Review – Draft – Do Not Cite, Quote or Release During Review ***

TABLE 8-29 - INCREMENTAL LIFETIME SOCIETAL COSTS FOR MY'S 1975-2029, BY ALTERNATIVE, PASSENGER CAR, 3% DISCOUNT RATE, CO₂ (BILLIONS OF 2016\$)

	Alternative							
	1	2	3	4	5	6	7	8
Model Years	2021-2026	2021-2026	2021-2026	2021-2026	2022-2026	2021-2026	2021-2026	2022-2026
Annual Rate of Stringency Increase	0.0%/Year PC 0.0%/Year LT	0.5%/Year PC 0.5%/Year LT	0.5%/Year PC 0.5%/Year LT	1.0%/Year PC 2.0%/Year LT	1.0%/Year PC 2.0%/Year LT	2.0%/Year PC 3.0%/Year LT	2.0%/Year PC 3.0%/Year LT	2.0%/Year PC 3.0%/Year LT
AC/Off-Cycle Procedures	No Change	No Change	Phaseout 2022- 2026	No Change	No Change	No Change	Phaseout 2022- 2026	No Change
Technology Costs	-97.9	-94.0	-88.2	-82.6	-60.9	-58.8	-40.8	-40.1
Advanced Technology Value Loss	-12.4	-11.9	-11.9	-11.6	-9.7	-11.0	-6.7	-8.5
Congestion Costs	-21.6	-20.8	-18.5	-16.7	-13.8	-10.8	-4.7	-7.2
Noise Costs	-0.3	-0.3	-0.2	-0.2	-0.2	-0.1	-0.1	-0.1
Non-Rebound Fatality Costs	-15.0	-14.7	-12.9	-11.2	-10.8	-7.0	-1.6	-4.4
Non-Rebound Non-Fatal Crash Costs	-23.5	-23.0	-20.2	-17.5	-16.9	-10.9	-2.5	-6.8
Rebound Fatality Costs	-19.3	-18.4	-16.4	-15.0	-9.9	-9.2	-6.0	-6.1
Non-Fatal Crash Costs	-30.1	-28.7	-25.7	-23.5	-15.4	-14.3	-9.3	-9.5
Total Societal Costs	-220.0	-211.9	-194.2	-178.3	-137.5	-122.1	-71.6	-82.6

*** EO 12866 Review – Draft – Do Not Cite, Quote or Release During Review ***

TABLE 8-30 - INCREMENTAL LIFETIME SOCIETAL COSTS FOR MY'S 1975-2029, BY ALTERNATIVE, PASSENGER CAR, 7% DISCOUNT RATE, CAFE (BILLIONS OF 2016\$)

	Alternative							
	1	2	3	4	5	6	7	8
Model Years	2021-2026	2021-2026	2021-2026	2021-2026	2022-2026	2021-2026	2021-2026	2022-2026
Annual Rate of Stringency Increase	0.0%/Year PC 0.0%/Year LT	0.5%/Year PC 0.5%/Year LT	0.5%/Year PC 0.5%/Year LT	1.0%/Year PC 2.0%/Year LT	1.0%/Year PC 2.0%/Year LT	2.0%/Year PC 3.0%/Year LT	2.0%/Year PC 3.0%/Year LT	2.0%/Year PC 3.0%/Year LT
AC/Off-Cycle Procedures	No Change	No Change	Phaseout 2022- 2026	No Change	No Change	No Change	Phaseout 2022- 2026	No Change
Technology Costs	-85.9	-83.7	-79.7	-77.8	-65.3	-61.8	-48.3	-49.1
Advanced Technology Value Loss	-14.4	-14.4	-14.2	-14.3	-14.0	-13.7	-10.7	-12.5
Congestion Costs	-13.9	-13.4	-12.6	-12.0	-10.0	-8.9	-5.7	-6.3
Noise Costs	-0.2	-0.2	-0.2	-0.2	-0.1	-0.1	-0.1	-0.1
Non-Rebound Fatality Costs	-8.7	-8.2	-7.4	-6.9	-6.5	-4.9	-1.6	-3.0
Non-Rebound Non-Fatal Crash Costs	-13.7	-12.8	-11.6	-10.8	-10.2	-7.6	-2.5	-4.7
Rebound Fatality Costs	-12.5	-12.2	-11.7	-11.1	-8.4	-8.3	-6.7	-6.0
Non-Fatal Crash Costs	-19.6	-19.0	-18.3	-17.4	-13.2	-13.0	-10.5	-9.4
Total Societal Costs	-168.9	-163.8	-155.6	-150.4	-127.9	-118.4	-86.0	-91.1

*** EO 12866 Review – Draft – Do Not Cite, Quote or Release During Review ***

TABLE 8-31 - INCREMENTAL LIFETIME SOCIETAL COSTS FOR MY'S 1975-2029, BY ALTERNATIVE, PASSENGER CAR, 7% DISCOUNT RATE, CO₂ (BILLIONS OF 2016\$)

	Alternative							
	1	2	3	4	5	6	7	8
Model Years	2021-2026	2021-2026	2021-2026	2021-2026	2022-2026	2021-2026	2021-2026	2022-2026
Annual Rate of Stringency Increase	0.0%/Year PC 0.0%/Year LT	0.5%/Year PC 0.5%/Year LT	0.5%/Year PC 0.5%/Year LT	1.0%/Year PC 2.0%/Year LT	1.0%/Year PC 2.0%/Year LT	2.0%/Year PC 3.0%/Year LT	2.0%/Year PC 3.0%/Year LT	2.0%/Year PC 3.0%/Year LT
AC/Off-Cycle Procedures	No Change	No Change	Phaseout 2022- 2026	No Change	No Change	No Change	Phaseout 2022- 2026	No Change
Technology Costs	-73.2	-70.1	-66.0	-61.9	-44.7	-44.1	-31.0	-29.6
Advanced Technology Value Loss	-9.1	-8.8	-8.8	-8.5	-6.9	-8.0	-5.0	-6.1
Congestion Costs	-11.6	-11.2	-9.9	-9.2	-7.3	-5.9	-2.8	-4.0
Noise Costs	-0.2	-0.1	-0.1	-0.1	-0.1	-0.1	0.0	-0.1
Non-Rebound Fatality Costs	-7.1	-6.9	-6.1	-5.4	-5.3	-3.5	-0.9	-2.2
Non-Rebound Non-Fatal Crash Costs	-11.0	-10.9	-9.5	-8.4	-8.2	-5.4	-1.4	-3.5
Rebound Fatality Costs	-11.8	-11.2	-10.0	-9.2	-5.9	-5.6	-3.7	-3.6
Non-Fatal Crash Costs	-18.4	-17.5	-15.7	-14.4	-9.2	-8.7	-5.7	-5.7
Total Societal Costs	-142.3	-136.8	-126.2	-117.0	-87.7	-81.3	-50.4	-54.9

*** EO 12866 Review – Draft – Do Not Cite, Quote or Release During Review ***

TABLE 8-32 - INCREMENTAL LIFETIME SOCIETAL COSTS FOR MY'S 1975-2029, BY ALTERNATIVE, LIGHT TRUCK, 3% DISCOUNT RATE, CAFE (BILLIONS OF 2016\$)

	Alternative							
	1	2	3	4	5	6	7	8
Model Years	2021-2026	2021-2026	2021-2026	2021-2026	2022-2026	2021-2026	2021-2026	2022-2026
Annual Rate of Stringency Increase	0.0%/Year PC 0.0%/Year LT	0.5%/Year PC 0.5%/Year LT	0.5%/Year PC 0.5%/Year LT	1.0%/Year PC 2.0%/Year LT	1.0%/Year PC 2.0%/Year LT	2.0%/Year PC 3.0%/Year LT	2.0%/Year PC 3.0%/Year LT	2.0%/Year PC 3.0%/Year LT
AC/Off-Cycle Procedures	No Change	No Change	Phaseout 2022- 2026	No Change	No Change	No Change	Phaseout 2022- 2026	No Change
Technology Costs	-141.5	-134.4	-124.8	-109.1	-84.8	-68.3	-31.5	-32.9
Advanced Technology Value Loss	-16.3	-16.3	-16.3	-16.2	-16.2	-15.9	-10.9	-15.5
Congestion Costs	-26.4	-23.9	-22.3	-16.7	-10.5	-9.0	-5.0	-4.7
Noise Costs	-0.4	-0.4	-0.3	-0.3	-0.2	-0.1	-0.1	-0.1
Non-Rebound Fatality Costs	-18.1	-16.2	-15.4	-11.5	-6.2	-5.5	-3.4	-2.7
Non-Rebound Non-Fatal Crash Costs	-28.3	-25.4	-24.1	-18.0	-9.7	-8.6	-5.3	-4.2
Rebound Fatality Costs	-21.5	-19.6	-18.2	-14.1	-10.0	-8.4	-4.4	-4.6
Non-Fatal Crash Costs	-33.7	-30.7	-28.4	-22.0	-15.6	-13.1	-6.9	-7.2
Total Societal Costs	-286.1	-266.8	-249.9	-207.9	-153.1	-128.9	-67.5	-71.9

*** EO 12866 Review – Draft – Do Not Cite, Quote or Release During Review ***

TABLE 8-33 - INCREMENTAL LIFETIME SOCIETAL COSTS FOR MY'S 1975-2029, BY ALTERNATIVE, LIGHT TRUCK, 3% DISCOUNT RATE, CO₂ (BILLIONS OF 2016\$)

	Alternative							
	1	2	3	4	5	6	7	8
Model Years	2021-2026	2021-2026	2021-2026	2021-2026	2022-2026	2021-2026	2021-2026	2022-2026
Annual Rate of Stringency Increase	0.0%/Year PC 0.0%/Year LT	0.5%/Year PC 0.5%/Year LT	0.5%/Year PC 0.5%/Year LT	1.0%/Year PC 2.0%/Year LT	1.0%/Year PC 2.0%/Year LT	2.0%/Year PC 3.0%/Year LT	2.0%/Year PC 3.0%/Year LT	2.0%/Year PC 3.0%/Year LT
AC/Off-Cycle Procedures	No Change	No Change	Phaseout 2022- 2026	No Change	No Change	No Change	Phaseout 2022- 2026	No Change
Technology Costs	-109.6	-105.9	-101.9	-81.0	-50.5	-51.9	-23.2	-17.5
Advanced Technology Value Loss	-5.8	-5.8	-5.8	-5.5	-3.8	-3.9	-1.5	-1.9
Congestion Costs	-28.4	-26.8	-24.6	-16.5	-8.3	-7.7	-3.6	-2.5
Noise Costs	-0.4	-0.4	-0.4	-0.2	-0.1	-0.1	-0.1	0.0
Non-Rebound Fatality Costs	-24.0	-22.5	-20.1	-13.2	-6.4	-5.6	-2.7	-2.0
Non-Rebound Non-Fatal Crash Costs	-37.5	-35.1	-31.5	-20.6	-10.0	-8.7	-4.2	-3.1
Rebound Fatality Costs	-18.6	-17.7	-16.6	-11.1	-6.2	-6.0	-2.8	-1.8
Non-Fatal Crash Costs	-29.0	-27.7	-26.0	-17.4	-9.7	-9.4	-4.3	-2.9
Total Societal Costs	-253.3	-242.0	-227.0	-165.6	-95.0	-93.3	-42.3	-31.8

*** EO 12866 Review – Draft – Do Not Cite, Quote or Release During Review ***

TABLE 8-34 - INCREMENTAL LIFETIME SOCIETAL COSTS FOR MY'S 1975-2029, BY ALTERNATIVE, LIGHT TRUCK, 7% DISCOUNT RATE, CAFE (BILLIONS OF 2016\$)

	Alternative							
	1	2	3	4	5	6	7	8
Model Years	2021-2026	2021-2026	2021-2026	2021-2026	2022-2026	2021-2026	2021-2026	2022-2026
Annual Rate of Stringency Increase	0.0%/Year PC 0.0%/Year LT	0.5%/Year PC 0.5%/Year LT	0.5%/Year PC 0.5%/Year LT	1.0%/Year PC 2.0%/Year LT	1.0%/Year PC 2.0%/Year LT	2.0%/Year PC 3.0%/Year LT	2.0%/Year PC 3.0%/Year LT	2.0%/Year PC 3.0%/Year LT
AC/Off-Cycle Procedures	No Change	No Change	Phaseout 2022- 2026	No Change	No Change	No Change	Phaseout 2022- 2026	No Change
Technology Costs	-108.3	-102.8	-95.3	-83.6	-65.2	-52.7	-24.9	-25.3
Advanced Technology Value Loss	-12.0	-12.0	-12.0	-12.0	-12.0	-11.7	-8.2	-11.4
Congestion Costs	-15.3	-13.8	-13.0	-9.8	-6.1	-5.4	-3.1	-2.7
Noise Costs	-0.2	-0.2	-0.2	-0.1	-0.1	-0.1	0.0	0.0
Non-Rebound Fatality Costs	-9.7	-8.7	-8.3	-6.2	-3.2	-3.0	-2.1	-1.4
Non-Rebound Non-Fatal Crash Costs	-15.2	-13.6	-13.0	-9.7	-5.0	-4.8	-3.3	-2.2
Rebound Fatality Costs	-13.3	-12.1	-11.2	-8.7	-6.2	-5.3	-2.8	-2.9
Non-Fatal Crash Costs	-20.9	-19.0	-17.6	-13.7	-9.7	-8.3	-4.5	-4.5
Total Societal Costs	-194.9	-182.2	-170.6	-143.9	-107.5	-91.2	-49.0	-50.4

*** EO 12866 Review – Draft – Do Not Cite, Quote or Release During Review ***

TABLE 8-35 - INCREMENTAL LIFETIME SOCIETAL COSTS FOR MY'S 1975-2029, BY ALTERNATIVE, LIGHT TRUCK, 7% DISCOUNT RATE, CO₂ (BILLIONS OF 2016\$)

	Alternative							
	1	2	3	4	5	6	7	8
Model Years	2021-2026	2021-2026	2021-2026	2021-2026	2022-2026	2021-2026	2021-2026	2022-2026
Annual Rate of Stringency Increase	0.0%/Year PC 0.0%/Year LT	0.5%/Year PC 0.5%/Year LT	0.5%/Year PC 0.5%/Year LT	1.0%/Year PC 2.0%/Year LT	1.0%/Year PC 2.0%/Year LT	2.0%/Year PC 3.0%/Year LT	2.0%/Year PC 3.0%/Year LT	2.0%/Year PC 3.0%/Year LT
AC/Off-Cycle Procedures	No Change	No Change	Phaseout 2022- 2026	No Change	No Change	No Change	Phaseout 2022- 2026	No Change
Technology Costs	-82.2	-79.3	-76.5	-60.8	-37.8	-39.6	-18.3	-13.5
Advanced Technology Value Loss	-4.2	-4.2	-4.2	-4.0	-2.7	-2.9	-1.1	-1.4
Congestion Costs	-16.1	-15.2	-14.0	-9.3	-4.6	-4.4	-2.2	-1.3
Noise Costs	-0.2	-0.2	-0.2	-0.1	-0.1	-0.1	0.0	0.0
Non-Rebound Fatality Costs	-12.7	-11.9	-10.8	-7.0	-3.1	-2.9	-1.6	-0.9
Non-Rebound Non-Fatal Crash Costs	-19.9	-18.6	-16.8	-10.9	-4.9	-4.5	-2.5	-1.4
Rebound Fatality Costs	-11.3	-10.8	-10.2	-6.8	-3.8	-3.8	-1.8	-1.2
Non-Fatal Crash Costs	-17.8	-16.9	-16.0	-10.7	-5.9	-5.9	-2.8	-1.8
Total Societal Costs	-164.5	-157.3	-148.7	-109.6	-62.9	-64.0	-30.3	-21.6

*** EO 12866 Review – Draft – Do Not Cite, Quote or Release During Review ***

TABLE 8-36 - INCREMENTAL LIFETIME SOCIETAL COSTS FOR MY'S 1975-2029, BY ALTERNATIVE, COMBINED LIGHT-DUTY, 3% DISCOUNT RATE, CAFE (BILLIONS OF 2016\$)

	Alternative							
	1	2	3	4	5	6	7	8
Model Years	2021-2026	2021-2026	2021-2026	2021-2026	2022-2026	2021-2026	2021-2026	2022-2026
Annual Rate of Stringency Increase	0.0%/Year PC 0.0%/Year LT	0.5%/Year PC 0.5%/Year LT	0.5%/Year PC 0.5%/Year LT	1.0%/Year PC 2.0%/Year LT	1.0%/Year PC 2.0%/Year LT	2.0%/Year PC 3.0%/Year LT	2.0%/Year PC 3.0%/Year LT	2.0%/Year PC 3.0%/Year LT
AC/Off-Cycle Procedures	No Change	No Change	Phaseout 2022- 2026	No Change	No Change	No Change	Phaseout 2022- 2026	No Change
Technology Costs	-255.1	-245.2	-230.1	-211.7	-171.4	-149.2	-93.8	-97.4
Advanced Technology Value Loss	-35.9	-35.8	-35.5	-35.6	-35.3	-34.5	-25.4	-32.3
Congestion Costs	-51.3	-47.8	-44.7	-37.8	-28.1	-24.4	-14.2	-15.5
Noise Costs	-0.7	-0.7	-0.6	-0.5	-0.4	-0.3	-0.2	-0.2
Non-Rebound Fatality Costs	-35.4	-32.5	-30.2	-25.0	-18.6	-14.8	-6.3	-8.4
Non-Rebound Non-Fatal Crash Costs	-55.4	-50.8	-47.2	-39.1	-29.1	-23.1	-9.8	-13.2
Rebound Fatality Costs	-41.7	-39.3	-37.1	-32.0	-23.7	-21.7	-14.9	-14.3
Non-Fatal Crash Costs	-65.3	-61.4	-58.0	-50.0	-37.1	-33.9	-23.4	-22.4
Total Societal Costs	-540.9	-513.4	-483.4	-431.8	-343.8	-301.9	-188.0	-203.8

*** EO 12866 Review – Draft – Do Not Cite, Quote or Release During Review ***

TABLE 8-37 - INCREMENTAL LIFETIME SOCIETAL COSTS FOR MY'S 1975-2029, BY ALTERNATIVE, COMBINED LIGHT-DUTY, 3% DISCOUNT RATE, CO₂ (BILLIONS OF 2016

	Alternative							
	1	2	3	4	5	6	7	8
Model Years	2021-2026	2021-2026	2021-2026	2021-2026	2022-2026	2021-2026	2021-2026	2022-2026
Annual Rate of Stringency Increase	0.0%/Year PC 0.0%/Year LT	0.5%/Year PC 0.5%/Year LT	0.5%/Year PC 0.5%/Year LT	1.0%/Year PC 2.0%/Year LT	1.0%/Year PC 2.0%/Year LT	2.0%/Year PC 3.0%/Year LT	2.0%/Year PC 3.0%/Year LT	2.0%/Year PC 3.0%/Year LT
AC/Off-Cycle Procedures	No Change	No Change	Phaseout 2022- 2026	No Change	No Change	No Change	Phaseout 2022- 2026	No Change
Technology Costs	-207.5	-199.9	-190.1	-163.6	-111.4	-110.7	-63.9	-57.5
Advanced Technology Value Loss	-18.2	-17.8	-17.8	-17.1	-13.5	-15.0	-8.2	-10.4
Congestion Costs	-50.0	-47.6	-43.1	-33.2	-22.1	-18.4	-8.3	-9.7
Noise Costs	-0.7	-0.7	-0.6	-0.5	-0.3	-0.3	-0.1	-0.1
Non-Rebound Fatality Costs	-39.0	-37.2	-33.0	-24.4	-17.2	-12.5	-4.3	-6.4
Non-Rebound Non-Fatal Crash Costs	-61.0	-58.2	-51.7	-38.1	-26.9	-19.6	-6.7	-9.9
Rebound Fatality Costs	-37.8	-36.1	-33.1	-26.1	-16.0	-15.2	-8.7	-7.9
Non-Fatal Crash Costs	-59.1	-56.5	-51.7	-40.9	-25.1	-23.8	-13.6	-12.4
Total Societal Costs	-473.3	-453.9	-421.1	-343.9	-232.6	-215.4	-113.9	-114.4

*** EO 12866 Review – Draft – Do Not Cite, Quote or Release During Review ***

TABLE 8-38 - INCREMENTAL LIFETIME SOCIETAL COSTS FOR MY'S 1975-2029, BY ALTERNATIVE, COMBINED LIGHT-DUTY, 7% DISCOUNT RATE, CAFE (BILLIONS OF 2016\$)

	Alternative							
	1	2	3	4	5	6	7	8
Model Years	2021-2026	2021-2026	2021-2026	2021-2026	2022-2026	2021-2026	2021-2026	2022-2026
Annual Rate of Stringency Increase	0.0%/Year PC 0.0%/Year LT	0.5%/Year PC 0.5%/Year LT	0.5%/Year PC 0.5%/Year LT	1.0%/Year PC 2.0%/Year LT	1.0%/Year PC 2.0%/Year LT	2.0%/Year PC 3.0%/Year LT	2.0%/Year PC 3.0%/Year LT	2.0%/Year PC 3.0%/Year LT
AC/Off-Cycle Procedures	No Change	No Change	Phaseout 2022- 2026	No Change	No Change	No Change	Phaseout 2022- 2026	No Change
Technology Costs	-194.2	-186.5	-174.9	-161.4	-130.6	-114.5	-73.2	-74.4
Advanced Technology Value Loss	-26.4	-26.3	-26.2	-26.2	-26.0	-25.4	-18.9	-23.9
Congestion Costs	-29.2	-27.2	-25.5	-21.7	-16.1	-14.3	-8.8	-9.0
Noise Costs	-0.4	-0.4	-0.4	-0.3	-0.2	-0.2	-0.1	-0.1
Non-Rebound Fatality Costs	-18.5	-16.9	-15.7	-13.1	-9.7	-7.9	-3.7	-4.4
Non-Rebound Non-Fatal Crash Costs	-28.9	-26.5	-24.6	-20.6	-15.2	-12.4	-5.7	-6.9
Rebound Fatality Costs	-25.9	-24.3	-23.0	-19.9	-14.6	-13.6	-9.6	-8.9
Non-Fatal Crash Costs	-40.4	-38.0	-35.9	-31.1	-22.9	-21.3	-15.0	-13.9
Total Societal Costs	-363.9	-346.1	-326.2	-294.3	-235.3	-209.6	-135.0	-141.5

*** EO 12866 Review – Draft – Do Not Cite, Quote or Release During Review ***

TABLE 8-39 - INCREMENTAL LIFETIME SOCIETAL COSTS FOR MY'S 1975-2029, BY ALTERNATIVE, COMBINED LIGHT-DUTY, 7% DISCOUNT RATE, CO₂ (BILLIONS OF 2016\$)

	Alternative							
	1	2	3	4	5	6	7	8
Model Years	2021-2026	2021-2026	2021-2026	2021-2026	2022-2026	2021-2026	2021-2026	2022-2026
Annual Rate of Stringency Increase	0.0%/Year PC 0.0%/Year LT	0.5%/Year PC 0.5%/Year LT	0.5%/Year PC 0.5%/Year LT	1.0%/Year PC 2.0%/Year LT	1.0%/Year PC 2.0%/Year LT	2.0%/Year PC 3.0%/Year LT	2.0%/Year PC 3.0%/Year LT	2.0%/Year PC 3.0%/Year LT
AC/Off-Cycle Procedures	No Change	No Change	Phaseout 2022- 2026	No Change	No Change	No Change	Phaseout 2022- 2026	No Change
Technology Costs	-155.4	-149.5	-142.5	-122.6	-82.5	-83.7	-49.3	-43.1
Advanced Technology Value Loss	-13.4	-13.0	-13.0	-12.5	-9.7	-10.9	-6.1	-7.5
Congestion Costs	-27.7	-26.3	-23.9	-18.5	-11.9	-10.3	-5.0	-5.3
Noise Costs	-0.4	-0.4	-0.3	-0.3	-0.2	-0.1	-0.1	-0.1
Non-Rebound Fatality Costs	-19.8	-18.9	-16.8	-12.3	-8.4	-6.4	-2.4	-3.2
Non-Rebound Non-Fatal Crash Costs	-30.9	-29.5	-26.3	-19.3	-13.2	-10.0	-3.8	-4.9
Rebound Fatality Costs	-23.1	-22.0	-20.3	-16.0	-9.7	-9.3	-5.4	-4.8
Non-Fatal Crash Costs	-36.1	-34.5	-31.7	-25.0	-15.1	-14.6	-8.5	-7.5
Total Societal Costs	-306.8	-294.0	-274.9	-226.6	-150.6	-145.3	-80.7	-76.4

*** EO 12866 Review – Draft – Do Not Cite, Quote or Release During Review ***

**TABLE 8-40 - INCREMENTAL TOTAL COSTS BY SOCIETAL PERSPECTIVE, PASSENGER CARS,
3% DISCOUNT RATE, CAFE (BILLIONS OF 2016\$)**

Passenger Cars	MY 1977- 2016	MY 2017	MY 2018	MY 2019	MY 2020	MY 2021	MY 2022	MY 2023	MY 2024	MY 2025	MY 2026	MY 2027	MY 2028	MY 2029	MY TOTAL
0.0%PC/0.0%LT, MYs 2021-2026	-58.9	-7.3	-8.6	-9.6	-13.6	-19.4	-21.1	-21.5	-20.2	-18.6	-16.3	-14.0	-13.2	-12.4	-254.8
0.5%PC/0.5%LT, MYs 2021-2026	-56.1	-6.9	-8.2	-9.3	-13.2	-18.7	-20.5	-20.9	-19.6	-18.1	-15.8	-13.9	-13.0	-12.3	-246.5
0.5%PC/0.5%LT, MYs 2021-2026, AC/Off-Cycle Phaseout	-52.6	-6.4	-7.7	-8.8	-12.7	-18.0	-19.7	-19.9	-18.6	-17.1	-14.4	-13.3	-12.5	-11.8	-233.5
1.0%PC/2.0%LT, MYs 2021-2026	-47.5	-5.8	-6.8	-7.9	-11.8	-17.2	-19.0	-19.3	-18.1	-16.7	-14.3	-13.7	-13.2	-12.8	-223.9
1.0%PC/2.0%LT, MYs 2022-2026	-37.8	-4.2	-4.7	-5.4	-9.1	-13.7	-16.7	-17.2	-16.3	-15.3	-13.0	-12.9	-12.5	-12.1	-190.7
2.0%PC/3.0%LT, MYs 2021-2026	-32.8	-3.9	-4.9	-6.0	-9.6	-14.1	-15.2	-15.3	-13.4	-13.2	-10.6	-11.7	-11.2	-11.0	-173.0
2.0%PC/3.0%LT, MYs 2021-2026, AC/Off-Cycle Phaseout	-20.4	-2.4	-3.5	-4.4	-7.9	-11.4	-12.0	-11.2	-9.2	-8.5	-5.6	-8.4	-7.8	-7.8	-120.5
2.0%PC/3.0%LT, MYs 2022-2026	-20.9	-2.4	-2.9	-3.5	-7.0	-10.5	-12.6	-12.8	-11.7	-10.8	-8.4	-9.7	-9.3	-9.3	-131.8

*** EO 12866 Review – Draft – Do Not Cite, Quote or Release During Review ***

**TABLE 8-41 - INCREMENTAL TOTAL COSTS BY SOCIETAL PERSPECTIVE, PASSENGER CARS,
3% DISCOUNT RATE, CO₂ (BILLIONS OF 2016\$)**

Passenger Cars	MY 1977- 2016	MY 2017	MY 2018	MY 2019	MY 2020	MY 2021	MY 2022	MY 2023	MY 2024	MY 2025	MY 2026	MY 2027	MY 2028	MY 2029	MY TOTAL
0.0%PC/0.0%LT, MYs 2021-2026	-48.8	-6.7	-8.4	-9.3	-12.2	-15.4	-17.4	-17.0	-16.8	-15.6	-14.6	-14.0	-12.9	-10.9	-220.0
0.5%PC/0.5%LT, MYs 2021-2026	-46.8	-6.3	-8.0	-8.8	-11.6	-14.6	-16.9	-16.6	-16.5	-15.2	-14.0	-13.7	-12.5	-10.5	-211.9
0.5%PC/0.5%LT, MYs 2021-2026, AC/Off- Cycle Phaseout	-44.3	-5.9	-7.6	-8.3	-10.9	-13.8	-15.8	-15.3	-14.6	-13.2	-12.3	-12.1	-11.0	-9.2	-194.2
1.0%PC/2.0%LT, MYs 2021-2026	-36.9	-4.8	-6.4	-7.1	-9.4	-12.2	-14.7	-14.7	-14.0	-13.1	-12.1	-12.0	-11.1	-9.7	-178.3
1.0%PC/2.0%LT, MYs 2022-2026	-24.8	-2.5	-2.9	-3.2	-5.3	-7.7	-11.6	-12.0	-11.6	-11.8	-10.3	-12.0	-11.4	-10.4	-137.5
2.0%PC/3.0%LT, MYs 2021-2026	-24.1	-2.9	-3.3	-3.7	-5.7	-8.1	-10.1	-9.9	-9.6	-9.6	-8.2	-9.4	-8.9	-8.4	-122.1
2.0%PC/3.0%LT, MYs 2021-2026, AC/Off- Cycle Phaseout	-13.5	-1.4	-1.9	-2.0	-4.0	-5.7	-6.7	-5.9	-5.2	-4.7	-2.9	-6.0	-5.9	-5.8	-71.6
2.0%PC/3.0%LT, MYs 2022-2026	-12.1	-0.8	-1.2	-1.4	-3.0	-4.8	-7.7	-7.6	-7.7	-7.4	-5.8	-7.8	-7.7	-7.4	-82.6

*** EO 12866 Review – Draft – Do Not Cite, Quote or Release During Review ***

**TABLE 8-42 - INCREMENTAL TOTAL COSTS BY SOCIETAL PERSPECTIVE, PASSENGER CARS,
7% DISCOUNT RATE, CAFE (BILLIONS OF 2016\$)**

Passenger Cars	MY 1977- 2016	MY 2017	MY 2018	MY 2019	MY 2020	MY 2021	MY 2022	MY 2023	MY 2024	MY 2025	MY 2026	MY 2027	MY 2028	MY 2029	MY TOTAL
0.0%PC/0.0%LT, MYs 2021-2026	-37.0	-4.4	-5.5	-6.3	-9.5	-14.0	-15.1	-15.2	-13.9	-12.6	-10.8	-9.0	-8.2	-7.4	-168.9
0.5%PC/0.5%LT, MYs 2021-2026	-35.3	-4.2	-5.3	-6.1	-9.3	-13.6	-14.7	-14.8	-13.5	-12.2	-10.4	-8.9	-8.1	-7.3	-163.8
0.5%PC/0.5%LT, MYs 2021-2026, AC/Off-Cycle Phaseout	-33.0	-3.9	-5.0	-5.8	-9.0	-13.1	-14.2	-14.1	-12.9	-11.6	-9.6	-8.5	-7.7	-7.1	-155.6
1.0%PC/2.0%LT, MYs 2021-2026	-29.9	-3.6	-4.5	-5.3	-8.5	-12.7	-13.9	-13.8	-12.7	-11.4	-9.5	-8.8	-8.2	-7.5	-150.4
1.0%PC/2.0%LT, MYs 2022-2026	-23.8	-2.5	-3.0	-3.5	-6.6	-10.2	-12.2	-12.4	-11.5	-10.5	-8.7	-8.3	-7.7	-7.1	-127.9
2.0%PC/3.0%LT, MYs 2021-2026	-20.9	-2.5	-3.4	-4.3	-7.3	-10.7	-11.3	-11.2	-9.6	-9.2	-7.2	-7.5	-6.9	-6.5	-118.4
2.0%PC/3.0%LT, MYs 2021-2026, AC/Off-Cycle Phaseout	-13.3	-1.7	-2.7	-3.4	-6.3	-8.9	-9.3	-8.5	-6.9	-6.2	-4.0	-5.4	-4.8	-4.6	-86.0
2.0%PC/3.0%LT, MYs 2022-2026	-13.2	-1.5	-2.0	-2.5	-5.4	-8.1	-9.5	-9.4	-8.4	-7.6	-5.8	-6.3	-5.8	-5.5	-91.1

*** EO 12866 Review – Draft – Do Not Cite, Quote or Release During Review ***

**TABLE 8-43 - INCREMENTAL TOTAL COSTS BY SOCIETAL PERSPECTIVE, PASSENGER CARS,
7% DISCOUNT RATE, CO₂ (BILLIONS OF 2016\$)**

Passenger Cars	MY 1977- 2016	MY 2017	MY 2018	MY 2019	MY 2020	MY 2021	MY 2022	MY 2023	MY 2024	MY 2025	MY 2026	MY 2027	MY 2028	MY 2029	MY TOTAL
0.0%PC/0.0%LT, MYs 2021-2026	-30.1	-3.9	-5.3	-6.0	-8.3	-10.6	-12.1	-11.7	-11.3	-10.3	-9.5	-8.8	-7.9	-6.6	-142.3
0.5%PC/0.5%LT, MYs 2021-2026	-28.8	-3.6	-5.1	-5.6	-7.8	-10.0	-11.7	-11.4	-11.0	-10.0	-9.1	-8.6	-7.7	-6.3	-136.8
0.5%PC/0.5%LT, MYs 2021-2026, AC/Off-Cycle Phaseout	-27.4	-3.4	-4.8	-5.4	-7.4	-9.6	-11.0	-10.5	-9.9	-8.7	-8.1	-7.7	-6.8	-5.6	-126.2
1.0%PC/2.0%LT, MYs 2021-2026	-22.8	-2.9	-4.2	-4.7	-6.6	-8.6	-10.4	-10.3	-9.6	-8.8	-7.9	-7.6	-6.9	-5.8	-117.0
1.0%PC/2.0%LT, MYs 2022-2026	-15.1	-1.2	-1.5	-1.7	-3.5	-5.3	-8.1	-8.3	-7.9	-7.8	-6.8	-7.5	-6.9	-6.1	-87.7
2.0%PC/3.0%LT, MYs 2021-2026	-15.1	-1.7	-2.2	-2.4	-4.1	-5.9	-7.4	-7.2	-6.8	-6.6	-5.5	-6.0	-5.5	-5.0	-81.3
2.0%PC/3.0%LT, MYs 2021-2026, AC/Off-Cycle Phaseout	-8.7	-1.0	-1.4	-1.5	-3.1	-4.4	-5.1	-4.5	-3.9	-3.5	-2.2	-3.9	-3.7	-3.5	-50.4
2.0%PC/3.0%LT, MYs 2022-2026	-7.5	-0.3	-0.6	-0.8	-2.2	-3.6	-5.6	-5.6	-5.5	-5.2	-4.0	-5.0	-4.7	-4.4	-54.9

*** EO 12866 Review – Draft – Do Not Cite, Quote or Release During Review ***

**TABLE 8-44 - INCREMENTAL TOTAL COSTS BY SOCIETAL PERSPECTIVE, LIGHT TRUCKS,
3% DISCOUNT RATE, CAFE (BILLIONS OF 2016\$)**

Light Trucks	MY 1977- 2016	MY 2017	MY 2018	MY 2019	MY 2020	MY 2021	MY 2022	MY 2023	MY 2024	MY 2025	MY 2026	MY 2027	MY 2028	MY 2029	MY TOTAL
0.0%PC/0.0%LT, MYs 2021-2026	-28.3	-3.4	-7.3	-10.6	-13.2	-19.7	-21.1	-22.5	-23.7	-25.4	-26.8	-27.5	-28.3	-28.5	-286.1
0.5%PC/0.5%LT, MYs 2021-2026	-25.7	-3.0	-6.2	-9.3	-12.0	-18.5	-19.9	-21.3	-22.5	-24.1	-25.2	-25.8	-26.6	-26.7	-266.8
0.5%PC/0.5%LT, MYs 2021-2026, AC/Off-Cycle Phaseout	-24.5	-2.8	-5.5	-8.3	-11.0	-17.2	-18.7	-20.1	-21.4	-23.0	-23.8	-24.2	-24.7	-24.7	-249.9
1.0%PC/2.0%LT, MYs 2021-2026	-20.0	-2.3	-4.7	-7.2	-9.3	-14.8	-15.9	-17.4	-18.4	-19.7	-19.8	-19.4	-19.6	-19.4	-207.9
1.0%PC/2.0%LT, MYs 2022-2026	-14.2	-1.4	-3.4	-5.7	-7.4	-11.5	-12.3	-12.9	-13.6	-14.3	-14.3	-14.1	-14.1	-13.9	-153.1
2.0%PC/3.0%LT, MYs 2021-2026	-13.4	-1.4	-3.0	-4.1	-5.9	-10.0	-10.5	-11.6	-12.2	-12.5	-11.7	-11.1	-10.8	-10.6	-128.9
2.0%PC/3.0%LT, MYs 2021-2026, AC/Off-Cycle Phaseout	-8.2	-0.8	-1.6	-1.9	-3.3	-5.7	-5.7	-7.0	-7.5	-7.2	-5.3	-4.9	-4.3	-4.2	-67.5
2.0%PC/3.0%LT, MYs 2022-2026	-7.5	-0.7	-1.3	-1.9	-2.9	-5.1	-5.4	-6.1	-6.8	-7.6	-7.2	-6.8	-6.4	-6.2	-71.9

*** EO 12866 Review – Draft – Do Not Cite, Quote or Release During Review ***

**TABLE 8-45 - INCREMENTAL TOTAL COSTS BY SOCIETAL PERSPECTIVE, LIGHT TRUCKS,
3% DISCOUNT RATE, CO₂ (BILLIONS OF 2016\$)**

Light Trucks	MY 1977- 2016	MY 2017	MY 2018	MY 2019	MY 2020	MY 2021	MY 2022	MY 2023	MY 2024	MY 2025	MY 2026	MY 2027	MY 2028	MY 2029	MY TOTAL
0.0%PC/0.0%LT, MYs 2021-2026	-26.7	-3.3	-5.1	-8.1	-10.1	-14.3	-15.5	-18.3	-20.1	-21.4	-24.9	-26.9	-28.6	-30.0	-253.3
0.5%PC/0.5%LT, MYs 2021-2026	-25.0	-3.0	-4.6	-7.6	-9.5	-13.7	-14.8	-17.6	-19.3	-20.5	-23.8	-25.8	-27.6	-29.0	-242.0
0.5%PC/0.5%LT, MYs 2021-2026, AC/Off-Cycle Phaseout	-22.9	-2.6	-4.1	-7.2	-9.0	-13.1	-14.3	-16.9	-18.5	-19.6	-22.5	-24.0	-25.5	-26.7	-227.0
1.0%PC/2.0%LT, MYs 2021-2026	-16.4	-1.7	-2.8	-5.0	-6.1	-9.4	-10.1	-12.5	-13.8	-14.4	-16.6	-18.0	-19.1	-19.7	-165.6
1.0%PC/2.0%LT, MYs 2022-2026	-9.8	-1.1	-1.9	-2.9	-3.8	-5.7	-6.0	-7.1	-7.8	-7.9	-9.4	-9.8	-10.4	-11.3	-95.0
2.0%PC/3.0%LT, MYs 2021-2026	-8.4	-0.8	-1.6	-3.3	-4.3	-6.5	-6.8	-8.2	-8.8	-8.3	-9.5	-8.8	-8.9	-9.1	-93.3
2.0%PC/3.0%LT, MYs 2021-2026, AC/Off-Cycle Phaseout	-4.1	-0.2	-0.6	-1.1	-2.1	-3.8	-3.8	-5.1	-5.5	-4.5	-4.8	-3.0	-2.1	-1.7	-42.3
2.0%PC/3.0%LT, MYs 2022-2026	-3.7	-0.4	-0.7	-1.1	-1.7	-2.3	-2.0	-2.6	-2.8	-2.5	-3.5	-2.7	-2.8	-2.8	-31.8

*** EO 12866 Review – Draft – Do Not Cite, Quote or Release During Review ***

**TABLE 8-46 - INCREMENTAL TOTAL COSTS BY SOCIETAL PERSPECTIVE, LIGHT TRUCKS,
7% DISCOUNT RATE, CAFE (BILLIONS OF 2016\$)**

Light Trucks	MY 1977- 2016	MY 2017	MY 2018	MY 2019	MY 2020	MY 2021	MY 2022	MY 2023	MY 2024	MY 2025	MY 2026	MY 2027	MY 2028	MY 2029	MY TOTAL
0.0%PC/0.0%LT, MYs 2021-2026	-17.2	-2.0	-5.7	-8.5	-10.5	-15.7	-16.2	-16.6	-16.9	-17.4	-17.6	-17.3	-17.0	-16.4	-194.9
0.5%PC/0.5%LT, MYs 2021-2026	-15.6	-1.8	-4.8	-7.5	-9.6	-14.8	-15.4	-15.8	-16.1	-16.6	-16.6	-16.3	-16.0	-15.4	-182.2
0.5%PC/0.5%LT, MYs 2021-2026, AC/Off-Cycle Phaseout	-14.9	-1.7	-4.2	-6.6	-8.8	-13.8	-14.4	-14.9	-15.3	-15.8	-15.7	-15.3	-14.9	-14.3	-170.6
1.0%PC/2.0%LT, MYs 2021-2026	-12.2	-1.4	-3.8	-5.9	-7.5	-12.0	-12.4	-13.0	-13.2	-13.7	-13.1	-12.4	-11.9	-11.3	-143.9
1.0%PC/2.0%LT, MYs 2022-2026	-8.5	-0.8	-2.7	-4.8	-6.1	-9.4	-9.7	-9.8	-10.0	-10.1	-9.6	-9.1	-8.7	-8.2	-107.5
2.0%PC/3.0%LT, MYs 2021-2026	-8.3	-1.0	-2.5	-3.4	-4.9	-8.2	-8.3	-8.8	-8.9	-8.8	-7.9	-7.2	-6.7	-6.3	-91.2
2.0%PC/3.0%LT, MYs 2021-2026, AC/Off-Cycle Phaseout	-5.3	-0.7	-1.4	-1.6	-2.9	-4.8	-4.6	-5.3	-5.5	-5.1	-3.5	-3.1	-2.7	-2.5	-49.0
2.0%PC/3.0%LT, MYs 2022-2026	-4.5	-0.4	-1.0	-1.5	-2.4	-4.2	-4.3	-4.7	-5.0	-5.3	-4.8	-4.4	-4.0	-3.7	-50.4

*** EO 12866 Review – Draft – Do Not Cite, Quote or Release During Review ***

**TABLE 8-47 - INCREMENTAL TOTAL COSTS BY SOCIETAL PERSPECTIVE, LIGHT TRUCKS,
7% DISCOUNT RATE, CO₂ (BILLIONS OF 2016\$)**

Light Trucks	MY 1977- 2016	MY 2017	MY 2018	MY 2019	MY 2020	MY 2021	MY 2022	MY 2023	MY 2024	MY 2025	MY 2026	MY 2027	MY 2028	MY 2029	MY TOTAL
0.0%PC/0.0%LT, MYs 2021-2026	-15.9	-1.7	-3.3	-6.0	-7.6	-10.9	-11.5	-13.1	-13.9	-14.2	-15.9	-16.5	-16.9	-17.0	-164.5
0.5%PC/0.5%LT, MYs 2021-2026	-14.9	-1.5	-3.0	-5.7	-7.2	-10.5	-11.0	-12.6	-13.3	-13.6	-15.2	-15.9	-16.4	-16.5	-157.3
0.5%PC/0.5%LT, MYs 2021-2026, AC/Off-Cycle Phaseout	-13.7	-1.3	-2.7	-5.4	-6.9	-10.1	-10.7	-12.2	-12.8	-13.1	-14.4	-14.8	-15.1	-15.2	-148.7
1.0%PC/2.0%LT, MYs 2021-2026	-9.7	-0.8	-1.9	-3.9	-4.7	-7.4	-7.7	-9.2	-9.7	-9.7	-10.8	-11.2	-11.5	-11.4	-109.6
1.0%PC/2.0%LT, MYs 2022-2026	-5.7	-0.5	-1.2	-2.2	-2.9	-4.4	-4.6	-5.2	-5.5	-5.4	-6.1	-6.2	-6.3	-6.6	-62.9
2.0%PC/3.0%LT, MYs 2021-2026	-5.0	-0.4	-1.1	-2.7	-3.5	-5.3	-5.3	-6.1	-6.3	-5.8	-6.2	-5.5	-5.4	-5.3	-64.0
2.0%PC/3.0%LT, MYs 2021-2026, AC/Off-Cycle Phaseout	-2.5	-0.2	-0.5	-0.9	-1.8	-3.2	-3.0	-3.9	-4.0	-3.1	-3.1	-1.8	-1.3	-1.0	-30.3
2.0%PC/3.0%LT, MYs 2022-2026	-2.1	-0.2	-0.6	-0.9	-1.4	-1.8	-1.6	-2.0	-2.0	-1.7	-2.3	-1.7	-1.7	-1.7	-21.6

*** EO 12866 Review – Draft – Do Not Cite, Quote or Release During Review ***

**TABLE 8-48 - INCREMENTAL TOTAL COSTS BY SOCIETAL PERSPECTIVE, COMBINED LIGHT-DUTY,
3% DISCOUNT RATE, CAFE (BILLIONS OF 2016\$)**

Passenger Cars and Light Trucks	MY 1977-2016	MY 2017	MY 2018	MY 2019	MY 2020	MY 2021	MY 2022	MY 2023	MY 2024	MY 2025	MY 2026	MY 2027	MY 2028	MY 2029	MY TOTAL
0.0%PC/0.0%LT, MYs 2021-2026	-87.2	-10.6	-15.8	-20.2	-26.7	-39.1	-42.2	-44.1	-43.9	-44.0	-43.1	-41.5	-41.5	-40.9	-540.9
0.5%PC/0.5%LT, MYs 2021-2026	-81.9	-10.0	-14.4	-18.6	-25.1	-37.2	-40.4	-42.2	-42.1	-42.2	-41.0	-39.7	-39.6	-39.0	-513.4
0.5%PC/0.5%LT, MYs 2021-2026, AC/Off-Cycle Phaseout	-77.0	-9.3	-13.2	-17.1	-23.6	-35.3	-38.4	-40.0	-40.0	-40.0	-38.2	-37.5	-37.2	-36.6	-483.4
1.0%PC/2.0%LT, MYs 2021-2026	-67.5	-8.0	-11.6	-15.1	-21.1	-31.9	-34.9	-36.7	-36.5	-36.4	-34.1	-33.2	-32.8	-32.1	-431.8
1.0%PC/2.0%LT, MYs 2022-2026	-51.9	-5.6	-8.1	-11.1	-16.4	-25.2	-28.9	-30.1	-30.0	-29.6	-27.3	-26.9	-26.5	-26.0	-343.8
2.0%PC/3.0%LT, MYs 2021-2026	-46.2	-5.3	-8.0	-10.1	-15.6	-24.0	-25.7	-26.8	-25.6	-25.8	-22.3	-22.8	-22.0	-21.6	-301.9
2.0%PC/3.0%LT, MYs 2021-2026, AC/Off-Cycle Phaseout	-28.6	-3.2	-5.1	-6.3	-11.2	-17.1	-17.7	-18.2	-16.7	-15.7	-10.8	-13.3	-12.1	-12.0	-188.0
2.0%PC/3.0%LT, MYs 2022-2026	-28.4	-3.0	-4.3	-5.4	-10.0	-15.6	-18.0	-18.9	-18.5	-18.3	-15.6	-16.5	-15.7	-15.5	-203.8

*** EO 12866 Review – Draft – Do Not Cite, Quote or Release During Review ***

**TABLE 8-49 - INCREMENTAL TOTAL COSTS BY SOCIETAL PERSPECTIVE, COMBINED LIGHT-DUTY,
3% DISCOUNT RATE, CO₂ (BILLIONS OF 2016\$)**

Passenger Cars and Light Trucks	MY 1977-2016	MY 2017	MY 2018	MY 2019	MY 2020	MY 2021	MY 2022	MY 2023	MY 2024	MY 2025	MY 2026	MY 2027	MY 2028	MY 2029	MY TOTAL
0.0%PC/0.0%LT, MYs 2021-2026	-75.4	-10.0	-13.4	-17.4	-22.3	-29.6	-32.9	-35.3	-37.0	-37.0	-39.5	-41.0	-41.6	-40.9	-473.3
0.5%PC/0.5%LT, MYs 2021-2026	-71.7	-9.3	-12.6	-16.5	-21.1	-28.3	-31.8	-34.2	-35.8	-35.7	-37.9	-39.5	-40.1	-39.5	-453.9
0.5%PC/0.5%LT, MYs 2021-2026, AC/Off-Cycle Phaseout	-67.2	-8.5	-11.7	-15.5	-19.9	-26.9	-30.0	-32.2	-33.1	-32.8	-34.8	-36.2	-36.5	-35.9	-421.1
1.0%PC/2.0%LT, MYs 2021-2026	-53.3	-6.5	-9.2	-12.1	-15.5	-21.6	-24.8	-27.2	-27.8	-27.6	-28.7	-29.9	-30.3	-29.5	-343.9
1.0%PC/2.0%LT, MYs 2022-2026	-34.6	-3.7	-4.8	-6.1	-9.1	-13.5	-17.7	-19.1	-19.4	-19.6	-19.8	-21.9	-21.8	-21.6	-232.6
2.0%PC/3.0%LT, MYs 2021-2026	-32.5	-3.6	-4.9	-7.0	-10.0	-14.7	-16.9	-18.2	-18.4	-18.0	-17.7	-18.2	-17.8	-17.5	-215.4
2.0%PC/3.0%LT, MYs 2021-2026, AC/Off-Cycle Phaseout	-17.6	-1.7	-2.5	-3.1	-6.0	-9.4	-10.4	-11.0	-10.7	-9.2	-7.6	-9.1	-8.0	-7.5	-113.9
2.0%PC/3.0%LT, MYs 2022-2026	-15.9	-1.2	-1.9	-2.5	-4.7	-7.1	-9.7	-10.3	-10.5	-9.9	-9.4	-10.5	-10.5	-10.2	-114.4

*** EO 12866 Review – Draft – Do Not Cite, Quote or Release During Review ***

**TABLE 8-50 - INCREMENTAL TOTAL COSTS BY SOCIETAL PERSPECTIVE, COMBINED LIGHT-DUTY,
7% DISCOUNT RATE, CAFE (BILLIONS OF 2016\$)**

Passenger Cars and Light Trucks	MY 1977-2016	MY 2017	MY 2018	MY 2019	MY 2020	MY 2021	MY 2022	MY 2023	MY 2024	MY 2025	MY 2026	MY 2027	MY 2028	MY 2029	MY TOTAL
0.0%PC/0.0%LT, MYs 2021-2026	-54.2	-6.4	-11.2	-14.8	-20.1	-29.7	-31.3	-31.8	-30.7	-29.9	-28.4	-26.3	-25.2	-23.8	-363.9
0.5%PC/0.5%LT, MYs 2021-2026	-50.9	-6.0	-10.1	-13.7	-18.9	-28.4	-30.1	-30.6	-29.6	-28.8	-27.1	-25.2	-24.1	-22.7	-346.1
0.5%PC/0.5%LT, MYs 2021-2026, AC/Off-Cycle Phaseout	-47.9	-5.6	-9.2	-12.5	-17.8	-27.0	-28.7	-29.0	-28.2	-27.4	-25.3	-23.8	-22.6	-21.3	-326.2
1.0%PC/2.0%LT, MYs 2021-2026	-42.2	-5.0	-8.3	-11.2	-16.1	-24.6	-26.3	-26.8	-25.9	-25.1	-22.7	-21.2	-20.1	-18.8	-294.3
1.0%PC/2.0%LT, MYs 2022-2026	-32.3	-3.3	-5.7	-8.3	-12.7	-19.6	-21.9	-22.2	-21.4	-20.6	-18.3	-17.3	-16.3	-15.3	-235.3
2.0%PC/3.0%LT, MYs 2021-2026	-29.2	-3.5	-5.9	-7.7	-12.2	-18.9	-19.7	-19.9	-18.5	-18.0	-15.1	-14.7	-13.6	-12.8	-209.6
2.0%PC/3.0%LT, MYs 2021-2026, AC/Off-Cycle Phaseout	-18.6	-2.4	-4.2	-5.0	-9.2	-13.7	-13.9	-13.8	-12.4	-11.2	-7.5	-8.5	-7.5	-7.1	-135.0
2.0%PC/3.0%LT, MYs 2022-2026	-17.8	-1.9	-3.1	-4.0	-7.9	-12.3	-13.8	-14.1	-13.4	-13.0	-10.6	-10.7	-9.8	-9.2	-141.5

*** EO 12866 Review – Draft – Do Not Cite, Quote or Release During Review ***

**TABLE 8-51 - INCREMENTAL TOTAL COSTS BY SOCIETAL PERSPECTIVE, COMBINED LIGHT-DUTY,
7% DISCOUNT RATE, CO₂ (BILLIONS OF 2016\$)**

Passenger Cars and Light Trucks	MY 1977-2016	MY 2017	MY 2018	MY 2019	MY 2020	MY 2021	MY 2022	MY 2023	MY 2024	MY 2025	MY 2026	MY 2027	MY 2028	MY 2029	MY TOTAL
0.0%PC/0.0%LT, MYs 2021-2026	-46.0	-5.6	-8.7	-12.0	-15.9	-21.5	-23.6	-24.8	-25.2	-24.5	-25.3	-25.4	-24.9	-23.6	-306.8
0.5%PC/0.5%LT, MYs 2021-2026	-43.7	-5.2	-8.0	-11.3	-15.0	-20.5	-22.8	-24.0	-24.4	-23.6	-24.3	-24.5	-24.0	-22.8	-294.0
0.5%PC/0.5%LT, MYs 2021-2026, AC/Off-Cycle Phaseout	-41.1	-4.8	-7.6	-10.8	-14.3	-19.7	-21.7	-22.7	-22.7	-21.8	-22.5	-22.5	-22.0	-20.8	-274.9
1.0%PC/2.0%LT, MYs 2021-2026	-32.6	-3.7	-6.1	-8.6	-11.3	-16.0	-18.1	-19.4	-19.3	-18.5	-18.7	-18.8	-18.3	-17.2	-226.6
1.0%PC/2.0%LT, MYs 2022-2026	-20.7	-1.7	-2.7	-3.9	-6.4	-9.8	-12.7	-13.6	-13.4	-13.2	-12.9	-13.7	-13.3	-12.7	-150.6
2.0%PC/3.0%LT, MYs 2021-2026	-20.0	-2.1	-3.3	-5.1	-7.6	-11.2	-12.6	-13.3	-13.1	-12.4	-11.8	-11.5	-10.9	-10.3	-145.3
2.0%PC/3.0%LT, MYs 2021-2026, AC/Off-Cycle Phaseout	-11.2	-1.1	-1.9	-2.4	-4.9	-7.6	-8.2	-8.4	-7.9	-6.6	-5.3	-5.8	-4.9	-4.4	-80.7
2.0%PC/3.0%LT, MYs 2022-2026	-9.7	-0.5	-1.2	-1.7	-3.5	-5.4	-7.2	-7.5	-7.5	-6.9	-6.3	-6.6	-6.4	-6.0	-76.4

*** EO 12866 Review – Draft – Do Not Cite, Quote or Release During Review ***

**TABLE 8-52 - AVERAGE INCREMENTAL TECHNOLOGY COSTS AND CIVIL PENALTIES PER VEHICLE,
PASSENGER CARS, CAFE (2016\$)**

Passenger Cars	MY 2017	MY 2018	MY 2019	MY 2020	MY 2021	MY 2022	MY 2023	MY 2024	MY 2025	MY 2026	MY 2027	MY 2028	MY 2029
0.00%/Y Pc and 0.00%/Y Lt During 2021-2026	-\$98	-\$206	-\$291	-\$609	-\$1,029	-\$1,324	-\$1,556	-\$1,659	-\$1,759	-\$1,772	-\$1,744	-\$1,716	-\$1,686
0.50%/Y Pc and 0.50%/Y Lt During 2021-2026	-\$96	-\$199	-\$282	-\$593	-\$998	-\$1,290	-\$1,513	-\$1,617	-\$1,717	-\$1,725	-\$1,699	-\$1,669	-\$1,638
0.50%/Y Pc and 0.50%/Y Lt During 2021-2026 with AC and Off-Cycle Adj. Phaseout but No Target Offset	-\$85	-\$184	-\$267	-\$577	-\$967	-\$1,252	-\$1,457	-\$1,559	-\$1,651	-\$1,621	-\$1,590	-\$1,556	-\$1,527
1.00%/Y Pc and 2.00%/Y Lt During 2021-2026	-\$91	-\$182	-\$261	-\$571	-\$958	-\$1,238	-\$1,440	-\$1,537	-\$1,613	-\$1,562	-\$1,515	-\$1,475	-\$1,439
1.00%/Y Pc and 2.00%/Y Lt During 2022-2026	-\$47	-\$105	-\$171	-\$460	-\$796	-\$1,049	-\$1,236	-\$1,324	-\$1,386	-\$1,335	-\$1,303	-\$1,266	-\$1,232
2.00%/Y Pc and 3.00%/Y Lt During 2021-2026	-\$68	-\$152	-\$230	-\$515	-\$833	-\$1,033	-\$1,183	-\$1,215	-\$1,272	-\$1,146	-\$1,112	-\$1,071	-\$1,040
2.00%/Y Pc and 3.00%/Y Lt During 2021-2026 with AC and Off-Cycle Adj. Phaseout but No Target Offset	-\$70	-\$156	-\$211	-\$476	-\$730	-\$885	-\$974	-\$984	-\$969	-\$754	-\$729	-\$699	-\$677
2.00%/Y Pc and 3.00%/Y Lt During 2022-2026	-\$35	-\$92	-\$148	-\$416	-\$664	-\$843	-\$965	-\$1,012	-\$1,030	-\$907	-\$882	-\$846	-\$821

*** EO 12866 Review – Draft – Do Not Cite, Quote or Release During Review ***

**TABLE 8-53 - AVERAGE INCREMENTAL TECHNOLOGY COSTS PER VEHICLE,
PASSENGER CARS, CO₂ (2016\$)**

Passenger Cars	MY 2017	MY 2018	MY 2019	MY 2020	MY 2021	MY 2022	MY 2023	MY 2024	MY 2025	MY 2026	MY 2027	MY 2028	MY 2029
0.00%/Y Pc and 0.00%/Y Lt During 2021-2026	-\$79	-\$194	-\$258	-\$476	-\$696	-\$980	-\$1,186	-\$1,321	-\$1,451	-\$1,591	-\$1,652	-\$1,675	-\$1,661
0.50%/Y Pc and 0.50%/Y Lt During 2021-2026	-\$66	-\$180	-\$238	-\$443	-\$652	-\$935	-\$1,142	-\$1,278	-\$1,405	-\$1,539	-\$1,601	-\$1,625	-\$1,613
0.50%/Y Pc and 0.50%/Y Lt During 2021-2026 with AC and Off-Cycle Adj. Phaseout but No Target Offset	-\$66	-\$180	-\$236	-\$432	-\$634	-\$895	-\$1,089	-\$1,197	-\$1,312	-\$1,435	-\$1,486	-\$1,498	-\$1,482
1.00%/Y Pc and 2.00%/Y Lt During 2021-2026	-\$64	-\$168	-\$219	-\$405	-\$594	-\$854	-\$1,047	-\$1,138	-\$1,223	-\$1,325	-\$1,375	-\$1,388	-\$1,356
1.00%/Y Pc and 2.00%/Y Lt During 2022-2026	\$17	-\$24	-\$51	-\$210	-\$372	-\$610	-\$796	-\$874	-\$987	-\$1,059	-\$1,114	-\$1,126	-\$1,112
2.00%/Y Pc and 3.00%/Y Lt During 2021-2026	-\$41	-\$94	-\$127	-\$286	-\$455	-\$654	-\$773	-\$837	-\$914	-\$939	-\$959	-\$943	-\$912
2.00%/Y Pc and 3.00%/Y Lt During 2021-2026 with AC and Off-Cycle Adj. Phaseout but No Target Offset	-\$36	-\$85	-\$104	-\$251	-\$373	-\$500	-\$569	-\$601	-\$623	-\$587	-\$592	-\$586	-\$557
2.00%/Y Pc and 3.00%/Y Lt During 2022-2026	\$17	-\$20	-\$46	-\$157	-\$279	-\$435	-\$542	-\$597	-\$667	-\$669	-\$696	-\$684	-\$659

*** EO 12866 Review – Draft – Do Not Cite, Quote or Release During Review ***

**TABLE 8-54 - AVERAGE INCREMENTAL TECHNOLOGY COSTS AND CIVIL PENALTIES PER VEHICLE,
LIGHT TRUCKS, CAFE (2016\$)**

Light Trucks	MY 2017	MY 2018	MY 2019	MY 2020	MY 2021	MY 2022	MY 2023	MY 2024	MY 2025	MY 2026	MY 2027	MY 2028	MY 2029
0.00%/Y Pc and 0.00%/Y Lt During 2021-2026	-\$94	-\$488	-\$833	-\$1,111	-\$1,770	-\$1,902	-\$1,987	-\$2,097	-\$2,219	-\$2,284	-\$2,247	-\$2,212	-\$2,164
0.50%/Y Pc and 0.50%/Y Lt During 2021-2026	-\$89	-\$425	-\$758	-\$1,038	-\$1,696	-\$1,828	-\$1,914	-\$2,024	-\$2,139	-\$2,165	-\$2,131	-\$2,091	-\$2,045
0.50%/Y Pc and 0.50%/Y Lt During 2021-2026 with AC and Off-Cycle Adj. Phaseout but No Target Offset	-\$81	-\$360	-\$656	-\$940	-\$1,579	-\$1,712	-\$1,801	-\$1,908	-\$2,018	-\$2,010	-\$1,977	-\$1,940	-\$1,897
1.00%/Y Pc and 2.00%/Y Lt During 2021-2026	-\$88	-\$349	-\$613	-\$843	-\$1,401	-\$1,515	-\$1,605	-\$1,688	-\$1,777	-\$1,706	-\$1,661	-\$1,622	-\$1,568
1.00%/Y Pc and 2.00%/Y Lt During 2022-2026	-\$53	-\$271	-\$522	-\$699	-\$1,112	-\$1,228	-\$1,271	-\$1,315	-\$1,364	-\$1,276	-\$1,235	-\$1,201	-\$1,158
2.00%/Y Pc and 3.00%/Y Lt During 2021-2026	-\$69	-\$241	-\$360	-\$547	-\$955	-\$1,016	-\$1,061	-\$1,099	-\$1,140	-\$992	-\$962	-\$923	-\$889
2.00%/Y Pc and 3.00%/Y Lt During 2021-2026 with AC and Off-Cycle Adj. Phaseout but No Target Offset	-\$57	-\$142	-\$177	-\$317	-\$530	-\$526	-\$588	-\$605	-\$570	-\$307	-\$293	-\$272	-\$259
2.00%/Y Pc and 3.00%/Y Lt During 2022-2026	-\$29	-\$95	-\$146	-\$249	-\$434	-\$477	-\$528	-\$556	-\$605	-\$498	-\$469	-\$437	-\$421

*** EO 12866 Review – Draft – Do Not Cite, Quote or Release During Review ***

**TABLE 8-55 - AVERAGE INCREMENTAL TECHNOLOGY COSTS PER VEHICLE,
LIGHT TRUCKS, CO₂ (2016\$)**

Light Trucks	MY 2017	MY 2018	MY 2019	MY 2020	MY 2021	MY 2022	MY 2023	MY 2024	MY 2025	MY 2026	MY 2027	MY 2028	MY 2029
0.00%/Y Pc and 0.00%/Y Lt During 2021-2026	-\$39	-\$215	-\$527	-\$736	-\$1,177	-\$1,302	-\$1,431	-\$1,519	-\$1,585	-\$1,802	-\$1,949	-\$2,110	-\$2,174
0.50%/Y Pc and 0.50%/Y Lt During 2021-2026	-\$27	-\$188	-\$498	-\$702	-\$1,137	-\$1,264	-\$1,395	-\$1,479	-\$1,540	-\$1,734	-\$1,882	-\$2,045	-\$2,111
0.50%/Y Pc and 0.50%/Y Lt During 2021-2026 with AC and Off-Cycle Adj. Phaseout but No Target Offset	-\$27	-\$182	-\$493	-\$693	-\$1,119	-\$1,246	-\$1,368	-\$1,432	-\$1,483	-\$1,646	-\$1,768	-\$1,924	-\$1,983
1.00%/Y Pc and 2.00%/Y Lt During 2021-2026	-\$23	-\$147	-\$388	-\$526	-\$890	-\$989	-\$1,101	-\$1,147	-\$1,194	-\$1,297	-\$1,396	-\$1,526	-\$1,556
1.00%/Y Pc and 2.00%/Y Lt During 2022-2026	-\$15	-\$94	-\$206	-\$322	-\$537	-\$620	-\$682	-\$709	-\$758	-\$795	-\$866	-\$983	-\$1,035
2.00%/Y Pc and 3.00%/Y Lt During 2021-2026	-\$22	-\$111	-\$306	-\$421	-\$665	-\$709	-\$772	-\$792	-\$790	-\$791	-\$741	-\$801	-\$798
2.00%/Y Pc and 3.00%/Y Lt During 2021-2026 with AC and Off-Cycle Adj. Phaseout but No Target Offset	-\$22	-\$66	-\$123	-\$237	-\$428	-\$424	-\$466	-\$460	-\$379	-\$282	-\$160	-\$154	-\$123
2.00%/Y Pc and 3.00%/Y Lt During 2022-2026	-\$15	-\$62	-\$101	-\$172	-\$244	-\$246	-\$267	-\$269	-\$256	-\$244	-\$183	-\$250	-\$271

*** EO 12866 Review – Draft – Do Not Cite, Quote or Release During Review ***

**TABLE 8-56 - AVERAGE INCREMENTAL TECHNOLOGY COSTS AND CIVIL PENALTIES PER VEHICLE,
COMBINED LIGHT-DUTY, CAFE (2016\$)**

Passenger Cars and Light Trucks	MY 2017	MY 2018	MY 2019	MY 2020	MY 2021	MY 2022	MY 2023	MY 2024	MY 2025	MY 2026	MY 2027	MY 2028	MY 2029
0.00%/Y Pc and 0.00%/Y Lt During 2021-2026	-\$96	-\$337	-\$540	-\$839	-\$1,370	-\$1,591	-\$1,755	-\$1,862	-\$1,973	-\$2,011	-\$1,980	-\$1,950	-\$1,912
0.50%/Y Pc and 0.50%/Y Lt During 2021-2026	-\$93	-\$304	-\$501	-\$797	-\$1,320	-\$1,538	-\$1,699	-\$1,806	-\$1,914	-\$1,931	-\$1,903	-\$1,870	-\$1,832
0.50%/Y Pc and 0.50%/Y Lt During 2021-2026 with AC and Off-Cycle Adj. Phaseout but No Target Offset	-\$83	-\$265	-\$446	-\$744	-\$1,249	-\$1,464	-\$1,617	-\$1,722	-\$1,823	-\$1,804	-\$1,773	-\$1,739	-\$1,704
1.00%/Y Pc and 2.00%/Y Lt During 2021-2026	-\$89	-\$260	-\$423	-\$696	-\$1,162	-\$1,366	-\$1,517	-\$1,609	-\$1,692	-\$1,633	-\$1,587	-\$1,548	-\$1,504
1.00%/Y Pc and 2.00%/Y Lt During 2022-2026	-\$50	-\$182	-\$333	-\$570	-\$941	-\$1,132	-\$1,253	-\$1,321	-\$1,378	-\$1,312	-\$1,275	-\$1,239	-\$1,201
2.00%/Y Pc and 3.00%/Y Lt During 2021-2026	-\$68	-\$193	-\$290	-\$530	-\$889	-\$1,026	-\$1,128	-\$1,164	-\$1,213	-\$1,079	-\$1,045	-\$1,004	-\$971
2.00%/Y Pc and 3.00%/Y Lt During 2021-2026 with AC and Off-Cycle Adj. Phaseout but No Target Offset	-\$64	-\$149	-\$196	-\$403	-\$638	-\$720	-\$798	-\$811	-\$788	-\$551	-\$527	-\$500	-\$482
2.00%/Y Pc and 3.00%/Y Lt During 2022-2026	-\$32	-\$93	-\$147	-\$339	-\$558	-\$674	-\$764	-\$802	-\$835	-\$721	-\$690	-\$655	-\$634

*** EO 12866 Review – Draft – Do Not Cite, Quote or Release During Review ***

**TABLE 8-57 - AVERAGE INCREMENTAL TECHNOLOGY COSTS PER VEHICLE,
COMBINED LIGHT-DUTY, CO₂ (2016\$)**

Passenger Cars and Light Trucks	MY 2017	MY 2018	MY 2019	MY 2020	MY 2021	MY 2022	MY 2023	MY 2024	MY 2025	MY 2026	MY 2027	MY 2028	MY 2029
0.00%/Y Pc and 0.00%/Y Lt During 2021-2026	-\$61	-\$204	-\$382	-\$595	-\$916	-\$1,128	-\$1,300	-\$1,414	-\$1,514	-\$1,691	-\$1,793	-\$1,882	-\$1,906
0.50%/Y Pc and 0.50%/Y Lt During 2021-2026	-\$48	-\$184	-\$358	-\$562	-\$874	-\$1,086	-\$1,259	-\$1,372	-\$1,469	-\$1,631	-\$1,735	-\$1,826	-\$1,852
0.50%/Y Pc and 0.50%/Y Lt During 2021-2026 with AC and Off-Cycle Adj. Phaseout but No Target Offset	-\$48	-\$181	-\$354	-\$552	-\$856	-\$1,056	-\$1,218	-\$1,307	-\$1,392	-\$1,535	-\$1,620	-\$1,701	-\$1,722
1.00%/Y Pc and 2.00%/Y Lt During 2021-2026	-\$45	-\$158	-\$297	-\$461	-\$729	-\$916	-\$1,073	-\$1,144	-\$1,211	-\$1,316	-\$1,389	-\$1,458	-\$1,457
1.00%/Y Pc and 2.00%/Y Lt During 2022-2026	\$2	-\$57	-\$122	-\$262	-\$448	-\$615	-\$744	-\$799	-\$882	-\$939	-\$1,000	-\$1,063	-\$1,080
2.00%/Y Pc and 3.00%/Y Lt During 2021-2026	-\$32	-\$102	-\$209	-\$348	-\$551	-\$679	-\$773	-\$817	-\$857	-\$873	-\$860	-\$880	-\$862
2.00%/Y Pc and 3.00%/Y Lt During 2021-2026 with AC and Off-Cycle Adj. Phaseout but No Target Offset	-\$30	-\$76	-\$112	-\$245	-\$398	-\$465	-\$522	-\$536	-\$511	-\$448	-\$391	-\$384	-\$353
2.00%/Y Pc and 3.00%/Y Lt During 2022-2026	\$2	-\$39	-\$71	-\$164	-\$263	-\$348	-\$415	-\$445	-\$476	-\$473	-\$457	-\$481	-\$477

*** EO 12866 Review – Draft – Do Not Cite, Quote or Release During Review ***

**TABLE 8-58 - PER-VEHICLE NET PRESENT VALUE OF OWNERSHIP COSTS UNDER PREFERRED ALTERNATIVE,
PASSENGER CAR, 3% DISCOUNT RATE, CAFE (BILLIONS OF 2016\$)**

	MY 2017	MY 2018	MY 2019	MY 2020	MY 2021	MY 2022	MY 2023	MY 2024	MY 2025	MY 2026	MY 2027	MY 2028	MY 2029	MY 2030
Price Increase	-98	-206	-291	-609	-1029	-1324	-1556	-1659	-1759	-1772	-1744	-1716	-1686	-1648
Welfare Loss	-13	-19	-27	-57	-122	-169	-240	-272	-332	-351	-351	-352	-352	-352
Additional Ownership Costs	-24	-50	-71	-148	-251	-322	-377	-401	-424	-425	-417	-409	-400	-390
Total Consumer Costs	-135	-276	-388	-814	-1403	-1815	-2172	-2331	-2515	-2548	-2512	-2476	-2438	-2390

**TABLE 8-59 - PER-VEHICLE NET PRESENT VALUE OF OWNERSHIP COSTS UNDER PREFERRED ALTERNATIVE,
PASSENGER CAR, 3% DISCOUNT RATE, CO₂ (BILLIONS OF 2016\$)**

	MY 2017	MY 2018	MY 2019	MY 2020	MY 2021	MY 2022	MY 2023	MY 2024	MY 2025	MY 2026	MY 2027	MY 2028	MY 2029	MY 2030
Price Increase	-79	-194	-258	-476	-696	-980	-1186	-1321	-1451	-1591	-1652	-1675	-1661	-1633
Welfare Loss	-6	-7	-21	-44	-74	-109	-159	-172	-186	-215	-220	-232	-238	-238
Additional Ownership Costs	-19	-47	-63	-116	-170	-238	-286	-318	-347	-379	-392	-397	-392	-383
Total Consumer Costs	-103	-249	-342	-636	-939	-1327	-1631	-1811	-1984	-2184	-2264	-2304	-2290	-2254

*** EO 12866 Review – Draft – Do Not Cite, Quote or Release During Review ***

**TABLE 8-60 - PER-VEHICLE NET PRESENT VALUE OF OWNERSHIP COSTS UNDER PREFERRED ALTERNATIVE,
PASSENGER CAR, 7% DISCOUNT RATE, CAFE (BILLIONS OF 2016\$)**

	MY 2017	MY 2018	MY 2019	MY 2020	MY 2021	MY 2022	MY 2023	MY 2024	MY 2025	MY 2026	MY 2027	MY 2028	MY 2029	MY 2030
Price Increase	-98	-206	-291	-609	-1029	-1324	-1556	-1659	-1759	-1772	-1744	-1716	-1686	-1648
Welfare Loss	-13	-19	-27	-57	-122	-169	-240	-272	-332	-351	-351	-352	-352	-352
Additional Ownership Costs	-22	-46	-64	-134	-227	-291	-341	-363	-384	-385	-377	-370	-363	-354
Total Consumer Costs	-133	-271	-381	-800	-1379	-1785	-2137	-2294	-2475	-2508	-2473	-2438	-2400	-2354

**TABLE 8-61 - PER-VEHICLE NET PRESENT VALUE OF OWNERSHIP COSTS UNDER PREFERRED ALTERNATIVE,
PASSENGER CAR, 7% DISCOUNT RATE, CO₂ (BILLIONS OF 2016\$)**

	MY 2017	MY 2018	MY 2019	MY 2020	MY 2021	MY 2022	MY 2023	MY 2024	MY 2025	MY 2026	MY 2027	MY 2028	MY 2029	MY 2030
Price Increase	-79	-194	-258	-476	-696	-980	-1186	-1321	-1451	-1591	-1652	-1675	-1661	-1633
Welfare Loss	-6	-7	-21	-44	-74	-109	-159	-172	-186	-215	-220	-232	-238	-238
Additional Ownership Costs	-17	-43	-57	-105	-154	-216	-259	-288	-315	-343	-356	-360	-355	-347
Total Consumer Costs	-102	-244	-336	-626	-923	-1305	-1604	-1781	-1952	-2149	-2227	-2267	-2253	-2218

*** EO 12866 Review – Draft – Do Not Cite, Quote or Release During Review ***

**TABLE 8-62 - PER-VEHICLE NET PRESENT VALUE OF OWNERSHIP COSTS UNDER PREFERRED ALTERNATIVE,
LIGHT TRUCK, 3% DISCOUNT RATE, CAFE (BILLIONS OF 2016\$)**

	MY 2017	MY 2018	MY 2019	MY 2020	MY 2021	MY 2022	MY 2023	MY 2024	MY 2025	MY 2026	MY 2027	MY 2028	MY 2029	MY 2030
Price Increase	-94	-488	-833	-1111	-1770	-1902	-1987	-2097	-2219	-2284	-2247	-2212	-2164	-2114
Welfare Loss	-7	-21	-36	-72	-143	-161	-173	-233	-303	-339	-339	-339	-339	-339
Additional Ownership Costs	-23	-119	-203	-271	-431	-464	-484	-511	-541	-557	-548	-539	-527	-515
Total Consumer Costs	-125	-628	-1072	-1454	-2345	-2527	-2645	-2841	-3062	-3180	-3134	-3090	-3030	-2968

**TABLE 8-63 - PER-VEHICLE NET PRESENT VALUE OF OWNERSHIP COSTS UNDER PREFERRED ALTERNATIVE,
LIGHT TRUCK, 3% DISCOUNT RATE, CO₂ (BILLIONS OF 2016\$)**

	MY 2017	MY 2018	MY 2019	MY 2020	MY 2021	MY 2022	MY 2023	MY 2024	MY 2025	MY 2026	MY 2027	MY 2028	MY 2029	MY 2030
Price Increase	-39	-215	-527	-736	-1177	-1302	-1431	-1519	-1585	-1802	-1949	-2110	-2174	-2144
Welfare Loss	0	-1	-15	-15	-36	-38	-85	-102	-105	-126	-126	-126	-126	-126
Additional Ownership Costs	-10	-52	-129	-179	-287	-317	-349	-370	-386	-439	-475	-514	-530	-523
Total Consumer Costs	-49	-268	-670	-930	-1499	-1657	-1866	-1991	-2077	-2367	-2550	-2751	-2830	-2793

*** EO 12866 Review – Draft – Do Not Cite, Quote or Release During Review ***

**TABLE 8-64 - PER-VEHICLE NET PRESENT VALUE OF OWNERSHIP COSTS UNDER PREFERRED ALTERNATIVE,
LIGHT TRUCK, 7% DISCOUNT RATE, CAFE (BILLIONS OF 2016\$)**

	MY 2017	MY 2018	MY 2019	MY 2020	MY 2021	MY 2022	MY 2023	MY 2024	MY 2025	MY 2026	MY 2027	MY 2028	MY 2029	MY 2030
Price Increase	-94	-488	-833	-1111	-1770	-1902	-1987	-2097	-2219	-2284	-2247	-2212	-2164	-2114
Welfare Loss	-7	-21	-36	-72	-143	-161	-173	-233	-303	-339	-339	-339	-339	-339
Additional Ownership Costs	-21	-108	-184	-246	-391	-420	-439	-463	-490	-504	-496	-489	-478	-467
Total Consumer Costs	-122	-617	-1053	-1429	-2304	-2484	-2599	-2793	-3012	-3127	-3082	-3039	-2981	-2920

**TABLE 8-65 - PER-VEHICLE NET PRESENT VALUE OF OWNERSHIP COSTS UNDER PREFERRED ALTERNATIVE,
LIGHT TRUCK, 7% DISCOUNT RATE, CO₂ (BILLIONS OF 2016\$)**

	MY 2017	MY 2018	MY 2019	MY 2020	MY 2021	MY 2022	MY 2023	MY 2024	MY 2025	MY 2026	MY 2027	MY 2028	MY 2029	MY 2030
Price Increase	-39	-215	-527	-736	-1177	-1302	-1431	-1519	-1585	-1802	-1949	-2110	-2174	-2144
Welfare Loss	0	-1	-15	-15	-36	-38	-85	-102	-105	-126	-126	-126	-126	-126
Additional Ownership Costs	-9	-47	-116	-163	-260	-288	-316	-335	-350	-398	-430	-466	-480	-474
Total Consumer Costs	-48	-263	-658	-913	-1473	-1627	-1833	-1956	-2041	-2326	-2506	-2703	-2780	-2744

*** EO 12866 Review – Draft – Do Not Cite, Quote or Release During Review ***

TABLE 8-66 - PER-VEHICLE NET PRESENT VALUE OF OWNERSHIP COSTS UNDER PREFERRED ALTERNATIVE, COMBINED LIGHT-DUTY, 3% DISCOUNT RATE, CAFE (BILLIONS OF 2016\$)

	MY 2017	MY 2018	MY 2019	MY 2020	MY 2021	MY 2022	MY 2023	MY 2024	MY 2025	MY 2026	MY 2027	MY 2028	MY 2029	MY 2030
Price Increase	-96	-337	-540	-839	-1370	-1591	-1755	-1862	-1973	-2011	-1980	-1950	-1912	-1869
Welfare Loss	-10	-20	-31	-64	-132	-166	-209	-254	-318	-345	-345	-345	-345	-345
Additional Ownership Costs	-23	-82	-132	-205	-334	-391	-436	-466	-498	-513	-511	-507	-501	-493
Total Consumer Costs	-130	-439	-703	-1108	-1836	-2148	-2400	-2582	-2790	-2869	-2836	-2803	-2758	-2707

TABLE 8-67 - PER-VEHICLE NET PRESENT VALUE OF OWNERSHIP COSTS UNDER PREFERRED ALTERNATIVE, COMBINED LIGHT-DUTY, 3% DISCOUNT RATE, CO₂ (BILLIONS OF 2016\$)

	MY 2017	MY 2018	MY 2019	MY 2020	MY 2021	MY 2022	MY 2023	MY 2024	MY 2025	MY 2026	MY 2027	MY 2028	MY 2029	MY 2030
Price Increase	-61	-204	-382	-595	-916	-1128	-1300	-1414	-1514	-1691	-1793	-1882	-1906	-1879
Welfare Loss	-3	-4	-18	-31	-56	-76	-125	-139	-148	-173	-175	-182	-184	-184
Additional Ownership Costs	-15	-50	-93	-145	-223	-278	-327	-359	-390	-441	-470	-496	-508	-508
Total Consumer Costs	-78	-257	-493	-771	-1195	-1482	-1751	-1912	-2053	-2305	-2438	-2560	-2599	-2571

*** EO 12866 Review – Draft – Do Not Cite, Quote or Release During Review ***

TABLE 8-68 - PER-VEHICLE NET PRESENT VALUE OF OWNERSHIP COSTS UNDER PREFERRED ALTERNATIVE, COMBINED LIGHT-DUTY, 7% DISCOUNT RATE, CAFE (BILLIONS OF 2016\$)

	MY 2017	MY 2018	MY 2019	MY 2020	MY 2021	MY 2022	MY 2023	MY 2024	MY 2025	MY 2026	MY 2027	MY 2028	MY 2029	MY 2030
Price Increase	-96	-337	-540	-839	-1370	-1591	-1755	-1862	-1973	-2011	-1980	-1950	-1912	-1869
Welfare Loss	-10	-20	-31	-64	-132	-166	-209	-254	-318	-345	-345	-345	-345	-345
Additional Ownership Costs	-21	-74	-119	-185	-303	-355	-395	-423	-452	-465	-463	-460	-454	-446
Total Consumer Costs	-128	-431	-691	-1089	-1805	-2111	-2360	-2539	-2743	-2820	-2789	-2755	-2711	-2660

TABLE 8-69:– PER-VEHICLE NET PRESENT VALUE OF OWNERSHIP COSTS UNDER PREFERRED ALTERNATIVE, COMBINED LIGHT-DUTY, 7% DISCOUNT RATE, CO₂ (BILLIONS OF 2016\$)

	MY 2017	MY 2018	MY 2019	MY 2020	MY 2021	MY 2022	MY 2023	MY 2024	MY 2025	MY 2026	MY 2027	MY 2028	MY 2029	MY 2030
Price Increase	-61	-204	-382	-595	-916	-1128	-1300	-1414	-1514	-1691	-1793	-1882	-1906	-1879
Welfare Loss	-3	-4	-18	-31	-56	-76	-125	-139	-148	-173	-175	-182	-184	-184
Additional Ownership Costs	-13	-45	-84	-132	-202	-252	-296	-326	-354	-399	-426	-449	-460	-460
Total Consumer Costs	-77	-253	-484	-758	-1174	-1455	-1721	-1878	-2016	-2263	-2394	-2513	-2551	-2523

*** EO 12866 Review – Draft – Do Not Cite, Quote or Release During Review ***

**TABLE 8-70 - MY 2030 PER-VEHICLE NET PRESENT VALUE OF OWNERSHIP COSTS,
PASSENGER CAR, 3% DISCOUNT RATE, CAFE (BILLIONS OF 2016\$)**

	Alternative							
	1	2	3	4	5	6	7	8
Model Years	2021-2026	2021-2026	2021-2026	2021-2026	2022-2026	2021-2026	2021-2026	2022-2026
Annual Rate of Stringency Increase	0.0%/Year PC	0.5%/Year PC	0.5%/Year PC	1.0%/Year PC	1.0%/Year PC	2.0%/Year PC	2.0%/Year PC	2.0%/Year PC
	0.0%/Year LT	0.5%/Year LT	0.5%/Year LT	2.0%/Year LT	2.0%/Year LT	3.0%/Year LT	3.0%/Year LT	3.0%/Year LT
AC/Off-Cycle Procedures	No Change	No Change	Phaseout 2022-2026	No Change	No Change	No Change	Phaseout 2022-2026	No Change
Price Increase	-1648	-1601	-1492	-1404	-1201	-1011	-658	-796
Welfare Loss	-352	-350	-346	-348	-342	-328	-242	-298
Additional Ownership Costs	-390	-380	-354	-335	-288	-244	-159	-193
Total Consumer Costs	-2390	-2331	-2192	-2088	-1831	-1583	-1059	-1288

*** EO 12866 Review – Draft – Do Not Cite, Quote or Release During Review ***

**TABLE 8-71 - MY 2030 PER-VEHICLE NET PRESENT VALUE OF OWNERSHIP COSTS,
PASSENGER CAR, 3% DISCOUNT RATE, CO₂ (BILLIONS OF 2016\$)**

	Alternative							
	1	2	3	4	5	6	7	8
Model Years	2021- 2026	2021- 2026	2021- 2026	2021- 2026	2022- 2026	2021- 2026	2021- 2026	2022- 2026
Annual Rate of Stringency Increase	0.0%/Year PC	0.5%/Year PC	0.5%/Year PC	1.0%/Year PC	1.0%/Year PC	2.0%/Year PC	2.0%/Year PC	2.0%/Year PC
	0.0%/Year LT	0.5%/Year LT	0.5%/Year LT	2.0%/Year LT	2.0%/Year LT	3.0%/Year LT	3.0%/Year LT	3.0%/Year LT
AC/Off-Cycle Procedures	No Change	No Change	Phaseout 2022- 2026	No Change	No Change	No Change	Phaseout 2022- 2026	No Change
Price Increase	-1633	-1586	-1455	-1325	-1094	-887	-528	-641
Welfare Loss	-238	-232	-232	-228	-208	-218	-123	-174
Additional Ownership Costs	-383	-372	-341	-313	-261	-212	-127	-155
Total Consumer Costs	-2254	-2189	-2028	-1866	-1563	-1318	-778	-969

*** EO 12866 Review – Draft – Do Not Cite, Quote or Release During Review ***

**TABLE 8-72 - MY 2030 PER-VEHICLE NET PRESENT VALUE OF OWNERSHIP COSTS,
PASSENGER CAR, 7% DISCOUNT RATE, CAFE (BILLIONS OF 2016\$)**

	Alternative							
	1	2	3	4	5	6	7	8
Model Years	2021- 2026	2021- 2026	2021- 2026	2021- 2026	2022- 2026	2021- 2026	2021- 2026	2022- 2026
Annual Rate of Stringency Increase	0.0%/Year PC	0.5%/Year PC	0.5%/Year PC	1.0%/Year PC	1.0%/Year PC	2.0%/Year PC	2.0%/Year PC	2.0%/Year PC
	0.0%/Year LT	0.5%/Year LT	0.5%/Year LT	2.0%/Year LT	2.0%/Year LT	3.0%/Year LT	3.0%/Year LT	3.0%/Year LT
AC/Off-Cycle Procedures	No Change	No Change	Phaseout 2022- 2026	No Change	No Change	No Change	Phaseout 2022- 2026	No Change
Price Increase	-1648	-1601	-1492	-1404	-1201	-1011	-658	-796
Welfare Loss	-352	-350	-346	-348	-342	-328	-242	-298
Additional Ownership Costs	-354	-344	-321	-304	-261	-221	-144	-175
Total Consumer Costs	-2354	-2295	-2159	-2056	-1804	-1560	-1044	-1269

*** EO 12866 Review – Draft – Do Not Cite, Quote or Release During Review ***

**TABLE 8-73 - MY 2030 PER-VEHICLE NET PRESENT VALUE OF OWNERSHIP COSTS,
PASSENGER CAR, 7% DISCOUNT RATE, CO₂ (BILLIONS OF 2016\$)**

	Alternative							
	1	2	3	4	5	6	7	8
Model Years	2021- 2026	2021- 2026	2021- 2026	2021- 2026	2022- 2026	2021- 2026	2021- 2026	2022- 2026
Annual Rate of Stringency Increase	0.0%/Year PC	0.5%/Year PC	0.5%/Year PC	1.0%/Year PC	1.0%/Year PC	2.0%/Year PC	2.0%/Year PC	2.0%/Year PC
	0.0%/Year LT	0.5%/Year LT	0.5%/Year LT	2.0%/Year LT	2.0%/Year LT	3.0%/Year LT	3.0%/Year LT	3.0%/Year LT
AC/Off-Cycle Procedures	No Change	No Change	Phaseout 2022- 2026	No Change	No Change	No Change	Phaseout 2022- 2026	No Change
Price Increase	-1633	-1586	-1455	-1325	-1094	-887	-528	-641
Welfare Loss	-238	-232	-232	-228	-208	-218	-123	-174
Additional Ownership Costs	-347	-337	-309	-283	-237	-192	-115	-141
Total Consumer Costs	-2218	-2155	-1996	-1837	-1539	-1298	-766	-955

*** EO 12866 Review – Draft – Do Not Cite, Quote or Release During Review ***

**TABLE 8-74 - MY 2030 PER-VEHICLE NET PRESENT VALUE OF OWNERSHIP COSTS,
LIGHT TRUCK, 3% DISCOUNT RATE, CAFE (BILLIONS OF 2016\$)**

	Alternative							
	1	2	3	4	5	6	7	8
Model Years	2021- 2026	2021- 2026	2021- 2026	2021- 2026	2022- 2026	2021- 2026	2021- 2026	2022- 2026
Annual Rate of Stringency Increase	0.0%/Year PC	0.5%/Year PC	0.5%/Year PC	1.0%/Year PC	1.0%/Year PC	2.0%/Year PC	2.0%/Year PC	2.0%/Year PC
	0.0%/Year LT	0.5%/Year LT	0.5%/Year LT	2.0%/Year LT	2.0%/Year LT	3.0%/Year LT	3.0%/Year LT	3.0%/Year LT
AC/Off-Cycle Procedures	No Change	No Change	Phaseout 2022- 2026	No Change	No Change	No Change	Phaseout 2022- 2026	No Change
Price Increase	-2114	-1997	-1851	-1527	-1124	-857	-246	-402
Welfare Loss	-339	-339	-339	-339	-339	-328	-183	-317
Additional Ownership Costs	-515	-487	-451	-372	-274	-209	-60	-98
Total Consumer Costs	-2968	-2822	-2640	-2239	-1736	-1394	-489	-817

*** EO 12866 Review – Draft – Do Not Cite, Quote or Release During Review ***

**TABLE 8-75 - MY 2030 PER-VEHICLE NET PRESENT VALUE OF OWNERSHIP COSTS,
LIGHT TRUCK, 3% DISCOUNT RATE, CO₂ (BILLIONS OF 2016\$)**

	Alternative							
	1	2	3	4	5	6	7	8
Model Years	2021- 2026	2021- 2026	2021- 2026	2021- 2026	2022- 2026	2021- 2026	2021- 2026	2022- 2026
Annual Rate of Stringency Increase	0.0%/Year PC 0.0%/Year LT	0.5%/Year PC 0.5%/Year LT	0.5%/Year PC 0.5%/Year LT	1.0%/Year PC 2.0%/Year LT	1.0%/Year PC 2.0%/Year LT	2.0%/Year PC 3.0%/Year LT	2.0%/Year PC 3.0%/Year LT	2.0%/Year PC 3.0%/Year LT
AC/Off-Cycle Procedures	No Change	No Change	Phaseout 2022- 2026	No Change	No Change	No Change	Phaseout 2022- 2026	No Change
Price Increase	-2144	-2083	-1955	-1526	-1024	-774	-105	-263
Welfare Loss	-126	-126	-126	-114	-89	-77	-13	-39
Additional Ownership Costs	-523	-508	-476	-372	-250	-189	-26	-64
Total Consumer Costs	-2793	-2717	-2558	-2012	-1363	-1040	-144	-366

*** EO 12866 Review – Draft – Do Not Cite, Quote or Release During Review ***

**TABLE 8-76 - MY 2030 PER-VEHICLE NET PRESENT VALUE OF OWNERSHIP COSTS,
LIGHT TRUCK, 7% DISCOUNT RATE, CAFE (BILLIONS OF 2016\$)**

	Alternative							
	1	2	3	4	5	6	7	8
Model Years	2021- 2026	2021- 2026	2021- 2026	2021- 2026	2022- 2026	2021- 2026	2021- 2026	2022- 2026
Annual Rate of Stringency Increase	0.0%/Year PC	0.5%/Year PC	0.5%/Year PC	1.0%/Year PC	1.0%/Year PC	2.0%/Year PC	2.0%/Year PC	2.0%/Year PC
	0.0%/Year LT	0.5%/Year LT	0.5%/Year LT	2.0%/Year LT	2.0%/Year LT	3.0%/Year LT	3.0%/Year LT	3.0%/Year LT
AC/Off-Cycle Procedures	No Change	No Change	Phaseout 2022- 2026	No Change	No Change	No Change	Phaseout 2022- 2026	No Change
Price Increase	-2114	-1997	-1851	-1527	-1124	-857	-246	-402
Welfare Loss	-339	-339	-339	-339	-339	-328	-183	-317
Additional Ownership Costs	-467	-441	-409	-337	-248	-189	-54	-89
Total Consumer Costs	-2920	-2777	-2598	-2204	-1711	-1374	-483	-808

*** EO 12866 Review – Draft – Do Not Cite, Quote or Release During Review ***

**TABLE 8-77 - MY 2030 PER-VEHICLE NET PRESENT VALUE OF OWNERSHIP COSTS,
LIGHT TRUCK, 7% DISCOUNT RATE, CO₂ (BILLIONS OF 2016\$)**

	Alternative							
	1	2	3	4	5	6	7	8
Model Years	2021-2026	2021-2026	2021-2026	2021-2026	2022-2026	2021-2026	2021-2026	2022-2026
Annual Rate of Stringency Increase	0.0%/Year PC	0.5%/Year PC	0.5%/Year PC	1.0%/Year PC	1.0%/Year PC	2.0%/Year PC	2.0%/Year PC	2.0%/Year PC
	0.0%/Year LT	0.5%/Year LT	0.5%/Year LT	2.0%/Year LT	2.0%/Year LT	3.0%/Year LT	3.0%/Year LT	3.0%/Year LT
AC/Off-Cycle Procedures	No Change	No Change	Phaseout 2022-2026	No Change	No Change	No Change	Phaseout 2022-2026	No Change
Price Increase	-2144	-2083	-1955	-1526	-1024	-774	-105	-263
Welfare Loss	-126	-126	-126	-114	-89	-77	-13	-39
Additional Ownership Costs	-474	-460	-432	-337	-226	-171	-23	-58
Total Consumer Costs	-2744	-2669	-2513	-1978	-1339	-1022	-142	-360

*** EO 12866 Review – Draft – Do Not Cite, Quote or Release During Review ***

**TABLE 8-78 - MY 2030 PER-VEHICLE NET PRESENT VALUE OF OWNERSHIP COSTS,
COMBINED LIGHT-DUTY, 3% DISCOUNT RATE, CAFE (BILLIONS OF 2016\$)**

	Alternative							
	1	2	3	4	5	6	7	8
Model Years	2021- 2026	2021- 2026	2021- 2026	2021- 2026	2022- 2026	2021- 2026	2021- 2026	2022- 2026
Annual Rate of Stringency Increase	0.0%/Year PC	0.5%/Year PC	0.5%/Year PC	1.0%/Year PC	1.0%/Year PC	2.0%/Year PC	2.0%/Year PC	2.0%/Year PC
	0.0%/Year LT	0.5%/Year LT	0.5%/Year LT	2.0%/Year LT	2.0%/Year LT	3.0%/Year LT	3.0%/Year LT	3.0%/Year LT
AC/Off-Cycle Procedures	No Change	No Change	Phaseout 2022- 2026	No Change	No Change	No Change	Phaseout 2022- 2026	No Change
Price Increase	-1869	-1790	-1663	-1467	-1168	-941	-465	-612
Welfare Loss	-345	-344	-342	-343	-340	-328	-214	-307
Additional Ownership Costs	-493	-471	-437	-379	-298	-238	-117	-153
Total Consumer Costs	-2707	-2605	-2442	-2189	-1807	-1507	-796	-1073

*** EO 12866 Review – Draft – Do Not Cite, Quote or Release During Review ***

**TABLE 8-79 - MY 2030 PER-VEHICLE NET PRESENT VALUE OF OWNERSHIP COSTS,
COMBINED LIGHT-DUTY, 3% DISCOUNT RATE, CO₂ (BILLIONS OF 2016\$)**

	Alternative							
	1	2	3	4	5	6	7	8
Model Years	2021-2026	2021-2026	2021-2026	2021-2026	2022-2026	2021-2026	2021-2026	2022-2026
Annual Rate of Stringency Increase	0.0%/Year PC	0.5%/Year PC	0.5%/Year PC	1.0%/Year PC	1.0%/Year PC	2.0%/Year PC	2.0%/Year PC	2.0%/Year PC
	0.0%/Year LT	0.5%/Year LT	0.5%/Year LT	2.0%/Year LT	2.0%/Year LT	3.0%/Year LT	3.0%/Year LT	3.0%/Year LT
AC/Off-Cycle Procedures	No Change	No Change	Phaseout 2022-2026	No Change	No Change	No Change	Phaseout 2022-2026	No Change
Price Increase	-1879	-1825	-1696	-1428	-1067	-838	-329	-462
Welfare Loss	-184	-181	-181	-174	-151	-151	-70	-109
Additional Ownership Costs	-508	-494	-458	-380	-277	-217	-84	-116
Total Consumer Costs	-2571	-2500	-2335	-1982	-1495	-1206	-483	-688

*** EO 12866 Review – Draft – Do Not Cite, Quote or Release During Review ***

**TABLE 8-80 - MY 2030 PER-VEHICLE NET PRESENT VALUE OF OWNERSHIP COSTS,
COMBINED LIGHT-DUTY, 7% DISCOUNT RATE, CAFE (BILLIONS OF 2016\$)**

	Alternative							
	1	2	3	4	5	6	7	8
Model Years	2021- 2026	2021- 2026	2021- 2026	2021- 2026	2022- 2026	2021- 2026	2021- 2026	2022- 2026
Annual Rate of Stringency Increase	0.0%/Year PC	0.5%/Year PC	0.5%/Year PC	1.0%/Year PC	1.0%/Year PC	2.0%/Year PC	2.0%/Year PC	2.0%/Year PC
	0.0%/Year LT	0.5%/Year LT	0.5%/Year LT	2.0%/Year LT	2.0%/Year LT	3.0%/Year LT	3.0%/Year LT	3.0%/Year LT
AC/Off-Cycle Procedures	No Change	No Change	Phaseout 2022- 2026	No Change	No Change	No Change	Phaseout 2022- 2026	No Change
Price Increase	-1869	-1790	-1663	-1467	-1168	-941	-465	-612
Welfare Loss	-345	-344	-342	-343	-340	-328	-214	-307
Additional Ownership Costs	-446	-427	-396	-344	-270	-216	-106	-139
Total Consumer Costs	-2660	-2561	-2401	-2154	-1779	-1485	-785	-1058

*** EO 12866 Review – Draft – Do Not Cite, Quote or Release During Review ***

**TABLE 8-81 - MY 2030 PER-VEHICLE NET PRESENT VALUE OF OWNERSHIP COSTS,
COMBINED LIGHT-DUTY, 7% DISCOUNT RATE, CO₂ (BILLIONS OF 2016\$)**

	Alternative							
	1	2	3	4	5	6	7	8
Model Years	2021- 2026	2021- 2026	2021- 2026	2021- 2026	2022- 2026	2021- 2026	2021- 2026	2022- 2026
Annual Rate of Stringency Increase	0.0%/Year PC	0.5%/Year PC	0.5%/Year PC	1.0%/Year PC	1.0%/Year PC	2.0%/Year PC	2.0%/Year PC	2.0%/Year PC
	0.0%/Year LT	0.5%/Year LT	0.5%/Year LT	2.0%/Year LT	2.0%/Year LT	3.0%/Year LT	3.0%/Year LT	3.0%/Year LT
AC/Off-Cycle Procedures	No Change	No Change	Phaseout 2022- 2026	No Change	No Change	No Change	Phaseout 2022- 2026	No Change
Price Increase	-1879	-1825	-1696	-1428	-1067	-838	-329	-462
Welfare Loss	-184	-181	-181	-174	-151	-151	-70	-109
Additional Ownership Costs	-460	-447	-415	-345	-251	-197	-76	-105
Total Consumer Costs	-2523	-2454	-2292	-1946	-1469	-1186	-475	-677

8.2 Indirect Costs

Direct costs represent the cost associated with acquiring raw materials, fabricating parts, and assembling vehicles with the various technologies manufacturers are expected to use to meet future CAFE and CO₂ standards. They include materials, labor, and variable energy costs required to produce and assemble the vehicle. However, they do not include overhead costs required to develop and produce the vehicle, nor do they include costs incurred by manufacturers or dealers to sell vehicles, nor the profit manufacturers and dealers make from their investments. All of these items contribute to the price consumers ultimately pay for the vehicle. These components of retail prices are illustrated in Table 8-82 below.

TABLE 8-82 - RETAIL PRICE COMPONENTS

DIRECT COSTS	
Manufacturing Cost	Cost of materials, labor, and variable energy needed for production
INDIRECT COSTS	
Production Overhead	
Warranty	Cost of providing product warranty
Research and Development	Cost of developing and engineering the product
Depreciation and amortization	Depreciation and amortization of manufacturing facilities and equipment
Maintenance, repair, operations	Cost of maintaining and operating manufacturing facilities and equipment
Corporate Overhead	
General and Administrative	Salaries of nonmanufacturing labor, operations of corporate offices, etc.
Retirement	Cost of pensions for nonmanufacturing labor
Health Care	Cost of health care for nonmanufacturing labor
Selling Costs	
Transportation	Cost of transporting manufactured goods
Marketing	Manufacturer costs of advertising manufactured goods
Dealer Costs	
Dealer selling expense	Dealer selling and advertising expense
Dealer profit	Net Income to dealers from sales of new vehicles
Net income	Net income to manufacturers from production and sales of new vehicles

The indirect cost components are usually estimated using a markup factor relating total costs to direct costs. Over past rulemakings, two different methods were used to account for these costs – the Retail Price Equivalent (RPE) and the Indirect Cost Multiplier (ICM).

8.2.1 Retail Price Equivalent

Historically, the method most commonly used has been the retail price equivalent (RPE). The RPE markup factor is based on an examination of historical financial data contained in 10-K reports filed by manufacturers with the Securities and Exchange Commission (SEC). It represents the ratio between the retail price of motor vehicles and the direct costs of all activities that manufacturers engage in, including the design, development, manufacturing, assembly, and sales of new vehicles, refreshed vehicle designs, and modifications to meet safety or fuel

economy standards. Figure 8-1 indicates that for more than three decades, the retail price of motor vehicles has, on average, been roughly 50% above the direct cost expenditures of manufacturers. This ratio has been remarkably consistent, averaging roughly 1.5 with minor variations from year to year over this period. At no point has the RPE markup exceeded 1.6 or fallen below 1.4.⁵⁵² During this time frame, the average annual increase in real direct costs was 2.5%, and the average annual increase in real indirect costs was also 2.5%. Figure 8-1 illustrates the historical relationship between retail prices and direct manufacturing costs.⁵⁵³

An RPE of 1.5 does not imply that manufacturers automatically mark up each vehicle by exactly 50%. Rather, it means that, over time, consumer, market, and investor demand enabled manufacturers to set prices across their entire fleets at this level. It is the level of markup the competitive marketplace has produced, and which has enabled the industry to collect a profitable return that will attract enough investment capital to keep them operating as a viable business. Prices for any individual model may be marked up at a higher or lower rate depending on market demand. The consumer, who buys a popular vehicle, may subsidize the installation of a new technology in a less marketable vehicle. But, on average, the retail price to consumers has risen by \$1.50 for each dollar of direct costs incurred by manufacturers.

FIGURE 8-1 - HISTORICAL DATA FOR RETAIL PRICE EQUIVALENT (RPE), 1972-1997 AND 2007

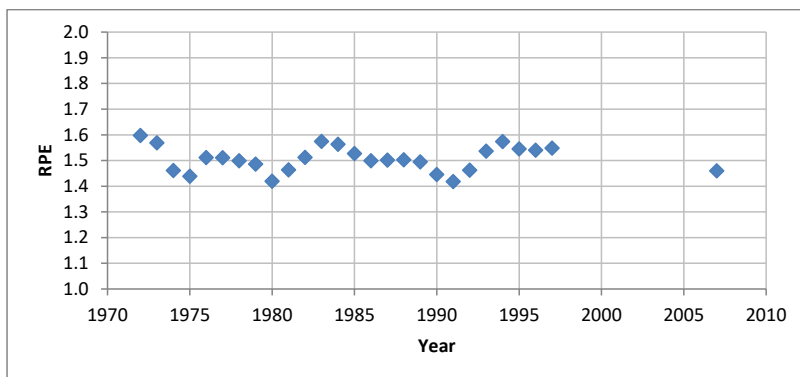

It is also important to note that direct costs associated with any specific technology will change over time as some combination of learning and resource price changes occurs. Resource costs, such as the price of steel, can fluctuate over time and can experience real long-term trends in

⁵⁵² Based on data from 1972-1997 and 2007. Data were not available for intervening years, but results for 2007 seem to indicate no significant change in the historical trend.

⁵⁵³ Rogozhin, A., Gallaher, M., & McManus, W. 2009, Automobile Industry Retail Price Equivalent and Indirect Cost Multipliers. Report by RTI International to Office of Transportation Air Quality. U.S. Environmental Protection Agency, RTI Project Number 0211577.002.004, February, Research Triangle Park, N.C.
Spinney, B.C., Faigin, B., Bowie, N., & St. Kratzke. 1999, Advanced Air Bag Systems Cost, Weight, and Lead Time analysis Summary Report, Contract NO. DTNH22-96-0-12003, Task Orders – 001, 003, and 005. Washington, D.C., U.S. Department of Transportation.

either direction, depending on supply and demand. However, the normal learning process generally reduces direct production costs as manufacturers refine production techniques and seek out less costly parts and materials for increasing production volumes. By contrast, this learning process does not generally influence indirect costs. The implied RPE for any given technology would thus be expected to grow over time as direct costs decline relative to indirect costs. The RPE for any given year is based on direct costs of technologies at different stages in their learning cycles, and which may have different implied RPEs than they did in previous years. The RPE averages 1.5 across the lifetime of technologies of all ages, with a lower average in earlier years of a technology’s life, and, because of learning effects on direct costs, a higher average in later years.

The RPE has been used in all NHTSA safety and most previous CAFE rulemakings to estimate costs. The National Academy of Sciences recommends RPEs of 1.5 for suppliers and 2.0 for in-house production be used to estimate total costs. The Alliance of Automobile Manufacturers also advocates these values as appropriate markup factors for estimating costs of technology changes. An RPE of 2.0 has also been adopted by a coalition of environmental and research groups (NESCCAF, ICCT, Southwest Research Institute, and TIAX-LLC) in a report on reducing heavy truck emissions, and 2.0 is recommended by the U.S. Department of Energy for estimating the cost of hybrid-electric and automotive fuel cell costs.

Table 8-83 below lists other estimates of the RPE. Note that all RPE estimates vary between 1.4 and 2.0, with most in the 1.4 to 1.7 range.

TABLE 8-83 - ALTERNATE ESTIMATES OF THE RPE⁵⁵⁴

Author and Year	Value, Comments
Jack Faucett Associates for EPA, 1985	1.26 initial value, later corrected to 1.7+ by Sierra research
Vyas et al, 2000	1.5 for outsourced, 2.0 for OEM, electric, and hybrid vehicles
NRC, 2002	1.4 (corrected to > by Duleep)
McKinsey and Company, 2003	1.7 based on European study

⁵⁵⁴ Duleep, K.G. “2008 Analysis of Technology Cost and Retail Price.” Presentation to Committee on Assessment of Technologies for Improving Light Duty Vehicle Fuel Economy, January 25, Detroit, MI.; Jack Faucett Associates, September 4, 1985. Update of EPA’s Motor Vehicle Emission Control Equipment Retail Price Equivalent (RPE) Calculation Formula. Chevy Chase, MD - Jack Faucett Associates; McKinsey & Company, October 2003. Preface to the Auto Sector Cases. *New Horizons - Multinational Company Investment in Developing Economies*, San Francisco, CA.; NRC (National Research Council), 2002. Effectiveness and Impact of Corporate Average Fuel Economy Standards, Washington, D.C. - The National Academies Press; NRC, 2011. Assessment of Fuel Economy Technologies for Light Duty Vehicles. Washington, D.C. - The National Academies Press; Sierra Research, Inc., November 21, 2007, Study of Industry-Average Mark-Up Factors used to Estimate Changes in Retail Price Equivalent (RPE) for Automotive Fuel Economy and Emissions Control Systems, Sacramento, CA - Sierra Research, Inc.; Vyas, A. Santini, D., & Cuenca, R. 2000. Comparison of Indirect Cost Multipliers for Vehicle Manufacturing. Center for Transportation Research, Argonne National Laboratory, April. Argonne, Ill.

CARB, 2004	1.4 (derived using the JFA initial 1.26 value, not the corrected 1.7+ value)
Sierra Research for AAA, 2007	2.0 or >, based on Chrysler data
Duleep, 2008	1.4, 1.56, 1.7 based on integration complexity
NRC, 2010	1.5 for Tier 1 supplier, 2.0 for OEM

The RPE has thus enjoyed widespread use and acceptance by a variety of governmental, academic, and industry organizations. The RPE has been the most commonly used basis for indirect cost markups in regulatory analyses. However, as noted above, the RPE is an aggregate measure across all technologies applied by manufacturers and is not technology specific. A more detailed examination of these technologies is possible through an alternative measure, the indirect cost multiplier, which was developed to focus more specifically on technologies used to meet CAFE and GHG standards.

8.2.2 Indirect Cost Multiplier

A second approach to accounting for indirect costs is the indirect cost multiplier (ICM). ICMs specifically evaluate the components of indirect costs that are likely to be affected by vehicle modifications associated with environmental regulation. EPA developed the ICM concept to enable the application of markups more specific to each technology. For example, the indirect cost implications of using tires with better rolling resistance would not be the same as those for developing an entire new hybrid vehicle technology, which would require far more R&D, capital investment, and management oversight. With more than 80 different technologies⁵⁵⁵ available to incrementally achieve fuel economy improvements, a wide range of indirect cost effects might be expected. ICMs attempt to isolate only those indirect costs that would have to change to develop a specific technology. Thus, for example, if a company were to hire additional staff to sell vehicles equipped with fuel economy improving technology, or to search the technology requirements of new GHG or CAFE standards, the cost of these staff would be included in ICMs. However, if these functions were accomplished by existing staff, they would not be included. For example, if an executive who normally devoted 10% of his time to fuel economy standards compliance were to have to devote 50% of his time in response to new more stringent requirements, his salary would not be included in ICMs because he would be paid the same salary regardless of whether he devoted his time to addressing CAFE requirements, developing new performance technologies, or improving the company's market share. ICMs thus do not account for the diverted resources required for manufacturers to meet these standards, but rather for the net change in costs manufacturers might experience because of hiring *additional* personal or acquiring *additional* assets or services.

⁵⁵⁵ There are roughly 40 different basic unique technologies, but variations among these technologies roughly double the possible number of different technology applications.

EPA developed both short-term and long-term ICMs. Long-term ICMs are lower than short-term ICMs. This decline reflects the belief of EPA staff that many indirect costs will decline over time. For example, research is initially required to develop a new technology and apply it throughout the vehicle fleet, but a lower level of research will be required to improve, maintain, or adapt that new technology to subsequent vehicle designs.

While the RPE was derived from data in financial statements, no similar data sources were available to estimate ICMs. ICMs are based on the RPE, broken into its components, as shown in Table 8-84. EPA then developed adjustment factors for those components, based on the complexity and time frame of low-, medium-, and high-complexity technologies. The adjustment factors were developed from two panels of EPA engineers with background in the automobile industry. Initially, a group of EPA engineers met and developed an estimate of ICMs for three different technologies. This “consensus” panel examined one low complexity technology, one medium complexity technology, and one high complexity technology, with the initial intent of using these technologies to represent ICM factors for all technologies falling in those categories. At a later date, a second panel was convened to examine three more technologies (one low, one medium, and one high complexity), using a modified Delphi approach to estimate indirect cost effects. The results from the second panel identified the same pattern as those of the original report - the indirect cost multipliers increase with the complexity of the technology and decrease over time. The values derived in process are higher than those in the RPE/IC Report by values ranging from 0.09 (that is, the multiplier increased from 1.20 to 1.29) to 0.19 (the multiplier increased from 1.45 to 1.64). This variation may be due to differences in the technologies used in each panel. The results are shown in Figure 8-2, together with the historical average RPE.

FIGURE 8-2 – INDIRECT COST MULTIPLIER (ICM) ESTIMATES FROM EPA CONSENSUS AND DELPHI PANELS, SHORT AND LONG

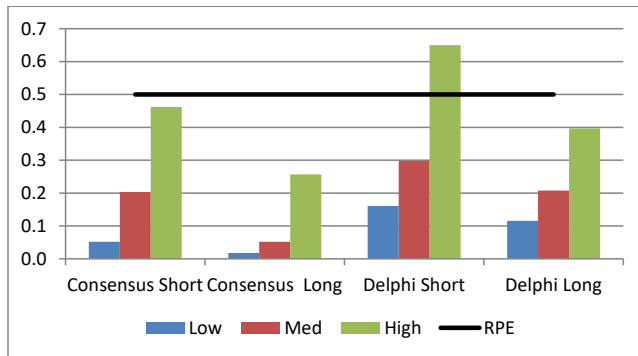

Commented [A30]: These are not multipliers; these values need to be added to 1 for them to be multipliers. As a result, this graph is inconsistent with the tables below showing the multipliers used.

In subsequent CAFE and GHG analyses for MYs 2011, as well as 2012-2016, a simple average of the two resulting ICMs in the low and medium technology complexity categories was applied to direct costs for all unexamined technologies in each specific category. For high complexity

technologies, the lower consensus-based estimate was used for high complexity technologies currently being produced, while the higher modified Delphi-based estimate was used for more advanced technologies, such as plug-in hybrid or electric vehicles, which had little or no current market penetration. ~~Note that, despite some misconceptions that continue to persist, ICMs as used in previous EPA and CAFE analyses do not include profit or “return on capital;” a fundamental difference from the RPE. However, prior to the 2012-2016 CAFE analysis, ICMs were modified to include provision for return on capital.~~

Commented [A31]: Suggested rewrite:
Note that, despite some misconceptions that continue to persist, ICMs do indeed include profit or “return on capital.”

8.2.3 Application of ICMs in the 2017-2025 Analysis

For the model year 2017-2025 rulemaking analysis, NHTSA and EPA revisited technologies evaluated by EPA staff and reconsidered their method of application. The agencies were concerned that averaging consensus and modified Delphi ICMs might not be the most accurate way to develop an estimate for the larger group of unexamined technologies. Specifically, there was concern that some technologies might not be representative of the larger groups they were chosen to represent. ~~Further, the agencies were concerned that the values developed under the consensus method were not subject to the same analytical discipline as those developed from the modified Delphi method. As a result, the agencies relied primarily on the modified Delphi-based technologies to establish their revised distributions.~~ Thus, for the MY2017-2025 analysis, the agencies used the following basis for estimating ICMs -

Commented [A32]: The decision (see Joint TSD p. 3-15) was based on the technologies used for the analyses: “EPA and NHTSA decided that the original light-duty RTI values, because of the technologies considered for low and medium complexity, should no longer be used and that we should rely solely on the modified-Delphi values for these complexity levels.”

- All low complexity technologies were estimated to equal the ICM of the modified Delphi-based low technology-passive aerodynamic improvements.
- All medium complexity technologies were estimated to equal the ICM of the modified Delphi-based medium technology-engine turbo downsizing.
- Strong hybrids and non-battery plug-in hybrid electric vehicles (PHEVs) were estimated to equal the ICM of the high complexity consensus-based high technology-hybrid electric vehicle.
- PHEVs with battery packs and full electric vehicles were estimated to equal the ICM of the high complexity modified Delphi-based high technology-plug-in hybrid electric vehicle.

In addition to shifting the proxy basis for each technology group, the agencies reexamined each technology’s complexity designation in light of the examined technologies that would serve as the basis for each group. The resulting designations together with the associated proxy technologies are shown in Table 8-84.

TABLE 8-84 - TECHNOLOGY DESIGNATIONS BY ICM CATEGORY, WITH PROXY TECHNOLOGY

Low Technology	Medium Technology	High Tech 1	High Tech 2
Passive Aerodynamic Improvements.	Engine Turbo Downsizing	Hybrid Electric Vehicle	Plug-in Hybrid Electric Vehicle

*** EO 12866 Review – Draft – Do Not Cite, Quote or Release During Review ***

Passive Aerodynamic Improv.	6-speed DCTs	Strong Hybrids	PHEV battery packs
Lubricant improvements	Mass Reduction 15-20%	PHEV and EV chargers	All Electric vehicles
Mass Reductions 3-10%	Turbocharging	PHEVs w/o batteries	
Aggressive Shift Logic	Cylinder deactivation		
Engine Friction Reduction	Dual valve timing and discreet lift		
Engine Downsizing	8-speed transmissions		
6 speed transmissions	12 volt start-stop systems		
Low Drag Brakes	Active aerodynamics		
Electro-hydraulic power steering	Diverting OHV/SOHC to DOHC		
Electronic power steering	Gasoline direct injection		
WT intake or coupled	Turbo downsizing		
Improved accessories	Turbo downsizing +EGR		
Early torque converter lockup	Diesel vehicles		
	Variable valve lift and timing		
	Lean-burn gasoline engines		

Many basic technologies noted in Table 8-84 have variations sharing the same complexity designation and ICM estimate. Table 8-85 lists each technology used in the CAFE model together with their ICM category and the year through which the short-term ICM would be applied. Note that the number behind each ICM category designation refers to the source of the ICM estimate, with 1 indicating the consensus panel and 2 indicating the modified Delphi panel.

TABLE 8-85 - ICM CATEGORIES AND SHORT TERM ICM SCHEDULES FOR CAFE TECHNOLOGIES

Technology	ICM	Short Term
	Category	Through
Low Friction Lubricants - Level 1	Low2	2018
Engine Friction Reduction - Level 1	Low2	2018
Low Friction Lubricants and Engine Friction Reduction - Level 2	Low2	2024
Variable Valve Timing (VVT) - Coupled Cam Phasing (CCP) on SOHC	Low2	2018
Discrete Variable Valve Lift (DVVL) on SOHC	Medium2	2018
Cylinder Deactivation on SOHC	Medium2	2018

*** EO 12866 Review – Draft – Do Not Cite, Quote or Release During Review ***

Variable Valve Timing (VVT) - Intake Cam Phasing (ICP)	Low2	2018
Variable Valve Timing (VVT) - Dual Cam Phasing (DCP)	Medium2	2018
Discrete Variable Valve Lift (DVVL) on DOHC	Medium2	2018
Continuously Variable Valve Lift (CVVL)	Medium2	2018
Cylinder Deactivation on DOHC	Medium2	2018
Stoichiometric Gasoline Direct Injection (GDI)	Medium2	2018
Cylinder Deactivation on OHV	Medium2	2018
Variable Valve Actuation - CCP and DVVL on OHV	Medium2	2018
Stoichiometric Gasoline Direct Injection (GDI) on OHV	Medium2	2018
Turbocharging and Downsizing - Level 1 (18 bar BMEP) - Small Displacement - Turbo	Medium2	2018
Turbocharging and Downsizing - Level 1 (18 bar BMEP) - Small Displacement - Downsize	Medium2	2018
Turbocharging and Downsizing - Level 1 (18 bar BMEP) - Medium Displacement - Turbo	Medium2	2018
Turbocharging and Downsizing - Level 1 (18 bar BMEP) - Medium Displacement - Downsize	Medium2	2018
Turbocharging and Downsizing - Level 1 (18 bar BMEP) - Large Displacement - Turbo	Medium2	2018
Turbocharging and Downsizing - Level 1 (18 bar BMEP) - Large Displacement - Downsize	Medium2	2018
Turbocharging and Downsizing - Level 2 (24 bar BMEP) - Small Displacement - Turbo	Medium2	2024
Turbocharging and Downsizing - Level 2 (24 bar BMEP) - Small Displacement - Downsize	Medium2	2018
Turbocharging and Downsizing - Level 2 (24 bar BMEP) - Medium Displacement - Turbo	Medium2	2024
Turbocharging and Downsizing - Level 2 (24 bar BMEP) - Medium Displacement - Downsize	Medium2	2018
Turbocharging and Downsizing - Level 2 (24 bar BMEP) - Large Displacement - Turbo	Medium2	2024
Turbocharging and Downsizing - Level 2 (24 bar BMEP) - Large Displacement - Downsize	Medium2	2018
Cooled Exhaust Gas Recirculation (EGR) - Level 1 (24 bar BMEP) - Small Displacement - Turbo	Medium2	2024
Cooled Exhaust Gas Recirculation (EGR) - Level 1 (24 bar BMEP) - Small Displacement - Downsize	Medium2	2018
Cooled Exhaust Gas Recirculation (EGR) - Level 1 (24 bar BMEP) - Medium Displacement - Turbo	Medium2	2024
Cooled Exhaust Gas Recirculation (EGR) - Level 1 (24 bar BMEP) - Medium Displacement - Downsize	Medium2	2018
Cooled Exhaust Gas Recirculation (EGR) - Level 1 (24 bar BMEP) - Large Displacement - Turbo	Medium2	2024
Cooled Exhaust Gas Recirculation (EGR) - Level 1 (24 bar BMEP) - Large Displacement - Downsize	Medium2	2018

*** EO 12866 Review – Draft – Do Not Cite, Quote or Release During Review ***

Cooled Exhaust Gas Recirculation (EGR) - Level 2 (27 bar BMEP) - Small Displacement - Turbo	Medium2	2024
Cooled Exhaust Gas Recirculation (EGR) - Level 2 (27 bar BMEP) - Small Displacement - Downsize	Medium2	2018
Cooled Exhaust Gas Recirculation (EGR) - Level 2 (27 bar BMEP) - Medium Displacement - Turbo	Medium2	2024
Cooled Exhaust Gas Recirculation (EGR) - Level 2 (27 bar BMEP) - Medium Displacement - Downsize	Medium2	2018
Cooled Exhaust Gas Recirculation (EGR) - Level 2 (27 bar BMEP) - Large Displacement - Turbo	Medium2	2024
Cooled Exhaust Gas Recirculation (EGR) - Level 2 (27 bar BMEP) - Large Displacement - Downsize	Medium2	2018
Advanced Diesel - Small Displacement	Medium2	2024
Advanced Diesel - Medium Displacement	Medium2	2024
Advanced Diesel - Large Displacement	Medium2	2024
6-Speed Manual/Improved Internals	Low2	2018
Improved Auto. Trans. Controls/Externals	Low2	2018
6-Speed Trans with Improved Internals (Auto)	Low2	2018
6-speed DCT	Medium2	2018
8-Speed Trans (Auto or DCT)	Medium2	2018
High Efficiency Gearbox w/ dry sump (Auto or DCT)	Low2	2024
Shift Optimizer	Low2	2024
Electric Power Steering	Low2	2018
Improved Accessories - Level 1	Low2	2018
Improved Accessories - Level 2 (w/ Alternator Regen and 70% efficient alternator)	Low2	2024
12V Micro-Hybrid (Stop-Start)	Medium2	2018
Integrated Starter Generator	High1	2018
Strong Hybrid (Powersplit or 2-Mode) - Level 1 – Battery	High1	2024
Strong Hybrid (Powersplit or 2-Mode) - Level 1 - Non-Battery	High1	2018
Conversion from SHEV1 to SHEV2	High1	2018
Strong Hybrid (P2 Parallel or 2-Mode) - Level 2 – Battery	High1	2024
Strong Hybrid (P2 Parallel or 2-Mode) - Level 2 - Non-Battery	High1	2018
Plug-in Hybrid - 20 mi range – Battery	High2	2024
Plug-in Hybrid - 20 mi range - Non-Battery	High1	2018
Plug-in Hybrid - 40 mi range – Battery	High2	2024
Plug-in Hybrid - 40 mi range - Non-Battery	High1	2018
Electric Vehicle (Early Adopter) - 75-mile range – Battery	High2	2024
Electric Vehicle (Early Adopter) - 75-mile range - Non-Battery	High2	2024
Electric Vehicle (Early Adopter) - 100-mile range – Battery	High2	2024
Electric Vehicle (Early Adopter) - 100-mile range - Non-Battery	High2	2024
Electric Vehicle (Early Adopter) - 150-mile range – Battery	High2	2024
Electric Vehicle (Early Adopter) - 150-mile range - Non-Battery	High2	2024
Electric Vehicle (Broad Market) - 150-mile range – Battery	High2	2024
Electric Vehicle (Broad Market) - 150-mile range - Non-Battery	High2	2024

*** EO 12866 Review – Draft – Do Not Cite, Quote or Release During Review ***

Fuel Cell Vehicle	High2	2024
Charger-PHEV20	High1	2024
Charger-PHEV40	High1	2024
Charger-EV	High1	2024
Charger Labor	None	2024
Mass Reduction - Level 1	Low2	2018
Mass Reduction - Level 2	Low2	2018
Mass Reduction - Level 3	Low2	2018
Mass Reduction - Level 4	Low2	2018
Mass Reduction - Level 5	Low2	2018
Low Rolling Resistance Tires - Level 1	Low2	2018
Low Rolling Resistance Tires - Level 2	Low2	2024
Low Rolling Resistance Tires - Level 3	Low2	2024
Low Drag Brakes	Low2	2018
Secondary Axle Disconnect	Low2	2018
Aero Drag Reduction, Level 1	Low2	2018
Aero Drag Reduction, Level 2	Medium2	2024

An additional adjustment was made to ICMs to account for the fact that they were derived from the RPE analysis for a specific year (2007). The agencies believed it would be more appropriate to base ICMs on the expected long-term average RPE rather than that of one specific year. To account for this, ICMs were normalized to an average RPE multiplier level of 1.5.

Table 8-86 lists values of ICMs by technology category used in the previous MY2017-2025 rulemaking. As noted previously, the Low 1 and Medium 1 categories, which were derived using the initial consensus panel, are not used. Short-term values applied to CAFE technologies thus range from 1.24 for Low complexity technologies, 1.39 for Medium complexity technologies, 1.56 for High1 complexity technologies, and 1.77 for High2 complexity technologies. When long-term ICMs are applied in the year following that noted in the far right column of

Table 8-86, these values will drop to 1.19 for Low, 1.29 for Medium, 1.35 for High1 and 1.50 for High2 complexity technologies.

TABLE 8-86 - ICMs BY TECHNOLOGY CATEGORY PREVIOUSLY USED IN 2017-2025 CAFE RULE

	ICM-Warranty		ICM-Other Indirect Costs		ICM Ratio -All Costs	
	Short Term	Long Term	Short Term	Long Term	Short Term	Long Term
ICMs2017+						
Low1	0.0384	0.0197	0.0833	0.0658	1.1217	1.0855
Low2	0.0116	0.0054	0.2303	0.1871	1.2419	1.1925
Medium1	0.0515	0.0252	0.2303	0.0910	1.2818	1.1162

Medium2	0.0446	0.0310	0.3427	0.2587	1.3872	1.2897
High1	0.0647	0.0318	0.4989	0.3136	1.5636	1.3454
High2	0.0736	0.0488	0.6964	0.4478	1.7700	1.4966

Note that ICMs for warranty costs are listed separately in Table 8-86

Table 8-86. This was done because warranty costs are treated differently than other indirect costs. In some previous analyses (prior to MY2017-2025), learning was applied directly to total costs. However, the agencies believe learning curves are more appropriately applied only to direct costs, with indirect costs established up front based on the ICM and held constant while direct costs are reduced by learning. Warranties are an exception to this because warranty costs involve future replacement of defective parts, and the cost of these parts would reflect the effect of learning. Warranty costs were thus treated as being subject to learning along with direct costs.⁵⁵⁶

The effect of learning on direct costs, together with the eventual substitution of lower long-term ICMs, causes the effective markup from ICMs to differ from the initial ICM on a yearly basis. An example of how this occurs is provided in Table 8-87.⁵⁵⁷ This table, which was originally developed for the MY2017-2025 analysis, traces the effect of learning on direct costs and its implications for both total costs and the ICM-based markup. Direct costs are assigned a value (proportion) of 1 to facilitate analysis on the same basis as ICMs (in an ICM markup factor, the proportion of direct costs is represented by 1 while the proportion of indirect costs is represented by the fraction of 1 to the right of the decimal.) Table 8-87 examines the effects of these factors on turbocharged downsized engines, one of the more prevalent CAFE technologies.

TABLE 8-87 - DERIVED ANNUAL ICMs FOR TURBOCHARGED DOWNSIZED ENGINES

Year	Learning #11	Direct Costs	Other Indirect	Warranty	Total Costs	Effective ICM-based Markup
2010	0.03					
2011	0.03					
2012	0.03	1	0.3427	0.0446	1.3872	1.387
2013	0.03	0.97	0.3427	0.0432451	1.3559	1.398
2014	0.03	0.9409	0.3427	0.0419478	1.3255	1.409
2015	0.03	0.912673	0.3427	0.0406893	1.2960	1.420
2016	0.03	0.8852928	0.3427	0.0394687	1.2674	1.432

Commented [A33]: This would benefit from a column showing indirect and total costs using the RPE method to make clear the different math involved and the differences/similarities in results.

⁵⁵⁶ Note - Warranty costs also involve labor costs for installation. This is typically done at dealerships, and it is unlikely labor costs would be subject to learning curves that affect motor vehicle parts or assembly costs. However, the portion of these costs that is due to labor versus that due to parts is unknown, so for this analysis, learning is applied to the full warranty cost.

⁵⁵⁷ Table 8-87 illustrates the learning process from the base year consistent with the direct cost estimate obtained by the agencies. It is a mature technology well into the flat portion of the learning curve. Note - costs that were actually applied in this rulemaking example begin with MY 2017.

*** EO 12866 Review – Draft – Do Not Cite, Quote or Release During Review ***

2017	0.02	0.867587	0.3427	0.0386793	1.2489	1.440
2018	0.02	0.8502352	0.3427	0.0379057	1.2308	1.448
2019	0.02	0.8332305	0.2587	0.0310	1.1229	1.348
2020	0.02	0.8165659	0.2587	0.0303882	1.1056	1.354
2021	0.02	0.8002346	0.2587	0.0297805	1.0887	1.360
2022	0.02	0.7842299	0.2587	0.0291849	1.0721	1.367
2023	0.02	0.7685453	0.2587	0.0286012	1.0558	1.374
2024	0.02	0.7531744	0.2587	0.0280291	1.0399	1.381
2025	0.02	0.7381109	0.2587	0.0274686	1.0243	1.388
2026	0.01	0.7307298	0.2587	0.0271939	1.0166	1.391
2027	0.01	0.7234225	0.2587	0.0269219	1.0090	1.395
2028	0.01	0.7161883	0.2587	0.0266527	1.0015	1.398
2029	0.01	0.7090264	0.2587	0.0263862	0.9941	1.402
2030	0.01	0.7019361	0.2587	0.0261223	0.9867	1.406
Average ICM-based markup 2017 through 2030 -						1.389

The second column of Table 8-87 lists the learning schedule applied to turbocharged downsized engines. Turbocharged downsized engines are a mature technology, so the learning schedule captures the relatively flat portion of the learning curve occurring after larger decreases have already reduced direct costs. The cost basis for turbocharged downsized engines in the analysis was effective in 2012, so this is the base year for this calculation when direct costs are set to 1. The third column shows the progressive decline in direct costs as the learning schedule in column 2 is applied to direct costs. Column 4 contains the value of all indirect costs except warranty. Turbocharged downsized engines are a medium-complexity technology, so this value is taken from the Medium2 row of

Table 8-86. The initial value in 2012 is the short-term value, which is used through 2018. During this time, these indirect costs are not affected by learning, and they remain constant. Beginning in 2019, the long-term ICM from Table 8-86 is applied. The fifth column contains warranty costs. As previously mentioned, these costs are considered to be affected by learning like direct costs, so they decline steadily until the long-term ICM is applied in 2019, at which point they drop noticeably before continuing their gradual decline. In the sixth column, direct and indirect costs are totaled. Results indicate a decline in total costs of roughly 30% during this 14-year period. The last column shows the effective ICM-based markup, which is derived by dividing total costs by direct costs. Over this period, the ICM-based markup rose from the initial short-term ICM level of 1.39 to 1.45 in 2018. It then declined to 1.35 in 2019 when the long-term ICM was applied to the 2019 direct cost. Over the remaining years, it gradually rises back up to 1.41 as learning continues to degrade direct costs.

There are thus two somewhat offsetting processes affecting total costs derived from ICMs. The first is the learning curve, which reduces direct costs, which raises the effective ICM-based markup. As noted previously, learning reflects learned efficiencies in assembly methods as well

*** EO 12866 Review – Draft – Do Not Cite, Quote or Release During Review ***

as reduced parts and materials costs. The second is the application of a long-term ICM, which reduces the effective ICM-based markup. This represents the reduced burden needed to maintain new technologies once they are fully developed. In this case, the two processes largely offset one another and produce an average real ICM over this 14-year period that roughly equals the original short-term ICM.

Figure 8-3 illustrates this process for each of the 4 technologies used to represent the universe of fuel economy and GHG improving technologies. As with the turbocharged engines, aerodynamic improvements and mild hybrid vehicles show a gradual increase in the effective ICM-based markup through the point where the long-term ICM is applied. At that time, the ICM-based markup makes an abrupt decline before beginning a gradual rise. The decline due to application of long-term ICMs is particularly pronounced in the case of the mild hybrid – even more so than for the advanced hybrid. The advanced hybrid ICM behaves somewhat differently because it is shown through its developing stages when more radical learning is applied, but only every few years. This produces a significant step-up in ICM levels concurrent with each learning application, followed by a sharp decline when the long-term ICM is applied. After that, it begins a gradual rise as more moderate learning is applied to reflect its shift to a mature technology. Note that as with the turbocharged downsized engine example above, for the aerodynamic improvements and mild hybrid technologies, the offsetting processes of learning and long-term ICMs result in an average ICM over the full time frame that is roughly equal to the initial short-term ICM. However, the advanced hybrid ICM rose to a level significantly higher than the initial ICM. This is a direct function of the rapid learning schedule applied in the early years to this developing technology. Brand new technologies might thus be expected to have effective lifetime ICM markups exceeding their initial ICMs, while more mature technologies are more likely to experience ICMs over their remaining life span that more closely approximate their initial ICMs.

FIGURE 8-3 - DERIVED ICM-BASED MARKUPS FOR ADVANCED HYBRIDS, WEAK HYBRIDS, TURBO DOWNSIZED ENGINES, AND PASSIVE AERODYNAMIC IMPROVEMENTS

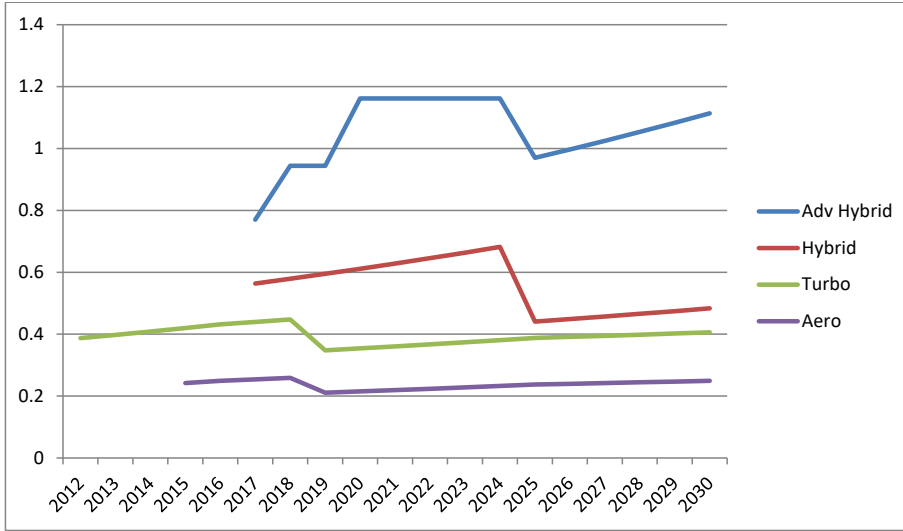

ICMs for these 4 technologies would drive the indirect cost markup rate for the analysis. However, the effect on total costs is also a function of the relative incidence of each of the 50+ technologies shown in Table 8-85, which are assumed to have ICMs similar to one of these 4 technologies. The net effect on costs of these ICMs is also influenced by the learning curve appropriate to each technology, creating numerous different and unique ICM paths. The average ICM applied by the model is also a function of each technologies direct cost and because ICMs are applied to direct costs, the measured indirect cost is proportionately higher for any given ICM when direct costs are higher. The average ICM applied to the fleet for any given model year is calculated as follows:

EQUATION 8-1 - AVERAGE ICM CALCULATION

$$\sum_{1}^{88} \frac{D_n A_n}{\sum_{1}^{88} D_n A_n} * ICM_n$$

Where -

- D = direct cost of each technology
- A = application rate for each technology
- ICM = average ICM applied to each technology
- n=1,88

The CAFE model predicts technology application rates assuming manufacturers will apply technologies to meet standards in a logical fashion based on estimated costs and benefits. The application rates will thus be different for each model year and for each alternative scenario examined. For the MY2017-2025 FRIA, to illustrate the effects of ICMs on total technology costs, NHTSA calculated the weighted average ICM across all technologies for the preferred alternative.⁵⁵⁸ This was done separately for each vehicle type and then aggregated based on predicted sales of each vehicle type used in the model. Results are shown in Table 8-88.

TABLE 8-88 - AVERAGE ICM-BASED MARKUPS APPLIED IN PREFERRED ALTERNATIVE SCENARIO MY 2017-2025 FRIA

Model Year	Passenger Cars	Light Trucks	All Vehicles
2017	0.393	0.370	0.383
2018	0.40	0.377	0.390
2019	0.315	0.308	0.312
2020	0.322	0.317	0.320
2021	0.330	0.323	0.327
2022	0.336	0.329	0.333
2023	0.344	0.337	0.341
2024	0.357	0.343	0.351
2025	0.340	0.319	0.331
All Years	0.348	0.336	0.343

The ICM-based markups in Table 8-88 were derived in a manner consistent with the way the RPE is measured, that is, they reflect combined influences of direct cost learning and changes in indirect cost requirements weighted by both the incidence of each technology’s adaptation and the relative direct cost of each technology. The results indicate generally higher ICMs for passenger cars than for light trucks. This is a function of the technologies estimated to be adopted for each respective vehicle type, especially in later years when hybrids and electric vehicles become more prevalent in the passenger car fleet. The influence of these advanced vehicles is driven primarily by their direct costs, which greatly outweigh the costs of other technologies. This results in the application of much more weight to their higher ICMs. This is most notable in MYs 2024 and 2025 for passenger cars, when electric vehicles begin to enter the fleet. The average ICM increased 0.013 in 2024 primarily because of these vehicles. It immediately dropped 0.017 in 2025 because both an additional application of steep (20%) learning is applied to the direct cost of these vehicles (which reduces their relative weight), and the long-term ICM becomes effective in that year (which decreases the absolute ICM factor).

⁵⁵⁸ For each alternative, this rulemaking examined numerous scenarios based on different assumptions, and these assumptions could influence the relative frequency of selection of different technologies, which in turn could affect the average ICM. The scenario examined here assumed a 3% discount rate, a 1-year payback period, real world application of expected civil penalties, and reflects expected voluntary over-compliance by manufacturers.

Both influences occur one year after these vehicles begin to enter the fleet because of CAFE requirements.

ICMs also change over time, again, reflecting the different mix of technologies present during earlier years but that are often replaced with more expensive technologies in later years. Across all model years, the wide-ranging application of diverse technologies required to meet CAFE and GHG standards produced an average ICM-based markup (or RPE equivalent) of approximately 1.34, applying only 67% of the indirect costs found in the RPE and implying total costs 11% below those predicted by the RPE-based calculation.

8.2.4 Uncertainty

As noted above, the RPE and ICM assign different markups over direct manufacturing costs, and thus imply different total cost estimates for CAFE and GHG technologies. While there is a level of uncertainty associated with both markups, this uncertainty stems from different issues. The RPE is derived from financial statements and thus is grounded in historical data. Although compilation of this data is subject to some level of interpretation, the two independent researchers who derived RPE estimates from these financial reports each reached essentially identical conclusions, placing the RPE at roughly 1.5. All other estimates of the RPE fall between 1.4 and 2.0, and most are between 1.4 and 1.7. There is thus a reasonable level of consistency among researchers that RPEs are 1.4 or greater. In addition, the RPE is a measure of the cumulative effects of all operations manufacturers undertake in the course of producing their vehicles, and is thus not specific to individual technologies, nor of CAFE or GHG technologies in particular. Because this provides only a single aggregate measure, using the RPE multiplier results in the application of a common incremental markup to all technologies. This assures the aggregate cost effect across all technologies is consistent with empirical data, but it does not allow for indirect cost discrimination among different technologies or over time. Because it is applied across all changes, this implies the markup for some technologies is likely to be understated, and for others it is likely to be overstated.

By contrast, the ICM process derives markups specific to several CAFE and GHG technologies, but these markups have no basis in empirical data. They are based on informed judgment of a panel of EPA engineers with auto industry experience regarding cost effects of a small sample (roughly 8%) of the 50+ technologies applied to achieve compliance with CAFE and GHG standards. Uncertainty regarding ICMs is thus based both on the accuracy of the initial assessments of the panel on the examined technologies and on the assumption that these 4 technologies are representative of the remaining technologies that were not examined. Both agencies attempted to categorize these technologies in the most representative way possible. However, while this represented the best judgment of EPA and NHTSA's engineering staffs, the actual effect on indirect costs remains uncertain for most technologies. As with RPEs, this means that even if ICMs were accurate for the specific technologies examined, indirect cost will be understated for some technologies and overstated for others.

Commented [A34]: Informed judgment is an empirical basis.

There was considerable uncertainty demonstrated in the ICM panel’s assessments, as illustrated by the range of estimates among the 14 modified Delphi panel members surrounding the central values reported by the panel. These ranges are shown in Table 8-89 and Figure 8-4, Figure 8-5, and Figure 8-6 below. For the low-complexity technology, passive aerodynamic improvements, panel responses ranged from a low of basically no indirect costs (1.001 short term and 1.0 long term), to a high of roughly a 40% markup (1.434 and 1.421). For the medium-complexity technology, turbo-charged and downsized engines, responses ranged from a low estimate implying almost no indirect cost (1.018 and 1.011), to a high estimate implying that indirect costs for this technology would roughly equal the average RPE (1.5) for all technologies (1.527 and 1.445). For the high-complexity technology, plug-in hybrid electric vehicles, responses ranged from a low estimate that these vehicles would require significantly less indirect cost than the average RPE (1.367 and 1.121) to a high estimate implying they would require more indirect costs than the average RPE (2.153 and 1.691). There was considerable diversity of opinion among the panel members.⁵⁵⁹ This is apparent in Figure 8-4, Figure 8-5, and Figure 8-6, which show the 14 panel members’ final estimates for short-term ICMs as scatter plots.

Commented [A35]: Since consensus was not a goal of the panel, and this text seeks to highlight the lack of consensus, then this text should be deleted.

TABLE 8-89 - INDIRECT COST MULTIPLIERS - MODIFIED DELPHI PANEL

	Short Run			Long Run		
	Low	Medium	High	Low	Medium	High
Average	1.16	1.29	1.64	1.12	1.2	1.39
Median	1.24	1.264	1.659	1.062	1.199	1.396
Minimum	1.001	1.018	1.367	1	1.011	1.121
Maximum	1.434	1.527	2.153	1.421	1.445	1.691
Std Deviation	0.141	0.145	0.207	0.137	0.131	0.152
t-distribution - Low	1.079	1.206	1.521	1.041	1.124	1.302
t-distribution - High	1.241	1.374	1.759	1.199	1.276	1.478

⁵⁵⁹ Sample confidence intervals, which mitigate the effect of outlying opinions, indicate a less extreme but still significant range of ICMs. Applying mean ICMs helps mitigate these potential differences, but there is clearly a significant level of uncertainty regarding indirect costs. A t-distribution is used to estimate confidence intervals because of the small sample size (14 panel members).

*** EO 12866 Review – Draft – Do Not Cite, Quote or Release During Review ***

FIGURE 8-4 - LOW COMPLEXITY ICM PANEL RESULTS

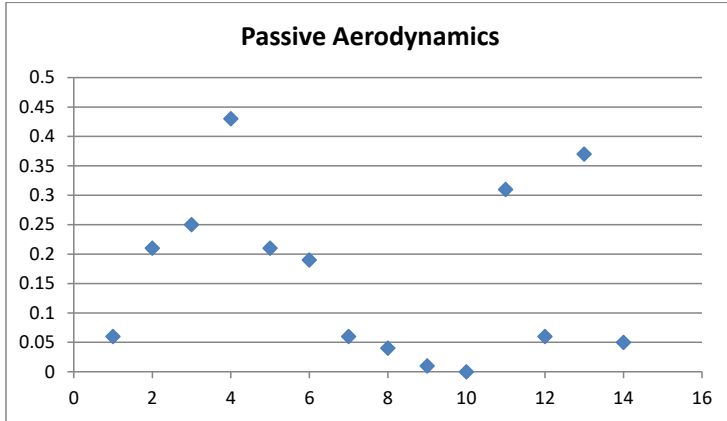

FIGURE 8-5 - MEDIUM COMPLEXITY ICM PANEL RESULTS

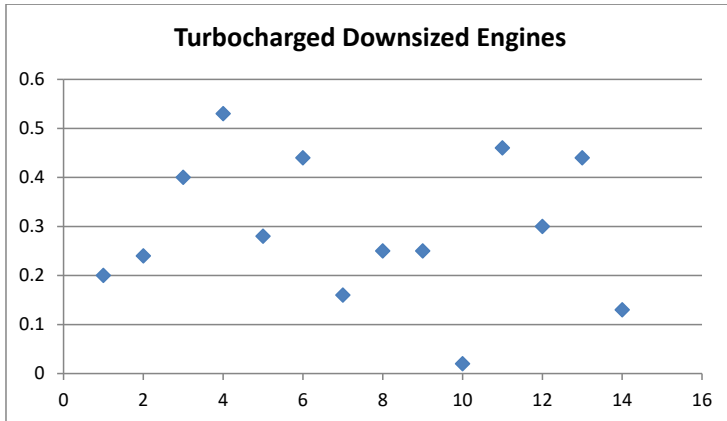
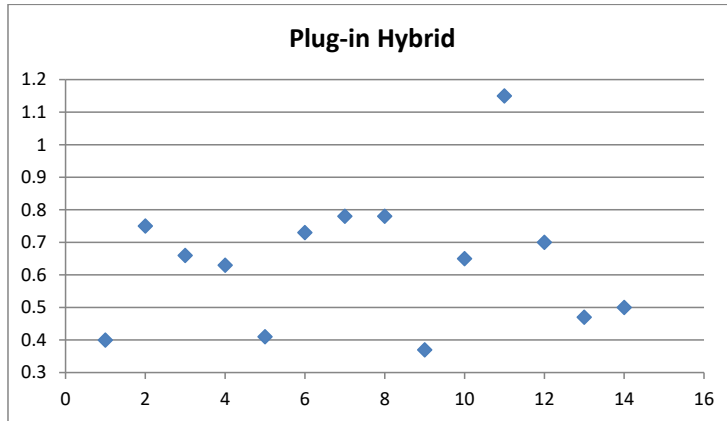

FIGURE 8-6 - HIGH COMPLEXITY ICM PANEL RESULTS



Although these results were based on modified Delphi panel techniques, it is apparent the goal of the Delphi process, an eventual consensus or convergence of opinion among panel experts, was not achieved. Given this lack of consensus and the divergence of ICM based results from the only available empirical measure (the RPE), there is considerable uncertainty that current ICM estimates provide a realistic basis of estimating indirect costs. ICMs have not been validated through a direct accounting of actual indirect costs for individual technologies, and they produce results that conflict with the only available empirical evidence of indirect cost markups. Further, they are intended to represent indirect costs specifically associated with the most comprehensive redesign effort ever undertaken by the auto industry, with virtually every make/model requiring ground-up design modifications to comply. This includes entirely new vehicle design concepts, extensive material substitution, and complete drivetrain redesigns, all of which require significant research efforts and assembly plant redesign. Under these circumstances, one might expect indirect costs to equal or possibly increase above the historical average, but not to decrease, as implied by estimated ICMs. For regulations, such as the CAFE and GHG emission standards under consideration, which drive changes to nearly every vehicle system, the overall average indirect costs should align with the RPE value. Applying RPE to the cost for each technology assures that alignment.

In the 2015 NAS study, the committee stated a conceptual agreement with the ICM method because ICM takes into account design challenges and the activities required to implement each technology. However, although endorsing ICMs as a concept, the NAS Committee stated “the empirical basis for such multipliers is still lacking, and, since their application depends on expert

Commented [A36]: Achieving consensus was not a goal of this panel. Suggest deleting this text.

Commented [A37]: RPE is based on aggregate estimates so is even further from accounting of costs for individual techs.

Commented [A38]: This ignores the advent of computing tools that so far exceed the ability of even 10 years ago that would suggest development costs are coming down. This is a very one sided argument that should, at least, point out the other possibilities. There’s no evidence being provided that supports these statements, so why limit the stated impacts to just one side?

judgment, it is not possible to determine whether the Agencies' ICMs are accurate or not.”⁵⁶⁰ NAS also stated “the specific values for the ICMs are critical because they may affect the overall estimates of costs and benefits for the overall standards and the cost effectiveness of the individual technologies.”⁵⁶¹ The committee encouraged continued research into ICMs given the lack of empirical data for them to evaluate ICMs used by the agencies in past analyses. EPA, for its part, continues to study the issue surrounding ICMs but has not pursued further efforts given resource constraints and demands in areas such as technology benchmarking and cost teardowns. On balance, ~~NHTSA considers the RPE method to be a more reliable basis for estimating indirect costs. The empirically derived RPE is currently a more reliable basis for estimating indirect costs.~~

Commented [A39]: Suggested rewrite:
On balance, NHTSA considers the RPE method to be a more reliable basis for estimating indirect costs.

8.2.5 Using RPE to Evaluate Indirect Costs in this Analysis

To ensure overall indirect costs in the analysis align with the historical RPE value, the primary analysis has been developed based on applying the RPE value of 1.5 to each technology. As noted previously, the RPE is the ratio of aggregate retail prices to aggregate direct manufacturing costs. The ratio already reflects the mixture of learned costs of technologies at various stages of maturity. Therefore, the RPE is applied directly to the learned direct cost for each technology in each year. This was previously done in the MY2017-2025 FRIA for the preferred alternative for that rulemaking, used in the above analysis of average ICMs.⁵⁶² Results are shown in Table 8-90.

Recognizing there is uncertainty in any estimate of indirect costs, a sensitivity analyses of indirect costs has also been conducted by applying a lower RPE value as a proxy for the ICM approach. This value was derived from a direct comparison of incremental technology costs determined in the MY 2017-2025 FRIA.⁵⁶² This analysis is summarized in Table 8-90 below. From this table, total costs were estimated to be roughly 18% lower using ICMs compared to the RPE. As previously mentioned, there are two different reasons for these differences. The first is the direct effect of applying a higher retail markup. The second is an indirect effect resulting from the influence these differing markups have on the order of the selection of technologies in the CAFE model, which can change as different direct cost levels interact with altered retail markups, shifting their relative overall effectiveness.

~~The relative effects of ICMs may vary somewhat by scenario, but in this case, the application of ICMs produces total technology cost estimates roughly 18% lower than those that would result from applying a single RPE factor to all technologies, or, conversely, the RPE produces estimates that averaged 21% higher than the ICM. Under the CAFE model construct, which will~~

⁵⁶⁰ National Research Council of the National Academies (2015). Cost, Effectiveness, and Deployment of Fuel Economy Technologies for Light-Duty Vehicles. https://www.nap.edu/resource/21744/deps_166210.pdf.

⁵⁶¹ Ibid.

⁵⁶² See Table 5-9a in Final Regulatory Impact Analysis, Corporate Average Fuel Economy for MY2017-MY2025 Passenger Cars and Light Trucks.

apply an alternate RPE to the same base technology profile to represent ICMs, this implies an RPE equivalent of 1.24 would produce similar net impacts [$1.5/(1+x) = 1.21$, $x=0.24$]. This value is applied for the ICM proxy estimate. The results are summarized in Table 8-91.

TABLE 8-90 - RELATIVE IMPACTS OF APPLYING ICMs VS. RPE TO DETERMINE INDIRECT COSTS

	Incremental Technology				
	Total Costs (Millions\$)			Ratios	Difference
Model Year	ICM	1.5 RPE	RPE/ICM	ICM/RPE	RPE-ICM
2017	\$3,722	\$3,749	1.01	0.99	0.01
2018	\$5,227	\$5,522	1.06	0.95	0.05
2019	\$8,256	\$9,604	1.16	0.86	0.14
2020	\$10,809	\$12,451	1.15	0.87	0.13
2021	\$14,033	\$16,214	1.16	0.87	0.13
2022	\$15,262	\$18,079	1.18	0.84	0.16
2023	\$16,883	\$20,806	1.23	0.81	0.19
2024	\$19,727	\$24,691	1.25	0.80	0.20
2025	\$20,015	\$27,244	1.36	0.73	0.27
Total	\$113,935	\$138,361	1.21	0.82	0.18

Commented [A40]: Why is this being done? Why not just use ICMs rather than this proxy and the explanation of what the proxy is?

Commented [A41]: It is not clear whether this table reflects the relative impact of ICMs vs RPE, or the impact of this “ICM proxy” vs RPE. This should be clarified.

TABLE 8-91 - SUMMARY RESULTS OF RPE APPLICATION – FORTHCOMING

[Table Forthcoming]

8.3 Learning Curves

Estimates of learning curves are applied to various technologies that are used to meet CAFE standards. Learning curves reflect the effect of experience and volume on the cost of production, which generally results in better utilization of resources, leading to higher and more efficient production. As manufacturers gain experience through production, they refine production techniques, raw material and component sources, and assembly methods to maximize efficiency and reduce production costs. Typically, learning curves reflect initial learning rates that are relatively high, followed by slower learning as easier improvements are made and production efficiency peaks. This eventually produces an asymptotic shape to the learning curve as small percent decreases are applied to gradually declining cost levels.

Many studies have examined manufacturing cost reduction of technologies over time because of the learning effect. The most well-known theory of the learning effect evolves from research

*** EO 12866 Review – Draft – Do Not Cite, Quote or Release During Review ***

conducted by T.P. Wright in the 1930s, known as Wright’s Learning Curve Model.⁵⁶³ Wright examined aircraft production and found that every doubling of cumulative production of airplanes resulted in decreasing labor hours at a fixed percentage. This fixed percentage is commonly referred to as the progress rate or progress ratio, where a lower rate implies faster learning as cumulative production increases. In developing Wright’s learning curve, the following equation represents the progress ratio, which can be rearranged to represent the natural slope of declining cost:

EQUATION 8-2 - WRIGHT’S LEARNING CURVE

$$r = 2^b \rightarrow b = \frac{\log(r)}{\log(2)}$$

Where:

r = progress ratio
 b = natural slope of the curve

In 1944, J.R. Crawford expanded upon Wright’s learning curve theory to develop a single unit cost model.⁵⁶⁴ Crawford’s model estimates the cost of the n^{th} unit produced given the following information is known - 1) cost to produce the first unit, 2) cumulative production of n units, and 3) the progress ratio.

EQUATION 8-3 - CRAWFORD’S LEARNING CURVE

$$Y_n = aX_n^b$$

Where:

Y = cost of the n^{th} unit of production
 X = cumulative number of n units produced
 a = cost of the first unit
 b = natural slope of the curve
 n = units of cumulative production

To illustrate Wright and Crawford’s theories in airplane production, a progress ratio of 80% would result in the curve’s natural slope, b , of -0.322. At a cost of \$1,000 to produce the first airplane, the estimated cost to produce the fifth airplane would be roughly \$596, as shown in the Equation 8-4.

⁵⁶³ Wright, T. P. (1936). Factors Affecting the Cost of Airplanes. *Journal of Aeronautical Sciences*, vol. 3 124-125. <http://www.uvm.edu/pdodds/research/papers/others/1936/wright1936a.pdf>.

⁵⁶⁴ Crawford, J.R. (1944). *Learning Curve, Ship Curve, Ratios, Related Data*. Burbank, California - Lockheed Aircraft Corporation.

EQUATION 8-4 - EXAMPLE OF WRIGHT AND CRAWFORD'S THEORIES

$$Y = \$1,000 * 5 \text{ units}^{-0.322} = \$595.64$$

FIGURE 8-7 - WRIGHT'S LEARNING CURVE (PROGRESS RATIO = 0.89)

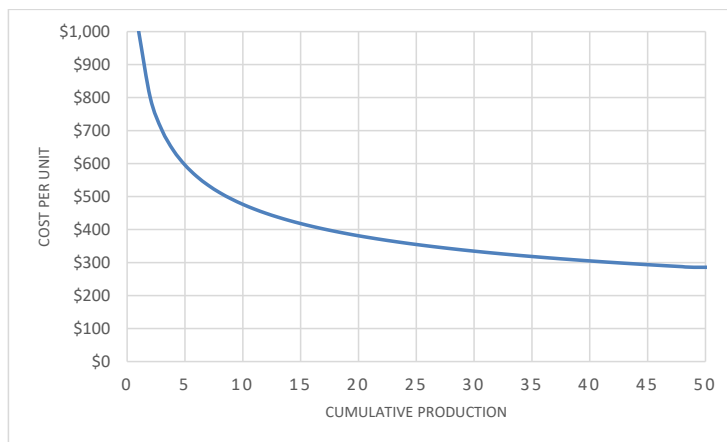

As pictured in Figure 8-7, Wright's learning curve shows the first unit is produced at a cost of \$1,000. Initially cost per unit falls rapidly for each successive unit produced. However, as production continues, cost falls more gradually at a decreasing rate. For each doubling of cumulative production at any level, cost per unit declines 20%, so that 80% of cost is retained.

8.3.1 Time vs. Volume-based Approach

In the previous joint CAFE/GHG rulemaking, the agencies had developed learning curves as a function of vehicle model year.⁵⁶⁵ Although the concept of this methodology is derived from Wright's cumulative production volume-based learning curve, its application for CAFE and GHG technologies is more of a function of time. More than a dozen learning curve schedules were developed, varying between fast and slow learning, and assigned to each technology corresponding to its level of complexity and maturity. The schedules were applied to the base year of direct manufacturing cost and incorporate a percentage of cost reduction by model year declining at a decreasing rate through the technology's production life. Some newer technologies experience 20% cost reductions for introductory model years, while mature or less complex technologies experience 0-3% cost reductions over a few years.

⁵⁶⁵ CAFE 2012 Final Rule, NHTSA DOT, 77 FR 62624.

In their 2015 report to Congress, the National Academy of Sciences (NAS) recommended the agencies should “...continue to conduct and review empirical evidence for the cost reductions that occur in the automobile industry with volume, especially for large-volume technologies that will be relied on to meet the CAFE/GHG standards.”⁵⁶⁶ In response, agency staff has incorporated statically projected cumulative volume production data of fuel economy improving technologies to help mitigate the previously used time-based method. Dynamic projections of cumulative production are not feasible with current CAFE model capabilities, so one set of projected cumulative production data for most vehicle technologies was developed for the purpose of determining cost impact. For many technologies produced and/or sold in the U.S., historical cumulative production data was obtained to establish a starting point for learning schedules. Groups of similar technologies and/or complexity may share identical learning schedules.

The slope of the learning curve, which determines the rate at which cost reductions occur, has been estimated using research from an extensive literature review and automotive cost tear-down reports. The slope of the learning curve is derived from the progress ratio of manufacturing automotive and other mobile source technologies.

8.3.2 Progress Ratio of Fuel Economy Improving Technologies

Learning curves vary among different types of manufactured products. Progress ratios can range from 70 to 100%, where 100% indicates no learning can be achieved.⁵⁶⁷ Learning effects tend to be greatest in operations where people often touch the product, while effects are less in operations consisting of more automated processes. With automotive manufacturing plant processes becoming increasingly automated, a progress ratio towards the higher end would seem more suitable. NHTSA incorporated findings from automotive cost-teardown studies with EPA’s literature review of learning-related studies to estimate a progress ratio used to determine learning schedules of fuel economy improving technologies.

EPA’s literature review examined and summarized 21 studies related to learning in manufacturing industries and mobile source manufacturing.⁵⁶⁸ The studies focus on many industries, including motor vehicles, ships, aviation, semiconductors, and environmental energy. Based on several criteria, EPA selected five studies providing quantitative analysis from the mobile source sector (the progress ratio estimates from each study is summarized in Table 8-92, below). Further, those studies expand on Wright’s Learning Curve function by using cumulative output as a predictor variable, and unit cost as the response variable. As a result, EPA

⁵⁶⁶ National Research Council of the National Academies (2015). Cost, Effectiveness, and Deployment of Fuel Economy Technologies for Light-Duty Vehicles. https://www.nap.edu/resource/21744/deps_166210.pdf.

⁵⁶⁷ Martin, J. What is a Learning Curve? *Management and Accounting Web*, University of South Florida. <https://www.maaw.info/LearningCurveSummary.htm>.

⁵⁶⁸ United States Environmental Protection Agency (2015). Cost Reduction through Learning in Manufacturing Industries and in the Manufacture of Mobile Sources. *Prepared by ICF International*. <https://19january2017snapshot.epa.gov/sites/production/files/2016-11/documents/420r16018.pdf>.

determined a best estimate of 83% as the progress ratio in mobile source industries. However, of those five studies, EPA placed less weight on the *Epple et al. (1991)* study, because of a disruption in learning due to incomplete knowledge transfer from the first shift to introduction of a second shift at a North American truck plant. While learning may have decelerated immediately after adding a second shift, unit costs continued to fall as the organization gained experience operating with both shifts. Disruptions are an essential part of the learning process and should not be discredited, and for this reason, the analysis uses a re-estimated average progress ratio of 84.8% from those five studies (equally-weighted).

TABLE 8-92 - PROGRESS RATIOS FROM EPA’S LITERATURE REVIEW

Author (Publication Date)	Industry	Progress Ratio (Cumulative Output Approach)
Argote et al. (1997) ⁵⁶⁹	Trucks	85%
Benkard (2000) ⁵⁷⁰	Aircraft (commercial)	82%
Epple et al. (1991) ⁵⁷¹	Trucks	90%
Epple et al. (1996) ⁵⁷²	Trucks	85%
Levitt et al. (2013) ⁵⁷³	Automobiles	82%

In addition to EPA’s literature review, this progress ratio estimate was informed based on NHTSA’s findings from automotive cost-teardown studies. NHTSA routinely performs evaluations of costs of previously issued Federal Motor Vehicle Safety Standards (FMVSS) for new motor vehicles and equipment. NHTSA’s contractors perform detailed engineering “tear-down” analyses for representative samples of vehicles, to estimate how much specific FMVSS add to the weight and retail price of a vehicle. As part of the effort, cost and production volume are examined for automotive safety technologies. In particular, the agency estimated costs from multiple cost tear-down studies for technologies with actual production data from the *Cost and weight added by the Federal Motor Vehicle Safety Standards for MY 1968-2012 passenger cars and LTVs* (2017).⁵⁷⁴

⁵⁶⁹ Argote, L., Epple, D., Rao, R. D., & Murphy, K. (1997). *The acquisition and depreciation of knowledge in a manufacturing organization - Turnover and plant productivity*. Working paper, Graduate School of Industrial Administration, Carnegie Mellon University.

⁵⁷⁰ Benkard, C. L. (2000). Learning and Forgetting - The Dynamics of Aircraft Production. *The American Economic Review*, 90(4), 1034–1054.

⁵⁷¹ Epple, D., Argote, L., & Devadas, R. (1991). Organizational Learning Curves - A Method for Investigating Intra-Plant Transfer of Knowledge Acquired through Learning by Doing. *Organization Science*, 2(1), 58–70.

⁵⁷² Epple, D., Argote, L., & Murphy, K. (1996). An Empirical Investigation of the Microstructure of Knowledge Acquisition and Transfer through Learning by Doing. *Operations Research*, 44(1), 77–86.

⁵⁷³ Levitt, S. D., List, J. A., & Syverson, C. (2013). Toward an Understanding of Learning by Doing - Evidence from an Automobile Assembly Plant. *Journal of Political Economy*, 121 (4), 643-681.

⁵⁷⁴ Simons, J. F. (2017, November). *Cost and weight added by the Federal Motor Vehicle Safety Standards for MY 1968-2012 Passenger Cars and LTVs* (Report No. DOT HS 812 354). Washington, D.C. - National Highway Traffic Safety Administration, 30-33.

In practice, it can be difficult to find the cost of the first unit produced; however, as production continues, cost information is more easily attainable. To estimate progress ratios for each of the safety technologies, both direct manufacturing cost and cumulative production volume are needed for at least two different points in time, specifically two different model years. With this information, Wright and Crawford’s Learning Curve function can be rearranged and used to estimate progress ratios without having the cost of the first unit of production. The function can be written in terms of the first unit of production a :

EQUATION 8-5 - LEARNING CURVE FUNCTION IN TERMS OF THE FIRST UNIT OF PRODUCTION

$$Y_n = aX_n^b \rightarrow a = \frac{Y_n}{X_n^b}$$

The rearranged Equation 8-5 can then be plugged into Wright and Crawford’s Learning Curve function and assigned as the first period of information. Note that when X_1^b equals one implying it is the first unit of production, then cost Y_1 would be equal to the cost of the first unit of production a . After X and Y for the first period are plugged in, the equation can be rearranged to solve for the learning curve slope b :

EQUATION 8-6 - SOLVE FOR SLOPE OF THE LEARNING CURVE

$$Y_2 = \left(\frac{Y_1}{X_1^b}\right) X_2^b \rightarrow b = \frac{\log\left(\frac{Y_2}{Y_1}\right)}{\log\left(\frac{X_2}{X_1}\right)}$$

Given that b is also equal to $\frac{\log(r)}{\log(2)}$, as mentioned earlier, the progress ratio r can be solved:

EQUATION 8-7 – SOLVE FOR PROGRESS RATIO

$$\frac{\log(r)}{\log(2)} = \frac{\log\left(\frac{Y_2}{Y_1}\right)}{\log\left(\frac{X_2}{X_1}\right)} \rightarrow r = 10^{\left[\frac{\log\left(\frac{Y_2}{Y_1}\right)}{\log\left(\frac{X_2}{X_1}\right)} \times \log(2)\right]}$$

By using Equation 8-7 in conjunction with cost and cumulative production information obtained from NHTSA’s cost and weight report, progress ratios were estimated for vehicle safety technologies to be used as a proxy for fuel economy improving technologies to determine learning effects.

NHTSA chose five vehicle safety technologies with sufficient data to estimate progress ratios of each, because these technologies are large-volume technologies and are used by almost all vehicle manufactures. Table 8-93 below includes these five technologies and yields an average progress rate of 92.4%:

TABLE 8-93 - PROGRESS RATIOS RESEARCHED BY NHTSA

Technology	Progress Ratio
Anti-lock Brake Systems	87%
Driver Airbags	93%
Manual 3-pt lap shoulder safety belts	96%
Adjustable Head Restraints	91%
Dual Master Cylinder	95%

For a final progress ratio to be used in the CAFE model, the five progress rates from EPA’s literature review and five progress rates from NHTSA’s evaluation of automotive safety technologies results were averaged. This resulted in an average progress rate of approximately 89%. Equal weight is placed on progress ratios from all 10 sources. More specifically, equal weight was placed on the *Eppe et al. (1991)* study, because disruptions are an essential part in the learning process, especially in effort to increase the rate of output.

8.3.3 Direct Manufacturing Cost and Learning Factor

Direct manufacturing costs for each fuel economy improving technology are obtained from various sources as discussed in Chapter 5 of this PRIA. For each technology, the costs are associated with a specific model year, and sometimes a specific production volume, or cumulative production volume. Some direct manufacturing costs are for future years at projected volumes; this is often true for technologies not yet in production. To establish a consistent basis for direct manufacturing costs in the rulemaking analysis, each technology cost is adjusted to MY2016 dollars. Regarding learning schedules, the base year is established as the MY in which direct manufacturing costs were assessed (with learning factor of 1.00). With the aforementioned data on cumulative production volume for each technology and the assumption of a 0.89 progress ratio for all automotive technologies, an implied cost for the very first unit produced (*a*) can be solved by rearranging Wright’s learning curve function as previously shown in Equation 8-5. For some technologies, the agencies used modestly different progress ratios to match detailed cost projections if available from another source (for instance, batteries).

Consequently, with all components of the learning function obtained (direct manufacturing cost at a point in time, cumulative production at a point in time and for future years, and progress ratio), the direct manufacturing cost reduction affected by learning for any given model year can be estimated. Further, a learning factor is calculated by assigning a factor of 1.00 to the base year for direct manufacturing cost. This factor indicates the percentage reduction for each successive model year from its base year, or percentage increase to previous model years. This “learning factor” can show when cumulative production volume has approximately doubled from the base year, which would be approximate to the progress ratio of 0.89. Another doubling of production would yield a learning factor of 0.79, then 0.7, and so on. Below is an example of an

*** EO 12866 Review – Draft – Do Not Cite, Quote or Release During Review ***

estimated learning curve for Stoichiometric Gasoline Direct Injection (SGDI) with a base year of MY 2013 for the assessed direct manufacturing cost, shown Figure 8-8.

FIGURE 8-8 - LEARNING CURVE AND PROJECTED CUMULATIVE PRODUCTION FOR STOICHIOMETRIC GASOLINE DIRECT INJECTION (SGDI)

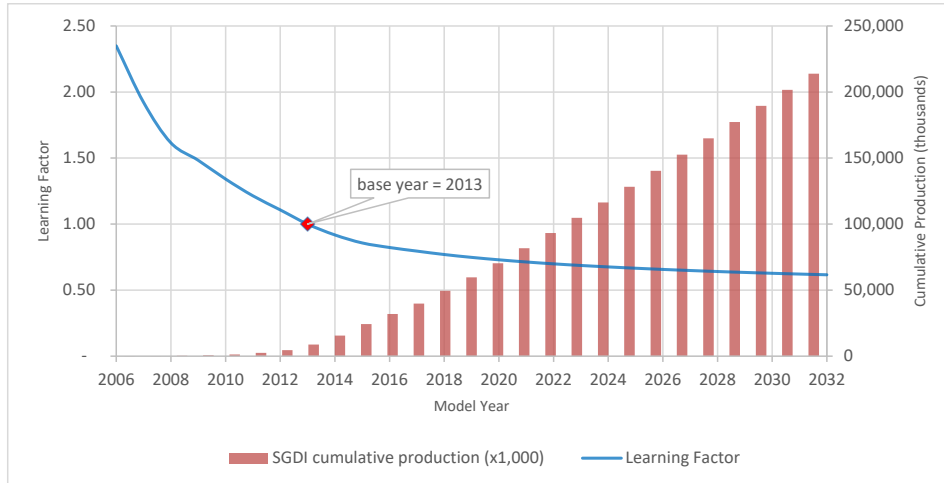

For future model years, the CAFE model projects penetration of each technology into the fleet; thus, based on the CAFE model, projections of annual production volume for each technology are available. The annual production volumes are then summed to derive the cumulative production volume as seen in the table above. Figure 8-9 shows examples of cumulative volume-based learning curves by model year for Stoichiometric Gasoline Direct Injection (SGDI), Cylinder Deactivation (DEAC), and Continuous Variable Transmission (CVT):

**FIGURE 8-9 - EXAMPLES OF LEARNING CURVES FOR SELECTED CAFE TECHNOLOGIES
(PROGRESS RATIO = 0.89)**

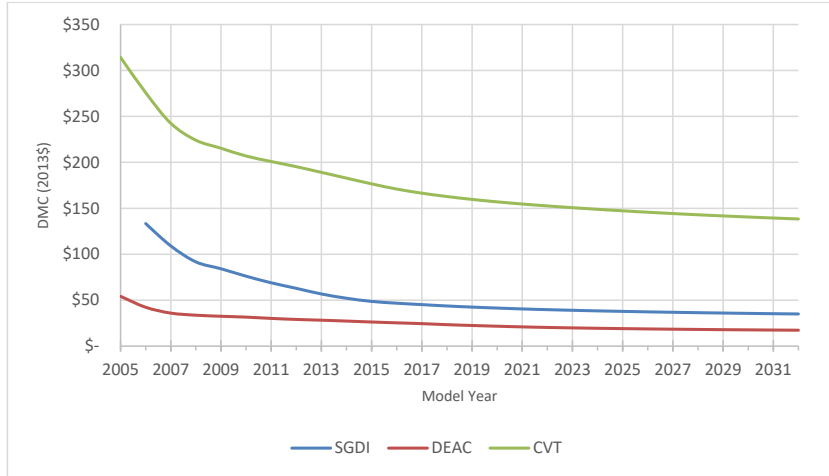

For the CAFE model, technologies are assigned a learning schedule presenting learning factors developed from methodology explained previously. Groups of similar technologies are assigned to the same learning schedule. The schedules with learning factors are listed in Table 8-94:

TABLE 8-94 - LEARNING CURVE SCHEDULES FOR CAFE TECHNOLOGIES

Technology	Model Years																
	2016	2017	2018	2019	2020	2021	2022	2023	2024	2025	2026	2027	2028	2029	2030	2031	2032
ADSL, DSLI, CONV, ROLL0, MR0, AERO0	1.00	1.00	1.00	1.00	1.00	1.00	1.00	1.00	1.00	1.00	1.00	1.00	1.00	1.00	1.00	1.00	1.00
LUBEFR1	0.80	0.76	0.74	0.72	0.71	0.69	0.68	0.67	0.66	0.65	0.64	0.64	0.63	0.62	0.62	0.61	0.61
LUBEFR2	1.00	1.00	1.00	0.86	0.78	0.72	0.67	0.64	0.62	0.60	0.58	0.57	0.56	0.55	0.54	0.53	0.53
LUBEFR3	1.00	1.00	1.00	1.00	1.00	1.00	1.00	1.00	0.85	0.77	0.72	0.68	0.66	0.64	0.62	0.61	0.59
VVT, VVL, SGDI, DEAC	0.97	0.96	0.95	0.94	0.94	0.93	0.93	0.92	0.91	0.91	0.90	0.90	0.89	0.89	0.89	0.88	0.88
HCR1	0.82	0.80	0.78	0.77	0.75	0.74	0.73	0.73	0.73	0.73	0.73	0.72	0.72	0.72	0.72	0.72	0.72
TURBO1	0.87	0.85	0.83	0.82	0.80	0.79	0.78	0.78	0.77	0.76	0.76	0.75	0.75	0.75	0.74	0.74	0.74
TURBO2, CEGR1	1.02	1.01	1.00	0.99	0.97	0.96	0.94	0.92	0.90	0.88	0.86	0.85	0.84	0.83	0.81	0.81	0.80
CNG	0.98	0.97	0.97	0.96	0.96	0.95	0.95	0.94	0.94	0.93	0.93	0.92	0.92	0.92	0.91	0.91	0.91
ADEAC	1.06	1.04	1.00	0.97	0.95	0.92	0.90	0.88	0.87	0.86	0.84	0.83	0.82	0.82	0.81	0.80	0.80
MT5	0.98	0.98	0.97	0.97	0.96	0.96	0.96	0.96	0.95	0.95	0.95	0.95	0.95	0.95	0.95	0.95	0.95
MT6	0.95	0.94	0.93	0.92	0.91	0.90	0.90	0.89	0.89	0.88	0.88	0.87	0.87	0.87	0.86	0.86	0.86

*** EO 12866 Review – Draft – Do Not Cite, Quote or Release During Review ***

MT7	1.14	1.06	1.00	0.96	0.89	0.84	0.78	0.75	0.72	0.70	0.68	0.65	0.63	0.62	0.61	0.59	0.58
AT5, AT6, AT8, DCT6, DCT8	0.99	0.99	0.99	0.99	0.99	0.99	0.99	0.99	0.99	0.99	0.99	0.98	0.98	0.98	0.98	0.98	0.98
AT6L2, AT7, AT8L2, AT8L3, AT9, AT10, AT10L2	1.00	1.00	1.00	0.89	0.84	0.80	0.78	0.76	0.74	0.73	0.72	0.71	0.70	0.70	0.69	0.69	0.68
CVT, CVTL2A, CVTL2B	0.93	0.91	0.90	0.89	0.87	0.87	0.86	0.85	0.84	0.84	0.83	0.82	0.82	0.81	0.81	0.80	0.80
EPS	0.94	0.93	0.91	0.89	0.88	0.86	0.85	0.84	0.82	0.81	0.80	0.79	0.78	0.77	0.77	0.76	0.75
IACC	1.00	0.93	0.88	0.83	0.79	0.76	0.73	0.71	0.69	0.67	0.66	0.64	0.63	0.62	0.61	0.60	0.60
SS12V	0.86	0.81	0.77	0.74	0.71	0.69	0.67	0.65	0.63	0.61	0.60	0.59	0.57	0.56	0.56	0.55	0.54
BISG	0.98	0.93	0.87	0.81	0.73	0.68	0.64	0.61	0.59	0.57	0.55	0.54	0.52	0.51	0.50	0.50	0.49
CISG, SHEVPS	0.96	0.93	0.89	0.86	0.83	0.81	0.78	0.76	0.73	0.71	0.69	0.68	0.67	0.66	0.65	0.64	0.64
SHEVP2	0.87	0.84	0.81	0.78	0.76	0.73	0.71	0.69	0.66	0.64	0.63	0.62	0.61	0.60	0.59	0.58	0.58
PHEV30	0.95	0.91	0.87	0.84	0.80	0.77	0.74	0.71	0.69	0.66	0.64	0.63	0.61	0.60	0.60	0.59	0.58
PHEV50	0.95	0.90	0.86	0.83	0.79	0.76	0.73	0.70	0.67	0.64	0.62	0.61	0.59	0.58	0.57	0.57	0.56
BEV200	0.93	0.87	0.81	0.76	0.72	0.67	0.63	0.60	0.56	0.53	0.51	0.49	0.48	0.46	0.45	0.45	0.44
FCVV	0.89	0.83	0.79	0.77	0.74	0.73	0.71	0.70	0.69	0.68	0.67	0.66	0.65	0.64	0.63	0.63	0.62
MR1	0.81	0.77	0.74	0.71	0.68	0.66	0.65	0.63	0.62	0.61	0.60	0.59	0.58	0.57	0.56	0.56	0.55
MR2	0.73	0.69	0.67	0.64	0.63	0.61	0.59	0.58	0.57	0.56	0.55	0.54	0.53	0.53	0.52	0.51	0.51
MR3	0.76	0.73	0.70	0.68	0.67	0.65	0.64	0.63	0.61	0.60	0.59	0.58	0.57	0.56	0.56	0.55	0.55
MR4	1.00	0.87	0.82	0.79	0.75	0.70	0.67	0.64	0.63	0.61	0.59	0.57	0.56	0.55	0.54	0.53	0.53
MR5	1.00	1.00	1.00	0.93	0.88	0.84	0.80	0.78	0.76	0.73	0.71	0.69	0.67	0.66	0.65	0.64	0.63
ROLL10	0.91	0.88	0.85	0.82	0.80	0.78	0.76	0.74	0.73	0.72	0.71	0.70	0.69	0.68	0.68	0.67	0.66
ROLL20	1.00	0.85	0.77	0.72	0.68	0.65	0.62	0.60	0.58	0.57	0.56	0.55	0.54	0.53	0.52	0.52	0.51
LDB	0.94	0.93	0.91	0.89	0.87	0.85	0.84	0.82	0.80	0.79	0.77	0.76	0.75	0.74	0.73	0.72	0.72
SAX	0.77	0.73	0.70	0.67	0.65	0.64	0.62	0.61	0.60	0.59	0.58	0.57	0.56	0.55	0.54	0.54	0.53
AERO5, AERO10, AERO15, AERO20	0.90	0.87	0.84	0.81	0.79	0.77	0.75	0.73	0.72	0.70	0.69	0.68	0.67	0.66	0.66	0.65	0.64
Batteries	1.19	1.14	1.09	1.05	1.00	0.96	0.91	0.87	0.83	0.79	0.76	0.72	0.69	0.66	0.63	0.60	0.58

9 Benefits

This chapter presents estimates of societal benefits, both at the aggregate and component levels. Part A provides estimates of impacts on lifetime societal benefits, incremental lifetime societal benefits, energy consumption, refueling time, petroleum market externalities, greenhouse gas emissions, and mobility. Part B provides estimates of impacts on greenhouse gas and criteria pollutant emissions, and a discussion of health effects associated with changes in emissions. Changes in emissions represent changes in benefits due to the corresponding changes in health quality.

9.1 Benefit Estimates

Monetized aggregate benefits were estimated separately for passenger cars and light trucks, as well as both combined. The negative values in these tables indicate that net reductions in fuel consumption or emissions and their resulting economic impacts (i.e., benefits) are less than the associated changes to congestion, noise or crash severity costs. Benefit levels parallel the differences in stringency among the alternatives that were examined.

Discount rates used are 3% and 7%, while undiscounted values are also presented where applicable. Lastly, results have been produced for both CAFE and CO₂ standards. The following is a brief description of the tables presenting aggregate benefits:

Table 9-1 through

Table 9-18 show lifetime societal benefits, by model year, under the preferred alternative. Lifetime societal benefits generally decrease at the model year level for passenger cars and light trucks; lifetime societal benefits are estimated to increase slightly for pre-MY 2019 passenger cars and pre-MY 2018 light trucks.

Table 9-19 through Table 9-30 show incremental lifetime societal benefits for MYs 1975-2029 for each alternative. Monetized benefits estimates are listed separately for fuel savings, reduced refueling time, petroleum market externalities, and reduction of greenhouse gases. Incremental societal benefits are estimated to be negative across all alternatives.

Table 9-31 through Table 9-42 show incremental present the estimated discounted lifetime societal benefits across the range of alternative CAFE and CO₂ standards evaluated in this analysis. The tables present results across model year; the results vary by vehicle and discount rate, with positive estimates for pre-MY 2020 vehicles in some cases, and negative estimates for all other vehicles.

Table 9-43 through Table 9-54 show per-vehicle net present value of ownership benefits, by model year, under the preferred alternative. Table 9-55 through Table 9-66 show MY 2030 per-vehicle net present value of ownership costs and benefits under each alternative. Estimates of owner benefits are listed separately as fuel savings, increased mobility, and reduced refueling time.

Table 9-67 through Table 9-72 summarize the fuel savings, in gallons, from all alternatives for passenger cars and light trucks, by model year. Similarly,

*** EO 12866 Review – Draft – Do Not Cite, Quote or Release During Review ***

Table 9-73 through Table 9-78 present the net change in electricity consumption from all alternatives for passenger cars and light trucks, by model year.

*** EO 12866 Review – Draft – Do Not Cite, Quote or Release During Review ***

**TABLE 9-1 - LIFETIME SOCIETAL BENEFITS FOR PREFERRED ALTERNATIVE BY MODEL YEAR, PASSENGER CAR
3% DISCOUNT RATE, CAFE (BILLIONS OF 2016\$)**

	1977-2016	MY 2017	MY 2018	MY 2019	MY 2020	MY 2021	MY 2022	MY 2023	MY 2024	MY 2025	MY 2026	MY 2027	MY 2028	MY 2029	TOTAL
Pre-Tax Fuel Savings	19.5	1.5	0.6	-0.1	-1.7	-4.3	-6.1	-7.4	-8.4	-9.2	-9.7	-9.8	-9.7	-9.6	-54.5
Rebound Fuel Benefit ¹	0.1	-0.1	-0.3	-0.5	-1.0	-1.8	-2.3	-2.5	-2.7	-2.8	-2.8	-2.7	-2.7	-2.7	-24.9
Refueling Time Benefit	0.1	0.1	0.0	0.0	-0.1	-0.3	-0.4	-0.4	-0.5	-0.5	-0.6	-0.6	-0.5	-0.5	-4.3
Rebound Fatality Costs, Off-setting Benefit ²	0.6	-0.1	-0.3	-0.5	-0.9	-1.6	-2.0	-2.2	-2.3	-2.3	-2.3	-2.2	-2.1	-2.1	-20.2
Rebound Non-Fatal Crash Costs, Off-setting Benefit ²	0.9	-0.1	-0.5	-0.8	-1.4	-2.5	-3.1	-3.4	-3.6	-3.6	-3.6	-3.4	-3.3	-3.2	-31.6
Petroleum Market Externality	1.6	0.1	0.0	0.0	-0.1	-0.4	-0.5	-0.6	-0.7	-0.8	-0.8	-0.8	-0.8	-0.8	-4.6
CO2 Damage Reduction Benefit	0.6	0.0	0.0	0.0	-0.1	-0.1	-0.2	-0.2	-0.3	-0.3	-0.3	-0.3	-0.3	-0.3	-1.8
NOx Damage Reduction Benefit	0.6	0.0	0.0	0.0	0.0	0.0	0.0	0.0	0.0	0.0	0.0	0.0	0.0	0.0	0.4
VOC Damage Reduction Benefit	0.2	0.0	0.0	0.0	0.0	0.0	0.0	0.0	0.0	0.0	0.0	0.0	0.0	0.0	0.1
PM Damage Reduction Benefit	1.3	0.1	0.1	0.1	0.0	0.0	-0.1	-0.1	-0.1	-0.1	-0.1	-0.2	-0.1	-0.1	0.5
SO ₂ Damage Reduction Benefit	0.4	0.0	0.0	0.0	0.0	-0.1	-0.1	-0.1	-0.1	-0.2	-0.2	-0.2	-0.2	-0.2	-0.9
Total Societal Benefits	25.9	1.6	-0.4	-1.8	-5.3	-11.1	-14.8	-17.0	-18.7	-19.8	-20.4	-20.3	-19.9	-19.7	-141.7

*** EO 12866 Review – Draft – Do Not Cite, Quote or Release During Review ***

¹ This value includes both the value of the fuel spent to drive rebound miles, and the consumer surplus representing the additional amount consumers would have, but did not spend to drive the additional miles.

² It is assumed that consumers that drive rebound miles fully internalize fatal and non-fatal crash costs. The miles are driven because they receive an equal and offsetting benefit from driving the miles. These cells report the magnitude of the offsetting benefits.

*** EO 12866 Review – Draft – Do Not Cite, Quote or Release During Review ***

**TABLE 9-2 - LIFETIME SOCIETAL BENEFITS FOR PREFERRED ALTERNATIVE BY MODEL YEAR, PASSENGER CAR
3% DISCOUNT RATE, CO₂ (BILLIONS OF 2016\$)**

	MY 1977- 2016	MY 2017	MY 2018	MY 2019	MY 2020	MY 2021	MY 2022	MY 2023	MY 2024	MY 2025	MY 2026	MY 2027	MY 2028	MY 2029	TOTAL
Pre-Tax Fuel Savings	16.2	1.5	0.6	0.2	-1.0	-2.5	-4.3	-5.9	-7.4	-9.1	-10.0	-10.6	-10.9	-11.1	-54.2
Rebound Fuel Benefit ¹	0.1	0.0	-0.3	-0.5	-0.8	-1.3	-1.8	-2.1	-2.4	-2.8	-2.9	-3.0	-3.1	-3.1	-24.1
Refueling Time Benefit	0.1	0.1	0.0	0.0	-0.1	-0.2	-0.3	-0.3	-0.4	-0.5	-0.6	-0.6	-0.6	-0.6	-4.0
Rebound Fatality Costs, Off-setting Benefit ²	0.5	-0.1	-0.3	-0.4	-0.7	-1.1	-1.6	-1.8	-2.0	-2.3	-2.4	-2.4	-2.4	-2.3	-19.3
Rebound Non-Fatal Crash Costs, Off-setting Benefit ²	0.8	-0.1	-0.5	-0.7	-1.1	-1.8	-2.4	-2.8	-3.2	-3.5	-3.7	-3.8	-3.7	-3.7	-30.1
Petroleum Market Externality	1.3	0.1	0.0	0.0	-0.1	-0.2	-0.4	-0.5	-0.6	-0.7	-0.8	-0.9	-0.9	-0.9	-4.4
CO ₂ Damage Reduction Benefit	0.5	0.1	0.0	0.0	0.0	-0.1	-0.1	-0.2	-0.2	-0.3	-0.3	-0.3	-0.4	-0.4	-1.8
NOx Damage Reduction Benefit	0.5	0.0	0.0	0.0	0.0	0.0	0.0	0.0	0.0	0.0	0.0	0.0	-0.1	-0.1	0.3
VOC Damage Reduction Benefit	0.2	0.0	0.0	0.0	0.0	0.0	0.0	0.0	0.0	0.0	0.0	0.0	0.0	0.0	0.1
PM Damage Reduction Benefit	1.1	0.1	0.1	0.1	0.0	0.0	0.0	-0.1	-0.1	-0.1	-0.1	-0.2	-0.2	-0.2	0.4
SO ₂ Damage Reduction Benefit	0.4	0.0	0.0	0.0	0.0	-0.1	-0.1	-0.1	-0.2	-0.2	-0.2	-0.2	-0.2	-0.2	-1.1
Total Societal Benefits	21.5	1.8	-0.2	-1.3	-3.8	-7.2	-11.0	-13.8	-16.5	-19.6	-21.1	-22.0	-22.4	-22.5	-138.2

*** EO 12866 Review – Draft – Do Not Cite, Quote or Release During Review ***

¹ This value includes both the value of the fuel spent to drive rebound miles, and the consumer surplus representing the additional amount consumers would have, but did not spend to drive the additional miles.

² It is assumed that consumers that drive rebound miles fully internalize fatal and non-fatal crash costs. The miles are driven because they receive an equal and offsetting benefit from driving the miles. These cells report the magnitude of the offsetting benefits.

*** EO 12866 Review – Draft – Do Not Cite, Quote or Release During Review ***

**TABLE 9-3 - LIFETIME SOCIETAL BENEFITS FOR PREFERRED ALTERNATIVE BY MODEL YEAR, PASSENGER CAR
7% DISCOUNT RATE, CAFE (BILLIONS OF 2016\$)**

	MY 1977- 2016	MY 2017	MY 2018	MY 2019	MY 2020	MY 2021	MY 2022	MY 2023	MY 2024	MY 2025	MY 2026	MY 2027	MY 2028	MY 2029	TOTAL
Pre-Tax Fuel Savings	12.1	0.6	0.0	-0.5	-1.6	-3.3	-4.4	-5.0	-5.4	-5.7	-5.8	-5.6	-5.3	-5.1	-34.9
Rebound Fuel Benefit ¹	0.0	-0.1	-0.3	-0.4	-0.7	-1.3	-1.5	-1.6	-1.7	-1.7	-1.6	-1.5	-1.4	-1.4	-15.1
Refueling Time Benefit	0.1	0.0	0.0	0.0	-0.1	-0.2	-0.3	-0.3	-0.3	-0.3	-0.3	-0.3	-0.3	-0.3	-2.7
Rebound Fatality Costs, Off-setting Benefit ²	0.4	-0.1	-0.3	-0.4	-0.7	-1.1	-1.3	-1.4	-1.4	-1.4	-1.3	-1.2	-1.2	-1.1	-12.5
Rebound Non-Fatal Crash Costs, Off-setting Benefit ²	0.6	-0.1	-0.4	-0.6	-1.0	-1.8	-2.1	-2.2	-2.2	-2.2	-2.1	-1.9	-1.8	-1.7	-19.6
Petroleum Market Externality	1.0	0.1	0.0	0.0	-0.1	-0.3	-0.4	-0.4	-0.4	-0.5	-0.5	-0.5	-0.4	-0.4	-2.9
CO2 Damage Reduction Benefit	0.4	0.0	0.0	0.0	-0.1	-0.1	-0.1	-0.2	-0.2	-0.2	-0.2	-0.2	-0.2	-0.2	-1.1
NOx Damage Reduction Benefit	0.3	0.0	0.0	0.0	0.0	0.0	0.0	0.0	0.0	0.0	0.0	0.0	0.0	0.0	0.2
VOC Damage Reduction Benefit	0.1	0.0	0.0	0.0	0.0	0.0	0.0	0.0	0.0	0.0	0.0	0.0	0.0	0.0	0.1
PM Damage Reduction Benefit	0.8	0.0	0.0	0.0	0.0	0.0	-0.1	-0.1	-0.1	-0.1	-0.1	-0.1	-0.1	-0.1	0.2
SO ₂ Damage Reduction Benefit	0.3	0.0	0.0	0.0	0.0	-0.1	-0.1	-0.1	-0.1	-0.1	-0.1	-0.1	-0.1	-0.1	-0.6
Total Societal Benefits	16.1	0.5	-0.9	-1.9	-4.3	-8.1	-10.3	-11.3	-11.9	-12.1	-12.0	-11.5	-10.9	-10.4	-89.0

*** EO 12866 Review – Draft – Do Not Cite, Quote or Release During Review ***

¹ This value includes both the value of the fuel spent to drive rebound miles, and the consumer surplus representing the additional amount consumers would have, but did not spend to drive the additional miles.

² It is assumed that consumers that drive rebound miles fully internalize fatal and non-fatal crash costs. The miles are driven because they receive an equal and offsetting benefit from driving the miles. These cells report the magnitude of the offsetting benefits.

*** EO 12866 Review – Draft – Do Not Cite, Quote or Release During Review ***

Table 9-4 - Lifetime Societal Benefits for Preferred Alternative by Model Year, Passenger Car

7% DISCOUNT RATE, CO₂ (BILLIONS OF 2016\$)

	MY 1977- 2016	MY 2017	MY 2018	MY 2019	MY 2020	MY 2021	MY 2022	MY 2023	MY 2024	MY 2025	MY 2026	MY 2027	MY 2028	MY 2029	TOTAL
Pre-Tax Fuel Savings	9.9	0.7	0.0	-0.3	-1.1	-2.1	-3.2	-4.1	-4.8	-5.6	-6.0	-6.0	-5.9	-5.9	-34.4
Rebound Fuel Benefit ¹	0.0	0.0	-0.3	-0.4	-0.6	-0.9	-1.2	-1.4	-1.5	-1.7	-1.7	-1.7	-1.6	-1.6	-14.5
Refueling Time Benefit	0.1	0.0	0.0	0.0	-0.1	-0.1	-0.2	-0.2	-0.3	-0.3	-0.3	-0.3	-0.3	-0.3	-2.5
Rebound Fatality Costs, Off-setting Benefit ²	0.3	-0.1	-0.2	-0.3	-0.5	-0.8	-1.1	-1.2	-1.3	-1.4	-1.4	-1.4	-1.3	-1.2	-11.8
Rebound Non-Fatal Crash Costs, Off-setting Benefit ²	0.5	-0.1	-0.4	-0.5	-0.8	-1.3	-1.6	-1.8	-2.0	-2.2	-2.2	-2.1	-2.0	-1.9	-18.4
Petroleum Market Externality	0.8	0.1	0.0	0.0	-0.1	-0.2	-0.3	-0.3	-0.4	-0.5	-0.5	-0.5	-0.5	-0.5	-2.8
CO ₂ Damage Reduction Benefit	0.3	0.0	0.0	0.0	0.0	-0.1	-0.1	-0.1	-0.2	-0.2	-0.2	-0.2	-0.2	-0.2	-1.1
NO _x Damage Reduction Benefit	0.3	0.0	0.0	0.0	0.0	0.0	0.0	0.0	0.0	0.0	0.0	0.0	0.0	0.0	0.2
VOC Damage Reduction Benefit	0.1	0.0	0.0	0.0	0.0	0.0	0.0	0.0	0.0	0.0	0.0	0.0	0.0	0.0	0.0
PM Damage Reduction Benefit	0.6	0.1	0.0	0.0	0.0	0.0	0.0	-0.1	-0.1	-0.1	-0.1	-0.1	-0.1	-0.1	0.1
SO ₂ Damage Reduction Benefit	0.2	0.0	0.0	0.0	0.0	-0.1	-0.1	-0.1	-0.1	-0.1	-0.1	-0.1	-0.1	-0.1	-0.7
Total Societal Benefits	13.1	0.7	-0.8	-1.5	-3.3	-5.5	-7.8	-9.3	-10.6	-12.0	-12.5	-12.5	-12.2	-11.8	-85.9

*** EO 12866 Review – Draft – Do Not Cite, Quote or Release During Review ***

¹ This value includes both the value of the fuel spent to drive rebound miles, and the consumer surplus representing the additional amount consumers would have, but did not spend to drive the additional miles.

² It is assumed that consumers that drive rebound miles fully internalize fatal and non-fatal crash costs. The miles are driven because they receive an equal and offsetting benefit from driving the miles. These cells report the magnitude of the offsetting benefits.

*** EO 12866 Review – Draft – Do Not Cite, Quote or Release During Review ***

**TABLE 9-5 - LIFETIME SOCIETAL BENEFITS FOR PREFERRED ALTERNATIVE BY MODEL YEAR, PASSENGER CAR
UNDISCOUNTED, CAFE (BILLIONS OF 2016\$)**

	MY 1977- 2016	MY 2017	MY 2018	MY 2019	MY 2020	MY 2021	MY 2022	MY 2023	MY 2024	MY 2025	MY 2026	MY 2027	MY 2028	MY 2029	TOTAL
Pre-Tax Fuel Savings	28.9	2.7	1.6	0.7	-1.5	-5.1	-7.9	-10.0	-11.9	-13.5	-14.8	-15.5	-15.7	-16.1	-78.1
Rebound Fuel Benefit ¹	0.1	-0.1	-0.4	-0.7	-1.3	-2.5	-3.2	-3.6	-4.0	-4.2	-4.4	-4.4	-4.5	-4.6	-38.0
Refueling Time Benefit	0.2	0.1	0.1	0.0	-0.1	-0.3	-0.5	-0.6	-0.7	-0.8	-0.9	-0.9	-0.9	-0.9	-6.1
Rebound Fatality Costs, Off-setting Benefit ²	0.9	-0.1	-0.4	-0.6	-1.2	-2.2	-2.8	-3.1	-3.3	-3.5	-3.5	-3.5	-3.5	-3.5	-30.4
Rebound Non-Fatal Crash Costs, Off-setting Benefit ²	1.4	-0.2	-0.6	-1.0	-1.9	-3.4	-4.3	-4.8	-5.2	-5.4	-5.5	-5.5	-5.5	-5.5	-47.5
Petroleum Market Externality	2.3	0.2	0.1	0.0	-0.1	-0.4	-0.7	-0.8	-1.0	-1.1	-1.2	-1.3	-1.3	-1.3	-6.5
CO2 Damage Reduction Benefit	0.9	0.1	0.1	0.0	0.0	-0.2	-0.3	-0.3	-0.4	-0.4	-0.5	-0.5	-0.5	-0.5	-2.5
NOx Damage Reduction Benefit	0.8	0.1	0.1	0.1	0.0	0.0	0.0	0.0	0.0	0.0	-0.1	-0.1	-0.1	-0.1	0.7
VOC Damage Reduction Benefit	0.3	0.0	0.0	0.0	0.0	0.0	0.0	0.0	0.0	0.0	0.0	0.0	0.0	0.0	0.2
PM Damage Reduction Benefit	1.9	0.2	0.1	0.1	0.1	0.0	-0.1	-0.1	-0.1	-0.2	-0.2	-0.2	-0.2	-0.2	1.1
SO ₂ Damage Reduction Benefit	0.6	0.1	0.0	0.0	0.0	-0.1	-0.1	-0.2	-0.2	-0.2	-0.2	-0.3	-0.3	-0.3	-1.2
Total Societal Benefits	38.4	3.1	0.6	-1.3	-6.1	-14.2	-19.9	-23.7	-27.0	-29.5	-31.4	-32.1	-32.5	-33.1	-208.5

*** EO 12866 Review – Draft – Do Not Cite, Quote or Release During Review ***

¹ This value includes both the value of the fuel spent to drive rebound miles, and the consumer surplus representing the additional amount consumers would have, but did not spend to drive the additional miles.

² It is assumed that consumers that drive rebound miles fully internalize fatal and non-fatal crash costs. The miles are driven because they receive an equal and offsetting benefit from driving the miles. These cells report the magnitude of the offsetting benefits.

*** EO 12866 Review – Draft – Do Not Cite, Quote or Release During Review ***

**TABLE 9-6 - LIFETIME SOCIETAL BENEFITS FOR PREFERRED ALTERNATIVE BY MODEL YEAR, PASSENGER CAR
UNDISCOUNTED, CO₂ (BILLIONS OF 2016\$)**

	MY 1977- 2016	MY 2017	MY 2018	MY 2019	MY 2020	MY 2021	MY 2022	MY 2023	MY 2024	MY 2025	MY 2026	MY 2027	MY 2028	MY 2029	TOTAL
Pre-Tax Fuel Savings	24.3	2.8	1.7	1.1	-0.5	-2.6	-5.4	-7.9	-10.3	-13.3	-15.3	-16.6	-17.6	-18.6	-78.1
Rebound Fuel Benefit ¹	0.1	0.0	-0.4	-0.6	-1.1	-1.8	-2.6	-3.1	-3.6	-4.2	-4.6	-4.9	-5.1	-5.3	-37.2
Refueling Time Benefit	0.2	0.1	0.1	0.0	0.0	-0.2	-0.3	-0.5	-0.6	-0.8	-0.9	-0.9	-1.0	-1.0	-5.7
Rebound Fatality Costs, Off-setting Benefit ²	0.7	0.0	-0.4	-0.5	-1.0	-1.5	-2.2	-2.5	-3.0	-3.4	-3.7	-3.9	-4.0	-4.0	-29.2
Rebound Non-Fatal Crash Costs, Off-setting Benefit ²	1.1	-0.1	-0.6	-0.8	-1.5	-2.4	-3.4	-3.9	-4.6	-5.4	-5.7	-6.0	-6.2	-6.2	-45.7
Petroleum Market Externality	2.0	0.2	0.1	0.1	0.0	-0.2	-0.4	-0.6	-0.8	-1.1	-1.2	-1.3	-1.4	-1.5	-6.4
CO ₂ Damage Reduction Benefit	0.8	0.1	0.1	0.0	0.0	-0.1	-0.2	-0.3	-0.3	-0.4	-0.5	-0.5	-0.6	-0.6	-2.5
NO _x Damage Reduction Benefit	0.7	0.1	0.1	0.1	0.0	0.0	0.0	0.0	0.0	0.0	-0.1	-0.1	-0.1	-0.1	0.6
VOC Damage Reduction Benefit	0.3	0.0	0.0	0.0	0.0	0.0	0.0	0.0	0.0	0.0	0.0	0.0	0.0	0.0	0.1
PM Damage Reduction Benefit	1.6	0.2	0.1	0.1	0.1	0.0	0.0	-0.1	-0.1	-0.2	-0.2	-0.2	-0.3	-0.3	0.9
SO ₂ Damage Reduction Benefit	0.5	0.1	0.0	0.0	0.0	-0.1	-0.1	-0.2	-0.2	-0.3	-0.3	-0.3	-0.3	-0.4	-1.6
Total Societal Benefits	32.4	3.4	0.9	-0.5	-4.0	-8.8	-14.5	-19.0	-23.7	-29.1	-32.5	-34.8	-36.6	-38.0	-204.8

*** EO 12866 Review – Draft – Do Not Cite, Quote or Release During Review ***

¹ This value includes both the value of the fuel spent to drive rebound miles, and the consumer surplus representing the additional amount consumers would have, but did not spend to drive the additional miles.

² It is assumed that consumers that drive rebound miles fully internalize fatal and non-fatal crash costs. The miles are driven because they receive an equal and offsetting benefit from driving the miles. These cells report the magnitude of the offsetting benefits.

*** EO 12866 Review – Draft – Do Not Cite, Quote or Release During Review ***

**TABLE 9-7 - LIFETIME SOCIETAL BENEFITS FOR PREFERRED ALTERNATIVE BY MODEL YEAR, LIGHT TRUCK
3% DISCOUNT RATE, CAFE (BILLIONS OF 2016\$)**

	1977-2016	MY 2017	MY 2018	MY 2019	MY 2020	MY 2021	MY 2022	MY 2023	MY 2024	MY 2025	MY 2026	MY 2027	MY 2028	MY 2029	TOTAL
Pre-Tax Fuel Savings	13.2	0.3	-1.8	-3.4	-4.9	-8.7	-9.1	-9.2	-9.5	-10.0	-9.9	-9.2	-8.5	-7.9	-78.6
Rebound Fuel Benefit ¹	0.0	-0.2	-0.7	-1.3	-1.7	-3.0	-3.2	-3.4	-3.5	-3.8	-3.9	-3.9	-3.9	-3.8	-36.2
Refueling Time Benefit	0.1	0.0	-0.1	-0.2	-0.2	-0.4	-0.4	-0.4	-0.5	-0.5	-0.5	-0.4	-0.4	-0.4	-4.2
Rebound Fatality Costs, Off-setting Benefit ²	0.3	-0.1	-0.5	-0.9	-1.1	-1.9	-2.0	-2.1	-2.1	-2.3	-2.3	-2.2	-2.2	-2.1	-21.5
Rebound Non-Fatal Crash Costs, Off-setting Benefit ²	0.5	-0.2	-0.8	-1.3	-1.8	-3.0	-3.1	-3.2	-3.3	-3.5	-3.6	-3.5	-3.4	-3.3	-33.7
Petroleum Market Externality	1.1	0.0	-0.2	-0.3	-0.4	-0.7	-0.7	-0.7	-0.8	-0.8	-0.8	-0.7	-0.7	-0.6	-6.4
CO2 Damage Reduction Benefit	0.4	0.0	-0.1	-0.1	-0.2	-0.3	-0.3	-0.3	-0.3	-0.3	-0.3	-0.3	-0.3	-0.3	-2.6
NOx Damage Reduction Benefit	0.6	0.0	0.0	0.0	0.0	0.0	0.0	0.0	0.0	0.0	0.0	0.0	0.0	0.0	0.4
VOC Damage Reduction Benefit	0.2	0.0	0.0	0.0	0.0	0.0	0.0	0.0	0.0	0.0	0.0	0.0	0.0	0.0	0.0
PM Damage Reduction Benefit	0.8	0.1	0.0	0.0	-0.1	-0.1	-0.1	-0.1	-0.1	-0.1	-0.1	-0.1	-0.1	-0.1	-0.2
SO ₂ Damage Reduction Benefit	0.3	0.0	-0.1	-0.1	-0.1	-0.2	-0.2	-0.2	-0.2	-0.2	-0.2	-0.2	-0.1	-0.1	-1.6
Total Societal Benefits	17.5	0.0	-4.2	-7.6	-10.5	-18.3	-19.3	-19.6	-20.4	-21.5	-21.7	-20.6	-19.6	-18.7	-184.6

¹ This value includes both the value of the fuel spent to drive rebound miles, and the consumer surplus representing the additional amount consumers would have, but did not spend to drive the additional miles.

*** EO 12866 Review – Draft – Do Not Cite, Quote or Release During Review ***

² It is assumed that consumers that drive rebound miles fully internalize fatal and non-fatal crash costs. The miles are driven because they receive an equal and offsetting benefit from driving the miles. These cells report the magnitude of the offsetting benefits.

*** EO 12866 Review – Draft – Do Not Cite, Quote or Release During Review ***

**TABLE 9-8 - LIFETIME SOCIETAL BENEFITS FOR PREFERRED ALTERNATIVE BY MODEL YEAR, LIGHT TRUCK
3% DISCOUNT RATE, CO₂ (BILLIONS OF 2016\$)**

	1977-2016	MY 2017	MY 2018	MY 2019	MY 2020	MY 2021	MY 2022	MY 2023	MY 2024	MY 2025	MY 2026	MY 2027	MY 2028	MY 2029	TOTAL
Pre-Tax Fuel Savings	12.5	1.1	-0.1	-1.8	-3.4	-6.2	-7.2	-7.1	-7.4	-7.4	-7.4	-7.3	-7.5	-7.1	-56.2
Rebound Fuel Benefit ¹	0.0	-0.1	-0.4	-0.9	-1.4	-2.4	-2.7	-2.9	-3.1	-3.2	-3.5	-3.6	-3.8	-3.9	-31.9
Refueling Time Benefit	0.1	0.0	0.0	-0.1	-0.2	-0.3	-0.3	-0.3	-0.4	-0.3	-0.3	-0.3	-0.3	-0.3	-3.2
Rebound Fatality Costs, Off-setting Benefit ²	0.3	0.0	-0.3	-0.6	-0.9	-1.5	-1.7	-1.7	-1.9	-1.9	-2.0	-2.1	-2.2	-2.2	-18.6
Rebound Non-Fatal Crash Costs, Off-setting Benefit ²	0.5	-0.1	-0.4	-0.9	-1.4	-2.3	-2.6	-2.7	-2.9	-3.0	-3.2	-3.3	-3.4	-3.4	-29.0
Petroleum Market Externality	1.0	0.1	0.0	-0.2	-0.3	-0.5	-0.6	-0.6	-0.6	-0.6	-0.6	-0.6	-0.6	-0.6	-4.6
CO2 Damage Reduction Benefit	0.4	0.0	0.0	-0.1	-0.1	-0.2	-0.2	-0.2	-0.2	-0.2	-0.2	-0.2	-0.3	-0.2	-1.8
NOx Damage Reduction Benefit	0.5	0.0	0.0	0.0	0.0	0.0	0.0	0.0	0.0	0.0	0.0	0.0	0.0	0.0	0.4
VOC Damage Reduction Benefit	0.2	0.0	0.0	0.0	0.0	0.0	0.0	0.0	0.0	0.0	0.0	0.0	0.0	0.0	0.1
PM Damage Reduction Benefit	0.8	0.1	0.0	0.0	0.0	-0.1	-0.1	-0.1	-0.1	-0.1	-0.1	-0.1	-0.1	0.0	0.3
SO ₂ Damage Reduction Benefit	0.3	0.0	0.0	-0.1	-0.1	-0.1	-0.2	-0.1	-0.1	-0.1	-0.1	-0.1	-0.1	-0.1	-1.0
Total Societal Benefits	16.5	1.2	-1.1	-4.6	-7.8	-13.6	-15.5	-15.8	-16.7	-16.9	-17.4	-17.7	-18.3	-17.9	-145.6

¹ This value includes both the value of the fuel spent to drive rebound miles, and the consumer surplus representing the additional amount consumers would have, but did not spend to drive the additional miles.

*** EO 12866 Review – Draft – Do Not Cite, Quote or Release During Review ***

² It is assumed that consumers that drive rebound miles fully internalize fatal and non-fatal crash costs. The miles are driven because they receive an equal and offsetting benefit from driving the miles. These cells report the magnitude of the offsetting benefits.

*** EO 12866 Review – Draft – Do Not Cite, Quote or Release During Review ***

**TABLE 9-9 - LIFETIME SOCIETAL BENEFITS FOR PREFERRED ALTERNATIVE BY MODEL YEAR, LIGHT TRUCK
7% DISCOUNT RATE, CAFE (BILLIONS OF 2016\$)**

	1977- 2016	MY 2017	MY 2018	MY 2019	MY 2020	MY 2021	MY 2022	MY 2023	MY 2024	MY 2025	MY 2026	MY 2027	MY 2028	MY 2029	TOTAL
Pre-Tax Fuel Savings	8.0	-0.1	-1.7	-2.8	-3.7	-6.1	-6.1	-5.9	-5.9	-5.9	-5.7	-5.1	-4.5	-4.0	-49.5
Rebound Fuel Benefit ¹	0.0	-0.1	-0.5	-0.9	-1.2	-2.1	-2.1	-2.1	-2.2	-2.2	-2.2	-2.1	-2.1	-2.0	-22.0
Refueling Time Benefit	0.0	0.0	-0.1	-0.1	-0.2	-0.3	-0.3	-0.3	-0.3	-0.3	-0.3	-0.2	-0.2	-0.2	-2.7
Rebound Fatality Costs, Off- setting Benefit ²	0.2	-0.1	-0.4	-0.6	-0.8	-1.3	-1.4	-1.3	-1.3	-1.4	-1.3	-1.3	-1.2	-1.1	-13.3
Rebound Non-Fatal Crash Costs, Off-setting Benefit ²	0.3	-0.2	-0.6	-1.0	-1.3	-2.1	-2.1	-2.1	-2.1	-2.1	-2.1	-2.0	-1.8	-1.7	-20.9
Petroleum Market Externality	0.6	0.0	-0.1	-0.2	-0.3	-0.5	-0.5	-0.5	-0.5	-0.5	-0.5	-0.4	-0.4	-0.3	-4.0
CO2 Damage Reduction Benefit	0.3	0.0	-0.1	-0.1	-0.1	-0.2	-0.2	-0.2	-0.2	-0.2	-0.2	-0.2	-0.1	-0.1	-1.6
NOx Damage Reduction Benefit	0.4	0.0	0.0	0.0	0.0	0.0	0.0	0.0	0.0	0.0	0.0	0.0	0.0	0.0	0.2
VOC Damage Reduction Benefit	0.1	0.0	0.0	0.0	0.0	0.0	0.0	0.0	0.0	0.0	0.0	0.0	0.0	0.0	0.0
PM Damage Reduction Benefit	0.5	0.0	0.0	0.0	-0.1	-0.1	-0.1	-0.1	-0.1	-0.1	-0.1	-0.1	0.0	0.0	-0.2
SO ₂ Damage Reduction Benefit	0.2	0.0	0.0	-0.1	-0.1	-0.1	-0.1	-0.1	-0.1	-0.1	-0.1	-0.1	-0.1	-0.1	-1.0
Total Societal Benefits	10.6	-0.5	-3.6	-5.9	-7.8	-12.8	-13.0	-12.7	-12.7	-12.9	-12.5	-11.4	-10.5	-9.6	-115.1

¹ This value includes both the value of the fuel spent to drive rebound miles, and the consumer surplus representing the additional amount consumers would have, but did not spend to drive the additional miles.

*** EO 12866 Review – Draft – Do Not Cite, Quote or Release During Review ***

² It is assumed that consumers that drive rebound miles fully internalize fatal and non-fatal crash costs. The miles are driven because they receive an equal and offsetting benefit from driving the miles. These cells report the magnitude of the offsetting benefits.

*** EO 12866 Review – Draft – Do Not Cite, Quote or Release During Review ***

**TABLE 9-10 - LIFETIME SOCIETAL BENEFITS FOR PREFERRED ALTERNATIVE BY MODEL YEAR, LIGHT TRUCK
7% DISCOUNT RATE, CO₂ (BILLIONS OF 2016\$)**

	1977-2016	MY 2017	MY 2018	MY 2019	MY 2020	MY 2021	MY 2022	MY 2023	MY 2024	MY 2025	MY 2026	MY 2027	MY 2028	MY 2029	TOTAL
Pre-Tax Fuel Savings	7.4	0.4	-0.4	-1.6	-2.7	-4.4	-4.9	-4.6	-4.7	-4.4	-4.3	-4.1	-4.0	-3.6	-36.0
Rebound Fuel Benefit ¹	0.0	0.0	-0.3	-0.7	-1.0	-1.7	-1.8	-1.8	-1.9	-1.9	-2.0	-2.0	-2.0	-2.0	-19.1
Refueling Time Benefit	0.0	0.0	0.0	-0.1	-0.1	-0.2	-0.2	-0.2	-0.2	-0.2	-0.2	-0.2	-0.2	-0.2	-2.0
Rebound Fatality Costs, Off-setting Benefit ²	0.2	0.0	-0.2	-0.5	-0.7	-1.0	-1.1	-1.1	-1.2	-1.1	-1.2	-1.2	-1.2	-1.1	-11.3
Rebound Non-Fatal Crash Costs, Off-setting Benefit ²	0.3	-0.1	-0.3	-0.7	-1.0	-1.6	-1.7	-1.8	-1.8	-1.8	-1.8	-1.8	-1.8	-1.8	-17.8
Petroleum Market Externality	0.6	0.0	0.0	-0.1	-0.2	-0.4	-0.4	-0.4	-0.4	-0.4	-0.4	-0.3	-0.3	-0.3	-3.0
CO ₂ Damage Reduction Benefit	0.2	0.0	0.0	-0.1	-0.1	-0.1	-0.2	-0.1	-0.2	-0.1	-0.1	-0.1	-0.1	-0.1	-1.2
NO _x Damage Reduction Benefit	0.3	0.0	0.0	0.0	0.0	0.0	0.0	0.0	0.0	0.0	0.0	0.0	0.0	0.0	0.2
VOC Damage Reduction Benefit	0.1	0.0	0.0	0.0	0.0	0.0	0.0	0.0	0.0	0.0	0.0	0.0	0.0	0.0	0.0
PM Damage Reduction Benefit	0.5	0.0	0.0	0.0	0.0	-0.1	-0.1	-0.1	-0.1	0.0	0.0	0.0	0.0	0.0	0.0
SO ₂ Damage Reduction Benefit	0.2	0.0	0.0	0.0	-0.1	-0.1	-0.1	-0.1	-0.1	-0.1	-0.1	-0.1	-0.1	-0.1	-0.7
Total Societal Benefits	9.8	0.4	-1.3	-3.8	-5.9	-9.6	10.5	10.3	10.4	10.2	10.1	-9.8	-9.8	-9.2	-90.7

¹ This value includes both the value of the fuel spent to drive rebound miles, and the consumer surplus representing the additional amount consumers would have, but did not spend to drive the additional miles.

*** EO 12866 Review – Draft – Do Not Cite, Quote or Release During Review ***

² It is assumed that consumers that drive rebound miles fully internalize fatal and non-fatal crash costs. The miles are driven because they receive an equal and offsetting benefit from driving the miles. These cells report the magnitude of the offsetting benefits.

*** EO 12866 Review – Draft – Do Not Cite, Quote or Release During Review ***

**TABLE 9-11 - LIFETIME SOCIETAL BENEFITS FOR PREFERRED ALTERNATIVE BY MODEL YEAR, LIGHT TRUCK
UNDISCOUNTED, CAFE (BILLIONS OF 2016\$)**

	1977- 2016	MY 2017	MY 2018	MY 2019	MY 2020	MY 2021	MY 2022	MY 2023	MY 2024	MY 2025	MY 2026	MY 2027	MY 2028	MY 2029	TOTAL
Pre-Tax Fuel Savings	20.2	1.1	-1.7	-3.9	-6.1	-	-	-	-	-	-	-	-	-	-116.2
Rebound Fuel Benefit ¹	0.0	-0.2	-0.9	-1.7	-2.3	-4.1	-4.6	-4.9	-5.3	-5.8	-6.2	-6.3	-6.5	-6.7	-55.7
Refueling Time Benefit	0.1	0.0	-0.1	-0.2	-0.3	-0.5	-0.6	-0.6	-0.7	-0.7	-0.7	-0.7	-0.6	-0.6	-6.2
Rebound Fatality Costs, Off- setting Benefit ²	0.5	-0.2	-0.7	-1.1	-1.5	-2.6	-2.8	-3.0	-3.2	-3.4	-3.6	-3.6	-3.7	-3.7	-32.4
Rebound Non-Fatal Crash Costs, Off-setting Benefit ²	0.8	-0.2	-1.0	-1.7	-2.4	-4.0	-4.4	-4.6	-5.0	-5.4	-5.6	-5.7	-5.7	-5.7	-50.7
Petroleum Market Externality	1.6	0.1	-0.1	-0.3	-0.5	-0.9	-1.0	-1.1	-1.2	-1.2	-1.3	-1.2	-1.2	-1.1	-9.4
CO2 Damage Reduction Benefit	0.7	0.0	-0.1	-0.1	-0.2	-0.4	-0.4	-0.4	-0.5	-0.5	-0.5	-0.5	-0.5	-0.5	-3.8
NOx Damage Reduction Benefit	0.8	0.0	0.0	0.0	0.0	0.0	0.0	0.0	0.0	0.0	0.0	0.0	0.0	0.0	0.6
VOC Damage Reduction Benefit	0.3	0.0	0.0	0.0	0.0	0.0	0.0	0.0	0.0	0.0	0.0	0.0	0.0	0.0	0.1
PM Damage Reduction Benefit	1.3	0.1	0.0	0.0	-0.1	-0.2	-0.2	-0.2	-0.2	-0.2	-0.2	-0.2	-0.1	-0.1	0.0
SO ₂ Damage Reduction Benefit	0.4	0.0	-0.1	-0.1	-0.1	-0.3	-0.3	-0.3	-0.3	-0.3	-0.3	-0.3	-0.2	-0.2	-2.2
Total Societal Benefits	26.7	0.9	-4.6	-9.2	13.5	24.8	27.0	28.3	30.4	33.0	34.2	33.5	32.9	32.3	-276.1

¹ This value includes both the value of the fuel spent to drive rebound miles, and the consumer surplus representing the additional amount consumers would have, but did not spend to drive the additional miles.

*** EO 12866 Review – Draft – Do Not Cite, Quote or Release During Review ***

² It is assumed that consumers that drive rebound miles fully internalize fatal and non-fatal crash costs. The miles are driven because they receive an equal and offsetting benefit from driving the miles. These cells report the magnitude of the offsetting benefits.

*** EO 12866 Review – Draft – Do Not Cite, Quote or Release During Review ***

**TABLE 9-12 - LIFETIME SOCIETAL BENEFITS FOR PREFERRED ALTERNATIVE BY MODEL YEAR, LIGHT TRUCK
UNDISCOUNTED, CO₂ (BILLIONS OF 2016\$)**

	1977-2016	MY 2017	MY 2018	MY 2019	MY 2020	MY 2021	MY 2022	MY 2023	MY 2024	MY 2025	MY 2026	MY 2027	MY 2028	MY 2029	TOTAL
Pre-Tax Fuel Savings	19.3	2.1	0.6	-1.7	-4.0	-8.0	-9.8	-10.0	-10.9	-11.2	-11.6	-11.8	-12.6	-12.2	-81.6
Rebound Fuel Benefit ¹	0.0	-0.1	-0.5	-1.2	-1.9	-3.3	-3.9	-4.2	-4.6	-5.0	-5.5	-6.0	-6.5	-6.8	-49.4
Refueling Time Benefit	0.1	0.1	0.0	-0.1	-0.2	-0.4	-0.5	-0.5	-0.5	-0.5	-0.5	-0.5	-0.6	-0.5	-4.6
Rebound Fatality Costs, Off-setting Benefit ²	0.5	0.0	-0.3	-0.8	-1.2	-2.0	-2.3	-2.5	-2.7	-2.9	-3.2	-3.4	-3.6	-3.7	-28.3
Rebound Non-Fatal Crash Costs, Off-setting Benefit ²	0.7	-0.1	-0.5	-1.2	-1.9	-3.1	-3.6	-3.9	-4.3	-4.5	-5.0	-5.3	-5.6	-5.8	-44.2
Petroleum Market Externality	1.6	0.2	0.0	-0.1	-0.3	-0.7	-0.8	-0.8	-0.9	-0.9	-0.9	-1.0	-1.0	-1.0	-6.7
CO ₂ Damage Reduction Benefit	0.6	0.1	0.0	-0.1	-0.1	-0.3	-0.3	-0.3	-0.4	-0.4	-0.4	-0.4	-0.4	-0.4	-2.7
NO _x Damage Reduction Benefit	0.8	0.1	0.0	0.0	0.0	0.0	0.0	0.0	0.0	0.0	0.0	0.0	0.0	0.0	0.7
VOC Damage Reduction Benefit	0.2	0.0	0.0	0.0	0.0	0.0	0.0	0.0	0.0	0.0	0.0	0.0	0.0	0.0	0.1
PM Damage Reduction Benefit	1.2	0.2	0.1	0.0	0.0	-0.1	-0.1	-0.1	-0.1	-0.1	-0.1	-0.1	-0.1	-0.1	0.7
SO ₂ Damage Reduction Benefit	0.4	0.0	0.0	-0.1	-0.1	-0.2	-0.2	-0.2	-0.2	-0.2	-0.2	-0.2	-0.2	-0.2	-1.4
Total Societal Benefits	25.5	2.5	-0.5	-5.2	-9.7	-18.1	-21.5	-22.5	-24.6	-25.7	-27.4	-28.7	-30.6	-30.8	-217.3

¹This value includes both the value of the fuel spent to drive rebound miles, and the consumer surplus representing the additional amount consumers would have, but did not spend to drive the additional miles.

*** EO 12866 Review – Draft – Do Not Cite, Quote or Release During Review ***

² It is assumed that consumers that drive rebound miles fully internalize fatal and non-fatal crash costs. The miles are driven because they receive an equal and offsetting benefit from driving the miles. These cells report the magnitude of the offsetting benefits.

*** EO 12866 Review – Draft – Do Not Cite, Quote or Release During Review ***

TABLE 9-13 - LIFETIME SOCIETAL BENEFITS FOR PREFERRED ALTERNATIVE BY MODEL YEAR, COMBINED LIGHT-DUTY, 3% DISCOUNT RATE, CAFE (BILLIONS OF 2016\$)

	1977-2016	MY 2017	MY 2018	MY 2019	MY 2020	MY 2021	MY 2022	MY 2023	MY 2024	MY 2025	MY 2026	MY 2027	MY 2028	MY 2029	TOTAL
Pre-Tax Fuel Savings	32.7	1.8	-1.2	-3.5	-6.6	-12.9	-15.3	-16.5	-17.9	-19.2	-19.7	-19.0	-18.2	-17.5	-133.1
Rebound Fuel Benefit ¹	0.1	-0.2	-1.1	-1.8	-2.7	-4.8	-5.5	-5.9	-6.2	-6.5	-6.7	-6.6	-6.6	-6.5	-61.1
Refueling Time Benefit	0.2	0.1	-0.1	-0.2	-0.4	-0.7	-0.8	-0.9	-0.9	-1.0	-1.0	-1.0	-0.9	-0.9	-8.5
Rebound Fatality Costs, Off-setting Benefit ²	0.9	-0.2	-0.8	-1.4	-2.1	-3.5	-4.0	-4.2	-4.4	-4.5	-4.6	-4.4	-4.3	-4.2	-41.7
Rebound Non-Fatal Crash Costs, Off-setting Benefit ²	1.5	-0.3	-1.3	-2.1	-3.2	-5.5	-6.2	-6.6	-6.9	-7.1	-7.1	-6.9	-6.8	-6.6	-65.3
Petroleum Market Externality	2.6	0.1	-0.1	-0.3	-0.5	-1.1	-1.2	-1.3	-1.5	-1.6	-1.6	-1.6	-1.5	-1.4	-11.0
CO2 Damage Reduction Benefit	1.1	0.1	0.0	-0.1	-0.2	-0.4	-0.5	-0.5	-0.6	-0.6	-0.6	-0.6	-0.6	-0.6	-4.3
NOx Damage Reduction Benefit	1.1	0.1	0.0	0.0	0.0	0.0	0.0	0.0	-0.1	-0.1	-0.1	-0.1	-0.1	-0.1	0.8
VOC Damage Reduction Benefit	0.4	0.0	0.0	0.0	0.0	0.0	0.0	0.0	0.0	0.0	0.0	0.0	0.0	0.0	0.1
PM Damage Reduction Benefit	2.1	0.2	0.1	0.0	0.0	-0.2	-0.2	-0.2	-0.2	-0.3	-0.3	-0.2	-0.2	-0.2	0.3
SO ₂ Damage Reduction Benefit	0.7	0.0	0.0	-0.1	-0.2	-0.3	-0.3	-0.3	-0.3	-0.3	-0.3	-0.3	-0.3	-0.3	-2.4
Total Societal Benefits	43.4	1.5	-4.6	-9.4	-15.9	-29.3	-34.1	-36.6	-39.1	-41.3	-42.1	-40.9	-39.5	-38.4	-326.2

¹ This value includes both the value of the fuel spent to drive rebound miles, and the consumer surplus representing the additional amount consumers would have, but did not spend to drive the additional miles.

*** EO 12866 Review – Draft – Do Not Cite, Quote or Release During Review ***

² It is assumed that consumers that drive rebound miles fully internalize fatal and non-fatal crash costs. The miles are driven because they receive an equal and offsetting benefit from driving the miles. These cells report the magnitude of the offsetting benefits.

*** EO 12866 Review – Draft – Do Not Cite, Quote or Release During Review ***

TABLE 9-14 - LIFETIME SOCIETAL BENEFITS FOR PREFERRED ALTERNATIVE BY MODEL YEAR, COMBINED LIGHT-DUTY, 3% DISCOUNT RATE, CO₂ (BILLIONS OF 2016\$)

	1977-2016	MY 2017	MY 2018	MY 2019	MY 2020	MY 2021	MY 2022	MY 2023	MY 2024	MY 2025	MY 2026	MY 2027	MY 2028	MY 2029	TOTAL
Pre-Tax Fuel Savings	28.7	2.6	0.5	-1.6	-4.4	-8.6	-11.5	-13.0	-14.8	-16.4	-17.4	-17.9	-18.4	-18.2	-110.4
Rebound Fuel Benefit ¹	0.1	-0.1	-0.7	-1.4	-2.2	-3.7	-4.5	-5.0	-5.5	-6.0	-6.4	-6.6	-6.9	-7.0	-56.0
Refueling Time Benefit	0.2	0.1	0.0	-0.1	-0.2	-0.4	-0.6	-0.7	-0.8	-0.9	-0.9	-0.9	-0.9	-0.9	-7.1
Rebound Fatality Costs, Off-setting Benefit ²	0.8	-0.1	-0.6	-1.0	-1.6	-2.6	-3.2	-3.5	-3.9	-4.2	-4.4	-4.5	-4.6	-4.5	-37.8
Rebound Non-Fatal Crash Costs, Off-setting Benefit ²	1.3	-0.1	-0.9	-1.6	-2.6	-4.1	-5.0	-5.5	-6.1	-6.5	-6.8	-7.0	-7.1	-7.1	-59.1
Petroleum Market Externality	2.3	0.2	0.0	-0.1	-0.4	-0.7	-0.9	-1.1	-1.2	-1.3	-1.4	-1.5	-1.5	-1.5	-9.0
CO2 Damage Reduction Benefit	0.9	0.1	0.0	0.0	-0.1	-0.3	-0.4	-0.4	-0.5	-0.5	-0.6	-0.6	-0.6	-0.6	-3.6
NOx Damage Reduction Benefit	1.0	0.1	0.1	0.0	0.0	0.0	0.0	0.0	0.0	-0.1	-0.1	-0.1	-0.1	-0.1	0.8
VOC Damage Reduction Benefit	0.3	0.0	0.0	0.0	0.0	0.0	0.0	0.0	0.0	0.0	0.0	0.0	0.0	0.0	0.1
PM Damage Reduction Benefit	1.8	0.2	0.1	0.1	0.0	-0.1	-0.1	-0.1	-0.2	-0.2	-0.2	-0.2	-0.2	-0.2	0.6
SO ₂ Damage Reduction Benefit	0.6	0.1	0.0	-0.1	-0.1	-0.2	-0.3	-0.2	-0.3	-0.3	-0.3	-0.3	-0.3	-0.3	-2.1
Total Societal Benefits	38.0	3.0	-1.4	-5.9	-11.6	-20.8	-26.6	-29.6	-33.2	-36.4	-38.6	-39.6	-40.7	-40.4	-283.7

¹ This value includes both the value of the fuel spent to drive rebound miles, and the consumer surplus representing the additional amount consumers would have, but did not spend to drive the additional miles.

*** EO 12866 Review – Draft – Do Not Cite, Quote or Release During Review ***

² It is assumed that consumers that drive rebound miles fully internalize fatal and non-fatal crash costs. The miles are driven because they receive an equal and offsetting benefit from driving the miles. These cells report the magnitude of the offsetting benefits.

TABLE 9-15 - LIFETIME SOCIETAL BENEFITS FOR PREFERRED ALTERNATIVE BY MODEL YEAR, COMBINED LIGHT-DUTY, 7% DISCOUNT RATE, CAFE (BILLIONS OF 2016\$)

	1977-2016	MY 2017	MY 2018	MY 2019	MY 2020	MY 2021	MY 2022	MY 2023	MY 2024	MY 2025	MY 2026	MY 2027	MY 2028	MY 2029	TOTAL
Pre-Tax Fuel Savings	20.1	0.5	-1.7	-3.2	-5.3	-9.3	10.5	10.9	11.3	11.6	11.5	10.7	-9.8	-9.1	-84.4
Rebound Fuel Benefit ¹	0.0	-0.2	-0.8	-1.3	-1.9	-3.3	-3.7	-3.8	-3.8	-3.9	-3.8	-3.7	-3.5	-3.4	-37.1
Refueling Time Benefit	0.1	0.0	-0.1	-0.2	-0.3	-0.5	-0.6	-0.6	-0.6	-0.6	-0.6	-0.6	-0.5	-0.5	-5.5
Rebound Fatality Costs, Off-setting Benefit ²	0.6	-0.2	-0.7	-1.0	-1.5	-2.5	-2.7	-2.8	-2.8	-2.8	-2.7	-2.5	-2.3	-2.2	-25.9
Rebound Non-Fatal Crash Costs, Off-setting Benefit ²	0.9	-0.3	-1.0	-1.6	-2.3	-3.8	-4.2	-4.3	-4.3	-4.3	-4.2	-3.9	-3.6	-3.4	-40.4
Petroleum Market Externality	1.6	0.0	-0.1	-0.3	-0.4	-0.8	-0.9	-0.9	-0.9	-1.0	-0.9	-0.9	-0.8	-0.7	-6.9
CO2 Damage Reduction Benefit	0.7	0.0	-0.1	-0.1	-0.2	-0.3	-0.3	-0.3	-0.4	-0.4	-0.4	-0.4	-0.3	-0.3	-2.7
NOx Damage Reduction Benefit	0.7	0.0	0.0	0.0	0.0	0.0	0.0	0.0	0.0	0.0	0.0	0.0	0.0	0.0	0.4
VOC Damage Reduction Benefit	0.3	0.0	0.0	0.0	0.0	0.0	0.0	0.0	0.0	0.0	0.0	0.0	0.0	0.0	0.1
PM Damage Reduction Benefit	1.3	0.1	0.0	0.0	-0.1	-0.1	-0.1	-0.1	-0.2	-0.2	-0.2	-0.1	-0.1	-0.1	0.0
SO ₂ Damage Reduction Benefit	0.5	0.0	-0.1	-0.1	-0.1	-0.2	-0.2	-0.2	-0.2	-0.2	-0.2	-0.2	-0.2	-0.2	-1.6
Total Societal Benefits	26.7	0.1	-4.5	-7.9	12.1	20.9	23.3	24.0	24.6	25.0	24.5	22.9	21.3	20.0	-204.1

¹ This value includes both the value of the fuel spent to drive rebound miles, and the consumer surplus representing the additional amount consumers would have, but did not spend to drive the additional miles.

² It is assumed that consumers that drive rebound miles fully internalize fatal and non-fatal crash costs. The miles are driven because they receive an equal and offsetting benefit from driving the miles. These cells report the magnitude of the offsetting benefits.

*** EO 12866 Review – Draft – Do Not Cite, Quote or Release During Review ***

TABLE 9-16 - LIFETIME SOCIETAL BENEFITS FOR PREFERRED ALTERNATIVE BY MODEL YEAR, COMBINED LIGHT-DUTY, 7% DISCOUNT RATE, CO₂ (BILLIONS OF 2016\$)

	MY 1977- 2016	MY 2017	MY 2018	MY 2019	MY 2020	MY 2021	MY 2022	MY 2023	MY 2024	MY 2025	MY 2026	MY 2027	MY 2028	MY 2029	TOTAL
Pre-Tax Fuel Savings	17.3	1.1	-0.4	-1.9	-3.8	-6.5	-8.1	-8.7	-9.5	10.1	10.2	10.1	10.0	-9.5	-70.3
Rebound Fuel Benefit ¹	0.0	-0.1	-0.5	-1.0	-1.6	-2.6	-3.0	-3.2	-3.4	-3.6	-3.7	-3.7	-3.7	-3.6	-33.6
Refueling Time Benefit	0.1	0.1	0.0	-0.1	-0.2	-0.3	-0.4	-0.5	-0.5	-0.5	-0.5	-0.5	-0.5	-0.5	-4.5
Rebound Fatality Costs, Off-setting Benefit ²	0.5	-0.1	-0.4	-0.8	-1.2	-1.8	-2.2	-2.3	-2.4	-2.5	-2.5	-2.5	-2.5	-2.3	-23.1
Rebound Non-Fatal Crash Costs, Off-setting Benefit ²	0.8	-0.1	-0.7	-1.2	-1.9	-2.9	-3.4	-3.6	-3.8	-3.9	-4.0	-3.9	-3.9	-3.7	-36.1
Petroleum Market Externality	1.4	0.1	0.0	-0.2	-0.3	-0.5	-0.7	-0.7	-0.8	-0.8	-0.8	-0.8	-0.8	-0.8	-5.8
CO ₂ Damage Reduction Benefit	0.6	0.0	0.0	-0.1	-0.1	-0.2	-0.3	-0.3	-0.3	-0.3	-0.3	-0.3	-0.3	-0.3	-2.3
NO _x Damage Reduction Benefit	0.6	0.0	0.0	0.0	0.0	0.0	0.0	0.0	0.0	0.0	0.0	0.0	0.0	0.0	0.4
VOC Damage Reduction Benefit	0.2	0.0	0.0	0.0	0.0	0.0	0.0	0.0	0.0	0.0	0.0	0.0	0.0	0.0	0.1
PM Damage Reduction Benefit	1.1	0.1	0.0	0.0	0.0	-0.1	-0.1	-0.1	-0.1	-0.1	-0.1	-0.1	-0.1	-0.1	0.1
SO ₂ Damage Reduction Benefit	0.4	0.0	0.0	-0.1	-0.1	-0.2	-0.2	-0.2	-0.2	-0.2	-0.2	-0.2	-0.2	-0.2	-1.4
Total Societal Benefits	22.9	1.1	-2.1	-5.3	-9.2	15.1	18.3	19.6	21.1	22.2	22.5	22.3	22.0	21.0	-176.6

¹ This value includes both the value of the fuel spent to drive rebound miles, and the consumer surplus representing the additional amount consumers would have, but did not spend to drive the additional miles.

² It is assumed that consumers that drive rebound miles fully internalize fatal and non-fatal crash costs. The miles are driven because they receive an equal and offsetting benefit from driving the miles. These cells report the magnitude of the offsetting benefits.

*** EO 12866 Review – Draft – Do Not Cite, Quote or Release During Review ***

TABLE 9-17 - LIFETIME SOCIETAL BENEFITS FOR PREFERRED ALTERNATIVE BY MODEL YEAR, COMBINED LIGHT-DUTY, UNDISCOUNTED, CAFE (BILLIONS OF 2016\$)

	MY 1977- 2016	MY 2017	MY 2018	MY 2019	MY 2020	MY 2021	MY 2022	MY 2023	MY 2024	MY 2025	MY 2026	MY 2027	MY 2028	MY 2029	TOTAL
Pre-Tax Fuel Savings	49.1	3.8	-0.1	-3.2	-7.6	16.8	20.7	23.2	26.1	28.8	30.5	30.4	30.0	29.7	-194.4
Rebound Fuel Benefit ¹	0.1	-0.3	-1.3	-2.4	-3.6	-6.6	-7.8	-8.6	-9.3	10.1	10.6	10.8	11.1	11.3	-93.7
Refueling Time Benefit	0.3	0.2	0.0	-0.2	-0.4	-0.9	-1.1	-1.2	-1.4	-1.5	-1.6	-1.6	-1.5	-1.5	-12.3
Rebound Fatality Costs, Off-setting Benefit ²	1.4	-0.3	-1.1	-1.7	-2.7	-4.8	-5.6	-6.1	-6.5	-6.9	-7.1	-7.1	-7.2	-7.2	-62.8
Rebound Non-Fatal Crash Costs, Off-setting Benefit ²	2.2	-0.4	-1.6	-2.7	-4.2	-7.4	-8.7	-9.5	10.2	10.8	11.2	11.2	11.2	11.3	-98.2
Petroleum Market Externality	4.0	0.3	0.0	-0.3	-0.6	-1.4	-1.7	-1.9	-2.1	-2.4	-2.5	-2.5	-2.5	-2.4	-16.0
CO2 Damage Reduction Benefit	1.6	0.1	0.0	-0.1	-0.2	-0.5	-0.7	-0.7	-0.8	-0.9	-1.0	-1.0	-1.0	-1.0	-6.4
NOx Damage Reduction Benefit	1.7	0.1	0.1	0.1	0.0	0.0	0.0	-0.1	-0.1	-0.1	-0.1	-0.1	-0.1	-0.1	1.3
VOC Damage Reduction Benefit	0.6	0.0	0.0	0.0	0.0	0.0	0.0	0.0	0.0	-0.1	-0.1	-0.1	-0.1	-0.1	0.2
PM Damage Reduction Benefit	3.2	0.3	0.2	0.1	0.0	-0.2	-0.2	-0.3	-0.3	-0.4	-0.4	-0.4	-0.4	-0.3	1.1
SO ₂ Damage Reduction Benefit	1.1	0.1	0.0	-0.1	-0.2	-0.4	-0.4	-0.5	-0.5	-0.5	-0.5	-0.5	-0.5	-0.5	-3.4
Total Societal Benefits	65.1	4.0	-4.0	10.5	19.6	38.9	46.9	52.0	57.4	62.4	65.6	65.6	65.4	65.4	-484.6

¹ This value includes both the value of the fuel spent to drive rebound miles, and the consumer surplus representing the additional amount consumers would have, but did not spend to drive the additional miles.

² It is assumed that consumers that drive rebound miles fully internalize fatal and non-fatal crash costs. The miles are driven because they receive an equal and offsetting benefit from driving the miles. These cells report the magnitude of the offsetting benefits.

*** EO 12866 Review – Draft – Do Not Cite, Quote or Release During Review ***

TABLE 9-18 - LIFETIME SOCIETAL BENEFITS FOR PREFERRED ALTERNATIVE BY MODEL YEAR, COMBINED LIGHT-DUTY, UNDISCOUNTED, CO₂ (BILLIONS OF 2016\$)

	MY 1977- 2016	MY 2017	MY 2018	MY 2019	MY 2020	MY 2021	MY 2022	MY 2023	MY 2024	MY 2025	MY 2026	MY 2027	MY 2028	MY 2029	TOTAL
Pre-Tax Fuel Savings	43.7	4.9	2.3	-0.6	-4.5	-10.6	-15.1	-17.9	-21.2	-24.4	-26.8	-28.4	-30.2	-30.8	-159.7
Rebound Fuel Benefit ¹	0.1	-0.1	-0.9	-1.8	-3.0	-5.1	-6.4	-7.3	-8.3	-9.2	-10.1	-10.9	-11.6	-12.1	-86.6
Refueling Time Benefit	0.3	0.2	0.1	0.0	-0.2	-0.5	-0.8	-0.9	-1.1	-1.3	-1.4	-1.5	-1.5	-1.6	-10.3
Rebound Fatality Costs, Off-setting Benefit ²	1.2	-0.1	-0.7	-1.3	-2.2	-3.6	-4.5	-5.0	-5.7	-6.3	-6.8	-7.2	-7.6	-7.7	-57.5
Rebound Non-Fatal Crash Costs, Off-setting Benefit ²	1.9	-0.1	-1.1	-2.1	-3.4	-5.6	-7.0	-7.9	-8.9	-9.9	-10.7	-11.3	-11.8	-12.0	-89.9
Petroleum Market Externality	3.5	0.4	0.2	-0.1	-0.4	-0.9	-1.2	-1.5	-1.7	-2.0	-2.2	-2.3	-2.5	-2.5	-13.1
CO ₂ Damage Reduction Benefit	1.4	0.2	0.1	0.0	-0.1	-0.3	-0.5	-0.6	-0.7	-0.8	-0.9	-0.9	-1.0	-1.0	-5.2
NO _x Damage Reduction Benefit	1.4	0.1	0.1	0.1	0.1	0.0	0.0	0.0	0.0	-0.1	-0.1	-0.1	-0.1	-0.1	1.3
VOC Damage Reduction Benefit	0.5	0.0	0.0	0.0	0.0	0.0	0.0	0.0	0.0	0.0	0.0	0.0	-0.1	-0.1	0.3
PM Damage Reduction Benefit	2.8	0.3	0.2	0.2	0.1	0.0	-0.1	-0.2	-0.2	-0.3	-0.3	-0.3	-0.3	-0.3	1.6
SO ₂ Damage Reduction Benefit	0.9	0.1	0.0	0.0	-0.1	-0.2	-0.3	-0.3	-0.4	-0.5	-0.5	-0.5	-0.6	-0.6	-3.0
Total Societal Benefits	57.9	5.9	0.4	-5.6	-13.7	-26.9	-36.0	-41.6	-48.4	-54.8	-59.8	-63.5	-67.2	-68.8	-422.1

¹ This value includes both the value of the fuel spent to drive rebound miles, and the consumer surplus representing the additional amount consumers would have, but did not spend to drive the additional miles.

² It is assumed that consumers that drive rebound miles fully internalize fatal and non-fatal crash costs. The miles are driven because they receive an equal and offsetting benefit from driving the miles. These cells report the magnitude of the offsetting benefits.

*** EO 12866 Review – Draft – Do Not Cite, Quote or Release During Review ***

TABLE 9-19 - INCREMENTAL LIFETIME SOCIETAL BENEFITS FOR MY'S 1975-2029, BY ALTERNATIVE, PASSENGER CAR, 3% DISCOUNT RATE, CAFE (BILLIONS OF 2016\$)

	Alternative							
	1	2	3	4	5	6	7	8
Model Years	2021-2026	2021-2026	2021-2026	2021-2026	2022-2026	2021-2026	2021-2026	2022-2026
Annual Rate of Stringency Increase	0.0%/Year PC 0.0%/Year LT	0.5%/Year PC 0.5%/Year LT	0.5%/Year PC 0.5%/Year LT	1.0%/Year PC 2.0%/Year LT	1.0%/Year PC 2.0%/Year LT	2.0%/Year PC 3.0%/Year LT	2.0%/Year PC 3.0%/Year LT	2.0%/Year PC 3.0%/Year LT
AC/Off-Cycle Procedures	No Change	No Change	Phaseout 2022- 2026	No Change	No Change	No Change	Phaseout 2022- 2026	No Change
Pre-Tax Fuel Savings	-54.5	-53.6	-52.5	-50.3	-37.1	-38.1	-34.6	-28.9
Rebound Fuel Benefit ¹	-24.9	-24.1	-23.0	-21.7	-16.6	-15.7	-12.1	-11.3
Refueling Time Benefit	-4.3	-4.2	-4.0	-3.8	-2.9	-2.9	-2.4	-2.1
Rebound Fatality Costs, Off-setting Benefit ²	-20.2	-19.6	-18.9	-17.9	-13.8	-13.3	-10.5	-9.7
Rebound Non-Fatal Crash Costs, Off-setting Benefit ²	-31.6	-30.7	-29.5	-28.0	-21.5	-20.7	-16.5	-15.2
Petroleum Market Externality	-4.6	-4.5	-4.4	-4.2	-3.1	-3.2	-2.9	-2.5
CO2 Damage Reduction Benefit	-1.8	-1.7	-1.7	-1.6	-1.2	-1.2	-1.1	-0.9
NOx Damage Reduction Benefit	0.4	0.4	0.3	0.3	0.2	0.2	0.0	0.1
VOC Damage Reduction Benefit	0.1	0.1	0.1	0.1	0.1	0.0	0.0	0.0
PM Damage Reduction Benefit	0.5	0.5	0.4	0.3	0.3	0.1	-0.1	0.0
SO2 Damage Reduction Benefit	-0.9	-0.9	-0.9	-0.8	-0.5	-0.6	-0.5	-0.4
Total Societal Benefits	-141.7	-138.4	-134.1	-127.8	-96.1	-95.3	-80.7	-70.9

¹ This value includes both the value of the fuel spent to drive rebound miles, and the consumer surplus representing the additional amount consumers would have, but did not spend to drive the additional miles.

² It is assumed that consumers that drive rebound miles fully internalize fatal and non-fatal crash costs. The miles are driven because they receive an equal and offsetting benefit from driving the miles. These cells report the magnitude of the offsetting benefits.

*** EO 12866 Review – Draft – Do Not Cite, Quote or Release During Review ***

TABLE 9-20 - INCREMENTAL LIFETIME SOCIETAL BENEFITS FOR MY'S 1975-2029, BY ALTERNATIVE, PASSENGER CAR, 3% DISCOUNT RATE, CO₂ (BILLIONS OF 2016\$)

	Alternative							
	1	2	3	4	5	6	7	8
Model Years	2021-2026	2021-2026	2021-2026	2021-2026	2022-2026	2021-2026	2021-2026	2022-2026
Annual Rate of Stringency Increase	0.0%/Year PC 0.0%/Year LT	0.5%/Year PC 0.5%/Year LT	0.5%/Year PC 0.5%/Year LT	1.0%/Year PC 2.0%/Year LT	1.0%/Year PC 2.0%/Year LT	2.0%/Year PC 3.0%/Year LT	2.0%/Year PC 3.0%/Year LT	2.0%/Year PC 3.0%/Year LT
AC/Off-Cycle Procedures	No Change	No Change	Phaseout 2022- 2026	No Change	No Change	No Change	Phaseout 2022- 2026	No Change
Pre-Tax Fuel Savings	-54.2	-51.7	-46.2	-43.0	-25.1	-25.9	-20.1	-17.7
Rebound Fuel Benefit ¹	-24.1	-22.9	-20.4	-18.5	-12.0	-11.2	-7.0	-7.3
Refueling Time Benefit	-4.0	-3.8	-3.4	-3.1	-1.9	-1.9	-1.4	-1.2
Rebound Fatality Costs, Off-setting Benefit ²	-19.3	-18.4	-16.4	-15.0	-9.9	-9.2	-6.0	-6.1
Rebound Non-Fatal Crash Costs, Off-setting Benefit ²	-30.1	-28.7	-25.7	-23.5	-15.4	-14.3	-9.3	-9.5
Petroleum Market Externality	-4.4	-4.2	-3.8	-3.5	-2.0	-2.1	-1.6	-1.4
CO ₂ Damage Reduction Benefit	-1.8	-1.7	-1.5	-1.4	-0.8	-0.8	-0.7	-0.6
NO _x Damage Reduction Benefit	0.3	0.3	0.3	0.2	0.2	0.1	0.0	0.1
VOC Damage Reduction Benefit	0.1	0.1	0.1	0.1	0.0	0.0	0.0	0.0
PM Damage Reduction Benefit	0.4	0.4	0.4	0.2	0.3	0.2	-0.1	0.0
SO ₂ Damage Reduction Benefit	-1.1	-1.1	-1.0	-0.9	-0.5	-0.5	-0.4	-0.3
Total Societal Benefits	-138.2	-131.7	-117.6	-108.4	-67.2	-65.7	-46.5	-44.1

¹ This value includes both the value of the fuel spent to drive rebound miles, and the consumer surplus representing the additional amount consumers would have, but did not spend to drive the additional miles.

² It is assumed that consumers that drive rebound miles fully internalize fatal and non-fatal crash costs. The miles are driven because they receive an equal and offsetting benefit from driving the miles. These cells report the magnitude of the offsetting benefits.

*** EO 12866 Review – Draft – Do Not Cite, Quote or Release During Review ***

TABLE 9-21 - INCREMENTAL LIFETIME SOCIETAL BENEFITS FOR MY'S 1975-2029, BY ALTERNATIVE, PASSENGER CAR, 7% DISCOUNT RATE, CAFE (BILLIONS OF 2016\$)

	Alternative							
	1	2	3	4	5	6	7	8
Model Years	2021-2026	2021-2026	2021-2026	2021-2026	2022-2026	2021-2026	2021-2026	2022-2026
Annual Rate of Stringency Increase	0.0%/Year PC 0.0%/Year LT	0.5%/Year PC 0.5%/Year LT	0.5%/Year PC 0.5%/Year LT	1.0%/Year PC 2.0%/Year LT	1.0%/Year PC 2.0%/Year LT	2.0%/Year PC 3.0%/Year LT	2.0%/Year PC 3.0%/Year LT	2.0%/Year PC 3.0%/Year LT
AC/Off-Cycle Procedures	No Change	No Change	Phaseout 2022-2026	No Change	No Change	No Change	Phaseout 2022-2026	No Change
Pre-Tax Fuel Savings	-34.9	-34.2	-33.5	-31.9	-23.2	-24.3	-21.8	-18.0
Rebound Fuel Benefit ¹	-15.1	-14.7	-14.0	-13.3	-10.0	-9.7	-7.6	-6.9
Refueling Time Benefit	-2.7	-2.7	-2.6	-2.4	-1.8	-1.8	-1.6	-1.3
Rebound Fatality Costs, Off-setting Benefit ²	-12.5	-12.2	-11.7	-11.1	-8.4	-8.3	-6.7	-6.0
Rebound Non-Fatal Crash Costs, Off-setting Benefit ²	-19.6	-19.0	-18.3	-17.4	-13.2	-13.0	-10.5	-9.4
Petroleum Market Externality	-2.9	-2.8	-2.8	-2.7	-2.0	-2.0	-1.8	-1.5
CO2 Damage Reduction Benefit	-1.1	-1.1	-1.1	-1.0	-0.8	-0.8	-0.7	-0.6
NOx Damage Reduction Benefit	0.2	0.2	0.2	0.2	0.1	0.1	0.0	0.1
VOC Damage Reduction Benefit	0.1	0.1	0.0	0.0	0.0	0.0	0.0	0.0
PM Damage Reduction Benefit	0.2	0.2	0.1	0.1	0.1	0.0	-0.1	0.0
SO2 Damage Reduction Benefit	-0.6	-0.6	-0.6	-0.5	-0.3	-0.4	-0.4	-0.2
Total Societal Benefits	-89.0	-86.9	-84.2	-80.0	-59.5	-60.2	-51.1	-44.0

¹ This value includes both the value of the fuel spent to drive rebound miles, and the consumer surplus representing the additional amount consumers would have, but did not spend to drive the additional miles.

² It is assumed that consumers that drive rebound miles fully internalize fatal and non-fatal crash costs. The miles are driven because they receive an equal and offsetting benefit from driving the miles. These cells report the magnitude of the offsetting benefits.

*** EO 12866 Review – Draft – Do Not Cite, Quote or Release During Review ***

TABLE 9-22 - INCREMENTAL LIFETIME SOCIETAL BENEFITS FOR MY'S 1975-2029, BY ALTERNATIVE, PASSENGER CAR, 7% DISCOUNT RATE, CO₂ (BILLIONS OF 2016\$)

	Alternative							
	1	2	3	4	5	6	7	8
Model Years	2021-2026	2021-2026	2021-2026	2021-2026	2022-2026	2021-2026	2021-2026	2022-2026
Annual Rate of Stringency Increase	0.0%/Year PC 0.0%/Year LT	0.5%/Year PC 0.5%/Year LT	0.5%/Year PC 0.5%/Year LT	1.0%/Year PC 2.0%/Year LT	1.0%/Year PC 2.0%/Year LT	2.0%/Year PC 3.0%/Year LT	2.0%/Year PC 3.0%/Year LT	2.0%/Year PC 3.0%/Year LT
AC/Off-Cycle Procedures	No Change	No Change	Phaseout 2022-2026	No Change	No Change	No Change	Phaseout 2022-2026	No Change
Pre-Tax Fuel Savings	-34.4	-32.8	-29.4	-27.2	-15.7	-16.1	-12.2	-10.7
Rebound Fuel Benefit ¹	-14.5	-13.7	-12.3	-11.1	-7.1	-6.7	-4.2	-4.3
Refueling Time Benefit	-2.5	-2.4	-2.2	-2.0	-1.2	-1.2	-0.9	-0.8
Rebound Fatality Costs, Off-setting Benefit ²	-11.8	-11.2	-10.0	-9.2	-5.9	-5.6	-3.7	-3.6
Rebound Non-Fatal Crash Costs, Off-setting Benefit ²	-18.4	-17.5	-15.7	-14.4	-9.2	-8.7	-5.7	-5.7
Petroleum Market Externality	-2.8	-2.7	-2.4	-2.2	-1.3	-1.3	-1.0	-0.9
CO ₂ Damage Reduction Benefit	-1.1	-1.1	-0.9	-0.9	-0.5	-0.5	-0.4	-0.3
NO _x Damage Reduction Benefit	0.2	0.1	0.1	0.1	0.1	0.1	0.0	0.0
VOC Damage Reduction Benefit	0.0	0.0	0.0	0.0	0.0	0.0	0.0	0.0
PM Damage Reduction Benefit	0.1	0.1	0.1	0.0	0.1	0.0	0.0	0.0
SO ₂ Damage Reduction Benefit	-0.7	-0.7	-0.6	-0.6	-0.3	-0.3	-0.2	-0.2
Total Societal Benefits	-85.9	-81.8	-73.3	-67.4	-41.0	-40.3	-28.4	-26.5

¹ This value includes both the value of the fuel spent to drive rebound miles, and the consumer surplus representing the additional amount consumers would have, but did not spend to drive the additional miles.

² It is assumed that consumers that drive rebound miles fully internalize fatal and non-fatal crash costs. The miles are driven because they receive an equal and offsetting benefit from driving the miles. These cells report the magnitude of the offsetting benefits.

*** EO 12866 Review – Draft – Do Not Cite, Quote or Release During Review ***

TABLE 9-23 - INCREMENTAL LIFETIME SOCIETAL BENEFITS FOR MY'S 1975-2029, BY ALTERNATIVE, LIGHT TRUCK, 3% DISCOUNT RATE, CAFE (BILLIONS OF 2016\$)

	Alternative							
	1	2	3	4	5	6	7	8
Model Years	2021-2026	2021-2026	2021-2026	2021-2026	2022-2026	2021-2026	2021-2026	2022-2026
Annual Rate of Stringency Increase	0.0%/Year PC 0.0%/Year LT	0.5%/Year PC 0.5%/Year LT	0.5%/Year PC 0.5%/Year LT	1.0%/Year PC 2.0%/Year LT	1.0%/Year PC 2.0%/Year LT	2.0%/Year PC 3.0%/Year LT	2.0%/Year PC 3.0%/Year LT	2.0%/Year PC 3.0%/Year LT
AC/Off-Cycle Procedures	No Change	No Change	Phaseout 2022-2026	No Change	No Change	No Change	Phaseout 2022-2026	No Change
Pre-Tax Fuel Savings	-78.6	-72.1	-66.9	-53.6	-40.6	-34.7	-17.7	-19.3
Rebound Fuel Benefit ¹	-36.2	-33.0	-30.4	-23.2	-16.2	-13.3	-6.8	-7.4
Refueling Time Benefit	-4.2	-3.9	-3.6	-3.0	-2.2	-2.0	-1.1	-1.1
Rebound Fatality Costs, Off-setting Benefit ²	-21.5	-19.6	-18.2	-14.1	-10.0	-8.4	-4.4	-4.6
Rebound Non-Fatal Crash Costs, Off-setting Benefit ²	-33.7	-30.7	-28.4	-22.0	-15.6	-13.1	-6.9	-7.2
Petroleum Market Externality	-6.4	-5.9	-5.5	-4.4	-3.3	-2.9	-1.5	-1.6
CO2 Damage Reduction Benefit	-2.6	-2.3	-2.2	-1.7	-1.3	-1.1	-0.6	-0.6
NOx Damage Reduction Benefit	0.4	0.3	0.3	0.3	0.2	0.2	0.1	0.1
VOC Damage Reduction Benefit	0.0	0.0	0.0	0.0	0.0	0.0	0.0	0.0
PM Damage Reduction Benefit	-0.2	-0.2	-0.2	-0.2	-0.2	-0.2	-0.1	-0.1
SO2 Damage Reduction Benefit	-1.6	-1.4	-1.3	-1.0	-0.7	-0.6	-0.3	-0.3
Total Societal Benefits	-184.6	-168.7	-156.2	-122.9	-90.0	-76.0	-39.2	-42.1

¹ This value includes both the value of the fuel spent to drive rebound miles, and the consumer surplus representing the additional amount consumers would have, but did not spend to drive the additional miles.

² It is assumed that consumers that drive rebound miles fully internalize fatal and non-fatal crash costs. The miles are driven because they receive an equal and offsetting benefit from driving the miles. These cells report the magnitude of the offsetting benefits.

*** EO 12866 Review – Draft – Do Not Cite, Quote or Release During Review ***

TABLE 9-24 - INCREMENTAL LIFETIME SOCIETAL BENEFITS FOR MY'S 1975-2029, BY ALTERNATIVE, LIGHT TRUCK, 3% DISCOUNT RATE, CO₂ (BILLIONS OF 2016\$)

	Alternative							
	1	2	3	4	5	6	7	8
Model Years	2021-2026	2021-2026	2021-2026	2021-2026	2022-2026	2021-2026	2021-2026	2022-2026
Annual Rate of Stringency Increase	0.0%/Year PC 0.0%/Year LT	0.5%/Year PC 0.5%/Year LT	0.5%/Year PC 0.5%/Year LT	1.0%/Year PC 2.0%/Year LT	1.0%/Year PC 2.0%/Year LT	2.0%/Year PC 3.0%/Year LT	2.0%/Year PC 3.0%/Year LT	2.0%/Year PC 3.0%/Year LT
AC/Off-Cycle Procedures	No Change	No Change	Phaseout 2022- 2026	No Change	No Change	No Change	Phaseout 2022- 2026	No Change
Pre-Tax Fuel Savings	-56.2	-54.2	-52.1	-35.1	-20.9	-21.3	-9.8	-6.0
Rebound Fuel Benefit ¹	-31.9	-30.5	-28.6	-19.0	-10.5	-10.1	-4.6	-3.1
Refueling Time Benefit	-3.2	-3.0	-2.9	-2.0	-1.2	-1.2	-0.5	-0.4
Rebound Fatality Costs, Off-setting Benefit ²	-18.6	-17.7	-16.6	-11.1	-6.2	-6.0	-2.8	-1.8
Rebound Non-Fatal Crash Costs, Off-setting Benefit ²	-29.0	-27.7	-26.0	-17.4	-9.7	-9.4	-4.3	-2.9
Petroleum Market Externality	-4.6	-4.5	-4.3	-2.9	-1.8	-1.8	-0.8	-0.5
CO2 Damage Reduction Benefit	-1.8	-1.8	-1.7	-1.1	-0.7	-0.7	-0.3	-0.2
NOx Damage Reduction Benefit	0.4	0.4	0.4	0.3	0.1	0.1	0.1	0.1
VOC Damage Reduction Benefit	0.1	0.1	0.0	0.0	0.0	0.0	0.0	0.0
PM Damage Reduction Benefit	0.3	0.2	0.1	0.1	0.0	0.0	-0.1	0.0
SO ₂ Damage Reduction Benefit	-1.0	-1.0	-0.9	-0.6	-0.3	-0.3	-0.1	0.0
Total Societal Benefits	-145.6	-139.6	-132.6	-88.8	-51.0	-50.7	-23.2	-14.9

¹ This value includes both the value of the fuel spent to drive rebound miles, and the consumer surplus representing the additional amount consumers would have, but did not spend to drive the additional miles.

² It is assumed that consumers that drive rebound miles fully internalize fatal and non-fatal crash costs. The miles are driven because they receive an equal and offsetting benefit from driving the miles. These cells report the magnitude of the offsetting benefits.

*** EO 12866 Review – Draft – Do Not Cite, Quote or Release During Review ***

TABLE 9-25 - INCREMENTAL LIFETIME SOCIETAL BENEFITS FOR MY'S 1975-2029, BY ALTERNATIVE, LIGHT TRUCK, 7% DISCOUNT RATE, CAFE (BILLIONS OF 2016\$)

	Alternative							
	1	2	3	4	5	6	7	8
Model Years	2021-2026	2021-2026	2021-2026	2021-2026	2022-2026	2021-2026	2021-2026	2022-2026
Annual Rate of Stringency Increase	0.0%/Year PC 0.0%/Year LT	0.5%/Year PC 0.5%/Year LT	0.5%/Year PC 0.5%/Year LT	1.0%/Year PC 2.0%/Year LT	1.0%/Year PC 2.0%/Year LT	2.0%/Year PC 3.0%/Year LT	2.0%/Year PC 3.0%/Year LT	2.0%/Year PC 3.0%/Year LT
AC/Off-Cycle Procedures	No Change	No Change	Phaseout 2022-2026	No Change	No Change	No Change	Phaseout 2022-2026	No Change
Pre-Tax Fuel Savings	-49.5	-45.3	-42.0	-33.7	-25.4	-21.8	-11.3	-12.0
Rebound Fuel Benefit ¹	-22.0	-20.0	-18.4	-14.1	-9.8	-8.2	-4.3	-4.5
Refueling Time Benefit	-2.7	-2.5	-2.3	-1.9	-1.4	-1.3	-0.7	-0.7
Rebound Fatality Costs, Off-setting Benefit ²	-13.3	-12.1	-11.2	-8.7	-6.2	-5.3	-2.8	-2.9
Rebound Non-Fatal Crash Costs, Off-setting Benefit ²	-20.9	-19.0	-17.6	-13.7	-9.7	-8.3	-4.5	-4.5
Petroleum Market Externality	-4.0	-3.7	-3.4	-2.8	-2.1	-1.8	-0.9	-1.0
CO2 Damage Reduction Benefit	-1.6	-1.5	-1.4	-1.1	-0.8	-0.7	-0.4	-0.4
NOx Damage Reduction Benefit	0.2	0.2	0.2	0.2	0.1	0.1	0.1	0.1
VOC Damage Reduction Benefit	0.0	0.0	0.0	0.0	0.0	0.0	0.0	0.0
PM Damage Reduction Benefit	-0.2	-0.2	-0.2	-0.2	-0.2	-0.1	-0.1	-0.1
SO ₂ Damage Reduction Benefit	-1.0	-0.9	-0.8	-0.7	-0.5	-0.4	-0.2	-0.2
Total Societal Benefits	-115.1	-104.9	-97.2	-76.7	-56.0	-47.7	-25.1	-26.1

¹ This value includes both the value of the fuel spent to drive rebound miles, and the consumer surplus representing the additional amount consumers would have, but did not spend to drive the additional miles.

² It is assumed that consumers that drive rebound miles fully internalize fatal and non-fatal crash costs. The miles are driven because they receive an equal and offsetting benefit from driving the miles. These cells report the magnitude of the offsetting benefits

*** EO 12866 Review – Draft – Do Not Cite, Quote or Release During Review ***

TABLE 9-26 - INCREMENTAL LIFETIME SOCIETAL BENEFITS FOR MY'S 1975-2029, BY ALTERNATIVE, LIGHT TRUCK, 7% DISCOUNT RATE, CO₂ (BILLIONS OF 2016\$)

	Alternative							
	1	2	3	4	5	6	7	8
Model Years	2021-2026	2021-2026	2021-2026	2021-2026	2022-2026	2021-2026	2021-2026	2022-2026
Annual Rate of Stringency Increase	0.0%/Year PC 0.0%/Year LT	0.5%/Year PC 0.5%/Year LT	0.5%/Year PC 0.5%/Year LT	1.0%/Year PC 2.0%/Year LT	1.0%/Year PC 2.0%/Year LT	2.0%/Year PC 3.0%/Year LT	2.0%/Year PC 3.0%/Year LT	2.0%/Year PC 3.0%/Year LT
AC/Off-Cycle Procedures	No Change	No Change	Phaseout 2022-2026	No Change	No Change	No Change	Phaseout 2022-2026	No Change
Pre-Tax Fuel Savings	-36.0	-34.6	-33.1	-22.3	-13.4	-13.6	-6.3	-4.1
Rebound Fuel Benefit ¹	-19.1	-18.3	-17.2	-11.4	-6.3	-6.2	-2.9	-1.9
Refueling Time Benefit	-2.0	-1.9	-1.8	-1.3	-0.8	-0.7	-0.3	-0.3
Rebound Fatality Costs, Off-setting Benefit ²	-11.3	-10.8	-10.2	-6.8	-3.8	-3.8	-1.8	-1.2
Rebound Non-Fatal Crash Costs, Off-setting Benefit ²	-17.8	-16.9	-16.0	-10.7	-5.9	-5.9	-2.8	-1.8
Petroleum Market Externality	-3.0	-2.8	-2.7	-1.9	-1.1	-1.1	-0.5	-0.4
CO ₂ Damage Reduction Benefit	-1.2	-1.1	-1.1	-0.7	-0.4	-0.4	-0.2	-0.1
NO _x Damage Reduction Benefit	0.2	0.2	0.2	0.1	0.1	0.1	0.0	0.0
VOC Damage Reduction Benefit	0.0	0.0	0.0	0.0	0.0	0.0	0.0	0.0
PM Damage Reduction Benefit	0.0	0.0	0.0	0.0	0.0	-0.1	-0.1	0.0
SO ₂ Damage Reduction Benefit	-0.7	-0.7	-0.6	-0.4	-0.2	-0.2	-0.1	0.0
Total Societal Benefits	-90.7	-86.9	-82.6	-55.2	-31.8	-32.0	-14.9	-9.7

¹ This value includes both the value of the fuel spent to drive rebound miles, and the consumer surplus representing the additional amount consumers would have, but did not spend to drive the additional miles.

² It is assumed that consumers that drive rebound miles fully internalize fatal and non-fatal crash costs. The miles are driven because they receive an equal and offsetting benefit from driving the miles. These cells report the magnitude of the offsetting benefits.

*** EO 12866 Review – Draft – Do Not Cite, Quote or Release During Review ***

TABLE 9-27 - INCREMENTAL LIFETIME SOCIETAL BENEFITS FOR MY’S 1975-2029, BY ALTERNATIVE, COMBINED LIGHT-DUTY, 3% DISCOUNT RATE, CAFE (BILLIONS OF 2016\$)

	Alternative							
	1	2	3	4	5	6	7	8
Model Years	2021-2026	2021-2026	2021-2026	2021-2026	2022-2026	2021-2026	2021-2026	2022-2026
Annual Rate of Stringency Increase	0.0%/Year PC 0.0%/Year LT	0.5%/Year PC 0.5%/Year LT	0.5%/Year PC 0.5%/Year LT	1.0%/Year PC 2.0%/Year LT	1.0%/Year PC 2.0%/Year LT	2.0%/Year PC 3.0%/Year LT	2.0%/Year PC 3.0%/Year LT	2.0%/Year PC 3.0%/Year LT
AC/Off-Cycle Procedures	No Change	No Change	Phaseout 2022-2026	No Change	No Change	No Change	Phaseout 2022-2026	No Change
Pre-Tax Fuel Savings	-133.1	-125.7	-119.3	-103.9	-77.7	-72.8	-52.3	-48.3
Rebound Fuel Benefit ¹	-61.1	-57.1	-53.4	-44.9	-32.8	-28.9	-18.9	-18.6
Refueling Time Benefit	-8.5	-8.1	-7.7	-6.8	-5.1	-4.8	-3.5	-3.2
Rebound Fatality Costs, Off-setting Benefit ²	-41.7	-39.3	-37.1	-32.0	-23.7	-21.7	-14.9	-14.3
Rebound Non-Fatal Crash Costs, Off-setting Benefit ²	-65.3	-61.4	-58.0	-50.0	-37.1	-33.9	-23.4	-22.4
Petroleum Market Externality	-11.0	-10.3	-9.8	-8.6	-6.5	-6.1	-4.4	-4.1
CO2 Damage Reduction Benefit	-4.3	-4.1	-3.9	-3.4	-2.5	-2.4	-1.7	-1.6
NOx Damage Reduction Benefit	0.8	0.7	0.6	0.5	0.4	0.4	0.2	0.2
VOC Damage Reduction Benefit	0.1	0.1	0.1	0.1	0.1	0.1	0.0	0.0
PM Damage Reduction Benefit	0.3	0.3	0.2	0.1	0.1	0.0	-0.2	-0.1
SO ₂ Damage Reduction Benefit	-2.4	-2.3	-2.2	-1.8	-1.3	-1.2	-0.8	-0.7
Total Societal Benefits	-326.2	-307.1	-290.3	-250.7	-186.1	-171.3	-119.9	-113.0

¹ This value includes both the value of the fuel spent to drive rebound miles, and the consumer surplus representing the additional amount consumers would have, but did not spend to drive the additional miles.

² It is assumed that consumers that drive rebound miles fully internalize fatal and non-fatal crash costs. The miles are driven because they receive an equal and offsetting benefit from driving the miles. These cells report the magnitude of the offsetting benefits.

*** EO 12866 Review – Draft – Do Not Cite, Quote or Release During Review ***

TABLE 9-28 - INCREMENTAL LIFETIME SOCIETAL BENEFITS FOR MY’S 1975-2029, BY ALTERNATIVE, COMBINED LIGHT-DUTY, 3% DISCOUNT RATE, CO₂ (BILLIONS OF 2016

	Alternative							
	1	2	3	4	5	6	7	8
Model Years	2021-2026	2021-2026	2021-2026	2021-2026	2022-2026	2021-2026	2021-2026	2022-2026
Annual Rate of Stringency Increase	0.0%/Year PC	0.5%/Year PC	0.5%/Year PC	1.0%/Year PC	1.0%/Year PC	2.0%/Year PC	2.0%/Year PC	2.0%/Year PC
	0.0%/Year LT	0.5%/Year LT	0.5%/Year LT	2.0%/Year LT	2.0%/Year LT	3.0%/Year LT	3.0%/Year LT	3.0%/Year LT
AC/Off-Cycle Procedures	No Change	No Change	Phaseout 2022-2026	No Change	No Change	No Change	Phaseout 2022-2026	No Change
Pre-Tax Fuel Savings	-110.4	-105.9	-98.3	-78.0	-46.0	-47.2	-29.9	-23.7
Rebound Fuel Benefit ¹	-56.0	-53.4	-49.0	-37.5	-22.6	-21.3	-11.5	-10.3
Refueling Time Benefit	-7.1	-6.8	-6.3	-5.1	-3.1	-3.1	-1.9	-1.6
Rebound Fatality Costs, Off-setting Benefit ²	-37.8	-36.1	-33.1	-26.1	-16.0	-15.2	-8.7	-7.9
Rebound Non-Fatal Crash Costs, Off-setting Benefit ²	-59.1	-56.5	-51.7	-40.9	-25.1	-23.8	-13.6	-12.4
Petroleum Market Externality	-9.0	-8.7	-8.1	-6.4	-3.8	-3.9	-2.4	-2.0
CO2 Damage Reduction Benefit	-3.6	-3.4	-3.2	-2.5	-1.5	-1.5	-1.0	-0.8
NOx Damage Reduction Benefit	0.8	0.7	0.6	0.5	0.3	0.3	0.1	0.1
VOC Damage Reduction Benefit	0.1	0.1	0.1	0.1	0.1	0.1	0.0	0.0
PM Damage Reduction Benefit	0.6	0.6	0.5	0.3	0.3	0.1	-0.2	0.1
SO ₂ Damage Reduction Benefit	-2.1	-2.1	-1.9	-1.5	-0.8	-0.8	-0.5	-0.3
Total Societal Benefits	-283.7	-271.4	-250.3	-197.2	-118.2	-116.4	-69.7	-59.0

¹ This value includes both the value of the fuel spent to drive rebound miles, and the consumer surplus representing the additional amount consumers would have, but did not spend to drive the additional miles.

² It is assumed that consumers that drive rebound miles fully internalize fatal and non-fatal crash costs. The miles are driven because they receive an equal and offsetting benefit from driving the miles. These cells report the magnitude of the offsetting benefits.

*** EO 12866 Review – Draft – Do Not Cite, Quote or Release During Review ***

TABLE 9-29 - INCREMENTAL LIFETIME SOCIETAL BENEFITS FOR MY’S 1975-2029, BY ALTERNATIVE, COMBINED LIGHT-DUTY, 7% DISCOUNT RATE, CAFE (BILLIONS OF 2016\$)

	Alternative							
	1	2	3	4	5	6	7	8
Model Years	2021-2026	2021-2026	2021-2026	2021-2026	2022-2026	2021-2026	2021-2026	2022-2026
Annual Rate of Stringency Increase	0.0%/Year PC 0.0%/Year LT	0.5%/Year PC 0.5%/Year LT	0.5%/Year PC 0.5%/Year LT	1.0%/Year PC 2.0%/Year LT	1.0%/Year PC 2.0%/Year LT	2.0%/Year PC 3.0%/Year LT	2.0%/Year PC 3.0%/Year LT	2.0%/Year PC 3.0%/Year LT
AC/Off-Cycle Procedures	No Change	No Change	Phaseout 2022-2026	No Change	No Change	No Change	Phaseout 2022-2026	No Change
Pre-Tax Fuel Savings	-84.4	-79.5	-75.5	-65.6	-48.7	-46.1	-33.1	-30.1
Rebound Fuel Benefit ¹	-37.1	-34.6	-32.4	-27.4	-19.9	-17.8	-11.9	-11.4
Refueling Time Benefit	-5.5	-5.2	-4.9	-4.3	-3.2	-3.1	-2.3	-2.0
Rebound Fatality Costs, Off-setting Benefit ²	-25.9	-24.3	-23.0	-19.9	-14.6	-13.6	-9.6	-8.9
Rebound Non-Fatal Crash Costs, Off-setting Benefit ²	-40.4	-38.0	-35.9	-31.1	-22.9	-21.3	-15.0	-13.9
Petroleum Market Externality	-6.9	-6.5	-6.2	-5.4	-4.0	-3.8	-2.8	-2.5
CO2 Damage Reduction Benefit	-2.7	-2.6	-2.4	-2.1	-1.6	-1.5	-1.1	-1.0
NOx Damage Reduction Benefit	0.4	0.4	0.4	0.3	0.2	0.2	0.1	0.1
VOC Damage Reduction Benefit	0.1	0.1	0.1	0.1	0.0	0.0	0.0	0.0
PM Damage Reduction Benefit	0.0	0.0	-0.1	-0.1	-0.1	-0.1	-0.2	-0.1
SO ₂ Damage Reduction Benefit	-1.6	-1.5	-1.4	-1.2	-0.8	-0.8	-0.5	-0.4
Total Societal Benefits	-204.1	-191.8	-181.4	-156.7	-115.5	-108.0	-76.2	-70.2

¹ This value includes both the value of the fuel spent to drive rebound miles, and the consumer surplus representing the additional amount consumers would have, but did not spend to drive the additional miles.

² It is assumed that consumers that drive rebound miles fully internalize fatal and non-fatal crash costs. The miles are driven because they receive an equal and offsetting benefit from driving the miles. These cells report the magnitude of the offsetting benefits.

*** EO 12866 Review – Draft – Do Not Cite, Quote or Release During Review ***

TABLE 9-30 - INCREMENTAL LIFETIME SOCIETAL BENEFITS FOR MY’S 1975-2029, BY ALTERNATIVE, COMBINED LIGHT-DUTY, 7% DISCOUNT RATE, CO₂ (BILLIONS OF 2016\$)

	Alternative							
	1	2	3	4	5	6	7	8
Model Years	2021-2026	2021-2026	2021-2026	2021-2026	2022-2026	2021-2026	2021-2026	2022-2026
Annual Rate of Stringency Increase	0.0%/Year PC 0.0%/Year LT	0.5%/Year PC 0.5%/Year LT	0.5%/Year PC 0.5%/Year LT	1.0%/Year PC 2.0%/Year LT	1.0%/Year PC 2.0%/Year LT	2.0%/Year PC 3.0%/Year LT	2.0%/Year PC 3.0%/Year LT	2.0%/Year PC 3.0%/Year LT
AC/Off-Cycle Procedures	No Change	No Change	Phaseout 2022-2026	No Change	No Change	No Change	Phaseout 2022-2026	No Change
Pre-Tax Fuel Savings	-70.3	-67.4	-62.5	-49.5	-29.1	-29.7	-18.5	-14.8
Rebound Fuel Benefit ¹	-33.6	-32.0	-29.5	-22.6	-13.4	-12.9	-7.1	-6.2
Refueling Time Benefit	-4.5	-4.3	-4.0	-3.2	-2.0	-2.0	-1.2	-1.0
Rebound Fatality Costs, Off-setting Benefit ²	-23.1	-22.0	-20.3	-16.0	-9.7	-9.3	-5.4	-4.8
Rebound Non-Fatal Crash Costs, Off-setting Benefit ²	-36.1	-34.5	-31.7	-25.0	-15.1	-14.6	-8.5	-7.5
Petroleum Market Externality	-5.8	-5.5	-5.1	-4.1	-2.4	-2.5	-1.5	-1.2
CO ₂ Damage Reduction Benefit	-2.3	-2.2	-2.0	-1.6	-0.9	-1.0	-0.6	-0.5
NO _x Damage Reduction Benefit	0.4	0.4	0.3	0.3	0.2	0.1	0.1	0.1
VOC Damage Reduction Benefit	0.1	0.1	0.1	0.0	0.0	0.0	0.0	0.0
PM Damage Reduction Benefit	0.1	0.1	0.1	0.0	0.1	0.0	-0.1	0.0
SO ₂ Damage Reduction Benefit	-1.4	-1.3	-1.2	-1.0	-0.5	-0.5	-0.3	-0.2
Total Societal Benefits	-176.6	-168.7	-155.9	-122.6	-72.8	-72.3	-43.2	-36.1

¹ This value includes both the value of the fuel spent to drive rebound miles, and the consumer surplus representing the additional amount consumers would have, but did not spend to drive the additional miles.

² It is assumed that consumers that drive rebound miles fully internalize fatal and non-fatal crash costs. The miles are driven because they receive an equal and offsetting benefit from driving the miles. These cells report the magnitude of the offsetting benefits.

*** EO 12866 Review – Draft – Do Not Cite, Quote or Release During Review ***

**TABLE 9-31 - PRESENT VALUE OF LIFETIME SOCIETAL BENEFITS, PASSENGER CARS,
3% DISCOUNT RATE, CAFE (BILLIONS OF 2016\$)**

Passenger Cars	MY 1977- 2016	MY 2017	MY 2018	MY 2019	MY 2020	MY 2021	MY 2022	MY 2023	MY 2024	MY 2025	MY 2026	MY 2027	MY 2028	MY 2029	MY TOTAL
0.0%PC/0.0%LT, MYs 2021-2026	25.9	1.6	-0.4	-1.8	-5.3	-	-	-	-	-	-	-	-	-	-141.7
0.5%PC/0.5%LT, MYs 2021-2026	24.7	1.4	-0.4	-1.9	-5.3	-	-	-	-	-	-	-	-	-	-138.4
0.5%PC/0.5%LT, MYs 2021-2026, AC/Off-Cycle Phaseout	23.1	1.3	-0.5	-1.9	-5.4	-	-	-	-	-	-	-	-	-	-134.1
1.0%PC/2.0%LT, MYs 2021-2026	20.8	1.0	-0.5	-1.9	-5.3	-	-	-	-	-	-	-	-	-	-127.8
1.0%PC/2.0%LT, MYs 2022-2026	16.6	1.1	0.5	-0.2	-3.2	-7.2	-	-	-	-	-	-	-	-	-96.1
2.0%PC/3.0%LT, MYs 2021-2026	14.4	0.4	-0.9	-2.2	-5.3	-9.4	-	-	-	-	-	-	-	-	-95.3
2.0%PC/3.0%LT, MYs 2021-2026, AC/Off-Cycle Phaseout	8.9	-0.2	-1.5	-2.6	-5.6	-8.9	-	-	-	-	-8.2	-7.0	-6.7	-6.5	-80.7
2.0%PC/3.0%LT, MYs 2022-2026	9.2	0.5	0.0	-0.5	-3.3	-6.1	-7.9	-9.2	-	-	-9.1	-8.3	-7.9	-7.6	-70.9

*** EO 12866 Review – Draft – Do Not Cite, Quote or Release During Review ***

**TABLE 9-32 - PRESENT VALUE OF LIFETIME SOCIETAL BENEFITS, PASSENGER CARS,
3% DISCOUNT RATE, CO₂ (BILLIONS OF 2016\$)**

Passenger Cars	MY 1977- 2016	MY 2017	MY 2018	MY 2019	MY 2020	MY 2021	MY 2022	MY 2023	MY 2024	MY 2025	MY 2026	MY 2027	MY 2028	MY 2029	MY TOTAL
0.0%PC/0.0%LT, MYs 2021-2026	21.5	1.8	-0.2	-1.3	-3.8	-7.2	-	-	-	-	-	-	-	-	-138.2
0.5%PC/0.5%LT, MYs 2021-2026	20.6	1.9	-0.1	-1.1	-3.5	-6.8	-	-	-	-	-	-	-	-	-131.7
0.5%PC/0.5%LT, MYs 2021-2026, AC/Off-Cycle Phaseout	19.5	1.7	-0.3	-1.2	-3.2	-6.4	-9.7	-	-	-	-	-	-	-	-117.6
1.0%PC/2.0%LT, MYs 2021-2026	16.2	1.3	-0.5	-1.4	-3.2	-6.2	-9.2	-	-	-	-	-	-	-	-108.4
1.0%PC/2.0%LT, MYs 2022-2026	10.9	1.4	1.1	0.9	-0.6	-3.0	-5.2	-7.1	-8.2	-	-	-	-	-	-67.2
2.0%PC/3.0%LT, MYs 2021-2026	10.6	0.7	0.3	-0.1	-1.6	-4.0	-6.0	-7.2	-8.1	-	-	-	-	-9.8	-65.7
2.0%PC/3.0%LT, MYs 2021-2026, AC/Off-Cycle Phaseout	5.9	0.2	-0.2	-0.4	-1.7	-3.5	-4.8	-5.5	-5.9	-7.2	-6.3	-5.7	-5.8	-5.4	-46.5
2.0%PC/3.0%LT, MYs 2022-2026	5.3	0.7	0.5	0.3	-0.8	-2.4	-3.4	-4.5	-5.1	-7.2	-6.9	-6.9	-7.0	-6.7	-44.1

*** EO 12866 Review – Draft – Do Not Cite, Quote or Release During Review ***

**TABLE 9-33 - PRESENT VALUE OF LIFETIME SOCIETAL BENEFITS, PASSENGER CARS,
7% DISCOUNT RATE, CAFE (BILLIONS OF 2016\$)**

Passenger Cars	MY 1977- 2016	MY 2017	MY 2018	MY 2019	MY 2020	MY 2021	MY 2022	MY 2023	MY 2024	MY 2025	MY 2026	MY 2027	MY 2028	MY 2029	MY TOTAL
0.0%PC/0.0%LT, MYs 2021-2026	16.1	0.5	-0.9	-1.9	-4.3	-8.1	-	-	-	-	-	-	-	-	-89.0
0.5%PC/0.5%LT, MYs 2021-2026	15.3	0.5	-0.9	-1.9	-4.3	-7.9	-	-	-	-	-	-	-	-	-86.9
0.5%PC/0.5%LT, MYs 2021-2026, AC/Off-Cycle Phaseout	14.4	0.4	-0.9	-1.9	-4.3	-7.8	-9.8	-	-	-	-	-	-9.8	-9.3	-84.2
1.0%PC/2.0%LT, MYs 2021-2026	13.0	0.3	-0.8	-1.8	-4.2	-7.6	-9.5	-	-	-	-	-9.6	-8.9	-8.4	-80.0
1.0%PC/2.0%LT, MYs 2022-2026	10.3	0.4	0.0	-0.4	-2.6	-5.2	-6.9	-8.0	-8.5	-8.8	-8.3	-7.7	-7.1	-6.7	-59.5
2.0%PC/3.0%LT, MYs 2021-2026	9.1	0.0	-1.0	-1.9	-4.1	-6.7	-7.8	-8.3	-7.9	-7.9	-6.8	-6.1	-5.6	-5.2	-60.2
2.0%PC/3.0%LT, MYs 2021-2026, AC/Off-Cycle Phaseout	5.7	-0.3	-1.3	-2.1	-4.1	-6.3	-7.0	-7.1	-6.6	-6.3	-4.8	-3.9	-3.6	-3.4	-51.1
2.0%PC/3.0%LT, MYs 2022-2026	5.8	0.2	-0.2	-0.6	-2.5	-4.4	-5.4	-6.0	-6.3	-6.3	-5.3	-4.6	-4.3	-4.0	-44.0

*** EO 12866 Review – Draft – Do Not Cite, Quote or Release During Review ***

**TABLE 9-34 - PRESENT VALUE OF LIFETIME SOCIETAL BENEFITS, PASSENGER CARS,
7% DISCOUNT RATE, CO₂ (BILLIONS OF 2016\$)**

Passenger Cars	MY 1977- 2016	MY 2017	MY 2018	MY 2019	MY 2020	MY 2021	MY 2022	MY 2023	MY 2024	MY 2025	MY 2026	MY 2027	MY 2028	MY 2029	MY TOTAL
0.0%PC/0.0%LT, MYs 2021-2026	13.1	0.7	-0.8	-1.5	-3.3	-5.5	-7.8	-9.3	-	-	-	-	-	-	-89.0
0.5%PC/0.5%LT, MYs 2021-2026	12.6	0.8	-0.7	-1.4	-3.0	-5.1	-7.4	-8.9	-	-	-	-	-	-	-86.9
0.5%PC/0.5%LT, MYs 2021-2026, AC/Off-Cycle Phaseout	11.9	0.7	-0.8	-1.4	-2.8	-4.9	-6.9	-8.3	-9.1	-	-	-	-	-9.9	-84.2
1.0%PC/2.0%LT, MYs 2021-2026	9.9	0.5	-0.8	-1.4	-2.7	-4.6	-6.5	-7.8	-8.5	-9.3	-9.4	-9.3	-9.0	-8.6	-80.0
1.0%PC/2.0%LT, MYs 2022-2026	6.6	0.8	0.5	0.4	-0.7	-2.3	-3.7	-4.8	-5.3	-6.6	-6.7	-6.6	-6.5	-6.2	-59.5
2.0%PC/3.0%LT, MYs 2021-2026	6.6	0.3	0.0	-0.3	-1.3	-3.0	-4.1	-4.8	-5.1	-6.2	-6.0	-5.7	-5.5	-5.1	-60.2
2.0%PC/3.0%LT, MYs 2021-2026, AC/Off-Cycle Phaseout	3.8	0.0	-0.3	-0.4	-1.3	-2.5	-3.2	-3.6	-3.7	-4.3	-3.7	-3.2	-3.1	-2.8	-51.1
2.0%PC/3.0%LT, MYs 2022-2026	3.3	0.4	0.2	0.1	-0.7	-1.8	-2.4	-2.9	-3.2	-4.3	-4.0	-3.9	-3.8	-3.5	-44.0

*** EO 12866 Review – Draft – Do Not Cite, Quote or Release During Review ***

**TABLE 9-35 - PRESENT VALUE OF LIFETIME SOCIETAL BENEFITS, LIGHT TRUCKS,
3% DISCOUNT RATE, CAFE (BILLIONS OF 2016\$)**

Light Trucks	MY 1977- 2016	MY 2017	MY 2018	MY 2019	MY 2020	MY 2021	MY 2022	MY 2023	MY 2024	MY 2025	MY 2026	MY 2027	MY 2028	MY 2029	MY TOTAL
0.0%PC/0.0%LT, MYs 2021-2026	17.5	0.0	-4.2	-7.6	-	-	-	-	-	-	-	-	-	-	-184.6
0.5%PC/0.5%LT, MYs 2021-2026	16.0	-0.1	-3.2	-6.2	-9.2	-	-	-	-	-	-	-	-	-	-168.7
0.5%PC/0.5%LT, MYs 2021-2026, AC/Off-Cycle Phaseout	15.2	-0.2	-3.0	-5.6	-8.6	-	-	-	-	-	-	-	-	-	-156.2
1.0%PC/2.0%LT, MYs 2021-2026	12.5	-0.5	-2.8	-4.9	-6.8	-	-	-	-	-	-	-	-	-	-122.9
1.0%PC/2.0%LT, MYs 2022-2026	8.9	0.1	-1.6	-3.6	-5.1	-8.8	-	-	-	-	-	-	-	-	-90.0
2.0%PC/3.0%LT, MYs 2021-2026	8.3	-0.8	-2.2	-3.2	-4.9	-8.8	-8.6	-8.6	-8.3	-9.1	-7.8	-7.6	-7.3	-7.0	-76.0
2.0%PC/3.0%LT, MYs 2021-2026, AC/Off-Cycle Phaseout	5.1	-1.0	-1.8	-2.2	-3.5	-6.1	-5.2	-5.3	-4.9	-4.8	-2.5	-2.4	-2.4	-2.3	-39.2
2.0%PC/3.0%LT, MYs 2022-2026	4.7	-0.1	-0.8	-1.4	-2.2	-4.1	-4.6	-4.9	-5.1	-5.9	-4.7	-4.5	-4.3	-4.2	-42.1

*** EO 12866 Review – Draft – Do Not Cite, Quote or Release During Review ***

**TABLE 9-36 - PRESENT VALUE OF LIFETIME SOCIETAL BENEFITS, LIGHT TRUCKS,
3% DISCOUNT RATE, CO₂ (BILLIONS OF 2016\$)**

Light Trucks	MY 1977- 2016	MY 2017	MY 2018	MY 2019	MY 2020	MY 2021	MY 2022	MY 2023	MY 2024	MY 2025	MY 2026	MY 2027	MY 2028	MY 2029	MY TOTAL
0.0%PC/0.0%LT, MYs 2021-2026	16.5	1.2	-1.1	-4.6	-7.8	-	-	-	-	-	-	-	-	-	-145.6
0.5%PC/0.5%LT, MYs 2021-2026	15.5	1.3	-0.9	-4.3	-7.4	-	-	-	-	-	-	-	-	-	-139.6
0.5%PC/0.5%LT, MYs 2021-2026, AC/Off-Cycle Phaseout	14.2	1.0	-1.0	-4.4	-7.4	-	-	-	-	-	-	-	-	-	-132.6
1.0%PC/2.0%LT, MYs 2021-2026	10.2	0.6	-0.8	-3.2	-4.6	-8.6	-	-	-	-	-9.9	-9.9	-	-	-88.8
1.0%PC/2.0%LT, MYs 2022-2026	6.1	0.4	-0.4	-1.5	-2.4	-4.5	-5.6	-5.7	-5.8	-6.5	-5.5	-6.0	-6.8	-6.8	-51.0
2.0%PC/3.0%LT, MYs 2021-2026	5.3	0.1	-0.8	-2.3	-3.3	-5.7	-6.2	-6.2	-6.2	-6.4	-5.2	-4.5	-4.9	-4.5	-50.7
2.0%PC/3.0%LT, MYs 2021-2026, AC/Off-Cycle Phaseout	2.6	-0.2	-0.4	-0.9	-1.9	-3.7	-3.9	-3.7	-3.5	-3.3	-1.7	-0.7	-1.0	-0.8	-23.2
2.0%PC/3.0%LT, MYs 2022-2026	2.4	0.0	-0.2	-0.7	-1.3	-1.7	-1.9	-1.9	-2.0	-2.1	-1.2	-1.1	-1.6	-1.7	-14.9

*** EO 12866 Review – Draft – Do Not Cite, Quote or Release During Review ***

**TABLE 9-37 - PRESENT VALUE OF LIFETIME SOCIETAL BENEFITS, LIGHT TRUCKS,
7% DISCOUNT RATE, CAFE (BILLIONS OF 2016\$)**

Light Trucks	MY 1977- 2016	MY 2017	MY 2018	MY 2019	MY 2020	MY 2021	MY 2022	MY 2023	MY 2024	MY 2025	MY 2026	MY 2027	MY 2028	MY 2029	MY TOTAL
0.0%PC/0.0%LT, MYs 2021-2026	10.6	-0.5	-3.6	-5.9	-7.8	-12.8	-13.0	-12.7	-12.7	-12.9	-12.5	-11.4	-10.5	-9.6	-115.1
0.5%PC/0.5%LT, MYs 2021-2026	9.7	-0.5	-2.8	-4.9	-6.8	-11.8	-12.1	-11.9	-11.9	-12.0	-11.3	-10.4	-9.5	-8.7	-104.9
0.5%PC/0.5%LT, MYs 2021-2026, AC/Off-Cycle Phaseout	9.2	-0.5	-2.6	-4.4	-6.3	-11.0	-11.3	-11.1	-11.1	-11.2	-10.4	-9.5	-8.8	-8.1	-97.2
1.0%PC/2.0%LT, MYs 2021-2026	7.6	-0.7	-2.3	-3.9	-5.0	-8.8	-8.9	-8.8	-8.7	-8.9	-7.9	-7.3	-6.8	-6.2	-76.7
1.0%PC/2.0%LT, MYs 2022-2026	5.3	-0.1	-1.4	-2.8	-3.7	-6.1	-6.8	-6.6	-6.5	-6.6	-5.8	-5.4	-5.0	-4.6	-56.0
2.0%PC/3.0%LT, MYs 2021-2026	5.1	-0.8	-1.8	-2.5	-3.6	-6.1	-5.8	-5.5	-5.2	-5.4	-4.5	-4.2	-3.9	-3.6	-47.7
2.0%PC/3.0%LT, MYs 2021-2026, AC/Off-Cycle Phaseout	3.3	-0.9	-1.4	-1.6	-2.5	-4.2	-3.4	-3.4	-3.0	-2.8	-1.5	-1.3	-1.3	-1.2	-25.1
2.0%PC/3.0%LT, MYs 2022-2026	2.9	-0.1	-0.7	-1.1	-1.6	-2.9	-3.1	-3.2	-3.1	-3.5	-2.7	-2.5	-2.3	-2.1	-26.1

*** EO 12866 Review – Draft – Do Not Cite, Quote or Release During Review ***

**TABLE 9-38 - PRESENT VALUE OF LIFETIME SOCIETAL BENEFITS, LIGHT TRUCKS,
7% DISCOUNT RATE, CO₂ (BILLIONS OF 2016\$)**

Light Trucks	MY 1977- 2016	MY 2017	MY 2018	MY 2019	MY 2020	MY 2021	MY 2022	MY 2023	MY 2024	MY 2025	MY 2026	MY 2027	MY 2028	MY 2029	MY TOTAL
0.0%PC/0.0%LT, MYs 2021-2026	9.8	0.4	-1.3	-3.8	-5.9	-9.6	-10.5	-10.3	-10.4	-10.2	-10.1	-9.8	-9.8	-9.2	-115.1
0.5%PC/0.5%LT, MYs 2021-2026	9.2	0.5	-1.1	-3.6	-5.6	-9.2	-10.2	-10.0	-10.2	-9.8	-9.5	-9.3	-9.3	-8.7	-104.9
0.5%PC/0.5%LT, MYs 2021-2026, AC/Off- Cycle Phaseout	8.5	0.4	-1.1	-3.6	-5.6	-9.0	-10.0	-9.8	-9.7	-9.3	-8.7	-8.3	-8.4	-7.9	-97.2
1.0%PC/2.0%LT, MYs 2021-2026	6.0	0.2	-0.9	-2.6	-3.5	-6.0	-6.7	-6.7	-6.6	-6.5	-5.7	-5.5	-5.6	-5.2	-76.7
1.0%PC/2.0%LT, MYs 2022-2026	3.5	0.1	-0.5	-1.2	-1.8	-3.2	-3.8	-3.7	-3.6	-3.9	-3.2	-3.3	-3.6	-3.5	-56.0
2.0%PC/3.0%LT, MYs 2021-2026	3.1	0.0	-0.7	-1.8	-2.4	-4.0	-4.2	-4.0	-3.8	-3.8	-3.0	-2.5	-2.6	-2.3	-47.7
2.0%PC/3.0%LT, MYs 2021-2026, AC/Off- Cycle Phaseout	1.6	-0.2	-0.3	-0.7	-1.3	-2.6	-2.6	-2.3	-2.2	-2.0	-1.0	-0.4	-0.5	-0.4	-25.1
2.0%PC/3.0%LT, MYs 2022-2026	1.4	-0.1	-0.2	-0.5	-0.9	-1.2	-1.3	-1.3	-1.3	-1.2	-0.7	-0.6	-0.9	-0.9	-26.1

*** EO 12866 Review – Draft – Do Not Cite, Quote or Release During Review ***

**TABLE 9-39 - PRESENT VALUE OF LIFETIME SOCIETAL BENEFITS, COMBINED,
3% DISCOUNT RATE, CAFE (BILLIONS OF 2016\$)**

Passenger Cars and Light Trucks	MY 1977-2016	MY 2017	MY 2018	MY 2019	MY 2020	MY 2021	MY 2022	MY 2023	MY 2024	MY 2025	MY 2026	MY 2027	MY 2028	MY 2029	MY TOTAL
0.0%PC/0.0%LT, MYs 2021-2026	43.4	1.5	-4.6	-9.4	-15.9	-29.3	-34.1	-36.6	-39.1	-41.3	-42.1	-40.9	-39.5	-38.4	-326.2
0.5%PC/0.5%LT, MYs 2021-2026	40.6	1.3	-3.6	-8.1	-14.6	-27.7	-32.4	-34.9	-37.4	-39.5	-39.5	-38.4	-37.0	-36.0	-307.1
0.5%PC/0.5%LT, MYs 2021-2026, AC/Off-Cycle Phaseout	38.3	1.1	-3.5	-7.5	-14.0	-26.4	-30.9	-33.3	-35.8	-37.7	-37.0	-35.7	-34.5	-33.5	-290.3
1.0%PC/2.0%LT, MYs 2021-2026	33.3	0.5	-3.3	-6.8	-12.1	-23.1	-26.9	-29.1	-31.1	-32.9	-31.6	-30.2	-29.1	-28.1	-250.7
1.0%PC/2.0%LT, MYs 2022-2026	25.5	1.2	-1.1	-3.8	-8.3	-15.9	-20.1	-22.4	-23.9	-25.5	-24.3	-23.3	-22.5	-21.7	-186.1
2.0%PC/3.0%LT, MYs 2021-2026	22.7	-0.4	-3.2	-5.5	-10.3	-18.3	-20.0	-21.1	-20.8	-22.0	-19.5	-18.4	-17.6	-17.0	-171.3
2.0%PC/3.0%LT, MYs 2021-2026, AC/Off-Cycle Phaseout	14.0	-1.2	-3.2	-4.8	-9.0	-15.0	-15.5	-16.3	-15.5	-15.2	-10.8	-9.4	-9.1	-8.8	-119.9
2.0%PC/3.0%LT, MYs 2022-2026	13.9	0.4	-0.8	-2.0	-5.6	-10.2	-12.5	-14.1	-15.1	-16.4	-13.9	-12.8	-12.2	-11.8	-113.0

*** EO 12866 Review – Draft – Do Not Cite, Quote or Release During Review ***

**TABLE 9-40 - PRESENT VALUE OF LIFETIME SOCIETAL BENEFITS, COMBINED,
3% DISCOUNT RATE, CO₂ (BILLIONS OF 2016\$)**

Passenger Cars and Light Trucks	MY 1977-2016	MY 2017	MY 2018	MY 2019	MY 2020	MY 2021	MY 2022	MY 2023	MY 2024	MY 2025	MY 2026	MY 2027	MY 2028	MY 2029	MY TOTAL
0.0%PC/0.0%LT, MYs 2021-2026	38.0	3.0	-1.4	-5.9	-11.6	-20.8	-26.6	-29.6	-33.2	-36.4	-38.6	-39.6	-40.7	-40.4	-283.7
0.5%PC/0.5%LT, MYs 2021-2026	36.1	3.1	-1.0	-5.4	-10.9	-19.8	-25.6	-28.6	-32.2	-35.3	-36.5	-37.8	-38.9	-38.7	-271.4
0.5%PC/0.5%LT, MYs 2021-2026, AC/Off-Cycle Phaseout	33.7	2.7	-1.3	-5.7	-10.7	-19.2	-24.6	-27.4	-29.7	-32.4	-33.2	-33.7	-34.5	-34.3	-250.3
1.0%PC/2.0%LT, MYs 2021-2026	26.4	1.9	-1.3	-4.6	-7.8	-14.7	-19.2	-22.0	-23.9	-26.0	-25.9	-26.3	-27.0	-26.7	-197.2
1.0%PC/2.0%LT, MYs 2022-2026	17.1	1.8	0.7	-0.6	-3.0	-7.6	-10.7	-12.8	-14.1	-17.2	-16.8	-17.6	-18.7	-18.7	-118.2
2.0%PC/3.0%LT, MYs 2021-2026	15.9	0.9	-0.5	-2.4	-4.8	-9.7	-12.2	-13.4	-14.3	-16.6	-15.3	-14.6	-15.0	-14.3	-116.4
2.0%PC/3.0%LT, MYs 2021-2026, AC/Off-Cycle Phaseout	8.5	0.0	-0.6	-1.4	-3.6	-7.3	-8.6	-9.2	-9.4	-10.6	-8.1	-6.4	-6.8	-6.2	-69.7
2.0%PC/3.0%LT, MYs 2022-2026	7.7	0.7	0.2	-0.4	-2.1	-4.1	-5.3	-6.4	-7.1	-9.2	-8.1	-8.0	-8.6	-8.4	-59.0

*** EO 12866 Review – Draft – Do Not Cite, Quote or Release During Review ***

**TABLE 9-41 - PRESENT VALUE OF LIFETIME SOCIETAL BENEFITS, COMBINED,
7% DISCOUNT RATE, CAFE (BILLIONS OF 2016\$)**

Passenger Cars and Light Trucks	MY 1977-2016	MY 2017	MY 2018	MY 2019	MY 2020	MY 2021	MY 2022	MY 2023	MY 2024	MY 2025	MY 2026	MY 2027	MY 2028	MY 2029	MY TOTAL
0.0%PC/0.0%LT, MYs 2021-2026	26.7	0.1	-4.5	-7.9	-12.1	-20.9	-23.3	-24.0	-24.6	-25.0	-24.5	-22.9	-21.3	-20.0	-204.1
0.5%PC/0.5%LT, MYs 2021-2026	25.0	-0.1	-3.7	-6.8	-11.1	-19.7	-22.1	-22.8	-23.5	-23.9	-23.0	-21.5	-20.0	-18.7	-191.8
0.5%PC/0.5%LT, MYs 2021-2026, AC/Off-Cycle Phaseout	23.6	-0.1	-3.5	-6.4	-10.7	-18.8	-21.1	-21.8	-22.5	-22.8	-21.5	-20.0	-18.6	-17.4	-181.4
1.0%PC/2.0%LT, MYs 2021-2026	20.6	-0.4	-3.2	-5.7	-9.2	-16.4	-18.3	-19.0	-19.6	-19.9	-18.4	-16.9	-15.7	-14.6	-156.7
1.0%PC/2.0%LT, MYs 2022-2026	15.7	0.3	-1.4	-3.2	-6.3	-11.3	-13.6	-14.6	-15.0	-15.4	-14.1	-13.1	-12.1	-11.3	-115.5
2.0%PC/3.0%LT, MYs 2021-2026	14.2	-0.8	-2.8	-4.4	-7.7	-12.9	-13.6	-13.8	-13.1	-13.3	-11.3	-10.3	-9.5	-8.8	-108.0
2.0%PC/3.0%LT, MYs 2021-2026, AC/Off-Cycle Phaseout	9.0	-1.2	-2.6	-3.7	-6.6	-10.5	-10.4	-10.5	-9.6	-9.1	-6.3	-5.3	-4.9	-4.6	-76.2
2.0%PC/3.0%LT, MYs 2022-2026	8.6	0.0	-0.8	-1.7	-4.2	-7.2	-8.5	-9.2	-9.5	-9.8	-8.1	-7.2	-6.6	-6.1	-70.2

*** EO 12866 Review – Draft – Do Not Cite, Quote or Release During Review ***

**TABLE 9-42 - PRESENT VALUE OF LIFETIME SOCIETAL BENEFITS, COMBINED,
7% DISCOUNT RATE, CO₂ (BILLIONS OF 2016\$)**

Passenger Cars and Light Trucks	MY 1977- 2016	MY 2017	MY 2018	MY 2019	MY 2020	MY 2021	MY 2022	MY 2023	MY 2024	MY 2025	MY 2026	MY 2027	MY 2028	MY 2029	MY TOTAL
0.0%PC/0.0%LT, MYs 2021-2026	22.9	1.1	-2.1	-5.3	-9.2	-15.1	-18.3	-19.6	-21.1	-22.2	-22.5	-22.3	-22.0	-21.0	-204.1
0.5%PC/0.5%LT, MYs 2021-2026	21.8	1.3	-1.8	-4.9	-8.6	-14.4	-17.6	-18.9	-20.4	-21.4	-21.4	-21.2	-21.0	-20.1	-191.8
0.5%PC/0.5%LT, MYs 2021-2026, AC/Off-Cycle Phaseout	20.4	1.1	-1.9	-5.0	-8.4	-13.9	-16.9	-18.1	-18.8	-19.7	-19.4	-18.9	-18.6	-17.8	-181.4
1.0%PC/2.0%LT, MYs 2021-2026	16.0	0.7	-1.7	-4.0	-6.1	-10.6	-13.2	-14.5	-15.1	-15.7	-15.1	-14.8	-14.6	-13.8	-156.7
1.0%PC/2.0%LT, MYs 2022-2026	10.1	0.9	0.0	-0.9	-2.5	-5.6	-7.4	-8.5	-8.9	-10.4	-9.9	-9.9	-10.1	-9.7	-115.5
2.0%PC/3.0%LT, MYs 2021-2026	9.7	0.3	-0.8	-2.1	-3.7	-7.0	-8.3	-8.8	-9.0	-10.0	-8.9	-8.2	-8.1	-7.4	-108.0
2.0%PC/3.0%LT, MYs 2021-2026, AC/Off-Cycle Phaseout	5.4	-0.1	-0.6	-1.1	-2.7	-5.1	-5.8	-5.9	-5.9	-6.3	-4.7	-3.6	-3.7	-3.2	-76.2
2.0%PC/3.0%LT, MYs 2022-2026	4.6	0.3	0.0	-0.4	-1.6	-3.0	-3.6	-4.2	-4.5	-5.6	-4.7	-4.5	-4.6	-4.3	-70.2

*** EO 12866 Review – Draft – Do Not Cite, Quote or Release During Review ***

TABLE 9-43 - PER-VEHICLE NET PRESENT VALUE OF OWNERSHIP BENEFITS UNDER PREFERRED ALTERNATIVE, PASSENGER CAR, 3% DISCOUNT RATE, CAFE (BILLIONS OF 2016\$)

	MY 2017	MY 2018	MY 2019	MY 2020	MY 2021	MY 2022	MY 2023	MY 2024	MY 2025	MY 2026	MY 2027	MY 2028	MY 2029	MY 2030
Fuel Savings	178	67	-19	-232	-583	-794	-927	-1031	-1089	-1122	-1117	-1120	-1126	-1119
Mobility Benefit	2	-29	-51	-106	-211	-277	-314	-346	-364	-379	-381	-388	-398	-405
Refueling Benefit	36	30	26	13	-6	-20	-30	-39	-46	-52	-54	-55	-56	-55
Total Consumer Benefits	216	69	-45	-325	-799	-1090	-1271	-1416	-1500	-1553	-1552	-1562	-1580	-1580

TABLE 9-44 - PER-VEHICLE NET PRESENT VALUE OF OWNERSHIP BENEFITS UNDER PREFERRED ALTERNATIVE, PASSENGER CAR, 3% DISCOUNT RATE, CO₂ (BILLIONS OF 2016\$)

	MY 2017	MY 2018	MY 2019	MY 2020	MY 2021	MY 2022	MY 2023	MY 2024	MY 2025	MY 2026	MY 2027	MY 2028	MY 2029	MY 2030
Fuel Savings	189	76	18	-134	-337	-555	-695	-864	-1038	-1130	-1206	-1254	-1266	-1259
Mobility Benefit	10	-23	-41	-84	-150	-219	-262	-312	-363	-395	-420	-440	-452	-459
Refueling Benefit	46	40	37	28	17	3	-10	-21	-36	-45	-50	-55	-58	-61
Total Consumer Benefits	245	93	14	-189	-470	-772	-967	-1197	-1436	-1569	-1677	-1748	-1777	-1779

*** EO 12866 Review – Draft – Do Not Cite, Quote or Release During Review ***

TABLE 9-45 - PER-VEHICLE NET PRESENT VALUE OF OWNERSHIP BENEFITS UNDER PREFERRED ALTERNATIVE, PASSENGER CAR, 7% DISCOUNT RATE, CAFE (BILLIONS OF 2016\$)

	MY 2017	MY 2018	MY 2019	MY 2020	MY 2021	MY 2022	MY 2023	MY 2024	MY 2025	MY 2026	MY 2027	MY 2028	MY 2029	MY 2030
Fuel Savings	78	-6	-74	-242	-521	-689	-795	-878	-923	-949	-945	-947	-952	-948
Mobility Benefit	0	-24	-41	-85	-170	-223	-253	-280	-295	-307	-309	-315	-324	-330
Refueling Benefit	26	22	18	8	-7	-18	-27	-34	-40	-44	-46	-46	-47	-47
Total Consumer Benefits	104	-8	-97	-318	-697	-930	-1075	-1191	-1258	-1301	-1300	-1309	-1323	-1325

TABLE 9-46 - PER-VEHICLE NET PRESENT VALUE OF OWNERSHIP BENEFITS UNDER PREFERRED ALTERNATIVE, PASSENGER CAR, 7% DISCOUNT RATE, CO₂ (BILLIONS OF 2016\$)

	MY 2017	MY 2018	MY 2019	MY 2020	MY 2021	MY 2022	MY 2023	MY 2024	MY 2025	MY 2026	MY 2027	MY 2028	MY 2029	MY 2030
Fuel Savings	88	0	-46	-165	-326	-500	-611	-746	-885	-959	-1020	-1057	-1067	-1061
Mobility Benefit	6	-19	-33	-67	-121	-177	-212	-253	-294	-320	-341	-357	-368	-374
Refueling Benefit	35	30	27	21	11	0	-10	-20	-31	-38	-43	-47	-49	-52
Total Consumer Benefits	128	10	-52	-212	-435	-677	-833	-1018	-1211	-1317	-1404	-1461	-1484	-1487

*** EO 12866 Review – Draft – Do Not Cite, Quote or Release During Review ***

**TABLE 9-47 - PER-VEHICLE NET PRESENT VALUE OF OWNERSHIP BENEFITS UNDER PREFERRED ALTERNATIVE,
LIGHT TRUCK, 3% DISCOUNT RATE, CAFE (BILLIONS OF 2016\$)**

	MY 2017	MY 2018	MY 2019	MY 2020	MY 2021	MY 2022	MY 2023	MY 2024	MY 2025	MY 2026	MY 2027	MY 2028	MY 2029	MY 2030
Fuel Savings	43	-274	-524	-767	-1377	-1531	-1642	-1782	-1953	-2068	-2067	-2086	-2095	-2101
Mobility Benefit	-35	-101	-174	-233	-406	-449	-482	-520	-576	-612	-627	-646	-662	-677
Refueling Benefit	-28	-41	-49	-58	-81	-86	-87	-92	-95	-96	-92	-88	-85	-82
Total Consumer Benefits	-20	-416	-746	-1058	-1864	-2066	-2211	-2394	-2623	-2776	-2786	-2820	-2842	-2859

**TABLE 9-48 - PER-VEHICLE NET PRESENT VALUE OF OWNERSHIP BENEFITS UNDER PREFERRED ALTERNATIVE,
LIGHT TRUCK, 3% DISCOUNT RATE, CO₂ (BILLIONS OF 2016\$)**

	MY 2017	MY 2018	MY 2019	MY 2020	MY 2021	MY 2022	MY 2023	MY 2024	MY 2025	MY 2026	MY 2027	MY 2028	MY 2029	MY 2030
Fuel Savings	153	-20	-279	-535	-984	-1196	-1318	-1490	-1595	-1776	-1889	-2038	-2104	-2121
Mobility Benefit	-29	-65	-133	-196	-328	-379	-414	-458	-494	-545	-590	-641	-674	-692
Refueling Benefit	-33	-40	-49	-58	-74	-81	-82	-86	-87	-88	-88	-90	-88	-83
Total Consumer Benefits	90	-125	-461	-789	-1386	-1656	-1814	-2035	-2175	-2408	-2567	-2770	-2867	-2895

*** EO 12866 Review – Draft – Do Not Cite, Quote or Release During Review ***

TABLE 9-49 - PER-VEHICLE NET PRESENT VALUE OF OWNERSHIP BENEFITS UNDER PREFERRED ALTERNATIVE, LIGHT TRUCK, 7% DISCOUNT RATE, CAFE (BILLIONS OF 2016\$)

	MY 2017	MY 2018	MY 2019	MY 2020	MY 2021	MY 2022	MY 2023	MY 2024	MY 2025	MY 2026	MY 2027	MY 2028	MY 2029	MY 2030
Fuel Savings	-18	-262	-457	-647	-1126	-1247	-1334	-1444	-1580	-1671	-1671	-1687	-1695	-1700
Mobility Benefit	-27	-79	-138	-186	-326	-362	-389	-420	-465	-495	-507	-522	-536	-548
Refueling Benefit	-25	-35	-41	-49	-67	-70	-71	-75	-78	-78	-75	-72	-69	-67
Total Consumer Benefits	-71	-375	-636	-881	-1519	-1679	-1794	-1939	-2122	-2244	-2253	-2281	-2300	-2315

TABLE 9-50 - PER-VEHICLE NET PRESENT VALUE OF OWNERSHIP BENEFITS UNDER PREFERRED ALTERNATIVE, LIGHT TRUCK, 7% DISCOUNT RATE, CO₂ (BILLIONS OF 2016\$)

	MY 2017	MY 2018	MY 2019	MY 2020	MY 2021	MY 2022	MY 2023	MY 2024	MY 2025	MY 2026	MY 2027	MY 2028	MY 2029	MY 2030
Fuel Savings	59	-72	-274	-472	-824	-989	-1085	-1220	-1302	-1445	-1535	-1652	-1705	-1719
Mobility Benefit	-23	-50	-105	-156	-263	-305	-333	-369	-399	-440	-477	-518	-546	-560
Refueling Benefit	-30	-35	-42	-49	-61	-67	-68	-71	-71	-72	-72	-74	-72	-68
Total Consumer Benefits	6	-157	-420	-678	-1148	-1362	-1486	-1660	-1772	-1957	-2083	-2244	-2323	-2347

*** EO 12866 Review – Draft – Do Not Cite, Quote or Release During Review ***

TABLE 9-51 - PER-VEHICLE NET PRESENT VALUE OF OWNERSHIP BENEFITS UNDER PREFERRED ALTERNATIVE, COMBINED LIGHT-DUTY, 3% DISCOUNT RATE, CAFE (BILLIONS OF 2016\$)

	MY 2017	MY 2018	MY 2019	MY 2020	MY 2021	MY 2022	MY 2023	MY 2024	MY 2025	MY 2026	MY 2027	MY 2028	MY 2029	MY 2030
Fuel Savings	117	-91	-251	-478	-948	-1123	-1233	-1343	-1439	-1495	-1478	-1479	-1477	-1468
Mobility Benefit	-11	-59	-106	-163	-301	-356	-390	-425	-461	-485	-494	-506	-519	-529
Refueling Benefit	9	0	-7	-18	-39	-48	-54	-61	-67	-70	-70	-68	-67	-66
Total Consumer Benefits	114	-151	-364	-659	-1288	-1527	-1678	-1829	-1967	-2050	-2041	-2053	-2064	-2063

TABLE 9-52 - PER-VEHICLE NET PRESENT VALUE OF OWNERSHIP BENEFITS UNDER PREFERRED ALTERNATIVE, COMBINED LIGHT-DUTY, 3% DISCOUNT RATE, CO₂ (BILLIONS OF 2016\$)

	MY 2017	MY 2018	MY 2019	MY 2020	MY 2021	MY 2022	MY 2023	MY 2024	MY 2025	MY 2026	MY 2027	MY 2028	MY 2029	MY 2030
Fuel Savings	173	31	-119	-318	-633	-841	-955	-1112	-1235	-1347	-1429	-1513	-1534	-1519
Mobility Benefit	-3	-38	-81	-134	-233	-293	-331	-378	-421	-462	-497	-531	-553	-565
Refueling Benefit	12	6	0	-9	-23	-34	-41	-49	-57	-62	-65	-69	-69	-69
Total Consumer Benefits	182	0	-200	-461	-888	-1168	-1327	-1539	-1713	-1871	-1991	-2113	-2157	-2152

*** EO 12866 Review – Draft – Do Not Cite, Quote or Release During Review ***

TABLE 9-53 - PER-VEHICLE NET PRESENT VALUE OF OWNERSHIP BENEFITS UNDER PREFERRED ALTERNATIVE, COMBINED LIGHT-DUTY, 7% DISCOUNT RATE, CAFE (BILLIONS OF 2016\$)

	MY 2017	MY 2018	MY 2019	MY 2020	MY 2021	MY 2022	MY 2023	MY 2024	MY 2025	MY 2026	MY 2027	MY 2028	MY 2029	MY 2030
Fuel Savings	34	-125	-250	-428	-799	-938	-1025	-1111	-1187	-1231	-1218	-1219	-1218	-1211
Mobility Benefit	-10	-47	-85	-130	-242	-287	-315	-343	-373	-393	-400	-410	-421	-429
Refueling Benefit	4	-3	-8	-16	-33	-41	-46	-51	-56	-59	-58	-57	-56	-55
Total Consumer Benefits	29	-174	-343	-574	-1074	-1265	-1385	-1506	-1616	-1683	-1676	-1686	-1695	-1695

TABLE 9-54 - PER-VEHICLE NET PRESENT VALUE OF OWNERSHIP BENEFITS UNDER PREFERRED ALTERNATIVE, COMBINED LIGHT-DUTY, 7% DISCOUNT RATE, CO₂ (BILLIONS OF 2016\$)

	MY 2017	MY 2018	MY 2019	MY 2020	MY 2021	MY 2022	MY 2023	MY 2024	MY 2025	MY 2026	MY 2027	MY 2028	MY 2029	MY 2030
Fuel Savings	75	-33	-151	-306	-554	-718	-808	-932	-1030	-1118	-1183	-1249	-1266	-1254
Mobility Benefit	-3	-30	-65	-107	-187	-236	-267	-305	-341	-374	-402	-430	-449	-459
Refueling Benefit	7	2	-2	-10	-21	-29	-35	-41	-48	-52	-54	-57	-58	-57
Total Consumer Benefits	79	-61	-218	-423	-761	-984	-1110	-1278	-1418	-1545	-1640	-1737	-1773	-1770

*** EO 12866 Review – Draft – Do Not Cite, Quote or Release During Review ***

**TABLE 9-55 - MY 2030 PER-VEHICLE NET PRESENT VALUE OF OWNERSHIP BENEFITS,
PASSENGER CAR, 3% DISCOUNT RATE, CAFE (BILLIONS OF 2016\$)**

	Alternative							
	1	2	3	4	5	6	7	8
Model Years	2021-2026	2021-2026	2021-2026	2021-2026	2022-2026	2021-2026	2021-2026	2022-2026
Annual Rate of Stringency Increase	0.0%/Year PC 0.0%/Year LT	0.5%/Year PC 0.5%/Year LT	0.5%/Year PC 0.5%/Year LT	1.0%/Year PC 2.0%/Year LT	1.0%/Year PC 2.0%/Year LT	2.0%/Year PC 3.0%/Year LT	2.0%/Year PC 3.0%/Year LT	2.0%/Year PC 3.0%/Year LT
AC/Off-Cycle Procedures	No Change	No Change	Phaseout 2022-2026	No Change	No Change	No Change	Phaseout 2022-2026	No Change
Fuel Savings	-1119	-1089	-1029	-984	-817	-666	-463	-537
Mobility Benefit	-405	-391	-364	-341	-277	-220	-142	-169
Refueling Benefit	-55	-54	-51	-49	-41	-33	-24	-27
Total Consumer Benefits	-1580	-1533	-1444	-1374	-1134	-919	-629	-733

**TABLE 9-56 - MY 2030 PER-VEHICLE NET PRESENT VALUE OF OWNERSHIP BENEFITS,
PASSENGER CAR, 3% DISCOUNT RATE, CO₂ (BILLIONS OF 2016\$)**

	Alternative							
	1	2	3	4	5	6	7	8
Model Years	2021-2026	2021-2026	2021-2026	2021-2026	2022-2026	2021-2026	2021-2026	2022-2026
Annual Rate of Stringency Increase	0.0%/Year PC 0.0%/Year LT	0.5%/Year PC 0.5%/Year LT	0.5%/Year PC 0.5%/Year LT	1.0%/Year PC 2.0%/Year LT	1.0%/Year PC 2.0%/Year LT	2.0%/Year PC 3.0%/Year LT	2.0%/Year PC 3.0%/Year LT	2.0%/Year PC 3.0%/Year LT
AC/Off-Cycle Procedures	No Change	No Change	Phaseout 2022-2026	No Change	No Change	No Change	Phaseout 2022-2026	No Change
Fuel Savings	-1259	-1207	-1046	-949	-759	-626	-376	-473
Mobility Benefit	-459	-438	-379	-334	-260	-209	-114	-150
Refueling Benefit	-61	-59	-51	-46	-38	-31	-19	-23
Total Consumer Benefits	-1779	-1704	-1476	-1330	-1056	-867	-509	-647

*** EO 12866 Review – Draft – Do Not Cite, Quote or Release During Review ***

**TABLE 9-57 - MY 2030 PER-VEHICLE NET PRESENT VALUE OF OWNERSHIP BENEFITS,
PASSENGER CAR, 7% DISCOUNT RATE, CAFE (BILLIONS OF 2016\$)**

	Alternative							
	1	2	3	4	5	6	7	8
Model Years	2021-2026	2021-2026	2021-2026	2021-2026	2022-2026	2021-2026	2021-2026	2022-2026
Annual Rate of Stringency Increase	0.0%/Year PC 0.0%/Year LT	0.5%/Year PC 0.5%/Year LT	0.5%/Year PC 0.5%/Year LT	1.0%/Year PC 2.0%/Year LT	1.0%/Year PC 2.0%/Year LT	2.0%/Year PC 3.0%/Year LT	2.0%/Year PC 3.0%/Year LT	2.0%/Year PC 3.0%/Year LT
AC/Off-Cycle Procedures	No Change	No Change	Phaseout 2022-2026	No Change	No Change	No Change	Phaseout 2022-2026	No Change
Fuel Savings	-948	-920	-869	-827	-684	-557	-383	-445
Mobility Benefit	-330	-318	-296	-278	-225	-178	-116	-137
Refueling Benefit	-47	-46	-43	-41	-34	-28	-20	-23
Total Consumer Benefits	-1325	-1284	-1208	-1146	-944	-764	-518	-605

**TABLE 9-58 - MY 2030 PER-VEHICLE NET PRESENT VALUE OF OWNERSHIP BENEFITS,
PASSENGER CAR, 7% DISCOUNT RATE, CO₂ (BILLIONS OF 2016\$)**

	Alternative							
	1	2	3	4	5	6	7	8
Model Years	2021-2026	2021-2026	2021-2026	2021-2026	2022-2026	2021-2026	2021-2026	2022-2026
Annual Rate of Stringency Increase	0.0%/Year PC 0.0%/Year LT	0.5%/Year PC 0.5%/Year LT	0.5%/Year PC 0.5%/Year LT	1.0%/Year PC 2.0%/Year LT	1.0%/Year PC 2.0%/Year LT	2.0%/Year PC 3.0%/Year LT	2.0%/Year PC 3.0%/Year LT	2.0%/Year PC 3.0%/Year LT
AC/Off-Cycle Procedures	No Change	No Change	Phaseout 2022-2026	No Change	No Change	No Change	Phaseout 2022-2026	No Change
Fuel Savings	-1061	-1018	-884	-797	-636	-523	-309	-391
Mobility Benefit	-374	-357	-308	-272	-211	-170	-92	-122
Refueling Benefit	-52	-50	-43	-39	-32	-26	-16	-19
Total Consumer Benefits	-1487	-1424	-1236	-1109	-879	-719	-417	-532

*** EO 12866 Review – Draft – Do Not Cite, Quote or Release During Review ***

*** EO 12866 Review – Draft – Do Not Cite, Quote or Release During Review ***

**TABLE 9-59 - MY 2030 PER-VEHICLE NET PRESENT VALUE OF OWNERSHIP BENEFITS,
LIGHT TRUCK, 3% DISCOUNT RATE, CAFE (BILLIONS OF 2016\$)**

	Alternative							
	1	2	3	4	5	6	7	8
Model Years	2021-2026	2021-2026	2021-2026	2021-2026	2022-2026	2021-2026	2021-2026	2022-2026
Annual Rate of Stringency Increase	0.0%/Year PC 0.0%/Year LT	0.5%/Year PC 0.5%/Year LT	0.5%/Year PC 0.5%/Year LT	1.0%/Year PC 2.0%/Year LT	1.0%/Year PC 2.0%/Year LT	2.0%/Year PC 3.0%/Year LT	2.0%/Year PC 3.0%/Year LT	2.0%/Year PC 3.0%/Year LT
AC/Off-Cycle Procedures	No Change	No Change	Phaseout 2022-2026	No Change	No Change	No Change	Phaseout 2022-2026	No Change
Fuel Savings	-2101	-1920	-1775	-1339	-962	-736	-262	-432
Mobility Benefit	-677	-614	-562	-408	-279	-206	-70	-119
Refueling Benefit	-82	-75	-69	-52	-38	-29	-11	-17
Total Consumer Benefits	-2859	-2609	-2406	-1799	-1279	-971	-343	-569

**TABLE 9-60 - MY 2030 PER-VEHICLE NET PRESENT VALUE OF OWNERSHIP BENEFITS,
LIGHT TRUCK, 3% DISCOUNT RATE, CO₂ (BILLIONS OF 2016\$)**

	Alternative							
	1	2	3	4	5	6	7	8
Model Years	2021-2026	2021-2026	2021-2026	2021-2026	2022-2026	2021-2026	2021-2026	2022-2026
Annual Rate of Stringency Increase	0.0%/Year PC 0.0%/Year LT	0.5%/Year PC 0.5%/Year LT	0.5%/Year PC 0.5%/Year LT	1.0%/Year PC 2.0%/Year LT	1.0%/Year PC 2.0%/Year LT	2.0%/Year PC 3.0%/Year LT	2.0%/Year PC 3.0%/Year LT	2.0%/Year PC 3.0%/Year LT
AC/Off-Cycle Procedures	No Change	No Change	Phaseout 2022-2026	No Change	No Change	No Change	Phaseout 2022-2026	No Change
Fuel Savings	-2121	-2031	-1833	-1230	-761	-535	-98	-186
Mobility Benefit	-692	-660	-593	-389	-229	-152	-22	-49
Refueling Benefit	-83	-79	-71	-48	-30	-22	-3	-8
Total Consumer Benefits	-2895	-2771	-2497	-1667	-1020	-708	-124	-243

*** EO 12866 Review – Draft – Do Not Cite, Quote or Release During Review ***

*** EO 12866 Review – Draft – Do Not Cite, Quote or Release During Review ***

**TABLE 9-61 - MY 2030 PER-VEHICLE NET PRESENT VALUE OF OWNERSHIP BENEFITS,
LIGHT TRUCK, 7% DISCOUNT RATE, CAFE (BILLIONS OF 2016\$)**

	Alternative							
	1	2	3	4	5	6	7	8
Model Years	2021-2026	2021-2026	2021-2026	2021-2026	2022-2026	2021-2026	2021-2026	2022-2026
Annual Rate of Stringency Increase	0.0%/Year PC 0.0%/Year LT	0.5%/Year PC 0.5%/Year LT	0.5%/Year PC 0.5%/Year LT	1.0%/Year PC 2.0%/Year LT	1.0%/Year PC 2.0%/Year LT	2.0%/Year PC 3.0%/Year LT	2.0%/Year PC 3.0%/Year LT	2.0%/Year PC 3.0%/Year LT
AC/Off-Cycle Procedures	No Change	No Change	Phaseout 2022-2026	No Change	No Change	No Change	Phaseout 2022-2026	No Change
Fuel Savings	-1700	-1552	-1436	-1083	-778	-596	-212	-350
Mobility Benefit	-548	-497	-455	-330	-226	-166	-57	-96
Refueling Benefit	-67	-61	-57	-43	-31	-24	-9	-14
Total Consumer Benefits	-2315	-2110	-1947	-1456	-1035	-787	-278	-460

**TABLE 9-62 - MY 2030 PER-VEHICLE NET PRESENT VALUE OF OWNERSHIP BENEFITS,
LIGHT TRUCK, 7% DISCOUNT RATE, CO₂ (BILLIONS OF 2016\$)**

	Alternative							
	1	2	3	4	5	6	7	8
Model Years	2021-2026	2021-2026	2021-2026	2021-2026	2022-2026	2021-2026	2021-2026	2022-2026
Annual Rate of Stringency Increase	0.0%/Year PC 0.0%/Year LT	0.5%/Year PC 0.5%/Year LT	0.5%/Year PC 0.5%/Year LT	1.0%/Year PC 2.0%/Year LT	1.0%/Year PC 2.0%/Year LT	2.0%/Year PC 3.0%/Year LT	2.0%/Year PC 3.0%/Year LT	2.0%/Year PC 3.0%/Year LT
AC/Off-Cycle Procedures	No Change	No Change	Phaseout 2022-2026	No Change	No Change	No Change	Phaseout 2022-2026	No Change
Fuel Savings	-1719	-1645	-1482	-994	-616	-433	-80	-152
Mobility Benefit	-560	-534	-480	-315	-186	-123	-18	-40
Refueling Benefit	-68	-65	-58	-39	-25	-18	-3	-7
Total Consumer Benefits	-2347	-2244	-2021	-1347	-826	-574	-101	-198

*** EO 12866 Review – Draft – Do Not Cite, Quote or Release During Review ***

**TABLE 9-63 - MY 2030 PER-VEHICLE NET PRESENT VALUE OF OWNERSHIP BENEFITS,
COMBINED LIGHT-DUTY, 3% DISCOUNT RATE, CAFE (BILLIONS OF 2016\$)**

	Alternative							
	1	2	3	4	5	6	7	8
Model Years	2021-2026	2021-2026	2021-2026	2021-2026	2022-2026	2021-2026	2021-2026	2022-2026
Annual Rate of Stringency Increase	0.0%/Year PC	0.5%/Year PC	0.5%/Year PC	1.0%/Year PC	1.0%/Year PC	2.0%/Year PC	2.0%/Year PC	2.0%/Year PC
	0.0%/Year LT	0.5%/Year LT	0.5%/Year LT	2.0%/Year LT	2.0%/Year LT	3.0%/Year LT	3.0%/Year LT	3.0%/Year LT
AC/Off-Cycle Procedures	No Change	No Change	Phaseout 2022-2026	No Change	No Change	No Change	Phaseout 2022-2026	No Change
Fuel Savings	-1468	-1377	-1288	-1092	-850	-677	-359	-477
Mobility Benefit	-529	-493	-455	-373	-278	-213	-108	-145
Refueling Benefit	-66	-62	-58	-50	-39	-31	-17	-22
Total Consumer Benefits	-2063	-1932	-1801	-1514	-1167	-922	-484	-645

**TABLE 9-64 - MY 2030 PER-VEHICLE NET PRESENT VALUE OF OWNERSHIP BENEFITS,
COMBINED LIGHT-DUTY, 3% DISCOUNT RATE, CO₂ (BILLIONS OF 2016\$)**

	Alternative							
	1	2	3	4	5	6	7	8
Model Years	2021-2026	2021-2026	2021-2026	2021-2026	2022-2026	2021-2026	2021-2026	2022-2026
Annual Rate of Stringency Increase	0.0%/Year PC	0.5%/Year PC	0.5%/Year PC	1.0%/Year PC	1.0%/Year PC	2.0%/Year PC	2.0%/Year PC	2.0%/Year PC
	0.0%/Year LT	0.5%/Year LT	0.5%/Year LT	2.0%/Year LT	2.0%/Year LT	3.0%/Year LT	3.0%/Year LT	3.0%/Year LT
AC/Off-Cycle Procedures	No Change	No Change	Phaseout 2022-2026	No Change	No Change	No Change	Phaseout 2022-2026	No Change
Fuel Savings	-1519	-1453	-1288	-995	-716	-550	-234	-328
Mobility Benefit	-565	-539	-477	-360	-246	-183	-70	-102
Refueling Benefit	-69	-66	-58	-46	-33	-26	-11	-16
Total Consumer Benefits	-2152	-2058	-1824	-1401	-995	-759	-315	-446

*** EO 12866 Review – Draft – Do Not Cite, Quote or Release During Review ***

**TABLE 9-65 - MY 2030 PER-VEHICLE NET PRESENT VALUE OF OWNERSHIP BENEFITS,
COMBINED LIGHT-DUTY, 7% DISCOUNT RATE, CAFE (BILLIONS OF 2016\$)**

	Alternative							
	1	2	3	4	5	6	7	8
Model Years	2021-2026	2021-2026	2021-2026	2021-2026	2022-2026	2021-2026	2021-2026	2022-2026
Annual Rate of Stringency Increase	0.0%/Year PC 0.0%/Year LT	0.5%/Year PC 0.5%/Year LT	0.5%/Year PC 0.5%/Year LT	1.0%/Year PC 2.0%/Year LT	1.0%/Year PC 2.0%/Year LT	2.0%/Year PC 3.0%/Year LT	2.0%/Year PC 3.0%/Year LT	2.0%/Year PC 3.0%/Year LT
AC/Off-Cycle Procedures	No Change	No Change	Phaseout 2022-2026	No Change	No Change	No Change	Phaseout 2022-2026	No Change
Fuel Savings	-1211	-1135	-1062	-900	-700	-558	-295	-392
Mobility Benefit	-429	-400	-369	-302	-226	-173	-88	-118
Refueling Benefit	-55	-51	-48	-41	-32	-26	-14	-18
Total Consumer Benefits	-1695	-1586	-1480	-1243	-958	-757	-397	-528

**TABLE 9-66 - MY 2030 PER-VEHICLE NET PRESENT VALUE OF OWNERSHIP BENEFITS,
COMBINED LIGHT-DUTY, 7% DISCOUNT RATE, CO₂ (BILLIONS OF 2016\$)**

	Alternative							
	1	2	3	4	5	6	7	8
Model Years	2021-2026	2021-2026	2021-2026	2021-2026	2022-2026	2021-2026	2021-2026	2022-2026
Annual Rate of Stringency Increase	0.0%/Year PC 0.0%/Year LT	0.5%/Year PC 0.5%/Year LT	0.5%/Year PC 0.5%/Year LT	1.0%/Year PC 2.0%/Year LT	1.0%/Year PC 2.0%/Year LT	2.0%/Year PC 3.0%/Year LT	2.0%/Year PC 3.0%/Year LT	2.0%/Year PC 3.0%/Year LT
AC/Off-Cycle Procedures	No Change	No Change	Phaseout 2022-2026	No Change	No Change	No Change	Phaseout 2022-2026	No Change
Fuel Savings	-1254	-1199	-1063	-820	-591	-454	-192	-270
Mobility Benefit	-459	-438	-387	-292	-199	-148	-57	-83
Refueling Benefit	-57	-55	-48	-38	-28	-22	-9	-13
Total Consumer Benefits	-1770	-1692	-1498	-1151	-818	-624	-258	-366

*** EO 12866 Review – Draft – Do Not Cite, Quote or Release During Review ***

TABLE 9-67 - BILLIONS OF GALLONS OF LIQUID FUEL SAVED, PASSENGER CARS, UNDISCOUNTED OVER THE LIFETIME OF THE MODEL YEAR, CAFE

Passenger Cars	MY 1977-2016	MY 2017	MY 2018	MY 2019	MY 2020	MY 2021	MY 2022	MY 2023	MY 2024	MY 2025	MY 2026	MY 2027	MY 2028	MY 2029	MY TOTAL
0.0%PC/0.0%LT, MYs 2021-2026	10.7	0.9	0.5	0.1	-0.7	-2.1	-3.1	-3.9	-4.5	-5.1	-5.5	-5.7	-5.7	-5.8	-29.7
0.5%PC/0.5%LT, MYs 2021-2026	10.2	0.9	0.4	0.1	-0.8	-2.1	-3.0	-3.8	-4.4	-5.0	-5.3	-5.5	-5.5	-5.5	-29.3
0.5%PC/0.5%LT, MYs 2021-2026, AC/Off-Cycle Phaseout	9.6	0.8	0.4	0.0	-0.8	-2.1	-3.0	-3.7	-4.4	-4.9	-5.2	-5.1	-5.1	-5.1	-28.7
1.0%PC/2.0%LT, MYs 2021-2026	8.6	0.6	0.3	0.0	-0.8	-2.1	-3.0	-3.6	-4.2	-4.7	-4.8	-4.7	-4.6	-4.6	-27.7
1.0%PC/2.0%LT, MYs 2022-2026	6.9	0.6	0.4	0.3	-0.5	-1.4	-2.1	-2.8	-3.3	-3.7	-3.9	-3.7	-3.7	-3.6	-20.6
2.0%PC/3.0%LT, MYs 2021-2026	5.9	0.4	0.0	-0.3	-1.0	-2.0	-2.6	-3.0	-3.2	-3.4	-3.2	-2.9	-2.9	-2.8	-21.0
2.0%PC/3.0%LT, MYs 2021-2026, AC/Off-Cycle Phaseout	3.6	0.1	-0.2	-0.5	-1.2	-2.0	-2.5	-2.8	-2.9	-2.9	-2.4	-1.9	-1.9	-1.8	-19.3
2.0%PC/3.0%LT, MYs 2022-2026	3.8	0.3	0.2	0.0	-0.6	-1.3	-1.8	-2.2	-2.6	-2.8	-2.6	-2.3	-2.2	-2.1	-16.2

*** EO 12866 Review – Draft – Do Not Cite, Quote or Release During Review ***

**TABLE 9-68 - BILLIONS OF GALLONS OF LIQUID FUEL SAVED, PASSENGER CARS,
UNDISCOUNTED OVER THE LIFETIME OF THE MODEL YEAR, CO₂**

Passenger Cars	MY 1977- 2016	MY 2017	MY 2018	MY 2019	MY 2020	MY 2021	MY 2022	MY 2023	MY 2024	MY 2025	MY 2026	MY 2027	MY 2028	MY 2029	MY TOTAL
0.0%PC/0.0%LT, MYs 2021-2026	9.0	1.0	0.5	0.3	-0.3	-1.1	-2.1	-3.1	-3.9	-4.9	-5.6	-6.0	-6.3	-6.6	-29.4
0.5%PC/0.5%LT, MYs 2021-2026	8.6	1.0	0.5	0.3	-0.3	-1.0	-2.0	-2.9	-3.8	-4.8	-5.4	-5.8	-6.1	-6.4	-28.0
0.5%PC/0.5%LT, MYs 2021-2026, AC/Off-Cycle Phaseout	8.2	0.9	0.4	0.2	-0.3	-1.0	-1.9	-2.8	-3.4	-4.3	-4.9	-5.2	-5.4	-5.6	-25.0
1.0%PC/2.0%LT, MYs 2021-2026	6.8	0.7	0.3	0.1	-0.3	-1.1	-1.8	-2.6	-3.2	-3.9	-4.3	-4.5	-4.7	-4.8	-23.4
1.0%PC/2.0%LT, MYs 2022-2026	4.6	0.6	0.5	0.5	0.1	-0.4	-0.9	-1.5	-1.9	-2.6	-3.0	-3.1	-3.2	-3.4	-13.7
2.0%PC/3.0%LT, MYs 2021-2026	4.4	0.4	0.3	0.2	-0.1	-0.7	-1.2	-1.7	-2.0	-2.6	-2.8	-2.8	-2.8	-2.8	-14.3
2.0%PC/3.0%LT, MYs 2021-2026, AC/Off-Cycle Phaseout	2.4	0.1	0.0	0.0	-0.3	-0.8	-1.1	-1.4	-1.6	-2.0	-1.9	-1.6	-1.6	-1.6	-11.3
2.0%PC/3.0%LT, MYs 2022-2026	2.2	0.3	0.2	0.2	-0.1	-0.5	-0.7	-1.0	-1.2	-1.9	-1.9	-1.9	-1.9	-1.9	-9.9

*** EO 12866 Review – Draft – Do Not Cite, Quote or Release During Review ***

**TABLE 9-69 - BILLIONS OF GALLONS OF LIQUID FUEL SAVED, LIGHT TRUCKS,
UNDISCOUNTED OVER THE LIFETIME OF THE MODEL YEAR, CAFE**

Light Trucks	MY 1977- 2016	MY 2017	MY 2018	MY 2019	MY 2020	MY 2021	MY 2022	MY 2023	MY 2024	MY 2025	MY 2026	MY 2027	MY 2028	MY 2029	MY TOTAL
0.0%PC/0.0%LT, MYs 2021-2026	7.4	0.3	-0.8	-1.7	-2.5	-4.5	-4.8	-5.0	-5.3	-5.6	-5.7	-5.4	-5.1	-4.8	-43.5
0.5%PC/0.5%LT, MYs 2021-2026	6.8	0.2	-0.6	-1.3	-2.2	-4.2	-4.5	-4.7	-5.0	-5.3	-5.2	-4.9	-4.6	-4.4	-40.0
0.5%PC/0.5%LT, MYs 2021-2026, AC/Off-Cycle Phaseout	6.4	0.2	-0.5	-1.2	-2.0	-3.9	-4.3	-4.4	-4.7	-5.0	-4.8	-4.5	-4.3	-4.1	-37.1
1.0%PC/2.0%LT, MYs 2021-2026	5.3	0.0	-0.6	-1.1	-1.6	-3.2	-3.4	-3.5	-3.7	-4.0	-3.7	-3.6	-3.4	-3.3	-29.8
1.0%PC/2.0%LT, MYs 2022-2026	3.8	0.2	-0.3	-0.8	-1.2	-2.2	-2.7	-2.7	-2.8	-3.1	-2.8	-2.7	-2.6	-2.5	-22.6
2.0%PC/3.0%LT, MYs 2021-2026	3.5	-0.1	-0.5	-0.8	-1.2	-2.3	-2.3	-2.3	-2.2	-2.5	-2.2	-2.2	-2.1	-2.0	-19.3
2.0%PC/3.0%LT, MYs 2021-2026, AC/Off-Cycle Phaseout	2.1	-0.3	-0.5	-0.6	-0.9	-1.7	-1.4	-1.4	-1.3	-1.3	-0.7	-0.6	-0.7	-0.6	-9.9
2.0%PC/3.0%LT, MYs 2022-2026	2.0	0.0	-0.1	-0.3	-0.5	-1.1	-1.2	-1.3	-1.4	-1.7	-1.3	-1.3	-1.3	-1.2	-10.8

*** EO 12866 Review – Draft – Do Not Cite, Quote or Release During Review ***

**TABLE 9-70 - BILLIONS OF GALLONS OF LIQUID FUEL SAVED, LIGHT TRUCKS,
UNDISCOUNTED OVER THE LIFETIME OF THE MODEL YEAR, CO₂**

Light Trucks	MY 1977- 2016	MY 2017	MY 2018	MY 2019	MY 2020	MY 2021	MY 2022	MY 2023	MY 2024	MY 2025	MY 2026	MY 2027	MY 2028	MY 2029	MY TOTAL
0.0%PC/0.0%LT, MYs 2021-2026	7.1	0.7	0.1	-0.8	-1.7	-3.2	-3.7	-3.8	-4.1	-4.1	-4.2	-4.3	-4.5	-4.3	-30.8
0.5%PC/0.5%LT, MYs 2021-2026	6.6	0.7	0.1	-0.7	-1.6	-3.0	-3.7	-3.7	-4.0	-4.0	-4.0	-4.1	-4.3	-4.1	-29.7
0.5%PC/0.5%LT, MYs 2021-2026, AC/Off-Cycle Phaseout	6.1	0.6	0.1	-0.8	-1.6	-3.0	-3.7	-3.7	-3.8	-3.8	-3.6	-3.6	-3.9	-3.7	-28.7
1.0%PC/2.0%LT, MYs 2021-2026	4.4	0.4	0.0	-0.6	-1.0	-2.1	-2.5	-2.6	-2.7	-2.7	-2.4	-2.4	-2.6	-2.5	-19.3
1.0%PC/2.0%LT, MYs 2022-2026	2.7	0.2	0.0	-0.2	-0.5	-1.1	-1.4	-1.4	-1.5	-1.7	-1.4	-1.6	-1.9	-1.8	-11.5
2.0%PC/3.0%LT, MYs 2021-2026	2.3	0.1	-0.1	-0.5	-0.8	-1.4	-1.6	-1.6	-1.6	-1.7	-1.3	-1.1	-1.3	-1.2	-11.8
2.0%PC/3.0%LT, MYs 2021-2026, AC/Off-Cycle Phaseout	1.1	0.0	-0.1	-0.2	-0.5	-1.0	-1.0	-1.0	-0.9	-0.8	-0.3	-0.1	-0.2	-0.1	-5.1
2.0%PC/3.0%LT, MYs 2022-2026	1.0	0.0	0.0	-0.1	-0.3	-0.4	-0.5	-0.5	-0.6	-0.6	-0.2	-0.2	-0.4	-0.5	-3.3

*** EO 12866 Review – Draft – Do Not Cite, Quote or Release During Review ***

**TABLE 9-71 - BILLIONS OF GALLONS OF LIQUID FUEL SAVED, COMBINED,
UNDISCOUNTED OVER THE LIFETIME OF THE MODEL YEAR, CAFE**

Passenger Cars and Light Trucks	MY 1977- 2016	MY 2017	MY 2018	MY 2019	MY 2020	MY 2021	MY 2022	MY 2023	MY 2024	MY 2025	MY 2026	MY 2027	MY 2028	MY 2029	MY TOTAL
0.0%PC/0.0%LT, MYs 2021-2026	18.2	1.2	-0.4	-1.5	-3.2	-6.6	-8.0	-8.8	-9.8	-10.7	-11.2	-11.1	-10.8	-10.6	-73.2
0.5%PC/0.5%LT, MYs 2021-2026	17.0	1.1	-0.2	-1.3	-2.9	-6.3	-7.6	-8.5	-9.4	-10.3	-10.6	-10.4	-10.1	-9.9	-69.2
0.5%PC/0.5%LT, MYs 2021-2026, AC/Off-Cycle Phaseout	16.0	1.0	-0.2	-1.2	-2.8	-6.0	-7.3	-8.1	-9.1	-9.9	-9.9	-9.7	-9.4	-9.3	-65.8
1.0%PC/2.0%LT, MYs 2021-2026	13.9	0.7	-0.3	-1.1	-2.5	-5.3	-6.4	-7.1	-7.9	-8.7	-8.5	-8.3	-8.1	-7.8	-57.4
1.0%PC/2.0%LT, MYs 2022-2026	10.6	0.7	0.1	-0.5	-1.7	-3.6	-4.8	-5.5	-6.2	-6.8	-6.6	-6.5	-6.3	-6.1	-43.2
2.0%PC/3.0%LT, MYs 2021-2026	9.4	0.2	-0.5	-1.0	-2.3	-4.3	-4.9	-5.3	-5.4	-6.0	-5.4	-5.1	-5.0	-4.8	-40.3
2.0%PC/3.0%LT, MYs 2021-2026, AC/Off-Cycle Phaseout	5.7	-0.2	-0.7	-1.1	-2.1	-3.7	-3.9	-4.2	-4.2	-4.2	-3.1	-2.6	-2.6	-2.5	-29.1
2.0%PC/3.0%LT, MYs 2022-2026	5.8	0.3	0.0	-0.3	-1.2	-2.4	-3.0	-3.5	-4.0	-4.5	-3.9	-3.6	-3.5	-3.4	-27.0

*** EO 12866 Review – Draft – Do Not Cite, Quote or Release During Review ***

**TABLE 9-72 - BILLIONS OF GALLONS OF LIQUID FUEL SAVED, COMBINED,
UNDISCOUNTED OVER THE LIFETIME OF THE MODEL YEAR, CO₂**

Passenger Cars and Light Trucks	MY 1977- 2016	MY 2017	MY 2018	MY 2019	MY 2020	MY 2021	MY 2022	MY 2023	MY 2024	MY 2025	MY 2026	MY 2027	MY 2028	MY 2029	MY TOTAL
0.0%PC/0.0%LT, MYs 2021-2026	16.1	1.7	0.6	-0.5	-2.0	-4.3	-5.9	-6.9	-8.0	-9.1	-9.8	-10.3	-10.8	-11.0	-60.2
0.5%PC/0.5%LT, MYs 2021-2026	15.3	1.6	0.6	-0.4	-1.8	-4.1	-5.7	-6.7	-7.8	-8.8	-9.3	-9.8	-10.4	-10.5	-57.8
0.5%PC/0.5%LT, MYs 2021-2026, AC/Off-Cycle Phaseout	14.2	1.5	0.5	-0.6	-1.9	-4.1	-5.6	-6.5	-7.2	-8.2	-8.5	-8.8	-9.3	-9.3	-53.7
1.0%PC/2.0%LT, MYs 2021-2026	11.2	1.1	0.3	-0.6	-1.4	-3.1	-4.4	-5.2	-5.9	-6.6	-6.7	-6.9	-7.3	-7.3	-42.8
1.0%PC/2.0%LT, MYs 2022-2026	7.3	0.8	0.6	0.3	-0.3	-1.5	-2.3	-3.0	-3.4	-4.4	-4.4	-4.6	-5.1	-5.2	-25.2
2.0%PC/3.0%LT, MYs 2021-2026	6.7	0.5	0.2	-0.3	-0.9	-2.2	-2.8	-3.3	-3.6	-4.3	-4.1	-3.9	-4.1	-4.0	-26.1
2.0%PC/3.0%LT, MYs 2021-2026, AC/Off-Cycle Phaseout	3.5	0.1	-0.1	-0.2	-0.8	-1.8	-2.1	-2.4	-2.5	-2.9	-2.2	-1.6	-1.8	-1.7	-16.5
2.0%PC/3.0%LT, MYs 2022-2026	3.3	0.3	0.2	0.0	-0.4	-0.9	-1.1	-1.5	-1.8	-2.4	-2.1	-2.1	-2.3	-2.3	-13.2

*** EO 12866 Review – Draft – Do Not Cite, Quote or Release During Review ***

TABLE 9-73 - CHANGE IN ELECTRICITY CONSUMPTION (GW-H), PASSENGER CARS, UNDISCOUNTED OVER THE LIFETIME OF THE MODEL YEAR, CAFE

Passenger Cars	MY 1977-2016	MY 2017	MY 2018	MY 2019	MY 2020	MY 2021	MY 2022	MY 2023	MY 2024	MY 2025	MY 2026	MY 2027	MY 2028	MY 2029	MY TOTAL
0.0%PC/0.0%LT, MYs 2021-2026	-148	-159	-153	-300	-306	-1,393	-1,471	-1,695	-2,093	-2,886	-2,798	-2,704	-2,656	-2,627	-21,389
0.5%PC/0.5%LT, MYs 2021-2026	-142	-153	-147	-294	-299	-1,390	-1,472	-1,699	-2,096	-2,890	-2,802	-2,722	-2,675	-2,650	-21,429
0.5%PC/0.5%LT, MYs 2021-2026, AC/Off-Cycle Phaseout	-133	-142	-137	-284	-288	-1,365	-1,461	-1,545	-1,943	-2,754	-2,668	-2,615	-2,581	-2,562	-20,477
1.0%PC/2.0%LT, MYs 2021-2026	-119	-126	-120	-267	-269	-1,365	-1,462	-1,664	-2,069	-2,876	-2,807	-2,786	-2,771	-2,762	-21,462
1.0%PC/2.0%LT, MYs 2022-2026	-95	-101	-96	-243	-244	-1,354	-1,497	-1,569	-1,986	-2,812	-2,748	-2,734	-2,722	-2,718	-20,919
2.0%PC/3.0%LT, MYs 2021-2026	-79	-83	-78	-224	-224	-1,216	-1,331	-1,406	-1,823	-2,679	-2,640	-2,671	-2,657	-2,660	-19,771
2.0%PC/3.0%LT, MYs 2021-2026, AC/Off-Cycle Phaseout	-42	-42	-38	-184	-182	-871	-992	-1,078	-1,497	-2,362	-2,189	-2,275	-2,261	-2,266	-16,280
2.0%PC/3.0%LT, MYs 2022-2026	-51	-53	-50	-197	-197	-1,110	-1,262	-1,361	-1,787	-2,634	-2,599	-2,635	-2,624	-2,630	-19,190

*** EO 12866 Review – Draft – Do Not Cite, Quote or Release During Review ***

**TABLE 9-74 - CHANGE IN ELECTRICITY CONSUMPTION (GW-H), PASSENGER CARS,
UNDISCOUNTED OVER THE LIFETIME OF THE MODEL YEAR, CO₂**

Passenger Cars	MY 1977- 2016	MY 2017	MY 2018	MY 2019	MY 2020	MY 2021	MY 2022	MY 2023	MY 2024	MY 2025	MY 2026	MY 2027	MY 2028	MY 2029	MY TOTAL
0.0%PC/0.0%LT, MYs 2021-2026	-133	-138	-113	-114	-172	-203	-156	-51	15	102	-65	-15	-281	-232	-1,555
0.5%PC/0.5%LT, MYs 2021-2026	-129	-134	-109	-110	-116	-146	-109	-9	55	144	-24	20	-242	-192	-1,102
0.5%PC/0.5%LT, MYs 2021-2026, AC/Off-Cycle Phaseout	-122	-126	-100	-101	-107	-137	-132	-35	29	108	-71	-40	-321	-281	-1,435
1.0%PC/2.0%LT, MYs 2021-2026	-102	-106	-80	-81	-85	-115	-125	-43	13	57	-127	-101	-395	-380	-1,669
1.0%PC/2.0%LT, MYs 2022-2026	-75	-78	-76	-77	-81	-120	-166	-102	-66	-43	-230	-265	-572	-565	-2,516
2.0%PC/3.0%LT, MYs 2021-2026	-64	-65	-62	-61	-62	-93	-111	-59	-28	-10	-219	-249	-568	-596	-2,247
2.0%PC/3.0%LT, MYs 2021-2026, AC/Off-Cycle Phaseout	-30	-29	-26	-24	-22	-53	-72	-22	7	12	-208	-303	-633	-669	-2,071
2.0%PC/3.0%LT, MYs 2022-2026	-33	-34	-32	-32	-32	-71	-128	-87	-74	-50	-265	-315	-645	-674	-2,472

*** EO 12866 Review – Draft – Do Not Cite, Quote or Release During Review ***

**TABLE 9-75 - CHANGE IN ELECTRICITY CONSUMPTION (GW-H), LIGHT TRUCKS,
UNDISCOUNTED OVER THE LIFETIME OF THE MODEL YEAR, CAFE**

Light Trucks	MY 1977- 2016	MY 2017	MY 2018	MY 2019	MY 2020	MY 2021	MY 2022	MY 2023	MY 2024	MY 2025	MY 2026	MY 2027	MY 2028	MY 2029	MY TOTAL	
0.0%PC/0.0%LT, MYs 2021-2026	-52	-57	-191	-190	-184	-175	-178	-188	-	1,642	1,646	1,655	1,689	1,726	1,751	-11,324
0.5%PC/0.5%LT, MYs 2021-2026	-47	-51	-187	-186	-180	-171	-173	-182	-	1,637	1,640	1,651	1,684	1,718	1,742	-11,248
0.5%PC/0.5%LT, MYs 2021-2026, AC/Off-Cycle Phaseout	-44	-48	-184	-183	-177	-168	-170	-179	-	1,634	1,638	1,649	1,679	1,710	1,732	-11,194
1.0%PC/2.0%LT, MYs 2021-2026	-34	-36	-173	-172	-168	-160	-162	-171	-	1,625	1,627	1,637	1,657	1,682	1,701	-11,007
1.0%PC/2.0%LT, MYs 2022-2026	-24	-27	-165	-164	-160	-155	-151	-155	-	1,609	1,607	1,615	1,635	1,656	1,672	-10,795
2.0%PC/3.0%LT, MYs 2021-2026	-20	-19	-157	-156	-152	-145	-149	-156	-	1,613	1,608	1,612	1,625	1,644	1,657	-10,714
2.0%PC/3.0%LT, MYs 2021-2026, AC/Off-Cycle Phaseout	-9	-6	-144	-143	-140	-135	-140	-147	-	1,605	1,602	1,610	1,624	1,636	1,646	-10,587
2.0%PC/3.0%LT, MYs 2022-2026	-12	-13	-152	-152	-150	-147	-145	-148	-	1,602	1,599	1,603	1,618	1,634	1,645	-10,619

*** EO 12866 Review – Draft – Do Not Cite, Quote or Release During Review ***

**TABLE 9-76 - CHANGE IN ELECTRICITY CONSUMPTION (GW-H), LIGHT TRUCKS,
UNDISCOUNTED OVER THE LIFETIME OF THE MODEL YEAR, CO₂**

Light Trucks	MY 1977- 2016	MY 2017	MY 2018	MY 2019	MY 2020	MY 2021	MY 2022	MY 2023	MY 2024	MY 2025	MY 2026	MY 2027	MY 2028	MY 2029	MY TOTAL
0.0%PC/0.0%LT, MYs 2021-2026	-56	-56	-55	-56	-50	-45	-43	-1,861	-1,875	-1,889	-1,914	-1,942	-1,961	-1,991	-13,793
0.5%PC/0.5%LT, MYs 2021-2026	-53	-53	-52	-53	-48	-42	-39	-1,856	-1,870	-1,884	-1,911	-1,937	-1,957	-1,987	-13,743
0.5%PC/0.5%LT, MYs 2021-2026, AC/Off-Cycle Phaseout	-47	-47	-45	-46	-41	-35	-33	-1,849	-1,865	-1,879	-1,905	-1,929	-1,947	-1,974	-13,642
1.0%PC/2.0%LT, MYs 2021-2026	-33	-32	-30	-28	-25	-21	-17	-1,832	-1,846	-1,855	-1,878	-1,901	-1,916	-1,938	-13,352
1.0%PC/2.0%LT, MYs 2022-2026	-22	-22	-21	-21	-19	-16	-12	-1,821	-1,830	-1,830	-1,851	-1,864	-1,871	-1,891	-13,090
2.0%PC/3.0%LT, MYs 2021-2026	-15	-15	-13	-12	-11	-8	-7	-1,818	-1,828	-1,827	-1,848	-1,862	-1,870	-1,887	-13,019
2.0%PC/3.0%LT, MYs 2021-2026, AC/Off-Cycle Phaseout	-5	-4	-3	-2	0	2	2	-1,809	-1,820	-1,821	-1,841	-1,776	-1,777	-1,788	-12,643
2.0%PC/3.0%LT, MYs 2022-2026	-7	-7	-6	-6	-5	-5	-3	-1,809	-1,816	-1,214	-1,234	-1,239	-1,239	-1,246	-9,835

*** EO 12866 Review – Draft – Do Not Cite, Quote or Release During Review ***

**TABLE 9-77 - CHANGE IN ELECTRICITY CONSUMPTION (GW-H), COMBINED,
UNDISCOUNTED OVER THE LIFETIME OF THE MODEL YEAR, CAFE**

Passenger Cars and Light Trucks	MY 1977-2016	MY 2017	MY 2018	MY 2019	MY 2020	MY 2021	MY 2022	MY 2023	MY 2024	MY 2025	MY 2026	MY 2027	MY 2028	MY 2029	MY TOTAL
0.0%PC/0.0%LT, MYs 2021-2026	-200	-216	-344	-490	-490	-1,568	-1,649	-1,883	-3,735	-4,532	-4,453	-4,394	-4,382	-4,378	-32,713
0.5%PC/0.5%LT, MYs 2021-2026	-190	-204	-333	-480	-478	-1,560	-1,645	-1,880	-3,732	-4,530	-4,453	-4,405	-4,393	-4,393	-32,677
0.5%PC/0.5%LT, MYs 2021-2026, AC/Off-Cycle Phaseout	-177	-190	-320	-467	-465	-1,533	-1,631	-1,725	-3,577	-4,392	-4,317	-4,294	-4,291	-4,294	-31,671
1.0%PC/2.0%LT, MYs 2021-2026	-153	-162	-294	-439	-437	-1,524	-1,625	-1,835	-3,694	-4,503	-4,444	-4,443	-4,453	-4,463	-32,469
1.0%PC/2.0%LT, MYs 2022-2026	-120	-128	-261	-407	-404	-1,509	-1,647	-1,723	-3,595	-4,419	-4,363	-4,369	-4,378	-4,390	-31,714
2.0%PC/3.0%LT, MYs 2021-2026	-99	-102	-234	-380	-376	-1,361	-1,479	-1,563	-3,436	-4,287	-4,252	-4,296	-4,302	-4,318	-30,485
2.0%PC/3.0%LT, MYs 2021-2026, AC/Off-Cycle Phaseout	-51	-49	-182	-328	-322	-1,005	-1,132	-1,226	-3,102	-3,965	-3,799	-3,899	-3,896	-3,913	-26,867
2.0%PC/3.0%LT, MYs 2022-2026	-63	-66	-202	-349	-347	-1,258	-1,407	-1,508	-3,390	-4,233	-4,202	-4,253	-4,258	-4,275	-29,809

*** EO 12866 Review – Draft – Do Not Cite, Quote or Release During Review ***

**TABLE 9-78 - CHANGE IN ELECTRICITY CONSUMPTION (GW-H), COMBINED,
UNDISCOUNTED OVER THE LIFETIME OF THE MODEL YEAR, CO₂**

Passenger Cars and Light Trucks	MY 1977-2016	MY 2017	MY 2018	MY 2019	MY 2020	MY 2021	MY 2022	MY 2023	MY 2024	MY 2025	MY 2026	MY 2027	MY 2028	MY 2029	MY TOTAL
0.0%PC/0.0%LT, MYs 2021-2026	-189	-195	-167	-169	-223	-247	-199	-1,912	-1,860	-1,787	-1,979	-1,956	-2,242	-2,223	-15,348
0.5%PC/0.5%LT, MYs 2021-2026	-182	-188	-161	-163	-164	-189	-148	-1,865	-1,816	-1,741	-1,935	-1,917	-2,199	-2,179	-14,845
0.5%PC/0.5%LT, MYs 2021-2026, AC/Off-Cycle Phaseout	-168	-173	-145	-147	-148	-172	-165	-1,884	-1,836	-1,771	-1,976	-1,969	-2,268	-2,255	-15,078
1.0%PC/2.0%LT, MYs 2021-2026	-135	-138	-111	-108	-111	-136	-143	-1,875	-1,833	-1,797	-2,005	-2,002	-2,310	-2,317	-15,022
1.0%PC/2.0%LT, MYs 2022-2026	-96	-100	-97	-98	-100	-136	-178	-1,923	-1,896	-1,873	-2,080	-2,129	-2,443	-2,456	-15,606
2.0%PC/3.0%LT, MYs 2021-2026	-80	-80	-75	-73	-73	-100	-117	-1,877	-1,856	-1,837	-2,067	-2,111	-2,438	-2,483	-15,267
2.0%PC/3.0%LT, MYs 2021-2026, AC/Off-Cycle Phaseout	-35	-33	-28	-26	-23	-51	-70	-1,831	-1,813	-1,809	-2,049	-2,079	-2,410	-2,457	-14,714
2.0%PC/3.0%LT, MYs 2022-2026	-41	-41	-39	-38	-37	-75	-131	-1,896	-1,889	-1,264	-1,498	-1,554	-1,884	-1,920	-12,308

9.2 Energy and Environmental Impacts

9.2.1 Introduction

Today’s proposal directly involves the fuel economy and average CO₂ emissions of light-duty vehicles, and the proposal is expected to most directly and significantly impact national fuel consumption and CO₂ emissions. Fuel economy and CO₂ emissions are so closely related that it is expected that impacts on national fuel consumption and national CO₂ emissions to track in virtual lockstep.

Today’s proposal does not directly involve pollutants such as carbon monoxide, smog-forming pollutants (nitrogen oxides and unburned hydrocarbons), final particles, or “air toxics” (e.g., formaldehyde, acetaldehyde, benzene). While today’s proposal is expected to indirectly impact such emissions (by reducing travel demand and accelerating fleet turnover to newer and cleaner vehicles on one hand while, on the other, increasing activity at refineries and in the fuel distribution system), it is expected that these impacts will be much smaller than impacts on fuel use and CO₂ emissions, because standards for these other pollutants are independent of those for CO₂ emissions.

Following decades of successful regulation of criteria pollutants and air toxics, modern vehicles are already vastly cleaner than in the past, and it is expected that new vehicles will continue to improve. For example, the following chart shows trends in new vehicles’ emission rates for volatile organic compounds (VOCs) and nitrogen oxides (NO_x) — the two motor vehicle criteria pollutants that contribute to the formation of smog.

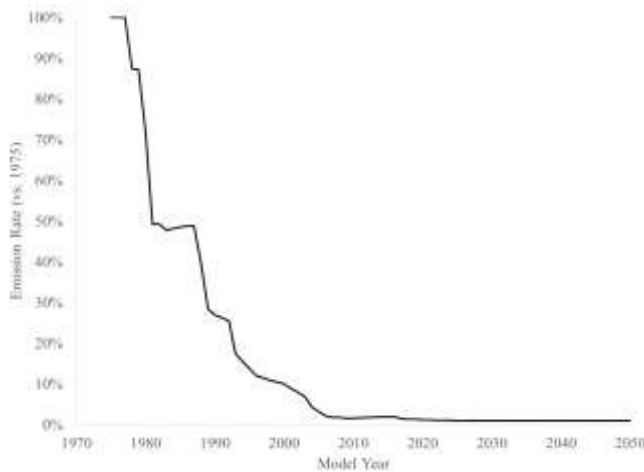

FIGURE 9-1 - NEW PASSENGER CAR EMISSION RATES RELATIVE TO 1975 LEVEL – SMOG-FORMING POLLUTANTS

Because new vehicles are so much cleaner than older models, it is expected that under any of the alternatives considered here for fuel economy and CO₂ standards, emissions of smog-forming pollutants would continue to decline nearly identically over the next two decades. The following chart shows estimated total fuel consumption, CO₂ emissions, and smog-forming emissions under the baseline and proposed standards (CAFE standards—trends for CO₂ standards would be very similar), using units that allow the three to be shown together: Because new vehicles are so much cleaner than older models, the agencies expect that under any of the alternatives considered here for fuel economy and CO₂ standards, emissions of smog-forming pollutants would continue to decline nearly identically over the next two decades. The following chart shows estimated total fuel consumption, CO₂ emissions, and smog-forming emissions under the baseline and proposed standards (CAFE standards—trends for CO₂ standards would be very similar), using units that allow the three to be shown together:

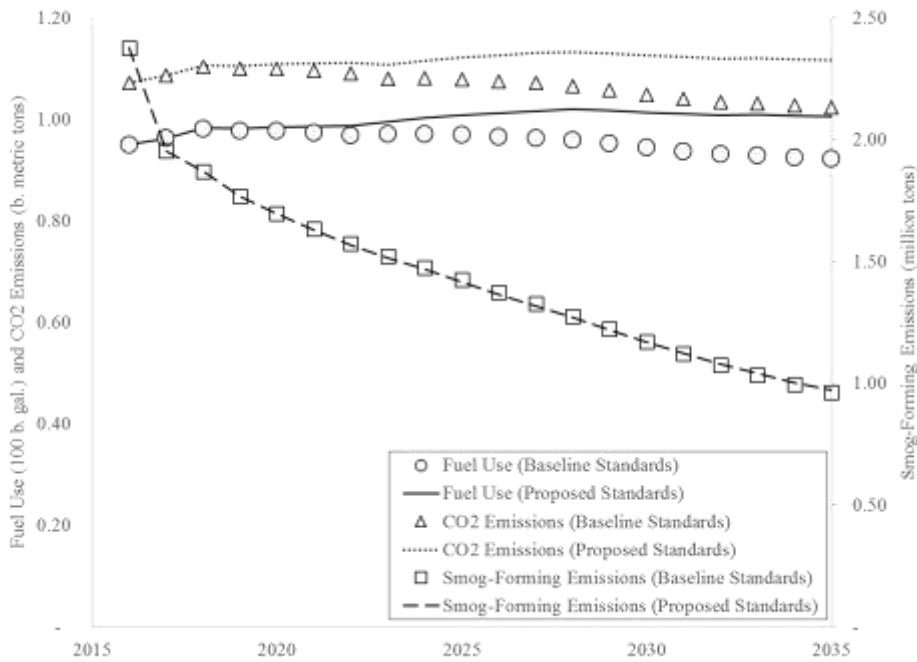

FIGURE 9-2 - ANNUAL FUEL CONSUMPTION AND EMISSIONS UNDER BASELINE AND PREFERRED CAFE STANDARDS

While the differences in fuel use and CO₂ emissions trends under the baseline and proposed standards are clear, the corresponding difference in smog-forming emissions trends is too small to discern. For these three measures, the following table shows percentage differences between the amounts shown above:

TABLE 9-79 - IMPACT OF PROPOSED CAFE STANDARDS ON ANNUAL FUEL USE AND EMISSIONS

Year	Fuel Use	CO ₂ Emissions	Smog-Forming Emissions
2016	0.0%	0.0%	0.0%
2017	0.1%	0.1%	0.0%
2018	0.2%	0.2%	0.0%
2019	0.4%	0.4%	-0.1%
2020	0.7%	0.7%	-0.1%
2021	1.3%	1.3%	-0.2%
2022	1.9%	1.9%	-0.3%
2023	2.6%	2.5%	-0.5%
2024	3.3%	3.3%	-0.6%
2025	4.0%	4.0%	-0.6%
2026	4.8%	4.8%	-0.6%
2027	5.5%	5.5%	-0.6%
2028	6.3%	6.2%	-0.5%
2029	6.9%	6.9%	-0.3%
2030	7.4%	7.4%	-0.1%
2031	7.9%	7.9%	0.1%
2032	8.3%	8.2%	0.3%
2033	8.6%	8.6%	0.6%
2034	8.9%	8.9%	0.8%
2035	9.2%	9.1%	1.0%

As indicated, for most of the coming two decades, it is estimated that, even as fuel consumption and CO₂ emissions would increase under the proposed standards (compared to fuel consumption and CO₂ emissions under the baseline standards), smog-forming pollution would actually decrease. During the two decades shown above, it is estimated that the proposed standards would increase aggregate fuel consumption and CO₂ emissions by approximately 4%, but would decrease aggregate smog-forming pollution by approximately 0.1% (because impacts of the reduced travel and accelerated fleet turnover would outweigh those of increased refining and fuel distribution).

As the analysis affirms, while fuel economy and CO₂ emissions are two sides (or, arguably, the same side) of the same coin, fuel economy and CO₂ are only incidentally related to pollutants

*** EO 12866 Review – Draft – Do Not Cite, Quote or Release During Review ***

such as smog, and any positive or negative impacts of today's notice on these other air quality problems would most likely be far too small to observe.

The remainder of this chapter summarizes the impacts on fuel consumption and emissions for both the proposed CAFE standards and the proposed CO₂ standards.

9.2.2 Energy and Warming Impacts

Chapter 2 of this PRIA and Section 5 of the preamble discusses, among other things, the need of the Nation to conserve energy, providing context for the estimated impacts on national-scale fuel consumption summarized below. Corresponding to these changes in fuel consumption, it is estimated that today's proposal will impact CO₂ emissions. CO₂ is one of several greenhouse gases that absorb infrared radiation, thereby trapping heat and making the planet warmer. The most important greenhouse gases directly emitted by human activities include carbon dioxide (CO₂), methane (CH₄), nitrous oxide (N₂O), and several fluorine-containing halogenated substances. Although CO₂, CH₄, and N₂O occur naturally in the atmosphere, human activities have changed their atmospheric concentrations. From the pre-industrial era (i.e., ending approximately 1750) to 2016, concentrations of these greenhouse gases have increased globally by 44, 163, and 22%, respectively.⁵⁷⁵ The Draft Environmental Impact Analysis (DEIS) accompanying today's notice discusses potential impacts of greenhouse gases at greater length, and also summaries analysis quantifying some of these impacts (e.g., average temperatures) for each of the considered regulatory alternatives.

⁵⁷⁵ Impacts and U.S. emissions of GHGs are discussed at greater length in EPA's 2018 *Inventory of U.S. Greenhouse Gas Emissions and Sinks* (EPA 430-R-18-003, April 12, 2018, available at <https://www.epa.gov/ghgemissions/inventory-us-greenhouse-gas-emissions-and-sinks>).

*** EO 12866 Review – Draft – Do Not Cite, Quote or Release During Review ***

9.2.2.1 CAFE Standards

TABLE 9-80 - CUMULATIVE CHANGES IN FUEL CONSUMPTION AND GHG EMISSIONS FOR MY'S 1975-2029 UNDER CAFE PROGRAM

Model Year Standards Through	MY 1977-2016	MY 2017	MY 2018	MY 2019	MY 2020	MY 2021	MY 2022	MY 2023	MY 2024	MY 2025	MY 2026	MY 2027	MY 2028	MY 2029	TOTAL
Upstream Emissions															
CO2 (million metric tons)	-40.4	-2.7	0.8	3.4	7.1	14.3	17.2	18.9	20.5	22.1	23.3	23.0	22.3	21.9	151.7
CH4 (thousand metric tons)	-357.7	-23.4	8.0	31.4	64.0	130.9	156.6	172.1	190.8	207.9	217.8	215.1	209.6	205.6	1,429
N2O (thousand metric tons)	-5.3	-0.3	0.2	0.6	1.1	2.1	2.4	2.5	2.8	3.1	3.2	3.2	3.1	3.0	21.6
Tailpipe Emissions															
CO2 (million metric tons)	-161.5	-10.7	3.2	13.7	28.4	59.1	71.2	78.9	88.1	96.2	100.6	99.4	96.9	95.1	658.6
CH4 (thousand metric tons)	-5.5	-0.6	-0.6	-0.6	-0.6	-0.6	-0.6	-0.5	-0.5	-0.4	-0.4	-0.4	-0.4	-0.4	-12.0
N2O (thousand metric tons)	-3.7	-0.5	-0.5	-0.5	-0.5	-0.6	-0.6	-0.6	-0.5	-0.5	-0.5	-0.5	-0.5	-0.6	-10.6
Total Emissions															
CO2 (million metric tons)	-201.9	-13.4	4.0	17.1	35.5	73.4	88.4	97.8	108.6	118.3	123.9	122.3	119.2	116.9	810.3
CH4 (thousand metric tons)	-363.2	-24.0	7.5	30.8	63.4	130.3	156.0	171.5	190.3	207.6	217.4	214.7	209.2	205.2	1,417
N2O (thousand metric tons)	-9.0	-0.8	-0.3	0.1	0.5	1.5	1.8	1.9	2.3	2.6	2.7	2.7	2.5	2.5	11.0
Fuel Consumption (billion Gallons)	-18.2	-1.2	0.4	1.5	3.2	6.6	8.0	8.8	9.8	10.7	11.2	11.1	10.8	10.6	73.2

*** EO 12866 Review – Draft – Do Not Cite, Quote or Release During Review ***

TABLE 9-81 - CUMULATIVE CHANGES IN CRITERIA POLLUTANT EMISSIONS FOR MY'S 1975-2029 UNDER CAFE PROGRAM

Model Year Standards Through	MY 1977-2016	MY 2017	MY 2018	MY 2019	MY 2020	MY 2021	MY 2022	MY 2023	MY 2024	MY 2025	MY 2026	MY 2027	MY 2028	MY 2029	TOTAL
Upstream Emissions															
CO (million metric tons)	0.0	0.0	0.0	0.0	0.0	0.0	0.0	0.0	0.0	0.0	0.0	0.0	0.0	0.0	0.1
VOC (thousand metric tons)	-52.6	-3.5	1.0	4.4	9.2	19.3	23.2	25.9	28.8	31.4	32.9	32.5	31.7	31.1	215.1
NOx (thousand metric tons)	-29.2	-1.9	0.7	2.6	5.3	10.8	12.9	14.1	15.4	16.7	17.5	17.3	16.8	16.4	115.4
SO2 (thousand metric tons)	-21.4	-1.3	0.7	2.0	4.0	7.6	9.0	9.6	9.9	10.6	11.2	11.1	10.8	10.6	74.4
PM (thousand metric tons)	-2.2	-0.1	0.1	0.2	0.4	0.8	1.0	1.1	1.2	1.3	1.3	1.3	1.3	1.3	8.8
Tailpipe Emissions															
CO (million metric tons)	-3.2	-0.2	-0.2	-0.2	-0.2	-0.2	-0.2	-0.2	-0.1	-0.1	-0.1	-0.1	-0.1	-0.1	-5.2
VOC (thousand metric tons)	-245.9	-10.4	-9.1	-8.9	-8.8	-8.5	-7.8	-7.0	-5.8	-4.7	-4.2	-4.0	-4.2	-4.2	-333.5
NOx (thousand metric tons)	-173.4	-12.9	-10.4	-10.2	-9.9	-9.5	-8.7	-7.7	-6.1	-4.8	-4.4	-4.3	-4.6	-4.6	-271.4
SO2 (thousand metric tons)	-0.8	-0.1	-0.1	-0.1	-0.1	-0.2	-0.2	-0.2	-0.1	-0.1	-0.1	-0.1	-0.1	-0.1	-2.5
PM (thousand metric tons)	-6.4	-0.7	-0.6	-0.5	-0.5	-0.4	-0.4	-0.4	-0.3	-0.3	-0.3	-0.3	-0.3	-0.3	-11.7
Total Emissions															
CO (million metric tons)	-3.2	-0.2	-0.2	-0.2	-0.2	-0.2	-0.2	-0.2	-0.1	-0.1	-0.1	-0.1	-0.1	-0.1	-5.2
VOC (thousand metric tons)	-298.5	-13.9	-8.1	-4.5	0.4	10.7	15.4	18.8	23.0	26.7	28.7	28.5	27.5	26.9	-118.4
NOx (thousand metric tons)	-202.7	-14.8	-9.7	-7.6	-4.6	1.3	4.2	6.4	9.3	11.9	13.1	13.0	12.2	11.8	-156.0
SO2 (thousand metric tons)	-22.1	-1.4	0.5	1.9	3.9	7.5	8.8	9.4	9.8	10.5	11.1	11.0	10.7	10.4	71.9
PM (thousand metric tons)	-8.6	-0.8	-0.5	-0.3	-0.1	0.4	0.6	0.7	0.8	1.0	1.0	1.0	1.0	0.9	-2.9

*** EO 12866 Review – Draft – Do Not Cite, Quote or Release During Review ***

9.2.2.2 CO₂ Standards

TABLE 9-82 - CUMULATIVE CHANGES IN FUEL CONSUMPTION AND GHG EMISSIONS FOR MY'S 1975-2029 UNDER CO₂ PROGRAM

Model Year Standards Through	MY 1977-2016	MY 2017	MY 2018	MY 2019	MY 2020	MY 2021	MY 2022	MY 2023	MY 2024	MY 2025	MY 2026	MY 2027	MY 2028	MY 2029	TOTAL
Upstream Emissions															
CO2 (million metric tons)	-35.7	-3.7	-1.3	1.2	4.5	9.6	13.1	14.6	17.1	19.5	21.1	22.1	23.2	23.4	128.6
CH4 (thousand metric tons)	-316.2	-32.2	-10.9	11.2	40.0	85.2	116.2	133.6	155.8	177.0	192.0	201.2	211.6	213.6	1,178
N2O (thousand metric tons)	-4.7	-0.5	-0.1	0.3	0.7	1.4	1.8	2.0	2.3	2.6	2.8	2.9	3.1	3.1	17.7
Tailpipe Emissions															
CO2 (million metric tons)	-142.9	-14.6	-5.3	4.6	17.6	38.1	52.4	61.4	71.5	81.1	88.0	92.2	97.0	97.9	538.8
CH4 (thousand metric tons)	-5.1	-0.7	-0.6	-0.6	-0.6	-0.6	-0.6	-0.5	-0.5	-0.4	-0.5	-0.5	-0.5	-0.5	-12.2
N2O (thousand metric tons)	-3.3	-0.5	-0.5	-0.5	-0.6	-0.6	-0.6	-0.6	-0.6	-0.6	-0.6	-0.6	-0.7	-0.7	-11.0
Total Emissions															
CO2 (million metric tons)	-178.6	-18.3	-6.5	5.8	22.1	47.6	65.5	75.9	88.6	100.6	109.1	114.3	120.1	121.3	667.3
CH4 (thousand metric tons)	-321.3	-32.8	-11.5	10.6	39.4	84.6	115.7	133.1	155.3	176.6	191.5	200.7	211.1	213.1	1,166
N2O (thousand metric tons)	-8.0	-0.9	-0.6	-0.3	0.1	0.8	1.2	1.4	1.7	2.0	2.2	2.3	2.4	2.5	6.7
Fuel Consumption (billion Gallons)	-16.1	-1.7	-0.6	0.5	2.0	4.3	5.9	6.9	8.0	9.1	9.8	10.3	10.8	11.0	60.2

*** EO 12866 Review – Draft – Do Not Cite, Quote or Release During Review ***

TABLE 9-83 - CUMULATIVE CHANGES IN CRITERIA POLLUTANT EMISSIONS FOR MY'S 1975-2029 UNDER CO2 PROGRAM

Model Year Standards Through	MY 1977-2016	MY 2017	MY 2018	MY 2019	MY 2020	MY 2021	MY 2022	MY 2023	MY 2024	MY 2025	MY 2026	MY 2027	MY 2028	MY 2029	TOTAL
Upstream Emissions															
CO (million metric tons)	0.0	0.0	0.0	0.0	0.0	0.0	0.0	0.0	0.0	0.0	0.0	0.0	0.0	0.0	0.0
VOC (thousand metric tons)	-46.6	-4.8	-1.8	1.4	5.7	12.4	17.1	20.1	23.4	26.5	28.8	30.2	31.7	32.1	176.2
NOx (thousand metric tons)	-25.8	-2.6	-0.9	0.9	3.3	7.1	9.6	10.9	12.7	14.4	15.6	16.3	17.1	17.3	95.9
SO2 (thousand metric tons)	-18.8	-1.9	-0.5	0.9	2.6	5.3	7.1	7.2	8.5	9.8	10.6	11.2	11.6	11.8	65.4
PM (thousand metric tons)	-1.9	-0.2	-0.1	0.1	0.3	0.5	0.7	0.8	1.0	1.1	1.2	1.2	1.3	1.3	7.3
Tailpipe Emissions															
CO (million metric tons)	-2.8	-0.2	-0.2	-0.2	-0.2	-0.2	-0.2	-0.2	-0.2	-0.1	-0.1	-0.1	-0.1	-0.1	-5.1
VOC (thousand metric tons)	-207.0	-10.9	-9.7	-9.5	-9.2	-8.9	-8.1	-7.0	-6.4	-5.5	-5.3	-5.4	-5.1	-4.8	-302.8
NOx (thousand metric tons)	-148.5	-13.7	-11.2	-10.9	-10.5	-9.9	-8.9	-7.6	-6.8	-5.7	-5.6	-5.7	-5.6	-5.4	-256.0
SO2 (thousand metric tons)	-0.7	-0.1	-0.1	-0.1	-0.1	-0.2	-0.2	-0.1	-0.1	-0.1	-0.1	-0.2	-0.2	-0.2	-2.6
PM (thousand metric tons)	-5.7	-0.7	-0.6	-0.6	-0.5	-0.4	-0.4	-0.4	-0.4	-0.4	-0.4	-0.4	-0.4	-0.4	-11.6
Total Emissions															
CO (million metric tons)	-2.8	-0.2	-0.2	-0.2	-0.2	-0.2	-0.2	-0.2	-0.1	-0.1	-0.1	-0.1	-0.1	-0.1	-5.0
VOC (thousand metric tons)	-253.6	-15.7	-11.4	-8.1	-3.6	3.5	9.0	13.1	17.0	21.0	23.5	24.8	26.6	27.2	-126.5
NOx (thousand metric tons)	-174.4	-16.3	-12.1	-10.0	-7.1	-2.9	0.7	3.3	5.9	8.8	10.0	10.6	11.5	11.9	-160.1
SO2 (thousand metric tons)	-19.5	-2.0	-0.6	0.7	2.5	5.2	6.9	7.1	8.4	9.7	10.5	11.0	11.5	11.6	62.8
PM (thousand metric tons)	-7.7	-0.9	-0.7	-0.5	-0.2	0.1	0.3	0.4	0.6	0.7	0.8	0.8	0.9	0.9	-4.3

9.2.3 Impacts on Emissions of Criteria and Toxic Pollutants

Although this proposal focuses on standards for fuel economy and CO₂, it will also have an impact on criteria and air toxic pollutant emissions, although as discussed above, it is expected that incremental impacts on criteria and air toxic pollutant emissions would be too small to observe under any of the regulatory alternatives under consideration. Nevertheless, the following chapters detail the criteria pollutant and air toxic inventory impacts of this proposal; the methodology used to calculate those impacts; the health and environmental effects associated with the criteria and toxic air pollutants that are being impacted by this proposal; the potential impact of this proposal on concentrations of criteria and air toxic pollutants in the ambient air; and other unquantified health and environmental effects.

9.2.3.1 Impacts

In addition to affecting fuel consumption and emissions of greenhouse gases, this rule would influence “non-GHG” pollutants, i.e., “criteria” air pollutants and their precursors, and air toxics. The proposal would affect emissions of carbon monoxide (CO), fine particulate matter (PM_{2.5}), sulfur dioxide (SO_x), volatile organic compounds (VOC), nitrogen oxides (NO_x), benzene, 1,3-butadiene, formaldehyde, acetaldehyde, and acrolein. Consistent with the evaluation conducted for the Environmental Impact Statement accompanying this NPRM, criteria air pollutant impacts were analyzed for years 2025 and 2035 [as a representation of future program impacts]. These estimates of non-GHG emission impacts are shown by pollutant in Table 9-84 through Table 9-91 and are broken down by the two drivers of these changes - a) “downstream” emission changes, reflecting the estimated effects of VMT rebound (discussed in Chapters 8.6.1 and 8.6.2 of the RIA), changes in vehicle fleet age, changes in vehicle emission standards, and changes in fuel consumption; and b) “upstream” emission increases because of increased refining and distribution of motor vehicle gasoline relative to the baseline. Program impacts on criteria and toxics emissions are discussed below, followed by individual discussions of the methodology used to calculate each of these three sources of impacts.

As shown in Table 9-83, it is estimated that in 2025 the light duty vehicle CAFE scenarios would result in reductions of NO_x, VOC, and CO, and increases in PM_{2.5} and SO_x.⁵⁷⁶ For NO_x, VOC, and CO, net reductions are estimated to result from lower downstream, or tailpipe emissions in the scenarios evaluated. This is a result of reduced VMT rebound as well as fewer older vehicles in the scenarios as compared to the baseline. Because the scenarios result in greater fuel consumption than the baseline, however, upstream emissions associated with fuel refining and distribution increase for all pollutants in all scenarios as compared to the baseline. Tailpipe emissions reductions for NO_x, VOC, and CO more than compensate for this increase in 2025. PM_{2.5} and SO_x, tailpipe emissions reductions are not great enough to compensate for increased emissions from fuel refining and distribution and therefore an overall increase in total PM_{2.5} and

⁵⁷⁶ While estimates for CY 2025 and 2035 are shown here, estimates through 2050 are shown in RIA Section 4.

*** EO 12866 Review – Draft – Do Not Cite, Quote or Release During Review ***

SOx is seen in 2025. Similar results can be seen in Table 9-85, which shows results for the CO₂ target scenarios.

Table 9-84 and Table 9-85 show that decreases in total CO result from all CAFE scenarios, while NOx, VOC, SO₂, and PM_{2.5} increase. Tailpipe CO emissions reductions more than offset increases in upstream CO emissions. For NOx, VOC, SO₂, and PM_{2.5} however, upstream emissions increases are not offset by tailpipe NOx, VOC, SO₂, and PM_{2.5} emissions reductions. Similar results can be seen in the CO₂ target scenarios for 2035 shown in Table 9-86 and Table 9-87, with the exception that NOx emissions decrease for scenarios 1-4 and increase for scenarios 5-8. For all criteria pollutants, the overall impact of the proposed program would be small compared to total U.S. inventories across all sectors.

*** EO 12866 Review – Draft – Do Not Cite, Quote or Release During Review ***

TABLE 9-84 - CRITERIA EMISSIONS IN 2025 (METRIC TONS) UNDER FUEL ECONOMY TARGETS

Alt.	CO			VOC			NOx			SO ₂			PM _{2.5}		
	Tailpipe	Upstream	Total	Tailpipe	Upstream	Total	Tailpipe	Upstream	Total	Tailpipe	Upstream	Total	Tailpipe	Upstream	Total
1	(174,789)	3,087	(171,703)	(15,250)	11,485	(3,765)	(11,506)	6,275	(5,231)	(73)	4,078	4,005	(303)	474	171
2	(163,704)	2,901	(160,802)	(14,308)	10,825	(3,482)	(10,732)	5,900	(4,832)	(68)	3,806	3,738	(283)	446	162
3	(155,704)	2,771	(152,933)	(13,596)	10,346	(3,249)	(10,220)	5,636	(4,584)	(64)	3,630	3,566	(270)	426	156
4	(136,685)	2,396	(134,289)	(12,117)	9,020	(3,097)	(8,980)	4,886	(4,094)	(54)	3,074	3,021	(235)	370	135
5	(102,784)	1,723	(101,061)	(9,260)	6,595	(2,664)	(6,708)	3,532	(3,176)	(37)	2,104	2,067	(175)	268	93
6	(98,207)	1,720	(96,487)	(8,862)	6,566	(2,295)	(6,550)	3,522	(3,027)	(35)	2,119	2,084	(167)	267	100
7	(71,136)	1,299	(69,837)	(6,460)	5,009	(1,451)	(4,810)	2,668	(2,141)	(25)	1,553	1,528	(120)	203	82
8	(58,049)	1,083	(56,966)	(5,285)	4,269	(1,016)	(3,786)	2,241	(1,546)	(20)	1,202	1,182	(98)	171	73

TABLE 9-85 - CRITERIA EMISSIONS IN 2025 (METRIC TONS) UNDER CO₂ TARGETS

Alt.	CO			VOC			NOx			SO ₂			PM _{2.5}		
	Tailpipe	Upstream	Total	Tailpipe	Upstream	Total	Tailpipe	Upstream	Total	Tailpipe	Upstream	Total	Tailpipe	Upstream	Total
1	(140,738)	2,528	(138,210)	(11,916)	9,242	(2,674)	(9,160)	5,104	(4,057)	(64)	3,504	3,440	(247)	384	137
2	(133,545)	2,430	(131,115)	(11,283)	8,879	(2,404)	(8,650)	4,905	(3,745)	(61)	3,370	3,309	(234)	369	135
3	(127,227)	2,276	(124,951)	(10,812)	8,331	(2,481)	(8,280)	4,596	(3,684)	(57)	3,143	3,086	(223)	346	123
4	(99,668)	1,784	(97,884)	(8,599)	6,571	(2,028)	(6,440)	3,609	(2,832)	(43)	2,428	2,385	(173)	272	99
5	(55,956)	1,006	(54,949)	(4,906)	3,793	(1,114)	(3,547)	2,049	(1,497)	(22)	1,290	1,268	(96)	155	59
6	(60,866)	1,078	(59,788)	(5,447)	4,043	(1,404)	(3,923)	2,193	(1,730)	(23)	1,397	1,374	(104)	166	62
7	(39,908)	725	(39,183)	(3,636)	2,638	(999)	(2,607)	1,451	(1,157)	(14)	849	836	(68)	115	47
8	(27,145)	501	(26,644)	(2,492)	1,960	(532)	(1,724)	1,030	(694)	(9)	573	564	(45)	78	33

TABLE 9-86 - CRITERIA EMISSIONS IN 2035 (METRIC TONS) UNDER FUEL ECONOMY TARGETS

Alt.	CO			VOC			NOx			SO ₂			PM _{2.5}		
	Tailpipe	Upstream	Total	Tailpipe	Upstream	Total	Tailpipe	Upstream	Total	Tailpipe	Upstream	Total	Tailpipe	Upstream	Total

*** EO 12866 Review – Draft – Do Not Cite, Quote or Release During Review ***

1	(286,582)	6,487	(280,095)	(14,905)	24,869	9,964	(13,034)	13,144	110	(196)	8,374	8,178	(719)	999	279
2	(266,262)	6,064	(260,197)	(13,911)	23,369	9,458	(12,097)	12,307	210	(181)	7,771	7,591	(669)	936	267
3	(248,134)	5,685	(242,449)	(13,015)	21,978	8,964	(11,285)	11,550	265	(167)	7,255	7,087	(622)	879	256
4	(204,450)	4,802	(199,647)	(10,979)	18,879	7,900	(9,301)	9,821	520	(130)	5,977	5,846	(507)	749	242
5	(151,495)	3,643	(147,852)	(8,287)	14,687	6,400	(6,889)	7,528	639	(90)	4,351	4,261	(372)	577	204
6	(121,828)	2,936	(118,892)	(6,869)	12,120	5,252	(5,585)	6,123	538	(68)	3,367	3,298	(297)	471	174
7	(57,583)	1,571	(56,012)	(3,568)	7,070	3,502	(2,689)	3,400	711	(29)	1,515	1,486	(139)	265	126
8	(74,726)	1,947	(72,779)	(4,259)	8,556	4,297	(3,422)	4,171	750	(39)	1,979	1,940	(180)	324	144

TABLE 9-87- CRITERIA EMISSIONS IN 2035 (METRIC TONS) UNDER CO₂ TARGETS

Alt.	CO			VOC			NO _x			SO ₂			PM _{2.5}		
	Tailpipe	Upstream	Total	Tailpipe	Upstream	Total	Tailpipe	Upstream	Total	Tailpipe	Upstream	Total	Tailpipe	Upstream	Total
1	(297,466)	6,499	(290,967)	(14,669)	24,139	9,471	(13,452)	12,989	(463)	(223)	8,797	8,574	(757)	980	223
2	(283,552)	6,218	(277,334)	(13,976)	23,108	9,132	(12,810)	12,430	(380)	(212)	8,409	8,196	(723)	938	215
3	(254,042)	5,517	(248,525)	(12,652)	20,631	7,979	(11,487)	11,055	(432)	(187)	7,407	7,220	(650)	835	185
4	(191,790)	4,282	(187,508)	(9,731)	16,221	6,490	(8,645)	8,627	(18)	(136)	5,653	5,517	(488)	653	165
5	(129,900)	2,917	(126,982)	(6,593)	11,366	4,773	(5,830)	5,946	116	(85)	3,704	3,620	(324)	452	128
6	(101,308)	2,337	(98,971)	(5,418)	9,299	3,881	(4,577)	4,802	225	(62)	2,875	2,812	(252)	366	114
7	(41,239)	1,274	(39,965)	(2,444)	4,247	1,804	(1,885)	2,431	546	(25)	1,047	1,023	(101)	230	129
8	(50,995)	1,291	(49,704)	(2,750)	5,353	2,604	(2,291)	2,697	406	(29)	1,492	1,463	(122)	206	84

*** EO 12866 Review – Draft – Do Not Cite, Quote or Release During Review ***

As shown in Table 9-88 through Table 9-91, it is estimated that the proposed program would result in small changes for air toxic emissions compared to total U.S. inventories across all sectors. In 2025, it is estimated the scenarios evaluated would reduce total acetaldehyde, acrolein, benzene, butadiene, and formaldehyde, toxics as compared to the baseline. This result is caused by greater VMT rebound miles assumed in the augural scenario and fewer rebound VMT in scenarios 1-8, and fewer older vehicles in the scenarios as compared to the baseline. Similarly, in 2035, acetaldehyde, benzene, butadiene, acrolein, and formaldehyde would all be reduced as compared to the baseline. As is the case with criteria emissions, upstream toxic emissions generally increase in the evaluated scenarios as compared to the baseline because of the greater amount of gasoline and diesel being refined and distributed.

*** EO 12866 Review – Draft – Do Not Cite, Quote or Release During Review ***

TABLE 9-88 - TOXIC EMISSIONS IN 2025 (METRIC TONS) UNDER FUEL ECONOMY TARGETS

Alt.	Acetaldehyde			Acrolein			Benzene			Butadiene			Formaldehyde		
	Tailpipe	Upstream	Total	Tailpipe	Upstream	Total	Tailpipe	Upstream	Total	Tailpipe	Upstream	Total	Tailpipe	Upstream	Total
1	(117)	2	(114)	(6)	0.3	(6)	(457)	44	(413)	(54)	0.5	(54)	(92)	16	(76)
2	(109)	2	(107)	(6)	0.3	(5)	(428)	41	(387)	(51)	0.4	(50)	(86)	15	(71)
3	(104)	2	(102)	(5)	0.3	(5)	(407)	40	(368)	(48)	0.4	(48)	(82)	15	(68)
4	(91)	2	(89)	(5)	0.2	(5)	(361)	34	(327)	(43)	0.4	(42)	(72)	13	(60)
5	(67)	1	(66)	(4)	0.2	(3)	(274)	25	(249)	(32)	0.3	(32)	(55)	9	(45)
6	(64)	1	(63)	(3)	0.2	(3)	(263)	25	(238)	(31)	0.3	(31)	(52)	9	(43)
7	(46)	1	(46)	(2)	0.1	(2)	(192)	19	(172)	(22)	0.2	(22)	(38)	7	(31)
8	(38)	1	(37)	(2)	0.1	(2)	(156)	16	(140)	(18)	0.2	(18)	(31)	6	(25)

TABLE 9-89 - TOXIC EMISSIONS IN 2025 (METRIC TONS) UNDER CO2 TARGETS

Alt.	Acetaldehyde			Acrolein			Benzene			Butadiene			Formaldehyde		
	Tailpipe	Upstream	Total	Tailpipe	Upstream	Total	Tailpipe	Upstream	Total	Tailpipe	Upstream	Total	Tailpipe	Upstream	Total
1	(95)	1.7	(93)	(5)	0.2	(5)	(361)	35	(325)	(43)	0.4	(43)	(74)	13	(61)
2	(90)	1.7	(88)	(5)	0.2	(5)	(341)	34	(308)	(41)	0.4	(41)	(70)	13	(57)
3	(86)	1.6	(84)	(4)	0.2	(4)	(327)	32	(295)	(39)	0.3	(39)	(67)	12	(55)
4	(67)	1.2	(65)	(4)	0.2	(3)	(258)	25	(233)	(31)	0.3	(31)	(52)	9	(43)
5	(37)	0.7	(36)	(2)	0.1	(2)	(146)	15	(132)	(18)	0.2	(17)	(29)	5	(24)
6	(40)	0.8	(39)	(2)	0.1	(2)	(161)	15	(146)	(19)	0.2	(19)	(32)	6	(26)
7	(26)	0.5	(25)	(1)	0.1	(1)	(107)	10	(97)	(12)	0.1	(12)	(21)	4	(17)
8	(18)	0.4	(17)	(1)	0.1	(1)	(73)	8	(66)	(9)	0.1	(9)	(15)	3	(12)

*** EO 12866 Review – Draft – Do Not Cite, Quote or Release During Review ***

TABLE 9-90 - TOXIC EMISSIONS IN 2035 (METRIC TONS) UNDER FUEL ECONOMY TARGETS

Alt.	Acetaldehyde			Acrolein			Benzene			Butadiene			Formaldehyde		
	Tailpipe	Upstream	Total	Tailpipe	Upstream	Total	Tailpipe	Upstream	Total	Tailpipe	Upstream	Total	Tailpipe	Upstream	Total
1	(275)	5	(270)	(14)	0.6	(14)	(535)	95	(440)	(83)	1.0	(82)	(140)	35	(104)
2	(255)	4	(251)	(13)	0.6	(13)	(499)	90	(409)	(77)	1.0	(76)	(130)	33	(97)
3	(238)	4	(234)	(12)	0.6	(12)	(466)	84	(382)	(72)	0.9	(71)	(121)	31	(90)
4	(195)	4	(192)	(10)	0.5	(10)	(391)	72	(318)	(60)	0.8	(60)	(101)	27	(74)
5	(144)	3	(141)	(8)	0.4	(7)	(294)	56	(237)	(45)	0.6	(45)	(75)	21	(55)
6	(115)	2	(113)	(6)	0.3	(6)	(241)	47	(194)	(37)	0.5	(36)	(61)	17	(44)
7	(54)	1	(52)	(3)	0.2	(3)	(120)	27	(92)	(18)	0.3	(18)	(29)	10	(19)
8	(70)	2	(69)	(4)	0.2	(4)	(149)	33	(116)	(23)	0.4	(23)	(38)	12	(26)

TABLE 9-91 - TOXIC EMISSIONS IN 2035 (METRIC TONS) UNDER CO₂ TARGETS

Alt.	Acetaldehyde			Acrolein			Benzene			Butadiene			Formaldehyde		
	Tailpipe	Upstream	Total	Tailpipe	Upstream	Total	Tailpipe	Upstream	Total	Tailpipe	Upstream	Total	Tailpipe	Upstream	Total
1	(288)	4.5	(283)	(15)	0.6	(14)	(537)	92	(445)	(84)	1.0	(83)	(143)	34	(109)
2	(275)	4.3	(270)	(14)	0.6	(13)	(512)	88	(424)	(80)	1.0	(79)	(136)	33	(103)
3	(246)	3.9	(242)	(12)	0.5	(12)	(461)	79	(382)	(72)	0.9	(71)	(122)	29	(93)
4	(185)	3.1	(182)	(10)	0.4	(9)	(354)	62	(292)	(55)	0.7	(55)	(93)	23	(70)
5	(125)	2.1	(123)	(7)	0.3	(6)	(242)	44	(198)	(38)	0.5	(38)	(64)	16	(48)
6	(97)	1.8	(95)	(5)	0.2	(5)	(194)	36	(158)	(30)	0.4	(30)	(50)	13	(37)
7	(39)	0.8	(38)	(2)	0.1	(2)	(84)	16	(67)	(13)	0.2	(12)	(21)	6	(15)
8	(48)	1.0	(47)	(3)	0.1	(3)	(99)	21	(79)	(16)	0.2	(15)	(26)	8	(18)

9.2.3.2 Methodology

For the downstream analysis, emission factors from the current version of the EPA “Motor Vehicle Emission Simulator” (MOVES2014a) model were used in conjunction with the CAFE model to estimate base VOC, CO, NO_x, PM and air toxics emission rates. Additional emissions from light duty cars and trucks attributable to the rebound effect were also calculated using the CAFE model. This proposal also assumes implementation of EPA’s Tier 3 emission standards.⁵⁷⁷

For the purposes of this emission analysis, it is assumed that all gasoline in the timeframe of the analysis is blended with 10% ethanol (E10). While electric vehicles have zero tailpipe emissions, it is assumed that manufacturers will plan for these vehicles in their regulatory compliance strategy for non-GHG emissions standards, and will not over-comply with those standards. Because the Tier 3 emissions standards are fleet-average standards (for all pollutants except formaldehyde and PM_{2.5}), it is assumed that if a manufacturer introduces EVs into its fleet, that it would correspondingly compensate through changes to vehicles elsewhere in its fleet, rather than meet an overall lower fleet-average emissions level. Consequently, no tailpipe pollutant benefit is assumed (other than CO₂, formaldehyde, and PM_{2.5}). The analysis does not estimate evaporative emissions from light-duty vehicles. Other factors which may impact downstream non-GHG emissions, but are not estimated in this analysis, include the potential for decreased criteria pollutant emissions because of increased air conditioner efficiency; reduced refueling emissions because of less frequent refueling events and reduced annual refueling volumes resulting from the CO₂ standards; and increased hot soak evaporative emissions because of the likely increase in number of trips associated with VMT rebound modeled in this proposal. In all, these additional analyses would likely result in small changes relative to the national inventory.

To determine the impacts of increased fuel production on upstream emissions, the impact of increased gasoline consumption by light-duty vehicles on the extraction and transportation of crude oil, refining of crude oil, and distribution and storage of finished gasoline was estimated. To assess the resulting increases in domestic emissions, the fraction of increased gasoline consumption that would be supplied by additional domestic refining of gasoline, and the fraction of that gasoline that would be refined from domestic crude oil was also estimated. Using NEMS, it was estimated that 50% of increased gasoline consumption would be supplied by increased domestic refining and that 90% of this additional refining would use imported crude petroleum. Emission factors for most upstream emission sources are based on the DOE Argonne National Laboratory’s GREET 2017 model,⁵⁷⁸ but emission factors developed by EPA were relied on for the air toxics estimated in this analysis - benzene, 1,3-butadiene, acetaldehyde, acrolein, and

⁵⁷⁷ See 79 FR 23414 (April 28, 2014). EPA’s Tier 3 emissions standards included standards for vehicle emissions and the sulfur content of gasoline.

⁵⁷⁸ Greenhouse Gas, Regulated Emissions, and Energy Use in Transportation model (GREET), U.S. Department of Energy, Argonne National Laboratory, <https://greet.es.anl.gov/>.

formaldehyde. These emission factors came from the MOVES 2014a model and were incorporated into the CAFE model.

Emission factors for electricity upstream emissions were also based on GREET 2017. GREET allows the user to either select a region of the country for the electricity upstream emissions or to use the U.S. average of electricity emissions. The regional emission factors reflect the specific mix of fuels used to generate electricity in the selected region. The U.S. mix provides an average of electricity-related emissions (in grams per million Btu) in the U.S. in a given calendar year. The GREET 2017 U.S. mix emission factors were used for the analysis. In order to capture projected changes in upstream emissions over time, upstream emission factors for gasoline, diesel, and electricity were taken from the GREET 2017 model in five year increments, beginning in 1995 and ending in 2040.

9.3 Health Effects of Non-GHG Pollutants

This section discusses health effects associated with exposure to some of the criteria and air toxic pollutants impacted by the proposed vehicle standards.

9.3.1 Particulate Matter

9.3.1.1 Background

Particulate matter is a highly complex mixture of solid particles and liquid droplets distributed among numerous atmospheric gases which interact with solid and liquid phases. Particles range in size from those smaller than 1 nanometer (10⁻⁹ meter) to more than 100 micrometers (µm, or 10⁻⁶ meter) in diameter (for reference, a typical strand of human hair is 70 µm in diameter and a grain of salt is approximately 100 µm). Atmospheric particles can be grouped into several classes according to their aerodynamic and physical sizes. Generally, the three broad classes of particles include ultrafine particles (UFPs, generally considered as particulates with a diameter less than or equal to 0.1 µm [typically based on physical size, thermal diffusivity or electrical mobility]), “fine” particles (PM_{2.5}; particles with a nominal mean aerodynamic diameter less than or equal to 2.5 µm), and “thoracic” particles (PM₁₀; particles with a nominal mean aerodynamic diameter less than or equal to 10 µm).⁵⁷⁹ Particles that fall within the size range between PM_{2.5} and PM₁₀, are referred to as “thoracic coarse particles” (PM_{10-2.5}, particles with a nominal mean aerodynamic diameter less than or equal to 10 µm and greater than 2.5 µm). EPA currently has standards that regulate PM_{2.5} and PM₁₀.⁵⁸⁰

⁵⁷⁹ U.S. EPA. (2009). Integrated Science Assessment for Particulate Matter (Final Report). U.S. Environmental Protection Agency, Washington, DC, EPA/600/R-08/139F. Figure 3-1.

⁵⁸⁰ Regulatory definitions of PM size fractions, and information on reference and equivalent methods for measuring PM in ambient air, are provided in 40 CFR parts 50, 53, and 58. With regard to national ambient air quality standards (NAAQS) which provide protection against health and welfare effects, the 24-hour PM₁₀ standard provides protection against effects associated with short-term exposure to thoracic coarse particles (i.e., PM_{10-2.5}).

Particles span many sizes and shapes and may consist of hundreds of different chemicals. Particles are emitted directly from sources and are also formed through atmospheric chemical reactions; the former are often referred to as “primary” particles, and the latter as “secondary” particles. Particle concentration and composition varies by time of year and location, and, in addition to differences in source emissions, is affected by several weather-related factors, such as temperature, clouds, humidity, and wind. A further layer of complexity comes from particles’ ability to shift between solid/liquid and gaseous phases, which is influenced by concentration and meteorology, especially temperature.

Fine particles are produced primarily by combustion processes and by transformations of gaseous emissions (e.g., sulfur oxides (SO_x), oxides of nitrogen, and volatile organic compounds (VOC)) in the atmosphere. The chemical and physical properties of PM_{2.5} may vary greatly with time, region, meteorology, and source category. Thus, PM_{2.5} may include a complex mixture of different components including sulfates, nitrates, organic compounds, elemental carbon and metal compounds. These particles can remain in the atmosphere for days to weeks and travel hundreds to thousands of kilometers.

9.3.1.2 Health Effects of PM

Scientific studies show exposure to ambient PM is associated with a broad range of health effects. These health effects are discussed in detail in the Integrated Science Assessment for Particulate Matter (PM ISA), which was finalized in December 2009.⁵⁸¹ The PM ISA summarizes health effects evidence for short- and long-term exposures to PM_{2.5}, PM_{10-2.5}, and ultrafine particles.⁵⁸² The PM ISA concludes that human exposures to ambient PM_{2.5} are associated with a number of adverse health effects and characterizes the weight of evidence for broad health categories (e.g., cardiovascular effects, respiratory effects, etc.).⁵⁸³ The discussion below highlights the PM ISA’s conclusions pertaining to health effects associated with both short- and long-term PM exposures. Further discussion of health effects associated with PM can also be found in the rulemaking documents for the most recent review of the PM NAAQS completed in 2012.^{584,585}

⁵⁸¹ U.S. EPA. (2009). Integrated Science Assessment for Particulate Matter (Final Report). U.S. Environmental Protection Agency, Washington, DC, EPA/600/R-08/139F.

⁵⁸² The ISA also evaluated evidence for PM components but did not reach causal determinations for components.

⁵⁸³ The causal framework draws upon the assessment and integration of evidence from across epidemiological, controlled human exposure, and toxicological studies, and the related uncertainties that ultimately influence our understanding of the evidence. This framework employs a five-level hierarchy that classifies the overall weight of evidence and causality using the following categorizations - causal relationship, likely to be causal relationship, suggestive of a causal relationship, inadequate to infer a causal relationship, and not likely to be a causal relationship (U.S. EPA. (2009). Integrated Science Assessment for Particulate Matter (Final Report). U.S. Environmental Protection Agency, Washington, DC, EPA/600/R-08/139F, Table 1-3).

⁵⁸⁴ 78 FR 3103-3104, January 15, 2013.

⁵⁸⁵ 77 FR 38906-38911, June 29, 2012.

EPA has concluded that “a causal relationship exists” between both long- and short-term exposures to PM_{2.5} and premature mortality and cardiovascular effects and that “a causal relationship is likely to exist” between long- and short-term PM_{2.5} exposures and respiratory effects. Further, there is evidence “suggestive of a causal relationship” between long-term PM_{2.5} exposures and other health effects, including developmental and reproductive effects (e.g., low birth weight, infant mortality) and carcinogenic, mutagenic, and genotoxic effects (e.g., lung cancer mortality).⁵⁸⁶

As summarized in the final rule resulting from the last review (2012) of the PM NAAQS, and discussed extensively in the 2009 PM ISA, the available scientific evidence significantly strengthens the link between long- and short-term exposure to PM_{2.5} and mortality, while providing indications that the magnitude of the PM_{2.5}-mortality association with long-term exposures may be larger than previously estimated.^{587,588} The strongest evidence comes from recent studies investigating long-term exposure to PM_{2.5} and cardiovascular-related mortality. The evidence supporting a causal relationship between long-term PM_{2.5} exposure and mortality also includes consideration of studies that demonstrated an improvement in community health following reductions in ambient fine particles.

Several studies evaluated in the 2009 PM ISA have examined the association between cardiovascular effects and long-term PM_{2.5} exposures in multi-city epidemiological studies conducted in the U.S. and Europe. These studies have provided new evidence linking long-term exposure to PM_{2.5} with an array of cardiovascular effects such as heart attacks, congestive heart failure, stroke, and mortality. This evidence is coherent with studies of effects associated with short-term exposure to PM_{2.5} that have observed associations with a continuum of effects ranging from subtle changes in indicators of cardiovascular health to serious clinical events, such as increased hospitalizations and emergency department visits due to cardiovascular disease and cardiovascular mortality.⁵⁸⁹

As detailed in the 2009 PM ISA, extended analyses of seminal epidemiological studies, as well as more recent epidemiological studies conducted in the U.S. and abroad, provide strong evidence of respiratory-related morbidity effects associated with long-term PM_{2.5} exposure. The strongest evidence for respiratory-related effects is from studies that evaluated decrements in

⁵⁸⁶ These causal inferences are based not only on the more expansive epidemiological evidence available in this review but also reflect consideration of important progress that has been made to advance our understanding of a number of potential biologic modes of action or pathways for PM-related cardiovascular and respiratory effects (U.S. EPA. (2009). Integrated Science Assessment for Particulate Matter (Final Report). U.S. Environmental Protection Agency, Washington, DC, EPA/600/R-08/139F, Chapter 5).

⁵⁸⁷ 78 FR 3103-3104, January 15, 2013.

⁵⁸⁸ U.S. EPA. (2009). Integrated Science Assessment for Particulate Matter (Final Report). U.S. Environmental Protection Agency, Washington, DC, EPA/600/R-08/139F, Chapter 6 (Section 6.5) and Chapter 7 (Section 7.6).

⁵⁸⁹ U.S. EPA. (2009). Integrated Science Assessment for Particulate Matter (Final Report). U.S. Environmental Protection Agency, Washington, DC, EPA/600/R-08/139F, Chapter 2 (Section 2.3.1 and 2.3.2) and Chapter 6.

lung function growth (in children), increased respiratory symptoms, and asthma development. The strongest evidence from short-term PM_{2.5} exposure studies has been observed for increased respiratory-related emergency department visits and hospital admissions for chronic obstructive pulmonary disease (COPD) and respiratory infections.⁵⁹⁰

The body of scientific evidence detailed in the 2009 PM ISA is still limited with respect to associations between long-term PM_{2.5} exposures and developmental and reproductive effects as well as cancer, mutagenic, and genotoxic effects. The strongest evidence for an association between PM_{2.5} and developmental and reproductive effects comes from epidemiological studies of low birth weight and infant mortality, especially due to respiratory causes during the post-neonatal period (i.e., 1 month to 12 months of age).⁵⁹¹ With regard to cancer effects, “[m]ultiple epidemiologic studies have shown a consistent positive association between PM_{2.5} and lung cancer mortality, but studies have generally not reported associations between PM_{2.5} and lung cancer incidence.”⁵⁹²

In addition to evaluating the health effects attributed to short- and long-term exposure to PM_{2.5}, the 2009 PM ISA also evaluated whether specific components or sources of PM_{2.5} are more strongly associated with specific health effects. An evaluation of those studies resulted in the 2009 PM ISA concluding that “many [components] of PM can be linked with differing health effects and the evidence is not yet sufficient to allow differentiation of those [components] or sources that are more closely related to specific health outcomes.”⁵⁹³

For PM_{10-2.5}, the 2009 PM ISA concluded that available evidence was “suggestive of a causal relationship” between short-term exposures to PM_{10-2.5} and cardiovascular effects (e.g., hospital admissions and Emergency Department (ED) visits, changes in cardiovascular function), respiratory effects (e.g., ED visits and hospital admissions, increase in markers of pulmonary inflammation), and premature mortality. The scientific evidence was “inadequate to infer a causal relationship” between long-term exposure to PM_{10-2.5} and various health effects.^{594,595,596}

For UFPs, the 2009 PM ISA concluded that the evidence was “suggestive of a causal relationship” between short-term exposures and cardiovascular effects, including changes in

⁵⁹⁰ U.S. EPA. (2009). Integrated Science Assessment for Particulate Matter (Final Report). U.S. Environmental Protection Agency, Washington, DC, EPA/600/R-08/139F, Chapter 2 (Section 2.3.1 and 2.3.2) and Chapter 6.

⁵⁹¹ U.S. EPA. (2009). Integrated Science Assessment for Particulate Matter (Final Report). U.S. Environmental Protection Agency, Washington, DC, EPA/600/R-08/139F, Chapter 2 (Section 2.3.1 and 2.3.2) and Chapter 7.

⁵⁹² U.S. EPA. (2009). Integrated Science Assessment for Particulate Matter (Final Report). U.S. Environmental Protection Agency, Washington, DC, EPA/600/R-08/139F. pg 2-13.

⁵⁹³ U.S. EPA. (2009). Integrated Science Assessment for Particulate Matter (Final Report). U.S. Environmental Protection Agency, Washington, DC, EPA/600/R-08/139F. pg 2-26.

⁵⁹⁴ U.S. EPA. (2009). Integrated Science Assessment for Particulate Matter (Final Report). U.S. Environmental Protection Agency, Washington, DC, EPA/600/R-08/139F. Section 2.3.4 and Table 2-6.

⁵⁹⁵ 78 FR 3167-3168, January 15, 2013.

⁵⁹⁶ 77 FR 38947-38951, June 29, 2012.

heart rhythm and vasomotor function (the ability of blood vessels to expand and contract). It also concluded that there was evidence “suggestive of a causal relationship” between short-term exposure to UFPs and respiratory effects, including lung function and pulmonary inflammation, with limited and inconsistent evidence for increases in ED visits and hospital admissions. Scientific evidence was “inadequate to infer a causal relationship” between short-term exposure to UFPs and additional health effects including premature mortality as well as long-term exposure to UFPs and all health outcomes evaluated.^{597,598}

The 2009 PM ISA conducted an evaluation of specific groups within the general population potentially at increased risk for experiencing adverse health effects related to PM exposures.^{599,600,601, 602} The evidence detailed in the 2009 PM ISA expands our understanding of previously identified at-risk populations and lifestages (i.e., children, older adults, and individuals with pre-existing heart and lung disease) and supports the identification of additional at-risk populations (e.g., persons with lower socioeconomic status, genetic differences). Additionally, there is emerging, though still limited, evidence for additional potentially at-risk populations and lifestages, such as those with diabetes, people who are obese, pregnant women, and the developing fetus.⁶⁰³

9.3.2 Ozone

9.3.2.1 Background

Ground-level ozone pollution is typically formed through reactions involving VOC and NOX in the lower atmosphere in the presence of sunlight. These pollutants, often referred to as ozone precursors, are emitted by many types of pollution sources, such as highway and nonroad motor vehicles and engines, power plants, chemical plants, refineries, makers of consumer and commercial products, industrial facilities, and smaller area sources.

The science of ozone formation, transport, and accumulation is complex. Ground-level ozone is produced and destroyed in a cyclical set of chemical reactions, many of which are sensitive to temperature and sunlight. When ambient temperatures and sunlight levels remain high for several days and the air is relatively stagnant, ozone and its precursors can build up and result in more ozone than typically occurs on a single high-temperature day. Ozone and its precursors can

⁵⁹⁷ U.S. EPA. (2009). Integrated Science Assessment for Particulate Matter (Final Report). U.S. Environmental Protection Agency, Washington, DC, EPA/600/R-08/139F. Section 2.3.5 and Table 2-6.

⁵⁹⁸ 78 FR 3121, January 15, 2013.

⁵⁹⁹ U.S. EPA. (2009). Integrated Science Assessment for Particulate Matter (Final Report). U.S. Environmental Protection Agency, Washington, DC, EPA/600/R-08/139F. Chapter 8 and Chapter 2.

⁶⁰⁰ 77 FR 38890, June 29, 2012.

⁶⁰¹ 78 FR 3104, January 15, 2013.

⁶⁰² U.S. EPA. (2011). Policy Assessment for the Review of the PM NAAQS. U.S. Environmental Protection Agency, Washington, DC, EPA/452/R-11-003. Section 2.2.1.

⁶⁰³ U.S. EPA. (2009). Integrated Science Assessment for Particulate Matter (Final Report). U.S. Environmental Protection Agency, Washington, DC, EPA/600/R-08/139F. Chapter 8 and Chapter 2 (Section 2.4.1).

be transported hundreds of miles downwind from precursor emissions, resulting in elevated ozone levels even in areas with low local VOC or NO_x emissions.

9.3.2.2 Health Effects of Ozone

This section provides a summary of the health effects associated with exposure to ambient concentrations of ozone.⁶⁰⁴ The information in this section is based on the information and conclusions in the February 2013 Integrated Science Assessment for Ozone (Ozone ISA), which formed the basis for EPA's revision to the primary and secondary standards in 2015.⁶⁰⁵ The Ozone ISA concludes that human exposures to ambient concentrations of ozone are associated with a number of adverse health effects and characterizes the weight of evidence for these health effects.⁶⁰⁶ The discussion below highlights the Ozone ISA's conclusions pertaining to health effects associated with both short-term and long-term periods of exposure to ozone.

For short-term exposure to ozone, the Ozone ISA concludes that respiratory effects, including lung function decrements, pulmonary inflammation, exacerbation of asthma, respiratory-related hospital admissions, and mortality, are causally associated with ozone exposure. It also concludes that cardiovascular effects, including decreased cardiac function and increased vascular disease, and total mortality are likely to be causally associated with short-term exposure to ozone and that evidence is suggestive of a causal relationship between central nervous system effects and short-term exposure to ozone.

For long-term exposure to ozone, the Ozone ISA concludes that respiratory effects, including new onset asthma, pulmonary inflammation and injury, are likely to be causally related with ozone exposure. The Ozone ISA characterizes the evidence as suggestive of a causal relationship for associations between long-term ozone exposure and cardiovascular effects, reproductive and developmental effects, central nervous system effects and total mortality. The evidence is inadequate to infer a causal relationship between chronic ozone exposure and increased risk of lung cancer.

Finally, inter-individual variation in human responses to ozone exposure can result in some groups being at increased risk for detrimental effects in response to exposure. In addition, some groups are at increased risk of exposure due to their activities, such as outdoor workers or children. The Ozone ISA identified several groups that are at increased risk for ozone-related

⁶⁰⁴ Human exposure to ozone varies over time due to changes in ambient ozone concentration and because people move between locations which have notable different ozone concentrations. Also, the amount of ozone delivered to the lung is not only influenced by the ambient concentrations but also by the individuals breathing route and rate.

⁶⁰⁵ U.S. EPA. Integrated Science Assessment of Ozone and Related Photochemical Oxidants (Final Report). U.S. Environmental Protection Agency, Washington, DC, EPA/600/R-10/076F, 2013. The ISA is available at <http://cfpub.epa.gov/ncea/isa/recordisplay.cfm?deid=247492#Download>.

⁶⁰⁶ The ISA evaluates evidence and draws conclusions on the causal nature of relationship between relevant pollutant exposures and health effects, assigning one of five "weight of evidence" determinations - causal relationship, likely to be a causal relationship, suggestive of, but not sufficient to infer, a causal relationship, inadequate to infer a causal relationship, and not likely to be a causal relationship. For more information on these levels of evidence, please refer to Table II in the Preamble of the ISA.

health effects. These groups are people with asthma, children and older adults, individuals with reduced intake of certain nutrients (i.e., Vitamins C and E), outdoor workers, and individuals having certain genetic variants related to oxidative metabolism or inflammation. Ozone exposure during childhood can have lasting effects through adulthood. Such effects include altered function of the respiratory and immune systems. Children absorb higher doses (normalized to lung surface area) of ambient ozone, compared to adults, due to their increased time spent outdoors, higher ventilation rates relative to body size, and a tendency to breathe a greater fraction of air through the mouth. Children also have a higher asthma prevalence compared to adults.

9.3.3 Nitrogen Oxides

9.3.3.1 Background

Oxides of nitrogen (NO_x) refers to nitric oxide and nitrogen dioxide (NO₂). For the NO_x NAAQS, NO₂ is the indicator. Most NO₂ is formed in the air through the oxidation of nitric oxide (NO) emitted when fuel is burned at a high temperature. NO_x is also a major contributor to secondary PM_{2.5} formation. NO_x and VOC are the two major precursors of ozone.

9.3.3.2 Health Effects of Nitrogen Oxides

The most recent review of the health effects of oxides of nitrogen completed by EPA can be found in the 2016 Integrated Science Assessment for Oxides of Nitrogen - Health Criteria (Oxides of Nitrogen ISA).⁶⁰⁷ The primary source of NO₂ is motor vehicle emissions, and ambient NO₂ concentrations tend to be highly correlated with other traffic-related pollutants. Thus, a key issue in characterizing the causality of NO₂-health effect relationships was evaluating the extent to which studies supported an effect of NO₂ that is independent of other traffic-related pollutants. EPA concluded that the findings for asthma exacerbation integrated from epidemiologic and controlled human exposure studies provided evidence that is sufficient to infer a causal relationship between respiratory effects and short-term NO₂ exposure. The strongest evidence supporting an independent effect of NO₂ exposure comes from controlled human exposure studies demonstrating increased airway responsiveness in individuals with asthma following ambient-relevant NO₂ exposures. The coherence of this evidence with epidemiologic findings for asthma hospital admissions and ED visits as well as lung function decrements and increased pulmonary inflammation in children with asthma describe a plausible pathway by which NO₂ exposure can cause an asthma exacerbation. The 2016 ISA for Oxides of Nitrogen also concluded that there is likely to be a causal relationship between long-term NO₂ exposure and respiratory effects. This conclusion is based on new epidemiologic evidence for associations of NO₂ with asthma development in children combined with biological plausibility from experimental studies.

⁶⁰⁷ U.S. EPA. Integrated Science Assessment for Oxides of Nitrogen – Health Criteria (2016 Final Report). U.S. Environmental Protection Agency, Washington, DC, EPA/600/R-15/068, 2016.

In evaluating a broader range of health effects, the 2016 ISA for Oxides of Nitrogen concluded evidence is “suggestive of, but not sufficient to infer, a causal relationship” between short-term NO₂ exposure and cardiovascular effects and mortality and between long-term NO₂ exposure and cardiovascular effects and diabetes, birth outcomes, and cancer. In addition, the scientific evidence is inadequate (insufficient consistency of epidemiologic and toxicological evidence) to infer a causal relationship for long-term NO₂ exposure with fertility, reproduction, and pregnancy, as well as with postnatal development. A key uncertainty in understanding the relationship between these non-respiratory health effects and short- or long-term exposure to NO₂ is copollutant confounding, particularly by other roadway pollutants. The available evidence for non-respiratory health effects does not adequately address whether NO₂ has an independent effect or whether it primarily represents effects related to other or a mixture of traffic-related pollutants.

The 2016 ISA for Oxides of Nitrogen concluded that people with asthma, children, and older adults are at increased risk for NO₂-related health effects. In these groups and lifestages, NO₂ is consistently related to larger effects on outcomes related to asthma exacerbation, for which there is confidence in the relationship with NO₂ exposure.

9.3.4 Sulfur Oxides

9.3.4.1 Background

Sulfur dioxide (SO₂), a member of the sulfur oxide (SO_x) family of gases, is formed from burning fuels containing sulfur (e.g., coal or oil derived), extracting gasoline from oil, or extracting metals from ore. SO₂ and its gas phase oxidation products can dissolve in water droplets and further oxidize to form sulfuric acid which reacts with ammonia to form sulfates, which are important components of ambient PM.

9.3.4.2 Health Effects of SO₂

Information on the health effects of SO₂ can be found in the 2008 Integrated Science Assessment for Sulfur Oxides – Health Criteria (SO_x ISA).⁶⁰⁸ Short-term peaks (5-10 minutes) of SO₂ have long been known to cause adverse respiratory health effects, particularly among individuals with asthma. In addition to those with asthma (both children and adults), potentially at-risk lifestages include all children and the elderly. During periods of elevated ventilation, asthmatics may experience symptomatic bronchoconstriction within minutes of exposure. Following an extensive evaluation of health evidence from epidemiologic and laboratory studies, EPA concluded that there is a causal relationship between respiratory health effects and short-term exposure to SO₂. Separately, based on an evaluation of the epidemiologic evidence of associations between short-term exposure to SO₂ and mortality, EPA concluded that the overall

⁶⁰⁸ U.S. EPA. (2008). *Integrated Science Assessment (ISA) for Sulfur Oxides – Health Criteria (Final Report)*. EPA/600/R-08/047F. Washington, DC - U.S. Environmental Protection Agency.

evidence is suggestive of a causal relationship between short-term exposure to SO₂ and mortality.

9.3.5 Carbon Monoxide

9.3.5.1 Background

Carbon monoxide is a colorless, odorless gas emitted from combustion processes. Nationally, particularly in urban areas, the majority of CO emissions to ambient air come from mobile sources.⁶⁰⁹

9.3.5.2 Health Effects of Carbon Monoxide

Information on the health effects of CO can be found in the January 2010 Integrated Science Assessment for Carbon Monoxide (CO ISA).⁶¹⁰ The CO ISA presents conclusions regarding the presence of causal relationships between CO exposure and categories of adverse health effects. This section provides a summary of the health effects associated with exposure to ambient concentrations of CO, along with the ISA conclusions.⁶¹¹

Controlled human exposure studies of subjects with coronary artery disease show a decrease in the time to onset of exercise-induced angina (chest pain) and electrocardiogram changes following CO exposure. In addition, epidemiologic studies observed associations between short-term CO exposure and cardiovascular morbidity, particularly increased emergency room visits and hospital admissions for coronary heart disease (including ischemic heart disease, myocardial infarction, and angina). Some epidemiologic evidence is also available for increased hospital admissions and emergency room visits for congestive heart failure and cardiovascular disease as a whole. The CO ISA concludes that a causal relationship is likely to exist between short-term exposures to CO and cardiovascular morbidity. It also concludes that available data are inadequate to conclude that a causal relationship exists between long-term exposures to CO and cardiovascular morbidity.

Animal studies show various neurological effects with in-utero CO exposure. Controlled human exposure studies report central nervous system and behavioral effects following low-level CO exposures, although the findings have not been consistent across all studies. The CO ISA

⁶⁰⁹ U.S. EPA, (2010). Integrated Science Assessment for Carbon Monoxide (Final Report). U.S. Environmental Protection Agency, Washington, DC, EPA/600/R-09/019F, 2010. Available at <http://cfpub.epa.gov/ncea/cfm/recordisplay.cfm?deid=218686>. See Section 2.1.

⁶¹⁰ U.S. EPA, (2010). Integrated Science Assessment for Carbon Monoxide (Final Report). U.S. Environmental Protection Agency, Washington, DC, EPA/600/R-09/019F, 2010. Available at <http://cfpub.epa.gov/ncea/cfm/recordisplay.cfm?deid=218686>.

⁶¹¹ Personal exposure includes contributions from many sources, and in many different environments. Total personal exposure to CO includes both ambient and nonambient components; and both components may contribute to adverse health effects.

concludes the evidence is suggestive of a causal relationship with both short- and long-term exposure to CO and central nervous system effects.

A number of studies cited in the CO ISA have evaluated the role of CO exposure in birth outcomes such as preterm birth or cardiac birth defects. There is limited epidemiologic evidence of a CO-induced effect on preterm births and birth defects, with weak evidence for a decrease in birth weight. Animal toxicological studies have found perinatal CO exposure to affect birth weight, as well as other developmental outcomes. The CO ISA concludes the evidence is suggestive of a causal relationship between long-term exposures to CO and developmental effects and birth outcomes.

Epidemiologic studies provide evidence of associations between short-term CO concentrations and respiratory morbidity such as changes in pulmonary function, respiratory symptoms, and hospital admissions. A limited number of epidemiologic studies considered copollutants such as ozone, SO₂, and PM in two-pollutant models and found that CO risk estimates were generally robust, although this limited evidence makes it difficult to disentangle effects attributed to CO itself from those of the larger complex air pollution mixture. Controlled human exposure studies have not extensively evaluated the effect of CO on respiratory morbidity. Animal studies at levels of 50-100 ppm CO show preliminary evidence of altered pulmonary vascular remodeling and oxidative injury. The CO ISA concludes that the evidence is suggestive of a causal relationship between short-term CO exposure and respiratory morbidity, and inadequate to conclude that a causal relationship exists between long-term exposure and respiratory morbidity.

Finally, the CO ISA concludes that the epidemiologic evidence is suggestive of a causal relationship between short-term concentrations of CO and mortality. Epidemiologic evidence suggests an association exists between short-term exposure to CO and mortality, but limited evidence is available to evaluate cause-specific mortality outcomes associated with CO exposure. In addition, the attenuation of CO risk estimates which was often observed in copollutant models contributes to the uncertainty as to whether CO is acting alone or as an indicator for other combustion-related pollutants. The CO ISA also concludes that there is not likely to be a causal relationship between relevant long-term exposures to CO and mortality.

9.3.6 Diesel Exhaust

9.3.6.1 Background

Diesel exhaust consists of a complex mixture composed of particulate matter, carbon dioxide, oxygen, nitrogen, water vapor, carbon monoxide, nitrogen compounds, sulfur compounds and numerous low-molecular-weight hydrocarbons. A number of these gaseous hydrocarbon components are individually known to be toxic, including aldehydes, benzene and 1,3-butadiene. The diesel particulate matter present in diesel exhaust consists mostly of fine particles (< 2.5 µm), of which a significant fraction is ultrafine particles (< 0.1 µm). These particles have a large surface area which makes them an excellent medium for adsorbing organics, and their small size

*** EO 12866 Review – Draft – Do Not Cite, Quote or Release During Review ***

makes them highly respirable. Many of the organic compounds present in the gases and on the particles, such as polycyclic organic matter, are individually known to have mutagenic and carcinogenic properties.

Diesel exhaust varies significantly in chemical composition and particle sizes between different engine types (heavy-duty, light-duty), engine operating conditions (idle, acceleration, deceleration), and fuel formulations (high/low sulfur fuel). Also, there are emissions differences between on-road and nonroad engines because the nonroad engines are generally of older technology. After being emitted in the engine exhaust, diesel exhaust undergoes dilution as well as chemical and physical changes in the atmosphere. The lifetime for some of the compounds present in diesel exhaust ranges from hours to days.

9.3.6.2 Health Effects of Diesel Exhaust

In EPA's 2002 Diesel Health Assessment Document (Diesel HAD), exposure to diesel exhaust was classified as likely to be carcinogenic to humans by inhalation from environmental exposures, in accordance with the revised draft 1996/1999 EPA cancer guidelines.^{612,613} A number of other agencies (National Institute for Occupational Safety and Health, the International Agency for Research on Cancer, the World Health Organization, California EPA, and the U.S. Department of Health and Human Services) had made similar hazard classifications prior to 2002. EPA also concluded in the 2002 Diesel HAD that it was not possible to calculate a cancer unit risk for diesel exhaust due to limitations in the exposure data for the occupational groups or the absence of a dose-response relationship.

In the absence of a cancer unit risk, the Diesel HAD sought to provide additional insight into the significance of the diesel exhaust cancer hazard by estimating possible ranges of risk that might be present in the population. An exploratory analysis was used to characterize a range of possible lung cancer risk. The outcome was that environmental risks of cancer from long-term diesel exhaust exposures could plausibly range from as low as 10⁻⁵ to as high as 10⁻³. Because of uncertainties, the analysis acknowledged that the risks could be lower than 10⁻⁵, and a zero risk from diesel exhaust exposure could not be ruled out.

Non-cancer health effects of acute and chronic exposure to diesel exhaust emissions are also of concern to EPA. EPA derived a diesel exhaust reference concentration (RfC) from consideration of four well-conducted chronic rat inhalation studies showing adverse pulmonary effects. The RfC is 5 µg/m³ for diesel exhaust measured as diesel particulate matter. This RfC does not consider allergenic effects such as those associated with asthma or immunologic or the potential for cardiac effects. There was emerging evidence in 2002, discussed in the Diesel HAD, that

⁶¹² U.S. EPA. (1999). *Guidelines for Carcinogen Risk Assessment*. Review Draft. NCEA-F-0644, July. Washington, DC - U.S. EPA. Retrieved on March 19, 2009 from <http://cfpub.epa.gov/ncea/cfm/recordisplay.cfm?deid=54932>.

⁶¹³ U.S. EPA (2002). *Health Assessment Document for Diesel Engine Exhaust*. EPA/600/8-90/057F Office of Research and Development, Washington DC. Retrieved on March 17, 2009 from <http://cfpub.epa.gov/ncea/cfm/recordisplay.cfm?deid=29060>. pp. 1-1 1-2.

exposure to diesel exhaust can exacerbate these effects, but the exposure-response data were lacking at that time to derive an RfC based on these then-emerging considerations. The EPA Diesel HAD states, “With [diesel particulate matter] being a ubiquitous component of ambient PM, there is an uncertainty about the adequacy of the existing [diesel exhaust] noncancer database to identify all of the pertinent [diesel exhaust]-caused noncancer health hazards.” The Diesel HAD also notes “that acute exposure to [diesel exhaust] has been associated with irritation of the eye, nose, and throat, respiratory symptoms (cough and phlegm), and neurophysiological symptoms such as headache, lightheadedness, nausea, vomiting, and numbness or tingling of the extremities.” The Diesel HAD noted that the cancer and noncancer hazard conclusions applied to the general use of diesel engines then on the market and as cleaner engines replace a substantial number of existing ones, the applicability of the conclusions would need to be reevaluated.

It is important to note that the Diesel HAD also briefly summarizes health effects associated with ambient PM and discusses EPA’s then-annual PM_{2.5} NAAQS of 15 µg/m³. In 2012, EPA revised the annual PM_{2.5} NAAQS to 12 µg/m³. There is a large and extensive body of human data showing a wide spectrum of adverse health effects associated with exposure to ambient PM, of which diesel exhaust is an important component. The PM_{2.5} NAAQS is designed to provide protection from the noncancer health effects and premature mortality attributed to exposure to PM_{2.5}. The contribution of diesel PM to total ambient PM varies in different regions of the country and also, within a region, from one area to another. The contribution can be high in near-roadway environments, for example, or in other locations where diesel engine use is concentrated.

Since 2002, several new studies have been published which continue to report increased lung cancer risk with occupational exposure to diesel exhaust from older engines. Of particular note since 2011 are three new epidemiology studies which have examined lung cancer in occupational populations, for example, truck drivers, underground nonmetal miners and other diesel motor-related occupations. These studies reported increased risk of lung cancer with exposure to diesel exhaust with evidence of positive exposure-response relationships to varying degrees.^{614,615,616} These newer studies (along with others that have appeared in the scientific literature) add to the evidence EPA evaluated in the 2002 Diesel HAD and further reinforces the concern that diesel exhaust exposure likely poses a lung cancer hazard. The findings from these newer studies do

⁶¹⁴ Garshick, Eric, Francine Laden, Jaime E. Hart, Mary E. Davis, Ellen A. Eisen, and Thomas J. Smith. 2012. Lung cancer and elemental carbon exposure in trucking industry workers. *Environmental Health Perspectives* 120(9) - 1301-1306.

⁶¹⁵ Silverman, D. T., Samanic, C. M., Lubin, J. H., Blair, A. E., Stewart, P. A., Vermeulen, R., & Attfield, M. D. (2012). The diesel exhaust in miners study - a nested case-control study of lung cancer and diesel exhaust. *Journal of the National Cancer Institute*.

⁶¹⁶ Olsson, Ann C., et al. "Exposure to diesel motor exhaust and lung cancer risk in a pooled analysis from case-control studies in Europe and Canada." *American journal of respiratory and critical care medicine* 183.7 (2011) - 941-948.

not necessarily apply to newer technology diesel engines because the newer engines have large reductions in the emission constituents compared to older technology diesel engines.

In light of the growing body of scientific literature evaluating the health effects of exposure to diesel exhaust, in June 2012 the World Health Organization's International Agency for Research on Cancer (IARC), a recognized international authority on the carcinogenic potential of chemicals and other agents, evaluated the full range of cancer-related health effects data for diesel engine exhaust. IARC concluded that diesel exhaust should be regarded as "carcinogenic to humans."⁶¹⁷ This designation was an update from its 1988 evaluation that considered the evidence to be indicative of a "probable human carcinogen."

9.3.7 Air Toxics

9.3.7.1 Background

Light-duty vehicle emissions contribute to ambient levels of air toxics that are known or suspected human or animal carcinogens, or that have noncancer health effects. The population experiences an elevated risk of cancer and other noncancer health effects from exposure to the class of pollutants known collectively as "air toxics."⁶¹⁸ These compounds include, but are not limited to, benzene, 1,3-butadiene, formaldehyde, acetaldehyde, acrolein, polycyclic organic matter, and naphthalene. These compounds were identified as national or regional risk drivers or contributors in the 2011 National-scale Air Toxics Assessment and have significant inventory contributions from mobile sources.⁶¹⁹

9.3.7.2 Benzene

EPA's Integrated Risk Information System (IRIS) database lists benzene as a known human carcinogen (causing leukemia) by all routes of exposure, and concludes that exposure is associated with additional health effects, including genetic changes in both humans and animals and increased proliferation of bone marrow cells in mice.^{620,621,622} EPA states in its IRIS

⁶¹⁷ IARC [International Agency for Research on Cancer]. (2013). Diesel and gasoline engine exhausts and some nitroarenes. IARC Monographs Volume 105. [Online at <http://monographs.iarc.fr/ENG/Monographs/vol105/index.php>].

⁶¹⁸ U.S. EPA. (2015) Summary of Results for the 2011 National-Scale Assessment. <http://www3.epa.gov/sites/production/files/2015-12/documents/2011-nata-summary-results.pdf>.

⁶¹⁹ U.S. EPA (2015) 2011 National Air Toxics Assessment. <http://www3.epa.gov/national-air-toxics-assessment/2011-national-air-toxics-assessment>.

⁶²⁰ U.S. EPA. (2000). Integrated Risk Information System File for Benzene. This material is available electronically at - <http://www3.epa.gov/iris/subst/0276.htm>.

⁶²¹ International Agency for Research on Cancer, IARC monographs on the evaluation of carcinogenic risk of chemicals to humans, Volume 29, some industrial chemicals and dyestuffs, International Agency for Research on Cancer, World Health Organization, Lyon, France 1982.

⁶²² Irons, R.D.; Stillman, W.S.; Colagiovanni, D.B.; Henry, V.A. (1992). Synergistic action of the benzene metabolite hydroquinone on myelopoietic stimulating activity of granulocyte/macrophage colony-stimulating factor in vitro, *Proc. Natl. Acad. Sci.* 89:3691-3695.

database that data indicate a causal relationship between benzene exposure and acute lymphocytic leukemia and suggest a relationship between benzene exposure and chronic non-lymphocytic leukemia and chronic lymphocytic leukemia. EPA's IRIS documentation for benzene also lists a range of 2.2×10^{-6} to 7.8×10^{-6} per $\mu\text{g}/\text{m}^3$ as the unit risk estimate (URE) for benzene.^{623,624} The International Agency for Research on Cancer (IARC) has determined that benzene is a human carcinogen and the U.S. Department of Health and Human Services (DHHS) has characterized benzene as a known human carcinogen.^{625, 626}

A number of adverse noncancer health effects including blood disorders, such as pre-leukemia and aplastic anemia, have also been associated with long-term exposure to benzene. The most sensitive noncancer effect observed in humans, based on current data, is the depression of the absolute lymphocyte count in blood. EPA's inhalation reference concentration (RfC) for benzene is $30 \mu\text{g}/\text{m}^3$. The RfC is based on suppressed absolute lymphocyte counts seen in humans under occupational exposure conditions. In addition, recent work, including studies sponsored by the Health Effects Institute, provides evidence that biochemical responses are occurring at lower levels of benzene exposure than previously known.^{627, 628, 629, 630} EPA's IRIS program has not yet evaluated these new data. EPA does not currently have an acute reference concentration for benzene. The Agency for Toxic Substances and Disease Registry (ATSDR) Minimal Risk Level (MRL) for acute exposure to benzene is $29 \mu\text{g}/\text{m}^3$ for 1-14 days exposure.

⁶²³ A unit risk estimate is defined as the increase in the lifetime risk of an individual who is exposed for a lifetime to $1 \mu\text{g}/\text{m}^3$ benzene in air.

⁶²⁴ U.S. EPA. (2000). Integrated Risk Information System File for Benzene. This material is available electronically at - <http://www3.epa.gov/iris/subst/0276.htm>.

⁶²⁵ International Agency for Research on Cancer (IARC). (1987). Monographs on the evaluation of carcinogenic risk of chemicals to humans, Volume 29, Supplement 7, Some industrial chemicals and dyestuffs, World Health Organization, Lyon, France.

⁶²⁶ NTP. (2014). 13th Report on Carcinogens. Research Triangle Park, NC - U.S. Department of Health and Human Services, Public Health Service, National Toxicology Program.

⁶²⁷ Qu, O.; Shore, R.; Li, G.; Jin, X.; Chen, C.L.; Cohen, B.; Melikian, A.; Eastmond, D.; Rappaport, S.; Li, H.; Rupa, D.; Suramaya, R.; Songnian, W.; Huifant, Y.; Meng, M.; Winnik, M.; Kwok, E.; Li, Y.; Mu, R.; Xu, B.; Zhang, X.; Li, K. (2003). HEI Report 115, Validation & Evaluation of Biomarkers in Workers Exposed to Benzene in China.

⁶²⁸ Qu, Q., R. Shore, G. Li, X. Jin, L.C. Chen, B. Cohen, et al. (2002). Hematological changes among Chinese workers with a broad range of benzene exposures. *Am. J. Industr. Med.* 42 - 275-285.

⁶²⁹ Lan, Qing, Zhang, L., Li, G., Vermeulen, R., et al. (2004). Hematotoxicity in Workers Exposed to Low Levels of Benzene. *Science* 306 - 1774-1776.

⁶³⁰ Turteltaub, K.W. and Mani, C. (2003). Benzene metabolism in rodents at doses relevant to human exposure from Urban Air. *Research Reports Health Effect Inst. Report No.113.*

9.3.7.3 1,3-Butadiene

EPA has characterized 1,3-butadiene as carcinogenic to humans by inhalation.^{631,632} The IARC has determined that 1,3-butadiene is a human carcinogen and the U.S. DHHS has characterized 1,3-butadiene as a known human carcinogen.^{633, 634, 635} There are numerous studies consistently demonstrating that 1,3-butadiene is metabolized into genotoxic metabolites by experimental animals and humans. The specific mechanisms of 1,3-butadiene-induced carcinogenesis are unknown; however, the scientific evidence strongly suggests that the carcinogenic effects are mediated by genotoxic metabolites. Animal data suggest that females may be more sensitive than males for cancer effects associated with 1,3-butadiene exposure; there are insufficient data in humans from which to draw conclusions about sensitive subpopulations. The URE for 1,3-butadiene is 3×10^{-5} per $\mu\text{g}/\text{m}^3$.⁶³⁶ 1,3-butadiene also causes a variety of reproductive and developmental effects in mice; no human data on these effects are available. The most sensitive effect was ovarian atrophy observed in a lifetime bioassay of female mice.⁶³⁷ Based on this critical effect and the benchmark concentration methodology, an RfC for chronic health effects was calculated at 0.9 ppb (approximately $2 \mu\text{g}/\text{m}^3$).

9.3.7.4 Formaldehyde

In 1991, EPA concluded that formaldehyde is a carcinogen based on nasal tumors in animal bioassays.⁶³⁸ An Inhalation URE for cancer and a Reference Dose for oral noncancer effects were developed by the agency and posted on the IRIS database. Since that time, the National

⁶³¹ U.S. EPA. (2002). Health Assessment of 1,3-Butadiene. Office of Research and Development, National Center for Environmental Assessment, Washington Office, Washington, DC. Report No. EPA600-P-98-001F. This document is available electronically at <http://www3.epa.gov/iris/supdocs/buta-sup.pdf>.

⁶³² U.S. EPA. (2002). "Full IRIS Summary for 1,3-butadiene (CASRN 106-99-0)" Environmental Protection Agency, Integrated Risk Information System (IRIS), Research and Development, National Center for Environmental Assessment, Washington, DC <http://www3.epa.gov/iris/subst/0139.htm>.

⁶³³ International Agency for Research on Cancer (IARC). (1999). Monographs on the evaluation of carcinogenic risk of chemicals to humans, Volume 71, Re-evaluation of some organic chemicals, hydrazine and hydrogen peroxide and Volume 97 (in preparation), World Health Organization, Lyon, France.

⁶³⁴ International Agency for Research on Cancer (IARC). (2008). Monographs on the evaluation of carcinogenic risk of chemicals to humans, 1,3-Butadiene, Ethylene Oxide and Vinyl Halides (Vinyl Fluoride, Vinyl Chloride and Vinyl Bromide) Volume 97, World Health Organization, Lyon, France.

⁶³⁵ NTP. (2014). 13th Report on Carcinogens. Research Triangle Park, NC - U.S. Department of Health and Human Services, Public Health Service, National Toxicology Program.

⁶³⁶ U.S. EPA. (2002). "Full IRIS Summary for 1,3-butadiene (CASRN 106-99-0)" Environmental Protection Agency, Integrated Risk Information System (IRIS), Research and Development, National Center for Environmental Assessment, Washington, DC <http://www3.epa.gov/iris/subst/0139.htm>.

⁶³⁷ Bevan, C.; Stadler, J.C.; Elliot, G.S.; et al. (1996). Subchronic toxicity of 4-vinylcyclohexene in rats and mice by inhalation. *Fundam. Appl. Toxicol.* 32:1-10.

⁶³⁸ EPA. Integrated Risk Information System. Formaldehyde (CASRN 50-00-0) <http://www3.epa.gov/iris/subst/0419.htm>.

Toxicology Program (NTP) and International Agency for Research on Cancer (IARC) have concluded that formaldehyde is a known human carcinogen.^{639,640}

The conclusions by IARC and NTP reflect the results of epidemiologic research published since 1991 in combination with previous animal, human and mechanistic evidence. Research conducted by the National Cancer Institute reported an increased risk of nasopharyngeal cancer and specific lymph hematopoietic malignancies among workers exposed to formaldehyde.^{641,642,643} A National Institute of Occupational Safety and Health study of garment workers also reported increased risk of death due to leukemia among workers exposed to formaldehyde.⁶⁴⁴ Extended follow-up of a cohort of British chemical workers did not report evidence of an increase in nasopharyngeal or lymph hematopoietic cancers, but a continuing statistically significant excess in lung cancers was reported.⁶⁴⁵ Finally, a study of embalmers reported formaldehyde exposures to be associated with an increased risk of myeloid leukemia but not brain cancer.⁶⁴⁶

Health effects of formaldehyde in addition to cancer were reviewed by the Agency for Toxic Substances and Disease Registry in 1999⁶⁴⁷, supplemented in 2010,⁶⁴⁸ and by the World Health Organization.⁶⁴⁹ These organizations reviewed the scientific literature concerning health effects linked to formaldehyde exposure to evaluate hazards and dose response relationships and defined exposure concentrations for minimal risk levels (MRLs). The health endpoints reviewed included sensory irritation of eyes and respiratory tract, reduced pulmonary function, nasal histopathology, and immune system effects. In addition, research on reproductive and

⁶³⁹ NTP. (2014). 13th Report on Carcinogens. Research Triangle Park, NC - U.S. Department of Health and Human Services, Public Health Service, National Toxicology Program.

⁶⁴⁰ IARC Monographs on the Evaluation of Carcinogenic Risks to Humans Volume 100F (2012) - Formaldehyde

⁶⁴¹ Hauptmann, M.; Lubin, J. H.; Stewart, P. A.; Hayes, R. B.; Blair, A. 2003. Mortality from lymphohematopoietic malignancies among workers in formaldehyde industries. *Journal of the National Cancer Institute* 95 - 1615-1623.

⁶⁴² Hauptmann, M.; Lubin, J. H.; Stewart, P. A.; Hayes, R. B.; Blair, A. 2004. Mortality from solid cancers among workers in formaldehyde industries. *American Journal of Epidemiology* 159 - 1117-1130.

⁶⁴³ Beane Freeman, L. E.; Blair, A.; Lubin, J. H.; Stewart, P. A.; Hayes, R. B.; Hoover, R. N.; Hauptmann, M. 2009. Mortality from lymph hematopoietic malignancies among workers in formaldehyde industries - The National Cancer Institute cohort. *J. National Cancer Inst.* 101 - 751-761.

⁶⁴⁴ Pinkerton, L. E. 2004. Mortality among a cohort of garment workers exposed to formaldehyde - an update. *Occup. Environ. Med.* 61 - 193-200.

⁶⁴⁵ Coggon, D, EC Harris, J Poole, KT Palmer. 2003. Extended follow-up of a cohort of British chemical workers exposed to formaldehyde. *J National Cancer Inst.* 95:1608-1615.

⁶⁴⁶ Hauptmann, M.; Stewart P. A.; Lubin J. H.; Beane Freeman, L. E.; Hornung, R. W.; Herrick, R. F.; Hoover, R. N.; Fraumeni, J. F.; Hayes, R. B. 2009. Mortality from lymph hematopoietic malignancies and brain cancer among embalmers exposed to formaldehyde. *Journal of the National Cancer Institute* 101:1696-1708.

⁶⁴⁷ ATSDR. 1999. Toxicological Profile for Formaldehyde, U.S. Department of Health and Human Services (HHS), July 1999.

⁶⁴⁸ ATSDR. 2010. Addendum to the Toxicological Profile for Formaldehyde. U.S. Department of Health and Human Services (HHS), October 2010.

⁶⁴⁹ IPCS. 2002. Concise International Chemical Assessment Document 40. Formaldehyde. World Health Organization.

developmental effects and neurological effects were discussed along with several studies that suggest that formaldehyde may increase the risk of asthma – particularly in the young.

EPA released a draft Toxicological Review of Formaldehyde – Inhalation Assessment through the IRIS program for peer review by the National Research Council (NRC) and public comment in June 2010.⁶⁵⁰ The draft assessment reviewed more recent research from animal and human studies on cancer and other health effects. The NRC released their review report in April 2011.⁶⁵¹ EPA is currently developing a revised draft assessment in response to this review.

9.3.7.5 Acetaldehyde

Acetaldehyde is classified in EPA's IRIS database as a probable human carcinogen, based on nasal tumors in rats, and is considered toxic by the inhalation, oral, and intravenous routes.⁶⁵² The URE in IRIS for acetaldehyde is 2.2×10^{-6} per $\mu\text{g}/\text{m}^3$.⁶⁵³ Acetaldehyde is reasonably anticipated to be a human carcinogen by the U.S. DHHS in the 13th Report on Carcinogens and is classified as possibly carcinogenic to humans (Group 2B) by the IARC.^{654,655} Acetaldehyde is currently listed on the IRIS Program Multi-Year Agenda for reassessment within the next few years.

The primary noncancer effects of exposure to acetaldehyde vapors include irritation of the eyes, skin, and respiratory tract.⁶⁵⁶ In short-term (4 week) rat studies, degeneration of olfactory epithelium was observed at various concentration levels of acetaldehyde exposure.^{657,658} Data from these studies were used by EPA to develop an inhalation reference concentration of 9

⁶⁵⁰ EPA (U.S. Environmental Protection Agency). 2010. Toxicological Review of Formaldehyde (CAS No. 50-00-0) – Inhalation Assessment - In Support of Summary Information on the Integrated Risk Information System (IRIS). External Review Draft. EPA/635/R-10/002A. U.S. Environmental Protection Agency, Washington DC [online]. Available - http://cfpub.epa.gov/ncea/irs_drats/recordisplay.cfm?deid=223614.

⁶⁵¹ NRC (National Research Council). 2011. Review of the Environmental Protection Agency's Draft IRIS Assessment of Formaldehyde. Washington DC - National Academies Press. http://books.nap.edu/openbook.php?record_id=13142.

⁶⁵² U.S. EPA (1991). Integrated Risk Information System File of Acetaldehyde. Research and Development, National Center for Environmental Assessment, Washington, DC. This material is available electronically at <http://www3.epa.gov/iris/subst/0290.htm>.

⁶⁵³ U.S. EPA (1991). Integrated Risk Information System File of Acetaldehyde. This material is available electronically at <http://www3.epa.gov/iris/subst/0290.htm>.

⁶⁵⁴ NTP. (2014). 13th Report on Carcinogens. Research Triangle Park, NC - U.S. Department of Health and Human Services, Public Health Service, National Toxicology Program.

⁶⁵⁵ International Agency for Research on Cancer (IARC). (1999). Re-evaluation of some organic chemicals, hydrazine, and hydrogen peroxide. IARC Monographs on the Evaluation of Carcinogenic Risk of Chemical to Humans, Vol 71. Lyon, France.

⁶⁵⁶ U.S. EPA (1991). Integrated Risk Information System File of Acetaldehyde. This material is available electronically at <http://www3.epa.gov/iris/subst/0290.htm>.

⁶⁵⁷ U.S. EPA. (2003). Integrated Risk Information System File of Acrolein. Research and Development, National Center for Environmental Assessment, Washington, DC. This material is available electronically at <http://www3.epa.gov/iris/subst/0364.htm>.

⁶⁵⁸ Appleman, L.M., R.A. Woutersen, and V.J. Feron. (1982). Inhalation toxicity of acetaldehyde in rats. I. Acute and subacute studies. Toxicology. 23 - 293-297.

$\mu\text{g}/\text{m}^3$. Some asthmatics have been shown to be a sensitive subpopulation to decrements in functional expiratory volume (FEV1 test) and bronchoconstriction upon acetaldehyde inhalation.⁶⁵⁹

9.3.7.6 Acrolein

EPA most recently evaluated the toxicological and health effects literature related to acrolein in 2003 and concluded that the human carcinogenic potential of acrolein could not be determined because the available data were inadequate. No information was available on the carcinogenic effects of acrolein in humans and the animal data provided inadequate evidence of carcinogenicity.⁶⁶⁰ The IARC determined in 1995 that acrolein was not classifiable as to its carcinogenicity in humans.⁶⁶¹

Lesions to the lungs and upper respiratory tract of rats, rabbits, and hamsters have been observed after subchronic exposure to acrolein.⁶⁶² The agency has developed an RfC for acrolein of 0.02 $\mu\text{g}/\text{m}^3$ and an RfD of 0.5 $\mu\text{g}/\text{kg}\text{-day}$.⁶⁶³

Acrolein is extremely acrid and irritating to humans when inhaled, with acute exposure resulting in upper respiratory tract irritation, mucus hypersecretion and congestion. The intense irritancy of this carbonyl has been demonstrated during controlled tests in human subjects, who suffer intolerable eye and nasal mucosal sensory reactions within minutes of exposure.⁶⁶⁴ These data and additional studies regarding acute effects of human exposure to acrolein are summarized in EPA's 2003 Toxicological Review of Acrolein.⁶⁶⁵ Studies in humans indicate that levels as low as 0.09 ppm (0.21 mg/m^3) for five minutes may elicit subjective complaints of eye irritation with increasing concentrations leading to more extensive eye, nose and respiratory symptoms. Acute exposures in animal studies report bronchial hyper-responsiveness. Based on animal data (more

⁶⁵⁹ Myou, S.; Fujimura, M.; Nishi K.; Ohka, T.; and Matsuda, T. (1993) Aerosolized acetaldehyde induces histamine-mediated bronchoconstriction in asthmatics. *Am. Rev. Respir. Dis.* 148(4 Pt 1) - 940-943.

⁶⁶⁰ U.S. EPA. (2003). Integrated Risk Information System File of Acrolein. Research and Development, National Center for Environmental Assessment, Washington, DC. This material is available at <http://www3.epa.gov/iris/subst/0364.htm>.

⁶⁶¹ International Agency for Research on Cancer (IARC). (1995). Monographs on the evaluation of carcinogenic risk of chemicals to humans, Volume 63. Dry cleaning, some chlorinated solvents and other industrial chemicals, World Health Organization, Lyon, France.

⁶⁶² U.S. EPA. (2003). Integrated Risk Information System File of Acrolein. Office of Research and Development, National Center for Environmental Assessment, Washington, DC. This material is available at <http://www3.epa.gov/iris/subst/0364.htm>.

⁶⁶³ U.S. EPA. (2003). Integrated Risk Information System File of Acrolein. Office of Research and Development, National Center for Environmental Assessment, Washington, DC. This material is available at <http://www3.epa.gov/iris/subst/0364.htm>.

⁶⁶⁴ U.S. EPA. (2003) Toxicological review of acrolein in support of summary information on Integrated Risk Information System (IRIS) National Center for Environmental Assessment, Washington, DC. EPA/635/R-03/003. p. 10. Available online at - <http://www3.epa.gov/ncea/iris/toxreviews/0364tr.pdf>.

⁶⁶⁵ U.S. EPA. (2003) Toxicological review of acrolein in support of summary information on Integrated Risk Information System (IRIS) National Center for Environmental Assessment, Washington, DC. EPA/635/R-03/003. Available online at - <http://www3.epa.gov/ncea/iris/toxreviews/0364tr.pdf>.

pronounced respiratory irritancy in mice with allergic airway disease in comparison to non-diseased mice⁶⁶⁶) and demonstration of similar effects in humans (e.g., reduction in respiratory rate), individuals with compromised respiratory function (e.g., emphysema, asthma) are expected to be at increased risk of developing adverse responses to strong respiratory irritants such as acrolein. EPA does not currently have an acute reference concentration for acrolein. The available health effect reference values for acrolein have been summarized by EPA and include an ATSDR MRL for acute exposure to acrolein of 7 µg/m³ for 1-14 days' exposure; and Reference Exposure Level (REL) values from the California Office of Environmental Health Hazard Assessment (OEHHA) for one-hour and 8-hour exposures of 2.5 µg/m³ and 0.7 µg/m³, respectively.⁶⁶⁷

9.3.7.7 Polycyclic Organic Matter

The term polycyclic organic matter (POM) defines a broad class of compounds that includes the polycyclic aromatic hydrocarbon compounds (PAHs). One of these compounds, naphthalene, is discussed separately below. POM compounds are formed primarily from combustion and are present in the atmosphere in gas and particulate form. Cancer is the major concern from exposure to POM. Epidemiologic studies have reported an increase in lung cancer in humans exposed to diesel exhaust, coke oven emissions, roofing tar emissions, and cigarette smoke; all of these mixtures contain POM compounds.^{668,669} Animal studies have reported respiratory tract tumors from inhalation exposure to benzo[a]pyrene and alimentary tract and liver tumors from oral exposure to benzo[a]pyrene.⁶⁷⁰ In 1997 EPA classified seven PAHs (benzo[a]pyrene, benz[a]anthracene, chrysene, benzo[b]fluoranthene, benzo[k]fluoranthene, dibenz[a,h]anthracene, and indeno[1,2,3-cd]pyrene) as Group B2, probable human carcinogens.⁶⁷¹ Since that time, studies have found that maternal exposures to PAHs in a population of pregnant women were associated with several adverse birth outcomes, including low birth weight and reduced length at birth, as well as impaired cognitive development in

⁶⁶⁶ Morris JB, Symanowicz PT, Olsen JE, et al. (2003). Immediate sensory nerve-mediated respiratory responses to irritants in healthy and allergic airway-diseased mice. *J Appl Physiol* 94(4):1563-1571.

⁶⁶⁷ U.S. EPA. (2009). Graphical Arrays of Chemical-Specific Health Effect Reference Values for Inhalation Exposures (Final Report). U.S. Environmental Protection Agency, Washington, DC, EPA/600/R-09/061, 2009. <http://cfpub.epa.gov/ncea/cfm/recordisplay.cfm?deid=211003>.

⁶⁶⁸ Agency for Toxic Substances and Disease Registry (ATSDR). (1995). Toxicological profile for Polycyclic Aromatic Hydrocarbons (PAHs). Atlanta, GA - U.S. Department of Health and Human Services, Public Health Service. Available electronically at <http://www.atsdr.cdc.gov/ToxProfiles/TP.asp?id=122&tid=25>.

⁶⁶⁹ U.S. EPA (2002). *Health Assessment Document for Diesel Engine Exhaust*. EPA/600/8-90/057F Office of Research and Development, Washington DC. <http://cfpub.epa.gov/ncea/cfm/recordisplay.cfm?deid=29060>.

⁶⁷⁰ International Agency for Research on Cancer (IARC). (2012). Monographs on the Evaluation of the Carcinogenic Risk of Chemicals for Humans, Chemical Agents and Related Occupations. Vol. 100F. Lyon, France.

⁶⁷¹ U.S. EPA (1997). Integrated Risk Information System File of indeno (1,2,3-cd) pyrene. Research and Development, National Center for Environmental Assessment, Washington, DC. This material is available electronically at <http://www3.epa.gov/ncea/iris/subst/0457.htm>.

preschool children (3 years of age).^{672,673} These and similar studies are being evaluated as a part of the ongoing IRIS reassessment of health effects associated with exposure to benzo[a]pyrene.

9.3.7.8 Naphthalene

Naphthalene is found in small quantities in gasoline and diesel fuels. Naphthalene emissions have been measured in larger quantities in both gasoline and diesel exhaust compared with evaporative emissions from mobile sources, indicating it is primarily a product of combustion. Acute (short-term) exposure of humans to naphthalene by inhalation, ingestion, or dermal contact is associated with hemolytic anemia and damage to the liver and the nervous system.⁶⁷⁴ Chronic (long term) exposure of workers and rodents to naphthalene has been reported to cause cataracts and retinal damage.⁶⁷⁵ EPA released an external review draft of a reassessment of the inhalation carcinogenicity of naphthalene based on a number of recent animal carcinogenicity studies.⁶⁷⁶ The draft reassessment completed external peer review.⁶⁷⁷ Based on external peer review comments received, a revised draft assessment that considers all routes of exposure, as well as cancer and noncancer effects, is under development. The external review draft does not represent official agency opinion and was released solely for the purposes of external peer review and public comment. The National Toxicology Program listed naphthalene as "reasonably anticipated to be a human carcinogen" in 2004 on the basis of bioassays reporting clear evidence of carcinogenicity in rats and some evidence of carcinogenicity in mice.⁶⁷⁸ California EPA has released a new risk assessment for naphthalene, and the IARC has reevaluated naphthalene and re-classified it as Group 2B - possibly carcinogenic to humans.⁶⁷⁹

⁶⁷² Perera, F.P.; Rauh, V.; Tsai, W.-Y.; et al. (2002). Effect of transplacental exposure to environmental pollutants on birth outcomes in a multiethnic population. *Environ Health Perspect*. 111 - 201-205.

⁶⁷³ Perera, F.P.; Rauh, V.; Whyatt, R.M.; Tsai, W.Y.; Tang, D.; Diaz, D.; Hoepner, L.; Barr, D.; Tu, Y.H.; Camann, D.; Kinney, P. (2006). Effect of prenatal exposure to airborne polycyclic aromatic hydrocarbons on neurodevelopment in the first 3 years of life among inner-city children. *Environ Health Perspect* 114 - 1287-1292.

⁶⁷⁴ U. S. EPA. 1998. Toxicological Review of Naphthalene (Reassessment of the Inhalation Cancer Risk), Environmental Protection Agency, Integrated Risk Information System, Research and Development, National Center for Environmental Assessment, Washington, DC. This material is available electronically at <http://www3.epa.gov/iris/subst/0436.htm>.

⁶⁷⁵ U. S. EPA. 1998. Toxicological Review of Naphthalene (Reassessment of the Inhalation Cancer Risk), Environmental Protection Agency, Integrated Risk Information System, Research and Development, National Center for Environmental Assessment, Washington, DC. This material is available electronically at <http://www3.epa.gov/iris/subst/0436.htm>.

⁶⁷⁶ U. S. EPA. (1998). Toxicological Review of Naphthalene (Reassessment of the Inhalation Cancer Risk), Environmental Protection Agency, Integrated Risk Information System, Research and Development, National Center for Environmental Assessment, Washington, DC. This material is available electronically at <http://www3.epa.gov/iris/subst/0436.htm>.

⁶⁷⁷ Oak Ridge Institute for Science and Education. (2004). External Peer Review for the IRIS Reassessment of the Inhalation Carcinogenicity of Naphthalene. August 2004. <http://cfpub.epa.gov/ncea/cfm/recordisplay.cfm?deid=84403>.

⁶⁷⁸ NTP. (2014). 13th Report on Carcinogens. U.S. Department of Health and Human Services, Public Health Service, National Toxicology Program.

⁶⁷⁹ International Agency for Research on Cancer (IARC). (2002). Monographs on the Evaluation of the Carcinogenic Risk of Chemicals for Humans. Vol. 82. Lyon, France.

*** EO 12866 Review – Draft – Do Not Cite, Quote or Release During Review ***

Naphthalene also causes a number of chronic non-cancer effects in animals, including abnormal cell changes and growth in respiratory and nasal tissues.⁶⁸⁰ The current EPA IRIS assessment includes noncancer data on hyperplasia and metaplasia in nasal tissue that form the basis of the inhalation RfC of 3 µg/m³.⁶⁸¹ The ATSDR MRL for acute exposure to naphthalene is 0.6 mg/kg/day.

9.3.7.9 Other Air Toxics

In addition to the compounds described above, other compounds in gaseous hydrocarbon and PM emissions from motor vehicles will be affected by this action. Mobile source air toxic compounds that will potentially be impacted include ethylbenzene, propionaldehyde, toluene, and xylene. Information regarding the health effects of these compounds can be found in EPA's IRIS database.⁶⁸²

9.3.7.10 Exposure and Health Effects Associated with Traffic

Locations in close proximity to major roadways generally have elevated concentrations of many air pollutants emitted from motor vehicles. Hundreds of such studies have been published in peer-reviewed journals, concluding that concentrations of CO, NO, NO₂, benzene, aldehydes, particulate matter, black carbon, and many other compounds are elevated in ambient air within approximately 300-600 meters (approximately 1,000-2,000 feet) of major roadways. Highest concentrations of most pollutants emitted directly by motor vehicles are found at locations within 50 meters (approximately 165 feet) of the edge of a roadway's traffic lanes.

A large-scale review of air quality measurements in the vicinity of major roadways between 1978 and 2008 concluded that the pollutants with the steepest concentration gradients in vicinities of roadways were CO, ultrafine particles, metals, elemental carbon (EC), NO, NO_x, and several VOCs.⁶⁸³ These pollutants showed a large reduction in concentrations within 100 meters downwind of the roadway. Pollutants that showed more gradual reductions with distance from roadways included benzene, NO₂, PM_{2.5}, and PM₁₀. In the review article, results varied based on the method of statistical analysis used to determine the trend.

For pollutants with relatively high background concentrations relative to near-road concentrations, detecting concentration gradients can be difficult. For example, many aldehydes have high background concentrations as a result of photochemical breakdown of precursors from

⁶⁸⁰ U. S. EPA. (1998). Toxicological Review of Naphthalene, Environmental Protection Agency, Integrated Risk Information System, Research and Development, National Center for Environmental Assessment, Washington, DC. This material is available electronically at <http://www3.epa.gov/iris/subst/0436.htm>.

⁶⁸¹ U.S. EPA. (1998). Toxicological Review of Naphthalene. Environmental Protection Agency, Integrated Risk Information System (IRIS), Research and Development, National Center for Environmental Assessment, Washington, DC <http://www3.epa.gov/iris/subst/0436.htm>.

⁶⁸² U.S. EPA Integrated Risk Information System (IRIS) database is available at - www3.epa.gov/iris

⁶⁸³ Karner, A.A.; Eisinger, D.S.; Niemeier, D.A. (2010). Near-roadway air quality - synthesizing the findings from real-world data. *Environ Sci Technol* 44 - 5334-5344.

many different organic compounds. This can make detection of gradients around roadways and other primary emission sources difficult. However, several studies have measured aldehydes in multiple weather conditions and found higher concentrations of many carbonyls downwind of roadways.^{684,685} These findings suggest a substantial roadway source of these carbonyls.

In the past 15 years, many studies have been published with results reporting that populations who live, work, or go to school near high-traffic roadways experience higher rates of numerous adverse health effects, compared to populations far away from major roads.⁶⁸⁶ In addition, numerous studies have found adverse health effects associated with spending time in traffic, such as commuting or walking along high-traffic roadways.^{687,688,689,690} The health outcomes with the strongest evidence linking them with traffic-associated air pollutants are respiratory effects, particularly in asthmatic children, and cardiovascular effects.

Numerous reviews of this body of health literature have been published as well. In 2010, an expert panel of the Health Effects Institute (HEI) published a review of hundreds of exposure, epidemiology, and toxicology studies.⁶⁹¹ The panel rated how the evidence for each type of health outcome supported a conclusion of a causal association with traffic-associated air pollution as either “sufficient,” “suggestive but not sufficient,” or “inadequate and insufficient.” The panel categorized evidence of a causal association for exacerbation of childhood asthma as “sufficient.” The panel categorized evidence of a causal association for new onset asthma as between “sufficient” and “suggestive but not sufficient.” “Suggestive of a causal association” was how the panel categorized evidence linking traffic-associated air pollutants with exacerbation of adult respiratory symptoms and lung function decrement. It categorized as “inadequate and insufficient” evidence of a causal relationship between traffic-related air

⁶⁸⁴ Liu, W.; Zhang, J.; Kwon, J.I; et I. (2006). Concentrations and source characteristics of airborne carbonyl compounds measured outside urban residences. *J Air Waste Manage Assoc* 56 - 1196-1204.

⁶⁸⁵ Cahill, T.M.; Charles, M.J.; Seaman, V.Y. (2010). Development and application of a sensitive method to determine concentrations of acrolein and other carbonyls in ambient air. Health Effects Institute Research Report 149. Available at <http://dx.doi.org>.

⁶⁸⁶ In the widely-used PubMed database of health publications, between January 1, 1990 and August 18, 2011, 605 publications contained the keywords “traffic, pollution, epidemiology,” with approximately half the studies published after 2007.

⁶⁸⁷ Laden, F.; Hart, J.E.; Smith, T.J.; Davis, M.E.; Garshick, E. (2007) Cause-specific mortality in the unionized U.S. trucking industry. *Environmental Health Perspect* 115:1192-1196.

⁶⁸⁸ Peters, A.; von Klot, S.; Heier, M.; Trentinaglia, I.; Hörmann, A.; Wichmann, H.E.; Löwel, H. (2004) Exposure to traffic and the onset of myocardial infarction. *New England J Med* 351 - 1721-1730.

⁶⁸⁹ Zanobetti, A.; Stone, P.H.; Spelzer, F.E.; Schwartz, J.D.; Coull, B.A.; Suh, H.H.; Nearling, B.D.; Mittleman, M.A.; Verrier, R.L.; Gold, D.R. (2009) T-wave alternans, air pollution and traffic in high-risk subjects. *Am J Cardiol* 104 - 665-670.

⁶⁹⁰ Dubowsky Adar, S.; Adamkiewicz, G.; Gold, D.R.; Schwartz, J.; Coull, B.A.; Suh, H. (2007) Ambient and microenvironmental particles and exhaled nitric oxide before and after a group bus trip. *Environ Health Perspect* 115 - 507-512.

⁶⁹¹ Health Effects Institute Panel on the Health Effects of Traffic-Related Air Pollution. (2010). Traffic-related air pollution - a critical review of the literature on emissions, exposure, and health effects. HEI Special Report 17. Available at <http://www.healtheffects.org>.

pollution and health care utilization for respiratory problems, new onset adult asthma, chronic obstructive pulmonary disease (COPD), nonasthmatic respiratory allergy, and cancer in adults and children. Other literature reviews have been published with conclusions generally similar to the HEI panel's.^{692,693,694,695} However, in 2014, researchers from the U.S. Centers for Disease Control and Prevention (CDC) published a systematic review and meta-analysis of studies evaluating the risk of childhood leukemia associated with traffic exposure and reported positive associations between “postnatal” proximity to traffic and leukemia risks, but no such association for “prenatal” exposures.⁶⁹⁶

Health outcomes with few publications suggest the possibility of other effects still lacking sufficient evidence to draw definitive conclusions. Among these outcomes with a small number of positive studies are neurological impacts (e.g., autism and reduced cognitive function) and reproductive outcomes (e.g., preterm birth, low birth weight).^{697,698,699,700}

In addition to health outcomes, particularly cardiopulmonary effects, conclusions of numerous studies suggest mechanisms by which traffic-related air pollution affects health. Numerous studies indicate that near-roadway exposures may increase systemic inflammation, affecting organ systems, including blood vessels and lungs.^{701,702,703,704} Long-term exposures in near-road

⁶⁹² Boothe, V.L.; Shendell, D.G. (2008). Potential health effects associated with residential proximity to freeways and primary roads - review of scientific literature, 1999-2006. *J Environ Health* 70 - 33-41.

⁶⁹³ Salam, M.T.; Islam, T.; Gilliland, F.D. (2008). Recent evidence for adverse effects of residential proximity to traffic sources on asthma. *Curr Opin Pulm Med* 14 - 3-8.

⁶⁹⁴ Sun, X.; Zhang, S.; Ma, X. (2014) No association between traffic density and risk of childhood leukemia - a meta-analysis. *Asia Pac J Cancer Prev* 15 - 5229-5232.

⁶⁹⁵ Raaschou-Nielsen, O.; Reynolds, P. (2006). Air pollution and childhood cancer - a review of the epidemiological literature. *Int J Cancer* 118 - 2920-9.

⁶⁹⁶ Boothe, V.L.; Boehmer, T.K.; Wendel, A.M.; Yip, F.Y. (2014) Residential traffic exposure and childhood leukemia - a systematic review and meta-analysis. *Am J Prev Med* 46 - 413-422.

⁶⁹⁷ Volk, H.E.; Hertz-Picciotto, I.; Delwiche, L.; et al. (2011). Residential proximity to freeways and autism in the CHARGE study. *Environ Health Perspect* 119 - 873-877.

⁶⁹⁸ Franco-Suglia, S.; Gryparis, A.; Wright, R.O.; et al. (2007). Association of black carbon with cognition among children in a prospective birth cohort study. *Am J Epidemiol.* doi - 10.1093/aje/kwm308. [Online at <http://dx.doi.org>].

⁶⁹⁹ Power, M.C.; Weisskopf, M.G.; Alexeef, S.E.; et al. (2011). Traffic-related air pollution and cognitive function in a cohort of older men. *Environ Health Perspect* 2011 - 682-687.

⁷⁰⁰ Wu, J.; Wilhelm, M.; Chung, J.; et al. (2011). Comparing exposure assessment methods for traffic-related air pollution in and adverse pregnancy outcome study. *Environ Res* 111 - 685-6692.

⁷⁰¹ Riediker, M. (2007). Cardiovascular effects of fine particulate matter components in highway patrol officers. *Inhal Toxicol* 19 - 99-105. doi - 10.1080/08958370701495238 Available at <http://dx.doi.org>.

⁷⁰² Alexeef, S.E.; Coull, B.A.; Gryparis, A.; et al. (2011). Medium-term exposure to traffic-related air pollution and markers of inflammation and endothelial function. *Environ Health Perspect* 119 - 481-486. doi:10.1289/ehp.1002560 Available at <http://dx.doi.org>.

⁷⁰³ Eckel, S.P.; Berhane, K.; Salam, M.T.; et al. (2011). Traffic-related pollution exposure and exhaled nitric oxide in the Children's Health Study. *Environ Health Perspect* (IN PRESS). doi:10.1289/ehp.1103516. Available at <http://dx.doi.org>.

⁷⁰⁴ Zhang, J.; McCreanor, J.E.; Cullinan, P.; et al. (2009). Health effects of real-world exposure diesel exhaust in persons with asthma. *Res Rep Health Effects Inst* 138. [Online at <http://www.healtheffects.org>].

environments have been associated with inflammation-associated conditions, such as atherosclerosis and asthma.^{705,706,707}

Several studies suggest that some factors may increase susceptibility to the effects of traffic-associated air pollution. Several studies have found stronger respiratory associations in children experiencing chronic social stress, such as in violent neighborhoods or in homes with high family stress.^{708,709,710}

The risks associated with residence, workplace, or schools near major roads are of potentially high public health significance due to the large population in such locations. According to the 2009 American Housing Survey, over 22 million homes (17.0 percent of all U.S. housing units) were located within 300 feet of an airport, railroad, or highway with four or more lanes. This corresponds to a population of more than 50 million U.S. residents in close proximity to high-traffic roadways or other transportation sources. Based on 2010 Census data, a 2013 publication estimated that 19 percent of the U.S. population (over 59 million people) lived within 500 meters of roads with at least 25,000 annual average daily traffic (AADT), while about 3.2 percent of the population lived within 100 meters (about 300 feet) of such roads.⁷¹¹ Another 2013 study estimated that 3.7 percent of the U.S. population (about 11.3 million people) lived within 150 meters (about 500 feet) of interstate highways or other freeways and expressways.⁷¹² On average, populations near major roads have higher fractions of minority residents and lower socioeconomic status. Furthermore, on average, Americans spend more than an hour traveling each day, bringing nearly all residents into a high-exposure microenvironment for part of the day.

In light of these concerns, EPA has required through the NAAQS process that air quality monitors be placed near high-traffic roadways for determining concentrations of CO, NO₂, and PM_{2.5} (in addition to those existing monitors located in neighborhoods and other locations farther away from pollution sources). Near-roadway monitors for NO₂ begin operation between 2014

⁷⁰⁵ Adar, S.D.; Klein, R.; Klein, E.K.; et al. (2010). Air pollution and the microvasculature - a cross-sectional assessment of in vivo retinal images in the population-based Multi-Ethnic Study of Atherosclerosis. *PLoS Med* 7(11) - E1000372. doi:10.1371/journal.pmed.1000372. Available at <http://dx.doi.org>.

⁷⁰⁶ Kan, H.; Heiss, G.; Rose, K.M.; et al. (2008). Prospective analysis of traffic exposure as a risk factor for incident coronary heart disease - the Atherosclerosis Risk in Communities (ARIC) study. *Environ Health Perspect* 116 - 1463-1468. doi:10.1289/ehp.11290. Available at <http://dx.doi.org>.

⁷⁰⁷ McConnell, R.; Islam, T.; Shankardass, K.; et al. (2010). Childhood incident asthma and traffic-related air pollution at home and school. *Environ Health Perspect* 1021-1026.

⁷⁰⁸ Islam, T.; Urban, R.; Gauderman, W.J.; et al. (2011). Parental stress increases the detrimental effect of traffic exposure on children's lung function. *Am J Respir Crit Care Med* (In press).

⁷⁰⁹ Clougherty, J.E.; Levy, J.I.; Kubzansky, L.D.; et al. (2007). Synergistic effects of traffic-related air pollution and exposure to violence on urban asthma etiology. *Environ Health Perspect* 115 - 1140-1146.

⁷¹⁰ Chen, E.; Schrier, H.M.; Strunk, R.C.; et al. (2008). Chronic traffic-related air pollution and stress interact to predict biologic and clinical outcomes in asthma. *Environ Health Perspect* 116 - 970-5.

⁷¹¹ Rowangould, G.M. (2013) A census of the U.S. near-roadway population - public health and environmental justice considerations. *Transportation Research Part D* 25 - 59-67.

⁷¹² Boehmer, T.K.; Foster, S.L.; Henry, J.R.; Woghiren-Akinnifesi, E.L.; Yip, F.Y. (2013) Residential proximity to major highways – United States, 2010. *Morbidity and Mortality Weekly Report* 62(3); 46-50.

*** EO 12866 Review – Draft – Do Not Cite, Quote or Release During Review ***

and 2017 in Core Based Statistical Areas (CBSAs) with population of at least 500,000. Monitors for CO and PM_{2.5} begin operation between 2015 and 2017. These monitors will further our understanding of exposure in these locations.

EPA and DOT continue to research near-road air quality, including the types of pollutants found in high concentrations near major roads and health problems associated with the mixture of pollutants near roads.

9.3.8 Environmental Justice

Environmental justice (EJ) is a principle asserting that all people deserve fair treatment and meaningful involvement with respect to environmental laws, regulations, and policies. EPA seeks to provide the same degree of protection from environmental health hazards for all people. DOT shares this goal and is informed about the potential environmental impacts of its rulemakings through its NEPA process (see NHTSA's DEIS). As referenced below, numerous studies have found that some environmental hazards are more prevalent in areas where racial/ethnic minorities and people with low socioeconomic status (SES) represent a higher fraction of the population compared with the general population. In addition, compared to non-Hispanic whites, some types of minorities may have greater levels of health problems during some life stages. For example, in 2014, about 13 percent of Black, non-Hispanic and 24 percent of Puerto Rican children were estimated to currently have asthma, compared with 8 percent of white, non-Hispanic children.⁷¹³

As discussed in the DEIS, concentrations of many air pollutants are elevated near high-traffic roadways. If minority populations and low-income populations disproportionately live near such roads, then an issue of EJ may be present. We reviewed existing scholarly literature examining the potential for disproportionate exposure among minorities and people with low SES, and we conducted our own evaluation of two national datasets - the U.S. Census Bureau's American Housing Survey for calendar year 2009 and the U.S. Department of Education's database of school locations.

Publications that address EJ issues generally report that populations living near major roadways (and other types of transportation infrastructure) tend to be composed of larger fractions of nonwhite residents. People living in neighborhoods near such sources of air pollution also tend to be lower in income than people living elsewhere. Numerous studies evaluating the demographics and socioeconomic status of populations or schools near roadways have found that they include a greater percentage of minority residents, as well as lower SES (indicated by variables such as median household income). Locations in these studies include Los Angeles,

⁷¹³ http://www.cdc.gov/asthma/most_recent_data.htm.

CA; Seattle, WA; Wayne County, MI; Orange County, FL; and the State of California
714,715,716,717,718,719 Such disparities may be due to multiple factors.⁷²⁰

People with low SES often live in neighborhoods with multiple stressors and health risk factors, including reduced health insurance coverage rates, higher smoking and drug use rates, limited access to fresh food, visible neighborhood violence, and elevated rates of obesity and some diseases such as asthma, diabetes, and ischemic heart disease. Although questions remain, several studies find stronger associations between air pollution and health in locations with such chronic neighborhood stress, suggesting that populations in these areas may be more susceptible to the effects of air pollution.^{721,722,723,724} Household-level stressors such as parental smoking and relationship stress also may increase susceptibility to the adverse effects of air pollution.^{725,726}

⁷¹⁴ Marshall, J.D. (2008) Environmental inequality - air pollution exposures in California's South Coast Air Basin.

⁷¹⁵ Su, J.G.; Larson, T.; Gould, T.; Cohen, M.; Buzzelli, M. (2010) Transboundary air pollution and environmental justice - Vancouver and Seattle compared. *GeoJournal* 57 - 595-608. doi:10.1007/s10708-009-9269-6 [Online at <http://dx.doi.org>].

⁷¹⁶ Chakraborty, J.; Zandbergen, P.A. (2007) Children at risk - measuring racial/ethnic disparities in potential exposure to air pollution at school and home. *J Epidemiol Community Health* 61 - 1074-1079. doi - 10.1136/jech.2006.054130 [Online at <http://dx.doi.org>].

⁷¹⁷ Green, R.S.; Smorodinsky, S.; Kim, J.J.; McLaughlin, R.; Ostro, B. (2003) Proximity of California public schools to busy roads. *Environ Health Perspect* 112 - 61-66. doi:10.1289/ehp.6566 [<http://dx.doi.org>].

⁷¹⁸ Wu, Y.; Batterman, S.A. (2006) Proximity of schools in Detroit, Michigan to automobile and truck traffic. *J Exposure Sci & Environ Epidemiol*. doi:10.1038/sj.jes.7500484 [Online at <http://dx.doi.org>].

⁷¹⁹ Su, J.G.; Jerrett, M.; de Nazelle, A.; Wolch, J. (2011) Does exposure to air pollution in urban parks have socioeconomic, racial, or ethnic gradients? *Environ Res* 111 - 319-328.

⁷²⁰ Depro, B.; Timmins, C. (2008) Mobility and environmental equity - do housing choices determine exposure to air pollution? North Carolina State University Center for Environmental and Resource Economic Policy

⁷²¹ Clougherty, J.E.; Kubzansky, L.D. (2009) A framework for examining social stress and susceptibility to air pollution in respiratory health. *Environ Health Perspect* 117 - 1351-1358. Doi:10.1289/ehp.0900612 [Online at <http://dx.doi.org>].

⁷²² Clougherty, J.E.; Levy, J.I.; Kubzansky, L.D.; Ryan, P.B.; Franco Suglia, S.; Jacobson Canner, M.; Wright, R.J. (2007) Synergistic effects of traffic-related air pollution and exposure to violence on urban asthma etiology. *Environ Health Perspect* 115 - 1140-1146. doi:10.1289/ehp.9863 [Online at <http://dx.doi.org>].

⁷²³ Finkelstein, M.M.; Jerrett, M.; DeLuca, P.; Finkelstein, N.; Verma, D.K.; Chapman, K.; Sears, M.R. (2003) Relation between income, air pollution and mortality - a cohort study. *Canadian Med Assn J* 169 - 397-402.

⁷²⁴ Shankardass, K.; McConnell, R.; Jerrett, M.; Milam, J.; Richardson, J.; Berhane, K. (2009) Parental stress increases the effect of traffic-related air pollution on childhood asthma incidence. *Proc Natl Acad Sci* 106 - 12406-12411. doi:10.1073/pnas.0812910106 [Online at <http://dx.doi.org>].

⁷²⁵ Lewis, A.S.; Sax, S.N.; Wason, S.C.; Campleman, S.L (2011) Non-chemical stressors and cumulative risk assessment - an overview of current initiatives and potential air pollutant interactions. *Int J Environ Res Public Health* 8 - 2020-2073. Doi:10.3390/ijerph8062020 [Online at <http://dx.doi.org>].

⁷²⁶ Rosa, M.J.; Jung, K.H.; Perzanowski, M.S.; Kelvin, E.A.; Darling, K.W.; Camann, D.E.; Chillrud, S.N.; Whyatt, R.M.; Kinney, P.L.; Perera, F.P.; Miller, R.L (2010) Prenatal exposure to polycyclic aromatic hydrocarbons, environmental tobacco smoke and asthma. *Respir Med (In press)*. doi:10.1016/j.rmed.2010.11.022 [Online at <http://dx.doi.org>].

More recently, three publications report nationwide analyses that compare the demographic patterns of people who do or do not live near major roadways.^{727,728,729} All three of these studies found that people living near major roadways are more likely to be minorities or low in SES. They also found that the outcomes of their analyses varied between regions within the U.S. However, only one such study looked at whether such conclusions were confounded by living in a location with higher population density and how demographics differ between locations nationwide. In general, it found that higher density areas have higher proportions of low income and minority residents.

We analyzed two national databases that allowed us to evaluate whether homes and schools were located near a major road and whether disparities in exposure may be occurring in these environments. The American Housing Survey (AHS) includes descriptive statistics of over 70,000 housing units across the nation. The study survey is conducted every two years by the U.S. Census Bureau. The second database we analyzed was the U.S. Department of Education’s Common Core of Data, which includes enrollment and location information for schools across the U.S.

In analyzing the 2009 AHS, we focused on whether or not a housing unit was located within 300 feet of “4-or-more lane highway, railroad, or airport.”⁷³⁰ We analyzed whether there were differences between households in such locations compared with those in locations farther from these transportation facilities.⁷³¹ We included other variables, such as land use category, region of country, and housing type. We found that homes with a nonwhite householder were 22-34 percent more likely to be located within 300 feet of these large transportation facilities than homes with white householders. Homes with a Hispanic householder were 17-33 percent more likely to be located within 300 feet of these large transportation facilities than homes with non-Hispanic householders. Households near large transportation facilities were, on average, lower in income and educational attainment, more likely to be a rental property and located in an urban area compared with households more distant from transportation facilities.

In examining schools near major roadways, we examined the Common Core of Data (CCD) from the U.S. Department of Education, which includes information on all public elementary and

⁷²⁷ Rowangould, G.M. (2013) A census of the U.S. near-roadway population - public health and environmental justice considerations. *Transportation Research Part D*; 59-67.

⁷²⁸ Tian, N.; Xue, J.; Barzyk, T.M. (2013) Evaluating socioeconomic and racial differences in traffic-related metrics in the United States using a GIS approach. *J Exposure Sci Environ Epidemiol* 23 - 215-222.

⁷²⁹ Boehmer, T.K.; Foster, S.L.; Henry, J.R.; Woghiren-Akinnifesi, E.L.; Yip, F.Y. (2013) Residential proximity to major highways – United States, 2010. *Morbidity and Mortality Weekly Report* 62(3) - 46-50.

⁷³⁰ This variable primarily represents roadway proximity. According to the Central Intelligence Agency’s World Factbook, in 2010, the United States had 6,506,204 km of roadways, 224,792 km of railways, and 15,079 airports. Highways thus represent the overwhelming majority of transportation facilities described by this factor in the AHS.

⁷³¹ Bailey, C. (2011) Demographic and Social Patterns in Housing Units Near Large Highways and other Transportation Sources. Memorandum to docket.

secondary schools and school districts nationwide.⁷³² To determine school proximities to major roadways, we used a geographic information system (GIS) to map each school and roadways based on the U.S. Census's TIGER roadway file.⁷³³ We found that minority students were overrepresented at schools within 200 meters of the largest roadways, and that schools within 200 meters of the largest roadways also had higher than expected numbers of students eligible for free or reduced-price lunches. For example, Black students represent 22 percent of students at schools located within 200 meters of a primary road, whereas Black students represent 17 percent of students in all U.S. schools. Hispanic students represent 30 percent of students at schools located within 200 meters of a primary road, whereas Hispanic students represent 22 percent of students in all U.S. schools.

Overall, there is substantial evidence that people who live or attend school near major roadways are more likely to be of a minority race, Hispanic ethnicity, and/or low SES. The emission reductions from these proposed standards will likely result in widespread air quality improvements, but the impact on pollution levels in close proximity to roadways will be most direct. Thus, these proposed standards will likely help in mitigating the disparity in racial, ethnic, and economically based exposures.

9.3.9 Environmental Effects of Non-GHG Pollutants

9.3.9.1 Visibility

Visibility can be defined as the degree to which the atmosphere is transparent to visible light.⁷³⁴ Visibility impairment is caused by light scattering and absorption by suspended particles and gases. Visibility is important because it has direct significance to people's enjoyment of daily activities in all parts of the country. Individuals value good visibility for the well-being it provides them directly, where they live and work, and in places where they enjoy recreational opportunities. Visibility is also highly valued in significant natural areas, such as national parks and wilderness areas, and special emphasis is given to protecting visibility in these areas. For more information on visibility see the final 2009 PM ISA.⁷³⁵

EPA is working to address visibility impairment. Reductions in air pollution from implementation of various programs associated with the Clean Air Act Amendments of 1990 (CAAA) provisions have resulted in substantial improvements in visibility and will continue to

⁷³² <http://nces.ed.gov/ccd/>.

⁷³³ Pedde, M.; Bailey, C. (2011) Identification of Schools within 200 Meters of U.S. Primary and Secondary Roads. Memorandum to the docket.

⁷³⁴ National Research Council, (1993). Protecting Visibility in National Parks and Wilderness Areas. National Academy of Sciences Committee on Haze in National Parks and Wilderness Areas. National Academy Press, Washington, DC. This book can be viewed on the National Academy Press Website at <http://www.nap.edu/books/0309048443/html/>.

⁷³⁵ U.S. EPA. (2009). Integrated Science Assessment for Particulate Matter (Final Report). U.S. Environmental Protection Agency, Washington, DC, EPA/600/R-08/139F.

*** EO 12866 Review – Draft – Do Not Cite, Quote or Release During Review ***

do so in the future. Because trends in haze are closely associated with trends in particulate sulfate and nitrate due to the relationship between their concentration and light extinction, visibility trends have improved as emissions of SO₂ and NO_x have decreased over time due to air pollution regulations such as the Acid Rain Program.⁷³⁶

In the Clean Air Act Amendments of 1977, Congress recognized visibility's value to society by establishing a national goal to protect national parks and wilderness areas from visibility impairment caused by manmade pollution.⁷³⁷ In 1999, EPA finalized the regional haze program to protect the visibility in Mandatory Class I Federal areas.⁷³⁸ There are 156 national parks, forests and wilderness areas categorized as Mandatory Class I Federal areas.⁷³⁹ These areas are defined in CAA Section 162 as those national parks exceeding 6,000 acres, wilderness areas and memorial parks exceeding 5,000 acres, and all international parks which were in existence on August 7, 1977.

EPA has also concluded that PM_{2.5} causes adverse effects on visibility in other areas that are not targeted by the Regional Haze Rule, such as urban areas, depending on PM_{2.5} concentrations and other factors such as dry chemical composition and relative humidity (i.e., an indicator of the water composition of the particles). EPA revised the PM_{2.5} standards in December 2012 and established a target level of protection that is expected to be met through attainment of the existing secondary standards for PM_{2.5}.

9.3.9.2 Plant and Ecosystem Effects of Ozone

The welfare effects of ozone can be observed across a variety of scales, i.e. subcellular, cellular, leaf, whole plant, population and ecosystem. Ozone can produce both acute and chronic injury in sensitive species depending on the concentration level and the duration of the exposure.⁷⁴⁰ In those sensitive species,⁷⁴¹ effects from repeated exposure to ozone throughout the growing season of the plant tend to accumulate, so that even low concentrations experienced for a longer duration have the potential to create chronic stress on vegetation.⁷⁴² Ozone damage to sensitive species includes impaired photosynthesis and visible injury to leaves. The impairment of

⁷³⁶ U.S. EPA. 2009 Final Report - Integrated Science Assessment for Particulate Matter. U.S. Environmental Protection Agency, Washington, DC, EPA/600/R-08/139F, 2009.

⁷³⁷ See Section 169(a) of the Clean Air Act.

⁷³⁸ 64 FR 35714, July 1, 1999.

⁷³⁹ 62 FR 38680-38681, July 18, 1997.

⁷⁴⁰ 73 FR 16486, March 27, 2008.

⁷⁴¹ 73 FR 16491, March 27, 2008. Only a small percentage of all the plant species growing within the U.S. (over 43,000 species have been catalogued in the USDA PLANTS database) have been studied with respect to ozone sensitivity.

⁷⁴² The concentration at which ozone levels overwhelm a plant's ability to detoxify or compensate for oxidant exposure varies. Thus, whether a plant is classified as sensitive or tolerant depends in part on the exposure levels being considered. Chapter 9, Section 9.3.4 of U.S. EPA, 2013 Integrated Science Assessment for Ozone and Related Photochemical Oxidants. Office of Research and Development/National Center for Environmental Assessment. U.S. Environmental Protection Agency. EPA 600/R-10/076F.

photosynthesis, the process by which the plant makes carbohydrates (its source of energy and food), can lead to reduced crop yields, timber production, and plant productivity and growth. Impaired photosynthesis can also lead to a reduction in root growth and carbohydrate storage below ground, resulting in other, more subtle plant and ecosystems impacts.⁷⁴³ These latter impacts include increased susceptibility of plants to insect attack, disease, harsh weather, interspecies competition and overall decreased plant vigor. The adverse effects of ozone on areas with sensitive species could potentially lead to species shifts and loss from the affected ecosystems,⁷⁴⁴ resulting in a loss or reduction in associated ecosystem goods and services. Additionally, visible ozone injury to leaves can result in a loss of aesthetic value in areas of special scenic significance like national parks and wilderness areas and reduced use of sensitive ornamentals in landscaping.⁷⁴⁵

The most recent Integrated Science Assessment (ISA) for Ozone presents more detailed information on how ozone affects vegetation and ecosystems.⁷⁴⁶ The ISA concludes that ambient concentrations of ozone are associated with a number of adverse welfare effects and characterizes the weight of evidence for different effects associated with ozone.⁷⁴⁷ The ISA concludes that visible foliar injury effects on vegetation, reduced vegetation growth, reduced productivity in terrestrial ecosystems, reduced yield and quality of agricultural crops, and alteration of below-ground biogeochemical cycles are causally associated with exposure to ozone. It also concludes that reduced carbon sequestration in terrestrial ecosystems, alteration of terrestrial ecosystem water cycling, and alteration of terrestrial community composition are likely to be causally associated with exposure to ozone.

9.3.9.3 Atmospheric Deposition

Wet and dry deposition of ambient particulate matter delivers a complex mixture of metals (e.g., mercury, zinc, lead, nickel, aluminum, and cadmium), organic compounds (e.g., polycyclic organic matter, dioxins, and furans) and inorganic compounds (e.g., nitrate, sulfate) to terrestrial and aquatic ecosystems. The chemical form of the compounds deposited depends on a variety of factors including ambient conditions (e.g., temperature, humidity, oxidant levels) and the sources of the material. Chemical and physical transformations of the compounds occur in the

⁷⁴³ 73 FR 16492, March 27, 2008.

⁷⁴⁴ 73 FR 16493-16494, March 27, 2008, Ozone impacts could be occurring in areas where plant species sensitive to ozone have not yet been studied or identified.

⁷⁴⁵ 73 FR 16490-16497, March 27, 2008.

⁷⁴⁶ U.S. EPA. Integrated Science Assessment of Ozone and Related Photochemical Oxidants (Final Report). U.S. Environmental Protection Agency, Washington, DC, EPA/600/R-10/076F, 2013. The ISA is available at <http://cfpub.epa.gov/ncea/isa/recordisplay.cfm?deid=247492#Download>.

⁷⁴⁷ The Ozone ISA evaluates the evidence associated with different ozone related health and welfare effects, assigning one of five “weight of evidence” determinations - causal relationship, likely to be a causal relationship, suggestive of a causal relationship, inadequate to infer a causal relationship, and not likely to be a causal relationship. For more information on these levels of evidence, please refer to Table II of the ISA.

atmosphere as well as the media onto which they deposit. These transformations in turn influence the fate, bioavailability and potential toxicity of these compounds.

Adverse impacts to human health and the environment can occur when particulate matter is deposited to soils, water, and biota.⁷⁴⁸ Deposition of heavy metals or other toxics may lead to the human ingestion of contaminated fish, impairment of drinking water, damage to terrestrial, freshwater and marine ecosystem components, and limits to recreational uses. Atmospheric deposition has been identified as a key component of the environmental and human health hazard posed by several pollutants including mercury, dioxin and PCBs.⁷⁴⁹

The ecological effects of acidifying deposition and nutrient enrichment are detailed in the Integrated Science Assessment for Oxides of Nitrogen and Sulfur-Ecological Criteria.⁷⁵⁰ Atmospheric deposition of nitrogen and sulfur contributes to acidification, altering biogeochemistry and affecting animal and plant life in terrestrial and aquatic ecosystems across the United States. The sensitivity of terrestrial and aquatic ecosystems to acidification from nitrogen and sulfur deposition is predominantly governed by geology. Prolonged exposure to excess nitrogen and sulfur deposition in sensitive areas acidifies lakes, rivers and soils. Increased acidity in surface waters creates inhospitable conditions for biota and affects the abundance and biodiversity of fishes, zooplankton and macroinvertebrates and ecosystem function. Over time, acidifying deposition also removes essential nutrients from forest soils, depleting the capacity of soils to neutralize future acid loadings and negatively affecting forest sustainability. Major effects in forests include a decline in sensitive tree species, such as red spruce (*Picea rubens*) and sugar maple (*Acer saccharum*). In addition to the role nitrogen deposition plays in acidification, nitrogen deposition also leads to nutrient enrichment and altered biogeochemical cycling. In aquatic systems increased nitrogen can alter species assemblages and cause eutrophication. In terrestrial systems nitrogen loading can lead to loss of nitrogen-sensitive lichen species, decreased biodiversity of grasslands, meadows and other sensitive habitats, and increased potential for invasive species.

Building materials including metals, stones, cements, and paints undergo natural weathering processes from exposure to environmental elements (e.g., wind, moisture, temperature fluctuations, sunlight, etc.). Pollution can worsen and accelerate these effects. Deposition of PM is associated with both physical damage (materials damage effects) and impaired aesthetic qualities (soiling effects). Wet and dry deposition of PM can physically affect materials, adding to the effects of natural weathering processes, by potentially promoting or accelerating the

⁷⁴⁸ U.S. EPA. Integrated Science Assessment for Particulate Matter (Final Report). U.S. Environmental Protection Agency, Washington, DC, EPA/600/R-08/139F, 2009.

⁷⁴⁹ U.S. EPA. (2000). Deposition of Air Pollutants to the Great Waters - Third Report to Congress. Office of Air Quality Planning and Standards. EPA-453/R-00-0005.

⁷⁵⁰ NO_x and SO_x secondary ISA⁷⁵⁰ U.S. EPA. Integrated Science Assessment (ISA) for Oxides of Nitrogen and Sulfur Ecological Criteria (Final Report). U.S. Environmental Protection Agency, Washington, DC, EPA/600/R-08/082F, 2008.

corrosion of metals, by degrading paints and by deteriorating building materials such as stone, concrete and marble.⁷⁵¹ The effects of PM are exacerbated by the presence of acidic gases and can be additive or synergistic due to the complex mixture of pollutants in the air and surface characteristics of the material. Acidic deposition has been shown to have an effect on materials including zinc/galvanized steel and other metal, carbonate stone (as monuments and building facings), and surface coatings (paints).⁷⁵² The effects on historic buildings and outdoor works of art are of particular concern because of the uniqueness and irreplaceability of many of these objects.

9.3.9.4 Environmental Effects of Air Toxics

Emissions from producing, transporting and combusting fuel contribute to ambient levels of pollutants that contribute to adverse effects on vegetation. Volatile organic compounds, some of which are considered air toxics, have long been suspected to play a role in vegetation damage.⁷⁵³ In laboratory experiments, a wide range of tolerance to VOCs has been observed.⁷⁵⁴ Decreases in harvested seed pod weight have been reported for the more sensitive plants, and some studies have reported effects on seed germination, flowering and fruit ripening. Effects of individual VOCs or their role in conjunction with other stressors (e.g., acidification, drought, temperature extremes) have not been well studied. In a recent study of a mixture of VOCs including ethanol and toluene on herbaceous plants, significant effects on seed production, leaf water content and photosynthetic efficiency were reported for some plant species.⁷⁵⁵

Research suggests an adverse impact of vehicle exhaust on plants, which has in some cases been attributed to aromatic compounds and in other cases to nitrogen oxides.^{756,757, 758}

⁷⁵¹ U.S. Environmental Protection Agency (U.S. EPA). 2009. Integrated Science Assessment for Particulate Matter (Final Report). EPA-600-R-08-139F. National Center for Environmental Assessment—RTP Division. December. Available on the Internet at <<http://cfpub.epa.gov/ncea/cfm/recordisplay.cfm?deid=216546>>.

⁷⁵² Irving, P.M., e.d. 1991. Acid Deposition - State of Science and Technology, Volume III, Terrestrial, Materials, Health, and Visibility Effects, The U.S. National Acid Precipitation Assessment Program, Chapter 24, page 24–76.

⁷⁵³ U.S. EPA. (1991). Effects of organic chemicals in the atmosphere on terrestrial plants. EPA/600/3-91/001.

⁷⁵⁴ Cape JN, ID Leith, J Binnie, J Content, M Donkin, M Skewes, DN Price AR Brown, AD Sharpe. (2003). Effects of VOCs on herbaceous plants in an open-top chamber experiment. *Environ. Pollut.* 124:341-343.

⁷⁵⁵ Cape JN, ID Leith, J Binnie, J Content, M Donkin, M Skewes, DN Price AR Brown, AD Sharpe. (2003). Effects of VOCs on herbaceous plants in an open-top chamber experiment. *Environ. Pollut.* 124:341-343.

⁷⁵⁶ Viskari E-L. (2000). Epicuticular wax of Norway spruce needles as indicator of traffic pollutant deposition. *Water, Air, and Soil Pollut.* 121:327-337.

⁷⁵⁷ Ugrekheilidze D, F Korte, G Kvesitadze. (1997). Uptake and transformation of benzene and toluene by plant leaves. *Ecotox. Environ. Safety* 37:24-29.

⁷⁵⁸ Kammerbauer H, H Selinger, R Rommelt, A Ziegler-Jons, D Knoppik, B Hock. (1987). Toxic components of motor vehicle emissions for the spruce *Picea abies*. *Environ. Pollut.* 48:235-243.

9.4 Air Quality Impacts of Non-GHG Pollutants

Changes in emissions of non-GHG pollutants due to this proposal will impact air quality. Information on current air quality and the results of our air quality modeling of the projected impacts of these rules are summarized in the following section.

9.4.1 Current Concentrations of Non-GHG Pollutants

Nationally, levels of PM_{2.5}, ozone, NO_x, SO_x, CO and air toxics are declining. However, as of April 22, 2016, more than 125 million people lived in counties designated nonattainment for one or more of the NAAQS, and this figure does not include the people living in areas with a risk of exceeding a NAAQS in the future. Many Americans continue to be exposed to ambient concentrations of air toxics at levels which have the potential to cause adverse health effects. In addition, populations who live, work, or attend school near major roads experience elevated exposure concentrations to a wide range of air pollutants.

9.4.1.1 Particulate Matter

There are two primary NAAQS for PM_{2.5} - an annual standard (12.0 micrograms per cubic meter (µg/m³)) set in 2012 and a 24-hour standard (35 µg/m³) set in 2006, and two secondary NAAQS for PM_{2.5} - an annual standard (15.0 µg/ m³) set in 1997 and a 24-hour standard (35 µg/m³) set in 2006.

There are many areas of the country that are currently in nonattainment for the annual and 24-hour primary PM_{2.5} NAAQS. In 2005 the EPA designated 39 nonattainment areas for the 1997 PM_{2.5} NAAQS. As of April 22, 2016, more than 23 million people lived in the 7 areas that are still designated as nonattainment for the 1997 annual PM_{2.5} NAAQS. These PM_{2.5} nonattainment areas are comprised of 33 full or partial counties. In December 2014 EPA designated 14 nonattainment areas for the 2012 annual PM_{2.5} NAAQS. In March 2015, EPA changed the initial designation from nonattainment to unclassifiable/attainment for four areas based on the availability of complete, certified 2014 air quality data showing these areas met the 2012 annual PM_{2.5} NAAQS. The EPA also changed the initial 2012 annual PM_{2.5} NAAQS designation from nonattainment to unclassifiable for the Louisville, Indiana-Kentucky area. As of April 22, 2016, 9 of these areas remain designated as nonattainment, and they are composed of 20 full or partial counties with a population of more than 23 million. On November 13, 2009 and February 3, 2011, the EPA designated 32 nonattainment areas for the 2006 24-hour PM_{2.5} NAAQS. As of April 22, 2016, 16 of these areas remain designated as nonattainment for the 2006 24-hour PM_{2.5} NAAQS, and they are composed of 46 full or partial counties with a population of more than 32 million. In total, there are currently 24 PM_{2.5} nonattainment areas with a population of more than 39 million people.

The EPA has already adopted many mobile source emission control programs that are expected to reduce ambient PM concentrations. As a result of these and other federal, state and local

*** EO 12866 Review – Draft – Do Not Cite, Quote or Release During Review ***

programs, the number of areas that fail to meet the PM_{2.5} NAAQS in the future is expected to decrease. However, even with the implementation of all current state and federal regulations, there are projected to be counties violating the PM_{2.5} NAAQS well into the future. States will need to meet the 2006 24-hour standards in the 2015-2019 timeframe and the 2012 primary annual standard in the 2021-2025 timeframe.

9.4.1.2 Ozone

The primary and secondary NAAQS for ozone are 8-hour standards with a level of 0.07 ppm. The most recent revision to the ozone standards was in 2015; the previous 8-hour ozone primary standard, set in 2008, had a level of 0.075 ppm. Final nonattainment designations for the 2008 ozone standard were issued on April 30, 2012, and May 31, 2012. As of April 22, 2016, there were 44 ozone nonattainment areas for the 2008 ozone NAAQS, composed of 216 full or partial counties, with a population of more than 120 million.

States with ozone nonattainment areas are required to take action to bring those areas into attainment. The attainment date assigned to an ozone nonattainment area is based on the area's classification. The attainment dates for areas designated nonattainment for the 2008 8-hour ozone NAAQS are in the 2015 to 2032 timeframe, depending on the severity of the problem in each area. Nonattainment area attainment dates associated with areas designated for the 2015 NAAQS will be in the 2020-2037 timeframe, depending on the severity of the problem in each area.

EPA has already adopted many emission control programs that are expected to reduce ambient ozone levels. As a result of these and other federal, state and local programs, 8-hour ozone levels are expected to improve in the future. However, even with the implementation of all current state and federal regulations, there are projected to be counties violating the ozone NAAQS well into the future. The emission reductions from this action, which will take effect as early as model year 2018, will be helpful to states as they work to attain and maintain the ozone NAAQS. The standards can assist areas with attainment dates in 2018 and beyond in attaining the NAAQS as expeditiously as practicable and may relieve areas with already stringent local regulations from some of the burden associated with adopting additional local controls.

9.4.1.3 Nitrogen Dioxide

The EPA most recently completed a review of the primary NAAQS for NO₂ in January 2010. There are two primary NAAQS for NO₂ - an annual standard (53 ppb) and a 1-hour standard (100 ppb). The EPA promulgated area designations in the Federal Register on February 17, 2012. In this initial round of designations, all areas of the country were designated as "unclassifiable/attainment" for the 2010 NO₂ NAAQS based on data from the existing air quality monitoring network. The EPA and state agencies are working to establish an expanded network of NO₂ monitors, expected to be deployed in the 2014-2017 timeframe. Once three years of air

*** EO 12866 Review – Draft – Do Not Cite, Quote or Release During Review ***

quality data have been collected from the expanded network, the EPA will be able to evaluate NO₂ air quality in additional locations.

9.4.1.4 Sulfur Dioxide

The EPA most recently completed a review of the primary SO₂ NAAQS in June 2010. The current primary NAAQS for SO₂ is a 1-hour standard of 75 ppb. The EPA finalized the initial area designations for 29 nonattainment areas in 16 states in a notice published in the Federal Register on August 5, 2013. In this first round of designations, EPA only designated nonattainment areas that were violating the standard based on existing air quality monitoring data provided by the states. The agency did not have sufficient information to designate any area as “attainment” or make final decisions about areas for which additional modeling or monitoring is needed (78 FR 47191, August 5, 2013). On March 2, 2015, the U.S. District Court for the Northern District of California accepted, as an enforceable order, an agreement between the EPA and Sierra Club and Natural Resources Defense Council to resolve litigation concerning the deadline for completing designations. The court’s order directs the EPA to complete designations for all remaining areas in the country in up to three additional rounds - the first round by July 2, 2016, the second round by December 31, 2017, and the final round by December 31, 2020.

9.4.1.5 Carbon Monoxide

There are two primary NAAQS for CO - an 8-hour standard (9 ppm) and a 1-hour standard (35 ppm). The primary NAAQS for CO were retained in August 2011. There are currently no CO nonattainment areas; as of September 27, 2010, all CO nonattainment areas have been re-designated to attainment.

The past designations were based on the existing community-wide monitoring network. EPA is making changes to the ambient air monitoring requirements for CO. The new requirements are expected to result in approximately 52 CO monitors operating near roads within 52 urban areas by January 2015 (76 FR 54294, August 31, 2011).

9.4.1.6 Diesel Exhaust PM

Because DPM is part of overall ambient PM and cannot be easily distinguished from overall PM, we do not have direct measurements of DPM in the ambient air. DPM concentrations are estimated using ambient air quality modeling based on DPM emission inventories. DPM emission inventories are computed as the exhaust PM emissions from mobile sources combusting diesel or residual oil fuel. DPM concentrations were recently estimated as part of the 2011 NATA. Areas with high concentrations are clustered in the Northeast, Great Lake States, California, and the Gulf Coast States and are also distributed throughout the rest of the U.S. The median DPM concentration calculated nationwide is 0.76 µg/m³.

9.4.1.7 Air Toxics

The most recent available data indicate that the majority of Americans continue to be exposed to ambient concentrations of air toxics at levels which have the potential to cause adverse health effects. The levels of air toxics to which people are exposed vary depending on where people live and work and the kinds of activities in which they engage, as discussed in detail in EPA's most recent Mobile Source Air Toxics Rule. According to the National Air Toxic Assessment (NATA) for 2011, mobile sources were responsible for 50% of outdoor anthropogenic toxic emissions and were the largest contributor to cancer and non-cancer risk from directly emitted pollutants. Mobile sources are also large contributors to precursor emissions which react to form air toxics. Formaldehyde is the largest contributor to cancer risk of all 71 pollutants quantitatively assessed in the 2011 NATA. Mobile sources were responsible for more than 25% of primary anthropogenic emissions of this pollutant in 2011 and are major contributors to formaldehyde precursor emissions. Benzene is also a large contributor to cancer risk, and mobile sources account for almost 80% of ambient exposure. Over the years, EPA has implemented a number of mobile source and fuel controls which have resulted in VOC reductions, which also reduced formaldehyde, benzene and other air toxic emissions.

9.4.2 Air Quality Impacts of Non-GHG Pollutants

9.4.2.1 Current Levels of Non-GHG Pollutants

This proposal may have impacts on ambient concentrations of criteria and air toxic pollutants. Nationally, levels of PM_{2.5}, ozone, NO_x, SO_x, CO and air toxics are declining.⁷⁵⁹ However, approximately 127 million people lived in counties that exceeded any NAAQS in 2008.⁷⁶⁰ These numbers do not include the people living in areas where there is a future risk of failing to maintain or attain the NAAQS. It is important to note that these numbers do not account for potential ozone, PM_{2.5}, CO, SO₂, NO₂ or lead nonattainment areas which have not yet been designated. Further, the majority of Americans continue to be exposed to ambient concentrations of air toxics at levels which have the potential to cause adverse health effects.⁷⁶¹ The levels of air toxics to which people are exposed vary depending on where people live and work and the kinds of activities in which they engage, as discussed in detail in U.S. EPA's mobile source air toxics rule.⁷⁶²

⁷⁵⁹ U. S. EPA (2010) Our Nation's Air - Status and Trends through 2008. Office of Air Quality Planning and Standards, Research Triangle Park, NC. Publication No. EPA 454/R-09-002. <http://www.epa.gov/airtrends/2010/>.

⁷⁶⁰ See U. S. EPA Air - Status and Trends, *id.*

⁷⁶¹ U. S. Environmental Protection Agency (2007). Control of Hazardous Air Pollutants from Mobile Sources; Final Rule. 72 FR 8434, February 26, 2007.

⁷⁶² See U. S. EPA 2007, *id.*

9.4.2.2 Impacts of Proposed Standards on Future Ambient Concentrations of PM_{2.5}, Ozone and Air Toxics

Full-scale photochemical air quality modeling is necessary to accurately project levels of criteria pollutants and air toxics. For the final rulemaking, a national-scale air quality modeling analysis will be performed to analyze the impacts of the standards on PM_{2.5}, ozone, and selected air toxics (i.e., benzene, formaldehyde, acetaldehyde, acrolein and 1,3-butadiene). The length of time needed to prepare the necessary emissions inventories, in addition to the processing time associated with the modeling itself, has precluded air quality modeling for this proposal.

Section VII.D.2 of the preamble presents projections of the changes in criteria pollutant and air toxics emissions because of the proposed vehicle standards; the basis for those estimates is set out in this chapter. The atmospheric chemistry related to ambient concentrations of PM_{2.5}, ozone and air toxics is very complex, and making predictions based solely on emissions changes is extremely difficult. However, based on the magnitude of the emissions changes predicted to result from the proposed standards, EPA expects that there will be an improvement in ambient air quality, pending a more comprehensive analysis for the final rulemaking.

9.4.3 Other Unquantified Health and Environmental Effects

In addition, the NPRM seeks comment on whether there are any other health and environmental impacts associated with advancements in technologies that should be considered. For example, the use of technologies and other strategies to reduce fuel consumption and/or GHG emissions could have effects on a vehicle's life-cycle impacts (e.g., materials usage, manufacturing, end of life disposal), beyond the issues regarding fuel production and distribution (upstream) GHG emissions discussed in Section VII.D.2 of the preamble. The NPRM seeks comment on any studies or research in this area that should be considered in the future to assess a fuller range of health and environmental impacts from the light-duty vehicle fleet shifting to different technologies and/or materials. At this point, there is insufficient information about the lifecycle impacts of the myriad of available technologies, materials, and cradle-to-grave pathways to conduct the type of detailed assessments that would be needed in a regulatory context, but the NPRM requests comment on any current or future studies and research underway on this topic, and how such analysis could practicably and in a balanced way be integrated in the modeling, especially considering the characterization of specific vehicles in the analysis fleet and the characterization of specific technology options.

10 Impact of CAFE Standards on Vehicle Safety

In past CAFE rulemakings, NHTSA has examined the effect of CAFE standards on vehicle mass and the subsequent effect mass changes will have on vehicle safety. Although it was noted that there could also be impacts because of other factors, there was no basis for estimating those impacts. In this current analysis, NHTSA has expanded its safety analysis to include a more comprehensive measure of safety impacts. A number of factors can influence motor vehicle fatalities directly by influencing vehicle design or indirectly by influencing consumer behavior. These factors include:

- 1) Changes, which affect the crashworthiness of vehicles impact other vehicles or roadside objects, in vehicle mass made to reduce fuel consumption. NHTSA's statistical analysis of historical crash data to understand effects of vehicle mass and size on safety indicates reducing mass in light trucks generally improves safety, while reducing mass in passenger cars generally reduces safety. NHTSA's crash simulation modeling of vehicle design concepts for reducing mass revealed similar trends.⁷⁶³
- 2) The delay in the pace of consumer acquisition of newer safer vehicles that results from higher vehicle prices associated with technologies needed to meet higher CAFE standards. Because of a combination of safety regulations and voluntary safety improvements, passenger vehicles have become safer over time. Compared to prior decades, fatality rates have declined significantly because of technological safety improvements, as well as behavioral shifts such as increased seat belt use. The results of this analysis project that vehicle prices will be nearly \$1,900 higher under the aural CAFE standards compared to the preferred alternative that would hold stringency at MY 2020 levels in MYs 2021-2026. This will induce some consumers to delay or forgo the purchase of newer safer vehicles and slow the transition of the on-road fleet to one with the improved safety available in newer vehicles. This same factor can also shift the mix of passenger cars and light trucks.
- 3) Increased driving because of better fuel economy. The "rebound effect" predicts consumers will drive more when the cost of driving declines. More stringent CAFE standards reduce vehicle operating costs, and in response, some consumers may choose to drive more. Driving more increases exposure to risks associated with on-road transportation, and this added exposure translates into higher fatalities.

Although all three factors influence predicted fatality levels that may occur, only two of them – the changes in vehicle mass and the changes in the acquisition of safer vehicles – are actually imposed on consumers by CAFE standards. The safety of vehicles has improved over time and is

⁷⁶³ Draft Technical Assessment Report - Midterm Evaluation of Light-Duty Vehicle Greenhouse Gas Emission Standards and Corporate Average Fuel Economy Standards for Model Years 2022-2025, EPA-420-17-16-900, July 2016.

expected to continue improving in the future commensurate with the pace of safety technology innovation and implementation and motor vehicle safety regulation. Safety improvements will likely continue regardless of changes to CAFE standards. However, its pace may be modified if manufacturers choose to delay or forgo investments in safety technology because of the demand CAFE standards impose on research, development, and manufacturing budgets. Increased driving associated with rebound is a consumer choice. Improved CAFE will reduce driving costs, but nothing in the higher CAFE standards compels consumers to drive additional miles. If consumers choose to do so, they are making a decision that the utility of more driving exceeds the marginal operating costs as well as the added crash risk it entails. Thus, while the predicted fatality impacts with all three factors embedded into the model are measured, the fatalities associated with consumer choice decisions are accounted for separately from those resulting from technologies implemented in response to CAFE regulations or economic limitations resulting from CAFE regulation. Only those safety impacts associated with mass reduction and those resulting from higher vehicle prices are directly attributed to CAFE standards.⁷⁶⁴ This is reflected monetarily by valuing extra rebound miles at the full value of their added driving cost plus the added safety risk consumers experience, which completely offsets the societal impact of any added fatalities from this voluntary consumer choice.

10.1 Impact of Weight Reduction on Safety

The primary goals of CAFE and CO₂ standards are reducing fuel consumption and CO₂ emissions from the on-road light-duty vehicle fleet; in addition to these intended effects, the potential of the standards to affect vehicle safety is also considered.⁷⁶⁵ As a safety agency, NHTSA has long considered the potential for adverse safety consequences when establishing CAFE standards, and under the CAA, EPA considers factors related to public health and human welfare, including safety, in regulating emissions of air pollutants from mobile sources.

Safety trade-offs associated with fuel economy increases have occurred in the past, particularly before NHTSA CAFE standards were attribute-based; past safety trade-offs may have occurred

⁷⁶⁴ It could be argued fatalities resulting from consumer's decision to delay the purchase of newer safer vehicles is also a market decision implying consumers fully accept the added safety risk associated with this delay and value the time value of money saved by the delayed purchase more than this risk. This scenario is likely accurate for some purchasers. For others, the added cost may represent a threshold price increase effectively preventing them from being financially able to purchase a new vehicle. We have no way to determine the proportion of lost sales reflected by these two scenarios. The added driving from the rebound effect results from a positive benefit of CAFE, which reduces the cost of driving. By contrast, the effect of retaining older vehicles longer results from costs imposed on consumers, which potentially limit their purchase options. We, thus, attribute fatalities from retaining older vehicles to CAFE, but not those resulting from decisions to drive more. The NPRM requests comments on this assumption.

⁷⁶⁵ In this rulemaking document, "vehicle safety" is defined as societal fatality rates per vehicle mile of travel (VMT), including fatalities to occupants of all vehicles involved in collisions, plus any pedestrians. Injuries and property damage are not within the scope of the statistical models discussed in this section because of data limitations (e.g., limited information on observed or potential relationships between safety standards and injury and property damage outcomes, consistency of reported injury severity levels). Rather, injuries and property damage are represented within the CAFE model through adjustment factors based on observed relationships between societal costs of fatalities and societal injury and property damage costs.

*** EO 12866 Review – Draft – Do Not Cite, Quote or Release During Review ***

because manufacturers chose at the time, in response to CAFE standards, to build smaller and lighter vehicles. Although the agency now uses attribute-based standards, in part to protect against excessive vehicle downsizing, the agency must be mindful of the possibility of related safety trade-offs in the future. In cases where fuel economy improvements were achieved through reductions in vehicle size and mass, the smaller, lighter vehicles did not fare as well in crashes as larger, heavier vehicles, on average.

Historically, as shown in FARS data analyzed by NHTSA, the safest cars generally have been heavy and large, while cars with the highest fatal-crash rates have been light and small. The question, then, is whether past is necessarily a prologue when it comes to potential changes in vehicle size (both footprint and “overhang”) and mass in response to the more stringent future CAFE and GHG standards.

Manufacturers stated they will reduce vehicle mass as one of the cost-effective means of increasing fuel economy and reducing CO₂ to meet standards, and this expectation is incorporated into the modeling analysis supporting the standards. Because the analysis discerns a historical relationship between vehicle mass, size, and safety, it is reasonable to assume these relationships will continue in the future.

10.2 Historical Analyses of Vehicle Mass and Safety

Researchers have been using statistical analysis to examine the relationship of vehicle mass and safety in historical crash data for many years and continue to refine their techniques. In the MY 2012-2016 final rule, the agencies stated we would conduct further study and research into the interaction of mass, size, and safety to assist future rulemakings and start to work collaboratively by developing an interagency working group between NHTSA, EPA, DOE, and CARB to evaluate all aspects of mass, size, and safety. The team would seek to coordinate government-supported studies and independent research to the greatest extent possible to ensure the work is complementary to previous and ongoing research and to guide further research in this area.

The agencies also identified three specific areas to direct research in preparation for future CAFE/CO₂ rulemaking regarding statistical analysis of historical data. First, NHTSA would contract with an independent institution to review statistical methods NHTSA and DRI used to analyze historical data related to mass, size, and safety, and to provide recommendations on whether existing or other methods should be used for future statistical analysis of historical data. This study would include a consideration of potential near multicollinearity in the historical data and how best to address it in a regression analysis. The 2010 NHTSA report (*hereinafter* 2010

*** EO 12866 Review – Draft – Do Not Cite, Quote or Release During Review ***

Kahane report) was also peer reviewed by two other experts in the safety field - Farmer (Insurance Institute for Highway Safety) and Lie (Swedish Transport Administration).⁷⁶⁶

Second, NHTSA and EPA, in consultation with DOE, would update the MY 1991–1999 database where safety analyses in the NPRM and final rule are based with newer vehicle data and create a common database that could be made publicly available to address concerns that differences in data were leading to different results in statistical analyses by different researchers.

And third, to assess if the design of recent model year vehicles incorporating various mass reduction methods affect relationships among vehicle mass, size, and safety, the agencies sought to identify vehicles using material substitution and smart design and to assess if there is sufficient crash data involving those vehicles for statistical analysis. If sufficient data exists, statistical analysis would be conducted to compare the relationship among mass, size, and safety of these smart design vehicles to vehicles of similar size and mass with more traditional designs.

By the time of the MY2017-2025 final rule, significant progress was made on these tasks - The independent review of recent and updated statistical analyses of the relationship between vehicle mass, size, and crash fatality rates had been completed. NHTSA contracted with the University of Michigan Transportation Research Institute (UMTRI) to conduct this review, and the UMTRI team led by Green evaluated more than 20 papers, including studies done by NHTSA’s Kahane, Wenzel of the U.S. Department of Energy’s Lawrence Berkeley National Laboratory, Dynamic Research, Inc., and others. UMTRI’s basic findings will be discussed below.

Some commenters in recent CAFE rulemakings, including some vehicle manufacturers, suggested designs and materials of more recent model year vehicles may have weakened the historical statistical relationships between mass, size, and safety. It was agreed that the statistical analysis would be improved by using an updated database reflecting more recent safety technologies, vehicle designs and materials, and reflecting changes in the vehicle fleet. An updated database was created and employed for assessing safety effects for that final rule. The agencies also believed, as UMTRI found, different statistical analyses may have produced different results because they used slightly different datasets for their analyses.

To try to mitigate this issue and to support the current rulemaking, NHTSA created a common, updated database for statistical analysis consisting of crash data of model years 2000-2007 vehicles in calendar years 2002-2008, as compared to the database used in prior NHTSA analyses, which was based on model years 1991–1999 vehicles in calendar years 1995-2000. The new database was the most up-to-date possible, given the processing lead time for crash data and the need for enough crash cases to permit statistically meaningful analyses. NHTSA made the

⁷⁶⁶ All three peer reviews are available in Docket No. NHTSA-2010-0152. Docket can be accessed at <http://www.regulations.gov/> by typing ‘NHTSA-2010-0152’ under “enter keyword or ID” and then clicking on “Search.”

preliminary version of the new database, which was the basis for NHTSA’s 2011 preliminary report (*hereinafter* 2011 Kahane report), available to the public in May 2011, and an updated version in April 2012 (used in NHTSA’s 2012 final report, *hereinafter* 2012 Kahane report),⁷⁶⁷ enabling other researchers to analyze the same data and hopefully minimize discrepancies in results because of inconsistencies across databases.⁷⁶⁸

The agencies were aware several studies had been initiated using the 2011 version or the 2012 version of NHTSA’s newly established safety database. In addition to new Kahane studies, other recent and on-going studies include two by Wenzel at Lawrence Berkeley National Laboratory (LBNL) under contract with the U.S. DOE and one by Dynamic Research, Inc. (DRI) contracted by the International Council on Clean Transportation (ICCT). These studies took somewhat different approaches to examine the statistical relationship between fatality risk, vehicle mass, and size. In addition to a detailed assessment of the 2011 Kahane report, Wenzel considered the effect of mass and footprint reduction on casualty risk per crash, using data from 13 states. Casualty risk includes fatalities and serious or incapacitating injuries. Both LBNL studies were peer reviewed and subsequently revised and updated. DRI used models separating the effect of mass reduction on two components of fatality risk - crash avoidance and crashworthiness. The LBNL and DRI studies were available in the docket for the 2012 final rule.⁷⁶⁹

⁷⁶⁷ The new databases are available at <ftp://ftp.nhtsa.dot.gov/CAFE/>.

⁷⁶⁸ 75 Fed. Reg. 25324 (May 7, 2010); the discussion of planned statistical analyses is on pp. 25395-25396.

⁷⁶⁹ Wenzel, T. (2011a). Assessment of NHTSA’s Report “Relationships Between Fatality Risk, Mass, and Footprint in Model Year 2000-2007 Passenger Cars and LTVs – Draft Final Report.” (Docket No. NHTSA-2010-0152-0026). Berkeley, CA - Lawrence Berkeley National Laboratory; Wenzel, T. (2011b). An Analysis of the Relationship between Casualty Risk Per Crash and Vehicle Mass and Footprint for Model Year 2000-2007 Light-Duty Vehicles – Draft Final Report.” (Docket No. NHTSA-2010-0152-0028). Berkeley, CA - Lawrence Berkeley National Laboratory; Wenzel, T. (2012a). Assessment of NHTSA’s Report “Relationships Between Fatality Risk, Mass, and Footprint in Model Year 2000-2007 Passenger Cars and LTVs – Final Report.” (In Docket No. NHTSA-2010-0152). Berkeley, CA - Lawrence Berkeley National Laboratory; Wenzel, T. (2012b). An Analysis of the Relationship between Casualty Risk Per Crash and Vehicle Mass and Footprint for Model Year 2000-2007 Light-Duty Vehicles – Final Report.” (In Docket No. NHTSA-2010-0152). Berkeley, CA - Lawrence Berkeley National Laboratory; Van Auken, R.M., and Zellner, J. W. (2012a). Updated Analysis of the Effects of Passenger Vehicle Size and Weight on Safety, Phase I. Report No. DRI-TR-11-01. (Docket No. NHTSA-2010-0152-0030). Torrance, CA - Dynamic Research, Inc.; Van Auken, R.M., and Zellner, J. W. (2012b). Updated Analysis of the Effects of Passenger Vehicle Size and Weight on Safety, Phase II; Preliminary Analysis Based on 2002 to 2008 Calendar Year Data for 2000 to 2007 Model Year Light Passenger Vehicles to Induced-Exposure and Vehicle Size Variables. Report No. DRI-TR-12-01, Vols. 1-3. (Docket No. NHTSA-2010-0152-0032). Torrance, CA - Dynamic Research, Inc.; Van Auken, R.M., and Zellner, J. W. (2012c). Updated Analysis of the Effects of Passenger Vehicle Size and Weight on Safety, Phase II; Preliminary Analysis Based on 2002 to 2008 Calendar Year Data for 2000 to 2007 Model Year Light Passenger Vehicles to Induced-Exposure and Vehicle Size Variables. Report No. DRI-TR-12-01, Vols. 4-5. (Docket No. NHTSA-2010-0152-0033). Torrance, CA - Dynamic Research, Inc.; Van Auken, R.M., and Zellner, J. W. (2012d). Updated Analysis of the Effects of Passenger Vehicle Size and Weight on Safety; Sensitivity of the Estimates for 2002 to 2008 Calendar Year Data for 2000 to 2007 Model Year Light Passenger Vehicles to Induced-Exposure and Vehicle Size Variables. Report No. DRI-TR-12-03. (Docket No. NHTSA-2010-0152-0034). Torrance, CA - Dynamic Research, Inc.

*** EO 12866 Review – Draft – Do Not Cite, Quote or Release During Review ***

Since the publication of the MY2017-2025 final rule, NHTSA has sponsored, and is sponsoring, new studies and research to inform the current CAFE and CO₂ rulemaking. In addition, the National Academy of Sciences published a new report in this area.⁷⁷⁰ Throughout the rulemaking process, NHTSA's goal is to publish as much of the agency's research as possible. In establishing standards, all available data, studies, and information objectively without regard to whether they were sponsored by the agencies, will be considered.

Undertaking these tasks has helped come closer to resolving ongoing debates in statistical analysis research of historical crash data. It is intended that these conclusions will be applied going forward in future rulemakings, and it is believed the research will assist the public discussion of the issues.

10.2.1 2011 NHTSA Workshop on Vehicle Mass, Size, and Safety

On February 25, 2011, NHTSA hosted a workshop on mass reduction, vehicle size, and fleet safety at the Headquarters of the U.S. Department of Transportation in Washington, D.C.⁷⁷¹ The purpose of the workshop was to provide the agencies with a broad understanding of current research in the field and provide stakeholders and the public with an opportunity to weigh in on this issue. NHTSA also created a public docket to receive comments from interested parties who were unable to attend.

Speakers included Kahane of NHTSA, Wenzel of Lawrence Berkeley National Laboratory, Van Auken of Dynamic Research Inc. (DRI), Padmanaban of JP Research, Inc., Lund of the Insurance Institute for Highway Safety, Green of the University of Michigan Transportation Research Institute (UMTRI), Summers of NHTSA, Peterson of Lotus Engineering, Kamiji of Honda, German of the International Council on Clean Transportation (ICCT), Schmidt of the Alliance of Automobile Manufacturers, Nusholtz of Chrysler, and Field of the Massachusetts Institute of Technology.

The wide participation in the workshop allowed agencies to hear from a broad range of experts and stakeholders. Contributions were particularly relevant to the analysis of effects of mass reduction for the MY2017-2025 final rule. Presentations were divided into two sessions addressing two expansive sets of issues - statistical evidence of the roles of mass and size on safety, and engineering realities regarding structural crashworthiness, occupant injury, and advanced vehicle design. Some main points from the workshop were -

- Statistical studies of crash data attempting to identify relative recent historical effects of

⁷⁷⁰ National Academy of Sciences. *Cost, Effectiveness and Deployment of Fuel Economy Technologies for Light-Duty Vehicles*. (613 pp, 15MB, 2015). Committee on the Assessment of Technologies for Improving Fuel Economy of Light-Duty Vehicles, Phase 2; Board on Energy and Environmental Systems; Division on Engineering and Physical Sciences; National Research Council. The National Academies Press, Washington, D.C.

⁷⁷¹ A video recording, transcript, and the presentations from the NHTSA workshop on mass reduction, vehicle size and fleet safety is available at <http://www.nhtsa.gov/fuel-economy> (look for "NHTSA Workshop on Vehicle Mass-Size-Safety on Feb. 25").

vehicle mass and size on fleet safety shows complicated relationships with many confounding influences in data.

- Analyses must control for individual technologies with significant safety effects (e.g., Electronic Stability Control, airbags).
- Physics of a two-vehicle crash require the lighter vehicle experience a greater change in velocity, which, all else being equal, often leads to disproportionately more injury risk.
- The separation of key parameters is a challenge to analyses, as vehicle size has historically been highly correlated with vehicle mass.
- There was no consensus on whether smaller, lighter vehicles maneuver better, and thus avoid more crashes, than larger, heavier vehicles.
- Kahane's results from his 2010 report found a scenario, which took some mass out of heavier vehicles but little or no mass out of the lightest vehicles, did not affect safety in absolute terms, and noted if analyses were able to consider the mass of both vehicles in a two-vehicle crash, results may be more indicative of future crashes.

10.2.2 UMTRI Report

NHTSA contracted with the University of Michigan Transportation Research Institute (UMTRI) to conduct an independent review⁷⁷² of a set of statistical analyses of relationships between vehicle curb weight, footprint variables (track width, wheelbase), and fatality rates from vehicle crashes. The purpose of this review was to examine analysis methods, data sources, and assumptions of statistical studies, with the objective of identifying reasons for any differences in results. Another objective was to examine the suitability of various methods for estimating fatality risks of future vehicles.

UMTRI reviewed a set of papers, reports, and manuscripts provided by NHTSA (listed in Appendix A of UMTRI's report, which is available in the docket to the MY2017-2025 rulemaking) examining statistical relationships between fatality or casualty rates and vehicle properties such as curb weight, track width, wheelbase, and other variables.

Fundamentally, the UMTRI team concluded the database created by Kahane appeared to be an impressive collection of files from appropriate sources and the best ones available for answering the research questions considered in this study; the disaggregate logistic regression model used by NHTSA in its 2003 report (*hereinafter* 2003 Kahane report) seemed to be the most appropriate model, valid for the analysis in the context that it was used - finding general associations between fatality risk and mass, and general directions of reported associations were correct.

10.2.3 2012 LBNL Reports

⁷⁷² The review is independent in the sense it was conducted by an outside third party without any interest in the reported outcome.

In its 2012 “Phase 1” report,⁷⁷³ LBNL replicated the 2012 NHTSA baseline results and conducted 19 alternative regression models to test the sensitivity of the NHTSA baseline model to changes in the measure of risk, variables included, and data used. In its report, LBNL pointed out other vehicle attributes, driver characteristics, and crash circumstances were associated with much larger changes in risk than mass reduction.⁷⁷⁴ LBNL also demonstrated there was little correlation between mass and fatality risk by vehicle model, even after accounting for all other vehicle attributes, driver characteristics, and crash circumstances.

In its 2012 “Phase 2” report,⁷⁷⁵ LBNL used data from police reported crashes in the 13 states to study casualty (fatality plus severe injury) risk per VMT, and to divide risk per VMT into its two components - crash frequency (crashes per VMT) and crashworthiness/crash compatibility (risk per crash). LBNL found mass reduction was associated with increases in crash frequency and decreases in risk per crash. Preliminary versions LBNL’s Phase 1 and Phase 2 reports were reviewed by external reviewers, and comments were incorporated into final versions published in 2012.

10.2.4 2012 DRI Reports

DRI published three preliminary reports in 2012. DRI’s preliminary Phase I report updated its analysis of data from 1995 to 2000 and was able to replicate results from the 2003 Kahane report. DRI’s preliminary Phase II report replicated 2012 NHTSA baseline results and used a simultaneous two-stage model to estimate separate effects of mass reduction on crash frequency and fatality risk per crash. Results from DRI’s two-stage model were comparable to LBNL’s Phase 2 analysis - mass reduction was associated with increases in crash frequency and decreases in risk per crash. DRI’s preliminary summary report showed the effect of two alternative regression models - using stopped rather than non-culpable vehicles as the basis for the induced exposure database, and replacing vehicle footprint with its components wheelbase and track width. Under these two alternatives, mass reduction was associated with more beneficial changes

⁷⁷³ Wenzel, T. 2012a. Assessment of NHTSA’s Report “Relationships Between Fatality Risk, Mass, and Footprint in Model Year 2000-2007 Passenger Cars and LTVs.” Final report prepared for the Office of Energy Efficiency and Renewable Energy, US Department of Energy. Lawrence Berkeley National Laboratory. August. LBNL-5698E. <http://energy.lbl.gov/ea/teepa/pdf/lbnl-5698e.pdf>.

⁷⁷⁴ As stated at p. iv, Executive Summary of LBNL 2012 Phase 1 report, “many of the control variables NHTSA includes in its logistic regressions are statistically significant, and have a much larger estimated effect on fatality risk than vehicle mass. For example, installing torso side airbags, electronic stability control, or an automated braking system in a car is estimated to reduce fatality risk by approximately 10%; cars driven by men are estimated to have a 40% higher fatality risk than cars driven by women; and cars driven at night, on rural roads, or on roads with a speed limit higher than 55 mph are estimated to have a fatality risk over 100 times higher than cars driven during the daytime on low-speed non-rural roads.

⁷⁷⁵ Wenzel, T. 2012b. An Analysis of the Relationship between Casualty Risk per Crash and Vehicle Mass and Footprint for Model Year 2000-2007 Light-Duty Vehicles. Final report prepared for the Office of Energy Efficiency and Renewable Energy, US Department of Energy. Lawrence Berkeley National Laboratory. August. LBNL-5697E.

*** EO 12866 Review – Draft – Do Not Cite, Quote or Release During Review ***

in fatality risk. The three preliminary DRI reports were peer-reviewed with comments incorporated into the final versions published in 2013.

Results from LBNL's Phase 2 and DRI's Phase II reports implied the increase in fatality risk per VMT from mass reduction in lighter cars estimated by the NHTSA baseline model was because of increasing crash frequency and not increasing fatality risk once a crash had occurred, as mass was reduced. In the 2012 Kahane report, NHTSA argued effects of crash frequency could not be separated from risk per crash because of reporting bias in state crash data, such as lack of a crash severity measure, and possible bias because of underreporting of less severe crashes in certain states.

10.2.5 2013 NHTSA Workshop on Vehicle Mass, Size, and Safety

On May 13-14, 2013, NHTSA hosted a follow-on symposium to continue exploring relevant issues and concerns with mass, size, and potential safety tradeoffs, bringing together experts in the field to discuss questions to address CAFE standards for model years 2022-2025. The first day of the two-day symposium focused on engineering, while the second day investigated various methodologies for assessing statistical evidence of roles of vehicle mass and size on occupant safety.⁷⁷⁶

Speakers for the second day, focusing on the subject matter of this chapter, included Kahane of NHTSA, Nolan of the Insurance Institute for Highway, Nusholtz of Chrysler, Van Auken of Dynamic Research Incorporated, and Wenzel of Lawrence Berkeley National Laboratory. Summaries of the topics follow -

- Kahane gave an overview of statistical studies designed to determine the incremental change in societal risk as vehicle mass of a particular vehicle is modified while keeping its footprint (the product of wheelbase and track width) constant. The physics of crashes, in particular conservation of momentum and equal and opposite forces, imply mass reduction in the heaviest vehicles and/or mass increase in the lightest vehicles can reduce societal risk in two-vehicle crashes. It is, therefore, reasonable that reducing disparities in mass ratio in the vehicle fleet (such as by reducing the mass of heavy vehicles by a larger percentage than that of light vehicles) should reduce societal harm. This trend was noticed in data for model year 2000-2007 vehicles but only statistically significant for the lightest group of vehicles. This is similar to results found for model year 1991-1999 vehicles in a 2003 study. Kahane acknowledged numerous confounding factors such as maneuverability of different vehicle classes (although data indicated smaller cars were more likely to be involved in crashes), driver attributes and vulnerabilities, advances in restraint safety systems and vehicle structures, and electronic stability control.
- Wenzel replicated Kahane's results using the same data and methods but came to slightly different conclusions. Wenzel demonstrated that the effect of mass or footprint reduction

⁷⁷⁶ All presentations may be seen on NHTSA's web site at - <http://www.nhtsa.gov/Laws+&+Regulations/CAFE++Fuel+Economy/NHTSA+Vehicle+MassSize-Safety+Workshop>.

*** EO 12866 Review – Draft – Do Not Cite, Quote or Release During Review ***

estimated on societal risk is much smaller than the effect estimated for other vehicle attributes, driver characteristics, or crash circumstances. Wenzel plotted actual fatality risk versus weight by vehicle make and model, and estimated predicted risk by make and model after accounting for all control variables used in NHTSA's baseline model except for mass and footprint. The remaining, or residual risk, not explained by the control variables has no correlation with vehicle weight. Wenzel presented results of the 19 alternative regression models he conducted to test the sensitivity of results from NHTSA's baseline model. He also presented results from LBNL's Phase 2 analysis, which examined the effect of mass or footprint reduction on the two components of risk per VMT - crashes per VMT (crash frequency), and risk per crash (crashworthiness). His analysis of casualty risk using crash data from 13 states and his replication of the DRI two-state simultaneous regression model indicate mass reduction is associated with an increase in crash frequency but a decrease in risk per crash.

- Van Auken also replicated Kahane's results from the NHTSA baseline model and presented results from three sensitivity regression models. Replacing footprint with its components wheelbase and track width reduces the estimated increase in risk from mass reduction in cars and suggests reduction in light trucks decreases societal risk. Using stopped rather than non-culpable vehicles to derive the induced exposure dataset also reduces the estimated increase in risk from mass reduction in lighter-than-average cars and light trucks and estimates mass reduction in heavier cars and trucks decreases societal risk. Adding these changes to the NHTSA baseline model greatly reduces the estimated increase in risk from mass reduction in the lightest cars and is associated with decreases in risk for all other vehicle types. Van Auken described in more detail his two-stage simultaneous regression model, which allows risk per vehicle mile of travel to be decomposed into crashes per VMT (crash frequency) and risk per crash (crashworthiness/crash compatibility). As with Wenzel's analysis, Van Auken found mass reduction is associated with an increase in crash frequency but with a decrease in risk per crash. Once again, resulting trends were similar to those from Kahane and Wenzel. Van Auken explored the issue of inducing the exposure of vehicles via crash statistics in which relative exposure was measured by non-culpable vehicles in the crash database versus by its subset of stopped vehicles in the data and also investigated the effect of substituting footprint for track width and wheelbase as size variables in the regression.
- Nusholtz of Chrysler presented an analysis of the sensitivity of the fleet-wide fatality risk to changes in vehicle mass and size. He noted the difficulty in finding a definitive metric for "size." He dismissed some assertions of mass having negligible (or purely negative) effects on safety as leading to absurd conclusions in the extreme. He extended the methods of Joksch (1993) and Evans (1992) to estimate risk as a function of readily measurable vehicle attributes and reported crash characteristics. He used crash physics (closing speed, estimates of inelastic stiffness, and energy absorption) to estimate changes in fleet risk as a function of changes in these parameters. He observed mass is a dominant factor but believed crush space could begin to dominate if vehicles could be made larger. Nusholtz concurred removing more mass from larger vehicles could reduce risk but is not convinced such a strategy will be sufficient to meet fuel economy goals.

*** EO 12866 Review – Draft – Do Not Cite, Quote or Release During Review ***

He regards safety implications of mass reduction to be transition issues of greater importance so long as legacy heavier vehicles are used in significant numbers.

- Nolan analyzed historical trends in the fleet. While median vehicle mass has increased, safety technologies have enhanced the safety of current small cars to the level only achieved by larger cars in the past. In particular, electronic stability control has reduced the relative importance of some severe crash modes. While acknowledging smaller vehicles will always be at a disadvantage, there is hope further technological advances such as crash avoidance systems hold promise in advancing safety. Fleet safety would be enhanced if these technologies could quickly penetrate across the fleet to small cars as well as large ones.
- Nusholtz presented the results of an attempt to separate the effect of mass on crash outcome as distinct from the likelihood of the crash itself. It was acknowledged mass can affect both. Nusholtz emphasized crash parameters (e.g., closing speed) necessarily dominate. Kahane suggested reporting rates might be sufficiently different to affect results. Nusholtz cautioned physics and statistics must be considered but in a way connecting them to reality rather than abstractions. Nusholtz noted assessments of that effect are difficult because determining when and why a crash did not occur is problematic against the backdrop of confounding information.

10.2.6 Subsequent Analyses by LBNL

As part of its review of the 2012 DRI studies, LBNL recreated DRI's two-stage simultaneous regression model, which estimated the effect of mass or footprint reduction on the two components of fatality risk per VMT - number of crashes per VMT and risk of fatality per crash.⁷⁷⁷ LBNL first replicated DRI's methodology of taking a random "decimated" sample of crash data from 10 states for induced exposure records. Although LBNL was not able to exactly recreate DRI's results, its results were comparable to DRI's, and LBNL's Phase 2, analysis. That is, mass reduction is associated with - (1) increases in crash frequency for all vehicle types; and (2) with decreases in fatalities per crash for all vehicle types except heavier cars. LBNL then re-ran the two-stage regression model using all crash data from the 13 states NHTSA used in their baseline model and obtained similar results.

The LBNL Phase 2 study and DRI Phase II study had two unexpected results - mass reduction is associated with increased crash frequency but decreased risk per crash, and signs on some of the control variables are in the unexpected direction. Mass reduction could feasibly reduce crash risk due to increased maneuverability and braking capability; the converse result may reflect driver behavior (e.g., riskier maneuvers under higher power-to-weight ratios) or important structural

⁷⁷⁷ Wenzel, T. 2013. Assessment of DRI's Two-Stage Logistic Regression Model Used to Simultaneously Estimate the Relationship between Vehicle Mass or Size Reduction and U.S. Fatality Risk. Crashworthiness/Compatibility, and Crash Avoidance. Draft report prepared for the Office of Energy Efficiency and Renewable Energy, U.S. Department of Energy; Lawrence Berkeley National Laboratory, January.

*** EO 12866 Review – Draft – Do Not Cite, Quote or Release During Review ***

changes under lightweighting. Examples of unexpected signs for control variables include - side airbags in light trucks and CUVs/minivans were estimated to reduce crash frequency; the crash avoidance technologies electronic stability control (ESC) and antilock braking systems (ABS) were estimated to reduce risk once a crash had occurred; and all-wheel-drive and brand new vehicles were estimated to increase risk once a crash had occurred. In addition, male drivers were estimated to have essentially no effect on crash frequency but were associated with a statistically significant increase in fatality risk once a crash had occurred. In addition, driving at night, on high-speed or rural roads, was associated with higher increases in risk per crash than on crash frequency.

A possible explanation for these unexpected results is important control variables were not included in regression models. For example, crashes involving male drivers, in vehicles equipped with AWD, or occurring at night on rural or high-speed roads, may not be more frequent but are rather more severe than other crashes, leading to greater fatality or casualty risk. Drivers who select vehicles with certain safety features may tend to drive more carefully, resulting in vehicle safety features designed to improve crashworthiness or compatibility, such as side airbags, and are associated with lower crash frequency.

LBNL made several attempts to create a regression model that “corrected” these unexpected results. LBNL first examined results of three vehicle braking and handling tests conducted by Consumer Reports - the maximum speed achieved during the avoidance maneuver test, acceleration time from 45 to 60 mph, and dry braking distance.

When these three test results were added to the LBNL baseline regression model of the number of crashes per mile of vehicle travel in cars, none of the three handling/braking variables had the expected effect on crash frequency. In other words, an increase in maximum maneuver speed, the time to reach 60 miles per hour, or braking distance on dry pavement in cars, either separately or combined, was associated with a decrease in the likelihood of a crash, of any type or with a stationary object. Adding one or all of the three handling/braking variables had relatively little effect on the estimated relationship between mass or footprint reduction in cars and crash frequency, either in all types of crashes or only in crashes with stationary objects.

LBNL next tested the sensitivity of the relationship between mass or footprint reduction and crash frequency by adding five additional variables to the regression models - initial vehicle price, average household income, bad driver rating, alcohol/drug use, and seat belt use. An increase in vehicle price, household income, or belt use was associated with a decrease in crash frequency, while an increase in alcohol/drug use was associated with an increase in crash frequency, for all three vehicle types; a poor bad driver rating increases crash frequency in cars, but unexpectedly decreases crash frequency in light trucks and CUVs/minivans. Including these five variables, either individually or including all in the same regression model, did not change general results of the baseline LBNL regression model - mass reduction is associated with an increase in crash frequency in all three types of vehicles, while footprint reduction is associated

with an increase in crash frequency in cars and light trucks but with a decrease in crash frequency in CUVs/ minivans. The variable with the biggest effect was initial vehicle purchase price, which dramatically reduced the estimated increase in crash frequency in heavier-than-average cars (and in heavier-than-average light trucks, and all CUVs/minivans). These results suggest other, subtler, differences in vehicles and their drivers account for the unexpected finding lighter vehicles have higher crash frequencies than heavier vehicles for all three types of vehicles.

In the 2012 Kahane report NHTSA suggested two possible explanations for unexpected results in the LBNL Phase 2 analysis and the DRI and LBNL two-stage regression models - analyses did not account for the severity of the crash, and possible bias in the crashes reported to police in different states, with less severe crashes being under-reported for certain vehicle types. LBNL analyzed the first of Kahane's explanations for the unexpected result of mass reduction being associated with decreased risk per crash, by re-running the baseline Phase 2 regressions after excluding the least-severe crashes from the state crash databases objects. Only vehicles described as "disabled" or as having "severe" damage were included, while vehicles driven away from the crash site or had functional, none, or unknown damage were excluded. Excluding non-severe crashes had little effect on the relationship between mass reduction and crash frequency; in either LBNL's Phase 2 baseline model or the two-stage simultaneous model - mass reduction was associated with an increase in crash frequency and a decrease in risk per crash. Excluding the non-severe crashes also did not change unexpected results for other control variables - most of the side airbag variables and the crash compatibility variables in light trucks, continued to be associated with an increase in crash frequency, while antilock braking systems, electronic stability control, all-wheel drive, male drivers, young drivers, and driving at night, in rural counties, and on high speed roads continued to be associated with an increase in risk per crash.

DOE contracted with Wenzel of LBNL to conduct an assessment of NHTSA's updated 2016 study of the effect of mass and footprint reductions on U.S. fatality risk per vehicle miles traveled (LBNL 2016 "Phase 1" preliminary report), and to provide an analysis of the effect of mass and footprint reduction on casualty risk per police-reported crash, using independent data from 13 states (LBNL 2016 "Phase 2" preliminary report).

The 2016 LBNL Phase 1 report replicates the analysis in NHTSA's 2016 report (*hereinafter*, 2016 Puckett and Kindelberger report), using the same data and methods, and in many cases using the same SAS programs, to confirm NHTSA's results. The LBNL report confirms NHTSA's 2016 finding, holding footprint constant, each 100-lbs of mass reduction is associated with a 1.49% increase in fatality risk per vehicle miles travelled (VMT) for cars weighing less than 3,197 pounds, a 0.50% increase for cars weighing more than 3,197 pounds, a 0.10% decrease in risk for light trucks weighing less than 4,947 pounds, a 0.71% decrease in risk for light trucks weighing more than 4,947 pounds, and a 0.99% decrease in risk for CUVs/minivans.

*** EO 12866 Review – Draft – Do Not Cite, Quote or Release During Review ***

Wenzel tested the sensitivity of model estimates to changes in the measure of risk as well as control variables and data used in the regression models. Wenzel concluded there is a wide range in fatality risk by vehicle model for models possessing comparable mass or footprint, even after accounting for differences in drivers' age and gender, safety features installed, and crash times and locations.

The 2016 LBNL Phase 1 report notes many of the control variables NHTSA includes in its logistic regressions are statistically significant and have a much larger estimated effect on fatality risk than vehicle mass. For example, installing torso side airbags, electronic stability control, or an antilock braking system in a car is estimated to reduce fatality risk by at least 7%; cars driven by men are estimated to have a 40% higher fatality risk than cars driven by women; and cars driven at night, on rural roads, or on roads with a speed limit higher than 55 mph are estimated to have a fatality risk over 100 times higher than cars driven during the daytime on low-speed non-rural roads. While the estimated effect of mass reduction may result in a statistically-significant increase in risk in certain cases, the increase is small and is overwhelmed by other known vehicle, driver, and crash factors.

10.2.7 Presentation to NAS Subcommittee

Kahane, Wenzel, Ridella, Thomas of Honda, and Nolan of IIHS, were invited to the June 2013 NAS subcommittee on light-duty fuel economy to present results from their 2012 analyses. At the meeting, committee members raised several questions about the studies; presenters responded to these questions at the meeting, as well as in two emails in August 2013 and December 2014.

10.2.8 2015 National Academy of Sciences Report

In 2015, the National Academy of Sciences published the report “Cost, Effectiveness and Deployment of Fuel Economy Technologies for Light-Duty Vehicles.” The report is the result of the work of the Committee on Assessment of Technologies for Improving the Fuel Economy of Light-Duty Vehicles, Phase 2, established upon the request of NHTSA to help inform the midterm review. The committee was asked to assess the CAFE standard program and the analysis leading to the setting of standards, as well as to provide its opinion on costs and fuel consumption improvements of a variety of technologies likely to be implemented in the light-duty fleet between now and 2030.

The Committee found the estimates of mass reductions to be conservative for cars; the Committee projected mass reductions between 5% (for small and large cars) and 6.5% (for midsize cars) larger than the projections. The Committee acknowledged the possibility of negative safety effects during the transition period because of variances in how reductions occurred. Because of this, the Committee recommended NHTSA consider and, if necessary, take steps to mitigate this possibility.

10.2.9 NBER Working Paper

In a NBER working paper, Bento et al.⁷⁷⁸ (2017) present an analysis of relationships among traffic fatalities, CAFE standards, and distributions of MY 1989-2005 light-duty vehicle curb weights. Consistent with NHTSA’s mass-size-safety analyses, Bento et al. concluded decreases in the dispersion of curb weights have a positive effect on safety. A central conclusion in Bento et al. is the monetized value of the net safety improvements achieved under CAFE exceed costs of meeting CAFE standards (i.e., CAFE offers a positive net societal benefit independent of fuel-related impacts). However, NHTSA identified factors in the analysis limiting the inference that can be drawn with respect to CAFE rulemaking going forward. The temporal range of the analysis does not include current footprint-based standards that incentivize light-weighting existing models rather than switching to lighter models. The statistical approach in the analysis does not account for the rebound effect or effects of CAFE on vehicle sales (which affect per-mile fatality risk), and Bento et al. also represented annual CAFE compliance costs at a level substantially less than expected costs for model years in this rulemaking.

10.3 Recent NHTSA Analysis Supporting CAFE Rulemaking

As mentioned previously, NHTSA and EPA’s 2012 joint final rule for MYs 2017 and beyond set “footprint-based” standards, with footprint being defined as roughly equal to the wheelbase multiplied by the average of the front and rear track widths. Basing standards on vehicle footprint ideally helps to discourage vehicle manufacturers from downsizing their vehicles; the agencies set higher (more stringent) mile per gallon (mpg) targets for smaller-footprint vehicles but would not similarly discourage mass reduction that maintains footprint while potentially improving fuel economy. Several technologies, such as substitution of light, high-strength materials for conventional materials during vehicle redesigns, have the potential to reduce weight and conserve fuel while maintaining a vehicle’s footprint and maintaining or possibly improving the vehicle’s structural strength and handling.

In considering what technologies are available for improving fuel economy, including mass reduction, an important corollary issue for NHTSA to consider is the potential effect those technologies may have on safety. NHTSA has thus far specifically considered the likely effect of mass reduction that maintains footprint on fatal crashes. The relationship between a vehicle’s mass, size, and fatality risk is complex, and it varies in different types of crashes. NHTSA, along with others, has been examining this relationship for over a decade. The safety chapter of NHTSA’s April 2012 final regulatory impact analysis (FRIA) of CAFE standards for MY 2017-2021 passenger cars and light trucks included a statistical analysis of relationships between fatality risk, mass, and footprint in MY 2000-2007 passenger cars and LTVs (light trucks and

⁷⁷⁸ Bento, A., Gillingham, K., & K. Roth. (2017). The Effect of Fuel Economy Standards on Vehicle Weight Dispersion and Accident Fatalities. NBER Working Paper No. 23340.

*** EO 12866 Review – Draft – Do Not Cite, Quote or Release During Review ***

vans), based on calendar year (CY) 2002-2008 crash and vehicle-registration data;⁷⁷⁹ this analysis was also detailed in the 2012 Kahane report.

The principal findings and conclusions of the 2012 Kahane report were mass reduction in the lighter cars, even while holding footprint constant, would significantly increase fatality risk, whereas mass reduction in the heavier LTVs would reduce societal fatality risk by reducing the fatality risk of occupants of lighter vehicles colliding with those heavier LTVs. NHTSA concluded, as a result, any *reasonable* combination of mass reductions that held footprint constant in MY 2017-2021 vehicles – concentrated, at least to some extent, in the heavier LTVs and limited in the lighter cars – would likely be approximately safety-neutral; it would not significantly increase fatalities and might well decrease them.

NHTSA released a preliminary report (2016 Puckett and Kindelberger report) on the relationship between fatality risk, mass, and footprint in June 2016 in advance of the Draft TAR. The preliminary report covered the same scope as the 2012 Kahane report, offering a detailed description of the databases, modeling approach, and analytical results on relationships among vehicle size, mass, and fatalities that informed the Draft TAR. Results in the Draft TAR and the 2016 Puckett and Kindelberger report are consistent with results in the 2012 Kahane report; chiefly, societal effects of mass reduction are small, and mass reduction concentrated in larger vehicles is likely to have a beneficial effect on fatalities, while mass reduction concentrated in smaller vehicles is likely to have a detrimental effect on fatalities.

For the 2016 Puckett and Kindelberger report and Draft TAR, NHTSA, working closely with EPA and the DOE, performed an updated statistical analysis of relationships between fatality rates, mass and footprint, updating the crash and exposure databases to the latest available model years. The agencies analyzed updated databases that included MY 2003-2010 vehicles in CY 2005-2011 crashes. For this PRIA, databases are the most up-to-date possible (MY 2004-2011 vehicles in CY 2006-2012), given the processing time for crash data and the need for enough crash cases to permit statistically meaningful analyses. As in previous analyses, NHTSA has made the new databases available to the public at <http://www.nhtsa.gov/fuel-economy>, enabling other researchers to analyze the same data and hopefully minimizing discrepancies in results that would have been because of inconsistencies across databases.

10.4 Updated Analysis for this Rulemaking

The basic analytical method used to analyze the impacts of weight reduction on safety in this proposed rule is the same as in NHTSA’s 2012 Kahane report, 2016 Puckett and Kindelberger report, and the Draft TAR - the agency analyzed cross sections of the societal fatality rate per

⁷⁷⁹ Kahane, C. J. (2012). “Relationships Between Fatality Risk, Mass, and Footprint in Model Year 2000-2007 Passenger Cars and LTVs – Final Report,” Technical Report. Washington, D.C. - NHTSA, Report No. DOT-HS-811-665.

*** EO 12866 Review – Draft – Do Not Cite, Quote or Release During Review ***

billion vehicle miles of travel (VMT) by mass and footprint, while controlling for driver age, gender, and other factors, in separate logistic regressions by vehicle class and crash type. “Societal” fatality rates include fatalities to occupants of all the vehicles involved in the collisions, plus any pedestrians.

The temporal range of the data is now MY 2004-2011 vehicles in CY 2006-2012, updated from previous databases of MY 2000-2007 vehicles in CY2002-2008 (2012 Kahane Report) and MY 2003-2010 vehicles in CY 2005-2011 (2016 Puckett and Kindelberger report and Draft TAR). NHTSA purchased a file of odometer readings by make, model, and model year from Polk that helped inform the agency’s improved VMT estimates. As in the 2012 Kahane report, 2016 Puckett and Kindelberger report, and the Draft TAR, the vehicles are grouped into three classes - passenger cars (including both 2-door and 4-door cars); CUVs and minivans; and truck-based LTVs.

There are nine types of crashes specified in the analysis. Single-vehicle crashes include first-event rollovers, collisions with fixed objects, and collisions with pedestrians, bicycles and motorcycles. Two-vehicle crashes include collisions with - heavy-duty vehicles; car, CUV, or minivan < 3,187 pounds (the median curb weight of other, non-case, cars, CUVs and minivans in fatal crashes in the database); car, CUV, or minivan \geq 3,187 pounds; truck-based LTV < 4,360 pounds (the median curb weight of other truck-based LTVs in fatal crashes in the database); and truck-based LTV \geq 4,360 pounds. An additional crash type includes all other fatal crash types (e.g., collisions involving more than two vehicles, animals, or trains). Splitting the “other” vehicles into a lighter and a heavier group permits more accurate analyses of the mass effect in collisions of two light vehicles. Grouping partner-vehicle CUVs and minivans with cars rather than LTVs is more appropriate because their front-end profile and rigidity more closely resembles a car than a typical truck-based LTV.

The curb weight of passenger cars is formulated, as in the 2012 Kahane report, 2016 Puckett and Kindelberger report, and Draft TAR, as a two-piece linear variable to estimate one effect of mass reduction in the lighter cars and another effect in the heavier cars. The boundary between “lighter” and “heavier” cars is 3,201 pounds (which is the median mass of MY 2004-2011 cars in fatal crashes in CY 2006-2012, up from 3,106 for MY 2000-2007 cars in CY 2002-2008 in the 2012 NHTSA safety database, and up from 3,197 for MY 2003-2010 cars in CY 2005-2011 in the 2016 NHTSA safety database).

Likewise, for truck-based LTVs, curb weight is a two-piece linear variable with the boundary at 5,014 pounds (again, the MY 2004-2011 median, higher than the median of 4,594 for MY 2000-2007 LTVs in CY 2002-2008 and the median of 4,947 for MY 2003-2010 LTVs in CY 2005-2011). Curb weight is formulated as a simple linear variable for CUVs and minivans. Historically, CUVs and minivans have accounted for a relatively small share of new-vehicle sales over the range of the data, resulting in less crash data available than for cars or truck-based LTVs.

*** EO 12866 Review – Draft – Do Not Cite, Quote or Release During Review ***

For a given vehicle class and weight range (if applicable), regression coefficients for mass (while holding footprint constant) in the nine types of crashes are averaged, weighted by the number of baseline fatalities that would have occurred for the subgroup MY 2008-2011 vehicles in CY 2008-2012 if these vehicles had all been equipped with electronic stability control (ESC). The adjustment for ESC, a feature of the analysis added in 2012, takes into account results will be used to analyze effects of mass reduction in future vehicles, which will all be ESC-equipped, as required by NHTSA's regulations.

Techniques developed in the 2011 (preliminary) and 2012 (final) Kahane reports have been retained to test statistical significance and to estimate 95 percent confidence bounds (sampling error) for mass effects and to estimate the combined annual effect of removing 100 pounds of mass from every vehicle (or of removing different amounts of mass from the various classes of vehicles), while holding footprint constant.

NHTSA considered the near multicollinearity of mass and footprint to be a major issue in the 2010 Kahane report⁷⁸⁰ and voiced concern about inaccurately estimated regression coefficients.⁷⁸¹ High correlations between mass and footprint and variance inflation factors (VIF) have not changed from MY 1991-1999 to MY 2004-2011; large vehicles continued to be, on the average, heavier than small vehicles to the same extent as in the previous decade.⁷⁸²

Nevertheless, multicollinearity appears to have become less of a problem in the 2012 Kahane, 2016 Puckett and Kindelberger/Draft TAR, and current NHTSA analyses. Ultimately, only three of the 27 core models of fatality risk by vehicle type in the current analysis indicate the potential presence of effects of multicollinearity, with estimated effects of mass and footprint reduction greater than two percent per 100-pound mass reduction and one-square-foot footprint reduction, respectively; these three models include passenger cars and CUVs in first-event rollovers, and CUVs in collisions with LTVs greater than 4,360 pounds. This result is consistent with the 2016 Puckett and Kindelberger report, which also found only three cases out of 27 models with estimated effects of mass and footprint reduction greater than two percent per 100-pound mass reduction and one-square-foot footprint reduction.

⁷⁸⁰ Kahane, C. J. (2010). *Relationships Between Fatality Risk, Mass, and Footprint in Model Year 1991-1999 and Other Passenger Cars and LTVs*. Final Regulatory Impact Analysis - Corporate Average Fuel Economy for MY 2012-MY 2016 Passenger Cars and Light Trucks. Washington, D.C. - NHTSA, pp. 464-542, http://www.nhtsa.dot.gov/staticfiles/DO/NHTSA/Rulemaking/Rules/Associated%20Files/CAFE_2012-2016_FRIA_04012010.pdf.

⁷⁸¹ Van Auken and Green also discussed the issue in their presentations at the NHTSA Workshop on Vehicle Mass-Size-Safety in Washington, D.C. February 25, 2011, <http://www.nhtsa.gov/Laws+&+Regulations/CAFE+-+Fuel+Economy/NHTSA+Workshop+on+Vehicle+Mass-Size-Safety>.

⁷⁸² Greene, W. H. (1993). *Econometric Analysis*, Second Edition. New York - Macmillan Publishing Company, pp. 266-268; Allison, P.D. (1999), *Logistic Regression Using the SAS System*. Cary, NC - SAS Institute Inc., pp. 48-51. VIF scores are in the 6-9 range for curb weight and footprint in NHTSA's new database – i.e., in the somewhat unfavorable 2.5-10 range where near multicollinearity begins to become a concern in logistic regression analyses.

Table 10-1 presents the estimated percent increase in U.S. societal fatality risk per ten billion VMT for each 100-pound reduction in vehicle mass, while holding footprint constant, for each of the five vehicle classes:

TABLE 10-1 - FATALITY INCREASE (%) PER 100-POUND MASS REDUCTION WHILE HOLDING FOOTPRINT CONSTANT - MY 2004-2011, CY 2006-2012

	Point Estimate	95% Confidence Bounds
Cars < 3,197 pounds	1.20	-.35 to +2.75
Cars ≥ 3,197 pounds	0.42	-.67 to +1.50
CUVs and minivans	-0.25	-1.55 to +1.04
Truck-based LTVs < 4,947 pounds	0.31	- .51 to +1.13
Truck-based LTVs ≥ 4,947 pounds	-0.61	-1.46 to +.25

None of the estimated effects have 95-percent confidence bounds that exclude zero, and thus are not statistically significant at the 95-percent confidence level. Two estimated effects are statistically significant at the 85-percent level. Societal fatality risk is estimated to - (1) increase by 1.2 percent if mass is reduced by 100 pounds in the lighter cars; and (2) decrease by 0.61 percent if mass is reduced by 100 pounds in the heavier truck-based LTVs. The estimated increases in societal fatality risk for mass reduction in the heavier cars and the lighter truck-based LTVs, and the estimated decrease in societal fatality risk for mass reduction in CUVs and minivans are not significant, even at the 85-percent confidence level.

Confidence bounds estimate only the sampling error internal to the data used in the specific analysis that generated the point estimate. Point estimates are also sensitive to the modification of components of the analysis, as discussed at the end of this section. However, this degree of uncertainty is methodological in nature rather than statistical.

It is useful to compare the new results in Table 10-1 to results in the 2012 Kahane report (MY 2000-2007 vehicles in CY 2002-2008) and the 2016 Puckett and Kindelberger report and Draft TAR (MY 2003-2010 vehicles in CY 2005-2011), presented in Table 10-2 below:

TABLE 10-2 - FATALITY INCREASE (%) PER 100-POUND MASS REDUCTION WHILE HOLDING FOOTPRINT CONSTANT

Vehicle Class ⁷⁸³	2012 Report Point Estimate	2016 Report/Draft TAR Point Estimate	2012 Report 95% Confidence Bounds	2016 Report 95% Confidence Bounds

⁷⁸³ Median curb weights in the 2012 Kahane report - 3,106 pounds for cars, 4,594 pounds for truck-based LTVs. Median curb weights in the 2016 Puckett and Kindelberger report - 3,197 pounds for cars, 4,947 pounds for truck-based LTVs.

*** EO 12866 Review – Draft – Do Not Cite, Quote or Release During Review ***

Lighter Passenger Cars	1.56	1.49	+.39 to +2.73	-.30 to +3.27
Heavier Passenger Cars	.51	.50	-.59 to 1.60	-.59 to +1.60
CUVs and minivans	-.37	-.99	-1.55 to +.81	-2.17 to +.19
Lighter Truck-based LTVs	.52	-.10	-.45 to +1.48	-1.08 to +.88
Heavier Truck-based LTVs	-.34	-.72	-.97 to +.30	-1.45 to +.02

New results are directionally the same as in 2012; in the 2016 analysis, the estimate for lighter LTVs was of opposite sign (but small magnitude). Consistent with the 2012 Kahane and 2016 Puckett and Kindelberger reports, mass reductions in lighter cars are estimated to lead to increases in fatalities, and mass reductions in heavier LTVs are estimated to lead to decreases in fatalities. However, NHTSA does not consider this conclusion to be definitive because of the relatively wide confidence bounds of the estimates. The estimated mass effects are similar among analyses for both classes of passenger cars; for all reports, the estimate for lighter passenger cars is statistically significant at the 85-percent confidence level, while the estimate for heavier passenger cars is insignificant.

The estimated mass effect for heavier truck-based LTVs is stronger in this analysis and in the 2016 Puckett and Kindelberger report than in the 2012 Kahane report; both estimates are statistically significant at the 85-percent confidence level, unlike the corresponding insignificant estimate in the 2012 Kahane report. The estimated mass effect for lighter truck-based LTVs is insignificant and positive in this analysis and the 2012 Kahane report, while the corresponding estimate in the 2016 Puckett and Kindelberger report was insignificant and negative.

Vehicle mass continued an historical upward trend across the MYs in the newest databases. The average (VMT-weighted) masses of passenger cars and CUVs both increased by approximately 3% from MYs 2004 to 2011 (3,184 pounds to 3,289 pounds for passenger cars, and 3,821 pounds to 3,924 pounds for CUVs). Over the same period, the average mass of minivans increased by 6% (from 4,204 pounds to 4,462 pounds), and the average mass of LTVs increased by 10% (from 4,819 pounds to 5,311 pounds). Historical reasons for mass increases within vehicle classes include - manufacturers discontinuing lighter models; manufacturers re-designing models to be heavier and larger; and shifting consumer preferences with respect to cabin size and overall vehicle size.

The principal difference between heavier vehicles, especially truck-based LTVs, and lighter vehicles, especially passenger cars, is mass reduction has a different effect in collisions with another car or LTV. When two vehicles of unequal mass collide, the change in velocity (delta V) is greater in the lighter vehicle. Through conservation of momentum, the degree to which the delta V in the lighter vehicle is greater than in the heavier vehicle is proportional to the ratio of mass in the heavier vehicle to mass in the lighter vehicle:

EQUATION 10-1 - DELTA V FOR FOCAL VEHICLE

$$\Delta v_1 = \frac{m_2}{m_1} \Delta v_2$$

Where:

Δv_1 is the delta V for a focal vehicle, Δv_2 is the delta V for a partner vehicle, and $\frac{m_2}{m_1}$ is the mass of the partner vehicle divided by the mass of the focal vehicle.

Because fatality risk is a positive function of delta V, the fatality risk in the lighter vehicle in two-vehicle collisions is also higher. Removing some mass from the heavy vehicle reduces delta V in the lighter vehicle, where fatality risk is higher, resulting in a large benefit, offset by a small penalty because delta V increases in the heavy vehicle where fatality risk is low – adding up to a net societal benefit. Removing some mass from the lighter vehicle results in a large penalty offset by a small benefit – adding up to net harm.

These considerations drive the overall result - Mass reduction is associated with an increase in fatality risk in lighter cars, a decrease in fatality risk in heavier LTVs, CUVs, and minivans, and has smaller effects in the intermediate groups. Mass reduction may also be harmful in a crash with a movable object such as a small tree, which may break if hit by a high mass vehicle resulting in a lower delta V than may occur if hit by a lower mass vehicle which does not break the tree and therefore has a higher delta V. However, in some types of crashes not involving collisions between cars and LTVs, especially first-event rollovers and impacts with fixed objects, mass reduction may not be harmful and may be beneficial. To the extent lighter vehicles may respond more quickly to braking and steering, or may be more stable because their center of gravity is lower, they may more successfully avoid crashes or reduce the severity of crashes.

Farmer, Green, and Lie, who reviewed the 2010 Kahane report, again peer-reviewed the 2011 Kahane report.⁷⁸⁴ In preparing his 2012 report (along with the 2016 Puckett and Kindelberger report and Draft TAR), Kahane also took into account Wenzel's⁷⁸⁵ assessment of the preliminary report and its peer reviews, DRI's analyses published early in 2012, and public comments such as the International Council on Clean Transportation's comments submitted on NHTSA and EPA's 2010 notice of joint rulemaking.⁷⁸⁶ These comments prompted supplementary analyses, especially sensitivity tests, discussed at the end of this section.

⁷⁸⁴ Items 0035 (Lie), 0036 (Farmer) and 0037 (Green) in Docket No. NHTSA-2010-0152.

⁷⁸⁵ For the 2012 Wenzel reports see - "U.S. DOT/DOE - Final Report - An Analysis of the Relationship between Casualty Risk Per Crash and Vehicle Mass and Footprint for Model Year 2000-2007 Light Duty Vehicles," Docket NHTSA-0131-0315; "Lawrence Berkeley National Laboratory -Assessment of NHTSA Report Relationships Btw Fatality Risk Mass and Footprint in MY 2000-2007 PC and LTV," Docket NHTSA-2010-0131-0315; and a peer review of Wenzel's reports – "Final Report of Peer Review of LBNL Reports," Docket NHTSA-2010-0131-0328.

⁷⁸⁶ Item 0258 in Docket No. NHTSA-2010-0131.

The regression results are best suited to predict the effect of a small change in mass, leaving all other factors, including footprint, the same. With each additional change from the current environment (e.g., the scale of mass change, presence and prevalence of safety features, demographic characteristics), the model may become less accurate. It is recognized that the light-duty vehicle fleet in the MY 2021-2026 timeframe will be different from the MY 2004-2011 fleet analyzed here.

Nevertheless, one consideration provides some basis for confidence in applying regression results to estimate effects of relatively large mass reductions or mass reductions over longer periods. This is NHTSA's sixth evaluation of effects of mass reduction and/or downsizing,⁷⁸⁷ comprising databases ranging from MYs 1985 to 2011.

Results of the six studies are not identical, but they have been consistent to a point. During this time period, many makes and models have increased substantially in mass, sometimes as much as 30-40%.⁷⁸⁸ If the statistical analysis has, over the past years, been able to accommodate mass increases of this magnitude, perhaps it will also succeed in modeling effects of mass reductions of approximately 10-20%, should they occur in the future.

10.4.1 Calculation of MY2021-2026 Safety Impact

Neither CAFE standards nor this analysis mandate mass reduction, or mandate mass reduction occur in any specific manner. However, mass reduction is one of the technology applications available to manufacturers, and thus a degree of mass reduction is allowed within the CAFE model to - (1) determine capabilities of manufacturers; and (2) to predict cost and fuel consumption effects of improved CAFE standards.

⁷⁸⁷ As outlined throughout this section, NHTSA's six related studies include the new analysis supporting this rulemaking, and - Kahane, C. J. (2003). *Vehicle Weight, Fatality Risk and Crash Compatibility of Model Year 1991-99 Passenger Cars and Light Trucks*, NHTSA Technical Report. DOT HS 809 662. Washington, D.C. - NHTSA, <http://www.nrd.nhtsa.dot.gov/Pubs/809662.PDF>; Kahane, C. J. (2010). "Relationships Between Fatality Risk, Mass, and Footprint in Model Year 1991-1999 and Other Passenger Cars and LTVs," Final Regulatory Impact Analysis - Corporate Average Fuel Economy for MY 2012-MY 2016 Passenger Cars and Light Trucks. Washington, D.C. - NHTSA pp. 464-542, http://www.nhtsa.dot.gov/staticfiles/DOT/NHTSA/Rulemaking/Rules/Associated%20Files/CAFE_2012-2016_FRIA_04012010.pdf; Kahane, C. J. (2011). *Relationships Between Fatality Risk, Mass, and Footprint in Model Year 2000-2007 Passenger Cars and LTVs – Preliminary Report*. (Docket No. NHTSA-2010-0152- 0023). Washington, D.C. - NHTSA; Kahane, C.J. (2012). *Relationships Between Fatality Risk, Mass, and Footprint in Model Year 2000-2007 Passenger Cars and LTVs - Final Report*, NHTSA Technical Report. Washington, D.C. - NHTSA, Report No. DOT-HS-811-665; and Puckett, S.M. and Kindelberger, J.C. (2016, June). *Relationships between Fatality Risk, Mass, and Footprint in Model Year 2003-2010 Passenger Cars and LTVs – Preliminary Report*. (Docket No. NHTSA- 2016-0068). Washington, D.C. - NHTSA.

⁷⁸⁸ For example, one of the most popular models of small 4-door sedans increased in curb weight from 1,939 pounds in MY 1985 to 2,766 pounds in MY 2007, a 43% increase. A high-sales mid-size sedan grew from 2,385 to 3,354 pounds (41%); a best-selling pickup truck from 3,390 to 4,742 pounds (40%) in the basic model with 2-door cab and rear-wheel drive; and a popular minivan from 2,940 to 3,862 pounds (31%).

*** EO 12866 Review – Draft – Do Not Cite, Quote or Release During Review ***

The agency utilized the relationships between weight and safety from the new NHTSA analysis, expressed as percentage increases in fatalities per 100-pound weight reduction, and examined the weight impacts assumed in this CAFE analysis. The effects of mass reduction on safety were estimated relative to estimated baseline levels of safety across vehicle classes and model years. To identify baseline levels of safety, the agency examined effects of identifiable safety trends over lifetimes of vehicles produced in each model year. The projected effectiveness of existing and forthcoming safety technologies and expected on-road fleet penetration of safety technologies were incorporated into observed trends in fatality rates to estimate baseline fatality rates in future years across vehicle classes and model years.

The agency assumed safety trends will result in a reduction in the target population of fatalities from which the vehicle mass impacts are derived. Table 10-3 through Table 10-5 show results of NHTSA's vehicle mass-size-safety analysis over the cumulative lifetime of MY 1977-2029 vehicles based on the MY 2016 baseline fleet, accounting for the projected safety baselines. The reported fatality impacts are undiscounted, but the monetized safety impacts are discounted at three-percent and seven-percent discount rates. The reported fatality impacts are estimated increases or decreases in fatalities over the lifetime of the model year fleet. A positive number means that fatalities are projected to increase, a negative number (in parentheses) means that fatalities are projected to decrease.

Results are driven extensively by the degree to which mass is reduced in relatively light passenger cars and in relatively heavy vehicles because their coefficients in the logistic regression analysis have the most significant values. The analysis assumes that any impact on fatalities will occur over the lifetime of the vehicle, and that the chance of a fatality occurring in any particular year is directly related to the weighted vehicle miles traveled in that year.

*** EO 12866 Review – Draft – Do Not Cite, Quote or Release During Review ***

TABLE 10-3 - COMPARISON OF THE CALCULATED VEHICLE-MASS-RELATED FATALITY IMPACTS OVER THE LIFETIME OF MY 1977 THROUGH MY 2029 LIGHT-DUTY VEHICLES, BY POLICY ALTERNATIVE, RELATIVE TO AUGURAL STANDARDS, FATALITIES UNDISCOUNTED, DOLLARS DISCOUNTED AT 3% AND 7%

	Alternative							
	#1	#2	#3	#4	#5	#6	#7	#8
Model Years Affected by Policy	2021-2026	2021-2026	2021-2026	2021-2026	2022-2026	2021-2026	2021-2026	2022-2026
Annual Rate of Stringency Increase	0.0%/Year PC 0.0%/Year LT	0.5%/Year PC 0.5%/Year LT	0.5%/Year PC 0.5%/Year LT	1.0%/Year PC 2.0%/Year LT	1.0%/Year PC 2.0%/Year LT	2.0%/Year PC 3.0%/Year LT	2.0%/Year PC 3.0%/Year LT	2.0%/Year PC 3.0%/Year LT
AC/Off-Cycle Procedures	No Change	No Change	Phaseout 2022-2026	No Change	No Change	No Change	Phaseout 2022-2026	No Change
Fatalities	-165	-151	-147	-177	-156	-77	-16	-14
Fatality Costs (\$ Billion, 3% Discount Rate)	-1.0	-0.9	-0.9	-1.1	-1.0	-0.5	-0.1	-0.1
Fatality Costs (\$ Billion, 7% Discount Rate)	-0.5	-0.5	-0.5	-0.6	-0.5	-0.3	-0.1	0.0

*** EO 12866 Review – Draft – Do Not Cite, Quote or Release During Review ***

Non-Fatal Crash Costs (\$ Billion, 3% Discount Rate)	-1.5	-1.4	-1.4	-1.7	-1.5	-0.7	-0.1	-0.1
Non-Fatal Crash Costs (\$ Billion, 7% Discount Rate)	-0.8	-0.7	-0.7	-1.0	-0.9	-0.4	-0.1	-0.1
Total Crash Costs (\$ Billion, 3% Discount Rate)	-2.5	-2.3	-2.2	-2.8	-2.5	-1.2	-0.2	-0.2
Total Crash Costs (\$ Billion, 7% Discount Rate)	-1.3	-1.2	-1.2	-1.6	-1.4	-0.7	-0.1	-0.1

*** EO 12866 Review – Draft – Do Not Cite, Quote or Release During Review ***

TABLE 10-4 - COMPARISON OF THE CALCULATED VEHICLE-MASS-RELATED FATALITY IMPACTS OVER THE LIFETIME OF MY 1977 THROUGH MY 2029 PASSENGER CARS, BY POLICY ALTERNATIVE, RELATIVE TO AUGURAL STANDARDS, FATALITIES UNDISCOUNTED, DOLLARS DISCOUNTED AT 3% AND 7%

	Alternative							
	#1	#2	#3	#4	#5	#6	#7	#8
Model Years Affected by Policy	2021-2026	2021-2026	2021-2026	2021-2026	2022-2026	2021-2026	2021-2026	2022-2026
Annual Rate of Stringency Increase	0.0%/Year PC 0.0%/Year LT	0.5%/Year PC 0.5%/Year LT	0.5%/Year PC 0.5%/Year LT	1.0%/Year PC 2.0%/Year LT	1.0%/Year PC 2.0%/Year LT	2.0%/Year PC 3.0%/Year LT	2.0%/Year PC 3.0%/Year LT	2.0%/Year PC 3.0%/Year LT
AC/Off-Cycle Procedures	No Change	No Change	Phaseout 2022-2026	No Change	No Change	No Change	Phaseout 2022-2026	No Change
Fatalities	-285	-267	-239	-202	-171	-91	-22	-15
Fatality Costs (\$ Billion, 3% Discount Rate)	-1.8	-1.6	-1.5	-1.2	-1.1	-0.6	-0.1	-0.1
Fatality Costs (\$ Billion, 7% Discount Rate)	-1.0	-0.9	-0.8	-0.7	-0.6	-0.3	-0.1	0.0
Non-Fatal Crash Costs (\$ Billion, 3% Discount Rate)	-2.7	-2.6	-2.3	-2.0	-1.7	-0.9	-0.2	-0.1

*** EO 12866 Review – Draft – Do Not Cite, Quote or Release During Review ***

Non-Fatal Crash Costs (\$ Billion, 7% Discount Rate)	-1.6	-1.5	-1.3	-1.1	-1.0	-0.5	-0.1	-0.1
Total Crash Costs (\$ Billion, 3% Discount Rate)	-4.5	-4.2	-3.8	-3.2	-2.7	-1.4	-0.3	-0.2
Total Crash Costs (\$ Billion, 7% Discount Rate)	-2.6	-2.4	-2.2	-1.9	-1.6	-0.8	-0.2	-0.1

*** EO 12866 Review – Draft – Do Not Cite, Quote or Release During Review ***

TABLE 10-5 - COMPARISON OF THE CALCULATED VEHICLE-MASS-RELATED FATALITY IMPACTS OVER THE LIFETIME OF MY 1977 THROUGH MY 2029 LIGHT TRUCKS, BY POLICY ALTERNATIVE, RELATIVE TO AUGURAL STANDARDS, FATALITIES UNDISCOUNTED, DOLLARS DISCOUNTED AT 3% AND 7%

	Alternative							
	#1	#2	#3	#4	#5	#6	#7	#8
Model Years Affected by Policy	2021-2026	2021-2026	2021-2026	2021-2026	2022-2026	2021-2026	2021-2026	2022-2026
Annual Rate of Stringency Increase	0.0%/Year PC 0.0%/Year LT	0.5%/Year PC 0.5%/Year LT	0.5%/Year PC 0.5%/Year LT	1.0%/Year PC 2.0%/Year LT	1.0%/Year PC 2.0%/Year LT	2.0%/Year PC 3.0%/Year LT	2.0%/Year PC 3.0%/Year LT	2.0%/Year PC 3.0%/Year LT
AC/Off-Cycle Procedures	No Change	No Change	Phaseout 2022- 2026	No Change	No Change	No Change	Phaseout 2022- 2026	No Change
Fatalities	120	116	92	25	15	14	6	1
Fatality Costs (\$ Billion, 3% Discount Rate)	0.8	0.8	0.6	0.2	0.1	0.1	0.0	0.0
Fatality Costs (\$ Billion, 7% Discount Rate)	0.5	0.5	0.4	0.1	0.1	0.1	0.0	0.0

*** EO 12866 Review – Draft – Do Not Cite, Quote or Release During Review ***

Non-Fatal Crash Costs (\$ Billion, 3% Discount Rate)	1.2	1.2	0.9	0.2	0.2	0.1	0.1	0.0
Non-Fatal Crash Costs (\$ Billion, 7% Discount Rate)	0.8	0.7	0.6	0.1	0.1	0.1	0.0	0.0
Total Crash Costs (\$ Billion, 3% Discount Rate)	2.0	2.0	1.6	0.4	0.3	0.2	0.1	0.0
Total Crash Costs (\$ Billion, 7% Discount Rate)	1.3	1.2	1.0	0.2	0.2	0.1	0.1	0.0

*** EO 12866 Review – Draft – Do Not Cite, Quote or Release During Review ***

For all light-duty vehicles, mass changes are estimated to lead to a decrease in fatalities over the cumulative lifetime of MY 1977-2029 vehicles in all alternatives evaluated. The effects of mass changes on fatalities range from a combined decrease (relative to the augural standards, the baseline) of 14 fatalities for Alternative #8 to a combined decrease of 177 fatalities for Alternative #4. The difference in results by alternative depends upon how much weight reduction is used in that alternative and the types and sizes of vehicles to which the weight reduction applies. The decreases in fatalities are driven by impacts within passenger cars (decreases of between 15 and 285 fatalities) and are offset by impacts within light trucks (increases of between 1 and 120 fatalities).

Additionally, social effects of increasing fatalities can be monetized using NHTSA's estimated comprehensive cost per life of \$9,900,000 in 2016 dollars. This consists of a value of a statistical life of \$9.6 million in 2015 dollars plus external economic costs associated with fatalities such as medical care, insurance administration costs and legal costs, updated for inflation to 2016 dollars.

Typically, NHTSA would also estimate the effect on injuries and add that to social costs of fatalities, but in this case NHTSA does not have a model estimating the effect of vehicle mass on injuries. Blincoe et al. estimates that fatalities account for 39.5 percent of total comprehensive costs due to injury.⁷⁸⁹ If vehicle mass impacts non-fatal injuries proportionally to its impact on fatalities, then total costs would be approximately 2.53 (1/0.395) times the value of fatalities alone, or around \$25.07 million per fatality. NHTSA has selected this value as representative of the relationship between fatality costs and injury costs because this approach is internally consistent among NHTSA studies.

Changes in vehicle mass are estimated to decrease social safety costs over the lifetime of the nine model years by between \$190 million (for Alternative #8) and \$2.8 billion (for Alternative #4) relative to the augural standards at a three-percent discount rate, and by between \$97 million and \$1.6 billion at a seven-percent discount rate. The estimated decreases in social safety costs are driven by estimated decreases in costs associated with passenger cars, ranging from \$212 million (for Alternative #8) to \$4.5 billion (for Alternative #1) relative to the augural standards at a three-percent discount rate, and by between \$117 million and \$2.6 billion at a seven-percent discount rate. The estimated decreases in costs associated with passenger cars are offset by estimated increases in costs associated with light trucks, ranging from \$21 million (for Alternative #8) to \$2.0 billion (for Alternative #1) relative to the augural standards at a three-percent discount rate, and by between \$20 million and \$1.3 billion at a seven-percent discount rate.

⁷⁸⁹ Blincoe, L.J., Miller, T.R., Zaloshnja, E., & Lawrence, B.A. (2015). *The Economic and Social Impact of Motor Vehicle Crashes, 2010 (Revised)*. Report No. DOT HS 812 013. Washington, D.C. - NHTSA. The estimate of 39.5% (see Table 1-8) is equal to the estimated value of MAIS6 (fatal) injuries in vehicle incidents divided by the estimated value of MAIS0-MAIS6 (non-fatal and fatal) injuries in vehicle incidents.

*** EO 12866 Review – Draft – Do Not Cite, Quote or Release During Review ***

Table 10-6 through Table 10-8 presents average annual estimated safety effects of vehicle mass changes, for calendar years 2035-2045:

*** EO 12866 Review – Draft – Do Not Cite, Quote or Release During Review ***

TABLE 10-6 - COMPARISON OF THE CALCULATED ANNUAL AVERAGE VEHICLE-MASS-RELATED FATALITY IMPACTS FOR CY 2035-2045 IN LIGHT-DUTY VEHICLES, BY POLICY ALTERNATIVE, RELATIVE TO AUGURAL STANDARDS, FATALITIES UNDISCOUNTED, DOLLARS DISCOUNTED AT 3% AND 7%

	Alternative							
	#1	#2	#3	#4	#5	#6	#7	#8
Model Years Affected by Policy	2021-2026	2021-2026	2021-2026	2021-2026	2022-2026	2021-2026	2021-2026	2022-2026
Annual Rate of Stringency Increase	0.0%/Year PC	0.5%/Year PC	0.5%/Year PC	1.0%/Year PC	1.0%/Year PC	2.0%/Year PC	2.0%/Year PC	2.0%/Year PC
	0.0%/Year LT	0.5%/Year LT	0.5%/Year LT	2.0%/Year LT	2.0%/Year LT	3.0%/Year LT	3.0%/Year LT	3.0%/Year LT
AC/Off-Cycle Procedures	No Change	No Change	Phaseout 2022-2026	No Change	No Change	No Change	Phaseout 2022-2026	No Change
Fatalities	-23	-21	-18	-18	-18	-7	-1	-1
Fatality Costs (\$ Billion, 3% Discount Rate)	-0.11	-0.10	-0.09	-0.09	-0.09	-0.04	-0.01	0.00
Fatality Costs (\$ Billion, 7% Discount Rate)	-0.05	-0.04	-0.04	-0.04	-0.04	-0.01	0.00	0.00
Non-Fatal Crash Costs (\$ Billion, 3% Discount Rate)	-0.17	-0.16	-0.14	-0.14	-0.14	-0.06	-0.01	-0.01
Non-Fatal Crash Costs (\$ Billion, 7% Discount Rate)	-0.07	-0.07	-0.06	-0.06	-0.06	-0.02	0.00	0.00
Total Crash Costs (\$ Billion, 3% Discount Rate)	-0.29	-0.26	-0.23	-0.22	-0.22	-0.09	-0.02	-0.01
Total Crash Costs (\$ Billion, 7% Discount Rate)	-0.12	-0.11	-0.10	-0.09	-0.09	-0.04	-0.01	0.00

*** EO 12866 Review – Draft – Do Not Cite, Quote or Release During Review ***

TABLE 10-7 - COMPARISON OF THE CALCULATED ANNUAL AVERAGE VEHICLE-MASS-RELATED FATALITY IMPACTS FOR CY 2035-2045 IN PASSENGER CARS, BY POLICY ALTERNATIVE, RELATIVE TO AUGURAL STANDARDS, FATALITIES UNDISCOUNTED, DOLLARS DISCOUNTED AT 3% AND 7%

	Alternative							
	#1	#2	#3	#4	#5	#6	#7	#8
Model Years Affected by Policy	2021-2026	2021-2026	2021-2026	2021-2026	2022-2026	2021-2026	2021-2026	2022-2026
Annual Rate of Stringency Increase	0.0%/Year PC	0.5%/Year PC	0.5%/Year PC	1.0%/Year PC	1.0%/Year PC	2.0%/Year PC	2.0%/Year PC	2.0%/Year PC
	0.0%/Year LT	0.5%/Year LT	0.5%/Year LT	2.0%/Year LT	2.0%/Year LT	3.0%/Year LT	3.0%/Year LT	3.0%/Year LT
AC/Off-Cycle Procedures	No Change	No Change	Phaseout 2022-2026	No Change	No Change	No Change	Phaseout 2022-2026	No Change
Fatalities	-35	-32	-28	-22	-19	-9	-2	0
Fatality Costs (\$ Billion, 3% Discount Rate)	-0.17	-0.16	-0.14	-0.11	-0.10	-0.04	-0.01	0.00
Fatality Costs (\$ Billion, 7% Discount Rate)	-0.07	-0.07	-0.06	-0.04	-0.04	-0.02	0.00	0.00
Non-Fatal Crash Costs (\$ Billion, 3% Discount Rate)	-0.27	-0.25	-0.22	-0.17	-0.15	-0.07	-0.02	0.00
Non-Fatal Crash Costs (\$ Billion, 7% Discount Rate)	-0.11	-0.10	-0.09	-0.07	-0.06	-0.03	-0.01	0.00
Total Crash Costs (\$ Billion, 3% Discount Rate)	-0.44	-0.41	-0.36	-0.27	-0.24	-0.11	-0.03	0.01
Total Crash Costs (\$ Billion, 7% Discount Rate)	-0.18	-0.17	-0.15	-0.11	-0.10	-0.05	-0.01	0.00

*** EO 12866 Review – Draft – Do Not Cite, Quote or Release During Review ***

TABLE 10-8 - COMPARISON OF THE CALCULATED ANNUAL AVERAGE VEHICLE-MASS-RELATED FATALITY IMPACTS FOR CY 2035-2045 IN LIGHT TRUCKS, BY POLICY ALTERNATIVE, RELATIVE TO AUGURAL STANDARDS, FATALITIES UNDISCOUNTED, DOLLARS DISCOUNTED AT 3% AND 7%

	Alternative							
	#1	#2	#3	#4	#5	#6	#7	#8
Model Years Affected by Policy	2021-2026	2021-2026	2021-2026	2021-2026	2022-2026	2021-2026	2021-2026	2022-2026
Annual Rate of Stringency Increase	0.0%/Year PC 0.0%/Year LT	0.5%/Year PC 0.5%/Year LT	0.5%/Year PC 0.5%/Year LT	1.0%/Year PC 2.0%/Year LT	1.0%/Year PC 2.0%/Year LT	2.0%/Year PC 3.0%/Year LT	2.0%/Year PC 3.0%/Year LT	2.0%/Year PC 3.0%/Year LT
AC/Off-Cycle Procedures	No Change	No Change	Phaseout 2022- 2026	No Change	No Change	No Change	Phaseout 2022- 2026	No Change
Fatalities	12	12	10	4	2	2	1	-1
Fatality Costs (\$ Billion, 3% Discount Rate)	0.06	0.06	0.05	0.02	0.01	0.01	0.00	-0.01
Fatality Costs (\$ Billion, 7% Discount Rate)	0.02	0.02	0.02	0.01	0.00	0.00	0.00	0.00
Non-Fatal Crash Costs (\$ Billion, 3% Discount Rate)	0.09	0.09	0.08	0.03	0.01	0.01	0.01	-0.01
Non-Fatal Crash Costs (\$ Billion, 7% Discount Rate)	0.04	0.04	0.03	0.01	0.01	0.01	0.00	0.00
Total Crash Costs (\$ Billion, 3% Discount Rate)	0.15	0.15	0.12	0.05	0.02	0.02	0.01	-0.02
Total Crash Costs (\$ Billion, 7% Discount Rate)	0.06	0.06	0.05	0.02	0.01	0.01	0.00	-0.01

*** EO 12866 Review – Draft – Do Not Cite, Quote or Release During Review ***

For all light-duty vehicles, mass changes are estimated to lead to an average annual decrease in fatalities in all alternatives evaluated for calendar years 2035-2045. The effects of mass changes on fatalities range from a combined decrease (relative to the aogural standards) of 1 fatality per year for Alternative #8 to a combined increase of 23 fatalities per year for Alternative #1. The difference in the results by alternative depends upon how much weight reduction is used in that alternative and the types and sizes of vehicles to which the weight reduction applies. The decreases in fatalities are generally driven by impacts within passenger cars (decreases of between 0 and 35 fatalities per year relative to the aogural standards), and are generally offset by impacts within light trucks (ranging from a decrease of 1 fatality per year to an increase of 12 fatalities per year).

Changes in vehicle mass are estimated to decrease average annual social safety costs in CY 2035-2045 by between \$10 million (for Alternative #8) and \$287 million (for Alternative #1) relative to the aogural standards at a three-percent discount rate and by between \$4 million and \$118 million at a seven-percent discount rate. The estimated decreases in social safety costs are generally driven by estimated decreases in costs associated with passenger cars, with effects ranging from a decrease of \$440 million (for Alternative #1) to an increase of \$6 million (for Alternative #8) relative to the aogural standards at a three-percent discount rate, and ranging between -\$181 million and \$2 million at a seven-percent discount rate. The estimated decreases in costs associated with passenger cars are generally offset by estimated increases in costs associated with light trucks, with effects ranging from a decrease of \$16 million (for Alternative #8) to an increase of \$154 million (for Alternative #1) relative to the aogural standards at a three-percent discount rate, and ranging between -\$6 million and \$64 million at a seven-percent discount rate.

To help illuminate effects at the model year level, Table 10-9 presents the lifetime fatality impacts associated with vehicle mass changes for passenger cars, light trucks, and all light-duty vehicles by model year under Alternative #1, relative to the aogural standards:

*** EO 12866 Review – Draft – Do Not Cite, Quote or Release During Review ***

TABLE 10-9 - COMPARISON OF LIFETIME VEHICLE-MASS-RELATED FATALITY IMPACTS BY MODEL YEAR UNDER ALTERNATIVE #1, RELATIVE TO AUGURAL STANDARDS, FATALITIES UNDISCOUNTED

	MY 1977- 2016	MY 2017	MY 2018	MY 2019	MY 2020	MY 2021	MY 2022	MY 2023	MY 2024	MY 2025	MY 2026	MY 2027	MY 2028	MY 2029	TOTAL
Passenger Cars	-2	-3	-3	-3	-5	-10	-16	-28	-31	-36	-36	-37	-38	-38	-285
Light Trucks	-1	-1	-1	3	2	11	13	12	13	12	13	14	14	14	120
Total	-3	-4	-4	0	-3	1	-3	-16	-18	-24	-22	-23	-23	-23	-165

*** EO 12866 Review – Draft – Do Not Cite, Quote or Release During Review ***

Under Alternative #1, passenger car fatalities associated with mass changes are estimated to decrease generally from MY 2017 (decrease of 3 fatalities) through MY 2029 (decrease of 38 fatalities), peaking in MYs 2028 and 2029 (38 fatalities). Corresponding estimates of light truck fatalities associated with mass changes are generally positive and increasing from MY 2019 (increase of 3 fatalities) through MY 2029 (increase of 14 fatalities), peaking in MYs 2027 through 2029 (14 fatalities). Altogether, light-duty vehicle fatality reductions associated with mass changes under Alternative #1 are estimated to be concentrated among MY 2023 through MY 2029 vehicles (149 out of 165 net fatalities mitigated).

Table 10-10 and Table 10-11 present estimates of monetized lifetime social safety costs associated with mass changes by model year at three-percent and seven-percent discount rates, respectively:

*** EO 12866 Review – Draft – Do Not Cite, Quote or Release During Review ***

TABLE 10-10 - COMPARISON OF LIFETIME SOCIAL SAFETY COSTS ASSOCIATED WITH MASS CHANGES BY MODEL YEAR UNDER ALTERNATIVE #1, RELATIVE TO AUGURAL STANDARDS, DOLLARS DISCOUNTED AT 3%

	MY 1977- 2016	MY 2017	MY 2018	MY 2019	MY 2020	MY 2021	MY 2022	MY 2023	MY 2024	MY 2025	MY 2026	MY 2027	MY 2028	MY 2029	TOTAL
Passenger Cars	0.0	0.0	0.0	0.0	0.0	-0.1	-0.1	-0.2	-0.2	-0.2	-0.2	-0.2	-0.2	-0.2	-1.8
Light Trucks	0.0	0.0	0.0	0.0	0.0	0.1	0.1	0.1	0.1	0.1	0.1	0.1	0.1	0.1	0.8
Total	0.0	0.0	0.0	0.0	0.0	0.0	0.0	-0.1	-0.1	-0.2	-0.1	-0.1	-0.1	-0.1	-1.0

TABLE 10-11 - COMPARISON OF LIFETIME SOCIAL SAFETY COSTS ASSOCIATED WITH MASS CHANGES BY MODEL YEAR UNDER ALTERNATIVE #1, RELATIVE TO AUGURAL STANDARDS, DOLLARS DISCOUNTED AT 7%

	MY 1977- 2016	MY 2017	MY 2018	MY 2019	MY 2020	MY 2021	MY 2022	MY 2023	MY 2024	MY 2025	MY 2026	MY 2027	MY 2028	MY 2029	TOTAL
Passenger Cars	0.0	0.0	0.0	0.0	0.0	0.0	-0.1	-0.1	-0.1	-0.1	-0.1	-0.1	-0.1	-0.1	-1.0
Light Trucks	0.0	0.0	0.0	0.0	0.0	0.1	0.1	0.1	0.1	0.0	0.0	0.0	0.0	0.0	0.5
Total	0.0	0.0	0.0	0.0	0.0	0.0	0.0	-0.1	-0.1	-0.1	-0.1	-0.1	-0.1	-0.1	-0.5

Lifetime social safety costs are estimated to decrease generally by model year, with decreases associated with passenger cars generally offset partially by increases associated with light trucks. At a three-percent discount rate, decreases in lifetime social safety costs related to passenger cars are estimated to range from \$13 million for existing (MY 1977 through MY 2016) cars, to \$230 million for MY 2025 cars. The corresponding estimates at a seven-percent discount rate range from \$8 million to \$136 million. At a three-percent discount rate, impacts on lifetime social safety costs related to light trucks are estimated to range from a decrease of \$6 million for existing (MY 1977 through MY 2016) trucks to an increase of \$96 million for MY 2022 trucks. The corresponding estimates at a seven-percent discount rate range from \$3 million to \$65 million.

Consistent with the analysis of fatality impacts by model year in Table 10-5, decreases in lifetime social safety costs associated with mass changes are generally concentrated in MY 2023 through MY 2029 light-duty vehicles under Alternative #1. At a three-percent discount rate, 93 percent of the reduction in total lifetime costs (\$897 million out of \$962 million) is attributed to MY 2023 through MY 2029 light-duty vehicles; at a seven-percent discount rate, 97 percent of the reduction in total lifetime costs (\$500 million out of \$514 million) is attributed to MY 2023 through MY 2029 light-duty vehicles.

10.4.2 Sensitivity Analyses

Table 10-16 shows the table of principal findings and includes sampling-error confidence bounds for the five parameters used in the CAFE model. The confidence bounds represent the statistical uncertainty that is a consequence of having less than a census of data. NHTSA's 2011, 2012, and 2016 reports acknowledged another source of uncertainty - The baseline statistical model can be varied by choosing different control variables or redefining the vehicle classes or crash types, which for example, could produce different point estimates.

Beginning with the 2012 Kahane report, NHTSA has provided results of 11 plausible alternative models that serve as sensitivity tests of the baseline model. Each alternative model was tested or proposed by - Farmer (IIHS) or Green (UMTRI) in their peer reviews; Van Auken (DRI) in his public comments; or Wenzel in his parallel research for DOE. The 2012 Kahane and 2016 Puckett and Kindelberger reports provide further discussion of the models and the rationales behind them.

Alternative models use NHTSA's databases and regression-analysis approach but differ from the baseline model in one or more explanatory variables, assumptions, or data restrictions. NHTSA applied the 11 techniques to the latest databases to generate alternative CAFE model coefficients. The range of estimates produced by the sensitivity tests offers insight to the uncertainty inherent in the formulation of the models, subject to the caveat these 11 tests are, of course, not an exhaustive list of conceivable alternatives.

*** EO 12866 Review – Draft – Do Not Cite, Quote or Release During Review ***

The baseline and alternative results follow, ordered from the lowest to the highest estimated increase in societal risk per 100-pound reduction for cars weighing less than 3,201 pounds:

TABLE 10-12 - FATALITY INCREASE (%) PER 100-POUND MASS REDUCTION WHILE HOLDING FOOTPRINT* CONSTANT

		Cars < 3,201	Cars ≥ 3,201	CUVs & Minivans	LTVs† < 5,104	LTVs† ≥ 5,104
Baseline Estimate		1.2	0.42	-0.25	0.31	-0.61
95% confidence bounds (sampling error)	Lower:	-0.35	-0.67	-1.55	-0.51	-1.46
	Upper:	2.75	1.5	1.04	1.13	0.25
11 Alternative Models						
1. Without CY control variables		0.26	-0.07	-0.58	0.35	-0.24
2. By track width & wheelbase		0.66	0.54	-0.48	-0.44	-0.90
3. Track width/wheelbase w. stopped veh data		0.73	-0.02	-0.18	-0.77	-1.91
4. Without non-significant control variables		0.98	0.26	0.14	0.36	-0.50
5. With stopped-vehicle State data		1.32	-0.17	-0.08	0.21	-1.55
6. CUVs/minivans weighted by 2010 sales		1.2	0.42	-0.06	0.31	-0.61
7. Including muscle/police/AWD cars/big vans		1.56	1.01	-0.25	0.87	0.43
8. Limited to drivers with BAC=0		1.72	1.33	0.01	0.35	-0.74
9. Control for vehicle manufacturer		2.09	1.51	-0.01	1.12	0.3
10. Limited to good drivers‡		2.15	1.8	-0.33	0.4	-0.45
11. Control for vehicle manufacturer/nameplate		2.26	2.7	-0.55	1.13	0.50

*While holding track width and wheelbase constant (rather than footprint) in alternative model nos. 2 and 3.

†Excluding CUVs and minivans.

‡BAC=0, no drugs, valid license, at most 1 crash and 1 violation during the past 3 years.

For example, in cars weighing less than 3,201 pounds, the baseline estimate associates 100-pound mass reduction, while holding footprint constant, with a 1.56% increase in societal fatality

risk. The corresponding estimates for the 11 sensitivity tests range from a 0.26 to a 2.15% increase.

The sensitivity tests illustrate both the fragility and the robustness of baseline estimates. On the one hand, the variation among NHTSA's coefficients is quite large relative to the baseline estimate - In the preceding example of cars < 3,201 pounds, the estimated coefficients range from almost zero to almost double the baseline estimate. This result underscores the key relationship that the societal effect of mass reduction is small and, as Wenzel has said, it "is overwhelmed by other known vehicle, driver, and crash factors."⁷⁹⁰ In other words, varying how to model some of these other vehicle, driver, and crash factors, which is exactly what sensitivity tests do, can appreciably change the estimate of the societal effect of mass reduction.

On the other hand, variations are not particularly large in absolute terms. The ranges of alternative estimates are generally in line with the sampling-error confidence bounds for the baseline estimates. Generally, in alternative models as in the baseline models, mass reduction tends to be relatively more harmful in the lighter vehicles and more beneficial in the heavier vehicles, just as they are in the central analysis. In all models, the point estimate of NHTSA's coefficient is positive for the lightest vehicle class, cars < 3,201 pounds. In nine out of 11 models, the point estimate is negative for CUVs and minivans, and in eight out of 11 models the point estimate is negative for LTVs \geq 5,014 pounds.

10.4.3 Fleet Simulation Model

NHTSA has traditionally used real world crash data as the basis for projecting the future safety implications for regulatory changes. However, because lightweight vehicle designs are introducing fundamental changes to the structure of the vehicle, there is some concern that historical safety trends may not apply. To address this concern, NHTSA developed an approach to utilize lightweight vehicle designs to evaluate safety in a subset of real-world representative crashes. The methodology focused on frontal crashes because of the availability of existing vehicle and occupant restraint models. Representative crashes were simulated between baseline and lightweight vehicles against a range of vehicles and roadside objects using two different size belted driver occupants (adult male and small female) only. No passenger(s) or unbelted driver occupants were considered in this fleet simulation. The occupant injury risk from each simulation was calculated and summed to obtain combined occupant injury risk. The combined occupant injury risk was weighted according to the frequency of real world occurrences to develop overall societal risk for baseline and light-weighted vehicles. Note - The generic restraint system developed and used in the baseline occupant simulations was also used in the light-weighted vehicle occupant simulations as the purpose of this fleet simulation was to understand changes in societal injury risks because of mass reduction for different classes of

⁷⁹⁰ Wenzel, T. (2011). Assessment of NHTSA's Report "Relationships Between Fatality Risk, Mass, and Footprint in Model Year 2000-2007 Passenger Cars and LTVs." (Docket No. NHTSA-2010-0152-0026). Berkeley, CA - Lawrence Berkeley National Laboratory, p.iv.

*** EO 12866 Review – Draft – Do Not Cite, Quote or Release During Review ***

vehicles in frontal crashes. No modifications to the restraint systems were made for light-weighted vehicle occupant simulations. Any modifications to restraint systems to improve occupant injury risks or societal injury risks in the light-weighted vehicle, would have conflated results without identifying effects of mass reduction only. The following sections provide an overview of the fleet simulation study:

NHTSA contracted with George Washington University to develop a fleet simulation model⁷⁹¹ to study the impact and relationship of light-weighted vehicle design with injuries and fatalities. In this study, there were eight vehicles as follows:

- 2001 model year Ford Taurus finite element model baseline and two simple design variants included a 25% lighter vehicle while maintaining the same vehicle front end stiffness and 25% overall stiffer vehicle while maintaining the same overall vehicle mass.⁷⁹²
- 2011 model year Honda Accord finite element baseline vehicle and its 20% light-weight vehicle designed by Electricore. (This mass reduction study was sponsored by NHTSA).⁷⁹³
- 2009/2010 model year Toyota Venza finite element baseline vehicle and two design variants included a 20% light-weight vehicle model (2010 Venza) (Low option mass reduction vehicle funded by EPA and International Council on Clean Transportation (ICCT)) and a 35% light-weight vehicle (2009 Venza) (High option mass reduction vehicle funded by California Air Resources Board).⁷⁹⁴

Light weight vehicles were designed to have similar vehicle crash pulses as baseline vehicles. More than 440 vehicle crash simulations were conducted for the range of crash speeds and crash configurations to generate crash pulse and intrusion data points shown in Figure 10-1. The crash pulse data and intrusion data points will be used as inputs in the occupant simulation models.

⁷⁹¹ Samaha, R. R., Prasad, P., Marzougui, D., Cui, C., Digges, K., Summers, S., Patel S., Zhao, L., & Barsan-Anelli, A. (2014, August). Methodology for evaluating fleet protection of new vehicle designs - Application to lightweight vehicle designs. (Report No. DOT HS 812 051A). Washington, DC - National Highway Traffic Safety Administration.

⁷⁹² Samaha, R. R., Prasad, P., Marzougui, D., Cui, C., Digges, K., Summers, S., Patel, S., Zhao, L., & Barsan-Anelli, A. (2014, August). Methodology for evaluating fleet protection of new vehicle designs - Application to lightweight vehicle designs, appendices. (Report No. DOT HS 812 051B). Washington, DC - National Highway Traffic Safety Administration.

⁷⁹³ Singh, H., Kan, C-D., Marzougui, D., & Quong, S. (2016, February). Update to future midsize lightweight vehicle findings in response to manufacturer review and IIHS small-overlap testing (Report No. DOT HS 812 237). Washington, DC - National Highway Traffic Safety Administration.

⁷⁹⁴ U.S. Environmental Protection Agency (2012, August). Light-Duty Vehicle Mass Reduction and Cost Analysis — Midsize Crossover Utility Vehicle (Report No. EPA-420-R-12-026).

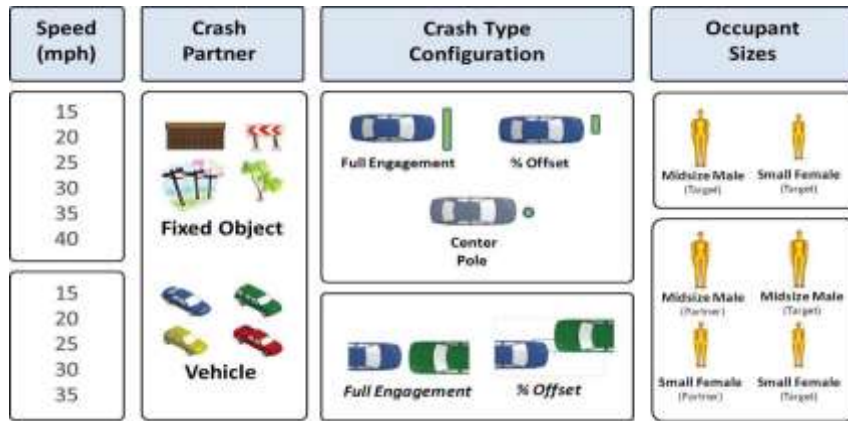









FIGURE 10-1 - VEHICLE CRASH SIMULATIONS

For vehicle-to-vehicle impact simulations, four finite element models were chosen to represent the fleet as shown in Table 10-17. The partner vehicle models were selected to represent a range of vehicle types and weights. It was assumed vehicle models would reflect the crash response for all vehicles of the same type, e.g. mid-size car. Only the safety or injury risk for the driver in the target vehicle and in the partner vehicle were evaluated in this study.

TABLE 10-13 - BASE VEHICLE MODELS USED IN THE FLEET SIMULATION STUDY

https://www.nhtsa.gov/crash-simulation-vehicle-models#12101		FE Weight / No. Parts /Elements	
Taurus (MY2000 – 2007)			1505 kg / 802 / 973,351
Yaris (MY2005 – 2013)			1100 kg / 917 / 1,514,068
Explorer (MY2002 – 2005)			2025 kg / 923 / 714,205
Silverado (MY2007 – 2013)			2270 kg / 719 / 963,482

As noted, vehicle simulations generated vehicle deformations and acceleration responses utilized to drive occupant restraint simulations and predict the risk of injury to the head, neck, chest, and lower extremities. In all, more than 1,520 occupant restraint simulations were conducted to evaluate the risk of injury for mid-size male and small female drivers.

The computed societal injury risk (SIR) for a target vehicle v in frontal crashes is an aggregate of individual serious crash injury risks weighted by real-world frequency of occurrence (v) of a frontal crash incident. A crash incident corresponds to a crash with different partners (Npartner) at a given impact speed (Pspeed), for a given driver occupant size (Loccsize), in the target or partner vehicle (T/P), in a given crash configuration (Mconfig), and in a single- or two-vehicle crash (Kevent). CIR (v) represents the combined injury risk (by body region) in a single crash incident. (v) designates the weighting factor, i.e., percent of occurrence, derived from National Automotive Sampling System Crashworthiness Data System (NASS CDS) for the crash incident. A driver age group of 16 to 50 years old was chosen to provide a population with a similar, i.e., more consistent, injury tolerance.

EQUATION 10-2 - SOCIETAL INJURY RISK

$$SIR_{frontal}(v) = \sum_{k=1}^{Kevent} \sum_{l=1}^{Loccsize} \sum_{m=1}^{Mconfig} \sum_{n=0}^{Npartner} \sum_{o=1}^{T/P} \sum_{p=1}^{Pspeed} w_{klmnop}(v) * CIR_{klmnop}(v)$$

Figure 10-2 shows how change in societal risk is computed.

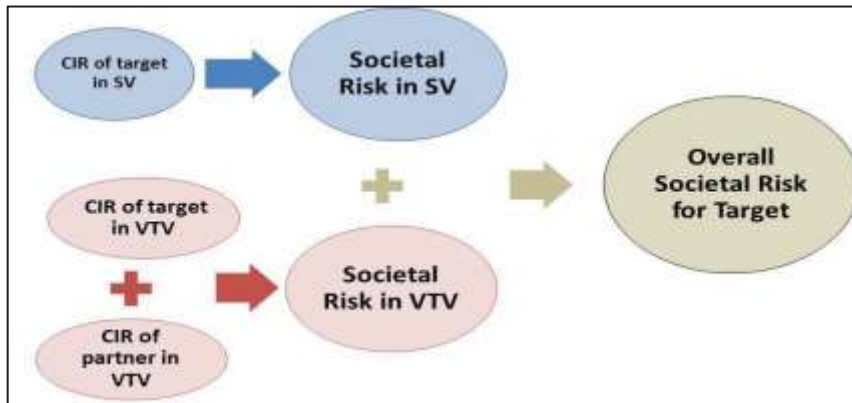

FIGURE 10-2 - DIAGRAM OF COMPUTATION FOR OVERALL CHANGE IN SOCIETAL RISK

The fleet simulation was performed using the best available engineering models, with base vehicle restraint and airbag settings, to estimate societal risks of future lightweight vehicles. The range of the predicted risks for the baseline vehicles is from 1.25% to 1.56%, with an average of 1.39%, for the NASS frontal crashes that were simulated. The change in driver injury risk between the baseline and light-weighted vehicles will provide insight into the estimate of modification needed in the restraint and airbag systems of lightweight vehicles. If the difference

*** EO 12866 Review – Draft – Do Not Cite, Quote or Release During Review ***

extends beyond the expected baseline vehicle restraint and airbag capability, then adjustments to the structural designs would be needed. Results from the fleet simulation study show the trend of increased societal injury risk for light-weighted vehicle designs, as compared to their baselines, occurs for both single vehicle and two-vehicle crashes. Results are listed in Table 10-14.

In general, the societal injury risk in the frontal crash simulation associated with the small size driver is elevated when compared to that of the mid-size driver. However, both occupant sizes had reasonable injury risk in the simulated impact configurations representative of the regulatory and consumer information testing. NHTSA examined three methods for combining injuries with different body regions. One observation was the baseline mid-size CUV model was more sensitive to leg injuries.

TABLE 10-14 - OVERALL SOCIETAL RISK CALCULATION RESULTS FOR MODEL RUNS, WITH BASE VEHICLE RESTRAINT AND AIRBAG SETTINGS BEING THE SAME FOR ALL VEHICLES, IN FRONTAL CRASH ONLY

Target Vehicle	Passenger Car Baseline	Passenger Car LW	CUV Baseline	CUV Low Option	CUV High Option
Weight (lbs)	3681	2964	3980	3313	2537
reduction		716		668	1444
% mass reduction		19%		17%	36%
Societal Risk I	1.56%	1.73%	1.36%	1.46%	1.57%
Delta Increase		0.17%		0.10%	0.21%
Societal Risk II	1.43%	1.57%	1.14%	1.20%	1.30%
Delta Increase		0.14%		0.06%	0.16%
Societal Risk IIP	1.44%	1.59%			
Delta Increase		0.15%			
Societal Risk I - Target + Partner Combined AIS3+ risk of Head, Neck, Chest & Femur Societal Risk II - Target + Partner Combined AIS3+ risk of Head, Neck, and Chest Societal Risk IIP - Target + Partner Combined AIS3+ risk of Head, Neck, and Chest with A-Pillar Intrusion Penalty					

This study only looked at lightweight designs for a midsize sedan and a mid-size CUV and did not examine safety implications for heavier vehicles. The study was also limited to only frontal crash configurations and considered just mid-size CUVs whereas the statistical regression model considered all CUVs and all crash modes.

*** EO 12866 Review – Draft – Do Not Cite, Quote or Release During Review ***

The change in the safety risk from the MY 2010 fleet simulation study was directionally consistent with results for passenger cars from NHTSA 2012 regression analysis study,⁷⁹⁵ which covered data for MY 2000-MY 2007. The NHTSA 2012 regression analysis study was updated in 2016 to reflect newer MY 2003 to MY 2010. Comparing the fleet simulation societal risk to the 2016 update of the NHTSA 2012 regression analysis and the updated analysis used in this NPRM, the risk assessment from the fleet simulation is similarly directionally consistent with the passenger car risk assessment from the regression analysis. As noted, fleet simulations were performed only in frontal crash mode and did not consider other crash modes including rollover crashes.⁷⁹⁶

This fleet simulation study does not provide information that can be used to modify coefficients derived for the NPRM regression analysis because of the restricted types of crashes⁷⁹⁷ and vehicle designs. As explained earlier, the fleet simulation study assumed restraint equipment to be as in the baseline model, in which restraints/airbags are not redesigned to be optimal with light-weighting.

10.4.4 Impact of Vehicle Scrappage and Sales Response on Fatalities

Previous versions of the CAFE model, and the accompanying regulatory analyses relying on it, did not carry a representation of the full on-road vehicle population, only those vehicles from model years regulated under proposed (or final) standards. The omission of an on-road fleet implicitly assumed the population of vehicles registered at the time a set of CAFE standards is promulgated is not affected by those standards. However, there are several mechanisms by which CAFE standards can affect the existing vehicle population. The most significant of these is deferred retirement of older vehicles. CAFE standards force manufacturers to apply fuel saving technologies to offered vehicles and then pass along the cost of those technologies (to the extent possible) to buyers of new vehicles. These price increases affect the length of loan terms and the desired length of ownership for new vehicle buyers and can discourage some buyers on the margin from buying a new vehicle in a given year. To the extent new vehicle purchases offset pending vehicle retirements, delaying new purchases in favor of continuing to use an aging vehicle affects the overall safety of the on-road fleet even if the vehicle whose retirement was delayed was not directly subject to a binding CAFE standard in the model year during its production.

The sales response in the CAFE model acts to modify new vehicle sales in two ways -

⁷⁹⁵ The 2012 Kahane study considered only fatalities, whereas, the fleet simulation study considered severe (AIS 3+) injuries and fatalities (DOT HS 811 665).

⁷⁹⁶ The risk assessment for CUV in the regression model combined CUVs and minivans in all crash modes and included belted and unbelted occupants.

⁷⁹⁷ The fleet simulation considered only frontal crashes.

*** EO 12866 Review – Draft – Do Not Cite, Quote or Release During Review ***

1. Changes in new vehicle prices either increase or decrease total sales (passenger cars and light trucks combined) each year in the context of forecasted macroeconomic conditions.
2. Changes in new vehicle attributes and fuel prices influence the share of new vehicles sold that are light trucks, and therefore also passenger cars.

These two responses change the total number of new vehicles sold in each model year across regulatory alternatives and the relative proportion of new vehicles that are passenger cars and light trucks. This response has two effects on safety. The first response slows the rate at which new vehicles, and their associated safety improvements, enter the on-road population. The second response influences the mix of vehicles on the road – with more stringent CAFE standards leading to a higher share of light trucks sold in the new vehicle market, assuming all else is equal. Light trucks have higher rates of fatal crashes when interacting with passenger cars and, as earlier sections discussed, different directional responses to mass reduction technology based on the existing mass and body style of the vehicle.

The sales response and scrappage response influence safety outcomes through the same basic mechanism, fleet turnover. In the case of the scrappage response, delaying fleet turnover keeps drivers in older vehicles likely to be less safe than newer model year vehicles that could replace them. Similarly, delaying the sale of new vehicles can force households to keep older vehicles in use longer, reallocate VMT within their household fleet, and generally meet travel demand through the use of older, less safe vehicles. As an illustration, if we simplify by ignoring, that the share of new vehicles that are passenger cars changes with the stringency of the alternatives, simply changing the number of new vehicles between scenarios affects the mileage accumulation of the fleet and therefore all fleet level effects. Reducing the number of new vehicles sold, relative to a baseline forecasted value, reduces the size of the registered vehicle fleet that is able to service the underlying demand for travel.

Consider a simple analysis that shows sales effects operating on a micro-scale for a single household whose choices of whether to purchase a new vehicle is affected by vehicle price, as in Figure 10-3. Rectangles represent a single household's vehicle fleet subject to two different CAFE standard scenarios. For both scenarios, in Period 1, the household has three cars, aged 3, 5, and 8. In period 2, without changes to CAFE standards and therefore no related changes in vehicle sales prices, the household buys a new car and scraps the 8-year-old car (car 3); the other two cars in the fleet each get a year older. In the case where CAFE standards become more stringent causing vehicle sales prices to increase, this household chooses to delay buying a new car, and each of their three existing cars gets a year older. In both cases, the three vehicles in period 2 have to serve the family's travel demand.

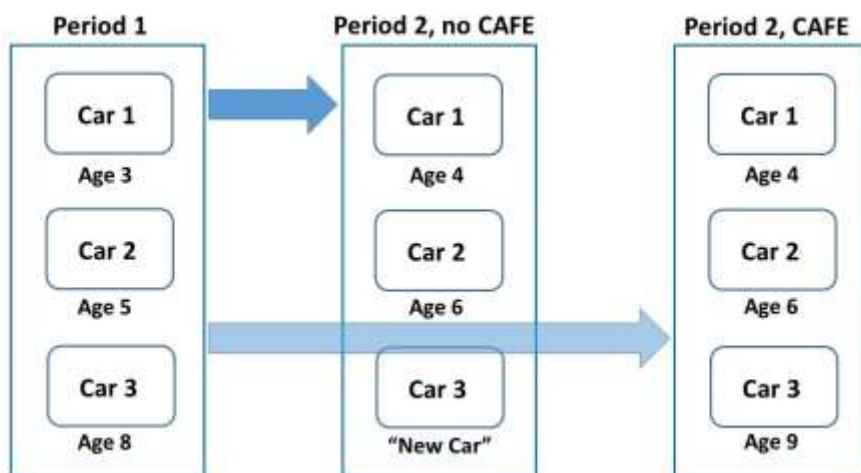

FIGURE 10-3 - HOUSEHOLD DECISIONS ABOUT FLEET MANAGEMENT

The scrappage effect is visible in the household’s vehicle fleet as it moves from period 1 to period 2 with changes in CAFE standards. In this case, Car 3 (now 9-years-old) remains in the household’s fleet to service demand for travel, when it would otherwise have been retired. While the scrappage effect can be symmetrical to the sales effect, it need not be. The “new car” in Figure 10-3 could be a new vehicle from the current model year or a used car that is of a newer vintage than the 8-year-old vehicle it replaces. The latter instance is an effect of scrappage decisions not directly affecting new vehicle sales. Eventually, new vehicles transition to the used car market, but that on average take several years, and the shift is slow. At the household level, the scrappage decision occurs in a single year, each year, for every vehicle in the fleet. To the extent CAFE standards affect new vehicle prices and fuel economies, relative to vehicles already owned, scrappage could accelerate or decelerate depending upon the direction (and magnitude) of the changes.

10.4.5 Safety Model

The analysis supporting the CAFE rule for MYs 2017 and beyond did not account for differences in exposure or inherent safety risk as vehicles aged throughout their useful lives. However, the relationship between vehicle age and fatality risk is an important one. In a 2013 Research Note,⁷⁹⁸ NHTSA’s National Center for Statistics and Analysis (NCSA) concluded a driver of a vehicle that is 4-7 years old is 10% more likely to be killed in a crash than the driver of a vehicle 0 – 3 years old, accounting for the other factors related to the crash. This trend continued for

⁷⁹⁸ “How Vehicle Age and Model Year Relate to Driver Injury Severity in Fatal Crashes,” DOT HS 811 825, NHTSA NCSA, August 2013.

older vehicles more generally, with a driver of a vehicle 18 years or older being 71% more likely to be killed in a crash than a driver in a new vehicle. While there are more registered vehicles that are 0 – 3 years old than there are 20 years or older (nearly three times as many) because most of the vehicles in earlier vintages are retired sooner, the average age of vehicles in the United States is 11.6 years old and has risen significantly in the past decade.⁷⁹⁹ This relationship reflects a general trend visible in the Fatality Analysis Reporting System (FARS) when looking at a series of calendar years - newer vintages are safer than older vintages, over time, at each age. This is likely because of advancements in safety technology, like side-impact airbags, electronic stability control, and (more recently) sophisticated crash avoidance systems starting to work their way into the vehicle population. In fact, the 2013 Research Note indicated that the percentage of occupants fatally injured in fatal crashes increased with vehicle age - from 27 percent for vehicles three or fewer years old, to 41 percent for vehicles 12-14 years old, to 50 percent for vehicles 18 or more years old.⁸⁰⁰

With an integrated fleet model now part of the analytical framework for CAFE analysis, any effects on fleet turnover (either from delayed vehicle retirement or deferred sales of new vehicles) will affect the distribution of both ages and model years present in the on-road fleet. Because each of these vintages carries with it inherent rates of fatal crashes, and newer vintages are generally safer than older ones, changing that distribution will change the total number of on-road fatalities under each regulatory alternative.

To estimate the empirical relationship between vehicle age, model year vintage, and fatalities, DOT conducted a statistical analysis linking data from the FARS database, a time series of Polk registration data to represent the on-road vehicle population, and assumed per-vehicle mileage accumulation rates (the derivation of which is discussed in detail in Chapter 7). These data were used to construct per-mile fatality rates that varied by vehicle vintage, accounting for the influence of vehicle age. However, unlike the NCSA study referenced above, any attempt to account for this relationship in the CAFE analysis faces two challenges. The first challenge is the CAFE model lacks the internal structure to account for other factors related to observed fatal crashes – for example, vehicle speed, seat belt use, drug use, or age of involved drivers or passengers. Vehicle interactions are simply not modeled at this level; the safety analysis in the CAFE model is statistical, using aggregate values to represent the totality of fleet interactions over time. The second challenge is perhaps the more significant of the two - the CAFE analysis is inherently forward-looking. To implement a statistical model analogous to the one developed by NCSA, the CAFE model would require forecasts of all factors considered in the NCSA model – about vehicle speeds in crashes, driver behavior, driver and passenger ages, vehicle vintages, and so on. In particular, the model would require distributions (joint distributions, in most cases)

⁷⁹⁹ Based on data acquired from Ward's Automotive.

⁸⁰⁰ [citation forthcoming] <https://crashstats.nhtsa.dot.gov/Api/Public/ViewPublication/812528>.

of these factors over a period of time spanning decades. Any such forecasts would be highly uncertain and would be likely to assume a continuation of current conditions.

Instead of trying to replicate the NCSA work at a similar level of detail, DOT conducted a simpler statistical analysis to separate the safety impact of the two factors the CAFE model explicitly accounts for - the distribution of vehicle ages in the fleet and the number of miles driven by those vehicles at each age. To accomplish this, DOT used data from the FARS database at a lower level of resolution; rather than looking at each crash and the specific factors that contributed to its occurrence, staff looked at the total number of fatal crashes involving light-duty vehicles over time with a focus on the influence of vehicle *age* and vehicle *vintage*. When considering the number of fatalities relative to the number of registered vehicles for a given model year (without regard to the passenger car/light-truck distinction, which has evolved over time and can create inconsistent comparisons), a somewhat noisy pattern develops. Using data from calendar year 1996 through 2015, some consistent stories develop. The points in Figure 10-4 represent the number of fatalities per registered vehicle with darker circles associated with increasingly current calendar years.

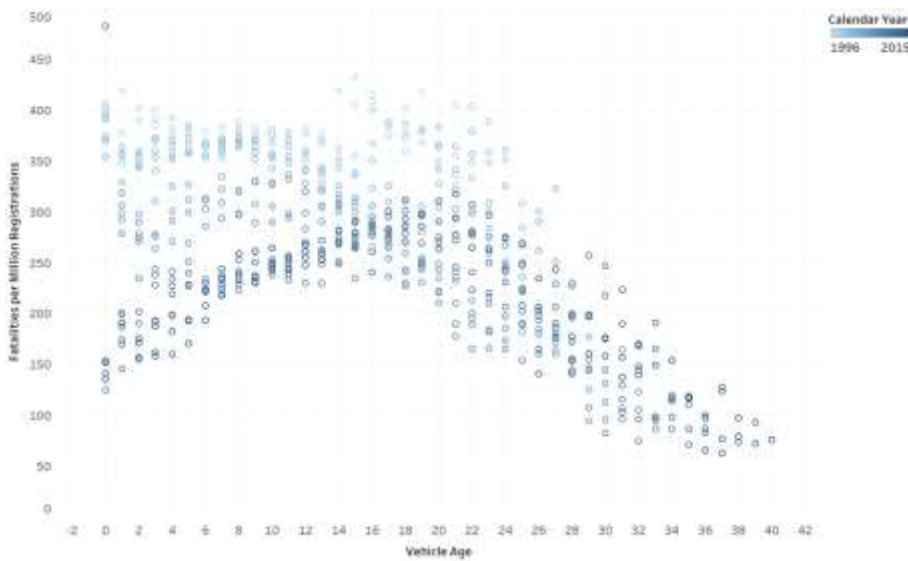

FIGURE 10-4 - FATALITIES PER MILLION REGISTERED VEHICLES, 1996 -2015

As shown in Figure 10-4, fatalities per registered vehicle have generally declined over time across all vehicle ages (the darker points representing newer vintages being closer to the x-axis)

and, across most recent calendar years, fatality rates (per registered vehicle) start out at a low point, rise through age 15 or so, then decline through age 30 (at which point little of the initial model year cohort is still registered). While this pattern is evident in the registration data, it is magnified by imposing a mileage accumulation schedule on the registered population and examining fatalities per billion miles of VMT.

The mileage accumulation schedule used in this analysis was developed using odometer readings of vehicles aged 0 – 15 years in calendar year 2015. The years spanned by the FARS database cover all model years from calendar year 1996 through 2015. Given that there is a significant number of years between the older vehicles in the 1996 CY data and the most recent model years in the odometer data that informed the mileage accumulation schedules, staff applied an elasticity of -0.20 to the change in the average cost per mile of vehicles over their lives. While the older vehicles had lower fuel economies, which would be associated with higher per-mile driving costs, they also (mostly) faced lower fuel prices. This adjustment increased the mileage accumulation for older vehicles, but not by large amounts. Because the CAFE model uses the mileage accumulation schedule and applies it to all vehicles in the fleet, it is necessary to use the same schedule to estimate per-mile fatality rates in the statistical analysis – even if the schedule is based on vehicles that look different than the oldest vehicles in the FARS dataset.

When the per-vehicle fatality rates are converted into per-mile fatality rates, the pattern observed in the registration comparison becomes clearer. As Figure 10-5 shows, the trend present in the fatality data on a per-registration basis, is even clearer on a per-mile basis - newer vintages are safer than older vintages, at each age, over time.

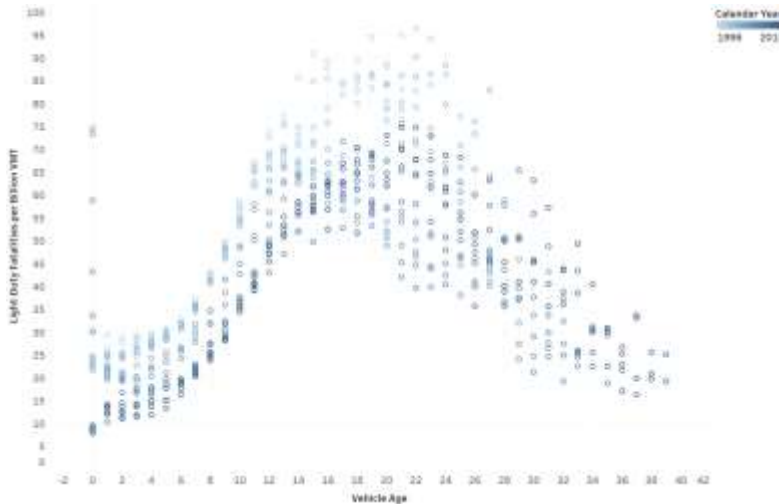

FIGURE 10-5 - FATALITIES PER BILLION VMT, 1996 - 2015

The shape of the curve in Figure 10-5 suggests a polynomial relationship between fatality rate and vehicle age, so DOT’s statistical model is based on that structure. The final model is a weighted quartic polynomial regression (by number of registered vehicles) on vehicle age with fixed effects for the model years present in the dataset.⁸⁰¹

EQUATION 10-3 - FATALITIES PER BILLION MILES

$$\text{Fatalities per billion miles} = \beta_0 * \text{Age} + \beta_1 * \text{Age}^2 + \beta_2 * \text{Age}^3 + \beta_3 * \text{Age}^4 + \sum \beta_i * \text{MY}_i,$$

for $i = \{1976, 1977, \dots, 2014\}$.

The coefficient estimates and model summary are in Table 10-15.

TABLE 10-15 - DESCRIPTION OF STATISTICAL MODEL

Coefficients:	Estimate	Std. Error
(Intercept)	28.59***	3.067
Vehicle Age	-3.63***	0.2298
Age ²	0.76***	0.03016
Age ³	-0.04***	0.001453
Age ⁴	0.0005***	2.25E-05
MY1976	-0.72	3.621
MY1977	-2.24	3.425
MY1978	-1.53	3.324
MY1979	-4.46	3.268
MY1980	-3.78	3.437
MY1981	-2.88	3.38
MY1982	-4.42	3.329
MY1983	-4.93	3.236
MY1984	-4.71	3.142
MY1985	-4.78	3.113
MY1986	-5.54.	3.092
MY1987	-5.86.	3.086
MY1988	-4.37	3.079
MY1989	-4.78	3.074
MY1990	-5.17.	3.077
MY1991	-5.84.	3.072
MY1992	-7.26*	3.07
MY1993	-7.92**	3.062
MY1994	-9.69**	3.058

⁸⁰¹ Note - The dataset included MY 1975, but that fixed effect is excluded from the set. The constant term acts as the fixed effect for 1975; all others are relative to that one.

*** EO 12866 Review – Draft – Do Not Cite, Quote or Release During Review ***

MY1995	-10.61***	3.053
MY1996	-12.07***	3.06
MY1997	-12.8***	3.056
MY.1998	-13.88***	3.057
MY1999	-14.91***	3.055
MY2000	-15.68***	3.054
MY2001	-16.33***	3.059
MY2002	-17.1***	3.06
MY2003	-17.7***	3.065
MY2004	-18.24***	3.069
MY2005	-18.91***	3.074
MY2006	-19.24***	3.083
MY2007	-19.85***	3.09
MY2008	-20.09***	3.108
MY2009	-20.11***	3.17
MY2010	-20.5***	3.172
MY2011	-20.74***	3.196
MY2012	-20.77***	3.229
MY2013	-21.49***	3.294
MY2014	-21.98***	3.528
Degrees of Freedom	565	
R-Squared	0.9459	
F-Statistic	248.1	
Residual Std. Error	6.949	

Significance codes - *** = 0; ** = 0.001; * = 0.05; = .01

This function is now embedded in the CAFE model, so the combination of VMT per vehicle and the distribution of ages and model years present in the on-road fleet determine the number of fatalities in a given calendar year. The model reproduces the observed fatalities of a given model year, at each age, reasonably well with more recent model years (to which the VMT schedule is a better match) estimated with smaller errors.

While the final specification was not the only one considered, the fact this model was intended to live inside the CAFE model to dynamically estimate fatalities for a dynamically changing on-road vehicle population was a constraining factor.

10.4.6 Predicting Future Safety Trends

The base model predicts a net increase in fatalities due primarily to slower adoption of safer vehicles and added driving because of less costly vehicle operating costs. In earlier calendar years, the improvement in safety of the on-road fleet produces a net reduction in fatalities, but

from the mid-2020s forward, the baseline model predicts no further increase in safety, and the added risk from more VMT and older vehicles produces a net increase in fatalities. This model thus reflects a conservative limitation; it implicitly assumes the trend toward increasingly safe vehicles that has been apparent for the past 3 decades will flatten in mid-2020s. The agency does not assert this is the most likely case. In fact, the development of advanced crash avoidance technologies in recent years indicates some level of safety improvement is almost certain to occur. The difficulty is for most of these technologies, their effectiveness against fatalities and the pace of their adoption are highly uncertain. Moreover, autonomous vehicles offer the possibility of significantly reducing or eventually even eliminating the effect of human error in crash causation, a contributing factor in roughly 94% of all crashes. This conservative assumption may cause the NPRM to understate the beneficial effect of proposed standards on improving (reducing) the number of fatalities.

Advanced technologies that are currently deployed or in development include:

Forward Collision Warning (FCW) systems are intended to passively assist the driver in avoiding or mitigating the impact of rear-end collisions (i.e., a vehicle striking the rear portion of a vehicle traveling in the same direction directly in front of it). FCW uses forward-looking vehicle detection capability, such as RADAR, LIDAR (laser), camera, etc., to detect other vehicles ahead and use the information from these sensors to warn the driver and to prevent crashes. FCW systems provide an audible, visual, or haptic warning, or any combination thereof, to alert the driver of an FCW-equipped vehicle of a potential collision with another vehicle or vehicles in the anticipated forward pathway of the vehicle.

Crash Imminent Braking (CIB) systems are intended to actively assist the driver by mitigating the impact of rear-end collisions. These safety systems have forward-looking vehicle detection capability provided by sensing technologies such as RADAR, LIDAR, video camera, etc. CIB systems mitigate crash severity by automatically applying the vehicle's brakes shortly before the expected impact (i.e., without requiring the driver to apply force to the brake pedal).

Dynamic Brake Support (DBS) is a technology that actively increases the amount of braking provided to the driver during a rear-end crash avoidance maneuver. If the driver has applied force to the brake pedal, DBS uses forward-looking sensor data provided by technologies such as RADAR, LIDAR, video cameras, etc. to assess the potential for a rear-end crash. Should DBS ascertain a crash is likely (i.e., the sensor data indicate the driver has not applied enough braking to avoid the crash), DBS automatically intervenes. Although the manner in which DBS has been implemented differs among vehicle manufacturers, the objective of the interventions is largely the same - to supplement the driver's commanded brake input by increasing the output of the foundation brake system. In some situations, the increased braking provided by DBS may allow the driver to avoid a crash. In other cases, DBS interventions mitigate crash severity.

*** EO 12866 Review – Draft – Do Not Cite, Quote or Release During Review ***

Pedestrian AEB (PAEB) systems provide automatic braking for vehicles when pedestrians are in the forward path of travel and the driver has taken insufficient action to avoid an imminent crash. Like CIB, PAEB safety systems use information from forward-looking sensors to automatically apply or supplement the brakes in certain driving situations in which the system determines a pedestrian is in imminent danger of being hit by the vehicle. Many PAEB systems use the same sensors and technologies used by CIB and DBS.

Rear Automatic Braking feature means installed vehicle equipment that has the ability to sense the presence of objects behind a reversing vehicle, alert the driver of the presence of the object(s) via auditory and visual alerts, and automatically engage the available braking system(s) to stop the vehicle.

Semi-automatic Headlamp Beam Switching device provides either automatic or manual control of headlamp beam switching at the option of the driver. When the control is automatic, headlamps switch from the upper beam to the lower beam when illuminated by headlamps on an approaching vehicle and switch back to the upper beam when the road ahead is dark. When the control is manual, the driver may obtain either beam manually regardless of the conditions ahead of the vehicle.

Rear Turn Signal Lamp Color Turn signal lamps are the signaling element of a turn signal system, which indicates the intention to turn or change direction by giving a flashing light on the side toward which the turn will be made. FMVSS No. 108 permits a rear turn signal lamp color of amber or red.

Lane Departure Warning (LDW) system is a driver assistance system that monitors lane markings on the road and alerts the driver when their vehicle is about to drift beyond a delineated edge line of their current travel lane.

Blind Spot Detection (BSD) systems uses digital camera imaging technology or radar sensor technology to detect one or more vehicles in either of the adjacent lanes that may not be apparent to the driver. The system warns the driver of an approaching vehicle's presence to help facilitate safe lane changes.

These technologies are either under development or are currently being offered, typically in luxury vehicles, as either optional or standard equipment.

To estimate baseline fatality rates in future years, NHTSA examined predicted results from a previous NCSA study⁸⁰² that measured the effect of known safety regulations on fatality rates. This study relied on statistical evaluations of the effectiveness of motor vehicle safety technologies based on real world performance in the on-road vehicle fleet to determine the effectiveness of each safety technology. These effectiveness rates were applied to existing

⁸⁰² Blincoe, L. and Shankar, U., "The Impact of Safety Standards and Behavioral Trends on Motor Vehicle Fatality Rates," National Highway Traffic Safety Administration, DOT HS 810 777, Washington, D.C., January, 2007.

fatality target populations and adjusted for current technology penetration in the on-road fleet, taking into account the retirement of existing vehicles and the pace of future penetration required to meet statutory compliance requirements, as well as adjustments for overlapping target populations. Based on these factors, as well as assumptions regarding future VMT, the study predicted future fatality levels and rates. Because the safety impact in the CAFE model independently predicts future VMT, the VMT growth rate was removed from the NCSA study to develop a prediction of vehicle fatality trends based only on the penetration pace of new safety technologies into the on-road fleet. These data were then normalized into relative safety factors with CY 2015 as the baseline (to match the baseline fatality year used in this CAFE analysis). These factors were then converted into equivalent fatality rates/100 million VMT by anchoring them to the 2015 fatality rate/100 million VMT published by NHTSA. Figure 10-6 below illustrates the modelling output and projected fatality trend from the analysis of the NCSA study, prior to adjustment to fatality rates/100 million VMT.

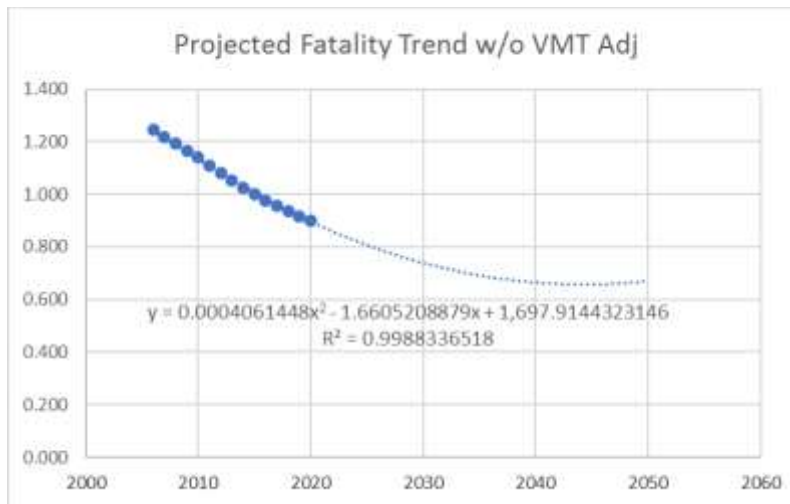

FIGURE 10-6 - PROJECTED FATALITY TREND WITHOUT VMT ADJUSTMENT

This model was based on inputs representing the impact of technology improvement through CY 2020. Projecting this trend beyond 2020 can be justified based on the continued transformation of the on-road fleet to 100% inclusion of the known safety technologies. Based on projections in the NCSA study, significant further technology penetration can be expected in the on-road fleet for side impact improvements (FMVSS 214), electronic stability control (FMVSS 126), upper interior head impact protection (FMVSS 301), tire pressure monitoring systems (FMVSS 138), ejection mitigation (FMVSS 226), and heavy truck stopping distance improvements (FMVSS

121). These technologies were estimated to be installed in only 40-70% of the on-road fleet as of CY2020, implying further safety improvement well beyond the 2020 calendar year.

The NCSA study focused on projections to reflect known technology adaptation requirements, but it was conducted prior to the 2008 recession, which disrupted the economy and changed travel patterns throughout the country. Thus, while the relative trends it predicts seem reasonable, they cannot account for the real-world disruption and recovery that occurred in the 2008-2015 timeframe. In addition, the NCSA study did not attempt to adjust for safety impacts that may have resulted from changes in the vehicle sales mix (vehicle types and sizes creating different interactions in crashes), in commuting patterns, or in shopping or socializing habits associated with internet access and use. To address this, the actual change in the fatality rate as measured by fatality counts and VMT estimates were examined. Figure 10-7 below illustrates the actual fatality rates measured from 2000 through 2016 and the modeled fatality rate trend based on these historical data.

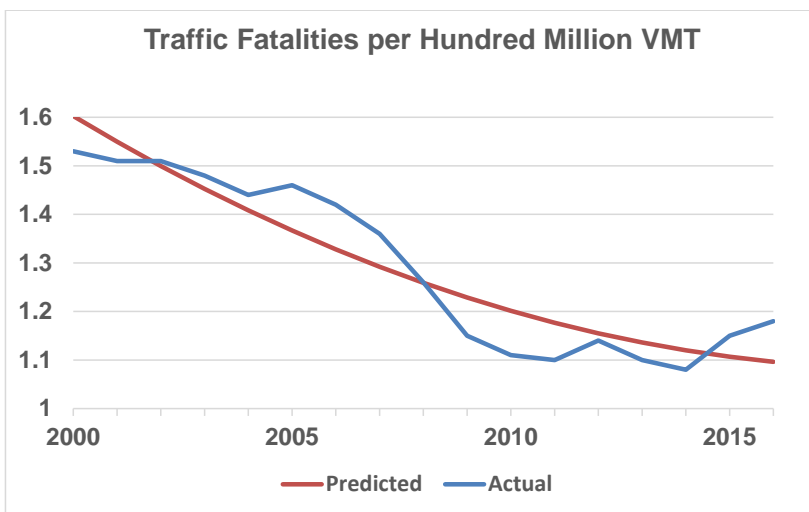

FIGURE 10-7 - TRAFFIC FATALITIES PER HUNDRED MILLION VMT

The effect of the recession and subsequent recovery can be seen in chaotic shift in the fatality rate trend starting in 2008. The generally gradual decline that had been occurring over the previous decade was interrupted by a slowdown in the rate of change followed by subsequent upward and downward shifts. More recently, the rate has begun to increase. These shifts reflect some combination of factors not captured in the NCSA analysis mentioned above. The significance of this is that although there was a steady increase in the penetration of safety technologies into the on-road fleet between 2008 and 2015, other unknown factors offset their

positive influence and eventually reversed the trend in vehicle safety rates. Because of the upward shift over the 2014-2015 period, this model, which does not reflect technology trend savings after 2015, will predict an upward shift of fatality rates after 2020.

Predicting future safety trends has significant uncertainty. Although further safety improvements are expected because of advanced safety technologies such as automatic braking and eventually, fully automated vehicles, the pace of development and extent of consumer acceptance of these improvements is uncertain. Thus, two imperfect models exist for predicting future safety trends. The NCSA model reflects the expected trend from required technologies and indicates continued improvement well beyond the 2020 timeframe, which is when the historical fatality rate based model breaks down. By contrast, the historical fatality rate model reflects shifts in safety not captured by the NCSA model, but gives arguably implausible results after 2020. It essentially represents a scenario in which economic, market, or behavioral factors minimize or offset much of the potential impact of future safety technology.

For the NPRM, the analysis examines a scenario projecting safety improvements beyond 2015 using a simple average of the NCSA and historical fatality rate models, accepting each as an illustration of different and conflicting possible future scenarios. As both models eventually curve up because of their quadratic form, each models' results are flattened at the point where they begin to trend upward. This occurs in 2045 for the NCSA model and in 2021 for the historical model. The results are shown in Figure 10-8 below. The results indicate roughly a 19% reduction in fatality rates between 2015 and 2050. This is a slower pace than what has historically occurred over the past several decades, but the biggest influence on historical rates was significant improvement in safety belt use, which was below 10% in 1960 and had risen to roughly 70% by 2000, and is now more than 90%. Because belt use is now above 90%, further such improvements are unlikely unless they come from new technologies.

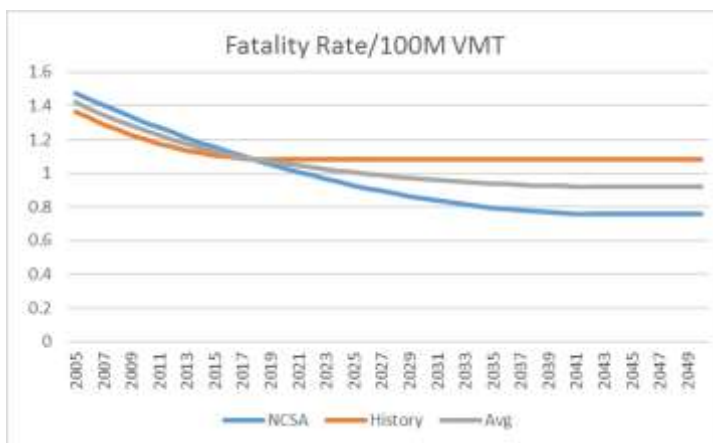

FIGURE 10-8 - FATALITY RATE PER 100M VEHICLE MILE TRAVELED

A difficulty with these trend models is they are based on calendar year predictions, which are derived from the full on-road vehicle fleet rather than the model year fleet, which is the basis for calculations in the CAFE model. As such they are useful primarily as indicators that vehicle safety has steadily improved over the past several decades, and given the advanced safety technologies under current development, some continuation of improvement in MY vehicle safety is expected over the near and mid-term future. To account for this, a model year safety trend continuing through about 2035 (Figure 10-9) was approximated. For this trend, actual data from FARS was used to calculate the change in fatality rates through 2007. The recession, which struck our economy in 2008, distorted normal behavioral patterns and affected both VMT and the mix of drivers and type of driving to an extent that recession-era data may not give an accurate picture of the safety trends inherent in the vehicles themselves. Therefore, beginning in 2008, a trend for safety improvement through about MY 2035 was approximated to reflect the continued effect of improved safety technologies such as advanced automatic braking, which manufacturers have announced will be in all new vehicles by MY 2022. We recognize this is only an estimate, and actual MY trends could be above or below the estimated line. The alternate trends were examined in the sensitivity analysis, and the NPRM seeks comment on the best way to address future safety trends.

Although the analysis projects vehicles will continue to become safer going forward to about 2035, corresponding cost information for technologies enabling this improvement is not available. In a standard elasticity model, sales impacts are a function of the percent change in vehicle price. Hypothetically, increasing the base price for added safety technologies would decrease the impact of higher prices due to impacts of CAFE standards on vehicle sales. The percentage change in baseline price would decrease, which would mean a lower elasticity effect, which would mean a lower impact on sales. NHTSA will consider possible ways to address this issue before the final rule, and request comments on the need and/or practicability for such an adjustment, as well as any data and other relevant information that could support such an analysis of these costs, as well as the future pace of technological adoption within the vehicle fleet.

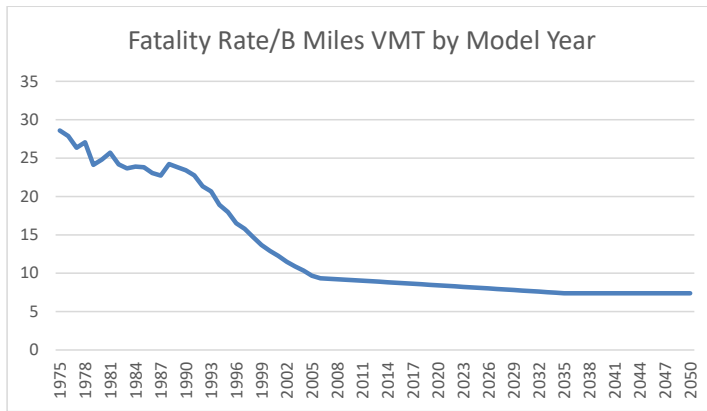

FIGURE 10-9 - FATALITY RATE – B MILES VMT BY MODEL YEAR

10.4.7 Adjusting for Behavioral Impacts

The influence of delayed purchases of new vehicles is estimated to have the most significant effect on safety imposed by CAFE standards. Because of a combination of safety regulations and voluntary safety improvements, passenger vehicles have become safer over time. Compared to prior decades, fatality rates have declined significantly because of technological improvements, as well as behavioral shifts, such as increased seat belt use. As these safer vehicles replace older less safe vehicles in the fleet, the on-road fleet is replaced with vehicles reflecting the improved fatality rates of newer, safer vehicles. However, fatality rates associated with different model year vehicles are influenced by the vehicle itself and by driver behavior. Over time, used vehicles are purchased by drivers in different demographic circumstances who also tend to have different behavioral characteristics. Data from the Fatality Analysis Reporting System (FARS) indicate that drivers of older vehicles, on average, tend to have lower belt use rates, are more likely to drive inebriated, and are more likely to drive over the speed limit. Additionally, older vehicles are more likely to be driven on rural roadways, which typically have higher speeds and produce more serious crashes. Figure 10-10, Figure 10-11, Figure 10-12, and Figure 10-13 below illustrate these relationships.⁸⁰³

⁸⁰³ Based on analysis of 2012-2016 FARS databases.

*** EO 12866 Review – Draft – Do Not Cite, Quote or Release During Review ***

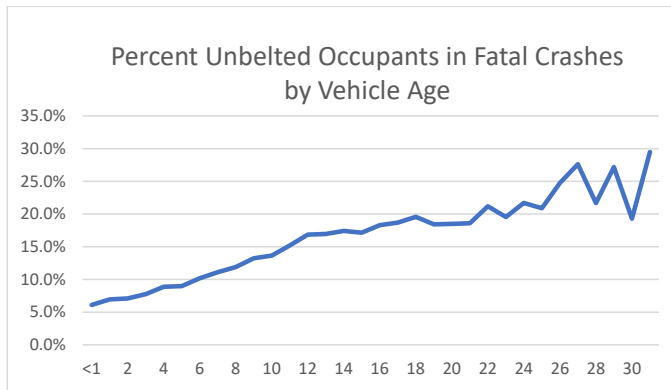

FIGURE 10-10 - PERCENT UNBELTED OCCUPANTS IN FATAL CRASHES

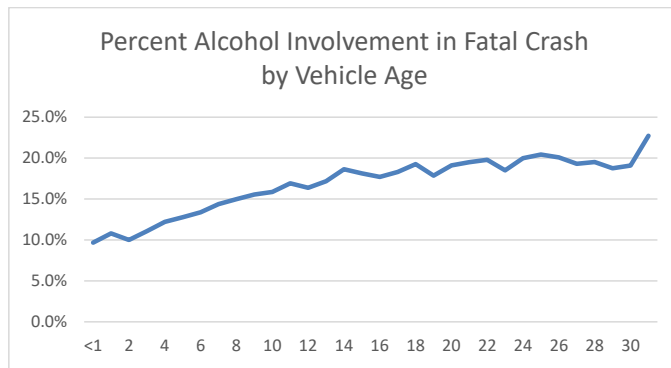

FIGURE 10-11 - PERCENT ALCOHOL INVOLVEMENT IN FATAL CRASHES

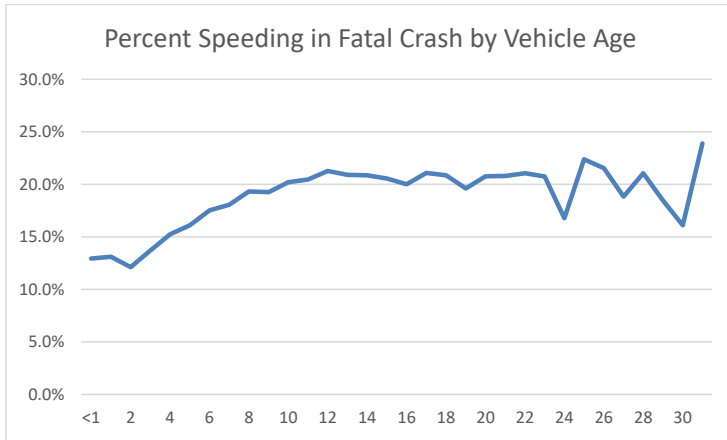

FIGURE 10-12 - PERCENT SPEEDING IN FATAL CRASH

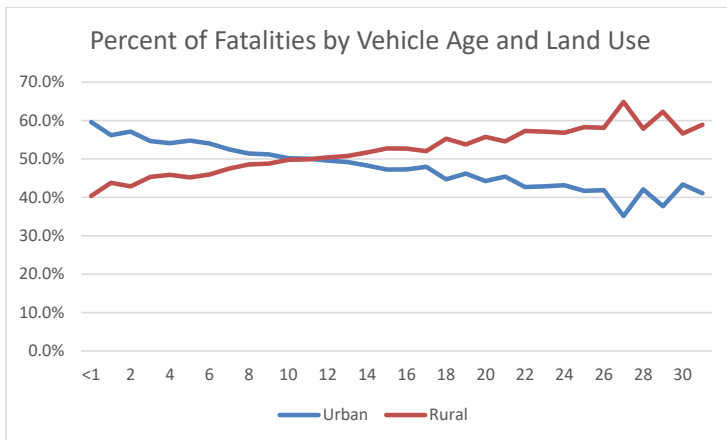

FIGURE 10-13 - PERCENT FATALITIES BY VEHICLE AGE AND LAND USE

The behavior being modelled and ascribed to CAFE involves decisions by drivers who are contemplating buying a new vehicle, and the purchase of a newer vehicle will not in itself cause those drivers to suddenly stop wearing seat belts, speed, drive under the influence, or shift driving to different land use areas. The goal of this analysis is to measure the effect of different vehicle designs that change by model year. The modelling process for estimating safety essentially involves substituting fatality rates of older MY vehicles for improved rates that would have been experienced with a newer vehicle. Therefore, it is important to control for behavioral aspects associated with vehicle age so only vehicle design differences are reflected in the

estimate of safety impacts. To address this, the CAFE safety model was run to control for vehicle age. That is, it does not reflect a decision to replace an older model year vehicle that is, for example, 10 years old with a new vehicle. Rather, it reflects the difference in the average fatality rate of each model year across its entire lifespan. This will account for most of the difference because of vehicle age, but it may still reflect a bias caused by the upward trend in societal seat belt use over time. Because of this secular trend, each subsequent model year's useful life will occur under increasingly higher average seat belt use rates. This could cause some level of behavioral safety improvement to be ascribed to the model year instead of the driver cohort. However, it is difficult to separate this effect from the belt use impacts of changing driver cohorts as vehicles age.

Glassbrenner⁸⁰⁴ analyzed the effect of improved safety in newer vehicles for model years 2001 through 2008. She developed several statistical regression models that specifically controlled for most behavioral factors to isolate model year vehicle characteristics. However, her study did not specifically report the change in MY fatality rates – rather, she reported total fatalities that could have been saved in a baseline year (2008) had all vehicles in the on-road fleet had the same safety features as the MY 2001 through MY 2008 vehicles. This study potentially provides a basis for comparison with results of the CAFE safety estimates. To make this comparison, the CY 2008 passenger car and light truck fatalities total from FARS were modified by subtracting the values found in Figure 7-17 of her study. This gives a stream of comparable hypothetical CY 2008 fatality totals under progressively less safe model year designs. Results indicated that had the 2008 on-road fleet been equipped with MY 2008 safety equipment and vehicle characteristics, total fatalities would have been reduced by 25% compared to vehicles that were actually on the road in 2008. Similar results were calculated for each model years' vehicle characteristics back to 2001.

For comparison, predicted MY fatality rates were derived from the CAFE safety model and applied to the CY 2008 VMT calculated by that model. This gives an estimate of CY 2008 fatalities under each model years' fatality rate, which, when compared to the predicted CY fatality total, gives a trendline comparable to the Glassbrenner trendline illustrating the change in MY fatality rates. Both models are sensitive to the initial 2008 baseline fatality total, and because the predicted CAFE total is somewhat lower than the actual total, the agency ran a third trendline to examine the influence of this difference. Results are shown in Figure 10-14.

Using the corrected fatality count, but retaining the predicted VMT changes the initial 2008 CY fatality rate to 12.62 (instead of 12.15) and produces the result shown in Figure 10-14. The CAFE model trendline shifts up, which narrows the difference in early years but expands it in later years. However, VMT and fatalities are linked in the CAFE model, so the actual level of the MY safety predicted by the CAFE curve has uncertainty. Perhaps the most meaningful result from this comparison is the difference in slopes; the CAFE model predicts more rapid change

⁸⁰⁴ DOT HS 811 572: An Analysis of Recent Improvement to Vehicle Safety, June 2012

through 2006, but in the last few years change decreases. This might reflect the trend in societal belt use, which rose steadily through 2005 and levelled off. Later model years' fatality rates would benefit from this trend while earlier model years would suffer. This seems consistent with using lifetime MY fatality rates to reflect MY change rather than first year MY fatality rates (although even first year rates would reflect this bias, but not as much).

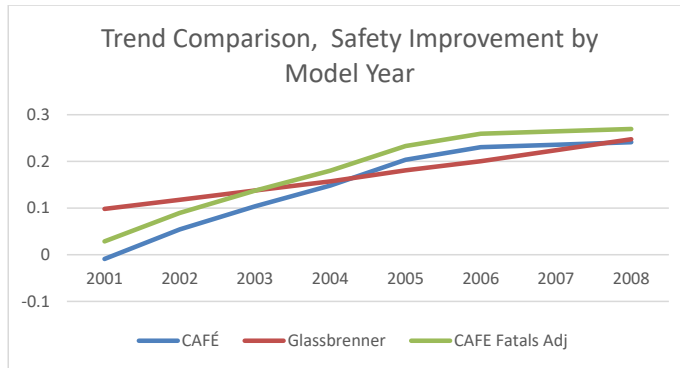

FIGURE 10-14 - SAFETY IMPROVEMENT TREND BY MODEL YEAR

To provide another perspective on safety impacts, NHTSA accessed data from a comprehensive study of the effects of safety technologies on motor vehicle fatalities. Kahane (2015)⁸⁰⁵ examined all safety effects of vehicle safety technologies from 1960 through 2012 and found these technologies saved more than 600,000 lives during that time span. Kahane is currently working under contract for NHTSA to update this study through 2016. At NHTSA's request, Kahane accessed his database to provide a measure of relative MY vehicle design safety by controlling for seat belt use. The result was a MY safety index illustrating the progress in vehicle safety by model year which isolates vehicle design from the primary behavioral impact – seat belt usage. The Kahane's index to MY 1975 was normalized and did the same to the "fixed effects" currently used from our safety model to compare the trends in MY safety from the two methods. Results are shown in Figure 10-15.

⁸⁰⁵ Kahane, C. J. (2015, January), Lives Saved by Safety Standards and Associated Vehicle Safety Technologies, 1960-2012 – Passenger Cars and LTVs – with Reviews of 26 FMVSS and the Effectiveness of their Associated Safety Technologies in Reducing Fatalities, Injuries, and Crashes (Report No. DOT HS-812-069), Washington D.C., NHTSA.

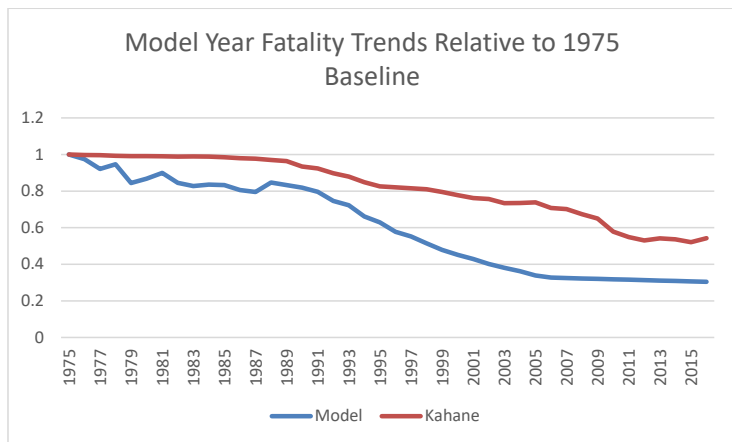

FIGURE 10-15 - FATALITY TRENDS RELATIVE TO 1975

From Figure 10-15 both approaches show similar long-term downward trends, but this model shows a steeper slope than Kahane’s model. The two models involve completely different approaches, so some difference is to be expected. However, it is also possible this reflects different methods used to isolate vehicle design safety from behavioral impacts. As discussed previously, NHTSA addressed this issue by removing vehicle age impacts from its model, whereas Kahane’s model does it by controlling for belt use. As noted previously, aside from the age impact on belt use associated with the different demographics driving older vehicles, there is a secular trend toward more belt use reflecting the increase in societal awareness of belt use importance over time. This trend is illustrated in Figure 10-16 below.⁸⁰⁶ NHTSA’s current approach removes the age trend in belt use, but it’s not clear whether it accounts for the full impacts of the secular trend as well. If not, some portion of the gap between the two trendlines could reflect behavioral impacts rather than vehicle design.

These models (NHTSA, Glassbrenner, and Kahane) involve differing approaches and assumptions contributing to uncertainty, and given this, their differences are not surprising. It is encouraging they show similar directional trends, reinforcing the basic concept being measured. NHTSA recognizes predicting future fatality impacts, as well as sales impacts that cause them, is a difficult and imprecise task. NHTSA will continue to investigate this issue, and the NPRM

⁸⁰⁶ Note - The drop occurring in 1994 reflects a shift in the basis for determining belt use rates. Effective in 1994, data were reported from the National Occupant Protection Survey (NOPUS). Prior to this, a conglomeration of state studies provided the basis. It is likely the pre-NOPUS surveys produced inflated results, especially in the 1991-1993 period.

seeks comment on these estimates as well as alternate methods for predicting the safety effects associated with delayed new vehicle purchases.

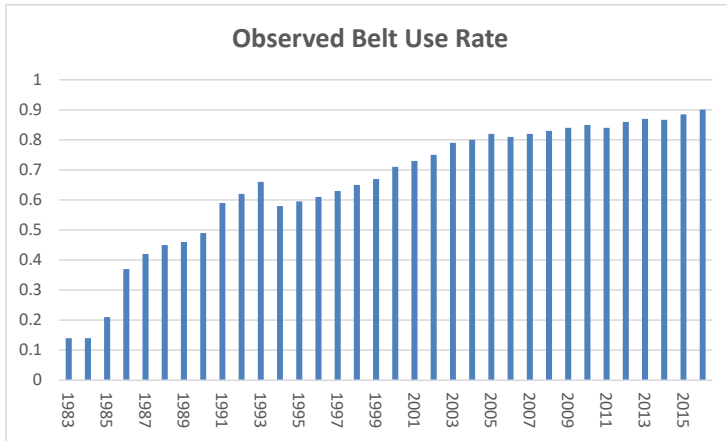

FIGURE 10-16 - OBSERVED SEAT BELT USE RATE

10.5 Impact of Rebound Effect on Fatalities

Based on historical data, it is possible to calculate a baseline fatality rate for vehicles of any model year vintage. By simply taking the total number of vehicles involved in fatal accidents over all ages for a model year and dividing by the cumulative VMT over the useful life of every vehicle produced in that model year, one arrives at a baseline hazard rate denominated in fatalities per billion miles. The fatalities associated with vehicles produced in that model year are then proportional to the cumulative lifetime VMT, where total fatalities equal the product of the baseline hazard rate and VMT. A more comprehensive discussion of the rebound effect and the basis for calculating its impact on mileage and risk is in Chapter 7 of this PRIA.

10.6 Adjustment for Non-Fatal Crashes

Fatalities estimated to be caused by various alternative CAFE standards are valued as a societal cost within the CAFE models' cost/benefit accounting. Their value is based on the comprehensive value of a fatality derived from data in Blincoe et al. (2015)⁸⁰⁷, adjusted to 2016 economics and updated to reflect the official DOT guidance on the value of a statistical life in 2016. This gives a societal value of \$9.9 million for each fatality. The CAFE safety model estimates effects on traffic fatalities but does not address corresponding effects on non-fatal

⁸⁰⁷ Blincoe, L., Miller, T.R., Zaloshnja, E., Lawrence, B. A., (May 2015, Revised) The Economic and Societal Impact of Motor Vehicle Crashes, 2010, (DOT HS 812 012), National Highway Traffic Safety Administration, Washington, D.C.

injuries and property damage that would result from the same factors influencing fatalities. To address this, we developed an adjustment factor that would account for these crashes.

Development of this factor is based on the assumption nonfatal crashes will be affected by CAFE standards in proportion to their nationwide incidence and severity. That is, NHTSA assumes the same injury profile, the relative number of cases of each injury severity level, that occur nationwide, will be increased or decreased because of CAFE. The agency recognizes this may not be the case, but the agency does not have data to support individual estimates across injury severities. There are reasons why this may not be true. For example, because older model year vehicles are generally less safe than newer vehicles, fatalities may make up a larger portion of the total injury picture than they do for newer vehicles. This would imply lower ratios across the non-fatal injury and PDO profile and would imply our adjustment may overstate total societal impacts. NHTSA requests comments on this assumption and alternative methods to estimate injury impacts.

The adjustment factor is derived from Tables 1-8 and I-3 in Blincoe et al (2015). Incidence in Table I-3 reflects the Abbreviated Injury Scale (AIS), which ranks nonfatal injury severity based on an ascending 5 level scale with the most severe injuries ranked as level 5. More information on the basis for these classifications is available from the Association for the Advancement of Automotive Medicine at <https://www.aaam.org/abbreviated-injury-scale-ais/>.

Table 1-3 in Blincoe et al. lists injured persons with their highest (maximum) injury determining the AIS level (MAIS). This scale is represented in terms of MAIS level, or maximum abbreviated injury scale. MAIS0 refers to uninjured occupants in injury vehicles, MAIS1 are generally considered minor injuries, MAIS2 moderate injuries, MAIS3 serious injuries, MAIS4 severe injuries, and MAIS5 critical injuries. PDO refers to property damage only crashes, and counts for PDOs refer to vehicles in which no one was injured. From Table 10-16, ratios of injury incidence/fatality are derived for each injury severity level as follows:

**TABLE 10-16 - RATIO OF INJURY INCIDENCE/FATALITY;
POLICE REPORTED AND UNREPORTED CRASHES**

Injury Level	Ratio
PDO	560.88
MAIS0	138.89
MAIS1	104.83
MAIS2	10.26
MAIS3	3.05
MAIS4	0.52
MAIS5	0.17
Fatal	1

*** EO 12866 Review – Draft – Do Not Cite, Quote or Release During Review ***

For each fatality that occurs nationwide in traffic crashes, there are 561 vehicles involved in PDOs, 139 uninjured occupants in injury vehicles, 105 minor injuries, 10 moderate injuries, 3 serious injuries, and fractional numbers of the most serious categories which include severe and critical nonfatal injuries. For each fatality ascribed to CAFE it is assumed there will be nonfatal crashes in these same ratios.

Property damage costs associated with delayed new vehicle purchases must be treated differently because crashes that subsequently occur damage older used vehicles instead of newer vehicles. Used vehicles are worth less and will cost less to repair, if they are repaired at all. The consumer's property damage loss is thus reduced by longer retention of these vehicles. To estimate this loss, average new and used vehicle prices were compared. New vehicle transaction prices were estimated from a study published by Kelley Blue Book.⁸⁰⁸ Based on these data, the average new vehicle transaction price in January 2017 was \$34,968. Used vehicle transaction prices were obtained from Edmonds Used Vehicle Market Report published in February of 2017.⁸⁰⁹ Edmonds data indicate the average used vehicle transaction price was \$19,189 in 2016. There is a minor timing discrepancy in these data because the new vehicle data represent January 2017, and the used vehicle price is for the average over 2016. NHTSA was unable to locate exact matching data at this time, but the agency believes the difference will be minor.

Based on these data, new vehicles are on average worth 82% more than used vehicles. To estimate the effect of higher property damage costs for newer vehicles on crashes, the per unit property damage costs from Table I-9 in Blincoe et al (2015) were multiplied by this factor. Results are illustrated in Table 10-17.

TABLE 10-17 - PROPERTY DAMAGE UNIT COST SAVINGS FROM RETAINED USED CARS

Injury Level	Original Unit Cost	Unit Cost Savings
PDO	\$2,444	\$2,007
MAIS0	\$1,828	\$1,501
MAIS1	\$5,404	\$4,438
MAIS2	\$5,778	\$4,745
MAIS3	\$10,882	\$8,937
MAIS4	\$16,328	\$13,409
MAIS5	\$15,092	\$12,394
Fatal	\$11,212	\$9,208

⁸⁰⁸ Press Release, "New-Car Transaction Prices Remain High, Up More Than 3 Percent Year-Over-Year in January 2017, According to Kelley Blue Book", February 1, 2017. <https://mediaroom.kbb.com/2017-02-01-New-Car-Transaction-Prices-Remain-High-Up-More-Than-3-Percent-Year-Over-Year-In-January-2017-According-To-Kelley-Blue-Book>.

⁸⁰⁹ Edmonds Used Vehicle Market Report, February 2017. https://dealers.edmunds.com/static/assets/articles/2017_Feb_Used_Market_Report.pdf

The total property damage cost reduction was then calculated as a function of the number of fatalities reduced or increased by CAFE as follows:

EQUATION 10-4 - TOTAL PROPERTY DAMAGE

$$S = \sum_{i=8}^n Fr_n p_n$$

Where:

- S = total property damage savings from retaining used vehicles longer
- F = change in fatalities estimated for CAFE due to retaining used vehicles
- r = ratio of nonfatal injuries or PDO vehicles to fatalities (F)
- p = value of property damage prevented by retaining older vehicle
- n = the 8 injury severity categories

The number of fatalities ascribed to CAFE because of older vehicle retention was multiplied by the unit cost per fatality from Table I-9 in Blincoe et al (2015) to determine the societal impact accounted for by these fatalities.⁸¹⁰ From Table I-8 in Blincoe et al (2015), NHTSA subtracted property damage costs from all injury severity levels and recalculated the total comprehensive value of societal losses from crashes. The agency then divided the portion of these crashes because of fatalities by the resulting total to estimate the portion of crashes excluding property damage that are accounted for by fatalities. Results indicate fatalities accounted for approximately 40% of all societal costs exclusive of property damage. NHTSA then divided the total cost of the added fatalities by 0.4 to estimate the total cost of all crashes prevented exclusive of the savings in property damage. After subtracting the total savings in property damage from this value, we divided the fatality cost by it to estimate that overall, fatalities account for 43% of the total costs that would result from older vehicle retention.

For the fatalities that occur because of mass effects or to the rebound effect, the calculation was more direct, a simple application of the ratio of the portion of costs produced by fatalities. In this case, there is no need to adjust for property damage because all impacts were derived from the mix of vehicles in the on-road fleet. Again, from Table I-8 in Blincoe et al (2015), we derive this ratio based on all cost factors including property damage to be .36. These calculations are summarized as follows:

EQUATION 10-5 - VALUE OF SOCIETAL IMPACTS OF ALL CRASHES

$$SV = Fv / (Fv/x - S) + M/c$$

⁸¹⁰ Note - These calculations used the original values in the Blincoe et al (2015) tables without adjusting for economics. These calculations produce ratios and are thus not sensitive to adjustments for inflation.

Where -

- SV = Value of societal Impacts of all crashes
- F = change in fatalities estimated for CAFE due to retaining used vehicles
- v = Comprehensive societal value of preventing 1 fatality
- x = Percent of total societal loss from crashes excluding property damage accounted for by fatalities
- S = total property damage savings from retaining used vehicles longer
- M = change in fatalities due to changes in vehicle mass to meet CAFE standards
- c = Percent of total societal loss from all cost factors in all crashes accounted for by fatalities

For purposes of application in the CAFE model, these two factors were combined based on the relative contribution to total fatalities of different factors. As noted, although a safety impact from the rebound effect is calculated, these impacts are considered to be freely chosen rather than imposed by CAFE and imply personal benefits at least equal to the sum of their added costs and safety consequences. The impacts of this nonfatal crash adjustment affect costs and benefits equally. When considering safety impacts actually imposed by CAFE standards, only those from mass changes and vehicle purchase delays are considered. NHTSA has two different factors depending on which metric is considered. The agency created these factors by weighting components by the relative contribution to changes in fatalities associated with each component. This process and results are shown in Table 10-22. Note - For the NPRM, NHTSA applied the average weighted factor to all fatalities. This will tend to slightly overstate costs because of sales and scrappage and understate costs associated with mass and rebound. The agency will consider ways to adjust this minor discrepancy for the final rule.

TABLE 10-18 - CONTRIBUTING FACTORS OF SOCIETAL IMPACTS

Contributing Factor	Fatalities Portion of Crash Costs	Weights - All Factors	Weights - CAFE Imposed Factors
Sales and Scrappage	0.4323	0.4107	0.935
Rebound Effect	0.3611	0.5607	
Mass	0.3611	0.0286	0.065
Total	NA	1	1
Weighted Factor		0.39	0.43

Table 10-19, Table 10-20,

*** EO 12866 Review – Draft – Do Not Cite, Quote or Release During Review ***

Table 10-21, and Table 10-22 summarize the safety effects of CAFE standards across the various alternatives under the 3% and 7% discount rates. As noted in Chapter 10.6, societal impacts are valued using a \$9.9 million value per statistical life (VSL). Fatalities in these tables are undiscounted – only the monetized societal impact is discounted.

**TABLE 10-19 - CHANGE IN SAFETY PARAMETERS FROM AUGURAL STANDARDS BASELINE
AVERAGE ANNUAL FATALITIES, CY 2036 – 2045, 3% DISCOUNT RATE**

Change in Safety Parameters from Augural Standards Baseline								
Average Annual Fatalities, CY 2036-2045, 3% Discount Rate								
	Alt 1	Alt 2	Alt 3	Alt 4	Alt 5	Alt 6	Alt 7	Alt 8
Fatalities								
Mass changes	-23	-21	-18	-18	-18	-7	-1	-1
Sales Impacts	-180	-162	-150	-112	-75	-60	-23	-35
Subtotal CAFE Atrb.	-202	-182	-169	-129	-93	-67	-24	-36
Rebound effect	-693	-650	-606	-512	-393	-312	-175	-221
Total	-896	-833	-775	-642	-486	-380	-200	-257
Fatalities - Societal Cost \$B								
Mass changes	-\$0.11	-\$0.10	-\$0.09	-\$0.09	-\$0.09	-\$0.04	-\$0.01	\$0.00
Sales Impacts	-\$0.90	-\$0.81	-\$0.75	-\$0.56	-\$0.38	-\$0.30	-\$0.11	-\$0.17
Subtotal CAFE Atrb.	-\$1.01	-\$0.91	-\$0.84	-\$0.65	-\$0.46	-\$0.34	-\$0.12	-\$0.18
Rebound effect	-\$3.43	-\$3.22	-\$3.00	-\$2.54	-\$1.95	-\$1.55	-\$0.87	-\$1.09
Total	-\$4.44	-\$4.13	-\$3.84	-\$3.18	-\$2.41	-\$1.88	-\$0.99	-\$1.27
Nonfatal Societal Cost \$B								
Mass changes	-\$0.17	-\$0.16	-\$0.14	-\$0.14	-\$0.14	-\$0.06	-\$0.01	-\$0.01
Sales Impacts	-\$1.41	-\$1.27	-\$1.18	-\$0.87	-\$0.59	-\$0.47	-\$0.18	-\$0.27
Subtotal CAFE Atrb.	-\$1.58	-\$1.43	-\$1.32	-\$1.01	-\$0.73	-\$0.53	-\$0.19	-\$0.28
Rebound effect	-\$5.37	-\$5.03	-\$4.69	-\$3.97	-\$3.04	-\$2.42	-\$1.36	-\$1.71
Total	-\$6.95	-\$6.46	-\$6.01	-\$4.98	-\$3.77	-\$2.94	-\$1.55	-\$1.99
Total Societal Cost \$B								

*** EO 12866 Review – Draft – Do Not Cite, Quote or Release During Review ***

Mass changes	-\$0.29	-\$0.26	-\$0.23	-\$0.22	-\$0.22	-\$0.09	-\$0.02	-\$0.01
Sales Impacts	-\$2.31	-\$2.08	-\$1.93	-\$1.43	-\$0.97	-\$0.77	-\$0.29	-\$0.45
Subtotal CAFE Atrb.	-\$2.60	-\$2.34	-\$2.16	-\$1.66	-\$1.19	-\$0.86	-\$0.31	-\$0.46
Rebound effect	-\$8.80	-\$8.25	-\$7.69	-\$6.50	-\$4.99	-\$3.96	-\$2.23	-\$2.80
Total	-\$11.39	-\$10.59	-\$9.85	-\$8.16	-\$6.18	-\$4.82	-\$2.54	-\$3.26

**TABLE 10-20 - CHANGE IN SAFETY PARAMETERS FROM AUGURAL STANDARDS BASELINE
AVERAGE ANNUAL FATALITIES, CY 2036 – 2045, 7% DISCOUNT RATE**

Change in Safety Parameters from Augural Standards Baseline								
Average Annual Fatalities, CY 2036-2045, 7% Discount Rate								
	Alt 1	Alt 2	Alt 3	Alt 4	Alt 5	Alt 6	Alt 7	Alt 8
Fatalities								
Mass changes	-23	-21	-18	-18	-18	-7	-1	-1
Sales Impacts	-180	-162	-150	-112	-75	-60	-23	-35
Subtotal CAFE Atrb.	-202	-182	-169	-129	-93	-67	-24	-36
Rebound effect	-693	-650	-606	-512	-393	-312	-175	-221
Total	-896	-833	-775	-642	-486	-380	-200	-257
Fatalities - Societal Cost \$B								
Mass changes	-\$0.05	-\$0.04	-\$0.04	-\$0.04	-\$0.04	-\$0.01	\$0.00	\$0.00
Sales Impacts	-\$0.38	-\$0.34	-\$0.32	-\$0.23	-\$0.16	-\$0.13	-\$0.05	-\$0.07
Subtotal CAFE Atrb.	-\$0.42	-\$0.38	-\$0.35	-\$0.27	-\$0.19	-\$0.14	-\$0.05	-\$0.07
Rebound effect	-\$1.42	-\$1.33	-\$1.24	-\$1.05	-\$0.80	-\$0.64	-\$0.36	-\$0.45
Total	-\$1.84	-\$1.71	-\$1.59	-\$1.32	-\$1.00	-\$0.78	-\$0.41	-\$0.53
Nonfatal Societal Costs \$B								

*** EO 12866 Review – Draft – Do Not Cite, Quote or Release During Review ***

Mass changes	-\$0.07	-\$0.07	-\$0.06	-\$0.06	-\$0.06	-\$0.02	\$0.00	\$0.00
Sales Impacts	-\$0.59	-\$0.53	-\$0.49	-\$0.37	-\$0.25	-\$0.20	-\$0.07	-\$0.11
Subtotal CAFE Attrib.	-\$0.66	-\$0.60	-\$0.55	-\$0.42	-\$0.30	-\$0.22	-\$0.08	-\$0.12
Rebound effect	-\$2.22	-\$2.08	-\$1.94	-\$1.64	-\$1.26	-\$1.00	-\$0.56	-\$0.71
Total	-\$2.88	-\$2.68	-\$2.49	-\$2.06	-\$1.56	-\$1.22	-\$0.64	-\$0.82
Total Societal Costs \$B								
Mass changes	-\$0.12	-\$0.11	-\$0.10	-\$0.09	-\$0.09	-\$0.04	-\$0.01	\$0.00
Sales Impacts	-\$0.97	-\$0.87	-\$0.81	-\$0.60	-\$0.41	-\$0.32	-\$0.12	-\$0.19
Subtotal CAFE Attrib.	-\$1.09	-\$0.98	-\$0.91	-\$0.69	-\$0.50	-\$0.36	-\$0.13	-\$0.19
Rebound effect	-\$3.64	-\$3.41	-\$3.18	-\$2.69	-\$2.06	-\$1.64	-\$0.92	-\$1.16
Total	-\$4.73	-\$4.39	-\$4.09	-\$3.38	-\$2.56	-\$2.00	-\$1.05	-\$1.35

**TABLE 10-21 - CHANGE IN SAFETY PARAMETERS FROM AUGURAL STANDARDS BASELINE
TOTAL FATALITIES MY 1977 – 2029, 3% DISCOUNT RATE**

Change in Safety Parameters from Augural Standards Baseline								
Total Fatalities MY 1977-2029, 3% Discount Rate								
	Alt 1	Alt 2	Alt 3	Alt 4	Alt 5	Alt 6	Alt 7	Alt 8
Fatalities								
Mass changes	-165	-151	-147	-177	-156	-77	-16	-14
Sales Impacts	-6196	-5693	-5274	-4292	-3185	-2543	-1036	-1502
Subtotal CAFE Attrib.	-6361	-5844	-5421	-4469	-3341	-2620	-1052	-1516
Rebound effect	-6345	-5972	-5634	-4855	-3620	-3259	-2212	-2174
Total	-12705	-11816	-11055	-9325	-6961	-5879	-3265	-3691

*** EO 12866 Review – Draft – Do Not Cite, Quote or Release During Review ***

Fatalities - Societal Costs \$B								
Mass changes	-\$0.96	-\$0.88	-\$0.86	-\$1.09	-\$0.96	-\$0.46	-\$0.09	-\$0.07
Sales Impacts	-\$34.48	-\$31.63	-\$29.32	-\$23.91	-\$17.66	-\$14.31	-\$6.19	-\$8.34
Subtotal CAFE Attrib.	-\$35.44	-\$32.51	-\$30.19	-\$25.00	-\$18.62	-\$14.78	-\$6.28	-\$8.41
Rebound effect	-\$41.73	-\$39.25	-\$37.06	-\$31.98	-\$23.72	-\$21.66	-\$14.93	- \$14.32
Total	-\$77.16	-\$71.76	-\$67.25	-\$56.98	-\$42.33	-\$36.44	-\$21.21	- \$22.73
Nonfatal Societal Costs \$B								
Mass changes	-\$1.51	-\$1.37	-\$1.35	-\$1.71	-\$1.50	-\$0.73	-\$0.15	-\$0.12
Sales Impacts	-\$53.92	-\$49.47	-\$45.86	-\$37.39	-\$27.62	-\$22.38	-\$9.67	- \$13.04
Subtotal CAFE Attrib.	-\$55.43	-\$50.84	-\$47.22	-\$39.10	-\$29.12	-\$23.11	-\$9.82	- \$13.16
Rebound effect	-\$65.26	-\$61.39	-\$57.96	-\$50.03	-\$37.10	-\$33.88	-\$23.35	- \$22.40
Total	-\$120.69	-\$112.23	-\$105.18	-\$89.12	-\$66.21	-\$56.99	-\$33.17	- \$35.56
Total Societal Costs \$B								
Mass changes	-\$2.47	-\$2.25	-\$2.22	-\$2.80	-\$2.46	-\$1.19	-\$0.24	-\$0.19
Sales Impacts	-\$88.40	-\$81.10	-\$75.19	-\$61.30	-\$45.27	-\$36.70	-\$15.86	- \$21.38
Subtotal CAFE Attrib.	-\$90.87	-\$83.35	-\$77.41	-\$64.09	-\$47.73	-\$37.89	-\$16.10	- \$21.57
Rebound effect	-\$106.99	-\$100.64	-\$95.02	-\$82.01	-\$60.81	-\$55.55	-\$38.29	- \$36.72
Total	-\$197.85	-\$183.99	-\$172.43	-\$146.10	-\$108.55	-\$93.43	-\$54.38	- \$58.29

*** EO 12866 Review – Draft – Do Not Cite, Quote or Release During Review ***

**TABLE 10-22 - CHANGE IN SAFETY PARAMETERS FROM AUGURAL STANDARDS BASELINE
TOTAL FATALITIES MY 1977 – 2029, 7% DISCOUNT RATE**

Change in Safety Parameters from Augural Standards Baseline								
Total Fatalities MY 1977-2029, 7% Discount Rate								
	Alt 1	Alt 2	Alt 3	Alt 4	Alt 5	Alt 6	Alt 7	Alt 8
Fatalities								
Mass changes	-165	-151	-147	-177	-156	-77	-16	-14
Sales Impacts	-6196	-5693	-5274	-4292	-3185	-2543	-1036	-1502
Subtotal CAFE Atrb.	-6361	-5844	-5421	-4469	-3341	-2620	-1052	-1516
Rebound effect	-6345	-5972	-5634	-4855	-3620	-3259	-2212	-2174
Total	-12705	-11816	-11055	-9325	-6961	-5879	-3265	-3691
Fatalities - Societal Costs \$B								
Mass changes	-\$0.51	-\$0.47	-\$0.47	-\$0.63	-\$0.55	-\$0.26	-\$0.05	-\$0.04
Sales Impacts	-\$17.95	-\$16.44	-\$15.27	-\$12.52	-\$9.19	-\$7.65	-\$3.62	-\$4.37
Subtotal CAFE Atrb.	-\$18.47	-\$16.91	-\$15.73	-\$13.15	-\$9.74	-\$7.91	-\$3.67	-\$4.41
Rebound effect	-\$25.86	-\$24.30	-\$22.97	-\$19.86	-\$14.62	-\$13.61	-\$9.56	-\$8.88
Total	-\$44.33	-\$41.21	-\$38.71	-\$33.01	-\$24.36	-\$21.53	-\$13.23	- \$13.29
Nonfatal Societal Costs \$B								
Mass changes	-\$0.80	-\$0.73	-\$0.73	-\$0.99	-\$0.86	-\$0.41	-\$0.08	-\$0.06
Sales Impacts	-\$28.08	-\$25.72	-\$23.88	-\$19.58	-\$14.38	-\$11.96	-\$5.66	-\$6.84
Subtotal CAFE Atrb.	-\$28.89	-\$26.45	-\$24.61	-\$20.56	-\$15.23	-\$12.38	-\$5.74	-\$6.90
Rebound effect	-\$40.45	-\$38.01	-\$35.93	-\$31.06	-\$22.86	-\$21.29	-\$14.95	- \$13.89
Total	-\$69.33	-\$64.46	-\$60.54	-\$51.63	-\$38.10	-\$33.67	-\$20.70	- \$20.78
Total Societal Costs \$B								
Mass changes	-\$1.32	-\$1.20	-\$1.20	-\$1.62	-\$1.41	-\$0.67	-\$0.13	-\$0.10
Sales Impacts	-\$46.04	-\$42.16	-\$39.14	-\$32.09	-\$23.57	-\$19.61	-\$9.29	- \$11.21
Subtotal CAFE Atrb.	-\$47.36	-\$43.36	-\$40.34	-\$33.71	-\$24.97	-\$20.29	-\$9.42	- \$11.31

*** EO 12866 Review – Draft – Do Not Cite, Quote or Release During Review ***

Rebound effect	-\$66.31	-\$62.31	-\$58.90	-\$50.92	-\$37.48	-\$34.91	-\$24.52	- \$22.77
Total	-\$113.66	-\$105.68	-\$99.25	-\$84.63	-\$62.46	-\$55.20	-\$33.93	- \$34.07

While NHTSA notes the value of rebound effect fatalities, as well as total fatalities from all causes, the agency does not add rebound effects to the other CAFE-related impacts because rebound-related fatalities and injuries result from risk that is freely chosen and offset by societal valuations that at a minimum exceed the aggregate value of safety consequences plus added vehicle operating and maintenance costs.⁸¹¹ These costs implicitly involve a cost and a benefit that are offsetting. The relevant safety impacts attributable to CAFE are highlighted in bold in the above tables.

⁸¹¹ It would also include some level of consumer surplus, which we have estimated using the standard triangular function. This is discussed in Section 8.5.1 of the PRIA.

11 Net Impacts

This chapter compares the costs of technologies needed to make improvements in fuel economy with the potential benefits, expressed in total costs (millions of dollars) from a societal perspective for each model year. The costs do not include CAFE civil penalties estimated to be paid by manufacturers to NHTSA, since these are transfer payments. Thus, the total costs shown in this section do not match the total costs shown in Chapter 8. These are incremental costs and benefits compared to the adjusted baseline of MY 2016. Chapter 11.3 presents sales and employment impacts. This chapter concludes with an evaluation of cumulative impacts across multiple fuel economy standards.

Payback periods are not reported in this section. Unlike previous CAFE analyses, in this analysis there is no incremental fuel-saving technology added to vehicles in the alternatives. Rather, technologies are removed from vehicles across the alternatives relative to the baseline. In turn, rather than facing upfront investment costs that are paid back throughout vehicle ownership (yielding a breakeven point that represents the end of a payback period), consumers receive immediate, upfront cost savings across all alternatives.

11.1 Net Impacts across Alternative Fuel Economy Standards

Table 11-1 and Table 11-2 present total costs, benefits and net benefits for the light-duty vehicle fleet across alternative fuel economy standards. Costs decrease under all alternatives, ranging from -\$541 billion to -\$188 billion at a three-percent discount rate, and from -\$364 billion to -\$135 billion at a seven-percent discount rate. Benefits also decrease under all alternatives, ranging from -\$326 billion to -\$113 billion at a three-percent discount rate, and from -\$204 billion to -\$70 billion at a seven-percent discount rate. Because benefits decrease by a lower amount than costs under all alternatives, net benefits are positive under all alternatives (ranging from \$68 billion to \$215 billion at a three-percent discount rate, and from \$59 billion to \$160 billion at a seven-percent discount rate). Table 11-3 through Table 11-8 provide the present value of net benefits.

*** EO 12866 Review – Draft – Do Not Cite, Quote or Release During Review ***

Table 11-9 through

*** EO 12866 Review – Draft – Do Not Cite, Quote or Release During Review ***

Table 11-17 present estimates of societal costs, benefits and net benefits under the CAFE model. Table 11-27 through Table 11-44 present societal costs, benefits and net benefits, consumer impacts and net consumer benefits for MY 2030 vehicles relative to MY 2016 vehicles under the CO₂ Program are presented.

*** EO 12866 Review – Draft – Do Not Cite, Quote or Release During Review ***

TABLE 11-1 - TOTAL COSTS, BENEFITS, AND NET BENEFITS, PASSENGER CARS AND LIGHT TRUCKS COMBINED, MYS 1977-2029, CAFE (BILLIONS 2016\$)

Alternative	3% Discount Rate			7% Discount Rate		
	Costs	Benefits	Net Benefits	Costs	Benefits	Net Benefits
0.0%PC/0.0%LT, MYS 2021-2026	-540.9	-326.2	214.6	-363.9	-204.1	159.7
0.5%PC/0.5%LT, MYS 2021-2026	-513.4	-307.1	206.3	-346.1	-191.8	154.3
0.5%PC/0.5%LT, MYS 2021-2026, AC/Off-Cycle Phaseout	-483.4	-290.3	193.1	-326.2	-181.4	144.8
1.0%PC/2.0%LT, MYS 2021-2026	-431.8	-250.7	181.1	-294.3	-156.7	137.6
1.0%PC/2.0%LT, MYS 2022-2026	-343.8	-186.1	157.6	-235.3	-115.5	119.9
2.0%PC/3.0%LT, MYS 2021-2026	-301.9	-171.3	130.6	-209.6	-108.0	101.6
2.0%PC/3.0%LT, MYS 2021-2026, AC/Off-Cycle Phaseout	-188.0	-119.9	68.1	-135.0	-76.2	58.8
2.0%PC/3.0%LT, MYS 2022-2026	-203.8	-113.0	90.7	-141.5	-70.2	71.3

TABLE 11-2 - TOTAL COSTS, BENEFITS, AND NET BENEFITS, PASSENGER CARS AND LIGHT TRUCKS COMBINED, MYS 1977-2029, CO₂ (BILLIONS 2016\$)

Alternative	3% Discount Rate			7% Discount Rate				
	Costs	Benefits	Net Benefits	Costs	Benefits	Net Benefits		
0.0%PC/0.0%LT, MYS 2021-2026	-473.3		-283.7	189.6	-306.8	-176.6	130.2	
0.5%PC/0.5%LT, MYS 2021-2026	-453.9		-271.4	182.5	-294.0	-168.7	125.3	
0.5%PC/0.5%LT, MYS 2021-2026, AC/Off-Cycle Phaseout	-421.1		-250.3	170.9	-274.9	-155.9	119.0	
1.0%PC/2.0%LT, MYS 2021-2026	-343.9		-197.2	146.7	-226.6	-122.6	104.0	
1.0%PC/2.0%LT, MYS 2022-2026	-232.6		-118.2	114.3	-150.6	-72.8	77.8	
2.0%PC/3.0%LT, MYS 2021-2026	-215.4		-116.4	98.9	-145.3	-72.3	73.0	
2.0%PC/3.0%LT, MYS 2021-2026, AC/Off-Cycle Phaseout	-113.9		-69.7	44.3	-80.7	-43.2	37.4	
2.0%PC/3.0%LT, MYS 2022-2026	-114.4		-59.0	55.4	-76.4	-36.1	40.3	

*** EO 12866 Review – Draft – Do Not Cite, Quote or Release During Review ***

TABLE 11-3 - PRESENT VALUE OF NET TOTAL BENEFITS, PASSENGER CARS, CAFE, 3% DISCOUNT RATE (BILLIONS 2016\$)

Passenger Cars	MY 1977- 2016	MY 2017	MY 2018	MY 2019	MY 2020	MY 2021	MY 2022	MY 2023	MY 2024	MY 2025	MY 2026	MY 2027	MY 2028	MY 2029	MY TOTAL
0.0%PC/0.0%LT, MYs 2021-2026	84.8	8.8	8.2	7.8	8.2	8.3	6.3	4.6	1.5	-1.1	-4.1	-6.2	-6.7	-7.3	113.1
0.5%PC/0.5%LT, MYs 2021-2026	80.8	8.4	7.8	7.4	7.8	8.0	6.1	4.4	1.3	-1.2	-4.1	-5.7	-6.2	-6.7	108.2
0.5%PC/0.5%LT, MYs 2021-2026, AC/Off-Cycle Phaseout	75.7	7.7	7.2	6.8	7.3	7.4	5.6	3.8	0.7	-1.8	-4.5	-5.1	-5.5	-5.8	99.4
1.0%PC/2.0%LT, MYs 2021-2026	68.3	6.7	6.3	6.0	6.5	6.8	5.3	3.8	1.1	-1.4	-3.6	-3.2	-3.2	-3.3	96.1
1.0%PC/2.0%LT, MYs 2022-2026	54.3	5.3	5.2	5.2	5.8	6.5	6.7	5.0	2.9	0.9	-1.2	-0.7	-0.7	-0.7	94.5
2.0%PC/3.0%LT, MYs 2021-2026	47.2	4.3	4.0	3.8	4.3	4.7	3.8	2.7	0.9	0.2	-1.1	0.9	0.9	1.0	77.7
2.0%PC/3.0%LT, MYs 2021-2026, AC/Off-Cycle Phaseout	29.3	2.3	2.1	1.8	2.3	2.4	1.7	0.2	-1.4	-1.9	-2.7	1.4	1.1	1.3	39.7
2.0%PC/3.0%LT, MYs 2022-2026	30.1	2.8	2.9	3.0	3.7	4.4	4.7	3.6	1.6	0.4	-0.8	1.5	1.4	1.6	60.9

*** EO 12866 Review – Draft – Do Not Cite, Quote or Release During Review ***

TABLE 11-4 - PRESENT VALUE OF NET TOTAL BENEFITS, PASSENGER CARS, CAFE, 7% DISCOUNT RATE (BILLIONS 2016\$)

Passenger Cars	MY 1977- 2016	MY 2017	MY 2018	MY 2019	MY 2020	MY 2021	MY 2022	MY 2023	MY 2024	MY 2025	MY 2026	MY 2027	MY 2028	MY 2029	MY TOTAL
0.0%PC/0.0%LT, MYs 2021-2026	53.1	4.9	4.6	4.4	5.2	5.9	4.8	3.9	1.9	0.5	-1.2	-2.5	-2.7	-3.0	79.9
0.5%PC/0.5%LT, MYs 2021-2026	50.6	4.7	4.4	4.2	5.0	5.7	4.7	3.8	1.9	0.4	-1.3	-2.2	-2.4	-2.6	77.0
0.5%PC/0.5%LT, MYs 2021-2026, AC/Off-Cycle Phaseout	47.4	4.3	4.1	3.9	4.7	5.4	4.4	3.4	1.5	0.1	-1.6	-1.9	-2.0	-2.2	71.4
1.0%PC/2.0%LT, MYs 2021-2026	43.0	3.8	3.7	3.5	4.3	5.1	4.4	3.6	1.9	0.4	-0.9	-0.8	-0.8	-0.9	70.4
1.0%PC/2.0%LT, MYs 2022-2026	34.1	3.0	3.0	3.1	4.0	5.0	5.3	4.4	2.9	1.7	0.4	0.6	0.5	0.4	68.3
2.0%PC/3.0%LT, MYs 2021-2026	30.0	2.5	2.4	2.3	3.2	3.9	3.6	2.9	1.7	1.3	0.3	1.4	1.3	1.2	58.1
2.0%PC/3.0%LT, MYs 2021-2026, AC/Off-Cycle Phaseout	19.0	1.5	1.5	1.3	2.1	2.6	2.3	1.3	0.2	-0.1	-0.8	1.5	1.2	1.2	34.9
2.0%PC/3.0%LT, MYs 2022-2026	19.0	1.7	1.8	2.0	2.9	3.7	4.1	3.4	2.1	1.3	0.4	1.6	1.5	1.5	47.0

*** EO 12866 Review – Draft – Do Not Cite, Quote or Release During Review ***

TABLE 11-5 - PRESENT VALUE OF NET TOTAL BENEFITS, LIGHT TRUCKS, CAFE, 3% DISCOUNT RATE (BILLIONS 2016\$)

Light Trucks	MY 1977-2016	MY 2017	MY 2018	MY 2019	MY 2020	MY 2021	MY 2022	MY 2023	MY 2024	MY 2025	MY 2026	MY 2027	MY 2028	MY 2029	MY TOTAL
0.0%PC/0.0%LT, MYs 2021-2026	45.8	3.4	3.0	3.0	2.6	1.4	1.8	2.9	3.3	3.9	5.1	6.9	8.7	9.8	101.6
0.5%PC/0.5%LT, MYs 2021-2026	41.7	2.9	3.0	3.1	2.7	1.6	1.9	2.9	3.3	3.9	5.5	7.1	8.7	9.7	98.1
0.5%PC/0.5%LT, MYs 2021-2026, AC/Off-Cycle Phaseout	39.6	2.6	2.5	2.7	2.4	1.5	1.9	3.0	3.5	4.2	5.7	7.0	8.2	8.9	93.7
1.0%PC/2.0%LT, MYs 2021-2026	32.5	1.8	2.0	2.3	2.5	2.1	2.7	3.8	4.3	4.8	6.1	6.2	6.8	7.3	85.0
1.0%PC/2.0%LT, MYs 2022-2026	23.1	1.5	1.8	2.1	2.3	2.7	2.2	2.7	3.2	3.3	4.3	4.3	4.7	5.0	63.1
2.0%PC/3.0%LT, MYs 2021-2026	21.7	0.6	0.8	0.9	1.0	1.1	1.9	3.0	3.9	3.5	4.0	3.4	3.6	3.7	52.9
2.0%PC/3.0%LT, MYs 2021-2026, AC/Off-Cycle Phaseout	13.4	-0.3	-0.2	-0.3	-0.1	-0.4	0.5	1.7	2.7	2.4	2.7	2.5	1.9	1.9	28.4
2.0%PC/3.0%LT, MYs 2022-2026	12.3	0.6	0.6	0.4	0.7	1.0	0.8	1.2	1.7	1.6	2.4	2.2	2.1	2.1	29.8

*** EO 12866 Review – Draft – Do Not Cite, Quote or Release During Review ***

TABLE 11-6 - PRESENT VALUE OF NET TOTAL BENEFITS, LIGHT TRUCKS, CAFE, 7% DISCOUNT RATE (BILLIONS 2016\$)

Light Trucks	MY 1977- 2016	MY 2017	MY 2018	MY 2019	MY 2020	MY 2021	MY 2022	MY 2023	MY 2024	MY 2025	MY 2026	MY 2027	MY 2028	MY 2029	MY TOTAL
0.0%PC/0.0%LT, MYs 2021-2026	27.8	1.5	2.1	2.6	2.7	2.9	3.2	3.9	4.2	4.5	5.2	5.9	6.5	6.8	79.8
0.5%PC/0.5%LT, MYs 2021-2026	25.3	1.3	2.1	2.6	2.8	3.0	3.3	3.9	4.2	4.5	5.3	5.9	6.5	6.7	77.3
0.5%PC/0.5%LT, MYs 2021-2026, AC/Off-Cycle Phaseout	24.1	1.2	1.6	2.2	2.5	2.8	3.2	3.9	4.2	4.6	5.3	5.7	6.1	6.2	73.4
1.0%PC/2.0%LT, MYs 2021-2026	19.8	0.7	1.4	2.1	2.5	3.1	3.6	4.2	4.5	4.8	5.3	5.0	5.1	5.1	67.3
1.0%PC/2.0%LT, MYs 2022-2026	13.8	0.7	1.3	2.0	2.4	3.3	3.0	3.2	3.5	3.5	3.8	3.7	3.7	3.6	51.5
2.0%PC/3.0%LT, MYs 2021-2026	13.4	0.2	0.7	0.9	1.3	2.1	2.6	3.2	3.7	3.4	3.4	2.9	2.8	2.7	43.5
2.0%PC/3.0%LT, MYs 2021-2026, AC/Off-Cycle Phaseout	8.6	-0.2	0.0	0.0	0.4	0.7	1.2	2.0	2.5	2.2	2.0	1.8	1.4	1.3	23.8
2.0%PC/3.0%LT, MYs 2022-2026	7.4	0.3	0.4	0.4	0.8	1.4	1.2	1.5	1.8	1.8	2.1	1.9	1.7	1.6	24.3

*** EO 12866 Review – Draft – Do Not Cite, Quote or Release During Review ***

TABLE 11-7 - PRESENT VALUE OF NET TOTAL BENEFITS, PASSENGER CARS AND LIGHT TRUCKS COMBINED, CAFE, 3% DISCOUNT RATE (BILLIONS 2016\$)

Passenger Cars and Light Trucks	MY 1977-2016	MY 2017	MY 2018	MY 2019	MY 2020	MY 2021	MY 2022	MY 2023	MY 2024	MY 2025	MY 2026	MY 2027	MY 2028	MY 2029	MY TOTAL
0.0%PC/0.0%LT, MYs 2021-2026	130.6	12.2	11.2	10.8	10.8	9.7	8.1	7.5	4.8	2.8	1.1	0.7	2.0	2.5	214.6
0.5%PC/0.5%LT, MYs 2021-2026	122.5	11.2	10.8	10.5	10.6	9.5	8.0	7.3	4.7	2.8	1.4	1.4	2.6	3.0	206.3
0.5%PC/0.5%LT, MYs 2021-2026, AC/Off-Cycle Phaseout	115.3	10.4	9.7	9.5	9.7	8.9	7.5	6.8	4.2	2.4	1.2	1.8	2.7	3.1	193.1
1.0%PC/2.0%LT, MYs 2021-2026	100.8	8.5	8.3	8.3	9.0	8.8	8.0	7.5	5.3	3.4	2.5	2.9	3.7	4.0	181.1
1.0%PC/2.0%LT, MYs 2022-2026	77.4	6.8	7.0	7.3	8.1	9.2	8.8	7.7	6.1	4.1	3.0	3.6	4.1	4.3	157.6
2.0%PC/3.0%LT, MYs 2021-2026	69.0	4.9	4.8	4.6	5.3	5.8	5.7	5.7	4.8	3.7	2.8	4.4	4.4	4.6	130.6
2.0%PC/3.0%LT, MYs 2021-2026, AC/Off-Cycle Phaseout	42.6	2.0	1.9	1.4	2.2	2.0	2.2	1.9	1.2	0.5	0.1	3.8	3.0	3.2	68.1
2.0%PC/3.0%LT, MYs 2022-2026	42.3	3.5	3.5	3.4	4.4	5.4	5.6	4.8	3.4	2.0	1.7	3.7	3.5	3.7	90.7

*** EO 12866 Review – Draft – Do Not Cite, Quote or Release During Review ***

TABLE 11-8 - PRESENT VALUE OF NET TOTAL BENEFITS, PASSENGER CARS AND LIGHT TRUCKS COMBINED, CAFE, 7% DISCOUNT RATE (BILLIONS 2016\$)

Passenger Cars and Light Trucks	MY 1977-2016	MY 2017	MY 2018	MY 2019	MY 2020	MY 2021	MY 2022	MY 2023	MY 2024	MY 2025	MY 2026	MY 2027	MY 2028	MY 2029	MY TOTAL
0.0%PC/0.0%LT, MYs 2021-2026	81.0	6.5	6.7	7.0	7.9	8.8	8.0	7.8	6.1	5.0	3.9	3.4	3.9	3.8	159.7
0.5%PC/0.5%LT, MYs 2021-2026	75.9	6.0	6.5	6.8	7.8	8.7	8.0	7.7	6.1	5.0	4.0	3.7	4.1	4.0	154.3
0.5%PC/0.5%LT, MYs 2021-2026, AC/Off-Cycle Phaseout	71.5	5.5	5.7	6.1	7.1	8.2	7.6	7.3	5.7	4.6	3.7	3.8	4.0	4.0	144.8
1.0%PC/2.0%LT, MYs 2021-2026	62.7	4.6	5.1	5.5	6.9	8.3	8.0	7.8	6.4	5.2	4.3	4.3	4.4	4.2	137.6
1.0%PC/2.0%LT, MYs 2022-2026	48.0	3.7	4.3	5.1	6.3	8.2	8.3	7.6	6.4	5.2	4.2	4.3	4.2	4.1	119.9
2.0%PC/3.0%LT, MYs 2021-2026	43.4	2.7	3.1	3.3	4.5	6.0	6.1	6.2	5.4	4.7	3.8	4.4	4.1	4.0	101.6
2.0%PC/3.0%LT, MYs 2021-2026, AC/Off-Cycle Phaseout	27.7	1.2	1.5	1.3	2.6	3.3	3.4	3.3	2.7	2.1	1.2	3.2	2.6	2.5	58.8
2.0%PC/3.0%LT, MYs 2022-2026	26.4	1.9	2.2	2.4	3.7	5.1	5.4	4.9	3.9	3.1	2.6	3.5	3.2	3.1	71.3

*** EO 12866 Review – Draft – Do Not Cite, Quote or Release During Review ***

TABLE11-9 - SOCIETAL COSTS, BENEFITS AND NET BENEFITS, PASSENGER CARS, CAFE, 3% DISCOUNT RATE (BILLIONS 2016\$)

	Alternative							
	1	2	3	4	5	6	7	8
Model Years	2021-2026	2021-2026	2021-2026	2021-2026	2022-2026	2021-2026	2021-2026	2022-2026
Annual Rate of Stringency Increase	0.0%/Year PC 0.0%/Year LT	0.5%/Year PC 0.5%/Year LT	0.5%/Year PC 0.5%/Year LT	1.0%/Year PC 2.0%/Year LT	1.0%/Year PC 2.0%/Year LT	2.0%/Year PC 3.0%/Year LT	2.0%/Year PC 3.0%/Year LT	2.0%/Year PC 3.0%/Year LT
AC/Off-Cycle Procedures	No Change	No Change	Phaseout 2022-2026	No Change	No Change	No Change	Phaseout 2022-2026	No Change
Societal Costs								
Technology Costs	-\$113.7	-\$110.7	-\$105.3	-\$102.6	-\$86.6	-\$80.9	-\$62.3	-\$64.5
Advanced Technology Value Loss	-\$19.6	-\$19.5	-\$19.3	-\$19.4	-\$19.1	-\$18.6	-\$14.5	-\$16.9
Congestion Costs	-\$24.9	-\$23.9	-\$22.4	-\$21.1	-\$17.6	-\$15.4	-\$9.2	-\$10.8
Noise Costs	-\$0.3	-\$0.3	-\$0.3	-\$0.3	-\$0.2	-\$0.2	-\$0.1	-\$0.1
Non-Rebound Fatality Costs	-\$17.3	-\$16.3	-\$14.8	-\$13.5	-\$12.4	-\$9.3	-\$2.9	-\$5.7
Non-Rebound Non-Fatal Crash Costs	-\$27.1	-\$25.5	-\$23.1	-\$21.1	-\$19.4	-\$14.5	-\$4.5	-\$8.9
Rebound Fatality Costs	-\$20.2	-\$19.6	-\$18.9	-\$17.9	-\$13.8	-\$13.3	-\$10.5	-\$9.7
Non-Fatal Crash Costs	-\$31.6	-\$30.7	-\$29.5	-\$28.0	-\$21.5	-\$20.7	-\$16.5	-\$15.2
Total Societal Costs	-\$254.8	-\$246.5	-\$233.5	-\$223.9	-\$190.7	-\$173.0	-\$120.5	-\$131.8
Societal Benefits								
Pre-Tax Fuel Savings	-\$54.5	-\$53.6	-\$52.5	-\$50.3	-\$37.1	-\$38.1	-\$34.6	-\$28.9
Rebound Fuel Benefit ¹	-\$24.9	-\$24.1	-\$23.0	-\$21.7	-\$16.6	-\$15.7	-\$12.1	-\$11.3
Refueling Time Benefit	-\$4.3	-\$4.2	-\$4.0	-\$3.8	-\$2.9	-\$2.9	-\$2.4	-\$2.1
Rebound Fatality Costs, Off-setting Benefit ²	-\$20.2	-\$19.6	-\$18.9	-\$17.9	-\$13.8	-\$13.3	-\$10.5	-\$9.7

*** EO 12866 Review – Draft – Do Not Cite, Quote or Release During Review ***

Rebound Non-Fatal Crash Costs, Off-setting Benefit ²	-\$31.6	-\$30.7	-\$29.5	-\$28.0	-\$21.5	-\$20.7	-\$16.5	-\$15.2
Petroleum Market Externality	-\$4.6	-\$4.5	-\$4.4	-\$4.2	-\$3.1	-\$3.2	-\$2.9	-\$2.5
CO2 Damage Reduction Benefit	-\$1.8	-\$1.7	-\$1.7	-\$1.6	-\$1.2	-\$1.2	-\$1.1	-\$0.9
NOx Damage Reduction Benefit	\$0.4	\$0.4	\$0.3	\$0.3	\$0.2	\$0.2	\$0.0	\$0.1
VOC Damage Reduction Benefit	\$0.1	\$0.1	\$0.1	\$0.1	\$0.1	\$0.0	\$0.0	\$0.0
PM Damage Reduction Benefit	\$0.5	\$0.5	\$0.4	\$0.3	\$0.3	\$0.1	-\$0.1	\$0.0
SO2 Damage Reduction Benefit	-\$0.9	-\$0.9	-\$0.9	-\$0.8	-\$0.5	-\$0.6	-\$0.5	-\$0.4
Total Societal Benefits	-\$141.7	-\$138.4	-\$134.1	-\$127.8	-\$96.1	-\$95.3	-\$80.7	-\$70.9
Net Total Benefits	\$113.1	\$108.2	\$99.4	\$96.1	\$94.5	\$77.7	\$39.7	\$60.9

¹ This value includes both the value of the fuel spent to drive rebound miles, and the consumer surplus representing the additional amount consumers would have, but did not spend to drive the additional miles.

² It is assumed that consumers that drive rebound miles fully internalize fatal and non-fatal crash costs. The miles are driven because they receive an equal and offsetting benefit from driving the miles. These cells report the magnitude of the offsetting benefits.

*** EO 12866 Review – Draft – Do Not Cite, Quote or Release During Review ***

TABLE 11-10 - SOCIETAL COSTS, BENEFITS AND NET BENEFITS, PASSENGER CARS, CAFE, 7% DISCOUNT RATE (BILLIONS 2016\$)

	Alternative							
	1	2	3	4	5	6	7	8
Model Years	2021-2026	2021-2026	2021-2026	2021-2026	2022-2026	2021-2026	2021-2026	2022-2026
Annual Rate of Stringency Increase	0.0%/Year PC 0.0%/Year LT	0.5%/Year PC 0.5%/Year LT	0.5%/Year PC 0.5%/Year LT	1.0%/Year PC 2.0%/Year LT	1.0%/Year PC 2.0%/Year LT	2.0%/Year PC 3.0%/Year LT	2.0%/Year PC 3.0%/Year LT	2.0%/Year PC 3.0%/Year LT
AC/Off-Cycle Procedures	No Change	No Change	Phaseout 2022-2026	No Change	No Change	No Change	Phaseout 2022-2026	No Change
Societal Costs								
Technology Costs	-\$85.9	-\$83.7	-\$79.7	-\$77.8	-\$65.3	-\$61.8	-\$48.3	-\$49.1
Advanced Technology Value Loss	-\$14.4	-\$14.4	-\$14.2	-\$14.3	-\$14.0	-\$13.7	-\$10.7	-\$12.5
Congestion Costs	-\$13.9	-\$13.4	-\$12.6	-\$12.0	-\$10.0	-\$8.9	-\$5.7	-\$6.3
Noise Costs	-\$0.2	-\$0.2	-\$0.2	-\$0.2	-\$0.1	-\$0.1	-\$0.1	-\$0.1
Non-Rebound Fatality Costs	-\$8.7	-\$8.2	-\$7.4	-\$6.9	-\$6.5	-\$4.9	-\$1.6	-\$3.0
Non-Rebound Non-Fatal Crash Costs	-\$13.7	-\$12.8	-\$11.6	-\$10.8	-\$10.2	-\$7.6	-\$2.5	-\$4.7
Rebound Fatality Costs	-\$12.5	-\$12.2	-\$11.7	-\$11.1	-\$8.4	-\$8.3	-\$6.7	-\$6.0
Non-Fatal Crash Costs	-\$19.6	-\$19.0	-\$18.3	-\$17.4	-\$13.2	-\$13.0	-\$10.5	-\$9.4
Total Societal Costs	-\$168.9	-\$163.8	-\$155.6	-\$150.4	-\$127.9	-\$118.4	-\$86.0	-\$91.1
Societal Benefits								
Pre-Tax Fuel Savings	-\$34.9	-\$34.2	-\$33.5	-\$31.9	-\$23.2	-\$24.3	-\$21.8	-\$18.0
Rebound Fuel Benefit ¹	-\$15.1	-\$14.7	-\$14.0	-\$13.3	-\$10.0	-\$9.7	-\$7.6	-\$6.9
Refueling Time Benefit	-\$2.7	-\$2.7	-\$2.6	-\$2.4	-\$1.8	-\$1.8	-\$1.6	-\$1.3
Rebound Fatality Costs, Off-setting Benefit ²	-\$12.5	-\$12.2	-\$11.7	-\$11.1	-\$8.4	-\$8.3	-\$6.7	-\$6.0

*** EO 12866 Review – Draft – Do Not Cite, Quote or Release During Review ***

Rebound Non-Fatal Crash Costs, Off-setting Benefit ²	-\$19.6	-\$19.0	-\$18.3	-\$17.4	-\$13.2	-\$13.0	-\$10.5	-\$9.4
Petroleum Market Externality	-\$2.9	-\$2.8	-\$2.8	-\$2.7	-\$2.0	-\$2.0	-\$1.8	-\$1.5
CO2 Damage Reduction Benefit	-\$1.1	-\$1.1	-\$1.1	-\$1.0	-\$0.8	-\$0.8	-\$0.7	-\$0.6
NOx Damage Reduction Benefit	\$0.2	\$0.2	\$0.2	\$0.2	\$0.1	\$0.1	\$0.0	\$0.1
VOC Damage Reduction Benefit	\$0.1	\$0.1	\$0.0	\$0.0	\$0.0	\$0.0	\$0.0	\$0.0
PM Damage Reduction Benefit	\$0.2	\$0.2	\$0.1	\$0.1	\$0.1	\$0.0	-\$0.1	\$0.0
SO2 Damage Reduction Benefit	-\$0.6	-\$0.6	-\$0.6	-\$0.5	-\$0.3	-\$0.4	-\$0.4	-\$0.2
Total Societal Benefits	-\$89.0	-\$86.9	-\$84.2	-\$80.0	-\$59.5	-\$60.2	-\$51.1	-\$44.0
Net Total Benefits	\$79.9	\$77.0	\$71.4	\$70.4	\$68.3	\$58.1	\$34.9	\$47.0

¹ This value includes both the value of the fuel spent to drive rebound miles, and the consumer surplus representing the additional amount consumers would have, but did not spend to drive the additional miles.

² It is assumed that consumers that drive rebound miles fully internalize fatal and non-fatal crash costs. The miles are driven because they receive an equal and offsetting benefit from driving the miles. These cells report the magnitude of the offsetting benefits.

*** EO 12866 Review – Draft – Do Not Cite, Quote or Release During Review ***

TABLE 11-11 - SOCIETAL COSTS, BENEFITS AND NET BENEFITS, PASSENGER CARS, CAFE, UNDISCOUNTED (BILLIONS 2016\$)

	Alternative							
	1	2	3	4	5	6	7	8
Model Years	2021-2026	2021-2026	2021-2026	2021-2026	2022-2026	2021-2026	2021-2026	2022-2026
Annual Rate of Stringency Increase	0.0%/Year PC 0.0%/Year LT	0.5%/Year PC 0.5%/Year LT	0.5%/Year PC 0.5%/Year LT	1.0%/Year PC 2.0%/Year LT	1.0%/Year PC 2.0%/Year LT	2.0%/Year PC 3.0%/Year LT	2.0%/Year PC 3.0%/Year LT	2.0%/Year PC 3.0%/Year LT
AC/Off-Cycle Procedures	No Change	No Change	Phaseout 2022-2026	No Change	No Change	No Change	Phaseout 2022-2026	No Change
Societal Costs								
Technology Costs	-\$142.5	-\$138.8	-\$131.9	-\$128.3	-\$108.6	-\$100.7	-\$76.7	-\$80.3
Advanced Technology Value Loss	-\$25.0	-\$24.9	-\$24.6	-\$24.8	-\$24.4	-\$23.7	-\$18.4	-\$21.5
Congestion Costs	-\$41.8	-\$40.0	-\$37.4	-\$34.9	-\$29.2	-\$25.1	-\$14.2	-\$17.4
Noise Costs	-\$0.6	-\$0.5	-\$0.5	-\$0.5	-\$0.4	-\$0.3	-\$0.2	-\$0.2
Non-Rebound Fatality Costs	-\$31.9	-\$30.0	-\$27.3	-\$24.6	-\$22.1	-\$16.6	-\$5.1	-\$10.2
Non-Rebound Non-Fatal Crash Costs	-\$50.0	-\$47.0	-\$42.7	-\$38.5	-\$34.5	-\$26.0	-\$8.0	-\$15.9
Rebound Fatality Costs	-\$30.4	-\$29.5	-\$28.4	-\$26.9	-\$20.8	-\$19.7	-\$15.5	-\$14.6
Non-Fatal Crash Costs	-\$47.5	-\$46.2	-\$44.4	-\$42.1	-\$32.6	-\$30.9	-\$24.2	-\$22.8
Total Societal Costs	-\$369.7	-\$357.0	-\$337.2	-\$320.6	-\$272.6	-\$243.0	-\$162.3	-\$183.0
Societal Benefits								
Pre-Tax Fuel Savings	-\$78.1	-\$77.0	-\$75.6	-\$73.0	-\$54.3	-\$55.3	-\$51.1	-\$42.9
Rebound Fuel Benefit ¹	-\$38.0	-\$36.8	-\$35.1	-\$33.1	-\$25.5	-\$23.7	-\$18.1	-\$17.2
Refueling Time Benefit	-\$6.1	-\$6.0	-\$5.8	-\$5.5	-\$4.2	-\$4.1	-\$3.6	-\$3.1
Rebound Fatality Costs, Off-setting Benefit ²	-\$30.4	-\$29.5	-\$28.4	-\$26.9	-\$20.8	-\$19.7	-\$15.5	-\$14.6

*** EO 12866 Review – Draft – Do Not Cite, Quote or Release During Review ***

Rebound Non-Fatal Crash Costs, Off-setting Benefit ²	-\$47.5	-\$46.2	-\$44.4	-\$42.1	-\$32.6	-\$30.9	-\$24.2	-\$22.8
Petroleum Market Externality	-\$6.5	-\$6.4	-\$6.3	-\$6.1	-\$4.6	-\$4.7	-\$4.3	-\$3.6
CO2 Damage Reduction Benefit	-\$2.5	-\$2.5	-\$2.5	-\$2.4	-\$1.8	-\$1.8	-\$1.7	-\$1.4
NOx Damage Reduction Benefit	\$0.7	\$0.6	\$0.6	\$0.5	\$0.4	\$0.3	\$0.1	\$0.2
VOC Damage Reduction Benefit	\$0.2	\$0.2	\$0.1	\$0.1	\$0.1	\$0.1	\$0.0	\$0.0
PM Damage Reduction Benefit	\$1.1	\$1.0	\$0.9	\$0.7	\$0.6	\$0.4	-\$0.2	\$0.1
SO2 Damage Reduction Benefit	-\$1.2	-\$1.2	-\$1.2	-\$1.1	-\$0.7	-\$0.8	-\$0.8	-\$0.5
Total Societal Benefits	-\$208.5	-\$203.8	-\$197.5	-\$189.0	-\$143.4	-\$140.2	-\$119.2	-\$105.8
Net Total Benefits	\$161.2	\$153.2	\$139.7	\$131.6	\$129.1	\$102.8	\$43.1	\$77.2

¹ This value includes both the value of the fuel spent to drive rebound miles, and the consumer surplus representing the additional amount consumers would have, but did not spend to drive the additional miles.

² It is assumed that consumers that drive rebound miles fully internalize fatal and non-fatal crash costs. The miles are driven because they receive an equal and offsetting benefit from driving the miles. These cells report the magnitude of the offsetting benefits.

*** EO 12866 Review – Draft – Do Not Cite, Quote or Release During Review ***

TABLE 11-12 - SOCIETAL COSTS, BENEFITS AND NET BENEFITS, LIGHT TRUCKS, CAFE, 3% DISCOUNT RATE (BILLIONS 2016\$)

	Alternative							
	1	2	3	4	5	6	7	8
Model Years	2021-2026	2021-2026	2021-2026	2021-2026	2022-2026	2021-2026	2021-2026	2022-2026
Annual Rate of Stringency Increase	0.0%/Year PC 0.0%/Year LT	0.5%/Year PC 0.5%/Year LT	0.5%/Year PC 0.5%/Year LT	1.0%/Year PC 2.0%/Year LT	1.0%/Year PC 2.0%/Year LT	2.0%/Year PC 3.0%/Year LT	2.0%/Year PC 3.0%/Year LT	2.0%/Year PC 3.0%/Year LT
AC/Off-Cycle Procedures	No Change	No Change	Phaseout 2022-2026	No Change	No Change	No Change	Phaseout 2022-2026	No Change
Societal Costs								
Technology Costs	-\$141.5	-\$134.4	-\$124.8	-\$109.1	-\$84.8	-\$68.3	-\$31.5	-\$32.9
Advanced Technology Value Loss	-\$16.3	-\$16.3	-\$16.3	-\$16.2	-\$16.2	-\$15.9	-\$10.9	-\$15.5
Congestion Costs	-\$26.4	-\$23.9	-\$22.3	-\$16.7	-\$10.5	-\$9.0	-\$5.0	-\$4.7
Noise Costs	-\$0.4	-\$0.4	-\$0.3	-\$0.3	-\$0.2	-\$0.1	-\$0.1	-\$0.1
Non-Rebound Fatality Costs	-\$18.1	-\$16.2	-\$15.4	-\$11.5	-\$6.2	-\$5.5	-\$3.4	-\$2.7
Non-Rebound Non-Fatal Crash Costs	-\$28.3	-\$25.4	-\$24.1	-\$18.0	-\$9.7	-\$8.6	-\$5.3	-\$4.2
Rebound Fatality Costs	-\$21.5	-\$19.6	-\$18.2	-\$14.1	-\$10.0	-\$8.4	-\$4.4	-\$4.6
Non-Fatal Crash Costs	-\$33.7	-\$30.7	-\$28.4	-\$22.0	-\$15.6	-\$13.1	-\$6.9	-\$7.2
Total Societal Costs	-\$286.1	-\$266.8	-\$249.9	-\$207.9	-\$153.1	-\$128.9	-\$67.5	-\$71.9
Societal Benefits								
Pre-Tax Fuel Savings	-\$78.6	-\$72.1	-\$66.9	-\$53.6	-\$40.6	-\$34.7	-\$17.7	-\$19.3
Rebound Fuel Benefit ¹	-\$36.2	-\$33.0	-\$30.4	-\$23.2	-\$16.2	-\$13.3	-\$6.8	-\$7.4
Refueling Time Benefit	-\$4.2	-\$3.9	-\$3.6	-\$3.0	-\$2.2	-\$2.0	-\$1.1	-\$1.1
Rebound Fatality Costs, Off-setting Benefit ²	-\$21.5	-\$19.6	-\$18.2	-\$14.1	-\$10.0	-\$8.4	-\$4.4	-\$4.6

*** EO 12866 Review – Draft – Do Not Cite, Quote or Release During Review ***

Rebound Non-Fatal Crash Costs, Off-setting Benefit ²	-\$33.7	-\$30.7	-\$28.4	-\$22.0	-\$15.6	-\$13.1	-\$6.9	-\$7.2
Petroleum Market Externality	-\$6.4	-\$5.9	-\$5.5	-\$4.4	-\$3.3	-\$2.9	-\$1.5	-\$1.6
CO2 Damage Reduction Benefit	-\$2.6	-\$2.3	-\$2.2	-\$1.7	-\$1.3	-\$1.1	-\$0.6	-\$0.6
NOx Damage Reduction Benefit	\$0.4	\$0.3	\$0.3	\$0.3	\$0.2	\$0.2	\$0.1	\$0.1
VOC Damage Reduction Benefit	\$0.0	\$0.0	\$0.0	\$0.0	\$0.0	\$0.0	\$0.0	\$0.0
PM Damage Reduction Benefit	-\$0.2	-\$0.2	-\$0.2	-\$0.2	-\$0.2	-\$0.2	-\$0.1	-\$0.1
SO2 Damage Reduction Benefit	-\$1.6	-\$1.4	-\$1.3	-\$1.0	-\$0.7	-\$0.6	-\$0.3	-\$0.3
Total Societal Benefits	-\$184.6	-\$168.7	-\$156.2	-\$122.9	-\$90.0	-\$76.0	-\$39.2	-\$42.1
Net Total Benefits	\$101.6	\$98.1	\$93.7	\$85.0	\$63.1	\$52.9	\$28.4	\$29.8

¹ This value includes both the value of the fuel spent to drive rebound miles, and the consumer surplus representing the additional amount consumers would have, but did not spend to drive the additional miles.

² It is assumed that consumers that drive rebound miles fully internalize fatal and non-fatal crash costs. The miles are driven because they receive an equal and offsetting benefit from driving the miles. These cells report the magnitude of the offsetting benefits.

*** EO 12866 Review – Draft – Do Not Cite, Quote or Release During Review ***

TABLE 11-13 - SOCIETAL COSTS, BENEFITS AND NET BENEFITS, LIGHT TRUCKS, CAFE, 7% DISCOUNT RATE (BILLIONS 2016\$)

	Alternative							
	1	2	3	4	5	6	7	8
Model Years	2021-2026	2021-2026	2021-2026	2021-2026	2022-2026	2021-2026	2021-2026	2022-2026
Annual Rate of Stringency Increase	0.0%/Year PC 0.0%/Year LT	0.5%/Year PC 0.5%/Year LT	0.5%/Year PC 0.5%/Year LT	1.0%/Year PC 2.0%/Year LT	1.0%/Year PC 2.0%/Year LT	2.0%/Year PC 3.0%/Year LT	2.0%/Year PC 3.0%/Year LT	2.0%/Year PC 3.0%/Year LT
AC/Off-Cycle Procedures	No Change	No Change	Phaseout 2022-2026	No Change	No Change	No Change	Phaseout 2022-2026	No Change
Societal Costs								
Technology Costs	-\$108.3	-\$102.8	-\$95.3	-\$83.6	-\$65.2	-\$52.7	-\$24.9	-\$25.3
Advanced Technology Value Loss	-\$12.0	-\$12.0	-\$12.0	-\$12.0	-\$12.0	-\$11.7	-\$8.2	-\$11.4
Congestion Costs	-\$15.3	-\$13.8	-\$13.0	-\$9.8	-\$6.1	-\$5.4	-\$3.1	-\$2.7
Noise Costs	-\$0.2	-\$0.2	-\$0.2	-\$0.1	-\$0.1	-\$0.1	\$0.0	\$0.0
Non-Rebound Fatality Costs	-\$9.7	-\$8.7	-\$8.3	-\$6.2	-\$3.2	-\$3.0	-\$2.1	-\$1.4
Non-Rebound Non-Fatal Crash Costs	-\$15.2	-\$13.6	-\$13.0	-\$9.7	-\$5.0	-\$4.8	-\$3.3	-\$2.2
Rebound Fatality Costs	-\$13.3	-\$12.1	-\$11.2	-\$8.7	-\$6.2	-\$5.3	-\$2.8	-\$2.9
Non-Fatal Crash Costs	-\$20.9	-\$19.0	-\$17.6	-\$13.7	-\$9.7	-\$8.3	-\$4.5	-\$4.5
Total Societal Costs	-\$194.9	-\$182.2	-\$170.6	-\$143.9	-\$107.5	-\$91.2	-\$49.0	-\$50.4
Societal Benefits								
Pre-Tax Fuel Savings	-\$49.5	-\$45.3	-\$42.0	-\$33.7	-\$25.4	-\$21.8	-\$11.3	-\$12.0
Rebound Fuel Benefit ¹	-\$22.0	-\$20.0	-\$18.4	-\$14.1	-\$9.8	-\$8.2	-\$4.3	-\$4.5
Refueling Time Benefit	-\$2.7	-\$2.5	-\$2.3	-\$1.9	-\$1.4	-\$1.3	-\$0.7	-\$0.7
Rebound Fatality Costs, Off-setting Benefit ²	-\$13.3	-\$12.1	-\$11.2	-\$8.7	-\$6.2	-\$5.3	-\$2.8	-\$2.9

*** EO 12866 Review – Draft – Do Not Cite, Quote or Release During Review ***

Rebound Non-Fatal Crash Costs, Off-setting Benefit ²	-\$20.9	-\$19.0	-\$17.6	-\$13.7	-\$9.7	-\$8.3	-\$4.5	-\$4.5
Petroleum Market Externality	-\$4.0	-\$3.7	-\$3.4	-\$2.8	-\$2.1	-\$1.8	-\$0.9	-\$1.0
CO2 Damage Reduction Benefit	-\$1.6	-\$1.5	-\$1.4	-\$1.1	-\$0.8	-\$0.7	-\$0.4	-\$0.4
NOx Damage Reduction Benefit	\$0.2	\$0.2	\$0.2	\$0.2	\$0.1	\$0.1	\$0.1	\$0.1
VOC Damage Reduction Benefit	\$0.0	\$0.0	\$0.0	\$0.0	\$0.0	\$0.0	\$0.0	\$0.0
PM Damage Reduction Benefit	-\$0.2	-\$0.2	-\$0.2	-\$0.2	-\$0.2	-\$0.1	-\$0.1	-\$0.1
SO2 Damage Reduction Benefit	-\$1.0	-\$0.9	-\$0.8	-\$0.7	-\$0.5	-\$0.4	-\$0.2	-\$0.2
Total Societal Benefits	-\$115.1	-\$104.9	-\$97.2	-\$76.7	-\$56.0	-\$47.7	-\$25.1	-\$26.1
Net Total Benefits	\$79.8	\$77.3	\$73.4	\$67.3	\$51.5	\$43.5	\$23.8	\$24.3

¹ This value includes both the value of the fuel spent to drive rebound miles, and the consumer surplus representing the additional amount consumers would have, but did not spend to drive the additional miles.

² It is assumed that consumers that drive rebound miles fully internalize fatal and non-fatal crash costs. The miles are driven because they receive an equal and offsetting benefit from driving the miles. These cells report the magnitude of the offsetting benefits.

*** EO 12866 Review – Draft – Do Not Cite, Quote or Release During Review ***

TABLE 11-14 - SOCIETAL COSTS, BENEFITS AND NET BENEFITS, LIGHT TRUCKS, CAFE, UNDISCOUNTED (BILLIONS 2016\$)

	Alternative							
	1	2	3	4	5	6	7	8
Model Years	2021-2026	2021-2026	2021-2026	2021-2026	2022-2026	2021-2026	2021-2026	2022-2026
Annual Rate of Stringency Increase	0.0%/Year PC 0.0%/Year LT	0.5%/Year PC 0.5%/Year LT	0.5%/Year PC 0.5%/Year LT	1.0%/Year PC 2.0%/Year LT	1.0%/Year PC 2.0%/Year LT	2.0%/Year PC 3.0%/Year LT	2.0%/Year PC 3.0%/Year LT	2.0%/Year PC 3.0%/Year LT
AC/Off-Cycle Procedures	No Change	No Change	Phaseout 2022-2026	No Change	No Change	No Change	Phaseout 2022-2026	No Change
Societal Costs								
Technology Costs	-\$175.8	-\$167.2	-\$155.3	-\$135.4	-\$104.9	-\$84.3	-\$38.1	-\$40.8
Advanced Technology Value Loss	-\$20.8	-\$20.8	-\$20.8	-\$20.8	-\$20.8	-\$20.3	-\$13.7	-\$19.7
Congestion Costs	-\$42.4	-\$38.4	-\$35.9	-\$26.8	-\$17.0	-\$14.2	-\$7.6	-\$7.6
Noise Costs	-\$0.6	-\$0.6	-\$0.5	-\$0.4	-\$0.3	-\$0.2	-\$0.1	-\$0.1
Non-Rebound Fatality Costs	-\$31.0	-\$27.8	-\$26.4	-\$19.6	-\$11.0	-\$9.3	-\$5.3	-\$4.8
Non-Rebound Non-Fatal Crash Costs	-\$48.5	-\$43.5	-\$41.2	-\$30.7	-\$17.2	-\$14.6	-\$8.3	-\$7.6
Rebound Fatality Costs	-\$32.4	-\$29.6	-\$27.4	-\$21.2	-\$15.0	-\$12.5	-\$6.4	-\$6.9
Non-Fatal Crash Costs	-\$50.7	-\$46.3	-\$42.9	-\$33.1	-\$23.5	-\$19.6	-\$10.1	-\$10.9
Total Societal Costs	-\$402.3	-\$374.1	-\$350.3	-\$288.0	-\$209.6	-\$175.0	-\$89.6	-\$98.4
Societal Benefits								
Pre-Tax Fuel Savings	-\$116.2	-\$106.9	-\$99.1	-\$79.4	-\$60.4	-\$51.3	-\$26.0	-\$28.8
Rebound Fuel Benefit ¹	-\$55.7	-\$50.8	-\$46.7	-\$35.6	-\$24.9	-\$20.2	-\$10.2	-\$11.3
Refueling Time Benefit	-\$6.2	-\$5.7	-\$5.3	-\$4.3	-\$3.2	-\$2.9	-\$1.6	-\$1.6
Rebound Fatality Costs, Off-setting Benefit ²	-\$32.4	-\$29.6	-\$27.4	-\$21.2	-\$15.0	-\$12.5	-\$6.4	-\$6.9

*** EO 12866 Review – Draft – Do Not Cite, Quote or Release During Review ***

Rebound Non-Fatal Crash Costs, Off-setting Benefit ²	-\$50.7	-\$46.3	-\$42.9	-\$33.1	-\$23.5	-\$19.6	-\$10.1	-\$10.9
Petroleum Market Externality	-\$9.4	-\$8.7	-\$8.1	-\$6.5	-\$5.0	-\$4.2	-\$2.2	-\$2.4
CO2 Damage Reduction Benefit	-\$3.8	-\$3.5	-\$3.3	-\$2.6	-\$2.0	-\$1.7	-\$0.9	-\$0.9
NOx Damage Reduction Benefit	\$0.6	\$0.5	\$0.5	\$0.4	\$0.3	\$0.3	\$0.2	\$0.1
VOC Damage Reduction Benefit	\$0.1	\$0.1	\$0.1	\$0.0	\$0.0	\$0.0	\$0.0	\$0.0
PM Damage Reduction Benefit	\$0.0	-\$0.1	\$0.0	-\$0.1	-\$0.2	-\$0.1	-\$0.1	-\$0.1
SO2 Damage Reduction Benefit	-\$2.2	-\$2.0	-\$1.9	-\$1.5	-\$1.1	-\$0.9	-\$0.4	-\$0.4
Total Societal Benefits	-\$276.1	-\$253.0	-\$234.1	-\$183.8	-\$134.9	-\$113.1	-\$57.4	-\$63.2
Net Total Benefits	\$126.2	\$121.2	\$116.3	\$104.1	\$74.7	\$61.9	\$32.2	\$35.2

¹ This value includes both the value of the fuel spent to drive rebound miles, and the consumer surplus representing the additional amount consumers would have, but did not spend to drive the additional miles.

² It is assumed that consumers that drive rebound miles fully internalize fatal and non-fatal crash costs. The miles are driven because they receive an equal and offsetting benefit from driving the miles. These cells report the magnitude of the offsetting benefits.

*** EO 12866 Review – Draft – Do Not Cite, Quote or Release During Review ***

TABLE 11-15 - SOCIETAL COSTS, BENEFITS AND NET BENEFITS, PASSENGER CARS AND LIGHT TRUCKS COMBINED, CAFE, 3% DISCOUNT RATE (BILLIONS 2016\$)

	Alternative							
	1	2	3	4	5	6	7	8
Model Years	2021-2026	2021-2026	2021-2026	2021-2026	2022-2026	2021-2026	2021-2026	2022-2026
Annual Rate of Stringency Increase	0.0%/Year PC 0.0%/Year LT	0.5%/Year PC 0.5%/Year LT	0.5%/Year PC 0.5%/Year LT	1.0%/Year PC 2.0%/Year LT	1.0%/Year PC 2.0%/Year LT	2.0%/Year PC 3.0%/Year LT	2.0%/Year PC 3.0%/Year LT	2.0%/Year PC 3.0%/Year LT
AC/Off-Cycle Procedures	No Change	No Change	Phaseout 2022-2026	No Change	No Change	No Change	Phaseout 2022-2026	No Change
Societal Costs								
Technology Costs	-\$255.1	-\$245.2	-\$230.1	-\$211.7	-\$171.4	-\$149.2	-\$93.8	-\$97.4
Advanced Technology Value Loss	-\$35.9	-\$35.8	-\$35.5	-\$35.6	-\$35.3	-\$34.5	-\$25.4	-\$32.3
Congestion Costs	-\$51.3	-\$47.8	-\$44.7	-\$37.8	-\$28.1	-\$24.4	-\$14.2	-\$15.5
Noise Costs	-\$0.7	-\$0.7	-\$0.6	-\$0.5	-\$0.4	-\$0.3	-\$0.2	-\$0.2
Non-Rebound Fatality Costs	-\$35.4	-\$32.5	-\$30.2	-\$25.0	-\$18.6	-\$14.8	-\$6.3	-\$8.4
Non-Rebound Non-Fatal Crash Costs	-\$55.4	-\$50.8	-\$47.2	-\$39.1	-\$29.1	-\$23.1	-\$9.8	-\$13.2
Rebound Fatality Costs	-\$41.7	-\$39.3	-\$37.1	-\$32.0	-\$23.7	-\$21.7	-\$14.9	-\$14.3
Non-Fatal Crash Costs	-\$65.3	-\$61.4	-\$58.0	-\$50.0	-\$37.1	-\$33.9	-\$23.4	-\$22.4
Total Societal Costs	-\$540.9	-\$513.4	-\$483.4	-\$431.8	-\$343.8	-\$301.9	-\$188.0	-\$203.8
Societal Benefits								
Pre-Tax Fuel Savings	-\$133.1	-\$125.7	-\$119.3	-\$103.9	-\$77.7	-\$72.8	-\$52.3	-\$48.3
Rebound Fuel Benefit ¹	-\$61.1	-\$57.1	-\$53.4	-\$44.9	-\$32.8	-\$28.9	-\$18.9	-\$18.6
Refueling Time Benefit	-\$8.5	-\$8.1	-\$7.7	-\$6.8	-\$5.1	-\$4.8	-\$3.5	-\$3.2
Rebound Fatality Costs, Off-setting Benefit ²	-\$41.7	-\$39.3	-\$37.1	-\$32.0	-\$23.7	-\$21.7	-\$14.9	-\$14.3

*** EO 12866 Review – Draft – Do Not Cite, Quote or Release During Review ***

Rebound Non-Fatal Crash Costs, Off-setting Benefit ²	-\$65.3	-\$61.4	-\$58.0	-\$50.0	-\$37.1	-\$33.9	-\$23.4	-\$22.4
Petroleum Market Externality	-\$11.0	-\$10.3	-\$9.8	-\$8.6	-\$6.5	-\$6.1	-\$4.4	-\$4.1
CO2 Damage Reduction Benefit	-\$4.3	-\$4.1	-\$3.9	-\$3.4	-\$2.5	-\$2.4	-\$1.7	-\$1.6
NOx Damage Reduction Benefit	\$0.8	\$0.7	\$0.6	\$0.5	\$0.4	\$0.4	\$0.2	\$0.2
VOC Damage Reduction Benefit	\$0.1	\$0.1	\$0.1	\$0.1	\$0.1	\$0.1	\$0.0	\$0.0
PM Damage Reduction Benefit	\$0.3	\$0.3	\$0.2	\$0.1	\$0.1	\$0.0	-\$0.2	-\$0.1
SO2 Damage Reduction Benefit	-\$2.4	-\$2.3	-\$2.2	-\$1.8	-\$1.3	-\$1.2	-\$0.8	-\$0.7
Total Societal Benefits	-\$326.2	-\$307.1	-\$290.3	-\$250.7	-\$186.1	-\$171.3	-\$119.9	-\$113.0
Net Total Benefits	\$214.6	\$206.3	\$193.1	\$181.1	\$157.6	\$130.6	\$68.1	\$90.7

¹ This value includes both the value of the fuel spent to drive rebound miles, and the consumer surplus representing the additional amount consumers would have, but did not spend to drive the additional miles.

² It is assumed that consumers that drive rebound miles fully internalize fatal and non-fatal crash costs. The miles are driven because they receive an equal and offsetting benefit from driving the miles. These cells report the magnitude of the offsetting benefits.

*** EO 12866 Review – Draft – Do Not Cite, Quote or Release During Review ***

TABLE 11-16 - SOCIETAL COSTS, BENEFITS AND NET BENEFITS, PASSENGER CARS AND LIGHT TRUCKS COMBINED, CAFE, 7% DISCOUNT RATE (BILLIONS 2016\$)

	Alternative							
	1	2	3	4	5	6	7	8
Model Years	2021-2026	2021-2026	2021-2026	2021-2026	2022-2026	2021-2026	2021-2026	2022-2026
Annual Rate of Stringency Increase	0.0%/Year PC 0.0%/Year LT	0.5%/Year PC 0.5%/Year LT	0.5%/Year PC 0.5%/Year LT	1.0%/Year PC 2.0%/Year LT	1.0%/Year PC 2.0%/Year LT	2.0%/Year PC 3.0%/Year LT	2.0%/Year PC 3.0%/Year LT	2.0%/Year PC 3.0%/Year LT
AC/Off-Cycle Procedures	No Change	No Change	Phaseout 2022-2026	No Change	No Change	No Change	Phaseout 2022-2026	No Change
Societal Costs								
Technology Costs	-\$194.2	-\$186.5	-\$174.9	-\$161.4	-\$130.6	-\$114.5	-\$73.2	-\$74.4
Advanced Technology Value Loss	-\$26.4	-\$26.3	-\$26.2	-\$26.2	-\$26.0	-\$25.4	-\$18.9	-\$23.9
Congestion Costs	-\$29.2	-\$27.2	-\$25.5	-\$21.7	-\$16.1	-\$14.3	-\$8.8	-\$9.0
Noise Costs	-\$0.4	-\$0.4	-\$0.4	-\$0.3	-\$0.2	-\$0.2	-\$0.1	-\$0.1
Non-Rebound Fatality Costs	-\$18.5	-\$16.9	-\$15.7	-\$13.1	-\$9.7	-\$7.9	-\$3.7	-\$4.4
Non-Rebound Non-Fatal Crash Costs	-\$28.9	-\$26.5	-\$24.6	-\$20.6	-\$15.2	-\$12.4	-\$5.7	-\$6.9
Rebound Fatality Costs	-\$25.9	-\$24.3	-\$23.0	-\$19.9	-\$14.6	-\$13.6	-\$9.6	-\$8.9
Non-Fatal Crash Costs	-\$40.4	-\$38.0	-\$35.9	-\$31.1	-\$22.9	-\$21.3	-\$15.0	-\$13.9
Total Societal Costs	-\$363.9	-\$346.1	-\$326.2	-\$294.3	-\$235.3	-\$209.6	-\$135.0	-\$141.5
Societal Benefits								
Pre-Tax Fuel Savings	-\$84.4	-\$79.5	-\$75.5	-\$65.6	-\$48.7	-\$46.1	-\$33.1	-\$30.1
Rebound Fuel Benefit ¹	-\$37.1	-\$34.6	-\$32.4	-\$27.4	-\$19.9	-\$17.8	-\$11.9	-\$11.4
Refueling Time Benefit	-\$5.5	-\$5.2	-\$4.9	-\$4.3	-\$3.2	-\$3.1	-\$2.3	-\$2.0

*** EO 12866 Review – Draft – Do Not Cite, Quote or Release During Review ***

Rebound Fatality Costs, Off-setting Benefit ²	-\$25.9	-\$24.3	-\$23.0	-\$19.9	-\$14.6	-\$13.6	-\$9.6	-\$8.9
Rebound Non-Fatal Crash Costs, Off-setting Benefit ²	-\$40.4	-\$38.0	-\$35.9	-\$31.1	-\$22.9	-\$21.3	-\$15.0	-\$13.9
Petroleum Market Externality	-\$6.9	-\$6.5	-\$6.2	-\$5.4	-\$4.0	-\$3.8	-\$2.8	-\$2.5
CO2 Damage Reduction Benefit	-\$2.7	-\$2.6	-\$2.4	-\$2.1	-\$1.6	-\$1.5	-\$1.1	-\$1.0
NOx Damage Reduction Benefit	\$0.4	\$0.4	\$0.4	\$0.3	\$0.2	\$0.2	\$0.1	\$0.1
VOC Damage Reduction Benefit	\$0.1	\$0.1	\$0.1	\$0.1	\$0.0	\$0.0	\$0.0	\$0.0
PM Damage Reduction Benefit	\$0.0	\$0.0	-\$0.1	-\$0.1	-\$0.1	-\$0.1	-\$0.2	-\$0.1
SO2 Damage Reduction Benefit	-\$1.6	-\$1.5	-\$1.4	-\$1.2	-\$0.8	-\$0.8	-\$0.5	-\$0.4
Total Societal Benefits	-\$204.1	-\$191.8	-\$181.4	-\$156.7	-\$115.5	-\$108.0	-\$76.2	-\$70.2
Net Total Benefits	\$159.7	\$154.3	\$144.8	\$137.6	\$119.9	\$101.6	\$58.8	\$71.3

¹ This value includes both the value of the fuel spent to drive rebound miles, and the consumer surplus representing the additional amount consumers would have, but did not spend to drive the additional miles.

² It is assumed that consumers that drive rebound miles fully internalize fatal and non-fatal crash costs. The miles are driven because they receive an equal and offsetting benefit from driving the miles. These cells report the magnitude of the offsetting benefits.

*** EO 12866 Review – Draft – Do Not Cite, Quote or Release During Review ***

TABLE 11-17 - SOCIETAL COSTS, BENEFITS AND NET BENEFITS, PASSENGER CARS AND LIGHT TRUCKS COMBINED, CAFE, UNDISCOUNTED (BILLIONS 2016\$)

	Alternative							
	1	2	3	4	5	6	7	8
Model Years	2021-2026	2021-2026	2021-2026	2021-2026	2022-2026	2021-2026	2021-2026	2022-2026
Annual Rate of Stringency Increase	0.0%/Year PC 0.0%/Year LT	0.5%/Year PC 0.5%/Year LT	0.5%/Year PC 0.5%/Year LT	1.0%/Year PC 2.0%/Year LT	1.0%/Year PC 2.0%/Year LT	2.0%/Year PC 3.0%/Year LT	2.0%/Year PC 3.0%/Year LT	2.0%/Year PC 3.0%/Year LT
AC/Off-Cycle Procedures	No Change	No Change	Phaseout 2022-2026	No Change	No Change	No Change	Phaseout 2022-2026	No Change
Societal Costs								
Technology Costs	-\$318.3	-\$306.0	-\$287.2	-\$263.7	-\$213.5	-\$185.0	-\$114.8	-\$121.1
Advanced Technology Value Loss	-\$45.8	-\$45.7	-\$45.4	-\$45.6	-\$45.1	-\$44.0	-\$32.1	-\$41.3
Congestion Costs	-\$84.2	-\$78.4	-\$73.3	-\$61.8	-\$46.2	-\$39.3	-\$21.8	-\$25.1
Noise Costs	-\$1.2	-\$1.1	-\$1.0	-\$0.9	-\$0.6	-\$0.5	-\$0.3	-\$0.3
Non-Rebound Fatality Costs	-\$63.0	-\$57.9	-\$53.7	-\$44.2	-\$33.1	-\$25.9	-\$10.4	-\$15.0
Non-Rebound Non-Fatal Crash Costs	-\$98.5	-\$90.5	-\$83.9	-\$69.2	-\$51.7	-\$40.6	-\$16.3	-\$23.5
Rebound Fatality Costs	-\$62.8	-\$59.1	-\$55.8	-\$48.1	-\$35.8	-\$32.3	-\$21.9	-\$21.5
Non-Fatal Crash Costs	-\$98.2	-\$92.5	-\$87.2	-\$75.2	-\$56.1	-\$50.5	-\$34.3	-\$33.7
Total Societal Costs	-\$772.1	-\$731.2	-\$687.5	-\$608.6	-\$482.1	-\$418.0	-\$251.9	-\$281.5
Societal Benefits								
Pre-Tax Fuel Savings	-\$194.4	-\$183.9	-\$174.7	-\$152.5	-\$114.7	-\$106.6	-\$77.0	-\$71.7
Rebound Fuel Benefit ¹	-\$93.7	-\$87.6	-\$81.8	-\$68.8	-\$50.4	-\$43.8	-\$28.2	-\$28.5
Refueling Time Benefit	-\$12.3	-\$11.7	-\$11.1	-\$9.9	-\$7.4	-\$7.0	-\$5.1	-\$4.7
Rebound Fatality Costs, Off-setting Benefit ²	-\$62.8	-\$59.1	-\$55.8	-\$48.1	-\$35.8	-\$32.3	-\$21.9	-\$21.5

*** EO 12866 Review – Draft – Do Not Cite, Quote or Release During Review ***

Rebound Non-Fatal Crash Costs, Off-setting Benefit ²	-\$98.2	-\$92.5	-\$87.2	-\$75.2	-\$56.1	-\$50.5	-\$34.3	-\$33.7
Petroleum Market Externality	-\$16.0	-\$15.1	-\$14.4	-\$12.6	-\$9.5	-\$8.9	-\$6.4	-\$6.0
CO2 Damage Reduction Benefit	-\$6.4	-\$6.0	-\$5.7	-\$5.0	-\$3.8	-\$3.5	-\$2.5	-\$2.4
NOx Damage Reduction Benefit	\$1.3	\$1.2	\$1.1	\$0.9	\$0.7	\$0.6	\$0.3	\$0.3
VOC Damage Reduction Benefit	\$0.2	\$0.2	\$0.2	\$0.2	\$0.1	\$0.1	\$0.0	\$0.0
PM Damage Reduction Benefit	\$1.1	\$1.0	\$0.8	\$0.6	\$0.5	\$0.2	-\$0.2	\$0.0
SO ₂ Damage Reduction Benefit	-\$3.4	-\$3.2	-\$3.1	-\$2.6	-\$1.8	-\$1.7	-\$1.1	-\$0.9
Total Societal Benefits	-\$484.6	-\$456.8	-\$431.6	-\$372.8	-\$278.3	-\$253.4	-\$176.6	-\$169.1
Net Total Benefits	\$287.5	\$274.4	\$255.9	\$235.7	\$203.8	\$164.7	\$75.3	\$112.4

¹ This value includes both the value of the fuel spent to drive rebound miles, and the consumer surplus representing the additional amount consumers would have, but did not spend to drive the additional miles.

² It is assumed that consumers that drive rebound miles fully internalize fatal and non-fatal crash costs. The miles are driven because they receive an equal and offsetting benefit from driving the miles. These cells report the magnitude of the offsetting benefits.

*** EO 12866 Review – Draft – Do Not Cite, Quote or Release During Review ***

TABLE 11-18 - CONSUMER IMPACTS AND NET CONSUMER BENEFITS, MY 2030 PASSENGER CARS RELATIVE TO AUGURAL STANDARDS, CAFE, 3% DISCOUNT RATE (BILLIONS 2016\$)

	Alternative							
	1	2	3	4	5	6	7	8
Model Years	2021-2026	2021-2026	2021-2026	2021-2026	2022-2026	2021-2026	2021-2026	2022-2026
Annual Rate of Stringency Increase	0.0%/Year PC 0.0%/Year LT	0.5%/Year PC 0.5%/Year LT	0.5%/Year PC 0.5%/Year LT	1.0%/Year PC 2.0%/Year LT	1.0%/Year PC 2.0%/Year LT	2.0%/Year PC 3.0%/Year LT	2.0%/Year PC 3.0%/Year LT	2.0%/Year PC 3.0%/Year LT
AC/Off-Cycle Procedures	No Change	No Change	Phaseout 2022-2026	No Change	No Change	No Change	Phaseout 2022-2026	No Change
Price Increase	-1648	-1601	-1492	-1404	-1201	-1011	-658	-796
Welfare Loss	-352	-350	-346	-348	-342	-328	-242	-298
Additional Ownership Costs	-390	-380	-354	-335	-288	-244	-159	-193
Fuel Savings	-1119	-1089	-1029	-984	-817	-666	-463	-537
Mobility Benefit	-405	-391	-364	-341	-277	-220	-142	-169
Refueling Benefit	-55	-54	-51	-49	-41	-33	-24	-27
Total Consumer Costs	-2390	-2331	-2192	-2088	-1831	-1583	-1059	-1288
Total Consumer Benefits	-1580	-1533	-1444	-1374	-1134	-919	-629	-733
Net Consumer Benefits	810	797	748	714	697	664	429	555

*** EO 12866 Review – Draft – Do Not Cite, Quote or Release During Review ***

TABLE 11-19 - CONSUMER IMPACTS AND NET CONSUMER BENEFITS, MY 2030 PASSENGER CARS RELATIVE TO AUGURAL STANDARDS, CAFE, 7% DISCOUNT RATE (BILLIONS 2016\$)

	Alternative							
	1	2	3	4	5	6	7	8
Model Years	2021-2026	2021-2026	2021-2026	2021-2026	2022-2026	2021-2026	2021-2026	2022-2026
Annual Rate of Stringency Increase	0.0%/Year PC 0.0%/Year LT	0.5%/Year PC 0.5%/Year LT	0.5%/Year PC 0.5%/Year LT	1.0%/Year PC 2.0%/Year LT	1.0%/Year PC 2.0%/Year LT	2.0%/Year PC 3.0%/Year LT	2.0%/Year PC 3.0%/Year LT	2.0%/Year PC 3.0%/Year LT
AC/Off-Cycle Procedures	No Change	No Change	Phaseout 2022-2026	No Change	No Change	No Change	Phaseout 2022-2026	No Change
Price Increase	-1648	-1601	-1492	-1404	-1201	-1011	-658	-796
Welfare Loss	-352	-350	-346	-348	-342	-328	-242	-298
Additional Ownership Costs	-354	-344	-321	-304	-261	-221	-144	-175
Fuel Savings	-948	-920	-869	-827	-684	-557	-383	-445
Mobility Benefit	-330	-318	-296	-278	-225	-178	-116	-137
Refueling Benefit	-47	-46	-43	-41	-34	-28	-20	-23
Total Consumer Costs	-2354	-2295	-2159	-2056	-1804	-1560	-1044	-1269
Total Consumer Benefits	-1325	-1284	-1208	-1146	-944	-764	-518	-605
Net Consumer Benefits	1029	1011	950	910	860	796	526	664

*** EO 12866 Review – Draft – Do Not Cite, Quote or Release During Review ***

TABLE 11-20 - CONSUMER IMPACTS AND NET CONSUMER BENEFITS, MY 2030 PASSENGER CARS RELATIVE TO AUGURAL STANDARDS, CAFE, UNDISCOUNTED (BILLIONS 2016\$)

	Alternative							
	1	2	3	4	5	6	7	8
Model Years	2021-2026	2021-2026	2021-2026	2021-2026	2022-2026	2021-2026	2021-2026	2022-2026
Annual Rate of Stringency Increase	0.0%/Year PC 0.0%/Year LT	0.5%/Year PC 0.5%/Year LT	0.5%/Year PC 0.5%/Year LT	1.0%/Year PC 2.0%/Year LT	1.0%/Year PC 2.0%/Year LT	2.0%/Year PC 3.0%/Year LT	2.0%/Year PC 3.0%/Year LT	2.0%/Year PC 3.0%/Year LT
AC/Off-Cycle Procedures	No Change	No Change	Phaseout 2022-2026	No Change	No Change	No Change	Phaseout 2022-2026	No Change
Price Increase	-1648	-1601	-1492	-1404	-1201	-1011	-658	-796
Welfare Loss	-352	-350	-346	-348	-342	-328	-242	-298
Additional Ownership Costs	-428	-416	-388	-368	-316	-267	-174	-211
Fuel Savings	-1286	-1253	-1185	-1140	-951	-776	-548	-632
Mobility Benefit	-489	-472	-440	-412	-334	-266	-172	-204
Refueling Benefit	-64	-62	-59	-57	-48	-39	-28	-32
Total Consumer Costs	-2428	-2368	-2226	-2120	-1859	-1607	-1074	-1306
Total Consumer Benefits	-1839	-1787	-1684	-1610	-1333	-1080	-748	-868
Net Consumer Benefits	589	581	542	510	526	526	326	438

*** EO 12866 Review – Draft – Do Not Cite, Quote or Release During Review ***

TABLE 11-21 - CONSUMER IMPACTS AND NET CONSUMER BENEFITS, MY 2030 LIGHT TRUCKS RELATIVE TO AUGURAL STANDARDS, CAFE, 3% DISCOUNT RATE (BILLIONS 2016\$)

	Alternative							
	1	2	3	4	5	6	7	8
Model Years	2021-2026	2021-2026	2021-2026	2021-2026	2022-2026	2021-2026	2021-2026	2022-2026
Annual Rate of Stringency Increase	0.0%/Year PC 0.0%/Year LT	0.5%/Year PC 0.5%/Year LT	0.5%/Year PC 0.5%/Year LT	1.0%/Year PC 2.0%/Year LT	1.0%/Year PC 2.0%/Year LT	2.0%/Year PC 3.0%/Year LT	2.0%/Year PC 3.0%/Year LT	2.0%/Year PC 3.0%/Year LT
AC/Off-Cycle Procedures	No Change	No Change	Phaseout 2022-2026	No Change	No Change	No Change	Phaseout 2022-2026	No Change
Price Increase	-2114	-1997	-1851	-1527	-1124	-857	-246	-402
Welfare Loss	-339	-339	-339	-339	-339	-328	-183	-317
Additional Ownership Costs	-515	-487	-451	-372	-274	-209	-60	-98
Fuel Savings	-2101	-1920	-1775	-1339	-962	-736	-262	-432
Mobility Benefit	-677	-614	-562	-408	-279	-206	-70	-119
Refueling Benefit	-82	-75	-69	-52	-38	-29	-11	-17
Total Consumer Costs	-2968	-2822	-2640	-2239	-1736	-1394	-489	-817
Total Consumer Benefits	-2859	-2609	-2406	-1799	-1279	-971	-343	-569
Net Consumer Benefits	110	214	235	439	457	423	146	249

*** EO 12866 Review – Draft – Do Not Cite, Quote or Release During Review ***

TABLE 11-22 - CONSUMER IMPACTS AND NET CONSUMER BENEFITS, MY 2030 LIGHT TRUCKS RELATIVE TO AUGURAL STANDARDS, CAFE, 7% DISCOUNT RATE (BILLIONS 2016\$)

	Alternative							
	1	2	3	4	5	6	7	8
Model Years	2021-2026	2021-2026	2021-2026	2021-2026	2022-2026	2021-2026	2021-2026	2022-2026
Annual Rate of Stringency Increase	0.0%/Year PC 0.0%/Year LT	0.5%/Year PC 0.5%/Year LT	0.5%/Year PC 0.5%/Year LT	1.0%/Year PC 2.0%/Year LT	1.0%/Year PC 2.0%/Year LT	2.0%/Year PC 3.0%/Year LT	2.0%/Year PC 3.0%/Year LT	2.0%/Year PC 3.0%/Year LT
AC/Off-Cycle Procedures	No Change	No Change	Phaseout 2022-2026	No Change	No Change	No Change	Phaseout 2022-2026	No Change
Price Increase	-2114	-1997	-1851	-1527	-1124	-857	-246	-402
Welfare Loss	-339	-339	-339	-339	-339	-328	-183	-317
Additional Ownership Costs	-467	-441	-409	-337	-248	-189	-54	-89
Fuel Savings	-1700	-1552	-1436	-1083	-778	-596	-212	-350
Mobility Benefit	-548	-497	-455	-330	-226	-166	-57	-96
Refueling Benefit	-67	-61	-57	-43	-31	-24	-9	-14
Total Consumer Costs	-2920	-2777	-2598	-2204	-1711	-1374	-483	-808
Total Consumer Benefits	-2315	-2110	-1947	-1456	-1035	-787	-278	-460
Net Consumer Benefits	605	667	652	748	676	588	205	348

*** EO 12866 Review – Draft – Do Not Cite, Quote or Release During Review ***

TABLE 11-23 - CONSUMER IMPACTS AND NET CONSUMER BENEFITS, MY 2030 LIGHT TRUCKS RELATIVE TO AUGURAL STANDARDS, CAFE, UNDISCOUNTED RATE (BILLIONS 2016\$)

	Alternative							
	1	2	3	4	5	6	7	8
Model Years	2021-2026	2021-2026	2021-2026	2021-2026	2022-2026	2021-2026	2021-2026	2022-2026
Annual Rate of Stringency Increase	0.0%/Year PC 0.0%/Year LT	0.5%/Year PC 0.5%/Year LT	0.5%/Year PC 0.5%/Year LT	1.0%/Year PC 2.0%/Year LT	1.0%/Year PC 2.0%/Year LT	2.0%/Year PC 3.0%/Year LT	2.0%/Year PC 3.0%/Year LT	2.0%/Year PC 3.0%/Year LT
AC/Off-Cycle Procedures	No Change	No Change	Phaseout 2022-2026	No Change	No Change	No Change	Phaseout 2022-2026	No Change
Price Increase	-2114	-1997	-1851	-1527	-1124	-857	-246	-402
Welfare Loss	-339	-339	-339	-339	-339	-328	-183	-317
Additional Ownership Costs	-565	-534	-495	-408	-300	-229	-66	-108
Fuel Savings	-2543	-2326	-2150	-1620	-1165	-889	-315	-522
Mobility Benefit	-822	-748	-683	-497	-340	-251	-86	-145
Refueling Benefit	-98	-90	-83	-63	-45	-35	-13	-21
Total Consumer Costs	-3018	-2869	-2684	-2275	-1763	-1414	-495	-827
Total Consumer Benefits	-3463	-3163	-2916	-2180	-1550	-1175	-414	-688
Net Consumer Benefits	-445	-294	-232	95	213	240	81	139

*** EO 12866 Review – Draft – Do Not Cite, Quote or Release During Review ***

TABLE 11-24 - CONSUMER IMPACTS AND NET CONSUMER BENEFITS, MY 2030 PASSENGER CARS AND LIGHT TRUCKS RELATIVE TO AUGURAL STANDARDS, CAFE, 3% DISCOUNT RATE (BILLIONS 2016\$)

	Alternative							
	1	2	3	4	5	6	7	8
Model Years	2021-2026	2021-2026	2021-2026	2021-2026	2022-2026	2021-2026	2021-2026	2022-2026
Annual Rate of Stringency Increase	0.0%/Year PC 0.0%/Year LT	0.5%/Year PC 0.5%/Year LT	0.5%/Year PC 0.5%/Year LT	1.0%/Year PC 2.0%/Year LT	1.0%/Year PC 2.0%/Year LT	2.0%/Year PC 3.0%/Year LT	2.0%/Year PC 3.0%/Year LT	2.0%/Year PC 3.0%/Year LT
AC/Off-Cycle Procedures	No Change	No Change	Phaseout 2022-2026	No Change	No Change	No Change	Phaseout 2022-2026	No Change
Price Increase	-1869	-1790	-1663	-1467	-1168	-941	-465	-612
Welfare Loss	-345	-344	-342	-343	-340	-328	-214	-307
Additional Ownership Costs	-493	-471	-437	-379	-298	-238	-117	-153
Fuel Savings	-1468	-1377	-1288	-1092	-850	-677	-359	-477
Mobility Benefit	-529	-493	-455	-373	-278	-213	-108	-145
Refueling Benefit	-66	-62	-58	-50	-39	-31	-17	-22
Total Consumer Costs	-2707	-2605	-2442	-2189	-1807	-1507	-796	-1073
Total Consumer Benefits	-2063	-1932	-1801	-1514	-1167	-922	-484	-645
Net Consumer Benefits	644	673	641	675	640	585	312	428

*** EO 12866 Review – Draft – Do Not Cite, Quote or Release During Review ***

TABLE 11-25 - CONSUMER IMPACTS AND NET CONSUMER BENEFITS, MY 2030 PASSENGER CARS AND LIGHT TRUCKS RELATIVE TO AUGURAL STANDARDS, CAFE, 7% DISCOUNT RATE (BILLIONS 2016\$)

	Alternative							
	1	2	3	4	5	6	7	8
Model Years	2021-2026	2021-2026	2021-2026	2021-2026	2022-2026	2021-2026	2021-2026	2022-2026
Annual Rate of Stringency Increase	0.0%/Year PC 0.0%/Year LT	0.5%/Year PC 0.5%/Year LT	0.5%/Year PC 0.5%/Year LT	1.0%/Year PC 2.0%/Year LT	1.0%/Year PC 2.0%/Year LT	2.0%/Year PC 3.0%/Year LT	2.0%/Year PC 3.0%/Year LT	2.0%/Year PC 3.0%/Year LT
AC/Off-Cycle Procedures	No Change	No Change	Phaseout 2022-2026	No Change	No Change	No Change	Phaseout 2022-2026	No Change
Price Increase	-1869	-1790	-1663	-1467	-1168	-941	-465	-612
Welfare Loss	-345	-344	-342	-343	-340	-328	-214	-307
Additional Ownership Costs	-446	-427	-396	-344	-270	-216	-106	-139
Fuel Savings	-1211	-1135	-1062	-900	-700	-558	-295	-392
Mobility Benefit	-429	-400	-369	-302	-226	-173	-88	-118
Refueling Benefit	-55	-51	-48	-41	-32	-26	-14	-18
Total Consumer Costs	-2660	-2561	-2401	-2154	-1779	-1485	-785	-1058
Total Consumer Benefits	-1695	-1586	-1480	-1243	-958	-757	-397	-528
Net Consumer Benefits	965	974	922	910	821	727	388	530

*** EO 12866 Review – Draft – Do Not Cite, Quote or Release During Review ***

TABLE 11-26 - CONSUMER IMPACTS AND NET CONSUMER BENEFITS, MY 2030 PASSENGER CARS AND LIGHT TRUCKS RELATIVE TO AUGURAL STANDARDS, CAFE, UNDISCOUNTED (BILLIONS 2016\$)

	Alternative							
	1	2	3	4	5	6	7	8
Model Years	2021-2026	2021-2026	2021-2026	2021-2026	2022-2026	2021-2026	2021-2026	2022-2026
Annual Rate of Stringency Increase	0.0%/Year PC 0.0%/Year LT	0.5%/Year PC 0.5%/Year LT	0.5%/Year PC 0.5%/Year LT	1.0%/Year PC 2.0%/Year LT	1.0%/Year PC 2.0%/Year LT	2.0%/Year PC 3.0%/Year LT	2.0%/Year PC 3.0%/Year LT	2.0%/Year PC 3.0%/Year LT
AC/Off-Cycle Procedures	No Change	No Change	Phaseout 2022-2026	No Change	No Change	No Change	Phaseout 2022-2026	No Change
Price Increase	-1869	-1790	-1663	-1467	-1168	-941	-465	-612
Welfare Loss	-345	-344	-342	-343	-340	-328	-214	-307
Additional Ownership Costs	-540	-517	-479	-416	-327	-261	-129	-168
Fuel Savings	-1738	-1631	-1527	-1293	-1008	-802	-426	-567
Mobility Benefit	-641	-598	-552	-452	-338	-259	-132	-177
Refueling Benefit	-77	-73	-68	-58	-46	-37	-21	-26
Total Consumer Costs	-2754	-2651	-2485	-2226	-1836	-1530	-808	-1088
Total Consumer Benefits	-2457	-2302	-2147	-1804	-1391	-1098	-579	-770
Net Consumer Benefits	298	349	338	422	445	432	229	318

*** EO 12866 Review – Draft – Do Not Cite, Quote or Release During Review ***

TABLE 11-27 - SOCIETAL COSTS, BENEFITS AND NET BENEFITS, PASSENGER CARS, CO₂, 3% DISCOUNT RATE (BILLIONS 2016\$)

	Alternative							
	1	2	3	4	5	6	7	8
Model Years	2021-2026	2021-2026	2021-2026	2021-2026	2022-2026	2021-2026	2021-2026	2022-2026
Annual Rate of Stringency Increase	0.0%/Year PC 0.0%/Year LT	0.5%/Year PC 0.5%/Year LT	0.5%/Year PC 0.5%/Year LT	1.0%/Year PC 2.0%/Year LT	1.0%/Year PC 2.0%/Year LT	2.0%/Year PC 3.0%/Year LT	2.0%/Year PC 3.0%/Year LT	2.0%/Year PC 3.0%/Year LT
AC/Off-Cycle Procedures	No Change	No Change	Phaseout 2022- 2026	No Change	No Change	No Change	Phaseout 2022- 2026	No Change
Societal Costs								
Technology Costs	-\$97.9	-\$94.0	-\$88.2	-\$82.6	-\$60.9	-\$58.8	-\$40.8	-\$40.1
Advanced Technology Value Loss	-\$12.4	-\$11.9	-\$11.9	-\$11.6	-\$9.7	-\$11.0	-\$6.7	-\$8.5
Congestion Costs	-\$21.6	-\$20.8	-\$18.5	-\$16.7	-\$13.8	-\$10.8	-\$4.7	-\$7.2
Noise Costs	-\$0.3	-\$0.3	-\$0.2	-\$0.2	-\$0.2	-\$0.1	-\$0.1	-\$0.1
Non-Rebound Fatality Costs	-\$15.0	-\$14.7	-\$12.9	-\$11.2	-\$10.8	-\$7.0	-\$1.6	-\$4.4
Non-Rebound Non-Fatal Crash Costs	-\$23.5	-\$23.0	-\$20.2	-\$17.5	-\$16.9	-\$10.9	-\$2.5	-\$6.8
Rebound Fatality Costs	-\$19.3	-\$18.4	-\$16.4	-\$15.0	-\$9.9	-\$9.2	-\$6.0	-\$6.1
Non-Fatal Crash Costs	-\$30.1	-\$28.7	-\$25.7	-\$23.5	-\$15.4	-\$14.3	-\$9.3	-\$9.5
Total Societal Costs	-\$220.0	-\$211.9	-\$194.2	-\$178.3	-\$137.5	-\$122.1	-\$71.6	-\$82.6
Societal Benefits								
Pre-Tax Fuel Savings	-\$54.2	-\$51.7	-\$46.2	-\$43.0	-\$25.1	-\$25.9	-\$20.1	-\$17.7
Rebound Fuel Benefit ¹	-\$24.1	-\$22.9	-\$20.4	-\$18.5	-\$12.0	-\$11.2	-\$7.0	-\$7.3
Refueling Time Benefit	-\$4.0	-\$3.8	-\$3.4	-\$3.1	-\$1.9	-\$1.9	-\$1.4	-\$1.2
Rebound Fatality Costs, Off-setting Benefit ²	-\$19.3	-\$18.4	-\$16.4	-\$15.0	-\$9.9	-\$9.2	-\$6.0	-\$6.1
Rebound Non-Fatal Crash Costs, Off-setting Benefit ²	-\$30.1	-\$28.7	-\$25.7	-\$23.5	-\$15.4	-\$14.3	-\$9.3	-\$9.5
Petroleum Market Externality	-\$4.4	-\$4.2	-\$3.8	-\$3.5	-\$2.0	-\$2.1	-\$1.6	-\$1.4
CO ₂ Damage Reduction Benefit	-\$1.8	-\$1.7	-\$1.5	-\$1.4	-\$0.8	-\$0.8	-\$0.7	-\$0.6
NO _x Damage Reduction Benefit	\$0.3	\$0.3	\$0.3	\$0.2	\$0.2	\$0.1	\$0.0	\$0.1
VOC Damage Reduction Benefit	\$0.1	\$0.1	\$0.1	\$0.1	\$0.0	\$0.0	\$0.0	\$0.0

*** EO 12866 Review – Draft – Do Not Cite, Quote or Release During Review ***

PM Damage Reduction Benefit	\$0.4	\$0.4	\$0.4	\$0.2	\$0.3	\$0.2	-\$0.1	\$0.0
SO ₂ Damage Reduction Benefit	-\$1.1	-\$1.1	-\$1.0	-\$0.9	-\$0.5	-\$0.5	-\$0.4	-\$0.3
Total Societal Benefits	-\$138.2	-\$131.7	-\$117.6	-\$108.4	-\$67.2	-\$65.7	-\$46.5	-\$44.1
Net Total Benefits	\$81.9	\$80.2	\$76.6	\$69.9	\$70.3	\$56.3	\$25.1	\$38.6

¹ This value includes both the value of the fuel spent to drive rebound miles, and the consumer surplus representing the additional amount consumers would have, but did not spend to drive the additional miles.

² It is assumed that consumers that drive rebound miles fully internalize fatal and non-fatal crash costs. The miles are driven because they receive an equal and offsetting benefit from driving the miles. These cells report the magnitude of the offsetting benefits.

*** EO 12866 Review – Draft – Do Not Cite, Quote or Release During Review ***

TABLE 11-28 - SOCIETAL COSTS, BENEFITS AND NET BENEFITS, PASSENGER CARS, CO₂, 7% DISCOUNT RATE (BILLIONS 2016\$)

	Alternative							
	1	2	3	4	5	6	7	8
Model Years	2021-2026	2021-2026	2021-2026	2021-2026	2022-2026	2021-2026	2021-2026	2022-2026
Annual Rate of Stringency Increase	0.0%/Year PC 0.0%/Year LT	0.5%/Year PC 0.5%/Year LT	0.5%/Year PC 0.5%/Year LT	1.0%/Year PC 2.0%/Year LT	1.0%/Year PC 2.0%/Year LT	2.0%/Year PC 3.0%/Year LT	2.0%/Year PC 3.0%/Year LT	2.0%/Year PC 3.0%/Year LT
AC/Off-Cycle Procedures	No Change	No Change	Phaseout 2022- 2026	No Change	No Change	No Change	Phaseout 2022- 2026	No Change
Societal Costs								
Technology Costs	-\$73.2	-\$70.1	-\$66.0	-\$61.9	-\$44.7	-\$44.1	-\$31.0	-\$29.6
Advanced Technology Value Loss	-\$9.1	-\$8.8	-\$8.8	-\$8.5	-\$6.9	-\$8.0	-\$5.0	-\$6.1
Congestion Costs	-\$11.6	-\$11.2	-\$9.9	-\$9.2	-\$7.3	-\$5.9	-\$2.8	-\$4.0
Noise Costs	-\$0.2	-\$0.1	-\$0.1	-\$0.1	-\$0.1	-\$0.1	\$0.0	-\$0.1
Non-Rebound Fatality Costs	-\$7.1	-\$6.9	-\$6.1	-\$5.4	-\$5.3	-\$3.5	-\$0.9	-\$2.2
Non-Rebound Non-Fatal Crash Costs	-\$11.0	-\$10.9	-\$9.5	-\$8.4	-\$8.2	-\$5.4	-\$1.4	-\$3.5
Rebound Fatality Costs	-\$11.8	-\$11.2	-\$10.0	-\$9.2	-\$5.9	-\$5.6	-\$3.7	-\$3.6
Non-Fatal Crash Costs	-\$18.4	-\$17.5	-\$15.7	-\$14.4	-\$9.2	-\$8.7	-\$5.7	-\$5.7
Total Societal Costs	-\$142.3	-\$136.8	-\$126.2	-\$117.0	-\$87.7	-\$81.3	-\$50.4	-\$54.9
Societal Benefits								
Pre-Tax Fuel Savings	-\$34.4	-\$32.8	-\$29.4	-\$27.2	-\$15.7	-\$16.1	-\$12.2	-\$10.7
Rebound Fuel Benefit ¹	-\$14.5	-\$13.7	-\$12.3	-\$11.1	-\$7.1	-\$6.7	-\$4.2	-\$4.3
Refueling Time Benefit	-\$2.5	-\$2.4	-\$2.2	-\$2.0	-\$1.2	-\$1.2	-\$0.9	-\$0.8
Rebound Fatality Costs, Off-setting Benefit ²	-\$11.8	-\$11.2	-\$10.0	-\$9.2	-\$5.9	-\$5.6	-\$3.7	-\$3.6
Rebound Non-Fatal Crash Costs, Off-setting Benefit ²	-\$18.4	-\$17.5	-\$15.7	-\$14.4	-\$9.2	-\$8.7	-\$5.7	-\$5.7
Petroleum Market Externality	-\$2.8	-\$2.7	-\$2.4	-\$2.2	-\$1.3	-\$1.3	-\$1.0	-\$0.9
CO ₂ Damage Reduction Benefit	-\$1.1	-\$1.1	-\$0.9	-\$0.9	-\$0.5	-\$0.5	-\$0.4	-\$0.3
NO _x Damage Reduction Benefit	\$0.2	\$0.1	\$0.1	\$0.1	\$0.1	\$0.1	\$0.0	\$0.0
VOC Damage Reduction Benefit	\$0.0	\$0.0	\$0.0	\$0.0	\$0.0	\$0.0	\$0.0	\$0.0

*** EO 12866 Review – Draft – Do Not Cite, Quote or Release During Review ***

PM Damage Reduction Benefit	\$0.1	\$0.1	\$0.1	\$0.0	\$0.1	\$0.0	\$0.0	\$0.0
SO ₂ Damage Reduction Benefit	-\$0.7	-\$0.7	-\$0.6	-\$0.6	-\$0.3	-\$0.3	-\$0.2	-\$0.2
Total Societal Benefits	-\$85.9	-\$81.8	-\$73.3	-\$67.4	-\$41.0	-\$40.3	-\$28.4	-\$26.5
Net Total Benefits	\$56.4	\$55.0	\$52.9	\$49.6	\$46.7	\$41.0	\$22.0	\$28.4

¹ This value includes both the value of the fuel spent to drive rebound miles, and the consumer surplus representing the additional amount consumers would have, but did not spend to drive the additional miles.

² It is assumed that consumers that drive rebound miles fully internalize fatal and non-fatal crash costs. The miles are driven because they receive an equal and offsetting benefit from driving the miles. These cells report the magnitude of the offsetting benefits.

*** EO 12866 Review – Draft – Do Not Cite, Quote or Release During Review ***

TABLE 11-29 - SOCIETAL COSTS, BENEFITS AND NET BENEFITS, PASSENGER CARS, CO₂, UNDISCOUNTED (BILLIONS 2016\$)

	Alternative							
	1	2	3	4	5	6	7	8
Model Years	2021-2026	2021-2026	2021-2026	2021-2026	2022-2026	2021-2026	2021-2026	2022-2026
Annual Rate of Stringency Increase	0.0%/Year PC 0.0%/Year LT	0.5%/Year PC 0.5%/Year LT	0.5%/Year PC 0.5%/Year LT	1.0%/Year PC 2.0%/Year LT	1.0%/Year PC 2.0%/Year LT	2.0%/Year PC 3.0%/Year LT	2.0%/Year PC 3.0%/Year LT	2.0%/Year PC 3.0%/Year LT
AC/Off-Cycle Procedures	No Change	No Change	Phaseout 2022- 2026	No Change	No Change	No Change	Phaseout 2022- 2026	No Change
Societal Costs								
Technology Costs	-\$123.7	-\$118.9	-\$111.5	-\$104.2	-\$77.9	-\$74.1	-\$50.9	-\$51.0
Advanced Technology Value Loss	-\$15.9	-\$15.3	-\$15.3	-\$14.9	-\$12.6	-\$14.2	-\$8.5	-\$11.0
Congestion Costs	-\$37.5	-\$36.1	-\$32.1	-\$28.7	-\$23.8	-\$18.2	-\$7.5	-\$11.9
Noise Costs	-\$0.5	-\$0.5	-\$0.4	-\$0.4	-\$0.3	-\$0.2	-\$0.1	-\$0.2
Non-Rebound Fatality Costs	-\$29.0	-\$28.4	-\$25.1	-\$21.3	-\$20.1	-\$12.9	-\$2.9	-\$7.9
Non-Rebound Non-Fatal Crash Costs	-\$45.4	-\$44.4	-\$39.2	-\$33.3	-\$31.4	-\$20.2	-\$4.5	-\$12.3
Rebound Fatality Costs	-\$29.2	-\$27.9	-\$24.9	-\$22.8	-\$15.2	-\$14.0	-\$9.0	-\$9.4
Non-Fatal Crash Costs	-\$45.7	-\$43.7	-\$39.0	-\$35.6	-\$23.8	-\$21.9	-\$14.1	-\$14.7
Total Societal Costs	-\$327.0	-\$315.3	-\$287.6	-\$261.2	-\$205.2	-\$175.7	-\$97.4	-\$118.4
Societal Benefits								
Pre-Tax Fuel Savings	-\$78.1	-\$74.5	-\$66.3	-\$62.4	-\$36.4	-\$38.3	-\$30.6	-\$26.8
Rebound Fuel Benefit ¹	-\$37.2	-\$35.4	-\$31.5	-\$28.5	-\$18.9	-\$17.3	-\$10.7	-\$11.4
Refueling Time Benefit	-\$5.7	-\$5.5	-\$4.9	-\$4.5	-\$2.8	-\$2.8	-\$2.1	-\$1.9
Rebound Fatality Costs, Off-setting Benefit ²	-\$29.2	-\$27.9	-\$24.9	-\$22.8	-\$15.2	-\$14.0	-\$9.0	-\$9.4
Rebound Non-Fatal Crash Costs, Off-setting Benefit ²	-\$45.7	-\$43.7	-\$39.0	-\$35.6	-\$23.8	-\$21.9	-\$14.1	-\$14.7
Petroleum Market Externality	-\$6.4	-\$6.1	-\$5.4	-\$5.1	-\$3.0	-\$3.1	-\$2.5	-\$2.2
CO ₂ Damage Reduction Benefit	-\$2.5	-\$2.4	-\$2.1	-\$2.0	-\$1.2	-\$1.2	-\$1.0	-\$0.9
NO _x Damage Reduction Benefit	\$0.6	\$0.6	\$0.5	\$0.4	\$0.3	\$0.3	\$0.1	\$0.1
VOC Damage Reduction Benefit	\$0.1	\$0.1	\$0.1	\$0.1	\$0.1	\$0.1	\$0.0	\$0.0

*** EO 12866 Review – Draft – Do Not Cite, Quote or Release During Review ***

PM Damage Reduction Benefit	\$0.9	\$0.9	\$0.9	\$0.6	\$0.6	\$0.4	-\$0.1	\$0.1
SO ₂ Damage Reduction Benefit	-\$1.6	-\$1.5	-\$1.4	-\$1.3	-\$0.7	-\$0.7	-\$0.6	-\$0.5
Total Societal Benefits	-\$204.8	-\$195.4	-\$174.0	-\$161.1	-\$100.9	-\$98.7	-\$70.6	-\$67.4
Net Total Benefits	\$122.2	\$119.9	\$113.5	\$100.1	\$104.3	\$76.9	\$26.8	\$51.0

¹ This value includes both the value of the fuel spent to drive rebound miles, and the consumer surplus representing the additional amount consumers would have, but did not spend to drive the additional miles.

² It is assumed that consumers that drive rebound miles fully internalize fatal and non-fatal crash costs. The miles are driven because they receive an equal and offsetting benefit from driving the miles. These cells report the magnitude of the offsetting benefits.

*** EO 12866 Review – Draft – Do Not Cite, Quote or Release During Review ***

TABLE 11-30 - SOCIETAL COSTS, BENEFITS AND NET BENEFITS, LIGHT TRUCKS, CO₂, 3% DISCOUNT RATE (BILLIONS 2016\$)

	Alternative							
	1	2	3	4	5	6	7	8
Model Years	2021-2026	2021-2026	2021-2026	2021-2026	2022-2026	2021-2026	2021-2026	2022-2026
Annual Rate of Stringency Increase	0.0%/Year PC 0.0%/Year LT	0.5%/Year PC 0.5%/Year LT	0.5%/Year PC 0.5%/Year LT	1.0%/Year PC 2.0%/Year LT	1.0%/Year PC 2.0%/Year LT	2.0%/Year PC 3.0%/Year LT	2.0%/Year PC 3.0%/Year LT	2.0%/Year PC 3.0%/Year LT
AC/Off-Cycle Procedures	No Change	No Change	Phaseout 2022- 2026	No Change	No Change	No Change	Phaseout 2022- 2026	No Change
Societal Costs								
Technology Costs	-\$109.6	-\$105.9	-\$101.9	-\$81.0	-\$50.5	-\$51.9	-\$23.2	-\$17.5
Advanced Technology Value Loss	-\$5.8	-\$5.8	-\$5.8	-\$5.5	-\$3.8	-\$3.9	-\$1.5	-\$1.9
Congestion Costs	-\$28.4	-\$26.8	-\$24.6	-\$16.5	-\$8.3	-\$7.7	-\$3.6	-\$2.5
Noise Costs	-\$0.4	-\$0.4	-\$0.4	-\$0.2	-\$0.1	-\$0.1	-\$0.1	\$0.0
Non-Rebound Fatality Costs	-\$24.0	-\$22.5	-\$20.1	-\$13.2	-\$6.4	-\$5.6	-\$2.7	-\$2.0
Non-Rebound Non-Fatal Crash Costs	-\$37.5	-\$35.1	-\$31.5	-\$20.6	-\$10.0	-\$8.7	-\$4.2	-\$3.1
Rebound Fatality Costs	-\$18.6	-\$17.7	-\$16.6	-\$11.1	-\$6.2	-\$6.0	-\$2.8	-\$1.8
Non-Fatal Crash Costs	-\$29.0	-\$27.7	-\$26.0	-\$17.4	-\$9.7	-\$9.4	-\$4.3	-\$2.9
Total Societal Costs	-\$253.3	-\$242.0	-\$227.0	-\$165.6	-\$95.0	-\$93.3	-\$42.3	-\$31.8
Societal Benefits								
Pre-Tax Fuel Savings	-\$56.2	-\$54.2	-\$52.1	-\$35.1	-\$20.9	-\$21.3	-\$9.8	-\$6.0
Rebound Fuel Benefit ¹	-\$31.9	-\$30.5	-\$28.6	-\$19.0	-\$10.5	-\$10.1	-\$4.6	-\$3.1
Refueling Time Benefit	-\$3.2	-\$3.0	-\$2.9	-\$2.0	-\$1.2	-\$1.2	-\$0.5	-\$0.4
Rebound Fatality Costs, Off-setting Benefit ²	-\$18.6	-\$17.7	-\$16.6	-\$11.1	-\$6.2	-\$6.0	-\$2.8	-\$1.8
Rebound Non-Fatal Crash Costs, Off-setting Benefit ²	-\$29.0	-\$27.7	-\$26.0	-\$17.4	-\$9.7	-\$9.4	-\$4.3	-\$2.9
Petroleum Market Externality	-\$4.6	-\$4.5	-\$4.3	-\$2.9	-\$1.8	-\$1.8	-\$0.8	-\$0.5
CO ₂ Damage Reduction Benefit	-\$1.8	-\$1.8	-\$1.7	-\$1.1	-\$0.7	-\$0.7	-\$0.3	-\$0.2
NO _x Damage Reduction Benefit	\$0.4	\$0.4	\$0.4	\$0.3	\$0.1	\$0.1	\$0.1	\$0.1
VOC Damage Reduction Benefit	\$0.1	\$0.1	\$0.0	\$0.0	\$0.0	\$0.0	\$0.0	\$0.0

*** EO 12866 Review – Draft – Do Not Cite, Quote or Release During Review ***

PM Damage Reduction Benefit	\$0.3	\$0.2	\$0.1	\$0.1	\$0.0	\$0.0	-\$0.1	\$0.0
SO ₂ Damage Reduction Benefit	-\$1.0	-\$1.0	-\$0.9	-\$0.6	-\$0.3	-\$0.3	-\$0.1	\$0.0
Total Societal Benefits	-\$145.6	-\$139.6	-\$132.6	-\$88.8	-\$51.0	-\$50.7	-\$23.2	-\$14.9
Net Total Benefits	\$107.7	\$102.3	\$94.3	\$76.9	\$44.0	\$42.6	\$19.2	\$16.9

¹ This value includes both the value of the fuel spent to drive rebound miles, and the consumer surplus representing the additional amount consumers would have, but did not spend to drive the additional miles.

² It is assumed that consumers that drive rebound miles fully internalize fatal and non-fatal crash costs. The miles are driven because they receive an equal and offsetting benefit from driving the miles. These cells report the magnitude of the offsetting benefits.

*** EO 12866 Review – Draft – Do Not Cite, Quote or Release During Review ***

TABLE 11-31 - SOCIETAL COSTS, BENEFITS AND NET BENEFITS, LIGHT TRUCKS, CO₂, 7% DISCOUNT RATE (BILLIONS 2016\$)

	Alternative							
	1	2	3	4	5	6	7	8
Model Years	2021-2026	2021-2026	2021-2026	2021-2026	2022-2026	2021-2026	2021-2026	2022-2026
Annual Rate of Stringency Increase	0.0%/Year PC 0.0%/Year LT	0.5%/Year PC 0.5%/Year LT	0.5%/Year PC 0.5%/Year LT	1.0%/Year PC 2.0%/Year LT	1.0%/Year PC 2.0%/Year LT	2.0%/Year PC 3.0%/Year LT	2.0%/Year PC 3.0%/Year LT	2.0%/Year PC 3.0%/Year LT
AC/Off-Cycle Procedures	No Change	No Change	Phaseout 2022- 2026	No Change	No Change	No Change	Phaseout 2022- 2026	No Change
Societal Costs								
Technology Costs	-\$82.2	-\$79.3	-\$76.5	-\$60.8	-\$37.8	-\$39.6	-\$18.3	-\$13.5
Advanced Technology Value Loss	-\$4.2	-\$4.2	-\$4.2	-\$4.0	-\$2.7	-\$2.9	-\$1.1	-\$1.4
Congestion Costs	-\$16.1	-\$15.2	-\$14.0	-\$9.3	-\$4.6	-\$4.4	-\$2.2	-\$1.3
Noise Costs	-\$0.2	-\$0.2	-\$0.2	-\$0.1	-\$0.1	-\$0.1	\$0.0	\$0.0
Non-Rebound Fatality Costs	-\$12.7	-\$11.9	-\$10.8	-\$7.0	-\$3.1	-\$2.9	-\$1.6	-\$0.9
Non-Rebound Non-Fatal Crash Costs	-\$19.9	-\$18.6	-\$16.8	-\$10.9	-\$4.9	-\$4.5	-\$2.5	-\$1.4
Rebound Fatality Costs	-\$11.3	-\$10.8	-\$10.2	-\$6.8	-\$3.8	-\$3.8	-\$1.8	-\$1.2
Non-Fatal Crash Costs	-\$17.8	-\$16.9	-\$16.0	-\$10.7	-\$5.9	-\$5.9	-\$2.8	-\$1.8
Total Societal Costs	-\$164.5	-\$157.3	-\$148.7	-\$109.6	-\$62.9	-\$64.0	-\$30.3	-\$21.6
Societal Benefits								
Pre-Tax Fuel Savings	-\$36.0	-\$34.6	-\$33.1	-\$22.3	-\$13.4	-\$13.6	-\$6.3	-\$4.1
Rebound Fuel Benefit ¹	-\$19.1	-\$18.3	-\$17.2	-\$11.4	-\$6.3	-\$6.2	-\$2.9	-\$1.9
Refueling Time Benefit	-\$2.0	-\$1.9	-\$1.8	-\$1.3	-\$0.8	-\$0.7	-\$0.3	-\$0.3
Rebound Fatality Costs, Off-setting Benefit ²	-\$11.3	-\$10.8	-\$10.2	-\$6.8	-\$3.8	-\$3.8	-\$1.8	-\$1.2
Rebound Non-Fatal Crash Costs, Off-setting Benefit ²	-\$17.8	-\$16.9	-\$16.0	-\$10.7	-\$5.9	-\$5.9	-\$2.8	-\$1.8
Petroleum Market Externality	-\$3.0	-\$2.8	-\$2.7	-\$1.9	-\$1.1	-\$1.1	-\$0.5	-\$0.4
CO ₂ Damage Reduction Benefit	-\$1.2	-\$1.1	-\$1.1	-\$0.7	-\$0.4	-\$0.4	-\$0.2	-\$0.1
NO _x Damage Reduction Benefit	\$0.2	\$0.2	\$0.2	\$0.1	\$0.1	\$0.1	\$0.0	\$0.0
VOC Damage Reduction Benefit	\$0.0	\$0.0	\$0.0	\$0.0	\$0.0	\$0.0	\$0.0	\$0.0

*** EO 12866 Review – Draft – Do Not Cite, Quote or Release During Review ***

PM Damage Reduction Benefit	\$0.0	\$0.0	\$0.0	\$0.0	\$0.0	-\$0.1	-\$0.1	\$0.0
SO ₂ Damage Reduction Benefit	-\$0.7	-\$0.7	-\$0.6	-\$0.4	-\$0.2	-\$0.2	-\$0.1	\$0.0
Total Societal Benefits	-\$90.7	-\$86.9	-\$82.6	-\$55.2	-\$31.8	-\$32.0	-\$14.9	-\$9.7
Net Total Benefits	\$73.8	\$70.4	\$66.2	\$54.3	\$31.0	\$32.0	\$15.4	\$11.9

¹This value includes both the value of the fuel spent to drive rebound miles, and the consumer surplus representing the additional amount consumers would have, but did not spend to drive the additional miles.

² It is assumed that consumers that drive rebound miles fully internalize fatal and non-fatal crash costs. The miles are driven because they receive an equal and offsetting benefit from driving the miles. These cells report the magnitude of the offsetting benefits.

*** EO 12866 Review – Draft – Do Not Cite, Quote or Release During Review ***

TABLE 11-32 - SOCIETAL COSTS, BENEFITS AND NET BENEFITS, LIGHT TRUCKS, CO₂, UNDISCOUNTED (BILLIONS 2016\$)

	Alternative							
	1	2	3	4	5	6	7	8
Model Years	2021-2026	2021-2026	2021-2026	2021-2026	2022-2026	2021-2026	2021-2026	2022-2026
Annual Rate of Stringency Increase	0.0%/Year PC 0.0%/Year LT	0.5%/Year PC 0.5%/Year LT	0.5%/Year PC 0.5%/Year LT	1.0%/Year PC 2.0%/Year LT	1.0%/Year PC 2.0%/Year LT	2.0%/Year PC 3.0%/Year LT	2.0%/Year PC 3.0%/Year LT	2.0%/Year PC 3.0%/Year LT
AC/Off-Cycle Procedures	No Change	No Change	Phaseout 2022- 2026	No Change	No Change	No Change	Phaseout 2022- 2026	No Change
Societal Costs								
Technology Costs	-\$138.3	-\$133.7	-\$128.5	-\$102.1	-\$63.8	-\$64.6	-\$28.0	-\$21.6
Advanced Technology Value Loss	-\$7.5	-\$7.5	-\$7.5	-\$7.1	-\$4.9	-\$5.1	-\$1.9	-\$2.5
Congestion Costs	-\$46.5	-\$44.0	-\$40.0	-\$27.0	-\$14.1	-\$12.5	-\$5.5	-\$4.3
Noise Costs	-\$0.7	-\$0.7	-\$0.6	-\$0.4	-\$0.2	-\$0.2	-\$0.1	-\$0.1
Non-Rebound Fatality Costs	-\$41.2	-\$38.7	-\$34.4	-\$22.9	-\$11.8	-\$9.8	-\$4.3	-\$3.8
Non-Rebound Non-Fatal Crash Costs	-\$64.5	-\$60.5	-\$53.8	-\$35.8	-\$18.5	-\$15.3	-\$6.8	-\$6.0
Rebound Fatality Costs	-\$28.3	-\$27.0	-\$25.3	-\$16.9	-\$9.5	-\$9.0	-\$4.1	-\$2.8
Non-Fatal Crash Costs	-\$44.2	-\$42.2	-\$39.6	-\$26.5	-\$14.8	-\$14.2	-\$6.3	-\$4.3
Total Societal Costs	-\$371.1	-\$354.3	-\$329.7	-\$238.7	-\$137.6	-\$130.6	-\$57.0	-\$45.4
Societal Benefits								
Pre-Tax Fuel Savings	-\$81.6	-\$78.8	-\$76.2	-\$51.1	-\$30.1	-\$30.9	-\$14.3	-\$8.2
Rebound Fuel Benefit ¹	-\$49.4	-\$47.2	-\$44.2	-\$29.5	-\$16.4	-\$15.5	-\$6.8	-\$4.7
Refueling Time Benefit	-\$4.6	-\$4.4	-\$4.2	-\$2.8	-\$1.7	-\$1.7	-\$0.7	-\$0.5
Rebound Fatality Costs, Off-setting Benefit ²	-\$28.3	-\$27.0	-\$25.3	-\$16.9	-\$9.5	-\$9.0	-\$4.1	-\$2.8
Rebound Non-Fatal Crash Costs, Off-setting Benefit ²	-\$44.2	-\$42.2	-\$39.6	-\$26.5	-\$14.8	-\$14.2	-\$6.3	-\$4.3
Petroleum Market Externality	-\$6.7	-\$6.5	-\$6.3	-\$4.3	-\$2.6	-\$2.6	-\$1.1	-\$0.8
CO ₂ Damage Reduction Benefit	-\$2.7	-\$2.6	-\$2.5	-\$1.7	-\$1.0	-\$1.0	-\$0.4	-\$0.3
NO _x Damage Reduction Benefit	\$0.7	\$0.7	\$0.6	\$0.4	\$0.2	\$0.2	\$0.1	\$0.1
VOC Damage Reduction Benefit	\$0.1	\$0.1	\$0.1	\$0.1	\$0.0	\$0.0	\$0.0	\$0.0

*** EO 12866 Review – Draft – Do Not Cite, Quote or Release During Review ***

PM Damage Reduction Benefit	\$0.7	\$0.6	\$0.5	\$0.3	\$0.2	\$0.0	-\$0.1	\$0.1
SO ₂ Damage Reduction Benefit	-\$1.4	-\$1.4	-\$1.3	-\$0.8	-\$0.4	-\$0.4	-\$0.1	\$0.0
Total Societal Benefits	-\$217.3	-\$208.7	-\$198.3	-\$132.7	-\$75.9	-\$75.0	-\$33.9	-\$21.4
Net Total Benefits	\$153.9	\$145.6	\$131.4	\$106.0	\$61.7	\$55.6	\$23.1	\$24.0

¹ This value includes both the value of the fuel spent to drive rebound miles, and the consumer surplus representing the additional amount consumers would have, but did not spend to drive the additional miles.

² It is assumed that consumers that drive rebound miles fully internalize fatal and non-fatal crash costs. The miles are driven because they receive an equal and offsetting benefit from driving the miles. These cells report the magnitude of the offsetting benefits.

*** EO 12866 Review – Draft – Do Not Cite, Quote or Release During Review ***

TABLE 11-33 - SOCIETAL COSTS, BENEFITS AND NET BENEFITS, PASSENGER CARS AND LIGHT TRUCKS COMBINED, CO₂, 3% DISCOUNT RATE (BILLIONS 2016\$)

	Alternative							
	1	2	3	4	5	6	7	8
Model Years	2021-2026	2021-2026	2021-2026	2021-2026	2022-2026	2021-2026	2021-2026	2022-2026
Annual Rate of Stringency Increase	0.0%/Year PC 0.0%/Year LT	0.5%/Year PC 0.5%/Year LT	0.5%/Year PC 0.5%/Year LT	1.0%/Year PC 2.0%/Year LT	1.0%/Year PC 2.0%/Year LT	2.0%/Year PC 3.0%/Year LT	2.0%/Year PC 3.0%/Year LT	2.0%/Year PC 3.0%/Year LT
AC/Off-Cycle Procedures	No Change	No Change	Phaseout 2022- 2026	No Change	No Change	No Change	Phaseout 2022- 2026	No Change
Societal Costs								
Technology Costs	-\$207.5	-\$199.9	-\$190.1	-\$163.6	-\$111.4	-\$110.7	-\$63.9	-\$57.5
Advanced Technology Value Loss	-\$18.2	-\$17.8	-\$17.8	-\$17.1	-\$13.5	-\$15.0	-\$8.2	-\$10.4
Congestion Costs	-\$50.0	-\$47.6	-\$43.1	-\$33.2	-\$22.1	-\$18.4	-\$8.3	-\$9.7
Noise Costs	-\$0.7	-\$0.7	-\$0.6	-\$0.5	-\$0.3	-\$0.3	-\$0.1	-\$0.1
Non-Rebound Fatality Costs	-\$39.0	-\$37.2	-\$33.0	-\$24.4	-\$17.2	-\$12.5	-\$4.3	-\$6.4
Non-Rebound Non-Fatal Crash Costs	-\$61.0	-\$58.2	-\$51.7	-\$38.1	-\$26.9	-\$19.6	-\$6.7	-\$9.9
Rebound Fatality Costs	-\$37.8	-\$36.1	-\$33.1	-\$26.1	-\$16.0	-\$15.2	-\$8.7	-\$7.9
Non-Fatal Crash Costs	-\$59.1	-\$56.5	-\$51.7	-\$40.9	-\$25.1	-\$23.8	-\$13.6	-\$12.4
Total Societal Costs	-\$473.3	-\$453.9	-\$421.1	-\$343.9	-\$232.6	-\$215.4	-\$113.9	-\$114.4
Societal Benefits								
Pre-Tax Fuel Savings	-\$110.4	-\$105.9	-\$98.3	-\$78.0	-\$46.0	-\$47.2	-\$29.9	-\$23.7
Rebound Fuel Benefit ¹	-\$56.0	-\$53.4	-\$49.0	-\$37.5	-\$22.6	-\$21.3	-\$11.5	-\$10.3
Refueling Time Benefit	-\$7.1	-\$6.8	-\$6.3	-\$5.1	-\$3.1	-\$3.1	-\$1.9	-\$1.6
Rebound Fatality Costs, Off-setting Benefit ²	-\$37.8	-\$36.1	-\$33.1	-\$26.1	-\$16.0	-\$15.2	-\$8.7	-\$7.9
Rebound Non-Fatal Crash Costs, Off-setting Benefit ²	-\$59.1	-\$56.5	-\$51.7	-\$40.9	-\$25.1	-\$23.8	-\$13.6	-\$12.4
Petroleum Market Externality	-\$9.0	-\$8.7	-\$8.1	-\$6.4	-\$3.8	-\$3.9	-\$2.4	-\$2.0
CO ₂ Damage Reduction Benefit	-\$3.6	-\$3.4	-\$3.2	-\$2.5	-\$1.5	-\$1.5	-\$1.0	-\$0.8
NO _x Damage Reduction Benefit	\$0.8	\$0.7	\$0.6	\$0.5	\$0.3	\$0.3	\$0.1	\$0.1

*** EO 12866 Review – Draft – Do Not Cite, Quote or Release During Review ***

VOC Damage Reduction Benefit	\$0.1	\$0.1	\$0.1	\$0.1	\$0.1	\$0.1	\$0.0	\$0.0
PM Damage Reduction Benefit	\$0.6	\$0.6	\$0.5	\$0.3	\$0.3	\$0.1	-\$0.2	\$0.1
SO ₂ Damage Reduction Benefit	-\$2.1	-\$2.1	-\$1.9	-\$1.5	-\$0.8	-\$0.8	-\$0.5	-\$0.3
Total Societal Benefits	-\$283.7	-\$271.4	-\$250.3	-\$197.2	-\$118.2	-\$116.4	-\$69.7	-\$59.0
Net Total Benefits	\$189.6	\$182.5	\$170.9	\$146.7	\$114.3	\$98.9	\$44.3	\$55.4

¹ This value includes both the value of the fuel spent to drive rebound miles, and the consumer surplus representing the additional amount consumers would have, but did not spend to drive the additional miles.

² It is assumed that consumers that drive rebound miles fully internalize fatal and non-fatal crash costs. The miles are driven because they receive an equal and offsetting benefit from driving the miles. These cells report the magnitude of the offsetting benefits.

*** EO 12866 Review – Draft – Do Not Cite, Quote or Release During Review ***

TABLE 11-34 - SOCIETAL COSTS, BENEFITS AND NET BENEFITS, PASSENGER CARS AND LIGHT TRUCKS COMBINED, CO₂, 7% DISCOUNT RATE (BILLIONS 2016\$)

	Alternative							
	1	2	3	4	5	6	7	8
Model Years	2021-2026	2021-2026	2021-2026	2021-2026	2022-2026	2021-2026	2021-2026	2022-2026
Annual Rate of Stringency Increase	0.0%/Year PC 0.0%/Year LT	0.5%/Year PC 0.5%/Year LT	0.5%/Year PC 0.5%/Year LT	1.0%/Year PC 2.0%/Year LT	1.0%/Year PC 2.0%/Year LT	2.0%/Year PC 3.0%/Year LT	2.0%/Year PC 3.0%/Year LT	2.0%/Year PC 3.0%/Year LT
AC/Off-Cycle Procedures	No Change	No Change	Phaseout 2022- 2026	No Change	No Change	No Change	Phaseout 2022- 2026	No Change
Societal Costs								
Technology Costs	-\$155.4	-\$149.5	-\$142.5	-\$122.6	-\$82.5	-\$83.7	-\$49.3	-\$43.1
Advanced Technology Value Loss	-\$13.4	-\$13.0	-\$13.0	-\$12.5	-\$9.7	-\$10.9	-\$6.1	-\$7.5
Congestion Costs	-\$27.7	-\$26.3	-\$23.9	-\$18.5	-\$11.9	-\$10.3	-\$5.0	-\$5.3
Noise Costs	-\$0.4	-\$0.4	-\$0.3	-\$0.3	-\$0.2	-\$0.1	-\$0.1	-\$0.1
Non-Rebound Fatality Costs	-\$19.8	-\$18.9	-\$16.8	-\$12.3	-\$8.4	-\$6.4	-\$2.4	-\$3.2
Non-Rebound Non-Fatal Crash Costs	-\$30.9	-\$29.5	-\$26.3	-\$19.3	-\$13.2	-\$10.0	-\$3.8	-\$4.9
Rebound Fatality Costs	-\$23.1	-\$22.0	-\$20.3	-\$16.0	-\$9.7	-\$9.3	-\$5.4	-\$4.8
Non-Fatal Crash Costs	-\$36.1	-\$34.5	-\$31.7	-\$25.0	-\$15.1	-\$14.6	-\$8.5	-\$7.5
Total Societal Costs	-\$306.8	-\$294.0	-\$274.9	-\$226.6	-\$150.6	-\$145.3	-\$80.7	-\$76.4
Societal Benefits								
Pre-Tax Fuel Savings	-\$70.3	-\$67.4	-\$62.5	-\$49.5	-\$29.1	-\$29.7	-\$18.5	-\$14.8
Rebound Fuel Benefit ¹	-\$33.6	-\$32.0	-\$29.5	-\$22.6	-\$13.4	-\$12.9	-\$7.1	-\$6.2
Refueling Time Benefit	-\$4.5	-\$4.3	-\$4.0	-\$3.2	-\$2.0	-\$2.0	-\$1.2	-\$1.0
Rebound Fatality Costs, Off-setting Benefit ²	-\$23.1	-\$22.0	-\$20.3	-\$16.0	-\$9.7	-\$9.3	-\$5.4	-\$4.8
Rebound Non-Fatal Crash Costs, Off-setting Benefit ²	-\$36.1	-\$34.5	-\$31.7	-\$25.0	-\$15.1	-\$14.6	-\$8.5	-\$7.5
Petroleum Market Externality	-\$5.8	-\$5.5	-\$5.1	-\$4.1	-\$2.4	-\$2.5	-\$1.5	-\$1.2
CO ₂ Damage Reduction Benefit	-\$2.3	-\$2.2	-\$2.0	-\$1.6	-\$0.9	-\$1.0	-\$0.6	-\$0.5
NO _x Damage Reduction Benefit	\$0.4	\$0.4	\$0.3	\$0.3	\$0.2	\$0.1	\$0.1	\$0.1

*** EO 12866 Review – Draft – Do Not Cite, Quote or Release During Review ***

VOC Damage Reduction Benefit	\$0.1	\$0.1	\$0.1	\$0.0	\$0.0	\$0.0	\$0.0	\$0.0
PM Damage Reduction Benefit	\$0.1	\$0.1	\$0.1	\$0.0	\$0.1	\$0.0	-\$0.1	\$0.0
SO ₂ Damage Reduction Benefit	-\$1.4	-\$1.3	-\$1.2	-\$1.0	-\$0.5	-\$0.5	-\$0.3	-\$0.2
Total Societal Benefits	-\$176.6	-\$168.7	-\$155.9	-\$122.6	-\$72.8	-\$72.3	-\$43.2	-\$36.1
Net Total Benefits	\$130.2	\$125.3	\$119.0	\$104.0	\$77.8	\$73.0	\$37.4	\$40.3

¹ This value includes both the value of the fuel spent to drive rebound miles, and the consumer surplus representing the additional amount consumers would have, but did not spend to drive the additional miles.

² It is assumed that consumers that drive rebound miles fully internalize fatal and non-fatal crash costs. The miles are driven because they receive an equal and offsetting benefit from driving the miles. These cells report the magnitude of the offsetting benefits.

*** EO 12866 Review – Draft – Do Not Cite, Quote or Release During Review ***

TABLE 11-35 - SOCIETAL COSTS, BENEFITS AND NET BENEFITS, PASSENGER CARS AND LIGHT TRUCKS COMBINED, CO₂, UNDISCOUNTED (BILLIONS 2016\$)

	Alternative							
	1	2	3	4	5	6	7	8
Model Years	2021-2026	2021-2026	2021-2026	2021-2026	2022-2026	2021-2026	2021-2026	2022-2026
Annual Rate of Stringency Increase	0.0%/Year PC 0.0%/Year LT	0.5%/Year PC 0.5%/Year LT	0.5%/Year PC 0.5%/Year LT	1.0%/Year PC 2.0%/Year LT	1.0%/Year PC 2.0%/Year LT	2.0%/Year PC 3.0%/Year LT	2.0%/Year PC 3.0%/Year LT	2.0%/Year PC 3.0%/Year LT
AC/Off-Cycle Procedures	No Change	No Change	Phaseout 2022- 2026	No Change	No Change	No Change	Phaseout 2022- 2026	No Change
Societal Costs								
Technology Costs	-\$262.1	-\$252.7	-\$240.0	-\$206.4	-\$141.7	-\$138.7	-\$78.9	-\$72.6
Advanced Technology Value Loss	-\$23.4	-\$22.8	-\$22.8	-\$22.0	-\$17.5	-\$19.2	-\$10.4	-\$13.5
Congestion Costs	-\$83.9	-\$80.0	-\$72.2	-\$55.6	-\$37.9	-\$30.7	-\$13.0	-\$16.2
Noise Costs	-\$1.2	-\$1.1	-\$1.0	-\$0.8	-\$0.5	-\$0.4	-\$0.2	-\$0.2
Non-Rebound Fatality Costs	-\$70.2	-\$67.1	-\$59.5	-\$44.2	-\$31.9	-\$22.7	-\$7.2	-\$11.7
Non-Rebound Non-Fatal Crash Costs	-\$109.9	-\$105.0	-\$93.0	-\$69.1	-\$49.9	-\$35.5	-\$11.2	-\$18.3
Rebound Fatality Costs	-\$57.5	-\$54.9	-\$50.2	-\$39.7	-\$24.7	-\$23.0	-\$13.0	-\$12.2
Non-Fatal Crash Costs	-\$89.9	-\$85.9	-\$78.5	-\$62.1	-\$38.6	-\$36.0	-\$20.4	-\$19.0
Total Societal Costs	-\$698.1	-\$669.6	-\$617.2	-\$499.9	-\$342.8	-\$306.3	-\$154.4	-\$163.8
Societal Benefits								
Pre-Tax Fuel Savings	-\$159.7	-\$153.3	-\$142.5	-\$113.5	-\$66.5	-\$69.2	-\$44.9	-\$35.0
Rebound Fuel Benefit ¹	-\$86.6	-\$82.6	-\$75.7	-\$57.9	-\$35.3	-\$32.8	-\$17.5	-\$16.1
Refueling Time Benefit	-\$10.3	-\$9.8	-\$9.1	-\$7.4	-\$4.5	-\$4.5	-\$2.9	-\$2.4
Rebound Fatality Costs, Off-setting Benefit ²	-\$57.5	-\$54.9	-\$50.2	-\$39.7	-\$24.7	-\$23.0	-\$13.0	-\$12.2
Rebound Non-Fatal Crash Costs, Off-setting Benefit ²	-\$89.9	-\$85.9	-\$78.5	-\$62.1	-\$38.6	-\$36.0	-\$20.4	-\$19.0
Petroleum Market Externality	-\$13.1	-\$12.6	-\$11.7	-\$9.3	-\$5.5	-\$5.7	-\$3.6	-\$2.9
CO2 Damage Reduction Benefit	-\$5.2	-\$5.0	-\$4.6	-\$3.7	-\$2.2	-\$2.3	-\$1.5	-\$1.1
NOx Damage Reduction Benefit	\$1.3	\$1.2	\$1.1	\$0.8	\$0.6	\$0.4	\$0.1	\$0.2

*** EO 12866 Review – Draft – Do Not Cite, Quote or Release During Review ***

VOC Damage Reduction Benefit	\$0.3	\$0.2	\$0.2	\$0.2	\$0.1	\$0.1	\$0.0	\$0.0
PM Damage Reduction Benefit	\$1.6	\$1.5	\$1.3	\$0.9	\$0.8	\$0.4	-\$0.2	\$0.2
SO ₂ Damage Reduction Benefit	-\$3.0	-\$2.9	-\$2.7	-\$2.1	-\$1.1	-\$1.2	-\$0.7	-\$0.5
Total Societal Benefits	-\$422.1	-\$404.0	-\$372.3	-\$293.7	-\$176.9	-\$173.8	-\$104.5	-\$88.8
Net Total Benefits	\$276.0	\$265.5	\$244.9	\$206.1	\$165.9	\$132.5	\$49.9	\$75.0

¹ This value includes both the value of the fuel spent to drive rebound miles, and the consumer surplus representing the additional amount consumers would have, but did not spend to drive the additional miles.

² It is assumed that consumers that drive rebound miles fully internalize fatal and non-fatal crash costs. The miles are driven because they receive an equal and offsetting benefit from driving the miles. These cells report the magnitude of the offsetting benefits.

*** EO 12866 Review – Draft – Do Not Cite, Quote or Release During Review ***

TABLE 11-36 - CONSUMER IMPACTS AND NET CONSUMER BENEFITS, MY 2030 PASSENGER CARS RELATIVE TO PREVIOUSLY- ISSUED CO₂ STANDARDS, CO₂, 3% DISCOUNT RATE (BILLIONS 2016\$)

	Alternative							
	1	2	3	4	5	6	7	8
Model Years	2021-2026	2021-2026	2021-2026	2021-2026	2022-2026	2021-2026	2021-2026	2022-2026
Annual Rate of Stringency Increase	0.0%/Year PC 0.0%/Year LT	0.5%/Year PC 0.5%/Year LT	0.5%/Year PC 0.5%/Year LT	1.0%/Year PC 2.0%/Year LT	1.0%/Year PC 2.0%/Year LT	2.0%/Year PC 3.0%/Year LT	2.0%/Year PC 3.0%/Year LT	2.0%/Year PC 3.0%/Year LT
AC/Off-Cycle Procedures	No Change	No Change	Phaseout 2022-2026	No Change	No Change	No Change	Phaseout 2022-2026	No Change
Price Increase	-1633	-1586	-1455	-1325	-1094	-887	-528	-641
Welfare Loss	-238	-232	-232	-228	-208	-218	-123	-174
Additional Ownership Costs	-383	-372	-341	-313	-261	-212	-127	-155
Fuel Savings	-1259	-1207	-1046	-949	-759	-626	-376	-473
Mobility Benefit	-459	-438	-379	-334	-260	-209	-114	-150
Refueling Benefit	-61	-59	-51	-46	-38	-31	-19	-23
Total Consumer Costs	-2254	-2189	-2028	-1866	-1563	-1318	-778	-969
Total Consumer Benefits	-1779	-1704	-1476	-1330	-1056	-867	-509	-647
Net Consumer Benefits	475	486	552	536	507	451	269	322

¹ This value includes both the value of the fuel spent to drive rebound miles, and the consumer surplus representing the additional amount consumers would have, but did not spend to drive the additional miles.

² It is assumed that consumers that drive rebound miles fully internalize fatal and non-fatal crash costs. The miles are driven because they receive an equal and offsetting benefit from driving the miles. These cells report the magnitude of the offsetting benefits.

*** EO 12866 Review – Draft – Do Not Cite, Quote or Release During Review ***

TABLE 11-37 - CONSUMER IMPACTS AND NET CONSUMER BENEFITS, MY 2030 PASSENGER CARS RELATIVE TO PREVIOUSLY- ISSUED CO₂ STANDARDS, CO₂, 7% DISCOUNT RATE (BILLIONS 2016\$)

	Alternative							
	1	2	3	4	5	6	7	8
Model Years	2021-2026	2021-2026	2021-2026	2021-2026	2022-2026	2021-2026	2021-2026	2022-2026
Annual Rate of Stringency Increase	0.0%/Year PC 0.0%/Year LT	0.5%/Year PC 0.5%/Year LT	0.5%/Year PC 0.5%/Year LT	1.0%/Year PC 2.0%/Year LT	1.0%/Year PC 2.0%/Year LT	2.0%/Year PC 3.0%/Year LT	2.0%/Year PC 3.0%/Year LT	2.0%/Year PC 3.0%/Year LT
AC/Off-Cycle Procedures	No Change	No Change	Phaseout 2022-2026	No Change	No Change	No Change	Phaseout 2022-2026	No Change
Price Increase	-1633	-1586	-1455	-1325	-1094	-887	-528	-641
Welfare Loss	-238	-232	-232	-228	-208	-218	-123	-174
Additional Ownership Costs	-347	-337	-309	-283	-237	-192	-115	-141
Fuel Savings	-1061	-1018	-884	-797	-636	-523	-309	-391
Mobility Benefit	-374	-357	-308	-272	-211	-170	-92	-122
Refueling Benefit	-52	-50	-43	-39	-32	-26	-16	-19
Total Consumer Costs	-2218	-2155	-1996	-1837	-1539	-1298	-766	-955
Total Consumer Benefits	-1487	-1424	-1236	-1109	-879	-719	-417	-532
Net Consumer Benefits	731	730	761	728	660	579	348	423

*** EO 12866 Review – Draft – Do Not Cite, Quote or Release During Review ***

TABLE 11-38 - CONSUMER IMPACTS AND NET CONSUMER BENEFITS, MY 2030 PASSENGER CARS RELATIVE TO PREVIOUSLY- ISSUED CO₂ STANDARDS, CO₂, UNDISCOUNTED (BILLIONS 2016\$)

	Alternative							
	1	2	3	4	5	6	7	8
Model Years	2021-2026	2021-2026	2021-2026	2021-2026	2022-2026	2021-2026	2021-2026	2022-2026
Annual Rate of Stringency Increase	0.0%/Year PC 0.0%/Year LT	0.5%/Year PC 0.5%/Year LT	0.5%/Year PC 0.5%/Year LT	1.0%/Year PC 2.0%/Year LT	1.0%/Year PC 2.0%/Year LT	2.0%/Year PC 3.0%/Year LT	2.0%/Year PC 3.0%/Year LT	2.0%/Year PC 3.0%/Year LT
AC/Off-Cycle Procedures	No Change	No Change	Phaseout 2022-2026	No Change	No Change	No Change	Phaseout 2022-2026	No Change
Price Increase	-1633	-1586	-1455	-1325	-1094	-887	-528	-641
Welfare Loss	-238	-232	-232	-228	-208	-218	-123	-174
Additional Ownership Costs	-420	-407	-374	-343	-286	-233	-140	-170
Fuel Savings	-1454	-1394	-1205	-1099	-884	-733	-449	-561
Mobility Benefit	-554	-528	-458	-404	-314	-253	-137	-182
Refueling Benefit	-71	-68	-59	-54	-44	-36	-22	-28
Total Consumer Costs	-2291	-2225	-2061	-1896	-1589	-1338	-790	-984
Total Consumer Benefits	-2079	-1990	-1721	-1557	-1241	-1022	-608	-770
Net Consumer Benefits	212	235	340	339	347	316	182	214

*** EO 12866 Review – Draft – Do Not Cite, Quote or Release During Review ***

Table 11-39 - Consumer Impacts and Net Consumer Benefits, MY 2030 Light Trucks Relative to Previously-Issued CO₂ Standards, CO₂, 3% Discount Rate (Billions 2016\$)

	Alternative							
	1	2	3	4	5	6	7	8
Model Years	2021-2026	2021-2026	2021-2026	2021-2026	2022-2026	2021-2026	2021-2026	2022-2026
Annual Rate of Stringency Increase	0.0%/Year PC 0.0%/Year LT	0.5%/Year PC 0.5%/Year LT	0.5%/Year PC 0.5%/Year LT	1.0%/Year PC 2.0%/Year LT	1.0%/Year PC 2.0%/Year LT	2.0%/Year PC 3.0%/Year LT	2.0%/Year PC 3.0%/Year LT	2.0%/Year PC 3.0%/Year LT
AC/Off-Cycle Procedures	No Change	No Change	Phaseout 2022-2026	No Change	No Change	No Change	Phaseout 2022-2026	No Change
Price Increase	-2144	-2083	-1955	-1526	-1024	-774	-105	-263
Welfare Loss	-126	-126	-126	-114	-89	-77	-13	-39
Additional Ownership Costs	-523	-508	-476	-372	-250	-189	-26	-64
Fuel Savings	-2121	-2031	-1833	-1230	-761	-535	-98	-186
Mobility Benefit	-692	-660	-593	-389	-229	-152	-22	-49
Refueling Benefit	-83	-79	-71	-48	-30	-22	-3	-8
Total Consumer Costs	-2793	-2717	-2558	-2012	-1363	-1040	-144	-366
Total Consumer Benefits	-2895	-2771	-2497	-1667	-1020	-708	-124	-243
Net Consumer Benefits	-102	-54	61	345	342	332	20	123

*** EO 12866 Review – Draft – Do Not Cite, Quote or Release During Review ***

Table 11-40 - Consumer Impacts and Net Consumer Benefits, MY 2030 Light Trucks Relative to Previously-Issued CO₂ Standards, CO₂, 7% Discount Rate (Billions 2016\$)

	Alternative							
	1	2	3	4	5	6	7	8
Model Years	2021-2026	2021-2026	2021-2026	2021-2026	2022-2026	2021-2026	2021-2026	2022-2026
Annual Rate of Stringency Increase	0.0%/Year PC 0.0%/Year LT	0.5%/Year PC 0.5%/Year LT	0.5%/Year PC 0.5%/Year LT	1.0%/Year PC 2.0%/Year LT	1.0%/Year PC 2.0%/Year LT	2.0%/Year PC 3.0%/Year LT	2.0%/Year PC 3.0%/Year LT	2.0%/Year PC 3.0%/Year LT
AC/Off-Cycle Procedures	No Change	No Change	Phaseout 2022-2026	No Change	No Change	No Change	Phaseout 2022-2026	No Change
Price Increase	-2144	-2083	-1955	-1526	-1024	-774	-105	-263
Welfare Loss	-126	-126	-126	-114	-89	-77	-13	-39
Additional Ownership Costs	-474	-460	-432	-337	-226	-171	-23	-58
Fuel Savings	-1719	-1645	-1482	-994	-616	-433	-80	-152
Mobility Benefit	-560	-534	-480	-315	-186	-123	-18	-40
Refueling Benefit	-68	-65	-58	-39	-25	-18	-3	-7
Total Consumer Costs	-2744	-2669	-2513	-1978	-1339	-1022	-142	-360
Total Consumer Benefits	-2347	-2244	-2021	-1347	-826	-574	-101	-198
Net Consumer Benefits	397	425	493	630	513	448	41	162

*** EO 12866 Review – Draft – Do Not Cite, Quote or Release During Review ***

Table 11-41 - Consumer Impacts and Net Consumer Benefits, MY 2030 Light Trucks Relative to Previously-Issued CO₂ Standards, CO₂, Undiscounted Rate (Billions 2016\$)

	Alternative							
	1	2	3	4	5	6	7	8
Model Years	2021-2026	2021-2026	2021-2026	2021-2026	2022-2026	2021-2026	2021-2026	2022-2026
Annual Rate of Stringency Increase	0.0%/Year PC 0.0%/Year LT	0.5%/Year PC 0.5%/Year LT	0.5%/Year PC 0.5%/Year LT	1.0%/Year PC 2.0%/Year LT	1.0%/Year PC 2.0%/Year LT	2.0%/Year PC 3.0%/Year LT	2.0%/Year PC 3.0%/Year LT	2.0%/Year PC 3.0%/Year LT
AC/Off-Cycle Procedures	No Change	No Change	Phaseout 2022-2026	No Change	No Change	No Change	Phaseout 2022-2026	No Change
Price Increase	-2144	-2083	-1955	-1526	-1024	-774	-105	-263
Welfare Loss	-126	-126	-126	-114	-89	-77	-13	-39
Additional Ownership Costs	-573	-557	-523	-408	-274	-207	-28	-70
Fuel Savings	-2563	-2457	-2220	-1491	-918	-644	-116	-221
Mobility Benefit	-840	-802	-722	-474	-279	-185	-27	-60
Refueling Benefit	-99	-95	-85	-58	-36	-26	-4	-9
Total Consumer Costs	-2844	-2766	-2604	-2048	-1387	-1058	-147	-372
Total Consumer Benefits	-3502	-3354	-3027	-2023	-1234	-855	-147	-291
Net Consumer Benefits	-659	-588	-423	26	153	203	-1	82

*** EO 12866 Review – Draft – Do Not Cite, Quote or Release During Review ***

Table 11-42 - Consumer Impacts and Net Consumer Benefits, MY 2030 Passenger Cars and Light Trucks Relative to Previously-Issued CO₂ Standards, CO₂, 3% Discount Rate (Billions 2016\$)

	Alternative							
	1	2	3	4	5	6	7	8
Model Years	2021-2026	2021-2026	2021-2026	2021-2026	2022-2026	2021-2026	2021-2026	2022-2026
Annual Rate of Stringency Increase	0.0%/Year PC 0.0%/Year LT	0.5%/Year PC 0.5%/Year LT	0.5%/Year PC 0.5%/Year LT	1.0%/Year PC 2.0%/Year LT	1.0%/Year PC 2.0%/Year LT	2.0%/Year PC 3.0%/Year LT	2.0%/Year PC 3.0%/Year LT	2.0%/Year PC 3.0%/Year LT
AC/Off-Cycle Procedures	No Change	No Change	Phaseout 2022-2026	No Change	No Change	No Change	Phaseout 2022-2026	No Change
Price Increase	-1879	-1825	-1696	-1428	-1067	-838	-329	-462
Welfare Loss	-184	-181	-181	-174	-151	-151	-70	-109
Additional Ownership Costs	-508	-494	-458	-380	-277	-217	-84	-116
Fuel Savings	-1519	-1453	-1288	-995	-716	-550	-234	-328
Mobility Benefit	-565	-539	-477	-360	-246	-183	-70	-102
Refueling Benefit	-69	-66	-58	-46	-33	-26	-11	-16
Total Consumer Costs	-2571	-2500	-2335	-1982	-1495	-1206	-483	-688
Total Consumer Benefits	-2152	-2058	-1824	-1401	-995	-759	-315	-446
Net Consumer Benefits	418	442	511	581	500	447	168	241

*** EO 12866 Review – Draft – Do Not Cite, Quote or Release During Review ***

Table 11-43 - Consumer Impacts and Net Consumer Benefits, MY 2030 Passenger Cars and Light Trucks Relative to Previously-Issued CO₂ Standards, CO₂, 7% Discount Rate (Billions 2016\$)

	Alternative							
	1	2	3	4	5	6	7	8
Model Years	2021-2026	2021-2026	2021-2026	2021-2026	2022-2026	2021-2026	2021-2026	2022-2026
Annual Rate of Stringency Increase	0.0%/Year PC 0.0%/Year LT	0.5%/Year PC 0.5%/Year LT	0.5%/Year PC 0.5%/Year LT	1.0%/Year PC 2.0%/Year LT	1.0%/Year PC 2.0%/Year LT	2.0%/Year PC 3.0%/Year LT	2.0%/Year PC 3.0%/Year LT	2.0%/Year PC 3.0%/Year LT
AC/Off-Cycle Procedures	No Change	No Change	Phaseout 2022-2026	No Change	No Change	No Change	Phaseout 2022-2026	No Change
Price Increase	-1879	-1825	-1696	-1428	-1067	-838	-329	-462
Welfare Loss	-184	-181	-181	-174	-151	-151	-70	-109
Additional Ownership Costs	-460	-447	-415	-345	-251	-197	-76	-105
Fuel Savings	-1254	-1199	-1063	-820	-591	-454	-192	-270
Mobility Benefit	-459	-438	-387	-292	-199	-148	-57	-83
Refueling Benefit	-57	-55	-48	-38	-28	-22	-9	-13
Total Consumer Costs	-2523	-2454	-2292	-1946	-1469	-1186	-475	-677
Total Consumer Benefits	-1770	-1692	-1498	-1151	-818	-624	-258	-366
Net Consumer Benefits	753	762	793	795	651	562	217	311

*** EO 12866 Review – Draft – Do Not Cite, Quote or Release During Review ***

Table 11-44 - Consumer Impacts and Net Consumer Benefits, MY 2030 Passenger Cars and Light Trucks Relative to Previously-Issued CO₂ Standards, CO₂, Undiscounted (Billions 2016\$)

	Alternative							
	1	2	3	4	5	6	7	8
Model Years	2021-2026	2021-2026	2021-2026	2021-2026	2022-2026	2021-2026	2021-2026	2022-2026
Annual Rate of Stringency Increase	0.0%/Year PC 0.0%/Year LT	0.5%/Year PC 0.5%/Year LT	0.5%/Year PC 0.5%/Year LT	1.0%/Year PC 2.0%/Year LT	1.0%/Year PC 2.0%/Year LT	2.0%/Year PC 3.0%/Year LT	2.0%/Year PC 3.0%/Year LT	2.0%/Year PC 3.0%/Year LT
AC/Off-Cycle Procedures	No Change	No Change	Phaseout 2022-2026	No Change	No Change	No Change	Phaseout 2022-2026	No Change
Price Increase	-1879	-1825	-1696	-1428	-1067	-838	-329	-462
Welfare Loss	-184	-181	-181	-174	-151	-151	-70	-109
Additional Ownership Costs	-557	-541	-502	-417	-304	-238	-92	-127
Fuel Savings	-1797	-1719	-1525	-1177	-846	-651	-278	-389
Mobility Benefit	-684	-653	-579	-437	-298	-222	-85	-124
Refueling Benefit	-81	-77	-68	-54	-39	-31	-13	-19
Total Consumer Costs	-2620	-2548	-2379	-2019	-1522	-1227	-491	-699
Total Consumer Benefits	-2562	-2450	-2172	-1668	-1184	-903	-376	-532
Net Consumer Benefits	58	98	207	350	339	324	115	167

11.2 Net Impacts under the Preferred Alternative

This section reviews impacts under the preferred alternative. Table 11-45 and Table 11-46 indicate that, under the preferred alternative, average vehicle prices would decrease by \$1,869 (\$2,114 for light trucks and \$1,648 for passenger cars). The estimated net savings to consumers are positive for purchases of light trucks (\$110 per vehicle at a three-percent discount rate and \$605 at a seven-percent discount rate) and passenger cars (\$810 at a three-percent discount rate and \$1,029 at a seven-percent discount rate). Fatalities are estimated to decrease by 6,361 under the preferred alternative when excluding rebound miles, and by another 6,345 when accounting for rebound miles. Net societal benefits are positive under the preferred alternative (\$215 billion at a three-percent discount rate, \$160 billion at a seven-percent discount rate).

TABLE 11-45 - PREFERRED ALTERNATIVE, SUMMARY OF IMPACTS, CAFE PROGRAM

Category	Light Truck	Passenger Car	Combined Fleet
Required MPG for MY 2026+	31.3	43.7	37.0
Achieved MPG for MY 2026+	33.6	46.7	39.7
Achieved MPG for MY 2020	31.6	43.9	37.2
Per Vehicle Price Increase	-\$2,114	-\$1,648	-\$1,869
MY 2030 Lifetime Fuel Savings (per vehicle), Discounted at 3%	-\$2,101	-\$1,119	-\$1,468
MY 2030 Lifetime Fuel Savings (per vehicle), Discounted at 7%	-\$1,700	-\$948	-\$1,211
MY 2030 Lifetime Net Consumer Savings (per vehicle), Discounted at 3%	\$110	\$810	\$644
MY 2030 Lifetime Net Consumer Savings (per vehicle), Discounted at 7%	\$605	\$1,029	\$965
Total Lifetime Fuel Savings (bGallons)	-44	-30	-73
Total Lifetime CO2 Reductions (million metric tons)	-482	-329	-810
Fatalities (Excluding Rebound Miles)	-3,134	-3,227	-6,361
Fatalities (Associated with Rebound Miles)	-3,276	-3,068	-6,345
Total Technology Costs (\$b), Discounted at 3%	-\$141	-\$114	-\$255
Total Technology Costs (\$b), Discounted at 7%	-\$108	-\$86	-\$194
Total Net Societal Benefits (\$b), Discounted at 3%	\$102	\$113	\$215
Total Net Societal Benefits (\$b), Discounted at 7%	\$80	\$80	\$160

*** EO 12866 Review – Draft – Do Not Cite, Quote or Release During Review ***

TABLE 11-46 - PREFERRED ALTERNATIVE, SUMMARY OF IMPACTS, CO₂ PROGRAM

Category	Light Truck	Passenger Car	Combined Fleet
Required MPG for MY 2026+	31.3	43.7	37.1
Achieved MPG for MY 2026+	33.4	45.9	39.3
Achieved MPG for MY 2020	31.4	43.0	36.7
Per Vehicle Price Increase	-\$2,144	-\$1,633	-\$1,879
MY 2030 Lifetime Fuel Savings (per vehicle), Discounted at 3%	-\$2,121	-\$1,259	-\$1,519
MY 2030 Lifetime Fuel Savings (per vehicle), Discounted at 7%	-\$1,719	-\$1,061	-\$1,254
MY 2030 Lifetime Net Consumer Savings (per vehicle), Discounted at 3%	-\$102	\$475	\$418
MY 2030 Lifetime Net Consumer Savings (per vehicle), Discounted at 7%	\$397	\$731	\$753
Total Lifetime Fuel Savings (bGallons)	-31	-29	-60
Total Lifetime CO ₂ Reductions (million metric tons)	-341	-326	-667
Fatalities (Excluding Rebound Miles)	-4,163	-2,932	-7,095
Fatalities (Associated with Rebound Miles)	-2,854	-2,954	-5,808
Total Technology Costs (\$b), Discounted at 3%	-\$110	-\$98	-\$207
Total Technology Costs (\$b), Discounted at 7%	-\$82	-\$73	-\$155
Total Net Societal Benefits (\$b), Discounted at 3%	\$108	\$82	\$190
Total Net Societal Benefits (\$b), Discounted at 7%	\$74	\$56	\$130

Table 11-47 presents estimated impacts for MY 1977-2029 vehicles under the preferred alternative. The estimated decrease in costs is partially offset by a decrease in benefits, yielding positive net benefits (\$215 billion at a three-percent discount rate, and \$160 billion at a seven-percent discount rate).

TABLE 11-47 - ESTIMATED MY 1977-2029 COSTS, BENEFITS, AND NET BENEFITS UNDER THE PREFERRED ALTERNATIVE (BILLIONS 2016\$)

Cumulative Across MYs 1977-2029				
	Totals		Annualized	
	3% Discount Rate	7% Discount Rate	3% Discount Rate	7% Discount Rate
Costs	-540.9	-363.9	-20.7	-26.2
Benefits	-326.2	-204.1	-12.5	-14.7
Net Benefits	214.6	159.7	8.2	11.5

*** EO 12866 Review – Draft – Do Not Cite, Quote or Release During Review ***

Table 11-48 through Table 11-56 present estimated costs and benefits by model year under the preferred alternative as calculated by the CAFE model; equivalent results under the CO₂ Program are presented in Table 11-66 through Table 11-74. Table 11-57 through Table 11-65 present estimated consumer impacts and net consumer benefits by model under the preferred alternative as calculated by the CAFE model; equivalent results under the CO₂ Program are presented in Table 11-75 through Table 11-83.

*** EO 12866 Review – Draft – Do Not Cite, Quote or Release During Review ***

**TABLE 11-48 - COST AND BENEFIT ESTIMATES, PASSENGER CARS, PREFERRED ALTERNATIVE, CAFE, 3% DISCOUNT RATE
(BILLIONS 2016\$)**

Passenger Cars and Light Trucks	MY 1977-2016	MY 2017	MY 2018	MY 2019	MY 2020	MY 2021	MY 2022	MY 2023	MY 2024	MY 2025	MY 2026	MY 2027	MY 2028	MY 2029	MY TOTAL
Societal Costs															
Technology Costs	0.0	-0.9	-1.9	-2.6	-5.3	-8.8	-10.8	-12.2	-12.4	-12.7	-12.4	-11.8	-11.2	-10.7	-113.7
Advanced Technology Value Loss	0.0	-0.1	-0.2	-0.2	-0.5	-1.0	-1.4	-1.9	-2.1	-2.5	-2.5	-2.4	-2.4	-2.3	-19.6
Congestion Costs	-12.2	-1.3	-1.4	-1.5	-1.7	-2.1	-1.9	-1.5	-1.1	-0.6	-0.2	0.2	0.2	0.3	-24.9
Noise Costs	-0.2	0.0	0.0	0.0	0.0	0.0	0.0	0.0	0.0	0.0	0.0	0.0	0.0	0.0	-0.3
Non-Rebound Fatality Costs	-18.8	-1.8	-1.7	-1.6	-1.5	-1.3	-0.7	-0.1	0.5	1.2	1.8	2.2	2.2	2.2	-17.3
Non-Rebound Non-Fatal Crash Costs	-29.3	-2.8	-2.6	-2.5	-2.3	-2.1	-1.1	-0.2	0.8	1.8	2.8	3.4	3.4	3.5	-27.1
Rebound Fatality Costs	0.6 ³	-0.1	-0.3	-0.5	-0.9	-1.6	-2.0	-2.2	-2.3	-2.3	-2.3	-2.2	-2.1	-2.1	-20.2
Non-Fatal Crash Costs	0.9 ³	-0.1	-0.5	-0.8	-1.4	-2.5	-3.1	-3.4	-3.6	-3.6	-3.6	-3.4	-3.3	-3.2	-31.6
Total Societal Costs	-58.9	-7.3	-8.6	-9.6	-13.6	-19.4	-21.1	-21.5	-20.2	-18.6	-16.3	-14.0	-13.2	-12.4	-254.8
Societal Benefits															
Pre-Tax Fuel Savings	19.5	1.5	0.6	-0.1	-1.7	-4.3	-6.1	-7.4	-8.4	-9.2	-9.7	-9.8	-9.7	-9.6	-54.5
Rebound Fuel Benefit ¹	0.1	-0.1	-0.3	-0.5	-1.0	-1.8	-2.3	-2.5	-2.7	-2.8	-2.8	-2.7	-2.7	-2.7	-24.9
Refueling Time Benefit	0.1	0.1	0.0	0.0	-0.1	-0.3	-0.4	-0.4	-0.5	-0.5	-0.6	-0.6	-0.5	-0.5	-4.3
Rebound Fatality Costs, Off-setting Benefit ²	0.6	-0.1	-0.3	-0.5	-0.9	-1.6	-2.0	-2.2	-2.3	-2.3	-2.3	-2.2	-2.1	-2.1	-20.2

*** EO 12866 Review – Draft – Do Not Cite, Quote or Release During Review ***

Rebound Non-Fatal Crash Costs, Off-setting Benefit ²	0.9	-0.1	-0.5	-0.8	-1.4	-2.5	-3.1	-3.4	-3.6	-3.6	-3.6	-3.4	-3.3	-3.2	-31.6
Petroleum Market Externality	1.6	0.1	0.0	0.0	-0.1	-0.4	-0.5	-0.6	-0.7	-0.8	-0.8	-0.8	-0.8	-0.8	-4.6
CO2 Damage Reduction Benefit	0.6	0.0	0.0	0.0	-0.1	-0.1	-0.2	-0.2	-0.3	-0.3	-0.3	-0.3	-0.3	-0.3	-1.8
NOx Damage Reduction Benefit	0.6	0.0	0.0	0.0	0.0	0.0	0.0	0.0	0.0	0.0	0.0	0.0	0.0	0.0	0.4
VOC Damage Reduction Benefit	0.2	0.0	0.0	0.0	0.0	0.0	0.0	0.0	0.0	0.0	0.0	0.0	0.0	0.0	0.1
PM Damage Reduction Benefit	1.3	0.1	0.1	0.1	0.0	0.0	-0.1	-0.1	-0.1	-0.1	-0.1	-0.2	-0.1	-0.1	0.5
SO2 Damage Reduction Benefit	0.4	0.0	0.0	0.0	0.0	-0.1	-0.1	-0.1	-0.1	-0.2	-0.2	-0.2	-0.2	-0.2	-0.9
Total Social Benefits	25.9	1.6	-0.4	-1.8	-5.3	-11.1	-14.8	-17.0	-18.7	-19.8	-20.4	-20.3	-19.9	-19.7	-141.7
Net Total Benefits	84.8	8.8	8.2	7.8	8.2	8.3	6.3	4.6	1.5	-1.1	-4.1	-6.2	-6.7	-7.3	113.1

¹ This value includes both the value of the fuel spent to drive rebound miles, and the consumer surplus representing the additional amount consumers would have, but did not spend to drive the additional miles.

² It is assumed that consumers that drive rebound miles fully internalize fatal and non-fatal crash costs. The miles are driven because they receive an equal and offsetting benefit from driving the miles. These cells report the magnitude of the offsetting benefits.

³ Note that MY's 1977-2016 have fixed fuel economy values across regulatory alternatives, but that the 2017 AEO fuel price projections generally increase over time. This results in a reduction of driving when the rebound effect is included. However, fewer MY 1977-2016 vehicle remain on the road in the preferred scenario than the baseline standards, making the increment of fatal/non-fatal crash costs due to rebound miles positive. This is true for the fatal/non-fatal crash costs for MY's 1977-2016 reported in all tables.

*** EO 12866 Review – Draft – Do Not Cite, Quote or Release During Review ***

**TABLE 11-49 - COST AND BENEFIT ESTIMATES, PASSENGER CARS, PREFERRED ALTERNATIVE, CAFE, 7% DISCOUNT RATE
(BILLIONS 2016\$)**

Passenger Cars and Light Trucks	MY 1977-2016	MY 2017	MY 2018	MY 2019	MY 2020	MY 2021	MY 2022	MY 2023	MY 2024	MY 2025	MY 2026	MY 2027	MY 2028	MY 2029	MY TOTAL
Societal Costs															
Technology Costs	0.0	-0.9	-1.8	-2.4	-4.7	-7.5	-8.9	-9.7	-9.5	-9.3	-8.8	-8.0	-7.4	-6.8	-85.9
Advanced Technology Value Loss	0.0	-0.1	-0.2	-0.2	-0.4	-0.9	-1.2	-1.5	-1.6	-1.8	-1.8	-1.7	-1.6	-1.5	-14.4
Congestion Costs	-7.6	-0.7	-0.8	-0.8	-1.0	-1.2	-1.1	-0.8	-0.5	-0.2	0.0	0.2	0.3	0.3	-13.9
Noise Costs	-0.1	0.0	0.0	0.0	0.0	0.0	0.0	0.0	0.0	0.0	0.0	0.0	0.0	0.0	-0.2
Non-Rebound Fatality Costs	-11.8	-0.9	-0.8	-0.8	-0.7	-0.6	-0.2	0.2	0.6	0.9	1.2	1.4	1.3	1.3	-8.7
Non-Rebound Non-Fatal Crash Costs	-18.5	-1.5	-1.3	-1.2	-1.0	-0.9	-0.3	0.3	0.9	1.5	1.9	2.2	2.1	2.0	-13.7
Rebound Fatality Costs	0.4	-0.1	-0.3	-0.4	-0.7	-1.1	-1.3	-1.4	-1.4	-1.4	-1.3	-1.2	-1.2	-1.1	-12.5
Non-Fatal Crash Costs	0.6	-0.1	-0.4	-0.6	-1.0	-1.8	-2.1	-2.2	-2.2	-2.2	-2.1	-1.9	-1.8	-1.7	-19.6
Total Societal Costs	-37.0	-4.4	-5.5	-6.3	-9.5	-14.0	-15.1	-15.2	-13.9	-12.6	-10.8	-9.0	-8.2	-7.4	-168.9
Societal Benefits															
Pre-Tax Fuel Savings	12.1	0.6	0.0	-0.5	-1.6	-3.3	-4.4	-5.0	-5.4	-5.7	-5.8	-5.6	-5.3	-5.1	-34.9
Rebound Fuel Benefit ¹	0.0	-0.1	-0.3	-0.4	-0.7	-1.3	-1.5	-1.6	-1.7	-1.7	-1.6	-1.5	-1.4	-1.4	-15.1
Refueling Time Benefit	0.1	0.0	0.0	0.0	-0.1	-0.2	-0.3	-0.3	-0.3	-0.3	-0.3	-0.3	-0.3	-0.3	-2.7
Rebound Fatality Costs, Off-setting Benefit ²	0.4	-0.1	-0.3	-0.4	-0.7	-1.1	-1.3	-1.4	-1.4	-1.4	-1.3	-1.2	-1.2	-1.1	-12.5
Rebound Non-Fatal Crash Costs, Off-setting Benefit ²	0.6	-0.1	-0.4	-0.6	-1.0	-1.8	-2.1	-2.2	-2.2	-2.2	-2.1	-1.9	-1.8	-1.7	-19.6

*** EO 12866 Review – Draft – Do Not Cite, Quote or Release During Review ***

Petroleum Market Externality	1.0	0.1	0.0	0.0	-0.1	-0.3	-0.4	-0.4	-0.4	-0.5	-0.5	-0.5	-0.4	-0.4	-2.9
CO2 Damage Reduction Benefit	0.4	0.0	0.0	0.0	-0.1	-0.1	-0.1	-0.2	-0.2	-0.2	-0.2	-0.2	-0.2	-0.2	-1.1
NOx Damage Reduction Benefit	0.3	0.0	0.0	0.0	0.0	0.0	0.0	0.0	0.0	0.0	0.0	0.0	0.0	0.0	0.2
VOC Damage Reduction Benefit	0.1	0.0	0.0	0.0	0.0	0.0	0.0	0.0	0.0	0.0	0.0	0.0	0.0	0.0	0.1
PM Damage Reduction Benefit	0.8	0.0	0.0	0.0	0.0	0.0	-0.1	-0.1	-0.1	-0.1	-0.1	-0.1	-0.1	-0.1	0.2
SO2 Damage Reduction Benefit	0.3	0.0	0.0	0.0	0.0	-0.1	-0.1	-0.1	-0.1	-0.1	-0.1	-0.1	-0.1	-0.1	-0.6
Total Social Benefits	16.1	0.5	-0.9	-1.9	-4.3	-8.1	-10.3	-11.3	-11.9	-12.1	-12.0	-11.5	-10.9	-10.4	-89.0
Net Total Benefits	53.1	4.9	4.6	4.4	5.2	5.9	4.8	3.9	1.9	0.5	-1.2	-2.5	-2.7	-3.0	79.9

¹ This value includes both the value of the fuel spent to drive rebound miles, and the consumer surplus representing the additional amount consumers would have, but did not spend to drive the additional miles.

² It is assumed that consumers that drive rebound miles fully internalize fatal and non-fatal crash costs. The miles are driven because they receive an equal and offsetting benefit from driving the miles. These cells report the magnitude of the offsetting benefits.

*** EO 12866 Review – Draft – Do Not Cite, Quote or Release During Review ***

TABLE 11-50 - COST AND BENEFIT ESTIMATES, PASSENGER CARS, PREFERRED ALTERNATIVE, CAFE, UNDISCOUNTED (BILLIONS 2016\$)

Passenger Cars and Light Trucks	MY 1977-2016	MY 2017	MY 2018	MY 2019	MY 2020	MY 2021	MY 2022	MY 2023	MY 2024	MY 2025	MY 2026	MY 2027	MY 2028	MY 2029	MY TOTAL
Societal Costs															
Technology Costs	0.0	-0.9	-2.0	-2.8	-5.8	-9.9	-12.5	-14.6	-15.3	-16.0	-16.2	-15.8	-15.5	-15.3	-142.5
Advanced Technology Value Loss	0.0	-0.1	-0.2	-0.3	-0.5	-1.2	-1.6	-2.3	-2.6	-3.1	-3.3	-3.3	-3.3	-3.3	-25.0
Congestion Costs	-18.0	-2.2	-2.3	-2.5	-2.8	-3.4	-3.2	-2.7	-2.2	-1.5	-0.7	-0.2	-0.1	0.0	-41.8
Noise Costs	-0.2	0.0	0.0	0.0	0.0	0.0	0.0	0.0	0.0	0.0	0.0	0.0	0.0	0.0	-0.6
Non-Rebound Fatality Costs	-27.6	-3.1	-2.9	-2.9	-2.7	-2.5	-1.7	-0.9	0.1	1.1	2.2	2.9	3.0	3.2	-31.9
Non-Rebound Non-Fatal Crash Costs	-43.2	-4.8	-4.6	-4.5	-4.3	-4.0	-2.7	-1.4	0.1	1.8	3.4	4.5	4.7	5.0	-50.0
Rebound Fatality Costs	0.9	-0.1	-0.4	-0.6	-1.2	-2.2	-2.8	-3.1	-3.3	-3.5	-3.5	-3.5	-3.5	-3.5	-30.4
Non-Fatal Crash Costs	1.4	-0.2	-0.6	-1.0	-1.9	-3.4	-4.3	-4.8	-5.2	-5.4	-5.5	-5.5	-5.5	-5.5	-47.5
Total Societal Costs	-86.8	-11.4	-13.0	-14.5	-19.3	-26.6	-28.9	-29.8	-28.4	-26.7	-23.8	-20.9	-20.3	-19.5	-369.7
Societal Benefits															
Pre-Tax Fuel Savings	28.9	2.7	1.6	0.7	-1.5	-5.1	-7.9	-10.0	-11.9	-13.5	-14.8	-15.5	-15.7	-16.1	-78.1
Rebound Fuel Benefit ¹	0.1	-0.1	-0.4	-0.7	-1.3	-2.5	-3.2	-3.6	-4.0	-4.2	-4.4	-4.4	-4.5	-4.6	-38.0
Refueling Time Benefit	0.2	0.1	0.1	0.0	-0.1	-0.3	-0.5	-0.6	-0.7	-0.8	-0.9	-0.9	-0.9	-0.9	-6.1
Rebound Fatality Costs, Off-setting Benefit ²	0.9	-0.1	-0.4	-0.6	-1.2	-2.2	-2.8	-3.1	-3.3	-3.5	-3.5	-3.5	-3.5	-3.5	-30.4
Rebound Non-Fatal Crash Costs, Off-setting Benefit ²	1.4	-0.2	-0.6	-1.0	-1.9	-3.4	-4.3	-4.8	-5.2	-5.4	-5.5	-5.5	-5.5	-5.5	-47.5

*** EO 12866 Review – Draft – Do Not Cite, Quote or Release During Review ***

Petroleum Market Externality	2.3	0.2	0.1	0.0	-0.1	-0.4	-0.7	-0.8	-1.0	-1.1	-1.2	-1.3	-1.3	-1.3	-6.5
CO2 Damage Reduction Benefit	0.9	0.1	0.1	0.0	0.0	-0.2	-0.3	-0.3	-0.4	-0.4	-0.5	-0.5	-0.5	-0.5	-2.5
NOx Damage Reduction Benefit	0.8	0.1	0.1	0.1	0.0	0.0	0.0	0.0	0.0	0.0	-0.1	-0.1	-0.1	-0.1	0.7
VOC Damage Reduction Benefit	0.3	0.0	0.0	0.0	0.0	0.0	0.0	0.0	0.0	0.0	0.0	0.0	0.0	0.0	0.2
PM Damage Reduction Benefit	1.9	0.2	0.1	0.1	0.1	0.0	-0.1	-0.1	-0.1	-0.2	-0.2	-0.2	-0.2	-0.2	1.1
SO2 Damage Reduction Benefit	0.6	0.1	0.0	0.0	0.0	-0.1	-0.1	-0.2	-0.2	-0.2	-0.2	-0.3	-0.3	-0.3	-1.2
Total Social Benefits	38.4	3.1	0.6	-1.3	-6.1	-14.2	-19.9	-23.7	-27.0	-29.5	-31.4	-32.1	-32.5	-33.1	-208.5
Net Total Benefits	125.2	14.5	13.6	13.2	13.2	12.4	9.0	6.1	1.4	-2.8	-7.6	-11.2	-12.2	-13.7	161.2

¹ This value includes both the value of the fuel spent to drive rebound miles, and the consumer surplus representing the additional amount consumers would have, but did not spend to drive the additional miles.

² It is assumed that consumers that drive rebound miles fully internalize fatal and non-fatal crash costs. The miles are driven because they receive an equal and offsetting benefit from driving the miles. These cells report the magnitude of the offsetting benefits.

*** EO 12866 Review – Draft – Do Not Cite, Quote or Release During Review ***

**TABLE 11-51 - COST AND BENEFIT ESTIMATES, LIGHT TRUCKS, PREFERRED ALTERNATIVE, CAFE, 3% DISCOUNT RATE
(BILLIONS 2016\$)**

Passenger Cars and Light Trucks	MY 1977-2016	MY 2017	MY 2018	MY 2019	MY 2020	MY 2021	MY 2022	MY 2023	MY 2024	MY 2025	MY 2026	MY 2027	MY 2028	MY 2029	MY TOTAL
Societal Costs															
Technology Costs	0.0	-0.7	-3.8	-6.4	-8.3	-12.9	-13.4	-13.6	-13.8	-14.1	-14.3	-13.8	-13.4	-12.8	-141.5
Advanced Technology Value Loss	0.0	-0.1	-0.2	-0.3	-0.5	-1.0	-1.1	-1.2	-1.6	-2.0	-2.1	-2.1	-2.1	-2.0	-16.3
Congestion Costs	-5.2	-0.5	-0.6	-0.8	-0.9	-1.2	-1.4	-1.6	-1.8	-2.0	-2.2	-2.5	-2.8	-3.0	-26.4
Noise Costs	-0.1	0.0	0.0	0.0	0.0	0.0	0.0	0.0	0.0	0.0	0.0	0.0	0.0	0.0	-0.4
Non-Rebound Fatality Costs	-9.3	-0.7	-0.5	-0.3	-0.2	0.1	0.0	-0.3	-0.4	-0.6	-0.9	-1.3	-1.7	-2.0	-18.1
Non-Rebound Non-Fatal Crash Costs	-14.5	-1.1	-0.8	-0.5	-0.3	0.2	0.0	-0.5	-0.7	-0.9	-1.3	-2.0	-2.7	-3.2	-28.3
Rebound Fatality Costs	0.3	-0.1	-0.5	-0.9	-1.1	-1.9	-2.0	-2.1	-2.1	-2.3	-2.3	-2.2	-2.2	-2.1	-21.5
Non-Fatal Crash Costs	0.5	-0.2	-0.8	-1.3	-1.8	-3.0	-3.1	-3.2	-3.3	-3.5	-3.6	-3.5	-3.4	-3.3	-33.7
Total Societal Costs	-28.3	-3.4	-7.3	-10.6	-13.2	-19.7	-21.1	-22.5	-23.7	-25.4	-26.8	-27.5	-28.3	-28.5	-286.1
Societal Benefits															
Pre-Tax Fuel Savings	13.2	0.3	-1.8	-3.4	-4.9	-8.7	-9.1	-9.2	-9.5	-10.0	-9.9	-9.2	-8.5	-7.9	-78.6
Rebound Fuel Benefit1	0.0	-0.2	-0.7	-1.3	-1.7	-3.0	-3.2	-3.4	-3.5	-3.8	-3.9	-3.9	-3.9	-3.8	-36.2
Refueling Time Benefit	0.1	0.0	-0.1	-0.2	-0.2	-0.4	-0.4	-0.4	-0.5	-0.5	-0.5	-0.4	-0.4	-0.4	-4.2
Rebound Fatality Costs, Off-setting Benefit2	0.3	-0.1	-0.5	-0.9	-1.1	-1.9	-2.0	-2.1	-2.1	-2.3	-2.3	-2.2	-2.2	-2.1	-21.5
Rebound Non-Fatal Crash Costs, Off-setting Benefit2	0.5	-0.2	-0.8	-1.3	-1.8	-3.0	-3.1	-3.2	-3.3	-3.5	-3.6	-3.5	-3.4	-3.3	-33.7

*** EO 12866 Review – Draft – Do Not Cite, Quote or Release During Review ***

Petroleum Market Externality	1.1	0.0	-0.2	-0.3	-0.4	-0.7	-0.7	-0.7	-0.8	-0.8	-0.8	-0.7	-0.7	-0.6	-6.4
CO2 Damage Reduction Benefit	0.4	0.0	-0.1	-0.1	-0.2	-0.3	-0.3	-0.3	-0.3	-0.3	-0.3	-0.3	-0.3	-0.3	-2.6
NOx Damage Reduction Benefit	0.6	0.0	0.0	0.0	0.0	0.0	0.0	0.0	0.0	0.0	0.0	0.0	0.0	0.0	0.4
VOC Damage Reduction Benefit	0.2	0.0	0.0	0.0	0.0	0.0	0.0	0.0	0.0	0.0	0.0	0.0	0.0	0.0	0.0
PM Damage Reduction Benefit	0.8	0.1	0.0	0.0	-0.1	-0.1	-0.1	-0.1	-0.1	-0.1	-0.1	-0.1	-0.1	-0.1	-0.2
SO2 Damage Reduction Benefit	0.3	0.0	-0.1	-0.1	-0.1	-0.2	-0.2	-0.2	-0.2	-0.2	-0.2	-0.2	-0.1	-0.1	-1.6
Total Social Benefits	17.5	0.0	-4.2	-7.6	-10.5	-18.3	-19.3	-19.6	-20.4	-21.5	-21.7	-20.6	-19.6	-18.7	-184.6
Net Total Benefits	45.8	3.4	3.0	3.0	2.6	1.4	1.8	2.9	3.3	3.9	5.1	6.9	8.7	9.8	101.6

¹ This value includes both the value of the fuel spent to drive rebound miles, and the consumer surplus representing the additional amount consumers would have, but did not spend to drive the additional miles.

² It is assumed that consumers that drive rebound miles fully internalize fatal and non-fatal crash costs. The miles are driven because they receive an equal and offsetting benefit from driving the miles. These cells report the magnitude of the offsetting benefits.

*** EO 12866 Review – Draft – Do Not Cite, Quote or Release During Review ***

**TABLE 11-52 - COST AND BENEFIT ESTIMATES, LIGHT TRUCKS, PREFERRED ALTERNATIVE, CAFE, 7% DISCOUNT RATE
(BILLIONS 2016\$)**

Passenger Cars and Light Trucks	MY 1977-2016	MY 2017	MY 2018	MY 2019	MY 2020	MY 2021	MY 2022	MY 2023	MY 2024	MY 2025	MY 2026	MY 2027	MY 2028	MY 2029	MY TOTAL
Societal Costs															
Technology Costs	0.0	-0.7	-3.7	-5.9	-7.4	-11.0	-11.1	-10.8	-10.6	-10.4	-10.2	-9.5	-8.8	-8.1	-108.3
Advanced Technology Value Loss	0.0	-0.1	-0.2	-0.3	-0.5	-0.9	-0.9	-0.9	-1.2	-1.5	-1.5	-1.4	-1.4	-1.3	-12.0
Congestion Costs	-3.2	-0.2	-0.4	-0.5	-0.5	-0.8	-0.9	-1.0	-1.1	-1.2	-1.3	-1.4	-1.5	-1.5	-15.3
Noise Costs	0.0	0.0	0.0	0.0	0.0	0.0	0.0	0.0	0.0	0.0	0.0	0.0	0.0	0.0	-0.2
Non-Rebound Fatality Costs	-5.7	-0.3	-0.2	-0.1	0.0	0.2	0.1	-0.2	-0.2	-0.3	-0.5	-0.7	-0.9	-1.0	-9.7
Non-Rebound Non-Fatal Crash Costs	-8.9	-0.4	-0.2	-0.1	0.0	0.3	0.1	-0.2	-0.3	-0.5	-0.7	-1.1	-1.4	-1.6	-15.2
Rebound Fatality Costs	0.2	-0.1	-0.4	-0.6	-0.8	-1.3	-1.4	-1.3	-1.3	-1.4	-1.3	-1.3	-1.2	-1.1	-13.3
Non-Fatal Crash Costs	0.3	-0.2	-0.6	-1.0	-1.3	-2.1	-2.1	-2.1	-2.1	-2.1	-2.1	-2.0	-1.8	-1.7	-20.9
Total Societal Costs	-17.2	-2.0	-5.7	-8.5	-10.5	-15.7	-16.2	-16.6	-16.9	-17.4	-17.6	-17.3	-17.0	-16.4	-194.9
Societal Benefits															
Pre-Tax Fuel Savings	8.0	-0.1	-1.7	-2.8	-3.7	-6.1	-6.1	-5.9	-5.9	-5.9	-5.7	-5.1	-4.5	-4.0	-49.5
Rebound Fuel Benefit ¹	0.0	-0.1	-0.5	-0.9	-1.2	-2.1	-2.1	-2.1	-2.2	-2.2	-2.2	-2.1	-2.1	-2.0	-22.0
Refueling Time Benefit	0.0	0.0	-0.1	-0.1	-0.2	-0.3	-0.3	-0.3	-0.3	-0.3	-0.3	-0.2	-0.2	-0.2	-2.7
Rebound Fatality Costs, Off-setting Benefit ²	0.2	-0.1	-0.4	-0.6	-0.8	-1.3	-1.4	-1.3	-1.3	-1.4	-1.3	-1.3	-1.2	-1.1	-13.3
Rebound Non-Fatal Crash Costs, Off-setting Benefit ²	0.3	-0.2	-0.6	-1.0	-1.3	-2.1	-2.1	-2.1	-2.1	-2.1	-2.1	-2.0	-1.8	-1.7	-20.9

*** EO 12866 Review – Draft – Do Not Cite, Quote or Release During Review ***

Petroleum Market Externality	0.6	0.0	-0.1	-0.2	-0.3	-0.5	-0.5	-0.5	-0.5	-0.5	-0.5	-0.4	-0.4	-0.3	-4.0
CO2 Damage Reduction Benefit	0.3	0.0	-0.1	-0.1	-0.1	-0.2	-0.2	-0.2	-0.2	-0.2	-0.2	-0.2	-0.1	-0.1	-1.6
NOx Damage Reduction Benefit	0.4	0.0	0.0	0.0	0.0	0.0	0.0	0.0	0.0	0.0	0.0	0.0	0.0	0.0	0.2
VOC Damage Reduction Benefit	0.1	0.0	0.0	0.0	0.0	0.0	0.0	0.0	0.0	0.0	0.0	0.0	0.0	0.0	0.0
PM Damage Reduction Benefit	0.5	0.0	0.0	0.0	-0.1	-0.1	-0.1	-0.1	-0.1	-0.1	-0.1	-0.1	0.0	0.0	-0.2
SO2 Damage Reduction Benefit	0.2	0.0	0.0	-0.1	-0.1	-0.1	-0.1	-0.1	-0.1	-0.1	-0.1	-0.1	-0.1	-0.1	-1.0
Total Social Benefits	10.6	-0.5	-3.6	-5.9	-7.8	-12.8	-13.0	-12.7	-12.7	-12.9	-12.5	-11.4	-10.5	-9.6	-115.1
Net Total Benefits	27.8	1.5	2.1	2.6	2.7	2.9	3.2	3.9	4.2	4.5	5.2	5.9	6.5	6.8	79.8

¹ This value includes both the value of the fuel spent to drive rebound miles, and the consumer surplus representing the additional amount consumers would have, but did not spend to drive the additional miles.

² It is assumed that consumers that drive rebound miles fully internalize fatal and non-fatal crash costs. The miles are driven because they receive an equal and offsetting benefit from driving the miles. These cells report the magnitude of the offsetting benefits.

*** EO 12866 Review – Draft – Do Not Cite, Quote or Release During Review ***

TABLE 11-53 - COST AND BENEFIT ESTIMATES, LIGHT TRUCKS, PREFERRED ALTERNATIVE, CAFE, UNDISCOUNTED (BILLIONS 2016\$)

Passenger Cars and Light Trucks	MY 1977-2016	MY 2017	MY 2018	MY 2019	MY 2020	MY 2021	MY 2022	MY 2023	MY 2024	MY 2025	MY 2026	MY 2027	MY 2028	MY 2029	MY TOTAL
Societal Costs															
Technology Costs	0.0	-0.7	-4.0	-6.8	-9.1	-14.5	-15.5	-16.2	-17.0	-17.9	-18.7	-18.6	-18.5	-18.3	-175.8
Advanced Technology Value Loss	0.0	-0.1	-0.2	-0.3	-0.6	-1.2	-1.3	-1.4	-1.9	-2.5	-2.8	-2.8	-2.9	-2.9	-20.8
Congestion Costs	-8.0	-0.9	-1.1	-1.3	-1.4	-1.8	-2.1	-2.5	-2.7	-3.1	-3.5	-4.1	-4.7	-5.2	-42.4
Noise Costs	-0.1	0.0	0.0	0.0	0.0	0.0	0.0	0.0	0.0	0.0	-0.1	-0.1	-0.1	-0.1	-0.6
Non-Rebound Fatality Costs	-14.1	-1.3	-1.1	-0.9	-0.6	-0.1	-0.2	-0.7	-0.8	-1.0	-1.5	-2.2	-3.0	-3.6	-31.0
Non-Rebound Non-Fatal Crash Costs	-22.0	-2.1	-1.7	-1.3	-1.0	-0.2	-0.4	-1.0	-1.2	-1.6	-2.3	-3.4	-4.7	-5.6	-48.5
Rebound Fatality Costs	0.5	-0.2	-0.7	-1.1	-1.5	-2.6	-2.8	-3.0	-3.2	-3.4	-3.6	-3.6	-3.7	-3.7	-32.4
Non-Fatal Crash Costs	0.8	-0.2	-1.0	-1.7	-2.4	-4.0	-4.4	-4.6	-5.0	-5.4	-5.6	-5.7	-5.7	-5.7	-50.7
Total Societal Costs	-42.9	-5.5	-9.6	-13.4	-16.6	-24.3	-26.8	-29.5	-31.9	-35.0	-38.1	-40.5	-43.2	-45.1	-402.3
Societal Benefits															
Pre-Tax Fuel Savings	20.2	1.1	-1.7	-3.9	-6.1	-11.7	-12.7	-13.2	-14.2	-15.3	-15.7	-15.0	-14.3	-13.6	-116.2
Rebound Fuel Benefit ¹	0.0	-0.2	-0.9	-1.7	-2.3	-4.1	-4.6	-4.9	-5.3	-5.8	-6.2	-6.3	-6.5	-6.7	-55.7
Refueling Time Benefit	0.1	0.0	-0.1	-0.2	-0.3	-0.5	-0.6	-0.6	-0.7	-0.7	-0.7	-0.7	-0.6	-0.6	-6.2
Rebound Fatality Costs, Off-setting Benefit ²	0.5	-0.2	-0.7	-1.1	-1.5	-2.6	-2.8	-3.0	-3.2	-3.4	-3.6	-3.6	-3.7	-3.7	-32.4
Rebound Non-Fatal Crash Costs, Off-setting Benefit ²	0.8	-0.2	-1.0	-1.7	-2.4	-4.0	-4.4	-4.6	-5.0	-5.4	-5.6	-5.7	-5.7	-5.7	-50.7

*** EO 12866 Review – Draft – Do Not Cite, Quote or Release During Review ***

Petroleum Market Externality	1.6	0.1	-0.1	-0.3	-0.5	-0.9	-1.0	-1.1	-1.2	-1.2	-1.3	-1.2	-1.2	-1.1	-9.4
CO2 Damage Reduction Benefit	0.7	0.0	-0.1	-0.1	-0.2	-0.4	-0.4	-0.4	-0.5	-0.5	-0.5	-0.5	-0.5	-0.5	-3.8
NOx Damage Reduction Benefit	0.8	0.0	0.0	0.0	0.0	0.0	0.0	0.0	0.0	0.0	0.0	0.0	0.0	0.0	0.6
VOC Damage Reduction Benefit	0.3	0.0	0.0	0.0	0.0	0.0	0.0	0.0	0.0	0.0	0.0	0.0	0.0	0.0	0.1
PM Damage Reduction Benefit	1.3	0.1	0.0	0.0	-0.1	-0.2	-0.2	-0.2	-0.2	-0.2	-0.2	-0.2	-0.1	-0.1	0.0
SO2 Damage Reduction Benefit	0.4	0.0	-0.1	-0.1	-0.1	-0.3	-0.3	-0.3	-0.3	-0.3	-0.3	-0.3	-0.2	-0.2	-2.2
Total Social Benefits	26.7	0.9	-4.6	-9.2	-13.5	-24.8	-27.0	-28.3	-30.4	-33.0	-34.2	-33.5	-32.9	-32.3	-276.1
Net Total Benefits	69.6	6.4	5.0	4.2	3.0	-0.4	-0.2	1.2	1.5	2.0	3.8	7.0	10.4	12.8	126.2

¹ This value includes both the value of the fuel spent to drive rebound miles, and the consumer surplus representing the additional amount consumers would have, but did not spend to drive the additional miles.

² It is assumed that consumers that drive rebound miles fully internalize fatal and non-fatal crash costs. The miles are driven because they receive an equal and offsetting benefit from driving the miles. These cells report the magnitude of the offsetting benefits.

*** EO 12866 Review – Draft – Do Not Cite, Quote or Release During Review ***

TABLE 11-54 - COST AND BENEFIT ESTIMATES, PASSENGER CARS AND LIGHT TRUCKS COMBINED, PREFERRED ALTERNATIVE, CAFE, 3% DISCOUNT RATE (BILLIONS 2016\$)

Passenger Cars and Light Trucks	MY 1977-2016	MY 2017	MY 2018	MY 2019	MY 2020	MY 2021	MY 2022	MY 2023	MY 2024	MY 2025	MY 2026	MY 2027	MY 2028	MY 2029	MY TOTAL
Societal Costs															
Technology Costs	0.0	-1.6	-5.7	-9.0	-13.6	-21.6	-24.2	-25.8	-26.3	-26.8	-26.7	-25.6	-24.6	-23.5	-255.1
Advanced Technology Value Loss	0.0	-0.2	-0.3	-0.5	-1.0	-2.1	-2.5	-3.1	-3.7	-4.4	-4.7	-4.5	-4.4	-4.3	-35.9
Congestion Costs	-17.4	-1.9	-2.0	-2.3	-2.6	-3.3	-3.3	-3.2	-2.9	-2.6	-2.4	-2.3	-2.5	-2.7	-51.3
Noise Costs	-0.2	0.0	0.0	0.0	0.0	0.0	0.0	0.0	0.0	0.0	0.0	0.0	0.0	0.0	-0.7
Non-Rebound Fatality Costs	-28.1	-2.5	-2.1	-1.9	-1.7	-1.2	-0.7	-0.4	0.1	0.6	0.9	0.9	0.5	0.2	-35.4
Non-Rebound Non-Fatal Crash Costs	-43.9	-3.9	-3.4	-3.0	-2.6	-1.9	-1.1	-0.7	0.2	0.9	1.5	1.4	0.7	0.3	-55.4
Rebound Fatality Costs	0.9	-0.2	-0.8	-1.4	-2.1	-3.5	-4.0	-4.2	-4.4	-4.5	-4.6	-4.4	-4.3	-4.2	-41.7
Non-Fatal Crash Costs	1.5	-0.3	-1.3	-2.1	-3.2	-5.5	-6.2	-6.6	-6.9	-7.1	-7.1	-6.9	-6.8	-6.6	-65.3
Total Societal Costs	-87.2	-10.6	-15.8	-20.2	-26.7	-39.1	-42.2	-44.1	-43.9	-44.0	-43.1	-41.5	-41.5	-40.9	-540.9
Societal Benefits															
Pre-Tax Fuel Savings	32.7	1.8	-1.2	-3.5	-6.6	-12.9	-15.3	-16.5	-17.9	-19.2	-19.7	-19.0	-18.2	-17.5	-133.1
Rebound Fuel Benefit ¹	0.1	-0.2	-1.1	-1.8	-2.7	-4.8	-5.5	-5.9	-6.2	-6.5	-6.7	-6.6	-6.6	-6.5	-61.1
Refueling Time Benefit	0.2	0.1	-0.1	-0.2	-0.4	-0.7	-0.8	-0.9	-0.9	-1.0	-1.0	-1.0	-0.9	-0.9	-8.5
Rebound Fatality Costs, Off-setting Benefit ²	0.9	-0.2	-0.8	-1.4	-2.1	-3.5	-4.0	-4.2	-4.4	-4.5	-4.6	-4.4	-4.3	-4.2	-41.7

*** EO 12866 Review – Draft – Do Not Cite, Quote or Release During Review ***

Rebound Non-Fatal Crash Costs, Off-setting Benefit ²	1.5	-0.3	-1.3	-2.1	-3.2	-5.5	-6.2	-6.6	-6.9	-7.1	-7.1	-6.9	-6.8	-6.6	-65.3
Petroleum Market Externality	2.6	0.1	-0.1	-0.3	-0.5	-1.1	-1.2	-1.3	-1.5	-1.6	-1.6	-1.6	-1.5	-1.4	-11.0
CO2 Damage Reduction Benefit	1.1	0.1	0.0	-0.1	-0.2	-0.4	-0.5	-0.5	-0.6	-0.6	-0.6	-0.6	-0.6	-0.6	-4.3
NOx Damage Reduction Benefit	1.1	0.1	0.0	0.0	0.0	0.0	0.0	0.0	-0.1	-0.1	-0.1	-0.1	-0.1	-0.1	0.8
VOC Damage Reduction Benefit	0.4	0.0	0.0	0.0	0.0	0.0	0.0	0.0	0.0	0.0	0.0	0.0	0.0	0.0	0.1
PM Damage Reduction Benefit	2.1	0.2	0.1	0.0	0.0	-0.2	-0.2	-0.2	-0.2	-0.3	-0.3	-0.2	-0.2	-0.2	0.3
SO2 Damage Reduction Benefit	0.7	0.0	0.0	-0.1	-0.2	-0.3	-0.3	-0.3	-0.3	-0.3	-0.3	-0.3	-0.3	-0.3	-2.4
Total Social Benefits	43.4	1.5	-4.6	-9.4	-15.9	-29.3	-34.1	-36.6	-39.1	-41.3	-42.1	-40.9	-39.5	-38.4	-326.2
Net Total Benefits	130.6	12.2	11.2	10.8	10.8	9.7	8.1	7.5	4.8	2.8	1.1	0.7	2.0	2.5	214.6

¹ This value includes both the value of the fuel spent to drive rebound miles, and the consumer surplus representing the additional amount consumers would have, but did not spend to drive the additional miles.

² It is assumed that consumers that drive rebound miles fully internalize fatal and non-fatal crash costs. The miles are driven because they receive an equal and offsetting benefit from driving the miles. These cells report the magnitude of the offsetting benefits.

*** EO 12866 Review – Draft – Do Not Cite, Quote or Release During Review ***

TABLE 11-55 - COST AND BENEFIT ESTIMATES, PASSENGER CARS AND LIGHT TRUCKS COMBINED, PREFERRED ALTERNATIVE, CAFE, 7% DISCOUNT RATE (BILLIONS 2016\$)

Passenger Cars and Light Trucks	MY 1977-2016	MY 2017	MY 2018	MY 2019	MY 2020	MY 2021	MY 2022	MY 2023	MY 2024	MY 2025	MY 2026	MY 2027	MY 2028	MY 2029	MY TOTAL
Societal Costs															
Technology Costs	0.0	-1.6	-5.5	-8.4	-12.1	-18.6	-20.0	-20.5	-20.1	-19.8	-19.0	-17.5	-16.2	-14.9	-194.2
Advanced Technology Value Loss	0.0	-0.2	-0.3	-0.5	-0.9	-1.8	-2.1	-2.5	-2.8	-3.3	-3.3	-3.1	-2.9	-2.7	-26.4
Congestion Costs	-10.8	-1.0	-1.1	-1.3	-1.5	-2.0	-2.0	-1.8	-1.6	-1.4	-1.2	-1.1	-1.2	-1.2	-29.2
Noise Costs	-0.1	0.0	0.0	0.0	0.0	0.0	0.0	0.0	0.0	0.0	0.0	0.0	0.0	0.0	-0.4
Non-Rebound Fatality Costs	-17.5	-1.2	-1.0	-0.8	-0.7	-0.4	-0.1	0.0	0.4	0.6	0.8	0.7	0.4	0.3	-18.5
Non-Rebound Non-Fatal Crash Costs	-27.3	-1.9	-1.5	-1.3	-1.0	-0.6	-0.2	0.1	0.6	1.0	1.2	1.1	0.7	0.4	-28.9
Rebound Fatality Costs	0.6	-0.2	-0.7	-1.0	-1.5	-2.5	-2.7	-2.8	-2.8	-2.8	-2.7	-2.5	-2.3	-2.2	-25.9
Non-Fatal Crash Costs	0.9	-0.3	-1.0	-1.6	-2.3	-3.8	-4.2	-4.3	-4.3	-4.3	-4.2	-3.9	-3.6	-3.4	-40.4
Total Societal Costs	-54.2	-6.4	-11.2	-14.8	-20.1	-29.7	-31.3	-31.8	-30.7	-29.9	-28.4	-26.3	-25.2	-23.8	-363.9
Societal Benefits															
Pre-Tax Fuel Savings	20.1	0.5	-1.7	-3.2	-5.3	-9.3	-10.5	-10.9	-11.3	-11.6	-11.5	-10.7	-9.8	-9.1	-84.4
Rebound Fuel Benefit ¹	0.0	-0.2	-0.8	-1.3	-1.9	-3.3	-3.7	-3.8	-3.8	-3.9	-3.8	-3.7	-3.5	-3.4	-37.1
Refueling Time Benefit	0.1	0.0	-0.1	-0.2	-0.3	-0.5	-0.6	-0.6	-0.6	-0.6	-0.6	-0.6	-0.5	-0.5	-5.5
Rebound Fatality Costs, Off-setting Benefit ²	0.6	-0.2	-0.7	-1.0	-1.5	-2.5	-2.7	-2.8	-2.8	-2.8	-2.7	-2.5	-2.3	-2.2	-25.9
Rebound Non-Fatal Crash Costs, Off-setting Benefit ²	0.9	-0.3	-1.0	-1.6	-2.3	-3.8	-4.2	-4.3	-4.3	-4.3	-4.2	-3.9	-3.6	-3.4	-40.4

*** EO 12866 Review – Draft – Do Not Cite, Quote or Release During Review ***

Petroleum Market Externality	1.6	0.0	-0.1	-0.3	-0.4	-0.8	-0.9	-0.9	-0.9	-1.0	-0.9	-0.9	-0.8	-0.7	-6.9
CO2 Damage Reduction Benefit	0.7	0.0	-0.1	-0.1	-0.2	-0.3	-0.3	-0.3	-0.4	-0.4	-0.4	-0.4	-0.3	-0.3	-2.7
NOx Damage Reduction Benefit	0.7	0.0	0.0	0.0	0.0	0.0	0.0	0.0	0.0	0.0	0.0	0.0	0.0	0.0	0.4
VOC Damage Reduction Benefit	0.3	0.0	0.0	0.0	0.0	0.0	0.0	0.0	0.0	0.0	0.0	0.0	0.0	0.0	0.1
PM Damage Reduction Benefit	1.3	0.1	0.0	0.0	-0.1	-0.1	-0.1	-0.1	-0.2	-0.2	-0.2	-0.1	-0.1	-0.1	0.0
SO2 Damage Reduction Benefit	0.5	0.0	-0.1	-0.1	-0.1	-0.2	-0.2	-0.2	-0.2	-0.2	-0.2	-0.2	-0.2	-0.2	-1.6
Total Social Benefits	26.7	0.1	-4.5	-7.9	-12.1	-20.9	-23.3	-24.0	-24.6	-25.0	-24.5	-22.9	-21.3	-20.0	-204.1
Net Total Benefits	81.0	6.5	6.7	7.0	7.9	8.8	8.0	7.8	6.1	5.0	3.9	3.4	3.9	3.8	159.7

¹ This value includes both the value of the fuel spent to drive rebound miles, and the consumer surplus representing the additional amount consumers would have, but did not spend to drive the additional miles.

² It is assumed that consumers that drive rebound miles fully internalize fatal and non-fatal crash costs. The miles are driven because they receive an equal and offsetting benefit from driving the miles. These cells report the magnitude of the offsetting benefits.

*** EO 12866 Review – Draft – Do Not Cite, Quote or Release During Review ***

TABLE 11-56 - COST AND BENEFIT ESTIMATES, PASSENGER CARS AND LIGHT TRUCKS COMBINED, PREFERRED ALTERNATIVE, CAFE, UNDISCOUNTED (BILLIONS 2016\$)

Passenger Cars and Light Trucks	MY 1977-2016	MY 2017	MY 2018	MY 2019	MY 2020	MY 2021	MY 2022	MY 2023	MY 2024	MY 2025	MY 2026	MY 2027	MY 2028	MY 2029	MY TOTAL
Societal Costs															
Technology Costs	0.0	-1.6	-5.9	-9.6	-14.9	-24.3	-28.0	-30.8	-32.3	-34.0	-34.9	-34.4	-34.1	-33.5	-318.3
Advanced Technology Value Loss	0.0	-0.2	-0.3	-0.5	-1.1	-2.3	-2.9	-3.7	-4.5	-5.6	-6.1	-6.1	-6.1	-6.2	-45.8
Congestion Costs	-26.0	-3.2	-3.4	-3.8	-4.2	-5.2	-5.3	-5.2	-4.9	-4.6	-4.3	-4.3	-4.8	-5.1	-84.2
Noise Costs	-0.4	0.0	0.0	-0.1	-0.1	-0.1	-0.1	-0.1	-0.1	-0.1	-0.1	-0.1	-0.1	-0.1	-1.2
Non-Rebound Fatality Costs	-41.7	-4.4	-4.0	-3.7	-3.4	-2.6	-2.0	-1.5	-0.7	0.1	0.7	0.7	0.0	-0.4	-63.0
Non-Rebound Non-Fatal Crash Costs	-65.2	-6.9	-6.2	-5.8	-5.3	-4.1	-3.1	-2.4	-1.1	0.2	1.1	1.1	0.0	-0.7	-98.5
Rebound Fatality Costs	1.4	-0.3	-1.1	-1.7	-2.7	-4.8	-5.6	-6.1	-6.5	-6.9	-7.1	-7.1	-7.2	-7.2	-62.8
Non-Fatal Crash Costs	2.2	-0.4	-1.6	-2.7	-4.2	-7.4	-8.7	-9.5	-10.2	-10.8	-11.2	-11.2	-11.2	-11.3	-98.2
Total Societal Costs	-129.7	-16.9	-22.6	-27.9	-35.8	-50.9	-55.7	-59.3	-60.3	-61.7	-61.9	-61.4	-63.5	-64.5	-772.1
Societal Benefits															
Pre-Tax Fuel Savings	49.1	3.8	-0.1	-3.2	-7.6	-16.8	-20.7	-23.2	-26.1	-28.8	-30.5	-30.4	-30.0	-29.7	-194.4
Rebound Fuel Benefit ¹	0.1	-0.3	-1.3	-2.4	-3.6	-6.6	-7.8	-8.6	-9.3	-10.1	-10.6	-10.8	-11.1	-11.3	-93.7
Refueling Time Benefit	0.3	0.2	0.0	-0.2	-0.4	-0.9	-1.1	-1.2	-1.4	-1.5	-1.6	-1.6	-1.5	-1.5	-12.3
Rebound Fatality Costs, Off-setting Benefit ²	1.4	-0.3	-1.1	-1.7	-2.7	-4.8	-5.6	-6.1	-6.5	-6.9	-7.1	-7.1	-7.2	-7.2	-62.8

*** EO 12866 Review – Draft – Do Not Cite, Quote or Release During Review ***

Rebound Non-Fatal Crash Costs, Off-setting Benefit ²	2.2	-0.4	-1.6	-2.7	-4.2	-7.4	-8.7	-9.5	-10.2	-10.8	-11.2	-11.2	-11.2	-11.3	-98.2
Petroleum Market Externality	4.0	0.3	0.0	-0.3	-0.6	-1.4	-1.7	-1.9	-2.1	-2.4	-2.5	-2.5	-2.5	-2.4	-16.0
CO2 Damage Reduction Benefit	1.6	0.1	0.0	-0.1	-0.2	-0.5	-0.7	-0.7	-0.8	-0.9	-1.0	-1.0	-1.0	-1.0	-6.4
NOx Damage Reduction Benefit	1.7	0.1	0.1	0.1	0.0	0.0	0.0	-0.1	-0.1	-0.1	-0.1	-0.1	-0.1	-0.1	1.3
VOC Damage Reduction Benefit	0.6	0.0	0.0	0.0	0.0	0.0	0.0	0.0	0.0	-0.1	-0.1	-0.1	-0.1	-0.1	0.2
PM Damage Reduction Benefit	3.2	0.3	0.2	0.1	0.0	-0.2	-0.2	-0.3	-0.3	-0.4	-0.4	-0.4	-0.4	-0.3	1.1
SO2 Damage Reduction Benefit	1.1	0.1	0.0	-0.1	-0.2	-0.4	-0.4	-0.5	-0.5	-0.5	-0.5	-0.5	-0.5	-0.5	-3.4
Total Social Benefits	65.1	4.0	-4.0	-10.5	-19.6	-38.9	-46.9	-52.0	-57.4	-62.4	-65.6	-65.6	-65.4	-65.4	-484.6
Net Total Benefits	194.8	20.9	18.6	17.4	16.2	12.0	8.8	7.3	2.9	-0.8	-3.7	-4.2	-1.9	-0.9	287.5

¹ This value includes both the value of the fuel spent to drive rebound miles, and the consumer surplus representing the additional amount consumers would have, but did not spend to drive the additional miles.

² It is assumed that consumers that drive rebound miles fully internalize fatal and non-fatal crash costs. The miles are driven because they receive an equal and offsetting benefit from driving the miles. These cells report the magnitude of the offsetting benefits.

*** EO 12866 Review – Draft – Do Not Cite, Quote or Release During Review ***

TABLE 11-57 - CONSUMER IMPACTS AND NET CONSUMER BENEFITS, PASSENGER CARS, PREFERRED ALTERNATIVE, CAFE, 3% DISCOUNT RATE (BILLIONS 2016\$)

	MY 2017	MY 2018	MY 2019	MY 2020	MY 2021	MY 2022	MY 2023	MY 2024	MY 2025	MY 2026	MY 2027	MY 2028	MY 2029	MY 2030
Price Increase	-98	-206	-291	-609	-1029	-1324	-1556	-1659	-1759	-1772	-1744	-1716	-1686	-1648
Welfare Loss	-13	-19	-27	-57	-122	-169	-240	-272	-332	-351	-351	-352	-352	-352
Additional Ownership Costs	-24	-50	-71	-148	-251	-322	-377	-401	-424	-425	-417	-409	-400	-390
Fuel Savings	178	67	-19	-232	-583	-794	-927	-1031	-1089	-1122	-1117	-1120	-1126	-1119
Mobility Benefit	2	-29	-51	-106	-211	-277	-314	-346	-364	-379	-381	-388	-398	-405
Refueling Benefit	36	30	26	13	-6	-20	-30	-39	-46	-52	-54	-55	-56	-55
Total Consumer Costs	-135	-276	-388	-814	-1403	-1815	-2172	-2331	-2515	-2548	-2512	-2476	-2438	-2390
Total Consumer Benefits	216	69	-45	-325	-799	-1090	-1271	-1416	-1500	-1553	-1552	-1562	-1580	-1580
Net Consumer Benefits	351	344	343	489	603	725	901	916	1016	995	960	914	858	810

*** EO 12866 Review – Draft – Do Not Cite, Quote or Release During Review ***

TABLE 11-58 - CONSUMER IMPACTS AND NET CONSUMER BENEFITS, PASSENGER CARS, PREFERRED ALTERNATIVE, CAFE,7% DISCOUNT RATE (BILLIONS 2016\$)

	MY 2017	MY 2018	MY 2019	MY 2020	MY 2021	MY 2022	MY 2023	MY 2024	MY 2025	MY 2026	MY 2027	MY 2028	MY 2029	MY 2030
Price Increase	-98	-206	-291	-609	-1029	-1324	-1556	-1659	-1759	-1772	-1744	-1716	-1686	-1648
Welfare Loss	-13	-19	-27	-57	-122	-169	-240	-272	-332	-351	-351	-352	-352	-352
Additional Ownership Costs	-22	-46	-64	-134	-227	-291	-341	-363	-384	-385	-377	-370	-363	-354
Fuel Savings	78	-6	-74	-242	-521	-689	-795	-878	-923	-949	-945	-947	-952	-948
Mobility Benefit	0	-24	-41	-85	-170	-223	-253	-280	-295	-307	-309	-315	-324	-330
Refueling Benefit	26	22	18	8	-7	-18	-27	-34	-40	-44	-46	-46	-47	-47
Total Consumer Costs	-133	-271	-381	-800	-1379	-1785	-2137	-2294	-2475	-2508	-2473	-2438	-2400	-2354
Total Consumer Benefits	104	-8	-97	-318	-697	-930	-1075	-1191	-1258	-1301	-1300	-1309	-1323	-1325
Net Consumer Benefits	237	263	284	482	682	855	1062	1103	1217	1207	1173	1129	1077	1029

*** EO 12866 Review – Draft – Do Not Cite, Quote or Release During Review ***

TABLE 11-59 - CONSUMER IMPACTS AND NET CONSUMER BENEFITS, PASSENGER CARS, PREFERRED ALTERNATIVE, CAFE, UNDISCOUNTED (BILLIONS 2016\$)

	MY 2017	MY 2018	MY 2019	MY 2020	MY 2021	MY 2022	MY 2023	MY 2024	MY 2025	MY 2026	MY 2027	MY 2028	MY 2029	MY 2030
Price Increase	-98	-206	-291	-609	-1029	-1324	-1556	-1659	-1759	-1772	-1744	-1716	-1686	-1648
Welfare Loss	-13	-19	-27	-57	-122	-169	-240	-272	-332	-351	-351	-352	-352	-352
Additional Ownership Costs	-26	-55	-78	-163	-275	-353	-413	-439	-465	-466	-457	-448	-439	-428
Fuel Savings	328	186	77	-190	-623	-883	-1047	-1176	-1249	-1291	-1284	-1287	-1294	-1286
Mobility Benefit	5	-34	-62	-130	-258	-337	-382	-420	-442	-459	-462	-470	-481	-489
Refueling Benefit	49	41	35	20	-3	-20	-33	-44	-52	-59	-62	-63	-64	-64
Total Consumer Costs	-137	-280	-395	-828	-1427	-1846	-2208	-2370	-2556	-2589	-2553	-2516	-2476	-2428
Total Consumer Benefits	382	192	50	-299	-884	-1240	-1462	-1640	-1743	-1809	-1808	-1820	-1839	-1839
Net Consumer Benefits	519	473	445	529	543	606	747	730	813	780	745	696	637	589

*** EO 12866 Review – Draft – Do Not Cite, Quote or Release During Review ***

TABLE 11-60 - CONSUMER IMPACTS AND NET CONSUMER BENEFITS, LIGHT TRUCKS, PREFERRED ALTERNATIVE, CAFE, 3% DISCOUNT RATE (BILLIONS 2016\$)

	MY 2017	MY 2018	MY 2019	MY 2020	MY 2021	MY 2022	MY 2023	MY 2024	MY 2025	MY 2026	MY 2027	MY 2028	MY 2029	MY 2030
Price Increase	-94	-488	-833	-1111	-1770	-1902	-1987	-2097	-2219	-2284	-2247	-2212	-2164	-2114
Welfare Loss	-7	-21	-36	-72	-143	-161	-173	-233	-303	-339	-339	-339	-339	-339
Additional Ownership Costs	-23	-119	-203	-271	-431	-464	-484	-511	-541	-557	-548	-539	-527	-515
Fuel Savings	43	-274	-524	-767	-1377	-1531	-1642	-1782	-1953	-2068	-2067	-2086	-2095	-2101
Mobility Benefit	-35	-101	-174	-233	-406	-449	-482	-520	-576	-612	-627	-646	-662	-677
Refueling Benefit	-28	-41	-49	-58	-81	-86	-87	-92	-95	-96	-92	-88	-85	-82
Total Consumer Costs	-125	-628	-1072	-1454	-2345	-2527	-2645	-2841	-3062	-3180	-3134	-3090	-3030	-2968
Total Consumer Benefits	-20	-416	-746	-1058	-1864	-2066	-2211	-2394	-2623	-2776	-2786	-2820	-2842	-2859
Net Consumer Benefits	105	212	326	396	481	461	434	448	439	404	347	270	188	110

*** EO 12866 Review – Draft – Do Not Cite, Quote or Release During Review ***

TABLE 11-61 - CONSUMER IMPACTS AND NET CONSUMER BENEFITS, LIGHT TRUCKS, PREFERRED ALTERNATIVE, CAFE, 7% DISCOUNT RATE (BILLIONS 2016\$)

	MY 2017	MY 2018	MY 2019	MY 2020	MY 2021	MY 2022	MY 2023	MY 2024	MY 2025	MY 2026	MY 2027	MY 2028	MY 2029	MY 2030
Price Increase	-94	-488	-833	-1111	-1770	-1902	-1987	-2097	-2219	-2284	-2247	-2212	-2164	-2114
Welfare Loss	-7	-21	-36	-72	-143	-161	-173	-233	-303	-339	-339	-339	-339	-339
Additional Ownership Costs	-21	-108	-184	-246	-391	-420	-439	-463	-490	-504	-496	-489	-478	-467
Fuel Savings	-18	-262	-457	-647	-1126	-1247	-1334	-1444	-1580	-1671	-1671	-1687	-1695	-1700
Mobility Benefit	-27	-79	-138	-186	-326	-362	-389	-420	-465	-495	-507	-522	-536	-548
Refueling Benefit	-25	-35	-41	-49	-67	-70	-71	-75	-78	-78	-75	-72	-69	-67
Total Consumer Costs	-122	-617	-1053	-1429	-2304	-2484	-2599	-2793	-3012	-3127	-3082	-3039	-2981	-2920
Total Consumer Benefits	-71	-375	-636	-881	-1519	-1679	-1794	-1939	-2122	-2244	-2253	-2281	-2300	-2315
Net Consumer Benefits	52	241	417	547	786	805	805	854	889	883	829	759	681	605

*** EO 12866 Review – Draft – Do Not Cite, Quote or Release During Review ***

TABLE 11-62 - CONSUMER IMPACTS AND NET CONSUMER BENEFITS, LIGHT TRUCKS, PREFERRED ALTERNATIVE, CAFE, UNDISCOUNTED (BILLIONS 2016\$)

	MY 2017	MY 2018	MY 2019	MY 2020	MY 2021	MY 2022	MY 2023	MY 2024	MY 2025	MY 2026	MY 2027	MY 2028	MY 2029	MY 2030
Price Increase	-94	-488	-833	-1111	-1770	-1902	-1987	-2097	-2219	-2284	-2247	-2212	-2164	-2114
Welfare Loss	-7	-21	-36	-72	-143	-161	-173	-233	-303	-339	-339	-339	-339	-339
Additional Ownership Costs	-25	-131	-223	-297	-473	-509	-531	-561	-593	-611	-601	-591	-578	-565
Fuel Savings	152	-256	-570	-877	-1645	-1838	-1977	-2151	-2364	-2506	-2504	-2527	-2537	-2543
Mobility Benefit	-43	-127	-216	-288	-498	-550	-590	-636	-702	-745	-764	-787	-806	-822
Refueling Benefit	-30	-46	-56	-68	-97	-102	-104	-110	-114	-115	-111	-106	-102	-98
Total Consumer Costs	-127	-640	-1092	-1480	-2387	-2572	-2692	-2891	-3115	-3233	-3187	-3142	-3081	-3018
Total Consumer Benefits	79	-429	-842	-1233	-2240	-2490	-2671	-2897	-3180	-3367	-3379	-3419	-3445	-3463
Net Consumer Benefits	206	210	250	247	147	82	21	-6	-65	-133	-192	-277	-364	-445

*** EO 12866 Review – Draft – Do Not Cite, Quote or Release During Review ***

TABLE 11-63 - CONSUMER IMPACTS AND NET CONSUMER BENEFITS, PASSENGER CARS AND LIGHT TRUCKS COMBINED, PREFERRED ALTERNATIVE, CAFE, 3% DISCOUNT RATE (BILLIONS 2016\$)

	MY 2017	MY 2018	MY 2019	MY 2020	MY 2021	MY 2022	MY 2023	MY 2024	MY 2025	MY 2026	MY 2027	MY 2028	MY 2029	MY 2030
Price Increase	-96	-337	-540	-839	-1370	-1591	-1755	-1862	-1973	-2011	-1980	-1950	-1912	-1869
Welfare Loss	-10	-20	-31	-64	-132	-166	-209	-254	-318	-345	-345	-345	-345	-345
Additional Ownership Costs	-23	-82	-132	-205	-334	-391	-436	-466	-498	-513	-511	-507	-501	-493
Fuel Savings	117	-91	-251	-478	-948	-1123	-1233	-1343	-1439	-1495	-1478	-1479	-1477	-1468
Mobility Benefit	-11	-59	-106	-163	-301	-356	-390	-425	-461	-485	-494	-506	-519	-529
Refueling Benefit	9	0	-7	-18	-39	-48	-54	-61	-67	-70	-70	-68	-67	-66
Total Consumer Costs	-130	-439	-703	-1108	-1836	-2148	-2400	-2582	-2790	-2869	-2836	-2803	-2758	-2707
Total Consumer Benefits	114	-151	-364	-659	-1288	-1527	-1678	-1829	-1967	-2050	-2041	-2053	-2064	-2063
Net Consumer Benefits	244	288	339	449	548	621	722	753	823	818	795	749	695	644

*** EO 12866 Review – Draft – Do Not Cite, Quote or Release During Review ***

TABLE 11-64 - CONSUMER IMPACTS AND NET CONSUMER BENEFITS, PASSENGER CARS AND LIGHT TRUCKS COMBINED, PREFERRED ALTERNATIVE, CAFE, 7% DISCOUNT RATE (BILLIONS 2016\$)

	MY 2017	MY 2018	MY 2019	MY 2020	MY 2021	MY 2022	MY 2023	MY 2024	MY 2025	MY 2026	MY 2027	MY 2028	MY 2029	MY 2030
Price Increase	-96	-337	-540	-839	-1370	-1591	-1755	-1862	-1973	-2011	-1980	-1950	-1912	-1869
Welfare Loss	-10	-20	-31	-64	-132	-166	-209	-254	-318	-345	-345	-345	-345	-345
Additional Ownership Costs	-21	-74	-119	-185	-303	-355	-395	-423	-452	-465	-463	-460	-454	-446
Fuel Savings	34	-125	-250	-428	-799	-938	-1025	-1111	-1187	-1231	-1218	-1219	-1218	-1211
Mobility Benefit	-10	-47	-85	-130	-242	-287	-315	-343	-373	-393	-400	-410	-421	-429
Refueling Benefit	4	-3	-8	-16	-33	-41	-46	-51	-56	-59	-58	-57	-56	-55
Total Consumer Costs	-128	-431	-691	-1089	-1805	-2111	-2360	-2539	-2743	-2820	-2789	-2755	-2711	-2660
Total Consumer Benefits	29	-174	-343	-574	-1074	-1265	-1385	-1506	-1616	-1683	-1676	-1686	-1695	-1695
Net Consumer Benefits	157	257	348	514	731	846	974	1033	1127	1138	1113	1070	1017	965

*** EO 12866 Review – Draft – Do Not Cite, Quote or Release During Review ***

TABLE 11-65 - CONSUMER IMPACTS AND NET CONSUMER BENEFITS, PASSENGER CARS AND LIGHT TRUCKS COMBINED, PREFERRED ALTERNATIVE, CAFE, UNDISCOUNTED (BILLIONS 2016\$)

	MY 2017	MY 2018	MY 2019	MY 2020	MY 2021	MY 2022	MY 2023	MY 2024	MY 2025	MY 2026	MY 2027	MY 2028	MY 2029	MY 2030
Price Increase	-96	-337	-540	-839	-1370	-1591	-1755	-1862	-1973	-2011	-1980	-1950	-1912	-1869
Welfare Loss	-10	-20	-31	-64	-132	-166	-209	-254	-318	-345	-345	-345	-345	-345
Additional Ownership Costs	-26	-90	-144	-224	-366	-429	-479	-511	-546	-563	-560	-556	-549	-540
Fuel Savings	248	-19	-221	-505	-1093	-1310	-1447	-1584	-1703	-1773	-1752	-1753	-1750	-1738
Mobility Benefit	-12	-73	-131	-201	-369	-435	-477	-518	-561	-590	-600	-615	-630	-641
Refueling Benefit	15	4	-4	-18	-44	-56	-63	-72	-78	-83	-82	-80	-79	-77
Total Consumer Costs	-132	-447	-716	-1128	-1869	-2185	-2443	-2628	-2838	-2918	-2886	-2852	-2807	-2754
Total Consumer Benefits	251	-89	-356	-724	-1506	-1800	-1987	-2173	-2343	-2446	-2434	-2448	-2459	-2457
Net Consumer Benefits	384	358	359	404	363	385	456	454	495	472	452	404	347	298

*** EO 12866 Review – Draft – Do Not Cite, Quote or Release During Review ***

**TABLE 11-66 - COST AND BENEFIT ESTIMATES, PASSENGER CARS, PREFERRED ALTERNATIVE, CO₂, 3% DISCOUNT RATE
(BILLIONS 2016\$)**

	MY 1977- 2016	MY 2017	MY 2018	MY 2019	MY 2020	MY 2021	MY 2022	MY 2023	MY 2024	MY 2025	MY 2026	MY 2027	MY 2028	MY 2029	TOTAL
Societal Costs															
Technology Costs	\$0.0	-\$0.7	-\$1.7	-\$2.3	-\$4.2	-\$6.0	-\$8.1	-\$9.4	\$10.1	\$10.7	\$11.3	\$11.4	\$11.2	\$10.7	-\$97.9
Advanced Technology Value Loss	\$0.0	-\$0.1	-\$0.1	-\$0.2	-\$0.4	-\$0.6	-\$0.9	-\$1.3	-\$1.3	-\$1.4	-\$1.6	-\$1.5	-\$1.6	-\$1.6	-\$12.4
Congestion Costs	-\$10.1	-\$1.3	-\$1.4	-\$1.5	-\$1.6	-\$1.8	-\$1.7	-\$1.2	-\$1.0	-\$0.6	-\$0.1	\$0.0	\$0.2	\$0.6	-\$21.6
Noise Costs	-\$0.1	\$0.0	\$0.0	\$0.0	\$0.0	\$0.0	\$0.0	\$0.0	\$0.0	\$0.0	\$0.0	\$0.0	\$0.0	\$0.0	-\$0.3
Non-Rebound Fatality Costs	-\$15.5	-\$1.7	-\$1.7	-\$1.7	-\$1.6	-\$1.5	-\$1.1	-\$0.2	\$0.3	\$1.1	\$1.7	\$2.0	\$2.2	\$2.6	-\$15.0
Non-Rebound Non-Fatal Crash Costs	-\$24.3	-\$2.7	-\$2.7	-\$2.6	-\$2.5	-\$2.4	-\$1.6	-\$0.3	\$0.5	\$1.7	\$2.7	\$3.1	\$3.5	\$4.1	-\$23.5
Rebound Fatality Costs	\$0.5	-\$0.1	-\$0.3	-\$0.4	-\$0.7	-\$1.1	-\$1.6	-\$1.8	-\$2.0	-\$2.3	-\$2.4	-\$2.4	-\$2.4	-\$2.3	-\$19.3
Non-Fatal Crash Costs	\$0.8	-\$0.1	-\$0.5	-\$0.7	-\$1.1	-\$1.8	-\$2.4	-\$2.8	-\$3.2	-\$3.5	-\$3.7	-\$3.8	-\$3.7	-\$3.7	-\$30.1
Total Societal Costs	-\$48.8	-\$6.7	-\$8.4	-\$9.3	\$12.2	\$15.4	\$17.4	\$17.0	\$16.8	\$15.6	\$14.6	\$14.0	\$12.9	\$10.9	-\$220.0
Societal Benefits															
Pre-Tax Fuel Savings	\$16.2	\$1.5	\$0.6	\$0.2	-\$1.0	-\$2.5	-\$4.3	-\$5.9	-\$7.4	-\$9.1	\$10.0	\$10.6	\$10.9	\$11.1	-\$54.2
Rebound Fuel Benefit ¹	\$0.1	\$0.0	-\$0.3	-\$0.5	-\$0.8	-\$1.3	-\$1.8	-\$2.1	-\$2.4	-\$2.8	-\$2.9	-\$3.0	-\$3.1	-\$3.1	-\$24.1

*** EO 12866 Review – Draft – Do Not Cite, Quote or Release During Review ***

Refueling Time Benefit	\$0.1	\$0.1	\$0.0	\$0.0	-\$0.1	-\$0.2	-\$0.3	-\$0.3	-\$0.4	-\$0.5	-\$0.6	-\$0.6	-\$0.6	-\$0.6	-\$4.0
Rebound Fatality Costs, Off-setting Benefit ²	\$0.5	-\$0.1	-\$0.3	-\$0.4	-\$0.7	-\$1.1	-\$1.6	-\$1.8	-\$2.0	-\$2.3	-\$2.4	-\$2.4	-\$2.4	-\$2.3	-\$19.3
Rebound Non-Fatal Crash Costs, Off-setting Benefit ²	\$0.8	-\$0.1	-\$0.5	-\$0.7	-\$1.1	-\$1.8	-\$2.4	-\$2.8	-\$3.2	-\$3.5	-\$3.7	-\$3.8	-\$3.7	-\$3.7	-\$30.1
Petroleum Market Externality	\$1.3	\$0.1	\$0.0	\$0.0	-\$0.1	-\$0.2	-\$0.4	-\$0.5	-\$0.6	-\$0.7	-\$0.8	-\$0.9	-\$0.9	-\$0.9	-\$4.4
CO2 Damage Reduction Benefit	\$0.5	\$0.1	\$0.0	\$0.0	\$0.0	-\$0.1	-\$0.1	-\$0.2	-\$0.2	-\$0.3	-\$0.3	-\$0.3	-\$0.4	-\$0.4	-\$1.8
NOx Damage Reduction Benefit	\$0.5	\$0.0	\$0.0	\$0.0	\$0.0	\$0.0	\$0.0	\$0.0	\$0.0	\$0.0	\$0.0	\$0.0	-\$0.1	-\$0.1	\$0.3
VOC Damage Reduction Benefit	\$0.2	\$0.0	\$0.0	\$0.0	\$0.0	\$0.0	\$0.0	\$0.0	\$0.0	\$0.0	\$0.0	\$0.0	\$0.0	\$0.0	\$0.1
PM Damage Reduction Benefit	\$1.1	\$0.1	\$0.1	\$0.1	\$0.0	\$0.0	\$0.0	-\$0.1	-\$0.1	-\$0.1	-\$0.1	-\$0.2	-\$0.2	-\$0.2	\$0.4
SO ₂ Damage Reduction Benefit	\$0.4	\$0.0	\$0.0	\$0.0	\$0.0	-\$0.1	-\$0.1	-\$0.1	-\$0.2	-\$0.2	-\$0.2	-\$0.2	-\$0.2	-\$0.2	-\$1.1
Total Social Benefits	\$21.5	\$1.8	-\$0.2	-\$1.3	-\$3.8	-\$7.2	\$11.0	\$13.8	\$16.5	\$19.6	\$21.1	\$22.0	\$22.4	\$22.5	-\$138.2
Net Total Benefits	\$70.3	\$8.5	\$8.1	\$8.0	\$8.4	\$8.2	\$6.4	\$3.2	\$0.3	-\$3.9	-\$6.5	-\$7.9	-\$9.4	-\$11.6	\$81.9

*** EO 12866 Review – Draft – Do Not Cite, Quote or Release During Review ***

¹ This value includes both the value of the fuel spent to drive rebound miles, and the consumer surplus representing the additional amount consumers would have, but did not spend to drive the additional miles.

² It is assumed that consumers that drive rebound miles fully internalize fatal and non-fatal crash costs. The miles are driven because they receive an equal and offsetting benefit from driving the miles. These cells report the magnitude of the offsetting benefits.

*** EO 12866 Review – Draft – Do Not Cite, Quote or Release During Review ***

**TABLE 11-67 - COST AND BENEFIT ESTIMATES, PASSENGER CARS, PREFERRED ALTERNATIVE, CO₂, 7% DISCOUNT RATE
(BILLIONS 2016\$)**

	MY 1977- 2016	MY 2017	MY 2018	MY 2019	MY 2020	MY 2021	MY 2022	MY 2023	MY 2024	MY 2025	MY 2026	MY 2027	MY 2028	MY 2029	TOTAL
Societal Costs															
Technology Costs	\$0.0	-\$0.7	-\$1.7	-\$2.1	-\$3.7	-\$5.1	-\$6.7	-\$7.5	-\$7.7	-\$7.9	-\$8.0	-\$7.8	-\$7.4	-\$6.8	-\$73.2
Advanced Technology Value Loss	\$0.0	-\$0.1	-\$0.1	-\$0.2	-\$0.3	-\$0.5	-\$0.7	-\$1.0	-\$1.0	-\$1.0	-\$1.1	-\$1.0	-\$1.0	-\$1.0	-\$9.1
Congestion Costs	-\$6.2	-\$0.7	-\$0.8	-\$0.8	-\$0.9	-\$1.0	-\$0.9	-\$0.6	-\$0.4	-\$0.2	\$0.1	\$0.1	\$0.2	\$0.4	-\$11.6
Noise Costs	-\$0.1	\$0.0	\$0.0	\$0.0	\$0.0	\$0.0	\$0.0	\$0.0	\$0.0	\$0.0	\$0.0	\$0.0	\$0.0	\$0.0	-\$0.2
Non-Rebound Fatality Costs	-\$9.6	-\$0.9	-\$0.9	-\$0.8	-\$0.8	-\$0.7	-\$0.4	\$0.2	\$0.5	\$0.9	\$1.2	\$1.3	\$1.4	\$1.5	-\$7.1
Non-Rebound Non-Fatal Crash Costs	-\$15.0	-\$1.4	-\$1.3	-\$1.3	-\$1.2	-\$1.1	-\$0.6	\$0.2	\$0.7	\$1.4	\$1.9	\$2.0	\$2.2	\$2.4	-\$11.0
Rebound Fatality Costs	\$0.3	-\$0.1	-\$0.2	-\$0.3	-\$0.5	-\$0.8	-\$1.1	-\$1.2	-\$1.3	-\$1.4	-\$1.4	-\$1.4	-\$1.3	-\$1.2	-\$11.8
Non-Fatal Crash Costs	\$0.5	-\$0.1	-\$0.4	-\$0.5	-\$0.8	-\$1.3	-\$1.6	-\$1.8	-\$2.0	-\$2.2	-\$2.2	-\$2.1	-\$2.0	-\$1.9	-\$18.4
Total Societal Costs	-\$30.1	-\$3.9	-\$5.3	-\$6.0	-\$8.3	\$10.6	\$12.1	\$11.7	\$11.3	\$10.3	-\$9.5	-\$8.8	-\$7.9	-\$6.6	-\$142.3
Societal Benefits															
Pre-Tax Fuel Savings	\$9.9	\$0.7	\$0.0	-\$0.3	-\$1.1	-\$2.1	-\$3.2	-\$4.1	-\$4.8	-\$5.6	-\$6.0	-\$6.0	-\$5.9	-\$5.9	-\$34.4
Rebound Fuel Benefit ¹	\$0.0	\$0.0	-\$0.3	-\$0.4	-\$0.6	-\$0.9	-\$1.2	-\$1.4	-\$1.5	-\$1.7	-\$1.7	-\$1.7	-\$1.6	-\$1.6	-\$14.5

*** EO 12866 Review – Draft – Do Not Cite, Quote or Release During Review ***

Refueling Time Benefit	\$0.1	\$0.0	\$0.0	\$0.0	-\$0.1	-\$0.1	-\$0.2	-\$0.2	-\$0.3	-\$0.3	-\$0.3	-\$0.3	-\$0.3	-\$0.3	-\$2.5
Rebound Fatality Costs, Off-setting Benefit ²	\$0.3	-\$0.1	-\$0.2	-\$0.3	-\$0.5	-\$0.8	-\$1.1	-\$1.2	-\$1.3	-\$1.4	-\$1.4	-\$1.4	-\$1.3	-\$1.2	-\$11.8
Rebound Non-Fatal Crash Costs, Off-setting Benefit ²	\$0.5	-\$0.1	-\$0.4	-\$0.5	-\$0.8	-\$1.3	-\$1.6	-\$1.8	-\$2.0	-\$2.2	-\$2.2	-\$2.1	-\$2.0	-\$1.9	-\$18.4
Petroleum Market Externality	\$0.8	\$0.1	\$0.0	\$0.0	-\$0.1	-\$0.2	-\$0.3	-\$0.3	-\$0.4	-\$0.5	-\$0.5	-\$0.5	-\$0.5	-\$0.5	-\$2.8
CO2 Damage Reduction Benefit	\$0.3	\$0.0	\$0.0	\$0.0	\$0.0	-\$0.1	-\$0.1	-\$0.1	-\$0.2	-\$0.2	-\$0.2	-\$0.2	-\$0.2	-\$0.2	-\$1.1
NOx Damage Reduction Benefit	\$0.3	\$0.0	\$0.0	\$0.0	\$0.0	\$0.0	\$0.0	\$0.0	\$0.0	\$0.0	\$0.0	\$0.0	\$0.0	\$0.0	\$0.2
VOC Damage Reduction Benefit	\$0.1	\$0.0	\$0.0	\$0.0	\$0.0	\$0.0	\$0.0	\$0.0	\$0.0	\$0.0	\$0.0	\$0.0	\$0.0	\$0.0	\$0.0
PM Damage Reduction Benefit	\$0.6	\$0.1	\$0.0	\$0.0	\$0.0	\$0.0	\$0.0	-\$0.1	-\$0.1	-\$0.1	-\$0.1	-\$0.1	-\$0.1	-\$0.1	\$0.1
SO ₂ Damage Reduction Benefit	\$0.2	\$0.0	\$0.0	\$0.0	\$0.0	-\$0.1	-\$0.1	-\$0.1	-\$0.1	-\$0.1	-\$0.1	-\$0.1	-\$0.1	-\$0.1	-\$0.7
Total Social Benefits	\$13.1	\$0.7	-\$0.8	-\$1.5	-\$3.3	-\$5.5	-\$7.8	-\$9.3	\$10.6	\$12.0	\$12.5	\$12.5	\$12.2	\$11.8	-\$85.9
Net Total Benefits	\$43.2	\$4.7	\$4.5	\$4.5	\$5.0	\$5.1	\$4.3	\$2.4	\$0.7	-\$1.7	-\$3.0	-\$3.6	-\$4.3	-\$5.3	\$56.4

*** EO 12866 Review – Draft – Do Not Cite, Quote or Release During Review ***

¹ This value includes both the value of the fuel spent to drive rebound miles, and the consumer surplus representing the additional amount consumers would have, but did not spend to drive the additional miles.

² It is assumed that consumers that drive rebound miles fully internalize fatal and non-fatal crash costs. The miles are driven because they receive an equal and offsetting benefit from driving the miles. These cells report the magnitude of the offsetting benefits.

*** EO 12866 Review – Draft – Do Not Cite, Quote or Release During Review ***

TABLE 11-68 - COST AND BENEFIT ESTIMATES, PASSENGER CARS, PREFERRED ALTERNATIVE, CO₂, UNDISCOUNTED (BILLIONS 2016\$)

	MY 1977- 2016	MY 2017	MY 2018	MY 2019	MY 2020	MY 2021	MY 2022	MY 2023	MY 2024	MY 2025	MY 2026	MY 2027	MY 2028	MY 2029	TOTAL
Societal Costs															
Technology Costs	\$0.0	-\$0.7	-\$1.8	-\$2.4	-\$4.5	-\$6.7	-\$9.4	-	-	-	-	-	-	-	-\$123.7
Advanced Technology Value Loss	\$0.0	-\$0.1	-\$0.1	-\$0.2	-\$0.4	-\$0.7	-\$1.0	-\$1.5	-\$1.6	-\$1.8	-\$2.0	-\$2.1	-\$2.2	-\$2.2	-\$15.9
Congestion Costs	-\$15.2	-\$2.1	-\$2.3	-\$2.5	-\$2.7	-\$3.1	-\$3.0	-\$2.3	-\$2.0	-\$1.4	-\$0.7	-\$0.5	-\$0.1	\$0.5	-\$37.5
Noise Costs	-\$0.2	\$0.0	\$0.0	\$0.0	\$0.0	\$0.0	\$0.0	\$0.0	\$0.0	\$0.0	\$0.0	\$0.0	\$0.0	\$0.0	-\$0.5
Non-Rebound Fatality Costs	-\$23.2	-\$3.0	-\$3.0	-\$3.0	-\$3.0	-\$2.9	-\$2.2	-\$1.1	-\$0.3	\$1.0	\$2.0	\$2.5	\$3.1	\$3.9	-\$29.0
Non-Rebound Non-Fatal Crash Costs	-\$36.2	-\$4.6	-\$4.7	-\$4.7	-\$4.7	-\$4.5	-\$3.5	-\$1.7	-\$0.4	\$1.5	\$3.2	\$3.9	\$4.8	\$6.1	-\$45.4
Rebound Fatality Costs	\$0.7	\$0.0	-\$0.4	-\$0.5	-\$1.0	-\$1.5	-\$2.2	-\$2.5	-\$3.0	-\$3.4	-\$3.7	-\$3.9	-\$4.0	-\$4.0	-\$29.2
Non-Fatal Crash Costs	\$1.1	-\$0.1	-\$0.6	-\$0.8	-\$1.5	-\$2.4	-\$3.4	-\$3.9	-\$4.6	-\$5.4	-\$5.7	-\$6.0	-\$6.2	-\$6.2	-\$45.7
Total Societal Costs	-\$72.9	\$10.7	\$12.8	\$14.2	\$17.8	\$22.0	\$24.8	\$24.3	\$24.4	\$23.0	\$21.7	\$21.3	\$20.0	\$17.2	-\$327.0
Societal Benefits															
Pre-Tax Fuel Savings	\$24.3	\$2.8	\$1.7	\$1.1	-\$0.5	-\$2.6	-\$5.4	-\$7.9	\$10.3	\$13.3	\$15.3	\$16.6	\$17.6	\$18.6	-\$78.1
Rebound Fuel Benefit ¹	\$0.1	\$0.0	-\$0.4	-\$0.6	-\$1.1	-\$1.8	-\$2.6	-\$3.1	-\$3.6	-\$4.2	-\$4.6	-\$4.9	-\$5.1	-\$5.3	-\$37.2

*** EO 12866 Review – Draft – Do Not Cite, Quote or Release During Review ***

Refueling Time Benefit	\$0.2	\$0.1	\$0.1	\$0.0	\$0.0	-\$0.2	-\$0.3	-\$0.5	-\$0.6	-\$0.8	-\$0.9	-\$0.9	-\$1.0	-\$1.0	-\$5.7
Rebound Fatality Costs, Off-setting Benefit ²	\$0.7	\$0.0	-\$0.4	-\$0.5	-\$1.0	-\$1.5	-\$2.2	-\$2.5	-\$3.0	-\$3.4	-\$3.7	-\$3.9	-\$4.0	-\$4.0	-\$29.2
Rebound Non-Fatal Crash Costs, Off-setting Benefit ²	\$1.1	-\$0.1	-\$0.6	-\$0.8	-\$1.5	-\$2.4	-\$3.4	-\$3.9	-\$4.6	-\$5.4	-\$5.7	-\$6.0	-\$6.2	-\$6.2	-\$45.7
Petroleum Market Externality	\$2.0	\$0.2	\$0.1	\$0.1	\$0.0	-\$0.2	-\$0.4	-\$0.6	-\$0.8	-\$1.1	-\$1.2	-\$1.3	-\$1.4	-\$1.5	-\$6.4
CO2 Damage Reduction Benefit	\$0.8	\$0.1	\$0.1	\$0.0	\$0.0	-\$0.1	-\$0.2	-\$0.3	-\$0.3	-\$0.4	-\$0.5	-\$0.5	-\$0.6	-\$0.6	-\$2.5
NOx Damage Reduction Benefit	\$0.7	\$0.1	\$0.1	\$0.1	\$0.0	\$0.0	\$0.0	\$0.0	\$0.0	\$0.0	-\$0.1	-\$0.1	-\$0.1	-\$0.1	\$0.6
VOC Damage Reduction Benefit	\$0.3	\$0.0	\$0.0	\$0.0	\$0.0	\$0.0	\$0.0	\$0.0	\$0.0	\$0.0	\$0.0	\$0.0	\$0.0	\$0.0	\$0.1
PM Damage Reduction Benefit	\$1.6	\$0.2	\$0.1	\$0.1	\$0.1	\$0.0	\$0.0	-\$0.1	-\$0.1	-\$0.2	-\$0.2	-\$0.2	-\$0.3	-\$0.3	\$0.9
SO ₂ Damage Reduction Benefit	\$0.5	\$0.1	\$0.0	\$0.0	\$0.0	-\$0.1	-\$0.1	-\$0.2	-\$0.2	-\$0.3	-\$0.3	-\$0.3	-\$0.3	-\$0.4	-\$1.6
Total Social Benefits	\$32.4	\$3.4	\$0.9	-\$0.5	-\$4.0	-\$8.8	\$14.5	\$19.0	\$23.7	\$29.1	\$32.5	\$34.8	\$36.6	\$38.0	-\$204.8
Net Total Benefits	\$105.3	\$14.1	\$13.7	\$13.7	\$13.9	\$13.2	\$10.2	\$5.3	\$0.7	-\$6.1	\$10.8	\$13.5	\$16.6	\$20.8	\$122.2

*** EO 12866 Review – Draft – Do Not Cite, Quote or Release During Review ***

¹ This value includes both the value of the fuel spent to drive rebound miles, and the consumer surplus representing the additional amount consumers would have, but did not spend to drive the additional miles.

² It is assumed that consumers that drive rebound miles fully internalize fatal and non-fatal crash costs. The miles are driven because they receive an equal and offsetting benefit from driving the miles. These cells report the magnitude of the offsetting benefits.

*** EO 12866 Review – Draft – Do Not Cite, Quote or Release During Review ***

TABLE 11-69 - COST AND BENEFIT ESTIMATES, LIGHT TRUCKS, PREFERRED ALTERNATIVE, CO₂, 3% DISCOUNT RATE (BILLIONS 2016\$)

	MY 1977- 2016	MY 2017	MY 2018	MY 2019	MY 2020	MY 2021	MY 2022	MY 2023	MY 2024	MY 2025	MY 2026	MY 2027	MY 2028	MY 2029	TOTAL
Societal Costs															
Technology Costs	\$0.0	-\$0.3	-\$1.7	-\$4.0	-\$5.5	-\$8.5	-\$9.1	-\$9.9	\$10.2	\$10.4	\$11.6	\$12.3	\$13.0	\$13.1	-\$109.6
Advanced Technology Value Loss	\$0.0	\$0.0	\$0.0	-\$0.1	-\$0.1	-\$0.3	-\$0.3	-\$0.6	-\$0.7	-\$0.7	-\$0.8	-\$0.8	-\$0.8	-\$0.8	-\$5.8
Congestion Costs	-\$5.0	-\$0.6	-\$0.7	-\$0.8	-\$0.9	-\$1.1	-\$1.3	-\$1.7	-\$1.9	-\$2.2	-\$2.6	-\$2.9	-\$3.2	-\$3.5	-\$28.4
Noise Costs	-\$0.1	\$0.0	\$0.0	\$0.0	\$0.0	\$0.0	\$0.0	\$0.0	\$0.0	\$0.0	\$0.0	\$0.0	\$0.0	-\$0.1	-\$0.4
Non-Rebound Fatality Costs	-\$8.7	-\$0.9	-\$0.8	-\$0.6	-\$0.5	-\$0.2	-\$0.2	-\$0.7	-\$1.0	-\$1.2	-\$1.8	-\$2.2	-\$2.4	-\$2.7	-\$24.0
Non-Rebound Non-Fatal Crash Costs	\$13.7	-\$1.4	-\$1.2	-\$1.0	-\$0.7	-\$0.4	-\$0.3	-\$1.1	-\$1.5	-\$1.9	-\$2.8	-\$3.4	-\$3.7	-\$4.3	-\$37.5
Rebound Fatality Costs	\$0.3	\$0.0	-\$0.3	-\$0.6	-\$0.9	-\$1.5	-\$1.7	-\$1.7	-\$1.9	-\$1.9	-\$2.0	-\$2.1	-\$2.2	-\$2.2	-\$18.6
Non-Fatal Crash Costs	\$0.5	-\$0.1	-\$0.4	-\$0.9	-\$1.4	-\$2.3	-\$2.6	-\$2.7	-\$2.9	-\$3.0	-\$3.2	-\$3.3	-\$3.4	-\$3.4	-\$29.0
Total Societal Costs	\$26.7	-\$3.3	-\$5.1	-\$8.1	\$10.1	\$14.3	\$15.5	\$18.3	\$20.1	\$21.4	\$24.9	\$26.9	\$28.6	\$30.0	-\$253.3
Societal Benefits															
Pre-Tax Fuel Savings	\$12.5	\$1.1	-\$0.1	-\$1.8	-\$3.4	-\$6.2	-\$7.2	-\$7.1	-\$7.4	-\$7.4	-\$7.4	-\$7.3	-\$7.5	-\$7.1	-\$56.2

*** EO 12866 Review – Draft – Do Not Cite, Quote or Release During Review ***

Rebound Fuel Benefit ¹	\$0.0	-\$0.1	-\$0.4	-\$0.9	-\$1.4	-\$2.4	-\$2.7	-\$2.9	-\$3.1	-\$3.2	-\$3.5	-\$3.6	-\$3.8	-\$3.9	-\$31.9
Refueling Time Benefit	\$0.1	\$0.0	\$0.0	-\$0.1	-\$0.2	-\$0.3	-\$0.3	-\$0.3	-\$0.4	-\$0.3	-\$0.3	-\$0.3	-\$0.3	-\$0.3	-\$3.2
Rebound Fatality Costs, Off-setting Benefit ²	\$0.3	\$0.0	-\$0.3	-\$0.6	-\$0.9	-\$1.5	-\$1.7	-\$1.7	-\$1.9	-\$1.9	-\$2.0	-\$2.1	-\$2.2	-\$2.2	-\$18.6
Rebound Non-Fatal Crash Costs, Off-setting Benefit ²	\$0.5	-\$0.1	-\$0.4	-\$0.9	-\$1.4	-\$2.3	-\$2.6	-\$2.7	-\$2.9	-\$3.0	-\$3.2	-\$3.3	-\$3.4	-\$3.4	-\$29.0
Petroleum Market Externality	\$1.0	\$0.1	\$0.0	-\$0.2	-\$0.3	-\$0.5	-\$0.6	-\$0.6	-\$0.6	-\$0.6	-\$0.6	-\$0.6	-\$0.6	-\$0.6	-\$4.6
CO2 Damage Reduction Benefit	\$0.4	\$0.0	\$0.0	-\$0.1	-\$0.1	-\$0.2	-\$0.2	-\$0.2	-\$0.2	-\$0.2	-\$0.2	-\$0.2	-\$0.3	-\$0.2	-\$1.8
NOx Damage Reduction Benefit	\$0.5	\$0.0	\$0.0	\$0.0	\$0.0	\$0.0	\$0.0	\$0.0	\$0.0	\$0.0	\$0.0	\$0.0	\$0.0	\$0.0	\$0.4
VOC Damage Reduction Benefit	\$0.2	\$0.0	\$0.0	\$0.0	\$0.0	\$0.0	\$0.0	\$0.0	\$0.0	\$0.0	\$0.0	\$0.0	\$0.0	\$0.0	\$0.1
PM Damage Reduction Benefit	\$0.8	\$0.1	\$0.0	\$0.0	\$0.0	-\$0.1	-\$0.1	-\$0.1	-\$0.1	-\$0.1	-\$0.1	-\$0.1	-\$0.1	\$0.0	\$0.3
SO ₂ Damage Reduction Benefit	\$0.3	\$0.0	\$0.0	-\$0.1	-\$0.1	-\$0.1	-\$0.2	-\$0.1	-\$0.1	-\$0.1	-\$0.1	-\$0.1	-\$0.1	-\$0.1	-\$1.0

*** EO 12866 Review – Draft – Do Not Cite, Quote or Release During Review ***

Total Social Benefits	\$16.5	\$1.2	-\$1.1	-\$4.6	-\$7.8	-	-	-	-	-	-	-	-	-	-	-\$145.6
Net Total Benefits	\$43.2	\$4.5	\$3.9	\$3.5	\$2.2	\$0.7	\$0.0	\$2.6	\$3.5	\$4.5	\$7.5	\$9.3	\$10.3	\$12.1	\$107.7	

¹This value includes both the value of the fuel spent to drive rebound miles, and the consumer surplus representing the additional amount consumers would have, but did not spend to drive the additional miles.

² It is assumed that consumers that drive rebound miles fully internalize fatal and non-fatal crash costs. The miles are driven because they receive an equal and offsetting benefit from driving the miles. These cells report the magnitude of the offsetting benefits.

*** EO 12866 Review – Draft – Do Not Cite, Quote or Release During Review ***

TABLE 11-70 - COST AND BENEFIT ESTIMATES, LIGHT TRUCKS, PREFERRED ALTERNATIVE, CO₂, 7% DISCOUNT RATE (BILLIONS 2016\$)

	MY 1977- 2016	MY 2017	MY 2018	MY 2019	MY 2020	MY 2021	MY 2022	MY 2023	MY 2024	MY 2025	MY 2026	MY 2027	MY 2028	MY 2029	TOTAL
Societal Costs															
Technology Costs	\$0.0	-\$0.3	-\$1.6	-\$3.7	-\$4.9	-\$7.3	-\$7.6	-\$7.8	-\$7.8	-\$7.7	-\$8.2	-\$8.4	-\$8.6	-\$8.3	-\$82.2
Advanced Technology Value Loss	\$0.0	\$0.0	\$0.0	-\$0.1	-\$0.1	-\$0.2	-\$0.2	-\$0.5	-\$0.5	-\$0.5	-\$0.6	-\$0.5	-\$0.5	-\$0.5	-\$4.2
Congestion Costs	-\$3.0	-\$0.3	-\$0.3	-\$0.4	-\$0.5	-\$0.7	-\$0.8	-\$1.0	-\$1.2	-\$1.3	-\$1.5	-\$1.6	-\$1.7	-\$1.8	-\$16.1
Noise Costs	\$0.0	\$0.0	\$0.0	\$0.0	\$0.0	\$0.0	\$0.0	\$0.0	\$0.0	\$0.0	\$0.0	\$0.0	\$0.0	\$0.0	-\$0.2
Non-Rebound Fatality Costs	-\$5.2	-\$0.4	-\$0.3	-\$0.2	-\$0.1	\$0.0	\$0.0	-\$0.3	-\$0.5	-\$0.7	-\$1.0	-\$1.2	-\$1.2	-\$1.4	-\$12.7
Non-Rebound Non-Fatal Crash Costs	-\$8.2	-\$0.6	-\$0.5	-\$0.4	-\$0.2	\$0.0	\$0.0	-\$0.5	-\$0.8	-\$1.1	-\$1.6	-\$1.8	-\$1.9	-\$2.2	-\$19.9
Rebound Fatality Costs	\$0.2	\$0.0	-\$0.2	-\$0.5	-\$0.7	-\$1.0	-\$1.1	-\$1.1	-\$1.2	-\$1.1	-\$1.2	-\$1.2	-\$1.2	-\$1.1	-\$11.3
Non-Fatal Crash Costs	\$0.3	-\$0.1	-\$0.3	-\$0.7	-\$1.0	-\$1.6	-\$1.7	-\$1.8	-\$1.8	-\$1.8	-\$1.8	-\$1.8	-\$1.8	-\$1.8	-\$17.8
Total Societal Costs	-	-\$1.7	-\$3.3	-\$6.0	-\$7.6	\$10.9	\$11.5	\$13.1	\$13.9	\$14.2	\$15.9	\$16.5	\$16.9	\$17.0	-\$164.5
Societal Benefits															
Pre-Tax Fuel Savings	\$7.4	\$0.4	-\$0.4	-\$1.6	-\$2.7	-\$4.4	-\$4.9	-\$4.6	-\$4.7	-\$4.4	-\$4.3	-\$4.1	-\$4.0	-\$3.6	-\$36.0
Rebound Fuel Benefit ¹	\$0.0	\$0.0	-\$0.3	-\$0.7	-\$1.0	-\$1.7	-\$1.8	-\$1.8	-\$1.9	-\$1.9	-\$2.0	-\$2.0	-\$2.0	-\$2.0	-\$19.1

*** EO 12866 Review – Draft – Do Not Cite, Quote or Release During Review ***

Refueling Time Benefit	\$0.0	\$0.0	\$0.0	-\$0.1	-\$0.1	-\$0.2	-\$0.2	-\$0.2	-\$0.2	-\$0.2	-\$0.2	-\$0.2	-\$0.2	-\$0.2	-\$2.0
Rebound Fatality Costs, Off-setting Benefit ²	\$0.2	\$0.0	-\$0.2	-\$0.5	-\$0.7	-\$1.0	-\$1.1	-\$1.1	-\$1.2	-\$1.1	-\$1.2	-\$1.2	-\$1.2	-\$1.1	-\$11.3
Rebound Non-Fatal Crash Costs, Off-setting Benefit ²	\$0.3	-\$0.1	-\$0.3	-\$0.7	-\$1.0	-\$1.6	-\$1.7	-\$1.8	-\$1.8	-\$1.8	-\$1.8	-\$1.8	-\$1.8	-\$1.8	-\$17.8
Petroleum Market Externality	\$0.6	\$0.0	\$0.0	-\$0.1	-\$0.2	-\$0.4	-\$0.4	-\$0.4	-\$0.4	-\$0.4	-\$0.4	-\$0.3	-\$0.3	-\$0.3	-\$3.0
CO2 Damage Reduction Benefit	\$0.2	\$0.0	\$0.0	-\$0.1	-\$0.1	-\$0.1	-\$0.2	-\$0.1	-\$0.2	-\$0.1	-\$0.1	-\$0.1	-\$0.1	-\$0.1	-\$1.2
NOx Damage Reduction Benefit	\$0.3	\$0.0	\$0.0	\$0.0	\$0.0	\$0.0	\$0.0	\$0.0	\$0.0	\$0.0	\$0.0	\$0.0	\$0.0	\$0.0	\$0.2
VOC Damage Reduction Benefit	\$0.1	\$0.0	\$0.0	\$0.0	\$0.0	\$0.0	\$0.0	\$0.0	\$0.0	\$0.0	\$0.0	\$0.0	\$0.0	\$0.0	\$0.0
PM Damage Reduction Benefit	\$0.5	\$0.0	\$0.0	\$0.0	\$0.0	-\$0.1	-\$0.1	-\$0.1	-\$0.1	\$0.0	\$0.0	\$0.0	\$0.0	\$0.0	\$0.0
SO ₂ Damage Reduction Benefit	\$0.2	\$0.0	\$0.0	\$0.0	-\$0.1	-\$0.1	-\$0.1	-\$0.1	-\$0.1	-\$0.1	-\$0.1	-\$0.1	-\$0.1	-\$0.1	-\$0.7
Total Social Benefits	\$9.8	\$0.4	-\$1.3	-\$3.8	-\$5.9	-\$9.6	-	-	-	-	\$10.1	-\$9.8	-\$9.8	-\$9.2	-\$90.7
Net Total Benefits	\$25.8	\$2.1	\$2.0	\$2.2	\$1.6	\$1.3	\$1.0	\$2.8	\$3.4	\$4.0	\$5.8	\$6.7	\$7.2	\$7.8	\$73.8

*** EO 12866 Review – Draft – Do Not Cite, Quote or Release During Review ***

¹ This value includes both the value of the fuel spent to drive rebound miles, and the consumer surplus representing the additional amount consumers would have, but did not spend to drive the additional miles.

² It is assumed that consumers that drive rebound miles fully internalize fatal and non-fatal crash costs. The miles are driven because they receive an equal and offsetting benefit from driving the miles. These cells report the magnitude of the offsetting benefits.

*** EO 12866 Review – Draft – Do Not Cite, Quote or Release During Review ***

TABLE 11-71 - COST AND BENEFIT ESTIMATES, LIGHT TRUCKS, PREFERRED ALTERNATIVE, CO2, UNDISCOUNTED (BILLIONS 2016\$)

	MY 1977- 2016	MY 2017	MY 2018	MY 2019	MY 2020	MY 2021	MY 2022	MY 2023	MY 2024	MY 2025	MY 2026	MY 2027	MY 2028	MY 2029	TOTAL
Societal Costs															
Technology Costs	\$0.0	-\$0.3	-\$1.7	-\$4.2	-\$6.0	-\$9.6	\$10.6	\$11.8	\$12.6	\$13.2	\$15.1	\$16.5	\$18.0	\$18.7	-\$138.3
Advanced Technology Value Loss	\$0.0	\$0.0	\$0.0	-\$0.1	-\$0.1	-\$0.3	-\$0.3	-\$0.7	-\$0.8	-\$0.9	-\$1.1	-\$1.1	-\$1.1	-\$1.1	-\$7.5
Congestion Costs	-\$7.7	-\$1.1	-\$1.2	-\$1.4	-\$1.5	-\$1.8	-\$2.0	-\$2.6	-\$3.1	-\$3.5	-\$4.3	-\$4.9	-\$5.4	-\$6.1	-\$46.5
Noise Costs	-\$0.1	\$0.0	\$0.0	\$0.0	\$0.0	\$0.0	\$0.0	\$0.0	\$0.0	-\$0.1	-\$0.1	-\$0.1	-\$0.1	-\$0.1	-\$0.7
Non-Rebound Fatality Costs	\$13.4	-\$1.7	-\$1.6	-\$1.3	-\$1.1	-\$0.7	-\$0.6	-\$1.3	-\$1.7	-\$2.1	-\$3.0	-\$3.7	-\$4.1	-\$4.9	-\$41.2
Non-Rebound Non-Fatal Crash Costs	\$21.0	-\$2.6	-\$2.4	-\$2.1	-\$1.7	-\$1.1	-\$1.0	-\$2.0	-\$2.7	-\$3.3	-\$4.7	-\$5.8	-\$6.4	-\$7.6	-\$64.5
Rebound Fatality Costs	\$0.5	\$0.0	-\$0.3	-\$0.8	-\$1.2	-\$2.0	-\$2.3	-\$2.5	-\$2.7	-\$2.9	-\$3.2	-\$3.4	-\$3.6	-\$3.7	-\$28.3
Non-Fatal Crash Costs	\$0.7	-\$0.1	-\$0.5	-\$1.2	-\$1.9	-\$3.1	-\$3.6	-\$3.9	-\$4.3	-\$4.5	-\$5.0	-\$5.3	-\$5.6	-\$5.8	-\$44.2
Total Societal Costs	\$41.0	-\$5.8	-\$7.8	\$11.2	\$13.5	\$18.6	\$20.5	\$24.8	\$28.0	\$30.5	\$36.5	\$40.6	\$44.4	\$47.9	-\$371.1
Societal Benefits															
Pre-Tax Fuel Savings	\$19.3	\$2.1	\$0.6	-\$1.7	-\$4.0	-\$8.0	-\$9.8	\$10.0	\$10.9	\$11.2	\$11.6	\$11.8	\$12.6	\$12.2	-\$81.6
Rebound Fuel Benefit ¹	\$0.0	-\$0.1	-\$0.5	-\$1.2	-\$1.9	-\$3.3	-\$3.9	-\$4.2	-\$4.6	-\$5.0	-\$5.5	-\$6.0	-\$6.5	-\$6.8	-\$49.4

*** EO 12866 Review – Draft – Do Not Cite, Quote or Release During Review ***

Refueling Time Benefit	\$0.1	\$0.1	\$0.0	-\$0.1	-\$0.2	-\$0.4	-\$0.5	-\$0.5	-\$0.5	-\$0.5	-\$0.5	-\$0.5	-\$0.6	-\$0.5	-\$4.6
Rebound Fatality Costs, Off-setting Benefit ²	\$0.5	\$0.0	-\$0.3	-\$0.8	-\$1.2	-\$2.0	-\$2.3	-\$2.5	-\$2.7	-\$2.9	-\$3.2	-\$3.4	-\$3.6	-\$3.7	-\$28.3
Rebound Non-Fatal Crash Costs, Off-setting Benefit ²	\$0.7	-\$0.1	-\$0.5	-\$1.2	-\$1.9	-\$3.1	-\$3.6	-\$3.9	-\$4.3	-\$4.5	-\$5.0	-\$5.3	-\$5.6	-\$5.8	-\$44.2
Petroleum Market Externality	\$1.6	\$0.2	\$0.0	-\$0.1	-\$0.3	-\$0.7	-\$0.8	-\$0.8	-\$0.9	-\$0.9	-\$0.9	-\$1.0	-\$1.0	-\$1.0	-\$6.7
CO2 Damage Reduction Benefit	\$0.6	\$0.1	\$0.0	-\$0.1	-\$0.1	-\$0.3	-\$0.3	-\$0.3	-\$0.4	-\$0.4	-\$0.4	-\$0.4	-\$0.4	-\$0.4	-\$2.7
NOx Damage Reduction Benefit	\$0.8	\$0.1	\$0.0	\$0.0	\$0.0	\$0.0	\$0.0	\$0.0	\$0.0	\$0.0	\$0.0	\$0.0	\$0.0	\$0.0	\$0.7
VOC Damage Reduction Benefit	\$0.2	\$0.0	\$0.0	\$0.0	\$0.0	\$0.0	\$0.0	\$0.0	\$0.0	\$0.0	\$0.0	\$0.0	\$0.0	\$0.0	\$0.1
PM Damage Reduction Benefit	\$1.2	\$0.2	\$0.1	\$0.0	\$0.0	-\$0.1	-\$0.1	-\$0.1	-\$0.1	-\$0.1	-\$0.1	-\$0.1	-\$0.1	-\$0.1	\$0.7
SO ₂ Damage Reduction Benefit	\$0.4	\$0.0	\$0.0	-\$0.1	-\$0.1	-\$0.2	-\$0.2	-\$0.2	-\$0.2	-\$0.2	-\$0.2	-\$0.2	-\$0.2	-\$0.2	-\$1.4
Total Social Benefits	\$25.5	\$2.5	-\$0.5	-\$5.2	-\$9.7	\$18.1	\$21.5	\$22.5	\$24.6	\$25.7	\$27.4	\$28.7	\$30.6	\$30.8	-\$217.3
Net Total Benefits	\$66.5	\$8.3	\$7.3	\$6.0	\$3.8	\$0.5	-\$1.0	\$2.3	\$3.3	\$4.8	\$9.1	\$12.0	\$13.7	\$17.1	\$153.9

*** EO 12866 Review – Draft – Do Not Cite, Quote or Release During Review ***

¹ This value includes both the value of the fuel spent to drive rebound miles, and the consumer surplus representing the additional amount consumers would have, but did not spend to drive the additional miles.

² It is assumed that consumers that drive rebound miles fully internalize fatal and non-fatal crash costs. The miles are driven because they receive an equal and offsetting benefit from driving the miles. These cells report the magnitude of the offsetting benefits.

*** EO 12866 Review – Draft – Do Not Cite, Quote or Release During Review ***

TABLE 11-72 - COST AND BENEFIT ESTIMATES, PASSENGER CARS AND LIGHT TRUCKS COMBINED, PREFERRED ALTERNATIVE, CO2, 3% DISCOUNT RATE (BILLIONS 2016\$)

	MY 1977- 2016	MY 2017	MY 2018	MY 2019	MY 2020	MY 2021	MY 2022	MY 2023	MY 2024	MY 2025	MY 2026	MY 2027	MY 2028	MY 2029	TOTAL	
Societal Costs																
Technology Costs	\$0.0	-\$1.0	-\$3.4	-\$6.3	-\$9.6	-	\$14.5	\$17.2	\$19.3	\$20.4	\$21.1	\$22.9	\$23.7	\$24.2	\$23.8	-\$207.5
Advanced Technology Value Loss	\$0.0	-\$0.1	-\$0.1	-\$0.3	-\$0.5	-\$0.9	-\$1.2	-\$1.9	-\$2.0	-\$2.1	-\$2.4	-\$2.3	-\$2.3	-\$2.3	-\$2.3	-\$18.2
Congestion Costs	-\$15.1	-\$1.9	-\$2.1	-\$2.3	-\$2.5	-\$3.0	-\$3.0	-\$2.9	-\$2.9	-\$2.7	-\$2.8	-\$2.9	-\$3.0	-\$2.9	-\$2.9	-\$50.0
Noise Costs	-\$0.2	\$0.0	\$0.0	\$0.0	\$0.0	\$0.0	\$0.0	\$0.0	\$0.0	\$0.0	\$0.0	\$0.0	\$0.0	\$0.0	\$0.0	-\$0.7
Non-Rebound Fatality Costs	-\$24.2	-\$2.6	-\$2.5	-\$2.3	-\$2.1	-\$1.8	-\$1.3	-\$0.9	-\$0.7	-\$0.1	-\$0.1	-\$0.2	-\$0.1	-\$0.1	-\$0.1	-\$39.0
Non-Rebound Non-Fatal Crash Costs	-\$37.9	-\$4.1	-\$3.9	-\$3.6	-\$3.3	-\$2.8	-\$2.0	-\$1.4	-\$1.0	-\$0.2	-\$0.1	-\$0.3	-\$0.2	-\$0.1	-\$0.1	-\$61.0
Rebound Fatality Costs	\$0.8	-\$0.1	-\$0.6	-\$1.0	-\$1.6	-\$2.6	-\$3.2	-\$3.5	-\$3.9	-\$4.2	-\$4.4	-\$4.5	-\$4.6	-\$4.6	-\$4.5	-\$37.8
Non-Fatal Crash Costs	\$1.3	-\$0.1	-\$0.9	-\$1.6	-\$2.6	-\$4.1	-\$5.0	-\$5.5	-\$6.1	-\$6.5	-\$6.8	-\$7.0	-\$7.1	-\$7.1	-\$7.1	-\$59.1
Total Societal Costs	-\$75.4	\$10.0	\$13.4	\$17.4	\$22.3	\$29.6	\$32.9	\$35.3	\$37.0	\$37.0	\$39.5	\$41.0	\$41.6	\$40.9	-\$473.3	
Societal Benefits																
Pre-Tax Fuel Savings	\$28.7	\$2.6	\$0.5	-\$1.6	-\$4.4	-\$8.6	\$11.5	\$13.0	\$14.8	\$16.4	\$17.4	\$17.9	\$18.4	\$18.2	\$18.2	-\$110.4

*** EO 12866 Review – Draft – Do Not Cite, Quote or Release During Review ***

Rebound Fuel Benefit ¹	\$0.1	-\$0.1	-\$0.7	-\$1.4	-\$2.2	-\$3.7	-\$4.5	-\$5.0	-\$5.5	-\$6.0	-\$6.4	-\$6.6	-\$6.9	-\$7.0	-\$56.0
Refueling Time Benefit	\$0.2	\$0.1	\$0.0	-\$0.1	-\$0.2	-\$0.4	-\$0.6	-\$0.7	-\$0.8	-\$0.9	-\$0.9	-\$0.9	-\$0.9	-\$0.9	-\$7.1
Rebound Fatality Costs, Off-setting Benefit ²	\$0.8	-\$0.1	-\$0.6	-\$1.0	-\$1.6	-\$2.6	-\$3.2	-\$3.5	-\$3.9	-\$4.2	-\$4.4	-\$4.5	-\$4.6	-\$4.5	-\$37.8
Rebound Non-Fatal Crash Costs, Off-setting Benefit ²	\$1.3	-\$0.1	-\$0.9	-\$1.6	-\$2.6	-\$4.1	-\$5.0	-\$5.5	-\$6.1	-\$6.5	-\$6.8	-\$7.0	-\$7.1	-\$7.1	-\$59.1
Petroleum Market Externality	\$2.3	\$0.2	\$0.0	-\$0.1	-\$0.4	-\$0.7	-\$0.9	-\$1.1	-\$1.2	-\$1.3	-\$1.4	-\$1.5	-\$1.5	-\$1.5	-\$9.0
CO2 Damage Reduction Benefit	\$0.9	\$0.1	\$0.0	\$0.0	-\$0.1	-\$0.3	-\$0.4	-\$0.4	-\$0.5	-\$0.5	-\$0.6	-\$0.6	-\$0.6	-\$0.6	-\$3.6
NOx Damage Reduction Benefit	\$1.0	\$0.1	\$0.1	\$0.0	\$0.0	\$0.0	\$0.0	\$0.0	\$0.0	-\$0.1	-\$0.1	-\$0.1	-\$0.1	-\$0.1	\$0.8
VOC Damage Reduction Benefit	\$0.3	\$0.0	\$0.0	\$0.0	\$0.0	\$0.0	\$0.0	\$0.0	\$0.0	\$0.0	\$0.0	\$0.0	\$0.0	\$0.0	\$0.1
PM Damage Reduction Benefit	\$1.8	\$0.2	\$0.1	\$0.1	\$0.0	-\$0.1	-\$0.1	-\$0.1	-\$0.2	-\$0.2	-\$0.2	-\$0.2	-\$0.2	-\$0.2	\$0.6
SO ₂ Damage Reduction Benefit	\$0.6	\$0.1	\$0.0	-\$0.1	-\$0.1	-\$0.2	-\$0.3	-\$0.2	-\$0.3	-\$0.3	-\$0.3	-\$0.3	-\$0.3	-\$0.3	-\$2.1

*** EO 12866 Review – Draft – Do Not Cite, Quote or Release During Review ***

Total Social Benefits	\$38.0	\$3.0	-\$1.4	-\$5.9	- \$11.6	- \$20.8	- \$26.6	- \$29.6	- \$33.2	- \$36.4	- \$38.6	- \$39.6	- \$40.7	- \$40.4	-\$283.7
Net Total Benefits	\$113.4	\$13.0	\$12.1	\$11.5	\$10.6	\$8.9	\$6.4	\$5.8	\$3.7	\$0.6	\$0.9	\$1.3	\$0.9	\$0.5	\$189.6

¹ This value includes both the value of the fuel spent to drive rebound miles, and the consumer surplus representing the additional amount consumers would have, but did not spend to drive the additional miles.

² It is assumed that consumers that drive rebound miles fully internalize fatal and non-fatal crash costs. The miles are driven because they receive an equal and offsetting benefit from driving the miles. These cells report the magnitude of the offsetting benefits.

*** EO 12866 Review – Draft – Do Not Cite, Quote or Release During Review ***

TABLE 11-73 - COST AND BENEFIT ESTIMATES, PASSENGER CARS AND LIGHT TRUCKS COMBINED, PREFERRED ALTERNATIVE, CO₂, 7% DISCOUNT RATE (BILLIONS 2016\$)

	MY 1977- 2016	MY 2017	MY 2018	MY 2019	MY 2020	MY 2021	MY 2022	MY 2023	MY 2024	MY 2025	MY 2026	MY 2027	MY 2028	MY 2029	TOTAL
Societal Costs															
Technology Costs	\$0.0	-\$1.0	-\$3.3	-\$5.8	-\$8.6	\$12.4	\$14.3	\$15.3	\$15.6	\$15.6	\$16.3	\$16.2	\$15.9	\$15.1	-\$155.4
Advanced Technology Value Loss	\$0.0	-\$0.1	-\$0.1	-\$0.3	-\$0.4	-\$0.8	-\$1.0	-\$1.5	-\$1.5	-\$1.5	-\$1.7	-\$1.6	-\$1.5	-\$1.5	-\$13.4
Congestion Costs	-\$9.2	-\$1.0	-\$1.1	-\$1.2	-\$1.4	-\$1.7	-\$1.7	-\$1.6	-\$1.6	-\$1.4	-\$1.4	-\$1.5	-\$1.4	-\$1.4	-\$27.7
Noise Costs	-\$0.1	\$0.0	\$0.0	\$0.0	\$0.0	\$0.0	\$0.0	\$0.0	\$0.0	\$0.0	\$0.0	\$0.0	\$0.0	\$0.0	-\$0.4
Non-Rebound Fatality Costs	\$14.8	-\$1.3	-\$1.2	-\$1.0	-\$0.9	-\$0.7	-\$0.4	-\$0.2	-\$0.1	\$0.2	\$0.2	\$0.1	\$0.1	\$0.1	-\$19.8
Non-Rebound Non-Fatal Crash Costs	\$23.2	-\$2.0	-\$1.9	-\$1.6	-\$1.4	-\$1.1	-\$0.6	-\$0.3	-\$0.1	\$0.4	\$0.4	\$0.2	\$0.2	\$0.2	-\$30.9
Rebound Fatality Costs	\$0.5	-\$0.1	-\$0.4	-\$0.8	-\$1.2	-\$1.8	-\$2.2	-\$2.3	-\$2.4	-\$2.5	-\$2.5	-\$2.5	-\$2.5	-\$2.3	-\$23.1
Non-Fatal Crash Costs	\$0.8	-\$0.1	-\$0.7	-\$1.2	-\$1.9	-\$2.9	-\$3.4	-\$3.6	-\$3.8	-\$3.9	-\$4.0	-\$3.9	-\$3.9	-\$3.7	-\$36.1
Total Societal Costs	\$46.0	-\$5.6	-\$8.7	\$12.0	\$15.9	\$21.5	\$23.6	\$24.8	\$25.2	\$24.5	\$25.3	\$25.4	\$24.9	\$23.6	-\$306.8
Societal Benefits															
Pre-Tax Fuel Savings	\$17.3	\$1.1	-\$0.4	-\$1.9	-\$3.8	-\$6.5	-\$8.1	-\$8.7	-\$9.5	\$10.1	\$10.2	\$10.1	\$10.0	-\$9.5	-\$70.3

*** EO 12866 Review – Draft – Do Not Cite, Quote or Release During Review ***

Rebound Fuel Benefit ¹	\$0.0	-\$0.1	-\$0.5	-\$1.0	-\$1.6	-\$2.6	-\$3.0	-\$3.2	-\$3.4	-\$3.6	-\$3.7	-\$3.7	-\$3.7	-\$3.6	-\$33.6
Refueling Time Benefit	\$0.1	\$0.1	\$0.0	-\$0.1	-\$0.2	-\$0.3	-\$0.4	-\$0.5	-\$0.5	-\$0.5	-\$0.5	-\$0.5	-\$0.5	-\$0.5	-\$4.5
Rebound Fatality Costs, Off-setting Benefit ²	\$0.5	-\$0.1	-\$0.4	-\$0.8	-\$1.2	-\$1.8	-\$2.2	-\$2.3	-\$2.4	-\$2.5	-\$2.5	-\$2.5	-\$2.5	-\$2.3	-\$23.1
Rebound Non-Fatal Crash Costs, Off-setting Benefit ²	\$0.8	-\$0.1	-\$0.7	-\$1.2	-\$1.9	-\$2.9	-\$3.4	-\$3.6	-\$3.8	-\$3.9	-\$4.0	-\$3.9	-\$3.9	-\$3.7	-\$36.1
Petroleum Market Externality	\$1.4	\$0.1	\$0.0	-\$0.2	-\$0.3	-\$0.5	-\$0.7	-\$0.7	-\$0.8	-\$0.8	-\$0.8	-\$0.8	-\$0.8	-\$0.8	-\$5.8
CO2 Damage Reduction Benefit	\$0.6	\$0.0	\$0.0	-\$0.1	-\$0.1	-\$0.2	-\$0.3	-\$0.3	-\$0.3	-\$0.3	-\$0.3	-\$0.3	-\$0.3	-\$0.3	-\$2.3
NOx Damage Reduction Benefit	\$0.6	\$0.0	\$0.0	\$0.0	\$0.0	\$0.0	\$0.0	\$0.0	\$0.0	\$0.0	\$0.0	\$0.0	\$0.0	\$0.0	\$0.4
VOC Damage Reduction Benefit	\$0.2	\$0.0	\$0.0	\$0.0	\$0.0	\$0.0	\$0.0	\$0.0	\$0.0	\$0.0	\$0.0	\$0.0	\$0.0	\$0.0	\$0.1
PM Damage Reduction Benefit	\$1.1	\$0.1	\$0.0	\$0.0	\$0.0	-\$0.1	-\$0.1	-\$0.1	-\$0.1	-\$0.1	-\$0.1	-\$0.1	-\$0.1	-\$0.1	\$0.1
SO ₂ Damage Reduction Benefit	\$0.4	\$0.0	\$0.0	-\$0.1	-\$0.1	-\$0.2	-\$0.2	-\$0.2	-\$0.2	-\$0.2	-\$0.2	-\$0.2	-\$0.2	-\$0.2	-\$1.4

*** EO 12866 Review – Draft – Do Not Cite, Quote or Release During Review ***

Total Social Benefits	\$22.9	\$1.1	-\$2.1	-\$5.3	-\$9.2	-	-	-	-	-	-	-	-	-	-	-\$176.6
Net Total Benefits	\$69.0	\$6.8	\$6.5	\$6.7	\$6.7	\$6.4	\$5.2	\$5.2	\$4.1	\$2.3	\$2.8	\$3.1	\$2.9	\$2.6	\$130.2	

¹This value includes both the value of the fuel spent to drive rebound miles, and the consumer surplus representing the additional amount consumers would have, but did not spend to drive the additional miles.

²It is assumed that consumers that drive rebound miles fully internalize fatal and non-fatal crash costs. The miles are driven because they receive an equal and offsetting benefit from driving the miles. These cells report the magnitude of the offsetting benefits.

*** EO 12866 Review – Draft – Do Not Cite, Quote or Release During Review ***

TABLE 11-74 - COST AND BENEFIT ESTIMATES, PASSENGER CARS AND LIGHT TRUCKS COMBINED, PREFERRED ALTERNATIVE, CO₂, UNDISCOUNTED (BILLIONS 2016\$)

	MY 1977- 2016	MY 2017	MY 2018	MY 2019	MY 2020	MY 2021	MY 2022	MY 2023	MY 2024	MY 2025	MY 2026	MY 2027	MY 2028	MY 2029	TOTAL
Societal Costs															
Technology Costs	\$0.0	-\$1.0	-\$3.5	-\$6.7	\$10.5	\$16.3	\$20.0	\$23.0	\$25.0	\$26.8	\$29.9	\$31.9	\$33.5	\$34.0	-\$262.1
Advanced Technology Value Loss	\$0.0	-\$0.1	-\$0.1	-\$0.3	-\$0.5	-\$1.0	-\$1.4	-\$2.2	-\$2.5	-\$2.6	-\$3.1	-\$3.1	-\$3.2	-\$3.3	-\$23.4
Congestion Costs	-\$22.9	-\$3.2	-\$3.5	-\$3.9	-\$4.2	-\$4.9	-\$5.0	-\$4.9	-\$5.1	-\$4.9	-\$5.0	-\$5.4	-\$5.5	-\$5.6	-\$83.9
Noise Costs	-\$0.3	\$0.0	\$0.0	-\$0.1	-\$0.1	-\$0.1	-\$0.1	-\$0.1	-\$0.1	-\$0.1	-\$0.1	-\$0.1	-\$0.1	-\$0.1	-\$1.2
Non-Rebound Fatality Costs	-\$36.6	-\$4.6	-\$4.5	-\$4.3	-\$4.1	-\$3.6	-\$2.9	-\$2.4	-\$2.0	-\$1.1	-\$1.0	-\$1.2	-\$1.0	-\$1.0	-\$70.2
Non-Rebound Non-Fatal Crash Costs	-\$57.2	-\$7.3	-\$7.1	-\$6.8	-\$6.4	-\$5.6	-\$4.5	-\$3.7	-\$3.1	-\$1.8	-\$1.5	-\$1.8	-\$1.6	-\$1.5	-\$109.9
Rebound Fatality Costs	\$1.2	-\$0.1	-\$0.7	-\$1.3	-\$2.2	-\$3.6	-\$4.5	-\$5.0	-\$5.7	-\$6.3	-\$6.8	-\$7.2	-\$7.6	-\$7.7	-\$57.5
Non-Fatal Crash Costs	\$1.9	-\$0.1	-\$1.1	-\$2.1	-\$3.4	-\$5.6	-\$7.0	-\$7.9	-\$8.9	-\$9.9	\$10.7	\$11.3	\$11.8	\$12.0	-\$89.9
Total Societal Costs	- \$113.9	- \$16.5	- \$20.6	- \$25.4	- \$31.4	- \$40.6	- \$45.2	- \$49.1	- \$52.4	- \$53.5	- \$58.1	- \$62.0	- \$64.4	- \$65.1	-\$698.1
Societal Benefits															
Pre-Tax Fuel Savings	\$43.7	\$4.9	\$2.3	-\$0.6	-\$4.5	\$10.6	\$15.1	\$17.9	\$21.2	\$24.4	\$26.8	\$28.4	\$30.2	\$30.8	-\$159.7

*** EO 12866 Review – Draft – Do Not Cite, Quote or Release During Review ***

Rebound Fuel Benefit ¹	\$0.1	-\$0.1	-\$0.9	-\$1.8	-\$3.0	-\$5.1	-\$6.4	-\$7.3	-\$8.3	-\$9.2	-	-	-	-	-\$86.6
Refueling Time Benefit	\$0.3	\$0.2	\$0.1	\$0.0	-\$0.2	-\$0.5	-\$0.8	-\$0.9	-\$1.1	-\$1.3	-\$1.4	-\$1.5	-\$1.5	-\$1.6	-\$10.3
Rebound Fatality Costs, Off-setting Benefit ²	\$1.2	-\$0.1	-\$0.7	-\$1.3	-\$2.2	-\$3.6	-\$4.5	-\$5.0	-\$5.7	-\$6.3	-\$6.8	-\$7.2	-\$7.6	-\$7.7	-\$57.5
Rebound Non-Fatal Crash Costs, Off-setting Benefit ²	\$1.9	-\$0.1	-\$1.1	-\$2.1	-\$3.4	-\$5.6	-\$7.0	-\$7.9	-\$8.9	-\$9.9	-	-	-	-	-\$89.9
Petroleum Market Externality	\$3.5	\$0.4	\$0.2	-\$0.1	-\$0.4	-\$0.9	-\$1.2	-\$1.5	-\$1.7	-\$2.0	-\$2.2	-\$2.3	-\$2.5	-\$2.5	-\$13.1
CO2 Damage Reduction Benefit	\$1.4	\$0.2	\$0.1	\$0.0	-\$0.1	-\$0.3	-\$0.5	-\$0.6	-\$0.7	-\$0.8	-\$0.9	-\$0.9	-\$1.0	-\$1.0	-\$5.2
NOx Damage Reduction Benefit	\$1.4	\$0.1	\$0.1	\$0.1	\$0.1	\$0.0	\$0.0	\$0.0	\$0.0	-\$0.1	-\$0.1	-\$0.1	-\$0.1	-\$0.1	\$1.3
VOC Damage Reduction Benefit	\$0.5	\$0.0	\$0.0	\$0.0	\$0.0	\$0.0	\$0.0	\$0.0	\$0.0	\$0.0	\$0.0	\$0.0	-\$0.1	-\$0.1	\$0.3
PM Damage Reduction Benefit	\$2.8	\$0.3	\$0.2	\$0.2	\$0.1	\$0.0	-\$0.1	-\$0.2	-\$0.2	-\$0.3	-\$0.3	-\$0.3	-\$0.3	-\$0.3	\$1.6
SO ₂ Damage Reduction Benefit	\$0.9	\$0.1	\$0.0	\$0.0	-\$0.1	-\$0.2	-\$0.3	-\$0.3	-\$0.4	-\$0.5	-\$0.5	-\$0.5	-\$0.6	-\$0.6	-\$3.0

*** EO 12866 Review – Draft – Do Not Cite, Quote or Release During Review ***

Total Social Benefits	\$57.9	\$5.9	\$0.4	-\$5.6	-	\$13.7	\$26.9	\$36.0	\$41.6	\$48.4	\$54.8	\$59.8	\$63.5	\$67.2	\$68.8	-\$422.1
Net Total Benefits	\$171.8	\$22.4	\$20.9	\$19.7	\$17.7	\$13.7	\$9.2	\$7.6	\$4.0	-\$1.3	-\$1.7	-\$1.5	-\$2.8	-\$3.6	\$276.0	

¹ This value includes both the value of the fuel spent to drive rebound miles, and the consumer surplus representing the additional amount consumers would have, but did not spend to drive the additional miles.

² It is assumed that consumers that drive rebound miles fully internalize fatal and non-fatal crash costs. The miles are driven because they receive an equal and offsetting benefit from driving the miles. These cells report the magnitude of the offsetting benefits.

*** EO 12866 Review – Draft – Do Not Cite, Quote or Release During Review ***

TABLE 11-75 - CONSUMER IMPACTS AND NET CONSUMER BENEFITS, PASSENGER CARS, PREFERRED ALTERNATIVE, CO₂, 3% DISCOUNT RATE (BILLIONS 2016\$)

	MY 2017	MY 2018	MY 2019	MY 2020	MY 2021	MY 2022	MY 2023	MY 2024	MY 2025	MY 2026	MY 2027	MY 2028	MY 2029	MY 2030
Price Increase	-79	-194	-258	-476	-696	-980	-1186	-1321	-1451	-1591	-1652	-1675	-1661	-1633
Welfare Loss	-6	-7	-21	-44	-74	-109	-159	-172	-186	-215	-220	-232	-238	-238
Additional Ownership Costs	-19	-47	-63	-116	-170	-238	-286	-318	-347	-379	-392	-397	-392	-383
Fuel Savings	189	76	18	-134	-337	-555	-695	-864	-1038	-1130	-1206	-1254	-1266	-1259
Mobility Benefit	10	-23	-41	-84	-150	-219	-262	-312	-363	-395	-420	-440	-452	-459
Refueling Benefit	46	40	37	28	17	3	-10	-21	-36	-45	-50	-55	-58	-61
Total Consumer Costs	-103	-249	-342	-636	-939	-1327	-1631	-1811	-1984	-2184	-2264	-2304	-2290	-2254
Total Consumer Benefits	245	93	14	-189	-470	-772	-967	-1197	-1436	-1569	-1677	-1748	-1777	-1779
Net Consumer Benefits	348	342	356	448	469	555	665	613	548	615	587	556	514	475

*** EO 12866 Review – Draft – Do Not Cite, Quote or Release During Review ***

TABLE 11-76 - CONSUMER IMPACTS AND NET CONSUMER BENEFITS, PASSENGER CARS, PREFERRED ALTERNATIVE, CO₂, 7% DISCOUNT RATE (BILLIONS 2016\$)

	MY 2017	MY 2018	MY 2019	MY 2020	MY 2021	MY 2022	MY 2023	MY 2024	MY 2025	MY 2026	MY 2027	MY 2028	MY 2029	MY 2030
Price Increase	-79	-194	-258	-476	-696	-980	-1186	-1321	-1451	-1591	-1652	-1675	-1661	-1633
Welfare Loss	-6	-7	-21	-44	-74	-109	-159	-172	-186	-215	-220	-232	-238	-238
Additional Ownership Costs	-17	-43	-57	-105	-154	-216	-259	-288	-315	-343	-356	-360	-355	-347
Fuel Savings	88	0	-46	-165	-326	-500	-611	-746	-885	-959	-1020	-1057	-1067	-1061
Mobility Benefit	6	-19	-33	-67	-121	-177	-212	-253	-294	-320	-341	-357	-368	-374
Refueling Benefit	35	30	27	21	11	0	-10	-20	-31	-38	-43	-47	-49	-52
Total Consumer Costs	-102	-244	-336	-626	-923	-1305	-1604	-1781	-1952	-2149	-2227	-2267	-2253	-2218
Total Consumer Benefits	128	10	-52	-212	-435	-677	-833	-1018	-1211	-1317	-1404	-1461	-1484	-1487
Net Consumer Benefits	230	254	284	414	488	628	771	763	741	831	823	806	769	731

*** EO 12866 Review – Draft – Do Not Cite, Quote or Release During Review ***

TABLE 11-77 - CONSUMER IMPACTS AND NET CONSUMER BENEFITS, PASSENGER CARS, PREFERRED ALTERNATIVE, CO₂, UNDISCOUNTED (BILLIONS 2016\$)

	MY 2017	MY 2018	MY 2019	MY 2020	MY 2021	MY 2022	MY 2023	MY 2024	MY 2025	MY 2026	MY 2027	MY 2028	MY 2029	MY 2030
Price Increase	-79	-194	-258	-476	-696	-980	-1186	-1321	-1451	-1591	-1652	-1675	-1661	-1633
Welfare Loss	-6	-7	-21	-44	-74	-109	-159	-172	-186	-215	-220	-232	-238	-238
Additional Ownership Costs	-21	-52	-69	-127	-186	-261	-314	-348	-381	-416	-430	-435	-429	-420
Fuel Savings	341	199	125	-64	-317	-586	-759	-967	-1180	-1295	-1388	-1448	-1463	-1454
Mobility Benefit	15	-26	-49	-102	-184	-268	-319	-380	-440	-478	-509	-532	-546	-554
Refueling Benefit	61	53	49	39	25	7	-8	-22	-39	-50	-57	-63	-67	-71
Total Consumer Costs	-105	-253	-348	-648	-955	-1350	-1659	-1841	-2018	-2221	-2302	-2342	-2328	-2291
Total Consumer Benefits	416	226	126	-128	-477	-847	-1086	-1369	-1660	-1823	-1955	-2042	-2076	-2079
Net Consumer Benefits	522	479	474	520	479	503	573	472	358	398	347	300	252	212

*** EO 12866 Review – Draft – Do Not Cite, Quote or Release During Review ***

TABLE 11-78 - CONSUMER IMPACTS AND NET CONSUMER BENEFITS, LIGHT TRUCKS, PREFERRED ALTERNATIVE, CO₂, 3% DISCOUNT RATE (BILLIONS 2016\$)

	MY 2017	MY 2018	MY 2019	MY 2020	MY 2021	MY 2022	MY 2023	MY 2024	MY 2025	MY 2026	MY 2027	MY 2028	MY 2029	MY 2030
Price Increase	-39	-215	-527	-736	-1177	-1302	-1431	-1519	-1585	-1802	-1949	-2110	-2174	-2144
Welfare Loss	0	-1	-15	-15	-36	-38	-85	-102	-105	-126	-126	-126	-126	-126
Additional Ownership Costs	-10	-52	-129	-179	-287	-317	-349	-370	-386	-439	-475	-514	-530	-523
Fuel Savings	153	-20	-279	-535	-984	-1196	-1318	-1490	-1595	-1776	-1889	-2038	-2104	-2121
Mobility Benefit	-29	-65	-133	-196	-328	-379	-414	-458	-494	-545	-590	-641	-674	-692
Refueling Benefit	-33	-40	-49	-58	-74	-81	-82	-86	-87	-88	-88	-90	-88	-83
Total Consumer Costs	-49	-268	-670	-930	-1499	-1657	-1866	-1991	-2077	-2367	-2550	-2751	-2830	-2793
Total Consumer Benefits	90	-125	-461	-789	-1386	-1656	-1814	-2035	-2175	-2408	-2567	-2770	-2867	-2895
Net Consumer Benefits	139	143	210	141	114	0	51	-44	-98	-41	-17	-19	-37	-102

*** EO 12866 Review – Draft – Do Not Cite, Quote or Release During Review ***

TABLE 11-79 - CONSUMER IMPACTS AND NET CONSUMER BENEFITS, LIGHT TRUCKS, PREFERRED ALTERNATIVE, CO₂, 7% DISCOUNT RATE (BILLIONS 2016\$)

	MY 2017	MY 2018	MY 2019	MY 2020	MY 2021	MY 2022	MY 2023	MY 2024	MY 2025	MY 2026	MY 2027	MY 2028	MY 2029	MY 2030
Price Increase	-39	-215	-527	-736	-1177	-1302	-1431	-1519	-1585	-1802	-1949	-2110	-2174	-2144
Welfare Loss	0	-1	-15	-15	-36	-38	-85	-102	-105	-126	-126	-126	-126	-126
Additional Ownership Costs	-9	-47	-116	-163	-260	-288	-316	-335	-350	-398	-430	-466	-480	-474
Fuel Savings	59	-72	-274	-472	-824	-989	-1085	-1220	-1302	-1445	-1535	-1652	-1705	-1719
Mobility Benefit	-23	-50	-105	-156	-263	-305	-333	-369	-399	-440	-477	-518	-546	-560
Refueling Benefit	-30	-35	-42	-49	-61	-67	-68	-71	-71	-72	-72	-74	-72	-68
Total Consumer Costs	-48	-263	-658	-913	-1473	-1627	-1833	-1956	-2041	-2326	-2506	-2703	-2780	-2744
Total Consumer Benefits	6	-157	-420	-678	-1148	-1362	-1486	-1660	-1772	-1957	-2083	-2244	-2323	-2347
Net Consumer Benefits	54	106	238	236	324	265	346	296	269	369	422	458	458	397

*** EO 12866 Review – Draft – Do Not Cite, Quote or Release During Review ***

TABLE 11-80 - CONSUMER IMPACTS AND NET CONSUMER BENEFITS, LIGHT TRUCKS, PREFERRED ALTERNATIVE, CO₂, UNDISCOUNTED (BILLIONS 2016\$)

	MY 2017	MY 2018	MY 2019	MY 2020	MY 2021	MY 2022	MY 2023	MY 2024	MY 2025	MY 2026	MY 2027	MY 2028	MY 2029	MY 2030
Price Increase	-39	-215	-527	-736	-1177	-1302	-1431	-1519	-1585	-1802	-1949	-2110	-2174	-2144
Welfare Loss	0	-1	-15	-15	-36	-38	-85	-102	-105	-126	-126	-126	-126	-126
Additional Ownership Costs	-10	-57	-141	-197	-315	-348	-383	-406	-424	-482	-521	-564	-581	-573
Fuel Savings	304	77	-250	-575	-1142	-1408	-1562	-1778	-1909	-2135	-2276	-2462	-2544	-2563
Mobility Benefit	-36	-81	-164	-242	-403	-464	-506	-559	-602	-664	-719	-781	-820	-840
Refueling Benefit	-36	-44	-55	-67	-87	-96	-98	-103	-103	-105	-105	-108	-105	-99
Total Consumer Costs	-50	-273	-683	-947	-1527	-1687	-1899	-2027	-2114	-2410	-2596	-2801	-2881	-2844
Total Consumer Benefits	232	-48	-470	-884	-1631	-1968	-2165	-2440	-2614	-2903	-3100	-3351	-3469	-3502
Net Consumer Benefits	282	225	213	64	-103	-281	-266	-414	-499	-493	-503	-550	-588	-659

*** EO 12866 Review – Draft – Do Not Cite, Quote or Release During Review ***

**TABLE 11-81 - CONSUMER IMPACTS AND NET CONSUMER BENEFITS, PASSENGER CARS AND LIGHT TRUCKS COMBINED,
PREFERRED ALTERNATIVE, CO₂,
3% DISCOUNT RATE (BILLIONS 2016\$)**

	MY 2017	MY 2018	MY 2019	MY 2020	MY 2021	MY 2022	MY 2023	MY 2024	MY 2025	MY 2026	MY 2027	MY 2028	MY 2029	MY 2030
Price Increase	-61	-204	-382	-595	-916	-1128	-1300	-1414	-1514	-1691	-1793	-1882	-1906	-1879
Welfare Loss	-3	-4	-18	-31	-56	-76	-125	-139	-148	-173	-175	-182	-184	-184
Additional Ownership Costs	-15	-50	-93	-145	-223	-278	-327	-359	-390	-441	-470	-496	-508	-508
Fuel Savings	173	31	-119	-318	-633	-841	-955	-1112	-1235	-1347	-1429	-1513	-1534	-1519
Mobility Benefit	-3	-38	-81	-134	-233	-293	-331	-378	-421	-462	-497	-531	-553	-565
Refueling Benefit	12	6	0	-9	-23	-34	-41	-49	-57	-62	-65	-69	-69	-69
Total Consumer Costs	-78	-257	-493	-771	-1195	-1482	-1751	-1912	-2053	-2305	-2438	-2560	-2599	-2571
Total Consumer Benefits	182	0	-200	-461	-888	-1168	-1327	-1539	-1713	-1871	-1991	-2113	-2157	-2152
Net Consumer Benefits	261	257	293	310	307	313	425	373	340	433	447	447	442	418

*** EO 12866 Review – Draft – Do Not Cite, Quote or Release During Review ***

TABLE 11-82 - CONSUMER IMPACTS AND NET CONSUMER BENEFITS, PASSENGER CARS AND LIGHT TRUCKS COMBINED, PREFERRED ALTERNATIVE, CO₂, 7% DISCOUNT RATE (BILLIONS 2016\$)

	MY 2017	MY 2018	MY 2019	MY 2020	MY 2021	MY 2022	MY 2023	MY 2024	MY 2025	MY 2026	MY 2027	MY 2028	MY 2029	MY 2030
Price Increase	-61	-204	-382	-595	-916	-1128	-1300	-1414	-1514	-1691	-1793	-1882	-1906	-1879
Welfare Loss	-3	-4	-18	-31	-56	-76	-125	-139	-148	-173	-175	-182	-184	-184
Additional Ownership Costs	-13	-45	-84	-132	-202	-252	-296	-326	-354	-399	-426	-449	-460	-460
Fuel Savings	75	-33	-151	-306	-554	-718	-808	-932	-1030	-1118	-1183	-1249	-1266	-1254
Mobility Benefit	-3	-30	-65	-107	-187	-236	-267	-305	-341	-374	-402	-430	-449	-459
Refueling Benefit	7	2	-2	-10	-21	-29	-35	-41	-48	-52	-54	-57	-58	-57
Total Consumer Costs	-77	-253	-484	-758	-1174	-1455	-1721	-1878	-2016	-2263	-2394	-2513	-2551	-2523
Total Consumer Benefits	79	-61	-218	-423	-761	-984	-1110	-1278	-1418	-1545	-1640	-1737	-1773	-1770
Net Consumer Benefits	156	191	267	335	413	472	611	600	598	719	754	777	779	753

*** EO 12866 Review – Draft – Do Not Cite, Quote or Release During Review ***

**TABLE 11-83 - CONSUMER IMPACTS AND NET CONSUMER BENEFITS, PASSENGER CARS AND LIGHT TRUCKS COMBINED,
PREFERRED ALTERNATIVE, CO₂,
UNDISCOUNTED (BILLIONS 2016\$)**

	MY 2017	MY 2018	MY 2019	MY 2020	MY 2021	MY 2022	MY 2023	MY 2024	MY 2025	MY 2026	MY 2027	MY 2028	MY 2029	MY 2030
Price Increase	-61	-204	-382	-595	-916	-1128	-1300	-1414	-1514	-1691	-1793	-1882	-1906	-1879
Welfare Loss	-3	-4	-18	-31	-56	-76	-125	-139	-148	-173	-175	-182	-184	-184
Additional Ownership Costs	-16	-54	-102	-159	-245	-304	-358	-394	-428	-483	-516	-544	-557	-557
Fuel Savings	324	143	-48	-299	-694	-954	-1095	-1291	-1443	-1583	-1684	-1790	-1816	-1797
Mobility Benefit	-1	-46	-99	-165	-285	-358	-404	-461	-513	-562	-604	-645	-671	-684
Refueling Benefit	20	12	4	-7	-24	-38	-46	-56	-66	-72	-76	-80	-82	-81
Total Consumer Costs	-80	-262	-502	-785	-1217	-1508	-1783	-1947	-2090	-2347	-2484	-2608	-2648	-2620
Total Consumer Benefits	343	108	-143	-470	-1004	-1350	-1546	-1808	-2021	-2217	-2364	-2515	-2569	-2562
Net Consumer Benefits	422	371	359	315	213	158	237	139	69	130	120	92	79	58

11.3 Sales and Employment Impacts

Higher vehicle prices resulting from CAFE technologies will reduce new vehicle sales, which will in turn affect employment associated with those sales. Conversely, production of new technologies used to improve fuel economy will create new demand for production. Chapter 7 of this PRIA provides a comprehensive explanation of the process used to measure the impact of higher vehicle prices on sales of new vehicles.

The results of these estimates are shown below in Table 11-84, which lists the average vehicle price change each year for the preferred alternative that is associated with the sales impacts, and the employment impacts associated with these sales impacts. While values for employment impacts are reported as thousands of labor-years, changes in labor utilization would not necessarily involve the same number of changes in actual jobs, as auto industry employers may use a range of strategies (e.g., shift changes, overtime) beyond simply adding or eliminating jobs.

Chapter 7.6 of this PRIA discusses procedures used to estimate employment impacts. Note that employment impacts represent a net effect of labor years associated with changes in new vehicle sales and changes in labor years required to produce new technologies that improve fuel economy in order to achieve required standards. This estimate assumes that jobs that would have been created to achieve more-stringent standards would remain in the United States and would not be outsourced as a result of increased costs. Overall, relative to the baseline augural standards, the proposal would produce small increases in sales and small net decreases in labor requirements for MYs 2017-2030.

*** EO 12866 Review – Draft – Do Not Cite, Quote or Release During Review ***

**TABLE 11-84 - TECHNOLOGY COSTS, AVERAGE PRICES, SALES, AND LABOR UTILIZATION
UNDER BASELINE AND PROPOSED CAFE STANDARDS**

MY	Costs (\$b) for Tech. (beyond MY 2016)				Average Vehicle Prices (\$)				Annual Sales (million units)				Labor (1000s of Labor-Years)			
	Standards		Change		Standards		Change		Standards		Change		Standards		Change	
	Baseline	Proposed	Abs.	%	Baseline	Proposed	Abs.	%	Baseline	Proposed	Abs.	%	Baseline	Proposed	Abs.	%
2017	4	2	(2)	-41%	32,322	32,226	(96)	0%	16.83	16.83	-	0.0%	1,169	1,166	(3)	0%
2018	11	5	(6)	-53%	32,795	32,458	(337)	-1%	17.19	17.19	-	0.0%	1,208	1,198	(10)	-1%
2019	16	7	(10)	-58%	33,067	32,527	(540)	-2%	17.48	17.48	-	0.0%	1,237	1,220	(17)	-1%
2020	25	10	(15)	-60%	33,531	32,691	(839)	-3%	17.66	17.66	-	0.0%	1,263	1,236	(27)	-2%
2021	36	11	(24)	-68%	34,138	32,767	(1,370)	-4%	17.75	17.75	-	0.0%	1,293	1,244	(48)	-4%
2022	40	12	(28)	-70%	34,382	32,776	(1,606)	-5%	17.76	17.79	0.03	0.2%	1,301	1,248	(53)	-4%
2023	43	12	(31)	-72%	34,575	32,785	(1,790)	-5%	17.74	17.80	0.06	0.3%	1,306	1,249	(57)	-4%
2024	44	12	(32)	-73%	34,693	32,780	(1,913)	-6%	17.73	17.83	0.11	0.6%	1,306	1,251	(55)	-4%
2025	46	12	(34)	-74%	34,809	32,765	(2,044)	-6%	17.71	17.87	0.16	0.9%	1,309	1,253	(56)	-4%
2026	48	13	(35)	-73%	34,886	32,782	(2,104)	-6%	17.70	17.90	0.20	1.1%	1,312	1,257	(56)	-4%
2027	47	13	(34)	-73%	34,880	32,784	(2,096)	-6%	17.74	17.94	0.20	1.2%	1,315	1,260	(55)	-4%
2028	47	13	(34)	-73%	34,866	32,785	(2,081)	-6%	17.81	17.97	0.16	0.9%	1,320	1,261	(58)	-4%
2029	46	13	(34)	-72%	34,829	32,774	(2,055)	-6%	17.87	18.01	0.14	0.8%	1,323	1,264	(59)	-4%
2030	46	13	(33)	-72%	34,778	32,756	(2,021)	-6%	17.92	18.03	0.11	0.6%	1,325	1,265	(60)	-5%

11.4 Cumulative Impacts

Section 1(b) of Executive Order 13563, Improving Regulatory Planning and Review, requires the consideration, to the extent practicable, of “the costs of cumulative regulations.” To adhere to this requirement, costs of all NHTSA light vehicle safety final rules (i.e., Federal Motor Vehicle Safety Standards) with an expected full compliance date of MY 2016 or later were examined. In addition, proposed rules, which have been published in the Federal Register for light vehicles, are also identified, and preliminary cost estimates are provided. Furthermore, cost estimates from the proposed MY 2021-2026 fuel economy rule were analyzed. The baseline for cost estimates for this proposed rule is the 2016 baseline to estimate costs associated with the proposed rule for MY 2021-MY 2026 vehicles.

The costs being considered include manufacturing cost per vehicle for safety standards that often increase weight, possible other operational costs, and costs for meeting fuel economy requirements. Manufacturing cost estimates are not discounted because they occur at the time the vehicle is purchased; therefore, no discounting is necessary. For calculating costs related to meeting fuel economy standards, costs equal per-vehicle technology costs plus costs of fines. The CAFE-related consumer costs provided in this analysis are those resulting from the current CAFE model results for costs manufacturers would incur to achieve the MY 2021-2026 CAFE standards. The costs estimated in this analysis are based on an assumption that the 2020 standards would have been extended to apply to MYs 2021-2026 if the agency had not proposed higher standards.⁸¹² For fuel economy, the cost is based on updated estimates of costs of technologies in MY 2016. All costs from previous years are adjusted to 2016 dollars using the implicit price deflator for gross domestic product (GDP). For safety standards, the cost per affected vehicle includes the estimated cost from the range of costs and countermeasures that any vehicle might incur. The cost per average vehicle considers voluntary compliance with the rule. In other words, vehicles that already complied with the rule at the time of estimating the average cost for vehicles needing to meet the rule were not considered.

Results of this analysis show that compared to the MY 2016 baseline, safety standards that are already final rules and have been proposed (including this proposed rule) are estimated to add costs to the average passenger car and light truck. For fuel economy, when compared to MY 2020, this proposed rule is also estimated to add costs to these vehicles, as shown in Table 11-85 through Table 11-87. Based on the final safety rules and the proposed fuel economy rule,⁸¹³ the average passenger car will increase in price by \$282-\$331 and the average light truck will increase in price by \$296-\$340 in MY 2026 (with respect to MY 2016 for the safety standards and MY 2020 for this proposed fuel rule).

⁸¹² The consumer costs associated with the preferred alternative are much lower than the costs associated with the augural standards. For example, the average cost of buying a passenger car would be \$90 with the proposed rule in MY 2026, whereas the cost would be \$1,118 with the augural standards.

⁸¹³ The preferred alternative, Alternative 1 was used in the discussion.

*** EO 12866 Review – Draft – Do Not Cite, Quote or Release During Review ***

Table through Table 11-92 provide a breakdown of those costs by model year, by vehicle type, and equipment costs for safety and fuel economy rules.

TABLE 11-85 - SUMMARY OF ESTIMATED AVERAGE VEHICLE INCREASES IN TOTAL CONSUMER COST FOR SAFETY RULES AND PROPOSED FUEL RULE (IN 2016 DOLLARS)

Vehicle	Standards		Total (in 2016 \$)
	Safety (with respect to MY 2016 vehicles)	Fuel Economy (with respect to MY 2020 vehicles) ⁸¹⁴	
Passenger Car	\$1,623M - \$2,037M	\$816M	\$2,439M - \$2,853M
Light Truck	\$1,205M - \$1,547M	\$1,293M	\$2,498M - \$2,840M

TABLE 11-86 - COSTS OF PASSENGER CAR AND LIGHT TRUCK SAFETY FINAL RULEMAKINGS THAT TAKE EFFECT IN MY 2016 OR LATER (WITH A GVWR OF 10,000 LBS. OR LESS, IN 2016 DOLLARS⁸¹⁵)

Final	Effective Model Year	Cost Per Affected Vehicle	Average Cost Per Vehicle	Total Industry Cost
FMVSS No. 141, Minimum Sound Requirements for Hybrid and Electric Vehicle	2020	\$74-\$77 ⁸¹⁶	\$0.43-\$4.62 ⁸¹⁷	\$40M ⁸¹⁸
FMVSS No. 111, Rear Visibility	2016	\$137-\$156 ⁸¹⁹	\$20-\$62 ⁸²⁰	\$596M - \$680M ⁸²¹

⁸¹⁴ These costs are incremental costs expected in 2025 with respect to the cost in 2020. For 2021, the passenger car incremental cost was estimated to be \$440M. Likewise, costs are \$602M in 2022, \$759M in 2023, and \$800M in 2024. For LTVs, costs are \$879M, \$1,074M, \$1,149M, \$1,224M and \$1,221M in 2021, 2022, 2023, 2024, and 2025, respectively.

⁸¹⁵ BLS Consumer Price Index (CPI) was used to adjust from economics of original FRIA or Final Rule publication to current economics.

⁸¹⁶ LTV - \$74.04 and PC - \$76.51, FMVSS 141 FRIA.

⁸¹⁷ FMVSS 141 FRIA.

⁸¹⁸ PC - \$36,987,530 + LTV - \$3,437,620 = \$40M; FMVSS 141 FRIA.

⁸¹⁹ Low Estimate - \$136.55/vehicle, High Estimate \$155.58/vehicle. Source - FMVSS 111 FRIA.

⁸²⁰ LTV, Low Estimate \$20.21; LTV, High Estimate \$23.03; PC, Low Estimate \$54.35; PC, High Estimate \$61.92 Source - FMVSS 111 FRIA.

⁸²¹ LTV 130 Dash = \$161,672,706; PC 130 Dash = \$434,768,493; LTV 180 Mirror = \$184,212,092; PC 180 Mirror = \$495,381,167, Source FMVSS 111 FRIA.

*** EO 12866 Review – Draft – Do Not Cite, Quote or Release During Review ***

TABLE 11-87 - COSTS OF PASSENGER CAR AND LIGHT TRUCK SAFETY PROPOSED RULEMAKINGS THAT TAKE EFFECT IN MY 2016 OR LATER (WITH A GVWR OF 10,000 LBS. OR LESS, IN 2016 DOLLARS)

Proposed	Average Cost Per Vehicle*	Total Cost (in M's)
FMVSS No. 150, Vehicle-To-Vehicle Communication Technology for Light Vehicles, Proposed Rule ⁸²²	\$135.38 - \$176.89	\$2,192 - \$2,864

* The costs are based on Year 1. See the V2V PRIA for additional discussion.

TABLE 11-88 - FUEL ECONOMY COSTS OF PASSENGER CARS INCREMENTAL BY MODEL YEAR WITH RESPECT TO 2016, IN 2016 DOLLARS*

Effective Model Year	Incremental Consumer Cost for CAFE Requirements	Total Consumer Cost for CAFE Requirements (\$ millions)
2016	\$0	\$0
2017	\$41	\$359
2018	\$98	\$872
2019	\$128	\$1,168
2020	\$168	\$1,557
2021	\$215	\$1,997
2022	\$232	\$2,159
2023	\$250	\$2,316
2024	\$255	\$2,357
2025	\$255	\$2,359
2026	\$257	\$2,374

*The numbers were rounded to the nearest integer.

⁸²² Preliminary Regulatory Impact Analysis, FMVSS No. 150 Vehicle-to-Vehicle Communication Technology for Light Vehicles https://www.nhtsa.gov/sites/nhtsa.dot.gov/files/documents/v2v_pria_12-12-16_clean-2.pdf.

*** EO 12866 Review – Draft – Do Not Cite, Quote or Release During Review ***

TABLE 11-89 - FUEL ECONOMY COSTS OF LIGHT TRUCKS INCREMENTAL BY MODEL YEAR WITH RESPECT TO 2016, IN 2016 DOLLARS

Effective Model Year	Incremental Consumer Cost for CAFE Requirements	Total Consumer Cost for CAFE Requirements (\$ millions)
2016	\$0	\$0
2017	\$49	\$389
2018	\$128	\$1,047
2019	\$207	\$1,706
2020	\$259	\$2,142
2021	\$362	\$3,021
2022	\$384	\$3,215
2023	\$391	\$3,291
2024	\$399	\$3,366
2025	\$398	\$3,363
2026	\$406	3,435

TABLE 11-90 - FUEL ECONOMY COSTS OF PASSENGER CARS AND LIGHT TRUCKS INCREMENTAL BY MODEL YEAR (IN 2016 DOLLARS, WITH RESPECT TO MY 2016)

Effective Model Year	Passenger Cars	Light Trucks	Total Consumer Cost for CAFE Requirements (\$ millions)
2016	\$0	\$0	\$0
2017	\$359	\$389	\$748
2018	\$872	\$1,047	\$1,919
2019	\$1,168	\$1,706	\$2,875
2020	\$1,557	\$2,142	\$3,699
2021	\$1,997	\$3,021	\$5,018
2022	\$2,159	\$3,215	\$5,375
2023	\$2,316	\$3,291	\$5,607
2024	\$2,357	\$3,366	\$5,723
2025	\$2,359	\$3,363	\$5,722
2026	\$2,374	\$3,435	\$5,808

*** EO 12866 Review – Draft – Do Not Cite, Quote or Release During Review ***

TABLE 11-91 - FUEL ECONOMY COSTS OF PASSENGER CARS INCREMENTAL BY MODEL YEAR WITH RESPECT TO MY 2020, IN 2016 DOLLARS

MY	Incremental Consumer Cost for CAFE Requirements	Total Consumer Cost for CAFE Requirements, in millions
2021	\$47	\$440
2022	\$65	\$602
2023	\$82	\$759
2024	\$87	\$800
2025	\$88	\$802
2026	\$90	\$816

TABLE 11-92 - FUEL ECONOMY COSTS OF LIGHT TRUCKS INCREMENTAL BY MODEL YEAR WITH RESPECT TO MY 2020, IN 2016 DOLLARS

MY	Incremental Consumer Cost for CAFE Requirements	Total Consumer Cost for CAFE Requirements, in millions
2021	\$104	\$879
2022	\$125	\$1,074
2023	\$133	\$1,149
2024	\$140	\$1,224
2025	\$140	\$1,221
2026	\$148	\$1,293

TABLE 11-93 - SAFETY AND FUEL ECONOMY COSTS OF PASSENGER CARS INCREMENTAL BY MODEL YEAR WITH RESPECT TO MY 2020 (IN 2016 DOLLARS)

MY	Incremental Consumer Cost for CAFE Requirements		Total Consumer Cost for CAFE Requirements, in millions	
	Low	High	Low	High
2021	\$241	\$290	\$2,063	\$2,477
2022	\$259	\$308	\$2,225	\$2,639
2023	\$276	\$325	\$2,382	\$2,796
2024	\$282	\$331	\$2,423	\$2,837
2025	\$282	\$331	\$2,425	\$2,839
2026	\$284	\$333	\$2,439	\$2,853

TABLE 11-94 - SAFETY AND FUEL ECONOMY COSTS OF LIGHT TRUCKS INCREMENTAL BY MODEL YEAR WITH RESPECT TO MY 2020 (IN 2016 DOLLARS)

MY	Incremental Consumer Cost for CAFE Requirements		Total Consumer Cost for CAFE Requirements, in millions	
	Low	High	Low	High
2021	\$260	\$304	\$2,084	\$2,426
2022	\$281	\$325	\$2,279	\$2,621
2023	\$289	\$333	\$2,354	\$2,696
2024	\$296	\$341	\$2,429	\$2,771
2025	\$296	\$340	\$2,426	\$2,768

*** EO 12866 Review – Draft – Do Not Cite, Quote or Release During Review ***

2026	\$304	\$348	\$2,498	\$2,840
------	-------	-------	---------	---------

Table 11-95 shows cumulative safety and fuel economy costs on a per vehicle basis and total costs for the industry (multiplying average costs per vehicle by projected sales).

TABLE 11-95 - CUMULATIVE COST EFFECTS OF RECENT PASSENGER CARS RULES AND PROPOSALS WITH RESPECT TO MY 2020 VEHICLES (IN 2016 DOLLARS)

MY	Average Cost per Vehicle, Cumulative Safety and Fuel Economy Costs		Total Cost (in \$M's)	
	Low	High	Low	High
2021	\$501	\$594	\$4,147	\$4,903
2022	\$540	\$633	\$4,504	\$5,260
2023	\$565	\$658	\$4,736	\$5,492
2024	\$578	\$671	\$4,852	\$5,608
2025	\$578	\$671	\$4,851	\$5,607
2026	\$588	\$681	\$4,937	\$5,693

[Table will be forthcoming]

12 Sensitivity Analysis

As discussed at the beginning of this section, results presented today reflect the best judgments regarding many different factors. Based on analyses in past rulemakings, the agencies recognize that some analytical inputs are especially uncertain, some are likely to exert considerable influence over specific types of estimated impacts, and some are likely to do so for the bulk of the analysis. Alternative values were used to explore a range of potential inputs and the sensitivity of estimated impacts to changes in model inputs. Results of this sensitivity analysis are summarized below, and detailed model inputs and outputs are available on NHTSA’s web site.⁸²³ Regulatory alternatives are identical across all cases, except that one case includes an increase in civil penalty rate starting in MY 2019; NHTSA may consider changing the civil penalty rate in a separate regulatory action, and depending on the timing of any such action, the final rule to follow today’s proposal could reflect the change.⁸²⁴ The following table lists the cases included in the sensitivity analysis. The final rule could adopt any combination - or none - of these alternatives as reference case inputs, and the agencies invite comment on all of them.

TABLE 12-1 - CASES INCLUDED IN SENSITIVITY ANALYSIS

Sensitivity Case	Description
Reference Case	Reference case
Consumer Benefit at 50%	Assume 50% loss in consumer surplus – equivalent to the assumption that consumers will only value the calculated benefits they receive at 50 percent of the analysis estimates
Consumer Benefit at 75%	75% loss in consumer surplus
Fleet Share and Sales Response Disabled	New vehicle sales will remain at levels specified for MY 2016 in the market data input file
Disable Scrapage Price Effect	Keeps average new vehicle prices at MY2016 levels within the scrapage model throughout the model simulation; this disables the effect of slower scrapage when new vehicle prices increase across more stringent scenarios.
Disable Scrapage Price Effect and Fleet Share and Sales Response	Disables both the scrapage price effect and the fleet share and sales response.
High Oil Price	High fuel price estimates
High Oil Price with 60 Month Payback	High fuel price estimates and a 60-mo. payback period
Low Oil Price	Low fuel price estimates
Low Oil Price with 12 Month Payback	Low fuel price estimates and a 12-mo. payback period
High GDP	High GDP growth rate

⁸²³ The CAFE model and all inputs and outputs supporting today’s proposal are available at <https://www.nhtsa.gov/corporate-average-fuel-economy/compliance-and-effects-modeling-system>. [web link to be updated]

⁸²⁴ [reference will be forthcoming]

*** EO 12866 Review – Draft – Do Not Cite, Quote or Release During Review ***

High GDP with High Oil Price	High GDP growth rate and high fuel price estimates
High GDP with Low Oil Price	High GDP growth rate and low fuel price estimates
Low GDP	Low GDP growth rate
Low GDP with High Oil Price	Low GDP growth rate and high fuel price estimates
Low GDP with Low Oil Price	Low GDP growth rate and low fuel price estimates
On Road Gap 0.10	On-road gap (difference between rated fuel economy and observed fuel economy) is set to 0.1.
On Road Gap 0.30	On-road gap is set to 0.3
12 Month Payback Period	12-month payback period (i.e., voluntary application of technologies paying back within first year of vehicle ownership)
24 Month Payback Period	24-month payback period
36 Month Payback Period	36-month payback period
Rebound Effect at 10%	Rebound effect, the increase miles traveled as the cost of travel decreases, is set to 10%
Rebound Effect at 30%	Rebound effect set to 30%
Long Fleet Redesign Cadence	Redesign cadence (schedule of major technology upgrades for vehicles, engines, etc.) is extended to 1.2 times that of the reference case (rounded to nearest MY)
Short Fleet Redesign Cadence	Redesign cadence shortened to a 0.8 times that of the reference case (rounded to nearest MY)
Safety Coefficient at 5th Percentile	Lower bounds of confidence interval of safety coefficients
Safety Coefficient at 95th Percentile	Upper bounds of confidence interval of safety coefficients
Fatalities Flat Earlier	Improvements in successive MY vehicles stabilize 5 years earlier than central case
Fatalities Flat Later	Improvements in successive MY vehicles stabilize 5 years later than central case
High Social Cost of Carbon	High social cost of carbon
Low Social Cost of Carbon	Low social cost of carbon
High HEV Battery Costs	HEV battery costs 1/3 more than in reference case
Low HEV Battery Costs	HEV battery costs 1/3 less than in reference case
Exclude Strong Hybrids	Strong hybrids are excluded from the analysis

*** EO 12866 Review – Draft – Do Not Cite, Quote or Release During Review ***

Include HCR2 Engines	HCR2 (advanced high compression ratio engine) is included in the analysis
Fines at \$14 in 2019	CAFE compliance fines are set to \$14 beginning in 2019
Technology Cost Markup 1.10	Technology retail price equivalent (RPE) of 1.10 (i.e., 10% markup of direct costs)
Technology Cost Markup 1.19	Technology retail price equivalent (RPE) of 1.19 (i.e., 19% markup of direct costs)
Technology Cost Markup 1.24	Technology retail price equivalent (RPE) of 1.24 (i.e., 24% markup of direct costs)
Technology Cost Markup 1.37	Technology retail price equivalent (RPE) of 1.37 (i.e., 37% markup of direct costs)
Technology Cost Markup 1.75	Technology retail price equivalent (RPE) of 1.75 (i.e., 75% markup of direct costs)
Technology Cost Markup 2.00	Technology retail price equivalent (RPE) of 2.00 (i.e., 100% markup of direct costs)

*** EO 12866 Review – Draft – Do Not Cite, Quote or Release During Review ***

The remaining tables in the section summarize various estimated impacts as estimated for all of the cases included in the sensitivity analysis.

TABLE 12-2 - AVERAGE REQUIRED AND ACHIEVED CAFE LEVELS, VEHICLE SALES, AND EMPLOYMENT HOURS UNDER PROPOSED CAFE STANDARDS (MY 2029 COMBINED FLEET)

Sensitivity Case	Average Required CAFE Level (mpg)	Average Achieved CAFE Level (mpg)	Vehicle Sales (/1,000)	Labor Hours (/1,000)
Reference Case	37.0	38.5	18,006	2,527,566
Consumer Benefit at 50%	37.0	38.5	18,006	2,527,566
Consumer Benefit at 75%	37.0	38.5	18,006	2,527,566
Fleet Share and Sales Response Disabled	36.9	38.3	16,578	2,339,182
Disable Scrappage Price Effect	37.0	38.5	18,006	2,527,566
Disable Scrappage Price Effect and Fleet Share and Sales Response	36.9	38.3	16,578	2,339,182
High Oil Price	38.3	41.8	18,003	2,486,757
High Oil Price with 60 Month Payback	38.2	43.9	17,979	2,523,335
Low Oil Price	36.0	36.5	18,006	2,565,514
Low Oil Price with 12 Month Payback	36.0	36.4	18,000	2,568,358
High GDP	37.0	38.5	18,092	2,539,577
High GDP with High Oil Price	38.3	41.8	18,089	2,498,579
High GDP with Low Oil Price	36.0	36.5	18,092	2,577,706
Low GDP	37.0	38.5	17,457	2,450,461
Low GDP with High Oil Price	38.3	41.8	17,454	2,410,762
Low GDP with Low Oil Price	36.0	36.5	17,457	2,487,253
On Road Gap 0.10	37.0	38.3	18,004	2,527,853
On Road Gap 0.30	37.0	38.7	18,005	2,529,154
12 Month Payback Period	37.0	37.6	18,004	2,524,037
24 Month Payback Period	37.0	38.1	18,006	2,525,537
36 Month Payback Period	37.0	38.8	18,005	2,529,637
Rebound Effect at 10%	37.0	38.5	18,006	2,527,566
Rebound Effect at 30%	37.0	38.5	18,006	2,527,566
Long Fleet Redesign Cadence	37.0	38.6	18,000	2,533,377
Short Fleet Redesign Cadence	37.0	38.6	18,003	2,537,538
Safety Coefficient at 5th Percentile	37.0	38.5	18,006	2,527,566
Safety Coefficient at 95th Percentile	37.0	38.5	18,006	2,527,566
Fatalities Flat Earlier	37.0	38.5	18,006	2,527,566
Fatalities Flat Later	37.0	38.5	18,006	2,527,566
High Social Cost of Carbon	37.0	38.5	18,006	2,527,566
Low Social Cost of Carbon	37.0	38.5	18,006	2,527,566
High HEV Battery Costs	37.0	38.5	18,006	2,527,561
Low HEV Battery Costs	37.0	38.5	18,006	2,527,697
Exclude Strong Hybrids	37.0	38.5	18,006	2,527,575

*** EO 12866 Review – Draft – Do Not Cite, Quote or Release During Review ***

Include HCR2 Engines	37.0	39.8	18,012	2,523,637
Fines at \$14 in 2019	37.0	38.5	18,008	2,528,603
Technology Cost Markup 1.10	37.0	39.2	18,012	2,530,206
Technology Cost Markup 1.19	37.0	39.0	18,011	2,528,614
Technology Cost Markup 1.24	37.0	39.0	18,009	2,529,641
Technology Cost Markup 1.37	37.0	38.6	18,010	2,527,041
Technology Cost Markup 1.75	37.0	38.2	18,001	2,527,395
Technology Cost Markup 2.00	37.0	38.0	17,995	2,528,401

*** EO 12866 Review – Draft – Do Not Cite, Quote or Release During Review ***

TABLE 12-3 - AVERAGE REQUIRED AND ACHIEVED CO₂ LEVELS, VEHICLE SALES, AND EMPLOYMENT HOURS UNDER PROPOSED CO₂ STANDARDS (MY 2029 COMBINED FLEET)

Sensitivity Case	Average Required CO ₂ Level (mpg)	Average Achieved CO ₂ Level (g/mile)	Vehicle Sales (/1,000)	Labor Hours (/1,000)
Reference Case	240.1	226.0	18,011	2,525,040
Consumer Benefit at 50%	240.1	226.0	18,011	2,525,040
Consumer Benefit at 75%	240.1	226.0	18,011	2,525,040
Fleet Share and Sales Response Disabled	241.3	227.6	16,578	2,337,758
Disable Scrappage Price Effect	240.1	226.0	18,011	2,525,040
Disable Scrappage Price Effect and Fleet Share and Sales Response	241.3	227.6	16,578	2,337,758
High Oil Price	231.8	205.1	18,005	2,488,065
High Oil Price with 60 Month Payback	232.7	195.3	17,981	2,521,186
Low Oil Price	246.2	237.9	18,012	2,563,601
Low Oil Price with 12 Month Payback	246.2	239.4	18,009	2,564,131
High GDP	240.1	226.0	18,097	2,537,036
High GDP with High Oil Price	231.8	205.1	18,090	2,499,890
High GDP with Low Oil Price	246.2	237.9	18,098	2,575,762
Low GDP	240.1	226.0	17,461	2,448,595
Low GDP with High Oil Price	231.8	205.1	17,455	2,412,158
Low GDP with Low Oil Price	246.2	237.9	17,463	2,485,422
On Road Gap 0.10	240.1	226.9	18,010	2,524,634
On Road Gap 0.30	240.2	224.1	18,009	2,527,602
12 Month Payback Period	239.8	232.6	18,012	2,518,311
24 Month Payback Period	240.0	228.9	18,012	2,521,975
36 Month Payback Period	240.2	223.6	18,008	2,528,848
Rebound Effect at 10%	240.1	226.0	18,011	2,525,040
Rebound Effect at 30%	240.1	226.0	18,011	2,525,040
Long Fleet Redesign Cadence	240.0	223.5	18,003	2,537,970

*** EO 12866 Review – Draft – Do Not Cite, Quote or Release During Review ***

Short Fleet Redesign Cadence	240.3	225.5	18,009	2,532,235
Safety Coefficient at 5th Percentile	240.1	226.0	18,011	2,525,040
Safety Coefficient at 95th Percentile	240.1	226.0	18,011	2,525,040
Fatalities Flat Earlier	240.1	226.0	18,011	2,525,040
Fatalities Flat Later	240.1	226.0	18,011	2,525,040
High Social Cost of Carbon	240.1	226.0	18,011	2,525,040
Low Social Cost of Carbon	240.1	226.0	18,011	2,525,040
High HEV Battery Costs	240.1	226.0	18,011	2,525,034
Low HEV Battery Costs	240.1	225.5	18,011	2,524,796
Exclude Strong Hybrids	239.8	224.4	18,013	2,518,420
Include HCR2 Engines	240.1	218.9	18,015	2,516,999
Technology Cost Markup 1.10	240.3	219.1	18,014	2,530,134
Technology Cost Markup 1.19	240.3	221.6	18,015	2,527,001
Technology Cost Markup 1.24	240.2	223.6	18,016	2,525,381
Technology Cost Markup 1.37	240.2	225.0	18,013	2,525,710
Technology Cost Markup 1.75	240.0	226.9	18,007	2,526,131
Technology Cost Markup 2.00	240.0	229.3	18,004	2,524,548

*** EO 12866 Review – Draft – Do Not Cite, Quote or Release During Review ***

TABLE 12-4 - AVERAGE MY 2029 NEW VEHICLE PRICES UNDER BASELINE AND PROPOSED CAFE AND CO₂ STANDARDS

Sensitivity Case	CAFE Standards		CO ₂ Standards	
	Proposed	Baseline	Proposed	Baseline
Reference Case	\$32,774	\$34,829	\$32,681	\$34,765
Consumer Benefit at 50%	\$32,774	\$34,829	\$32,681	\$34,765
Consumer Benefit at 75%	\$32,774	\$34,829	\$32,681	\$34,765
Fleet Share and Sales Response Disabled	\$32,904	\$34,796	\$32,836	\$34,690
Disable Scrappage Price Effect	\$32,774	\$34,829	\$32,681	\$34,765
Disable Scrappage Price Effect and Fleet Share and Sales Response	\$32,904	\$34,796	\$32,836	\$34,690
High Oil Price	\$32,130	\$33,762	\$32,130	\$33,694
High Oil Price with 60 Month Payback	\$32,716	\$33,804	\$32,667	\$33,610
Low Oil Price	\$33,357	\$35,633	\$33,270	\$35,552
Low Oil Price with 12 Month Payback	\$33,393	\$35,646	\$33,292	\$35,590
High GDP	\$32,774	\$34,829	\$32,681	\$34,765
High GDP with High Oil Price	\$32,130	\$33,762	\$32,130	\$33,693
High GDP with Low Oil Price	\$33,357	\$35,633	\$33,270	\$35,552
Low GDP	\$32,774	\$34,834	\$32,689	\$34,763
Low GDP with High Oil Price	\$32,129	\$33,764	\$32,131	\$33,692
Low GDP with Low Oil Price	\$33,357	\$35,633	\$33,270	\$35,556
On Road Gap 0.10	\$32,774	\$34,836	\$32,678	\$34,786
On Road Gap 0.30	\$32,804	\$34,796	\$32,729	\$34,713
12 Month Payback Period	\$32,720	\$34,839	\$32,587	\$34,739
24 Month Payback Period	\$32,745	\$34,838	\$32,642	\$34,760
36 Month Payback Period	\$32,811	\$34,788	\$32,752	\$34,706
Rebound Effect at 10%	\$32,774	\$34,829	\$32,681	\$34,765
Rebound Effect at 30%	\$32,774	\$34,829	\$32,681	\$34,765
Long Fleet Redesign Cadence	\$32,848	\$34,759	\$32,862	\$34,625
Short Fleet Redesign Cadence	\$32,855	\$34,845	\$32,793	\$34,759
Safety Coefficient at 5th Percentile	\$32,774	\$34,829	\$32,681	\$34,765
Safety Coefficient at 95th Percentile	\$32,774	\$34,829	\$32,681	\$34,765
Fatalities Flat Earlier	\$32,774	\$34,829	\$32,681	\$34,765
Fatalities Flat Later	\$32,774	\$34,829	\$32,681	\$34,765
High Social Cost of Carbon	\$32,774	\$34,829	\$32,681	\$34,765
Low Social Cost of Carbon	\$32,774	\$34,829	\$32,681	\$34,765
High HEV Battery Costs	\$32,780	\$35,035	\$32,690	\$34,904
Low HEV Battery Costs	\$32,770	\$34,628	\$32,670	\$34,599
Exclude Strong Hybrids	\$32,769	\$34,620	\$32,579	\$34,275
Include HCR2 Engines	\$32,686	\$34,144	\$32,565	\$33,997
Fines at \$14 in 2019	\$32,787	\$34,863	n/a	n/a
Technology Cost Markup 1.10	\$32,654	\$34,113	\$32,623	\$34,021
Technology Cost Markup 1.19	\$32,676	\$34,253	\$32,611	\$34,155
Technology Cost Markup 1.24	\$32,712	\$34,342	\$32,604	\$34,260
Technology Cost Markup 1.37	\$32,716	\$34,592	\$32,647	\$34,497
Technology Cost Markup 1.75	\$32,864	\$35,266	\$32,772	\$35,195
Technology Cost Markup 2.00	\$32,954	\$35,667	\$32,824	\$35,616

*** EO 12866 Review – Draft – Do Not Cite, Quote or Release During Review ***

TABLE 12-5 - CUMULATIVE CHANGES IN FLEET SIZE, TRAVEL (VMT), FATALITIES, FUEL CONSUMPTION AND CO₂ EMISSIONS THROUGH MY 2029 UNDER PROPOSED CAFE STANDARDS

Sensitivity Case	Fleet Size (m)	Share LT, CY 2040	CO2 (mmt)	VMT, Fatalities and Fuel Consumption with Rebound			VMT, Fatalities and Fuel Consumption without Rebound		
				VMT (b. mi.)	Fatalities	Fuel Cons. (b. gal.)	VMT (b. mi.)	Fatalities	Fuel Cons. (b. gal.)
Reference Case	-191	41%	810	-1,470	-12,705	73	-693	-6,361	98
Consumer Benefit at 50%	-191	41%	810	-1,470	-12,705	73	-693	-6,361	98
Consumer Benefit at 75%	-191	41%	810	-1,470	-12,705	73	-693	-6,361	98
Fleet Share and Sales Response Disabled	-203	29%	719	-1,552	-13,374	65	-827	-7,448	88
Disable Scrappage Price Effect	-43	166%	988	-915	-7,808	89	-140	-1,465	114
Disable Scrappage Price Effect and Fleet Share and Sales Response	-59	93%	896	-1,007	-8,552	81	-282	-2,623	104
High Oil Price	-178	45%	143	-1,530	-13,309	13	-692	-6,671	52
High Oil Price with 60 Month Payback	-104	32%	126	-914	-7,940	11	-380	-3,688	36
Low Oil Price	-184	40%	1,296	-1,252	-10,919	117	-626	-5,764	126
Low Oil Price with 12 Month Payback	-181	40%	1,293	-1,242	-10,815	117	-614	-5,645	126
High GDP	-191	40%	805	-1,467	-12,684	73	-693	-6,368	97
High GDP with High Oil Price	-177	45%	141	-1,526	-13,271	13	-692	-6,670	52
High GDP with Low Oil Price	-185	40%	1,288	-1,251	-10,911	116	-628	-5,776	126
Low GDP	-187	41%	789	-1,432	-12,379	71	-676	-6,201	95
Low GDP with High Oil Price	-173	47%	140	-1,491	-12,961	13	-673	-6,482	51
Low GDP with Low Oil Price	-180	41%	1,260	-1,224	-10,671	114	-614	-5,651	123
On Road Gap 0.10	-193	41%	748	-1,508	-13,016	68	-704	-6,458	90
On Road Gap 0.30	-182	39%	892	-1,393	-12,033	81	-652	-5,975	108
12 Month Payback Period	-210	46%	902	-1,666	-14,475	82	-783	-7,271	110
24 Month Payback Period	-203	43%	855	-1,576	-13,625	77	-748	-6,873	103

*** EO 12866 Review – Draft – Do Not Cite, Quote or Release During Review ***

36 Month Payback Period	-180	39%	764	-1,374	-11,863	69	-646	-5,917	92
Rebound Effect at 10%	-191	41%	947	-1,081	-9,533	86	-646	-5,917	92
Rebound Effect at 30%	-191	41%	674	-1,858	-15,878	61	-646	-5,917	92
Long Fleet Redesign Cadence	-173	42%	828	-1,382	-12,196	75	-624	-6,002	98
Short Fleet Redesign Cadence	-179	48%	628	-1,314	-11,578	57	-664	-6,278	77
Safety Coefficient at 5th Percentile	-191	41%	810	-1,470	-10,852	73	-693	-4,640	98
Safety Coefficient at 95th Percentile	-191	41%	810	-1,470	-14,553	73	-693	-8,076	98
Fatalities Flat Earlier	-191	41%	810	-1,470	-12,705	73	-693	-6,361	98
Fatalities Flat Later	-191	41%	810	-1,470	-12,705	73	-1,470	-12,705	73
High Social Cost of Carbon	-191	41%	810	-1,470	-12,705	73	-693	-6,361	98
Low Social Cost of Carbon	-191	41%	810	-1,470	-12,705	73	-693	-6,361	98
High HEV Battery Costs	-205	38%	791	-1,504	-13,026	72	-731	-6,716	96
Low HEV Battery Costs	-178	44%	831	-1,439	-12,409	75	-656	-6,020	100
Exclude Strong Hybrids	-185	46%	773	-1,431	-12,349	71	-691	-6,307	93
Include HCR2 Engines	-141	51%	623	-1,144	-9,918	56	-536	-4,951	74
Technology Cost Markup 1.10	-193	41%	781	-1,457	-12,598	71	-697	-6,401	95
Technology Cost Markup 1.19	-143	48%	698	-1,193	-10,304	63	-535	-4,940	85
Technology Cost Markup 1.24	-151	47%	723	-1,246	-10,760	65	-562	-5,180	87
Technology Cost Markup 1.37	-154	45%	716	-1,245	-10,753	65	-568	-5,224	86
Technology Cost Markup 1.75	-175	43%	803	-1,402	-12,135	73	-642	-5,926	97
Technology Cost Markup 2.00	-215	37%	838	-1,577	-13,671	76	-761	-7,012	101

*** EO 12866 Review – Draft – Do Not Cite, Quote or Release During Review ***

TABLE 12-6 - CUMULATIVE CHANGES IN FLEET SIZE, TRAVEL (VMT), FATALITIES, FUEL CONSUMPTION AND CO₂ EMISSIONS THROUGH MY 2029 UNDER PROPOSED CO₂ STANDARDS

Sensitivity Case	Fleet Size (m)	Share LT, CY 2040	CO ₂ (mmt)	VMT, Fatalities and Fuel Consumption with Rebound			VMT, Fatalities and Fuel Consumption without Rebound		
				VMT (b. mi.)	Fatalities	Fuel Cons. (b. gal.)	VMT (b. mi.)	Fatalities	Fuel Cons. (b. gal.)
Reference Case	-198	47%	667	-1,473	-12,903	60	-761	-7,095	83
Consumer Benefit at 50%	-198	47%	667	-1,473	-12,903	60	-761	-7,095	83
Consumer Benefit at 75%	-198	47%	667	-1,473	-12,903	60	-761	-7,095	83
Fleet Share and Sales Response Disabled	-202	33%	600	-1,500	-13,108	54	-841	-7,728	76
Disable Scrappage Price Effect	-56	148%	840	-929	-8,142	76	-220	-2,350	99
Disable Scrappage Price Effect and Fleet Share and Sales Response	-67	91%	768	-976	-8,521	69	-319	-3,153	91
High Oil Price	-175	45%	31	-1,297	-11,207	3	-710	-6,593	32
High Oil Price with 60 Month Payback	-98	40%	19	-707	-6,090	2	-386	-3,590	17
Low Oil Price	-188	46%	1,153	-1,264	-11,120	104	-674	-6,251	114
Low Oil Price with 12 Month Payback	-193	48%	1,210	-1,318	-11,557	109	-697	-6,442	120
High GDP	-198	46%	662	-1,471	-12,885	60	-762	-7,102	83
High GDP with High Oil Price	-174	45%	33	-1,295	-11,193	3	-706	-6,559	32
High GDP with Low Oil Price	-188	46%	1,144	-1,264	-11,115	103	-675	-6,266	113
Low GDP	-192	47%	649	-1,431	-12,534	59	-739	-6,887	81
Low GDP with High Oil Price	-170	46%	33	-1,263	-10,908	3	-687	-6,382	31
Low GDP with Low Oil Price	-183	46%	1,121	-1,235	-10,862	101	-660	-6,122	110
On Road Gap 0.10	-204	47%	637	-1,546	-13,527	57	-789	-7,361	79
On Road Gap 0.30	-185	44%	724	-1,370	-11,982	65	-702	-6,533	90
12 Month Payback Period	-224	52%	840	-1,758	-15,339	76	-877	-8,166	105
24 Month Payback Period	-204	48%	742	-1,564	-13,725	67	-786	-7,390	92

*** EO 12866 Review – Draft – Do Not Cite, Quote or Release During Review ***

36 Month Payback Period	-182	44%	597	-1,331	-11,661	54	-691	-6,441	75
Rebound Effect at 10%	-198	47%	796	-1,117	-9,999	72	-761	-7,095	83
Rebound Effect at 30%	-198	47%	539	-1,830	-15,807	49	-761	-7,095	83
Long Fleet Redesign Cadence	-181	49%	665	-1,368	-11,959	60	-697	-6,481	81
Short Fleet Redesign Cadence	-190	51%	673	-1,426	-12,383	61	-725	-6,675	83
Safety Coefficient at 5th Percentile	-198	47%	667	-1,473	-10,072	60	-761	-4,400	83
Safety Coefficient at 95th Percentile	-198	47%	667	-1,473	-15,726	60	-761	-9,781	83
Fatalities Flat Earlier	-198	47%	667	-1,473	-12,903	60	-761	-7,095	83
Fatalities Flat Later	-198	47%	667	-1,473	-12,903	60	-1,473	-12,903	60
High Social Cost of Carbon	-198	47%	667	-1,473	-12,903	60	-761	-7,095	83
Low Social Cost of Carbon	-198	47%	667	-1,473	-12,903	60	-761	-7,095	83
High HEV Battery Costs	-206	45%	653	-1,494	-13,088	59	-785	-7,311	82
Low HEV Battery Costs	-188	49%	671	-1,442	-12,647	60	-732	-6,863	83
Exclude Strong Hybrids	-173	50%	610	-1,334	-11,805	55	-684	-6,510	76
Include HCR2 Engines	-147	51%	495	-1,124	-9,935	45	-587	-5,569	61
Technology Cost Markup 1.10	-142	50%	521	-1,111	-9,640	47	-562	-5,174	65
Technology Cost Markup 1.19	-157	50%	587	-1,234	-10,728	53	-618	-5,711	73
Technology Cost Markup 1.24	-163	50%	599	-1,270	-11,051	54	-638	-5,899	75
Technology Cost Markup 1.37	-176	47%	659	-1,364	-11,919	59	-680	-6,345	82
Technology Cost Markup 1.75	-221	43%	701	-1,589	-13,949	63	-833	-7,792	88
Technology Cost Markup 2.00	-252	40%	738	-1,739	-15,293	67	-932	-8,716	93

*** EO 12866 Review – Draft – Do Not Cite, Quote or Release During Review ***

TABLE 12-7 - CHANGE IN TOTAL REGULATORY COSTS DURING MYS 2017-2029 UNDER PROPOSED CAFE AND CO₂ STANDARDS

Sensitivity Case	CAFE Standards		CO ₂ Standards	
	Total Regulatory Costs (\$b)	Percent Change from Reference Case	Total Regulatory Costs (\$b)	Percent Change from Reference Case
Reference Case	-322.2		-262.1	
Consumer Benefit at 50%	-322.2	0.0%	-262.1	0.0%
Consumer Benefit at 75%	-322.2	0.0%	-262.1	0.0%
Fleet Share and Sales Response Disabled	-301.0	-6.6%	-237.5	-9.4%
Disable Scrappage Price Effect	-322.2	0.0%	-262.1	0.0%
Disable Scrappage Price Effect and Fleet Share and Sales Response	-301.0	-6.6%	-237.5	-9.4%
High Oil Price	-258.9	-19.7%	-178.6	-31.8%
High Oil Price with 60 Month Payback	-190.1	-41.0%	-115.9	-55.8%
Low Oil Price	-354.4	10.0%	-302.8	15.6%
Low Oil Price with 12 Month Payback	-353.2	9.6%	-309.9	18.2%
High GDP	-322.5	0.1%	-262.3	0.1%
High GDP with High Oil Price	-259.0	-19.6%	-179.2	-31.6%
High GDP with Low Oil Price	-354.7	10.1%	-302.7	15.5%
Low GDP	-311.6	-3.3%	-250.8	-4.3%
Low GDP with High Oil Price	-250.1	-22.4%	-172.6	-34.1%
Low GDP with Low Oil Price	-341.9	6.1%	-292.6	11.7%
On Road Gap 0.10	-324.6	0.7%	-269.8	2.9%
On Road Gap 0.30	-316.1	-1.9%	-252.1	-3.8%
12 Month Payback Period	-330.8	2.7%	-289.7	10.6%
24 Month Payback Period	-327.7	1.7%	-273.3	4.3%
36 Month Payback Period	-313.5	-2.7%	-245.0	-6.5%
Rebound Effect at 10%	-322.2	0.0%	-262.1	0.0%
Rebound Effect at 30%	-322.2	0.0%	-262.1	0.0%
Long Fleet Redesign Cadence	-308.7	-4.2%	-251.4	-4.1%
Short Fleet Redesign Cadence	-258.6	-19.7%	-252.1	-3.8%
Safety Coefficient at 5th Percentile	-322.2	0.0%	-262.1	0.0%
Safety Coefficient at 95th Percentile	-322.2	0.0%	-262.1	0.0%
Fatalities Flat Earlier	-322.2	0.0%	-262.1	0.0%
Fatalities Flat Later	-322.2	0.0%	-262.1	0.0%
High Social Cost of Carbon	-322.2	0.0%	-262.1	0.0%
Low Social Cost of Carbon	-322.2	0.0%	-262.1	0.0%
High HEV Battery Costs	-357.0	10.8%	-279.2	6.5%
Low HEV Battery Costs	-287.3	-10.8%	-236.6	-9.7%
Exclude Strong Hybrids	-289.8	-10.1%	-203.5	-22.3%
Include HCR2 Engines	-210.9	-34.6%	-160.1	-38.9%
Fines at \$14 in 2019	-323.5	0.4%	n/a	n/a
Technology Cost Markup 1.10	-226.8	-29.6%	-168.4	-35.7%
Technology Cost Markup 1.19	-244.6	-24.1%	-193.9	-26.0%
Technology Cost Markup 1.24	-253.5	-21.3%	-202.7	-22.7%

*** EO 12866 Review – Draft – Do Not Cite, Quote or Release During Review ***

Technology Cost Markup 1.37	-292.2	-9.3%	-229.0	-12.6%
Technology Cost Markup 1.75	-380.3	18.0%	-310.5	18.5%
Technology Cost Markup 2.00	-434.1	34.7%	-370.1	41.2%

*** EO 12866 Review – Draft – Do Not Cite, Quote or Release During Review ***

TABLE 12-8 - INCREMENTAL COSTS AND BENEFITS – CUMULATIVE OVER USEFUL LIFE OF MYS 2017-2029 UNDER PROPOSED CAFE STANDARDS

Sensitivity Case	Social Costs	Total Costs	Private Benefits	Total Benefits	Net Benefits
Reference Case	-52.0	-540.9	-176.6	-326.2	214.6
Consumer Benefit at 50%	-52.0	-540.9	-176.6	-259.7	281.2
Consumer Benefit at 75%	-52.0	-540.9	-176.6	-293.0	247.9
Fleet Share and Sales Response Disabled	-56.4	-537.8	-164.6	-297.1	240.7
Disable Scrappage Price Effect	-33.4	-454.9	-177.1	-358.2	96.6
Disable Scrappage Price Effect and Fleet Share and Sales Response	-38.0	-452.5	-165.2	-329.1	123.4
High Oil Price	-55.6	-499.9	-278.4	-331.0	168.9
High Oil Price with 60 Month Payback	-33.8	-331.2	-177.3	-222.4	108.8
Low Oil Price	-43.2	-533.9	-121.0	-270.4	263.5
Low Oil Price with 12 Month Payback	-42.9	-536.4	-121.2	-270.0	266.4
High GDP	-52.0	-540.9	-176.0	-324.8	216.1
High GDP with High Oil Price	-55.6	-499.6	-277.3	-329.3	170.3
High GDP with Low Oil Price	-43.2	-534.0	-120.6	-269.3	264.8
Low GDP	-50.6	-524.7	-171.6	-317.0	207.7
Low GDP with High Oil Price	-54.0	-484.3	-271.0	-322.5	161.8
Low GDP with Low Oil Price	-42.2	-517.5	-117.5	-262.5	255.0
On Road Gap 0.10	-53.5	-550.1	-174.6	-312.2	237.9
On Road Gap 0.30	-49.4	-523.4	-178.6	-343.8	179.6
12 Month Payback Period	-59.0	-588.6	-200.1	-366.7	221.9
24 Month Payback Period	-55.7	-564.0	-187.8	-345.9	218.1
36 Month Payback Period	-48.5	-517.3	-165.8	-306.8	210.5
Rebound Effect at 10%	-37.0	-472.4	-100.3	-275.8	196.6
Rebound Effect at 30%	-67.0	-609.4	-266.2	-390.0	219.3
Long Fleet Redesign Cadence	-49.1	-545.3	-172.0	-323.6	221.7
Short Fleet Redesign Cadence	-44.8	-437.0	-144.6	-260.5	176.5
Safety Coefficient at 5th Percentile	-52.0	-510.6	-174.4	-324.1	186.5
Safety Coefficient at 95th Percentile	-52.0	-571.1	-178.8	-328.4	242.7
Fatalities Flat Earlier	-52.0	-540.9	-176.6	-326.2	214.6
Fatalities Flat Later	-52.0	-540.9	-69.6	-219.3	321.6
High Social Cost of Carbon	-52.0	-540.9	-176.6	-328.0	212.8
Low Social Cost of Carbon	-52.0	-540.9	-176.6	-322.7	218.2
High HEV Battery Costs	-53.1	-574.1	-175.5	-321.8	252.3
Low HEV Battery Costs	-51.1	-507.1	-177.8	-331.2	175.9
Exclude Strong Hybrids	-50.4	-499.6	-167.6	-307.3	192.3
Include HCR2 Engines	-40.3	-376.5	-135.5	-250.3	126.2
Fines at \$14 in 2019	-51.3	-531.3	-172.2	-316.8	214.5
Technology Cost Markup 1.10	-42.2	-416.7	-149.3	-277.6	139.1
Technology Cost Markup 1.19	-44.0	-439.3	-154.8	-287.8	151.5
Technology Cost Markup 1.24	-43.9	-446.4	-153.3	-285.0	161.4

*** EO 12866 Review – Draft – Do Not Cite, Quote or Release During Review ***

Technology Cost Markup 1.37	-49.7	-506.0	-172.4	-320.2	185.8
Technology Cost Markup 1.75	-55.7	-605.8	-185.3	-340.2	265.6
Technology Cost Markup 2.00	-58.5	-664.3	-191.1	-349.4	314.9

*** EO 12866 Review – Draft – Do Not Cite, Quote or Release During Review ***

TABLE 12-9 - INCREMENTAL COSTS AND BENEFITS – CUMULATIVE OVER USEFUL LIFE OF MYS 2017-2029 UNDER PROPOSED CO₂ STANDARDS

Sensitivity Case	Social Costs	Total Costs	Private Benefits	Total Benefits	Net Benefits
Reference Case	-50.7	-473.3	-160.1	-283.7	189.6
Consumer Benefit at 50%	-50.7	-473.3	-160.1	-228.5	244.8
Consumer Benefit at 75%	-50.7	-473.3	-160.1	-256.1	217.2
Fleet Share and Sales Response Disabled	-53.4	-459.7	-148.1	-259.0	200.7
Disable Scrappage Price Effect	-33.0	-391.5	-160.3	-313.8	77.7
Disable Scrappage Price Effect and Fleet Share and Sales Response	-36.1	-380.4	-148.4	-288.4	92.0
High Oil Price	-45.5	-373.3	-194.7	-210.2	163.1
High Oil Price with 60 Month Payback	-24.9	-223.0	-104.6	-114.3	108.7
Low Oil Price	-42.5	-470.6	-113.0	-245.8	224.9
Low Oil Price with 12 Month Payback	-44.3	-485.4	-119.0	-258.6	226.8
High GDP	-50.7	-473.4	-159.6	-282.5	190.9
High GDP with High Oil Price	-45.5	-374.4	-195.6	-211.4	163.0
High GDP with Low Oil Price	-42.5	-470.5	-112.6	-244.6	225.9
Low GDP	-49.2	-456.3	-155.3	-275.3	180.9
Low GDP with High Oil Price	-44.2	-362.1	-190.3	-206.0	156.1
Low GDP with Low Oil Price	-41.4	-456.6	-109.7	-238.5	218.2
On Road Gap 0.10	-53.4	-491.6	-162.4	-279.8	211.7
On Road Gap 0.30	-47.5	-448.6	-159.3	-294.6	154.1
12 Month Payback Period	-61.0	-549.6	-198.5	-353.6	196.0
24 Month Payback Period	-54.2	-500.2	-174.6	-311.8	188.3
36 Month Payback Period	-45.9	-434.5	-144.3	-255.4	179.1
Rebound Effect at 10%	-37.1	-411.2	-84.6	-232.5	178.7
Rebound Effect at 30%	-64.4	-535.4	-235.5	-335.0	200.4
Long Fleet Redesign Cadence	-47.4	-460.2	-150.4	-270.8	189.4
Short Fleet Redesign Cadence	-48.7	-457.1	-156.6	-280.2	176.8
Safety Coefficient at 5th Percentile	-50.7	-426.9	-157.9	-281.6	145.4
Safety Coefficient at 95th Percentile	-50.7	-519.6	-162.2	-285.9	233.7
Fatalities Flat Earlier	-50.7	-473.3	-160.1	-283.7	189.6
Fatalities Flat Later	-50.7	-473.3	-63.1	-186.8	286.5
High Social Cost of Carbon	-50.7	-473.3	-160.1	-285.2	188.1
Low Social Cost of Carbon	-50.7	-473.3	-160.1	-280.8	192.5
High HEV Battery Costs	-51.3	-489.4	-159.0	-280.2	209.3
Low HEV Battery Costs	-49.7	-448.8	-159.2	-283.6	165.2
Exclude Strong Hybrids	-46.0	-401.5	-144.9	-256.2	145.3
Include HCR2 Engines	-38.7	-329.6	-118.4	-210.1	119.5
Technology Cost Markup 1.10	-38.3	-338.8	-123.4	-219.7	119.1
Technology Cost Markup 1.19	-42.8	-381.4	-138.4	-247.1	134.2
Technology Cost Markup 1.24	-43.9	-393.6	-141.9	-252.6	141.0
Technology Cost Markup 1.37	-47.4	-429.9	-153.9	-276.3	153.6
Technology Cost Markup 1.75	-54.6	-529.6	-169.8	-299.8	229.8
Technology Cost Markup 2.00	-59.7	-603.1	-181.5	-318.7	284.4

*** EO 12866 Review – Draft – Do Not Cite, Quote or Release During Review ***

13 Flexibilities

The CAFE and CO₂ programs both offer a number of compliance flexibilities, discussed in more detail below. Some flexibilities are provided for by statute, and some have been implemented voluntarily through regulations. Compliance flexibilities have a great deal of theoretical attractiveness: if properly constructed, they can help to reduce overall regulatory costs while maintaining or improving programmatic benefits. If poorly constructed, then depending on what they are, they may create significant potential for market distortion (for instance, when manufacturers, in response to an incentive, produce vehicles for which there is no market, those vehicles must be discounted below their cost in order to sell).⁸²⁵ Use of compliance flexibilities, if not transparent, may also significantly complicate the public's ability to understand manufacturers' paths to compliance, and result in much greater expenditure of both private sector and government resources to track, account for, and manage. Moreover, to the extent that there is a market demand for vehicles with lower CO₂ emissions and higher fuel economy, compliance flexibilities may create competitive disadvantages for some manufacturers if they become overly reliant on them rather than simply improving their vehicles to meet that market demand. Conversely, rent seeking often leads manufacturers or other interest groups to push for particular flexibilities that coincide with manufacturers' existing product plans, to the disadvantage of other manufacturers who might be pursuing other paths. The beneficiaries of such flexibilities is often apparent from the nature of the request. In Preamble Section X, the NPRM identifies and seeks comment on a number of such flexibilities. Advocates for the increased general availability of flexibilities often attempt to justify the selection of an *apparently* higher stringency option at a lower cost, despite not *actually* improving fuel economy or reducing real-world CO₂ emissions compared to a lower stringency option with fewer flexibilities. Such approaches also result in rewarding automakers who invest in certain technological pathways, rather than being technology neutral and achieving less apparently stringent and more transparent standards.

We note that if standards are set at levels that are genuinely appropriate/maximum feasible, then the need for extensive compliance flexibilities should be low, if not absent. The NPRM discusses this concept further in Preamble Section X.

13.1 NHTSA Program Flexibilities

There are several compliance flexibilities that manufacturers can use to achieve compliance with CAFE standards beyond applying fuel economy-improving technologies. Some compliance flexibilities are statutorily mandated by Congress through EPCA and EISA, specifically program

⁸²⁵ Manufacturers are currently required by the state of California to produce certain percentages of their fleets with certain types of technologies, partly in order to help California meet self-imposed GHG reduction goals. While many manufacturers publicly discuss their commitment to these technologies, consumer interest in them thus far remains low despite often-large financial incentives from both manufacturers and the federal and state governments in the form of tax credits. The NPRM questions whether continuing to provide significant compliance incentives for technologies that consumers appear not to want is an efficient means to achieve either compliance or national goals (*see, e.g.*, Congress' phase-out of the AMFA dual-fueled vehicle incentive in EISA, 49 U.S.C. 32906).

credits, including the ability to carry-forward, carry-back, trade and transfer credits, and special fuel economy calculations for dual- and alternative-fueled vehicles (discussed in turn, below). However, 49 U.S.C. 32902(h) expressly prohibits NHTSA from considering the availability of statutorily-established credits (either for building dual- or alternative-fueled vehicles or from accumulated transfers or traders) in determining the level of the standards. Thus, NHTSA may not raise CAFE standards because manufacturers have enough of those credits to meet higher standards. This is an important difference from EPA’s authority under the CAA, which does not contain such a restriction, and which flexibility EPA has assumed in the past in determining appropriate levels of stringency for its program.

NHTSA also promulgated compliance flexibilities in response to EPA’s exercise of discretion under its EPCA authority to calculate fuel economy levels for individual vehicles and for fleets. These compliance flexibilities, which were first introduced in the 2012 rule for MYs 2017 and beyond, include air conditioning efficiency improvement and “off cycle” adjustments, and incentives for advanced technologies in full size pick-up trucks, including incentives for mild and strong hybrid electric full-size pickup trucks and performance-based incentives in full-size pickup trucks. As explained above, the NPRM seeks comment on all of these adjustments and incentives.

13.1.1 Program Credits and Credit Trading

Generating, trading, transfer, and applying CAFE credits is fundamentally governed by statutory mandates defined by Congress. As discussed above in Section X.B.1., program credits are generated when a vehicle manufacturer’s fleet over-complies with its determined standard for a given model year, meaning its vehicle fleet achieved a higher corporate average fuel economy value than the amount required by the CAFE program for that model year. Conversely, if the fleet average CAFE level does not meet the standard, the fleet would incur debits (also referred to as a shortfall). A manufacturer whose fleet generates credits in a given model year has several options for using those credits, including credit carry-back, credit carry-forward, credit transfers, and credit trading.

Credit “carry-back” means that manufacturers are able to use credits to offset a deficit that had accrued in a prior model year, while credit “carry-forward” means that manufacturers can bank credits and use them towards compliance in future model years. EPCA, as amended by EISA, requires NHTSA to allow manufacturers to carry back credits for up to three model years, and to carry forward credits for up to five model years.⁸²⁶ EPA also follows these same limitations under its GHG program.⁸²⁷

⁸²⁶ 49 U.S.C. 32903(a).

⁸²⁷ As part of its 2017-2025 GHG program final rulemaking, EPA did allow a one-time CO₂ carry-forward beyond 5 years, such that any credits generated from MYs 2010 through 2016 will be able to be used to comply with light duty vehicle GHG standards at any time through MY 2021.

*** EO 12866 Review – Draft – Do Not Cite, Quote or Release During Review ***

Credit “transfer” means the ability of manufacturers to move credits from their passenger car fleet to their light truck fleet, or vice versa. As part of the EISA amendments to EPCA, NHTSA was required to establish by regulation a CAFE credit transferring program, now codified at 49 CFR part 536, to allow a manufacturer to transfer credits between its car and truck fleets to achieve compliance with the standards. For example, credits earned by overcompliance with a manufacturer’s car fleet average standard could be used to offset debits incurred because of that manufacturer’s not meeting the truck fleet average standard in a given year. However, EISA imposed a cap on the amount by which a manufacturer could raise its CAFE standards through transferred credits: 1 mpg for MYs 2011-2013; 1.5 mpg for MYs 2014-2017; and 2 mpg for MYs 2018 and beyond.⁸²⁸ These statutory limits will continue to apply to the determination of compliance with the CAFE standards. EISA also prohibits the use of transferred credits to meet the minimum domestic passenger car fleet CAFE standard.⁸²⁹

In their 2016 petition for rulemaking, the Alliance of Automobile Manufacturers and Global Automakers (Alliance/Global or Petitioners) asked NHTSA to amend the definition of “transfer” as it pertains to compliance flexibilities.⁸³⁰ In particular, Alliance/Global requested that NHTSA add text to the definition of “transfer” stating that the statutory transfer cap in 49 U.S.C. 32903(g)(3) applies when the credits are transferred. Alliance/Global assert that adding this text to the definition is consistent with NHTSA’s prior position on this issue.

In the 2012-2016 final rule, NHTSA stated:

NHTSA interprets EISA not to prohibit the banking of transferred credits for use in later model years. Thus, NHTSA believes that the language of EISA may be read to allow manufacturers to transfer credits from one fleet that has an excess number of credits, within the limits specified, to another fleet that may also have excess credits instead of transferring only to a fleet that has a credit shortfall. This would mean that a manufacturer could transfer a certain number of credits each year and bank them, and then the credits could be carried forward or back ‘without limit’ later if and when a shortfall ever occurred in that same fleet.⁸³¹

Following that final rule, NHTSA clarified via interpretation that the transfer cap from EISA does not limit how many credits may be *transferred* in a given model year; but it does limit the *application* of transferred credits to a compliance category in a model year.⁸³² “Thus,

⁸²⁸ 49 U.S.C. 32903(g)(3).

⁸²⁹ 49 U.S.C. 32903(g)(4).

⁸³⁰ Auto Alliance and Global Automakers Petition for rulemaking on Corporate Average Fuel Economy (June 20, 2016) at 13.

⁸³¹ 75 FR 25666 (May 7, 2010).

⁸³² See, letter from O. Kevin Vincent, Chief Counsel, NHTSA to Tom Stricker, Toyota (July 5, 2011). Available online at <https://isearch.nhtsa.gov/files/10-004142%20--%20Toyota%20CAFE%20credit%20transfer%20banking%20--%205%20Jul%2011%20final%20for%20signature.htm> (last accessed April 18, 2018).

manufacturers may transfer as many credits into a compliance category as they wish, but transferred credits may not increase a manufacturer’s CAFE level beyond the statutory limits.”⁸³³

NHTSA believes the transfer caps in 49 U.S.C. 32903(g)(3) are still properly read to limit the application of credits in excess of those values. NHTSA understands that the language in the 2012-2016 final rule could be read to suggest that the transfer cap applies at the time credits are transferred. However, NHTSA believes its subsequent interpretation—that the transfer cap applies at the time the credits are used—is a more appropriate, plain language reading of the statute. While manufacturers have approached NHTSA with various interpretations that would allow them to circumvent the EISA transfer cap, NHTSA believes it is improper to ignore a transfer cap Congress clearly articulated. Therefore, NHTSA proposes to deny Alliance/Global’s petition to revise the definition of “transfer” in 49 CFR 536.3.

Credit “trading” means the ability of manufacturers to sell credits to, or purchase credits from, one another. EISA allowed NHTSA to establish by regulation a CAFE credit trading program, also now codified at 49 CFR Part 536, to allow credits to be traded between vehicle manufacturers. EISA also prohibits manufacturers from using traded credits to meet the minimum domestic passenger car CAFE standard.⁸³⁴

Under 49 CFR Part 536, credit holders (including, but not limited to manufacturers) have credit accounts with NHTSA where they can, as outlined above, hold credits, use them to achieve compliance with CAFE standards, transfer credits between compliance categories, or trade them. A credit may also be cancelled before its expiration date, if the credit holder so chooses. Traded and transferred credits are subject to an “adjustment factor” to ensure total oil savings are preserved, as required by EISA. EISA also prohibits credits earned before MY 2011 from being traded or transferred.

As discussed above, NHTSA is concerned with the potential for compliance flexibilities to have market-distorting unintended consequences. Given that the credit trading program is optional under EISA, we seek comment on whether the credit trading provisions in 49 CFR part 536 should cease to apply beginning in MY 2022.

13.1.1.1 Fuel Savings Adjustment Factor

Under NHTSA’s credit trading regulations, a fuel savings adjustment factor is applied when trading occurs between manufacturers, but not when a manufacturer carries credits forward or carries back credits within their own fleet. The Alliance/Global requested that NHTSA require manufacturers to apply the fuel savings adjustment factor when credits are carried forward or carried back within the same fleet, including for existing, unused credits.

⁸³³ *Id.*

⁸³⁴ 49 U.S.C. 32903(f)(2).

Per EISA, total oil savings must be preserved in NHTSA’s credit trading program.⁸³⁵ The provisions for credit transferring within a manufacturer’s fleet⁸³⁶ do not include the same requirement, however, NHTSA prescribed a fuel savings adjustment factor that applies to both credit trades between manufacturers and credit transfers between a manufacturer’s compliance fleets.⁸³⁷

When NHTSA initially considered the preservation of oil savings, the agency explained how one credit is not necessarily equal to another. For example, the fuel savings lost if the average fuel economy of a manufacturer falls one-tenth of an mpg below the level of a relatively low standard are greater than the average fuel savings gained by raising the average fuel economy of a manufacturer one-tenth of a mpg above the level of a relatively high CAFE standard.⁸³⁸ The effect of applying the adjustment factor is to increase the value of credits earned for exceeding a relatively low CAFE standard for credits that are intended to be applied to a compliance category with a relatively high CAFE standard, and to decrease the value of credits earned for exceeding a relatively high CAFE standard for credits that are intended to be applied to a compliance category with a relatively low CAFE standard.

Alliance/Global stated that while carry forward and carry back credits have been used for many years, the CAFE standards did not change during the Congressional CAFE freeze, meaning credits earned during those years were associated with the same amount of fuel savings from year to year.⁸³⁹ Alliance/Global suggest that because there is no longer a Congressional CAFE freeze, NHTSA should apply the adjustment factor when moving credits within a manufacturer’s fleet.

NHTSA has tentatively decided to deny Alliance/Global’s request to apply the fuel savings adjustment factor to credits that are carried forward or carried back within the same fleet, to the extent that the request would impact credits carried forward or backward retroactively within manufacturer’s compliance fleets (i.e., credits that were generated prior to MY 2021, when this rule takes effect). NHTSA has tentatively determined that applying the adjustment factor to credits earned in model years past would be inequitable. Manufacturers planned compliance strategies based, at least in part, on how credits could be carried forward and backward,

⁸³⁵ 49 U.S.C. 32903(f)(1).

⁸³⁶ 49 U.S.C. 32903(g).

⁸³⁷ See 49 CFR 536.5. See also 74 FR 14430 (Per NHTSA’s final rule for MY 2011 Average Fuel Economy Standards for Passenger Cars and Light Trucks, “There is no other clear expression of congressional intent in the text of the statute suggesting that NHTSA would have authority to adjust transferred credits, even in the interest of preserving oil savings. However, the goal of the CAFE program is energy conservation; ultimately, the U.S. would reap a greater benefit from ensuring that fuel oil savings are preserved for both trades and transfers. Furthermore, accounting for traded credits differently than for transferred credits does add unnecessary burden on program enforcement. Thus, NHTSA will adjust credits both when they are traded and when they are transferred so that no loss in fuel savings occurs.”).

⁸³⁸ 74 FR 14432.

⁸³⁹ Auto Alliance and Global Automakers Petition for rulemaking on Corporate Average Fuel Economy (June 20, 2016) at 10.

including the lack of an adjustment factor when credits are carried forward or backward within the same fleet. Thus, retroactively stating that manufacturers must apply the adjustment factor in this situation could disadvantage certain manufacturers, and result in windfalls for other manufacturers.

However, the NPRM seeks comment on whether the agency should apply the fuel savings adjustment factor to credits that are carried forward or carried back within the same fleet beginning with MY 2021.

13.1.1.2 VMT Estimates for Fuel Savings Adjustment Factor

NHTSA uses a vehicle miles traveled (VMT) estimate as part of its fuel savings adjustment equation to ensure that when traded or transferred credits are used, fuel economy credits are adjusted to ensure fuel oil savings is preserved.⁸⁴⁰ For model years 2017-2025, NHTSA finalized VMT values of 195,264 miles for passenger car credits, and 225,865 miles for light truck credits.⁸⁴¹ These VMT estimates harmonized with those used in EPA’s GHG program. For model years 2011-2016, NHTSA estimated different VMTs by model year.

Alliance/Global requested that NHTSA apply fixed VMT estimates to the fuel savings adjustment factor for MYs 2011-2016, similar to how NHTSA handles MYs 2017-2021. NHTSA rejected a similar request from the Alliance in the 2017 and later rulemaking, citing lack of scope, and expressing concern about the potential loss of fuel savings.⁸⁴²

Alliance/Global argue that data from MYs 2011-2016 demonstrate that no fuel savings would have been lost, as NHTSA had originally been concerned about. Alliance/Global assert that by not revising the MY 2012-2016 VMT estimates, credits earned during that timeframe were undervalued. Therefore, Alliance/Global argue that NHTSA should retroactively revise its VMT estimates to “reflect better the real world fuel economy results.”⁸⁴³

Such retroactive adjustments could unfairly penalize manufacturers for decisions they made based on the regulations as they existed at the time. As Alliance/Global acknowledge, adjusting vehicle miles travelled estimates would disproportionately affect manufacturers that have a credit deficit and were part of EPA’s temporary lead-time allowance alternative standards (TLAAS), which sunsets for model years 2021 and later. Given some manufacturers would be disproportionately harmed were we to accept Alliance/Global’s suggestion, NHTSA has tentatively decided to deny Alliance/Global’s request to retroactively change the agency’s VMT schedules for model years 2011-2016. Alliance/Global’s suggestion that a TLAAS manufacturer

⁸⁴⁰ See 49 CFR 536.4(c).

⁸⁴¹ 77 FR 63130 (October 15, 2012).

⁸⁴² *Id.*

⁸⁴³ Auto Alliance and Global Automakers Petition for rulemaking on Corporate Average Fuel Economy (June 20, 2016) at 11.

would be allowed to elect either approach does not change the fact that manufacturers in the TLAAS program made production decisions based on the regulations as understood at the time.

13.1.2 Special Fuel Economy Calculations for Dual and Alternative Fueled Vehicles

As discussed at length in prior rulemakings, EPCA, as amended by EISA, encouraged manufacturers to build alternative-fueled and dual- (or flexible-) fueled vehicles by providing special fuel economy calculations for “dedicated” (that is, 100%) alternative fueled vehicles and “dual-fueled” (that is, capable of running on either the alternative fuel or gasoline/diesel) vehicles.

Dedicated alternative fuel automobiles include electric, fuel cell, and compressed natural gas vehicles, among others. NHTSA’s provisions for dedicated alternative fuel vehicles in 49 U.S.C. 32905(a) state that the fuel economy of any dedicated automobile manufactured after 1992 shall be measured based on the fuel content of the alternative fuel used to operate the automobile. A gallon of liquid alternative fuel used to operate a dedicated automobile is deemed to contain .15 gallon of fuel. Under EPCA, for dedicated alternative fuel vehicles, there are no limits or phase-out for this special fuel economy calculation, unlike for dual-fueled vehicles, as discussed below.

EPCA’s statutory incentive for dual-fueled vehicles at 49 U.S.C. 32906 and the measurement methodology for dual-fueled vehicles at 49 U.S.C. 32905(b) and (d) expire in MY 2019, and therefore NHTSA had to examine the future of these provisions in the 2017 and later CAFE rulemaking.⁸⁴⁴ The analysis concluded that it would be inappropriate to measure dual-fueled vehicles’ fuel economy like that of conventional gasoline vehicles with no recognition of their alternative fuel capability, which would be contrary to the intent of EPCA/EISA. Accordingly, the agencies proposed that for MY 2020 and later vehicles, the general provisions authorizing EPA to establish testing and calculation procedures would provide discretion to set the CAFE calculation procedures for those vehicles.⁸⁴⁵ The methodology for EPA’s approach is outlined in the 2012 final rule for MYs 2017 and beyond at 77 FR 63128. The NPRM seeks comment on the current approach.

13.1.3 Incentives for Advanced Technologies in Full Size Pickup Trucks

In the 2012 final rule for MYs 2017 and beyond, EPA finalized criteria that would provide an adjustment to the fuel economy of a manufacturer’s full size pickup trucks if the manufacturer employed certain defined hybrid technologies for a significant quantity of those trucks.⁸⁴⁶ Additionally, EPA finalized an adjustment to the fuel economy of a manufacturer’s full sized pickup truck if it achieved a fuel economy performance level significantly above the CAFE target for its footprint.⁸⁴⁷ This performance-based incentive recognized that not all manufacturers

⁸⁴⁴ 77 FR 62651 (October 15, 2012).

⁸⁴⁵ 49 U.S.C. 32904(a), (c).

⁸⁴⁶ 77 FR 62651 (October 15, 2012).

⁸⁴⁷ *Id.*

may have wished to pursue hybridization, and aimed to reward manufacturers for applying fuel-saving technologies above and beyond what they might otherwise have done. EPA provided the incentive for its GHG program under its CAA authority, and for the CAFE program under its EPCA authority, similar to the A/C efficiency and off-cycle adjustment values described below.

EPA established limits on the vehicles eligible to qualify for these credits; a truck must meet minimum criteria for bed size and towing or payload capacity, and there are minimum sales thresholds (in terms of a percentage of a manufacturer's full-size pickup truck fleet) that a manufacturer must satisfy in order to qualify for the incentives. Additionally, the incentives phase out at different rates through 2025 – the mild hybrid incentive phases out in MY 2021, the strong hybrid incentive phases out in 2025, the 15% performance incentive (10 g/mi) credit phases out in MY 2021, and the 20% performance incentive (20 g/mi) credit is available for a maximum of five years between MYs 2017-2025, provided the vehicle's CO₂ emissions level does not increase.⁸⁴⁸

At the time of developing this proposal, no manufacturer has claimed these full-size pickup truck credits. Some vehicle manufacturers have announced potential collaborations, research projects, or possible future introduction these technologies for this segment.⁸⁴⁹ Additionally, similar to the incentive for hybridized pickup trucks, the agency is not aware of any vehicle manufacturers currently benefiting from the performance-based incentive. The NPRM seeks comment on whether to extend either the incentive for hybrid full size pickup trucks or the performance-based incentive past the dates that EPA specified in the 2012 final rule for MYs 2017 and beyond.

13.1.4 Air Conditioning Efficiency and Off-Cycle Adjustment Values

A/C efficiency and off-cycle fuel consumption improvement values (FCIVs) are compliance flexibilities made available under NHTSA's CAFE program through EPA's EPCA authority to calculate fuel economy levels for individual vehicles and for fleets. NHTSA modified its regulations in the 2012 final rule for MYs 2017 and beyond to reflect the fact that certain flexibilities, including A/C efficiency improving technologies and off-cycle technology fuel

⁸⁴⁸ 77 FR 62651-2 (October 15, 2012).

⁸⁴⁹ At the time of this proposal, there is awareness of some vehicle models that may qualify in future years should manufacturers choose to claim these credits. For example, the 2019 Ram 1500 introduces a mild hybrid "eTorque" system (Sam Abuelsamid, *2019 Ram 1500 Gets 48V Mild Hybrid On All Gas Engines*, FORBES (Jan. 15, 2019), <https://www.forbes.com/sites/samabuelsamid/2018/01/15/2019-ram-1500-gets-standard-48v-mild-hybrid-on-all-gas-engines/#2a0cc967e9e6>); Ford is expected to introduce a hybrid F-150 (Keith Naughton, *How Ford plans to market the gasoline-electric F-150*, Automotive News (November 30, 2017), <http://www.autonews.com/article/20171130/OEM05/171139990/ford-electric-f150-pickup-marketing>; and the Workhorse W-15 system includes both an electric battery pack and gasoline range extender (Workhorse W-15 Pickup, <http://workhorse.com/pickup/> (last accessed April 13, 2018)). .

consumption improvement values (FCIVs), may be used as part of the determination of a manufacturers' CAFE level.⁸⁵⁰

A/C is a virtually standard automotive accessory, with more than 95% of new cars and light trucks sold in the United States equipped with mobile air conditioning systems. A/C use places load on an engine, which results in additional fuel consumption; the high penetration rate of A/C systems throughout the light duty vehicle fleet means that they can significantly impact the total energy consumed, as well as GHG emissions resulting from refrigerant leakage.⁸⁵¹ A number of methods related to the A/C system components and their controls can be used to improve A/C system efficiencies.⁸⁵²

“Off-cycle” technologies are those that reduce vehicle fuel consumption and CO₂ emissions, but for which the fuel consumption reduction benefits are not recognized under the 2-cycle test procedure used to determine compliance with the fleet average standards. The CAFE city and highway test cycles, also commonly referred to together as the 2-cycle laboratory compliance tests (or 2-cycle tests), were developed in the early 1970s when few vehicles were equipped with A/C systems. The city test simulates city driving in the Los Angeles area at that time. The highway test simulates driving on secondary roads (not expressways). The cycles are effective in measuring improvements in most fuel economy improving technologies; however, they are unable to measure or underrepresent some fuel economy improving technologies because of limitations in the test cycles.

For example, air conditioning is turned off during 2-cycle testing. Any air conditioning system efficiency improvements that reduce load on the engine and improve fuel economy cannot be measured on the tests. Additionally, the city cycle includes less time at idle than today's real world driving, and the highway cycle is relatively low speed (average speed of 48 mph and peak speed of 60 mph). Other off-cycle technologies that improve fuel economy at idle, such as stop start, and those that improve fuel economy to the greatest extent at expressway speeds, such as

⁸⁵⁰ 77 FR 63130-34 (October 15, 2012). Instead of manufacturers gaining credits as done under the GHG program, a direct adjustment is made to the manufacturer's fuel economy fleet performance value.

⁸⁵¹ Notably, however, manufacturers cannot claim CAFE-related benefits for reducing A/C leakage or switching to an A/C refrigerant with a lower global warming potential, because while these improvements reduce GHGs consistent with the purpose of the CAA, they generally do not relate to fuel economy and thus are not relevant to the CAFE program.

⁸⁵² The approach for recognizing potential A/C efficiency gains is to utilize, in most cases, existing vehicle technology/componentry but improve the energy efficiency of the technology designs and operation. For example, most of the additional air conditioning-related load on an engine is because of the compressor, which pumps the refrigerant around the system loop. The less the compressor operates, the less load the compressor places on the engine resulting in less fuel consumption and CO₂ emissions. Thus, optimizing compressor operation with cabin demand using more sophisticated sensors, controls and control strategies, is one path to improving the efficiency of the A/C system. For further discussion of A/C efficiency technologies, see Section II.D of this NPRM and Chapter 5 of the accompanying PRIA.

active grille shutters which improve aerodynamics, receive less than their real-world benefits in the 2-cycle compliance tests.

Since EPA established its GHG program for light duty vehicles, NHTSA and EPA sought to harmonize their respective standards, despite separate statutory authorities limiting what the agencies could and could not consider. For example, for MYs 2012-2016, NHTSA was unable to consider improvements manufacturers made to passenger car A/C efficiency in calculating compliance.⁸⁵³ At that time, NHTSA stated that the agency’s statutory authority did not allow NHTSA to provide test procedure flexibilities that would account for A/C system and off-cycle fuel economy improvements.⁸⁵⁴ Thus, NHTSA calculated its standards in a way that allowed manufacturers to comply with the CAFE standards using 2-cycle procedures alone.

Of the two agencies, EPA was the first to establish an off-cycle technology program. For MYs 2012-2016, EPA allowed manufacturers to request off-cycle credits for “new and innovative technologies that achieve GHG reductions that are not reflected on current test procedures...”⁸⁵⁵ In the subsequent 2017 and beyond rulemaking, off-cycle technology was no longer required to be new and innovative, but rather only required to demonstrate improvements not reflected on test procedures.

At that time (starting with MY 2017), NHTSA considered off-cycle technologies and A/C efficiency improvements when assessing compliance with the CAFE program. Accounting for off-cycle technologies and A/C efficiency improvements in the CAFE program allowed manufacturers to design vehicles with improved fuel economy, even if the improvements would not show up on the two-cycle compliance test. In adding off-cycle and A/C efficiency improvements to NHTSA’s program, the agency was able to harmonize with EPA, which began accounting for these features in earlier GHG regulations.

13.1.4.1 Distinguishing “Credits” from Air Conditioning Efficiency and Off-Cycle Benefits

It is important to note some important differences between consideration given to A/C efficiency improvement and off-cycle technologies, and other flexibilities in the CAFE program. NHTSA accounts for A/C efficiency and off-cycle improvements through EPA test procedural changes that determine *fuel consumption improvement values*. While regarded by some as “credits” either as shorthand, or because there are many terms that overlap between NHTSA’s CAFE program and EPA’s GHG program, NHTSA’s CAFE program does not give manufacturers *credits* for implementing more efficient A/C systems, or introducing off-cycle technologies.⁸⁵⁶ That is,

⁸⁵³ 74 FR 49700 (September 28, 2009).

⁸⁵⁴ At that time, NHTSA stated “[m]odernizing the passenger car test procedures, or even providing similar credits, would not be possible under EPCA as currently written.” 75 FR 25557 (May 7, 2010).

⁸⁵⁵ 75 FR 25341 (May 7, 2010).

⁸⁵⁶ This is not to be confused with EPA’s parallel program, which refers to the GHG’s consideration of A/C improvements and off-cycle technologies as “credits.”

there is no bankable, tradable or transferrable credit earned by a manufacturer for implementing more efficient A/C systems or installing an off-cycle technology. In fact, the only credits provided for in NHTSA's CAFE program are those earned by overcompliance with a standard.⁸⁵⁷ What NHTSA does for off-cycle technologies and A/C efficiency improvements is adjust individual vehicle compliance values based on the fuel consumption improvement values of these technologies. As a result, a manufacturer's vehicle *as a whole* may exceed its fuel economy target, and be regarded as a credit-generating vehicle.

Illustrative of this confusion, in the 2016 Alliance/Global petition, the Petitioners asked NHTSA to avoid imposing unnecessary restrictions on the use of credits. Alliance/Global referenced language from an EPA report that stated compliance is assessed by measuring the tailpipe emissions of a manufacturer's vehicles, and then reducing vehicle compliance values depending on A/C efficiency improvements and off-cycle technologies.⁸⁵⁸ This language is consistent with NHTSA's statement in the 2017 and later final rule, in which explained how the agencies coordinate and apply off-cycle and A/C adjustments. "There will be separate improvement values for each type of credit, calculated separately for cars and for trucks. These improvement values are subtracted from the manufacturer's two-cycle-based fleet fuel consumption value to yield a final new fleet fuel consumption value, which would be inverted to determine a final fleet fuel CAFE value."⁸⁵⁹

Alliance/Global say because of this process, "technology credits earned in the current model year must be immediately applied toward any deficits in the current model year. This approach forces manufacturers to use their credits in a sub-optimal way, and can result in stranded credits."⁸⁶⁰ As explained in this section, NHTSA does not issue credits to manufacturers for improving A/C efficiency, nor does it issue credits for implementing off-cycle technologies. EPA does adjust fuel economy compliance values on a vehicle level for those vehicles that implement A/C efficiency improvements and off-cycle technologies.

NHTSA therefore proposes to deny Alliance/Global's request because what the petitioners⁸⁶¹ refer to as "technology credits" are actually fuel economy adjustment values applied to the fuel economy measurement of individual vehicles. Thus, these adjustments are not actually "credits," per the definition of a "credit" in EPCA/EISA and are not subject to the "carry forward" and "carry back" provisions in 49 U.S.C. 32903.

To alleviate confusion, and to ensure consistency in nomenclature, the NPRM is proposing to update language in its regulations to reflect that the use of the term "credits" to refer to A/C

⁸⁵⁷ 49 U.S.C. 32903.

⁸⁵⁸ *See*, Global/Alliance petition at P. 15.

⁸⁵⁹ 77 FR 62726 (October 15, 2012).

⁸⁶⁰ *Id.* at 16.

⁸⁶¹ The agencies also refer to A/C and off cycle technology adjustment values as "credits" sporadically throughout their regulations. The NPRM proposes to amend their respective regulatory texts to reflect these are adjustments and not actual credits that can be carried forward or back. For a further discussion, see above.

*** EO 12866 Review – Draft – Do Not Cite, Quote or Release During Review ***

efficiency and off-cycle technology adjustments – should actually be termed fuel consumption improvement values (FCIVs).

13.1.4.2 Petition Requests on A/C Efficiency and Off-Cycle Program Administration

As discussed above, NHTSA and EPA jointly administer the off-cycle program. The 2016 Alliance/Global petition requested that NHTSA and EPA make various adjustments to the off-cycle program; specifically, the petitioners requested that the agencies should:

- re-affirm that technologies meeting the stated definitions are entitled to the off-cycle credit at the values stated in the regulation;
- re-acknowledge that technologies shown to generate more emissions reductions than the pre-approved amount are entitled to additional credit;
- confirm that technologies not in the null vehicle set but which are demonstrated to provide emissions reductions benefits constitute off-cycle credits; and
- modify the off-cycle program to account for unanticipated delays in the approval process by providing that applications based on the 5-cycle methodology are to be deemed approved if not acted upon by the agencies within a specified timeframe (for instance 90 days), subject to any subsequent review of accuracy and good faith.

With respect to Alliance/Global’s request regarding off-cycle technologies that demonstrate emissions reductions greater than what is allowable from the menu, today’s preferred alternative retains this capability. As was the case for model years 2017-2021, a manufacturer is still eligible for a fuel consumption improvement value other than the default value provided for in the menu, provided the manufacturer demonstrates the fuel economy improvement.⁸⁶² This would include the two-tiered process for demonstrating the CO₂ reductions and fuel economy improvement.⁸⁶³

[Text forthcoming]

Alliance/Global’s requests to streamline aspects of the A/C efficiency and off-cycle programs in response to the issues outlined above have been considered. Among other things, the Alliance/Global requested providing for a default acceptance of petitions for off-cycle credits, provided that all required information has been provided, to accelerate the processing of off-cycle credit requests. While there is agreement that any continuation of the A/C efficiency and off-cycle program should incorporate programmatic improvements, there are significant concerns with the concept of accepting petition requests that do not address program issues like uncertainty in quantifying program benefits, or general program administration. The NPRM requests comment on these issues.

⁸⁶² 77 FR 62837 (October 15, 2012).

⁸⁶³ 40 CFR 86.1869-12.

Additionally, for a discussion of the considerations of inclusion of the off-cycle program in future CAFE and GHG standards, see Chapter 13.

13.1.4.3 Petition Requests on Including Air-Conditioning Efficiency Improvements in the CAFE Calculations for MYs 2010-2016

For model years 2012 through 2016, NHTSA was unable⁸⁶⁴ to consider improvements manufacturers made to passenger car A/C efficiency in calculating CAFE compliance.⁸⁶⁵ However, EPA did consider passenger car improvements to A/C efficiency for this timeframe. To allow manufacturers to build one fleet that complied with both EPA and NHTSA standards, NHTSA adjusted its standards to account for the differences borne out of A/C efficiency improvements. Specifically, the agencies converted EPA's g/mi standards to NHTSA mpg (CAFE) standards. Then, EPA then estimated the average amount of improvement manufacturers were expected to earn via improved A/C efficiency. From there, NHTSA took EPA's converted mpg standard and subtracted the average improvement attributable to improvement in A/C efficiency. NHTSA set its standard at this level to allow manufacturers to comply with both standards with similar levels of technology.⁸⁶⁶

In the Alliance/Global petition for rulemaking, the Petitioners requested that NHTSA and EPA revisit the average efficiency benefit calculated by EPA applicable to model years 2012 through 2016. The Alliance/Global argued that A/C efficiency improvements were not properly acknowledged in the CAFE program, and that manufacturers that exceeded the A/C efficiency improvements estimated by the agencies. The Petitioners request that EPA amend its regulations such that manufacturers would be entitled to additional A/C efficiency improvement benefits retroactively.

NHTSA has tentatively decided to retain the structure of the existing A/C efficiency program, and not extend it to model years 2010 through 2016. Likewise, EPA has tentatively decided not to modify its regulations to change the way A/C efficiency improvements are accounted for. The agencies believe this is appropriate as manufacturers decided what fuel economy-improving technologies to apply to vehicles based on the standards as finalized in 2010.⁸⁶⁷ This included deciding whether to apply traditional tailpipe technologies, or A/C efficiency improvements, or both. Granting A/C efficiency adjustments to manufacturers retroactively could result in arbitrarily varying levels of adjustments granted to manufacturers, similar to the Alliance/Global request regarding retroactive off-cycle adjustments. Thus, the agencies tentatively believe the

⁸⁶⁴ At that time, NHTSA stated “[m]odernizing the passenger car test procedures, or even providing similar credits, would not be possible under EPCA as currently written.” 75 FR 25557 (May 7, 2010).

⁸⁶⁵ 74 FR 49700 (September 28, 2009).

⁸⁶⁶ *Id.*

⁸⁶⁷ In the MY 2017 and beyond rulemaking, NHTSA reaffirmed its position it would not extend A/C efficiency improvement benefits to earlier model years. 77 FR 62720 (October 15, 2012).

existing A/C efficiency improvement structure for model years 2010 through 2016 should remain unchanged.

13.1.4.4 Petition Requests on Including Off-Cycle Improvements in the CAFE Calculations for MYs 2010-2016

As described above, NHTSA first allowed manufacturers to generate off-cycle technology fuel consumption improvement values equivalent to CO₂ off-cycle credits in MY 2017.⁸⁶⁸ In finalizing the rule covering MYs 2017 and beyond, NHTSA declined to retroactively extend its off-cycle program to apply to model years 2012 through 2016,⁸⁶⁹ explaining “NHTSA did not take [off-cycle credits] into account when adopting the CAFE standards for those model years. As such, extending the credit program to the CAFE program for those model years would not be appropriate.”⁸⁷⁰

The Alliance/Global petition for rulemaking asked NHTSA to reconsider calculating fuel economy for model years 2010 through 2016 to include off-cycle adjustments allowed under EPA’s program during that period. The Petitioners argued that NHTSA incorrectly stated the agency had taken off-cycle adjustments into consideration when setting standards for model years 2017 through 2025, but not for model years 2010-2016. The Alliance/Global also argued that because neither NHTSA nor EPA considered off-cycle adjustments in formulating the stringency of the 2012-2016 standards, NHTSA should retroactively grant manufacturers off-cycle adjustments for those model years as EPA did. Doing so, they say, would maintain consistency between the agencies’ programs.

Pursuant to the Alliance/Global request, NHTSA has reconsidered the idea of granting retroactive credits for model years 2010 through 2016. For the reasons that follow, NHTSA has tentatively decided that manufacturers should not be granted retroactive off-cycle adjustments for model years 2010 through 2016.

Of the two agencies, EPA was the first to establish an off-cycle technology program. For model years 2012 through 2016, EPA allowed manufacturers to request off-cycle credits for “new and innovative technologies that achieve GHG reductions that are not reflected on current test procedures...”⁸⁷¹ In the subsequent 2017 and beyond rulemaking, NHTSA joined EPA and included an off-cycle program for CAFE compliance.⁸⁷²

Commented [A42]: Incorrect.

⁸⁶⁸ 77 FR 62840 (October 15, 2012).

⁸⁶⁹ See *id.*; EPA decided to extend provisions from its MY 2017 and beyond off-cycle program to the 2012-2016 model years.

⁸⁷⁰ *Id.*

⁸⁷¹ 75 FR 25341 (May 7, 2010).

⁸⁷² From 2010 through 2012, neither NHTSA nor EPA had off-cycle technology programs. The agencies did not evaluate off-cycle benefits or contemplate the use of off-cycle technologies by manufacturers for those model years.

The Alliance/Global petition cites a statement in the 2012-2016 final rule as affirmation that NHTSA took off-cycle adjustments into account in formulating the 2012-2016 stringencies, and therefore should allow manufacturers earn off-cycle benefits in model years that have already passed. In particular, Alliance/Global point to a general statement where NHTSA, while discussing consideration of the effect of other motor vehicle standards of the Government on fuel economy, stated that that rulemaking resulted in consistent standards across the program.⁸⁷³ The Alliance/Global petition appears to take this statement as a blanket assertion that NHTSA’s consideration of all “relevant technologies” included off-cycle technologies. To the contrary, as quoted above, NHTSA explicitly stated it had not considered these off-cycle technologies.⁸⁷⁴

The fact that NHTSA had not taken off-cycle adjustments into consideration in setting its 2012-2016 standards makes granting this request inappropriate. Doing so would result in a question as to whether the 2012-2016 standards were maximum feasible under 49 U.S.C. 32902(b)(2)(B). If NHTSA had not considered industry’s ability to earn off-cycle adjustments—an incentive that allows manufacturers to utilize technologies other than those that were being modeled as part of NHTSA’s analysis—the agency could have concluded more stringent standards were maximum feasible. Additionally, granting off-cycle adjustments to manufacturers retroactively raises questions of equity. NHTSA issued its 2012-2016 standards without an off-cycle program, and manufacturers had no reason to suspect that NHTSA would allow the use off-cycle technologies to meet fuel economy standards. Therefore, manufacturers made fuel economy compliance decisions with the expectation that they would have to meet fuel economy standards using on-cycle technologies. Generating off-cycle adjustments retroactively would arbitrarily reward (and potentially disadvantage other) manufacturers for compliance decisions they made without the knowledge such technologies would be eligible for NHTSA’s off-cycle program. Thus, NHTSA has tentatively decided to deny Alliance/Global’s request for retroactive off-cycle adjustments.

It is worth noting that in the model years 2017 and later rulemaking, NHTSA and EPA did include off-cycle technologies in establishing the stringency of the standards. As Alliance/Global note, NHTSA and EPA limited their consideration to start-stop and active aerodynamic features, because of limited technical information on these technologies. At that time, the agencies stated they “have virtually no data on the cost, development time necessary, manufacturability, etc [sic] of these technologies. The agencies thus cannot project that some of these technologies are feasible within the 2017-2025 timeframe.”⁸⁷⁵

Therefore, NHTSA has tentatively concluded granting off-cycle credits to manufacturers for model years 2010 through 2012 is inappropriate.

⁸⁷³ *Id.*

⁸⁷⁴ Likewise, EPA stated it had not considered off-cycle technologies in finalizing the 2012-2016 rule. “Because these technologies are not nearly so well developed and understood, EPA is not prepared to consider them in assessing the stringency of the CO2 standards.” *Id.* at 25438.

⁸⁷⁵ Draft Joint Technical Support Document: Rulemaking for 2017-2025 Light-Duty Vehicle Greenhouse Gas Emission Standards and Corporate Average Fuel Economy Standards (November 2011). P. 5-57.

13.2 EPA Program Flexibilities

Commented [A43]: See comments on preamble.

[Additional text forthcoming]

The alternatives described above represent a range of stringencies from the proposed revised standards up to the “no action” alternative, where existing EPA standards would remain in place. EPA is requesting comment on a variety of “enhanced flexibilities” whereby EPA would make adjustments to current incentives and credits provisions and potentially add new flexibility opportunities to broaden the pathways manufacturers would have to meet standards. Such an approach would support the increased application of technologies that the automotive industry is developing and deploying that could potentially lead to further long-term emissions reductions and allow manufacturers to comply with standards while reducing costs. This could, for instance, be used to justify the selection of an *apparently* higher stringency option at a lower cost, despite not *actually* reducing real-world CO₂ emissions compared to a lower stringency option with fewer flexibilities. Such approaches would also result in rewarding automakers who invest in certain technological pathways, rather than being technology neutral and achieving less apparently stringent and more transparent standards.

Automakers and other stakeholders have expressed support for this type of approach. For example, Ford recently stated “[w]e support increasing clean car standards through 2025 and are not asking for a rollback. We want one set of standards nationally, along with additional flexibility to help us provide more affordable options for our customers.”⁸⁷⁶ Honda also recently stated their support for an approach that would retain the existing standards while extending the advanced technology multipliers for electrified vehicles, eliminate automakers’ responsibility for the impact of upstream emissions from the electric grid, and accommodate more off-cycle technologies.⁸⁷⁷

EPA has received input from automakers and other stakeholders, including suppliers and alternative fuels industries, supporting a variety of program flexibilities.⁸⁷⁸ EPA requests comments on the following and other flexibility concepts, including the scope of the flexibilities and the range of model years over which such provisions would be appropriate.

The concepts include but are not limited to:

Advanced Technology Incentives: The current EPA GHG program provides incentives for electric vehicles, fuel cell vehicles, plug-in hybrid vehicles, and natural gas vehicles. Currently,

⁸⁷⁶ “A Measure of Progress” By Bill Ford, Executive Chairman, Ford Motor Company, and Jim Hackett, President and CEO, Ford Motor Company, March 27, 2018, <https://medium.com/cityoftomorrow/a-measure-of-progress-bc34ad2b0ed>.

⁸⁷⁷ Honda Release “Our Perspective – Vehicle Greenhouse Gas and Fuel Economy Standards,” April 20, 2018, <http://news.honda.com/newsandviews/pov.aspx?id=10275-en>.

⁸⁷⁸ Memorandum to docket EPA-HQ-OAR-2018-0283 regarding meetings with the Alliance of Automobile Manufacturers on April 16, 2018 and Global Automakers on April 17, 2018.

*** EO 12866 Review – Draft – Do Not Cite, Quote or Release During Review ***

manufacturers are able to use a 0 g/mile emissions factor for all electric powered vehicles rather than having to account for the GHG emissions associated with upstream electricity generation up to a per-manufacturer cumulative production cap for MYs 2022-2025. The program also includes multiplier incentives that allow manufacturers to count advanced technology vehicles as more than one vehicle in the compliance calculations. The current multipliers begin with MY2017 and end after MY2021.⁸⁷⁹ Stakeholders have suggested that these incentives should be expanded to further support the production of advanced technologies by allowing manufacturers to continue to use the 0 g/mile emissions factor for electric powered vehicles rather than having to account for upstream electricity generation emissions and by extending and potentially increasing the multiplier incentives. EPA is considering a range of incentives to further encourage advanced technology vehicles. Examples of possible incentives and an estimate of their impact on the stringency of the standards is provided below. Global Automakers recently recommended a multiplier of 3.5 for EVs and fuel cell vehicles which falls within the range of the examples provided below.⁸⁸⁰ EPA requests comments on extending or increasing advanced technology incentives including the use of 0 g/mile emissions factor for electric powered vehicles and multiplier incentives, including multipliers in the range of 2 - 4.5.

Hybrid Incentives: The current program includes incentives for automakers to use strong and mild hybrids (or technologies that provide similar emissions benefits) in full size pick-up truck vehicles, provided the manufacturer meets specified production thresholds. Currently, the strong hybrid per vehicle credit is 20 g/mile, available through MY 2025, and the technology must be used on at least 10% of a company's full-size pickups to receive the credit for the model year. The program also includes a credit for mild hybrids of 10 g/mi during MYs 2017–2021. To be eligible a manufacturer would have to show that the mild hybrid technology is utilized in a specified portion of its truck fleet beginning with at least 20% of a company's full-size pickup production in MY 2017 and ramping up to at least 80% in MY 2021.

EPA received input from automakers that these incentives should be extended and available to all light-duty trucks (e.g., cross-over vehicles, minivans, sport utility vehicles, smaller-sized pick-ups) and not only full size pick-up trucks. Automakers also recommended that the program's production thresholds should be removed because they discourage the application of technology, since manufacturers cannot be confident of achieving the sales thresholds. Some stakeholders have also suggested an additional credit for strong and mild hybrid passenger cars. The NPRM seeks comment on whether these incentives should be expanded along the lines suggested by stakeholders. For example, Global Automakers recommends a 20 g/mile credit for strong hybrid light trucks and a 10 g/mile credit for strong hybrid passenger cars. These

⁸⁷⁹ The current multipliers are for EV/FCVs: 2017–2019—2.0, 2020—1.75, 2021—1.5; for PHEVs and dedicated and dual fuel CNG vehicles: 2017–2019—1.6, 2020—1.45, 2021—1.3.

⁸⁸⁰ Memorandum to docket EPA-HQ-OAR-2018-0283 regarding meetings with the Alliance of Automobile Manufacturers on April 16, 2018 and Global Automakers on April 17, 2018.

incentives could lead to additional product offerings of strong hybrids, and technologies that offer similar emissions reductions, which could enable manufacturers to achieve additional long-term GHG emissions reductions.

Off-cycle Emission Credits: Starting with MY2008, EPA started employing a “five-cycle” test methodology to measure fuel economy for the fuel economy label.⁸⁸¹ However, for GHG and CAFE compliance, EPA continues to use the established “two-cycle” (city and highway test cycles, also known as the FTP and HFET) test methodology. As learned through development of the “five-cycle” methodology and prior rulemakings, there are technologies that provide real-world GHG emissions and fuel consumption improvements, but those improvements are not fully reflected on the “two-cycle” test. EPA established the off-cycle credit program to provide an incentive for technologies that achieve CO₂ reductions but normally would not be chosen as a GHG control strategy, as their GHG benefits are not measured on the specified 2-cycle test. Automakers as well as auto suppliers have recommended several changes to the current off-cycle credits program to help it achieve that goal.⁸⁸² Automakers and suppliers have suggested changes including:

- Streamlining the program in ways that would give auto manufacturers more certainty and make it easier for manufacturers to earn credits;
- Expanding the current pre-defined off-cycle credit menu to include additional technologies and increasing credit levels where appropriate;
- Eliminating or increasing the credit cap on the pre- defined list of off-cycle technologies and revising the thermal technology credit cap; and
- A role for suppliers to seek approval of their technologies.

Under EPA’s existing regulations, there are three pathways by which a manufacturer may accrue off-cycle technology credits. The first is a predetermined list or “menu” of credit values for specific off-cycle technologies that may be used beginning for model year 2014.⁸⁸³ This pathway allows manufacturers to use conservative credit values established by EPA for a wide range of off-cycle technologies, with minimal data submittal or testing requirements. In cases where additional laboratory testing can demonstrate emission benefits, a second pathway allows manufacturers to use 5-cycle testing to demonstrate and justify off-cycle CO₂ credits.⁸⁸⁴ The additional emission tests allow emission benefits to be demonstrated over some elements of real-world driving not captured by the GHG compliance tests, including high speeds, rapid

⁸⁸¹ <https://www.epa.gov/vehicle-and-fuel-emissions-testing/dynamometer-drive-schedules>

⁸⁸² “Petition for Direct Final Rule with Regard to Various Aspects of the Corporate Average Fuel Economy Program and the Greenhouse Gas Program,” Auto Alliance and Global Automakers, June 20, 2016.

⁸⁸³ See 40 CFR 86.1869-12(b).

⁸⁸⁴ See 40 CFR 86.1869-12(c).

accelerations, and cold temperatures. Under this pathway, manufacturers submit test data to EPA and EPA decides whether to approve the off-cycle credits without soliciting public comment on the data. The third and last pathway allows manufacturers to seek EPA approval, through a notice and comment process, to use an alternative methodology other than the menu of 5-cycle methodology for determining the off-cycle technology CO₂ credits.⁸⁸⁵

The NPRM requests comments on changes to the off-cycle process that would streamline the program. Currently, under the third pathway, manufacturers submit an application that includes their methodology to be used to determine the off-cycle credit value and data that then undergoes a public review and comment process prior to an EPA decision regarding the application. Each manufacturer separately submits an application to EPA that must go through a public review and comment process even if the manufacturer uses a methodology previously approved by EPA. For example, under the current program, multiple manufacturers have submitted applications for high efficiency alternators and advanced air conditioning compressors using very similar methodologies and producing similar levels of credits.

The NPRM requests comment on revising the regulations to allow all auto manufacturers to make use of a methodology once it has been approved by EPA without the subsequent applications from other manufacturers undergoing the public review process. This would reduce redundancy present in the current program. Manufacturers would need to provide EPA with at least the same level of data and detail for the technology and methodology as the firm that went through the public comment process.

The NPRM also requests comment on revising the regulations to allow EPA to in effect add technologies to the pre-approved credit menu without going through a subsequent rulemaking. For example, if one or more manufacturers submit applications with sufficient supporting data for the same or similar technology, the data from that application(s) could potentially be used by EPA as the basis for adding technologies to the menu. The NPRM is requesting comment on revising the regulations to allow EPA to establish through a decision document a credit value, or scalable value as appropriate, and technology definitions or other criteria to be used for determining whether a technology qualifies for the new menu credit. This streamlined process of adding a technology to the menu would involve an opportunity for public review but not a formal rulemaking to revise the regulations, allowing EPA to add technologies to the menu in a timely manner, where EPA believes that sufficient data exists to estimate an appropriate credit level for that technology across the fleet. In this process, EPA could issue a decision document, after considering public comments, making the new menu credits available to all manufacturers (effectively adding the technology to the menu without changing the regulations each time). By adding technologies to the menu, EPA would eliminate the need for manufacturers to

⁸⁸⁵ See 40 CFR 86.1869-12(d).

subsequently submit individual applications for the technologies after the first application was approved.

In addition, the NPRM requests comments on modifying the menu through this current rulemaking to add technologies. As noted above, EPA has received data from multiple manufacturers on high efficiency alternators and advanced air conditioning compressors that could serve as the basis for new menu credits for these technologies.⁸⁸⁶ The NPRM requests comments on adding these technologies to the menu including comments on credit level and appropriate definitions.⁸⁸⁷ The NPRM also requests comments on other off-cycle technologies that EPA could consider adding to the menu including supporting data that could serve as the basis for the credit.

In 2014, EPA approved additional credits for Mercedes-Benz⁸⁸⁸ stop-start system through the off-cycle credit process based on data submitted by Mercedes on fleet idle time and its system's real-world effectiveness (i.e., how much of the time the system turns off the engine when the vehicle is stopped). Multiple auto manufacturers have requested that EPA revise the table menu value for stop-start technology based solely on one input value EPA considered, idle time, in the context of the Mercedes stop-start system, but no firms have provided additional data on any of the other factors which go into the consideration of a conservative value for stop-start systems. Systems vary significantly in hardware, design, and calibration, leading to wide variations in how much of the idle time the engine is actually turned off. EPA has learned that some stop-start systems may be less effective in the real world than the agency estimated in its 2012 rulemaking analysis, for example, due to systems having a disable switch available to the driver, or stop-start systems be disabled under certain temperature conditions or auxiliary loads, which would offset the benefits of the higher idle time estimates. The NPRM requests additional data from the OEMs, suppliers, and other stakeholders regarding a comprehensive update to the stop-start off-cycle credit table value.

The menu currently includes a fleetwide cap on credits of 10 g/mile⁸⁸⁹ to address the uncertainty surrounding the data and analysis used as the basis of the menu credits. Some stakeholders have expressed concern that the current cap may constrain manufacturers ability in the future to fully utilize the menu especially if the menu is expanded to include additional technologies, as described above. For example, Global Automakers suggested that the cap be raised from 10 g/mi to 15 g/mi. The NPRM requests comments on increasing the current cap, for example from the current 10 g/mile to 15 g/mile to accommodate increased use of the menu. The NPRM also requests comment on a concept that would replace the current menu cap with an individual

⁸⁸⁶ <https://www.epa.gov/vehicle-and-engine-certification/compliance-information-light-duty-greenhouse-gas-ghg-standards>

⁸⁸⁷ See EPA Memorandum to Docket EPA-HQ-OAR-2018-0283 "Potential Off-cycle Menu Credit Levels and Definitions for High Efficiency Alternators and Advanced Air Conditioning Compressors."

⁸⁸⁸ "EPA Decision Document: Mercedes-Benz Off-cycle Credits for MY2 2012-2016," EPA-420-R-14-025, September 2014.

⁸⁸⁹ 40 CFR 86.1869–12(b)(2).

*** EO 12866 Review – Draft – Do Not Cite, Quote or Release During Review ***

manufacturer cap that scales with the manufacturer's average fleetwide target levels. The cap would be based on a percentage of the manufacturer's fleetwide 2-cycle emissions performance, for example at 5-10% of CO₂ a manufacturer's emissions fleet wide target. With a cap of 5%, for a manufacturer with a 2-cycle fleetwide average CO₂ level of 200 g/mile, for example, the cap would be 10 g/mile. EPA believes this may be a reasonable and more technically correct approach for the caps, recognizing that in many cases the emissions benefits of off-cycle technologies correlate with the CO₂ levels of the vehicles, providing more or less emissions reductions depending on the CO₂ levels of the vehicles in the fleet. For example, applying stop-start to vehicles with higher vehicle idle CO₂ levels provide more emissions reductions than when applied to vehicles with lower idle emissions. This approach also would help account for the uncertainty associated with the menu credits and help ensure that off-cycle menu credits do not become an overwhelming portion of the manufacturers overall emissions reduction strategy.

The current GHG rule contains a CO₂ credit program for improvements to the efficiency of the air conditioning system on light-duty vehicles (see §86.1868-12). The total of A/C efficiency credits is calculated by summing the individual credit values for each efficiency improving technology used on a vehicle as specified in the air conditioning credit menu. The total credit sum for each vehicle is capped at 5.0 grams/mile for cars and 7.2 grams/mile for trucks. Additionally, the off-cycle credit program (see §86.1869-12) contains credit earning opportunities for technologies that reduce the thermal loads on the vehicle from environmental conditions (solar loads, parked interior ambient air temperature). These menu-based thermal control credits have separate cap limits under the off-cycle program of 3.0 grams/mile for cars and 4.3 grams/mile for trucks. The AC efficiency technologies and the thermal control technologies directly interact with each other because improved thermal control results in reduced air conditioning loads of the more efficient air conditioning technologies. Because of this interaction, an approach that would remove the thermal control credit program from the off-cycle credit program and combine them with the AC efficiency program would seem appropriate to quantify the combined impact. Additionally, a cap that reflects this combination of these two related programs may also be appropriate. For example, if combined, the credit cap for thermal controls and air conditioning efficiency could be the combined value of the current individual program caps of 8.0 grams/mile for cars and 11.5 grams/mile for trucks. This combined A/C efficiency and thermal controls cap would also apply to any additional thermal control or air conditioning efficiency technology credit generated through other off-cycle credit pathways. Also, by removing the thermal credits from the off-cycle menu, they would no longer be counted against the menu cap discussed above, representing a way to provide more room under the menu cap for other off-cycle technologies. The NPRM seeks comment on this approach and the appropriateness of the described per vehicle cap limits above.

As mentioned above, EPA has heard from many suppliers and their trade associations an interest in allowing suppliers to have a role in seeking off-cycle credits for their technologies. The NPRM requests comment on providing a pathway for suppliers, along with at least one auto

*** EO 12866 Review – Draft – Do Not Cite, Quote or Release During Review ***

OEM partner, to submit off-cycle applications for EPA approval. Auto manufacturers would remain entirely responsible for the full useful life emissions performance of the off-cycle technology as is currently the case, including, for example, existing responsibilities for defect reporting and the prohibition on defeat devices. Under such an approach, an application submitted by a supplier and vehicle manufacturer would establish a credit and/or methodology for demonstrating credits that all auto manufacturers could then use in their subsequent applications. This process could include full-vehicle simulation modeling that is compatible with EPA's ALPHA simulation tool. The NPRM requests comment on requiring that the supplier be partnered in a substantive way with one or more auto manufacturers to ensure that there is a practical interest in the technology prior to investing resources in the approval process. The supplier application would be subject to public review and comment prior to an EPA decision. However, once approved, the subsequent auto manufacturer applications requesting credits based on the supplier methodology would not be subject to public review. The NPRM also requests comments on a concept where supplier (with at least one auto manufacturer partner) demonstrated credits would be available provisionally for a limited period of time, allowing manufacturers to implement the technology and collect data on their vehicles in order to support a continuation of credits for the technology in the longer term. Also, the provisional credits could be included under the menu credit cap since they would be based on a general analysis of the technology rather than manufacturer-specific data. The NPRM requests comments on all aspects of this approach.

Incentives for Connected or Autonomous Vehicles: Connected and autonomous vehicles have the potential to significantly impact vehicle emissions in the future, with their aggregate impact being either positive or negative, depending on a large number of vehicle-specific and system-wide factors. Currently, connected or autonomous vehicles would be eligible for credits under the off-cycle program if a manufacturer provides data sufficient to demonstrate the real-world emissions benefits of such technology. However, demonstrating the incremental real-world benefits of these emerging technologies will be challenging. Stakeholders have suggested that EPA should consider an incentive for these technologies, without requiring individual manufacturers to demonstrate real world emissions benefits of the technologies. EPA believes that any near-term incentive program should include some demonstration that the technologies will be both truly new and have some connection to overall environmental benefits. The NPRM requests comment on such incentives as a way to facilitate increased use of these technologies, including some level of assurance that they will lead to future additional emissions reductions.

Among the possible approaches, the most basic credits could be awarded to manufacturers that produce vehicles with connected or automated technologies. For connected vehicles, a set amount of credit could be provided for each vehicle capable of Vehicle to Vehicle (V2V) or Vehicle to Infrastructure (V2I) communications. One possible example is to provide a set amount of credit, using the off-cycle menu, for any vehicle that can communicate basic safety messages (as outlined in SAE J2735) to other vehicles. The credits provided would be an

*** EO 12866 Review – Draft – Do Not Cite, Quote or Release During Review ***

incentive to enable future transportation system efficiencies, as these technologies on an individual vehicle are unlikely to impact emissions in any meaningful way. However, if these technologies are dispersed widely across the fleet they could, under some circumstances, lead to future emission reductions, and an incentive available to manufacturers now could help facilitate that transformation.

The rationale for providing credits for vehicle automation is similar to that for connected vehicles. EPA could provide a set credit for vehicles that achieve some specific threshold of automation, perhaps based on the industry standard SAE definitions (SAE J3016). Individual autonomous vehicles might achieve some emissions reductions, but the impact may increase as larger numbers of autonomous vehicles are on the road and can coordinate and provide system efficiencies. Providing credits for autonomous vehicles, again through a set credit, would provide manufacturers a clear incentive to bring these technologies to market. It would be important for any such program to incentivize only those approaches that could reasonably be expected to provide additional contributions to overall emission reductions, taking system effects into account. As above, EPA believes that any near-term incentive program should include some demonstration that the technologies are truly new and have some connection to environmental benefits overall.

A number of stakeholders have also requested that EPA consider credits for automated and connected vehicles that are placed in ridesharing or other high mileage applications, where any potential environmental benefits could be multiplied due to the high utilization of these vehicles. That is, credits could take into account that the per-mile emission reduction benefits would accrue across a larger number of miles for shared-use vehicles. There are likely many possible approaches that could accomplish this objective. As one example, a manufacturer who owns or partners with a shared-use mobility entity could receive credit for ensuring that their autonomous vehicles are used throughout the life of the vehicle in shared-use fleets rather than as personally owned vehicles. Such credits would be based off of the assumption that total vehicle miles travelled would be higher and, therefore, generate more emission reduction benefits, under the former case. Credits could be based off of the CO₂ emissions reduction of the autonomous fleet, taking into account the higher VMT of the shared-use fleet, relative to the average.

As suggested by this partial list of examples, a variety of approaches would be possible to incentivize the use of these technologies. The NPRM seeks comment on these and related approaches to incentivize autonomous and connected vehicle technologies where they would have the most beneficial effect on future emissions.

Credit Carry-forward: Currently, CO₂ credits may be carried forward, or banked, for 5 years, with the exception that MY 2010-2015 credits may be carried forward and used through MY 2021. Automakers have suggested a variety of ways in which GHG credit life could be extended under the Clean Air Act, including the ability for automakers to carry-forward MY2010 and later banked credits out to MY2025, extending the life of credits beyond 5 years, or even unlimited

credit life where credits would not expire. EPA believes longer credit life would provide manufacturers with additional flexibility to further integrate banked credits into their product plans, potentially reducing costs. The NPRM requests comments on extending credit carry-forward beyond the current five years, including unlimited credit life.

Natural Gas Vehicle Credits: Vehicles that are able to run on compressed natural gas (CNG) currently are eligible for an advanced technology multiplier credit for MYs 2017-2021. Dual-fueled natural gas vehicles, which can run either on natural gas or on gasoline, are also eligible for an advanced technology multiplier credit if the vehicles meet minimum CNG range requirements. EPA received input from several industry stakeholders who supported expanding these incentives to further incentivize vehicles capable of operating on natural gas, including treating incentives for natural gas vehicles on par with those for electric vehicles and other advanced technologies, and adjusting or removing the minimum range requirements for dual-fueled CNG vehicles. The NPRM requests comments on these potential additional incentives for natural gas fueled vehicles.

High Octane Blends: EPA received input from renewable fuel industry stakeholders and from the automotive industry supporting high octane blends as a way to enable GHG reducing technologies such as higher compression ratio engines. Stakeholders suggested that mid-level (e.g., E30) high octane ethanol blends should be considered and that EPA should consider requiring that mid-level blends be made available at service stations. Higher octane gasoline could provide manufacturers with more flexibility to meet more stringent standards by enabling opportunities for use of lower CO₂ emitting technologies (e.g., higher compression ratio engines, improved turbocharging, optimized engine combustion). The NPRM requests comment on if and how EPA could support the production and use of higher octane gasoline consistent with Title II of the Clean Air Act.

To illustrate how additional flexibilities would translate to a reduction in the stringency of the standards, EPA analyzed several examples as described below.⁸⁹⁰ The example flexibilities EPA selected for this analysis are 1) removing the requirement to account for upstream emissions associated with electricity use (i.e., extending the 0 g/mile emissions factor), 2) a range of higher multipliers for electric vehicles, and 3) additional credits for hybrids sold in the light-truck fleet. EPA estimated what each additional flexibility could contribute to estimate an equivalent percent per year CO₂ standard reduction it would represent on a fleetwide basis. The examples and results are provided in the table below for several example technology sales penetration values (3 and 6 percent for battery electric vehicles, 10 and 20 percent for mild hybrid light-trucks, 5 and 10 percent for strong hybrid light-trucks). These examples were chosen to provide a sense of the relationship between the additional flexibility and program stringency. For each example scenario, EPA made a number of assumptions regarding the fleet penetration of the technology, car/truck mix, and others, which are documented in the docket. Additional flexibilities could be

⁸⁹⁰ Cite docket memo.

*** EO 12866 Review – Draft – Do Not Cite, Quote or Release During Review ***

structured to provide a level of overall stringency equivalent to the full range of the Alternatives. The NPRM is requesting comment on in this proposal, from the proposed standards through more stringent alternatives described above in this section, including the “No Action” alternative.

TABLE 13-1 - EFFECT OF DIFFERENT EXAMPLE FLEXIBILITIES IN REDUCING PROGRAM STRINGENCY COMPARED TO THE CURRENT EPA STANDARDS (WHICH AVERAGE 4.7% PER YEAR STRINGENCY INCREASE FROM MY2020-2025)

Description of Flexibility	Equivalent fleetwide percent per year reduction in stringency provided by the flexibility
0 g/mile emissions factor for electricity	
@ 3 percent new electric vehicle sales	0.2%
@ 6 percent BEV new vehicle sales	0.4%
Multiplier of 2x for electric vehicles	
@ 3 percent BEV new vehicle sales	0.5%
@ 6 percent BEV new vehicle sales	0.9%
Multiplier of 4.5x for electric vehicles	
@ 3 percent BEV new vehicle sales	1.6%
@ 6 percent BEV new vehicle sales	3.2%
For all light trucks, 10 g/mile credit for mild hybrid and 20 g/mile for strong hybrid	
@ 10 percent mild & 5 percent strong hybrid penetration	0.1%
@ 20 percent mild & 10 percent strong hybrid penetration	0.2%
Combined effect of above flexibilities*	0.7% to 3.8%

(*) Note: Low end of combined effects includes 0 g/mi, 3 percent BEVs, 2x BEV multiplier, 10 percent mild hybrid light-truck penetration, and 5 percent strong hybrid light-truck penetration. High end of combined effects range includes 0 g/mi, 6 percent BEVs, 4.5x BEV multiplier, 20 percent mild hybrid light-truck penetration, and 10 percent strong hybrid light-truck penetration.

Table 13-2 shows three examples of scenarios for how enhanced flexibilities could impact overall program stringency. Example A reduces the stringency of the EPA CO₂ standard from 4.7% per year to 4.0% per year. Example C, which includes the maximum incentive flexibilities shown in Table XX, significantly reduces the EPA CO₂ program stringency from 4.7% per year to 0.8% per year. Increasing the BEV multipliers or hybrid credits beyond those listed in Table 13-1 by EPA would have the effect of further reducing the stringency of the standards. The NPRM requests comment on the potential use of enhanced program flexibilities as an alternative approach to establishing the appropriate CO₂ standards for MY2021-2025.

The NPRM solicits comment on the individual options for flexibilities, and on the potential for combining them as described in these example scenarios. For example, the NPRM solicits comments on how to take these flexibilities into account in considering the level of the standards and whether, for a given level of overall stringency, the factors discussed in section xx, EPA Justification for the Proposed GHG Standards, would support a relatively less stringent standard with fewer flexibilities or a relatively more stringent standard with more flexibilities. The

NPRM also solicits comment on whether any flexibilities or combinations of flexibilities in particular are more or less consistent with the Administrator’s rationale for proposing Alternative 1.

TABLE 13-2 - EFFECT OF DIFFERENT EXAMPLE FLEXIBILITIES IN REDUCING PROGRAM STRINGENCY COMPARED TO THE CURRENT EPA STANDARDS (WHICH AVERAGE 4.7% PER YEAR STRINGENCY INCREASE FROM MY2020-2025)

Example Enhanced Flexibility Scenarios	Average Year-over-Year Reduction in CO2 for MYs 2020-2025
No Action Alternative (the existing EPA standards)	4.7% per year
Example Enhanced Flexibility A: EPA extends the 0 g/mi factor and a multiplier of 2x for BEVs, and BEV sales achieve a level of 3% of new vehicle sales.	4.0% per year
Example Enhanced Flexibility B: EPA extends the 0 g/mi factor and a multiplier of 4.5x for BEVs, and BEV sales achieve a level of 3% of new vehicle sales.	2.8% per year
Example Enhanced Flexibility C: EPA extends the 0 g/mi factor and a multiplier of 4.5x for BEVs, and BEV sales achieve a level of 6% of new vehicle sales, mild hybrid light-trucks receive a 10g/mi credit and achieve 20% new sales, strong hybrid light-trucks receive a 20g/mi credit and achieve a 10% new sales level.	0.8% per year
Alternative 1 (EPA proposal)	0 % per year

13.3 Should NHTSA and EPA Continue to Account for Air Conditioning Efficiency and Off-Cycle Improvements?

As stated in the 2012 NPRM and final rules for MYs 2017 and beyond, the purpose of the off-cycle improvement incentive is to encourage the introduction and market penetration of off-cycle technologies that achieve real-world benefits.⁸⁹¹ In the 2012 NPRM, NHTSA stated,

because we and EPA do not believe that we can yet reasonably predict an average amount by which manufacturers will take advantage of [the off-cycle FCIV] opportunity, it did not seem reasonable for the proposed standards to include it in our stringency determination at this time. We expect to re-evaluate whether and how to include off-cycle credits in determining maximum feasible standards as the off-cycle technologies and how manufacturers may be expected to employ them become better defined in the future.⁸⁹²

⁸⁹¹ 77 FR 63134 (October 15, 2012).

⁸⁹² 76 FR 75226 (December 1, 2011).

By the 2012 final rule, NHTSA and EPA had determined that it was appropriate, under EPA’s EPCA authority for testing and calculation procedures, for the agencies to provide a fuel economy adjustment factor for off-cycle technologies.⁸⁹³ NHTSA assessed some amount of off-cycle credits in the determination of the maximum feasible standards for the MYs covered by that rulemaking.⁸⁹⁴

The agencies included a ~~protracted~~ discussion of the history and technological underpinnings of the A/C efficiency and off-cycle FCIV measurement procedures in the Draft TAR,⁸⁹⁵ however it is also appropriate to now revisit the basic question of, and accordingly seek comment on, how A/C efficiency and off-cycle credits and FCIVs fit in setting maximum feasible CAFE standards under EPCA/EISA, and GHG standards consistent with EPA’s authority under the CAA. It would be prudent to revisit factors that EPA identified in their first 2009 NPRM to establish GHG emissions standards,⁸⁹⁶ such as how it can be ensured that any off-cycle credits (and associated FCIVs) applied for using manufacturer proposed and agency approved test procedures are verifiable, reflect real-world reductions, are based on repeatable test procedures, and are developed through a transparent process along with appropriate opportunities for public comment. The NPRM also seeks to determine whether the program is still serving its originally intended purpose.

13.3.1 Why did the analysis consider alternatives that phased out the A/C efficiency and off-cycle programs?

As part of this rulemaking, the analysis considered alternatives that phase out the A/C efficiency and off-cycle compliance flexibilities to reassess the benefits and costs of including these flexibilities in the programs. The A/C efficiency and off-cycle programs have been the subject of discussion and debate since the MYs 2017 and beyond final rule. The Alliance of Automobile Manufacturers and Global Automakers petitioned the agencies to streamline aspects of both agencies’ A/C efficiency and off-cycle programs as part of a 2016 request to more broadly harmonize the CAFE and GHG programs (further discussion of the Alliance/Global petition is located above). On the other hand, other stakeholders have questioned the purpose and efficacy of the off-cycle credit program, specifically, whether the technology benefits are being accurately captured, and whether the programs are unrealistically inflating manufacturers’ compliance values. There are two factors that may be important to consider at this time, (1) manufacturer’s increasing use of A/C efficiency and off-cycle technologies to achieve compliance in light of the program’s increasing complexity; and (2) the questions of whether the A/C efficiency and off-cycle benefits are accurately being accounted for. In response to comments that the programs in their current form were actually impeding innovative technology growth, in particular from manufacturers, the analysis considered the concept that instead of

⁸⁹³ 77 FR 62628, 62649-50 (October 15, 2012).

⁸⁹⁴ 77 FR 62727, 63018 (October 15, 2012).

⁸⁹⁵ See Draft TAR at 5-207 et seq.

⁸⁹⁶ See 74 FR 49482 (September 28, 2009).

continuing to grow the A/C efficiency and off-cycle flexibilities that the agencies assess two alternatives that would set standards without the availability of A/C efficiency and off-cycle credits for compliance.

13.3.1.1 Manufacturer’s increasing reliance on the A/C efficiency and off-cycle programs to achieve compliance

Since the 2012 final rule for MYs 2017 and beyond and the Draft TAR, manufacturers have increasingly utilized A/C efficiency and off-cycle technology to achieve either credits under the GHG program, or fuel consumption improvement values (FCIVs) under the CAFE program. A/C efficiency and off-cycle technology use ranges among manufacturers, from some manufacturers claiming zero grams/mile (or the equivalent under the CAFE program), to some manufacturers claiming 7 grams/mile in MY 2016.⁸⁹⁷ Accordingly, with some manufacturers’ potentially reaching the credit cap (10 grams/mile) during the timeframe contemplated by this rulemaking, if not before, the analysis presents for discussion considerations relating to manufacturers’ increasing reliance on the A/C efficiency and off-cycle programs for compliance, and the administration of the programs.

The issues were not raised *sua sponte*; rather, manufacturers’ comments on the A/C efficiency and off-cycle programs have been increasing recently in volume. Specifically, manufacturers asserted in their 2016 comments to the Draft TAR that “[s]ignificant volumes of off-cycle credits will be essential for the industry in order to comply with the GHG and CAFE standards through 2025.”⁸⁹⁸ Similarly, in its request to more fully incorporate estimated costs for A/C efficiency and off-cycle technologies in their analysis, ICCT noted that “companies are clearly prioritizing [off-cycle] technologies over more advanced test-cycle efficiency technologies.”⁸⁹⁹

Concurrent with the Alliance/Global’s petition requesting action on various aspects of the A/C efficiency and off-cycle programs, other stakeholders raised issues about the programs that could be discussed at this time. For example, ACEEE commented on the Draft TAR that “an off-cycle technology that is common in current vehicles and is not reflected in the stringency of the standards has no place in the off-cycle credit program. The purpose of the program is to

⁸⁹⁷ Greenhouse Gas (GHG) Emission Standards for Light-Duty Vehicles: Manufacturer Performance Report, available at <https://www.epa.gov/regulations-emissions-vehicles-and-engines/greenhouse-gas-ghg-emission-standards-light-duty-vehicles>.

⁸⁹⁸ Alliance TAR comments at 162, Docket NHTSA-2016-0068-0095. It is important to note the Alliance submitted this statement in context of the CAFE and GHG levels set in the 2012 final rule for MYs 2017 and beyond. Specifically, the Alliance asserted “[t]he Agencies included off-cycle credits from only two technologies in their analyses for setting the stringency of the standards (engine stop start and active aerodynamic features). However, because the fuel consumption benefits of many other technologies were overestimated in the Agencies’ analyses, and the standards were therefore set at very challenging levels, off-cycle technologies and the associated GHG and fuel economy benefits are viewed by the industry as a critical area that must become a major source of credits.”

⁸⁹⁹ ICCT TAR Comments at 10, Docket EPA-HQ-OAR-2015-0827-4017.

*** EO 12866 Review – Draft – Do Not Cite, Quote or Release During Review ***

incentivize adoption of fuel saving technology, not to provide loopholes for manufacturers to achieve the standards on paper.”⁹⁰⁰

Compare these comments with EPA’s 2017 *Light-Duty Automotive Technology, Carbon Dioxide Emissions, and Fuel Economy Trends: 1975 Through 2017* report (hereinafter 2017 EPA Trends report), which estimated that A/C efficiency and off-cycle credits could, *at most*, “reduce adjusted MY 2016 CO₂ tailpipe emission values by about 7 g/mi, which would translate to an adjusted fuel economy increase of approximately 0.5 mpg.”⁹⁰¹ A/C and off-cycle flexibilities allow manufacturers to optionally apply a wide array of technologies to improve fuel economy. While the adoption of any particular technologies are not required or incentivized, the industry is in fact expanding its use of more cost-effective A/C efficiency and off-cycle technologies rather than other technology pathways. The NPRM accordingly seeks comment on how large of a role A/C efficiency and off-cycle technology should play in manufacturer compliance. Is an adjusted fuel economy increase of approximately 0.5 mpg noteworthy?

Next, when manufacturers are increasingly reliant on A/C efficiency and off-cycle technology to achieve compliance, administration of the flexibility becomes more significant. The Alliance commented that the industry “needs the off-cycle credit program to function effectively to fulfill the significant role that will be needed for generating large quantities of credits from [off-cycle] emission reduction.”⁹⁰² Moreover, the Alliance pointed out that “[l]imited Agency resources have delayed the processing of [petitions for off-cycle credits], and the delay impedes manufacturers’ ability to plan for compliance or make investment decisions.”⁹⁰³ More specifically, the Alliance commented that:

[c]ase-by-case approvals for off-cycle credit applications is excessively burdensome due to slow agency response and unnecessary testing. The procedures for granting off-cycle GHG credits are not being implemented per the provisions of the regulation and are not functioning to the level necessary for industry for long-term compliance. Without timely processing, EPA works against its stated intent of ‘provid[ing] an incentive for CO₂ and fuel consumption reducing off-cycle technologies that would otherwise not be developed because they do not offer a significant 2-cycle benefit.’⁹⁰⁴

⁹⁰⁰ ACEEE TAR Comments at 14, Docket NHTSA-2016-0068-0078.

⁹⁰¹ U.S. EPA, *Light-Duty Automotive Technology, Carbon Dioxide Emissions, and Fuel Economy Trends: 1975 Through 2017* at 141 (January 2018), EPA-420-R-18-001, available at <https://nepis.epa.gov/Exe/ZyPDF.cgi?Dockey=P100TGDW.pdf>.

⁹⁰² Alliance TAR Comments at 166, Docket NHTSA-2016-0068-0095.

⁹⁰³ Alliance TAR Comments at 167, Docket NHTSA-2016-0068-0095.

⁹⁰⁴ Alliance Comments to Docket EPA-HQ-OA-2017-0190.

Notably, the implementation of the off-cycle credit provisions has been described as “underperforming.”⁹⁰⁵

The Alliance’s “primarily regulatory need” as of the 2016 Draft TAR was “a renewed focus on removing all obstacles that are having the unintended result of slowing investment and implementation of [credit] technologies.”⁹⁰⁶ The Alliance stated generally that “[w]ith the pre-approved credit list properly administered, the off-cycle program can be expected to grow toward the credit caps that were established in the regulation, and these credit caps will become binding constraints for many or most automobile manufacturers. At that point, the credit caps will be counterproductive since they will impede greater implementation of the beneficial off-cycle technologies.”⁹⁰⁷ Similarly in regards to the agencies’ refusal to grant off-cycle credits for technologies like driver assistance systems, the Alliance stated that “[t]he unintended consequence of this is that automakers may not be able to continue to pursue technologies that do not provide certainty in supporting vehicle compliance.”⁹⁰⁸

These comments highlight the challenges to the agencies to assure improvement values from A/C efficiency and off-cycle technologies reflect verifiable, real-world fuel economy improvements, are attributable to specific vehicle models, are based on repeatable test procedures, and are developed through a transparent process with appropriate opportunities for public comment. The agencies believe this process and these considerations are important to assure the integrity and fairness of the A/C and off-cycle procedures. The agencies note that the menu and 5-cycle test methodologies are predefined and are not subject to the in-depth review that proposed new test procedures are subject to. The agencies seek comment on whether and how menu-based A/C and off-cycle credits should be implemented.

13.3.1.2 Potential for benefits to be double counted

Next, the agencies would like to mention the potential for technology benefits to be over-counted, but note that aspects of this issue are being addressed in this rulemaking. As stated in the 2012 final rule for MYs 2017 and beyond, fuel saving technologies integral to basic vehicle design (e.g., camless engines, variable compression ratio engines, micro air/hydraulic launch assist devices, advanced transmissions) should not be eligible for off-cycle credits. Specifically, “[b]eing integral, there is no need to provide an incentive for their use, and (more important), these technologies would be incorporated regardless. Granting credits would be a windfall.”⁹⁰⁹ Assumedly, because these technologies are integral to basic vehicle design, their benefit would be appropriately captured on the 2-cycle tests and 5-cycle tests. Similarly, ICCT commented

⁹⁰⁵ Alliance TAR Comments at 166, Docket NHTSA-2016-0068-0095.

⁹⁰⁶ Alliance TAR Comments at xiv, Docket NHTSA-2016-0068-0095.

⁹⁰⁷ Alliance TAR Comments at 164, Docket NHTSA-2016-0068-0095.

⁹⁰⁸ Alliance TAR Comments at 126, Docket NHTSA-2016-0068-0095.

⁹⁰⁹ 77 FR 62732 (October 15, 2012).

*** EO 12866 Review – Draft – Do Not Cite, Quote or Release During Review ***

that, “[i]n theory, off-cycle credits are a good idea, as they encourage real-world fuel consumption reduction for technologies that are not fully included on the official test cycles. However, real-world benefits only accrue if double-counting is avoided and the amount of the real-world fuel consumption reduction is accurately measured.”⁹¹⁰

Broadly, the agencies agree with the concept that capturing real world driving behavior is essential to accurately measure the true benefits of A/C efficiency and off-cycle technologies. One example where this holds true is in particular component testing as measured with the federal standardized testing procedure. For example, the federal test procedures provide specific guidance on how a vehicle should be installed on the dynamometer, if the vehicle’s windows should be open or closed, and the vehicle’s tire pressure. On the other hand, the regulations provide no specific guidance on how other components should be tested so the agencies and manufacturers can most accurately quantify benefits.

For example, to more accurately capture the benefit of a high efficiency alternator on the 2-cycle or 5-cycle test, the vehicle would need to run more systems that draw power from the alternator, like the infotainment system or temperature controlled seats. The agencies do not have guidance for these additional components in the tests as they are currently performed, due to the complexity of systems available in the light duty vehicle market. Essentially, the agencies are unsure of how to define in regulations what component systems need to be on or off during testing to accurately capture the benefit of component synergies. Developing guidance on specific systems would also likely require a significant amount of time and resources. The agencies seek comment on specific technologies that may be receiving more benefit based on the current test procedures, or more generally, any other issues related to integrated component testing.

The agencies note however, that the optional 5-cycle test procedure for determining A/C and off-cycle improvement values over-counts benefits. The 5-cycle test procedure weighs the 2-cycle tests used for compliance with 3 additional test cycles to better represent real-world factors impacting fuel economy and GHG emissions, including higher speeds and more aggressive driving, colder temperature operation, and the use of air conditioning. However, the current regulations erroneously do not require that the 2-cycle benefit be subtracted from the 5-cycle benefit, resulting in a credit calculation that is artificially too high and not reflecting actual real-world emission reductions that were intended. Since the 5-cycle test procedures include the 2-cycle tests used for compliance, the agencies believe the 2-cycle benefit should be subtracted from the 5-cycle benefit to avoid over-counting of benefits. Manufacturers interested in generating credits under the 5-cycle pathway identified this issue to the agencies, and have asked EPA to clarify the regulations. [EPA has announced its plans to propose technical corrections through a separate technical amendments rulemaking that would correct this error in the](#)

⁹¹⁰ ICCT TAR Comments at 10, Docket EPA-HQ-OAR-2015-0827-4017.

~~regulations.⁹¹¹ This issue is discussed in Section 13.2, above, and the agencies seek comment on how to implement this correction.~~

13.3.2 Why did the agencies propose the phase-out as modeled (e.g., year over year reductions in available FCIVs) for certain alternatives?

The CAFE model was used to assess the economic, technical, and environmental impacts of alternatives that kept the A/C efficiency and off-cycle programs as is, and alternatives that phased those programs out. As described fully in Section II.B, the CAFE model is a software simulation that begins with a recently produced fleet of vehicles and applies cost effective technologies to each manufacturers' fleet year-by-year, taking into consideration vehicle refresh and redesign schedules and common parts among vehicles. The CAFE model outputs technology pathways that manufacturers could use to comply with the proposed policy alternatives.

For this NPRM, the modeling analysis uses the off-cycle credits submitted by each manufacturer for MY 2017 compliance, and carries these forward to future years with a few exceptions. Several technologies described in Section 5.4.1 are associated with off-cycle credits. In particular, stop-start systems, integrated starter generators, and full hybrids are assumed to generate off-cycle credits when applied to improve fuel economy. Similarly, higher levels of aerodynamic improvements are assumed to require active grille shutters on the vehicle, which also qualify for off-cycle credits. The analysis assumes that any off-cycle credits that are associated with actions outside of technologies discussed in Section 5.4.1 (either chosen from the pre-approved menu or petitioned for separately) remain at levels identified by manufacturers in MY 2017. Any additional off-cycle credits that accrue as the result of explicit technology application are calculated dynamically in each year, for each alternative. This method allows the agencies to capture benefits and costs from A/C efficiency and off-cycle technologies as compared to an alternative where those technologies are not used for compliance purposes.

In considering potential future actions regarding the A/C efficiency and off-cycle flexibilities, it was recognized that removing the programs immediately would present a considerable challenge for manufacturers. Based on compliance and mid-model year data for MY 2017, the first model year that NHTSA accepted FCIVs for CAFE compliance, manufacturers have reported A/C efficiency and off-cycle FCIVs at noteworthy levels. EPA's MY 2016 Performance Report reported wide penetration of FCIVs from menu technologies, and noted some technologies widely employed by OEMs included active grill shutters, glass or glazing and stop-start systems. Additional details of individual manufacturers' MY 2016 performance and individual A/C and off-cycle technology penetration can be found on EPA's website.⁹¹² Accordingly, a phase-out was identified as a reasonable option for manufacturers to come into compliance with GHG or

⁹¹¹ See [Spring 2018 Regulatory Agenda, Light-Duty Vehicle GHG Program Technical Amendments, RIN 2060-AT75](https://www.reginfo.gov/public/do/eAgendaViewRule?pubId=201804&RIN=2060-AT75), <https://www.reginfo.gov/public/do/eAgendaViewRule?pubId=201804&RIN=2060-AT75>.

⁹¹² 'Manufacturer Performance Report for the 2016 Model Year,' EPA-420-R-18-002 (January 2018).

fuel economy standards without using A/C efficiency and off-cycle improvements for compliance.

Throughout the joint CAFE and GHG programs, the agencies propose to phase out flexibility and incentive programs rather than ending those programs abruptly, such as with the alternative fuel vehicle program (as mandated by EISA),⁹¹³ and the credit program for advanced technologies in pickup trucks.⁹¹⁴ Accordingly, an incremental decrease in the maximum A/C efficiency and off-cycle FCIVs a manufacturer can receive starting in MY 2022 and ending in MY 2026 was modeled. Table 13-3 below shows the incremental cap total starting in MY 2021 and reducing by the recommend value until MY 2026.

TABLE 13-3 - PROPOSED A/C EFFICIENCY AND OFF-CYCLE CAP REDUCTION IN CERTAIN ALTERNATIVES

Passenger Car							
MY	2020	2021	2022	2023	2024	2025	2026
AC Efficiency Cap (g/mile)	5	6	5	4	3	2	0
Off-Cycle Cap (g/mile)	10	10	8	6	4	2	0
Light Truck							
MY	2020	2021	2022	2023	2024	2025	2026
AC Efficiency Cap (g/mile)	7.2	6	5	4	3	2	0
Off-Cycle Cap (g/mile)	10	10	8	6	4	2	0

The MY 2016 fleet final compliance data to identify the starting point for the FCIV phase-out was reviewed.⁹¹⁵ For A/C efficiency technologies, 6 grams/mile was used as the starting point, which was the highest FCIV a single manufacturer had received in MY 2016. For off-cycle technologies, the maximum allowable cap of 10 gram/mile set in the 2012 final rule for MYs 2017 and beyond was used. Although no manufacturer had reached the 10 gram/mile cap as of MY 2016, there is a belief that it is still feasible for some manufacturers to reach the cap in MYs prior to 2021. Comment is invited on this methodology. What do the modeled alternatives show?

⁹¹³ 49 U.S.C. 32906.

⁹¹⁴ For further discussion of the advanced technology pickup truck program, see Section X.B.1.e.4, above.

⁹¹⁵ “Manufacturer Performance Report for the 2016 Model Year” Greenhouse Gas Emission Standards for Light-Duty Vehicles,” <https://nepis.epa.gov/Exe/ZyPDF.cgi?Dockey=P100TGIA.pdf>.

*** EO 12866 Review – Draft – Do Not Cite, Quote or Release During Review ***

A lower⁹¹⁶ and higher⁹¹⁷ stringency alternative with and without the A/C efficiency and off-cycle flexibilities were modeled to see the impact on regulatory costs, average vehicle prices, societal costs and benefits, average achieved fuel economy, and fuel consumption, among other attributes. The alternatives and associated impacts presented below are compared to a baseline where EPA’s GHG emissions standards for MYs 2022-2025 remain in effect and NHTSA’s augural CAFE standards would be in place (for further discussion of the interpretation of what baseline is appropriate, see preamble Section **Error! Reference source not found.** and PRIA Chapter 3).

The modeling results indicated no significant change in the fleet average achieved fuel economy, which is expected because the model only applies technologies to a manufacturers’ fleet until the standard is met. However, the change in regulatory costs, average vehicle prices, societal costs and societal net benefits is noteworthy. Without A/C efficiency and off-cycle technologies available, the CAFE model applied more costly technologies to the fleet. This trend was less noticeable with the low stringency alternative, however the advanced technology required to meet the high stringency alternative without A/C efficiency or off-cycle technology was more expensive. Similarly, although the CAFE model only applied technology to the fleet until the fleet met the standards, alternatives that did not employ A/C efficiency and off-cycle technologies saved more fuel and reduced GHG emissions more than alternatives that did employ the A/C efficiency and off-cycle technologies, and in significantly higher amounts for the higher stringency alternative. On average, the modeling shows that phasing out the A/C efficiency and off-cycle programs decreases fuel consumption over the “no change” scenario, but confirms that manufacturers will have to apply costlier technology to meet the standards.

The slight difference in fleet performance under the different alternatives confirms how the CAFE model considers the universe of applicable technologies, and dynamically identifies the most cost-effective combination of technologies for each manufacturer’s vehicle fleet based on the assumptions about each technology’s effectiveness, cost, and interaction with all other technologies. For further discussion of the technology pathways employed in the CAFE model, please refer to preamble Section **Error! Reference source not found.**

⁹¹⁶ Existing standards through MY 2020, then 0.5%/year increases for both passenger cars and light trucks, for MYs 2021-2026.

⁹¹⁷ Existing standards through MY 2020, then 2%/year increases for passenger cars and 3%/year increases for light trucks, for MYs 2021-2026.

14 Regulatory Flexibility Act and Unfunded Mandates Reform Act Analysis

14.1 Regulatory Flexibility Act

The Regulatory Flexibility Act (RFA) of 1980 (5 U.S.C §601 *et seq.*) requires agencies to evaluate potential effects of their proposed and final rules on small businesses, small organizations, and small government jurisdictions.

In particular, the RFA requires that agencies provide:

1. A description of reasons why action by the agency is being considered;
2. A succinct statement of the objectives of, and legal basis for, the proposed rule;
3. A description of and, where feasible, an estimate of the number of small entities to which the proposed rule will apply;
4. A description of the projected reporting, recording keeping, and other compliance requirements of a proposed rule, including an estimate of the classes of small entities, which will be subject to the requirement and the type of professional skills necessary for preparation of the report or record;
5. An identification, to the extent practicable, of all relevant federal rules, which may duplicate, overlap, or conflict with the proposed rule;
6. A description of any significant alternatives of the proposed rule, which accomplish stated objectives of applicable statutes and minimize any significant economic effect of the proposed rule on small entities.

Based on consideration of the following, the agencies certify that this proposal would not have a significant economic impact on a substantial number of small entities.

1. Description of the reason why action by the agency is being considered

NHTSA and EPA are issuing this proposed rule to adjust vehicle fuel economy standards.

2. Objectives of, and legal basis for, the proposed rule

The Energy Policy and Conservation Act (EPCA), as modified by the Energy Independence and Security Act, mandates the setting of average fuel economy standards that are maximum feasible. The fuel economy standards must be set separately for passenger vehicles (cars) and non-passenger vehicles (light trucks). The average fuel economy of the combined fleet of passenger cars and light trucks sold by manufacturers in the U.S. in model year 2020 equals or exceeds 35 miles per gallon. EPA is setting CO₂ emissions standards for passenger cars and light trucks under section 202 (a) of the Clean Air Act (CAA) ((42 U.S.C. 7521 (a)), and under its authority to measure passenger car and passenger car fleet fuel economy pursuant to EPCA.

3. Description and estimate of the number of small entities to which the proposed rule will apply

For purposes of assessing the impacts of this proposal on small entities, small entity is defined as: (1) a small business as defined by the Small Business Administration's (SBA) regulations at 13 CFR 121.201; (2) a small governmental jurisdiction that is a government of a city, county, town, school district or special district with a population of less than 50,000; and (3) a small organization that is any not-for profit enterprise which is independently owned and operated and is not dominant in its field. NHTSA and EPA are unaware of any small government entities or small organizations to which the requirements in this proposal would apply.

Small businesses are defined based on the North American Industry Classification System (NAICS) code. One of the criteria for determining size is the number of employees in the firm. For establishments primarily engaged in manufacturing or assembling automobiles, as well as light duty trucks, the firm must have less than 1,500 employees to be classified as a small business.⁹¹⁸ This proposed rule would affect motor vehicle manufacturers. There are 14 small manufacturers of passenger cars and SUVs of electric, hybrid, and internal combustion engines.

NHTSA believes the rulemaking would not have a significant economic effect on small vehicle manufacturers because under 49 CFR Part 525, passenger automobile manufacturers making less than 10,000 vehicles per year can petition NHTSA to have alternative standards set for those manufacturers. Those manufacturers currently not meeting required levels for their footprint can petition the agency for relief. If the standard is changed, it has no meaningful effect on these manufacturers because they still must go through the same process and petition for relief. Other small manufacturers (e.g. Faraday Future and Karma Automotive) producing electric vehicles would likely meet or exceed required standards.

Currently, there are 14 small passenger motor vehicle manufacturers in the United States. Table 14-1 provides information about the 14 small domestic manufacturers in model year 2017. All are small manufacturers, having significantly fewer than 1,000 employees. Many of these small manufacturers produce high performance luxury sports cars, which are produced in low volume with high price tags. A few of the manufacturers have plans to produce electric vehicles in large numbers; however, they have yet to start official production of such a vehicle.

EPA believes this rulemaking would not have a significant economic impact on a substantial number of small entities under the Regulatory Flexibility Act, as amended by the Small Business Regulatory Enforcement Fairness Act. EPA is exempting from the CO₂ standards any manufacturer, domestic or foreign, meeting SBA's size definitions of small business as described in 13 CFR 121.201. EPA adopted the same type of exemption for small businesses in the 2017 and later rulemaking. EPA estimates that small entities comprise less than 0.1% of total annual vehicle sales and exempting them will have a negligible impact on the CO₂ emissions reductions from the standards. Because EPA is exempting small businesses from the CO₂ standards, we are

⁹¹⁸ Classified in NAICS under Subsector 336 – Transportation Equipment Manufacturing for Automobile Manufacturing (336111), Light Truck (336112), and Heavy Duty Truck Manufacturing (336120). <https://www.sba.gov/document/support-table-size-standards>.

certifying that the rule will not have a significant economic impact on a substantial number of small entities. Therefore, EPA has not conducted a Regulatory Flexibility Analysis or a SBREFA SBAR Panel for the rule.

EPA regulations allow small businesses to voluntarily waive their small business exemption and optionally certify to the CO₂ standards. This allows small entity manufacturers to earn CO₂ credits under the CO₂ program, if their actual fleetwide CO₂ performance is better than their fleetwide CO₂ target standard. However, the exemption waiver is optional for small entities and thus we believe that manufacturers opt into the CO₂ program if it is economically advantageous for them to do so, for example in order to generate and sell CO₂ credits. Therefore, EPA believes this voluntary option does not affect EPA’s determination that the standards will impose no significant adverse impact on small entities.

TABLE 14-1 - SMALL DOMESTIC VEHICLE MANUFACTURERS

Manufacturers	Founded	Employees⁹¹⁹	Estimated Annual Production⁹²⁰	Sale Price per Unit
Karma Automotive	2014	625	900	\$130,000
BXR Motors	2008	< 10	< 100	\$155,000 to \$185,000
Falcon Motorsports	2009	5	< 100	\$300,000 to \$400,000
Lucra Cars	2005	8	< 100	\$100,000
Lyons Motor Car	2012	< 10	< 100	\$1,400,000
Rezvani Motors	2014	6	< 100	\$95,000 to \$270,000
Rossion Automotive	2007	6	< 100	\$90,000
Saleen	1984	51	< 100	\$100,000
Shelby American	1962	61	< 100	\$60,000 to \$250,000
Panoz	1988	20	< 100	\$155,000 to \$175,000
Faraday Future	2014	790	0	\$200,000 to \$300,000
Lucid Motor Car	2007	269	0	\$60,000
Rivian Automotive	2009	208	0	N/A
SF Motors	2016	204	0	N/A

4. A description of the projected reporting, record keeping and other compliance requirements of a proposed rule including an estimate of the classes of small entities which will be subject to the requirement and the type of professional skills necessary for preparation of the report or record.

⁹¹⁹ Number of employees as of March 2018, source: LinkedIn.com.

⁹²⁰ Rough estimate for mode year 2017.

*** EO 12866 Review – Draft – Do Not Cite, Quote or Release During Review ***

The projected reporting, recordkeeping, and other compliance requirements of this proposed rule are consistent with the requirements stated in past rulemakings. The burden on manufacturers that manufacture fewer than 10,000 vehicles remains the same as the existing standards. To comply with alternative standards, manufacturers that meet this production threshold are required to submit a petition suggesting and justifying an alternative standard. NHTSA estimates this 89 hours of work per fleet per manufacturer. NHTSA expects that the petition would be completed mainly by engineering staff, and would be reviewed by managers and attorneys. The information collection burden on small businesses is also discussed in Section XI of the NPRM and the Paperwork Reduction Act supporting statements in the docket for this rulemaking.

5. An identification, to the extent practicable, of all relevant Federal rules which may duplicate, overlap, or conflict with the proposed rule

EPA and NHTSA are proposing joint rules that complement each other. We know of no other Federal rules that duplicate, overlap, or conflict with the proposed rules.

6. A description of any significant alternatives to the proposal which accomplish the stated objectives of applicable statutes and which minimize any significant economic impact of the proposed rule on small entities.

The agencies have analyzed 9 different alternative fuel economy stringencies. However, there are no other alternatives that can achieve the stated objectives without installing fuel economy technologies into the vehicle that could significantly minimize the impact on small entities.

14.2 Unfunded Mandates Reform Act

Section 202 of the Unfunded Mandates Reform Act of 1995 (UMRA) requires Federal agencies to prepare a written assessment of costs, benefits, and other effects of a proposed or final rule that includes a Federal mandate likely to result in the expenditure by state, local, or tribal governments, in the aggregate, or by the private sector, of more than \$100 million in any one year (adjusted for inflation with base year of 1995). Adjusting this amount by the gross domestic product price deflator for 2016 results in \$148 million ($111.416/75.324 = 1.48$).⁹²¹ Before promulgating a rule for which a written statement is needed, section 205 of UMRA generally requires NHTSA and EPA to identify and consider a reasonable number of regulatory alternatives and to adopt the least costly, most cost-effective, or least burdensome alternative that achieves objectives of the rule. The provisions of section 205 do not apply when they are inconsistent with applicable laws. Moreover, section 205 allows NHTSA and EPA to adopt an

⁹²¹ Bureau of Economic Analysis, National Income and Product Accounts (NIPA), Table 1.1.9 Implicit Price Deflators for Gross Domestic Product. https://bea.gov/table/index_nipa.cfm.

*** EO 12866 Review – Draft – Do Not Cite, Quote or Release During Review ***

alternative other than the least costly, most cost-effective, or least burdensome alternative if the agency publishes with the proposed rule an explanation why that alternative was not adopted.

This proposed rule will not result in the expenditure by state, local, or tribal governments, in the aggregate, of more than \$148 million annually, but it will result in the expenditure of that magnitude by vehicle manufacturers and/or their suppliers. NHTSA and EPA considered a variety of alternative average fuel economy standards in the proposed rule, as well as flexibilities for manufacturers to comply with the proposed rule. NHTSA is statutorily required to set standards at the maximum feasible level achievable by manufacturers based on its consideration and balancing of relevant factors and has concluded fuel economy standards are the maximum feasible standards for the passenger car and light truck fleets for MYs 2021-2026 in light of statutory considerations.