



Templates

Issue 23

PRINT AT 100% SIZE

When printed
at the correct
size, this box
will measure
1in / 26mm
square

BLOSSOM & SHINE

Sharon Keightley page 73

APPLIQUÉ TEMPLATES

ACTUAL SIZE

PLEASE NOTE: Cut out the individual shapes for templates,
add ¼in seam allowances when cutting the fabric.

MILLY'S GARDEN PART A

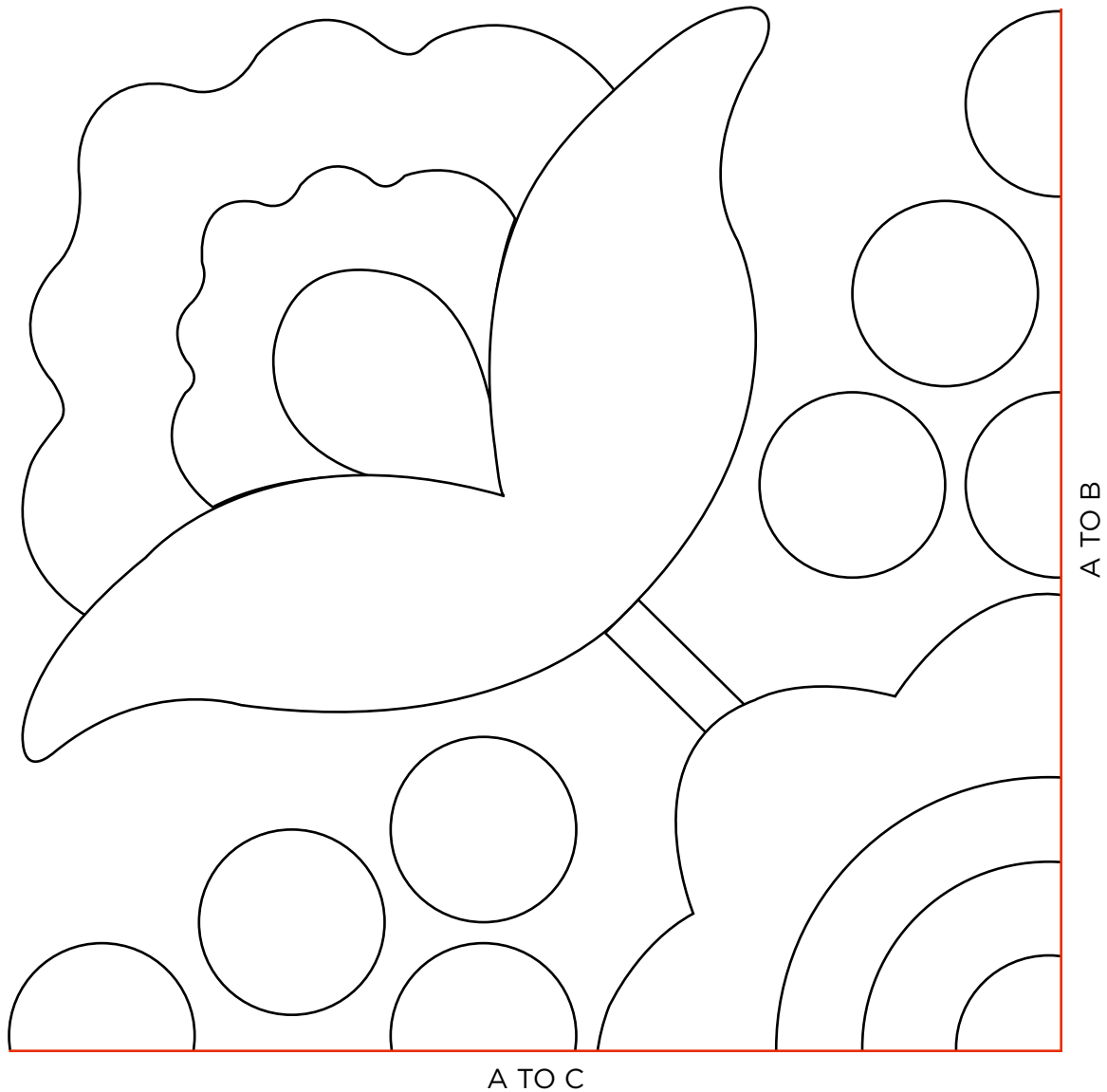

When printed at the correct size, this box will measure 1in / 26mm square

BLOSSOM & SHINE

Sharon Keightley page 73

AUNT BESSY'S SPARKLE

APPLIQUÉ TEMPLATES

ACTUAL SIZE

PLEASE NOTE: Cut out the individual shapes for templates, add ¼in seam allowances when cutting the fabric.

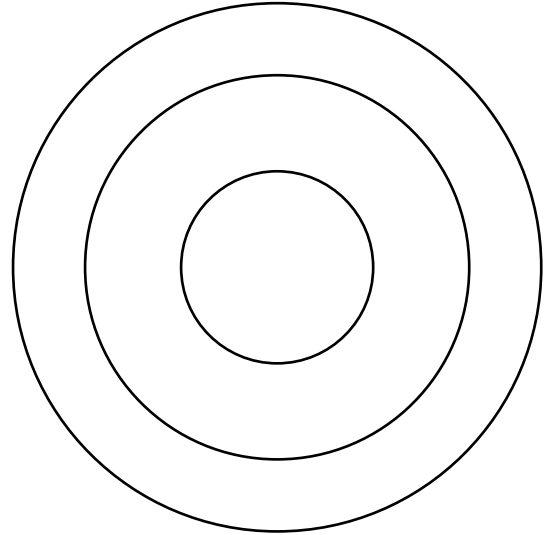

MILLY'S GARDEN PART B

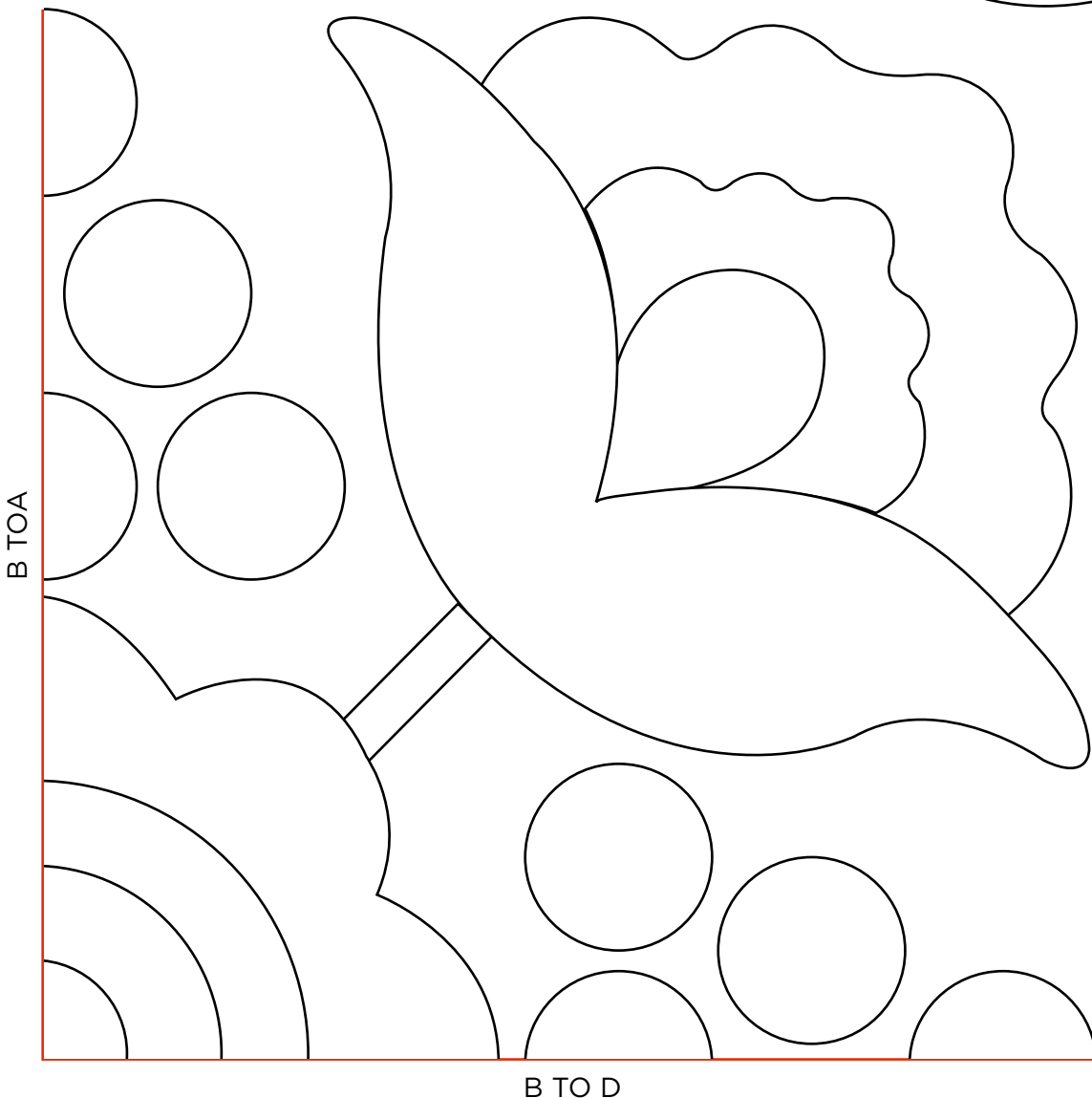

When printed
at the correct
size, this box
will measure
1in / 26mm
square

BLOSSOM & SHINE

Sharon Keightley page 73

APPLIQUÉ TEMPLATES

ACTUAL SIZE

PLEASE NOTE: Cut out the individual shapes for templates,
add ¼in seam allowances when cutting the fabric.

MILLY'S GARDEN
PART C

C TO A

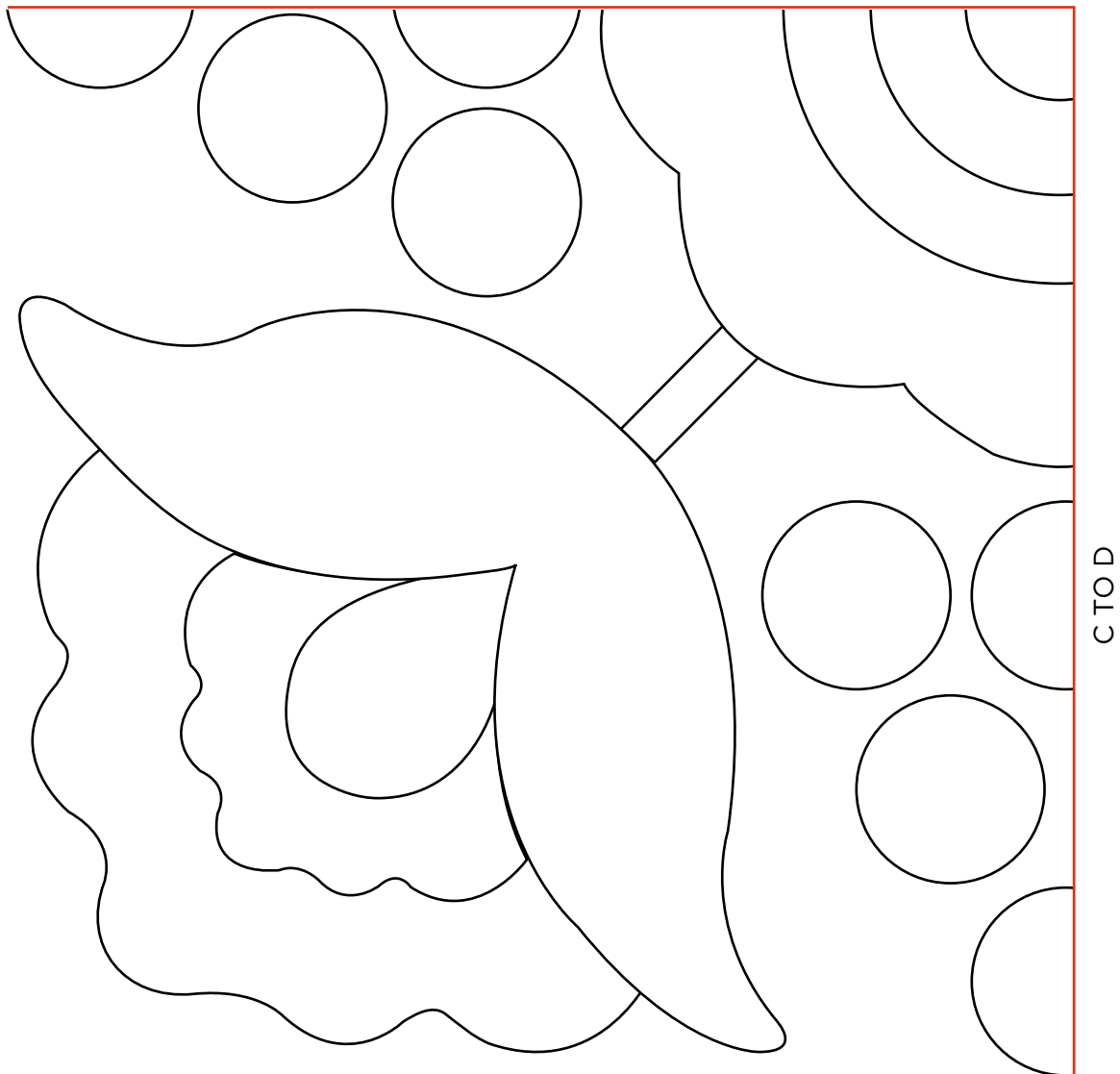

When printed
at the correct
size, this box
will measure
1in / 26mm
square

BLOSSOM & SHINE

Sharon Keightley page 73

APPLIQUÉ TEMPLATES

ACTUAL SIZE

PLEASE NOTE: Cut out the individual shapes for templates,
add ¼in seam allowances when cutting the fabric.

MILLY'S GARDEN PART D

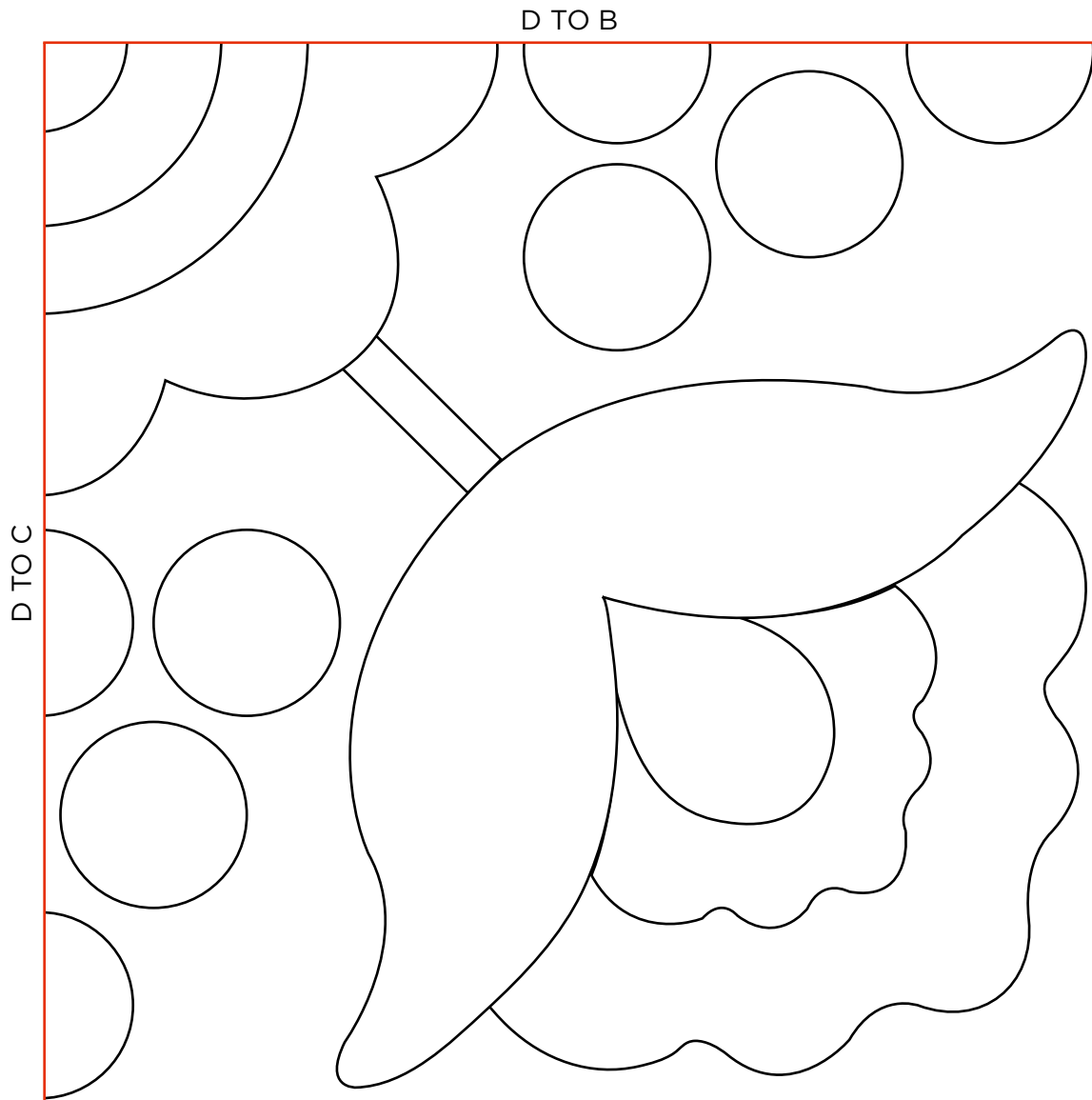

When printed
at the correct
size, this box
will measure
1in / 26mm
square

BLOCK OF THE MONTH

Jo Avery page 81

FOUNDATION PIECING TEMPLATES

ACTUAL SIZE
Includes seam allowances

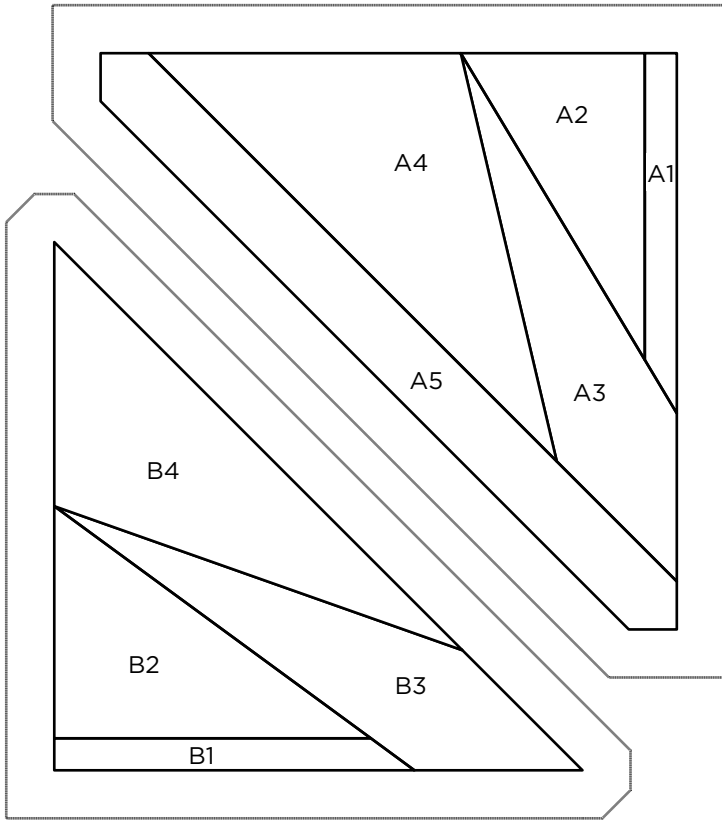

MAIN BLOCK

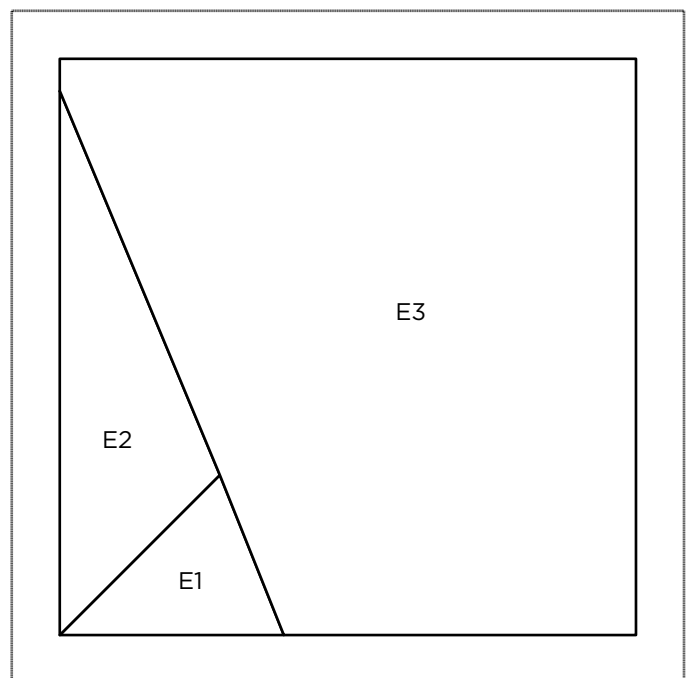
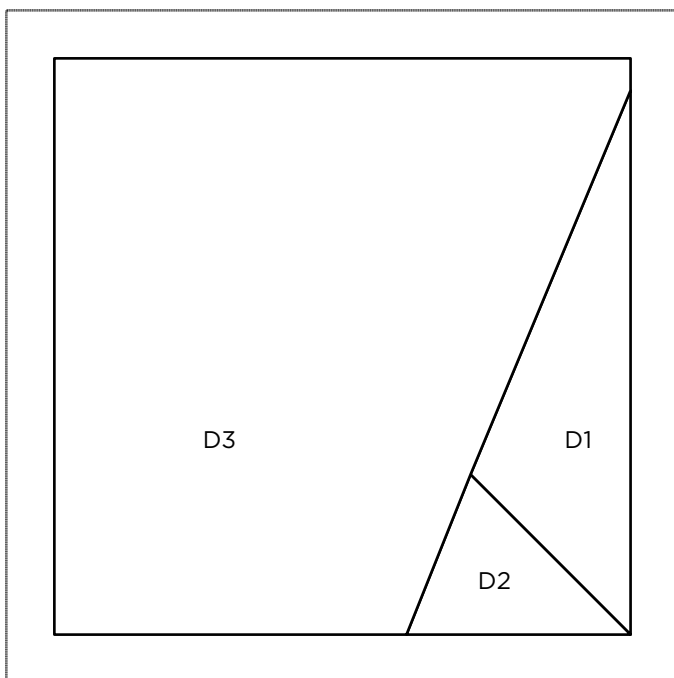
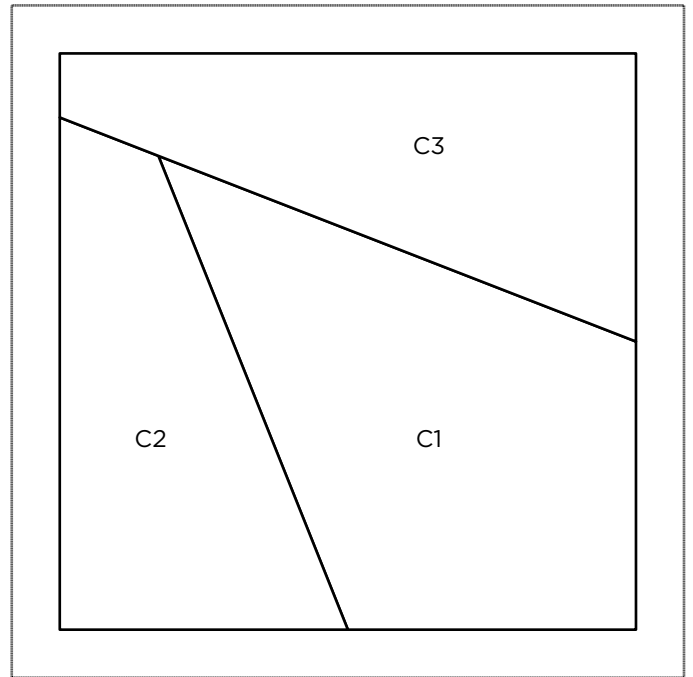

When printed at the correct size, this box will measure 1in / 26mm square

BLOCK OF THE MONTH

Jo Avery page 81

FOUNDATION PIECING TEMPLATES

ACTUAL SIZE
Includes seam allowances

VARIATION BLOCK

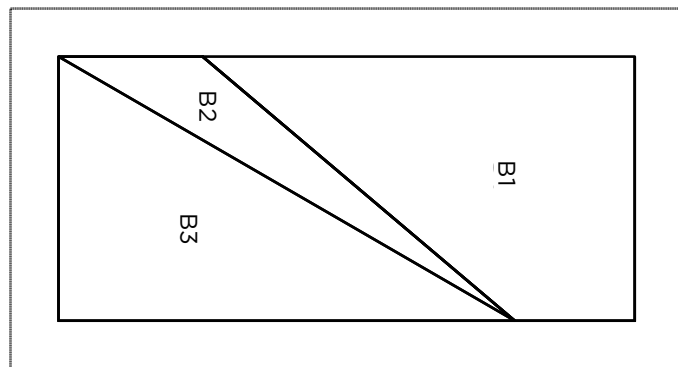
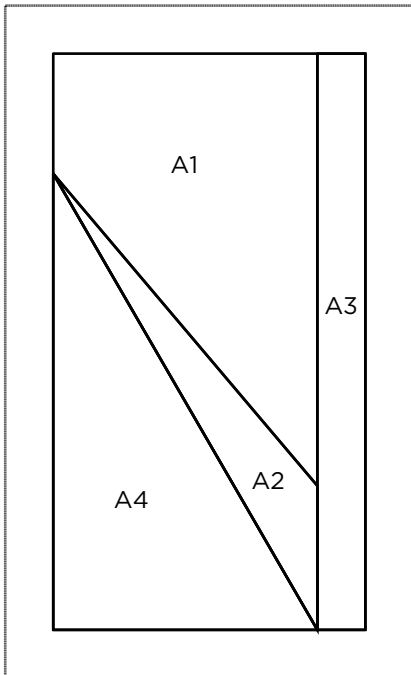

3 inch (without seam allowance)

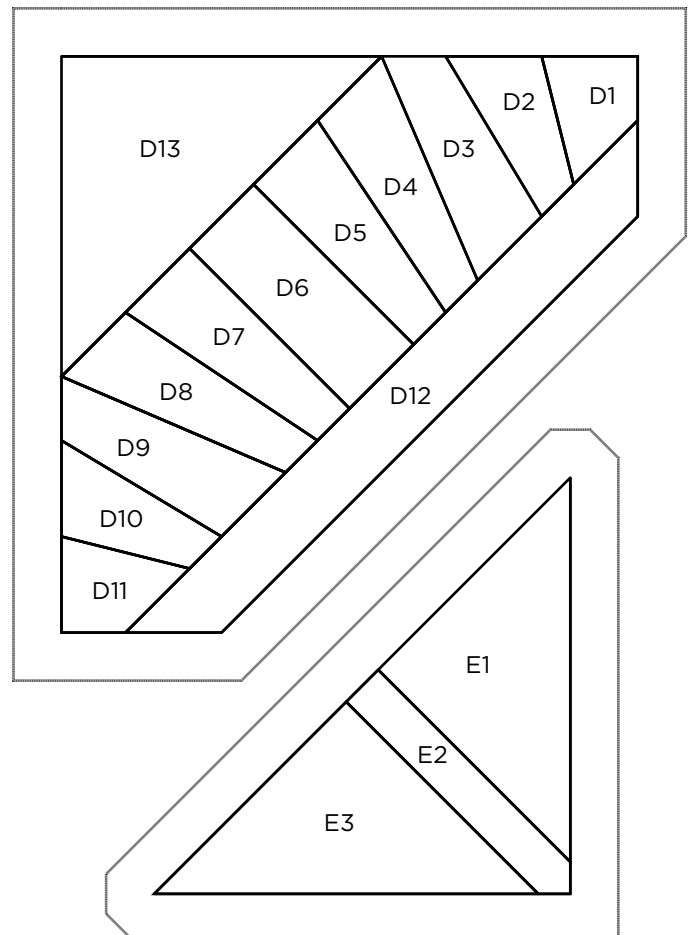
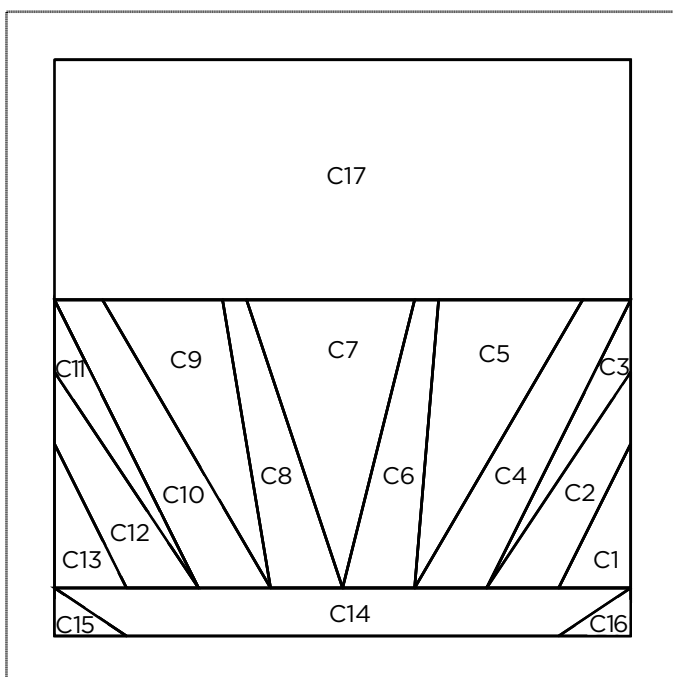

When printed
at the correct
size, this box
will measure
1in / 26mm
square

DANCING WITH DAISIES

Jo Colwill page 22

APPLIQUÉ TEMPLATES

ACTUAL SIZE

PLEASE NOTE: Appliqué templates DO NOT include seam allowances

Use a combination of these to build up your appliqué design, referring to the project diagrams

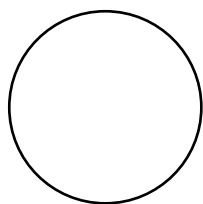

1IN CIRCLE

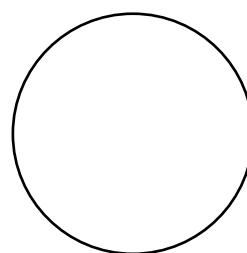

1/4IN CIRCLE

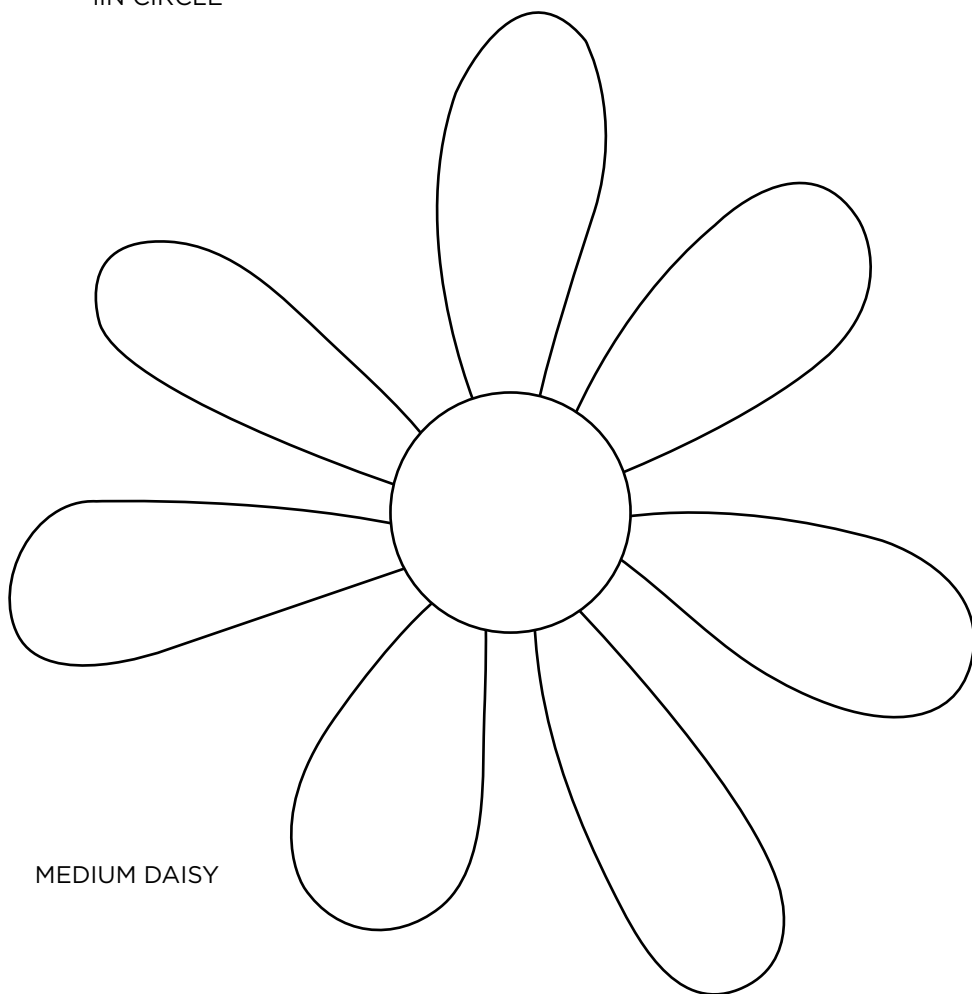

MEDIUM DAISY

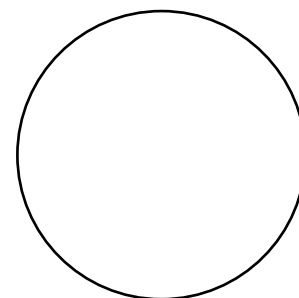

1 1/2IN CIRCLE

When printed
at the correct
size, this box
will measure
1in / 26mm
square

DANCING WITH DAISIES

Jo Colwill page 22

APPLIQUÉ TEMPLATES

ACTUAL SIZE

PLEASE NOTE: Appliqué templates DO NOT include seam allowances

Use a combination of these to build up your appliqué design, referring to the project diagrams

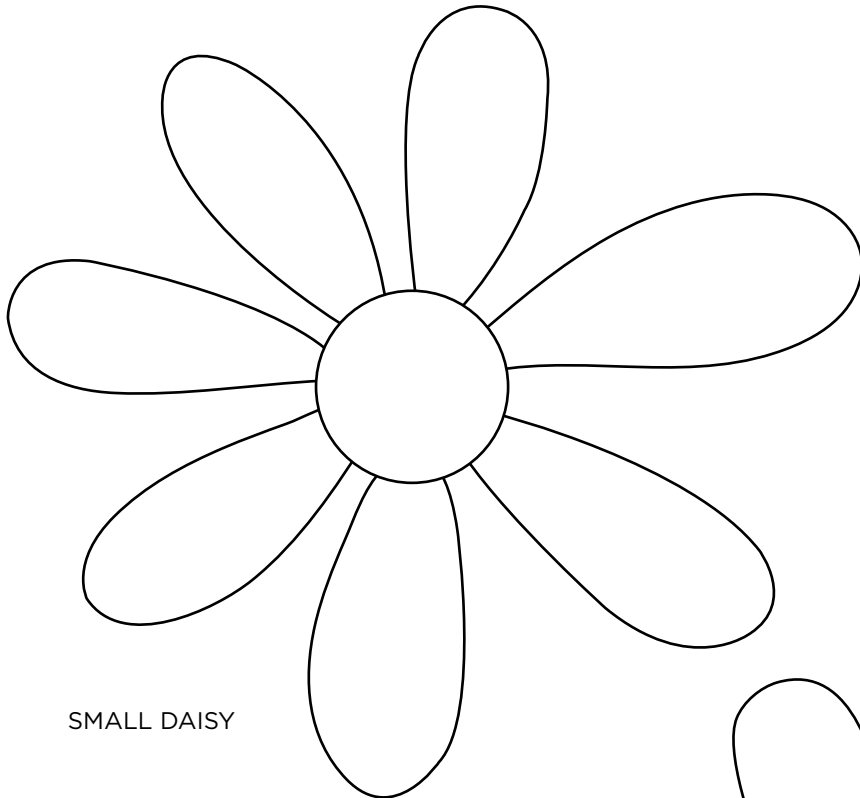

SMALL DAISY

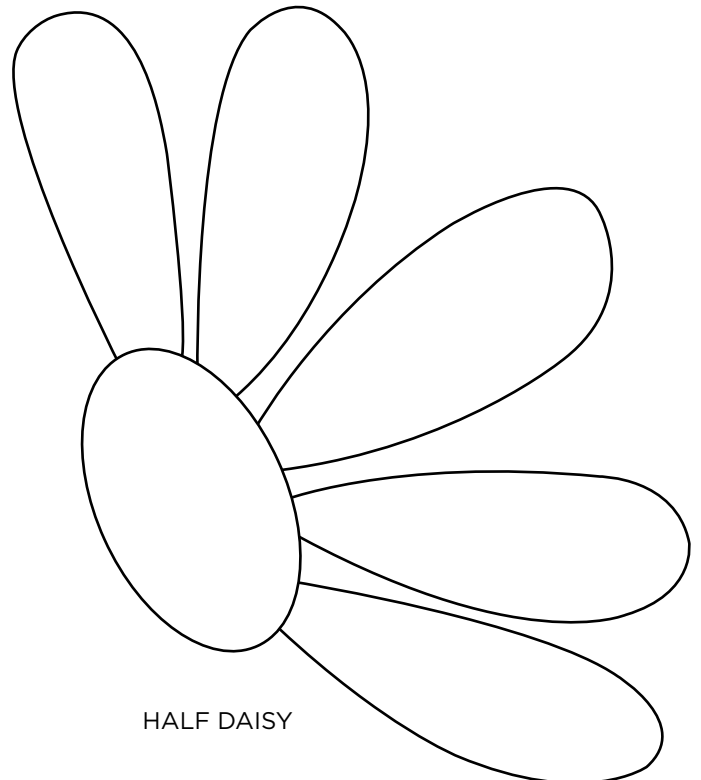

HALF DAISY

When printed
at the correct
size, this box
will measure
1in / 26mm
square

DANCING WITH DAISIES

Jo Colwill page 22

APPLIQUÉ TEMPLATES

ACTUAL SIZE

PLEASE NOTE: Appliqué templates DO NOT include seam allowances

Use a combination of these to build up your appliqué design, referring to the project diagrams

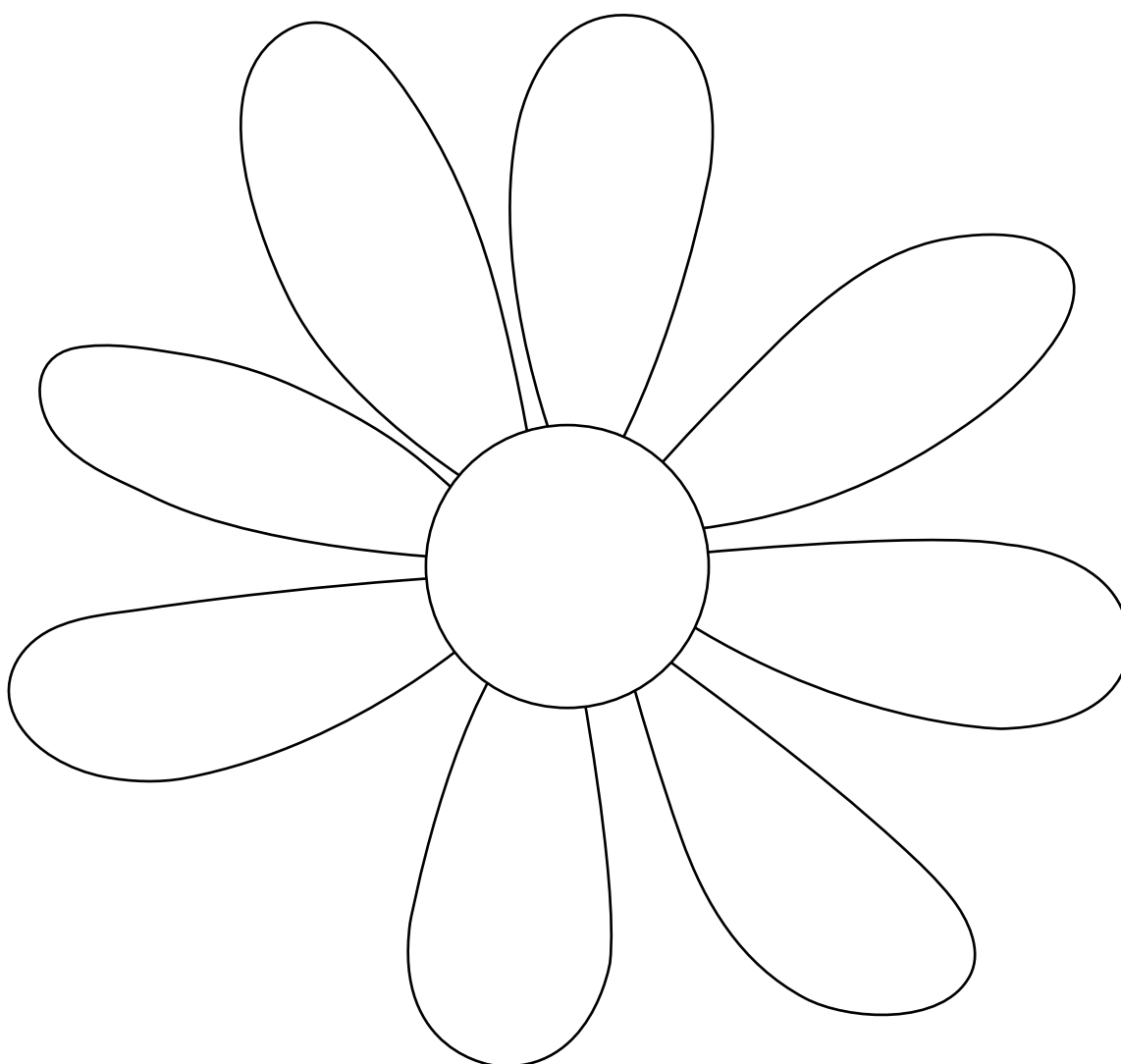

LARGE DAISY

When printed at the correct size, this box will measure 1in / 26mm square

QUILTER'S FRIEND

Mandy Shaw page 62

APPLIQUÉ TEMPLATES

ACTUAL SIZE

PLEASE NOTE: Appliqué templates DO NOT include seam allowances and have been reversed where necessary

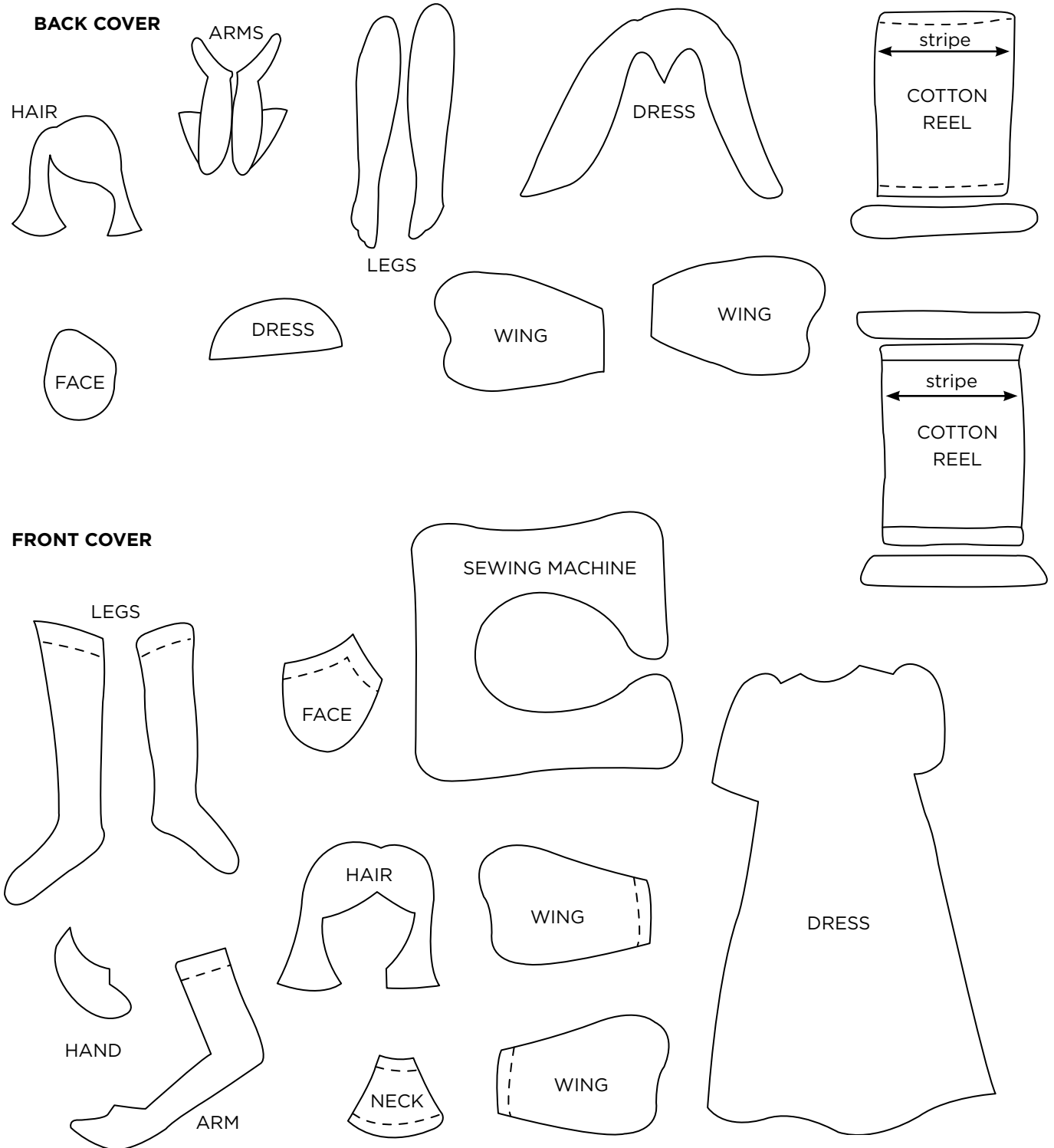

When printed at the correct size, this box will measure 1in / 26mm square

QUILTER'S FRIEND

Mandy Shaw page 62

APPLIQUÉ AND POCKET TEMPLATES

ACTUAL SIZE

PLEASE NOTE: Appliqué templates DO NOT include seam allowances and have been reversed where necessary

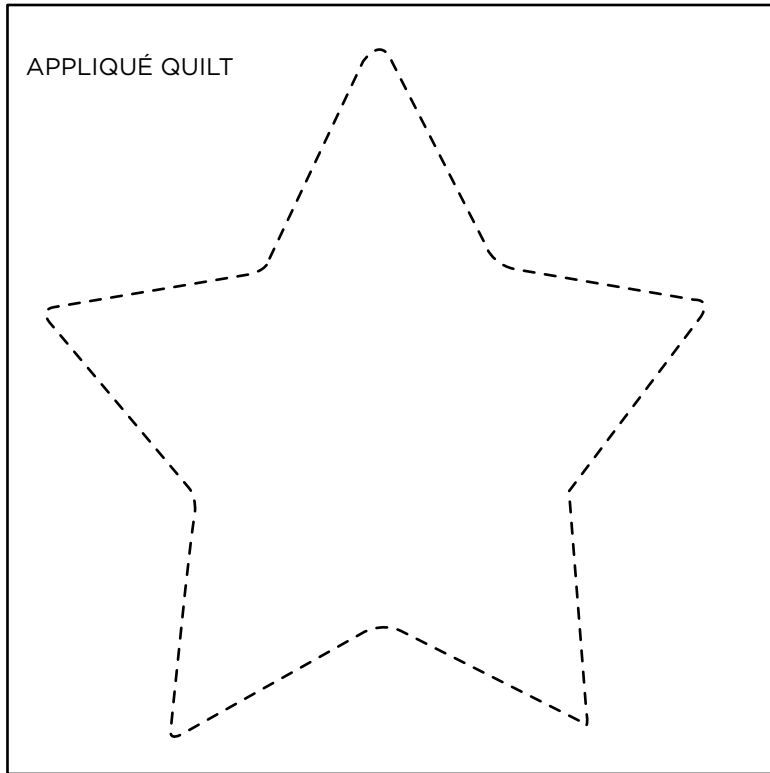

QUILT BORDERS

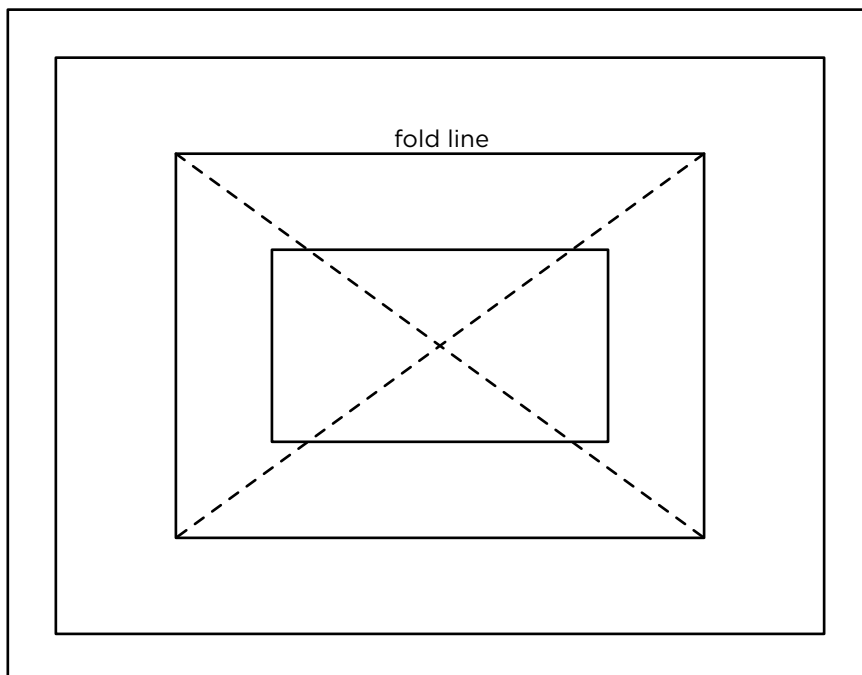
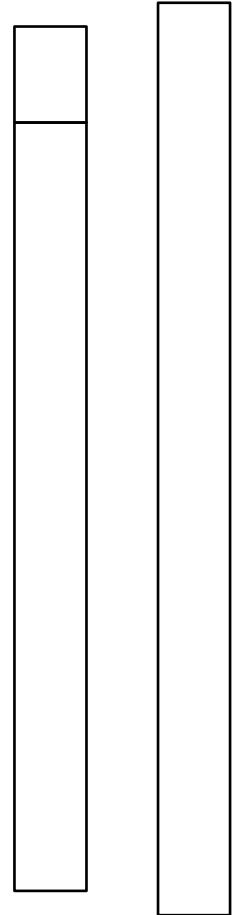

PHOTO HOLDER

When printed at the correct size, this box will measure 1in / 26mm square

QUILTER'S FRIEND

Mandy Shaw page 62

APPLIQUÉ AND POCKET TEMPLATES

ACTUAL SIZE

PLEASE NOTE: Appliqué templates DO NOT include seam allowances and have been reversed where necessary

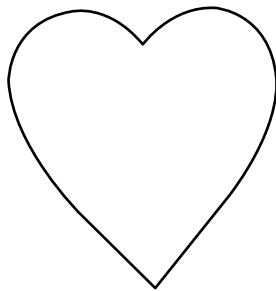

APPLIQUÉ
HEART

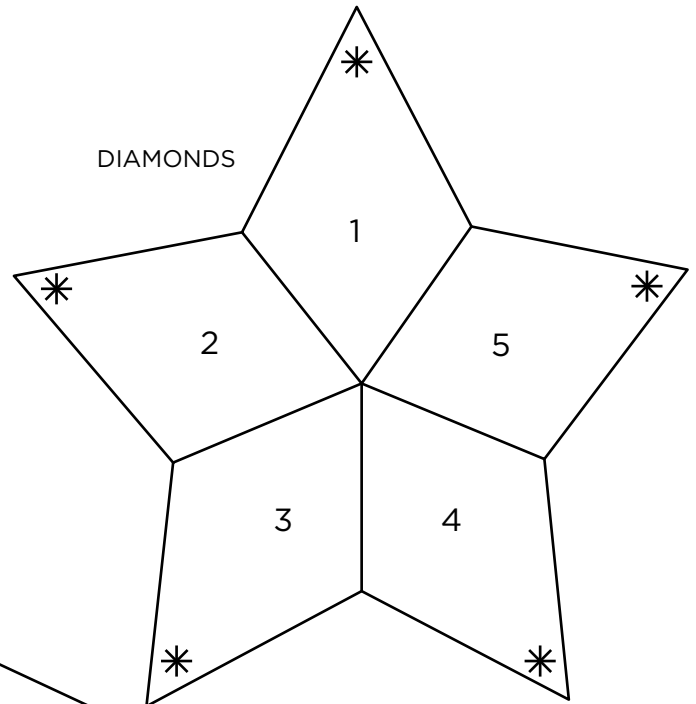

DIAMONDS

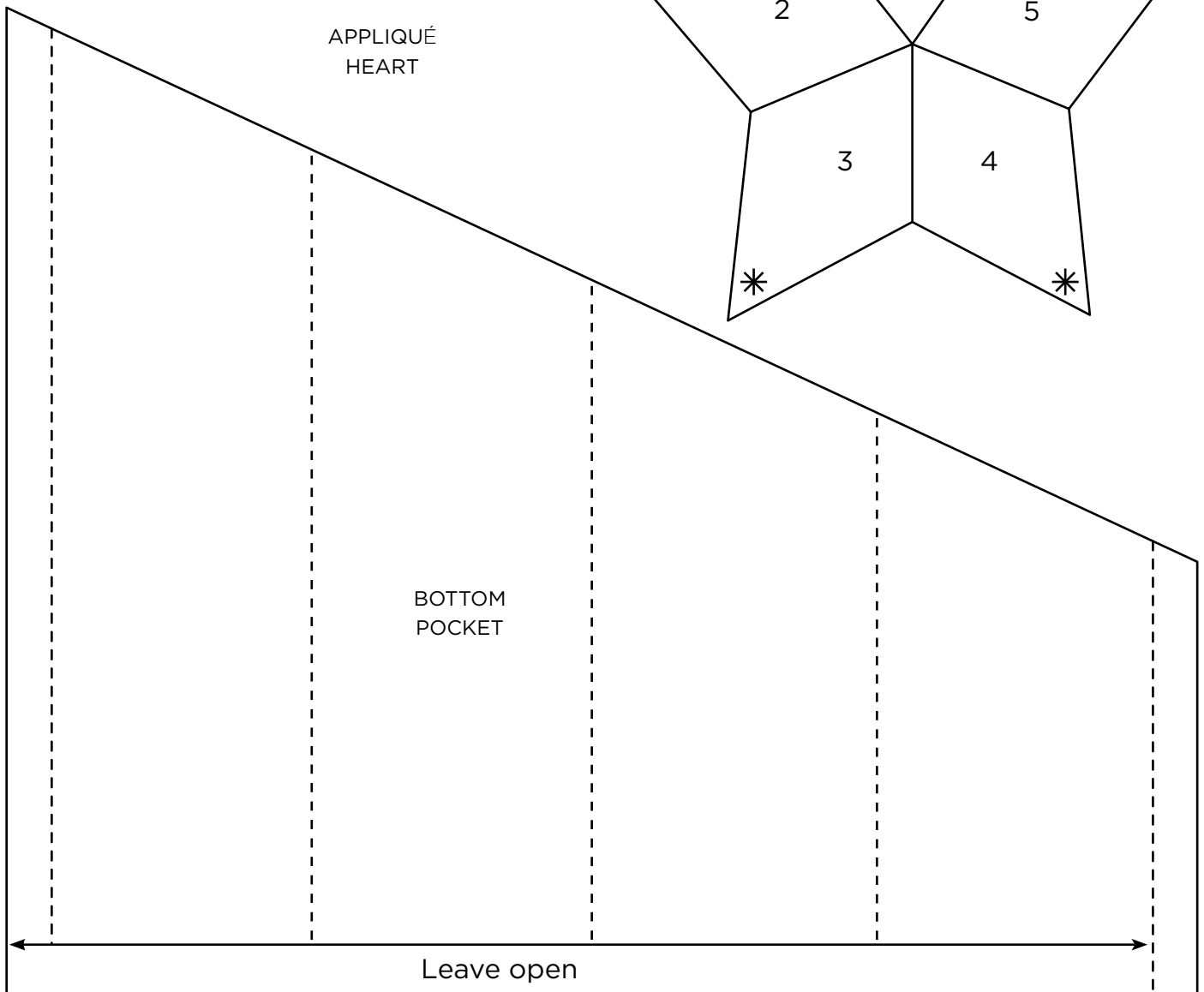

BOTTOM
POCKET

Leave open

When printed
at the correct
size, this box
will measure
1in / 26mm
square

QUILTER'S FRIEND

Mandy Shaw page 62

APPLIQUÉ AND POCKET TEMPLATES

ACTUAL SIZE

PLEASE NOTE:

Appliqué templates
DO NOT include seam
allowances and have been
reversed where necessary

APPLIQUÉ HEART
FOR NEEDLECASE

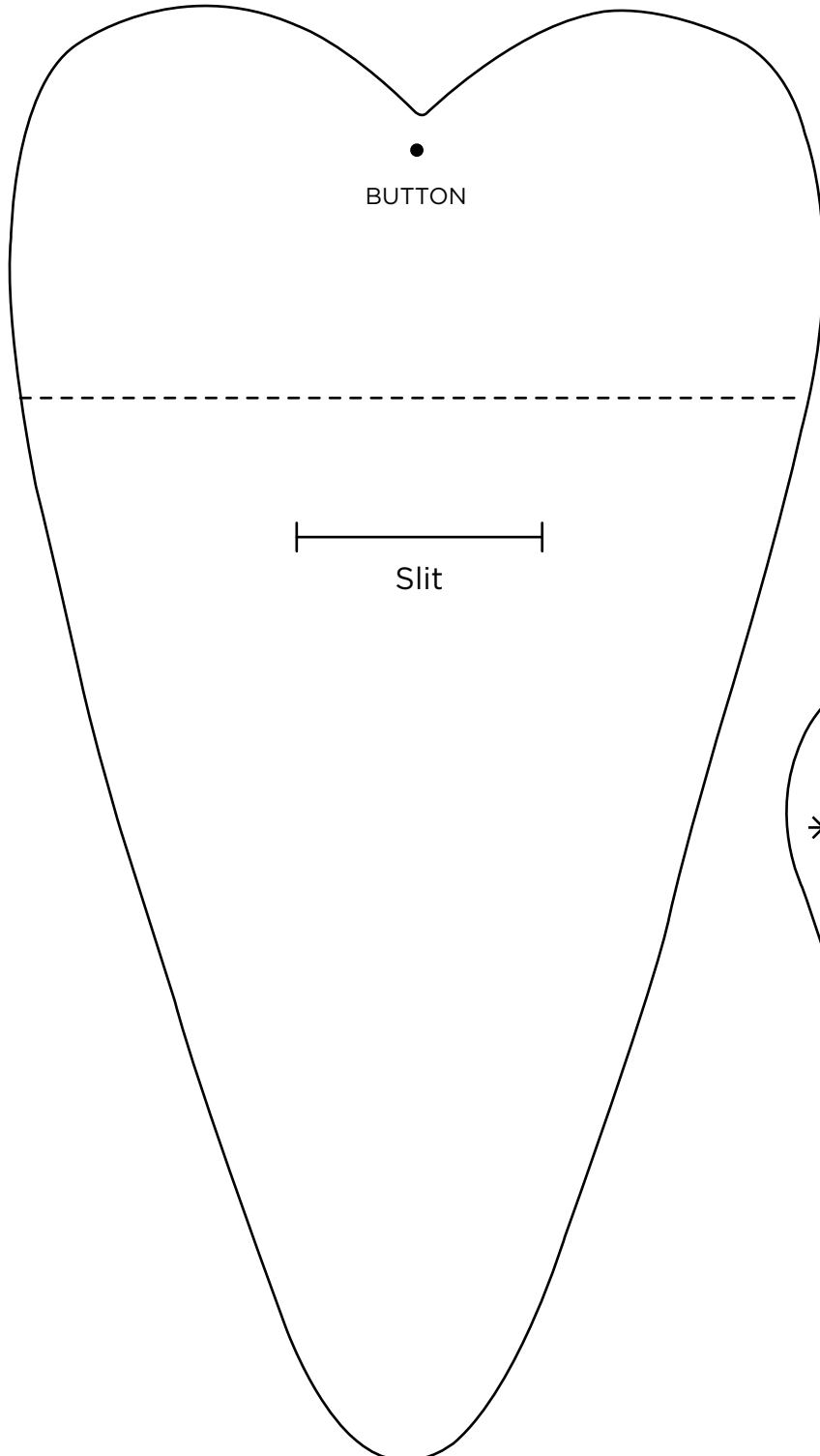
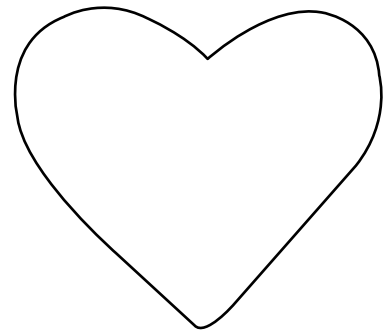

LARGE
SCISSOR KEEPER
HEART

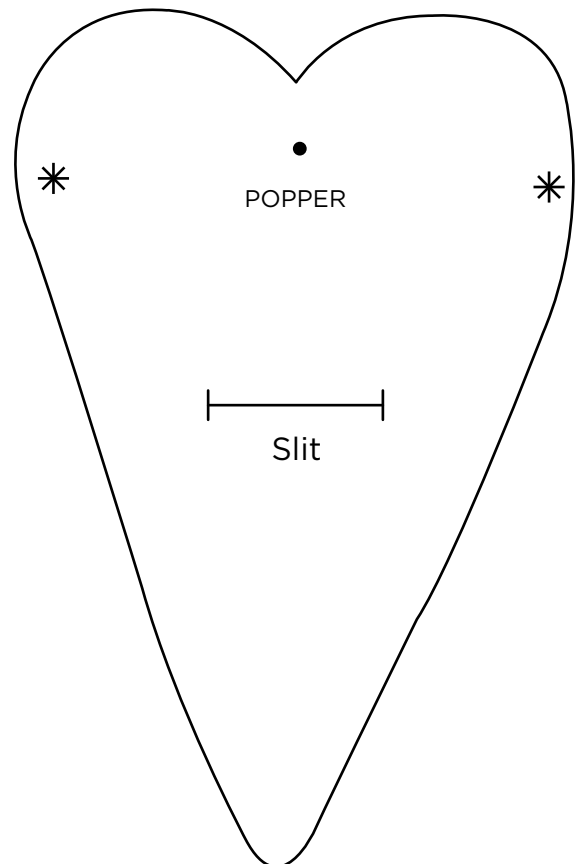

SMALL SCISSOR
KEEPER HEART

When printed
at the correct
size, this box
will measure
1in / 26mm
square

QUILTER'S FRIEND

Mandy Shaw page 62

APPLIQUÉ AND POCKET TEMPLATES

— —
ACTUAL SIZE

PLEASE NOTE: Appliqué templates DO NOT include seam allowances
and have been reversed where necessary

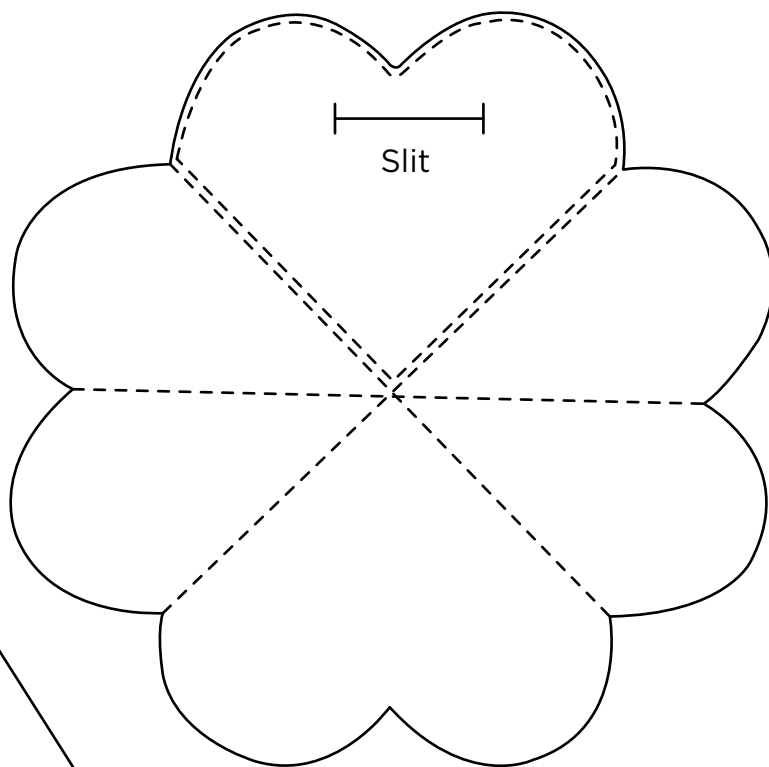

HEART NEEDLECASE

DIAGONAL POCKET
CUT ONE AND ONE
REVERSED

When printed
at the correct
size, this box
will measure
1in / 26mm
square

QUILTER'S FRIEND

Mandy Shaw page 62

APPLIQUÉ AND POCKET TEMPLATES

ACTUAL SIZE

PLEASE NOTE: Appliqué templates DO NOT include seam allowances
and have been reversed where necessary

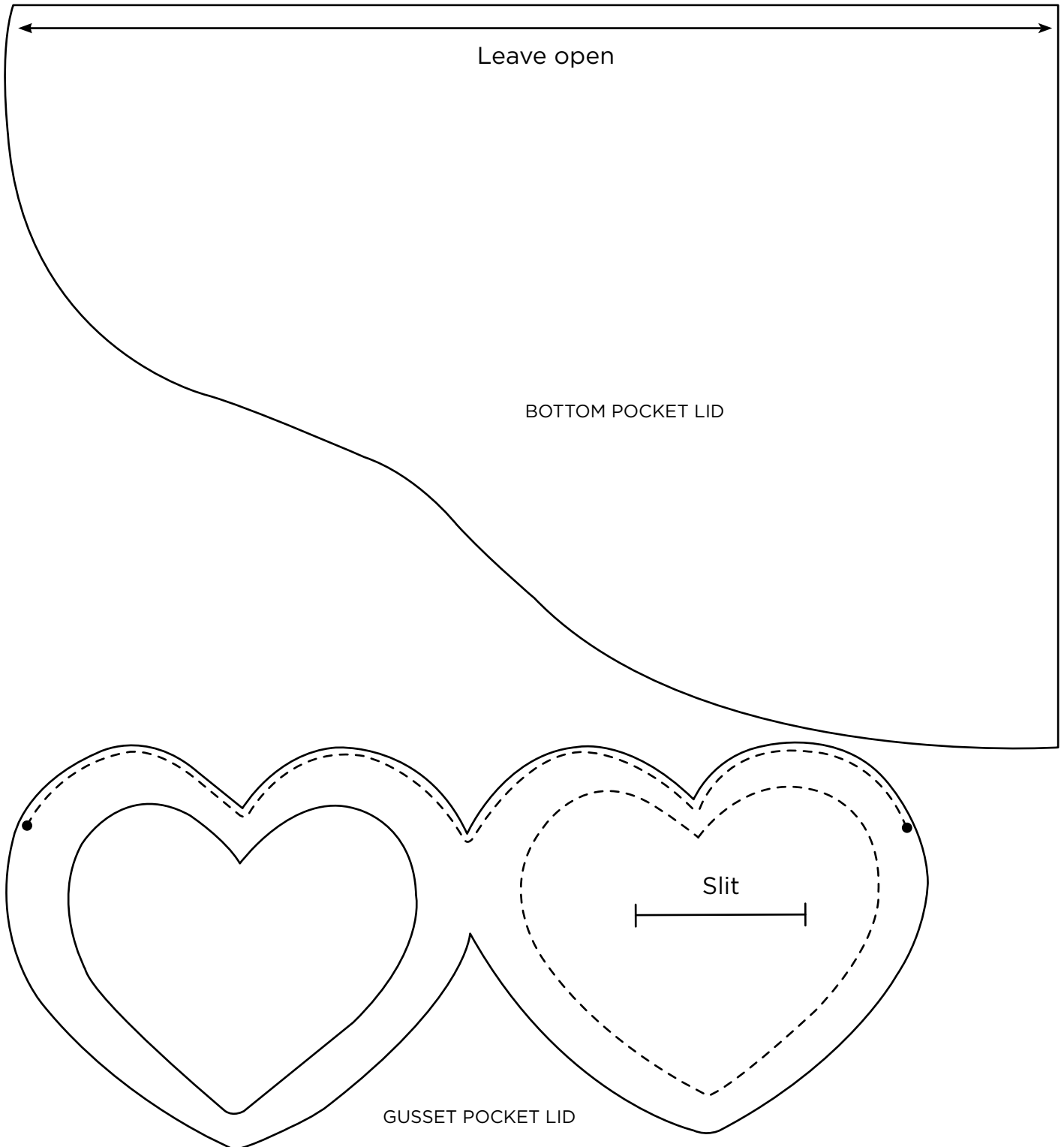

When printed
at the correct
size, this box
will measure
1in / 26mm
square

QUILTER'S FRIEND

Mandy Shaw page 62

APPLIQUÉ AND POCKET TEMPLATES

ACTUAL SIZE

PLEASE NOTE: Appliqué templates DO NOT include seam allowances
and have been reversed where necessary

ENVELOPE POCKET

