

UNCLASSIFIED



Australian Government
Department of Defence
Defence Science and
Technology Organisation

Investigation of using Radio Frequency Identification (RFID) System for Gear Tooth Crack Detection

Eric Lee

Aerospace Division
Defence Science and Technology Organisation

DSTO-TR-2983

ABSTRACT

This report examines the feasibility of using passive low frequency (LF) and high frequency (HF) radio frequency identification (RFID) systems as embedded sensors for early gear tooth crack detection. This study is part of the Divisional Enabling Research Program (DERP). The outcome is that Passive RFID systems are generally not suitable for gear tooth crack detection. However, a similar concept combining a tiny radio frequency transmitter with a vibration energy harvester system is proposed as an alternative to the RFID proposal.

RELEASE LIMITATION

Approved for public release

UNCLASSIFIED

UNCLASSIFIED

Published by

*Aerospace Division
DSTO Defence Science and Technology Organisation
506 Lorimer St
Fishermans Bend, Victoria 3207 Australia*

*Telephone: 1300 333 362
Fax: (03) 9626 7999*

*© Commonwealth of Australia 2014
AR-015-989
June 2014*

APPROVED FOR PUBLIC RELEASE

UNCLASSIFIED

UNCLASSIFIED

Investigation of using Radio Frequency Identification (RFID) System for Gear Tooth Crack Detection

Executive Summary

Vibration signal analysis is widely used to monitor condition of drive-train systems. Many health and usage monitoring systems (HUMS) manufacturers use various vibration algorithms, such as Synchronous Averaging, for gear crack detection in their system. However, the size of the crack needs to be significant before it can be detected in the vibration signal. The early detection of very small cracks requires a different approach.

A study was undertaken to assess the feasibility of using radio frequency identification (RFID) technology as a possible method for detecting small gear tooth cracks. The basic proposal is to extend the wire connecting the circuit board of the RFID tag with its antenna and bond this wire along the periphery of the gear to form a loop. Power for the tag is transmitted wirelessly via a RFID reader, which also acts as a receiver. Detection occurs when the wire loop is broken by a crack and the tag ceases to function; i.e. lost transmission signifies the probable presence of a gear tooth crack.

Due to budget constraints, the feasibility study was limited to a review of the literature. No physical trials of RFID equipment were conducted. RFID systems in the low frequency (LF) and high frequency (HF) ranges were targeted as they are relatively insensitive to environment effects. However, it was found that wireless communication distances shrink dramatically when placed in metal-rich environments, even with large purpose-designed antennas. Consequently, it is concluded that RFID systems are unlikely to be successful as gear crack detection sensors.

As a result of the study, it is recommended that an alternative concept using a miniature radio transmitter with a vibration energy harvester in place of the RFID system. The crack detection processes would essentially remain the same in this system; i.e. when a crack breaks the wire loop that links the radio transmitter with the energy harvester, the loss of transmission would signify the probable presence of a crack. However, the feasibility of using a tiny radio transmitter and energy harvester would require further detail investigation that is not covered in this study.

UNCLASSIFIED

UNCLASSIFIED

This page is intentionally blank

UNCLASSIFIED

UNCLASSIFIED

Author

Eric Lee

Aerospace Division

Dr. Eric Lee is a research scientist with more than 10 years experience in health and usage monitoring systems (HUMS). He joined DSTO in 2002 while completing his Masters by Research degree. His initial work at DSTO was in support of HUMS in helicopters, however in 2004 his focus shifted to HUMS issues related to propulsion systems. He commenced a PhD research degree in 2004, which he subsequently obtained in 2007. Dr. Lee's most recent work involved review of HUMS Validation Plan and Independent Verification & Validation of HUMS on ADF aircraft.

UNCLASSIFIED

UNCLASSIFIED

This page is intentionally blank

UNCLASSIFIED

Contents

ABBREVIATIONS

1. INTRODUCTION.....	1
2. RFID.....	2
2.1 Passive RFID.....	2
2.2 Environmental Effects.....	4
2.3 Costs	6
3. GEAR TOOTH CRACK DETECTION SENSOR	7
3.1 Concept	7
3.2 Selecting an Appropriate RFID System.....	8
3.3 Investigation Areas.....	9
4. LITERATURE REVIEW FINDINGS	11
5. ALTERNATIVE TECHNOLOGIES.....	15
6. CONCLUSION	18
7. REFERENCES	19

UNCLASSIFIED

DSTO-TR-2983

This page is intentionally blank

UNCLASSIFIED

Abbreviations

COTS	Commercial off-the-shelf
DERP	Divisional Enabling Research Program
EM	Electromagnetic
HF	High frequency
HUMS	Health and usage monitoring systems
LF	Low frequency
PCB	Printed circuit board
RF	Radio frequency
RFID	Radio frequency identification
UHF	Ultra high frequency

UNCLASSIFIED

DSTO-TR-2983

This page is intentionally blank

UNCLASSIFIED

1. Introduction

Vibration signal analysis for gear crack detection is a popular method endorsed by many health and usage monitoring system (HUMS) manufacturers. Analysis algorithms such as Synchronous Averaging have proven to be very reliable [1, 2], but still require sizeable damage to be present before a crack can be detected. To be able to detect a gear crack earlier, a different approach must be explored. One possible approach is to use embedded radio frequency identification (RFID) sensors.

RFID usually refers to a whole system, which consist of three main parts: RFID tag, RFID reader, and a computer. Figure 1 shows a basic schematic representation of a complete RFID system. RFID tags are small electronic devices that consist of a small chip and an antenna [4]. RFID tags fall into two basic categories: Passive and Active. Passive tags do not have batteries and have indefinite life expectancies. Active tags are powered by batteries where the batteries are either recharged or replaced. Active tags are generally larger than the passive tags. RFID products are also categorised into different frequencies. Tags and antennas are tuned or matched much the same way as a radio is tuned to a frequency to receive different channels. These frequencies are grouped into four basic ranges: low frequency (LF), high frequency (HF), very high frequency (VHF), and ultra high frequency (UHF). Table 1 shows the categorisation of RFID frequency ranges.

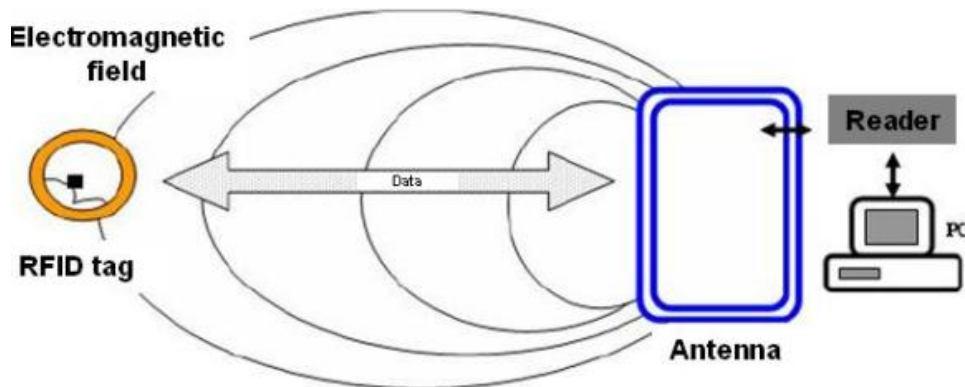

Figure 1 Basic schematic of complete RFID system [3]

Table 1 RFID Frequency Ranges [5]

		RANGE	RFID USES
LF	LOW FREQUENCY	30 kHz. to 300 kHz	125 kHz.
HF	HIGH FREQUENCY	3MHz. to 30 MHz.	13.56 MHz.
VHF	VERY HIGH FREQ.	30 MHz. To 300 MHz.	Not used for RFID
UHF	ULTRA HIGH FREQ.	300 MHz. To 3GHz.	868 MHz., 915 MHz

This study investigated the feasibility of using passive RFID for gear tooth crack detection. The proposal for this type of sensor is to modify the wire connection between the tag chip and the tag antenna where the wire follows the contour of the gear. When a tooth crack

breaks the modified wire connection, the RFID tag will stop transmitting to the RFID reader and the crack will be detected.

2. RFID

2.1 Passive RFID

This feasibility study is focusing on the use of passive RFID as a gear crack detection sensor. The passive RFID system usually consists of three components: an interrogator or reader, a passive tag, and a host computer system. The passive tag is constructed with an antenna and a silicon chip that includes basic modulation circuitry and non-volatile memory. The tag is energised by a time-varying electromagnetic (EM) radio frequency (RF) wave that is transmitted by the reader. This RF signal is called a carrier signal. Figure 2 shows an electromagnetic carrier signal, where the electric and the magnetic fields are orthogonal and quasi-static.

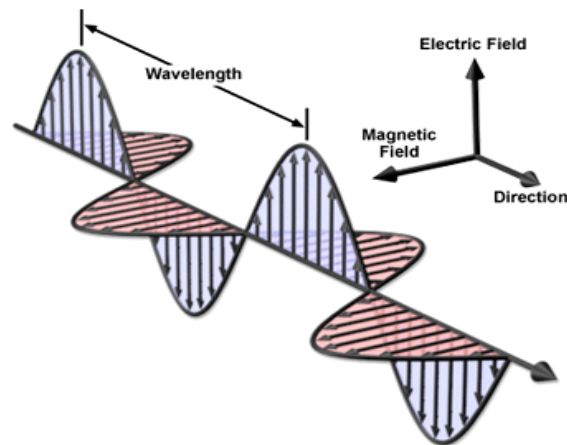

Figure 2 Electromagnetic Wave [6]

At present, there are two main types of RFID systems on the market: Near-Field coupling and Far-Field coupling. Near-Field coupling techniques are generally applied to RFID systems operating in the LF and HF bands (less than 100 MHz) with relatively short read distances. The EM field in the near-field region is reactive in nature. Information can be passed through the electric field using a dipole antenna, or through the magnetic field using a coil/loop antenna. Most Near-Field tags rely on the magnetic field passing through the inductive coil or loop in the tag. When the electronics within the tag apply a variable load to the coil or loop, a signal can be encoded as tiny variations in the magnetic field strength representing the tag's identity. The RFID reader can then recover this signal by monitoring the change in current through the reader's antenna. This technique is commonly referred to as load modulation [7]. Figure 3 shows a typical power and communication diagram of a Near-Field RFID system.

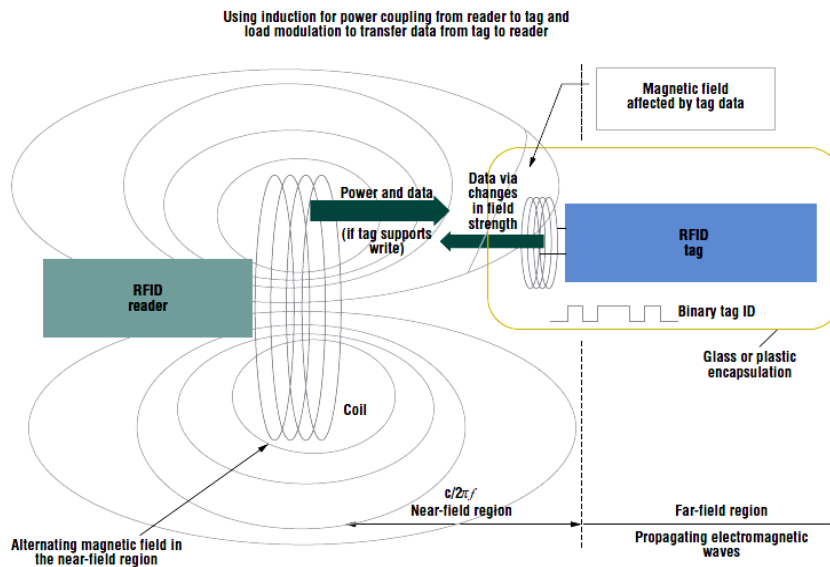

Figure 3 Near-Field power/communication mechanism for RFID tags operating at less than 100 MHz [8]

The EM field in the Far-Field region is radiative in nature. Coupling here captures EM energy as a potential difference at the tag's (dipole) antenna. Some of the energy incident on the tag's antenna is reflected back due to an impedance mismatch between the antenna and the load circuit. By changing the antenna's impedance over time, the tag can reflect back an energy pattern that corresponds to its own identity. This impedance mismatching technique is called backscattering [7]. As a general rule, tags that use Far-Field coupling operate with an EM field in the UHF band [8]. Far-Field RFID is typically used for ranges greater than 3 meters. Figure 4 shows a typical power and communication diagram for a Far-Field RFID system.

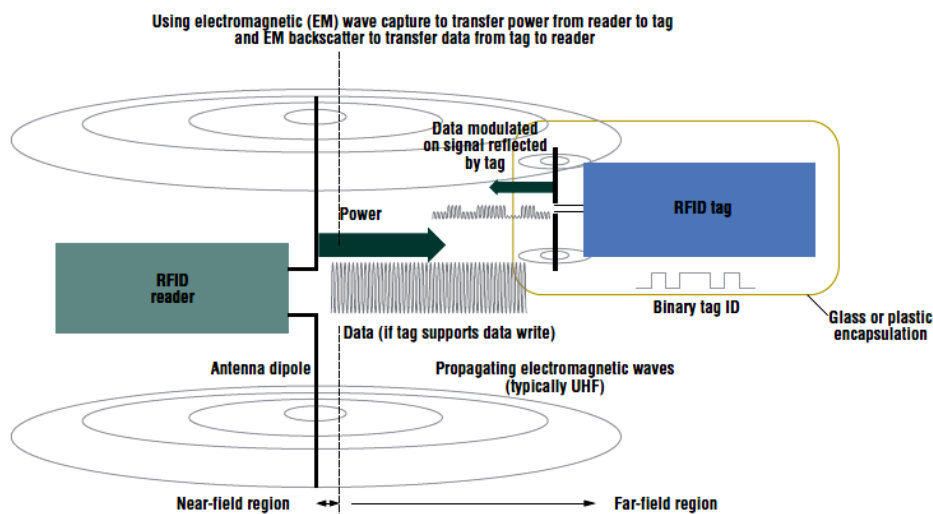

Figure 4 Far-Field power/communication mechanism for RFID tags operating at greater than 100 MHz [8]

As mentioned, Near-Field RFID systems generally use the LF and HF bands, and Far-Field RFID systems generally use the UHF band. A lesser known UHF RFID system that operates in the Near-Field region, called the Near-Field UHF RFID system, is getting more attention in recent years [9]. The basic concept of Near-Field UHF RFID is to use UHF frequencies (higher data transfer rate) in the near-field region and make these systems less susceptible to their surroundings. The coupling mechanism in Near-Field UHF RFID can be either magnetic or electric, depending on the particular reader antenna used and the type of environment in which it will operate. A number of companies offer Near-Field UHF RFID systems for item-level tagging, but most of these are derived from existing Near-Field and Far-Field systems. Those derived from existing Far-Field UHF RFID systems face problems such as the unintentional pickup of other tags in the far-field region. Those derived from existing Near-Field RFID systems tend to have better performance, but are more expensive since a special new reader antenna and tag antenna need to be developed [10]. Compared to existing Near-Field and Far-Field RFID systems, the Near-Field UHF RFID system is not as mature and still in development.

2.2 Environmental Effects

LF and HF RFID tags (i.e. those operating below 100 MHz and in the Near-Field region) have lower data transfer rates than UHF tags. However, they are less affected by environmental changes. For instance, a HF RFID tag can generally be used on an object with liquid content, but an UHF RFID tag cannot. If an UHF RFID system is used, the tag may be unreadable or the read distance will be severely reduced [11].

All RFID tags suffer performance degradation when used in a metal-rich environment. However, Near-Field (LF and HF) RFID systems perform better than UHF systems around metal. The radio waves do not bounce-off metal surfaces as easily in the case of Near-Field systems, causing fewer false readings [12]. In Far-Field (UHF) RFID systems, the radio waves are either scattered or absorbed by the metal structures.

Passive RFID tags obtain their energy from the interrogation fields generated by the RFID reader antenna. It is very important that optimal transfer of energy occurs during the interrogation between the reader and the tag. If the energy transfer is disrupted, causing an insufficient interrogation field to reach the tag, then the passive tag will not be readable or the read distance will be significantly reduced. In general, the presence of metal will cause various disruptions to the interrogation RF fields [11, 13].

For Near-Field systems less than 100 MHz, the antennas used for both reader and tag are generally based on a coil or loop design. To achieve wireless communication between the reader and the passive tag, the reader's RF magnetic flux loops must reach the passive tag antenna and vice versa as shown in Figure 5a. When the RFID passive tag or the reader is situated on a metallic surface, the antenna will be positioned near the metal. Eddy currents occur within the metal in the vicinity of the antenna due to reader or tag antenna magnetic flux. These eddy currents also produce a magnetic field (called a demagnetising field) that deflects the magnetic flux necessary for communication, as show in Figure 5b [14, 15].

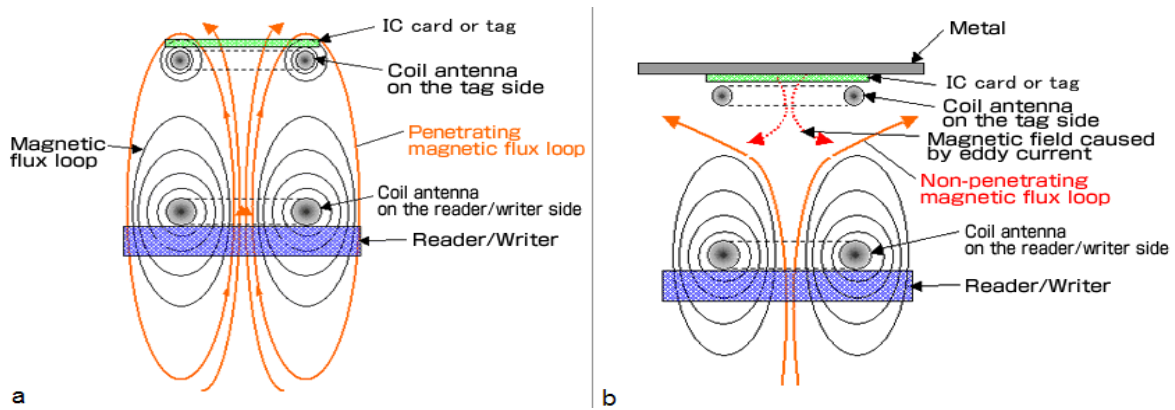

Figure 5 Communication condition without (a) and with (b) metal surface [14]

For Far-Field RFID systems over 100 MHz, the antennas used for both reader and tag are typically based on an electric dipole design. When an electric dipole antenna is placed near a metallic surface, it suffers a significant change in its impedance. The change of impedance detunes the antenna (it affects the resonant frequency of the antenna). Consequently, the energy transfer from the RFID reader to the tag or vice versa, is severely reduced. When less energy is transferred, the amount of power transferred is also reduced, which in turn affects the read range of the system. Placing a dipole antenna near a metallic surface also causes changes to other antenna parameters such as the directivity and the radiation pattern of the antenna [10]. Figure 5 shows a test result of placing five different commercial off-the-shelf (COTS) UHF RFID tags near a metal surface separated by non-metallic spacer layers. As shown in Figure 6, when the number of spacer layers is equal to two or less the read range is zero.

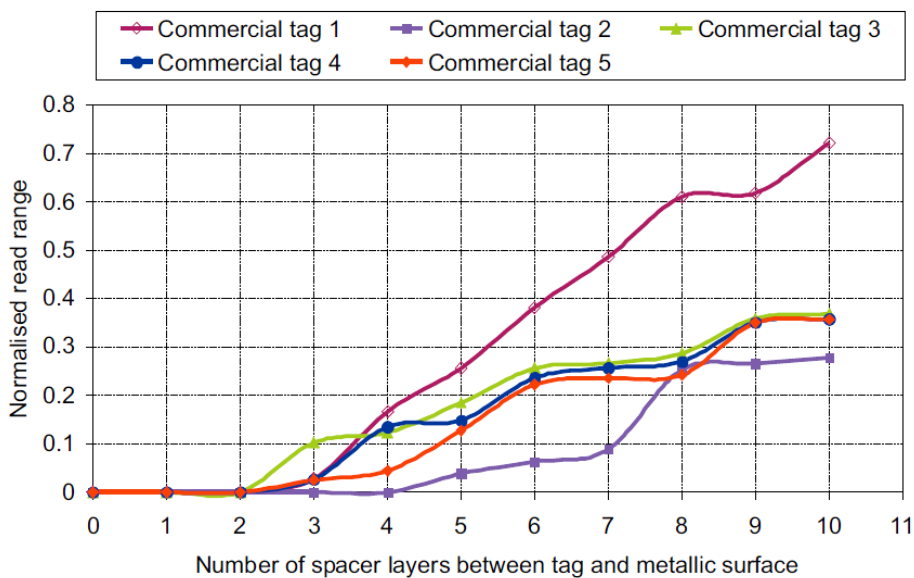

Figure 6 Read range results of COTS passive UHF RFID tags placed against a metal surface and separated by spacer layers (each layer is 0.8 mm) [11]

2.3 Costs

Tags and readers are generally the main up-front cost components of implementing an RFID system. However, the full cost of employing an RFID system also depends on the application and physical protection required (such as a housing to protect the tag/reader from heat, cold, and chemicals). To make a general comparison between the LF/HF RFID system (Near-Field) and the UHF RFID system (Far-Field), a brief look into the cost of the tag is conducted first. UHF tags in general cost less than the LF/HF tags due to simpler manufacturing process [16]. LF/HF tags incorporate more copper material in their antenna assembly, thus resulting in higher tag costs [17]. Furthermore, a typical HF tag loop antenna generally consists of two layers of many turns of etched copper that is difficult and expensive to manufacture [18]. Conversely, UHF tag antennas are generally smaller and consist of only one layer of conductive ink that is easier to produce [19]. Depending on the type, manufacturer, and quantity, passive HF RFID tags typically cost around \$1.00 each and passive UHF tags typically cost around \$0.50 each [20]. Figure 7 shows one example of a LF tag (a), one example of a HF tag (b), and one example of an UHF tag (c). It is obvious that the UHF RFID tag antenna has a much simpler structure than the LF/HF RFID tag antennas.

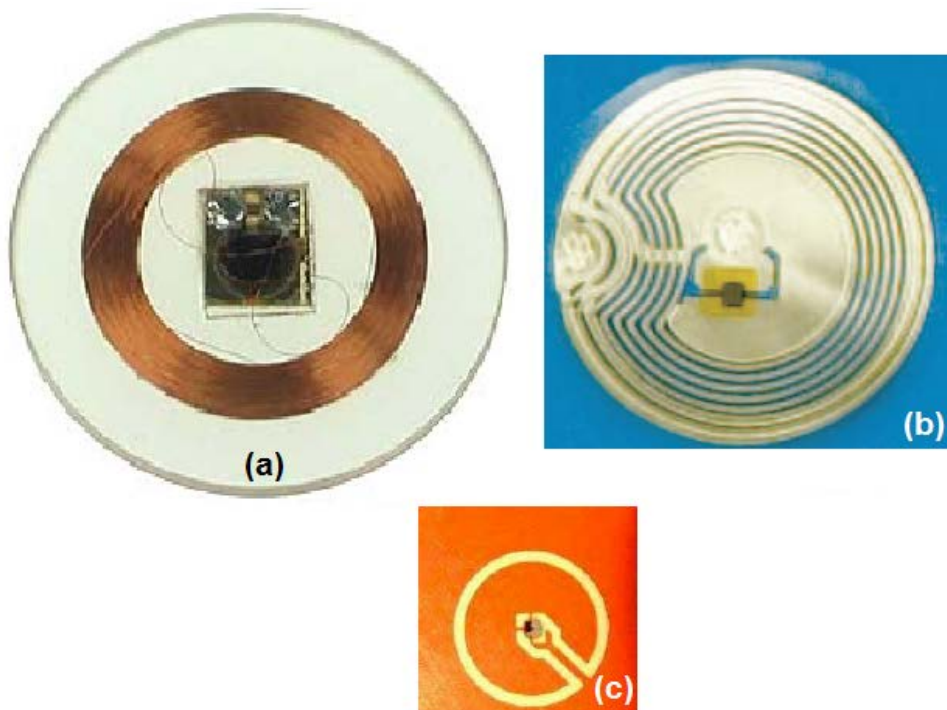

Figure 7 (a) LF passive RFID tag 30 mm in diameter, (b) HF passive RFID tag 24 mm in diameter, (c) UHF passive RFID tag 9 mm in diameter [17, 18, 19]

The RFID reader is the second major up-front cost component for an RFID system. The cost of a reader depends on its features and functionality. In many cases, purchasing a reader may not include the price of antenna and cabling. Dumb readers are generally cheaper but only have limited computing power. Intelligent readers are considerably more

expensive, as they are capable of filtering data, storing information, and executing commands. The price of HF and UHF RFID readers can range from \$500 to \$3000 depending on the function and frequency range required [16, 21]. Generally, the LF/HF RFID readers are cheaper than the UHF RFID readers as they use more established technology and less complexity in the reader design. Table 2 shows a brief summary of costs and technologies comparison between LF, HF and UHF RFID systems.

Table 2 Comparison of LF, HF and UHF RFID technologies [22]

	Low frequency (LF)	High frequency (HF)	Ultra High frequency (UHF)
Frequency Range:	125 kHz, 134.2 kHz	13.56 MHz (Global)	865 - 928 MHz (Regionally dependent)
Data transmission rate:	Slow data transmission rate	Higher data read rate than LF tags	Fast data transmission rate
Multiple reads capability:	Usually only single reads	Good	Excellent multiple reads capability
Tag Cost:	Relatively expensive	Varies depending on type of tag	UHF tags can be very low cost (at high volumes) due to the simpler manufacturing process.
Reader Cost:	Lower (more established technology)	Lower (more established technology)	Higher (newer and more complex technology)
Reader Antenna size:	Short-range mobile LF readers require only a small antenna	Short-range mobile HF readers require only a small antenna	Mobile UHF reader antennas are relatively large, reduced antenna sizes can be used if compromising on read range
Tag memory capacity:	Smaller memory sizes in comparison to passive HF RFID tags	Capable of relatively high memory capacity, typically 256 bits to 8 Kbytes	Smaller memory sizes in comparison to passive HF RFID tags, typically 96 bits to 1 Kbits

3. Gear Tooth Crack Detection Sensor

3.1 Concept

The concept of using a passive RFID tag as a gear tooth crack detection sensor requires the modification of the wire connection (Wire Bridge) between the RFID tag chip and the tag antenna, where the modified wire follows a section of the gear tooth contour. Figure 8 shows the concept of using multiple passive RFID tags as embedded tooth crack detection sensors. The wires shown in black are the modified connection between the tag chip and the tag antenna. Figure 8 is only shown for illustration purpose; the tags are neither in scale nor in an optimum arrangement. A tooth crack will be detected when the crack breaks the modified wire connection and the RFID passive tag ceases to function; i.e. the tag loses its ability to wirelessly communicate with the RFID reader. A loss of communication between the RFID tag and reader during gear meshing operation will signify the possible existence of a tooth crack.

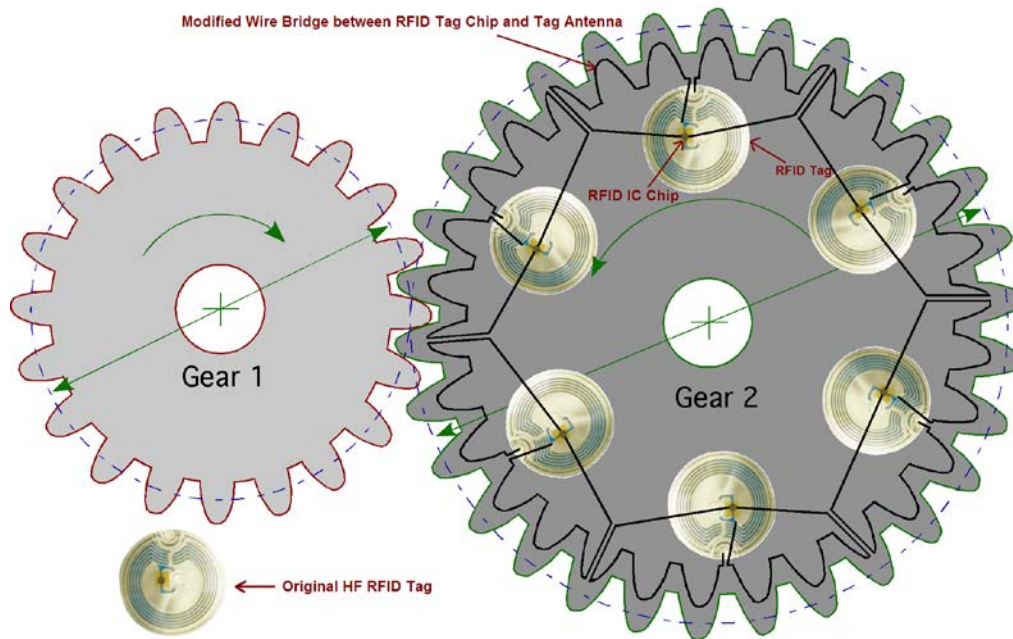

Figure 8 Concept of using passive RFID tags as embedded gear tooth crack detection sensors (tags are not in scale with the meshing gear)

3.2 Selecting an Appropriate RFID System

Choosing an ideal passive RFID system as a crack detection sensor will be difficult. There really is no such thing as a typical RFID system. The communication range between the reader and the tag is a balancing act between a number of engineering tradeoffs and ultimately depends on many factors. Factors that should be considered when selecting an RFID system are usually related to the tag and the reader antenna design. The following bullet points illustrate some of the common considerations when choosing an RFID system [23].

- Frequency Band: Depends on the regulations of the country where RFID system will be used.
- Size and Form: The tag needs to be able to be attached or embedded to the subject of interest.
- Read Range: Need to determine the minimum read distance required.
- Objects: RFID system performance changes when it is placed on different objects. Both the reader and tag antennas need to be tuned when they are applied on metallic objects. The current proposal is for metal gear tooth crack detection, therefore the RFID tag and antenna will be operating in a metal-rich and enclosed environment.
- Orientation or Polarisation: The orientation of the tag antenna with respect to the polarisation of the reader's EM field can have significant impact on the communication or the read distance. Mismatched orientations can easily cause 50 percent reduction in the read distance. For some RFID systems a 90 degree mismatch between the reader and the tag antennas will cause total loss of

communication. In most cases the best orientation is when the tag and the reader antennas are parallel to each other.

- Motion: RFID systems can be used in situations where the subjects are travelling on a conveyor belt at a certain speed. When compared to the static application, moving tags spend less time in the read field and require a higher read-rate capability. With the current proposal, the RFID tags mounted on the surface of the gear will be rotating with the gear, while the RFID reader antenna will be fixed at a stationary position where the tags pass directly underneath.
- Reliability: The RFID reader and tag must be able to sustain variations in temperature, humidity, and stress, as well as surviving such processes as insertion and lamination onto the gear.

As mentioned in the Section 2.2, higher RFID frequencies (i.e. more than 100 MHz, such as UHF) are more prone to environmental effects. RFID systems with higher frequencies have more difficulty penetrating dielectric materials such as liquids. Furthermore, higher RF frequencies are more easily deflected by metal surfaces. In terms of costs, although a UHF tag will cost less than a LF/HF tag, the UHF reader may cost many times more than the LF/HF reader due to its complexity. Considering the cost implications and the susceptibility of the UHF RFID to environmental effects, this feasibility study targets the LF/HF RFID systems (less than 100 MHz) for potential use as a gear tooth crack detection sensor. Lower-frequency RFID systems can be made inexpensively and have fewer problems with materials, but generally require larger antennas and higher RF power [24]. RFID tag size and read distance are also of prime concerns for a tooth crack detection sensor. The remaining sections of this feasibility study will investigate whether it is possible to maintain the minimum read distance required while selecting a tag size that can be fitted onto the surface of a meshing gear as shown in Figure 8.

3.3 Investigation Areas

This feasibility study focuses on the modification of an existing COTS passive RFID system for the purpose of gear tooth crack detection. The best RFID system for the crack detection in a metal-rich environment would unquestionably be a tailored system. However, a tailor-made RFID system requires significant effort in research and development and is beyond the scope of this study.

The main area of investigation of using LF/HF RFID systems as the tooth crack detection sensor is the modification of the wire connection between the tag antenna and the tag chip. This modification is likely to upset the impedance match between the antenna and the chip. Preliminary tests should be conducted to check the sensitivity of the passive tag due to the wire connection alteration. These preliminary tests can be done using an RFID experimenters' kit such as the one produced by Trossen Robotics [25]. This kit includes multiple LF passive tag types and a reader. Figure 9 shows an example of a modified wire connection configuration and the original LF passive tag. During the preliminary examination, the effect of various wire connection configurations (i.e. shapes and sizes) should be tested and the implications understood. If a slight alteration of the wire

connection causes a significant impact on the tag performance, then the concept of using LF/HF RFID systems as gear tooth crack sensor will not be feasible.

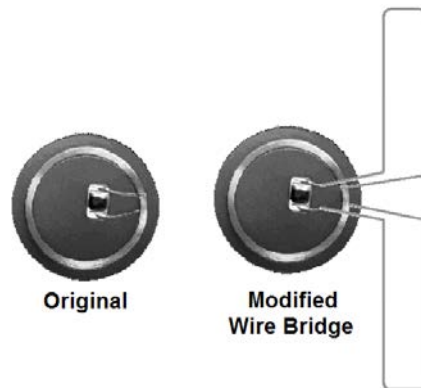

Figure 9 Original LF passive RFID tag and modified wire connection LF Passive RFID tag

If the alteration of the wire connection still permits satisfactory LF/HF tag performance, then a wire connection breakage trial needs to be conducted. The idea of using a passive RFID tag as a tooth crack detection sensor is for the crack to break the modified wire connection. It is anticipated that once the crack growth surpasses any section of the wire connection it will split the wire. A wire connection breakage trial has two main purposes: first, whether the wire breaks when the crack passes underneath it, and second, whether the wireless communication between the reader and the tag ceases to function when the wire breaks.

If the wire connection breakage trial does corroborate the two main purposes mentioned, the next course of investigation is a sensitivity test for the modified RFID tag on a metal surface. As mentioned in Section 2.2, a metal-rich environment will cause the RF to deflect, vary the radiation patterns, and alter the radiation directivities of the antennas. The most common way to alleviate these effects is to insert a magnetic layer in between the metal surface and the passive tag as shown in Figure 10. An investigation is required to see whether this magnetic solution can retain the necessary read distances for the modified passive tag. It is likely that epoxy resin will be used to bond the passive RFID tag onto the surface of the metal. Mixing magnetic particles into the epoxy resin may create the necessary magnetic layer required, and this approach should be investigated.

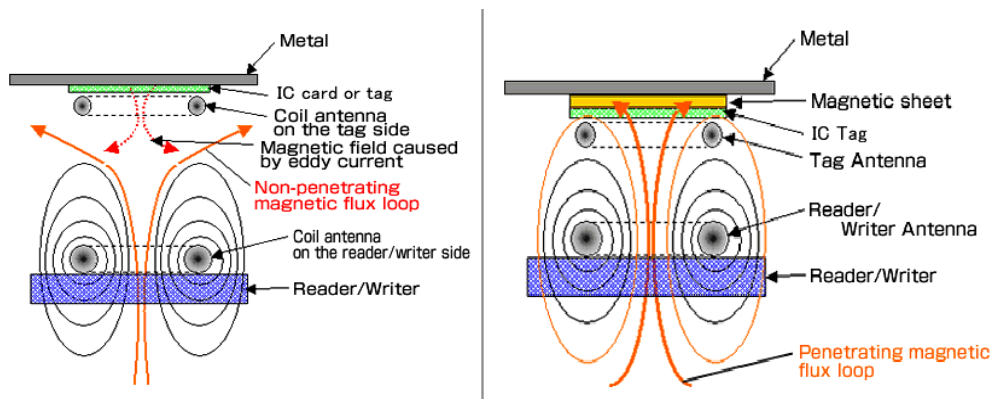

Figure 10 Passive RFID system without magnetic sheet insert (left) and with magnetic sheet insert (right) [14]

For a LF/HF RFID system to act as a gear tooth crack detection sensor, it must be able to work in a typical gearbox environment. In the case of a helicopter transmission system, the temperature within the gearbox, when running at 100 percent load, could reach as high as 100 degrees Celsius. Most of the COTS LF/HF passive tags only have maximum operational ranges in between 60 to 70 degrees Celsius [26]. To overcome the temperature issue a special durable flame retardant laminate material could be used. The HF RFID tag 113020 made by GAO RFID Inc. [26] uses such a durable laminate as the enclosure and can endure temperatures up to 200 degrees Celsius in oil, high humidities, and pressures up to 15-bar. The durable laminate material also allows the tag to withstand vibration and mechanical shock, as well as to be resistant to chemical hazards such as sulphuric acid and salt water. The use of such a durable enclosure needs to be investigated, especially its affect on the performance of the RFID system.

The last area of investigation should be the gear surface bonding of the modified RFID tag. In the case of an aircraft gearbox, the meshing gears within the gearbox are not subject to periodic inspection. Therefore, once the modified RFID tags are integrated within the gearbox, they have to stay intact for the life of the gearbox. In order to maintain a low false-alarm rate, a method that permanently bonds the modified RFID tags on the surface of the gear needs to be established.

4. Literature Review Findings

Due to budget cuts, the experimental tests mentioned in Section 3.3 could not be performed and the feasibility of using RFID tags as crack sensors could only be evaluated through a review of literature. As previously mentioned, the main drawback of using an RFID tag as a gear crack detection sensor is its incompatibility with metal structures. For this reason, the literature review focused on reports that illustrated successful RFID wireless communication within metal-rich environments. Special attention was paid to the area of read distance in relation to the passive tag size.

A paper by Adrian-Ioan et al. [27] states that to make RFID work in a metal environment two approaches can be taken. One approach, as mentioned in Section 3.3, involves the use of absorbent materials to form a barrier between the antenna and the metal surface. The other approach involves using a static antenna pattern which has in its structure a metal plate at a given distance. This antenna is calibrated on the system resonant frequency, and is relatively immune to other metallic structures in proximity [27]. The Multi-turn static antenna pattern used by Adrian-Ioan et al. [27] is shown in Figure 11. The external dimensions for this Multi-turn antenna are 32 cm by 22 cm. Table 3 contains the results of the Multi-turn antenna testing with gaps between the antenna and the metal plate ranging from 1 millimetre to 50 millimetres. Table 3 also contains test results of two other types of RFID antenna for comparison purposes; these two antennas are a loop antenna and a Printed Circuit Board (PCB) antenna. The RF frequency used for all the antennas was 13.56 MHz.

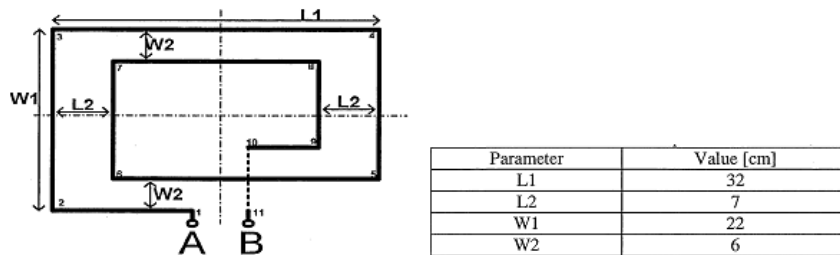

Figure 11 HF RFID Multi-turn static antenna pattern [28]

Table 3 Reading distance for parallel orientation of RFID tag [28]

Distance between antenna - metal plate [mm]	Reading distance in the center of the antenna for the tag oriented parallel with the antenna [cm]			Antenna type	External dimensions[cm]
	Loop antenna	PCB antenna	Multi-turn antenna		
1	5	0	5	Loop antenna	33x31
8	9	6	10	PCB Antenna	33x23
15	13	10	14		
25	21	17	20		
50	27	25	28		

A conference paper by Finis et al. [28] describes a series of steps for designing a HF antenna for metallic environments. These steps involve a sequence of mathematical modellings and simulations. The final product for the design is a HF rectangular loop antenna with dimensions of 64 cm by 22 cm as shown in Figure 12. During the actual testing the HF loop antenna was placed 2 cm away from the metal surface and various antenna output powers were used, as shown in Table 4.

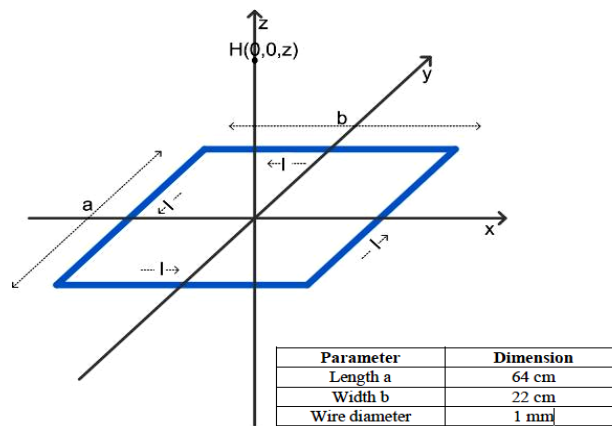

Figure 12 HF Loop Antenna [28]

Table 4 Reading distance for loop antenna [28]

Antenna output power [W]	Free space [cm]	Metal (tag parallel with antenna) [cm]	Metal (tag perpendicular with antenna) [cm]
1	40	14	8
2	48	17	10
3	56	25	15
4	64	23	12

A paper by D'Hoe et al. [13] describes a similar approach to Finis et al. [28]. The main difference is that D'Hoe et al. included a capacitance-matching circuit in their approach. The biggest problem with RFID in metal environment is the detuning of the antenna. If the metal environment is static, a capacitance-matching circuit can allow the RFID system to be tuned to this static environment. Unfortunately, a static environment in an industrial process is never achievable. In the paper, D'Hoe et al. show a new antenna concept that includes a permanent metal plate 10 mm behind the loop antenna. This creates a localised static environment that consequently makes the whole system less susceptible to detuning when inserted into other metal environments. The loop antenna shown in Figure 13 is the antenna used by D'Hoe's et al. It has dimensions of 36 cm by 36 cm and with a copper trace width of 4 cm. The schematic drawing in Figure 13 shows that the metal plate is situated 10 mm behind the loop antenna. The main disadvantage with the permanent metal plate in the design is the drastic reduction in RFID read distance. The read distance for the new loop antenna with permanent metal plate is 26 cm in free space, which is a decrease of 13 cm compared to the standard antenna. D'Hoe et al. tested the new antenna concept by placing it 2 cm in front of another metal plate. Table 5 shows the test results where the new loop antenna shows only 0.29% frequency shift (detuning), while the standard loop antenna shows 30.16% frequency shift.

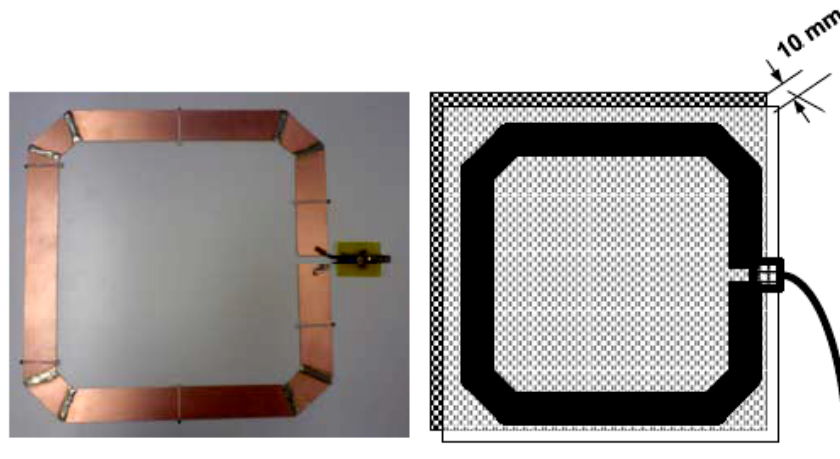

Figure 13 Antenna design with capacitance-matching circuit (left). Loop antenna schematic drawing with permanent metal plate 10 mm behind (right) [13].

Table 5 Influence of metal plate at the back using new antenna concept by D’Hoe [13]

Distance	Antenna type	Resonance frequency	Percentage of frequency shift	Difference between antennas
20 mm	Standard	17.65 MHz	30.16%	4.05 MHz
	New concept	13.60 MHz	0.29%	

The papers reviewed so far have shown different ways of making RFID systems operable in a metal environment. However, each approach comes with compromises. In the first paper the approach taken was the use of static antenna pattern design. This approach allows the passive tag to be readable in the metal environment, yet as the tag gets closer to the metal surface, the read distance is severely reduced. The second paper used mathematical modellings and simulations to construct an antenna that will work in a metal environment. But, for this antenna to work the antenna needs to be at least 2 centimetres away from the metal surface. The third paper used a metal back plate as part of its antenna design. This back plate was situated 1 centimetre behind the antenna and was used to create a localised static environment. This system only showed a small frequency shift when the antenna was placed 2 centimetres away from another metal surface. Nonetheless, this design still showed a significant read distance reduction compared to a non-metal environment.

Another problem with making passive LF/HF RFID systems work in a metal environment, as shown in the three papers reviewed, is the size of the antenna. The loop antenna in the first paper is the smallest, but its dimension is still 32 cm by 22 cm. With such dimension the read distance is only 5 centimetres when the antenna is placed 1

millimetre away from a metal surface. Since the main gearbox housing of a Black Hawk helicopter has a diameter roughly about 68 centimetres [29], even a purpose-designed RFID antenna will be too large and impractical for a military helicopter gearbox. If a purpose-designed metal compatible RFID antenna is too big to use, the chance of modifying an existing COTS RFID system to function as a crack detection sensor is highly unlikely.

5. Alternative Technologies

The basic concept of the proposed gear tooth crack detection sensor is to have a wire that follows the contour of the gear, when a crack breaks the wire a transmitter will stop transmitting due to the incomplete circuit. The RFID proposal is basically trying to satisfy this described concept. However, as established, the size of the RFID antenna and the read distance can not satisfy the existing constraints. In this section a brief overview is given for an alternative technology that may be used to overcome the shortfalls of RFID systems.

With the RFID model, the LF/HF passive tag is the transmitter and the antenna operates as a source of energy. The biggest problem of using RFID in metal environment is the size of the antenna and the transmission distance. If alternative technologies can be found to replace the RFID tag and the antenna, the tooth crack detection concept may still be feasible. One possible technology that has the potential to replace the passive RFID tag is a miniature transmitter. A brief search of the internet has found a very small transmitter called NTQ-1 produced by Lotek. Lotek is a company specialised in the design and manufacture of fish and wildlife telemetry equipment. NTQ-1 has a size of 5 mm by 3 mm by 10 mm and with a weight of 0.26 grams [30]. Figure 14 shows the schematic and the actual photo of the NTQ-1. With the battery attached the length of the transmitter is only 1 centimetre. This device is a battery powered radio transmitter and it has a maximum life of 33 days. To be used as a gear tooth crack detection sensor the battery would need to be replaced with a permanent power source.

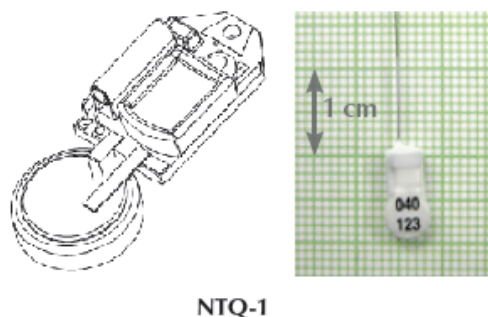

Figure 14 Schematic and a photo of the NTQ-1 transmitter [30]

With the RFID concept the power is wirelessly transmitted to the passive tag, whereas the energy for the small radio transmitter would need to be self generating and positioned on the same mesh gear. Figure 15 illustrates the concept of using NTQ-1 radio transmitter and a permanent power source to form the meshing gear tooth crack detection system. A tooth crack would be detected in the same way as the RFID concept; i.e. a tooth crack would break the wire connecting between the power source and the transmitter and the transmitter would stop functioning.

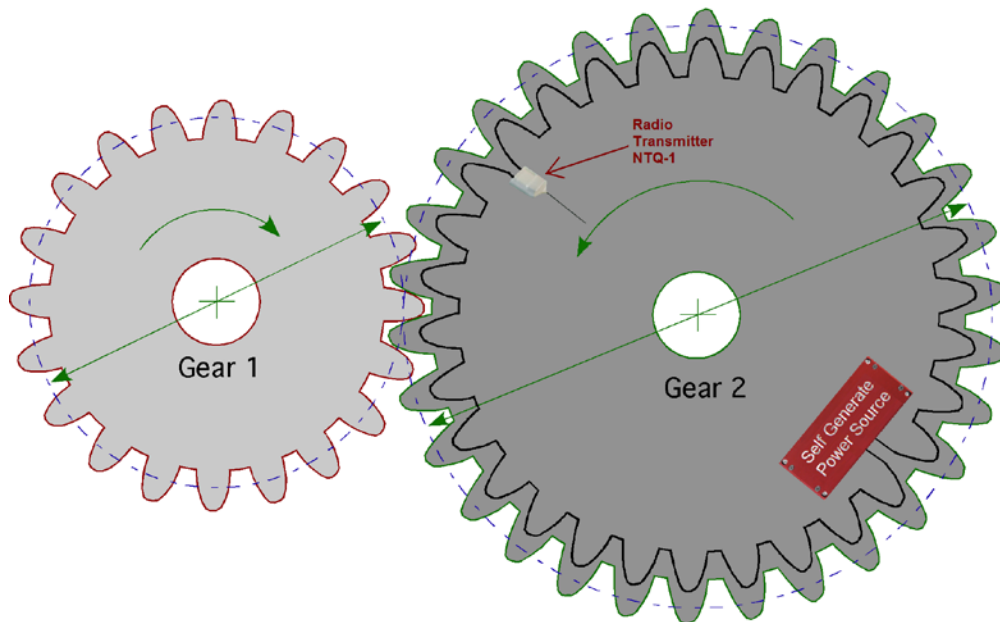

Figure 15 Concept of radio transmitter and permanent power source as embedded meshing gear tooth crack detection sensor (radio and power source are not in scale with the meshing gear)

The self-generating permanent power source could be achieved by exploiting energy harvester technology. When two meshing gears are in rotational contact they produce vibration. By harvesting this vibration energy and turning it into electrical energy, enough electricity may be accumulated to power the radio transmitter. Figure 16 shows a piezoelectric generator that could be used as a self-generating power source. This piezoelectric generator produces electricity during bending and is made by Piezo Systems Inc. [31]. The rated output power for this generator is 1.1 mW at a bending frequency of 250 Hz. A piezoelectric energy harvesting circuit would need to be incorporated to collect intermittent or continuous energy from the piezoelectric generator, and efficiently store the energy in an on-board capacitor bank. Figure 17 shows a piezoelectric energy harvesting module produced by Piezo System Inc. This energy harvesting module continuously monitors the charging process. When the capacitor reaches 5.2 V the system output is enabled to supply power to an external application. At this point 55 mJ of energy are available. When the output voltage drops to 3.1 V, power to the external application is switched off and it is not turned on again until the capacitor bank has been recharged to 5.2 V [32].

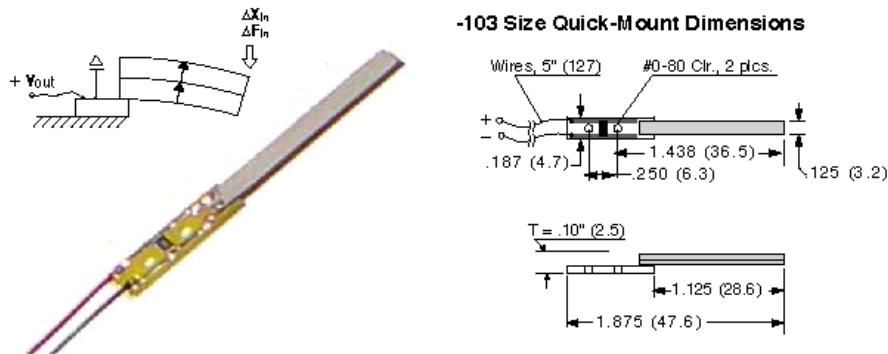

Figure 16 Piezoelectric Bending Generator [31]

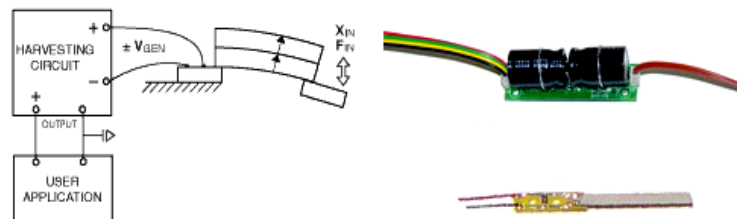

Figure 17 Piezoelectric Bender and Energy Harvesting Circuit [32]

Implementing the energy harvesting circuit design would only allow the radio transmitter to transmit when the capacitor has stored enough energy. As a result, the radio transmission will not be continuous. However, continuous monitoring is not necessary for gear tooth crack detection. The proposed concept detects a tooth crack when the crack breaks the connecting wire. The integrity of the wire could be checked at regular intervals; e.g. after each flight, just before the engine is shutdown. Interrogating the radio transmitter after each flight would also ensure that enough energy is stored in the capacitor for the system to function.

The described piezoelectric bending generator would need to operate in a gearbox environment. Factors such as centrifugal force and rotational vibration would need to be taken into consideration. The critical angle and position of the generator on the surface of the meshing gear need to be identified, where this attachment location allows ultimate energy harvesting.

6. Conclusion

A feasibility study for using RFID technology as a potential gear tooth crack detection sensor was undertaken. The specific RFID technology targeted was in the LF to HF frequency range, as tags in this range are less sensitive to the surrounding environment. A number of trials were recommended to assess the suitability of the RFID technology as a crack sensor. However due to budget constraints, these trials have not been conducted and a review of literature has been carried out instead. The literature review has found that for reasonable wireless read distances to be obtained near metal structures, the size of the LF/HF RFID antenna has to be relatively large. Furthermore, an RFID antenna designed for a metal environment is quite susceptible to minor alterations. The literature review also showed that metal-rich surroundings can exert noticeable effects on the RFID system even when the system is explicitly designed for a high tolerance to different environments. Large antennas, the sensitivity to antenna modifications, and the susceptibility to interference from metal-rich environments imply that LF/HF RFID systems are not suitable candidates for gear tooth crack detection sensors.

The gear tooth crack detection concept put forward in this proposal may still be feasible if the RFID tag is replaced with a very small radio transmitter. A permanent power source for the radio transmitter could be derived from technology such as vibration energy harvester. A brief outline of these two technologies and their utilisation as gear tooth crack sensors are given in the last section of this report. Again, these two alternative technologies would need further testing to substantiate their suitability as a gear tooth crack detection system.

7. References

1. Forrester, B. D. (1996) *Advanced vibration analysis techniques for fault detection and diagnosis in geared transmission systems*. [PhD thesis] Melbourne, Vic, Swinburne University.
2. Harry, J. D. (2002) *Gear crack detection using tooth analysis*. NASA TM-2002-211491, National Aeronautics and Space Administration.
3. smart-TEC, GmbH & Co. KG. [Accessed 14 August 2013]; Available from: http://www.smart-tec.com/uploads/pics/RFID_system_01.JPG
4. Shun, L. C. (2007) *RFID tag design*. [Final Year Project] Hong Kong, China, Chinese University of Hong Kong.
5. Control Electric Company Inc., *Types of RFID*. [Accessed 14 August 2013]; Available from: http://www.controlelectric.com/RFID/Types_of_RFID.html
6. National High Magnetic Field Laboratory, *How it works*. [Accessed 14 August 2013]; Available from: <http://www.magnet.fsu.edu/education/tutorials/tools/faradaycage.html>
7. Chawla, V., et al. (2007) An overview of passive RFID. *IEEE Communications Magazine* (Volume 45 Issue 9) 11-17
8. Mandeep, K., et al. (2011) RFID technology principles, advantages, limitations & its applications. *International Journal of Computer and Electrical Engineering* (Volume 3 No. 1) 1793-8163
9. Intermec Technologies Corporation. *UHF Vs HF RFID: New insight on the old debate*. (2007) [Accessed 14 August 2013]; Available from: http://www.intermec.com/public-files/white-papers/en/UHFvs.HF_RFID_wp.pdf
10. Pavel, V., Rao, K., and Steve, L. (2007) An overview of Near Field UHF RFID. *IEEE International Conference on RFID*, Grapevine Texas: 26-28 March 2007, IEEE
11. Ng, M. L. (2003) *Design of high performance RFID systems for metallic item identification*. [PhD Thesis] Adelaide, SA, University of Adelaide
12. The Norwegian Oil Industry Association (2008) *Recommended guidelines for deployment of RFID on the Norwegian continental shelf*. Norway, International Organization for Standardization
13. D'Hoe, K., et al. (2009) Influence of different types of metal plates on a high frequency RFID loop antenna: study and design. *Advances in electrical and computer engineering* (Volume 9 Issue 2) 3-8
14. Nitta Corporation, *Basic Principle*. [Accessed 14 August 2013]; Available from: <http://www.nitta.co.jp/english/product/sheet/rfid/top.html>
15. ARC Technologies Inc., *The problem: communication failure induced by nearby metals*. [Accessed 14 August 2013]; Available from: http://www.arc-tech.com/pdf/ARC_RFID_Brochure.pdf
16. Mohd-Yasin F., et al. (2008) Battle between HF and UHF RFID. *Microwave journal* (Volume 51 Issue 5) 152-166
17. Futurlec, *Pictures*. [Accessed 14 August 2013]; Available from: http://www.futurlec.com/Pictures/RFID_Tag.jpg

18. Texas Instruments, *Tag-it™ HF-I Plus Transponder Inlays Reference Guide*. [Accessed 14 August 2013]; Available from:
<http://www.ti.com/lit/ug/scbu004b/scbu004b.pdf>
19. RFIDTags.com, *UHF Passive tags vs HF passive tags – Part 1*. [Accessed 14 August 2013]; Available from:
<http://rfidtags.com/blog/uhf-passive-tags-vs-hf-passive-tags-part-1/>
20. SageData, *Cost*. [Accessed 14 August 2013]; Available from:
http://www.sagedata.com/learning_centre/rfid-tags-passive-uhf.html
21. RFID Journal, *RFID system components and costs*. [Accessed 14 August 2013]; Available from: <http://www.rfidjournal.com/article/view/1336/1>
22. Technology Solutions (UK), Ltd. *RFID Comparison*. [Accessed 14 August 2013]; Available from: http://www.tsl.uk.com/RFID_Comparison.htm
23. Artech House, *Principles of operation*. [Accessed 14 August 2013]; Available from:
http://www.artechhouse.com/uploads/public/documents/chapters/Lehpamer_194_CH05.pdf
24. TagSense, *What is the best RFID frequency*. [Accessed 14 August 2013]; Available from: <http://www.tagsense.com/ingles/faq/faq.html>
25. Trossen Robotics, *RFID starter kits*. [Accessed 14 August 2013]; Available from:
<http://www.trossenrobotics.com/p/RFID-experimenters-kit.aspx>
26. GAO RFID Inc., *Mount-on metal high frequency (HF) RFID tag*. [Accessed 14 August 2013]; Available from: <http://www.gaorfid.com/>
27. Adrian-Ioan, P., Valentin, P., Vasile-Gheorghita, G., Ilie, F., and Alexandru, L. (2012) 13.56 MHz RFID multi-turn antenna for metallic environments. *European conference on the use of modern information and communication technologies 5th Edition, Gent Belgium: 2012, ECUMICT*
28. Ilie, F., Valentin, P., Alexandru, L., Adrian-Ioan, P., and Stefan, S. (2012) The design and implementation of HF RFID loop antenna for metallic environments. *11th International Conference on Development and Application Systems, Suceava Romania: 17-19 May 2012*
29. 70351-08110. (1973) *Housing assembly matched set- main gearbox*. [Schematic Drawing], Sikorsky Aircraft
30. Lotek Wireless Fish & Wildlife Monitoring, *Nanotag Series*. [Accessed 14 August 2013]; Available from: <http://www.lotek.com/nanotag.pdf>
31. Piezo Systems Inc., *Standard quick-mount piezoelectric bending sensors*. [Accessed 14 August 2013]; Available from: <http://www.piezo.com/prodbg7qm.html>
32. Piezo Systems Inc., *Piezoelectric energy harvesting kit*. [Accessed 14 August 2013]; Available from: <http://www.piezo.com/prodproto4EHkit.html>

DEFENCE SCIENCE AND TECHNOLOGY ORGANISATION DOCUMENT CONTROL DATA				1. DLM/CAVEAT (OF DOCUMENT)	
2. TITLE Investigation of using Radio Frequency Identification (RFID) System for Gear Tooth Crack Detection			3. SECURITY CLASSIFICATION (FOR UNCLASSIFIED REPORTS THAT ARE LIMITED RELEASE USE (L) NEXT TO DOCUMENT CLASSIFICATION) Document (U) Title (U) Abstract (U)		
4. AUTHOR(S) Eric Lee			5. CORPORATE AUTHOR DSTO Defence Science and Technology Organisation 506 Lorimer St Fishermans Bend Victoria 3207 Australia		
6a. DSTO NUMBER DSTO-TR-2983		6b. AR NUMBER AR-015-989		6c. TYPE OF REPORT Technical Report	7. DOCUMENT DATE June 2014
8. FILE NUMBER 2013/1171875/1	9. TASK NUMBER LRR 07/250	10. TASK SPONSOR Aerospace Division	11. NO. OF PAGES 27		12. NO. OF REFERENCES 33
13. DSTO Publications Repository http://dspace.dsto.defence.gov.au/dspace/			14. RELEASE AUTHORITY Chief, Aerospace Division		
15. SECONDARY RELEASE STATEMENT OF THIS DOCUMENT <i>Approved for public release</i>					
OVERSEAS ENQUIRIES OUTSIDE STATED LIMITATIONS SHOULD BE REFERRED THROUGH DOCUMENT EXCHANGE, PO BOX 1500, EDINBURGH, SA 5111					
13. DSTO Publications Repository http://dspace.dsto.defence.gov.au/dspace/					
17. CITATION IN OTHER DOCUMENTS Yes					
18. DSTO RESEARCH LIBRARY THESAURUS RFID, Gear, Crack, Detection, Energy Harvester					
19. ABSTRACT This report examines the feasibility of using passive low frequency (LF) and high frequency (HF) radio frequency identification (RFID) systems as embedded sensors for early gear tooth crack detection. This study is part of the Divisional Enabling Research Program (DERP). The outcome is that Passive RFID systems are generally not suitable for gear tooth crack detection. However, a similar concept combining a tiny radio frequency transmitter with a vibration energy harvester system is proposed as an alternative to the RFID proposal.					