

UNCLASSIFIED

AD

AD-E403 699

Technical Report ARMET-TR-15017

## OVERVIEW OF EXPLOSIVE INITIATORS

Dr. Karl D. Oyler  
Neha Mehta  
Gartung Cheng

November 2015



U.S. ARMY ARMAMENT RESEARCH, DEVELOPMENT AND  
ENGINEERING CENTER

Munitions Engineering Technology Center

Picatinny Arsenal, New Jersey

Approved for public release; distribution is unlimited.

## UNCLASSIFIED

The views, opinions, and/or findings contained in this report are those of the author(s) and should not be construed as an official Department of the Army position, policy, or decision, unless so designated by other documentation.

The citation in this report of the names of commercial firms or commercially available products or services does not constitute official endorsement by or approval of the U.S. Government.

Destroy this report when no longer needed by any method that will prevent disclosure of its contents or reconstruction of the document. Do not return to the originator.

**UNCLASSIFIED**

REPORT DOCUMENTATION PAGE			Form Approved OMB No. 0704-01-0188		
<p>The public reporting burden for this collection of information is estimated to average 1 hour per response, including the time for reviewing instructions, searching existing data sources, gathering and maintaining the data needed, and completing and reviewing the collection of information. Send comments regarding this burden estimate or any other aspect of this collection of information, including suggestions for reducing the burden to Department of Defense, Washington Headquarters Services Directorate for Information Operations and Reports (0704-0188), 1215 Jefferson Davis Highway, Suite 1204, Arlington, VA 22202-4302. Respondents should be aware that notwithstanding any other provision of law, no person shall be subject to any penalty for failing to comply with a collection of information if it does not display a currently valid OMB control number.</p> <p><b>PLEASE DO NOT RETURN YOUR FORM TO THE ABOVE ADDRESS.</b></p>					
1. REPORT DATE (DD-MM-YYYY) November 2015		2. REPORT TYPE Final		3. DATES COVERED (From - To)	
4. TITLE AND SUBTITLE  OVERVIEW OF EXPLOSIVE INITIATORS			5a. CONTRACT NUMBER		
			5b. GRANT NUMBER		
			5c. PROGRAM ELEMENT NUMBER		
6. AUTHORS  Dr. Karl D. Oyler, Neha Mehta, and Gartung Cheng			5d. PROJECT NUMBER		
			5e. TASK NUMBER		
			5f. WORK UNIT NUMBER		
7. PERFORMING ORGANIZATION NAME(S) AND ADDRESS(ES) U.S. Army ARDEC, METC Energetics, Warheads & Manufacturing Directorate (RDAR-MEE-W) Picatinny Arsenal, NJ 07806-5000			8. PERFORMING ORGANIZATION REPORT NUMBER		
9. SPONSORING/MONITORING AGENCY NAME(S) AND ADDRESS(ES) U.S. Army ARDEC, ESIC Knowledge & Process Management (RDAR-EIK) Picatinny Arsenal, NJ 07806-5000			10. SPONSOR/MONITOR'S ACRONYM(S)		
			11. SPONSOR/MONITOR'S REPORT NUMBER(S) Technical Report ARMET-TR-15017		
12. DISTRIBUTION/AVAILABILITY STATEMENT  Approved for public release; distribution is unlimited.					
13. SUPPLEMENTARY NOTES					
14. ABSTRACT  The purpose of this report is to provide a general overview of common initiators used by the U.S. Military. This will include detonators (stab, electric), primers (percussion, electric), and some relevant fuze systems. A discussion of common primary explosives and formulations employed in the devices will also be included.					
15. SUBJECT TERMS Primary explosive    Initiator    Detonator    Primer    Blasting cap    Lead azide    Lead styphnate					
16. SECURITY CLASSIFICATION OF:			17. LIMITATION OF ABSTRACT  SAR	18. NUMBER OF PAGES 21	19a. NAME OF RESPONSIBLE PERSON Karl Oyler
a. REPORT U	b. ABSTRACT U	c. THIS PAGE U			19b. TELEPHONE NUMBER (Include area code) (973) 724-4784



# UNCLASSIFIED

## CONTENTS

	Page
Introduction	1
Primary Explosives	1
Current Primary Explosives	2
Detonators	6
Non-Electric Detonators	6
Electric Hotwire Detonators	7
Primers	9
Percussion Primers	9
Electric Primers	11
Fuzes	11
Conclusions	13
References	15
Distribution List	17

## FIGURES

1	Decomposition reaction of lead azide in the presence of carbon dioxide and water (ref. 9)	4
2	Common primary explosives	4
3	Cross section of the U.S. Army M55, a common stab detonator	6
4	Non electric versus electric blasting caps	7
5	Generic electric detonator, reproduced from reference 1	8
6	M100 military electric detonator	8
7	Location and diagram of a common percussion primer	9
8	Electric match	11
9	Diagram of the M67 fragmentation grenade and the incorporated M213 fuze	12
10	Diagram of M739A1 fuze used to trigger M107 projectiles upon impact	13



# UNCLASSIFIED

## INTRODUCTION

The term “initiator” defines a fairly broad group of devices that are intended to trigger an energetic material, be it an explosive, propellant, or pyrotechnic. They are the first portion of the explosive train and are designed to transform a small energy output, such as the impact of a spring-loaded striker or firing pin into the rapid release of much larger amounts of energy from the booster and/or main charges that follow them. To categorize initiators, a variety of vocabulary terms and nomenclatures exist, depending on the country/region and on what source is being consulted. In general, however, they can loosely be broken down into two main categories: detonators and primers (igniters). Detonators are designed to provide an explosive shockwave and are typically used to trigger less sensitive, more powerful secondary explosives (either in a booster or main charge) via sympathetic detonation, and their applications range from explosive munitions to demolition charges. Primers/igniters are more focused on a less violent flame and/or molten slag generating output, and their main applications include the percussion primers used in small arms ammunition to ignite propellant. Detonators and primers can each be further divided into subcategories based on their method of initiation, the most general being non electric versus electric. From there, well-known subclasses such as stab detonators, percussion primers, blasting caps, etc., can be differentiated (ref. 1).

- **Detonators**
  - Non electric
    - Friction-initiated “stab” detonators (M55, M61)
    - Non electric blasting caps (M7)
    - Flame-initiated “flash” detonators (Mk35, Mk50)
  - Electric (hotwire)
    - Electric detonators (M100)
    - Electric blasting caps (M6, commercial no. 8)
    - Exploding bridge-wire detonators
- **Primers (igniters)**
  - Non electric
    - Percussion primers
      - Rim-fired
      - Center-fired (no. 41, M42)
      - Battery cup (W209 shotgun shell primer)
  - Electric
    - Electric matches

One material that most initiators have in common is a primary explosive. These are rapidly detonating energetics that are intentionally designed to be sensitive and provide high explosive output from small quantities of material. Their purpose is to initiate more powerful, less sensitive energetics such as secondary explosives (RDX, HMX), propellants (double-base nitrocellulose-nitroglycerine powder), and pyrotechnics (Zr/Ni-based delay columns).

## PRIMARY EXPLOSIVES

Primaries are generically defined as explosives that can be initiated through the addition of a relatively small stimulus, be it impact, friction, shock, heat, or electrostatic discharge (ref. 2). On the whole, they tend to be less potent than the more powerful and more stable secondary explosives

such as RDX; instead of causing destruction, the main purpose of a primary explosive is generally to trigger these harder to initiate energetics. One of the most important characteristics of an effective primary explosive is an extremely swift deflagration to detonation transition, meaning that once the material is initiated, it quickly proceeds from a rapid combustion to a detonation (the reaction front becomes supersonic). This is a key feature because it allows the primary explosive charge (whether in a detonator, primer, or other initiator) to be kept small, which is an important aspect to safety and handling of munitions.

Although several compounds are employed as primary explosives in commercial and military applications throughout the world, currently the most popular are lead azide ( $\text{Pb}(\text{N}_3)_2$ ) and lead styphnate (both normal and basic forms) and tetrazene. With its high explosive performance, lead azide is most often implemented as the main primary explosive fill in detonators and blasting caps. Lead styphnate, on the other hand, is mainly found in primers and stab mixes where a more gentle touch is required to smoothly initiate a propellant or pyrotechnic formulation (table 1). Another relatively common primary explosive is tetrazene\* (1-(5-tetrazolyl)-3-guanyltetrazene hydrate); although relatively weak and not useful on its own, its high sensitivity is needed to assist in the initiation of both lead azide and lead styphnate to make them reliable for use in their formulation applications.

Table 1  
Basic explosive properties of lead primary explosives compared to RDX (ref. 3)

Material	Impact (J)	Friction (N)	ESD (mJ)	Density ( $\text{g}/\text{cm}^3$ )	DSC ( $^{\circ}\text{C}$ )	VOD (m/s)
Lead azide	0.089	< 1	5.0	4.80	315	5500
Lead styphnate	0.025	< 1	0.2	3.00	282	5200
RDX	7.5	120	> 250	1.82	205	8750

ESD - electrostatic discharge  
DSC - differential scanning calorimetry  
VOD - velocity of detonation

## Current Primary Explosives

### Lead Azide

Lead azide came to prominence around the 1920's, owing largely to its unique blend of performance and producibility characteristics, although it is not without its problems. The combination of its relatively long-term chemical and thermal stability, reliability, rapid build to detonation, and simple chemical synthesis are very difficult for alternative compounds to match, and from a cost and production standpoint of vital significance to both military and commercial manufacturers, the material has historically been relatively cheap and straightforward (sometimes dangerous) to produce in large quantities. As with most primary explosives, particle size, morphology and the presence of surfactants/coatings play a key role in determining whether the material performs well for its intended application and can also be handled safely. For this reason, a variety of lead azide types have been developed since the 1920's that are still in use today. Some of the most important types include:

- **Service lead azide (SLA)** (refs. 4 through 6) was developed by the British and does not involve a coating agent; instead, it makes use of the addition of acetic acid and sodium carbonate, which provides a nucleus to precipitate lead azide in a less-hazardous (compared to needle-

---

\*Numerous old references refer to this compound as "tetracene," which can lead to confusion with the completely unrelated tetracyclic aromatic compound of the same spelling.



## UNCLASSIFIED

shaped crystals) spherical morphology. The SLA has higher explosive performance than dextrinated lead azide (DLA) or RD1333/special purpose lead azide (SPLA) but is somewhat more sensitive.

- **Colloidal lead azide** is the purest form of lead azide used in the United States and is made by mixing dilute solutions of lead and azide salts. It has a very fine particle size of  $\sim 5 \mu\text{m}$ , making it ideal for its main application, which is as a coating on electric bridgewires for commercial electric detonators. It is known to be extremely sensitive to ESD.
- **Dextrinated lead azide (DLA)** (refs. 4 through 6) is considered to be the safest-to-handle form and the most common type now used commercially. It was developed in the United States in 1931 (ref. 4) as a solution to the numerous accidental explosions associated with attempts to manufacture pure lead azide. The key feature is the incorporation of dextrin (a short-chained, starch-based polysaccharide), which helps to desensitize the explosive by preventing the formation of large fragile crystals, albeit at the cost of performance and added hygroscopicity (ref. 5).
- **RD1333 and special purpose lead azide (SPLA)** (refs. 4 and 5). Although involving somewhat different processing pathways, both British-developed RD1333 (ref. 7) and the later U.S. developed SPLA are similar in that they have nearly identical performance requirements/specifications and make use of the sodium salt of carboxymethylcellulose as the desensitizing agent. As such, in the United States, the two types are often used interchangeably. The materials were developed to meet the need for lead azide, which performed better than DLA (especially in smaller detonators), while maintaining some of its safe handling characteristics. The SPLA makes up a large portion of the current U.S. military stockpile of lead azide, which has existed since the 1960s.
- **On-demand lead azide (ODLA)** (ref. 8) is a much more recent development compared to the others described in this report. It is a military-qualified process developed by the U.S. Army Armament Research, Development and Engineering Center, Picatinny Arsenal, NJ, which produces lead azide that meets the RD1333 specification and is considered the equivalent to RD1333 and SPLA. The main advantage is that it is produced in an on-demand, continuous fashion, therefore avoiding the hazards associated with handling large scale batches of the material. The small footprint and low cost of the processing equipment also means that it can be placed close to item production lines, further reducing the need for expensive and dangerous transport of lead azide on public roadways. The ODLA was qualified by the U.S. Army in 2012 and is currently being evaluated in larger-scale loading operations.

As mentioned previously, a key drawback to lead azide's use, apart from the lead content, is its tendency to slowly decompose under ambient conditions (fig. 1).

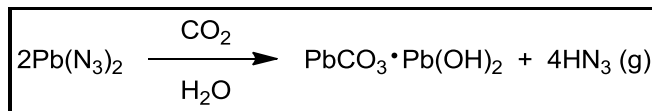

Figure 1

Decomposition reaction of lead azide in the presence of carbon dioxide and water (ref. 9)

This process not only degrades the explosive over time, but the hydrazoic acid ( $\text{HN}_3$ ) generated can go on to react with other exposed metal surfaces, most notably copper contained in pipes or in brass fixtures (ref. 10). This occurrence was blamed for several accidents associated with handling and storage of lead azide as well as incidences of premature firings of explosive items (ref. 9).

### Lead Styphnate

Lead styphnate, in both its normal and basic forms (fig. 2), started to gain serious attention around the same time as lead azide in the early twentieth century. It is noticeably less powerful than lead azide in terms of explosive force but tends to initiate more reliably and generate a high degree of heat output. For this reason, it has found a use alongside the somewhat harder to trigger lead azide in initiating applications, including percussion primers as well as the initial explosive components in both stab and electrically initiated detonators; it is not effective as a detonator transfer charge by itself. A major advantage of lead styphnate in primer applications is that it does not generate excessive residue which can cause the corrosion of gun barrels. Its manufacturing takes place all over the world, including the U.S. and at least fourteen locations in the European Union (EU); as of 2011, estimates put the total production of the material in the EU at somewhere between 10 and 100 tons per year. In general, it is considered to be more sensitive to ESD and flame relative to lead azide. It is also insoluble in water and most organic solvents.

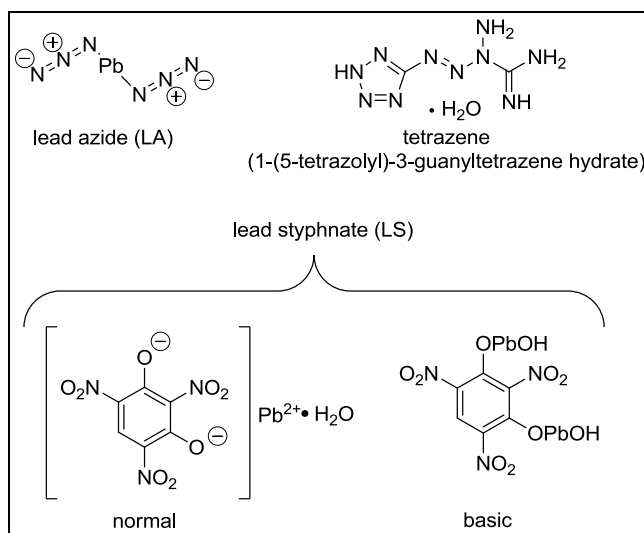

Figure 2

Common primary explosives

Basic lead styphnate is especially useful when incorporated into formulations with lead azide, such as the stab mixture NOL-130, as its basic nature does not encourage lead azide's tendency

toward hydrolysis (ref. 11). Normal lead styphnate was first reported in 1914 by Herz (ref. 12), who later developed a popular manufacturing method (ref. 13). Although basic lead styphnate tends to be superior in terms of thermal stability and compatibility with lead azide, normal lead styphnate is considered to be easier to control in terms of crystal habit (ref. 14). Both types are still in use and produced by manufacturers today.

### Formulations of Primary Explosives

Although lead azide in its many forms is used as a neat (standalone) material in detonator and blasting cap transfer charge applications, formulations of primary explosives are used quite regularly, both in detonator and primer applications (table 2). The formulations are typically combinations of the lead-based primary explosives with various pyrotechnic fuels and oxidizers; secondary explosives such as pentaerythritol tetranitrate (PETN) and RDX also occasionally find their way into some formulations when high gas output is required, such as for larger calibers of ammunition.

Table 2  
Examples of primary explosive formulations used in military primer and detonator applications

	NOL-130	NOL-60	PA-101	FA-956
Used for:	Detonator stab mix	Primers	M42-C1 primer	M115 medium caliber primer
<b>Constituents</b>				
Lead azide	20			
Basic lead styphnate	40	60	53	
Normal lead styphnate				37
Barium Nitrate	20	25	22	32
Tetrazene	5	5	5	4
Antimony trisulfide	15	10	10	15
PETN				7
Aluminum powder			10	

NOL = Naval Ordnance Laboratory  
PA = Picatinny Arsenal  
FA = Frankford Arsenal

Although the mixes can vary widely from application to application, in general there is a core mix of:

- Lead styphnate (basic or normal) - the flame/heat-sensitive primary explosive
- Tetrazene - an explosive side-kick to lead styphnate, which is used as a sensitizer to improve reliability
- Barium nitrate - a potent, non-hygroscopic oxidizer
- Antimony trisulfide - a fuel with sharp-edged crystals that increases sensitivity of the mix to friction

## DETONATORS

Detonators are useful for high explosive applications where a strong shockwave is needed to set off a secondary explosive charge or other energetic; they are frequently incorporated as parts of a larger fuze apparatus, which may also include additional pyrotechnic delays and/or booster charges. As such, detonators are essential for a huge number of explosive munitions including grenades, mortars, rockets, artillery rounds, and submunitions, etc. The two main types of detonators are stab and electric. A stab detonator (fig. 3), such as the U.S. Army M55 and M61, is designed to function by the mechanical impact of a firing pin whereas electric detonators such as the M100 are triggered by an electric impulse that causes resistive heating in an embedded metal bridgewire.

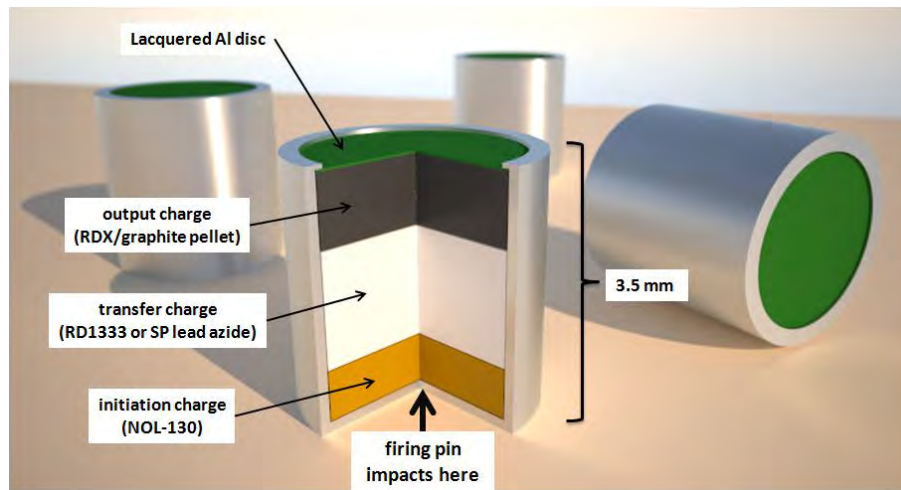

**Note:** NOL-130 = a formulation of lead styphnate, RD1333 lead azide, barium nitrate, antimony trisulfide, and tetrazene.

Figure 3  
Cross section of the U.S. Army M55, a common stab detonator

Blasting caps can be considered a subcategory of detonators as they possess similar design and purpose. The main difference between them and more traditional detonators is that they tend to be larger, and instead of being incorporated into a fuze housing, they are usually standalone and used for directly initiating secondary energetics, such as plastic explosives used in demolition charges. The caps themselves most typically employ DLA and lead styphnate as the main primary explosive materials, although diazodinitrophenol (DDNP) is frequently used also. As with detonators, they exist in both electric and non electric varieties. Common examples are the no. 8 commercial blasting cap, the M6 electric blasting cap, and the M7 non electric blasting cap.

### Non Electric Detonators

#### Stab Detonators

The stab detonator is a friction-triggered initiator that is generally set off when it is punctured by a firing pin with sufficient force. It almost always consists of three separate charges loaded into an aluminum or steel cup. The firing pin impacts the portion of the cup where the initiation charge (also called the stab mix) is located; the charge is typically a primary explosive formulation such as NOL-130, which is intended to be very sensitive to impact and friction. It contains both lead azide and lead styphnate as well as tetrazene for added sensitivity; a pyrotechnic fuel/oxidizer combination of antimony trisulfide and barium nitrate are also used for their extra energy output, as well as to provide an abrasive for added friction sensitivity. With the exception of the

addition of lead azide, the stab mix is essentially identical to common percussion primer formulations. The initiation charge is followed by a transfer charge of RD1333 lead azide which in turn is intended to set off an output charge consisting of a secondary explosive such as RDX or HMX.

### Non electric Blasting Caps

Non electric blasting caps are generally triggered by a cord of pyrotechnic safety fuse (fig. 4, top). This fuse is usually a long, flexible plastic or rubber tube filled with a pyrotechnic composition such as black powder, allowing for safe, remote initiation. A common military example is the M7 non electric blasting cap, which was designed with the goal of being capable of detonating all military explosives. It consists of an aluminum alloy cup containing an ignition charge of lead styphnate, a lead azide transfer charge, and an output/base charge of RDX. It is initiated by a time-blasting fuse or detonating cord.

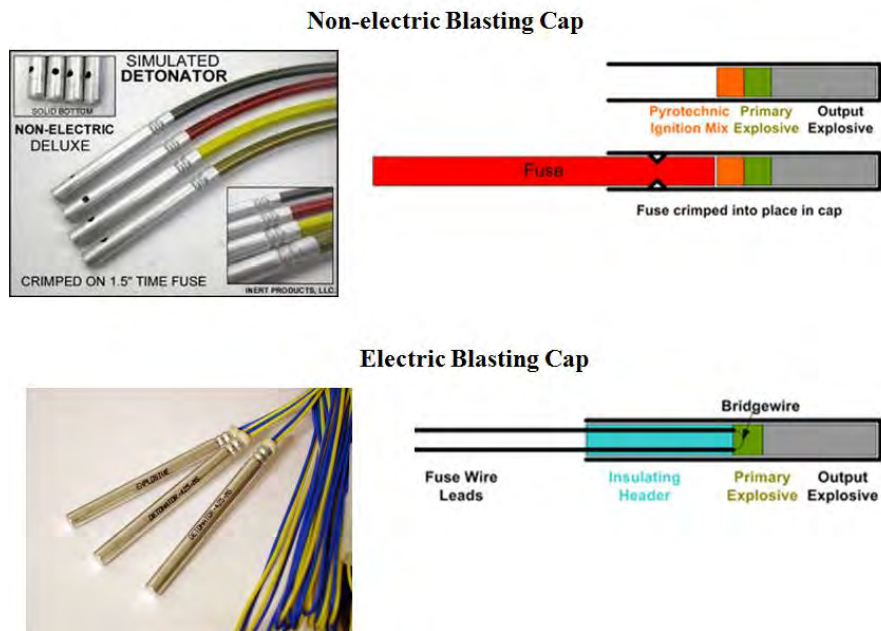

Figure 4  
Non electric versus electric blasting caps

### Electric Hotwire Detonators

Electric detonators are configured similarly to stab detonators, but in place of the stab mixture, they are usually set off by an electric bridgewire (hotwire) embedded in a small initiation charge (fig. 5). This charge can be as simple as a small “spot charge” of lead styphnate or may be a formulation. An electric current passing through the bridgewire (typically a metal alloy of nickel and chromium) generates resistive heating that in turn triggers the explosive. As in the case of the stab-initiated devices discussed previously, electric variants of blasting caps are also common for use in demolition and related activities.

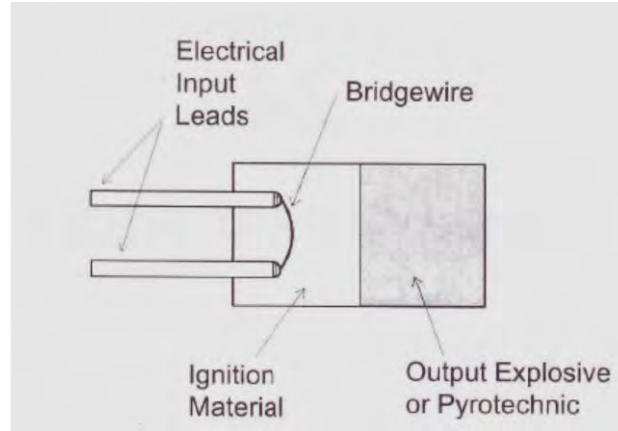

Figure 5  
Generic electric detonator, reproduced from reference 1

A commonly used military example is the M100 electric detonator (fig. 6), which is incorporated in a variety of explosive munitions. Its size is similar to the M55 stab detonator; in place of NOL-130 for the initiation charge, the M100 uses a spot charge of lead styphnate affixed to the hotwire by a binder such as nitrocellulose. This spot charge is triggered by the hotwire and in turn sets off an intermediate charge of RD1333 lead azide, which functions the output charge of HMX secondary explosive.

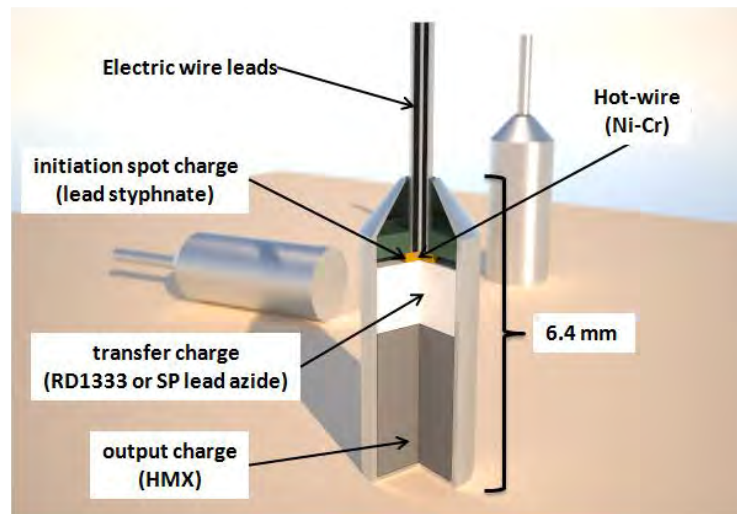

Figure 6  
M100 military electric detonator

### Electric Blasting Caps

Electric blasting caps (fig. 4, bottom) are configured very similarly to non electric, the only difference being the use of a hotwire-embedded initiation charge and electric wire leads in place of the pyrotechnic fuse cord. Electric caps require the use of an electric power source to trigger them, but this is inherently safer than the use of the fuse cord.

A most popular commercial example is the no. 8 blasting cap, which is 40 to 45 mm long, 7 mm in diameter, and loaded with 0.3 g of dextrinated lead azide and 1.2 g of RDX or HMX (ref. 1).

On the military side, the M6 electric blasting cap is a common example. It has the same purpose as the M7 but is designed to fire electrically. It is also an aluminum alloy cup, but the ignition charge is smokeless powder (nitrocellulose/nitroglycerin) combined with potassium chlorate and lead dinitro-ortho-cresol; the output/base charge is RDX. Two 12-ft wires connect the cap to a suitable electric power source; the wires are connected by a bridgewire that extends through the initiation charge.

## PRIMERS

Primers are now largely used as the initiators for the propellant in ammunition cartridges, both commercial and military, as well as for use in initiating other pyrotechnic formulations such as fuze delays. Typically, they are either percussion or electric. In contrast to detonators and blasting caps, the primer is usually not intended to generate a strong shock wave but instead to produce large amounts of slag-generating heat, which is used to smoothly ignite the propellant or pyrotechnic without shocking it.

### Percussion Primers

Percussion primers are by far the most common and come in a variety of sizes and configurations depending on the ammunition size and requirements. They function through the impact of the firing pin on the primer, which pinches the primary explosive-containing primer formulation between the outer cup and a small metal anvil. From there, the hot gases and molten slag produced go on to initiate the propellant bed, which rapidly deflagrates and ejects the bullet from the cartridge at a high rate of speed. A generic example is shown in figure 7.

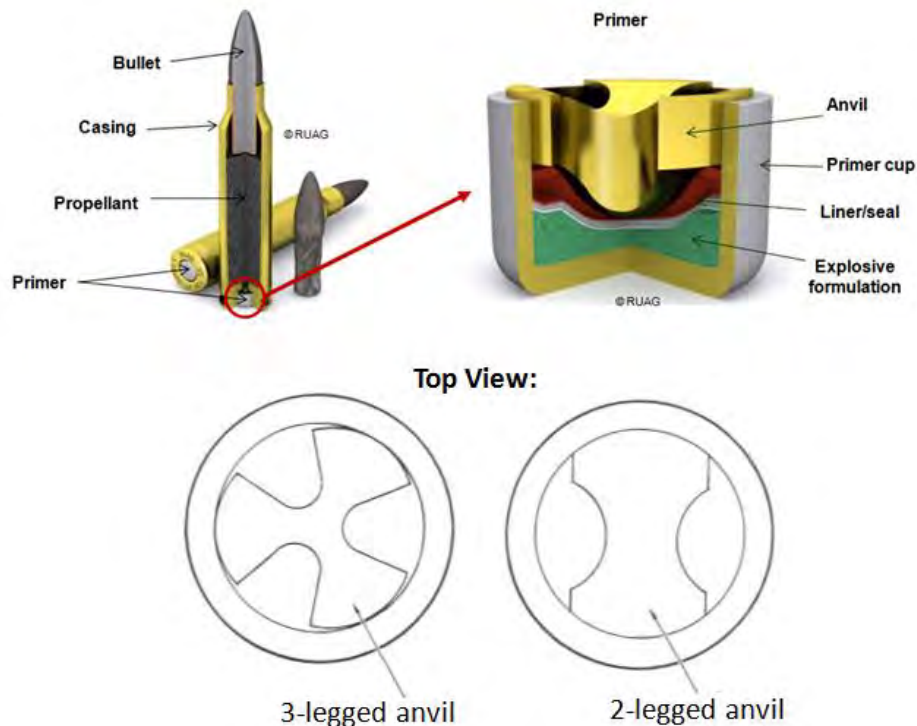

Figure 7  
Location and diagram of a common percussion primer

## UNCLASSIFIED

The primer formulation itself is generally very similar to those used in detonator stab mixes described previously; the main component is most often lead styphnate for military primers, along with other pyrotechnic additives. Countless percussion primer formulations exist, as they are often tweaked and adapted to the armament system of design. The formulations have generally evolved over time. Dating back to the mid-1800s, mercury fulminate-based formulations were the most commonly used primer mixes. In the 1920s, alternate priming mixes were discovered to replace mercury fulminate, as this previous composition was found to deteriorate rapidly under tropical conditions and cause potential health problems or concerns such as lethargy and nausea to the shooter after firing. Later primer mixes developed at Frankford Arsenal in the 1950s were based on lead styphnate, which is much more stable than mercury fulminate, and are still in widespread use today.

In their simplest form, most modern primers require at least five key components:

- **Primary explosive** -- lead styphnate, DDNP, etc.
- **Sensitizer** - tetrazene and/or calcium silicide, ground glass
- **Fuel** - antimony trisulfide, aluminum powder, etc.
- **Oxidizer** - usually barium nitrate
- **Binder** - Gum Arabic, polyvinyl alcohol, etc.

The role of the primary explosive, almost always lead styphnate in either the normal or basic form, is to provide an extremely rapid release of energy in the form of heat and pressure. Because lead styphnate is not sensitive enough on its own to initiate reliably in a typical primer configuration, a sensitizer is included; typically, this is the weaker but more sensitive explosive tetrazene (1-(5-tetrazolyl)-3-guanyl tetrazene hydrate). Occasionally, an inorganic sensitizer such as calcium silicide or even simple ground glass can be employed. The fuel/oxidizer combination is necessary in order to increase the heat and slag output required to smoothly ignite the propellant. The most common fuel is antimony trisulfide, chosen not only for its useful combustion properties but also for its sharp-edged crystal morphology which provides added friction sensitivity to the mixture. The oxidizer is almost always barium nitrate, which was selected in the early twentieth century as a replacement for the previously used potassium chlorate ( $\text{KClO}_3$ ) because it is not only non-hygroscopic but also does not form halogen salts as byproducts (many halogen salts absorb water from the atmosphere, and their residues were blamed for gun barrel corrosion). Finally, because of the varying densities and other properties of the disparate formulation ingredients, a suitable polymeric binder is required to maintain both the homogeneity and integrity of the primer formulation. This is generally Gum Arabic or a similar natural extract. Outside of the core formulation, other additives are often included. For instance, aluminum powder is frequently added as a more reactive fuel to boost energy output, and secondary explosives like PETN can be included as gas generators for primer applications that require more brisance. A common example is PA101, which contains basic lead styphnate, antimony trisulfide, barium nitrate, aluminum powder, and tetrazene (table 2). Commercial lead-free “green” primers also exist and often contain lead-free primary explosives such as DDNP or potassium 4,6-dinitrobenzofuroxan. To date, these primers have not been adapted for military use owing to their reputation for ineffectiveness and low reliability at extreme temperatures.

For comparison between formulations, the primer industry standard is to calculate the “all-fire energy” and “no-fire energy” from the statistical values and the mass of the steel ball using the formulas described in the footnotes to table 3. The “all-fire energy” can be thought of as the smallest energy input required to initiate the formulation 100% of the time, while conversely, the “no-fire energy” is a description of the highest energy input at which 0% of the primers function. Taken



together, these values paint a picture as to the overall reliability of the mix; if the “no-fire energy” is too low, the formulation is likely to be highly sensitive and present a safety issue to the user as well as in production; if the “all-fire energy” is too high, the mix will be unreliable and likely to generate an unacceptable number of duds. For this reason, primer military specifications require these values to fall in a defined range; in the case of the MIL-P-20444C requirement for the M42 primer, the “all-fire” must be less than or equal to 25.49, while the “no-fire” must be greater than or equal to 3.84. As an example, table 3 shows the performance of M42 primers produced by Olin and their comparison to the military specification requirements.

Table 3  
Primer sensitivity data for M42 primers produced by Olin

M42 primer	Hbar (in.)	S (in.)	Hbar+5S (in.)	Hbar-2S (in.)	All-fire Energy (in.oz)	No-fire Energy (in.oz)	Pressure (psi)
<b>MIL-P-20444C requirement</b>					<b>≤ 25.49</b>	<b>≥ 3.84</b>	
Olin (lead-based standard)	4.18	0.82	8.28	2.54	<b>16.06</b>	<b>4.93</b>	1379

Hbar = “average” height that ball must be dropped from to initiate primer (determined by Neyer analysis)  
 S = sigma (standard deviation of Hbar)  
 All-fire energy = (1.94 oz)\*(Hbar+5S)  
 No-fire energy = (1.94 oz)\*(Hbar-2S)  
 Psi = pounds per square inch

**Electric Primers**

The most common electric primer is the electric match (fig. 8); this can be thought of simply as an electric detonator without the detonator. It generally only consists of the hotwire embedded in a primary explosive formulation, often similar to those used in percussion primers. As such, its output is mainly in the form of heat and flame sufficient to trigger another pyrotechnic or propellant and not a typical secondary explosive.

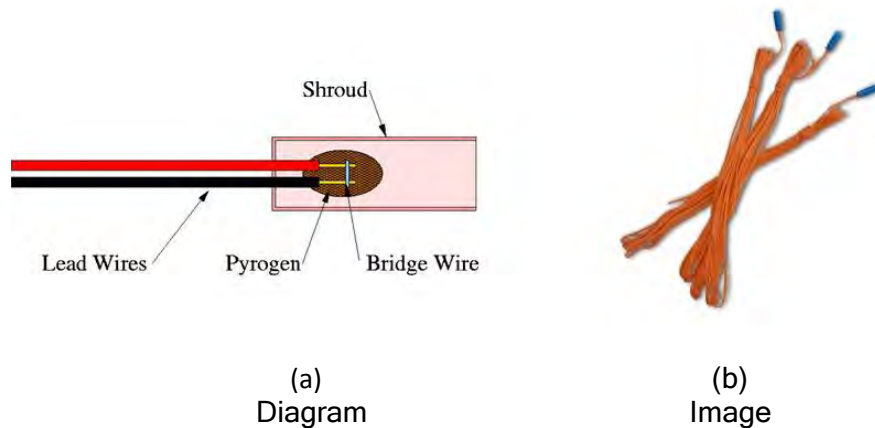

Figure 8  
Electric match

**FUZES**

Generically, a fuze is the device that, as a whole, initiates the munition it is incorporated into once a user desired criteria is met, such as: an interval of time elapses, a target being struck, being stepped on, etc. As such, a fuze generally incorporates an initiator like those described previously

with other mechanisms, like a delay column or proximity detector. Fuze can also be spelled differently, i.e., fuze with a “z” and fuse with an “s” to differentiate its purpose and complexity. The official convention is that fuze refers to the simplest devices, such as a pyrotechnic safety fuze used to trigger a blasting cap from a safe distance or something similar. Fuze, on the other hand, is meant to refer to the more complicated mechanisms found in advanced military munitions (hand grenades, artillery shells, aerial bombs, landmines, etc.). In general, they can be categorized based on their initiation mechanism, such as:

- Time delay
- Impact
- Proximity
- Radio/remote
- Pressure (barometric)

Although more sophisticated than the simpler fuse cords, military fuzes can vary greatly in complexity, often incorporating multiple initiators and other energetic components. An example is the M213 fuze used in the M67 fragmentation hand grenade (fig. 9). The M213 fuze functions when the handle is released and a spring-loaded striker impacts the M42 percussion primer, causing it to jettison flame and hot slag into the Zr/Ni based delay column, which is calibrated to burn for approximately 3 sec before reaching the lead styphnate, lead azide, and RDX in the C70 detonator. Not quite the size of a pinky finger, this detonator explodes with sufficient force to trigger the main Comp B charge of the grenade.

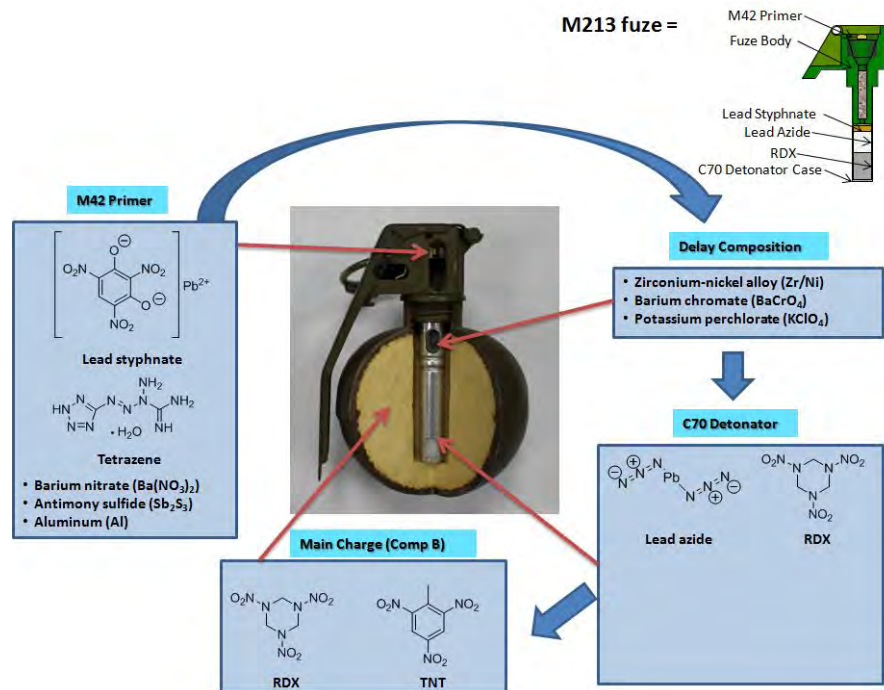

Figure 9  
Diagram of the M67 fragmentation grenade and the incorporated M213 fuze

Fuzes often incorporate safety mechanisms, such as so-called safety and arming (S&A) features that help limit accidental initiation via methods such as physically separating detonators and/or primers until they are ready for use.

Another example is the M739A1 fuze used for large artillery projectiles such as the M107; it incorporates an impact-triggered M55 stab detonator along with a booster charge and S&A, which keep the detonator out-of-line until it undergoes setback forces following the artillery shell's launch (fig. 10).

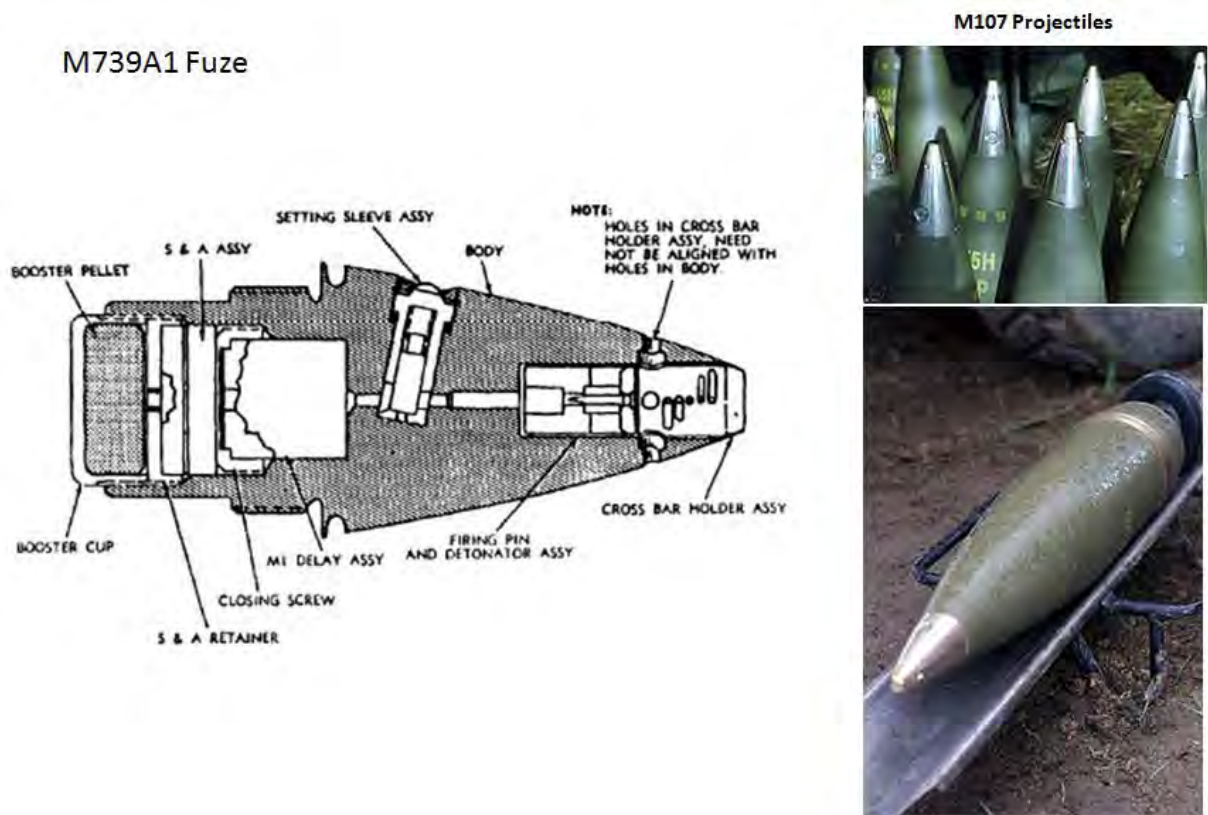

Figure 10  
Diagram of M739A1 fuze used to trigger M107 projectiles upon impact

## CONCLUSIONS

Initiators play an essential role to all forms of explosive, propellant, and pyrotechnic devices. Although they seemingly can take on a confusing array of configurations and mechanisms, most of the time initiators can be broadly broken down into subcategories such as shock-output detonators and flame-output primers/igniters, which can additionally be classified by their means of initiation (non-electric versus electric). This review provides a general means of identifying and differentiating some of the more commonly used explosive initiators but should by no means be considered an exhaustive survey.



# UNCLASSIFIED

## REFERENCES

- 1 Cooper, P. W., "Explosives Engineering," Wiley-VCH, New York, NY, 1996.
- 2 Davis, T. L., "The Chemistry of Powder and Explosives," GSG & Associates, San Pedro, CA, 1943.
- 3 Klapötke, T. M., "Chemistry of High-Energy Materials, 2nd Edition," Walter de Gruyter GmbH & Co., Berlin, 2012.
- 4 Federoff, B. T., "Encyclopedia of Explosives and Related Items," U.S. Army ARDEC, Picatinny Arsenal, NJ, 1960.
- 5 Costain, T., Wells, F. B., Processes for the Manufacture of Lead and Silver Azide, in H. D. Fair, R. F. Walker (Eds.), "Energetic Materials Volume 2: Technology of the Inorganic Azides," Plenum Press, New York, NY, USA, pp. 11 to 54, 1977.
- 6 Agrawal, J. P., "High Energy Materials: Propellants, Explosives, and Pyrotechnics," Wiley-VCH, Weinheim, 2010.
- 7 Taylor, G. W. C., Napier, S. E., "Preparation of Explosive Substances Containing Carboxymethyl Cellulose," U.S. Patent 3,291,664, 1966.
- 8 Perich, A., Cordaro, E. A., Cheng, G., Mehta, N., Stec, D., "On-Demand Lead Azide Production," U.S. Patent 7,407,638, 2008.
- 9 Gilligan, W. H., Kamlet, M. J., "Synthesis of Mercuric 5-Nitrotetrazole," White Oak Laboratory, Naval Surface Weapons Center NSWC/WOL/TR 76-146, 1976.
- 10 Warren, K. S., Rinkenbach, W. H., "Study of the Action of Lead Azide on Copper," U.S. Army ARDEC, Picatinny Arsenal, NJ, Technical Report No. 1152, 1942.
- 11 Taylor, G. W. C., Thomas, A. T., "Lead Styphnate Part 4: The Monobasic Lead Salts of Trinitroresorcinol, Polymorphic Modifications and the Development of R.D. 1346 and R.D. 1349," Explosives Research & Development Establishment Report No. 9/R/62, 1962.
- 12 Herz, E., "Lead Salt of Trinitroresorcin," British Patent 17961, 1915.
- 13 Herz, E., "Manufacture of Lead Styphnate," U.S. Patent 1,999,728, 1935.
- 14 Taylor, G. W. C., Thomas, A. T., "Manufacture of Basic Lead Styphnate," U.S. Patent 3,894,068, 1975.



UNCLASSIFIED

DISTRIBUTION LIST

U.S. Army ARDEC  
ATTN: RDAR-EIK  
RDAR-MEE-W, K. Oyler  
N. Mehta  
G. Cheng  
Picatinny Arsenal, NJ 07806-5000

Defense Technical Information Center (DTIC)  
ATTN: Accessions Division  
8725 John J. Kingman Road, Ste. 0944  
Fort Belvoir, VA 22060-6218

GIDEP Operations Center  
P.O. Box 8000  
Corona, CA 91718-8000  
gidep@gidep.org

REVIEW AND APPROVAL OF ARDEC TECHNICAL REPORTS

Overview of Explosive Initiators

Title

1/23/15  
Date received by LCSD

Dr. Karl Oyler

ARMET-JR-15017

Author/Project Engineer

Report number (to be assigned by LCSD)

X4784

B.3022

RDAR-MEE-W

Extension

Building

Author's/Project Engineers Office  
(Division, Laboratory, Symbol)

PART 1. Must be signed before the report can be edited.

- a. The draft copy of this report has been reviewed for technical accuracy and is approved for editing.
- b. Use Distribution Statement A x, B     , C     , D     , E     , F      or X      for the reason checked on the continuation of this form. Reason,                     
  1. If Statement A is selected, the report will be released to the National Technical Information Service (NTIS) for sale to the general public. Only unclassified reports whose distribution is not limited or controlled in any way are released to NTIS.
  2. If Statement B, C, D, E, F, or X is selected, the report will be released to the Defense Technical Information Center (DTIC) which will limit distribution according to the conditions indicated in the statement.
- c. The distribution list for this report has been reviewed for accuracy and completeness.

X

Steven M. Nicolich

JAN 13, 2015  
(Date)

Division Chief

PART 2. To be signed either when draft report is submitted or after review of reproduction copy.

This report is approved for publication.

Steven M. Nicolich

JAN 13, 2015  
(Date)

Division Chief

Andrew Pskowski

1/19/15

RDAR-CIS

(Date)

LCSD 49 supersedes SMCAR Form 49, 20 Dec 06