

HANDBOOK OF
OPERATING INSTRUCTIONS

for

RADAR SET
AN/APN-9

CARL H. SKINNER

RESTRICTED
(For Official Use Only)

Published under joint authority of the United States War and Navy Departments and the Air Council of the United Kingdom.

SECURITY NOTICE

FOR U. S. PERSONNEL: This document contains information affecting the national defense of the United States within the meaning of the Espionage Act, 50 U.S.C., 31 and 32, as amended. Its transmission or the revelation of its contents in any manner to an unauthorized person is prohibited by law. (AR 380-5) (ARTS 75½ & 76, U. S. N. REGS-1920.)

The information contained in restricted documents and the essential characteristics of restricted materiel will not be communicated to the public or to the press, but may be given to any

person known to be in the service of the United States and to persons of undoubted loyalty and discretion who are cooperating in Government work.

FOR BRITISH PERSONNEL: For Official Use Only—Not to be communicated to anyone outside His Majesty's Service. Not to be published. The information given in this document is not to be communicated, either directly or indirectly, to the press or to any person not holding an official position in His Majesty's Service.

LIST OF REVISED PAGES ISSUED

NOTE: A heavy black vertical line, to the left of the text on revised pages, indicates the extent of the revision. This line is omitted where more than 50 percent of the page is revised.

ADDITIONAL COPIES OF THIS PUBLICATION MAY BE OBTAINED AS FOLLOWS:

AAF ACTIVITIES.—Submit requisitions to the Commanding General, Fairfield Air Service Command, Patterson Field, Fairfield, Ohio, Attention: Publications Distribution Branch, in accordance with AAF Regulation No. 5-9. Also, for details of Technical Order distribution, see T. O. No. 00-25-3.

NAVY ACTIVITIES.—Submit requests to the Chief, Bureau of Aeronautics, Navy Department, Washington, D. C.

BRITISH ACTIVITIES.—Submit requirements on Form 294A, in duplicate, to the Air Publications and Forms Store, New College, Leadhall Lane, Harrogate, Yorkshire, England.

TABLE OF CONTENTS

| <i>Section</i> | <i>Page</i> | <i>Section</i> | <i>Page</i> |
|---|-------------|--|-------------|
| Destruction of Abandoned Materiel in the Combat Zone | iii | b. Operation with Ground Waves | 3-2 |
| Unsatisfactory Report | iii | c. Operation with Ground Waves Accompanied by Sky Waves | 3-10 |
| I. DESCRIPTION | 1-1—1-2 | d. Operation with Sky Waves | 3-11 |
| 1. General | 1-1 | e. Navigation along a LORAN Line of Position | 3-12 |
| 2. Equipment Supplied | 1-1 | IV. EMERGENCY OPERATION AND REPAIR | 4-0—4-9 |
| 3. Equipment Required but Not Supplied | 1-1 | 1. Check of Counter and Station Selector Adjustment | 4-0 |
| II. INSTALLATION AND ADJUSTMENT | 2-1—2-12 | a. Counter Indications | 4-0 |
| 1. Preliminary Procedure | 2-1 | b. Station Feed Back Rates | 4-2 |
| a. Unpacking of Equipment | 2-1 | 2. Emergency Adjustment | 4-3 |
| b. Bench Test | 2-1 | a. Counter Adjustments | 4-3 |
| 2. Installation | 2-1 | b. Station Rate Adjustments | 4-5 |
| a. Location | 2-1 | c. Right-Left Control | 4-6 |
| b. Procedure | 2-1 | d. Brilliance Control | 4-6 |
| c. Cable Connections | 2-1 | e. Focus Control | 4-6 |
| 3. Adjustments | 2-1 | f. Centering of Traces | 4-6 |
| a. Equipment Required | 2-1 | g. Amplitude of Traces | 4-7 |
| b. Preliminary Check | 2-1 | b. Marker Size | 4-8 |
| c. Receiver-Indicator Adjustment | 2-2 | i. Cross Hair | 4-8 |
| 4. After-Installation Tests | 2-12 | j. Coarse Delay | 4-8 |
| III. OPERATION | 3-1—3-13 | k. Fine Delay | 4-9 |
| 1. Starting and Stopping Equipment | 3-1 | 3. Fuse Replacement | 4-9 |
| a. To Start Equipment | 3-1 | V. SUPPLEMENTARY DATA | 5-0—5-3 |
| b. To Stop Equipment | 3-2 | 1. Tube Complement | 5-0 |
| 2. Operation | 3-2 | 2. Fuse Complement | 5-0 |
| a. General | 3-2 | 3. Pilot Lamp Complement | 5-0 |



LIST OF ILLUSTRATIONS

| <i>Figure</i> | <i>Page</i> | <i>Figure</i> | <i>Page</i> |
|--|-------------|--|-------------|
| 1-1. Receiver-Indicator R-65/APN-9 —Exterior View, Left Side | iv | 3-9—3-13. Receiver-Indicator Operation —Identification of LORAN Stations .. | 3-3 |
| 1-2. Receiver-Indicator R-65/APN-9 —Exterior View, Right Side | 1-2 | 3-14—3-24. Receiver-Indicator Operation —Timing of Receiver-Indicator .. | 3-4—3-5 |
| 2-1—2-5. Power Supply Voltage Check | 2-1—2-2 | 3-25—3-34. Receiver-Indicator Operation —Indicated Time Difference | 3-6—3-10 |
| 2-6—2-54. Receiver-Indicator Adjustments .. | 2-2—2-12 | 3-35. Ground and Sky Wave Signals —Position "2" | 3-11 |
| 3-1—3-4. Receiver-Indicator Operation "ON" Procedure | 3-1 | 3-36. Sky Wave Signals—Position "1" | 3-11 |
| 3-5. Receiver-Indicator "OFF" Procedure | 3-2 | 3-37. Sky Wave Signals—Position "2" | 3-11 |
| 3-6. Wave Paths | 3-2 | 3-38—3-40. "Dangerous" Pulse Splitting .. | 3-11—3-12 |
| 3-7. Indicated Order of Wave Paths | 3-2 | 3-41—3-44. Receiver-Indicator Operation —Navigation along a LORAN Line of Position | 3-12—3-13 |
| 3-8. Ground and Sky Wave Signals —Position "1" | 3-2 | | |

LIST OF ILLUSTRATIONS (Continued)

| <i>Figure</i> | <i>Page</i> | <i>Figure</i> | <i>Page</i> |
|---------------|---|---------------|-------------|
| 4-1—4-9. | Receiver-Indicator Indications for Correct Timing—Counter Indications | 4-0—4-2 | |
| 4-10—4-11. | Receiver-Indicator Indications for Correct Timing—Station Feed-Back Rates | 4-2—4-3 | |
| 4-12—4-16. | Receiver-Indicator Emergency Operation—Counter Adjustments | 4-4—4-5 | |
| 4-17—4-19. | Receiver-Indicator Emergency Operation—Station Rate Adjustments | 4-5 | |
| 4-20. | R-L Screw Driver Adjustment | 4-6 | |
| 4-21. | "BRILL." Screw Driver Adjustment | 4-6 | |
| 4-22. | "FOCUS" Screw Driver Adjustment | 4-6 | |
| 4-23—4-27. | Receiver-Indicator Emergency Operation—Centering of Traces | 4-6—4-7 | |
| 4-28—4-31. | Receiver-Indicator Emergency Operation—Amplitude of Traces | 4-7—4-8 | |
| 4-32. | "MARKER AMPL." Adjustment | 4-8 | |
| 4-33. | "CROSS HAIR" Adjustment | 4-8 | |
| 4-34—4-37. | Receiver-Indicator Emergency Operation—Coarse Delay | 4-8—4-9 | |
| 4-38. | "FINE DELAY" Adjustment | 4-9 | |
| 4-39. | Fuse Replacement | 4-9 | |
| 5-1. | Location of Spare Fuse | 5-0 | |
| 5-2. | Location of Pilot Light | 5-0 | |
| 5-3. | Radar Set AN/APN-9—Dimensional Outline Drawing | 5-1 | |
| 5-4. | Power Supply Cable Assembly Drawings—Cording and Antenna Switch Connection Diagrams | 5-2 | |
| 5-5. | Antenna Cable Assembly Drawing | 5-3 | |



SAFETY NOTICE

This equipment employs high voltages which are dangerous and may be fatal if contacted by operating personnel. Exercise extreme caution when working with the equipment.

Destruction of Abandoned Materiel in the Combat Zone

In case it should become necessary to prevent the capture of this equipment and when ordered to do so, DESTROY IT SO THAT NO PART OF IT CAN BE SALVAGED, RECOGNIZED, OR USED BY THE ENEMY. BURN ALL PAPERS AND BOOKS.

Means:—

1. Explosives, when provided.
2. Hammers, axes, sledges, machetes, or whatever heavy object is readily available.
3. Burning by means of incendiaries such as gasoline, oil, paper, or wood.
4. Grenades and shots from available arms.
5. Burying all debris or disposing of it in streams or other bodies of water, where possible and when time permits.

Procedure:—

1. Obliterate all identifying marks. Destroy nameplates and circuit labels.
2. Demolish all panels, castings, switch- and instrument-boards.
3. Destroy all controls, switches, relays, connections, and meters.
4. Rip out all wiring and cut interconnections of electrical equipment. Smash gas, oil, and water-cooling systems in gas-engine generators, etc.
5. Smash every electrical or mechanical part, whether rotating, moving, or fixed.
6. Break up all operating instruments such as keys, phones, microphones, etc.
7. Destroy all classes of carrying cases, straps, containers, etc.
8. Bury or scatter all debris.

DESTROY EVERYTHING!



Unsatisfactory Report

For U. S. Army Air Force Personnel:

In the event of malfunctioning, unsatisfactory design, or unsatisfactory installation of any of the component units of this equipment, or if the material contained in this book is considered inadequate or erroneous, an Unsatisfactory Report, AAF Form No. 54, or a report in similar form, shall be submitted in accordance with the provisions of Army Air Force Regulation No. 15-54, listing:

1. Station and organization.
2. Nameplate data (type number or complete nomenclature if nameplate is not attached to the equipment).
3. Date and nature of failure.
4. Airplane model and serial number.
5. Remedy used or proposed to prevent recurrence.
6. Handbook errors or inadequacies, if applicable.

For U. S. Navy Personnel:

Report of failure of any part of this equipment during its guaranteed life shall be made on Form N. Aer. 4112, "Report of Unsatisfactory or Defective Material," or a report in similar form, and forwarded in accordance with the latest instructions of the Bureau of Aeronautics. In addition to other distribution required, one copy shall be furnished to the inspector of Naval Materiel (location to be specified) and the Bureau of Ships. Such reports of failure shall include:

1. Reporting activity.
2. Nameplate data.
3. Date placed in service.
4. Part which failed.
5. Nature and cause of failure.
6. Replacement needed (yes—no).
7. Remedy used or proposed to prevent recurrence.

For British Personnel:

Form 1022 procedure shall be used when reporting failure of radio equipment.

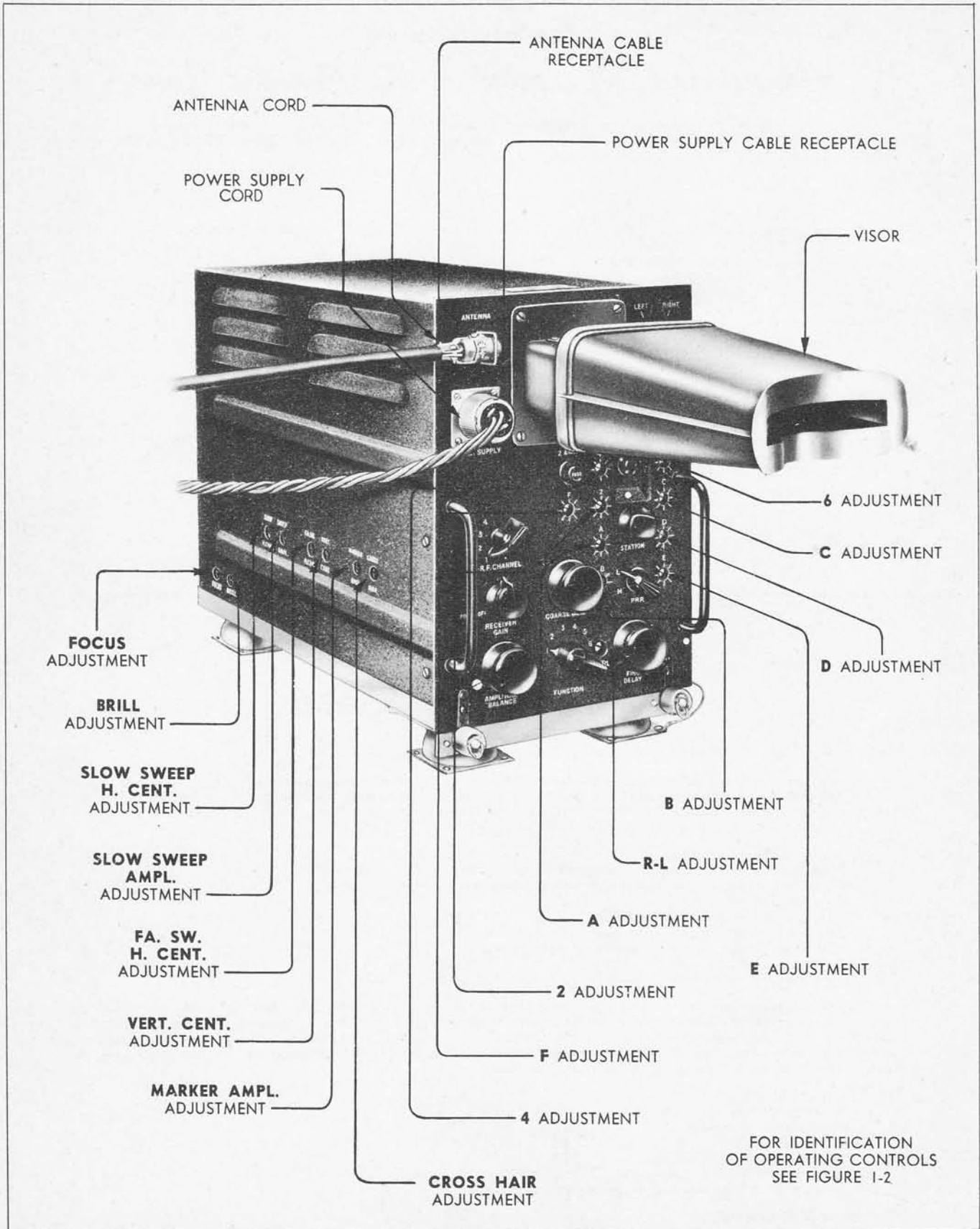

Figure 1-1. Receiver-Indicator R-65/APN-9—Exterior View, Left Side

SECTION I DESCRIPTION

1. GENERAL.

(See figure 1-1.)

a. Radar Set AN/APN-9 is an airborne navigation equipment composed of Receiver-Indicator R-65/APN-9, equipped with a detachable visor, the necessary cables, and an antenna switch (not shown). It is mounted on a shock Mounting FT-446 or MT-203/APN. The equipment operates on the LORAN principle. It receives, amplifies, and detects the LORAN signals and displays them on the screen of a cathode ray indicator tube in the receiver-indicator.

b. Radar Set AN/APN-9 will operate at any altitude between sea level and 40,000 feet. It is designed to oper-

ate satisfactorily within a temperature range of -55°C . (-67°F .) to $+50^{\circ}\text{C}$. ($+122^{\circ}\text{F}$.)

c. The power supply frequency is between 400 and 2400 cycles per second. The nominal power supply voltages are 80 and 115 volts, selected by the connections of the power connector plug (see fig. 5-4). The power consumption is 225 volt amperes at 0.9 power factor, when the "RECEIVER GAIN" control is adjusted for maximum gain.

2. EQUIPMENT SUPPLIED.

The following equipment is supplied with Radar Set AN/APN-9.

| Quantity of Equipment | Name of Unit | Army Type Designation | Navy Type Designation | Overall Dimensions (inches) | Weight (pounds) |
|-----------------------|--|-----------------------|-----------------------|--|-----------------|
| 1 | Receiver-Indicator including 1 lens, 1 visor, 1 crystal and a complete tube complement | R-65/APN-9 | R-65/APN-9 | 9 $\frac{1}{8}$ x 12 $\frac{1}{4}$ x 30 $\frac{9}{16}$ with visor 9 $\frac{1}{8}$ x 12 $\frac{1}{4}$ x 22 $\frac{15}{16}$ without visor | 36 max. |

3. EQUIPMENT REQUIRED BUT NOT SUPPLIED.

The equipment required for the operation of Radar Set AN/APN-9 but not supplied is listed below.

| Quantity of Equipment | Name of Unit | Army Type Designation | Navy Type Designation | Required Characteristics |
|-----------------------|--------------------------------------|----------------------------|-----------------------|----------------------------------|
| 1 | Radio Frequency Cable | RG-8/U | RG-8/U | Coaxial antenna cable |
| 1 | Coupling or Coupling | MC-277 MC-277-A | | For Radio Frequency Cable RG-8/U |
| 1 | Switch (DPDT) or Switch (TPDT) | SA-13/U SW-225 | SA-13/U | Antenna switch |
| 1 | Cable Clamp | M-297 | | |
| 1 | Plug | PL-166 | | For power supply |
| 1 | Mounting | FT-446 or MT-203/APN | | |

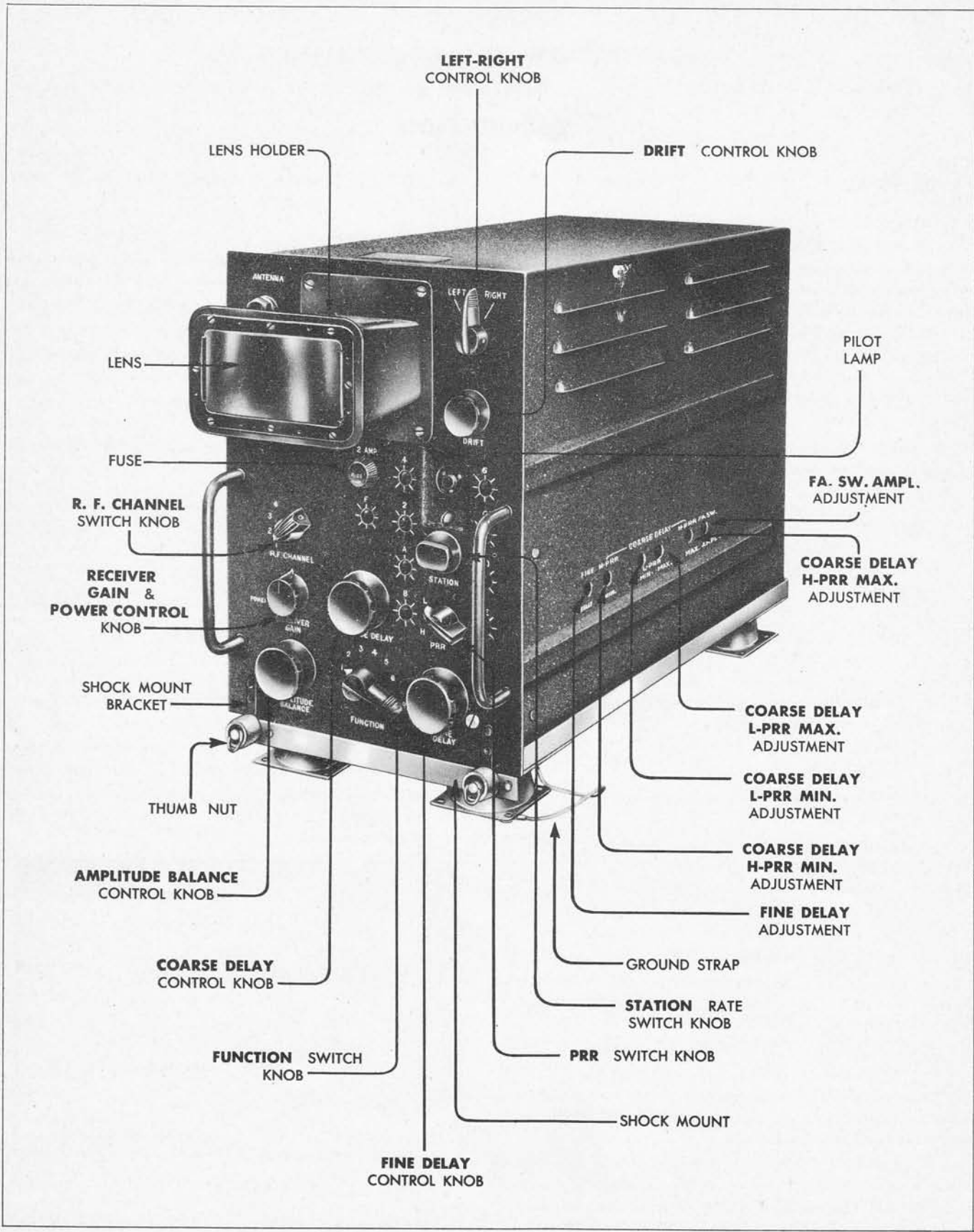

Figure 1-2. Receiver-Indicator R-65/APN-9—Exterior View, Right Side

SECTION II INSTALLATION AND ADJUSTMENT

1. PRELIMINARY PROCEDURE.

a. UNPACKING OF EQUIPMENT.—Carefully unpack the receiver-indicator and the visor and remove from the packing case. Give the equipment a complete visual inspection for external damage. Remove chassis from cover and check to see that all tubes are undamaged and inserted in the proper sockets.

b. BENCH TEST.—Follow the procedure outlined in section II, paragraph 3*c*(1) through (44). If the counter circuit adjustments are not correct as determined by these checks, reject the receiver-indicator and return to maintenance shop for proper alignment.

2. INSTALLATION.

a. LOCATION.—Select a position for Radar Set AN/APN-9 such that sufficient clearance is provided to permit adjusting the controls located on the right and left hand sides of the receiver-indicator assembly. The operator, when seated, must have a clear view of the screen.

b. PROCEDURE.

(1) Install Mounting FT-446 or Mounting MT-203/APN, by following the instructions found in figure 5-3.

(*a*) Use four No. 8 machine screws for each foot.

(*b*) Fasten each foot of the shock mount securely to the support provided.

(*c*) Connect the ground strap of the shock mount to the nearest metal part of the airplane making certain that the metal is free of all paint, grease, etc., so that a secure electrical connection is made.

(2) To install Receiver-Indicator R-65/APN-9 proceed as follows:

(*a*) Carefully place the receiver-indicator on the shock mount frame.

(*b*) Insert two spring plungers which protrude from the back of the receiver-indicator through the holes located at the back of the shock mount frame.

(*c*) Tighten the knurled thumb nuts on the front of the shock mount frame to the two brackets on the front of the receiver-indicator.

(*d*) Make certain that it rides securely on the shock mount and that nothing prevents the shock mount from functioning correctly.

c. CABLE CONNECTIONS.

(1) MAKING CABLES. — No sharp bends or breaks must appear in the cable assembly and ample slack must always be present to permit quick and easy connection and disconnection.

(*a*) POWER SUPPLY CABLE.—Assemble the power supply cable according to the instructions given in figure 5-4. The cable used will depend upon the airplane power supply installation. Install a two-wire cable except when an inverter starting relay is used; in that case, a four-wire cable is installed. The connections of

the power leads to the plug will depend upon the voltage of the airplane power supply. The power leads must be No. 18, and not over 30 feet long between the point of measurement of the line voltage and the power plug. The leads of the starting relay must be of sufficient capacity to carry the prescribed current safely.

(*b*) ANTENNA CABLE. — Assemble this as shown in figure 5-5.

(2) INTERCONNECTION OF UNITS.

(*a*) The receiver end of the antenna cable is connected to Coupling MC-277 on the receiver-indicator.

(*b*) The other end connects to the antenna receptacle (color-coded green) of the antenna Switch SA-13/U or SW-225. Switch SW-225 (TPDT) is installed when Antenna Tuning Unit BC-306-B is used with the liaison set, and Switch SA-13/U (DPDT) is installed when Antenna Tuning Unit BC-306-A is used with the liaison set. (See fig. 5-4.) Both Switch SW-225 and SA-13/U lead to the liaison set trailing wire antenna reel and to the fixed antenna of the airplane.

(*c*) The power supply cable connects to Plug PL-166 on the receiver-indicator and to the airplane power supply installation.

3. ADJUSTMENTS.

WARNING

This equipment employs high voltages which are dangerous and may be fatal if contacted by operating personnel. Use extreme caution when working with it.

a. EQUIPMENT REQUIRED.—To perform all tests mentioned in this book which require input pulses use Test Set TS-251/UP.

b. PRELIMINARY CHECK. — Figures 2-1 through 2-5 are power supply voltage checks.

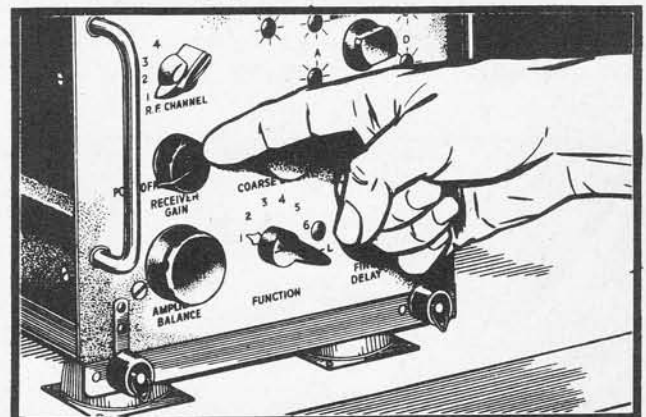

Figure 2-1

(1) Turn the "RECEIVER GAIN" control knob to the maximum counterclockwise position marked "POWER OFF."

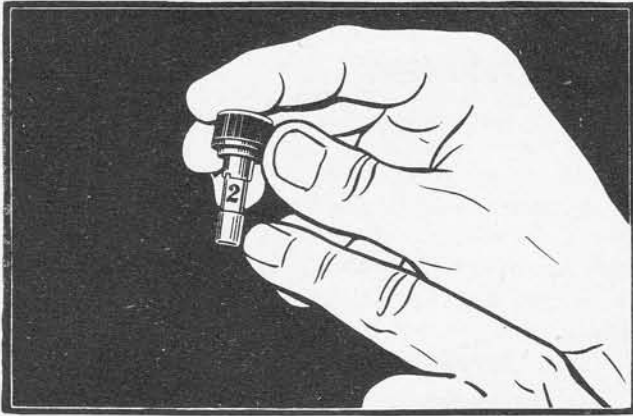

Figure 2-2

(2) Remove the receiver-indicator fuse, and note the amperage marking. If the voltage is 115 volts, a 2-ampere fuse must be used. If the voltage is 80 volts, a 3-ampere fuse must be used.

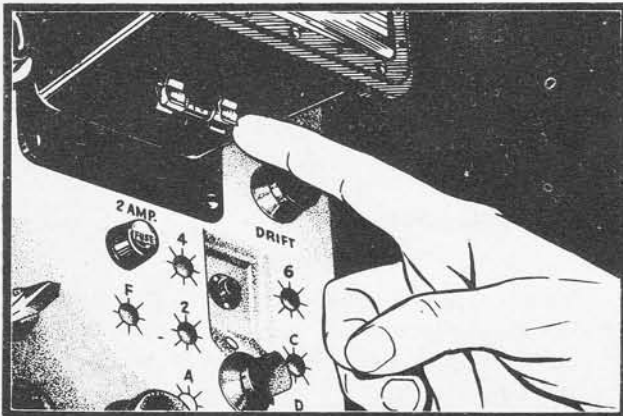

Figure 2-3

(3) Check to see that the amperage of the spare fuse corresponds to the amperage of the fuse to be installed in the receiver-indicator.

(4) Place the airplane power supply in operation and measure the line voltage, using Voltmeter IS-156 or equivalent.

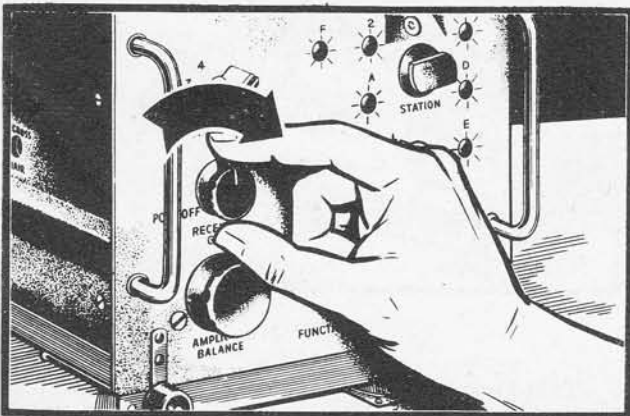

Figure 2-4

(5) Turn on the power of the receiver-indicator by rotating the "RECEIVER GAIN" control knob in a clockwise direction.

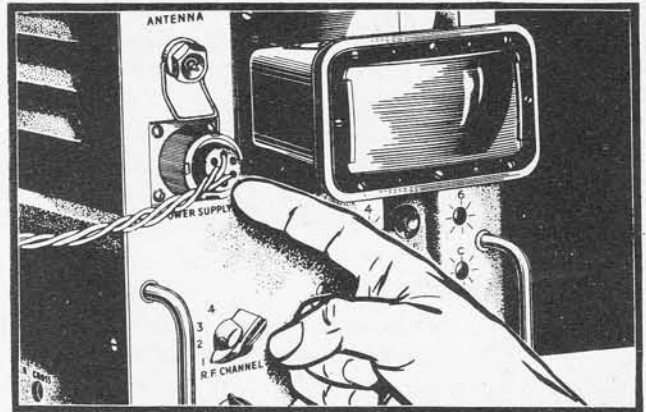

Figure 2-5

(6) Read the line voltage again. It should be approximately 80 or 115 volts, depending upon the voltage of the power supply. If either of the above readings does not indicate a correct voltage, adjustments must be made in the main power supply system until the voltmeter indicates the specified 80 or 115 volts.

c. RECEIVER-INDICATOR ADJUSTMENTS.

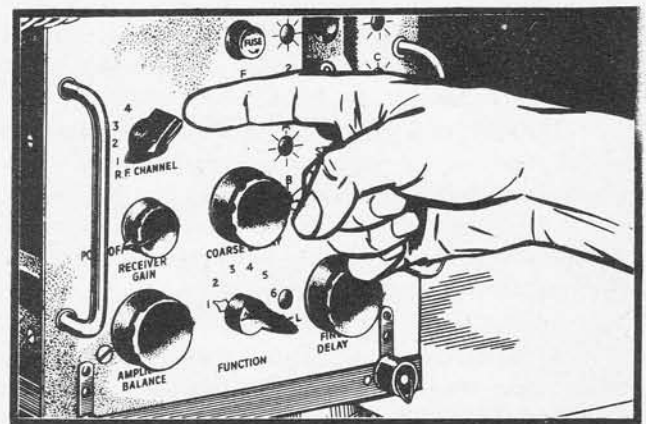

Figure 2-6

(1) Turn the "R.F. CHANNEL" switch to position "1."

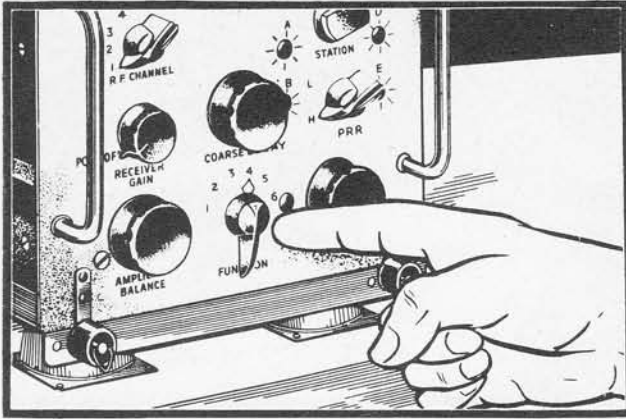

Figure 2-7

(2) Turn the "FUNCTION" switch to position "4."

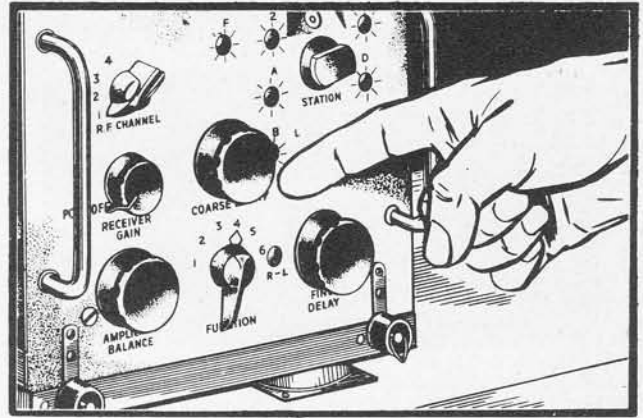

Figure 2-10

(5) Turn the "COARSE DELAY" control to its maximum clockwise position.

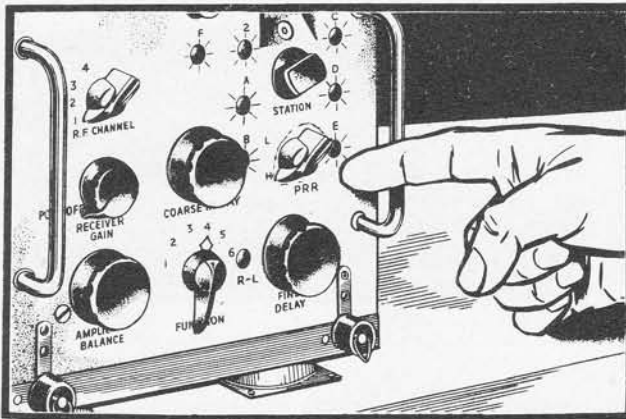

Figure 2-8

(3) Turn the "PRR" (pulse recurrence rate) switch to position "H."

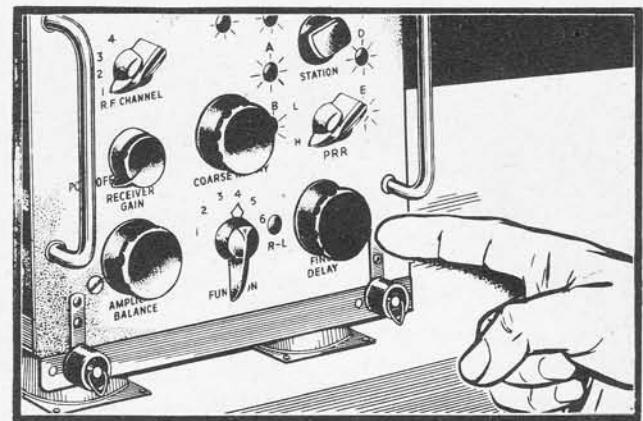

Figure 2-11

(6) Turn the "FINE DELAY" control to its maximum clockwise position.

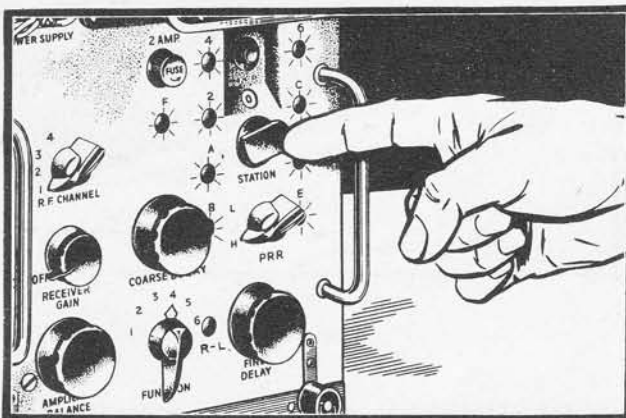

Figure 2-9

(4) Turn the "STATION" switch to position "O."

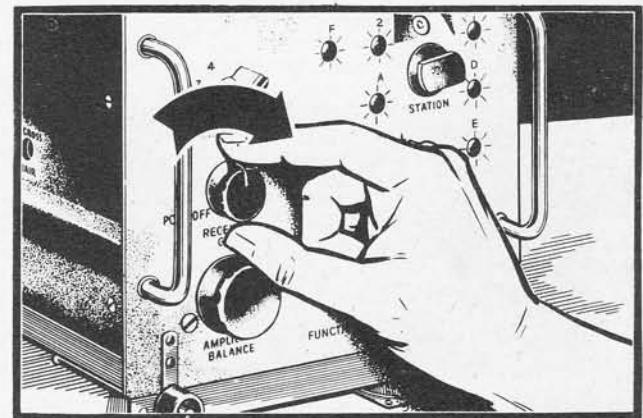

Figure 2-12

(7) Turn the power supply on, by rotating the "RECEIVER GAIN" control in a clockwise direction and see that the pilot lamp lights. Wait four to five minutes for the set to warm up.

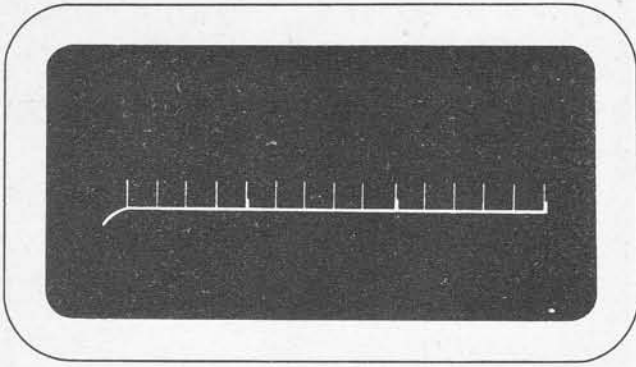

Figure 2-13

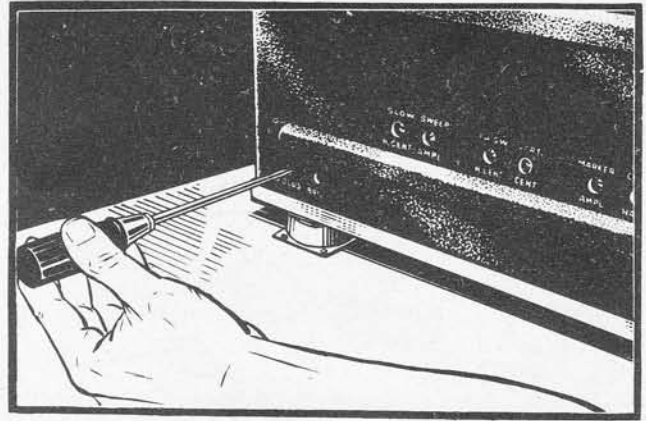

Figure 2-16

(8) Observe the trace on the indicator screen.

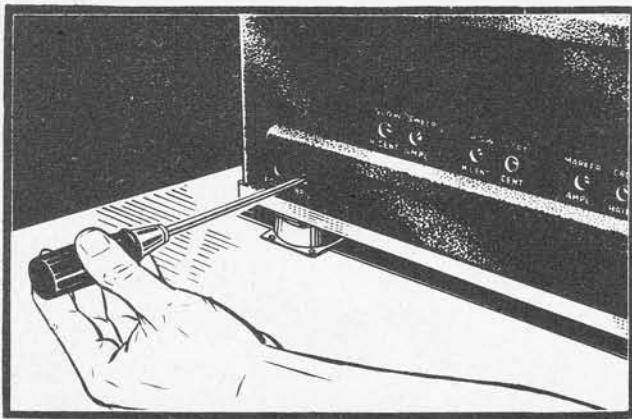

Figure 2-14

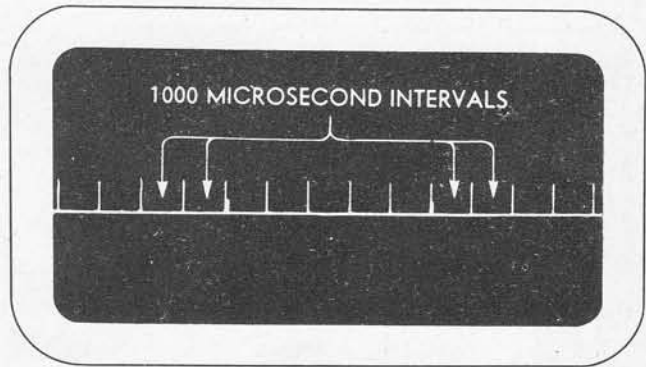

Figure 2-17

(9) If not trace has appeared, adjust the "BRILL" screw driver control on the left side panel of the receiver-indicator until a trace appears.

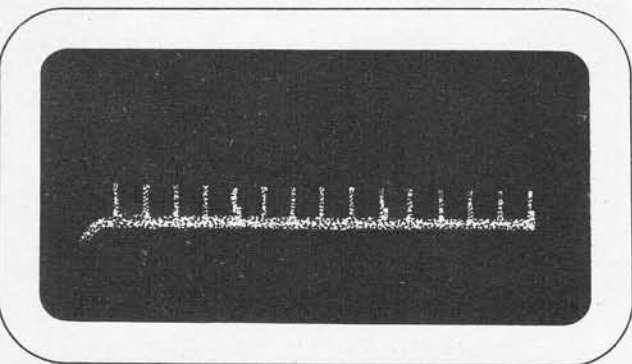

Figure 2-15

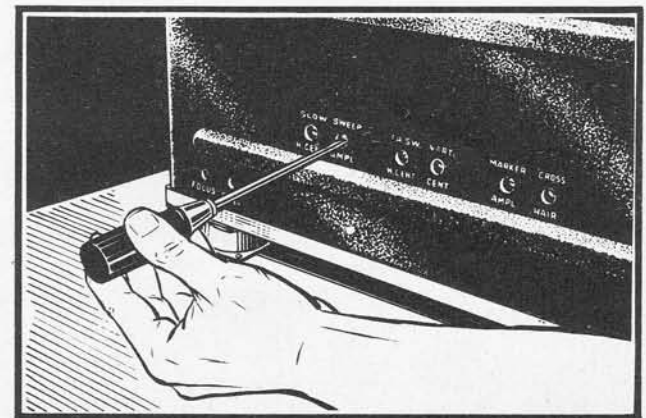

Figure 2-18

(10) If the trace is blurred, adjust the "FOCUS" screw driver control on the panel on the left side of the receiver-indicator until the trace is sharp and clear.

(11) If the trace amplitude is incorrect (that is, if the length of the trace is too long or too short) adjust the "SLOW SWEEP AMPL." screw driver control on the left side until the trace covers approximately the diameter of the screen.

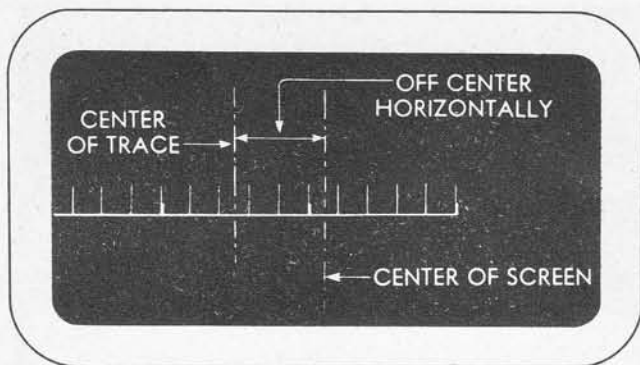

Figure 2-19

(12) If the trace is not centered horizontally, adjust the "SLOW SWEEP H. CENT." screw driver control on the left hand side until it is properly centered. Repeat and coordinate (11) and (12) until the amplitude and centering of the trace is correct.

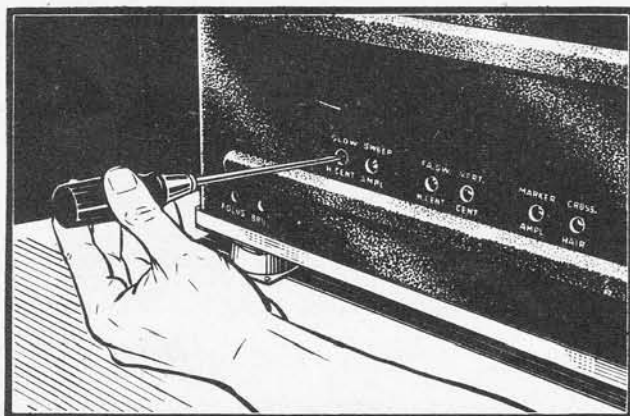

Figure 2-20

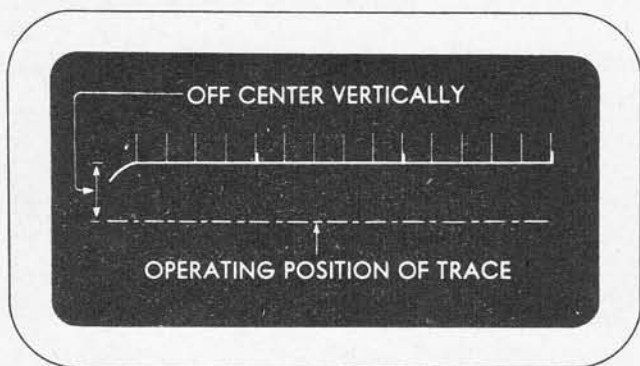

Figure 2-21

(13) If the trace is not centered vertically, adjust the "VERT. CENT." control on the left side of the receiver-indicator until the trace is correctly centered.

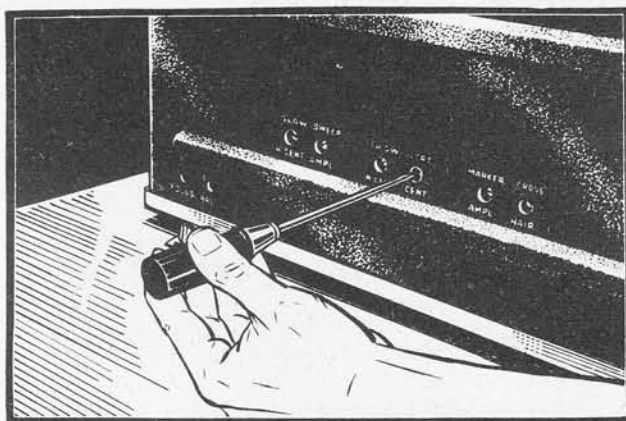

Figure 2-22

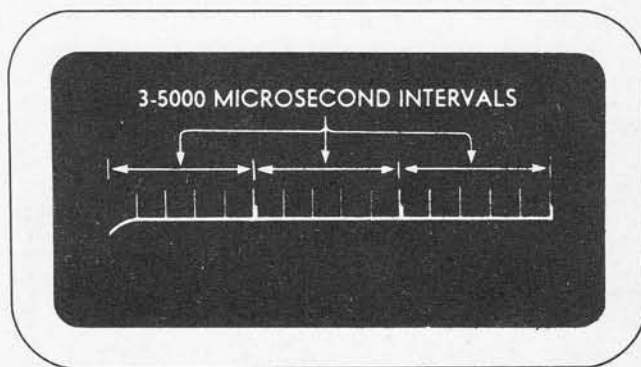

Figure 2-23

(14) With the "PRR" switch set to position "H," count *three* 5000-microsecond intervals between the extreme right and left ends of the trace.

CAUTION

If the number of intervals counted in (15) and (16) are incorrect reject the receiver transmitter and return to maintenance shop for proper alignment. If it is imperative that the defective unit be placed in operation immediately refer to section IV, paragraphs 1 and 2 for proper instruction.

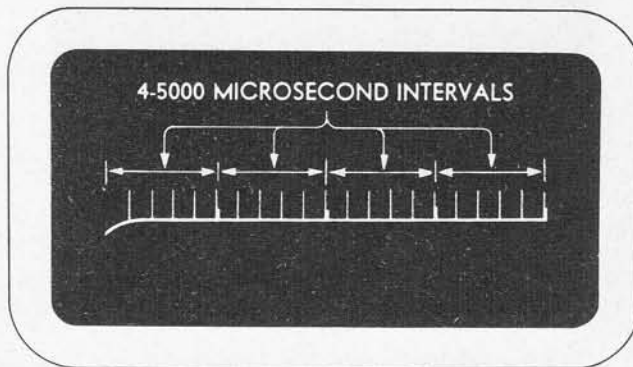

Figure 2-24

Section II
Paragraph 3

RESTRICTED
AN 08-30APN9-2

(15) Turn the "PRR" switch to position "L" and count *four* 5000-microsecond intervals between the extreme right and left ends of the trace.

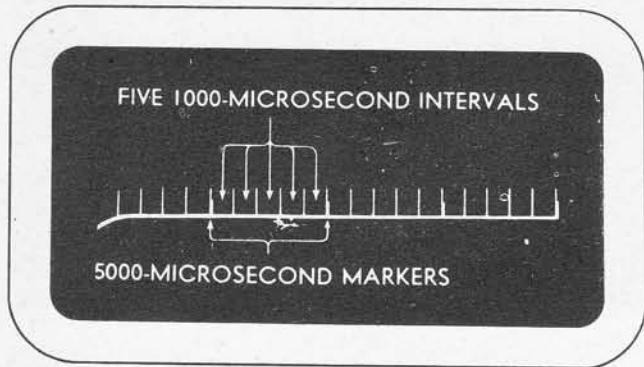

Figure 2-25

(16) Count *five* 1000-microsecond intervals between the 5000-microsecond markers.

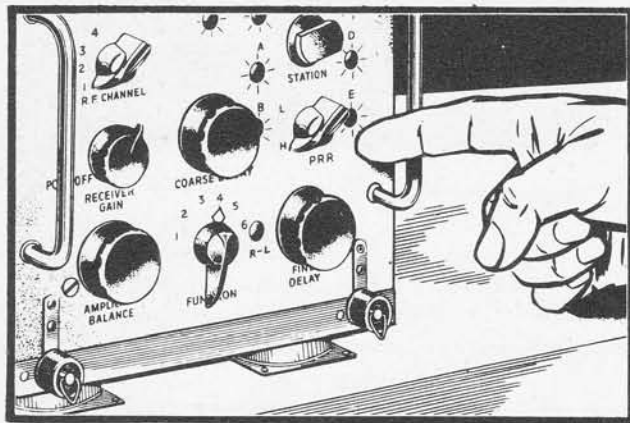

Figure 2-26

(17) Turn the "PRR" switch to position "H."

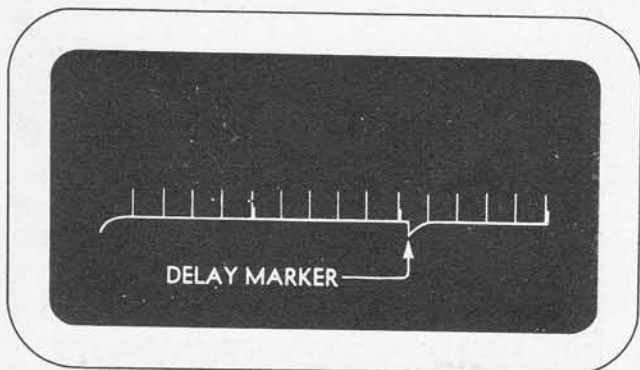

Figure 2-27

If the variable delay marker appears on the trace, with the "COARSE DELAY" and "FINE DELAY" controls in their extreme clockwise position . . .

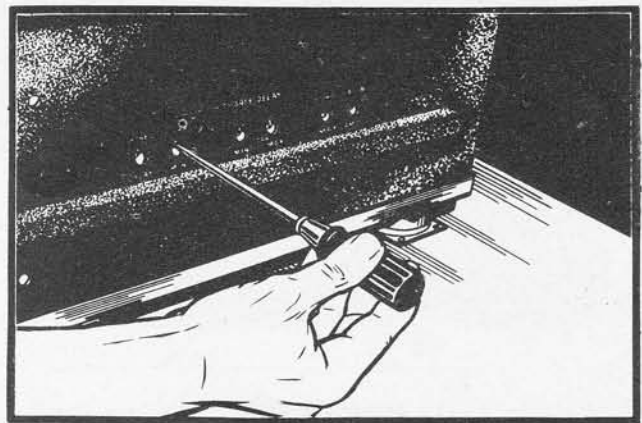

Figure 2-28

(18) . . . Slowly turn the "COARSE DELAY H-PRR. MIN." control on the right hand side of the receiver-indicator to a point slightly beyond where the variable delay marker disappears.

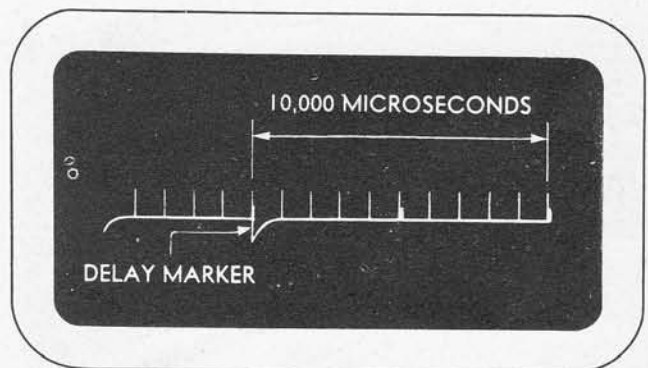

Figure 2-29

(19) With the "PRR" switch set at "H," turn the "COARSE DELAY" knob to the maximum counter-clockwise position; the variable delay marker now appears on the trace. Count the 1000-microsecond intervals between the variable delay marker and the extreme right hand end of the trace.

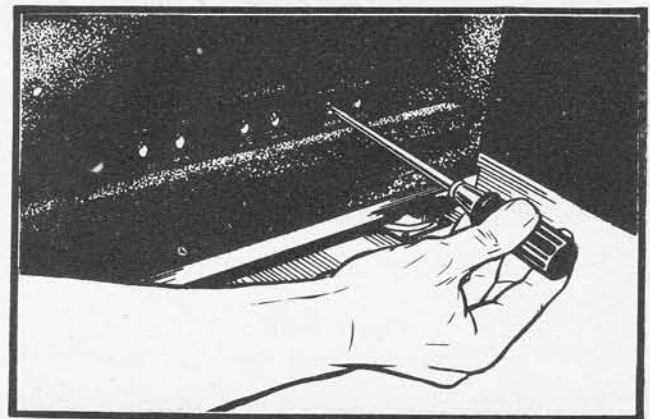

Figure 2-30

(20) If this time interval is more than 12,000 or less than 10,500 microseconds, adjust the "COARSE DELAY H-PRR MAX." control on the right hand side until the delay marker appears between 11,000 and 11,500 microseconds. Repeat (18) to (20) until the delay range is correct.

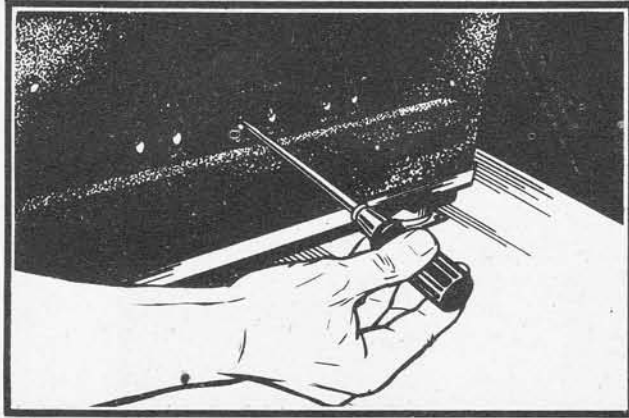

Figure 2-31

(21) If the variable delay marker appears on the trace with the "PRR" switch set at position "L," with the "COARSE DELAY" and "FINE DELAY" controls in their extreme clockwise positions, slowly turn the "COARSE DELAY L-PRR. MIN." control on the right hand side of the receiver-indicator to a point slightly beyond where the delay marker disappears.

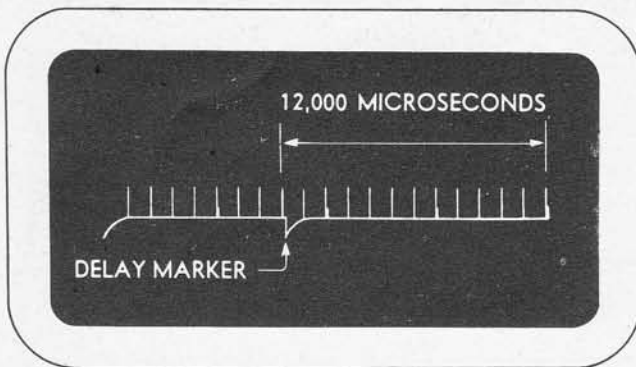

Figure 2-32

(22) Turn the "COARSE DELAY" knob to the maximum counterclockwise position and count the 1000-microsecond intervals between the variable delay marker and the extreme right hand end of the trace.

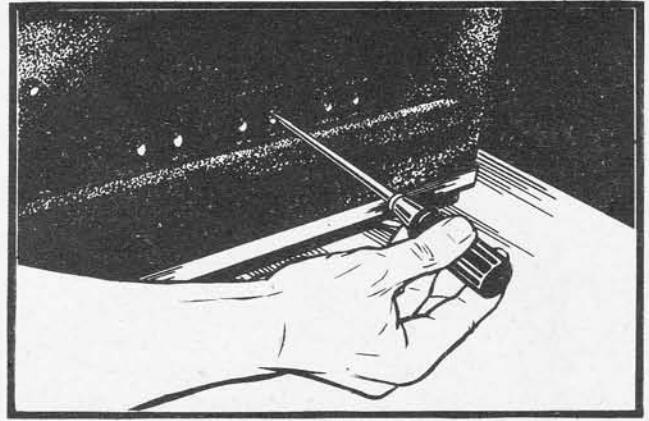

Figure 2-33

(23) If this time interval is more than 15,000 microseconds or less than 12,000 microseconds, adjust the "COARSE DELAY L-PRR MAX." on the right hand side of the receiver-indicator until the delay marker appears between 13,500 and 14,000 microseconds. Repeat (21), (22), and (23) until the delay range is correct.

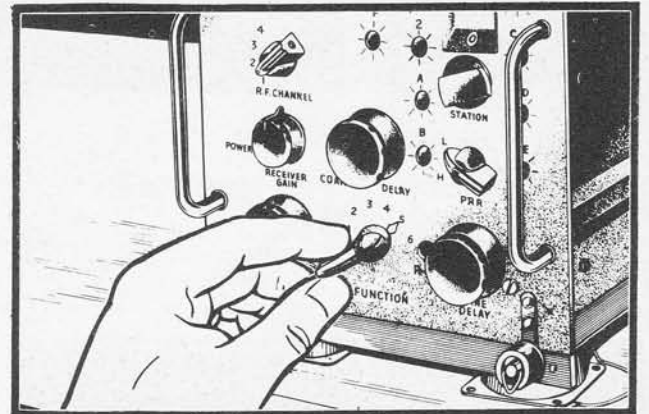

Figure 2-34

(24) Turn the "FUNCTION" switch to position "5."

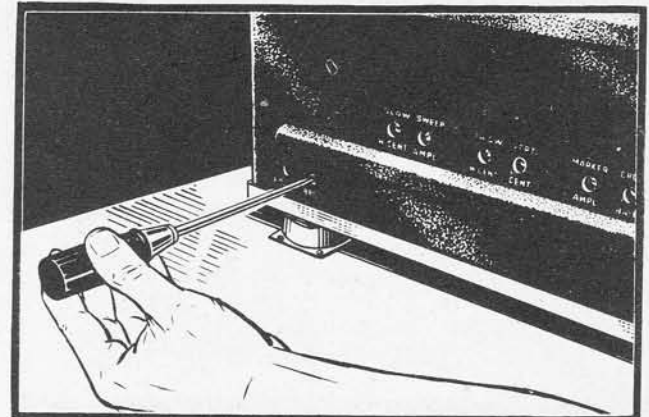

Figure 2-35

(25) If not trace appears, adjust the "BRILL." screw driver control on the left hand side of the receiver-indicator until the trace appears. Readjust the "FOCUS" control until the trace is sharp and clear.

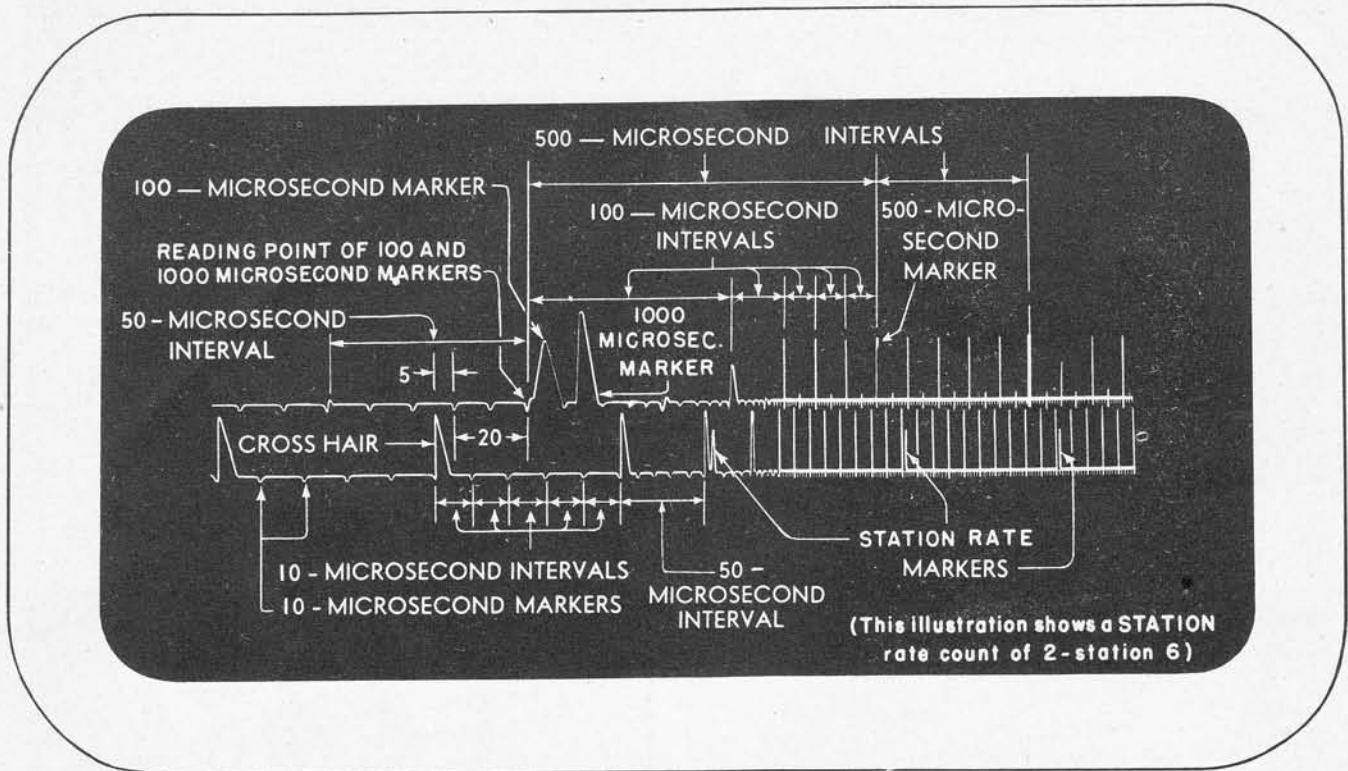

Figure 2-36

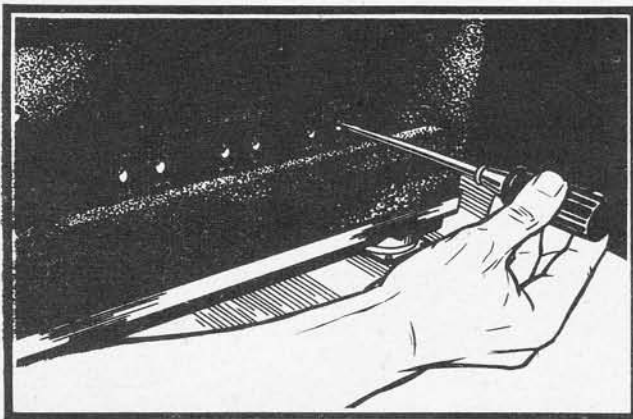

Figure 2-37

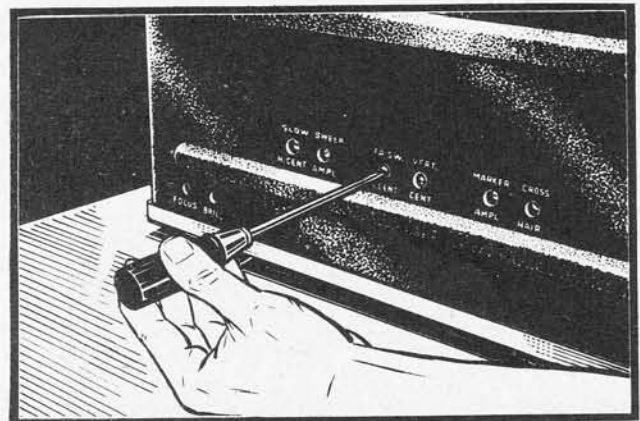

Figure 2-38

(26) The pattern on the indicator screen should appear as illustrated in figure 2-36. If the trace amplitude is incorrect (that is, if the length of the trace is too long or too short), adjust the "FA. SW. AMPL." screw driver control on the right hand side of the receiver-indicator until the traces assume a normal length.

(27) To center the traces horizontally, adjust the "FA. SW. H. CENT." screw driver control on the left hand side of the receiver-indicator until the traces are properly centered as shown in figure 2-36. Repeat and coordinate (26) and (27) until the amplitude and the centering of the traces is correct.

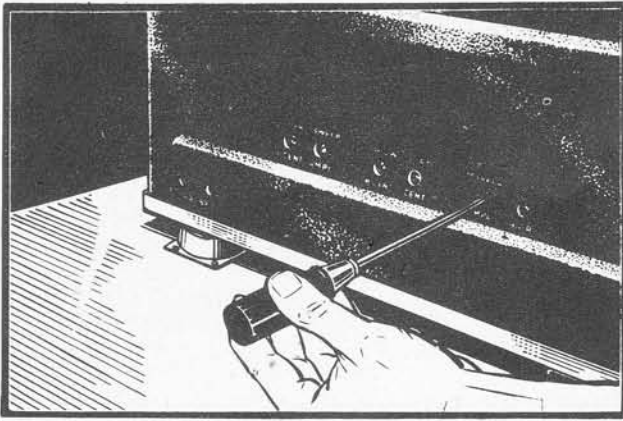

Figure 2-39

(28) If the heights of the markers do not permit easy identification, adjust the "MARKER AMPL." control on the left hand side of the receiver-indicator.

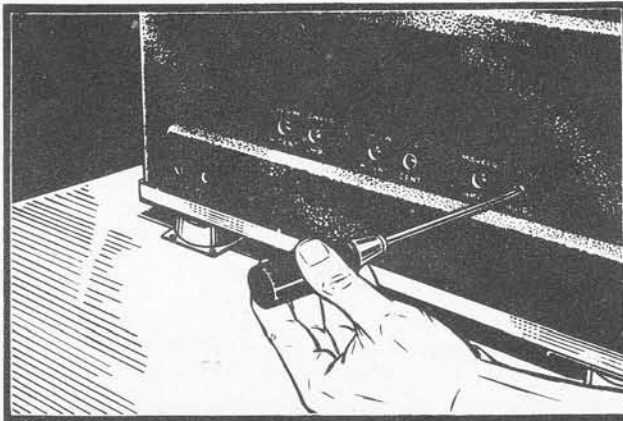

Figure 2-40

(29) If the position of the cross hair in relation to the upper trace is not properly located, adjust the "CROSS HAIR" screw driver control on the left hand side of the receiver-indicator until the spacing between the two traces is as shown in figure 2-36.

(30) Read the lower trace and count five 10-microsecond intervals between the 50-microsecond markers as shown in figure 2-36.

(31) Read the upper trace and count two 50-microsecond intervals between the 100-microsecond markers as shown in figure 2-36.

(32) Read the upper trace and count five 100-microsecond intervals between the 500-microsecond markers as shown in figure 2-36.

(33) Read the upper trace and count two 500-microsecond intervals between the 1000-microsecond markers as shown in figure 2-36.

CAUTION

If the number of intervals counted in (30) through (33) are incorrect reject the receiver-transmitter and return to maintenance shop for proper alignment. If it is imperative that the defective unit be placed in operation immediately refer to section IV, paragraphs 1 and 2 for proper instruction.

(34) Count the number of 50-microsecond intervals between the cross hair and the first "STATION" rate marker. Repeat this operation for the other "STATION" rate settings, "1" to "7" inclusive. The counts observed must agree with the table as shown below. Figure 2-36 shows a Station Rate of "6."

| "STATION" Rate Switch Setting | 50-Microsecond Intervals |
|-------------------------------|--------------------------|
| 0 | 8 |
| 1 | 7 |
| 2 | 6 |
| 3 | 5 |
| 4 | 4 |
| 5 | 3 |
| 6 | 2 |
| 7 | 1 |

(35) With the "STATION" rate switch set at station "4," move the "RIGHT-LEFT" switch to right and count two 50-microsecond intervals between the cross hair and the first "STATION" rate marker.

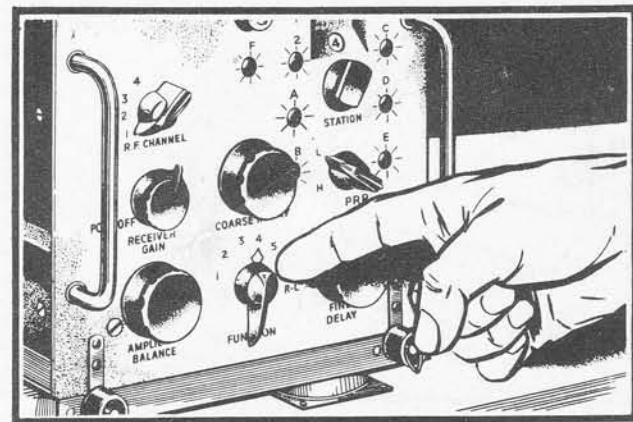

Figure 2-41

(36) Turn the "FUNCTION" switch to position "4."

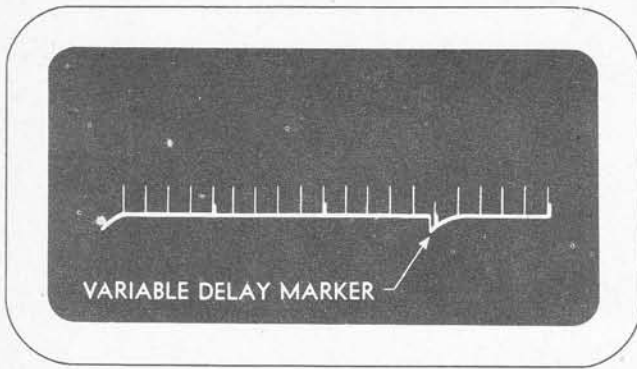

Figure 2-42

(37) With the "FINE DELAY" control set at its maximum clockwise position, turn the "COARSE DELAY" control until the variable delay marker is between 5000 and 5500 microseconds, and make an approximate reading of the indicated time difference.

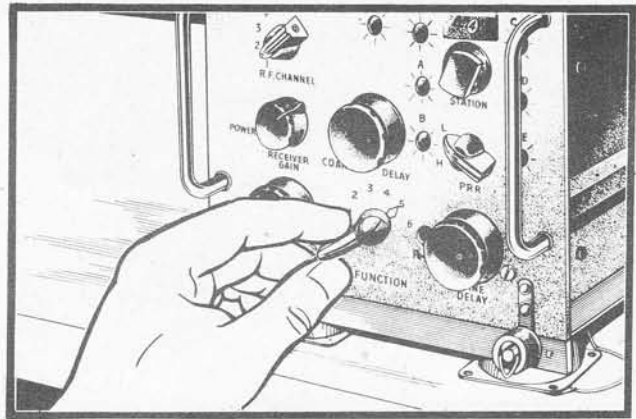

Figure 2-45

(40) Turn the "FUNCTION" switch to position "5," and complete the reading of the indicated time difference.

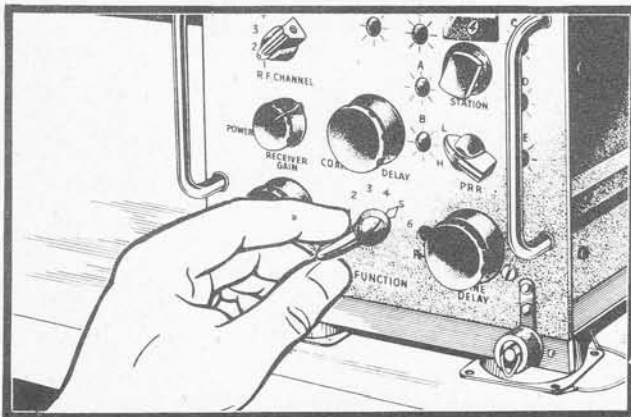

Figure 2-43

(38) Turn the "FUNCTION" switch to position "5," and complete the reading of the indicated time difference.

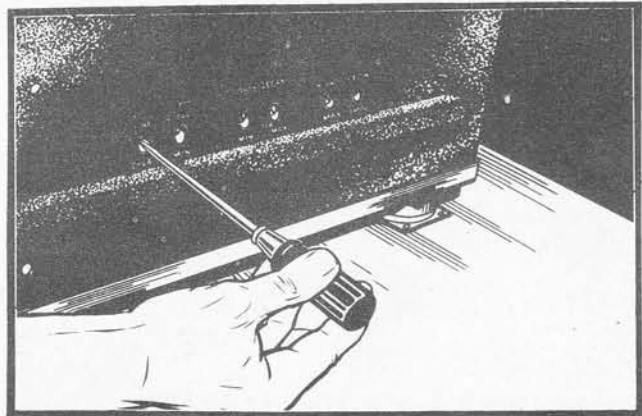

Figure 2-46

(41) Using the readings obtained in (38) and (40), the difference in microseconds should not be less than 700 microseconds, nor more than 1500 microseconds. If outside these limits, adjust the "FINE DELAY" screw driver adjustment to provide a 950-microsecond range as measured in (37) to (40) inclusive.

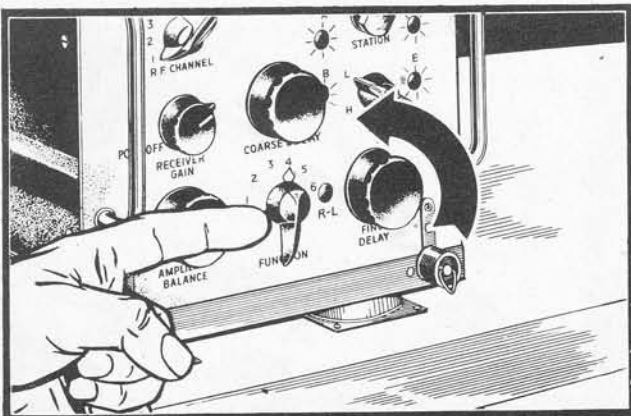

Figure 2-44

(39) Turn the "FUNCTION" switch to position 4. Turn the "FINE DELAY" control to the maximum counterclockwise position. Make an approximate reading of the indicated time difference.

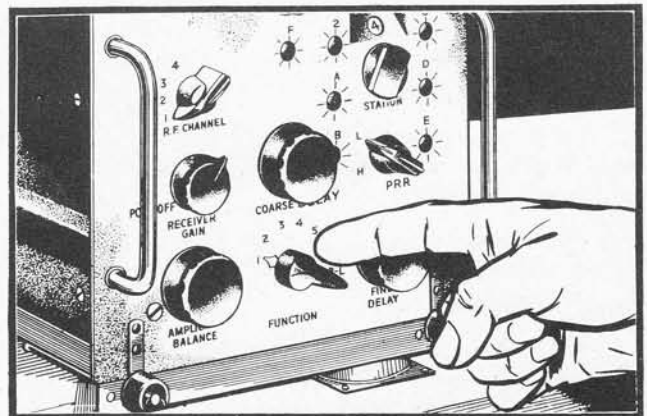

Figure 2-47

(42) Turn the "FUNCTION" switch to position 1.

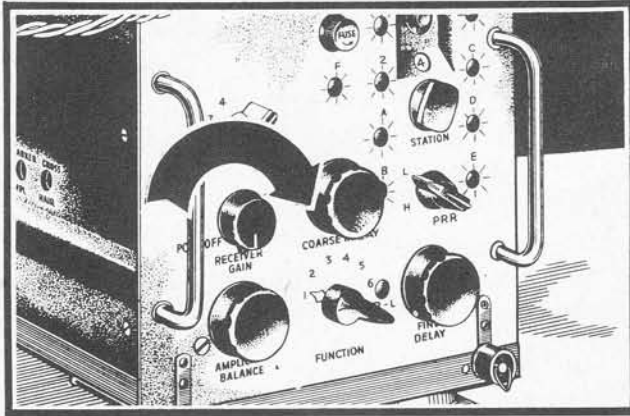

Figure 2-48

(43) Turn the "RECEIVER GAIN" control to the maximum clockwise position.

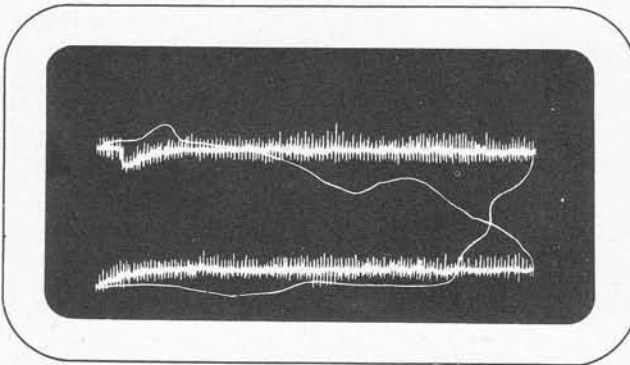

Figure 2-49

(44) Observe the height of the "grass" on the screen of the receiver-indicator, and note that the space between the "grass" at the upper and lower trace is not more than shown in the above illustration. Turn the "R.F. CHANNEL" switch to positions 2, 3, and 4, and at each position, note that the "grass" amplitude is not less than shown in the above illustration (approximately 1/4 inch).

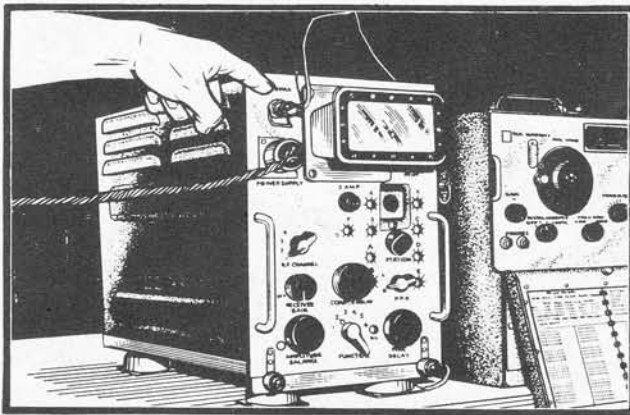

Figure 2-50

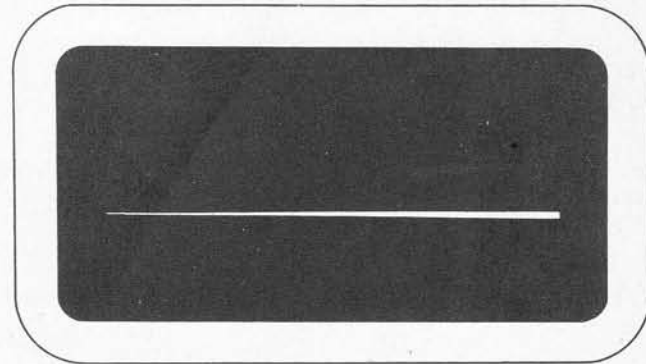

Figure 2-51

(46) Turn the "FUNCTION" switch to position "3," and observe the trace on the indicator screen.

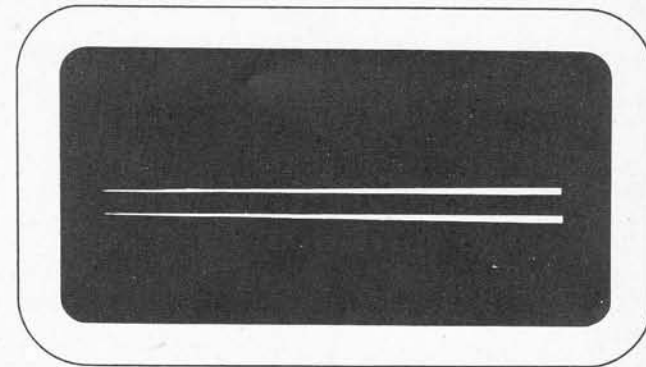

Figure 2-52

(47) Turn the "FUNCTION" switch to position "6," and observe the trace on the indicator screen.

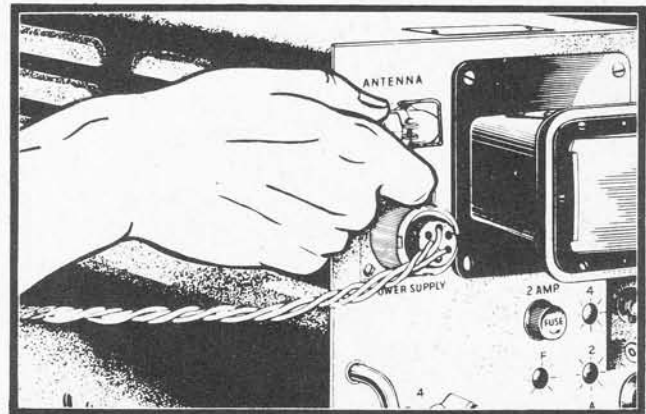

Figure 2-53

Section II
Paragraphs 3-4

RESTRICTED
AN 08-30APN9-2

(48) Attach and clamp the antenna cable to the "ANTENNA" connector of the receiver-indicator.

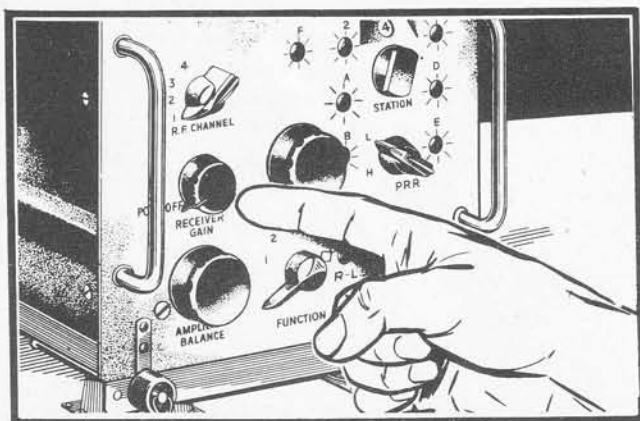

Figure 2-54

(49) Turn the equipment "OFF" by turning the "RECEIVER GAIN" control knob to "POWER OFF."

4. AFTER-INSTALLATION TEST.

- a. Remove operating fuse.
- b. Remove cover from power Plug PL-166.
- c. Turn power switch on "RECEIVER-GAIN" control.

d. Check a-c supply voltage between pin 1 and pin 3, if 115-volt supply is used. If 80-volt supply is used, check between pin 1 and pin 2.

CAUTION

Damage to the equipment will result if pins 1 and 3 are not used with 115-volt supply or pins 1 and 2 with 80-volt supply.

- e. Turn equipment off.
- f. When the supply voltage is found to be correct and connected to the proper pins, replace fuse. Check both operating and spare fuses for proper value: two amperes for 115-volt operation, and three amperes for 80-volt operation.
- g. Turn equipment on and check to see that pilot light is on and that traces appear on the cathode ray tube.
- h. Turn equipment off.
- i. See that the metal braid of the antenna cable is well bonded to the frame of the aircraft near the knife switch and that the center conductor is attached to the knife portion of the knife switch.
- j. With an ohmmeter check the antenna cable to see that the center conductor is not shorted to ground.
- k. See that the visor is securely in place.
- l. Check to see that the ground strap of shock mount is well bonded to the frame of the aircraft.

SECTION III OPERATION

IMPORTANT

Correct results will be given by this equipment only if the counter and station rates are in correct adjustments. If the receiver-indicator cannot be synchronized with the ground stations, the expected stations are not received, or the "fix" does not correspond with the expected location; check the counter and station rates as directed in section IV, paragraph 1.

1. STARTING AND STOPPING EQUIPMENT.

a. TO START EQUIPMENT.—Figures 3-1 to 3-4 illustrate receiver-indicator "ON" procedure..

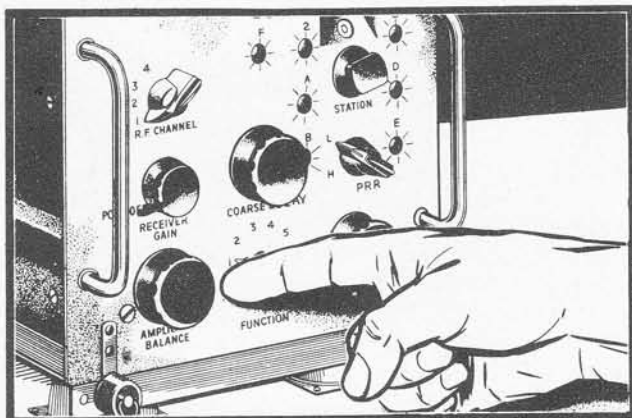

Figure 3-1

(1) Set the "AMPLITUDE BALANCE" control at its center position of rotation.

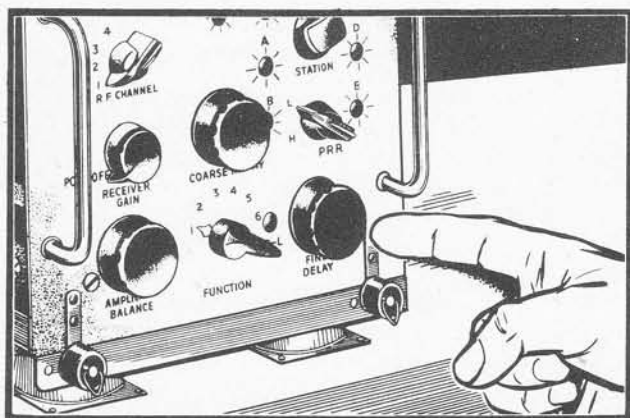

Figure 3-2

(2) Set the "FINE DELAY" control at its center position of rotation.

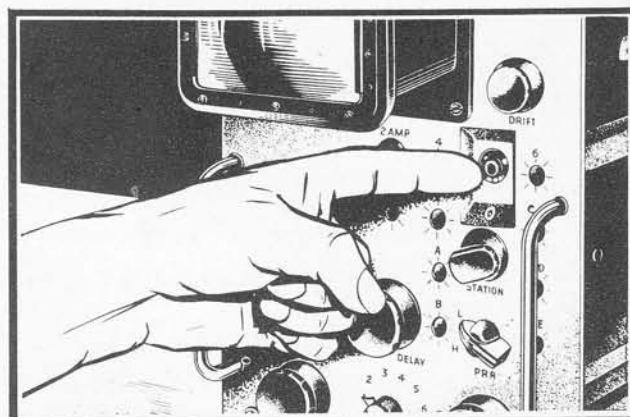

Figure 3-3

(3) Set the "DRIFT" control at its center position of rotation. This is necessary only for equipment which is being operated for the first time. After operation, the control remains in the position where it was last used.

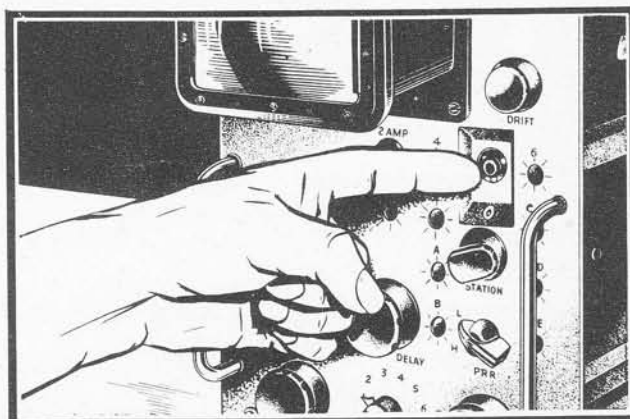

Figure 3-4

(4) Turn the "RECEIVER GAIN" control clockwise until the "STATION" rate identification (pilot light) illuminates. Wait at least five minutes to allow the equipment to warm up.

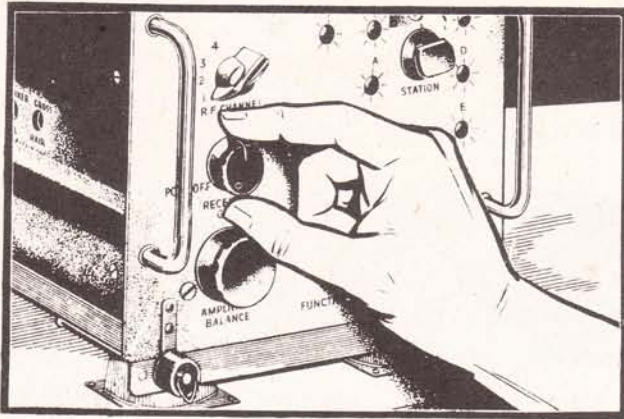

Figure 3-5—Receiver-Indicator "OFF" Procedure

b. TO STOP EQUIPMENT.

(1) Turn the "RECEIVER GAIN" control to "POWER OFF" and check to see that the pilot light is not illuminated and that the pattern on the indicator screen has disappeared.

2. OPERATION.

a. GENERAL.—The signals received by the receiver-indicator may be either ground waves, sky waves, or ground and sky waves. This depends upon the location of the airplane in relation to the LORAN transmitting stations and whether reception is made during day or night. Figure 3-6 shows the paths of ground waves and sky waves.

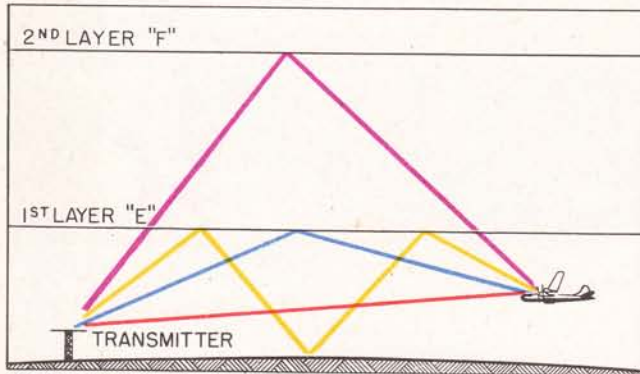

Figure 3-6. Wave Paths

The operator will notice that the ground wave path (red) is the most direct path between the transmitting station and the airplane, while the sky waves follow a longer path depending upon the number of reflections from the ionosphere and the ground during the path of travel between the transmitting station and the airplane. The sky wave path reflected from the first layer of the ionosphere (blue) is the next most direct path between the transmitting station and the airplane. By comparing figure 3-6 and figure 3-7, see the relationship between the paths of the various waves and the order in which they appear on the indicator screen.

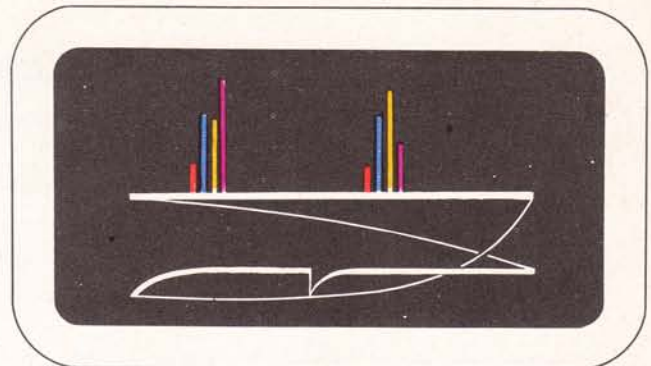

Figure 3-7. Indicated Order of Wave Paths

During reception of ground waves accompanied by sky waves, it is extremely important for the operator to distinguish ground waves from sky waves, and to use only the corresponding *ground wave signals* in each train of multiple signals.

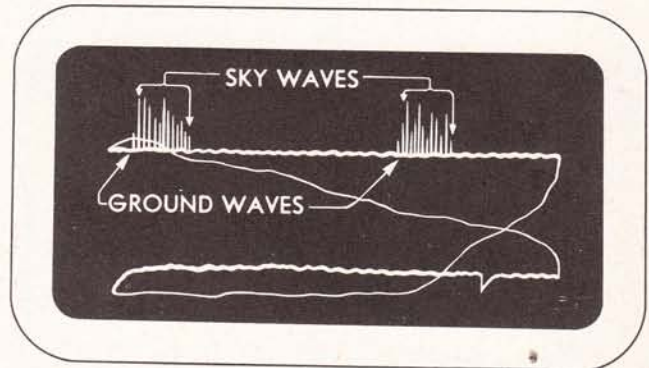

Figure 3-8. Ground and Sky Wave Signals
—Position "1"

Figure 3-8 shows the multiple signals resulting from simultaneous reception of ground waves and sky waves. The ground wave will always be the pulse preceding a multiplicity of sky waves and the operator must match the ground wave of one train of signals with the corresponding ground wave of the other train of signals.

A characteristic of sky waves to be observed is that the sky wave will have a tendency to fade; that is, their height will tend to vary while a ground wave will remain relatively constant in height. Another characteristic of sky waves is that they tend to split.

Note

During intervals when proper timing of the ground stations is being maintained, the stations will key their pulses continuously; accurate readings cannot be made while either of the pulses of a pair of stations is blinking.

b. OPERATION WITH GROUND WAVES.

(1) IDENTIFICATION OF LORAN STATIONS.

Figures 3-9 to 3-13 are for receiver-indicator operation, identification of LORAN stations.

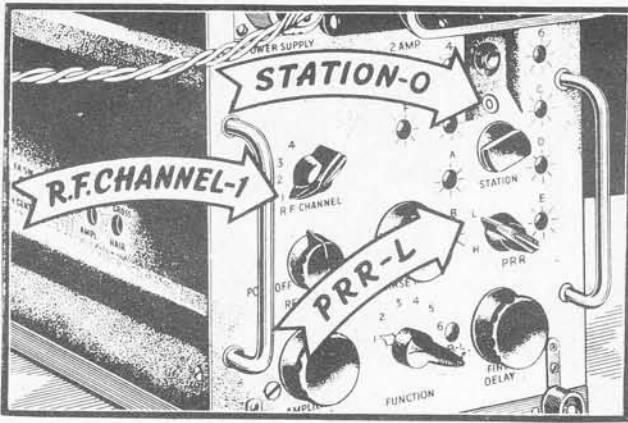

Figure 3-9

(a) Referring to the approximate geographical location of the airplane, on LORAN charts, determine which "R.F. CHANNEL-PRR" rate, and "STATION" rate to use and set the corresponding controls accordingly.

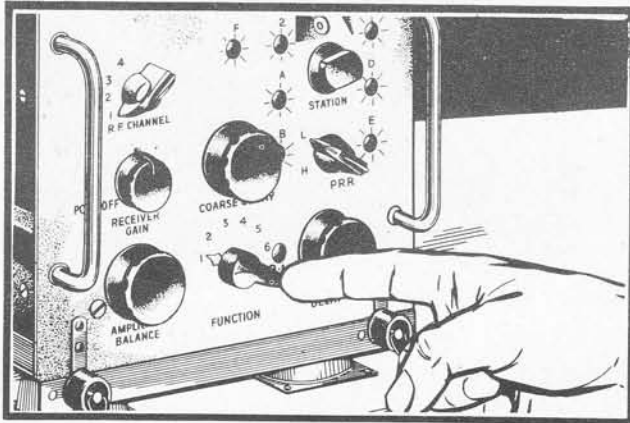

Figure 3-10

(b) Set the "FUNCTION" switch at position 1.

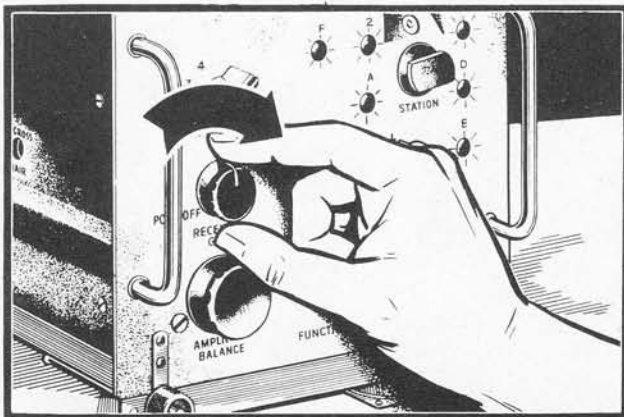

Figure 3-11

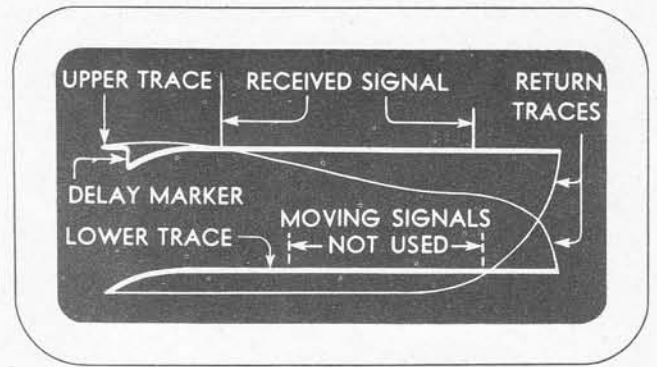

Figure 3-12

(c) Rotate the "RECEIVER GAIN" control clockwise until the received signals appear on the indicator screen. If the proper "R.F. CHANNEL-PRR," and "STATION" rate control settings have been selected, one pair of received signals should be stationary, or nearly stationary on the horizontal traces.

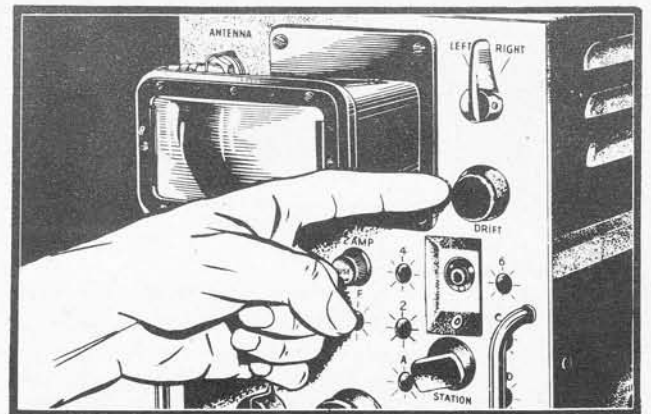

Figure 3-13

(d) If required to correct a slight movement, turn the "DRIFT" control until the received signals are stationary. If none of the received signals remain stationary, consult the LORAN charts, and select another pair of LORAN stations. The positions of the "R.F. CHANNEL-PRR," and "STATION" rate controls must be reset to conform with this new selection of LORAN stations.

(2) TIMING OF RECEIVER - INDICATOR. — Figures 3-14 to 3-24 are for receiver-indicator operation, timing of receiver-indicator.

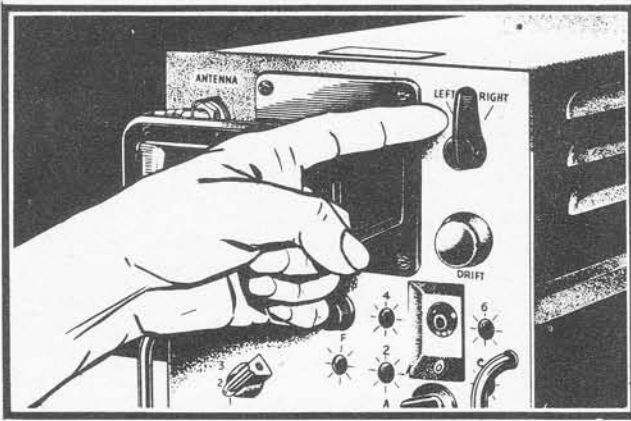

Figure 3-14

(a) After the drift of the received signals has been stopped, if both signals do not appear on the lower trace, turn the "RIGHT-LEFT" switch to right or left, as required, to place both signals on the lower trace.

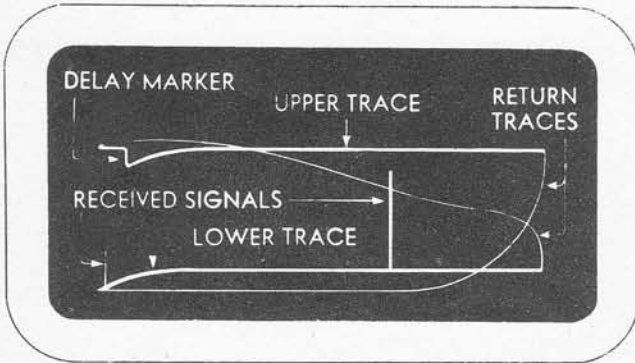

Figure 3-15

(b) With both received signals located on the lower trace, turn the "RIGHT-LEFT" switch to the left until the received signal appearing at the left moves to the extreme left end of the lower trace. If necessary, make a closer setting of the "DRIFT" control to hold the signal at this position.

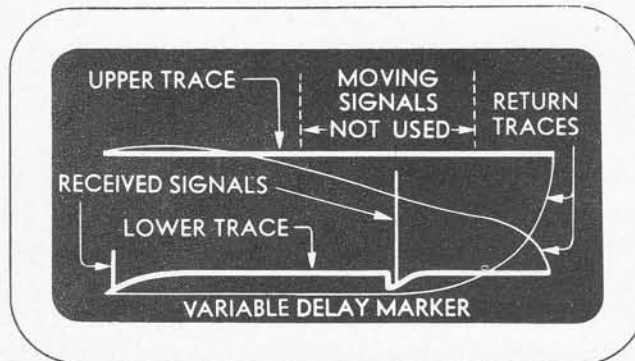

Figure 3-16

(c) Adjust the "COARSE DELAY" control until the variable delay marker is placed under the received signal appearing to the right.

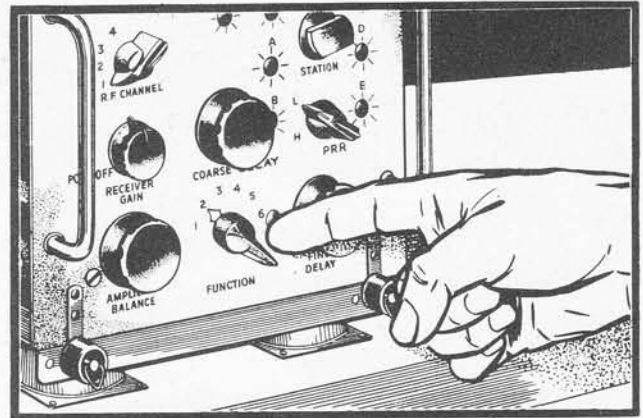

Figure 3-17

(d) Turn the "FUNCTION" switch to position "2."

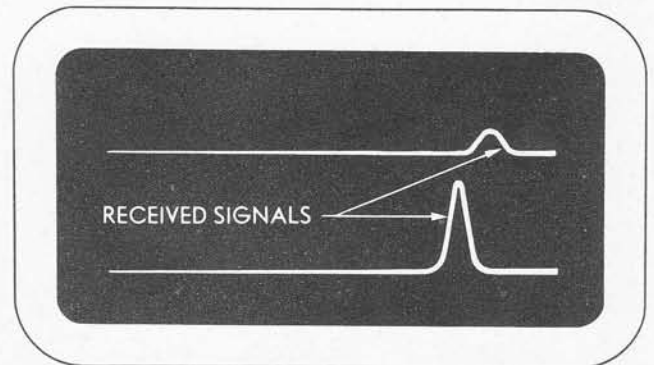

Figure 3-18

(e) If the received signals in the upper and lower traces are not of the same height and correct amplitude, adjust the "RECEIVER GAIN" and "AMPLITUDE BALANCE" controls.

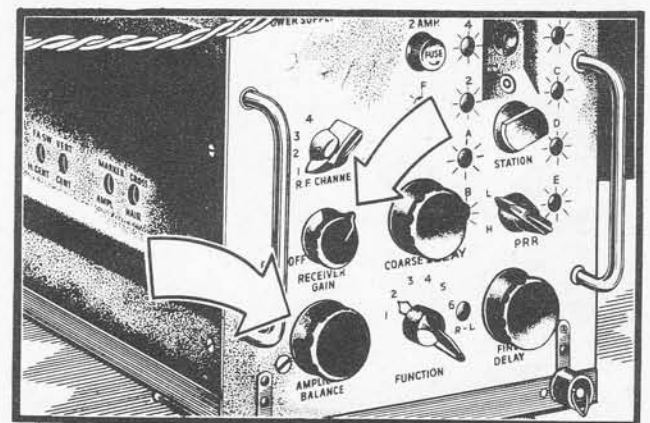

Figure 3-19

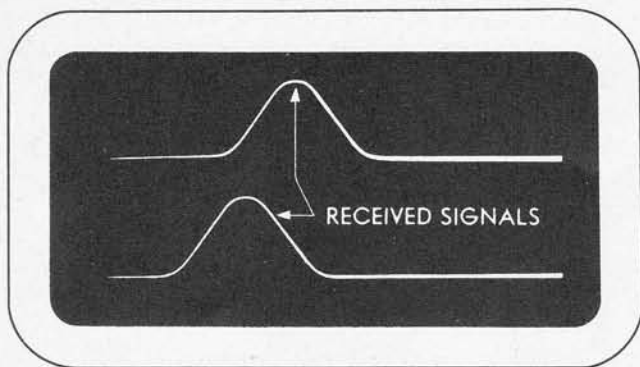

Figure 3-20

(f) Turn the "RIGHT-LEFT" switch to the left until the signals on each trace are moved to the left. If the received signals *drift*, adjust the "DRIFT" control until movement ceases. Turn the "RIGHT-LEFT" switch to left or right until the signals are located in the required position.

(g) If the received signals are not lined up one directly over the other as in the above illustration, adjust the "FINE DELAY" control until one signal is directly over the other as shown in the illustration below.

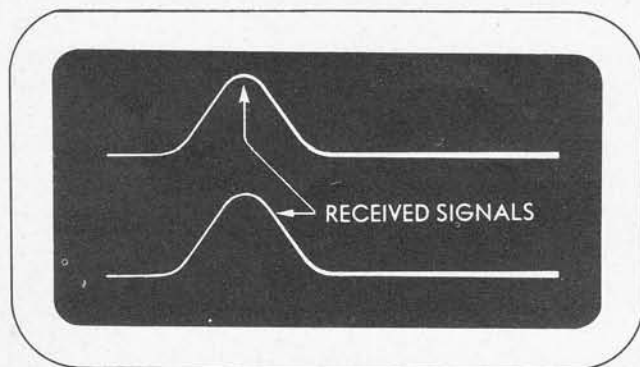

Figure 3-21

If the signals do not line up as in the above illustration and the "FINE DELAY" control has reached the limits of its maximum clockwise rotation, slowly turn the "COARSE DELAY" control counterclockwise until the signal on the lower trace jumps one step to the right. The signals can now be lined up by turning the "FINE DELAY" control counterclockwise. If the signals do not line up as in (f) above and the "FINE DELAY" control has reached the limit of its maximum counterclockwise rotation, turn the "FINE DELAY" control to its maximum clockwise position. Slowly turn the "COARSE DELAY" control clockwise until the signal on the lower trace jumps one step to the left. The signal on the lower trace can now be lined up with the signal on the upper trace by turning the "FINE DELAY" control counterclockwise.

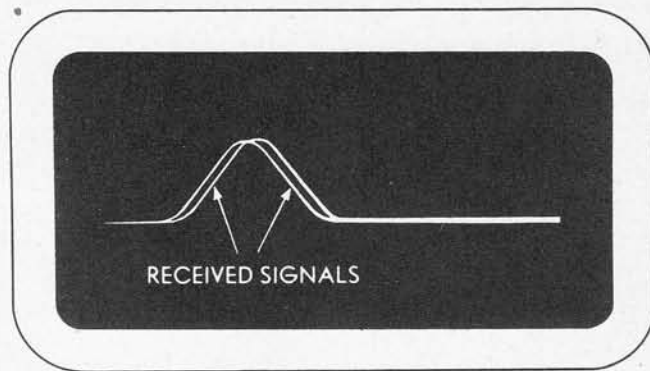

Figure 3-22

(b) Turn the "FUNCTION" switch to position "3." The upper and lower traces now will be superimposed and the received signals should be coincident. If the received signals do not coincide, as illustrated above,

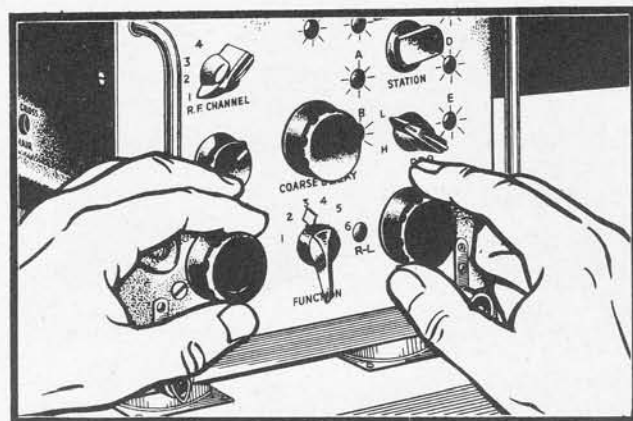

Figure 3-23

adjust the "FINE DELAY" control and the "AMPLITUDE BALANCE" control until the signals do coincide. If the received signals drift, adjust the "DRIFT" control until movement ceases. Turn the "RIGHT-LEFT" switch to the left or right positions as required until the signals are located in the required position as shown in the illustration below.

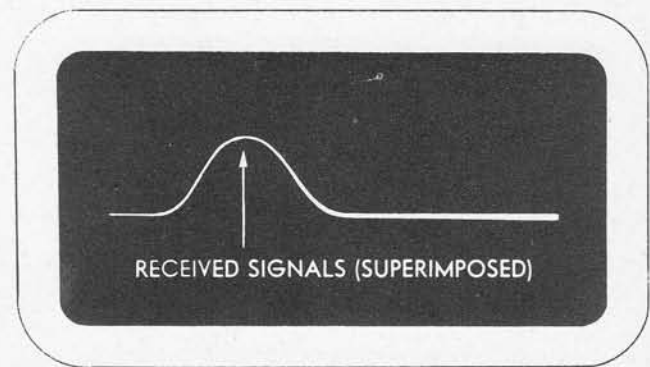

Figure 3-24

Note

Matching by superposition is not possible when one or both signals are weak compared to the noise level. The operator must mentally average the fluctuating signals and match the averages. This operation is often most easily performed with the "FUNCTION" switch turned to position "6."

(3) INDICATED TIME DIFFERENCE BETWEEN SIGNALS.—Figures 3-25 to 3-34 are for receiver-indicator operation, timing of receiver-indicator.

CAUTION

To avoid serious errors, do not change the setting of any controls except the function switch.

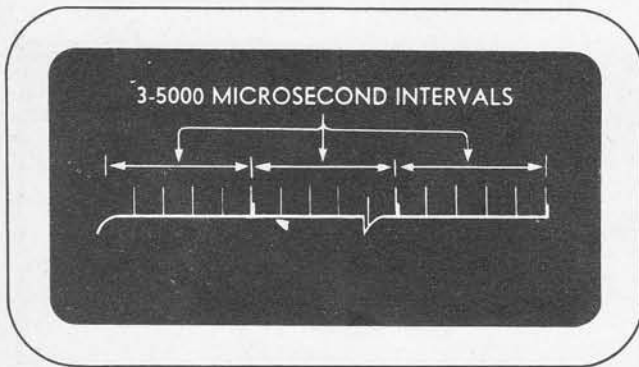

Figure 3-25

(a) Turn the "FUNCTION" switch to position "4." A single trace divided into 5,000- and 1,000-microsecond intervals should appear on the indicator screen. If the "PRR" switch has been set to position "H," the length of the trace will be divided into *three* 5,000-microsecond intervals, each 5,000-microsecond interval subdivided into *five* 1,000-microsecond intervals.

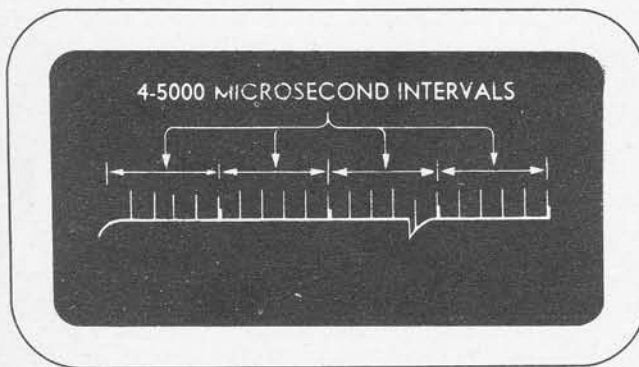

Figure 3-26

If the "PRR" switch has been set at position "L," the length of the trace on the indicator screen will be divided into *four* 5,000-microsecond intervals, each 5,000-microsecond interval subdivided into *five* 1,000-microsecond intervals.

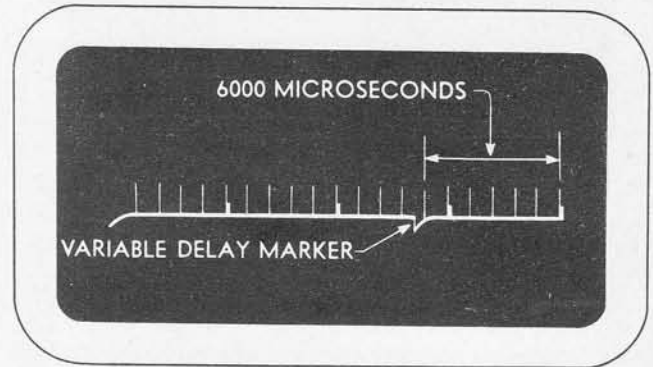

Figure 3-27

(b) The position of the variable delay marker on the trace depends upon the time difference of the received signals. Measure the indicated time difference by counting the number of 1000-microsecond intervals from the extreme right end of the trace (0 microsecond) to the nearest 1,000-microsecond marker to the right of the sharp edge of the variable delay marker. Estimate the remaining distance in microseconds between this 1,000-microsecond marker and the sharp edge of the variable delay marker to furnish a check on the final reading. The above illustration indicates a reading of approximately 6,250 microseconds. This reading will be within plus or minus 250 microseconds of the correct value.



Figure 3-28

CAUTION

Make separate notes of the resultant reading; that is, note the number of complete 1,000-microsecond intervals in one column and note the estimated number of microseconds in the remaining indicated time difference in another column.

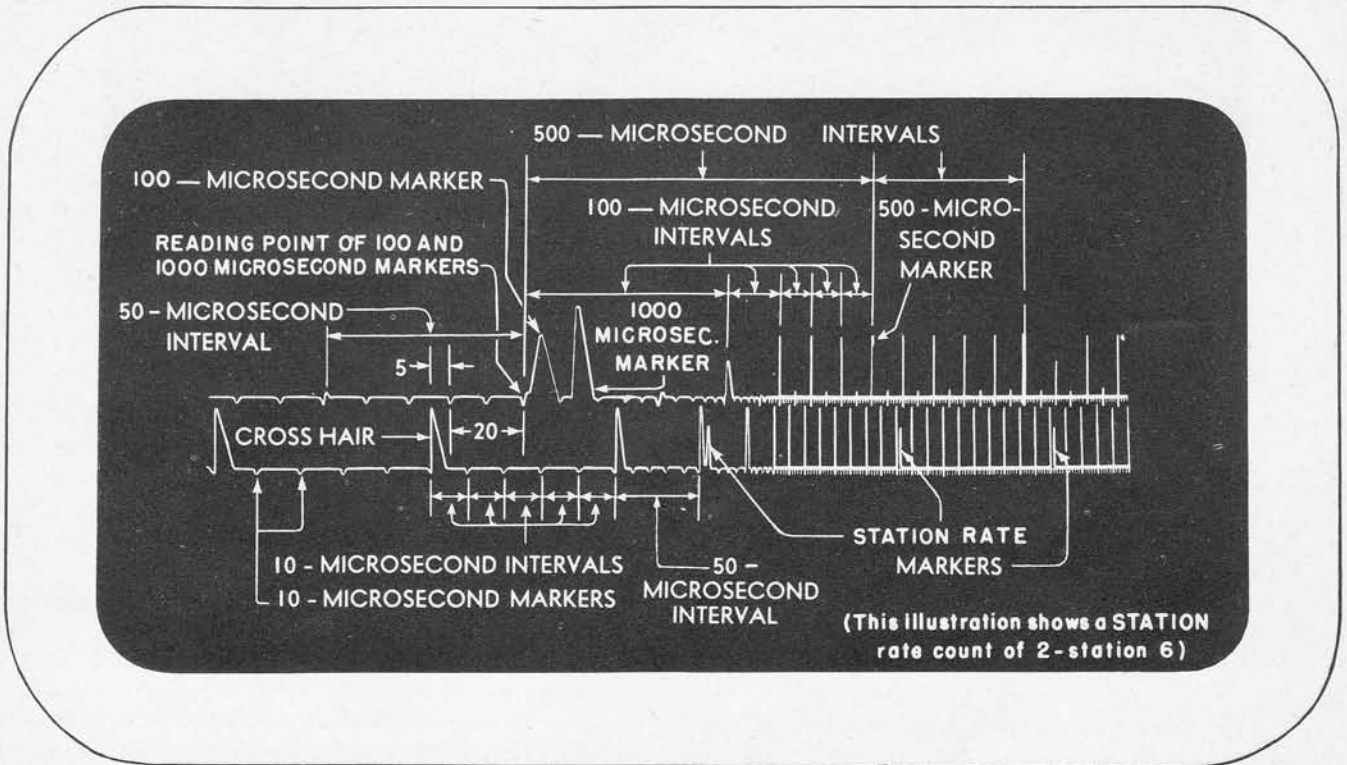

Figure 3-29

(c) Turn the "FUNCTION" switch to position "5." Two traces should appear on the indicator screen; the upper trace divided into 10, 50-, 100-, 500-, and 1,000-microsecond intervals and the lower trace divided into 10- and 50-microsecond intervals. The cross hair used for reading the indicated time difference appears on the lower trace and is always the 50-microsecond

marker located approximately 40 to 70 microseconds from the left hand termination of the trace. Another 50-microsecond marker usually appears to the left of the cross hair. Do not confuse this marker with the cross hair. (See fig. 3-29.) Step (b) resulted in a reading within 250 microseconds of the correct value. It is now possible to obtain a reading to within one microsecond by proceeding as follows.

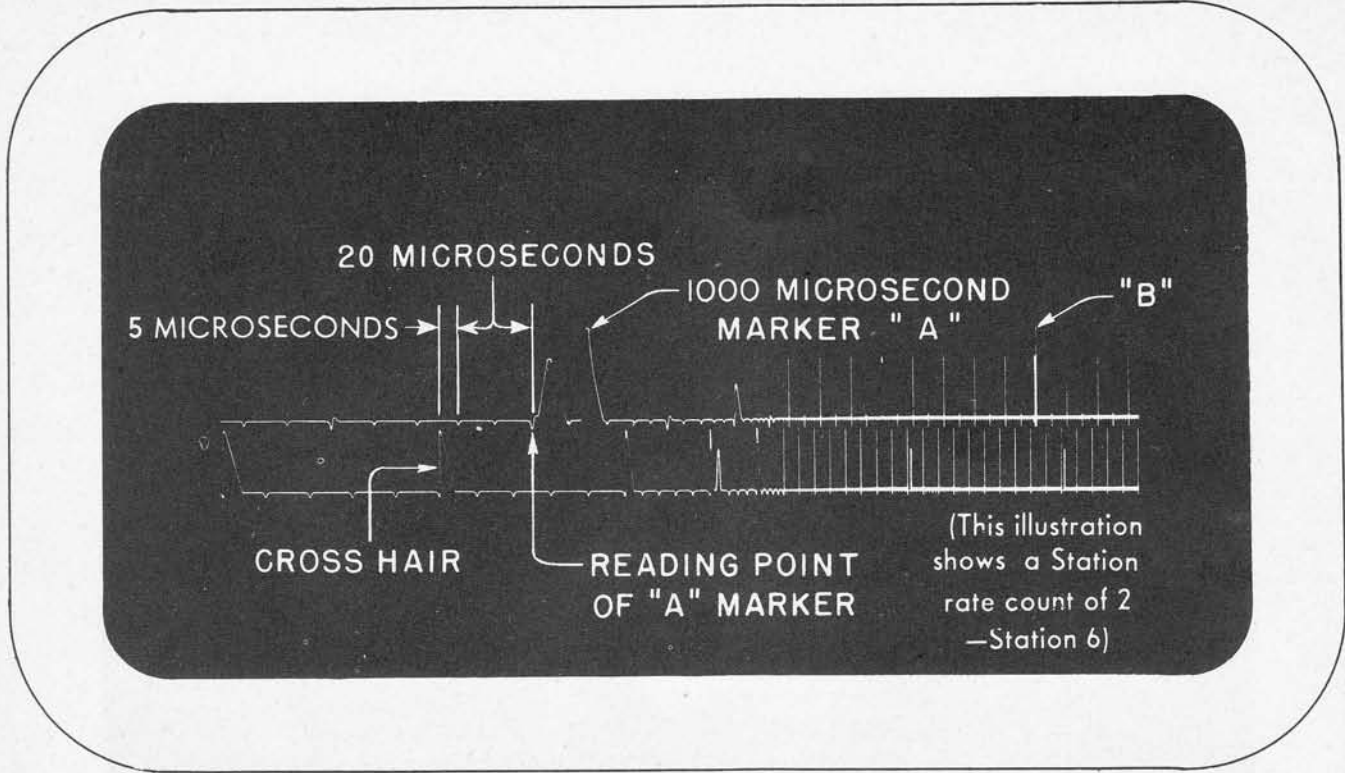

Figure 3-30

(d) Locate the first 1,000-microsecond marker on the upper trace whose *reading point* is to the right of the cross hair. (The above illustration shows two 1,000-microsecond markers, A and B. It is extremely important whenever marker A is the first 1,000-microsecond marker to the right of the cross hair, that the *reading point* of this marker is always the point from which measurements are made.) This 1,000-microsecond marker is the same marker that completed the last 1,000-microsecond interval read in (b).

(e) Now locate the first 10-microsecond marker on the upper trace to the right of the cross hair. The time interval between this 10-microsecond marker and the reading point of the 1,000-microsecond marker identified in (d) is read by counting the intervals indicated by the 500-, 100-, 50-, and 10-microsecond markers. In the above illustration, this reading indicates a value of 20 microseconds.

(f) Estimate the interval between the cross hair and the first 10-microsecond marker on the upper trace to the right of the cross hair. The above illustration indicates a value for this interval of approximately five microseconds. The reading now obtained is the total of three readings.

| | | | | |
|-----|-------|---|-------|--------------|
| 1st | — (b) | = | 6,000 | microseconds |
| 2nd | — (e) | = | 20 | microseconds |
| 3rd | — (f) | = | 5 | microseconds |
| | Total | | 6,025 | microseconds |

Always add 100 microseconds to the total fine reading. This will bring the above figure to a final total of 6,125 microseconds, which represents the indicated time difference.

Note

The following examples of possible indicated time difference explains (a) through (f).

1. EXAMPLE 1.

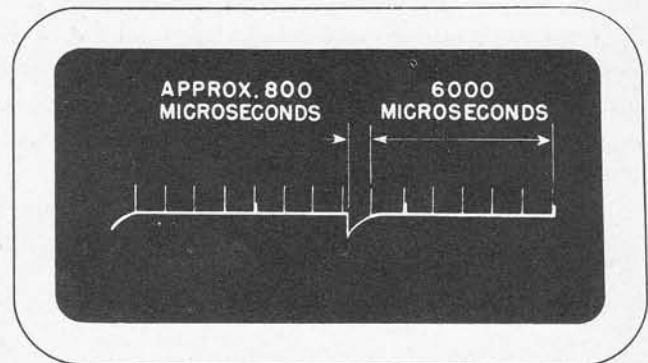

Figure 3-31

"FUNCTION" switch at position "4."—The above illustration indicates a reading of 6 complete 1,000-microsecond intervals (6,000 microseconds) plus an estimate of approximately 750 microseconds for the remaining interval.

IMPORTANT

Master both examples 1 and 2 as they develop important points relative to time readings.

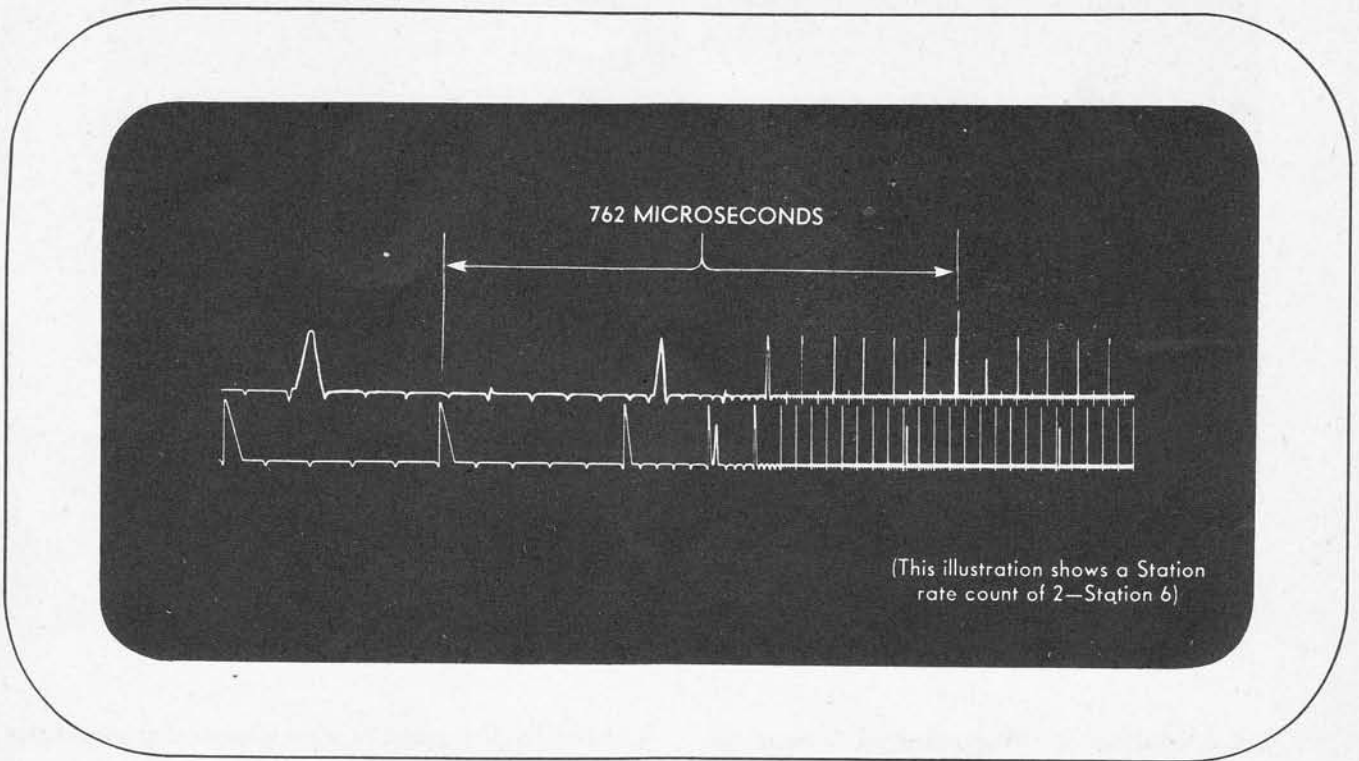

Figure 3-32

With the "FUNCTION" switch at position "5," a fine reading of 762 microseconds to which 100 microseconds must be added is indicated, making a total fine reading of 862 microseconds. When this amount is added to the number of complete 1,000-microsecond

intervals read in "FUNCTION" switch position "4," the final total is 6,862 microseconds. The estimated interval (750 microseconds) read in position "4" is supplanted by a finer reading of 862 microseconds.

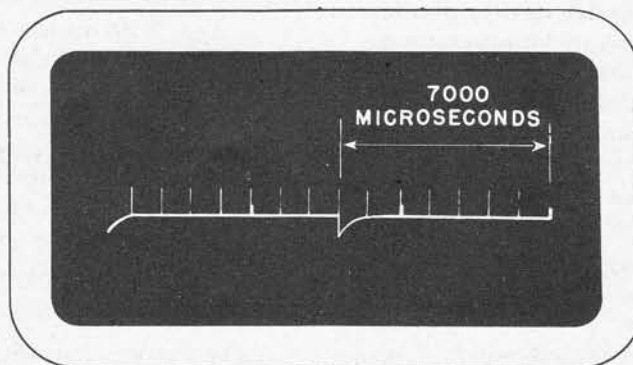

Figure 3-33. Function Switch at Position "4"

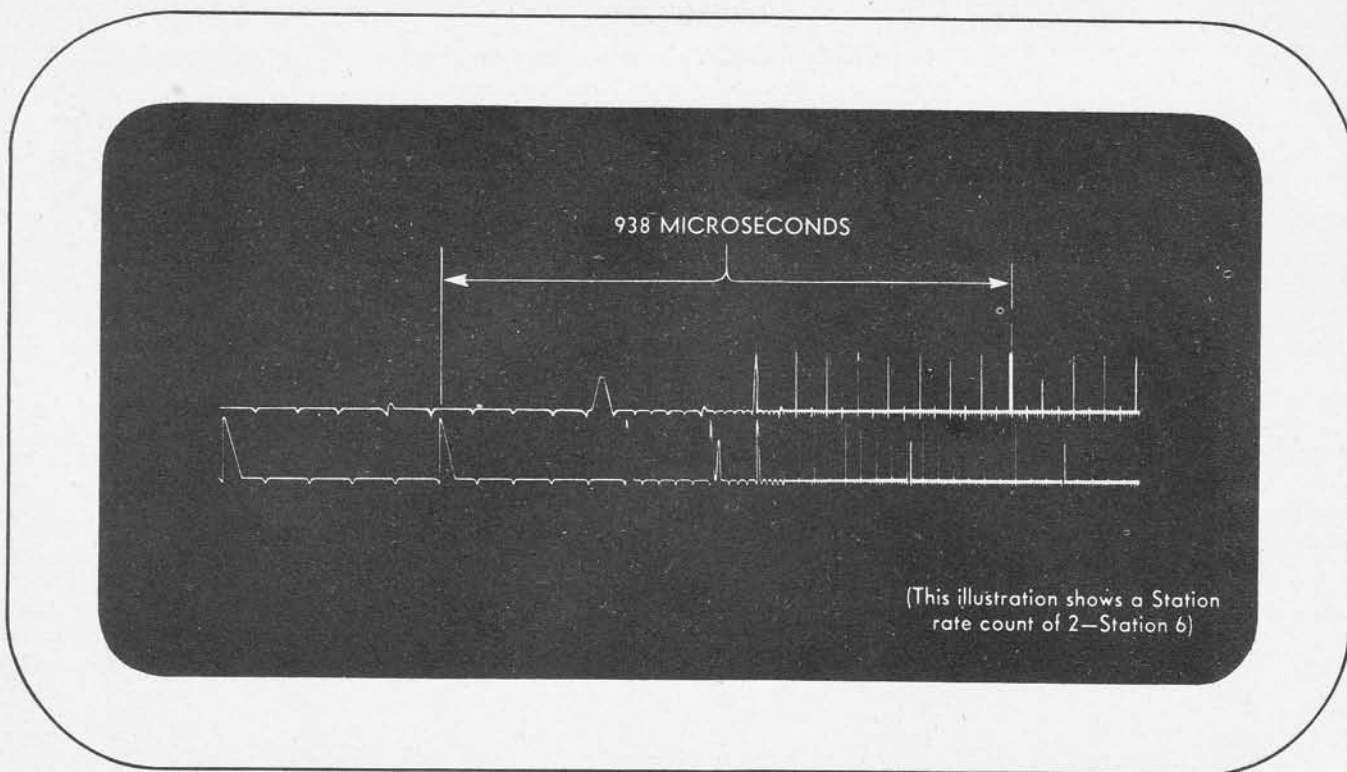

Figure 3-34. Function Switch at Position "5"

2. EXAMPLE 2.—A reading of 7 complete 1,000-microsecond intervals (7,000 microseconds), with a remaining interval too small to be estimated, is illustrated in figure 3-33.

The above illustration (fig. 3-34) indicates a fine reading of 938 microseconds to which 100 microseconds must be added, making a total fine reading of 1,038 microseconds. Whenever the total fine reading exceeds 1,000 microseconds, normally only that number of microseconds over 1,000 is added to the number of complete 1,000-microsecond intervals read in position "4." In this instance, instead of adding 1,038 microseconds to the reading obtained in position "4," the final reading is 7,000 microseconds plus 38, or 7,038 microseconds. The estimated interval (100 microseconds) read in position "4," is supplanted by a finer reading of 38 microseconds. However, if on "FUNCTION" switch position "4," the position of the variable delay marker appears to be coincident with a 1,000-microsecond marker, thereby making it difficult to ascertain the number of complete 1,000-microsecond intervals, the operator should make a reading in "FUNCTION" switch position "5."

If the total fine reading obtained in position "5" exceeds 1,000 microseconds, it indicates that the variable delay marker in position "4" is actually to the left of the 1,000-microsecond marker to which it appeared coincident. The operator can now ascertain the number of complete 1,000-microsecond intervals indicated in "FUNCTION" switch position "4." To this number of complete 1,000-microsecond intervals must be

added only the number of microseconds exceeding 1,000 read in the fine total reading.

If the total fine reading obtained in position "5" is less than 1,000 microseconds, it indicates that the variable delay marker in "FUNCTION" switch position 4 is actually to the right of the 1,000 microsecond delay marker to which it appeared coincident. The operator is now able to compute the correct number of complete 1,000-microsecond intervals. To this amount, add the total fine reading obtained in "FUNCTION" switch position "5."

The final reading obtained in positions "4" and "5" should approximate the total estimated reading made in position "4."

(g) With the true value of the indicated time difference established, locate the position of the airplane on one LORAN line of position by referring to the LORAN charts. The entire operation procedure as described in section III, paragraph 2, must now be repeated to establish the second LORAN line of position. The intersection of the two LORAN lines of position "fixes" the position of the airplane.

c. OPERATION WITH GROUND WAVES ACCOMPANIED BY SKY WAVES.

(1) During operation, multiple signal reception often occurs due to the reception of both ground waves and sky waves. Figure 3-7 shows the pulses as they might appear on the indicator screen in "FUNCTION" switch position "1."

(2) The operation of the receiver-indicator, during the reception of ground waves accompanied by sky waves, is exactly the same as outlined in section III, paragraph 2b.

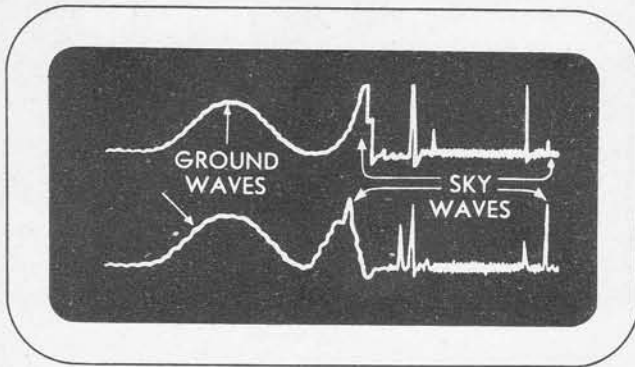

Figure 3-35. Ground and Sky Wave Signals — Position "2"

(3) Figure 3-35 shows the pattern of ground waves and sky waves in "FUNCTION" switch position "2." Note that the train of signals on the upper trace has essentially the same shape and characteristics as the train of signals on the lower trace.

(4) To ascertain that the ground waves as shown in figure 2-35 actually are the direct signals from the transmitting station, move both trains of signals to the right side of the indicator screen by the use of the "RIGHT-LEFT" switch, and observe that no other signals appear to the left of the selected ground wave signal.

(5) Turn the "RECEIVER GAIN" control clockwise and observe that no other signal appears preceding the selected ground wave signal.

d. OPERATION WITH SKY WAVES.

(1) During operation with sky waves only, it is extremely important that the operator matches the first sky waves preceding each train of sky waves. Figure 3-36 illustrates sky wave trains as they appear with "FUNCTION" switch at position 1.

(2) In "FUNCTION" switch position 2, the sky wave trains will appear as shown in figure 3-37.

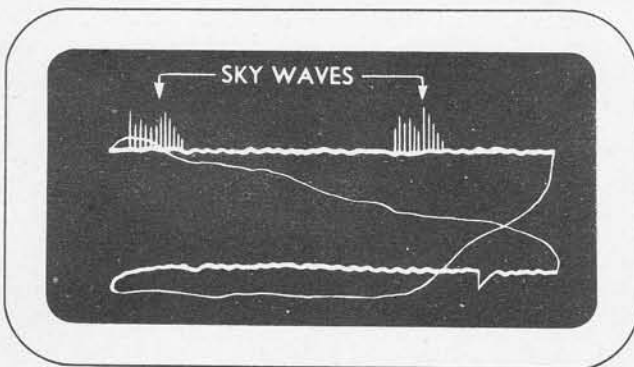

Figure 3-36. Sky Wave Signals — Position "1"

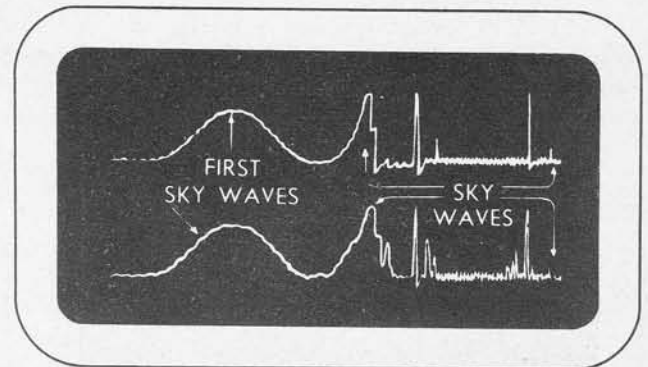

Figure 3-37. Sky Wave Signals — Position "2"

To ascertain that the sky waves selected to be matched are the first received sky wave signals, the operator should follow the instructions as outlined in section III, paragraph 2b. Sky waves tend to split and this makes matching of the selected sky waves difficult. The following illustrations show half a cycle of splitting during which the leading edge of the pulse indication is distorted, as it might be observed with the "FUNCTION" switch in positions "2," "3," or "6."

(3) For the purpose of clarity, the sky waves which are not used have been omitted from the following illustrations and only the first sky wave is shown, since it is the only sky wave used for matching.

Figures 3-38 to 3-40 are dangerous pulse splitting examples. Figure 3-8 shows the character of a signal pulse at the beginning of a splitting cycle. Figure 3-39 shows its character as it may appear shortly afterwards in the middle of the splitting cycle, and finally figure 3-40 shows the climax when the leading edge has completely disappeared. The character of the received pulses will next successively assume the form they had in the middle and the beginning of the splitting cycle and return to normal.

(4) Another type of splitting is characterized by the fact that the trailing edges of the pulses are distorted in the same manner described above.

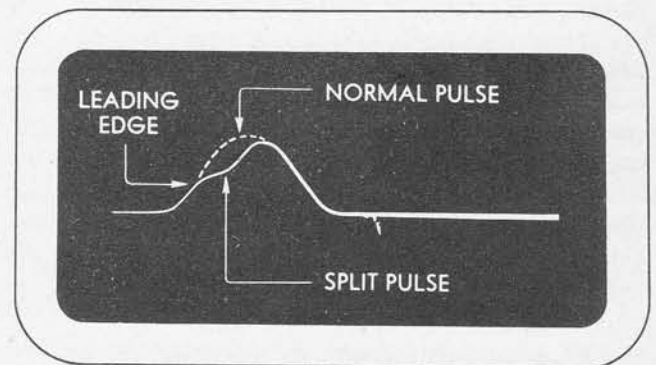

Figure 3-38

(5) With either type of splitting the operator should study its character until he has a correct mental picture of the normal pulse shapes, in order to match the pulses correctly. *This is extremely important since the*

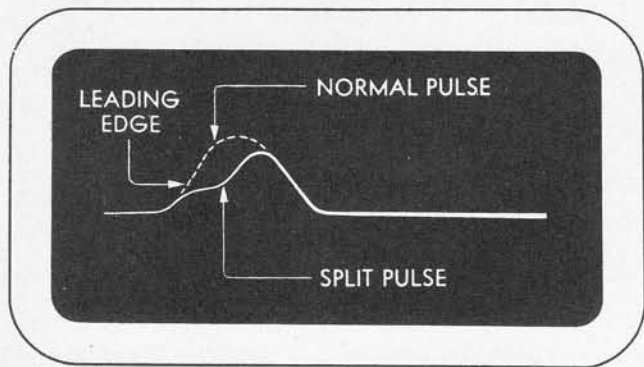

Figure 3-39

pulses at the climax as shown in figure 3-40 and the counterpart for the other type of splitting resemble normal pulses, but if they are matched without regard to missing part of the pulses, serious errors will result in the reading of the indicated time difference.

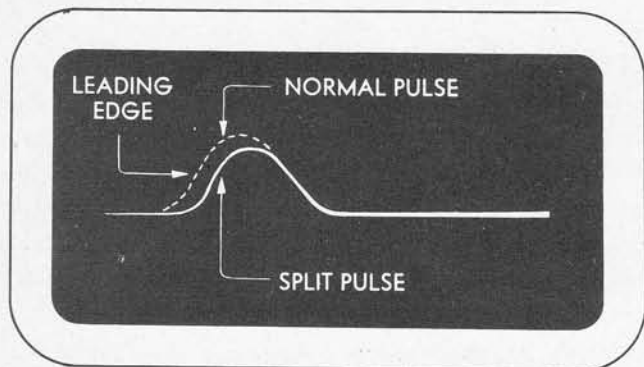

Figure 3-40

e. NAVIGATION ALONG A LORAN LINE OF POSITION.—Figures 3-41 to 3-44 are for receiver-indicator operation, navigation along a "LORAN" line of position. If the reading obtained as outlined in the above operational procedures fixes the airplane on a LORAN line of position that coincides with the airplane's plotted course, the operator may employ the receiver-indicator to fly this course by following the steps enumerated below.

CAUTION

To avoid serious errors, do not change the setting of coarse and fine delay controls during this operation.

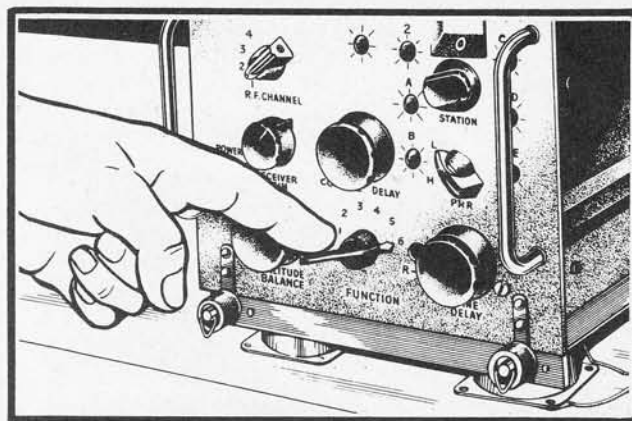

Figure 3-41

(1) Turn the "FUNCTION" switch to position "6."

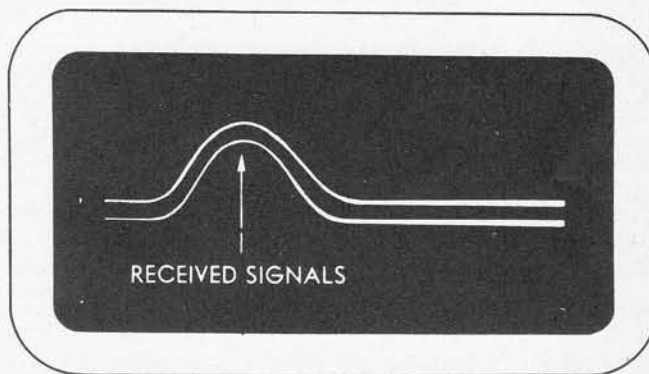

Figure 3-42

(2) The above illustration shows the relationship of the received signals that must be maintained in order to fly the airplane along the LORAN line of position which coincides with the plotted course of the airplane. In order to maintain the above relationship, it may be necessary to periodically adjust "RECEIVER GAIN," "AMPLITUDE BALANCE," "DRIFT," and "RIGHT-LEFT" controls. It is advisable to check the indicated time difference occasionally to insure that the proper LORAN line is being navigated.

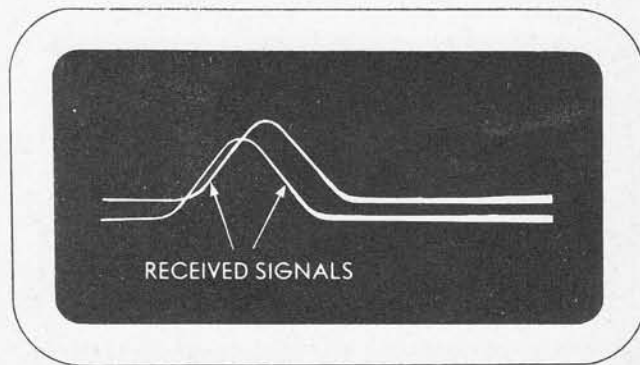

Figure 3-43

If the relation of the received signals on the indicator screen changes, as shown in figure 3-43, the operator then is aware that the ground track of the airplane has deviated from the selected course.

(3) The pilot can change the heading of the airplane either to the left or to right until the received signals on the indicator screen move back to the required and original position as shown in (2). The movement of the received signal appearing on the indicator screen does not inform the operator whether the course of the airplane must be corrected to the right or left, but if after the heading of the airplane has been changed and the received signals continue to drift apart, the operator knows that the airplane heading must be changed to the opposite direction until the received signals assume the correct relation. (See fig. 3-44.)



Figure 3-44

SECTION IV EMERGENCY OPERATION AND REPAIR

1. CHECK OF COUNTER AND STATION SELECTOR ADJUSTMENTS.

Operating results will be correct only if the counter and station rates are adjusted correctly. If the receiver-indicator cannot be synchronized with the ground stations, the expected stations are not received, or the *fix* does not correspond with the expected location, check the counter and station rates as follows:

a. COUNTER INDICATIONS.—Figures 4-1 to 4-9 are receiver-indicator indications for correct timing, counter indications.

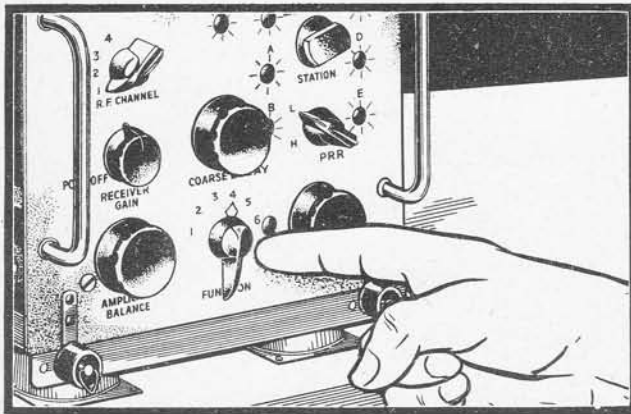

Figure 4-1

(1) Turn the "FUNCTION" switch to position "4."

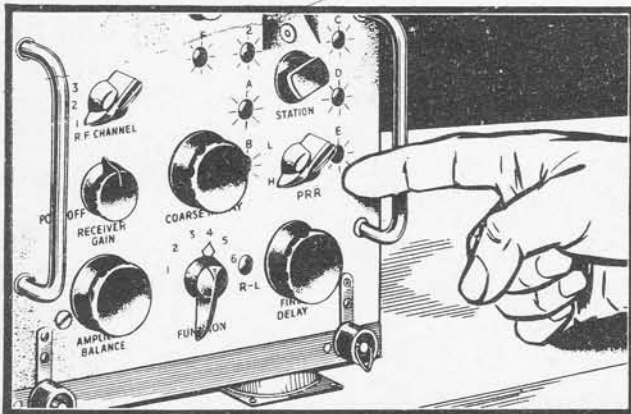

Figure 4-2

(2) Turn the "PRR" switch to position "H."

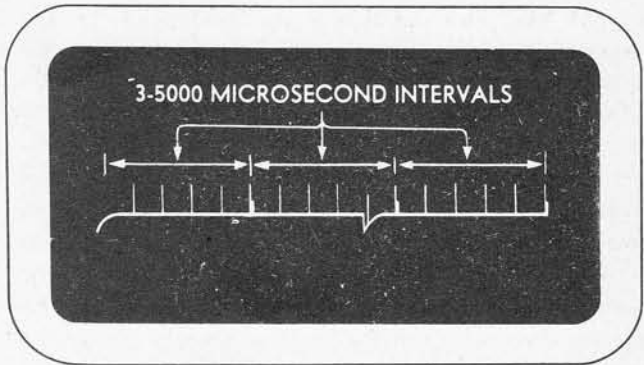

Figure 4-3

(3) Count *three* 5,000 - microsecond intervals between the extreme right and left ends of the trace.

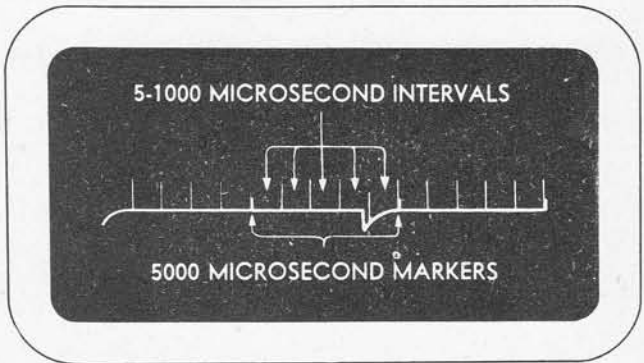

Figure 4-4

(4) Count *five* 1,000-microsecond intervals between the 5,000-microsecond markers.

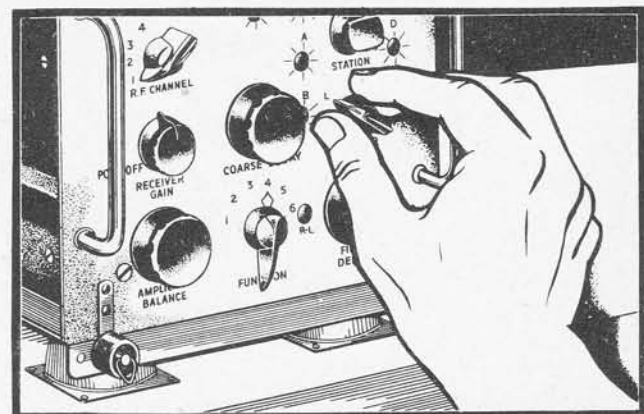

Figure 4-5

(5) Turn the "PRR" switch to position "L."

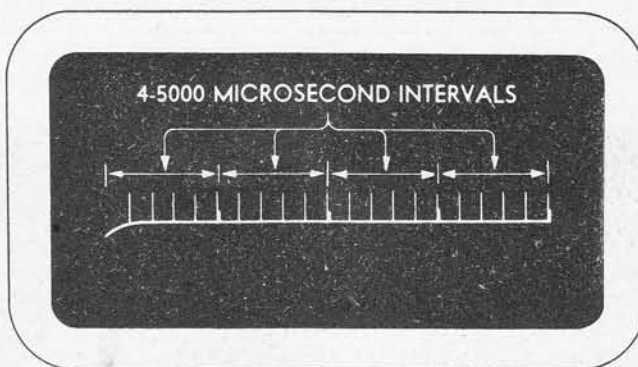

Figure 4-6

(6) Count *four* 5,000-microsecond intervals between the extreme right and left ends of the trace.

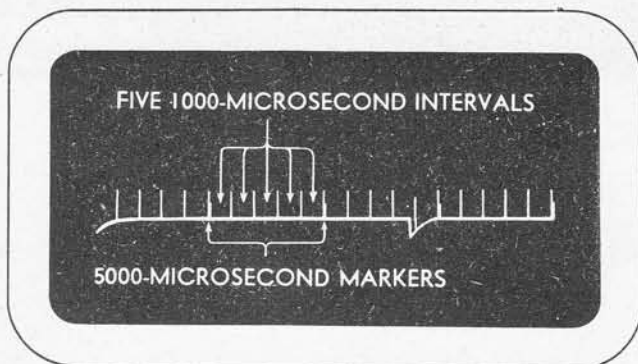

Figure 4-7

(7) Count *five* 1,000-microsecond intervals between the 5,000-microsecond markers.

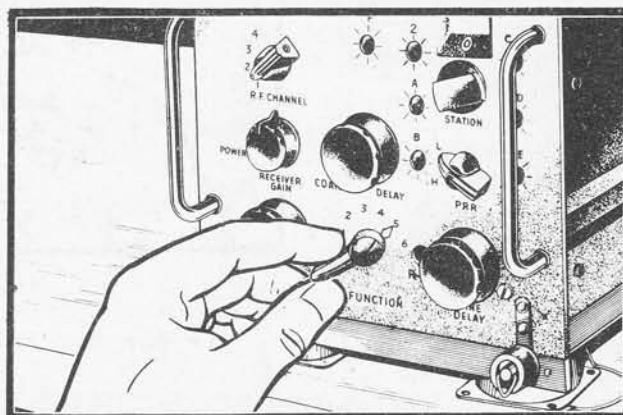

Figure 4-8

(8) Turn the "FUNCTION" switch to position "5."

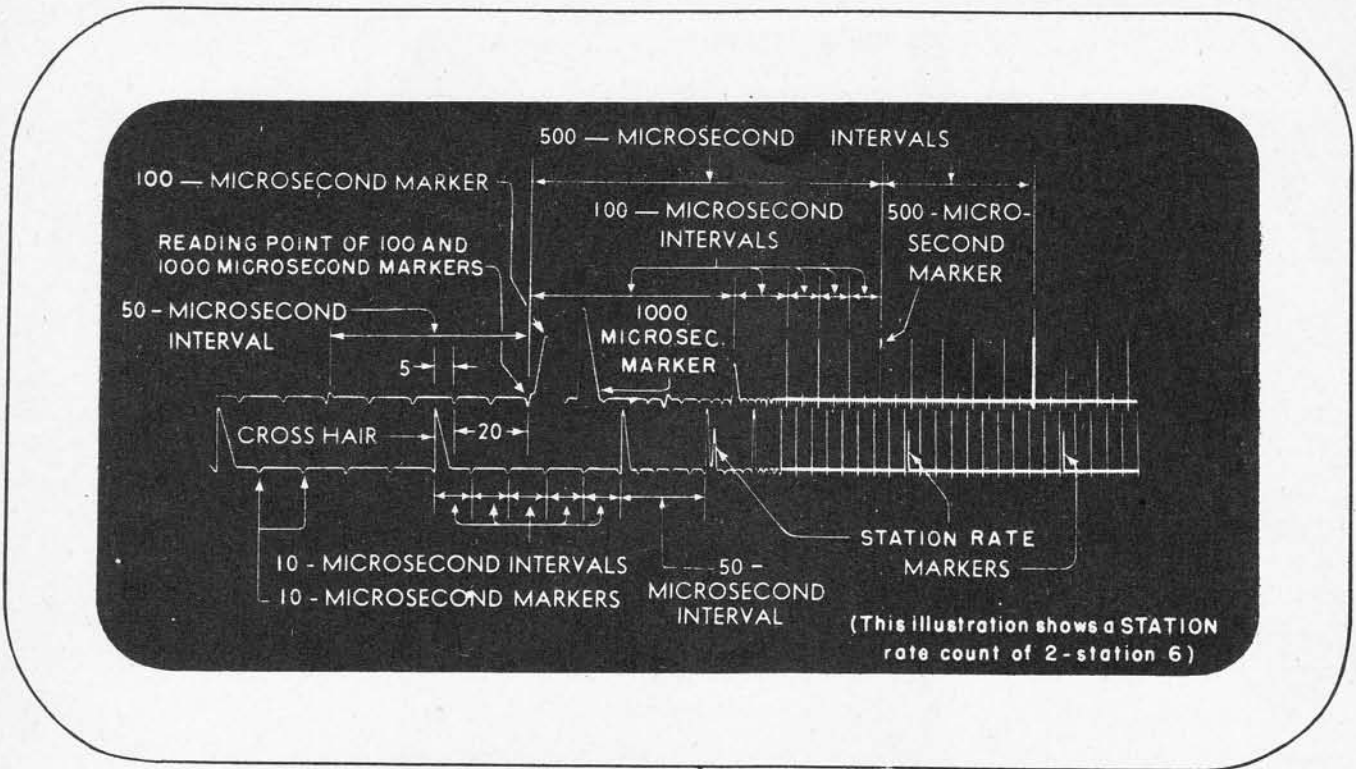

Figure 4-9

(9) Count *five* 10-microsecond intervals between 50-microsecond markers on the lower trace.

(10) Count *two* 50-microsecond intervals between 100-microsecond markers on the upper trace.

(11) Count *five* 100-microsecond intervals between 500-microsecond markers on the upper trace.

(12) Count *two* 500-microsecond intervals between 1,000-microsecond markers on the upper trace.

Note

The operator must become thoroughly familiar with the above counter indications, so that he may, during operations, notice any deviations from the correct indications outlined above.

b. STATION FEED-BACK RATES.—Figures 4-10 to 4-11 are receiver-indicator indications for correct timing, station feed-back rates.

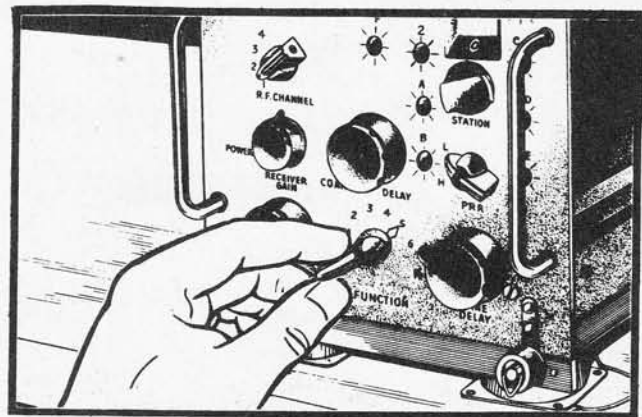

Figure 4-10

(1) Turn the "FUNCTION" switch to position "5."

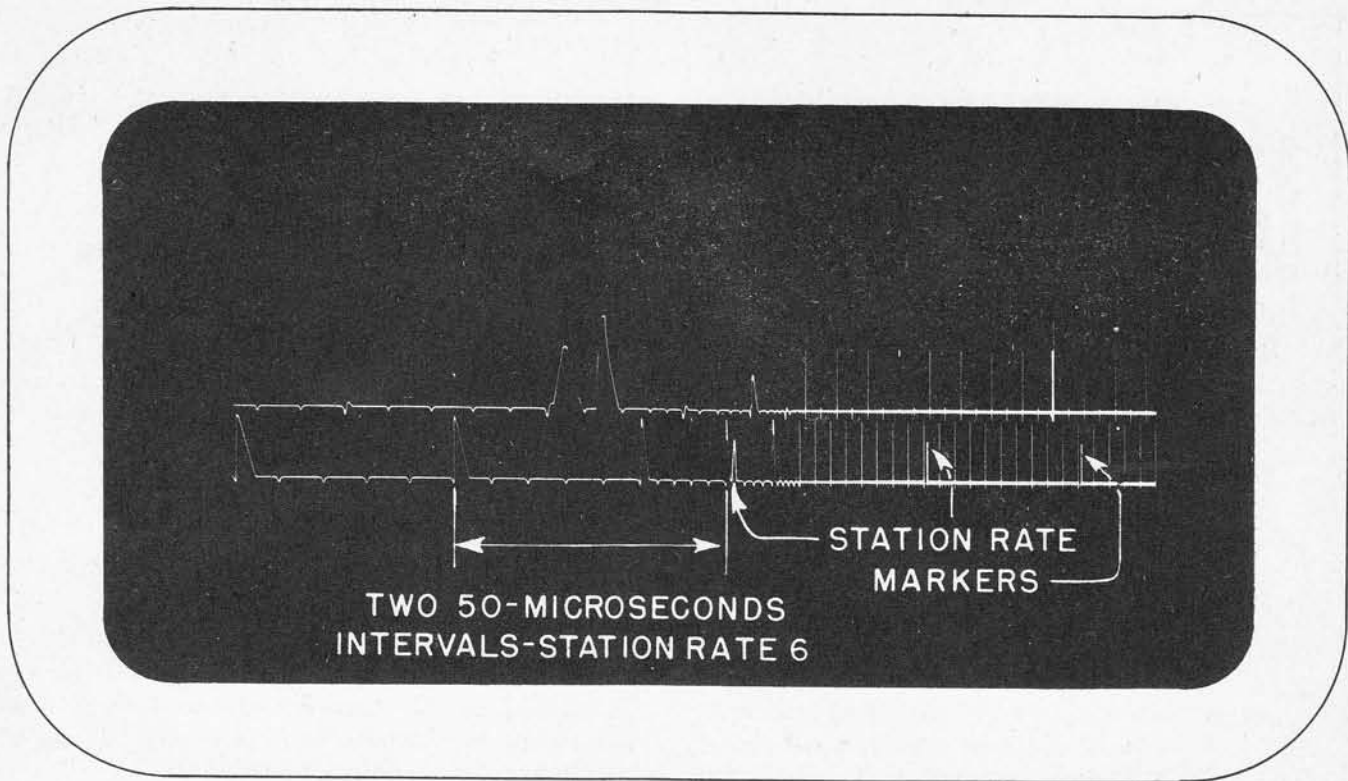

Figure 4-11

(2) Observe the "STATION" rate markers on the lower trace. Set the "STATION" rate switch at "0" and count the number of 50-microsecond intervals between the cross hair and the first "STATION" rate marker. Repeat this operation for "STATION" rate settings "1" to "7," inclusive. The counts observed must agree with the table below.

| "STATION" Rate Switch Setting | 50- Microsecond Intervals |
|-------------------------------------|---------------------------------|
| 0 | 8 |
| 1 | 7 |
| 2 | 6 |
| 3 | 5 |
| 4 | 4 |
| 5 | 3 |
| 6 | 2 |
| 7 | 1 |

(3) With the "STATION" rate switch set at position "4," move the "RIGHT-LEFT" switch to right and count the two 50-microsecond intervals between the cross hair and the first "STATION" rate marker.

(4) Repeat the above (2) and (3) with the "PRR" switch set at the "H" and "L" position.

Note

If during flight, these indications show a faulty count or station rate adjustment or if the "LEFT-RIGHT" switch action is unsatisfactory with the "FUNCTION" switch at position "1," the operator should refer to section IV, paragraph 2.

2. EMERGENCY ADJUSTMENT.

The following adjustments are to be made only after the operator has checked section IV, paragraph 1, and has found that the equipment does not function properly.

a. COUNTER ADJUSTMENTS.—Figures 4-12 to 4-16 are for receiver-indicator emergency operation counter adjustments.

Note

These are step adjustments in which the count changes in steps as the screw driver adjustment is moved. When making adjustments, attempt to set the control in the center of the range which produces the correct count. Make these adjustments only if certain that the count is incorrect. *Only the correct count should be adjusted. The set should be realigned in a maintenance shop as soon as possible after these adjustments have been made.*

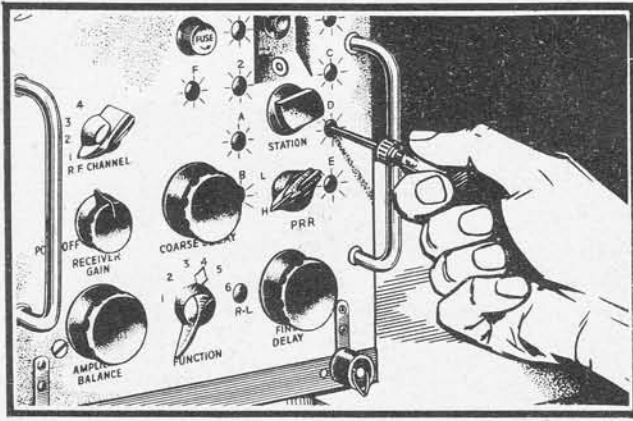

Figure 4-12

(1) THREE 5,000-MICROSECOND INTERVAL COUNT.—With the "FUNCTION" switch at position "4," the "PRR" switch at "H," "STATION" rate at "0," and the "COARSE DELAY" control set at its maximum clockwise position, adjust the 'D' screw driver control on the front panel until three 5,000-microsecond intervals appear between the extreme right and left ends of the trace.

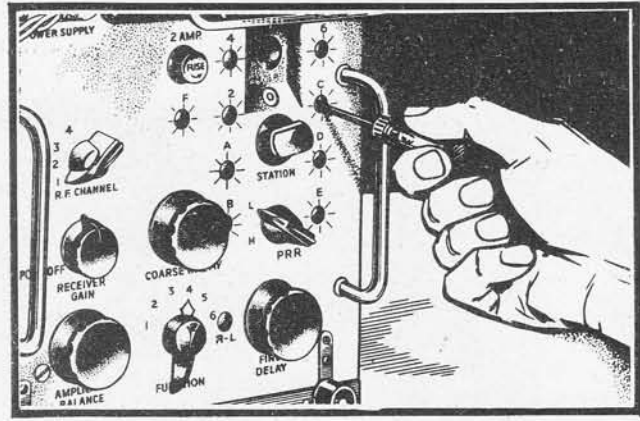

Figure 4-14

(3) FIVE 1,000 - MICROSECOND INTERVAL COUNT.—With the "FUNCTION" switch at position "4," adjust the "C" screw driver control on the front panel until five 1,000-microsecond intervals appear between the 5,000-microsecond markers.

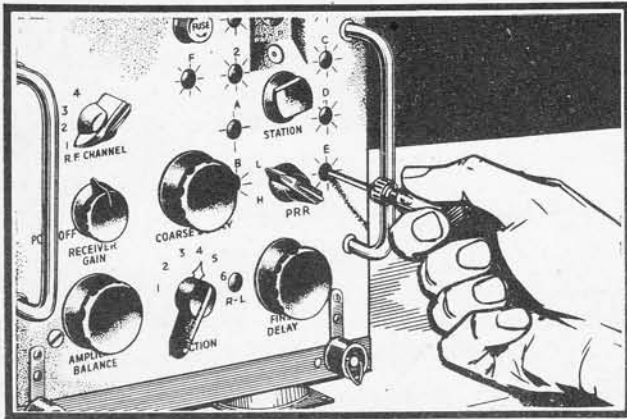

Figure 4-13

(2) FOUR 5,000 - MICROSECOND INTERVAL COUNT.—With the "FUNCTION" switch at position "4," and the "PRR" switch turned to "L," adjust the "E" screw driver control on the front panel until four 5,000-microsecond intervals appear between the extreme right and left ends of the trace.

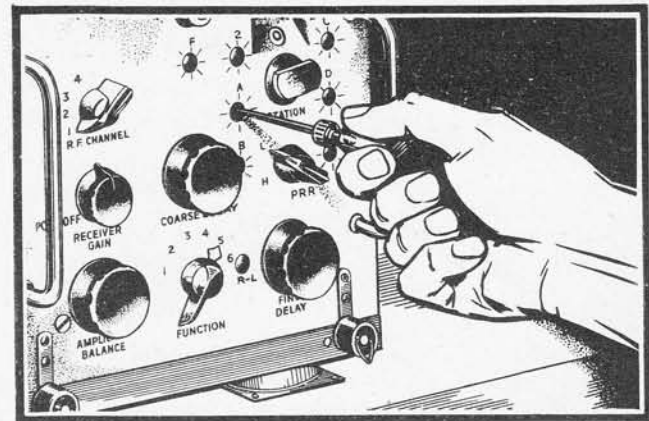

Figure 4-15

(4) 10-MICROSECOND INTERVAL COUNT.—Set the "FUNCTION" switch to position "5," adjust the "A" screw driver control on the front panel, until five 10-microsecond intervals appear between the 50-microsecond markers.

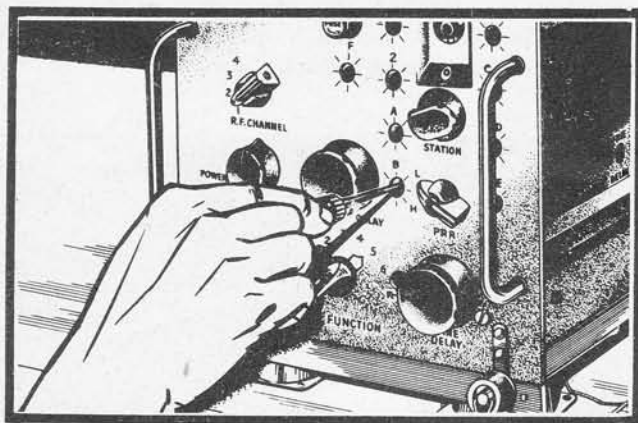

Figure 4-16

(5) 100-MICROSECOND INTERVAL COUNT. With the "FUNCTION" switch set to position "5," adjust the "B" screw driver control on the front panel until five 100-microsecond intervals appear between the 500-microsecond markers.

b. STATION RATE ADJUSTMENTS.—Figures 4-17 to 4-19 are for receiver-indicator emergency operation station rate adjustments.

When the "STATION" rate switch settings do not agree with the 50-microsecond interval counts as listed in section IV, paragraph 1b(2), the following adjustments will be necessary.

(1) When "STATION" rate "0" is incorrect, center the controls as described in "COUNTER ADJUSTMENTS," section IV, paragraph 2a(1) to (5) inclusive.

(2) When "STATION" rate "1" is incorrect, center the controls as described in "COUNTER ADJUSTMENTS," section IV, paragraph 2a(1) to (5) inclusive.

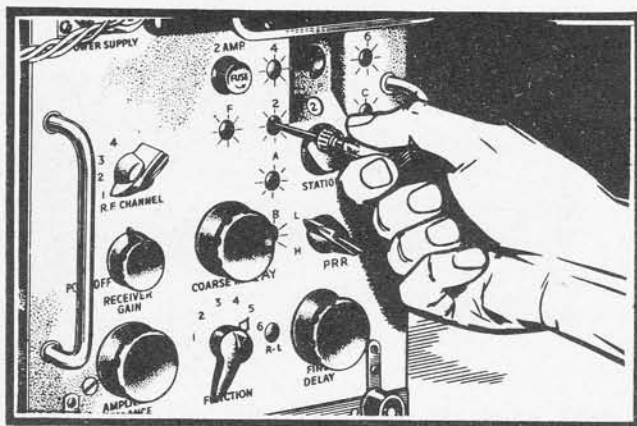

Figure 4-17

(3) When "STATION" rate "2" is incorrect, adjust the "2" screw driver control on the front panel until there are six 50-microsecond intervals between the cross

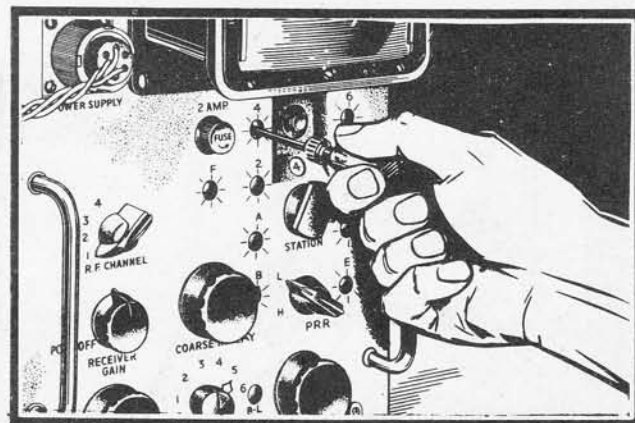

Figure 4-18

(5) When "STATION" rate 4 is incorrect, adjust the "4" screw driver control on the front panel until there are four 50-microsecond intervals between the cross hair and the first station rate marker on the lower trace. If this adjustment is not possible, center the adjustment of the controls as described in section IV, paragraph 2a(1) to (5) inclusive.

(6) When "STATION" rate 5 is incorrect, repeat (5) as described directly above. If a correct count is not produced, center the controls as described in section IV, paragraph 2a(1) to (5) inclusive.

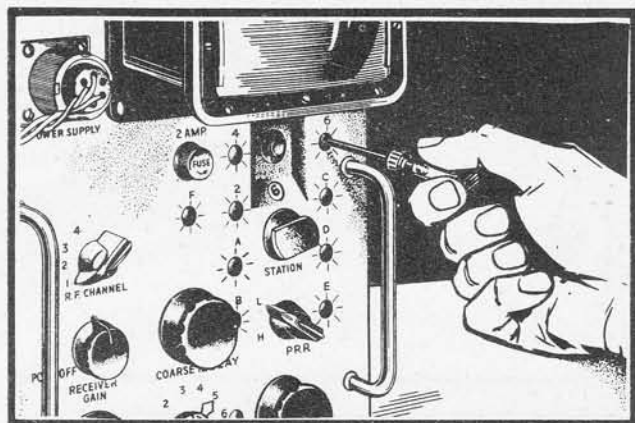

Figure 4-19

(7) When "STATION" rate "6" is incorrect, adjust the "6" screw driver control on the front panel until

Section IV
Paragraph 2

RESTRICTED
AN 08-30APN9-2

there are two 50-microsecond intervals between the cross hair and the first "STATION" rate marker on the lower trace. If this adjustment is not possible, center the adjustment of the controls as outlined in section IV, paragraph 2a(1) to (5) inclusive. The "FUNCTION" switch is set at position "5" for this adjustment.

(8) When "STATION" rate "7" is incorrect, repeat (7) as described directly above. If the correct count is not produced, center the adjustment of the controls as described in section IV, paragraph 2a(1) to (5) inclusive.

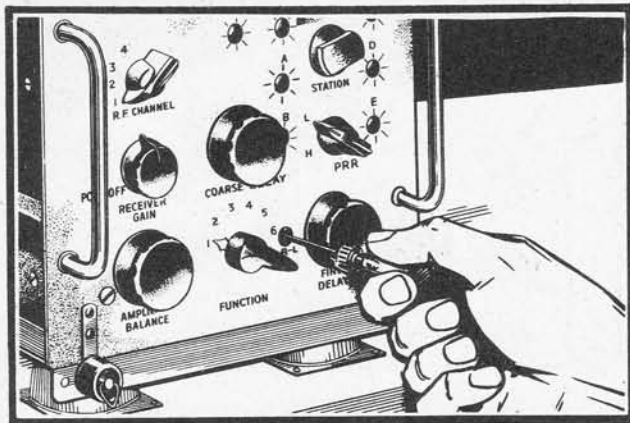

Figure 4-20. "R-L" Screw Driver Adjustment

c. RIGHT-LEFT CONTROL.—If the right action of the "RIGHT-LEFT" switch is unsatisfactory with the "FUNCTION" switch set at position "1," adjust the "R-L" screw driver adjustment on the front panel until the right action is satisfactory, using signals for indications. The LORAN ground signal may be the source of these signals, or if Test Set TS-251/UP is available it may be used.

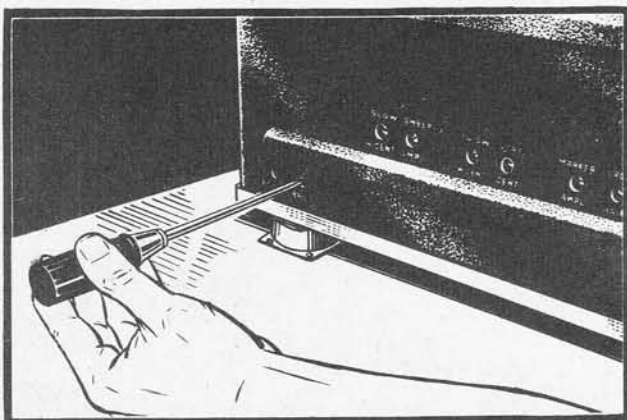

Figure 4-21. "BRILL." Screw Driver Adjustment

d. BRILLIANCE CONTROL.—Watch the indicator screen. If no trace has appeared, turn the "FUNCTION"

switch to position "5," and adjust the "BRILL." screw driver control on the panel on the left side of the receiver-indicator until the trace appears.

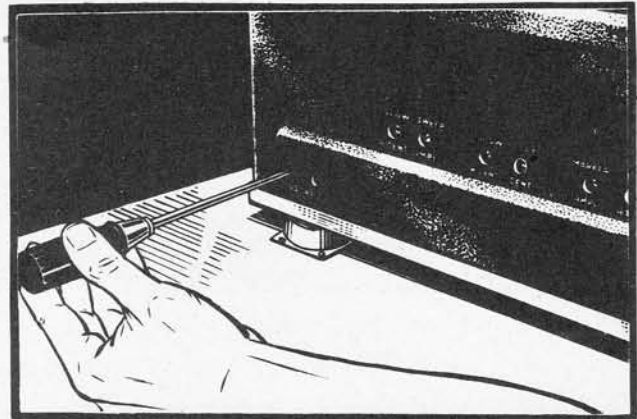

Figure 4-22. "FOCUS" Screw Driver Adjustment

e. FOCUS CONTROL.—If the trace is blurred, with the "FUNCTION" switch in position 5, adjust the "FOCUS" screw driver control on the panel on the left side of the receiver-indicator until the trace is sharp and clear.

f. CENTERING OF TRACES.—Figures 4-23 to 4-27 are for receiver-indicator emergency operation, centering of traces.

(1) To center the trace *vertically* with the "FUNCTION" switch set at positions "1," "2," "3," "4," "5," or "6," proceed as follows:

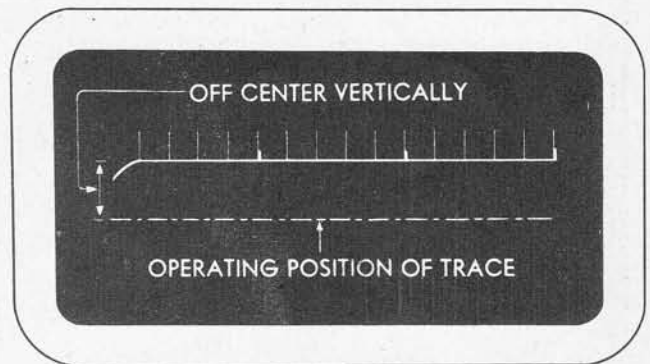

Figure 4-23

If the trace is not centered *vertically*, adjust the "VERT. CENT." control on the left side of the receiver-indicator until the trace is correctly centered.

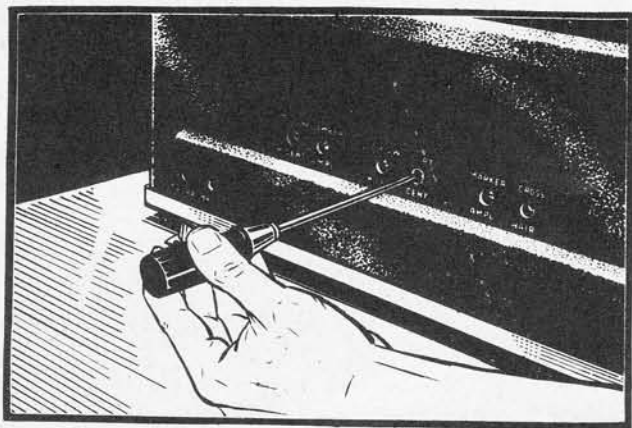

Figure 4-24

(2) To center the trace *horizontally*, with the "FUNCTION" switch set at position "1," or "4," proceed as follows:

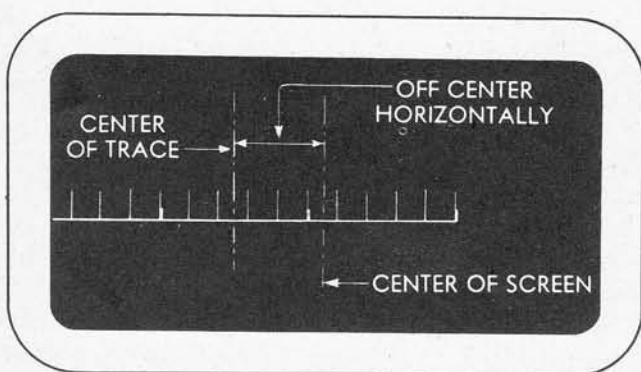

Figure 4-25

If the trace is not centered *horizontally*, adjust the "SLOW SWEEP H. CENT." screw driver control on the left hand side until the trace is properly centered.

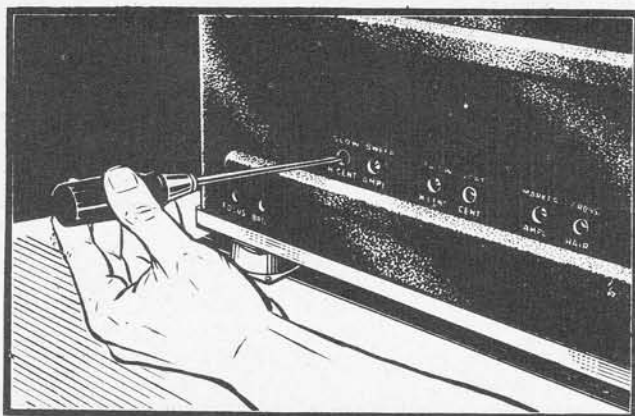

Figure 4-26

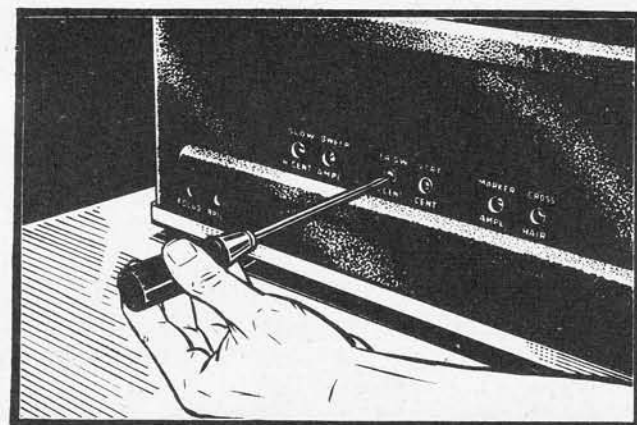

Figure 4-27

Adjust the "FA. SW. H. CENT." screw driver control on the left hand side of the receiver-indicator until the traces are properly centered.

g. AMPLITUDE OF TRACES.—Figures 4-28 to 4-31 are for receiver-indicator emergency operation, amplitude of traces.

(1) For adjusting amplitude of traces with "FUNCTION" switch set at positions "1" or "4," proceed as follows:

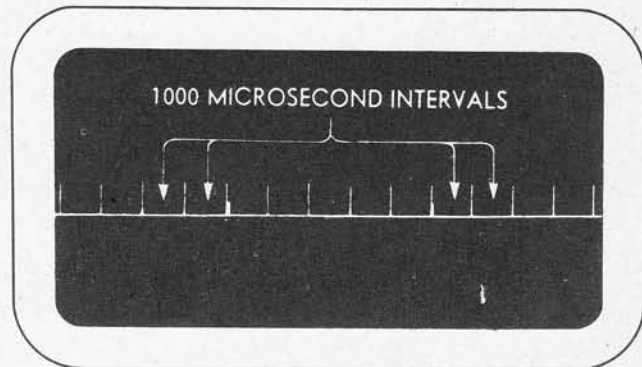

Figure 4-28

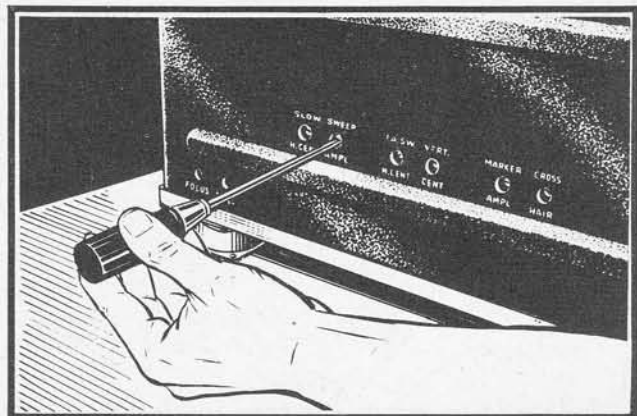

Figure 4-29

Adjust the "SLOW SWEEP AMPL." screw driver control on the left side until the trace assumes a normal length.

(2) To adjust the amplitude of the traces with the "FUNCTION" switch set at positions "2," "3," "5," or "6," proceed as follows:

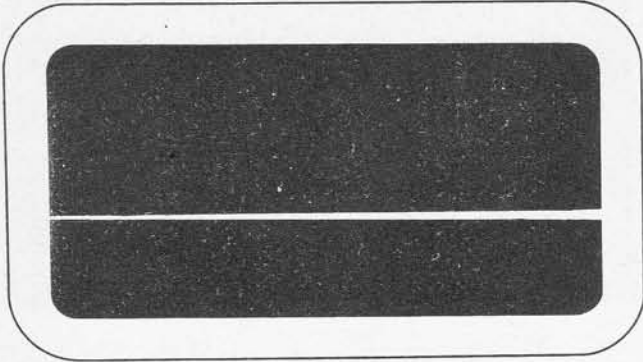

Figure 4-30

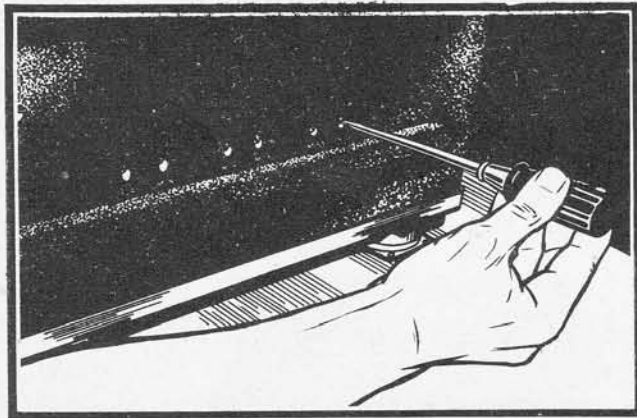

Figure 4-31

Adjust the "FA. SW. AMPL." screw driver control on the right hand side of the receiver-indicator until the traces assume a normal length.

b. MARKER SIZE. — ("FUNCTION" switch position "5".)

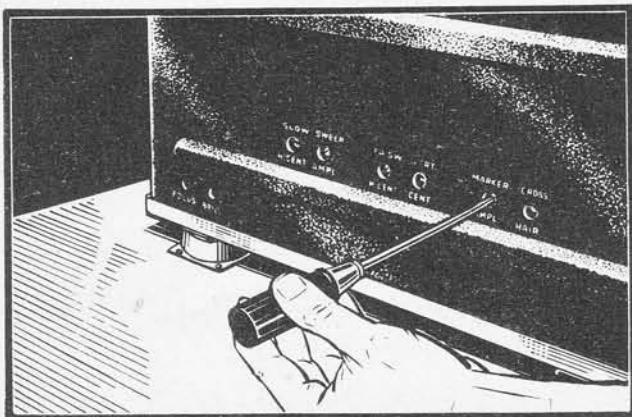

Figure 4-32. "MARKER AMPL." Adjustments

If the heights of the markers do not permit the operator to identify them readily, adjust the "MARKER AMPL." control on the left hand side of the receiver-indicator.

i. CROSS HAIR. — ("FUNCTION" switch position "5".)

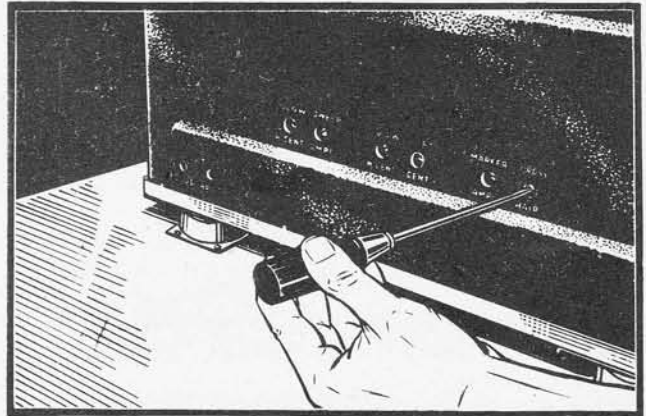

Figure 4-33. "CROSS HAIR" Adjustment

If the position of the cross hair in relation to the upper trace is incorrect, adjust the "CROSS HAIR" screw driver control on the left hand side of the receiver-indicator.

j. COARSE DELAY.—Figures 4-34 to 4-37 are for receiver-indicator emergency operation, coarse delay. If the range of the "COARSE DELAY" control is insufficient to adjust the delay for a desired station, proceed as follows:

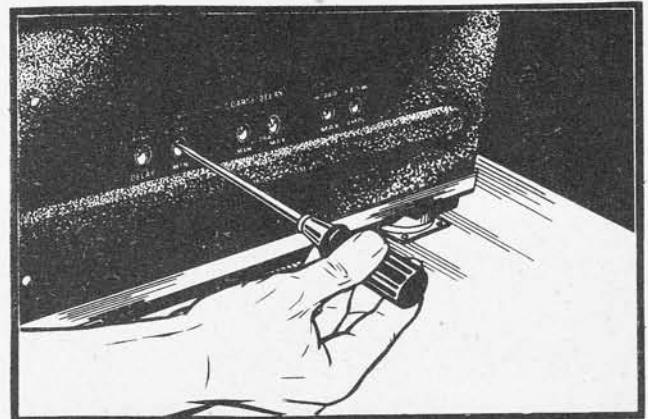

Figure 4-34

(1) If the variable delay marker cannot be placed far enough to the right with the "PRR" switch set at "H," adjust the "COARSE DELAY H-PRR MIN." screw driver control on the right side of the receiver-indicator.

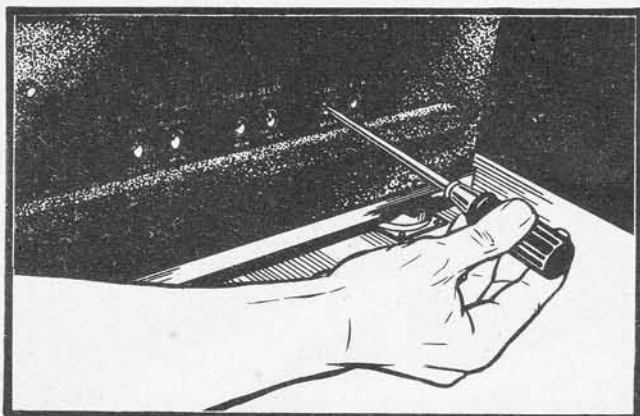

Figure 4-35

(2) If the variable delay marker cannot be placed far enough to the left with the "PRR" switch set at "H," adjust the "COARSE DELAY H-PRR MAX." control on the right side of the receiver-indicator.

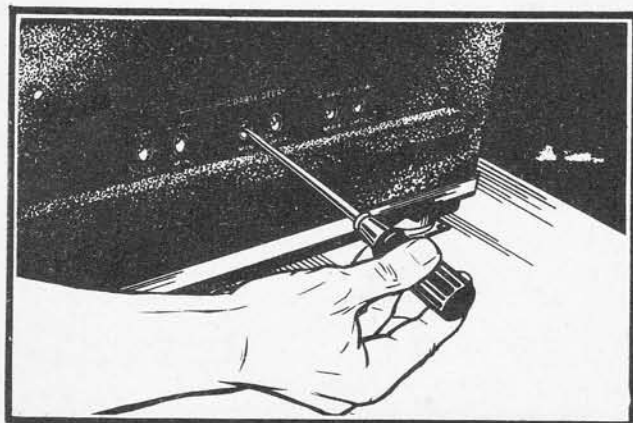

Figure 4-36

(3) If the variable delay marker cannot be placed far enough to the right with the "PRR" switch set at "L," adjust the "COARSE DELAY L-PRR MIN." control on the right side of the receiver-indicator.

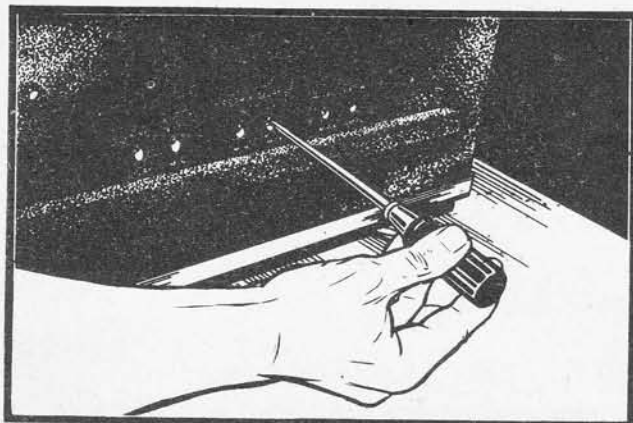

Figure 4-37

(4) If the variable delay marker cannot be placed far enough to the left with the "PRR" switch set at "L," adjust the "COARSE DELAY L-PRR MAX." control on the right side of the receiver-indicator.

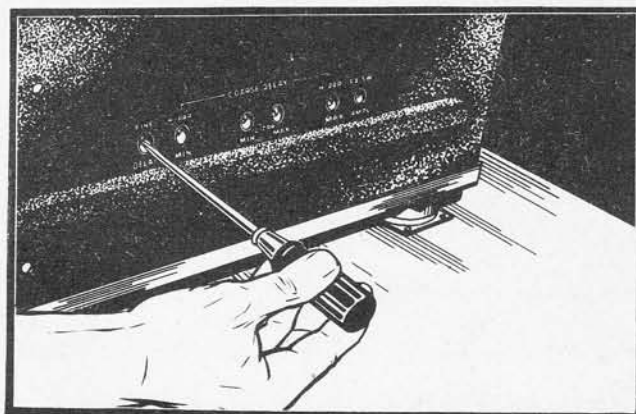

Figure 4-38. "FINE DELAY" Adjustment

k. FINE DELAY.—If the "FINE DELAY" range is not sufficient (700 microseconds), adjust the "FINE DELAY" adjustment on the right hand side of the receiver-indicator.

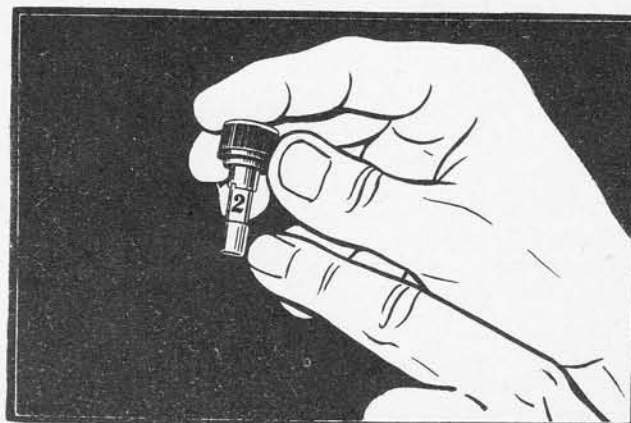

Figure 4-39. Fuse Replacement

3. FUSE REPLACEMENT.

If the pilot light is not illuminated and no trace pattern appears on the indicator-screen replace the active fuse with the spare fuse, which is located in a fuse clip under the lens holder on the front of the receiver-indicator. Remove the "FUSE" knob by turning as indicated, remove used fuse and replace with the new one.

SECTION V
SUPPLEMENTARY DATA

1. TUBE COMPLEMENT.

The Receiver-Indicator R-65/APN-9 contains a total of 35 tubes of the types and quantities shown below:

| Quantity | Stock No. | Type Designation | |
|----------|-------------|------------------|---------|
| | | JAN | VT |
| 1 | 2J2X2 | JAN-2X2 | VT-119 |
| 1 | 2J5Y3GT/G | JAN-5Y3GT/G | VT-197A |
| 1 | 2J6Y6G | JAN-6Y6G | VT-168A |
| 2 | 2J6SJ7 | JAN-6SJ7 | VT-116 |
| 1 | 2J0C3/VR105 | JAN-0C3/VR105 | VT-200 |
| 3 | 2J6SL7GT | JAN-6SL7GT | VT-229 |
| 13 | 2J6SN7GT | JAN-6SN7GT | VT-231 |
| 1 | 2J6N7 | JAN-6N7 | VT-96 |
| 1 | 2J3BP1 | JAN-3BP1 | |
| 7 | 2J6H6 | JAN-6H6 | VT-90 |
| 3 | 2J6SK7 | JAN-6SK7 | VT-117 |
| 1 | 2J6SA7 | JAN-6SA7 | VT-150 |

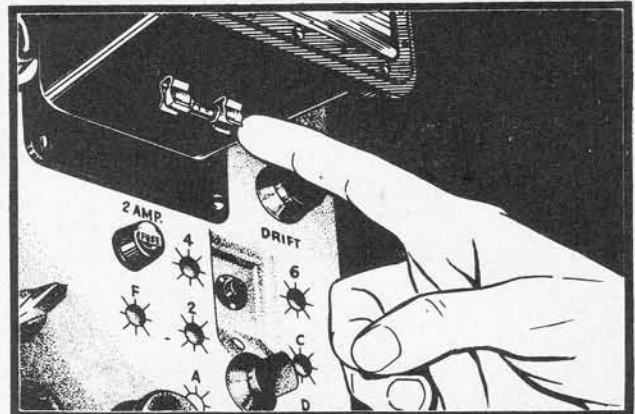

Figure 5-1. Location of Spare Fuse

2. FUSE COMPLEMENT.

| Type | Stock No. | Current Rating | Location | |
|------------|-----------------------|------------------------|-------------|--|
| | | | Active Fuse | Spare Fuse |
| 4AG 4AG | 3Z2602.7 3Z1937-37 | 2 amperes 3 amperes | Front panel | Under lens holder on the front of the receiver-indicator |

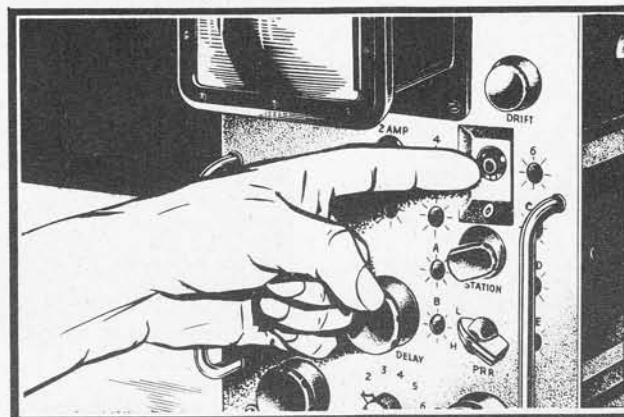

Figure 5-2. Location of Pilot Light

3. PILOT LAMP COMPLEMENT.

| Type Designation | Stock No. | Location |
|---|-----------|-------------|
| Mazda Type 322, 3 volt equivalent to Signal Corps LM-32 | 2Z5932 | Front panel |

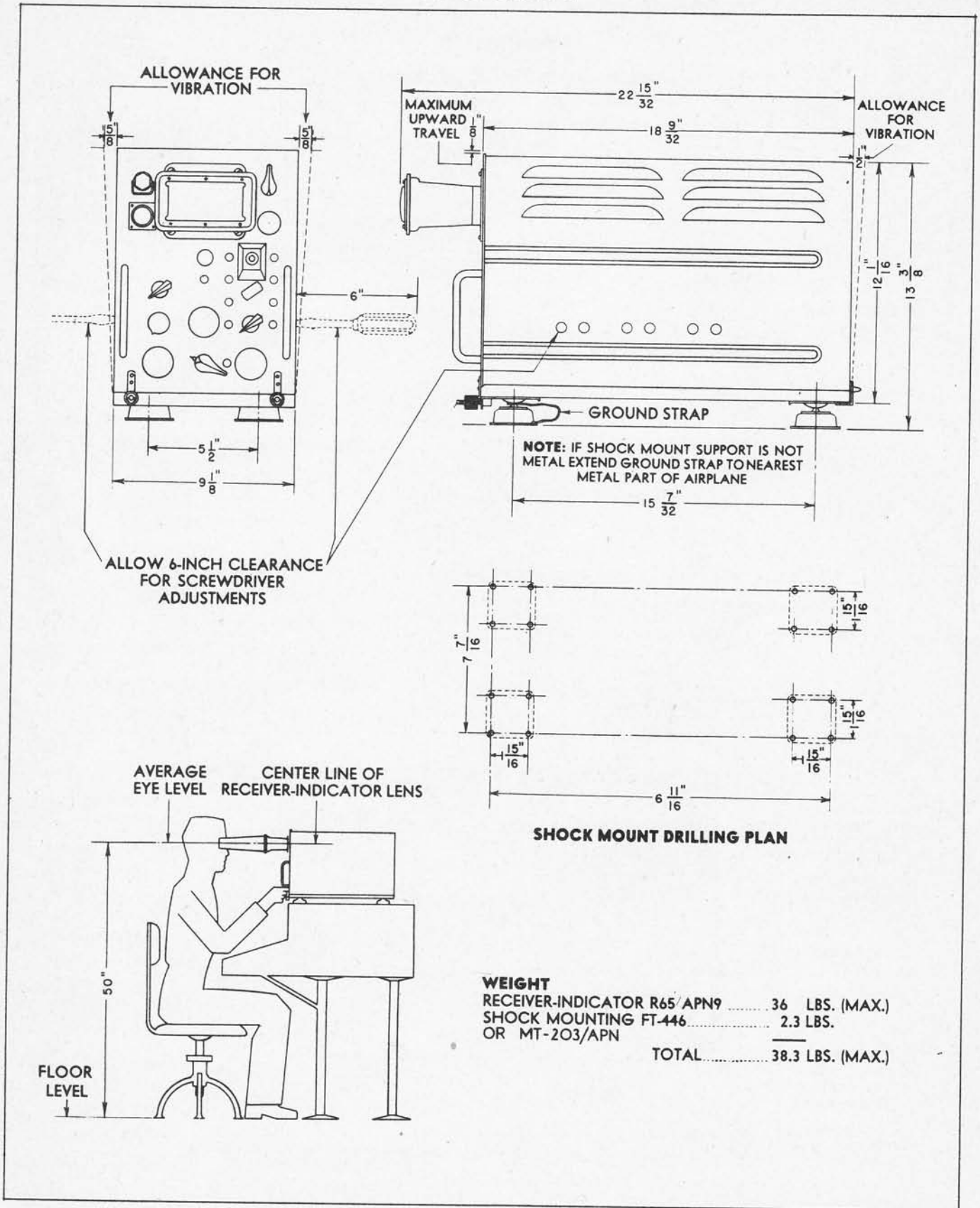
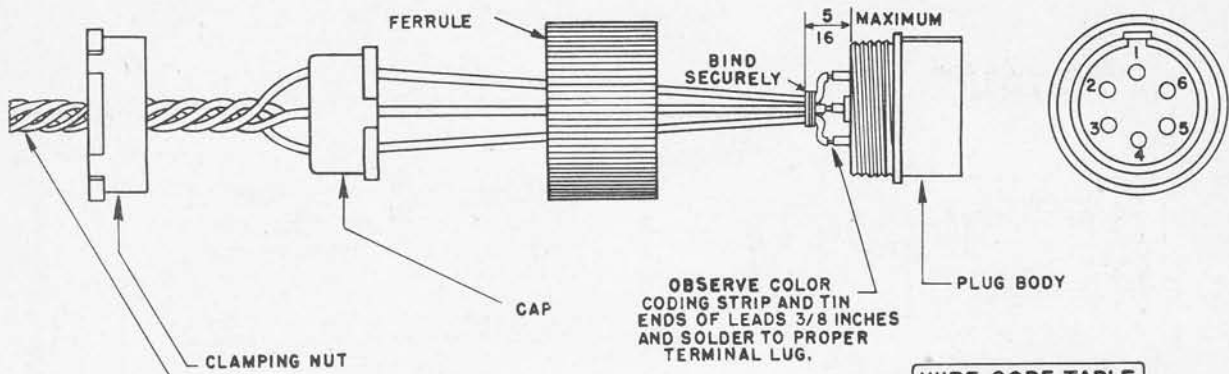
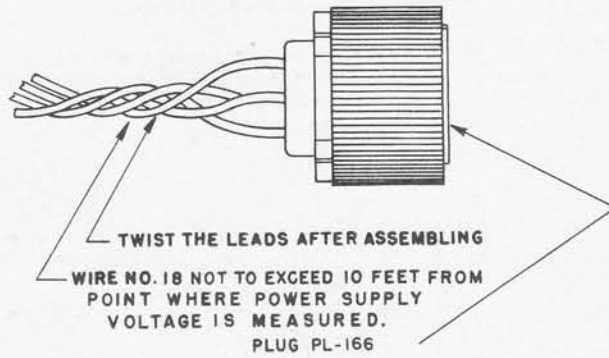

Figure 5-3. Radar Set AN/APN-9 — Dimensional Outline Drawing



POWER SUPPLY CABLE



WIRE CODE TABLE

NO. 1
115. VOLT, USING STARTING RELAY SWITCH

| TERMINAL NO. | COLOR |
|--------------|--------|
| 1 | YELLOW |
| 2 | BLANK |
| 3 | BLUE |
| 4 | PINK |
| 5 | BLANK |
| 6 | BROWN |

NO. 2
115 VOLT, WITHOUT USING STARTING RELAY SWITCH

| TERMINAL NO. | COLOR |
|--------------|--------|
| 1 | YELLOW |
| 2 | BLANK |
| 3 | BLUE |
| 4 | BLANK |
| 5 | BLANK |
| 6 | BLANK |

NO. 3
80. VOLT, USING STARTING RELAY SWITCH

| TERMINAL NO. | COLOR |
|--------------|--------|
| 1 | YELLOW |
| 2 | GREEN |
| 3 | BLANK |
| 4 | PINK |
| 5 | BLANK |
| 6 | BROWN |

NO. 4
80 VOLT, WITHOUT USING STARTING RELAY SWITCH

| TERMINAL NO. | COLOR |
|--------------|--------|
| 1 | YELLOW |
| 2 | GREEN |
| 3 | BLANK |
| 4 | BLANK |
| 5 | BLANK |
| 6 | BLANK |

CORDING DIAGRAM

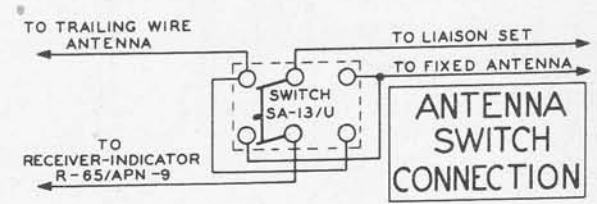
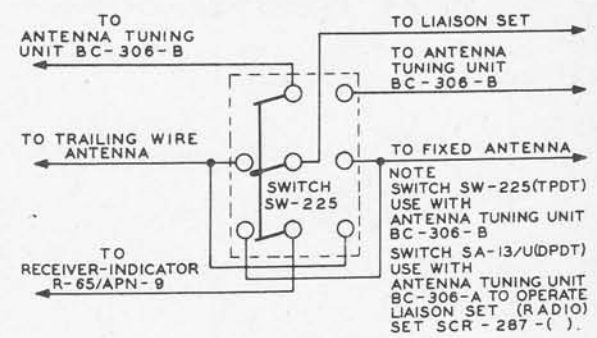
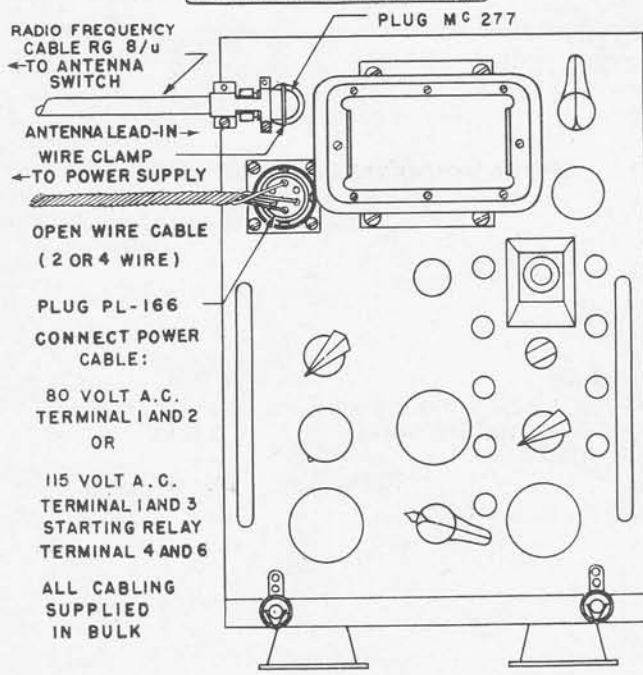

Figure 5-4. Power Supply Cable Assembly Drawings, Cording and Antenna Switch Connection Diagrams

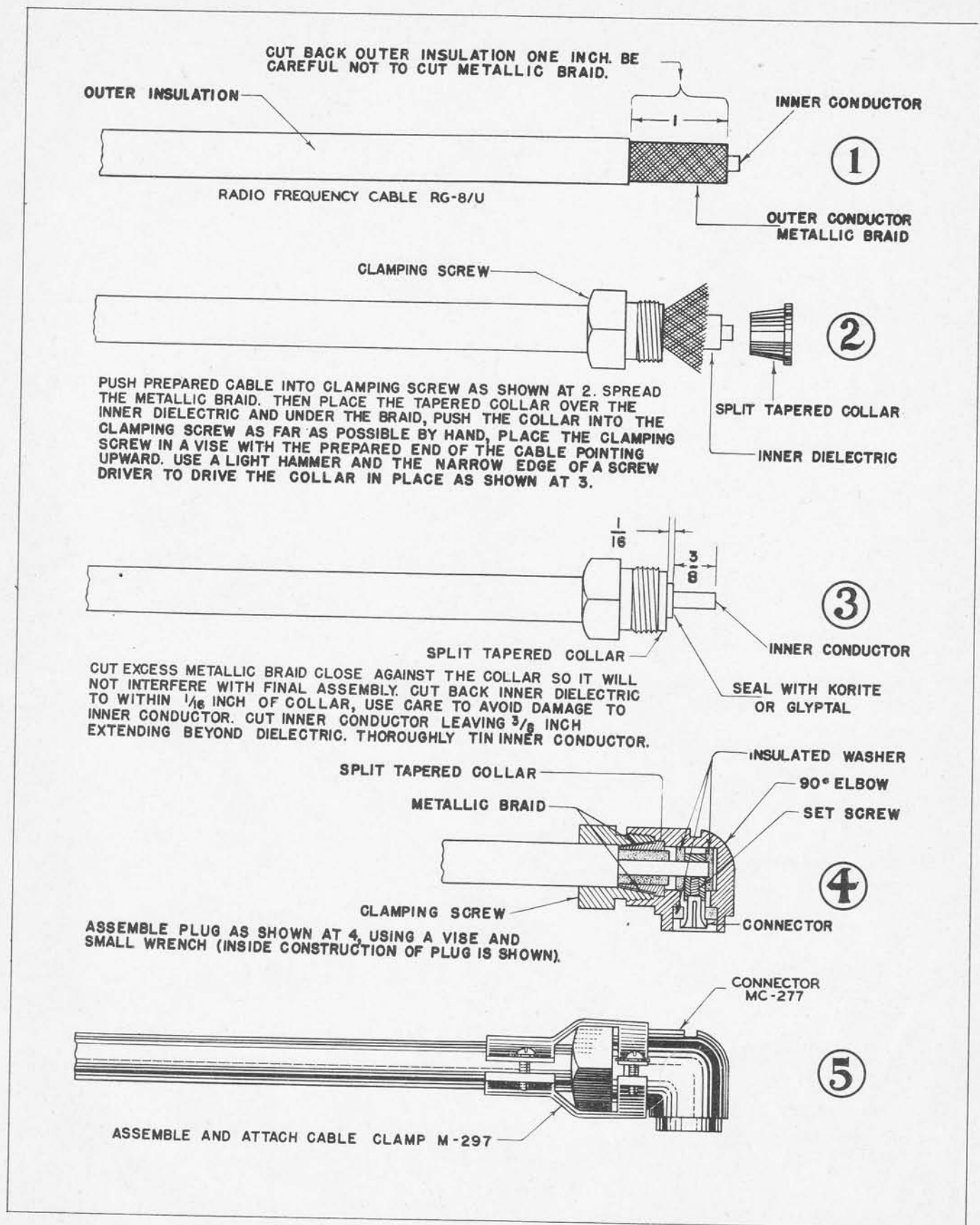

Figure 5-5. Antenna Cable Assembly Drawing