

International Telecommunication Union

ITU-T

TELECOMMUNICATION
STANDARDIZATION SECTOR
OF ITU

X.906

(10/2014)

SERIES X: DATA NETWORKS, OPEN SYSTEM
COMMUNICATIONS AND SECURITY

Open distributed processing

**Information technology – Open distributed
processing – Use of UML for ODP system
specifications**

Recommendation ITU-T X.906

ITU-T



ITU-T X-SERIES RECOMMENDATIONS
DATA NETWORKS, OPEN SYSTEM COMMUNICATIONS AND SECURITY

PUBLIC DATA NETWORKS	
Services and facilities	X.1–X.19
Interfaces	X.20–X.49
Transmission, signalling and switching	X.50–X.89
Network aspects	X.90–X.149
Maintenance	X.150–X.179
Administrative arrangements	X.180–X.199
OPEN SYSTEMS INTERCONNECTION	
Model and notation	X.200–X.209
Service definitions	X.210–X.219
Connection-mode protocol specifications	X.220–X.229
Connectionless-mode protocol specifications	X.230–X.239
PICS proformas	X.240–X.259
Protocol Identification	X.260–X.269
Security Protocols	X.270–X.279
Layer Managed Objects	X.280–X.289
Conformance testing	X.290–X.299
INTERWORKING BETWEEN NETWORKS	
General	X.300–X.349
Satellite data transmission systems	X.350–X.369
IP-based networks	X.370–X.379
MESSAGE HANDLING SYSTEMS	X.400–X.499
DIRECTORY	X.500–X.599
OSI NETWORKING AND SYSTEM ASPECTS	
Networking	X.600–X.629
Efficiency	X.630–X.639
Quality of service	X.640–X.649
Naming, Addressing and Registration	X.650–X.679
Abstract Syntax Notation One (ASN.1)	X.680–X.699
OSI MANAGEMENT	
Systems management framework and architecture	X.700–X.709
Management communication service and protocol	X.710–X.719
Structure of management information	X.720–X.729
Management functions and ODMA functions	X.730–X.799
SECURITY	X.800–X.849
OSI APPLICATIONS	
Commitment, concurrency and recovery	X.850–X.859
Transaction processing	X.860–X.879
Remote operations	X.880–X.889
Generic applications of ASN.1	X.890–X.899
OPEN DISTRIBUTED PROCESSING	X.900–X.999
INFORMATION AND NETWORK SECURITY	X.1000–X.1099
SECURE APPLICATIONS AND SERVICES	X.1100–X.1199
CYBERSPACE SECURITY	X.1200–X.1299
SECURE APPLICATIONS AND SERVICES	X.1300–X.1399
CYBERSECURITY INFORMATION EXCHANGE	X.1500–X.1599
CLOUD COMPUTING SECURITY	X.1600–X.1699

For further details, please refer to the list of ITU-T Recommendations.

**Information technology – Open distributed processing –
Use of UML for ODP system specifications**

Summary

Rec. ITU-T X.906 | ISO/IEC 19793 defines use of the Unified Modelling Language (UML 2.4.1 Superstructure Specification, ISO/IEC 19505-2, for expressing system specifications in terms of the viewpoint specifications defined by the reference model of open distributed processing (RM-ODP, Rec. ITU-T X.901 to X.904 | ISO/IEC 10746 Parts 1 to 4) and the Enterprise Language (Rec. ITU-T X.911 | ISO/IEC 15414). It covers:

- a) the expression of a system specification in terms of RM-ODP viewpoint specifications using defined Unified Modeling Language (UML) concepts and extensions (e.g., structuring rules, technology mappings, etc.);
- b) relationships between the resultant RM-ODP viewpoint specifications.

This Recommendation | International Standard refines and extends the definition of how open distributed processing (ODP) systems are specified by defining the use of the Unified Modelling Language for the expression of ODP system specifications.

History

Edition	Recommendation	Approval	Study Group	Unique ID*
1.0	ITU-T X.906	2007-11-13	17	11.1002/1000/9261
1.1	ITU-T X.906 (2007) Cor.1	2009-10-29	17	11.1002/1000/10244
2.0	ITU-T X.906	2014-10-07	17	11.1002/1000/12152

* To access the Recommendation, type the URL <http://handle.itu.int/> in the address field of your web browser, followed by the Recommendation's unique ID. For example, <http://handle.itu.int/11.1002/1000/11830-en>.

FOREWORD

The International Telecommunication Union (ITU) is the United Nations specialized agency in the field of telecommunications, information and communication technologies (ICTs). The ITU Telecommunication Standardization Sector (ITU-T) is a permanent organ of ITU. ITU-T is responsible for studying technical, operating and tariff questions and issuing Recommendations on them with a view to standardizing telecommunications on a worldwide basis.

The World Telecommunication Standardization Assembly (WTSA), which meets every four years, establishes the topics for study by the ITU-T study groups which, in turn, produce Recommendations on these topics.

The approval of ITU-T Recommendations is covered by the procedure laid down in WTSA Resolution 1.

In some areas of information technology which fall within ITU-T's purview, the necessary standards are prepared on a collaborative basis with ISO and IEC.

NOTE

In this Recommendation, the expression "Administration" is used for conciseness to indicate both a telecommunication administration and a recognized operating agency.

Compliance with this Recommendation is voluntary. However, the Recommendation may contain certain mandatory provisions (to ensure, e.g., interoperability or applicability) and compliance with the Recommendation is achieved when all of these mandatory provisions are met. The words "shall" or some other obligatory language such as "must" and the negative equivalents are used to express requirements. The use of such words does not suggest that compliance with the Recommendation is required of any party.

INTELLECTUAL PROPERTY RIGHTS

ITU draws attention to the possibility that the practice or implementation of this Recommendation may involve the use of a claimed Intellectual Property Right. ITU takes no position concerning the evidence, validity or applicability of claimed Intellectual Property Rights, whether asserted by ITU members or others outside of the Recommendation development process.

As of the date of approval of this Recommendation, ITU had not received notice of intellectual property, protected by patents, which may be required to implement this Recommendation. However, implementers are cautioned that this may not represent the latest information and are therefore strongly urged to consult the TSB patent database at <http://www.itu.int/ITU-T/ipr/>.

© ITU 2015

All rights reserved. No part of this publication may be reproduced, by any means whatsoever, without the prior written permission of ITU.

CONTENTS

	<i>Page</i>
0.1 RM-ODP	v
0.2 UML.....	v
0.3 Overview and motivation	vi
1 Scope	1
2 Normative references.....	1
2.1 Identical Recommendations International Standards	1
2.2 Additional References	1
3 Definitions	2
3.1 Definitions from ODP standards	2
3.2 Definitions from the Enterprise Language	2
3.3 Definitions from the Unified Modeling Language	2
4 Abbreviations	3
5 Conventions.....	3
6 Overview of modelling and system specification approach	4
6.1 Introduction.....	4
6.2 Overview of ODP concepts (extracted from RM-ODP Part 1)	4
6.3 Overview of UML concepts.....	8
6.4 Universes of discourse, ODP specifications and UML models.....	10
6.5 Modelling concepts and UML profiles for ODP viewpoint languages and correspondences	11
6.6 General principles for expressing and structuring ODP system specifications using UML.....	11
6.7 Correspondences between viewpoint specifications	12
7 Enterprise specification	13
7.1 Modelling concepts	13
7.2 UML profile	19
7.3 Enterprise specification structure (in UML terms).....	28
7.4 Viewpoint correspondences for the enterprise language	29
8 Information specification.....	30
8.1 Modelling concepts	30
8.2 UML profile	32
8.3 Information specification structure (in UML terms)	34
8.4 Viewpoint correspondences for the information language	35
9 Computational specification.....	36
9.1 Modelling concepts	36
9.2 UML profile	41
9.3 Computational specification structure (in UML terms).....	47
9.4 Viewpoint correspondences for the computational language	47
10 Engineering specification	48
10.1 Modelling concepts	48
10.2 UML profile	56
10.3 Engineering specification structure (in UML terms).....	62
10.4 Viewpoint correspondences for the engineering language	62
11 Technology specification.....	63
11.1 Modelling concepts	63
11.2 UML profile	63
11.3 Technology specification structure (in UML terms)	64
11.4 Viewpoint correspondences for the technology language	65
12 Correspondences specification	65
12.1 Modelling concepts	65
12.2 UML profile	66
13 Modelling conformance in ODP system specifications.....	67
13.1 Modelling conformance concepts	67

	<i>Page</i>
13.2 UML profile	67
14 Conformance and compliance to this Recommendation International Standard	68
14.1 Conformance	68
14.2 Compliance	68
Annex A – An example of ODP specifications using UML.....	69
A.1 The Templeman Library system.....	69
A.2 Enterprise specification in UML.....	70
A.3 Information specification in UML	83
A.4 Computational specification in UML.....	91
A.5 Engineering specification in UML.....	96
A.6 Technology specification in UML	107
Annex B – An example of the representation of deontic concepts	111
B.1 The scenario	111
B.2 Expressing the deontic constraints	112
INDEX	117

Introduction

The rapid growth of distributed processing has led to the adoption of the reference model of open distributed processing (RM-ODP), which provides a coordinating framework for the standardization of open distributed processing (ODP). It creates an architecture within which support of distribution, interworking and portability can be integrated. This architecture provides a framework for the specification of ODP systems.

The reference model of open distributed processing is based on precise concepts derived from current distributed processing developments and, as far as possible, on the use of formal description techniques for specification of the architecture. It does not recommend any notation.

The Unified Modeling Language™ (UML®) was developed by the Object Management Group™ (OMG™). It provides a notation for modelling in support of information system design and is widely used throughout the IT industry as the language and notation of choice.

This Recommendation | International Standard refines and extends the definition of how ODP systems are specified by defining the use of the unified modelling language for the expression of ODP system specifications.

0.1 RM-ODP

The RM-ODP consists of:

- Part 1 [Rec. ITU-T X.901 | ISO/IEC 10746-1]: Overview, which contains a motivational overview of ODP, giving scoping, justification and explanation of key concepts, and an outline of the ODP architecture. It contains explanatory material on how the RM-ODP is to be interpreted and applied by its users, who may include standards writers and architects of ODP systems. It also contains a categorization of required areas of standardization expressed in terms of the reference points for conformance identified in Rec. ITU-T X.903 | ISO/IEC 10746-3. This part is informative.
- Part 2 [Rec. ITU-T X.902 | ISO/IEC 10746-2]: Foundations, which contains the definition of the concepts and analytical framework for normalised description of (arbitrary) distributed processing systems. It introduces the principles of conformance to ODP standards and the way in which they are applied. This is only to a level of detail sufficient to support Rec. ITU-T X.903 | ISO/IEC 10746-3 and to establish requirements for new specification techniques. This part is normative.
- Part 3 [Rec. ITU-T X.903 | ISO/IEC 10746-3]: Architecture, which contains the specification of the required characteristics that qualify distributed processing as open. These are the constraints to which ODP standards shall conform. It uses the descriptive techniques from Rec. ITU-T X.902 | ISO/IEC 10746-2. This part is normative.
- Part 4 [Rec. ITU-T X.904 | ISO/IEC 10746-4]: Architectural semantics, which contains a formalization of the ODP modelling concepts defined in Rec. ITU-T X.902 | ISO/IEC 10746-2 clauses 8 and 9. The formalization is achieved by interpreting each concept in terms of the constructs of one or more of the different standardized formal description techniques. This part is normative.

In the same series as the RM-ODP are a number of other standards and recommendations, and, of these, the chief that concerns this Recommendation | International Standard is:

- The Enterprise Language [Rec. ITU-T X.911 | ISO/IEC 15414], which refines and extends the enterprise language defined in Rec. ITU-T X.903 | ISO/IEC 10746-3 to enable full enterprise viewpoint specification of an ODP system.

0.2 UML

The Unified Modelling Language (UML) is a visual language for specifying and documenting the artefacts of systems. It is a general-purpose modelling language that can be used with all major object and component methods and that can be applied to all application domains (e.g., in health, finance, telecommunications, or aerospace) and implementation platforms (e.g., J2EE, CORBA®, .NET).

The version of UML currently adopted as an International Standard (ISO/IEC 19505) is UML 2.4.1. UML version 2 has been structured modularly, with the ability to select only those parts of the language that are of direct interest. It is extensible, so it can be easily tailored to meet the specific user requirements. The UML specification defines thirteen types of diagram, divided in two categories that represent, respectively, the static structure of the objects in a system (structure diagrams) and the dynamic behaviour of the objects in a system (behaviour diagrams). In addition, UML incorporates extension mechanisms that allow the definition of new dialects of UML (managed using UML profiles) to customize the language for particular platforms and domains.

The UML specification is defined using a metamodeling approach (i.e., a metamodel is used to specify the model that comprises UML). That metamodel has been constructed so that the resulting family of UML languages is fully aligned with the rest of the OMG specifications (e.g., MOF™, OCL, XMI®) and to allow the exchange of models between tools.

0.3 Overview and motivation

Part 3 of the reference model, Rec. ITU-T X.903 | ISO/IEC 10746-3 defines a framework for the specification of ODP systems comprising

- a) five viewpoints, called enterprise, information, computational, engineering and technology, which provide a basis for the specification of ODP systems;
- b) a viewpoint language for each viewpoint, defining concepts and rules for specifying ODP systems from the corresponding viewpoint.

This Recommendation | International Standard defines:

- use of the viewpoints prescribed by the RM-ODP to structure UML system specifications;
- rules for expressing RM-ODP viewpoint languages and specifications with UML and UML extensions (e.g., UML profiles).

It allows UML tools to be used to process viewpoint specifications, facilitating the software design process. Currently there is growing interest in the use of UML for system modelling. However, there is no widely agreed approach to the structuring of such specifications. This adds to the cost of adopting the use of UML for system specification, hampers communication between system developers and makes it difficult to relate or merge system specifications where there is a need to integrate IT systems.

The RM-ODP defines essential concepts necessary to specify open distributed processing systems from five prescribed viewpoints and provides a framework for the structuring of specifications for distributed systems. However, the RM-ODP prescribes neither a notation, nor a model development method.

This Recommendation | International Standard provides the necessary framework for ODP system specification using UML. It defines both a UML based notation for the expression of such specifications, and an approach for structuring of them using the notation, thus providing the basis for model development methods.

By defining how UML and UML extensions should be used to express RM-ODP viewpoint specifications, the standard enables the ODP viewpoints and ODP architecture to provide the needed framework for system specification using UML.

This Recommendation | International Standard contains the following annexes:

- Annex A: An example of ODP specifications using UML;
- Annex B: An example of the representation of deontic concepts.

These annexes are not normative.

**INTERNATIONAL STANDARD
ITU-T RECOMMENDATION**

**Information technology – Open distributed processing –
Use of UML for ODP system specifications**

1 Scope

This Recommendation | International Standard defines use of the unified modelling language (UML 2.4.1 superstructure specification, ISO/IEC 19505-2, for expressing system specifications in terms of the viewpoint specifications defined by the reference model of open distributed processing (RM-ODP, Rec. ITU-T X.901 to X.904 | ISO/IEC 10746 Parts 1 to 4) and the Enterprise Language (Rec. ITU-T X.911 | ISO/IEC 15414). It covers:

- a) the expression of a system specification in terms of RM-ODP viewpoint specifications using defined UML concepts and extensions (e.g., structuring rules, technology mappings, etc.);
- b) relationships between the resultant RM-ODP viewpoint specifications.

This Recommendation | International Standard is intended for the following audiences:

- ODP modellers who want to use the UML notation for expressing their ODP specifications in a graphical and standard way;
- UML modellers who want to use the RM-ODP concepts and mechanisms to structure their UML system specifications;
- modelling tool suppliers, who wish to develop UML-based tools that are capable of expressing RM-ODP viewpoint specifications.

2 Normative references

The following Recommendations and International Standards contain provisions which, through reference in this text, constitute provisions of this Recommendation | International Standard. At the time of publication, the editions indicated were valid. All Recommendations and Standards are subject to revision, and parties to agreements based on this Recommendation | International Standard are encouraged to investigate the possibility of applying the most recent edition of the Recommendations and Standards listed below. Members of IEC and ISO maintain registers of currently valid International Standards. The Telecommunication Standardization Bureau of the ITU maintains a list of currently valid ITU-T Recommendations.

2.1 Identical Recommendations | International Standards

- Recommendation ITU-T X.901 (1997) | ISO/IEC 10746-1:1998, *Information technology – Open Distributed Processing – Reference Model: Overview*.
- Recommendation ITU-T X.902 (2009) | ISO/IEC 10746-2:2010, *Information technology – Open Distributed Processing – Reference Model: Foundations*.
- Recommendation ITU-T X.903 (2009) | ISO/IEC 10746-3:2010, *Information technology – Open Distributed Processing – Reference Model: Architecture*.
- Recommendation ITU-T X.904 (1997) | ISO/IEC 10746-4:1998, *Information technology – Open Distributed Processing – Reference Model: Architectural semantics*.
- Recommendation ITU-T X.911 (2012) | ISO/IEC 15414:2013, *Information technology – Open distributed processing – Reference model – Enterprise language*.
- Recommendation ITU-T X.725 | ISO/IEC 10165-7, *Information Technology – Open Systems Interconnection – Structure of Management Information – Part 7: General Relationship Model*

2.2 Additional References

- Recommendation ITU-T X.950 (1997), *Information technology – Open distributed processing – Trading function: Specification*.
- Recommendation ITU-T X.960 (1999), *Information Technology – Open Distributed Processing – Type Repository Function*.

3 Definitions

For the purposes of this Recommendation | International Standard, the following definitions apply.

3.1 Definitions from ODP standards

3.1.1 Modelling concept definitions

This Recommendation | International Standard makes use of the following terms as defined in Rec. ITU-T X.902 | ISO/IEC 10746-2:

abstraction; action; activity; architecture; atomicity; behaviour (of an object); binding; class; client object; communication; composition; component object [2-5.1]; composite object; configuration (of objects); conformance point; consumer object; contract; creation; data; decomposition; deletion; distributed processing; distribution transparency; <X> domain; entity; environment; information; initiating object; instance; instantiation (of an <X> template); internal action; interaction; interchange reference point; interface; interface signature; interworking reference point; introduction; invariant; location in space; location in time; name; naming context; naming domain; notification; object; obligation; ODP standards; ODP system; open distributed processing; perceptual reference point; permission; persistence; producer object; programmatic reference point; prohibition; proposition; quality of service; reference point; refinement; role; server object; spawn action; stability; state (of an object); subdomain; subtype; supertype; system; <X> template; term; terminating behaviour; trading; type (of an <X>); viewpoint (on a system).

3.1.2 Viewpoint language definitions

This Recommendation | International Standard makes use of the following terms as defined in Rec. ITU-T X.903 | ISO/IEC 10746-3:

binder; capsule; channel; cluster; community; computational behaviour; computational binding object; computational object; computational interface; computational viewpoint; dynamic schema; engineering viewpoint; distributed binding; enterprise object; enterprise viewpoint; <X> federation; information object; information viewpoint; interceptor; invariant schema; node; nucleus; operation; protocol object; static schema; stream; stub; technology viewpoint; <viewpoint> language.

3.2 Definitions from the Enterprise Language

This Recommendation | International Standard makes use of the following terms as defined in Rec. ITU-T X.911 | ISO/IEC 15414:

actor (with respect to an action); agent; artefact (with respect to an action); authorization; commitment; community object; declaration; delegation; evaluation; field of application (of a specification); interface role; objective (of an <X>); party; policy; prescription; principal; process; resource (with respect to an action); scope (of a system); step; violation.

3.3 Definitions from the Unified Modeling Language

This Recommendation | International Standard makes use of the following terms as defined in ISO/IEC 19505-2:

abstract class; action; activity; activity diagram; aggregate; aggregation; association; association class; association end; attribute; behaviour; behaviour diagram; binary association; binding; call; class; classifier; classification; class diagram; client; collaboration; collaboration occurrence; comment; communication diagram; component; component diagram; composite; composite structure diagram; composition; concrete class; connector; constraint; container; context; delegation; dependency; deployment diagram; derived element; diagram; distribution unit; dynamic classification; element; entry action; enumeration; event; exception; execution occurrence; exit action; export; expression; extend; extension; feature; final state; fire; generalizable element; generalization; guard condition; implementation; implementation class; implementation inheritance; import; include; inheritance; initial state; instance; interaction; interaction diagram; interaction overview diagram; interface; internal transition; lifeline; link; link end; message; metaclass; metamodel; method; multiple classification;

multiplicity; n-ary association; name; namespace; node; object; object diagram; object flow state; object lifeline; operation; package; parameter; parent; part; partition; pattern; persistent object; pin; port; post-condition; pre-condition; primitive type; profile; property; pseudo-state; realization; receive [a message]; receiver; reception; refinement; relationship; role; scenario; send [a message]; sender; sequence diagram; signal; signature; slot; state; state machine diagram; state machine; static classification; stereotype; stimulus; structural feature; structure diagram; subactivity state; subclass; submachine state; substate; subpackage; subsystem; subtype; superclass; supertype; supplier; tagged value; time event; time expression; timing diagram; trace; transition; type; usage; use case; use case diagram; value; visibility.

4 Abbreviations

For the purposes of this Recommendation | International Standard, the following abbreviations apply.

BEO	Basic Engineering Object
IXIT	Implementation extra Information for Test
MOF	Meta Object Facility
OCL	Object Constraint Language
ODP	Open Distributed Processing
OMG	Object Management Group
QoS	Quality of Service
RM-ODP	Reference Model of Open Distributed Processing
UML	Unified Modeling Language
UOD	Universe Of Discourse
XMI	XML Metadata Interchange

NOTE – UML, CORBA, XMI, MOF, OMG, Object Management Group, and Unified Modeling Language are either registered trademarks or trademarks of Object Management Group, Inc. in the United States or other countries.

5 Conventions

In the text that follows, the following conventions apply.

Rec. ITU-T X.902 | ISO/IEC 10746-2 (RM-ODP Part 2: Foundations) and Rec. ITU-T X.903 | ISO/IEC 10746-3 (RM-ODP Part 3: Architecture) are referred to as "Part 2" and "Part 3" of the RM-ODP, respectively.

Rec. ITU-T X.911 | ISO/IEC 15414 (RM-ODP Enterprise Language) is referred to as "the Enterprise Language".

The UML superstructure specification (see [2.2]) is referred to as "the UML specification". The UML notation defined in the UML specification is referred to as "UML".

References to the normative text of this Recommendation | International Standard, to the text of Parts 2 and 3 of the RM-ODP, to the Enterprise Language and to UML are expressed in one of these forms:

- [n.n] – a reference to clause n.n of this Recommendation | International Standard.
- [Part 2 – n.n] – a reference to clause n.n of RM-ODP Part 2;
- [Part 3 – n.n] – a reference to clause n.n of RM-ODP Part 3;
- [E/L – n.n] – a reference to clause n.n of the Enterprise Language;
- [UML – n.n] – a reference to clause n.n of the UML specification;

For example, [Part 2 – 9.4] is a reference to subclause 9.4 of Part 2 of the RM-ODP; and [6.5] is a reference to clause 6.5 of this Recommendation | International Standard. These references are for the convenience of the reader.

NOTE – The clauses correspond to the specific dated versions of the documents referenced in clause 2.

In the clauses that follow, except in the headings, terms in *italic* typeface are terms of the RM-ODP viewpoint languages as defined in Parts 2 and 3 of the RM-ODP, or in the Enterprise Language. UML concepts are shown in sans-serif typeface. UML stereotype names are shown in normal font, enclosed in guillemets (« and »).

The following conventions apply to the UML diagrams:

- Association end names are placed at the end of the association that is adjacent to the class playing the role. Association end names are omitted if they do not add meaning to the diagram. In this case, the implied association end name is the name of the class at that end of the association, but starting in lower case.
- Cardinalities of associations are placed adjacent to the class that has the cardinality.
- Where there are no attributes, the attribute part of the class box is suppressed.
- Black diamonds are used to represent whole-part associations, with no cardinality or role name at the whole end of the association, and no role name at the part end of the association. The meaning is that the part cannot exist without exactly one instance of the whole.
- Nouns are used in association end names, rather than verbs.
- Class names representing ODP concepts start with upper case.
- Arrowheads accompanying association names are avoided.
- Icons associated with stereotypes are used in some of the UML figures in this Recommendation | International Standard. This is done to aid understanding, but the icons are not normative.

6 Overview of modelling and system specification approach

6.1 Introduction

This clause provides an introduction to this Recommendation | International Standard, covering:

- an overview of ODP system specification concepts;
- an overview of UML concepts;
- an explanation of the relationships between ODP models, the subjects of those models (universes of discourse), and the UML models that express the ODP models;
- an overview of the structuring principles for system specifications defined in the document;
- an explanation of the concept of correspondences (relationships) between viewpoint specifications.

6.2 Overview of ODP concepts (extracted from RM-ODP Part 1)

An overview of the ODP modelling concepts and the structuring rules for their use is given in RM-ODP Part 1 (Rec. ITU-T X.901 | ISO/IEC 10746-1: Overview) and the concepts and structuring rules are formally defined in RM-ODP Parts 2 and 3. The text that follows (i.e., the rest of [6.2]), is abstracted from the text in RM-ODP Part 1. RM-ODP Parts 2 and 3 are the authoritative standards, and should be followed in case of any conflict between those Parts and this clause.

The framework for system specification provided by the RM-ODP has four fundamental elements:

- an object modelling approach to system specification;
- the specification of a system in terms of separate but interrelated viewpoint specifications;
- the definition of a system infrastructure providing distribution transparencies for system applications;
- a framework for assessing system conformance.

6.2.1 Object modelling

Object modelling provides a formalization of the well-established design practices of abstraction and encapsulation:

- Abstraction allows the description of system functionality to be separated from details of system implementation;
- Encapsulation allows the hiding of heterogeneity, the localization of failure, the implementation of security and the hiding of the mechanisms of service provision from the service user.

The object modelling concepts cover:

- basic modelling concepts: providing rigorous definitions of a minimum set of concepts (action, object, interaction and interface) that form the basis for ODP system descriptions and are applicable in all viewpoints;
- specification concepts: addressing notions such as type and class that are necessary for reasoning about specifications and the relations between specifications, providing general tools for design, and establishing requirements on specification languages;
- structuring concepts: building on the basic modelling concepts and the specification concepts to address recurrent structures in distributed systems, and covering such concerns as policy, obligation, naming, behaviour, dependability and communication.

6.2.2 Viewpoint specifications

A *viewpoint* (on a system) is an abstraction that yields a specification of the whole system related to a particular set of concerns. Five *viewpoints* have been chosen to be both simple and complete, covering all the domains of architectural design. These five viewpoints (see Figure 1) are:

- the *enterprise* viewpoint, which is concerned with the purpose, scope and policies governing the activities of the specified system within the organization of which it is a part;
- the *information* viewpoint, which is concerned with the kinds of information handled by the system and constraints on the use and interpretation of that information;
- the *computational* viewpoint, which is concerned with the functional decomposition of the system into a set of objects that interact at interfaces – enabling system distribution;
- the *engineering* viewpoint, which is concerned with the infrastructure required to support system distribution;
- the *technology* viewpoint, which is concerned with the choice of technology to support system distribution.

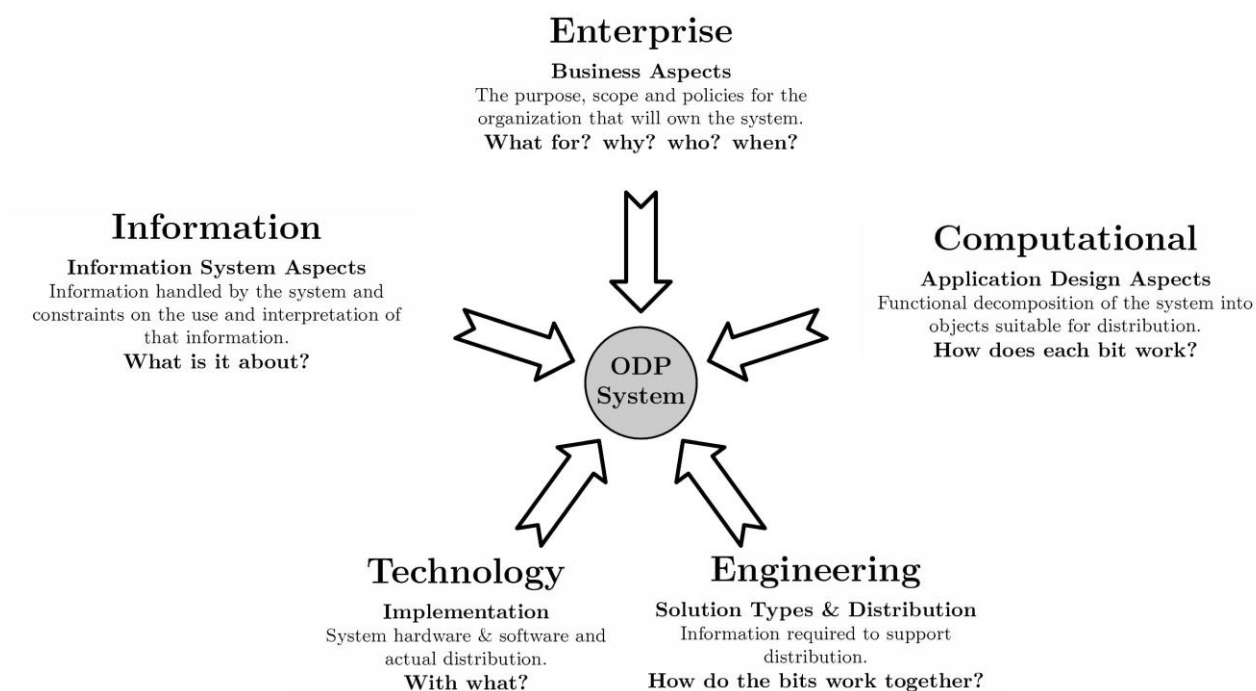

Figure 1 – RM-ODP viewpoints

For each *viewpoint* there is an associated *viewpoint language* which can be used to specify a system from that viewpoint. The object modelling concepts give a common basis for the *viewpoint languages* and make it possible to identify relationships between the different *viewpoint* specifications and to assert correspondences between the models of the system in different *viewpoints* (see [6.7]).

NOTE – Although the different viewpoints can be independently defined and there is no explicit order imposed by the RM-ODP for specifying them, a common practice is to start by developing the *enterprise* specification of the system, and then prepare the

information and *computational* specifications. These two specifications may have constraints over each other. An iterative specification process is quite common too, whereby each *viewpoint* specification may be revised and refined as the other two are developed. Correspondences between the elements of these three *viewpoints* are defined during this process. After that, the *engineering* specification of the system is prepared, based on the *computational* specification. Correspondences between the elements of these *viewpoints* are then defined together with the newly specified elements. Finally, the *technology* specification is produced based on the *engineering* specification. Again, some refinements may be performed on the rest of the *viewpoint* specifications, due to the new requirements and constraints imposed by the particular selection of technology.

6.2.3 Distribution transparency

Distribution transparencies enable complexities associated with system distribution to be hidden from applications where these complexities are irrelevant to the application's purpose. For example:

- *access transparency* masks differences of data representation and invocation mechanisms for services between systems;
- *location transparency* masks the need for an application to have information about location in order to invoke a service;
- *relocation transparency* masks the relocation of a service from applications using it;
- *replication transparency* masks the fact that multiple copies of a service may be provided in order to provide reliability and availability.

ODP standards define functions and structures to realize distribution *transparencies*. However, there are performance and cost trade-offs associated with each *transparency* and only selected *transparencies* will be relevant in many cases. Thus, a conforming ODP system shall implement those *transparencies* that it supports in accordance with the relevant standards, but it is not required to support all *transparencies*.

6.2.4 Conformance

The basic characteristics of heterogeneity and evolution imply that different parts of a distributed system can be purchased separately, from different vendors. It is therefore very important that the behaviours of the different parts of a system are clearly defined, and that it is possible to assign responsibility for any failure to meet the system's specifications.

The framework defined to govern the assessment of conformance addresses these issues. RM-ODP Part 2 defines four classes of reference points: programmatic reference point, perceptual reference point, interworking reference point, and interchange reference point. The reference points in those classes are the candidate for conformance points. Part 2 covers:

- identification of the reference points within an architecture that provide candidate conformance points within a specification of testable components;
- identification of the conformance points within the set of viewpoint specifications at which observations of conformance can be made;
- definition of classes of conformance point;
- specification of the nature of conformance statements to be made in each viewpoint and the relation between them.

6.2.5 Enterprise language

The enterprise language provides the modelling concepts necessary to model an *ODP system* in the context of the business or organization in which it operates. An enterprise specification defines the purpose, *scope*, and *policies* of an *ODP system* and it provides the basis for checking conformance of system implementations. The purpose of the system is defined by the specified *behaviour* of the system while *policies* capture further restrictions of the *behaviour* between the system and its *environment*, or within the system itself related to the business decisions of the system owners.

NOTE 1 – An enterprise specification of a system may therefore be thought of as a statement of the "requirements" for the system. However, it must be emphasized that it is not fundamentally different from any other element of the specification for the system.

In an enterprise specification, the system is modelled by one or more *enterprise objects* within the *communities of enterprise objects* that model its *environment*, and by the *roles* in which these objects are involved. These *roles* model, for example, the users, owners and providers of information processed by the system.

NOTE 2 – There is a question of modelling style to be considered that has particular significance for an enterprise specification, which is intended to be approachable for a subject matter expert. This is concerned with whether to name model elements in terms of instances or types. Thus it is common practice to express an enterprise specification in terms of anonymous *objects*,

named by their *type*, e.g., including in enterprise specifications phrases such as "a **customer** *enterprise object* fulfils the role **applicant**", when what is actually meant is "an (anonymous) *enterprise object*, conforming to the *enterprise object type customer*, fulfils the role **applicant**".

An important aspect of an enterprise specification is the expression of deontic constraints, such as obligation, permission and prohibition. Concepts are included to simplify the expression of the dynamics of these constraints by representing them as objects that can be transferred between communities, allowing the description of delegation and of transfer of responsibility.

6.2.6 Information language

The individual components of a distributed system should share a common understanding of the information they communicate when they interact, or the system will not behave as expected. These items of information are handled, in one way or another, by *information objects* in the system. To ensure that the interpretation of these items is consistent, the information language defines concepts for the specification of the meaning of information stored within, and manipulated by, an ODP system, independently of the way the information processing functions themselves are to be implemented.

Information held by the *ODP system* about entities in the real world, including the *ODP system* itself, is modelled in an information specification in terms of *information objects* and their relationships and *behaviour*. Basic information elements are modelled by atomic *information objects*. More complex information is modelled as composite *information objects* each modelling relationships over a set of constituent *information objects*.

The information specification comprises a set of related schemata, namely, the *invariant*, *static* and *dynamic* schemata:

- an *invariant schema* models relationships between *information objects* that must always be true, for all valid behaviours of the system;
- a *static schema* models assertions that must be true at a single point in time. A common use of static schemata is to specify the initial *state* of an *information object*;
- a *dynamic schema* specifies how the information can evolve as the system operates.

6.2.7 Computational language

The computational viewpoint is directly concerned with the distribution of processing, but not with the interaction mechanisms that enable distribution to occur. The computational specification decomposes the system into *computational objects* performing individual functions and interacting at *interfaces*. It thus provides the basis for decisions on how to distribute the jobs to be done because *objects* can be located independently, assuming communications mechanisms can be defined in the engineering specification to support the behaviour at the *interfaces* to those *objects*.

The heart of the computational language is the computational object model, which constrains the computational specification by defining:

- the form of *interface* an *object* can have;
- the way that *interfaces* can be bound and the forms of *interaction* that can take place at them;
- the *actions* an *object* can perform, in particular the creation of new *objects* and *interfaces*, and the establishment of *bindings*.

The computational object model provides the basis for ensuring consistency between different engineering and technology specifications (including programming languages and communication mechanisms) since they must be consistent with the same computational object model. This consistency allows open interworking and portability of components in the resulting implementation.

The computational language enables the specifier to model constraints on the distribution of an application (in terms of *environment contracts* associated with individual *interfaces* and *interface bindings* of *computational objects*) without specifying the actual degree of distribution in the computational specification; this latter is specified in the engineering and technology specifications. This ensures that the computational specification of an application is not based on any unstated assumptions affecting the distribution of *engineering* and *technology objects*. Because of this, the configuration and degree of distribution of the hardware on which ODP applications are run can easily be altered, subject to the stated environment constraints, without having a major impact on the application software.

6.2.8 Engineering language

The engineering language focuses on the way object interaction is achieved and on the resources needed for it to take place. It defines concepts for describing the infrastructure required to support selectable, distribution transparent

interactions between *objects*, and rules for structuring communication *channels* between *objects*, and for structuring systems for the purposes of resource management. These rules can be modelled as *engineering templates* (for example, an *engineering channel template*).

Thus the computational viewpoint is concerned with when and why *objects* interact, while the engineering viewpoint is concerned with how they interact. In the engineering language, the main concern is the support of *interactions* between *computational objects*. As a consequence, there are very direct links between the viewpoint descriptions: *computational objects* are visible in the engineering viewpoint as *basic engineering objects* and computational bindings, whether implicit or explicit, are visible as either *channels* or local *bindings*.

The concepts and rules are sufficient to enable specification of internal interfaces within the infrastructure, enabling the definition of distinct conformance points for different transparencies and the possibility of standardization of a generic infrastructure into which standardized transparency modules can be placed.

The engineering language assumes a virtual machine that corresponds to a platform offering minimal support for distribution.

NOTE – The functionality of the virtual machine assumed by the engineering language corresponds, for example, to a set of computing systems with stand-alone operating system facilities plus communication facilities. In practice, the functionality available from current vendor technology, for example when it offers a CORBA or J2EE environment, already provides significant elements of the functionality to be covered by the engineering specification.

Thus, the engineering specification is interpreted in this Recommendation | International Standard as defining the mechanisms and functions required to support distributed interaction between objects in an ODP system, making use of the supporting functionality provided by the specific vendor technology defined by the technology specification.

6.2.9 Technology language

The technology specification describes the implementation of the ODP system in terms of a configuration of *technology objects* modelling the hardware and software components of the implementation. It is constrained by cost and availability of technology objects (hardware and software products) that would satisfy this specification. These may conform to *implementable standards*, which are effectively templates for *technology objects*. Thus, the technology viewpoint provides a link between the set of viewpoint specifications and the real implementation, by listing the standards used to provide the necessary basic operations in the other viewpoint specifications; the aim of the technology specification is to provide the extra information needed for implementation and testing by selecting standard solutions for basic components and communication mechanisms.

6.3 Overview of UML concepts

The unified modelling language (UML) is a visual language for specifying, constructing and documenting the artefacts of systems. It is a general-purpose modelling language that can be used with all major object and component methods and that can be applied to all application domains (e.g., in health, finance, telecommunications, or aerospace) and implementation platforms (e.g., J2EE, CORBA, .NET). However, not all of UML modelling capabilities are necessarily useful in all domains or applications. Therefore, the UML specification has a modular structure, with the ability to select only those parts of the language that are of direct interest, and is extensible, so it can be easily customized.

The UML specification defines thirteen types of diagram, divided in two categories that represent, respectively, the static structure of the objects in a system (structure diagrams), and the dynamic behaviour of the objects in a system (behaviour diagrams). In addition, the UML specification incorporates extension mechanisms that allow the definition of new dialects of UML to customize the language for particular platforms and domains.

6.3.1 Structural models

Structural models specify the structure of objects in a model. They are represented in:

- class diagrams, which show a collection of declarative (static) model elements, such as classes, types, and their contents;
- object diagrams, which encompass objects and their relationships at a point in time. An object diagram may be considered a special case of a class diagram or a communication diagram;
- component diagrams, which show the organizations and dependencies among components;
- deployment diagrams, which represent the execution architecture of systems. They represent system artefacts as nodes, which are connected through communication paths to create network systems of arbitrary complexity. Nodes are typically defined in a nested manner, and represent either hardware devices or software execution environments;

- composite structure diagrams, which depict the internal structure of a classifier, including the interaction points of the classifier to other parts of the system. They show the configuration of parts that jointly perform the behaviour of the containing classifier;
- package diagrams, which depict how model elements are organized into packages and the dependencies among them, including package imports and package extensions.

6.3.2 Behavioural models

Behavioural models specify the behaviour of objects in a model. They are represented by:

- use case diagrams, each of which illustrates the relationships among actors and the system, and use cases;
- state machine diagrams, which specify the sequences of states that an object or an interaction goes through during its life in response to events, together with its responses and actions;
- activity diagrams, which depict behaviour using a control and data-flow model;
- interaction diagrams, which emphasize object interactions and can be one of the following:
 - sequence diagrams, that depict interactions by focusing on the sequence of messages that are exchanged, along with their corresponding event occurrences on the lifelines. Unlike a communication diagram, a sequence diagram includes time sequences, but does not include object relationships. A sequence diagram can exist in a generic form (that describes all possible scenarios) and in an instance form (that describes one actual scenario). Sequence diagrams and communication diagrams express similar information, but show it in different ways;
 - communication diagrams, which focus on the interactions between lifelines where the architecture of the internal structure and how this corresponds with the message passing is central. The sequencing of messages is given through a sequence numbering scheme. Sequence diagrams and communication diagrams express similar information, but show it in different ways;
 - interaction overview diagrams, which represent interactions through a variant of activity diagrams in a way that promotes overview of the control flow; in these diagrams each node can itself be an interaction diagram;
 - timing diagrams, which show the change in state or condition of a lifeline (representing a classifier instance or classifier role) over linear time. The most common usage is to show the change in state of an object over time in response to accepted events or stimuli.

6.3.3 Model management

Model management concerns the structuring of a model, including any extensions used, in terms of the groupings of model elements that comprise it. There are three grouping elements:

- models, which are used to capture different views of a physical system;
- packages, which are used within a model to group model elements;
- subsystems, which represents behavioural units in the physical system being modelled.

6.3.4 Extension mechanisms

UML provides a rich set of modelling concepts and notations that have been carefully designed to meet the needs of typical software modelling projects. However, users may sometimes require additional features beyond those defined in the UML specification.

UML can be extended in two ways. First, a new dialect of UML can be defined by using profiles to customize the language for particular platforms (e.g., J2EE/EJB, .NET/COM+) and domains (e.g., in health, finance, telecommunications, or aerospace). Alternatively, a new language related to UML can be specified by reusing part of the UML InfrastructureLibrary package and augmenting it with appropriate metaclasses and metarelationships. The former case defines a new dialect of UML, while the latter case defines a new member of the UML family of languages.

A profile is a kind of package that extends a reference metamodel. The primary extension construct is the stereotype, which defines how an existing metaclass may be extended, and enables the use of platform or domain specific terminology or notation in place of or in addition to the ones used for the base metaclass being extended. Just like a class, a stereotype may have properties, which are referred to as tag definitions. When a stereotype is applied to a model element, the values of the properties are referred to as tagged values.

Constraints are frequently defined in a profile, and typically define well-formedness rules that are more constraining, but consistent with, those specified by the reference metamodel. The constraints that are part of the profile are evaluated when the profile has been applied to a package, and need to be satisfied in order for the model to be well formed.

6.4 Universes of discourse, ODP specifications and UML models

In using the techniques described in this Recommendation | International Standard, it is necessary to understand the relationships between the subject of a model, i.e., its universe of discourse (UOD), ODP specifications for that UOD, and how those ODP specifications are expressed in UML.

The four main sets of notions involved in understanding these relationships are:

- the entities, and the relationships amongst them, in the UOD being modelled;
- the ODP specifications that model that UOD;
- the UML models that express the ODP specifications;
- the UML notation (diagramming techniques and other mechanisms) by means of which the UML models are represented.

There are three important kinds of relationship between these notions:

- first, in the same way that an ODP *object* models an entity (a concrete or abstract thing of interest), an ODP specification **models** a UOD. The modeller uses the concepts and structuring rules of RM-ODP Part 2, together with those of the relevant ODP viewpoint languages (RM-ODP Part 3 and the Enterprise Language), to produce a specification that models relevant facts and assertions about the entities that exist in the UOD. The rules for this kind of relationship are stated in Parts 2 and 3 of the RM-ODP and in the Enterprise Language;
- second, each model element (i.e., instance of an ODP viewpoint language concept) in the ODP specifications is **expressed** by one or more UML elements (instance of a UML metaclass, specialized as necessary through the relevant profile) in a UML model, which is thus an expression of the ODP specification. The rules for this kind of relationship are stated in this Recommendation | International Standard;
- third, the UML notation is used to **represent**, graphically or otherwise, the underlying UML model. The rules for this kind of relationship are stated in the UML standard.

This Recommendation | International Standard addresses the three simple relationships described above, and the terms that are highlighted above are invariably used to refer to them.

While there are other derived relationships between elements in this chain (e.g., between UOD and UML model), they are not otherwise referred to in this Recommendation | International Standard. These relationships are illustrated in Figure 2.

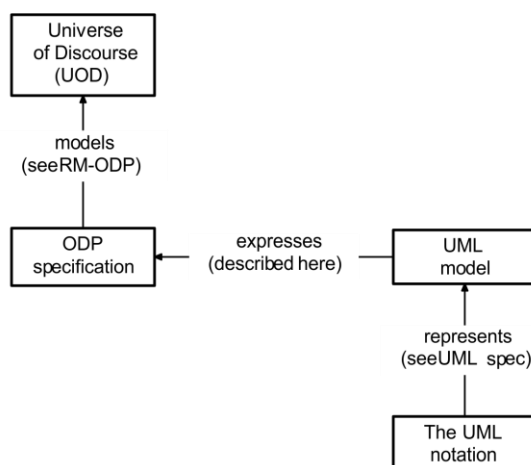

Figure 2 – Relationships between UOD, ODP specifications, and UML models

6.5 Modelling concepts and UML profiles for ODP viewpoint languages and correspondences

Clauses 7 to 11 of this Recommendation | International Standard are devoted, in turn, to each of the five ODP Viewpoints (enterprise, information, computational, engineering, and technology).

The first subclause of each of these clauses provides an overview of the ODP modelling concepts for that viewpoint. The ODP viewpoint modelling concepts are described using text as well as a simplified set of UML class diagrams, which show the major modelling concepts for the ODP viewpoint as classes, and binary associations (including cardinality constraints) that may exist between these viewpoint concepts. These diagrams together with the text can be considered as specifying MOF compliant metamodels for the subset of the ODP viewpoint concepts defined in Parts 2 and 3 of the ODP reference model that are used in this Recommendation | International Standard.

NOTE 1 – In the case of the Enterprise Language, the metamodel is standardized in Rec. ITU-T X.911 | ISO/IEC 15414 and reproduced here; if there is any discrepancy, the Enterprise Language version is definitive.

The second subclause of each of these clauses provides a specification of a UML profile for that ODP viewpoint. UML based ODP viewpoint models can be expressed using the notation defined for the UML profile for that viewpoint.

Any ODP viewpoint model expressed using the UML profile for that ODP viewpoint satisfies the constraints specified in each of the corresponding ODP viewpoint metamodels defined in this Recommendation | International Standard.

NOTE 2 – It is an implementation issue whether the constraints defined in each ODP viewpoint metamodel are enforced by tools which construct ODP viewpoint models using that viewpoint's ODP profile.

Clause 12 deals with correspondences between viewpoints, and is structured in the same way as clauses 7 to 11.

6.6 General principles for expressing and structuring ODP system specifications using UML

This clause defines the structuring style for ODP system specifications, expressed using the UML profiles defined in Clauses 7 to 12 of this Recommendation | International Standard. ODP system specifications that are in compliance with this Recommendation | International Standard will use this structuring style.

The ODP system specification will consist of a single UML model stereotyped as «ODP_SystemSpec», that contains a set of models, one for each viewpoint specification, each stereotyped as «<X>_Spec», where <X> is the viewpoint concerned. Each viewpoint specification, which consists of a coherent set of instances of the concepts described in that viewpoint language, uses the appropriate UML profile for that language, as described in Clauses 7 to 11 of this Recommendation | International Standard. There will also be a set of correspondence specifications (see clause 12).

In this Recommendation | International Standard, stereotypes are used to represent domain specific specializations of UML metaclasses in order to express the semantics of the RM-ODP viewpoint language concerned.

In general, the way in which the UML is used to express a given viewpoint specification (which will consist of a coherent set of instances of the concepts described in each viewpoint language) is such that:

- each of the viewpoint language concepts is expressed by one or more extended UML metaclasses (expressed by the use of stereotypes);

- the relationships (meta-associations) between the viewpoint language concepts (e.g., "a *community* has exactly one *objective*" in the enterprise language) is similarly expressed, preferably by meta-associations between the corresponding UML metaclasses (e.g., "Class may be associated with Class") or, failing that, by use of specific additional UML elements.

This is done in a way that is consistent with the semantics of the UML metamodel.

6.7 Correspondences between viewpoint specifications

6.7.1 ODP Correspondences

The correspondences between viewpoint specifications are defined in Part 3 of the RM-ODP and in the Enterprise Language. The text that follows in this clause is abstracted from these standards, which remain the authoritative standards, and should be followed in case of conflicts between this Recommendation | International Standard and those standards.

A set of specifications of an ODP system written in different viewpoint languages should not make mutually contradictory statements i.e., they should be mutually consistent. Thus, a complete specification of a system includes statements of correspondences between terms and language constructs relating one viewpoint specification to another viewpoint specification, showing that the consistency requirement is met.

The key to consistency is the idea of correspondences between different viewpoint specifications, i.e., a statement that some terms or structures in one specification correspond to other terms and specifications in a second specification. The underlying rationale in identifying correspondences between different viewpoint specifications of the same ODP system is that there are some entities that are modelled in one viewpoint specification, which are also modelled in another viewpoint specification. The requirement for consistency between viewpoint specifications is driven by the fact that what is specified in one viewpoint specification about an entity needs to be consistent with what is said about the same entity in any other viewpoint specification. This includes the consistency of that entity's properties, structure and behaviour.

The specifications produced in different ODP viewpoints are each complete statements in their respective languages, with their own locally significant names, and so cannot be related without additional information in the form of correspondence statements that make clear how constraints from different viewpoints apply to particular elements of a single system to determine its overall behaviour. The correspondence statements are statements that relate the various different viewpoint specifications, but do not form part of any one of them. The correspondences can be established in two ways:

- by declaring correspondences between terms in two different viewpoint languages, stating how their meanings relate. This implies that the two languages are defined in such a way that they have a common, or at least a related, set of foundation concepts and structuring rules. Such correspondences between languages necessarily imply and entail correspondences relating to all things of interest which the languages are used to model (e.g., things modelled by objects or actions);
- by considering the extension of terms in each language, and asserting that particular entities being modelled in the two specifications are in fact the same entity. This relates the specifications by identifying which observations need to be interpretable in both specifications.

The correspondence statements to be provided in a system specification are specified in Part 3 and in the Enterprise Language of the RM-ODP, and in clauses 7 to 11 of this Recommendation | International Standard. They fall into two categories:

- some correspondences are required in all ODP specifications; these are called *required correspondences*. If the correspondence is not valid in all instances in which the concepts related occur, the specification simply is not a valid ODP specification;
- in other cases, there is a requirement that the specifier provides a list of items in two specifications that correspond, but the content of this list is the result of a design choice; these are called *required correspondence statements*.

NOTE – In RM-ODP Part 3, the following correspondences are explicitly specified:

- between computational and information ([Part 3 – 10.1]);
- between engineering and computational ([Part 3 – 10.2]).

In the Enterprise Language standard, the following correspondences are specified;

- between enterprise and information ([E/L – 11.2]);
- between enterprise and computational ([E/L – 11.3]);

- between enterprise and engineering ([E/L – 11.4]).

6.7.2 Expressing ODP correspondences in UML

Correspondences between ODP modelling elements of different viewpoints are expressed using the UML profile defined in clause 12 of this Recommendation | International Standard. The main concept introduced is the correspondence link. A correspondence link is established between two viewpoint specifications, and each of its ends refers to a set of *terms* involved in the correspondence relationship. A *correspondence statement* is expressed by a constraint applied to this link, and is used for checking consistency between viewpoint specifications.

7 Enterprise specification

7.1 Modelling concepts

An enterprise specification uses the RM-ODP enterprise language. The modelling concepts and the structuring rules of the enterprise language are defined in [Part 3 – 5] and expanded upon in [E/L – 6 and 7]. They are summarized in this clause. In case of conflict between the explanations herein and the text in Part 3 or the Enterprise Language, the latter documents should be followed.

The set of diagrams at the end of this clause (i.e., at [7.1.8]) summarizes a metamodel for the enterprise language, defined in Rec. ITU-T X.911 | ISO/IEC 15414.

7.1.1 System concepts

An enterprise specification describes an *ODP system* and relevant aspects of its *environment*. An *ODP System* is a kind of *enterprise object*. The *enterprise objects* that interact with a given *enterprise object* form part of the *environment* of that *enterprise object*.

The *ODP System* has a *scope*, which defines the *behaviour* that the system is expected to exhibit. An enterprise specification has a *field of application* which describes its usability properties.

These system concepts are illustrated in Figure 3.

7.1.2 Community concepts

The fundamental concept of the enterprise language is a *community*, which is a configuration of *enterprise objects*, formed to meet an *objective*. Any *objective* may be refined into a set of *subobjectives*. A *community* is specified in a *contract*, which models the agreement amongst the entities to work together to meet the *objective*. Thus the *contract*:

- states the *objective* for which the *community* exists;
- governs the *structure*, the *behaviour* and the *policies* of the *community*;
- constrains the *behaviour* of the members of the *community*;
- states the rules for the assignment of *enterprise objects* to *roles*.

Each *enterprise object* models some entity (abstract or concrete thing of interest) in the UOD. A particular kind of *enterprise object* is a *community object*, which models, as a single object, an entity that is elsewhere in the model refined as a *community*.

The configuration of a *community* is modelled in terms of the way *enterprise objects* interact in fulfilling *roles*, which identify *behaviours* intended to meet the *objective* of the *community* concerned.

The community concepts are illustrated in Figure 4.

7.1.3 Behaviour concepts

A *behaviour* is a collection of *actions* (things that happen), with constraints on when they occur. An *enterprise object* may be involved in (play *roles* in) an *action* in one or more of the following three ways:

- if it participates in the *action* it is an *actor* with respect to that *action*;
- if it is referenced (i.e. mentioned) in the *action*, it is an *artefact* with respect to that *action*;
- if it is essential to the (performance of) that *action*, and requires allocation or may become unavailable, it is a *resource* with respect to that *action*.

A *role* identifies a specific *behaviour* of an *enterprise object* in a *community*. Such *behaviour* is observable as a set of *interactions* in which the *object* participates, and relationships between them. This implies that the *behaviour* of an *object* has to be viewed in the context of the corresponding *behaviour* of the *objects* with which it interacts.

Communities may be open or closed; that is they may or may not interact with their *environment*. Where a *role* that is in (i.e., is part of the configuration of) a *community* identifies *behaviour* that takes place with the participation of one or more *objects* that are not in that *community*, it is an *interface role*.

The modelling of *behaviour* may be structured into one or more *processes*, each of which is a graph of *steps* taking place in a prescribed manner and which contributes to the fulfilment of an *objective*. In this approach, a *step* is an abstraction of an *action* in which the *enterprise objects* that participate in that *action* may be unspecified. A *step* may be refined as a *process*, itself consisting of a set of *steps*.

A *violation* is a specific *behaviour* of an *enterprise object* that is prohibited in a *community contract*. The *contract* may specify some specific *behaviour* that is to take place when a *violation* occurs.

The behaviour concepts are illustrated in Figures 4 and 5.

7.1.4 Deontic concepts

The specification of enterprise *behaviour* typically involves the expression of deontic constraints such as obligations, permissions and prohibitions. These are incorporated into an object-based model by introducing *enterprise objects* called *deontic tokens*. If an active *enterprise object* has an associated *deontic token*, then the corresponding deontic constraint applies to the *object's* behaviour. However, *deontic tokens* are not themselves active *enterprise objects* and are not directly involved in interactions by taking action roles. Each *deontic token* is associated with exactly one active *enterprise object*. There are three types of *deontic token*:

- a *burden* represents an *obligation* on the objects with which it is associated;
- a *permit* represents a *permission* held by the objects with which it is associated;
- an *embargo* represents a *prohibition* affecting the objects with which it is associated.

These deontic constraints are created or modified by specific types of *action* which are called *speech acts*. A *speech act* may result in the creation of *deontic tokens* or the transfer of such *tokens* between *objects* playing particular *action-roles* in the *speech act*. The destruction of a *token* at the end of its lifecycle is also generally performed by a *speech act*, although *tokens* may destroy themselves as a result of a timeout or other trigger.

NOTE – The set of *tokens* held by the *objects* concerned determines whether a *speech act* can take place and what its consequences are. For example:

- it may be necessary for an *object* to hold a *permit* before it can perform a *speech act*;
- having an *embargo* may prevent an *object* from performing a *speech act*, even though the *action* would otherwise be permitted by the *object's* role;
- a *burden* held by an *object* may be discharged as a result of its performing a *speech act*;
- the performance of a delegation *speech act* may transfer a group of *tokens* (for example, *burdens* and *permits*) to the *object* to which responsibility is delegated.

A deontic token may be in either an active or a pending state. When it is in an active state, the constraint it carries is applied to control the behaviour of the active enterprise object that holds it. However, when it is in the pending state, this constraint is masked so that it does not affect the current behaviour.

The deontic concepts are illustrated in Figures 4, 7 and 8.

7.1.5 Policy concepts

A *policy* is a constraint on a system specification foreseen at design time, but whose detail is determined subsequent to the original design, and capable of being modified from time to time in order to manage the system in changing circumstances. It identifies the specification of *behaviour*, or constraints on *behaviour*, that can be changed during the lifetime of the ODP system, or that can be changed to tailor a single specification to apply to a range of different ODP systems.

The specification of a *policy* includes:

- the name of the *policy*;
- the rules, modelled as *obligations*, *permissions*, *prohibitions* and *authorizations*;
- the elements of the enterprise specification affected by the *policy*;

- the policy envelope that constrains the possible restrictions or behaviours that are acceptable as policy values;
- any *behaviour* for changing the *policy*;
- a default policy value to be used until any explicit initial change takes place.

Where there is a requirement to model dynamic policy setting, a *policy* can be changed by a *behaviour*.

A *policy* may also constrain the structure (configuration) of a *community*, by governing the assignment of *roles* to *enterprise objects*. Such a *policy* is called an *assignment policy*.

NOTE – For a given *policy envelope*, only one *policy value* is in force at a point in time. This policy value may be selected from a set of values defined in the policy envelope or it may be a statement in a policy language that is consistent with constraints in the policy envelope.

The policy concepts are illustrated in Figure 6.

7.1.6 Accountability concepts

Accountability concepts concern the modelled behaviour of *parties*. A *party* is an *enterprise object* modelling a natural person or any other entity considered to have some of the rights, powers and duties of a natural person, and which can therefore be considered accountable for its *actions*. A *party* may delegate authority to another *enterprise object* (which may or may not be a *party*), in which case it is referred to as the *principal* in that *action of delegation*, and the *enterprise object* to whom authority is delegated is the *agent* of that *party*.

Only *parties* can take part in accountable *actions*. Such *actions* may take the following forms:

- *prescription*: an *action* that establishes a rule;
- *commitment*: an *action* resulting in an obligation by one or more of the participants in the act to comply with a rule or perform a *contract*;
- *declaration*: an *action* that establishes a state of affairs in the *environment* of the *object* making the *declaration*;
- *evaluation*: an *action* that assesses the value of something;
- *delegation*: an *action* that assigns authority, responsibility or a function to another *object*.

The accountability concepts are illustrated in Figure 7.

7.1.7 Structure of an enterprise specification

An enterprise specification is structured in terms of *communities* and *community objects*.

Each *community* is modelled in terms of the following concepts and the relationships between them:

- the *objective* and subobjectives (of the *community*);
- the *behaviour* of the *community*, modelled in terms of *actions* and constraints on the order in which they may occur. *Behaviour* can be structured to emphasize:
 - *roles* fulfilled by *enterprise objects* that interact as members of the *community*;
 - *processes* that model sequences of *actions*, carried out by one or more *enterprise objects*;
- *enterprise objects* that fulfil the *roles* in the *community*;
- *policies* constraining the *behaviour*;

Some *enterprise objects* may be composite objects and are subclassified as *community objects* and refined as *communities*.

At some level of detail the *ODP system* will be present in the model as an *enterprise object*.

7.1.8 Summary of the enterprise language metamodel

The diagrams below (Figures 3 to 8) illustrate the concepts of the enterprise language and the relationships between them.

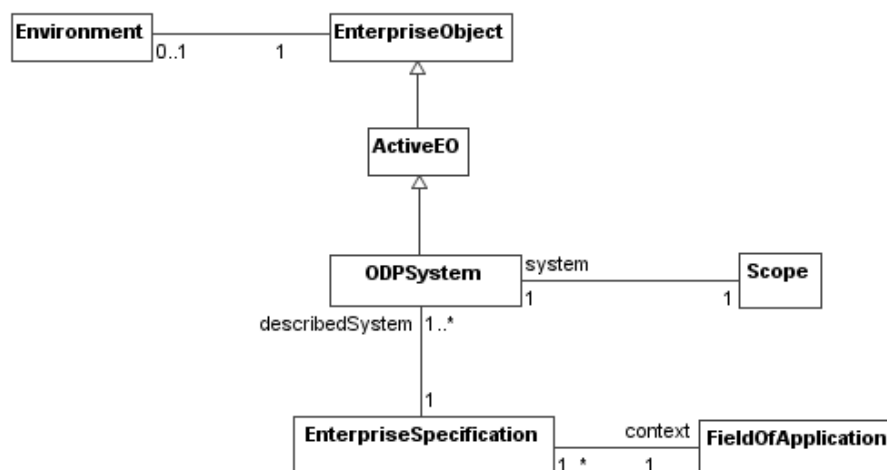

Figure 3 – System concepts

NOTE – The concept of environment was introduced in Part 2 in order to allow description of the properties of some particular object by introducing a representation of all the other elements in a model with which it might interact, directly or indirectly. As such, in particular, it represents some abstraction of the other objects in the model, but this abstraction relationship is not visible in any model.

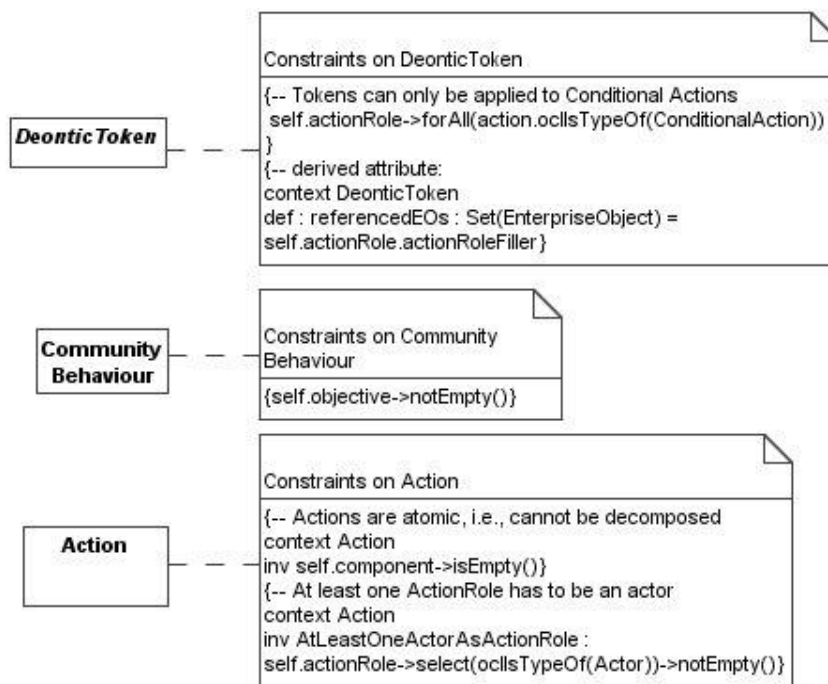
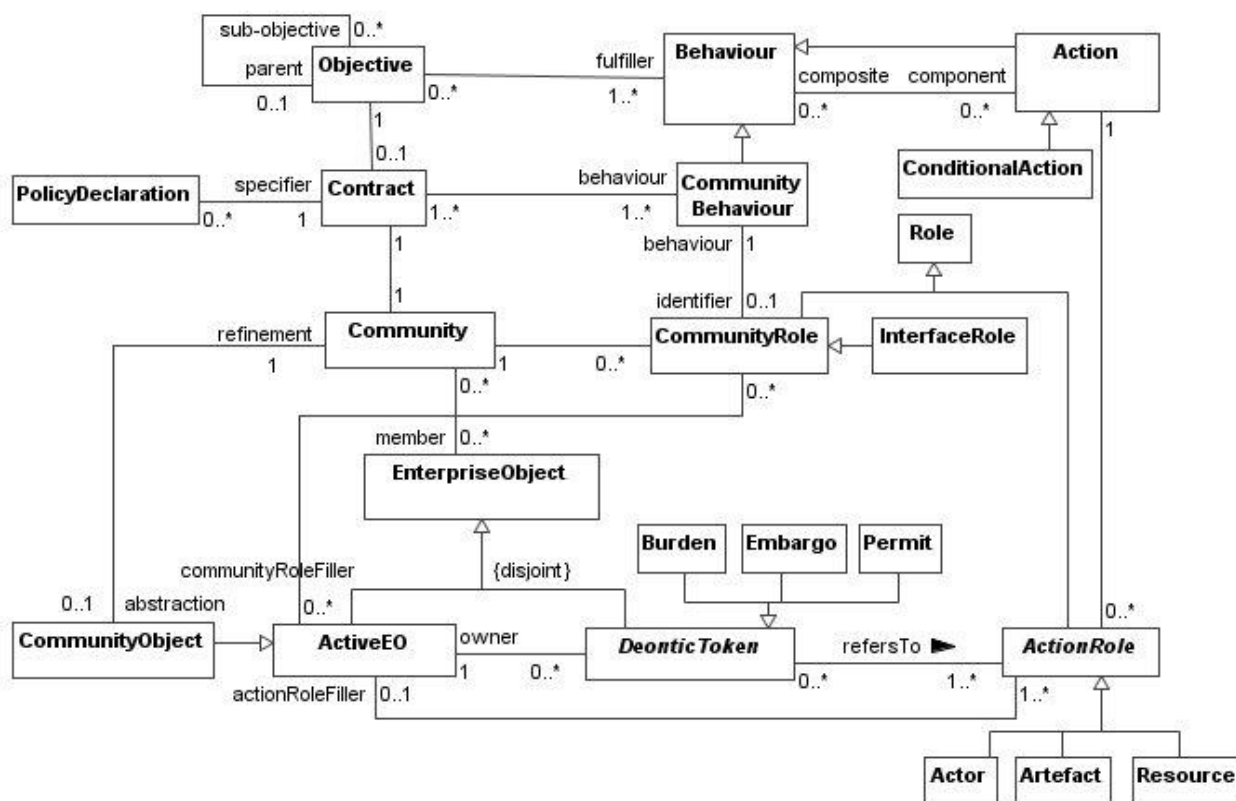

Figure 4 – Community concepts

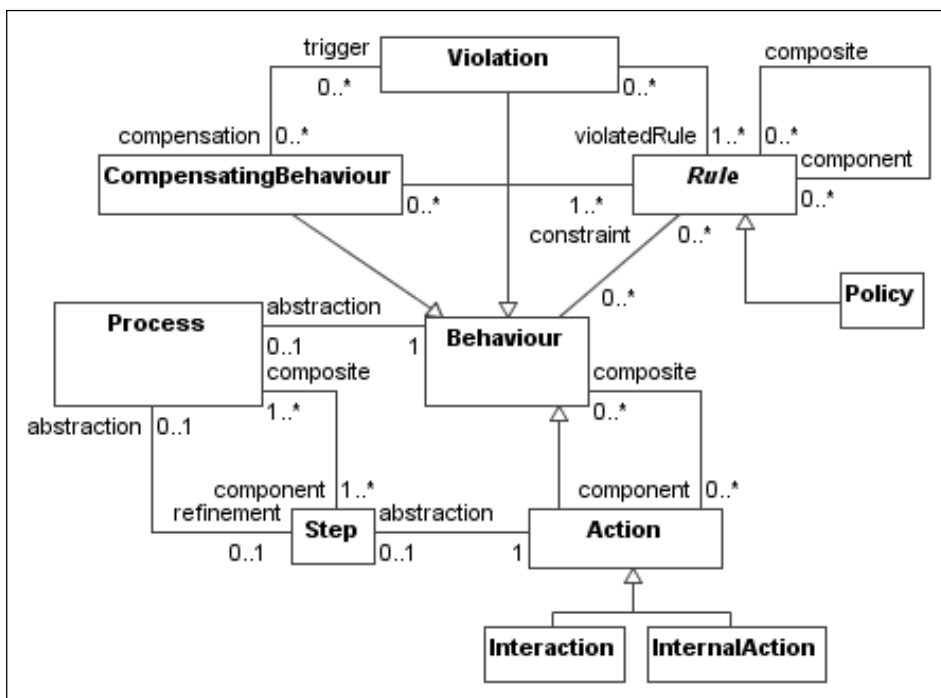

Figure 5 – Behaviour concepts

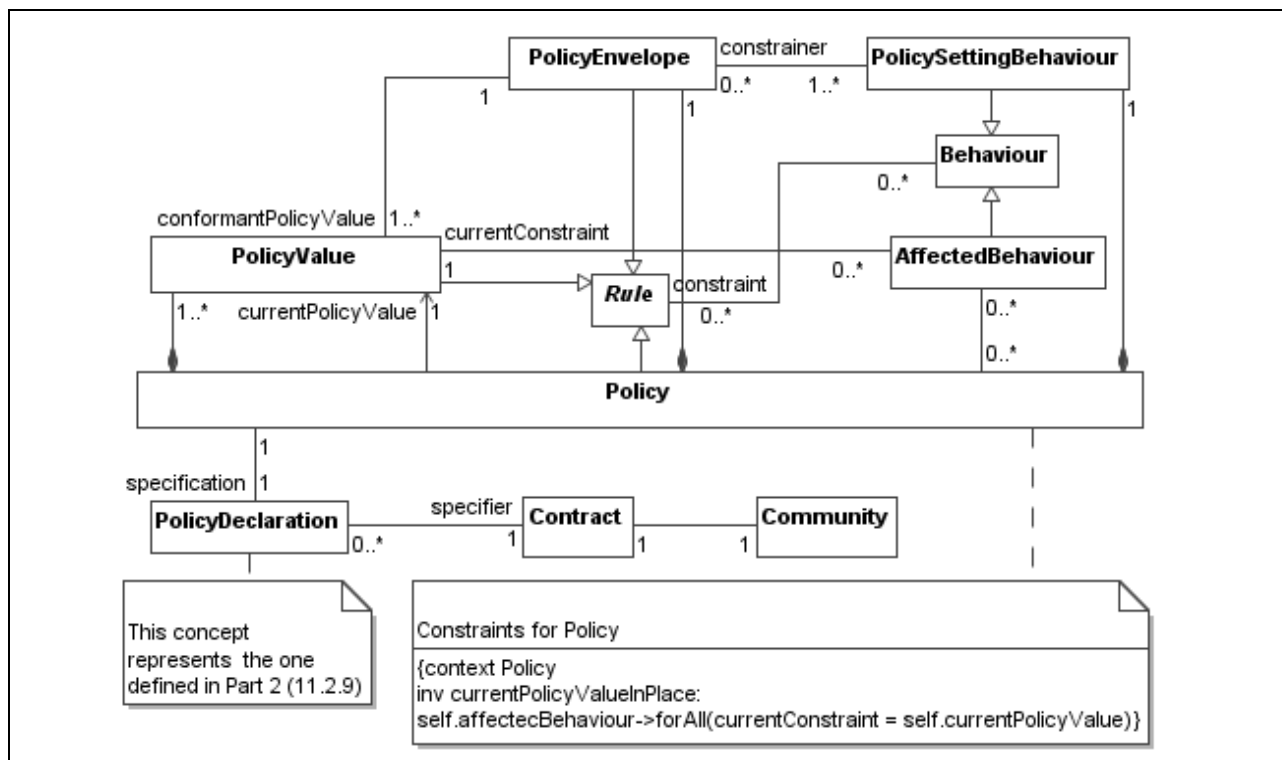

Figure 6 – Policy concepts

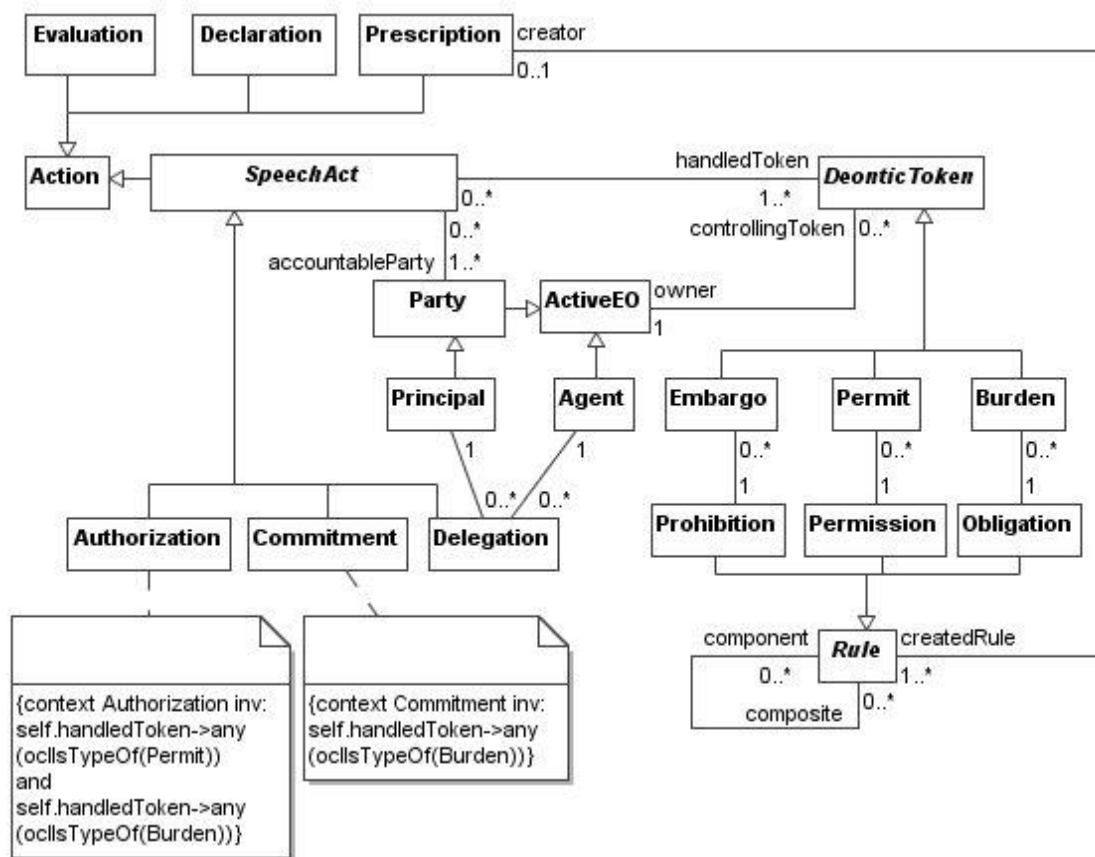

Figure 7 – Deontic and accountability concepts

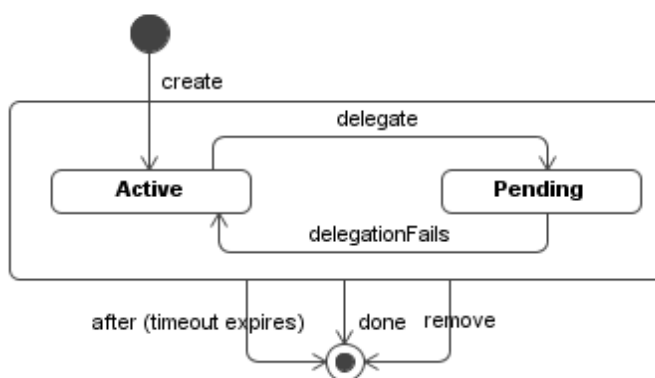

Figure 8 – Deontic token lifecycle

7.2 UML profile

NOTE – This Recommendation | International Standard defines UML expressions for concepts likely to be found in concrete elements within practical specifications. Some of the ODP concepts are abstract, expressing the categorization of the practical concepts. The abstract concepts are mentioned, but no UML expression is offered.

This clause specifies how the ODP enterprise concepts described in the previous clause are expressed in UML in an enterprise specification. A brief explanation of the UML concepts used in the expression of each concept is given, together with a justification of the expression used.

7.2.1 ODP system

An *ODP System* is an *enterprise object*. It is expressed in UML by an instanceSpecification of a UML class stereotyped as «EV_ODPSystem», see [7.2.6]. That class expresses the *enterprise object type*. Note also that modelling purposes

may require that an *ODP system* be further detailed as a *community*, in which case the *enterprise object* that models it is classified as a *community object* and refined as a *community*, see [7.2.4].

7.2.2 Scope

The *scope* of an *ODP system* is the set of *behaviours* that the system is expected to exhibit, e.g., its *roles*. It is not, therefore, expressed by any single UML element, but by the set of elements that express its *behaviour*.

7.2.3 Field of application

The *field of application* is a property of the enterprise specification as a whole, and is expressed by a tag definition of stereotype «Enterprise_Spec». This tag definition is named EV_FieldOfApplication, and is of type string. That string contains the description of the *field of application* of the enterprise specification.

7.2.4 Community

A *community* is modelled in terms of its *type*, which is expressed by a component stereotyped as «EV_Community». This is included in a package stereotyped as «EV_CommunityContract» that contains the specification of the *community*, i.e., its *objective*, its *behaviour*, and any *enterprise objects* and *object types* that are specific to the *community* concerned (see [7.2.9]). Where a specific *entity* (e.g., organizational unit) is being modelled it is expressed by an instanceSpecification of a component stereotyped as «EV_Community».

Any component expressing a *community* will have exactly one association, stereotyped as «EV_ObjectiveOf» to a class stereotyped as «EV_Objective», that expresses the *objective* of the *community*, and a set of realizations, each stereotyped as «EV_CommunityBehaviour», to the UML classifier elements expressing its *roles* and the associated *behaviour* (*interactions, actions, steps and processes*).

See also [7.2.8] and [7.2.9].

7.2.5 Enterprise object

An *enterprise object* is generally specified in terms of its *type*, which is expressed by a class stereotyped as «EV_Object».

NOTE – The UML concept of class is different to the ODP concept of *class*. A UML class is a "description" of a set of objects, while an ODP *class* is the set of *objects* itself. Therefore, the UML concept of class is closer to the ODP concept of *type*, and there is no UML concept corresponding to the ODP concept of *class*. Therefore, no UML expression for the ODP concept of *class* is provided.

Any class stereotyped as «EV_Object» may have any number of associations, each stereotyped as «EV_FulfilRole», with any number of classes stereotyped as «EV_Role» in one or more *community*, modelling the fact that the *enterprise objects* of that *type* fulfil the *roles*.

Where an *enterprise object* is required to represent a specific entity in the UOD, it is expressed by an instanceSpecification of a class that is stereotyped as «EV_Object».

7.2.6 Object types and templates as enterprise objects

There are cases where there is the need to model the *type* or *template* of an *enterprise object* at the instance level. An example is the case of a generic factory, which is invoked by passing it a representation of a *template* (which has *type template*), and responds by instantiating the *template* and returning a reference to the created *object*. To indicate that an *object* is derived from a given *template*, we need to represent both the *template object* and the instantiated *object* in the model. Likewise for *types*, to indicate that an *object* conforms to a given *type*, we need to represent both the *object* and its *object type* in the model.

Both *type objects* and *template objects* are *enterprise objects*, and therefore are expressed by classes that express their *type* or *template*. To distinguish them from other *enterprise objects*, such classes are stereotyped «EV_TypeObject» or «EV_TemplateObject», respectively. Both stereotypes inherit from «EV_Object».

The relationship between an *enterprise object* and the *object* that represents its *template*, or the *objects* that represent its *types* can be expressed as an attribute of the class that expresses the *enterprise object*.

For example, in some specifications, such as in the ODP trading function specification, there is the need to specify the *type* of a service, so the trader can locate objects implementing such a service. The diagram shown in Figure 9 represents the specification of an *enterprise object*, **PrintService**, and of its *type*, **PrintServiceType**, expressed so that the *object* is able to know and access its *type* (i.e., the *type* of the *object* is accessible as part of its metadata, by means of an attribute of the class that expresses its specification)



Figure 9 – An explicit representation of the type of an enterprise object so that the object can access its type

7.2.7 Community object

A *community object* is an *enterprise object* that is refined in the model as a *community*. Like any other enterprise object a *community object* is modelled in terms of its type, which is expressed by a class stereotyped as «EV_CommunityObject», which is, in turn, a specialization of «EV_Object». This class has a dependency, stereotyped as «EV_RefinesAsCommunity», to the component stereotyped as «EV_Community» which expresses the *type* of the *community* that refines it.

7.2.8 Objective

An *objective* (of a *community*) is expressed by a class, stereotyped as «EV_Objective». This class has an association, stereotyped as «EV_ObjectiveOf» with the component, stereotyped as «EV_Community» that describes the *community* being specified.

NOTE – When an *objective* is refined into *subobjectives*, the *subobjective* is also expressed by a class stereotyped «EV_Objective» and the relationship between *objective* and *subobjectives* will be a composition.

7.2.9 Contract

A *contract* for a *community* specifies the *objective* of that *community*, and how that *objective* can be met (i.e., its *behaviour* and *policies*). It is the specification of that *community* as it appears in the enterprise specification. The expression of *contract* is by a package stereotyped as «EV_CommunityContract».

In the name space of the package will be the UML elements expressing the *community* itself, its *objective*, its *roles* and the associated *behaviour* (*actions*, *interactions*, *steps* and *processes*), and the *policy* and accountability concepts specific to the *community*. Relationships between all these UML elements may also be included in this package's namespace. The package may also contain some or all of the elements expressing the *enterprise objects* that fulfil its *roles*. (Those elements expressing *enterprise objects* that fulfil *roles* in other *communities* may be contained in any one of the packages expressing those *communities*.)

7.2.10 Behaviour

7.2.10.1 General

NOTE – In this clause phrases such as "*interactions* between *roles*" and "*steps* performed by *roles*" should be read as "*interactions* between *enterprise objects* fulfilling *roles*" and "*steps* performed by *enterprise objects* fulfilling *roles*" respectively.

A *behaviour* is a set of *actions* with constraints on when they may occur. It is not expressed by any single UML element. It is expressed by a set of elements expressing the *behaviour* as a set of *processes* of a *community* in which the *steps* are *behaviours* of *roles* in the *community*. Where required, the *behaviour* of a *role* can be further detailed in terms of a set of elements expressing the *behaviour* in terms of *internal actions* of the *role* and *interactions* between the *role* and other *roles* in the *community*. Where behaviour needs to be expressed in a more generic way than given below, a state machine stereotyped as «EV_Behaviour» is used.

Annex A illustrates the application of the concepts described in the following clauses (7.2.10.2 and 7.2.10.3).

7.2.10.2 Behaviour as processes and steps

Where the *behaviour* is modelled in terms of *processes* of a *community*, a *process* is expressed by an activity stereotyped as «EV_Process» in the namespace of the component, stereotyped as «EV_Community», that expresses the *community* that uses this *process* to achieve its *objective*. This activity has a realization link, stereotyped as «EV_CommunityBehaviour» from that component. Within this activity:

- the *steps* of the *process* are expressed by callBehaviorActions, stereotyped as «EV_Step»;
- the *refinement* of a *step*, as a *process*, is expressed by associating the relevant callBehaviorAction, stereotyped as «EV_Step», that expresses the *step*, with an activity, stereotyped as «EV_Process», that expresses the *refinement*;

- activityPartitions (stereotyped as «EV_Role») represent classes (also stereotyped as «EV_Role») that express the *roles* of the *enterprise objects* in the name space of the package (stereotyped as «EV_CommunityContract») that expresses the *community* in which the *role* is specified; similarly, activityPartitions (stereotyped as «EV_Object») represent classes (also stereotyped as «EV_Object») that express the *enterprise objects* defined as local to the community concerned;
- where a *step* is not refined as a *process*, the callBehaviorAction, stereotyped as «EV_Step», that expresses the *step*, is associated with an opaqueBehavior specified in the context of the corresponding class stereotyped as «EV_Role» that expresses the *role* of the *enterprise object* that performs the *step*;
NOTE – An opaqueBehavior can express, in an appropriate language, any level of detail about the step that is required to meet the modelling objectives.
- the *artefacts* that are referenced in the *steps* are expressed by objectNodes, stereotyped as «EV_Artifact».

In general, the complete *behaviour* for a *role* is modelled by the *actions* for that *role* in a number of *processes*.

7.2.10.3 Behaviour as interactions between roles

The detailed *behaviour* of individual *roles* may be expressed by the following combination of UML elements:

- one or more classes each having one or more associations with the class stereotyped as «EV_Role» that expresses the *role* being specified. Each of these classes is stereotyped as «EV_Interaction». The relationship is expressed with an association, stereotyped as «EV_InteractionInitiator» or «EV_InteractionResponder» as appropriate;
- each class stereotyped as «EV_Interaction» will have associations with classes that are stereotyped as «EV_Role», where there is an *interaction* between these *roles*. An «EV_Interaction» is composed of signals, each also stereotyped as «EV_Interaction». *Enterprise objects* that are referenced in the *interactions* are represented by the values of the properties of the signals;
- each class stereotyped as «EV_Interaction» shall have an operation +occur():void that defines the behaviour that takes place when the interaction occurs. It can also be used to specify pre- and post-conditions on the interaction, which can be represented as OCL constraints on the occur() operation. This operation links the static, template-like, view of interactions with the occurrences of the interaction in the community behaviour;
- one or more stateMachines for which the context is the class stereotyped as «EV_Role», that define the constraints on the receiving and sending of information by an *enterprise object* fulfilling the *role* and any associated *internal actions* of the *enterprise object*. Each of these stateMachines shows the sending and receiving of the signals, each stereotyped as «EV_Artifact», associated with the *interactions* of the *role*, and thus shows the logical ordering of these *interactions*, and defines the *internal actions* of the *role* in terms of the behaviors associated with the states.
- An *assignment policy* is expressed in the same way as any other *policy*; see 7.2.15.

The *internal actions* identified in (the states of) the stateMachines for the «EV_Role» correspond to the actions in an activityPartition expressing the *role* in the corresponding activityDiagrams, and the properties of the signals correspond to the objectNodes in the corresponding activityDiagrams.

7.2.10.4 Interface role

An *interface role* is expressed by a class stereotyped as an «EV_InterfaceRole», which inherits from «EV_Role». The part of the *behaviour* identified by the *interface role* that takes place with the participation of one or more external *objects* (*objects* that do not form part of the decomposition of the *community object* that is refined by that *community*) is modelled by an *interaction* with a *role* that identifies the required *behaviour* of the external *objects*. This *behaviour* is expressed by a class stereotyped as «EV_Interaction» that has associations with each of the classes (stereotyped as «EV_InterfaceRole») that express the *interface role* on the one hand and some *roles* or *local objects* within the *community* (stereotyped as «EV_Role» or «EV_Object») on the other.

7.2.10.5 Violation

A *violation* is expressed by a state machine stereotyped as «EV_Violation» that inherits from «EV_Behaviour».

7.2.11 Action Roles

7.2.11.1 Actor (with respect to an action)

The concept *actor* is a relationship between an *enterprise object* and an *action*. There is no single UML element that expresses an instance of the RM-ODP enterprise language concept, *actor*. *Actors* in a model may be identified from either or both of:

- an examination of the *interaction* model where the existence of *actors* will be indicated by the associations, stereotyped as «EV_FulfilsRole», between the classes stereotyped as «EV_Role» and «EV_Object», respectively, taken in combination with the stateMachine that expresses the *behaviour* of the relevant *role*;
- in an examination of the *process* model, the presence of an «EV_Step» in an «EV_Role» activityPartition indicates that the *enterprise object* fulfilling the *role* is an *actor* for the *step* concerned.

7.2.11.2 Artefact (with respect to an action)

The concept *artefact* is also a relationship between an *enterprise object* and an *action*. In an *interaction* model, an *artefact* referenced in an *action* is expressed by a signal stereotyped as «EV_Artefact», which has two associations:

- one association, stereotyped as «EV_ArtefactRole», will be with the «EV_Object» class expressing the *enterprise object* that is an *artefact* with respect to the *action*;
- the other association, stereotyped as «EV_ArtefactReference», will be with the «EV_Interaction» class that expresses the *action* or *interaction* for which the *enterprise object* is an *artefact*.

In a *process* model, it is possible to express each instance of *artefact* with a single UML element, namely an objectFlow stereotyped as «EV_Artefact».

7.2.11.3 Resource (with respect to an action)

No specific UML metaclass is extended to express this concept. If required, the fact that some *behaviour* requires the existence of an *enterprise object* as a *resource* may be stated in a comment on that *behaviour*.

7.2.12 Deontic concepts

7.2.12.1 Burden

A *burden* is expressed in UML either as a class stereotyped as «EV_Burden» or as an ObjectNode stereotyped as «EV_Burden».

The presence of an *obligation* is implied by the representation of a *burden*. If a less specific expression is required, the fact that some *behaviour* places or fulfils an *obligation* may be stated in a constraint stereotyped as «EV_Obligation» on that *behaviour*.

NOTE – The specifier selects an appropriate level of detail for the specification. Obligations are either reified as burdens or represented as constraints, but the style chosen in a particular specification should be consistent.

7.2.12.2 Permit

A *permit* is expressed in UML either as a class stereotyped as «EV_Permit» or as an ObjectNode stereotyped as «EV_Permit».

The presence of a *permission* is implied by the representation of a *permit*. If a less specific expression is required, the fact that some *behaviour* requires or creates a *permission* may be stated in a constraint stereotyped as «EV_Permission» on that *behaviour*.

NOTE – The specifier selects an appropriate level of detail for the specification. Permissions are either reified as permits or represented as constraints, but the style chosen in a particular specification should be consistent.

7.2.12.3 Embargo

An *embargo* is expressed in UML either as a class stereotyped as «EV_Embargo» or as an ObjectNode stereotyped as «EV_Embargo».

The presence of a *prohibition* is implied by the representation of an *embargo*. If a less specific expression is required, the fact that some *behaviour* requires or creates a *prohibition* may be stated in a constraint stereotyped as «EV_Prohibition» on that *behaviour*.

NOTE – The specifier selects an appropriate level of detail for the specification. Prohibitions are either reified as embargos or represented as constraints, but the style chosen in a particular specification should be consistent.

7.2.13 Policy

Policies are expressed in UML using a combination of elements, which together are used to express the following:

- the *policy* itself, including its current value and the envelope that defines the range of values that are possible;
- the *objects* and the *behaviour* constrained by the *policy*;
- the *behaviour* by which the *policy value* may be changed and *objects* that are allowed to exhibit that *behaviour*.

The *policy* is expressed by a class stereotyped as «EV_PolicyDeclaration», with a constraint stereotyped as «EV_PolicyEnvelopeRule» expressing the range permitted for the policy.

Each *policy value* is expressed by a class stereotyped as «EV_PolicyValue» which has the role "current value" in an association with the «EV_PolicyDeclaration» class that expresses the *policy*. In this way, the *policy* allows the *policy envelope* to restrict the current *policy value*.

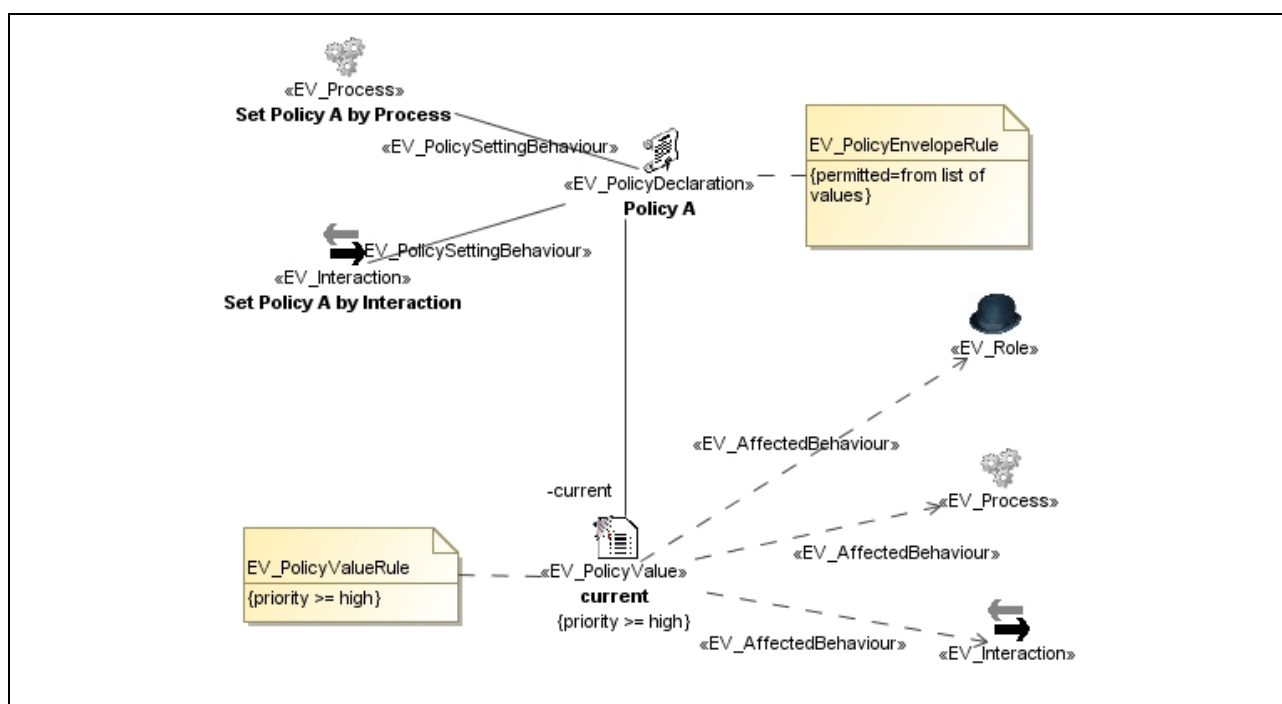

Figure 10 – Pattern for UML expression of a policy

Where the enterprise specification includes elements modelling the *behaviour* concerned with setting the *policy value*, this is modelled by *roles* identifying *behaviour* that may be detailed as *processes* or *interactions*, with associations, stereotyped as «EV_PolicySettingBehaviour», between the classes expressing the *policy envelope* and the classes expressing the *behaviour*.

The relationships between a *policy* and the *behaviours* that it constrains are expressed by one or more dependencies, stereotyped as «EV_AffectedBehaviour», from the classes expressing the *behaviours* to the class expressing the *policy*.

Unless the set of *policy values* is pre-determined, a set of constraints stereotyped as «EV_PolicyEnvelopeRule» expressing rules governing acceptable *policy values* is attached to the «EV_PolicyDeclaration» class.

Attached to each «EV_PolicyValue» class is a set of constraints stereotyped as «EV_PolicyValueRule», which together express *behaviour* rules related to the *policy value*. These rules, which may comprise *obligations*, *permissions*, *prohibitions*, *authorizations*, or other expressions, may be expressed in OCL or other suitable notation.

The pattern for expression of *policy* and its impact on other parts of an enterprise specification is shown in Figure 10.

7.2.14 Accountability concepts

7.2.14.1 Party

A *party* is an *enterprise object* modelling an entity with some of the rights, powers and duties of a natural person. It is expressed in UML by an instanceSpecification of a class stereotyped as «EV_Party», which must also be stereotyped as «EV_Object».

7.2.14.2 Accountable action

An *action* may be *accountable* when it is part of the *behaviour* identified by a *role* fulfilled by a *party*. This is expressed in UML with an association, stereotyped as «EV_Accountable», between the class expressing the *role* and the class or activity expressing the *interaction* or *process* respectively in which the accountable *party* participates.

NOTE – Where this construct is used for a *process*, this only indicates that the *role* is accountable for those *steps* that it performs, and not for those performed by some other *role*. This is a limitation of the semantics of the UML approach chosen, as it is not possible to associate a classifier with the element expressing *steps*.

7.2.14.3 Authorization

An *authorization* is expressed in UML by an instanceSpecification of a class stereotyped as «EV_Authorization», which is a specialization of «EV_Behaviour».

7.2.14.4 Delegation

A *Delegation* is expressed in UML by an association, stereotyped as «EV_Delegation», between two classes stereotyped as «EV_Object» with association ends showing the *party* which is the *principal* and the *enterprise object* which is the *agent* to whom the delegation is made.

7.2.14.5 Principal

A *principal* is an *enterprise object* modelling an entity responsible for the *acts* of its *agent* in consequence of some *delegation*. It is expressed in UML by an instanceSpecification of a class stereotyped as «EV_Principal», which is a specialization of «EV_Object».

7.2.14.6 Agent

An *agent* is an *enterprise object* modelling an entity performing *acts* on behalf of a *principal* in consequence of some *delegation*. It is expressed in UML by an instanceSpecification of a class stereotyped as «EV_Agent», which is a specialization of «EV_Object».

7.2.14.7 Prescription

A *prescription* is expressed in UML by an instanceSpecification of a class stereotyped as «EV_Prescription», which is a specialization of «EV_Behaviour».

7.2.14.8 Commitment

A *commitment* is expressed in UML by an instanceSpecification of a class stereotyped as «EV_Commitment», which is a specialization of «EV_Behaviour».

7.2.14.9 Declaration

A *declaration* is expressed in UML by an instanceSpecification of a class stereotyped as «EV_Declaration», which is a specialization of «EV_Behaviour».

7.2.14.10 Evaluation

An *evaluation* is expressed in UML by an instanceSpecification of a class stereotyped as «EV_Evaluation», which is a specialization of «EV_Behaviour».

7.2.15 Summary of UML extensions for the enterprise language

The enterprise language profile (EV_Profile) specifies how the enterprise viewpoint modelling concepts relate to and are expressed in standard UML using stereotypes, tag definitions, and constraints.

The following diagrams (Figures 11 to 15) show a graphical representation of the UML profile for the enterprise language, using the notation provided by UML.

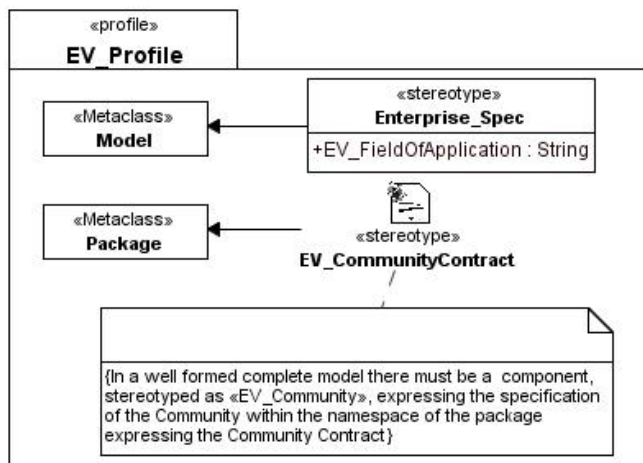

Figure 11 – Model management

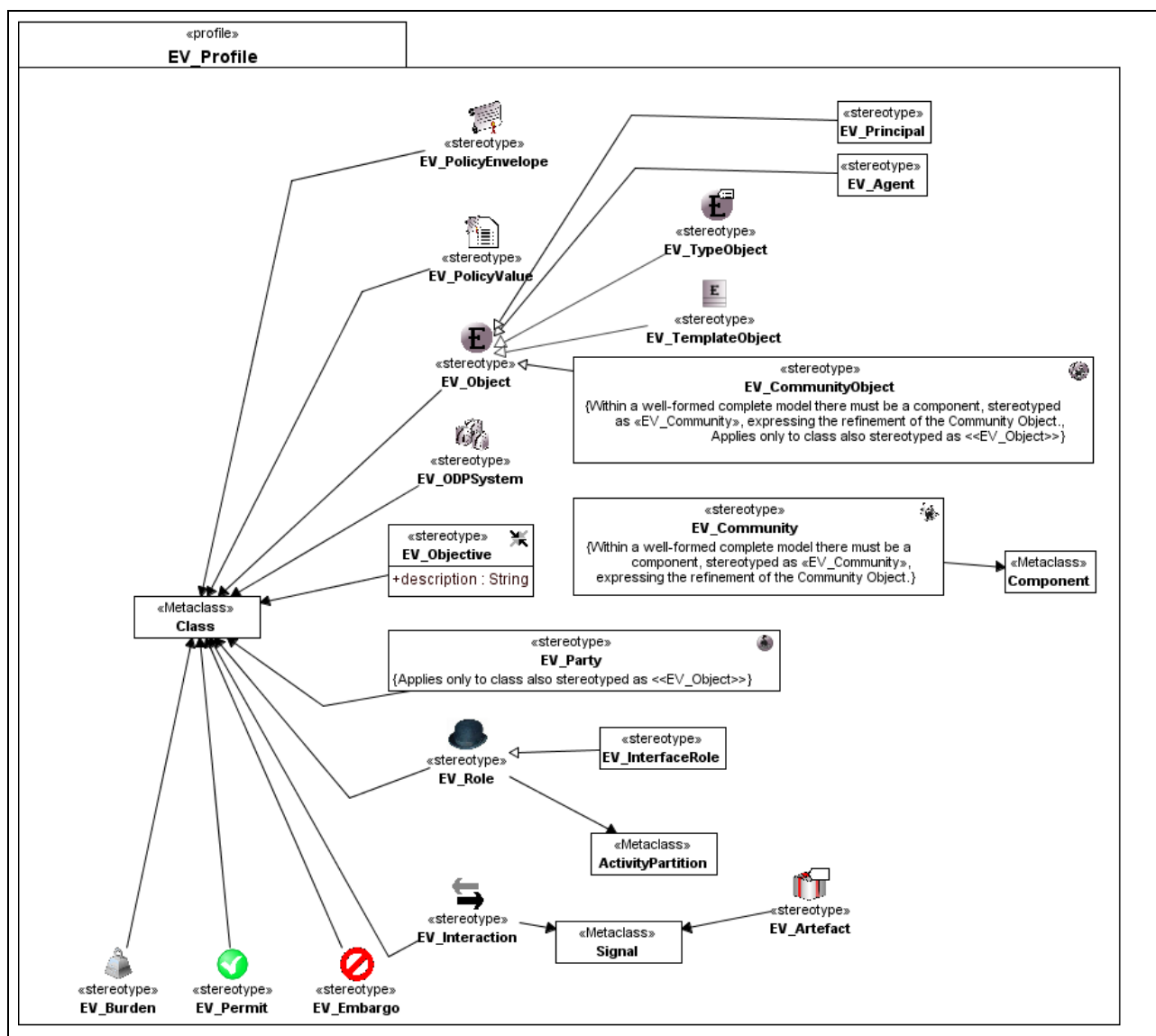

Figure 12 – Classifiers

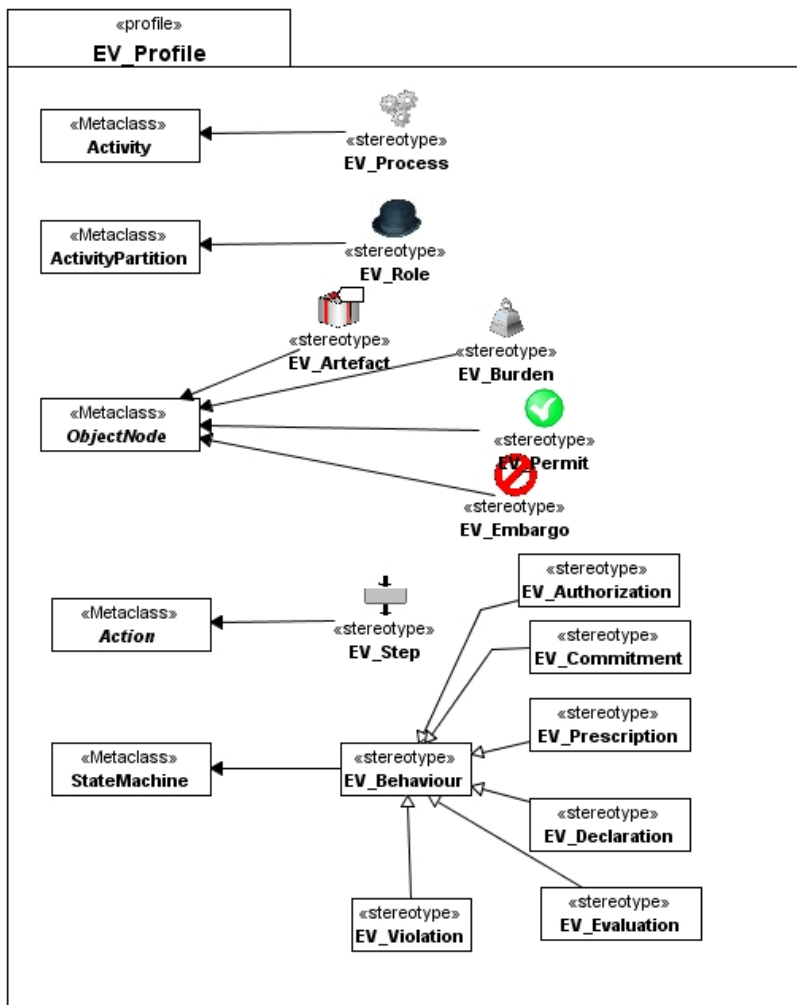

Figure 13 – Activities

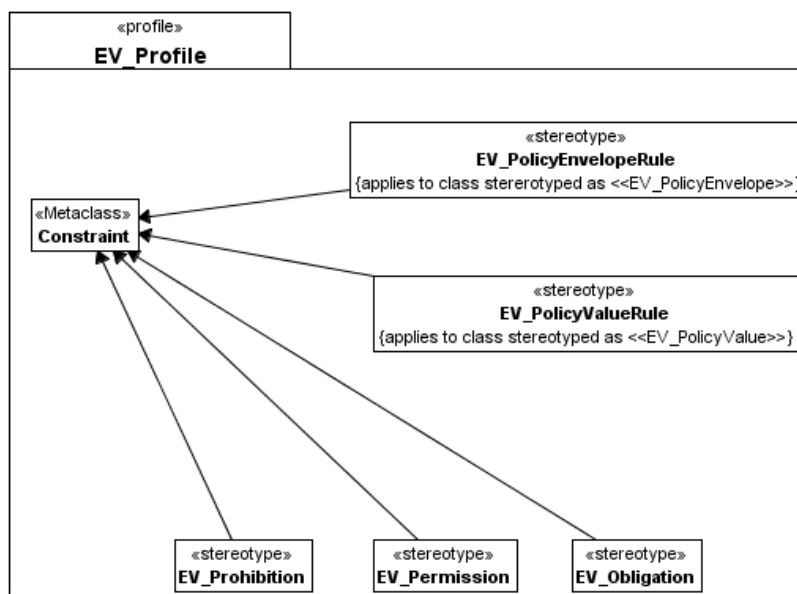

Figure 14 – Constraints

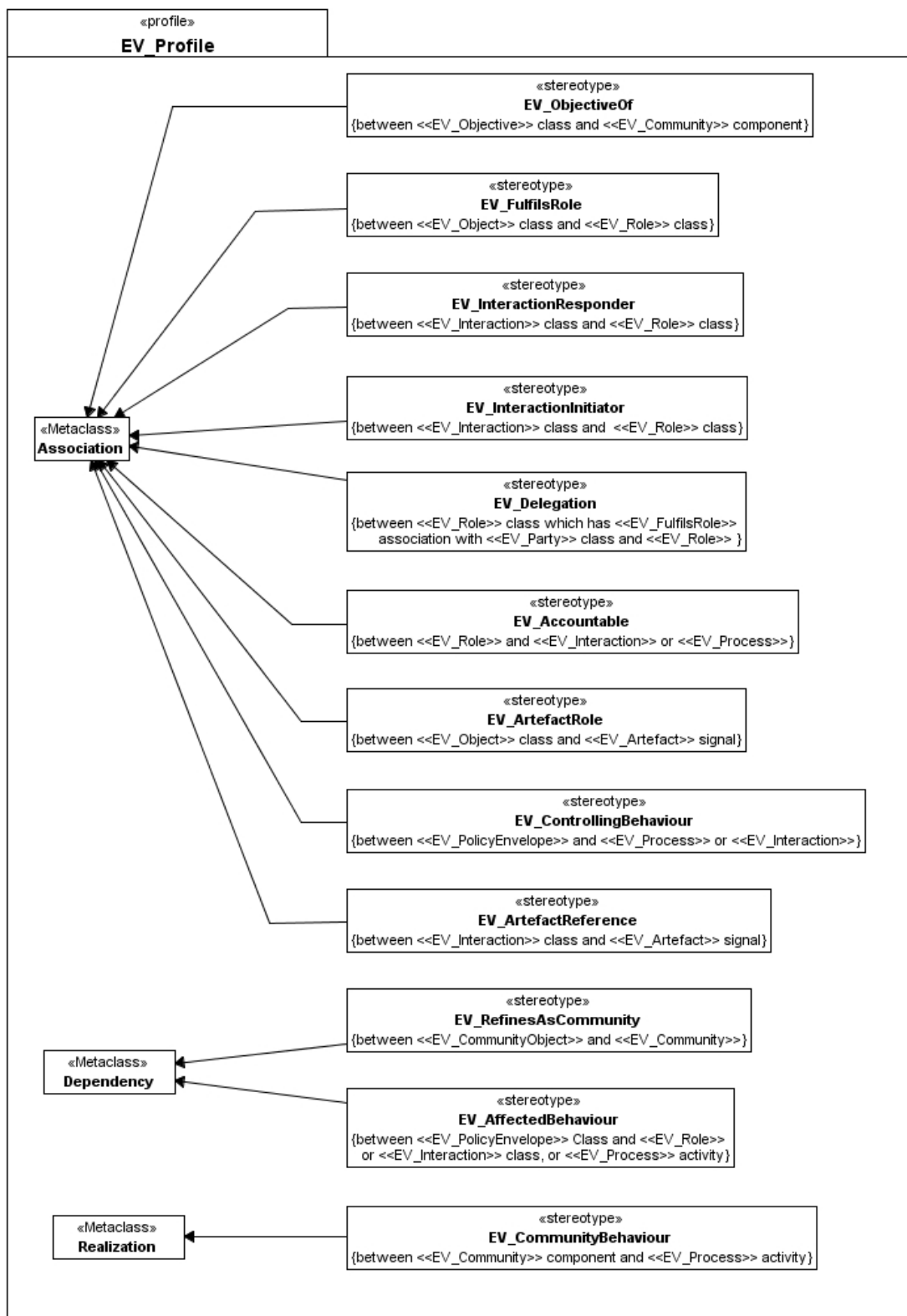

Figure 15 – Relationships

7.3 Enterprise specification structure (in UML terms)

An enterprise specification is contained in a model, stereotyped as «Enterprise_Spec». At the top level within this model there are one or more packages, stereotyped as «EV_CommunityContract», that include, where necessary, classes, each stereotyped as «EV_CommunityObject», expressing the relevant *communities* as *community objects*.

Within each «EV_CommunityContract» package, there is a single component, stereotyped as «EV_Community» and a single class, stereotyped as «EV_Objective», as well as other elements, packaged as convenient, expressing *behaviour* (*roles, processes and interactions*), and *enterprise objects* that are local to the *community*.

7.4 Viewpoint correspondences for the enterprise language

7.4.1 Contents of this clause

This clause describes the correspondence concepts for the enterprise language, but not how they are expressed in UML. The latter is covered in clause 12.

7.4.2 Enterprise and information viewpoint specification correspondences

In general, not all the elements of the enterprise specification of a system need to correspond to elements of its information specification. However, the information viewpoint shall conform to the *policies* of the enterprise viewpoint and, likewise, all enterprise *policies* shall be consistent with the *static, dynamic, and invariant* schemata of the information specification.

Where there is a correspondence between enterprise and information elements (e.g., between an *enterprise object* and the *information object* that stores the relevant information about it), the specifier shall provide:

- for each *enterprise object* in the enterprise specification, a list of those *information objects* (if any) that model information or information processing concerning the entity modelled by that *enterprise object*;
- for each *role* in each *community* in the enterprise specification, a list of those *information object types* (if any) that specify information or information processing of an *enterprise object* fulfilling that *role*;
- for each *policy* in the enterprise specification, a list of the *invariant, static and dynamic schemata of information objects* (if any) that correspond to the *enterprise objects* to which that *policy* applies; an *information object* is included if it corresponds to the *enterprise community* that is subject to that *policy*;
- for each *action* in the enterprise specification, the *information objects* (if any) subject to a *dynamic schema* constraining that *action*;
- for each relationship between *enterprise objects*, the *invariant schema* (if any) which constrains *objects* in that relationship;
- for each relationship between *enterprise roles*, the *invariant schema* (if any) which constrains *objects* fulfilling *roles* in that relationship.

7.4.3 Enterprise and computational viewpoint specification correspondences

Not all the elements of the enterprise specification of a system need to correspond to elements of its computational specification. In particular, not all *states, behaviours and policies* of an enterprise specification need to correspond to *states and behaviours* of a computational specification. There may exist transitional computational states within pieces of computational *behaviour* which are abstracted as atomic transitions in the enterprise specification.

Where there is a correspondence between enterprise and computational elements, the specifier shall provide:

- for each *enterprise object* in the enterprise specification, that configuration of *computational objects* (if any) that realizes the required *behaviour*;
- for each *interaction* in the enterprise specification, a list of those *computational interfaces and operations or streams* (if any) that correspond to the enterprise *interaction*, together with a statement of whether this correspondence applies to all occurrences of the *interaction*, or is qualified by a *predicate*;
- for each *role* affected by a *policy* in the enterprise specification, a list of the *computational object types* (if any) that exhibit choices in the computational *behaviour* that are modified by the *policy*;
- for each *interaction* between *roles* in the enterprise specification, a list of *computational binding object types* (if any) that are constrained by the enterprise *interaction*;
- for each enterprise *interaction type*, a list of computational *behaviour types* (if any) of computational *behaviours* capable of carrying out an *interaction* of that enterprise *interaction type*.

7.4.4 Enterprise and engineering viewpoint specification correspondences

Not all the elements of the enterprise specification of a system need to correspond to elements of its engineering specification. Where there is a correspondence between enterprise and engineering elements, the specifier shall provide:

- for each *enterprise object* in the enterprise specification, the set of those *engineering nodes* (if any) with their *nuclei*, *capsules*, and *clusters*, all of which support some or all of its *behaviour*;
- for each *interaction* between *roles* in the enterprise specification, a list of *engineering channel types* and *stubs*, *binders*, *protocol objects* and *interceptors* (if any) that are constrained by the enterprise *interaction*.

NOTE 1 – The engineering nodes may result from rules about assigning support for the behaviour of enterprise objects to nodes. These rules may capture policies from the enterprise specification.

NOTE 2 – The engineering channel types and stubs, binders or protocol objects may be constrained by enterprise policies.

7.4.5 Enterprise and technology viewpoint specification correspondences

In accordance with [Part 2 – 15.5] and [Part 3 – 5.3], an implementer provides, as part of the claim of conformance, the chain of interpretations that permits observation at conformance points to be interpreted in terms of enterprise concepts. While there may be specific correspondences between enterprise *policies* and technology viewpoint specifications that require the use of particular technologies, there are neither required correspondences nor required correspondence statements.

NOTE – Although there are no required viewpoint correspondences between enterprise and technology specifications, there may be cases where part of an enterprise specification has a direct relationship with a technology specification or a choice of technology. Such examples include enterprise *policies* covering performance (e.g., response time), reliability, and security.

8 Information specification

8.1 Modelling concepts

An information specification uses the RM-ODP information language. The modelling concepts and the structuring rules of the information language are defined in [Part 3 – 6]. They are summarized in this clause. Except where otherwise stated, in case of conflict between the explanations herein and the text in Part 3, the latter document should be followed.

The set of diagrams at the end of this clause (i.e., at [8.1.10]) summarizes a metamodel for the information language.

The information viewpoint is concerned with information modelling. It focuses on the semantics of information and information processing in the *ODP system*. The individual components of a distributed system must share a common understanding of the information they communicate when they interact, or the system will not behave as expected. These items of information are handled, in one way or another, by one or more *objects* in the system. To ensure that the interpretation of these items is consistent, the information language defines concepts for the specification of the meaning of information stored within, and manipulated by, an *ODP system*, independently of the way the information processing functions themselves are to be implemented.

In the ODP reference model, the information language uses a basic set of concepts and structuring rules, including those from Part 2 of RM-ODP, and three concepts specific to the information viewpoint: *invariant schema*, *static schema*, and *dynamic schema*.

8.1.1 Information object

Information held by the ODP system about entities in the real world, including the ODP system itself, is modelled in an information specification in terms of *information objects*, and their relationships and *behaviour*.

Basic information elements are modelled by atomic *information objects*. More complex information is modelled as composite *information objects* modelling relationships over a set of constituent *information objects*. *Information objects*, as any other ODP *object*, exhibit *behaviour*, *state*, *identity*, and *encapsulation*.

NOTE – *Information objects* may have *operations*, although information operations are names for significant stimuli for state changes, and are not necessarily the same as *computational operations*.

8.1.2 Information object type

The *type* of an *information object* is a predicate characterizing a collection of *information objects*.

8.1.3 Information object class

A *class* of *information objects* is the set of all *information objects* satisfying a given *type*.

8.1.4 Information object template

An *information object template* is the specification of the common features of a collection of *information objects* in sufficient detail that an *information object* can be instantiated using it. *Information object templates* may reference *static*, *invariant* and *dynamic schemata*.

8.1.5 Information action and action types

An *action* is a model of something that happens in the real world. *Types* of *actions* are modelled by *action types*. An *action* in the information viewpoint is associated with at least one *information object*.

Actions can be either *internal actions* or *interactions*. An *internal action* always takes place without the participation of the *environment* of the *object*. An *interaction* takes place with the participation of the *environment* of the *object*. *Objects* can only interact at *interfaces*. ODP *interactions* are instances of ODP *communications*.

8.1.6 Invariant schema

An *invariant schema* is a set of predicates on one or more *information objects* which must always be true. The predicates constrain the possible states and state changes of the *objects* to which they apply.

An *invariant schema* can also describe the specification of the *types* of one or more *information objects*, that will always be satisfied by whatever behaviour the *objects* might exhibit.

8.1.7 Static schema

A *static schema* is a specification of the state of one or more *information objects*, at some point in time, subject to the constraints of any *invariant schemata*.

8.1.8 Dynamic schema

A *dynamic schema* is a specification of the allowable state changes of one or more *information objects*, subject to the constraints of any *invariant schemata*. A *dynamic schema* specifies how the information can evolve as the system operates. In addition to describing state changes, *dynamic schemata* can also create and delete *information objects*, and allow reclassifications of instances from one *type* to another. Furthermore, in the information language, a state change involving a set of *objects* can be regarded as an *interaction* between those *objects*. Not all the *objects* involved in the *interaction* need to change state; some of the *objects* may be involved in a read-only manner.

8.1.9 Structure of an information specification

An information specification defines the semantics of information and the semantics of information processing in an ODP system in terms of a configuration of *information objects*, the *behaviour* of these *objects*, and *environment contracts* for the *objects* in the system. More precisely, an information specification is structured in terms of:

- a configuration of *information objects*, described by a set of *static schemata*;
- the *behaviour* of those *information objects*, described by a set of *dynamic schemata*; and
- the constraints that apply to either of the above (*invariant schemata*).

The different schemata may apply to the whole system, or they may apply to particular domains within it. Particularly in large and rapidly evolving systems, the reconciliation and federation of separate information domains will be one of the major tasks to be undertaken in order to manage information.

There are also some considerations that need to be taken into account when specifying the information viewpoint of an ODP system:

- *information objects* are either atomic or are modelled as a composition of component *information objects*. When an *information object* is a composite *object*, the schemata are composed as well;
- allowable state changes specified by a *dynamic schema* can include the creation of new *information objects* and the deletion of *information objects* involved in the *dynamic schema*. Allowable state changes can be subject to ordering and temporal constraints;
- the configuration of *information objects* is independent from distribution, i.e., there is no sense or focus on distribution in this viewpoint.

8.1.10 Summary of the information language metamodel

The diagram below (Figure 16) illustrates the concepts of the information language and the relationships between them. The descriptions of the concepts have been given above. The descriptions of the relationships between the concepts are included in the description of the concepts.

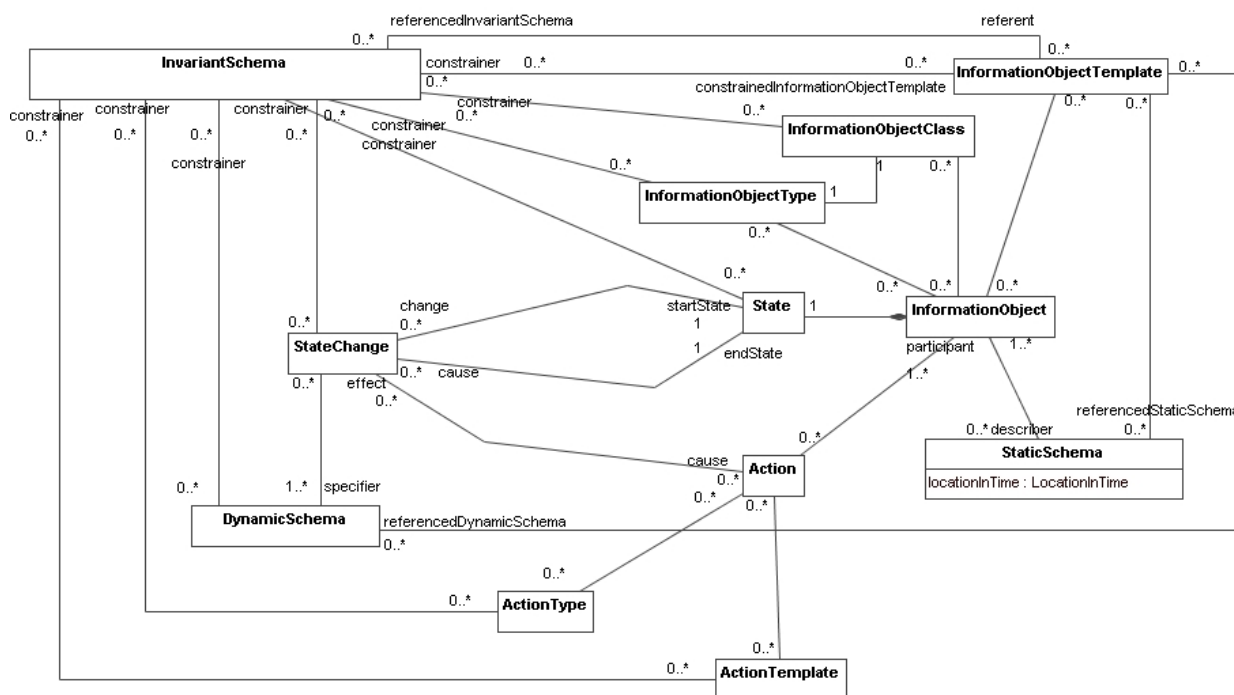

Figure 16 – Information language concepts

8.2 UML profile

This clause specifies how the ODP information concepts described in the previous clause are expressed in UML in an information specification. A brief explanation of the UML concepts used in the expression of each concept is given, together with a justification of the expression used.

NOTE – In this clause UML expressions are only defined for those concepts for which use has been demonstrated through an example, included in the main body of this Recommendation | International Standard or in its annexes. Where no example has been identified, the concept concerned is mentioned, but no UML expression is offered.

8.2.1 Information object

An *information object* is generally specified in terms of its *type*, which is expressed by a class stereotyped as «IV_Object».

Where an *information object* is required to represent a specific entity in the UOD, it is expressed by an instanceSpecification of a class that is stereotyped as «IV_Object».

8.2.2 Object types and templates as information objects

There are cases where there is the need to model the *type* or *template* of an *information object* at the instance level. An example is the case of a generic factory, which is invoked by passing it a representation of a *template* (which has *type template*), and responds by instantiating the *template* and returning a reference to the created *object*. To indicate that an *object* is derived from a given *template*, we need to represent both the *template object* and the instantiated *object* in the model. Likewise for *types*, to indicate that an *object* conforms to a given *type*, we need to represent both the *object* and its *object type* in the model.

Both *type objects* and *template objects* are *information objects*, and therefore are expressed by classes that express their *type* or *template*. To distinguish them from other *information objects*, such classes are stereotyped «IV_TypeObject» or «IV_TemplateObject», respectively. Both stereotypes inherit from «IV_Object».

The relationship between an *information object* and the *object* that represents its *template*, or the *objects* that represent its *types*, can be expressed as an attribute of the class that specifies the *information object*.

For example, the diagram shown in Figure 17 represents the specification of an *information object*, **Loan**, and of its *type*, **MyLoanType**, expressed so that the *object* is able to know and access its *type* (i.e., the *type* of the *object* is accessible as part of its metadata, by means of an attribute of the class that expresses its specification)

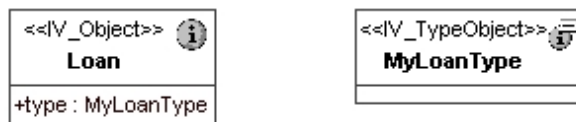

Figure 17 – An explicit representation of the type of an information object so that the object can access its type

8.2.3 Information action and action types

An *interaction* is expressed by a signal sent or received by the stateMachines of the *information objects* concerned. An *action type* is expressed by a signal stereotyped as «IV_Action».

In the information viewpoint, *actions* are mainly used for describing events that cause state changes, or for implementing *communications* between *objects*, i.e., flows of information.

In an information specification, an *internal action* is expressed by an internal transition of a state of the stateMachine for the *information object* concerned.

8.2.4 Relationships between information objects and between information object types

A relationship between *information object types*, when modelled as part of the *state* of the *objects* of those *types*, can be expressed by an association between the classes expressing those *types*. Instances of these associations (i.e., links) will express the relationships between the *information objects*.

When associations between *information objects* are modelled in ODP as *invariant schemata*, the UML expressions defined in clause 8.2.5 apply.

8.2.5 Invariant schema

Invariant schemata may impose different kinds of constraints in an information specification.

First, *invariant schemata* can provide the specification of the *types* of one or more *information objects*, that will always be satisfied by whatever *behaviour* the *objects* might exhibit. This kind of *invariant schema* may be expressed in a UML Package stereotyped as «IV_InvariantSchema», which specifies a set of *object types* (in terms of the set of classes that express such *object types*), their possible relationships (expressed by associations), and constraints on those *object types*, on their relationships, and possibly on their *behaviours* (expressed by the specification of the corresponding stateMachines). The association multiplicities and the constraints on the different modelling elements will constrain the possible states and state changes of the elements to which they apply.

NOTE 1 – OCL is the recommended notation for expressing the constraints on the modelling elements that form part of the UML expression of an *invariant schema*. However, other notations can be used when OCL does not provide enough expressive power, or is not appropriate due to the kind of expected user of the specification. For example, a temporal logic formula or an English text can be used for expressing a constraint that imposes some kind of fairness requirement on the *behaviour* of the *system* (e.g., "Objects of class X will produce requests to objects of class Y, no later than a given time T after condition A on objects of classes X, Y and Z is satisfied").

There are cases, however, in which an *invariant schema* in an information viewpoint specification is defined over a set of concrete *information objects*. Such a kind of *invariant schema* may be expressed by a package stereotyped as «IV_InvariantSchema», that contains the corresponding set of objects. The constraints on these objects, together with the specifications of the classifiers of these objects, constrain the possible states and state changes of the objects.

NOTE 2 – The classifiers of the objects will constrain the possible states and state changes of the objects to which they apply (through the associations, stateMachines, and constraints of these classifiers).

Finally, individual constraints stereotyped as «IV_InvariantSchema» can also be used to express *invariant schemata*.

8.2.6 Static schema

A *static schema* is expressed by a package stereotyped as «IV_StaticSchema» of objects, their attribute links, their link ends, which have an associated target link end which is navigable, and their classifiers.

NOTE – The possible associations of the *information objects* described in a *static schema* with other *objects* not contemplated in the schema need not be included in the package, since they are not part of the specification provided by the *schema*. Therefore, whenever the absence of an association instance (i.e., a link) needs to be expressed, it should be explicitly stated (e.g., by using constraints attached to the appropriate objects).

8.2.7 Dynamic schema

A *dynamic schema* is expressed in terms of stateMachines for the *information objects* in the information specification, stereotyped as «IV_DynamicSchema». The *actions* that relate to the *state* changes are expressed by signals that are sent and received on transitions of the stateMachines.

8.2.8 Summary of the UML extensions for the information language

The information language profile (IV_Profile) specifies how the information viewpoint modelling concepts relate to, and are expressed in, standard UML using stereotypes, tag definitions, and constraints.

Figure 18 shows the graphical representation of the UML profile for the information language, using the notation provided by UML.

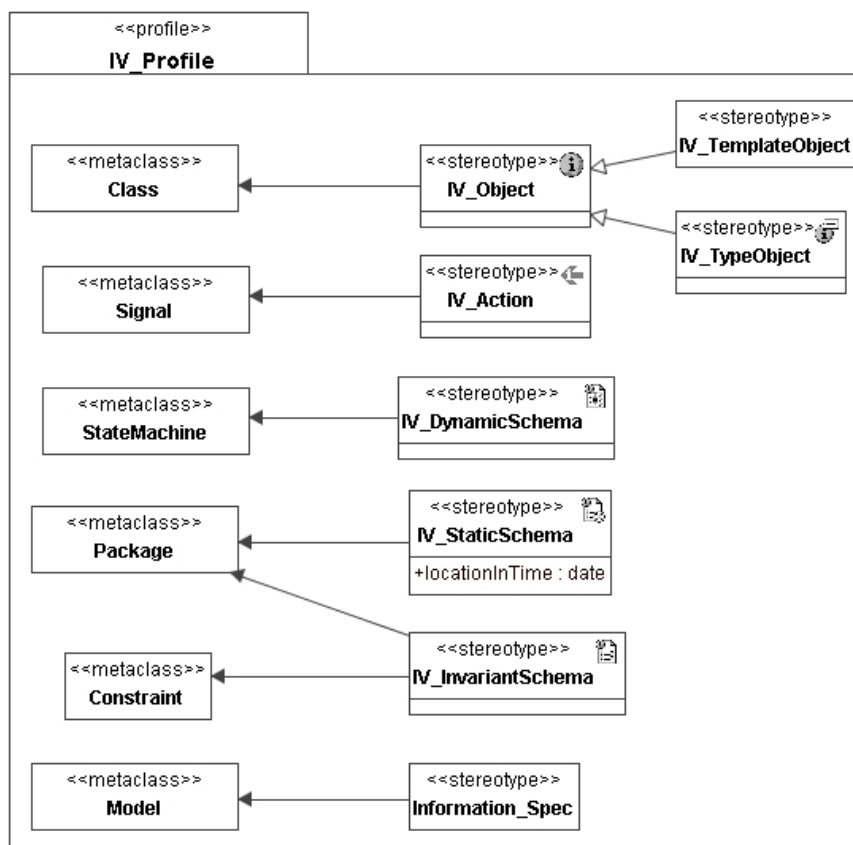

Figure 18 – Graphical representation of the information language profile

8.3 Information specification structure (in UML terms)

All the elements expressing the information specification are defined within a model, stereotyped «Information_Spec». Such a model contains the packages that express the *invariant*, *static* and *dynamic schemata* of the system.

These packages may be defined and organized as follows:

- in the first place, a set of «IV_InvariantSchema» packages with class diagrams will define the *information object* and *object types* of the system, their relationships, and the constraints on these elements;
- second, a set of «IV_StaticSchema» packages with object diagrams will express the state of the system, or parts of it, at specific locations in time that may be of interest to any of the system stakeholders. The classifiers of the instanceSpecifications of these diagrams should have been previously defined in the «IV_InvariantSchema» packages that define the structure and composition of the system;
- third, *dynamic schemata* expressed by individual stateMachines will be associated with the corresponding elements in the previous packages. Thus, individual stateMachines will be associated with the corresponding classifiers or instanceSpecifications. Likewise, constraints describing invariants and pre- and post-conditions of signals will be associated to the states of the stateMachines and with the corresponding classifier definitions;
- Finally, a set of «IV_InvariantSchema» constraints will impose further constraints on the elements of all the previous packages. Such constraints can be either directly attached to the corresponding elements, establishing an implicit context by attachment, or they can form part of a separate piece of specification in which the context of each constraint is explicitly established by naming.

8.4 Viewpoint correspondences for the information language

8.4.1 Contents of this clause

This clause describes the correspondence concepts for the information language, but not how they are expressed in UML. The latter is covered in clause 12.

8.4.2 Enterprise and information viewpoint specification correspondences

In general, not all the elements of the enterprise specification of a system need to correspond to elements of its information specification. However, the information viewpoint shall conform to the *policies* of the enterprise viewpoint and, likewise, all enterprise *policies* shall be consistent with the *static, dynamic, invariant schemata* of the information specification.

Where there is a correspondence between information and enterprise elements (e.g., between an *enterprise object* and the *information object* that stores the relevant information about it), the specifier shall provide:

- for each *enterprise object* and for each *artefact role* in an enterprise *action*, the corresponding configuration of *information objects* (if any) that model them in the information viewpoint;
- for each enterprise *role, action* and *process* in the enterprise viewpoint, the corresponding *dynamic* and *invariant schema* definitions in the information viewpoint that specify that *behaviour*;
- for each enterprise *policy* in the enterprise viewpoint, the constraints in the corresponding *schemata* that implement it, since enterprise *policies* may become constraints in any of the *schemata*.

NOTE – In the case of a notional incremental development process of the ODP viewpoint specifications, whereby the information specifications are developed taking into account the previously defined enterprise specifications, *information objects* may be discovered through examination of an enterprise specification. For example, each *artefact* referenced in any *actions* in which an *ODP System* participates will correspond in some way with one or more *information objects*.

8.4.3 Information and computational viewpoint specification correspondences

Not all the elements of the information specification of a system need to correspond to elements of its computational specification. In particular, not all states of an information specification need to correspond to states of a computational specification. There may exist transitional computational states within pieces of computational behaviour that are abstracted as atomic transitions in the information specification.

Where an *information object* corresponds to a set of *computational objects*, the *static* and *invariant schemata* of the *information object* correspond to possible *states* of the *computational objects*. Every change in state of an *information object* corresponds either to some set of *interactions* between *computational objects*, or to an *internal action* of a *computational object*. The *invariant* and *dynamic schemata* of the *information object* correspond to the *behaviour* and *environment contract* of the *computational objects*.

8.4.4 Information and technology viewpoint specification correspondences

While there may be specific correspondences between information *schemata* and technology viewpoint specifications that require the use of particular technologies, there are neither required correspondences nor required correspondence statements.

NOTE – There may be cases where part of an information viewpoint specification has a direct relationship with a technology viewpoint specification or a choice of technology. Such examples include *invariant schemata* covering performance (e.g., response time) or security.

9 Computational specification

9.1 Modelling concepts

A computational specification uses the RM-ODP computational language. The modelling concepts and the structuring rules of the computational language are defined in [Part 3 – 7]. Some of the concepts in Part 2 of RM-ODP are also used when defining the computational language concepts. The concepts and structuring rules are summarized in this clause. Except where otherwise stated, in case of conflict between the explanations herein and the text in Parts 2 or 3, the latter document should be followed.

The set of diagrams at the end of this clause (i.e., at [9.1.22]) summarizes a metamodel for the computational language.

NOTE – Another partial metamodel for the computational language can be found in Rec. ITU-T X.960|ISO/IEC 14769: Type Repository Function, which is concerned with the storage and management of computational type systems. That metamodel is therefore a partial view concentrating on the computational type system, rather than on system design in general. Readers should be aware that:

- a) cardinality constraints on types are not, in general, the same as the cardinality constraints on instances – an interface must be associated with an object, but an interface type can be defined independently of an object type;
- b) the different focus there leads to different choices of primary relations, so that some relations that are explicit in that metamodel are derived in this representation, and vice versa.

If there is any ambiguity, statements in this Recommendation | International Standard take precedence.

9.1.1 Computational object

An *object* is a model of an entity. An *object* is characterized by its *behaviour* and, dually, by its *state*. An *object* is distinct from any other *object*. An *object* is encapsulated, i.e., any change in its *state* can only occur as a result of an *internal action* or as a result of an *interaction* with its *environment*.

A *computational object* is an *object* as seen in the computational viewpoint. It models functional decomposition and interacts with other *computational objects*. Since it is an *object*, it has *state* and *behaviour*, and *interactions* are achieved through *interfaces*.

9.1.2 Interface [Part 2 – 8.4]

An *interface* is an abstraction of the *behaviour* of an *object* that consists of a subset of the *interactions* of that *object* together with a set of constraints on when they can occur.

9.1.3 Interaction [Part 2 – 8.3]

An *interaction* is one of two defined kinds of *actions*. *Action* itself is defined as something that happens, and every *action* of interest for modelling purposes is associated with at least one *object*. The set of *actions* associated with an *object* is partitioned into *internal actions* and *interactions*. An *internal action* always takes place without the participation of the *environment* of the *object*. An *interaction* takes place with the participation of the *environment* of the *object*.

9.1.4 Environment contract [Part 2 – 11.2.3]

Environment contract is a contract between an *object* and its *environment*, including Quality of Service (QoS) constraints, usage and management constraints.

QoS constraints include:

- temporal constraints (e.g., deadlines);
- volume constraints (e.g., throughput);

- dependency constraints covering aspects of availability, reliability, maintainability, security and safety (e.g., mean time between failures).

QoS constraints can imply usage and management constraints. For instance, some QoS constraints (e.g., availability) are satisfied by provision of one or more distribution transparencies (e.g., replication).

An *environment contract* can describe both:

- requirements placed on an *object's environment* for the correct *behaviour* of the *object*;
- constraints on the *object behaviour* in a correct *environment*.

9.1.5 Behaviour (of an object) [Part 2 – 8.6]

Behaviour of an *object* is a collection of *actions* with a set of constraints on when they may occur.

The specification language in use determines the constraints that may be modelled. Constraints may include, for example, sequentiality, nondeterminism, concurrency or real-time constraints.

Behaviour may include internal actions.

The *actions* that actually take place are restricted by the *environment* in which the *object* is placed.

9.1.6 Signal [Part 3 – 7.1.1]

A *signal* is an atomic shared *action* resulting in one-way *communication* from an initiating object to a responding object.

9.1.7 Operation [Part 3 – 7.1.3]

An *operation* is an *interaction* between a client *object* and a server *object* which is either an *interrogation* or an *announcement*.

9.1.2 Announcement [Part 3 – 7.1.3]

An *announcement* is an *interaction*, the *invocation*, initiated by a client *object* resulting in the conveyance of information from that client *object* to a server *object*, requesting a function to be performed by that server *object*.

9.1.9 Interrogation [Part 3 – 7.1.4]

An *interrogation* is an *interaction* consisting of:

- one *interaction*, the *invocation*, initiated by a client *object*, resulting in the conveyance of information from that client *object* to a server *object*, requesting a function to be performed by the server *object*;
followed by
- a second *interaction*, the *termination*, initiated by the server *object*, resulting in the conveyance of information from the server *object* to the client *object* in response to the invocation.

9.1.10 Flow [Part 3 – 7.1.5]

A *flow* is an abstraction of a sequence of *interactions*, resulting in conveyance of information from a producer *object* to a consumer *object*.

NOTE – A flow may be used to abstract over, for example, the exact structure of a sequence of interactions, or over a continuous interaction including the special case of an analogue information flow.

9.1.11 Signal interface [Part 3 – 7.1.6]

A *signal interface* is an *interface* in which all the *interactions* are *signals*.

9.1.12 Operation interface [Part 3 – 7.1.7]

An *operation interface* is an *interface* in which all the *interactions* are *operations*.

9.1.13 Stream interface [Part 3 – 7.1.4]

A *stream interface* is an *interface* in which all the *interactions* are *flows*.

9.1.14 Computational object template [Part 3 – 7.1.9]

A *computational object template* is an *object template* which comprises a set of computational *interface templates* that the object can instantiate, a *behaviour* specification and an *environment contract* specification.

9.1.15 Computational interface template [Part 3 – 7.1.9]

A *computational interface template* is an *interface template* for either a *signal interface*, a *stream interface* or an *operation interface*. A *computational interface template* comprises a *signal*, a *stream* or an *operation interface signature* as appropriate, a *behaviour* specification and *environment contract* specification.

9.1.16 Signal interface signature [Part 3 – 7.1.11]

A *signal interface signature* is an *interface signature* for a *signal interface*. A *signal interface signature* comprises a finite set of *action templates*, one for each *signal type* in the *interface*. Each *action template* comprises the name for the *signal*, the number, names and types of its parameters and an indication of causality (initiating or responding, but not both) with respect to the *object* that instantiates the *template*.

9.1.17 Operation interface signature [Part 3 – 7.1.12]

An *operation interface signature* is an *interface signature* for an *operation interface*. An *operation interface signature* comprises a set of *announcement* and *interrogation signatures* as appropriate, one for each *operation type* in the *interface*, together with an indication of causality (client or server, but not both) for the *interface* as a whole, with respect to the *object* which instantiates the *template*.

Each *announcement signature* is an *action template* containing the name of the *invocation* and the number, names and types of its parameters.

Each *interrogation signature* comprises an *action template* with the following elements:

- the name of the *invocation*;
- the number, names and types of its parameters;
- a finite, non-empty set of *action templates*, one for each possible *termination type* of the *invocation*, each containing both the name of the *termination* and the number, names and types of its parameters.

9.1.18 Stream interface signature [Part 3 – 7.1.13]

A *stream interface signature* is an *interface signature* for a *stream interface*. A *stream interface* comprises a finite set of *action templates*, one for each *flow type* in the *stream interface*. Each *action template* for a *flow* contains the name of the *flow*, the *information type* of the *flow*, and an indication of causality for the *flow* (i.e., producer or consumer but not both) with respect to the object which instantiates the *template*.

9.1.19 Binding object [Part 3 – 7.1.14]

A *binding object* is a *computational object* that supports a *binding* between a set of other *computational objects*.

9.1.20 Binding [Part 2 – 13.4, Part 3 – 7.2.3]

A *binding behaviour* is an *establishing behaviour* between two or more *interfaces* (and hence between their supporting *objects*). The contractual context, resulting from a given *establishing behaviour*, is called a *binding*.

In Part 3, *binding* is defined with reference to *binding actions*. Use of such actions is called *explicit binding*. There are two kinds of *binding actions*: *primitive binding actions* and *compound binding actions*. A *primitive binding action* binds two *computational objects* directly. A *compound binding action* can be expressed in terms of *primitive binding actions* linking two or more *computational objects* via a *binding object*.

In notations which have no terms for expressing *binding actions*, *binding* is *implicit*. *Implicit binding* for other than server *operation interfaces* is not defined in the reference model.

9.1.21 Transparency schema [Part 3 – 16]

A *transparency schema* identifies those *transparencies* required by a computational specification. These transparencies are constraints for a mapping from the computational specification to a specification that uses specific ODP functions and engineering structures. It defines a combination of *distribution transparencies* assumed by the computational specification.

NOTE – As described in [Part 3 – 16], the *distribution transparencies* include *access transparency*, *failure transparency*, *location transparency*, *migration transparency*, *persistence transparency*, *relocation transparency*, *replication transparency*, and *transaction transparency*.

9.1.22 Structure of a computational specification

A computational specification describes the functional decomposition of an *ODP system*, in distribution transparent terms, as:

- a configuration of *computational objects*;
- the *internal actions* of those *objects*;
- the *interactions* that occur among those *objects*;
- *environment contracts* for those *objects* and their *interfaces*.

The set of *computational objects* specified by the computational specification constitute a configuration that will change as the *computational objects* instantiate further *computational objects* or *computational interfaces*, perform *binding actions*, effect control functions upon *binding objects*, delete *computational interfaces* or delete *computational objects*.

The computational language defines a set of rules that constrain a computational specification. These comprise:

- *interaction* rules, *binding* rules and *type* rules that provide distribution transparent interworking;
- *template* rules that apply to all *computational objects* and *computational interfaces*;
- *failure* rules that apply to all *computational objects* and identify the potential points of *failure* in computational activities.

9.1.23 Summary of the concepts of the computational metamodel

Figure 19 illustrates the concepts of the computational language and the relationships between them. The descriptions of the concepts have been given above. The descriptions of the relationships between the concepts are included in the description of the concepts.

NOTE – Some of the relationships between computational language concepts are not shown in Figure 19, e.g., the relationship between interface and signature, since they are related through their supertypes.

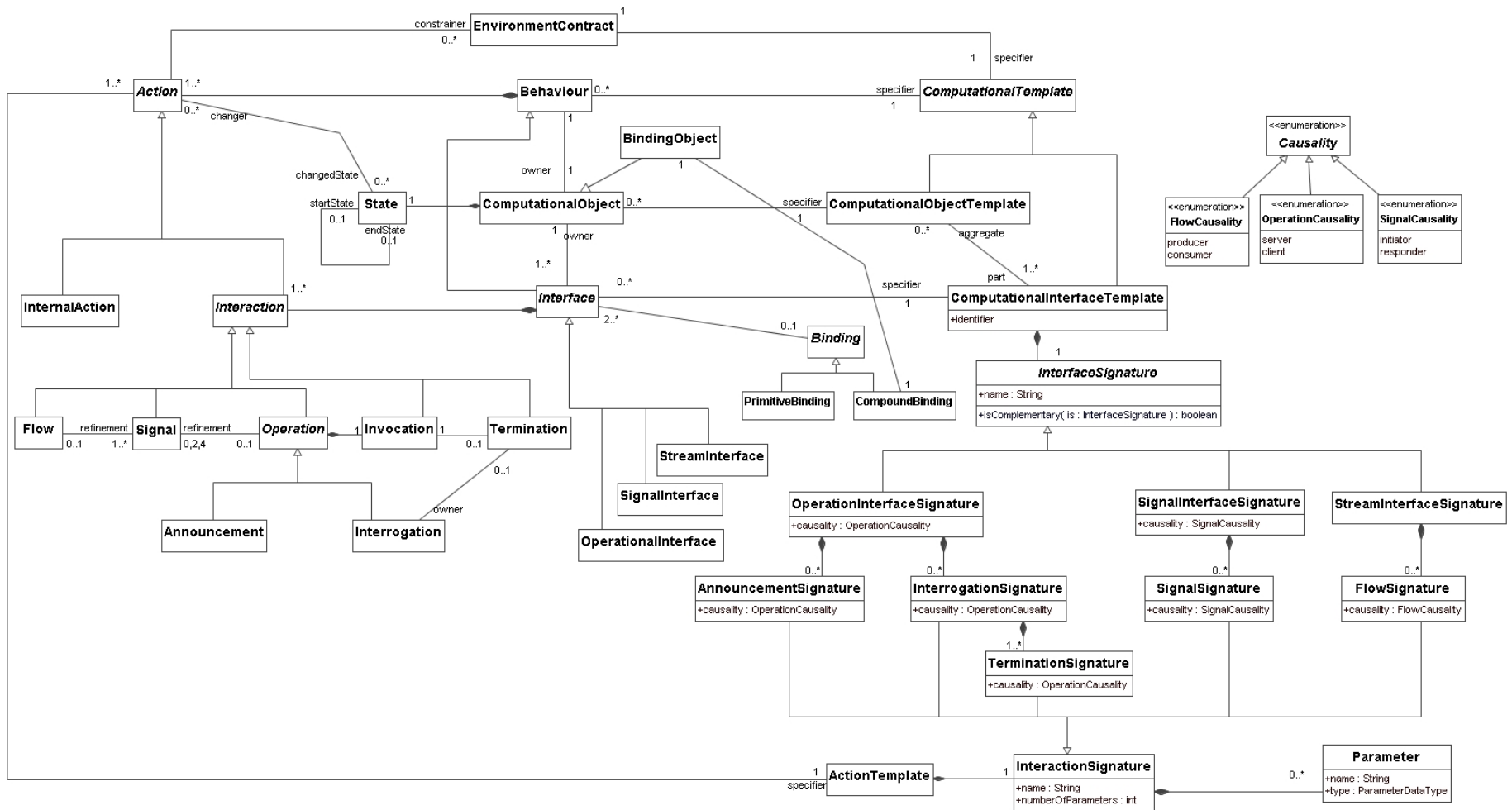

Figure 19 – Computational language concepts

The following restrictions apply to the elements of the diagram shown in Figure 19:

- A *binding object* is associated with at least two different *objects*;
- A *binding object* binds two or more *objects* through the same type of *interface* (*signal*, *announcement*, *interrogation*, or *flow*);
- All *interfaces* associated with a *signal interface signature* are *signal interfaces* [9.2.9], and all its constituent *interaction signatures* are *signal signatures*:
 - context** Signal **inv** SignalSignature: self.interface->forAll(oclIsTypeOf(SignalInterface))
 - context** SignalInterface **inv** SignalSignature: self.specifier->forAll(oclIsTypeOf(SignalSignature))
 - context** SignalInterface **inv** SignalInterfaceSignature:
self.specifier->forAll(oclIsTypeOf(SignalInterfaceSignature))
- All *interfaces* associated with an *operation interface signature* are *operation interfaces* [9.2.9], and all its constituent *interaction signatures* are *announcement*, *interrogation*, *invocation* or *termination signatures*:
 - context** Announcement **inv** AnnouncementSignature:
self.interface->forAll(oclIsTypeOf(OperationInterface))
 - context** Invocation **inv** InvocationSignature: self.interface->forAll(oclIsTypeOf(OperationInterface))
 - context** Termination **inv** TerminationSignature:
self.interface->forAll(oclIsTypeOf(OperationInterface))
 - context** OperationInterface **inv** OperationInterfaceSignature:
self.specifier->forAll(oclIsTypeOf(OperationInterfaceSignature))
- All *interfaces* associated with a *stream interface signature* are *stream interfaces* [9.2.9]:
 - context** Flow **inv** StreamSignature: self.interface->forAll(oclIsTypeOf(StreamInterface))
 - context** StreamInterface **inv** StreamInterfaceSignature:
self.specifier->forAll(oclIsTypeOf(StreamInterfaceSignature))

9.2 UML profile

This clause specifies how the ODP computational concepts described in the previous clause are expressed in UML in a computational specification. A brief explanation of the UML concepts used in the expression of each concept is given, together with a justification of the expression used.

NOTE 1 – In this clause UML expressions are only defined for those concepts for which use has been demonstrated through an example, included in the main body of this Recommendation | International Standard or in its annexes. Where no example has been identified, the concept concerned is mentioned, but no UML expression is offered.

NOTE 2 – The concepts and rules of the computational language concern the decomposition of the system's functionality into computational objects performing individual functions and interacting at interfaces and thus provide the basis for decisions on how to distribute the tasks to be done. This level of abstraction deals with aspects related to the software architecture of the system, and therefore the appropriate UML mechanisms for modelling software architectures are used in this text (components, ports, and interfaces).

NOTE 3 – The computational viewpoint assumes that the specifier selects a certain level of refinement below which the use of the concept of *computational object* ceases to be essential; these lower level specification concerns, such as the realization of the behaviour of *computational objects*, are outside the scope of the profile described here, and are addressed by other specification techniques and languages, including the direct use of UML concepts and rules. Thus, this profile covers the specification of *computational objects* at the level of UML components that interact through their ports, but leaves open to the specifier the way in which the internal realization of such components is specified.

9.2.1 Computational object

A *computational object* is generally specified in terms of its *template*, which is expressed by a component stereotyped as «CV_Object».

The attribute `isIndirectlyInstantiated` of such a component should be set to true. This attribute constrains the kind of instantiation that applies to a component. If false, the component is instantiated as an addressable instance. If true (default value), the component is defined at design-time, but at runtime (or execution-time) an instance specified by the component does not exist, that is, the component is instantiated indirectly, through the instantiation of its realizing classifiers or parts.

Where a *computational object* is required to represent a specific entity in the UOD, it is expressed by an `instanceSpecification` of a component that is stereotyped as «CV_Object».

Where there is the need to express a *computational object type*, it is also expressed by a UML component, stereotyped as «CV_Object». The attribute `isIndirectlyInstantiated` of the component stereotyped «CV_Object» should be set to true.

When a component stereotyped as «CV_Object» expresses a *computational object template*, the attribute `isAbstract` of such a component should be set to `false`, meaning that the component needs to provide all the information required to instantiate objects.

9.2.2 Object types and templates as computational objects

There are cases where there is the need to model the *type* or *template* of a *computational object* at the instance level. An example is the case of a generic factory, which is invoked by passing it a representation of a *template* (which has *type template*), and responds by instantiating the *template* and returning a reference to the created *object*. To indicate that an *object* is derived from a given *template*, we need to represent both the *template object* and the instantiated *object* in the model. Likewise for *types*, to indicate that an *object* conforms to a given *type*, we need to represent both the *object* and its *object type* in the model.

Both *type objects* and *template objects* are *computational objects*, and therefore are expressed by components that express their *type* or *template*. To distinguish them from other *computational objects*, such components are stereotyped «CV_TypeObject» or «CV_TemplateObject», respectively. Both stereotypes inherit from «CV_Object».

The relationship between a *computational object* and the *object* that represents its *template*, or the *objects* that represent its *types* can be expressed as an attribute of the class that specifies the *computational object*.

For example, in some specifications, such as in the ODP Trading Function specification, there is the need to specify the type of a service, so the trader can locate objects implementing such a service. The diagram shown in Figure 20 represents the specification of a *computational object*, **PrintService**, and of its *type*, **PrintServiceType**, expressed so that type can be manipulated by computational operations.

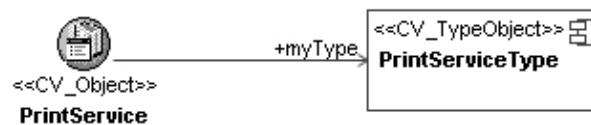

Figure 20 – An explicit representation of the type of a computational object so that the object can access its type

9.2.3 Binding object

A *binding object* is a kind of *computational object*, and is expressed by an `instanceSpecification` of a component, stereotyped as «CV_BindingObject», that represents its *type* or *template*.

The following two restrictions apply to *binding objects*, and therefore to components stereotyped «CV_BindingObject»:

- Any *binding object* is associated with at least two different *objects*;
- Any *binding object* binds two or more *objects* through the same *type* of *interface* (*signal*, *announcement*, *interrogation*, or *flow*).

9.2.4 Environment contract

An *environment contract* of a *computational object* is expressed by a set of constraints (stereotyped «CV_EnvironmentContract») applied to the component that expresses the *computational object*.

9.2.5 Signal

A *signal* is expressed by a message, stereotyped as «CV_Signal», sent by an *initiating object* and received by a *responding object*.

9.2.6 Announcement

An *announcement* is expressed by a message, stereotyped as «CV_Announcement», sent by a *client object* and received by a *server object* with no response expected.

9.2.7 Invocation

An *invocation* is a part of *interrogation* and is expressed by a message, stereotyped as «CV_Invocation», sent by a *client object* and received by a *server object*.

9.2.8 Termination

A *termination* is a part of an *interrogation* and is expressed by a message, stereotyped as «CV_Termination», sent by a *server object* and received by a *client object*.

9.2.9 Computational interface

Computational interface templates are expressed by ports, that can be stereotyped «CV_SignalInterface», «CV_OperationInterface» or «CV_StreamInterface» depending on the type of *interface* (*signal*, *operation* or *stream*). Thus, an *interface* of a *computational object* is expressed by a port of a component instance, instantiated from the corresponding component that expresses the *object's computational interface template*.

In order to express the *causality* of an *operation interface*, the stereotype «CV_OperationInterface» has a tag definition, *causality*, of type OperationCausality (an Enumeration type whose literals are client and server).

In order to express the *causality* of a *signal interface*, the stereotype «CV_SignalInterface» has a tag definition, *causality*, of type SignalCausality (an Enumeration type whose literals are consumer and producer).

The stereotype «CV_StreamInterface» does not have any tag definition, because *stream interfaces* do not have *causality*.

9.2.10 Computational interface signature

A *computational interface signature* is expressed by an interface, stereotyped «CV_SignalInterfaceSignature», «CV_OperationInterfaceSignature» or «CV_StreamInterfaceSignature» depending on the type of *interface signature* (*signal*, *operation* or *stream*).

9.2.11 Computational signature

A *computational signature* can be expressed by a reception, an operation, or an interface, depending on the sort of signature. Receptions are used to express *signatures* of *computational interactions* which are expressed by individual *signals* (*signals*, *announcements*, *invocations* and *terminations*). Operations can be used to express *interrogation signatures* that are composed of an *invocation signature* and a *termination signature*. Finally, interfaces are used for expressing *flow signatures* [9.2.18].

9.2.12 Signal signature

A *signal signature* is expressed by a reception, stereotyped as «CV_SignalSignature». This stereotyped reception expresses an *action template* which includes the name for the signal, the number, names and types of its parameters, and indication of whether it is initiating or responding.

9.2.13 Announcement signature

An *announcement signature* is a *signature* for an *announcement*. An *announcement signature* is expressed by a reception, stereotyped as «CV_AnnouncementSignature». This stereotyped interface expresses an *action template* which includes the name for the invocation, the number, names and types of its parameters, and an indication of whether it is a client or a server.

9.2.14 Invocation signature

An *invocation signature* is a *signature* for an *invocation* in an *interrogation*. An *invocation signature* is expressed by a reception, stereotyped as «CV_InvocationSignature». This stereotyped reception expresses an *action template* which includes the name for the *invocation*, the number, names and types of its parameters, and an indication of whether it is a client or a server.

9.2.15 Termination signature

A *termination signature* is a *signature* for a *termination* for *interrogation*. A *termination signature* is expressed by a reception, stereotyped as «CV_TerminationSignature». This stereotyped reception expresses an *action template* which includes the name for the *termination*, the number, names and types of its parameters, and indication of whether it is a client or a server.

The Stereotype «CV_TerminationSignature» has a tag definition, *invocation*, whose type is Reception, that refers to the *invocation* for which this reception is a *termination*.

9.2.16 Interrogation signature

An *interrogation signature* is a *signature* for an *interrogation*, which comprises signatures for an *invocation* and a *termination*.

In the case of an *interrogation signature* comprising one *invocation signature* and one *termination signature*, the *interrogation signature* can be expressed by an operation, stereotyped as «CV_InterrogationSignature». This stereotyped operation expresses an *action template* which includes the name for the *invocation*, the number, names and types of its parameters, the indication of whether it is a client or a server, and the number, names and types of the *termination's* parameters.

Alternatively, an *interrogation signature* can be modelled in terms of one *invocation signature* [9.2.14] and separate *termination signatures* [9.2.15].

NOTE – This alternative modelling approach may be used, for example, in the case of an *interrogation* comprising one *invocation* and possibly multiple kinds of *termination*.

9.2.17 Bindings

An *explicit primitive binding* is expressed by an assembly connector, stereotyped as «CV_PrimitiveBinding». Such a connector can be defined from a required interface to a provided interface, or from a required port to a provided port.

For example, suppose the following representation in UML of *operation interface signatures* **ServiceA** and **Service**, as shown in Figure 21:

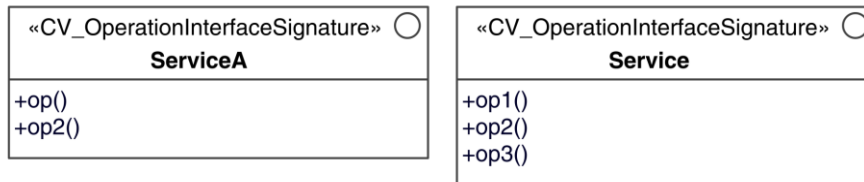

Figure 21 – Two operation interface signatures

Then, the diagram shown in Figure 22 represents an *explicit primitive binding* between the corresponding *interfaces* of *computational objects* **ClientA** and **Server**:

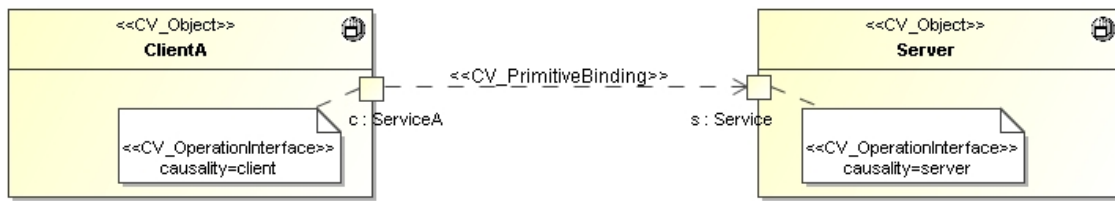

Figure 22 – An explicit primitive binding between two interfaces

As another example, assuming the specification of *operation interface signatures* **ServiceA** and **Service** as above, the diagram shown in Figure 23 represents an *explicit primitive binding* between the corresponding *interfaces* of *computational objects* **ClientA** and **Server**, but showing explicitly the *interface signatures* of both *interfaces* (stereotypes and tag values of the ports representing such *interfaces* have been omitted for clarity).

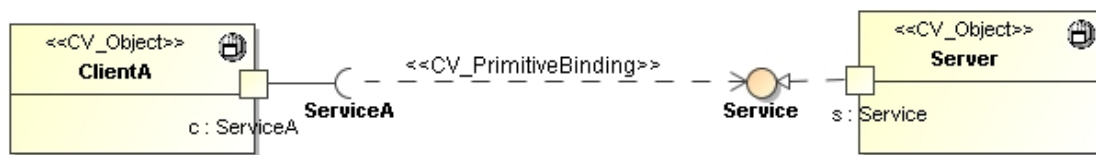

Figure 23 – An explicit primitive binding between two interfaces showing their interface signatures

The following restrictions apply to assembly connectors, stereotyped as «CV_PrimitiveBinding»:

- If they connect interfaces, they are both stereotyped «CV_OperationInterfaceSignature» and the *operation interface signature* expressed by the client interface is a *subtype* of the *operation interface signature* expressed by the server interface [Part 3 – 7.2.3];
- If they connect ports, then: (a) these ports are stereotyped «CV_SignalInterface», «CV_OperationInterface» or «CV_StreamInterface», (b) their stereotypes coincide, and (c) the *interface* expressed by the client port is *compatible* with the *interface* expressed by the server port, according to the *primitive binding rules* defined in [Part 3 – 7.2.3];
- If they connect ports stereotyped «CV_StreamInterface», the fact that *stream interfaces* do not have causality implies that the assignment of direction (that is, the designation of the client element) is irrelevant.

An *implicit primitive binding* can only happen between interfaces specifying *operation interface signatures*, and only when the required interface coincides with the provided interface; then there is no need to represent the connector.

NOTE – In this case the "ball and socket" connection representation can be used, as shown in Figure 24.

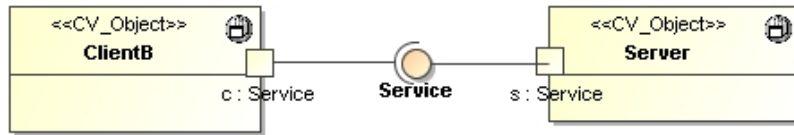

Figure 24 – An implicit primitive binding between two interfaces

Compound bindings are expressed by representing the corresponding *binding objects* and their *bindings* with the *bound objects*.

9.2.18 Flow

A *flow* is expressed by a property, stereotyped as «CV_Flow». The property belongs to an interface stereotyped as «CV_StreamInterfaceSignature», which represents the *stream interface signature* where the *flow* is defined.

The name of the property expresses the name of the *flow*. The type of the property expresses the *flow signature*, which is expressed by an interface, stereotyped as «CV_FlowSignature». The *causality* of the *flow* (*consumer* or *producer*) is expressed by the tag definition, causality, of stereotype «CV_Flow». The type of this tag definition is FlowCausality (an Enumeration type whose literals are producer and consumer).

For example, the diagram shown in Figure 25 represents the software architecture of a teleconference system, composed of two kinds of *computational objects* (Presenter and Participant) interacting at their *computational interfaces*.

The **Presenter** object provides one *operation interface* for control (expressed by the port **ctrl**, stereotyped «CV_OperationInterface», whose *signature* is expressed by the interface **IControl**), and one *stream interface* (expressed by the port **c**, stereotyped «CV_StreamInterface», whose *signature* is expressed by the interface **AVConference**). This *stream interface* defines four *flows*, one for producing video frames, two for producing audio frames, and one for consuming audio).

The **Participant** object offers the dual *interfaces*, one for controlling the **Participant**, and one for *binding* to its *stream interface*.

Control *interfaces* are bound using an *implicit binding*, whilst the *stream interfaces* are bound using a *primitive binding*, i.e., no *binding object* is required.

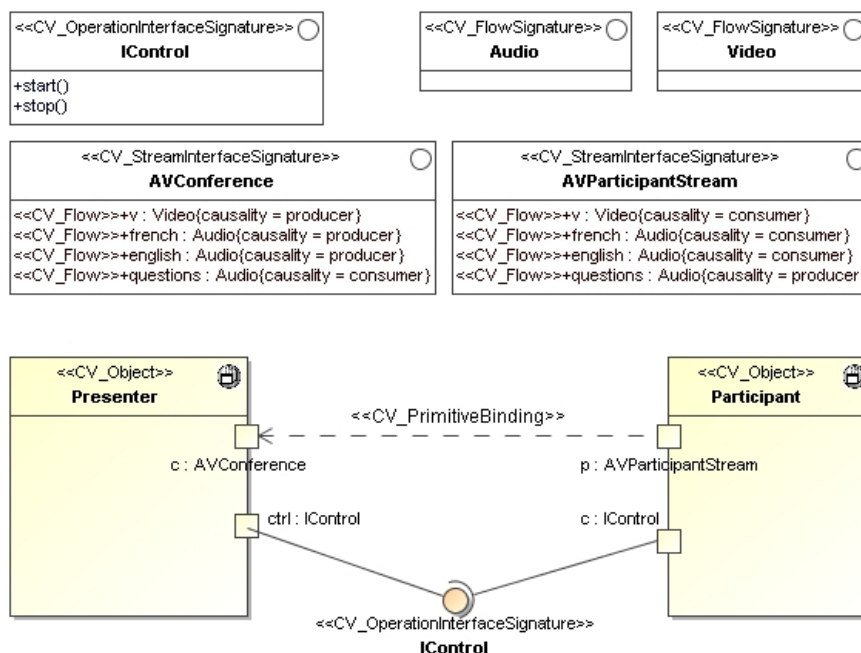

Figure 25 – An example of the specification of flows

9.2.19 Transparency schema

A *transparency schema* is expressed by a stereotype «CV_Transparency» defining a set of tags applied to a model that is stereotyped as «Computational_Spec», a «CV_Interface» or a «CV_Object». There is one tag for each of the

transparencies defined in [Part 3 – 16], except for *access* and *location* transparencies, which are mandatory for any computational specification.

The type of these tag definitions is boolean, and indicates whether the particular transparency is required for the computational specification or not.

9.2.20 Summary of the UML extensions for the computational language

The computational language profile (CV_Profile) specifies how the computational viewpoint modelling concepts relate to, and are expressed in, standard UML using stereotypes, tag definitions, and constraints.

The following shows diagrammatic representations of this UML profile.

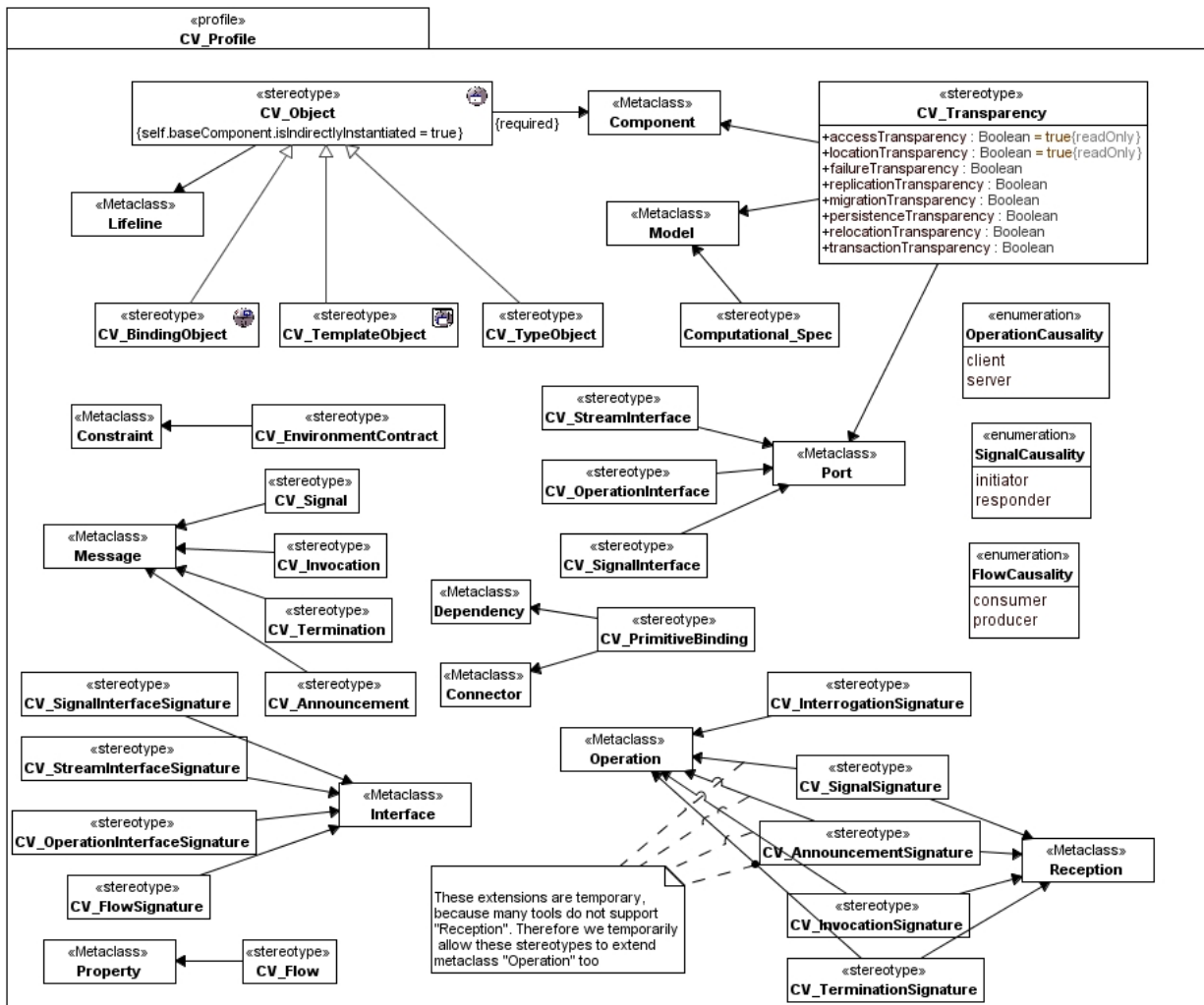

Figure 26 – Graphical representation of the computational language profile (using the UML notation)

The following constraints apply to the elements of the profile:

- The constraint `baseComponent.isIndirectlyInstantiated=true` means that the component is defined at design-time, but at runtime (or execution-time) an instance specified by the component does not exist, that is, the component is instantiated indirectly, through the instantiation of its realizing classifiers or parts;
- A component expressing a *computational object template* has ports and interfaces for *interaction* with other *computational objects*.

In addition, the elements of the computational language (shown in Figure 19) are subject to a set of restrictions, as described in [9.1.22]. The constraints that implement those restrictions on the corresponding profile elements should also apply.

9.3 Computational specification structure (in UML terms)

All the elements expressing the computational specification are defined within a model, stereotyped «Computational_Spec». Such a model contains packages that express:

- a configuration of *computational objects* with dependencies among those *objects* using required and provided interfaces and signatures they provide, with a component diagram;
- structure of *computational objects* including composition and decomposition of *computational objects*, with a component diagram;
- *environment contract* for *computational objects*, with constraints on elements;
- *interactions* between *computational objects*, and *interactions* between *composed computational objects* within a *computational object*, with UML activity diagrams, state charts, and interaction diagrams.

9.4 Viewpoint correspondences for the computational language

9.4.1 Contents of this clause

This clause describes the correspondence concepts for the computational language, but not how they are expressed in UML. The latter is covered in clause 12.

9.4.2 Enterprise and computational viewpoint specification correspondences

The specifier shall provide:

- for each *enterprise object* in the enterprise specification, the configuration of *computational objects* (if any) that realizes the required *behaviour*;
- for each *interaction* in the enterprise specification, a list of those *computational interfaces* and *operations* or *streams* (if any) that correspond to the enterprise *interaction*, together with a statement of whether this correspondence applies to all occurrences of the *interaction*, or is qualified by a predicate;
- for each *role* affected by a *policy* in the enterprise specification, a list of the *computational object types* (if any) that exhibit choices in the *computational behaviour* that are modified by the *policy*;
- for each *interaction* between *roles* in the enterprise specification, a list of *computational binding object types* (if any) that are constrained by the enterprise *interaction*;
- for each enterprise *interaction type*, a list of *computational behaviour types* (if any) capable of modelling (i.e., acting as a carrier for) the enterprise *interaction type*.

If a process based approach is taken, the specifier shall provide:

- for each *step* in the *process*, a list of participating *computational objects* which may fulfil one or more of *actor roles*, *artifact roles*, or *resource roles*.

9.4.3 Information and computational viewpoint specification correspondences

This Recommendation | International Standard does not prescribe exact correspondences between *information objects* and *computational objects*. In particular, not all *states* of a computational specification need to correspond to *states* of an information specification. There may exist transitional computational *states* within pieces of *computational behaviour* that are abstracted as atomic transitions in the information specification.

Where an *information object* corresponds to a set of *computational objects*, *static* and *invariant schemata* of an *information object* correspond to possible *states* of the *computational objects*. Every change in *state* of an *information object* corresponds either to some set of *interactions* between *computational objects* or to an *internal action* of a *computational object*. The *invariant* and *dynamic schemata* of the *information object* correspond to the *behaviour* and *environment contract* of the *computational objects*.

9.4.4 Computational and engineering viewpoint specification correspondences

Each *computational object* that is not a *binding object* corresponds to a set of one or more *basic engineering objects* (and any *channels* which connect them). All the *basic engineering objects* in the set correspond only to that *computational object*.

Except where transparencies which replicate objects are involved, each *computational interface* corresponds exactly to one *engineering interface*, and that *engineering interface* corresponds only to that *computational interface*.

NOTE 1 – The *engineering interface* is supported by one of the *basic engineering objects* that corresponds to the *computational object* supporting the *computational interface*.

Where transparencies that replicate *objects* are involved, each *computational interface* of the *objects* being replicated corresponds to a set of *engineering interfaces*, one for each of the *basic engineering objects* resulting from the replication. These *engineering interfaces* each correspond only to the original *computational interface*.

Each *computational interface* is identified by any member of a set of one or more *computational interface* identifiers. Each *engineering interface* is identified by any member of a set of one or more *engineering interface references*. Thus, since a *computational interface* corresponds to an *engineering interface*, an identifier for a *computational interface* can be modelled unambiguously by an *engineering interface reference* from the corresponding set.

Each *computational binding* (either *primitive bindings* or *compound bindings* with associated *binding objects*) corresponds to either an *engineering local binding* or an *engineering channel*. This *engineering local binding* or *channel* corresponds only to that *computational binding*. If the *computational binding* supports *operations*, the *engineering local binding* or *channel* shall support the interchange of at least:

- *computational signature* names;
- *computational operation* names;
- *computational termination* names;
- *invocation* and *termination* parameters (including *computational interface* identifiers and *computational interface signatures*).

Except where transparencies that replicate *objects* are involved, each *computational binding object control interface* has a corresponding *engineering interface*, and there exists a chain of *engineering interactions* linking that *interface* to any *stubs*, *binders*, *protocol objects* or *interceptors* to be controlled in support of the *computational binding*.

NOTE 2 – The set of *control interfaces* involved depends on the *type* of the *binding object*.

Each *computational interaction* corresponds to some chain of *engineering interactions*, starting and ending with an *interaction* involving one or more of the *basic engineering objects* corresponding to the interacting *computational objects*.

Each *computational signal* corresponds either to an *interaction* at an *engineering local binding* or to a chain of *engineering interactions* that provides the necessary consistent view of the *computational interaction*.

The transparency prescriptions in [Part 3 – 16] specify additional correspondences.

NOTE 3 – *Basic engineering objects* corresponding to different *computational objects* can be members of the same *cluster*.

NOTE 4 – In an entirely object-based computational language, data are represented as abstract data types (i.e., *interfaces* to *computational objects*).

NOTE 5 – *Computational interface* parameters (including those for abstract data types) can be passed by reference, such parameters correspond to *engineering interface* references.

NOTE 6 – *Computational interface* parameters (including those for abstract data types) can be passed by migrating or replicating the *object* supporting the *interface*. In the case of migration such parameters correspond to *cluster templates*.

NOTE 7 – If the abstract *state* of a *computational object* supporting an *interface* parameter is invariant, the *object* can be cloned rather than migrated.

NOTE 8 – *Cluster templates* can be represented as abstract data types. Thus strict correspondences between computational parameters and *engineering interface references* are sufficient. The use of *cluster templates* or data are important engineering optimisations and therefore not excluded.

10 Engineering specification

10.1 Modelling concepts

This clause is based on the modelling concepts for use in an engineering specification that are defined, together with the structuring rules for their use, in [Part 3 – 8]. The explanations of the concepts in the text that follows are not normative and, in case of conflicts between these explanations and the text in [Part 3 – 8], the latter should be followed.

An engineering specification includes the definition of mechanisms and functions required to support distributed interaction between objects in an ODP system. The concepts, rules and structures contained in an engineering specification (the engineering language) are dependent upon the functionality offered by the platform chosen for the ODP system.

The modelling concepts and structuring rules defined in [Part 3 – 8] assume a platform that offers only minimal support for distribution. Where the platform for the system offers significant support for distribution, a language and a UML profile appropriate for that platform can be used

The set of diagrams at the end of this clause (i.e., at [10.1.5]) summarizes a metamodel for the engineering language.

10.1.1 Basic concepts**10.1.1.1 Basic engineering object**

A *basic engineering object* is an *engineering object* that requires the support of a distributed infrastructure.

10.1.1.2 Cluster

A *cluster* is a configuration of *basic engineering objects* forming a single unit for the purposes of *deactivation*, *checkpointing*, *reactivation*, *recovery* and *migration*.

10.1.1.3 Cluster manager

A *cluster manager* is an *engineering object* that manages the *basic engineering objects* in a *cluster*.

10.1.1.4 Capsule

A *capsule* is a configuration of *engineering objects* forming a single unit for the purpose of encapsulation of processing and storage.

10.1.1.5 Capsule manager

A *capsule manager* is an *engineering object* that manages the *engineering objects* in a *capsule*.

10.1.1.6 Nucleus

A *nucleus* is an *engineering object* that coordinates processing, storage and communications functions for use by other *engineering objects* within the *node* to which it belongs.

10.1.1.7 Node

A *node* is a configuration of *engineering objects* forming a single unit for the purpose of *location in space*, and that embodies a set of processing, storage and communication functions.

10.1.1.8 Engineering interfaces and signatures

Engineering objects expose engineering interfaces. The set of related concepts dealing with interfaces and their corresponding signatures exactly parallel those defined in the computational viewpoint for computational objects. They are signal interface, operation interface, stream interface, signal interface signature, operation interface signature and stream interface signature.

10.1.2 Channel concepts**10.1.2.1 Channel**

A *channel* is a configuration of *stubs*, *binders*, *protocol objects* and *interceptors* providing a *binding* between a set of *interfaces* to *basic engineering objects*, through which *interaction* can occur.

10.1.2.2 Stub

A *stub* is an *engineering object* in a *channel*, which interprets the *interactions* conveyed by the *channel*, and performs any necessary transformation or monitoring based on this interpretation.

10.1.2.3 Binder

A *binder* is an *engineering object* in a *channel*, which maintains a *distributed binding* between interacting *basic engineering objects*.

10.1.2.4 <X> Interceptor

An *<X> interceptor* is an *engineering object* in a *channel*, placed at a boundary between *<X> domains*. An *<X> interceptor*:

- performs checks to enforce or monitor policies on permitted interactions between *basic engineering objects* in different *domains*;
- performs transformations to mask differences in interpretation of data by *basic engineering objects* in different *domains*.

10.1.2.5 Protocol object

A *protocol object* is an *engineering object* in a *channel*, which communicates with other *protocol objects* in the same *channel* to achieve interaction between *basic engineering objects* (possibly in different *clusters*, *capsules*, or *nodes*).

10.1.2.6 Communication domain

A *communication domain* is a set of *protocol objects* capable of interworking.

10.1.2.7 Communication interface

A *communication interface* is an *interface* of a *protocol object* that can be bound to an *interface* of either an *interceptor object* or another *protocol object* at an *interworking reference point*.

10.1.3 Identifier concepts

10.1.3.1 Binding endpoint identifier

A *binding endpoint identifier* is an identifier, in the naming context of a *capsule*, used by a *basic engineering object* to select one of the *bindings* in which it is involved, for the purpose of *interaction*.

10.1.3.2 Engineering interface reference

An *engineering interface reference* is an identifier, in the context of an *engineering interface reference management domain*, for an *engineering object interface* that is available for *distributed binding*.

10.1.3.3 Engineering interface reference management domain

An *engineering interface reference management domain* is a set of *nodes* forming a *naming domain* for the purpose of assigning *engineering interface references*.

10.1.3.4 Engineering interface reference management policy

An *engineering interface reference management policy* is a set of *permissions* and *prohibitions* that govern the *federation* of *engineering interface reference management domains*.

10.1.3.5 Cluster template

A *cluster template* is an *object template* for a configuration of *objects*, with any *activity* required to instantiate those *objects* and establish the initial *bindings*.

10.1.4 Checkpointing concepts

10.1.4.1 Checkpoint

A *checkpoint* is an *object template* derived from the state and structure of an *engineering object* that can be used to instantiate another *engineering object*, consistent with the state of the original *object* at the time of *checkpointing*.

10.1.4.2 Checkpointing

Checkpointing is to create a *checkpoint*. *Checkpoints* can only be created when the *engineering object* involved satisfies a pre-condition stated in a *checkpointing policy*.

10.1.4.3 Cluster checkpoint

A *cluster checkpoint* is a *cluster template* containing *checkpoints* of the *basic engineering objects* in a *cluster*.

10.1.4.4 Deactivation

Deactivation is to *checkpoint* a *cluster*, followed by deletion of the *cluster*.

10.1.4.5 Cloning

Cloning is to instantiate a *cluster* from a *cluster checkpoint*.

10.1.4.6 Recovery

Recovery is to clone a *cluster* after *cluster* failure or deletion.

10.1.4.7 Reactivation

Reactivation is to clone a *cluster* following its deactivation.

10.1.4.8 Migration

Migration is to move a *cluster* to a different *capsule*.

10.1.5 ODP functions in the context of the engineering viewpoint specifications

Part 3 of RM-ODP describes a set of functions required to support open distributed processing [Part 3 – 11 to 15]. They are grouped in four main categories:

- Management functions: node management function, object management function, cluster management function, and capsule management function;
- Coordination functions: event notification function, checkpointing and recovery function, deactivation and reactivation function, group function, replication function, migration function, engineering interface reference tracking function, transaction function and ACID transaction function;
- Repository functions: storage function, information organization function, relocation function, type repository function, and trading function;
- Security functions: access control function, security audit function, authentication function, integrity function, confidentiality function, non-repudiation function, and key management function;

This clause is only concerned with expressing the engineering specification of these ODP functions.

NOTE – Part 3 is not explicit about the detailed specification of these functions, neither does it explain how the specifications for individual functions can be combined to form specifications for components of ODP systems. Only two of these functions, the Type Repository and the Trading Function, are further refined and more extensively described. "Rec. ITU-T X.960 | ISO/IEC 14769 – Type Repository Function" and "Rec ITU-T X.950 | ISO/IEC 13235 – ODP Trading Function" contain their complete specifications.

10.1.6 Summary of the engineering language metamodel

The diagrams below (Figures 27 to 34) illustrate the concepts of the engineering language and the relationships between them. The descriptions of the concepts have been given above. The descriptions of the relationships between the concepts are included in the description of the concepts.

10.1.6.1 Engineering Objects

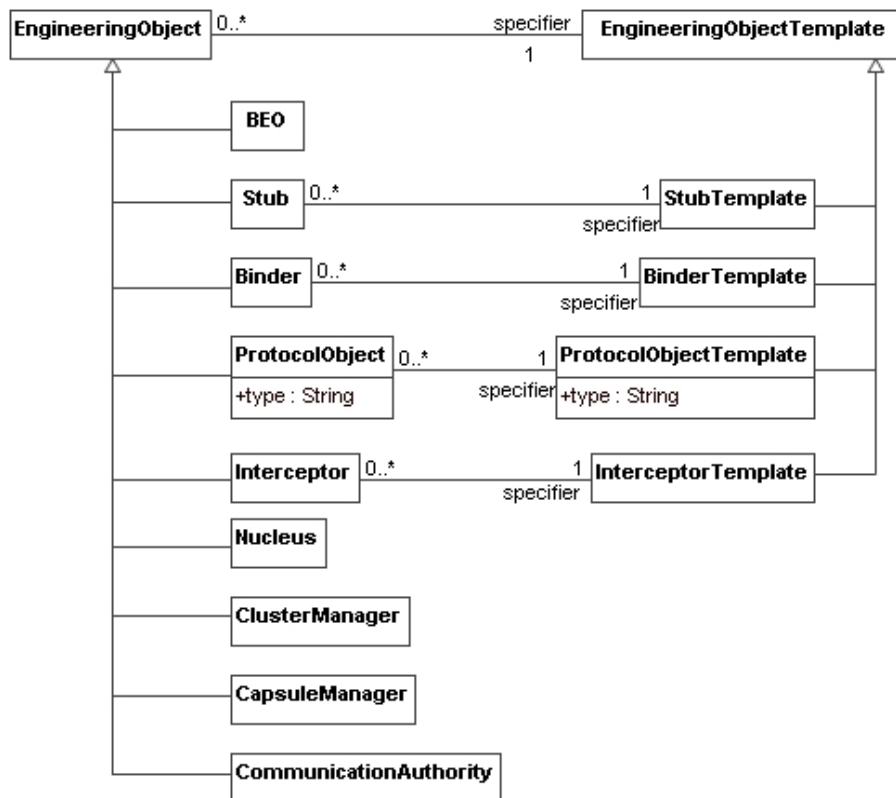

Figure 27 – Engineering objects

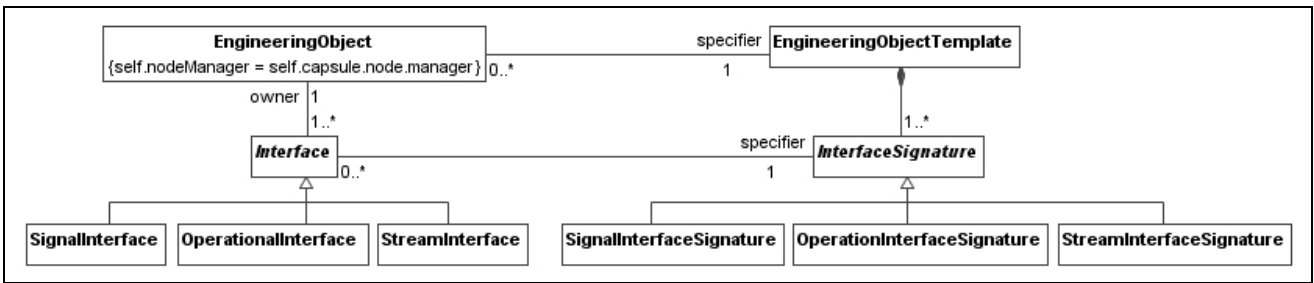

Figure 28 – Engineering interfaces

The following restrictions apply to the elements of the diagram shown in Figure 28:

- All *interfaces* associated with a *signal interface signature* are *signal interfaces*:
context SignalInterface **inv** SignalInterfaceSignature:
 self.specifier.oclIsTypeOf(SignalInterfaceSignature)
- All *interfaces* associated with an *operation interface signature* are *operation interfaces*:
context OperationInterface **inv** OperationInterfaceSignature:
 self.specifier.oclIsTypeOf(OperationInterfaceSignature)
- All *interfaces* associated with a *stream interface signature* are *stream interfaces*:
context StreamInterface **inv** StreamInterfaceSignature:
 self.specifier.oclIsTypeOf(StreamInterfaceSignature)

10.1.6.2 Node structure

The node structure is about structuring of a node with *nucleus*, *capsule*, *cluster* and various *engineering objects*.

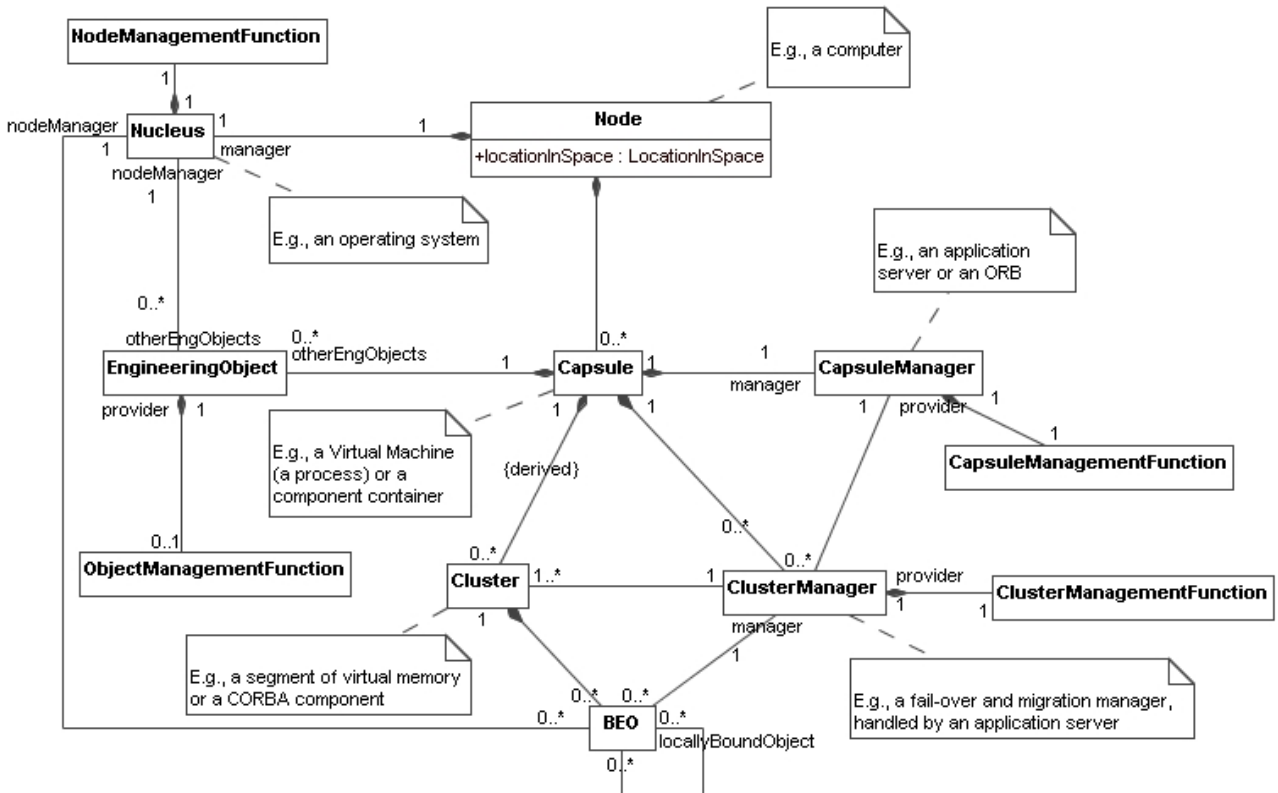

BEO- Basic Engineering Object

Figure 29 – Engineering language – basic concepts

The following constraints apply to the elements of the engineering language shown in Figure 29:

- In order for two *basic engineering objects (BEOs)* to be locally bound to each other, they must reside in the same *cluster*:

- context** BEO **inv** SameCluster:
 self.locallyBoundObject->forall (obj | obj.cluster = self.cluster)
- A *BEO* binds to the *node management interface* provided by the *Nucleus* associated with the *Node* that contains the *Capsule* that contains the *Cluster* that contains the *BEO*:

context BEO **inv** NodeManagerDerivationRule:
 self.nodeManager = self.cluster.capsule.node.manager
- The *engineering object's node manager* should be the same as the *node manager* associated with the *node* that contains the *Capsule* that contains the *engineering object*:

context EngineeringObject **inv** NodeManagerDerivationRule2:
 self.nodeManager = self.capsule.node.manager
- The *Capsule* to which a *Cluster* belongs is the *Capsule* to which the *Cluster's* manager belongs:

context Cluster **inv** CapsuleDerivationRule: self.capsule = self.manager.capsule
- Derivation Rule: The *CapsuleManager* to which the *ClusterManager* is bound is the *CapsuleManager* of the *Capsule* that contains the *Clusters* that the *CapsuleManager* manages:

context ClusterManager **inv** CapsuleManager:
 self.cluster->forall (c : capsule | c.manager = self.capsuleManager)
- The set of other *engineering objects* that the *Capsule* owns and the set of *ClusterManagers* that the *Capsule* owns are disjoint:

context Capsule **inv** NoOtherEOisClusterManager:
 self.otherEngObject->intersection(self.clusterManager)->isEmpty()
- The set of other *engineering objects* that the *Capsule* owns and the set of *CapsuleManagers* that the *Capsule* owns are disjoint:

context Capsule **inv** NoOtherEOisCapsuleManager:
 not self.otherEngObject->includes(self.manager)

10.1.6.3 Channels

This clause is about model elements that enable communication around *channels*.

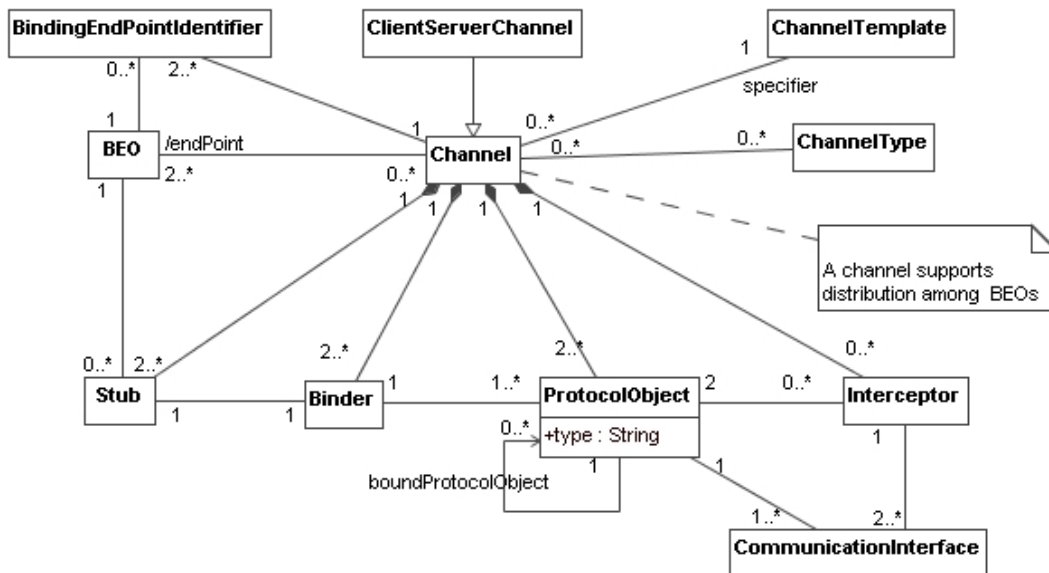

Figure 30 – Engineering language model – channels

The following constraints apply to the concepts illustrated in the diagram of Figure 30:

- Each *Stub* to which a *BEO* is related must be part of a *Channel* to which the *BEO* is related:

context BEO **inv** SameChannel:
 self.stub->forall (stub | self.channel->exists (channel | channel = stub.channel))
- For each *Channel* to which a *BEO* is related, the *BEO* must be related to exactly one *Stub* that is part of that *Channel*:

- context** BEO **inv** OneStubPerChannel:
`self.channel->forAll (channel | self.stub->select (stub | stub.channel = channel)->size () = 1)`
- The collection of *BEOs* that are the end points linked by a *Channel* is derived by adding to the collection, for each *Stub* in the *Channel*, the *BEO* to which the *Stub* is related:

context Channel **inv** EndPointDerivationRule:
`self.endPoint->includesAll(self.stub.bEO) and self.stub.bEO->includesAll(self.endPoint)`
- The *BEOs* constituting a *Channel's* endpoints must each reside in different *Clusters*:

context Channel **inv** EndPointsInDifferentClusters:
`self.endPoint->forAll (ep1, ep2 | ep1.cluster <> ep2.cluster)`
- The *BEO* and *Binder* to which a *Stub* is related are parts of the same *Channel* of which the *Stub* is a part:

context Stub **inv** SameChannelStub:
`self.bEO.channel = self.channel and self.binder.channel = self.channel`
- The *Stub* to which a *Binder* is related, and the *ProtocolObjects* to which the *Binder* is related, are all parts of the same *Channel* of which the *Binder* is a part:

context Binder **inv** SameChannelBinder:
`self.protocolObject->forAll (po | po.channel = self.channel) and self.stub.channel = self.channel`
- The *ProtocolObjects* for which an *Interceptor* provides protocol conversion must be part of the same *Channel* of which the *Interceptor* is a part:

context Interceptor **inv** SameChannelInterceptor:
`self.protocolObject->forAll (po | po.channel = self.channel)`
- Any *Interceptor* to which a *ProtocolObject* is related and the *Binder* to which the *ProtocolObject* is related are part of the same *Channel* of which the *ProtocolObject* is a part:

context ProtocolObject **inv** SameChannelPO:
`self.interceptor->forAll (i | i.channel = self.channel) and self.binder.channel = self.channel`
- In order for two *ProtocolObjects* to be associated, they must be of the same *type*:

context ProtocolObject **inv** SameType:
`self.boundProtocolObject->forAll (po | po.type = self.type)`

10.1.6.4 Domains

This clause is about kinds of *domains* and *object* membership of *domains* that make up *domains*.

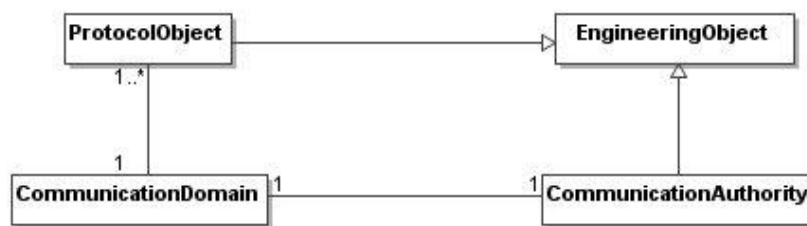

Figure 31 – Domains

The following restrictions apply to the model elements depicted in Figure 31:

- All members of a subdomain are members of its parent domain:

context Domain **inv** SubDomainIsSubSet:
`self.subDomain->forAll (subDomain | self.member->includes(subDomain.member))`
- Controlling objects should be associated to the corresponding domains:

context SecurityDomain **inv** ControllingObject:
`self.controllingObject.ocIsTypeOf(SecurityAuthority)`

context ManagementDomain **inv** ControllingObject:
`self.controllingObject.ocIsTypeOf(ManagementAuthority)`

context AddressingDomain **inv** ControllingObject:
`self.controllingObject.ocIsTypeOf(AddressingAuthority)`

context NamingDomain **inv** ControllingObject:
self.controllingObject.oclIsTypeOf(NamingAuthority)

10.1.6.5 Identifiers

This clause is mainly about identity, domain and policy management, with respect to *nodes* and *objects*.

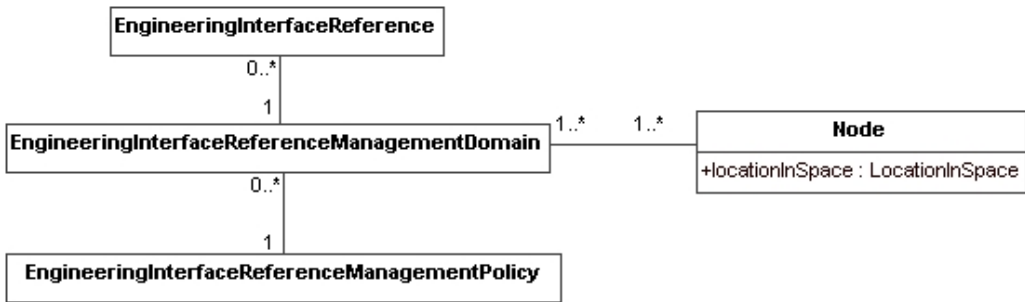

Figure 32 – Engineering language model – identifiers

10.1.6.6 Checkpoints

This clause is about *checkpoints* and *checkpointing behaviour*.

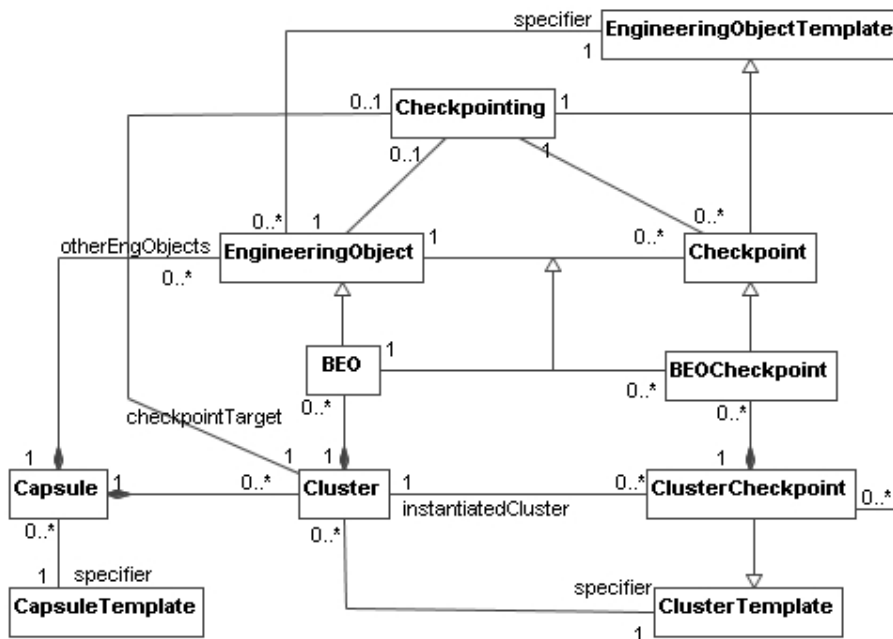

Figure 33 – Engineering language model – checkpoints

10.1.6.7 ODP functions

Figure 34 shows the ODP functions introduced in [10.1.5].

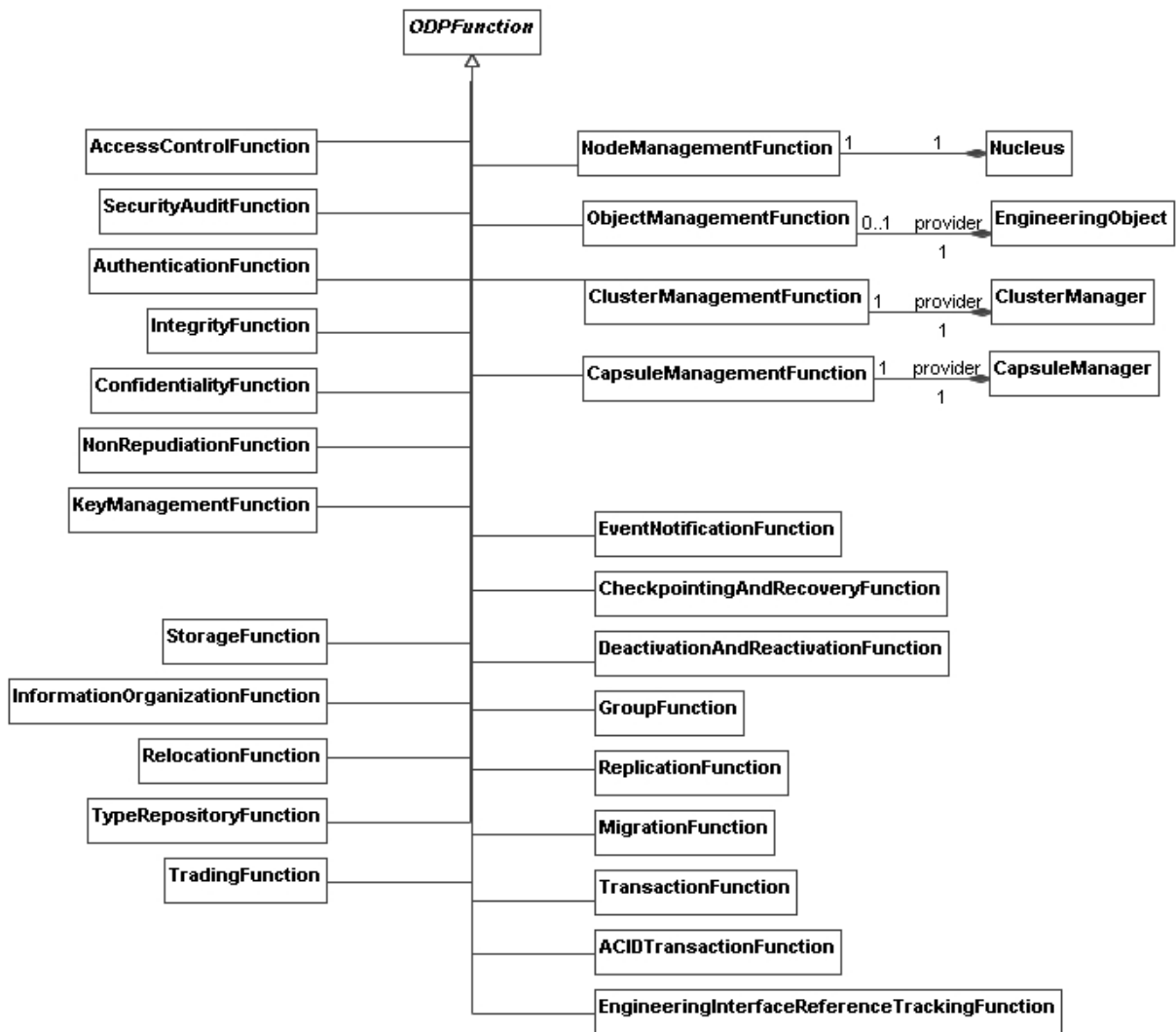

Figure 34 – Engineering language model – ODP functions

10.2 UML profile

This clause specifies how the ODP engineering concepts described in the previous clause are expressed in UML in an engineering specification. A brief explanation of the concepts used in the expression of each concept is given, together with a justification of the expression used.

NOTE 1 – In this clause UML expressions are only defined for those concepts for which use has been demonstrated through an example, included in the main body of this Recommendation | International Standard or in its annexes. Where no example has been identified, the concept concerned is mentioned, but no UML expression is offered.

NOTE 2 – Concepts are presented in the order in which they appear in Part 3.

NOTE 3 – The concepts and rules of the engineering language concern definition of mechanisms and functions required to support distributed interaction between objects in an ODP system, something which deals with aspects related to the software architecture of the system (e.g., distribution or replication) and therefore the appropriate UML mechanisms for modelling software architectures are used (components, ports, interfaces).

NOTE 4 – The engineering viewpoint assumes that the specifier selects a certain level of refinement below which the use of the concept of engineering object ceases to be essential; these lower level specification concerns, such as the realization of the behaviour of engineering objects, are outside the scope of the profile described here, and are addressed by other specification techniques and languages, including the direct use of UML concepts and rules. Thus, this profile covers the specification of engineering objects at the level of UML components that interact through their ports, but leaves open to the specifier the way in which the internal realization of such components is specified.

10.2.1 Engineering object templates and types

An *engineering object* is generally specified in terms of its *template*, which is expressed by a component stereotyped as «NV_Object».

The attribute `isIndirectlyInstantiated` of the component stereotyped «NV_Object» should be set to false. This attribute constrains the kind of instantiation that applies to a component. If false, the component is instantiated as an addressable instance.

The stereotype has the following attributes:

- `deployedNode`: String (defines a reference to a *node* where an *engineering object* is deployed);
- `securityDomain`: String (defines a reference of a *security domain* it may belong to);
- `managementDomain`: String (defines a reference of a *management domain* it may belong to).

Where an *engineering object* is required to represent a specific entity in the UOD, it is expressed by instanceSpecification of a component that is stereotyped as «NV_Object». *Basic engineering objects* are particular kinds of *engineering objects*. Therefore, the stereotype «NV_BEO» that expresses such objects, inherits from «NV_Object»

Where there is the need to express an *engineering object type*, it is also expressed by a component, stereotyped as «NV_Object». The attribute `isIndirectlyInstantiated` of the component stereotyped «NV_Object» should be set to false.

When a component stereotyped as «NV_Object» expresses an *engineering object template*, the attribute `isAbstract` of such a component should be set to false, meaning that the component needs to provide all the information required to instantiate objects.

10.2.2 Object types and templates as engineering objects

There are cases where there is the need to model the *type* or *template* of an *engineering object* at the instance level. An example is the case of a generic factory, which is invoked by passing it a representation of a *template* (which has *type template*), and responds by instantiating the *template* and returning a reference to the created *object*. To indicate that an *object* is derived from a given *template*, we need to represent both the *template object* and the instantiated *object* in the model. Likewise for *types*, to indicate that an *object* conforms to a given *type*, we need to represent both the *object* and its *object type* in the model.

Both *type objects* and *template objects* are *engineering objects*, and therefore are expressed by components, that express its *type* or *template*. To distinguish them from other *engineering objects*, such components are stereotyped «NV_TypeObject» or «NV_TemplateObject», respectively. Both stereotypes inherit from «NV_Object».

The relationship between an *engineering object* and the *object* that represents its *template*, or the *objects* that represent its *types*, can be expressed as an attribute of the class that specifies the *engineering object*.

For example, in some specifications, such as in the ODP trading function specification, there is the need to specify the type of a service, so a trader can locate objects implementing such a service. The diagram shown in Figure 35 represents the specification of a *engineering object*, **PrintService**, and of its *type*, **APrintServiceType**, expressed so that type can be manipulated by engineering operations.

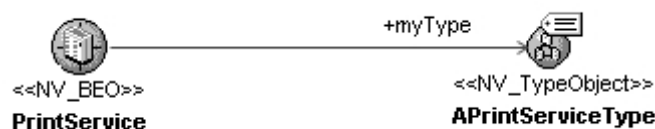

Figure 35 – An explicit representation of the type of an engineering object so that the object can access its type

10.2.3 Cluster

A *cluster* is expressed by an instanceSpecification of a component, stereotyped as «NV_Cluster». The component stereotyped as «NV_Cluster» expresses the *cluster type* or *template*. It includes a configuration of *basic engineering objects* and has *bindings* to required *channels* for *communication*.

10.2.4 Cluster manager

A *cluster manager* is expressed by an instanceSpecification of a component, stereotyped as «NV_ClusterManager». The component stereotyped as «NV_ClusterManager» expresses the *cluster manager type* or *template*.

10.2.5 Capsule

A *capsule* is expressed by an instanceSpecification of a component, stereotyped as «NV_Capsule». The component stereotyped as «NV_Capsule» expresses the *capsule type* or *template*.

10.2.6 Capsule manager

A *capsule manager* is expressed by an instanceSpecification of a component, stereotyped as «NV_CapsuleManager». The component stereotyped as «NV_CapsuleManager» expresses the *capsule manager type* or *template*.

10.2.7 Nucleus

A *nucleus* is expressed by an instanceSpecification of a component, stereotyped as «NV_Nucleus». The component stereotyped as «NV_Nucleus» expresses the *nucleus type* or *template*.

10.2.8 Node

A *node* is expressed by an instanceSpecification of a component, stereotyped as «NV_Node». The component stereotyped as «NV_Node» expresses the *node type* or *template*.

10.2.9 Channel

A *channel* is expressed by an instanceSpecification of a component, stereotyped as «NV_Channel». The component stereotyped as «NV_Channel» expresses the *channel type* or *template*. It consists of *stubs*, *binders*, *protocol objects*, and possibly *<X> interceptors*.

10.2.10 Stub

A *stub* is expressed by an instanceSpecification of a component, stereotyped as «NV_Stub». The component stereotyped as «NV_Stub» expresses the *stub type* or *template*.

10.2.11 Binder

A *binder* is expressed by an instanceSpecification of a component, stereotyped as «NV_Binder». The component stereotyped as «NV_Binder» expresses the *binder type* or *template*.

10.2.12 <X> Interceptor

An *interceptor* is expressed by an instanceSpecification of a component, stereotyped as «NV_Interceptor». The component stereotyped as «NV_Interceptor» expresses the *interceptor type* or *template*.

10.2.13 Protocol object

A *protocol object* is expressed by an instanceSpecification of a component, stereotyped as «NV_ProtocolObject». The component stereotyped as «NV_ProtocolObject» expresses the *protocol object type* or *template*.

10.2.14 Communication domain

A *communication domain* is expressed by a package, stereotyped as «NV_CommunicationDomain».

10.2.15 Engineering interfaces

10.2.15.1 Communication interface

A *communication interface* is expressed by a port stereotyped as «NV_CommunicationInterface», through which a *protocol object* is associated with other *protocol objects* or *interceptors* for a *communication*.

10.2.15.2 Operation interface

An *operation interface* is expressed by a port stereotyped as «NV_OperationInterface», through which a *basic engineering object* is associated with a *channel* or with another *basic engineering object*.

10.2.15.3 Stream interface

A *stream interface* is expressed by a port stereotyped as «NV_StreamInterface», through which a *basic engineering object* is associated with a *channel* or with another *basic engineering object*.

10.2.15.4 Signal interface

A *signal interface* is expressed by a port stereotyped as «NV_SignalInterface», through which a *basic engineering object* is associated with a *channel* or with another *basic engineering object*.

10.2.15.5 Engineering interface signature

An *engineering interface signature* is expressed by an interface, stereotyped «NV_SignalInterfaceSignature», «NV_OperationInterfaceSignature» or «NV_StreamInterfaceSignature» depending on the type of *interface signature* (*signal*, *operation* or *stream*).

10.2.16 Binding endpoint identifier

A *binding endpoint identifier* is expressed by a valueSpecification.

10.2.17 Engineering interface reference

An *engineering interface reference* is expressed by a class.

10.2.18 Engineering interface reference management domain

An *engineering interface reference management domain* is expressed by a package, stereotyped as «NV_InterfaceReferenceManagementDomain».

10.2.19 Engineering interface reference management policy

An *engineering interface reference management policy* is expressed by a constraint, stereotyped as «NV_InterfaceReferenceManagementPolicy».

10.2.20 Checkpoint

A *checkpoint* is expressed by an instanceSpecification of a component, stereotyped as «NV_Checkpoint». The instanceSpecification of a component expresses a checkpointed *object's* states at the time of checkpointing.

10.2.21 Checkpointing

A *checkpointing* is expressed by an activity, UML operation, and UML action stereotyped as «NV_Checkpointing».

10.2.22 Cluster checkpoint

A *cluster checkpoint* is expressed by an instanceSpecification of a component, stereotyped as «NV_ClusterCheckpoint». The instanceSpecification of a component expresses a checkpointed *cluster's* state at the time of checkpointing.

10.2.23 Deactivation

A *deactivation* is expressed by an activity, an operation, or an action stereotyped as «NV_Deactivation».

10.2.24 Cloning

A *cloning* is expressed by an activity, an operation, or an action stereotyped as «NV_Cloning».

10.2.25 Recovery

A *recovery* is expressed by an activity, an operation, or an action stereotyped as «NV_Recovery».

10.2.26 Reactivation

A *reactivation* is expressed by an activity, an operation, or an action stereotyped as «NV_Reactivation».

10.2.27 Migration

A *migration* is expressed by an activity, an operation, or an action stereotyped as «NV_Migration». A *migration*, as an ODP function, can also be expressed by an interface (see [10.2.28]).

10.2.28 ODP functions

The ODP functions described in [10.1.5] are expressed by interfaces, stereotyped as «NV_X», where X is the name of the function.

More precisely, the following stereotypes extend the UML metaclass interface to express the corresponding ODP function:

«NV_ObjectManagement», «NV_NodeManagement», «NV_ClusterManagement»,
 «NV_CapsuleManagement», «NV_EventNotification», «NV_CheckpointingAndRecovery»,
 «NV_DeactivationAndReactivation», «NV_Group», «NV_Replication», «NV_Migration»,
 «NV_InterfaceReferenceTracking», «NV_ACIDTransaction», «NV_Transaction», «NV_Storage»,
 «NV_InformationOrganization», «NV_Relocation», «NV_TypeRepository», «NV_Trading»,
 «NV_AccessControl», «NV_SecurityAudit», «NV_Authentication», «NV_Integrity», «NV_Confidentiality»,
 «NV_NonRepudiation» and «NV_KeyManagement».

10.2.29 Summary of the UML extensions for the engineering language

The engineering language profile (NV_Profile) specifies how the engineering viewpoint modelling concepts relate to, and are expressed in, standard UML using stereotypes, tag definitions, and constraints.

Figure 36 shows diagrammatic representations of this profile.

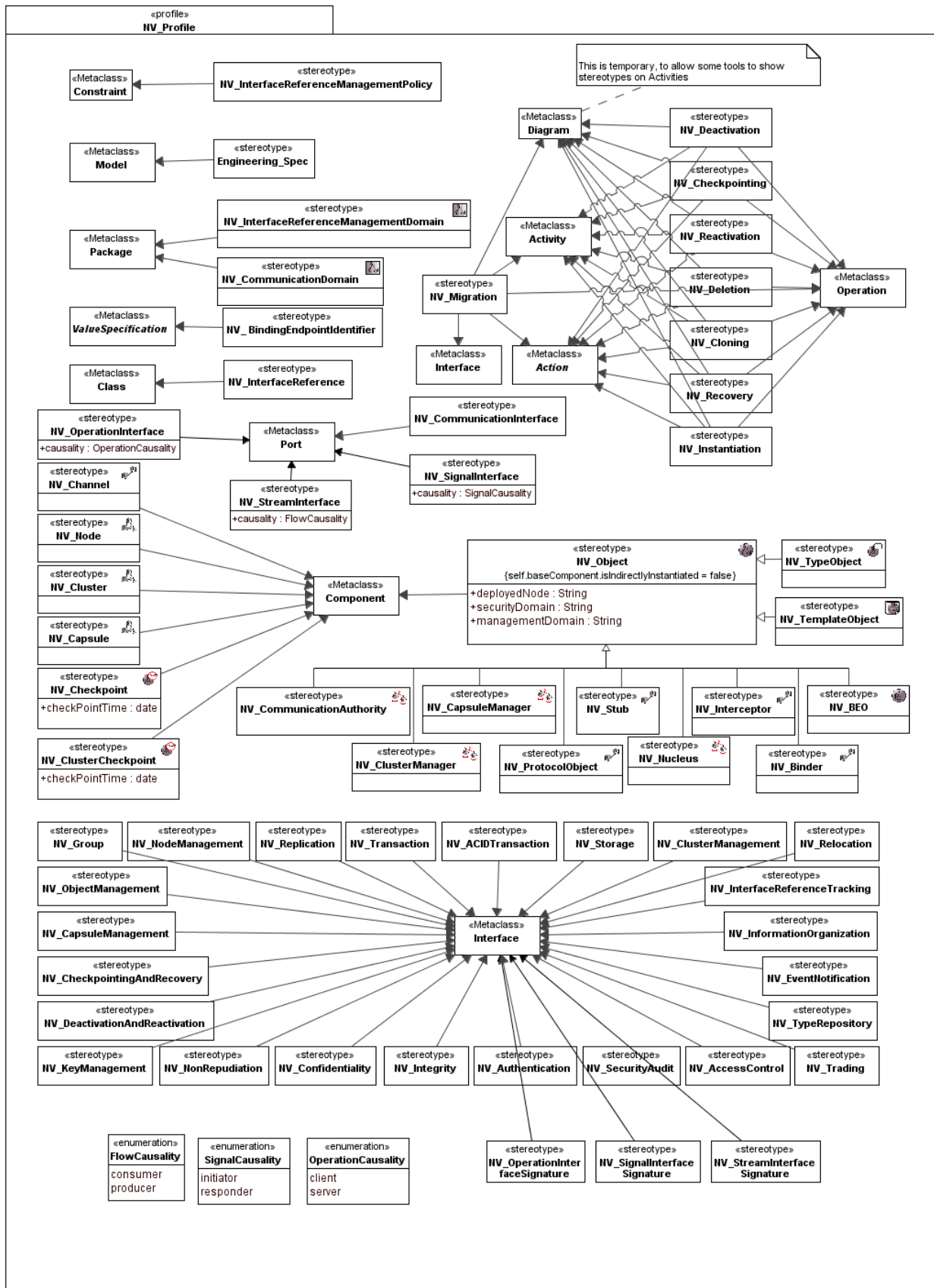

Figure 36 – Graphical representation of the engineering language profile (using the UML notation)

NOTE 1 – In the diagrams above, infrastructure mechanisms are not well represented using UML. It may be necessary to introduce roles for standard functional objects, like trader in the ODP Trading Function standard and recovery manager for recovery function, to cover these mechanisms as well as the ODP functions.

NOTE 2 – Not all management functions are shown in the above figure, e.g., thread management for nucleus.

10.3 Engineering specification structure (in UML terms)

An engineering specification defines the infrastructure required to support the functional distribution of an ODP system. This includes:

- identifying the ODP *functions* required to manage physical distribution, communication, processing and storage;
- identifying the *roles* of different *engineering objects* supporting the ODP functions (for example the *nucleus*).

NOTE – Some ODP functions have been standardized, others have been defined only in outline. Where a suitable definition exists, it can be brought into the engineering specification.

An engineering specification models a system in terms of:

- a configuration of *engineering objects*, structured as *clusters*, *capsules* and *nodes* (that will be expressed with UML component diagrams, including instanceSpecification of component for *capsule*, *clusters*, *basic engineering objects*, *capsule manager*, *cluster manager*, and *nucleus*);
- the *activities* that occur within those *engineering objects* (that will be expressed with UML activity diagrams);
- the *interactions* of those *engineering objects* (that will be expressed with UML sequence diagrams).

An engineering specification is constrained by the rules of the *engineering language*. These comprise:

- channel rules [Part 3 – 8.2.1], interface reference rules [Part 3 – 8.2.2], distributed binding rules [Part 3 – 8.2.3] and relocation rules [Part 3 – 8.2.4] for the provision of distribution transparent interaction among *engineering objects*;
- cluster rules [Part 3 – 8.2.5], capsule rules [Part 3 – 8.2.6] and node rules [Part 3 – 8.2.7] governing the *configuration* of *engineering objects*;
- failure rules [Part 3 – 8.2.9].

Those rules will be expressed with UML or OCL constraints for relevant elements.

All the elements expressing the engineering specification will be defined within a model, stereotyped «Engineering_Spec». Such a model contains packages that express:

- the structure of a *node*, including *nucleus*, *capsules*, *capsule managers*, *clusters*, *cluster managers*, *stub*, *binder*, *protocol objects*, *interceptors*, and *basic engineering objects*, with a component diagram;
- *channels*, with component diagrams and a package;
- *domains*, with a package;
- *interactions* among those *engineering objects*, with activity diagrams, stateMachines and interaction diagrams.

10.4 Viewpoint correspondences for the engineering language

10.4.1 Contents of this clause

This clause describes the correspondence concepts for the engineering language, but not how they are expressed in UML. The latter is covered in Clause 12.

10.4.2 Engineering and computational viewpoint specification correspondences

NOTE – The correspondence between an engineering specification and a computational specification can be derived from [9.4.4].

10.4.3 Engineering and technology viewpoint specification correspondences

Each *engineering object* corresponds to a set of one or more *technology objects*. The correspondence and implementable standards for each *technology object* are dependent on the choice of technology.

The engineering viewpoint specification does not have any correspondences to implementation.

Engineering objects and their *interfaces* correspond to *technology objects* and their *interfaces*, and thus will become *basic information source for testing* in the technology viewpoint.

11 Technology specification

11.1 Modelling concepts

A technology specification uses the RM-ODP technology language. The modelling concepts and the structuring rules of the technology language are defined in [Part 3 – 9]. They are summarized in this clause. Except where otherwise stated, in case of conflict between the explanations therein and the text in Part 3, the latter document should be followed.

The set of diagrams at the end of this clause (i.e., at [11.1.4]) summarizes a metamodel for the technology language.

11.1.1 Implementable standard

A template for a *technology object*.

11.1.2 Implementation

A process of instantiation whose validity can be subject to test.

11.1.3 Implementation eXtra Information for Test (IXIT)

Provides extra information for testing.

11.1.4 Summary of the technology language metamodel

Figure 37 below illustrates the concepts of the technology language and the relationships between them. The descriptions of the concepts have been given above. The descriptions of the relationships between the concepts are included in the description of the concepts.

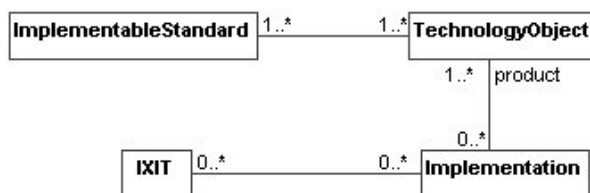

Figure 37 – Model of the technology language

11.2 UML profile

This clause specifies how the ODP technology concepts described in the previous clause are expressed in UML in a technology specification. A brief explanation of the UML concepts used in the expression of each concept is given, together with a justification of the expression used.

NOTE – In this clause UML expressions are only defined for those concepts for which use has been demonstrated through an example, included in the main body of this Recommendation | International Standard or in its annexes. Where no example has been identified, the concept concerned is mentioned, but no UML expression is offered.

11.2.1 Technology object

A *technology object* is generally specified in terms of its *type*, which is expressed by an artefact or a node, stereotyped as «TV_Object». *Technology object types* can be used to characterize the different kinds of *technology objects* that are used in a technology specification (such as PCs, application servers, LANs, WANs, etc.).

Where a *technology object* is required to represent a specific entity in the UOD, it is expressed by instanceSpecification of an artefact or a node that is stereotyped as «TV_Object».

11.2.2 Object types and templates as technology objects

There are cases where there is the need to model the *type* or *template* of a *technology object* at the instance level. An example is the case of a technology object, which needs to know the types of the objects it interacts with in order to fix the appropriate QoS constraints that rule their interactions.

Both *type objects* and *template objects* are *technology objects*, and therefore are expressed by nodes or artefacts, that express its *type* or *template*. To distinguish them from other *technology objects*, such classes are stereotyped «TV_TypeObject» or «TV_TemplateObject», respectively. Both stereotypes inherit from «TV_Object».

The relationship between a *technology object* and the *object* that represents its *template*, or the *objects* that represent its *types* can be expressed as an attribute of the node or artefact that specifies the *technology object*.

11.2.3 Implementable standard

An *implementable standard* is expressed by a component, stereotyped as «TV_ImplementableStandard».

11.2.4 Implementation

An *implementation* is expressed by an activity, stereotyped as «TV_Implementation».

11.2.5 IXIT

An *IXIT* is expressed by a comment, stereotyped as «TV_IXIT».

11.2.6 Summary of the UML extensions for the technology language

The technology language profile (TV_Profile) specifies how the engineering viewpoint modelling concepts relate to, and are expressed in, standard UML using stereotypes, tag definitions, and constraints.

Figure 38 shows diagrammatic representations of this profile. See clause [A.5] for a detailed specification of the stereotypes described here.

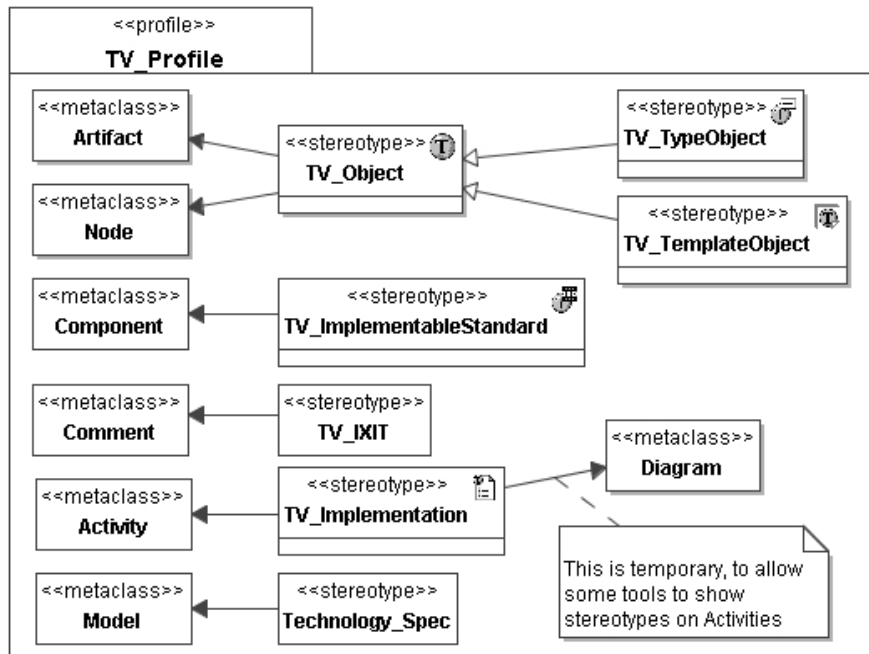

Figure 38 – Graphical representation of the technology language profile (using the UML notation)

The following restrictions apply to the elements depicted in Figure 38. They are derived from the corresponding constraints on the elements shown in Figure 37 and on their relationships:

- every *technology object* type is associated with at least one *implementable standard*.
- every *implementation standard* is associated with, or is implemented as, one or more *technology objects*.
- every *implementation* is associated with, or produces, one or more *technology objects*.

11.3 Technology specification structure (in UML terms)

A technology specification defines the choice of technology for an ODP system in terms of:

- a configuration of *technology objects*; and
- *interfaces* between the *technology objects*.

NOTE 1 – Links between deployment boxes may be used to model physical communication lines (e.g., to model multiple lines for redundancies).

NOTE 2 – A network (e.g., the Internet) may be modelled with a deployment box connected with other deployment boxes.

A technology specification states:

- how the specifications for an ODP system are implemented, which may be modelled with component instances and the relationships between them with text explanation;

- a taxonomy of such specifications, which may be provided with names of *implementable standards* described in stereotyped comments attached to a deployment diagram including a component instance diagram;
- information required from implementers to support testing, which may be specified with a stereotyped comment describing IXIT.

NOTE – Software architecture styles, such as SOA, MVC and N-tier, are considered mainly in the engineering viewpoint, since they are closely related to the distribution strategy.

All the elements expressing the technology specification will be contained within a model, stereotyped «Technology_Spec». Such a model contains packages that express:

- the structure of a *node* instance, including *node* instances within a *node* instance, *artefacts*, and networks, using a deployment diagram; and
- communication links among *nodes*, using a deployment diagram.

11.4 Viewpoint correspondences for the technology language

This clause describes the correspondence concepts for the technology language, but not how they are expressed in UML. The latter is covered in clause 12.

A set of one or more *technology objects* correspond to an *engineering object*, and they implement specified functionality in corresponding *engineering object* in technology specific way.

NOTE 1 – The choice of specific technology in the technology viewpoint may constrain the possible architecture or platform styles (or patterns) and deployment patterns in the engineering viewpoint specification.

NOTE 2 – A wide variety of factors, including procurement policy, extra-functional requirements etc., may influence the choice of technology, and therefore the technology specification.

12 Correspondences specification

12.1 Modelling concepts

A correspondences specification is composed of a set of correspondence specifications.

A complete specification includes six correspondence specifications:

- between the enterprise specification and the information specification;
- between the enterprise specification and the computational specification;
- between the enterprise specification and the engineering specification;
- between the computational specification and the information specification;
- between the computational specification and the engineering specification; and
- between the engineering specification and the technology specification.

12.1.1 Correspondence specification

A correspondence specification is composed of a set of correspondence rules and a set of correspondence links. It describes consistency relationships between *terms* belonging to two specifications based on different viewpoints.

When a correspondence rule and a correspondence link are related, this means that the constraint in the correspondence rule must be enforced by the set of *terms* referenced by the correspondence link.

12.1.2 Correspondence rule

A correspondence rule is expressed by a constraint that must be enforced by a set of *terms* belonging to two specifications from different viewpoints.

A correspondence rule may be:

- a correspondence statement as defined in clauses 7.4, 8.4, 9.4, 10.4, or 11.4;
- some other consistency rule resulting from a design choice.

12.1.3 Correspondence link

A correspondence link is established between two specifications from different viewpoints. Each end of the correspondence link is called a correspondence endpoint.

12.1.4 Correspondence endpoint

A correspondence endpoint is composed of terms involved in the consistency relationship.

12.1.5 Term

A *term* is a linguistic construct which may be used to refer to an entity. The reference may be to any kind of entity including a model of an entity or another linguistic construct.

NOTE – From the definition extracted from [Part 2 – 5], an ODP *term* is analogous to a UML element.

12.1.6 Summary of the Correspondences metamodel

The modelling concepts introduced for a correspondences specification are summarized in Figure 39.

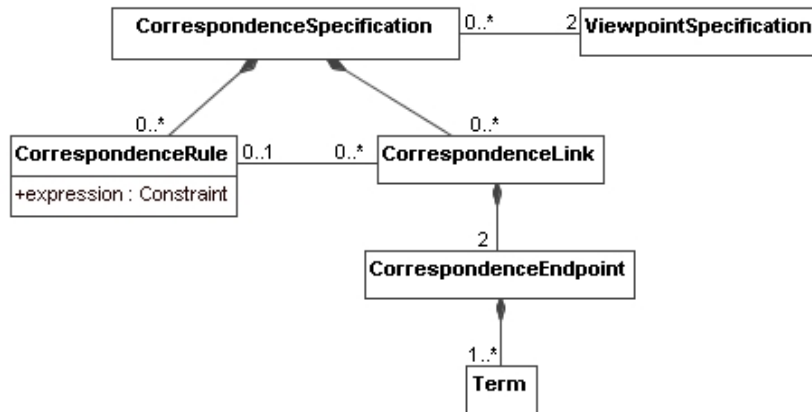

Figure 39 – Correspondences specification concepts

12.2 UML profile

This clause specifies how the modelling concepts for *correspondences specification* are expressed in UML.

12.2.1 Correspondence specification

A *correspondence specification* is expressed by a package, stereotyped as «CorrespondenceSpecification».

The relationship between a *correspondence specification* and the models expressing the viewpoints involved in the *correspondence specification* is expressed by a usage dependency, stereotyped as «CorrespondingSpecification». There are exactly two such dependencies for each *correspondence specification*.

12.2.2 Correspondence rule

A *correspondence rule* is expressed by a constraint, stereotyped as «CorrespondenceRule».

NOTE – The constraints expressing constraints defined in ODP standards may be defined outside the package expressing the correspondence specification to enable reuse among multiple specifications.

12.2.3 Correspondence link

A *correspondence link* is expressed either by a class, stereotyped as «CorrespondenceLink» or by a dependency stereotyped as «CorrespondenceLink».

It may be constrained by a constraint expressing the applicable *correspondence rule*.

The stereotype «CorrespondenceLink» has two tag definitions, named endPoint1 and endPoint2, which specify the two correspondence endpoints of the correspondence link (see [12.2.4]).

A constraint stereotyped as «CorrespondenceRule» is only applied to a class stereotyped as «CorrespondenceLink».

12.2.4 Correspondence endpoint

A *correspondence endpoint* is expressed by a tag definition of stereotype «CorrespondenceLink», which gives references to the elements expressing the *terms* involved in the *correspondence* relationship. Thus, this tag definition is typed by an element (see [12.2.5]) and has a multiplicity of 1..*.

NOTE – As many elements expressing ODP concepts cannot be used directly in a class diagram, tag definitions are used to allow indirect reference to those concepts.

12.2.5 Summary of the UML extensions for correspondences specification

Figure 40 shows a graphical representation of the UML profile for *correspondences specifications*.

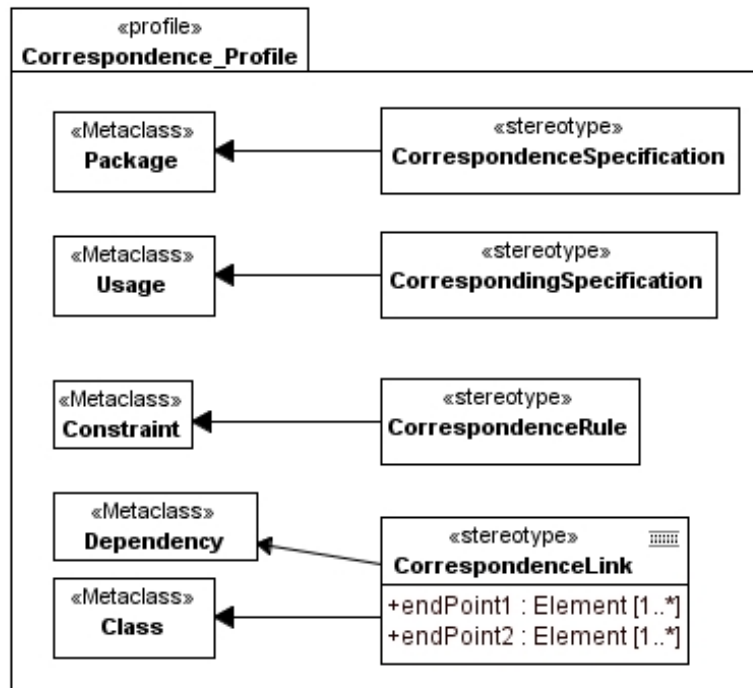

Figure 40 – Graphical representation of the UML profile for correspondences specifications

13 Modelling conformance in ODP system specifications

13.1 Modelling conformance concepts

Conformance relates an implementation to a specification. Any proposition that is true in the specification must be true for its implementation. A *conformance statement* is a statement that identifies *conformance points* of a specification and the behaviour which must be satisfied at these points. *Conformance statements* will only occur in specifications which are intended to constrain some feature of a real implementation, so that there exists, in principle, the possibility of testing.

The RM-ODP [Part 2 – 15] identifies certain *reference points* in the architecture as potentially declarable as *conformance points* in specifications. That is, as points at which conformance may be tested and which will, therefore, need to be accessible for test. However, the requirement that a particular *reference point* be considered a *conformance point* must be stated explicitly in the *conformance statement* of the specification concerned, together with the *conformance criteria* that should be satisfied at this point.

13.2 UML profile

Reference points are identified in the UML expression of an ODP specification by the use of the stereotype «ODP_ReferencePoint» (which extends a metaclass element) on the elements that express them. *Conformance statements* are expressed by comments stereotyped «ODP_ConformanceStatement», attached to the elements (stereotyped «ODP_ReferencePoint») that express the corresponding *reference points*. These comments describe the *conformance criteria* that should be satisfied at the *reference point*. Therefore, *conformance criteria* are those elements stereotyped «ODP_ReferencePoint», which have also attached a «ODP_ConformanceStatement» comment. It is possible to attach multiple «ODP_ConformanceStatement» comments to one element stereotyped «ODP_ReferencePoint», thus declaring several *conformance criteria* at the same *reference point*.

Figure 41 shows a diagrammatic representation of this UML profile.

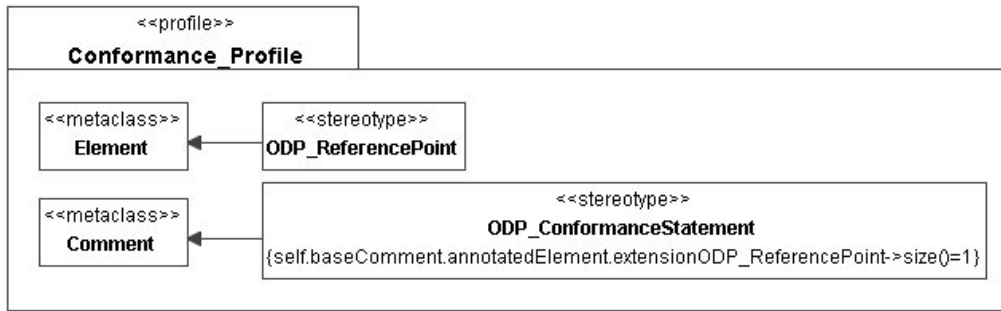

Figure 41 – UML profile for conformance

14 Conformance and compliance to this Recommendation | International Standard

14.1 Conformance

Levels of conformance may vary. At the least, implementations of tools claiming conformance to this Recommendation | International Standard must support:

- one or more of the UML profiles for viewpoint languages defined in clauses 7 to 11; further conformance may be claimed if the tool concerned supports policing or enforcing of the constraints specified for the stereotypes defined in the relative profiles;
- specification of the correspondences, as defined in clause 12, between ODP modelling elements in the viewpoint models supported by the tool, as defined in clauses 7.4, 8.4, 9.4, 10.4, and 11.4;
- the structuring style for ODP system specifications defined in clause 6.6.

NOTE – Claims of conformance to the metamodels alone are outside the scope of this Recommendation | International Standard.

14.2 Compliance

Specifications claiming compliance with this Recommendation | International Standard shall:

- use the structuring style defined in clause 6.6;
- use the UML profiles for the viewpoint languages defined in clauses 7 to 11 of this Recommendation | International Standard to express the concepts and structuring rules for which they are defined;
- specify the correspondences between ODP modelling elements in different viewpoint models using the tracing mechanisms defined in clauses 7.4, 8.4, 9.4, 10.4, and 11.4;
- specify conformance using the UML profile for conformance defined in clause 13.

Compliance to this Recommendation | International Standard does not preclude the use in a specification of concepts and structuring rules in Part 2 and Part 3, and in the Enterprise Language, that are not covered by this Recommendation | International Standard and the definitions of corresponding UML profile elements.

Annex A

An example of ODP specifications using UML

(This annex does not form an integral part of this Recommendation | International Standard.)

The following example illustrates the results of use of UML for expressing ODP system specifications. This annex is not normative.

A.1 The Templeman Library system

A.1.1 Introduction

This is an example of an ODP specification of a library system, using UML. The example is about the computerized system that supports the operations of a university library, in particular those related to the borrowing process of the library items. The system should keep track of the items of the university library, its borrowers, and their outstanding loans. The library system will be used by the library staff (librarian and assistants) to help them record loans, returns, etc. The borrowers will not interact directly with the library system.

NOTE – In the following, the *library system* (or the *system*, for short) will refer to the computerized system that supports the library operations, while the *library* will refer to the business itself, i.e., the environment of the *system*.

Instead of a general and abstract library, this example is based on the regulations that rule the borrowing process defined at the Templeman Library at the University of Kent at Canterbury, a library that has been previously used by different authors for illustrating some of the ODP concepts.

A.1.2 Rules of operation of the library

The basic rules that govern the borrowing process of that library are as follows:

- (1) Borrowing rights are given to all academic staff, and to postgraduate and undergraduate students of the University;
- (2) Library books and periodicals can be borrowed;
- (3) The librarian may temporarily withhold the circulation of library items, or dispose them when they are no longer appropriate for loan;
- (4) For requesting a loan, the borrower must hand the books or periodicals to a library assistant;
- (5) There are prescribed periods of loan and limits on the number of items allowed on loan to a borrower at any one time. These rules may vary from time to time, the librarian being responsible for setting the chosen policy. Typical limits are detailed below:
 - undergraduates may borrow eight books. They may not borrow periodicals. Books may be borrowed for four weeks;
 - postgraduates may borrow 16 books or periodicals. Periodicals may be borrowed for one week. Books may be borrowed for one month;
 - teaching staff may borrow 24 books or periodicals. Periodicals may be borrowed for one week. Books may be borrowed for up to one year;
- (6) Items borrowed must be returned by the due day and time which is specified when the item is borrowed;
- (7) Borrowers who fail to return an item when it is due will become liable to a charge at the rates prescribed until the book or periodical is returned to the library, and may have borrowing rights suspended;
- (8) Borrowers returning items must hand them in to an assistant at the main loan desk. Any charges due on overdue items must be paid at this time;
- (9) Failure to pay charges may result in suspension by the librarian of borrowing facilities

In the following, we will refer to these rules as the "textual regulations" of the library system. They will be the starting point for the ODP specifications below.

It is important to note that the textual regulations above leave many details of the system unspecified, such as when or how a borrower suspension is lifted by the librarian, or the precise information that needs to be kept in the system for each user and library item. The specification process followed here will help uncover such missing details progressively, so the appropriate stakeholders of the system can determine them by making the corresponding decisions.

A.1.3 Expressing the library system specification in UML

This Annex describes a specification of the different ODP viewpoints of such a system, using UML. For each of the viewpoints, this specification uses the corresponding languages defined in RM-ODP and, where appropriate, expresses the languages in terms of the UML notation.

The UML specifications of the ODP system will consist of one top-level model stereotyped «ODP_SystemSpec» composed of five models with the specifications of the five ODP viewpoints (Figure A.1), together with the models that describe the correspondences between them. These models will be described in the following clauses.

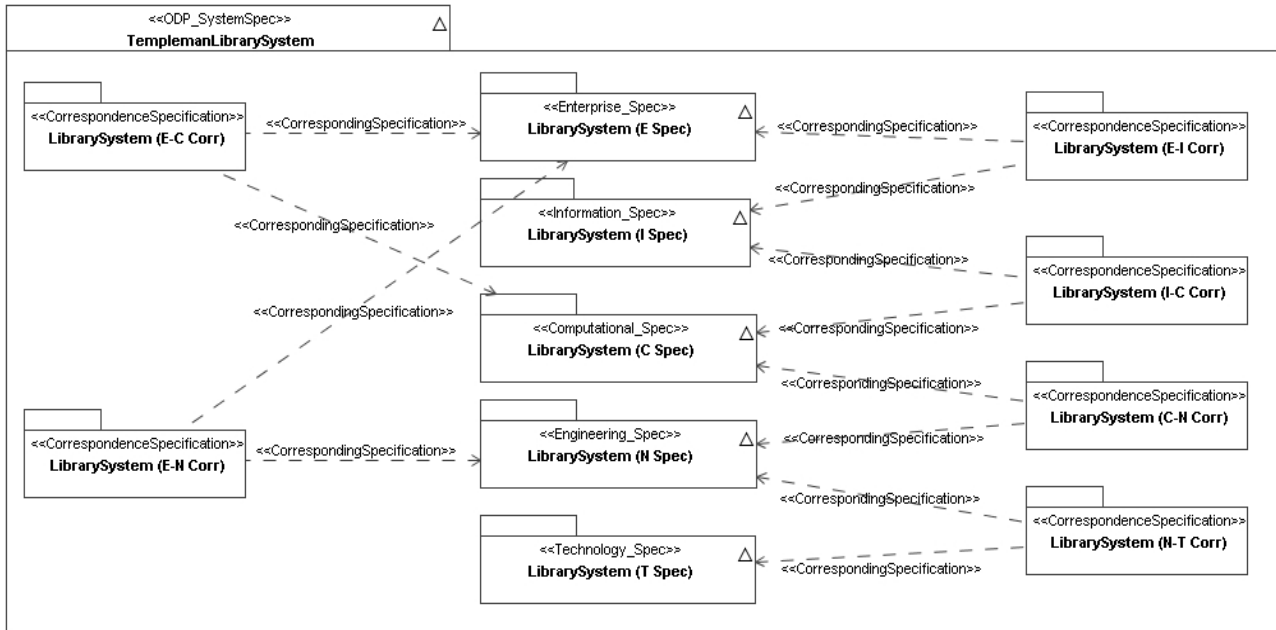

Figure A.1 – UML specification of the ODP system

A.2 Enterprise specification in UML

A.2.1 Basic enterprise concepts

The *enterprise viewpoint* is an abstraction of the system that focuses on the purpose (i.e., *objective*), *scope* and *policies* for that *system* and its *environment*. It describes the business requirements and how to meet them, but without having to worry about other system considerations, such as particular details of its software architecture, its computational processes, or the technology used to implement it.

















Four key concepts of the enterprise language are: *system*, *scope*, *enterprise specification*, and *field of application*. In the first place, the *system* to be specified is a computerized system that supports the operations of a university library, in particular those related to the borrowing process of the library items. This *system* has a name "the Templeman Library system" (or "TLS" for short).

The *scope* of the TLS system describes its expected *behaviour*, i.e., the way it is supposed to work and interact with its *environment* in the business context. In the enterprise language, the *scope* of the system is modelled as the set of roles it fulfils.

In UML, the enterprise specification of the TLS system is expressed by one model, stereotyped «Enterprise_Spec», which is shown in Figure A.2, and whose contents are further detailed in this clause.

In the figures that follow, to improve the clarity of the diagrams, the icons shown in Table A.1 have been used to represent instances of the corresponding stereotypes.

Table A.1 – Enterprise language icons

«EV_Community»	
«EV_Objective»	
«EV_Object»	
«EV_TypeObject»	
«EV_CommunityObject»	
«EV_ODPSystem»	
«EV_Role»	
«EV_Interaction»	
«EV_Process»	
«EV_Step»	
«EV_Artifact»	
«EV_PolicyEnvelope»	
«EV_PolicyValue»	
«EV_Burden»	
«EV_Permit»	
«EV_Embargo»	

The ODP Enterprise Language specification does not prescribe any particular method for building the enterprise specification of a system, as the approach taken will depend very much on the system being specified, the business that it will support, and the constraints that arise from the environment in which the system will operate. For this example, the following process has been followed:

1. Identify the *communities*, with which the system is involved, and their *objectives*;
2. Define the *behaviour* required to fulfil the *objectives* of the *communities*. This may be in the form of *processes*, their corresponding *actions*, and the participant *roles* in them. *Objects* may participate in *actions* as *actors* (if they participate in or perform the *action*), *artefacts* (if they are referenced in the *action*), and *resources* (if they are essential to the *action* and may become unavailable or used up);
3. In addition, depending on the modelling objectives, *behaviour* may be modelled in the form of *interactions* between *objects* fulfilling *roles*. This approach is appropriate when it is required to model a behaviour in detail;
4. Identify the *enterprise objects* in each *community*, (either as typical instances of a type, or as unique instances) and how they fill the *roles*;
5. Identify the *policies* that govern the *behaviour*;
6. Identify any behaviours that may change the rules that govern the system, and the *policies* that govern such behaviours (changes in the structure, behaviour or *policies* of a *community* can occur only if the specification includes the behaviour that can cause those changes);
7. Identify the *actions* that involve *accountability* of the different *parties*, and the possible *delegations*;

8. Identify any behaviour that may change the structure or the members of each *community* during its lifetime, and the *policies* that govern such *behaviour*.

Of course, the order of these activities needs not necessarily be linear, and nor will all activities be appropriate for all modelling situations.

A.2.2 Communities

As shown in Figure A.2, the enterprise specification of the library example contains two *communities* (the **Library** and the **Academic Community**). Each of these is specified in a package, stereotyped as «EV_CommunityContract», containing a component, stereotyped as «EV_Community» (as well as other elements specifying other aspects of the community). Each of these components has a dependency, stereotyped as «EV_RefinesAsCommunity», from the relevant class stereotyped as «EV_CommunityObject» (**Library** and **Academic Community**) which expresses the *community object* that models the *community* when considered as a single *object*. (Note that the **Academic Community** is included only to illustrate the principle that, at the top level, there may be more than one community. The **Academic Community** is not further detailed in this example.) For convenience, these *community objects* are included in a package named as **Enterprise Objects (global)**, which contains those *enterprise objects* that model entities whose scope is wider than the library itself. Examples of such enterprise objects are **Person** and the **University admin system**, with which the **Library System** has to interact.

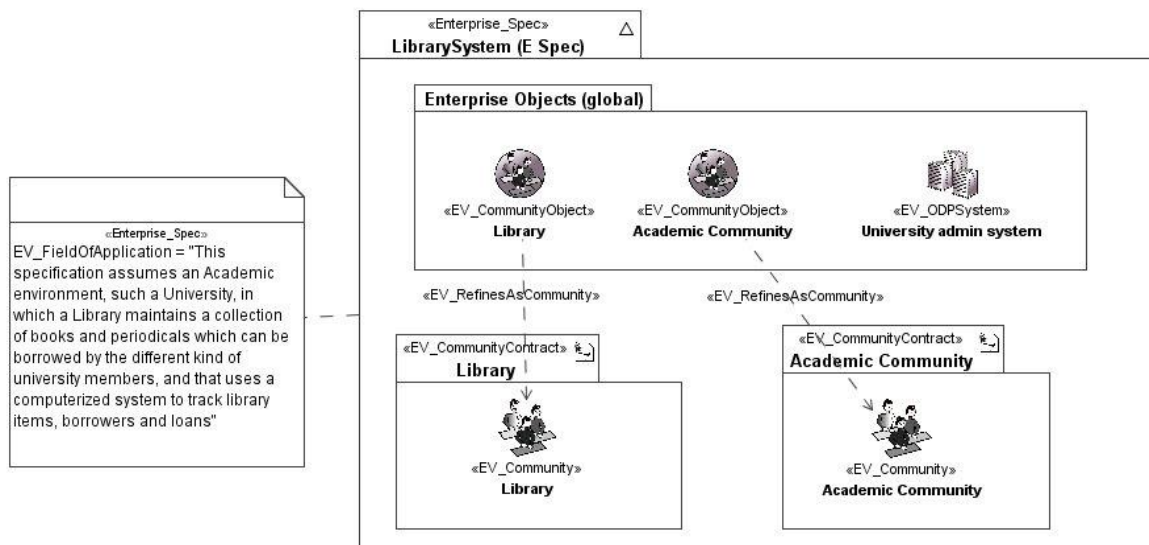

Figure A.2 – UML Enterprise specification of the Library system

The *field of application* of the enterprise specification describes the properties that the environment of the ODP system must have for the specification to be used. It is expressed in a tagged value of the package, stereotyped as «Enterprise_Spec» that contains the enterprise specification of the system.

A *community* is a configuration of *objects* modelling a collection of entities (e.g., human beings, information processing systems, resources of various kinds, and collections of these) that are subject to some implicit or explicit *contract* governing their collective behaviour, and that has been formed for a particular *objective*.

The package containing the specification of the **Library** *community* is stereotyped «EV_CommunityContract», and contains the component, **Library**, stereotyped as «EV_Community» that expresses that *community* and owns the *processes* of the *community*, three packages containing, respectively, the *roles* in the *community*, the set of *enterprise objects* specific to the *community* (**Library Enterprise Objects**, which model its structure), and the *policies* for the *community*, and one class (stereotyped «EV_Objective») which has a tagged value that expresses the *community objective* as follows: "To allow the use, by authorized borrowers, of the varying collection of library items, as fairly and efficiently as possible". This class has an association, stereotyped as «EV_ObjectiveOf», with the component expressing the **Library** *community*.

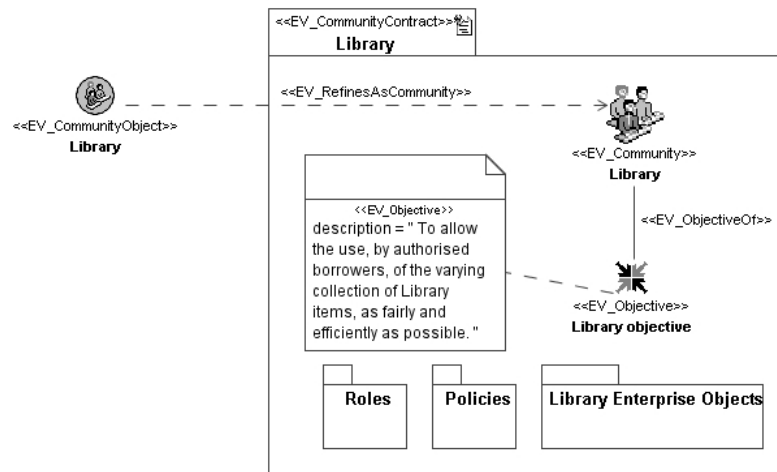

Figure A.3 – UML specification of the Library community

A.2.3 Processes

Processes specify behaviour in terms of (partially ordered) sets of steps, and are related to achieving some particular subobjective within the community. Steps are abstractions of actions, which may hide some of the objects participating in the actions.

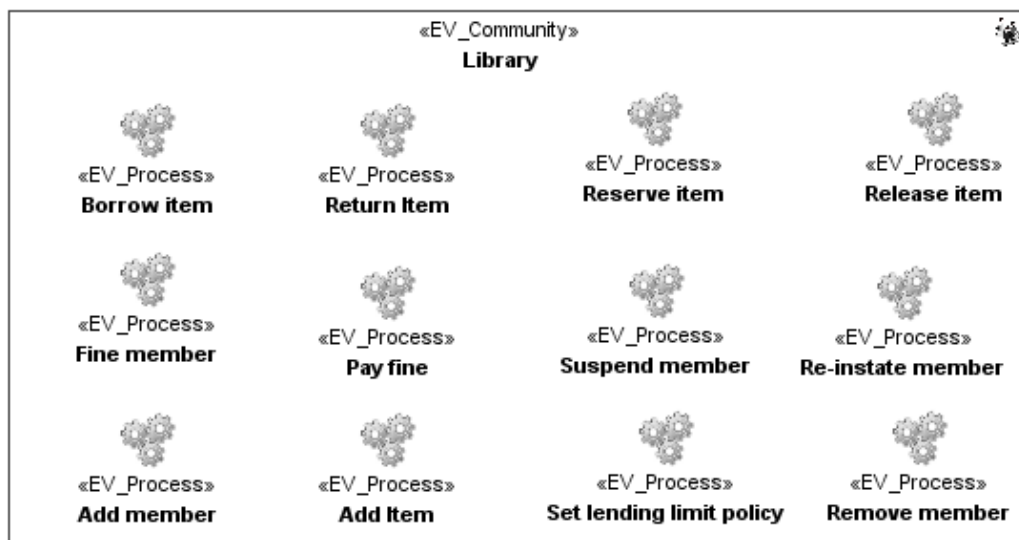

Figure A.4 – Processes

The processes of the Library community are expressed by a set of activities stereotyped as «EV_Process» that have the component that expresses it as their context, as shown in Figure A.4.

Each of these activities has associated with it an Activity Diagram that expresses the steps of the process, and identifies the roles involved in these steps (either as actor or as artefact roles). Actor roles are expressed by the activityPartitions (stereotyped «EV_Role»), and artefact roles are expressed by objectNodes (stereotyped «EV_Artefact»). In this example we detail the Borrow item and the Add member processes.

A.2.3.1 Borrow item process

In Figure A.5, the behaviour of the Library system role in the Borrow item process is defined by the actions in the activityPartition for the Library system role. The complete behaviour of the Library system role is the composition of its behaviours in all of the processes in which it is involved.

The process starts with a Borrower (a role filled by a Library member) performing the step State loan requirement. (The exact mechanism and procedures for doing this are not stated at this time, but it could be as simple as the borrower taking the item concerned to a desk for processing by the library assistant.) This step implies that a Loan (enterprise object) has come into existence, and this fact is modelled by an artefact of Loan expressed as an objectFlow, named in the model borrower requests which has the type Loan.

Note that in this example, *artefacts* have been further detailed by identifying for each, a state of the *enterprise object* that the *artefact* represents a usage of. This is not mandated by the enterprise language but allows the use of a UML feature to build an important bridge to the information specification. The resultant stateMachine of the class that expresses the *enterprise object* can form the basis for expressing a *dynamic schema* for the associated *information object type*. For details of the stateMachine for the **Loan enterprise object**, see Figure A.13. In this case the artefact represents the enterprise object **Loan** in the state **Requested by borrower**.

The **Assistant** (a *role* filled by a **Person** who is of type **Library Staff**), next performs the *step* **Check request**, which references, as an *artefact*, the *enterprise object* **Loan** in the state **Requested by assistant**. Again, this step, being part of the human behaviour associated with the system's operation, is not further detailed in this model, which is directed towards the system's specification. In a real life situation, such behaviour would need to be documented, and the model may be a good place to do it.

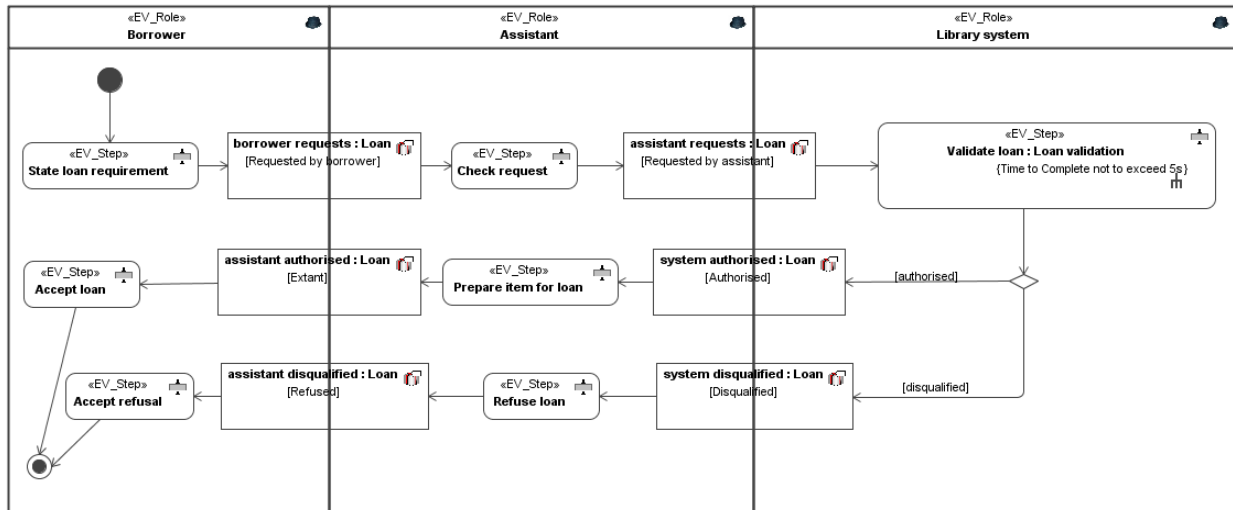

Figure A.5 – Borrow item process

Next the *enterprise object* **Library system** (filling the *role* **Library system**) performs the *step* **Validate loan**. This *step*, which may be more or less complex, depending on the rules of the library, and is constrained by the **Lending policies** (see Figure A.18), is not detailed at this level. Instead, as can be seen from the small forked symbol under the name of the *step*, the model element is linked, using the callBehavior feature, to a stateMachine which expresses the detailed *behaviour* of the *role* **Library system**, in this *process*. See Figure A.11 for this detail.

NOTE – The role **Library system** is filled by an enterprise object with the same name. It is a fact of life that in enterprise models, enterprise objects and the roles they fulfil often have the same name. This is due to the natural tendency of people to name things by the things they do, or to name behaviour by the thing that exhibits it. Since a key objective of an RM-ODP enterprise specification is to be approachable to the stakeholders it is not considered desirable to introduce artificial new names, and instead to make clear whether a role or an enterprise object is being referred to.

The remainder of Figure A.5 is largely self-explanatory and is not detailed further in textual form. It should be noted that the states of the enterprise object **Loan**, identified in the various *artefacts*, are not exhaustive. Other states, see Figure A.15, may also be discovered from considerations of other behaviour. For example, the sub-states of **Loan extant**, **Valid** and **Overdue**, are discovered from consideration of **Fining interactions** or **Fining processes**.

A.2.3.2 Add member process

As a further example of process modelling, Figure A.6 shows the top-level process involved when a prospective new member of the library applies to join. The diagram is largely self-explanatory, but it can be seen that through the use of *artefacts* a number of states of the **Library member enterprise object** (but by no means all of them), have been identified.

In this *process*, the **Library system** has 3 steps, which are detailed in two different ways. The simple case is for the two steps **Create member** and **Refuse new member**. Each of these is detailed by an opaqueBehavior owned by the *role* **Library system** see A.2.4.

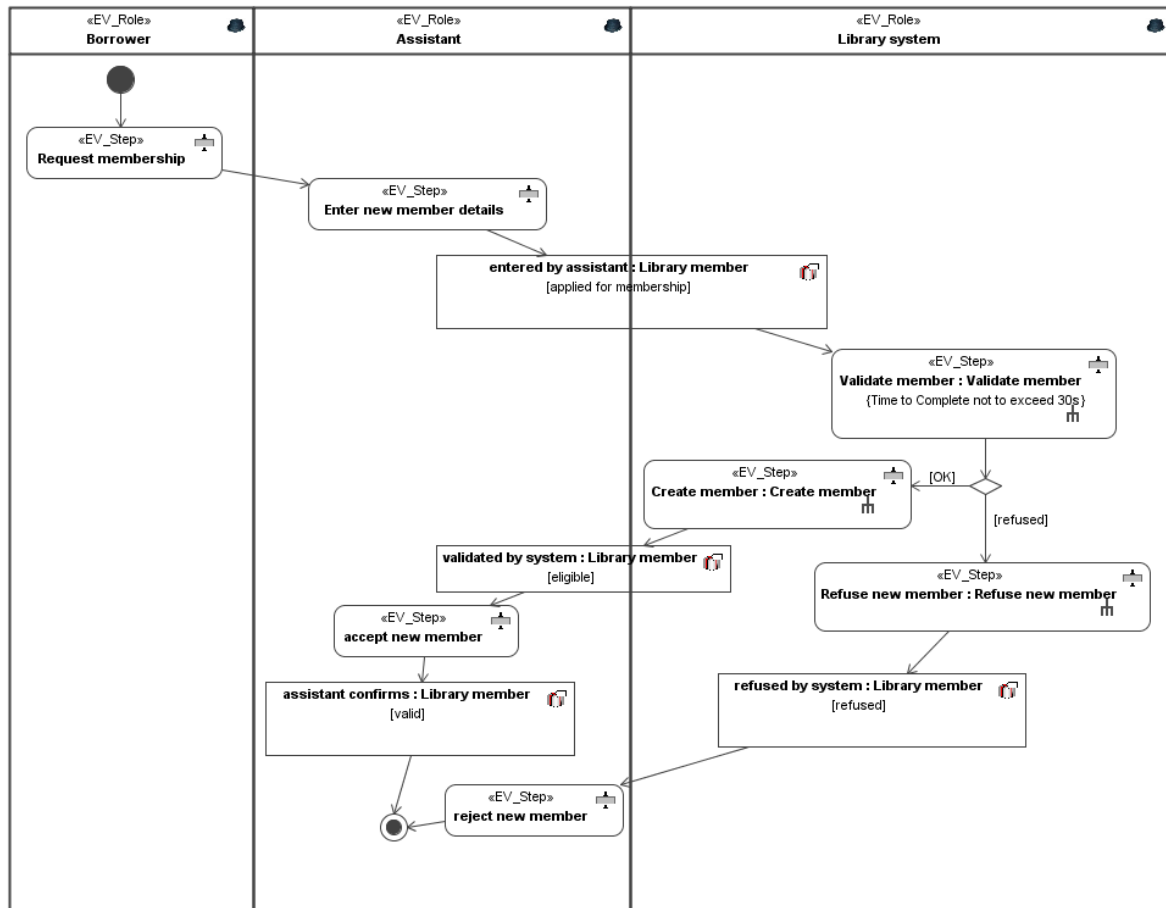

Figure A.6 – Add member process

The *step* **Validate member** is refined as a *process*, also named **Validate member**, which is owned by the *process* **Add member**. (It is unfortunate that there is no visual means of indicating which of the different detailing approaches is used; in the model, however, querying the model element concerned will show whether the detail of a step is provided by an activity expressing a *process*, a *stateMachine* expressing a set of *actions*, or an *opaqueBehavior* modelling directly the details of the behaviour required.) The *step* is performed, at the high level, by the **Library system** (*enterprise object* and *role*). In this example, for the purposes of illustration, it has been assumed that because appropriate technology is available, the actual check on validity of an application will be made by the agent best placed to do it, namely an *enterprise object* known as the **University admin system** (filling the *role* **University admin system**), and that a direct link will be made in order to check an applicant's credentials. The details of this *subprocess*, as well as the required states of the *enterprise object* **Library member**, are shown in Figure A.7. As in other activity diagrams, some of the *steps* performed by either the **Library system** *role* or the **University admin system** *role* are detailed elsewhere in the model, as indicated by the small forked symbol under the name of the *step*. In each case they are detailed by an *opaqueBehavior*, owned by the relevant *role*.

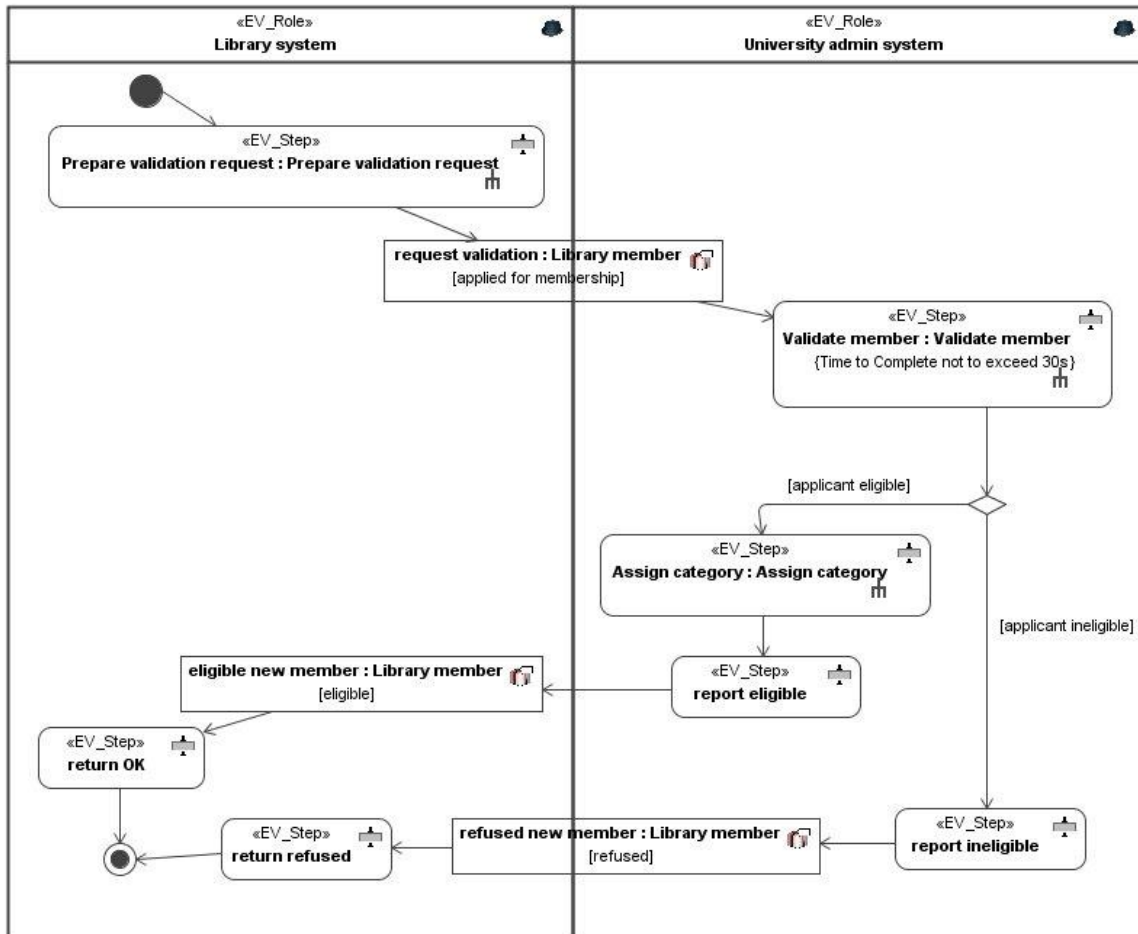

Figure A.7 – Validate member subprocess

A.2.4 Roles

From the textual description of the library (and, in real life more importantly, from discussions, interviews and workshops with stakeholders) we can identify several *roles* in the **Library community**, in particular borrowers with various privileges, librarians, library assistants, and the computerized system that supports the library operations (**Library System**). Figure A.8 shows these **Library roles** within the package that contains the specification of the *community*, each with a realization link to the component that expresses the *community*.

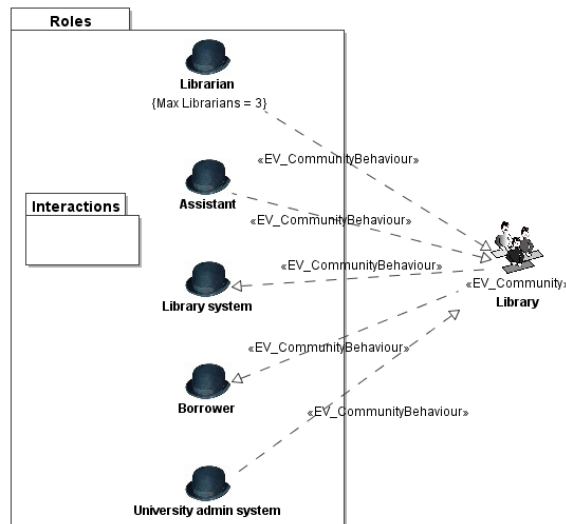

Figure A.8 – Library community roles

The *behaviour* identified by a *role* is expressed by the set of behavioralFeatures of the class that expresses the *role*. For example, the (partial) list of behavioralFeatures of the *role* Library system is specified in three opaqueBehaviors, which are **Create member**, **Prepare validation request**, and **Refuse new member**, and one stateMachine, **Loan validation**.

A.2.5 Interactions

Behaviour can also be modelled in terms of *interactions* between *roles* in a *community*. This is normally appropriate for modelling the detail of a particular interaction and the associated *behaviour* of the *roles* concerned where a *process* model lacks semantic power. In this example, we detail an interaction between the **Assistant** *role* and the **Library System** *role*, and the associated behaviour of the **Library System** *role* since we are concerned to specify in detail the behaviour which the **Library System** is required to provide.

The relationships between the classes expressing the *interaction* involved in the *behaviour* of requesting a loan, and those classes expressing the *roles* involved in this *interaction* is shown in Figure A.9. There is one *interaction* in this case: **Process loan** in which **Assistant** and **Library System** are involved. The relationship is expressed with an association, stereotyped as «EV_InteractionInitiator» or «EV_InteractionResponder» as appropriate. Note that, with delegated authority from the **Librarian** *role*, the **Assistant** *role* is performing an *Accountable action*, in performing its *actions* as part of the **Process loan** *interaction*.

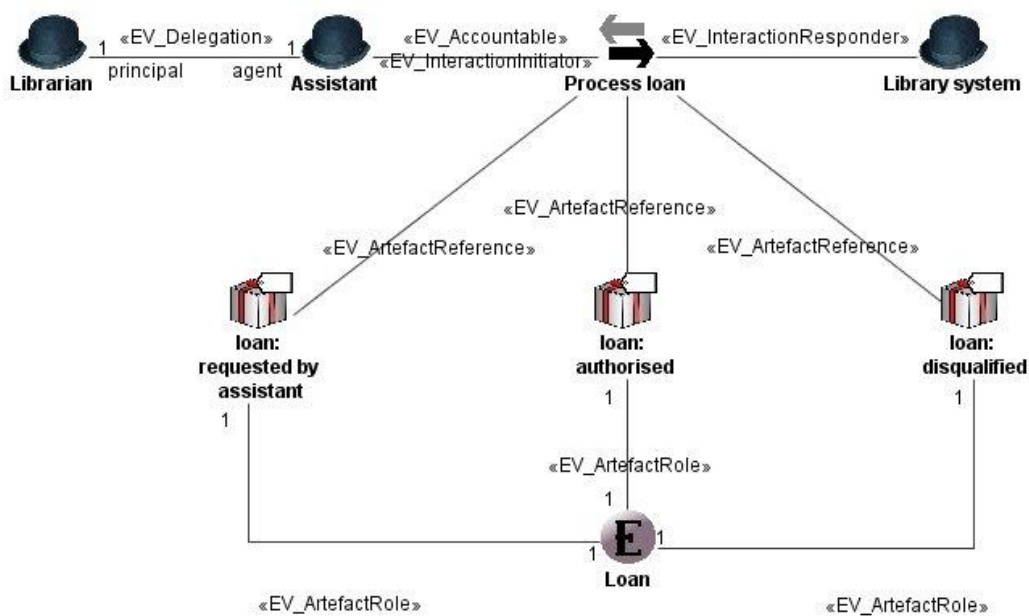

Figure A.9 – Process loan interaction

Figure A.9 also shows that the **Process loan** *interaction* is initiated by the *role* **Assistant** and responded to by the *role* **Library System** and involves, through associations which are each stereotyped as «EV_ArtefactReference», three signals, each stereotyped as «EV_Artefact», expressing *artefact roles* of the **Loan** enterprise object: **loan: request by assistant**, **loan: authorized** and **loan: disqualification** respectively.

Figure A.10 shows the stateMachine for the behaviour defined for the *role* **Library system**, in the **Process loan** *interaction*, with the *role* **Assistant**.

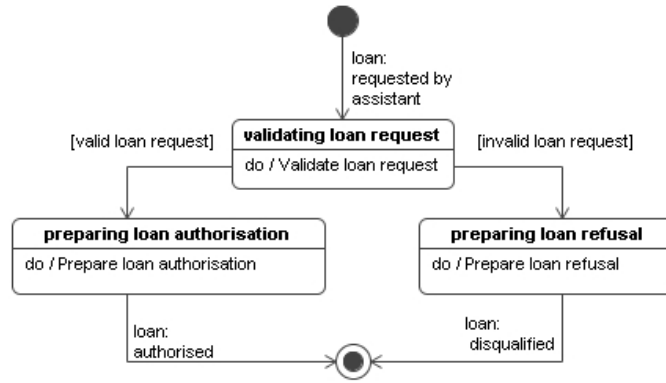

Figure A.10 – State diagram for Library system role in the Process loan interaction

This example has defined the *behaviour* of the **Library system** role in the **Request Item** interaction. The complete *behaviour* of the **Library system** role is the composition of its *behaviours* in all of the *interactions* in which it is involved (see A.4).

A.2.6 Enterprise Objects

A.2.6.1 Actors

Roles are fulfilled by *enterprise objects*. The fulfilment of *actor roles* in a *community* by *enterprise objects* is governed by *assignment rules*. Using UML, the fact that an *actor role* may be fulfilled by an *enterprise object* is expressed by an association, stereotyped as «EV_FulfilsRole», between the classes that express the *objects* and the *roles* concerned. *Assignment rules* can be constrained by the *policies* of the system, in which case there would be links between the *roles* and elements expressing the *policies*. Figure A.11 shows the UML expression of the basic (i.e., unconstrained by any *policies*) assignment rules of the **Library community**.

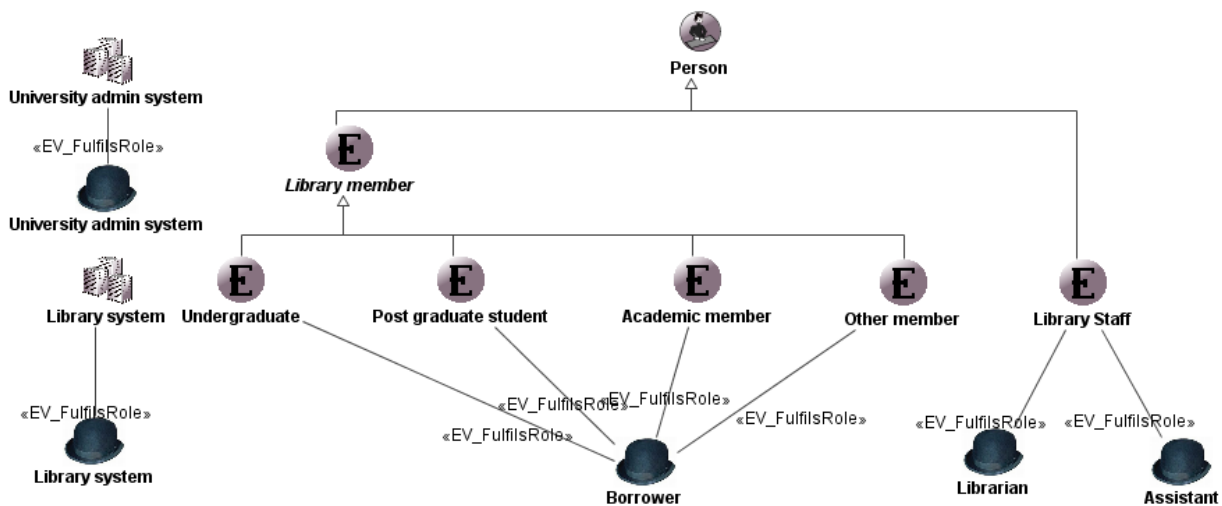

Figure A.11 – Actor role fulfilment and assignment rules

A.2.6.2 Artefacts

Enterprise objects may also participate in *actions* by filling *artefact roles*. In this example, **Loans** are *enterprise objects* that model the relationship that is established between a borrower and an item when she requests the item, and continues for a period from either the loan being refused or the item, having been loaned, being returned. **Loans** fulfil *artefact roles* in several *actions* (from *process* model, see *interaction* model, see A.2.5, above). In this case, the *actions* are **loan: authorized**, **loan: disqualified** and **loan: requested by assistant**.

A.2.6.3 Summary of enterprise objects

In summary, the *enterprise objects*, and the relationships between them, that have *roles* (either *actor* or *artefact*) in the **Library community** are shown in Figure A.12. Note that the list of such items includes *enterprise objects* that have wider scope than just the **Library community**.

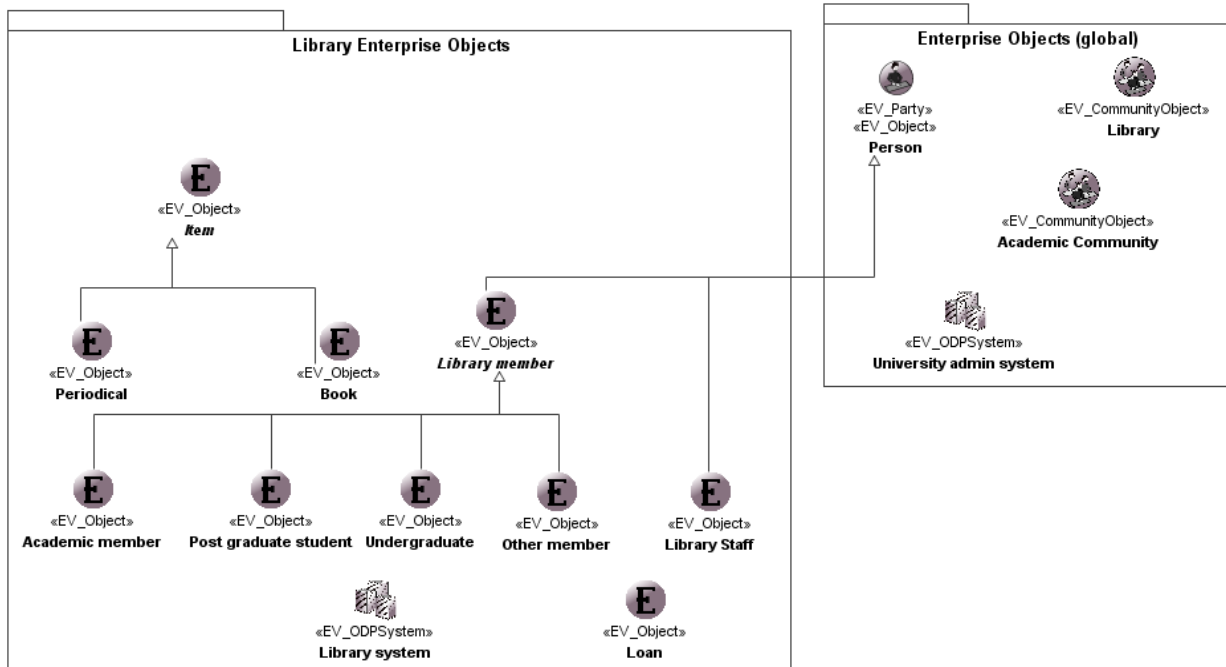

Figure A.12 – Enterprise objects

A.2.6.4 Enterprise object states

As noted in A.2.3.1, it is useful to model the states of the enterprise objects, because they may help specifying the corresponding *information object types*.

Figure A.13 is a stateMachine for the **Loan** enterprise object and is compiled from consideration of both the Process model (see A.2.3) and the Interaction model (see A.2.5).

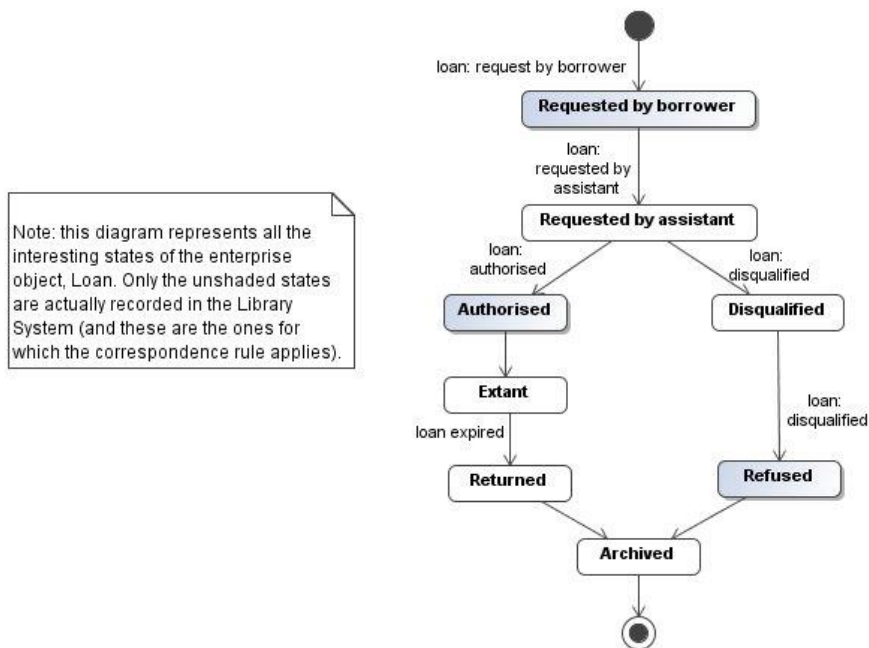

Figure A.13 – States of the Loan enterprise object

In a similar fashion, Figure A.14 is an incomplete diagram representing those of the states of the *enterprise object Library member* that have been identified from the process models that have been developed, including the **Add member process** shown in Figure A.6 and Figure A.7. It should be noted that these state diagrams will only be "complete" when all behaviour that the system under consideration is involved in, has been defined.

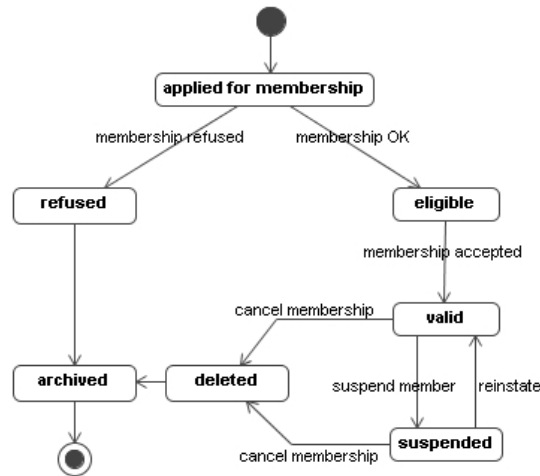

Figure A.14 – States of the Library member enterprise object

A.2.7 Policies

A.2.7.1 General

In an enterprise specification the concept, *policy*, is intended to be used where the desired *behaviour* of the system may be changed to meet particular circumstances.

The **Policies** package specifies the *community policies*, which constrain the structure or the *behaviour* of the *community*, or both. Therefore, the elements of that package will constrain the elements of the other two packages in the **Library Community** package (**Behaviour** and **Library Enterprise Objects**).

Providing an independent and modular specification of *policies* will enable the definition and implementation of some traceability mechanisms, both between and within viewpoints. Within the UML expression of the enterprise specification of a system, we need to be able to list all the elements affected by a given *policy*, and all the *policies* that constrain a given element, in case there is a change in the specification's elements or *policies*. But such independent expression of enterprise *policies* may also allow the definition of *correspondences* between these *policies* and other related elements from different ODP viewpoints (such as information *invariant schemata*). We expect UML modelling tools to exploit such traceability mechanisms, checking for absences of *policies* for some of the modelling elements, and also for *policy* conflicts and inconsistencies at various levels

In this relatively simple example, the aspects of the system that are most appropriate for use of this concept are in the rules regarding borrowing permissions (see A.1.2 rule (5)).

According to the considerations above, in order to be properly specified, *policies* need to identify the relevant enterprise elements to which they apply: *roles*, *objects*, *actions*, *processes*, *communities*, as well as their relationships. Such elements are precisely those described in the two other packages that form part of the enterprise specification of the system: **Enterprise Objects** and **Behaviour**.

A.2.7.2 Expressing ODP policies in UML

In this example we will express *policies* using the pattern shown in clause 7.1.5 and Figure 10, which corresponds to the elements that comprise the specification of an enterprise *policy* in the Enterprise Language [E/L – 7.9.2]:

- description: text with the description of the *policy* in natural language;
- controllingAuthority: an authority that controls the *policy* (in this case, a *role*);
- relatedBehaviour: an identified behaviour (i.e., *role*) that is subject to that authority;
- relatedObjects: optionally, an *object* or *objects* that may fulfil the *roles* involved;
- specificationConstraint: set of constraints on the modelling elements involved;
- affectedBehaviour: the subset of the related behaviour that is required, permitted, forbidden, or authorized.

The *behaviours*, *roles* and *objects* related to a *policy* specification in UML refer, of course, to the UML elements expressing these *behaviours*, *roles* and *objects*, respectively. Such elements will normally be used as contexts in the constraints that specify the *policy*. Note that all *policy* statements are made in a context that defines the elements in the specification to which the *policy* applies, and have a condition that specifies when the *policy* can be used. In this sense, OCL can be of real help. Each OCL constraint has a particular context, related to some element in the model. OCL statements can be directly associated to some elements in a diagram, establishing an implicit context by attachment, or

they can form part of a separate piece of specification in which the context of each statement is explicitly established by naming. Rules are expressed as constraints, using a given notation (such as OCL, or a specific policy language).

A.2.7.3 Expressing loan policies in the Templeman Library

Figure A.15 shows the structure of the **Policies** package.

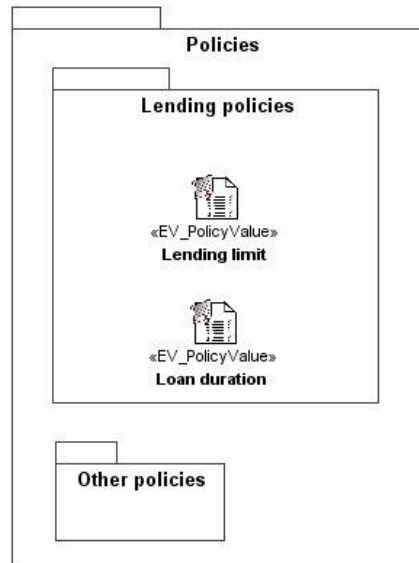

Figure A.15 – Structure of the policies package

Details of the **Lending Policies** are shown in Figures A.16 and A.17, which for illustrative purposes offer both behavioural modelling styles (i.e. with *processes* and *interactions*). From this it can be seen that the **Lending Limit Policy** is set by a *process* **Set lending limit policy** (located in the **Administrative Processes** package), and impacts on the *role* **Library System**, when taking part in the *process* **Borrow Item**, or the *interaction* of the same name.

Similarly the **Loan Duration policy** is set by the *interaction* **Set loan duration policy** (located in the **Administrative Interactions** package), and impacts on the *role* **Library System**, when taking part in the *process* **Fine Borrower**, or the *interaction* of the same name.

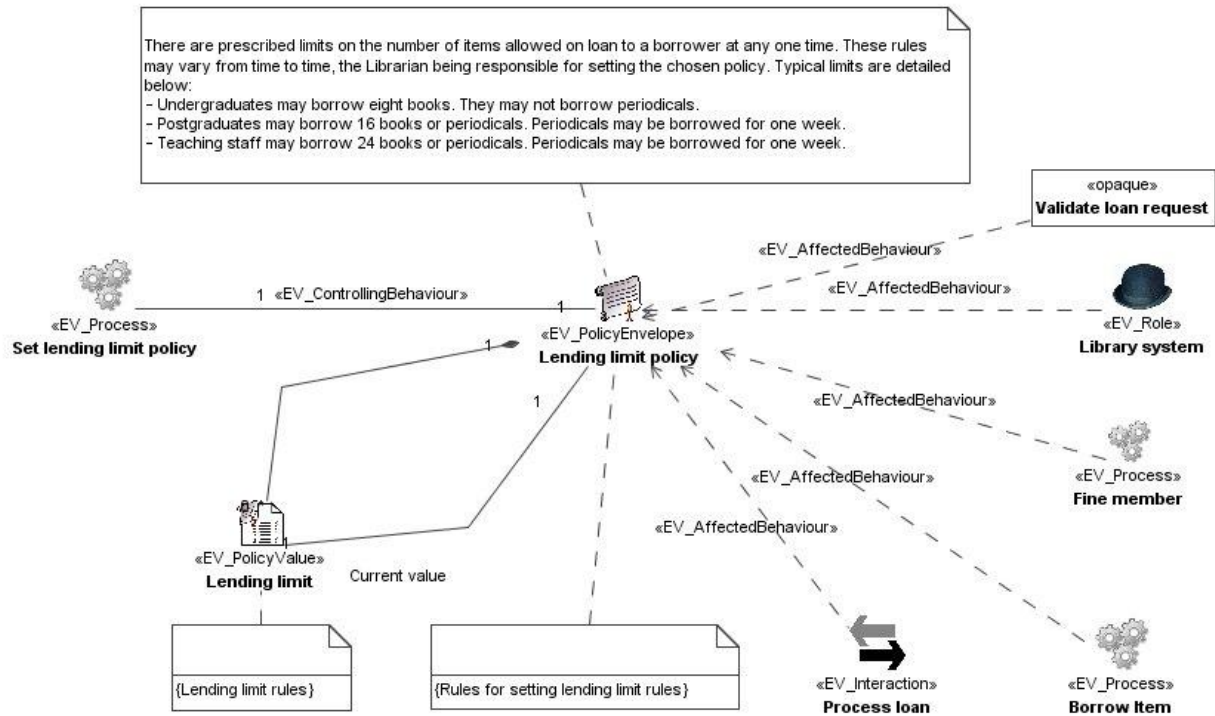

Figure A.16 – Examples of policy expressions: Lending limit policy

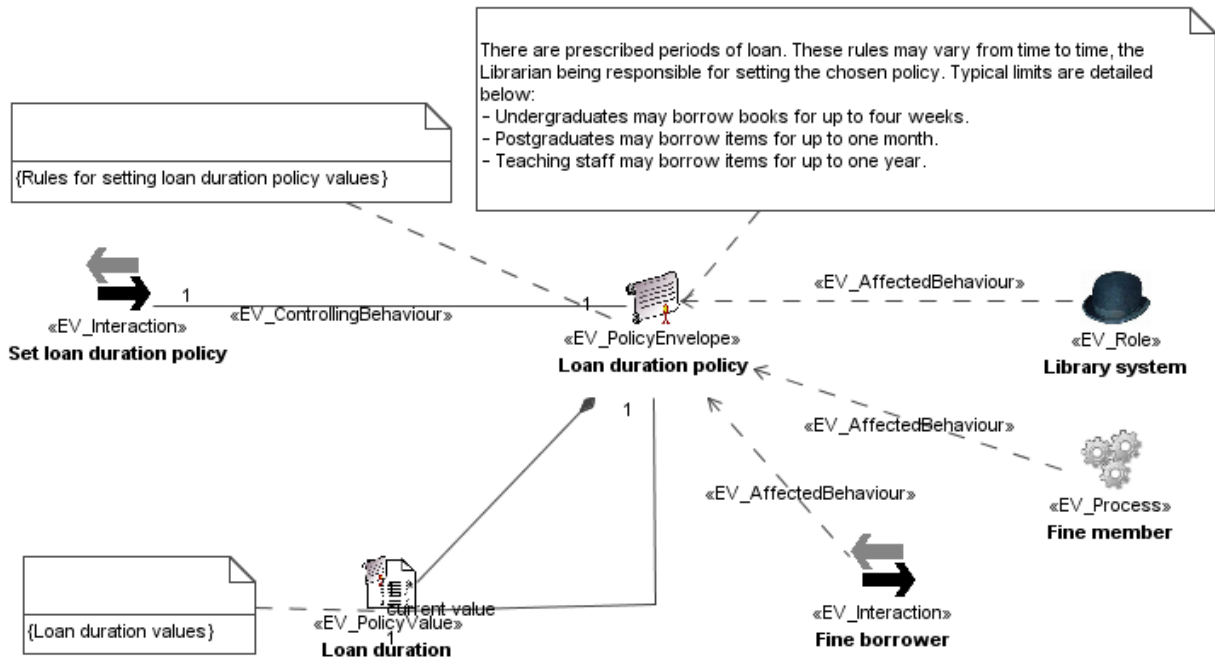

Figure A.17 – Examples of policy expressions: Loan duration policy

A.2.8 Accountability

An enterprise specification should also identify those *actions* that involve *accountability* of a *party*, where a *party* models a natural person or any other entity considered to have some of the rights, powers and duties of a natural person. *Principal parties* are responsible for the *acts* of any *parties* acting as their delegated *agents*, including their possible *commitments*, *prescriptions*, *evaluations*, *declarations*, and further *delegations*.

Accountable parties in a given *process* or *action* are expressed in the UML diagram that defines such *process* or *action*. The stereotype «EV_Accountable» on an association between an *actor* and an *action* indicates the *actor* that is *accountable* for the *action*. Figure A.18 shows an example of the use of such a stereotype, indicating that the **Assistant** is the *accountable party* for the **Process loan** action.

Delegations are expressed in UML by associations between *roles* in activity diagrams stereotyped «EV_Delegation», showing the *principal* and *agent parties* of each *delegation*. Such associations allow delegated *parties* to initiate or participate in *actions* on behalf of their *principals*. In particular, Figure A.18 specifies that the **Librarian** can delegate his *actions* to an **Assistant**. As previously mentioned, the *delegation* may convey some information about its duration, conditions, further *delegations* allowed, etc. Attributes of the «EV_Delegation» stereotype may be used to express such kinds of information.

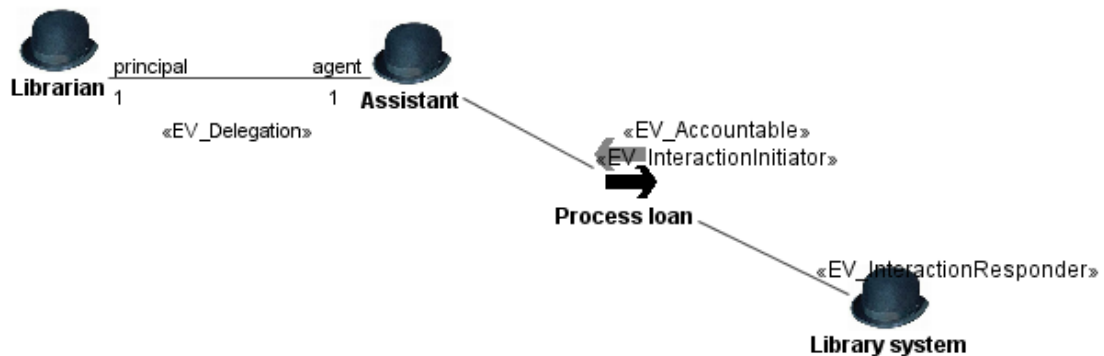

Figure A.18 – Example of delegation

A.3 Information specification in UML

A.3.1 Overview

The information viewpoint is concerned with information modelling. An information specification defines the semantics of information and the semantics of information processing in an ODP system, without having to worry about other system considerations, such as particular details of its implementation, the computational process, or the nature of the distributed architecture to be used. The information specification in this clause defines both the basic concepts for information used in this specification, and the *invariant*, *static* and *dynamic schemata*.

In the figures that follow, to improve the clarity of the diagrams, the icons shown in Table A.2 have been used to represent instances of the corresponding stereotypes.

Table A.2 – Information language icons.

«IV_Object»	
«IV_TypeObject»	
«IV_Action»	
«IV_InvariantSchema»	
«IV_StaticSchema»	
«IV_DynamicSchema»	

According to [8.4], the UML information specification of the Library system is expressed by one model, stereotyped «Information_Spec», that contains a set of packages that express the *invariant*, *dynamic*, and *static schemata* of the ODP information specification in UML. Figure A.19 shows the information specification of the library system, composed of four main packages. The following subclauses define these packages and their contents.

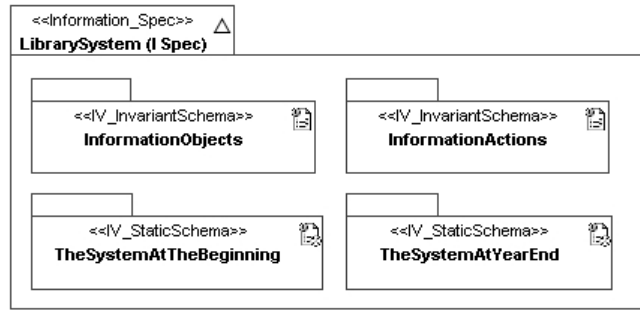

Figure A.19 – Structure of the information viewpoint specification of the library system (excerpt)

A.3.2 Basic elements

From the textual regulations of the library, and from the *objects*, *roles* and *artefacts* identified in the enterprise specification, several *information object types* can be identified, namely **Borrowers**, library **Items**, **Librarians** and **Library Assistants**. They describe the information stored and handled by the Templeman Library system about them. In addition, a **Calendar** *object* should model the passage of time, and **Loan** *objects* will model the relationships between **Borrowers** and **Items**. Figure A.20 shows a class diagram with all the basic *object types* used in this information specification. UML class **Person** contains the personal information about the library users, librarians and assistants.

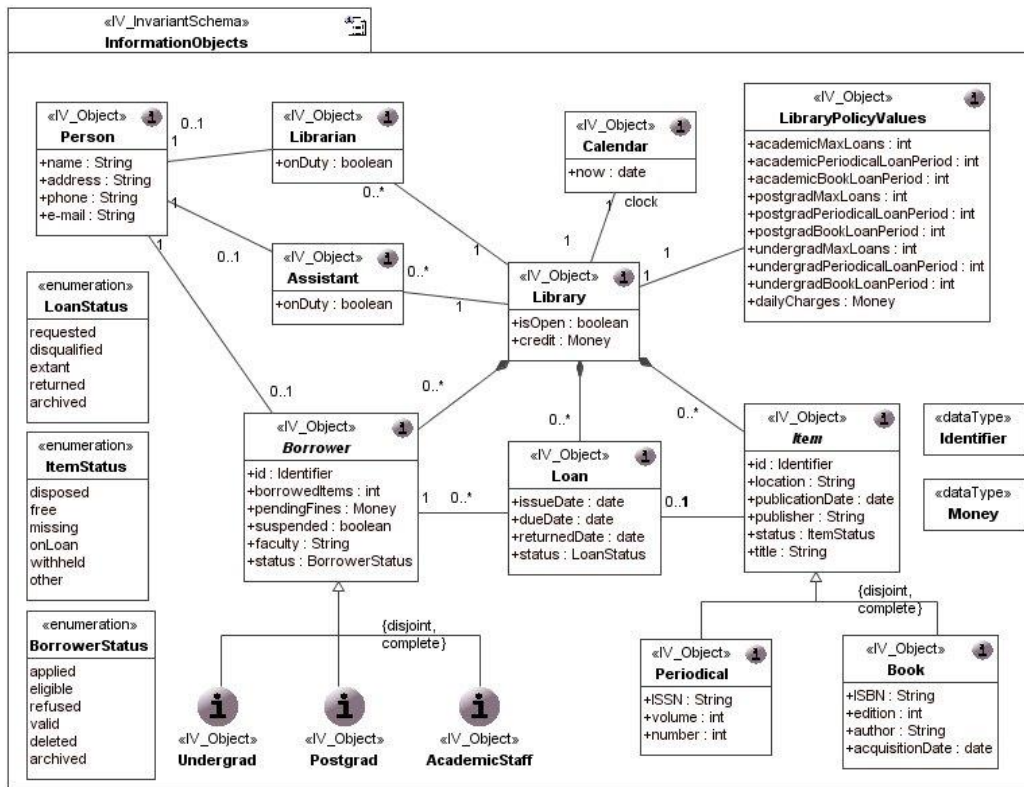

Figure A.20 – Object types of the information viewpoint specification of the library system

The attributes of each class define the information captured by this specification. Please notice that this information specification is built considering the elements of the enterprise specification described in clause A.2. The RM-ODP does not impose any methodology for the definition and use of the five viewpoints. However, for building the UML information viewpoint specifications of this particular example we have used its enterprise specifications. This approach greatly facilitates the definition of the ODP *correspondences* between the related entities that appear in the different viewpoints, and also simplifies the treatment of *consistency* among viewpoints. Viewpoint consistency tries to detect and resolve the possibility that different viewpoints may impose contradictory requirements on the same *system*.

In particular, this information specification incorporates the information kept in the system for each user and library staff (**name**, **address**, **phone**, **e-mail**), and for each **Library item**: **title**, **author**, **ISBN** or **ISSN**, its physical **location**, and its current **status**: **on-loan**, **free**, **withheld** (if the circulation of the item has been temporarily withheld), **disposed** (if the

item has been sold, donated, recycled, or discarded), **missing** (if the item is missing), or **other** (in case the item is in a status not contemplated by any of the previous options).

Information object LibraryPolicies contains the library system values associated to the *policies* identified in the Enterprise Viewpoint specification, such as the details about the daily rates to be charged to late-returners and the current loan limits and periods for the different kinds of users.

General and common parameters about the library are modelled by another *information object (Library)*. Its attribute **isOpen** stores whether the library is open or not to the public, while its attribute **credit** stores the cumulative credit obtained by collecting the payment of the fines. The **Library object** is a *composite information object* which includes the information about the current library **Borrowers**, **Items** and **Loans**. It also gathers the information about the rest of the objects of the system, expressed in terms of associations between this *object* and the **Librarian**, **Assistants**, **LibraryPolicy** and **Calendar objects**.

The classes in Figure A.20 express the ODP *information object types* of the library system information specification. Please notice that the information specification captures the information handled by the Templeman Library system, and there is no need to represent the computerized system itself (as happened in the enterprise viewpoint specification). This is one notable difference between the enterprise and the rest of the viewpoints. The enterprise viewpoint focuses on the *system* and its *environment* (and therefore the *system* needs to be modelled as one of the *enterprise objects* in the specification), while the rest of the viewpoints focus on the information, functionality, distribution, and technology of the *system* itself.

The class diagram in Figure A.20 also expresses constraints on the kinds of objects and the kinds of links that can appear in a valid *object* configuration of the information specification. Such restrictions on the classes, their attributes, and the multiplicity of the associations specify some *invariant schemata* of the information specification (see [A.3.3]).

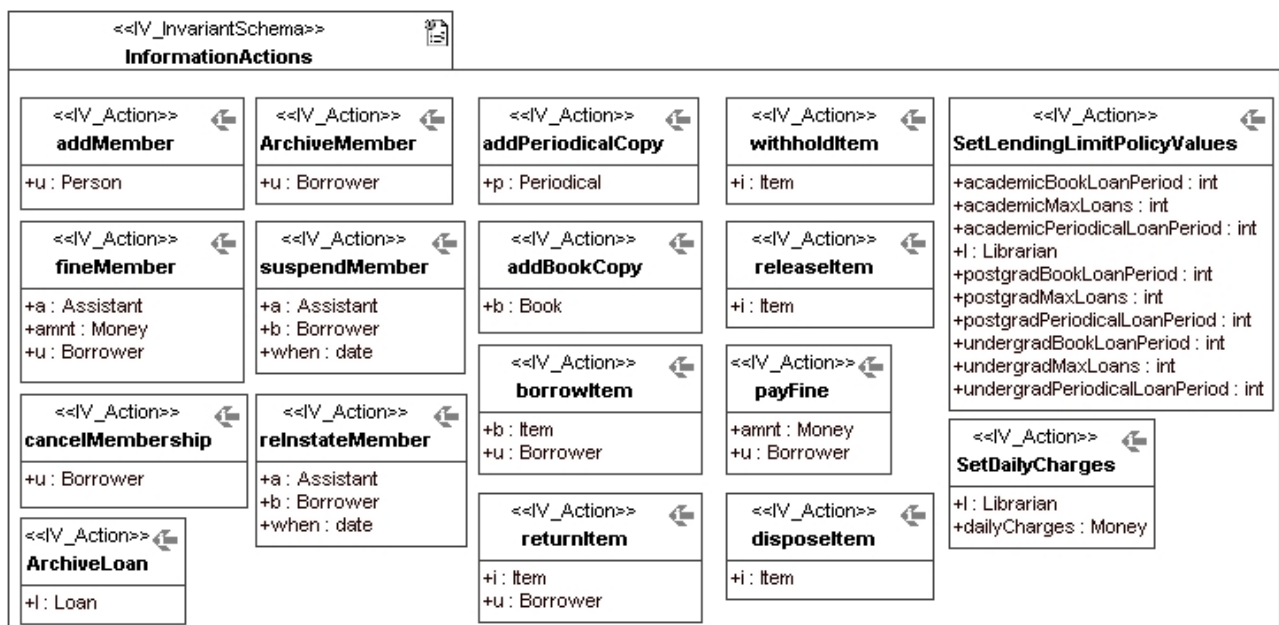

Figure A.21 – Action types of the information viewpoint specification of the library system

The information *actions* of this viewpoint specification are the ones described in Figure A.21. These *actions* have been identified from the *processes* and *interactions* defined in the enterprise viewpoint specification of the system. In the UML information specification, the information actions are expressed using a package that expresses the *invariant schema* that specifies the *action types* supported by the *information objects* of the system.

As *information action types*, they will all be expressed in this example by signals, which will trigger the state changes in the stateMachines of the objects. These stateMachines will express the *dynamic schemata* that will describe the *state* changes caused in the system by such *information actions*. Those *dynamic schemata* will be described later in clause A.3.5. Attributes of the signals model the information conveyed by the ODP *interactions* expressed by such signals.

Once we have defined the main *information object types* of the system, and the possible *actions* that may take place, the way the library system works (from the perspective of the information viewpoint) needs to be defined in terms of how information is processed. *Invariant*, *static* and *dynamic schemata* are the mechanisms defined for that purpose.

A.3.3 Invariant schemata

An *invariant schema* is the specification of the *types* of one or more *information objects* that will always be satisfied by whatever *behaviour* the *objects* may exhibit. The following are examples of *invariants* that can be defined for the library system:

1. Both library users and items should have unique identifiers in the system;
2. No item can be simultaneously referenced by two loans in the system;
3. There should be at most one **Librarian** and at least one **Assistant** on duty while the library is open;
4. The number of pending loans in the system should be consistent with the sum of the values of attribute **borrowedItems** of all the **Borrower** objects;
5. Borrowers who do not pay their fines will be eventually suspended;
6. Suspended borrowers who settle their debts will eventually be reinstated, and their borrowing rights restored.

Please note how some of these *invariants* have been incorporated into the UML class diagram that describes the system structure (shown in Figure A.20) in terms of the multiplicity of the associationEnds. This is the case, for instance, of invariant 2 (which is represented by a multiplicity "1" in the corresponding associationEnd).

Other invariants can be naturally expressed in UML by associating OCL constraints to some of the elements of the specification. For example, invariant 1 imposes that the identifiers of users and **Library** items should be unique in the system. This invariant can be expressed in terms of OCL constraints on the **Library** class:

```
-- Invariant 1
context Library
inv UniqueItemIdentifiers: self.item->isUnique(id)
inv UniqueMemberIdentifiers: self.borrower->isUnique(id)
```

Invariant 2 imposes that no item can be simultaneously referenced by two loans in the system. As mentioned before, this invariant has been implemented by a multiplicity "1" in the corresponding association end.

Invariant 3 states that there should be at most one **Librarian** and at least one **Assistant** on duty while the library is open.

```
-- Invariant 3
context Library inv AtMostOneLibrarianAndAtLeastOneAssistantWhileLibraryOpen:
self.isOpen implies
(self.librarian->select(onDuty)->size())<=1 and
(self.assistant->select(onDuty)->notEmpty())
```

Invariant 4, which imposes a consistency check on the system, such that the number of pending loans should be consistent with the sum of the number of pending loans of each user, can be also expressed by an OCL constraint on the **Library** class:

```
-- Invariant 4
context Library inv ConsistentNumberOfLoans:
( self.borrower.borrowedItems->sum() ) = ( self.loan->select(status=extant)->size() )
```

Other invariants may need to be expressed using different notations. In fact, invariants 5 and 6 can be considered as predicates in a given discrete linear temporal logic that imposes some fairness constraints. OCL is not expressive enough to specify them, although we can always either use a textual description of such predicates, or use any other notation (in this case we will consider an extension of OCL with the temporal logic operators "**always**" and "**eventually**"):

```
-- Invariant 5: Borrowers who do not pay their fines will eventually be suspended.
context Borrower inv: eventually always (fines = 0) or always eventually (suspended = true)

-- Invariant 6: Suspended borrowers who have paid their fines will eventually be released
context Borrower inv: eventually always (fines > 0) or always eventually (suspended = false)
```

Finally, other OCL constraints may express invariants relating to well-formedness rules of the model. For instance, the following constraint restricts the valid values of Loan objects:

```
context Loan inv ValidLoan: issueDate <= dueDate
```

Similarly, other OCL expressions can help determining the value of some of the system attributes, e.g., when the library is open:

```
context Library inv OpeningTimes:
(hour(self.clock.now) >= 8) and (hour(self.clock.now) < 5) implies self.isOpen = true
```

All these *invariants* are expressed as constraints, and specified in the **InformationObjects** package, associated with the corresponding elements.

A.3.4 Static schemata

Static schemata provide instantaneous views of information, for example at system initialization, or at any other specific moment in time that is relevant to any of the system stakeholders. This specification of the instantaneous state of the *objects* is precisely the one provided by UML object diagrams (also known as *snapshots* in some UML dialects).

For instance, the UML package shown in Figure A.22 expresses the initial state of the system, just before the library opens for the first time, when there are no items, borrowers, or loans. There are, however, one clock, one assistant, and one librarian registered in the Library at that moment in time. At least one assistant should be present in order for such a configuration of *objects* to respect the *invariant schemata* specified by the multiplicity of the associations in the class diagram shown in Figure A.20. Please note as well how the constraints on the **Library** object explicitly specify the multiplicity of the links, and how this *static schemata* defines the initial values of the variables that store the system policies, as described in the textual regulations of the library.

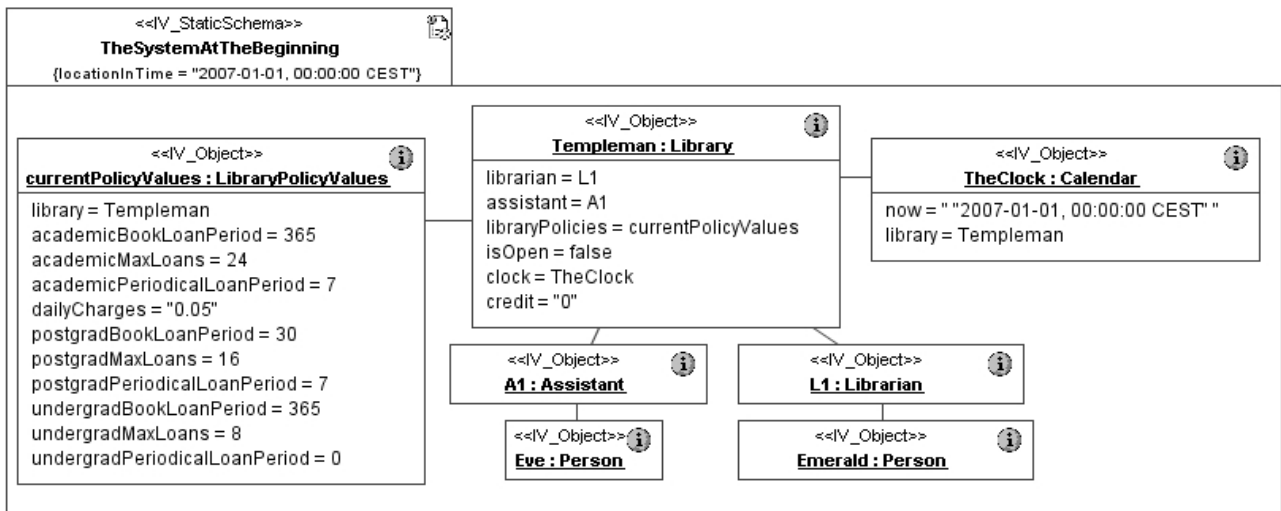

Figure A.22 – Static schema with the initial state of the Library system

Similarly, the UML object diagram shown in Figure A.23 expresses a *static schema* that models the state of the system at a moment in time (namely, at year end, when the state of the system should be recorded to serve as an inventory), in which there are only two **Borrowers** (John and Mary), one **Librarian** (Emerald), two **Assistants** (Eve and Pete), three **Books** (one copy of Ulysses and two copies of Dubliners), and one **Periodical** (today's edition of The Times). There is only one **Loan** (Mary borrowed one copy of Ulysses in March).

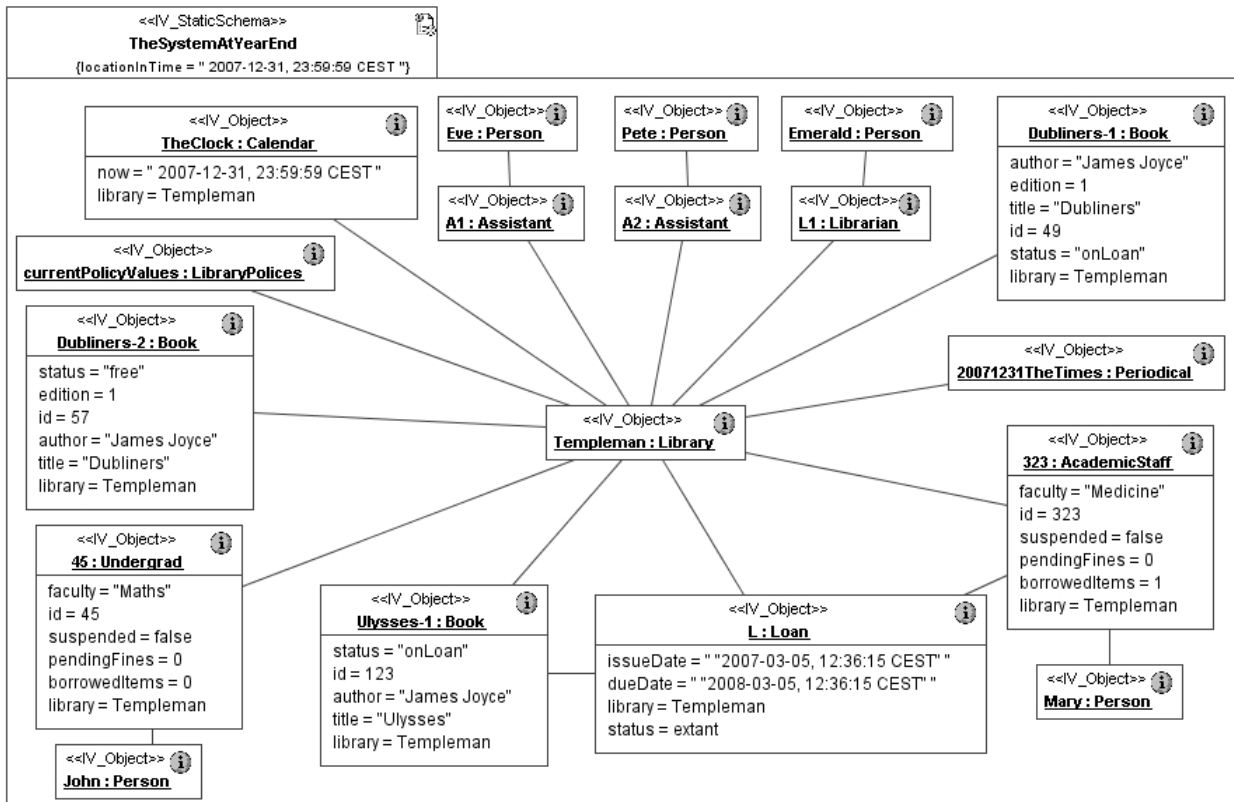

Figure A.23 – Static schema with the configuration of the Library system at day 95

A.3.5 Dynamic schemata: Description of the system behaviour

The way the system evolves is dictated by the *behaviour* of the *objects* of the system, which in the information viewpoint is modelled in terms of a set of *dynamic schemata*. They describe the allowed *state changes* of the system or of any subset of its constituent *information objects*.

This clause presents *dynamic information schemata* that describe changes of state associated with the *action types* identified in A.3.2. In this case, such *action types* have been expressed by signals stereotyped «IV_Action».

NOTE – It is worth noting here that some authors have proposed the use of UML operations for expressing *action types*. However, this approach presents some limitations. For example, it forces *actions* to be owned by one *object* (i.e., the *object* to which the operation is assigned). In general, it may be the case that more than one ODP *object* might be related to a single *action*, because ODP *interactions* are pieces of shared *behaviour*, with no necessarily single owner or initiator. However, the interaction model of the UML is based on message exchange between objects, which forces all UML operations to be assigned to only one object. Thus, if ODP *information actions* are expressed by UML operations, the system designer has to decide, for every *action*, the *object* to which an operation expressing the ODP *information action type* is assigned. This is in general a difficult decision, and therefore more practical applications are required in order to identify a set of guidelines or patterns to support the practising modeller in assigning ODP *action types* to UML classifiers.

The *behaviour* of every *information object* is specified using UML stateMachines, which describe its state changes as a consequence of the occurrence of the signals that express the possible *information actions* previously specified. These stateMachines express the *dynamic schemata* of the ODP information specifications. Please notice how a signal causes changes in all stateMachines that define a transition for it. In this way we can model, in a natural manner, the fact that an ODP *interaction* may cause a state change in all objects related to that *interaction*, i.e., an ODP *interaction* is a piece of shared behaviour. This would be very difficult to do if ODP *interactions* were expressed by operations.

In this case, the *dynamic schema* of the library is specified in terms of the stateMachines of the classifiers that support the actions defined in clause A.3.2, namely the **Librarian**, **Assistant**, **Borrower**, **Loan** and **Item**. Figures A.24, A.25 and A.26 show some of these stateMachines, for illustration purposes.

The specification of these stateMachines has been developed based on the enterprise specification of their corresponding *objects*. Thus, Figure A.24 depicts the stateMachine of the **Loan information object**, based on the corresponding stateMachine of the **Loan enterprise object** depicted in Figure A.13.

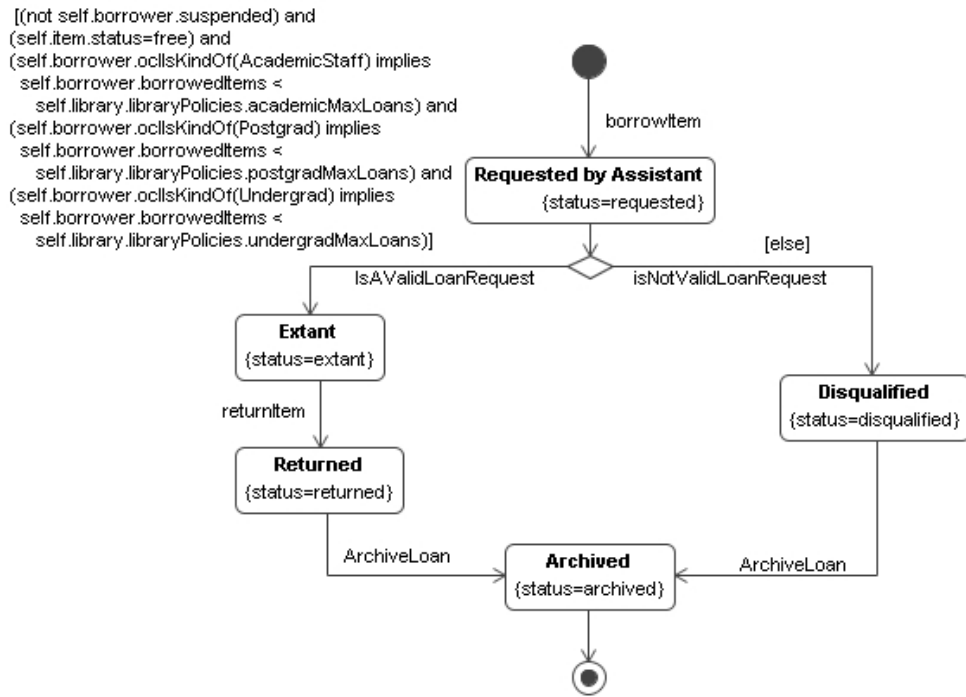

Figure A.24 – StateMachine of the Loan information object

Likewise, Figure A.25 shows the stateMachine of the **Borrower** information object, based on the corresponding stateMachine of the **Member** enterprise object depicted in Figure A.14. In the information specification, two of the states of the enterprise object, **Valid** and **Suspended**, have been refined (defining them as composite states) to show the effects of fines imposed by the assistants and debt settlements (**FineMember** and **PayFine** actions). Figure A.25 also shows the transitions between the states, and the valid actions accepted in each one.

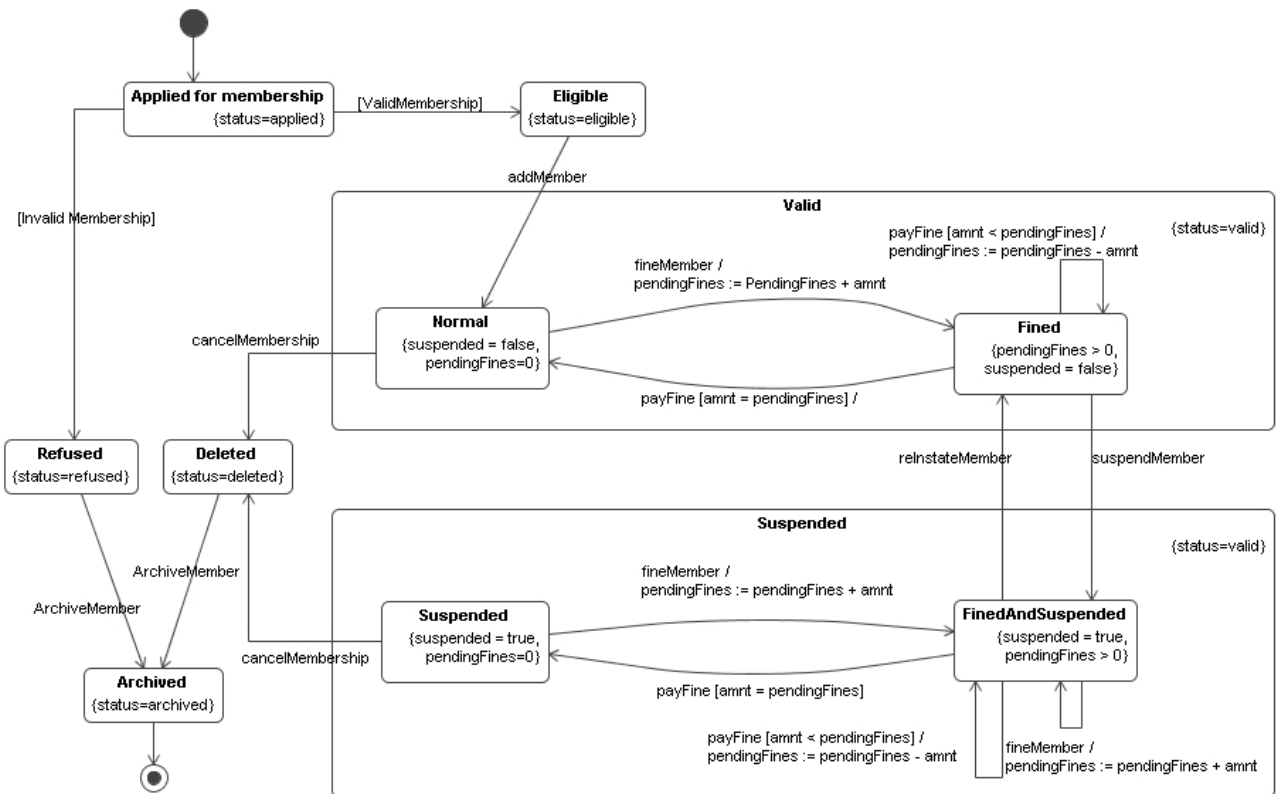

Figure A.25 – StateMachine of a Borrower information object

Finally, Figure A.26 shows the stateMachine of the **Item** information object.

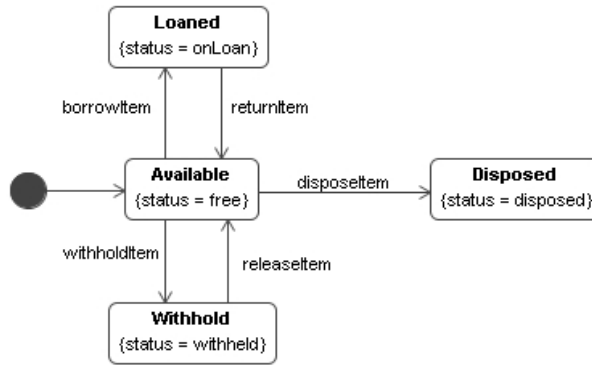

Figure A.26 – StateMachine of an Item information object

NOTE – The previous diagrams show not only the effect of the *actions* on the corresponding *information objects*, but also the *states* in which the *actions* are allowed, serving as pre- and post-conditions for those *actions*.

A.3.6 Correspondences between the enterprise and the information specifications

Correspondences between the Enterprise and Information specifications are expressed in the corresponding package **LibrarySystem (E-I Corr)**, as shown in Figure A.1. Correspondences are expressed using the correspondence profile (see [12.2]).

Figure A.27 shows an example of a *correspondence* between **Loan** enterprise and *information objects*. There is a top-level correspondence, **LoanCorrespondence**, which links these two types of *objects*. Such a correspondence is broken down into a set of correspondences, which establish particular details of it.

Thus, correspondence **LoanInstances** establishes that the sets of Loan instances in the enterprise and information models should be consistent. This is specified by stating that the set of names of the instances of enterprise loans should include the set of names of the instances of information loans.

Similarly, correspondence **CheckLoanAuthorization** establishes a correspondence between the opaqueBehavior `ValidateLoanRequest` of the **LibrarySystem** role (see Figures A.5, A.10 and A.16), and the transitions between states of the **Loan** information object (see Figure A.24).

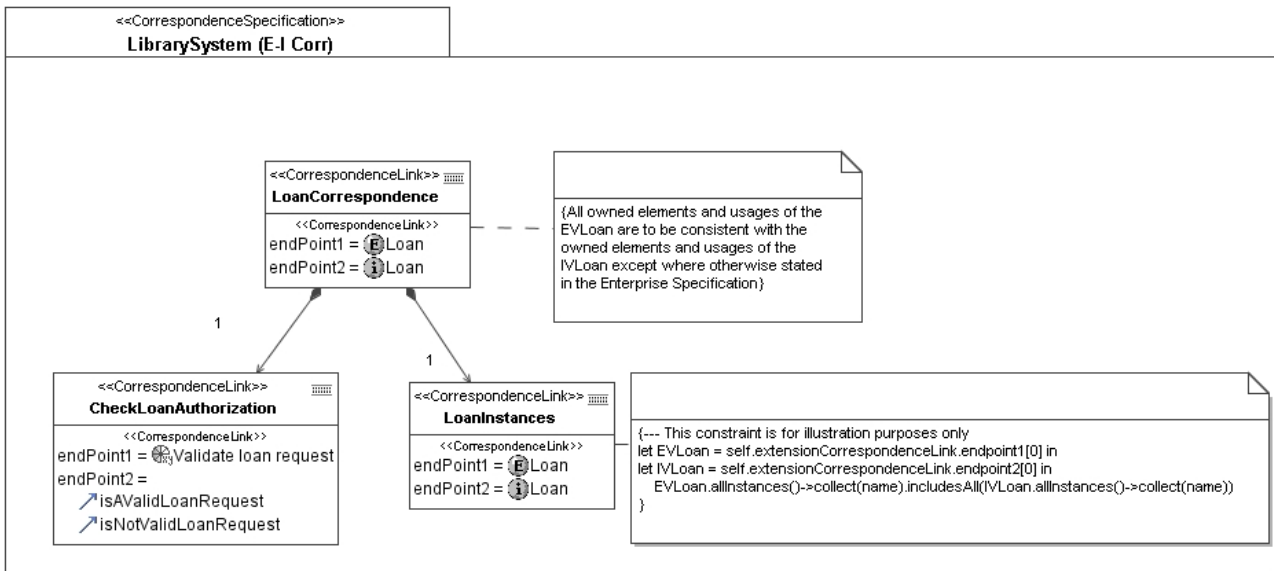

Figure A.27 – Example of correspondence between the enterprise and information specifications

Of course, top-level *correspondence* **LoanCorrespondence** is composed of more *correspondences*, not shown here for the sake of simplicity.

A.4 Computational specification in UML

A.4.1 Overview

The computational viewpoint is concerned with functional decomposition of an ODP system in distribution transparent terms. A computational specification defines units of function as *computational objects*, and the *interactions* among those *computational objects*, without considering their distribution over networks and nodes. This clause concentrates on the computational specification in UML of the borrowing process of the library system.

A.4.2 Computational objects and interfaces

The basic structure of the computational viewpoint specification of the Library system is shown in Figure A.28. Each package specifies the corresponding elements, and will be described in the following clauses. The elements of each package have been defined by making into components the functionality specified in the enterprise and information viewpoints, identifying the basic *operations* first and grouping them into *interfaces*. These *interfaces* define *operations* which handle data, as part of their parameters and return values. The *types* of these *parameters* are specified in the **DataTypes** package. Finally, the *computational objects* that own these *interfaces* are specified in the **ObjectTemplates** package.

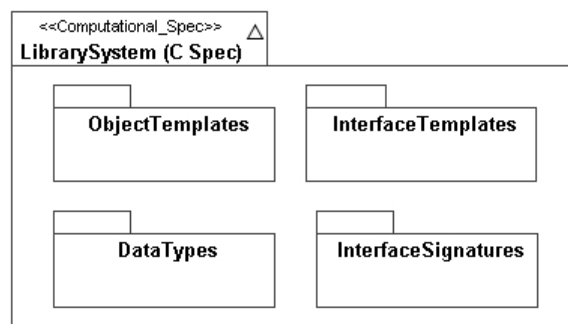





Figure A.28 – Basic structure of the computational viewpoint specification of the Library system

It is interesting to note that the decomposition of the system functionality into *computational objects* that interact at *interfaces* provides the software architecture of the application. In UML, we express such architecture using a component diagram that describes the *computational object templates* and the *computational interface templates* at which these *objects* interact.

In the library system example, the software architecture of the application is composed, at the highest level, of three main components: one that describes the basic functionality of the system (**LibrarySystemMainFunctionality**), and other two (**InterfaceToAssistant** and **InterfaceToLibrarian**) which specify the user interfaces that the application will offer to assistants and librarians to interact with it, respectively. This is shown in Figure A.29.

In the figures that follow, to improve the clarity of the diagrams, the icons shown in Table A.3 have been used to represent instances of the corresponding stereotypes.

Table A.3 – Computational language icons.

«CV_Object»	
«CV_BindingObject»	
«CV_TemplateObject»	

Each *computational object* is expressed as a component. *Object interfaces* are expressed as component ports. Finally, *interface signatures* are expressed as interfaces. Thus, *computational objects* interact which each other at *computational interfaces* (port instances), which are instantiated from their corresponding *interface templates* (ports). Each port uses or implements some interfaces, which specify the corresponding *interaction signatures*. In Figure A.29, the ports of the **InterfaceToAssistant** and **InterfaceToLibrarian** components make use of the services provided by the ports of the **LibrarySystemMainFunctionality** component.

Figure A.30 shows the interfaces that specify the *interaction signatures* of the Library system. They are all *operation interface signatures*, since our interaction mechanisms have been modelled as such. The way to identify these *operations*

is by inspecting the enterprise and information specifications, trying to capture and specify as *computational operations* the relevant *enterprise processes, steps, and actions* of the **LibrarySystem** *enterprise object*, together with the relevant *actions* of the information specification. The way to group them into *operation interfaces* that provide services depends on the designer's choice, and is usually based on the similarity of the functionality offered by each *operation*.

Once the high-level architecture of the application has been defined, the next step is to refine its components, specifying their internals. Figure A.31 shows the structure of the **LibrarySystemMainFunctionality** *computational object*. It has been refined into 6 *computational objects* (expressed as six components), each one dealing with a particular piece of functionality. Each component interacts with the rest through its ports, which express the corresponding *computational interfaces*. We can see how each port is of a particular type (described in the **InterfaceTemplate** package) and implements or uses several interfaces (which express the corresponding *interface signatures* shown in Figure A.30). The way to achieve such decomposition is something that again depends on the designer's choice.

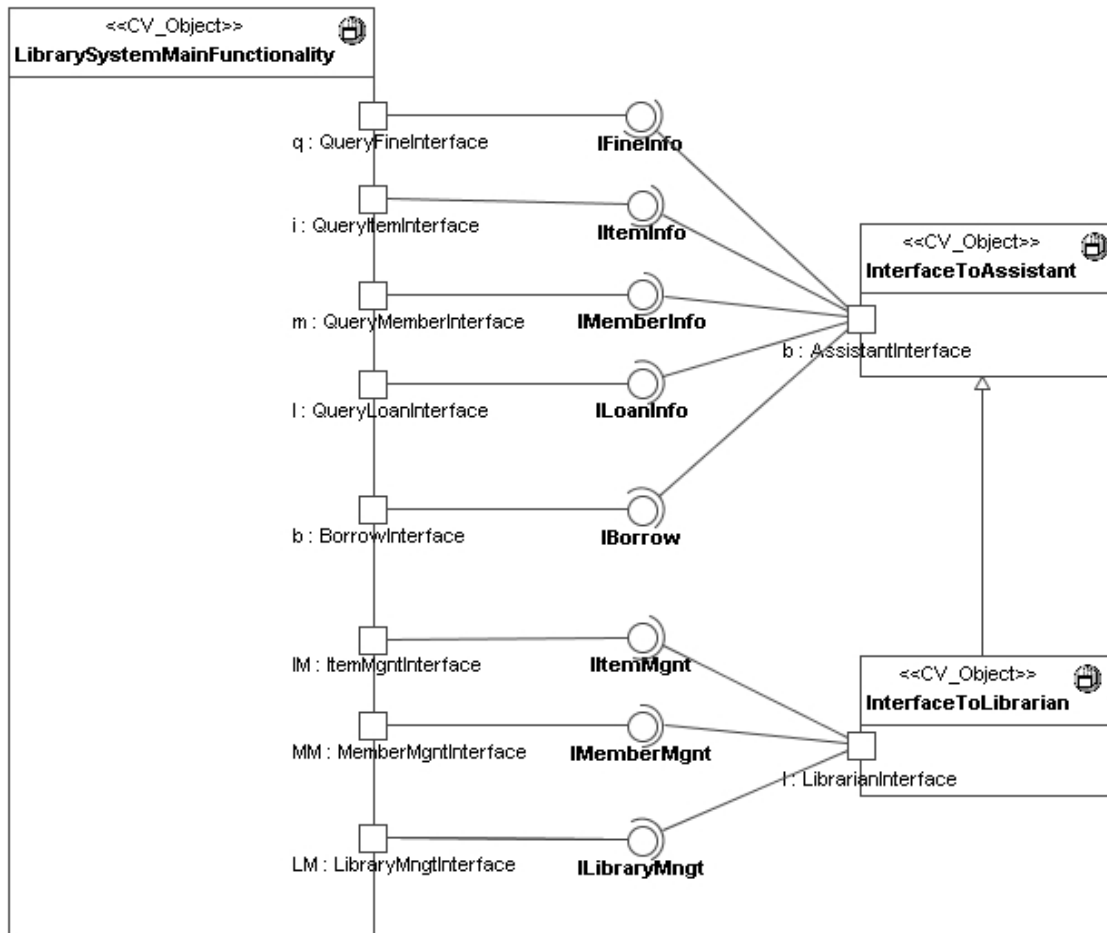

Figure A.29 – Component diagram with computational object templates and interface signatures of the system

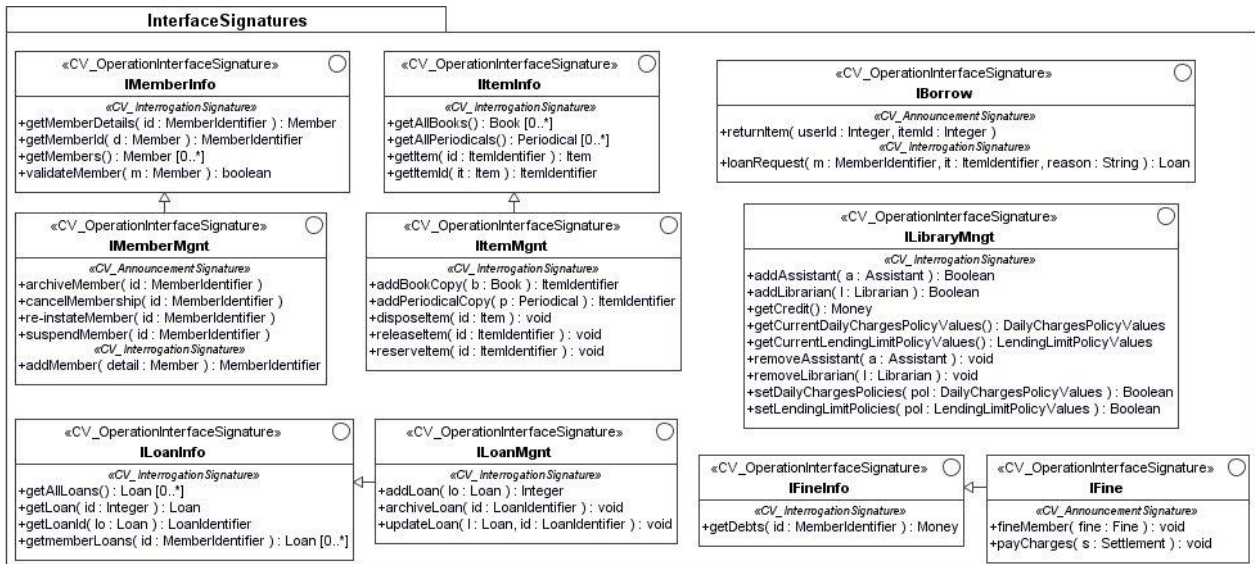

Figure A.30 – Interaction signatures

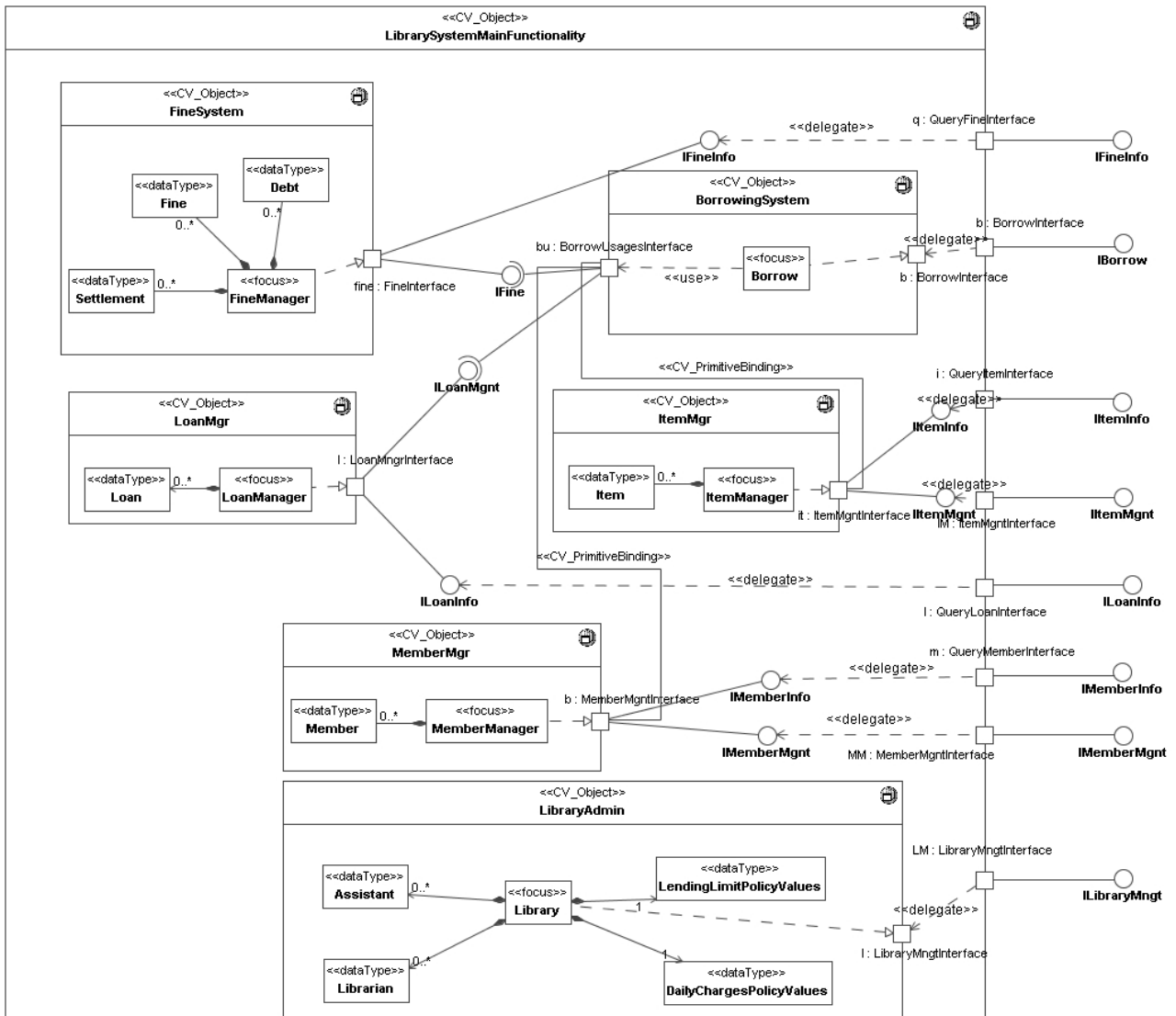

Figure A.31 – Internal structure of the LibrarySystemMainFunctionality computational object

The connections between the different components are shown using either the "ball and socket" notation that expresses *implicit primitive bindings* between the corresponding *computational objects* (see [9.2.17]), or some assembly connectors that express the *explicit primitive bindings*. We have also used some delegation connectors to map the external view of the component to its internal view (see [UML – 8.3.1]), specifying how the services provided by an external port are in fact provided by a port of one of its internal components.

Please note as well how in Figure A.31 we have included further information about the components, such as some of their internal realizing classifiers. For instance, the **LoanMgr** component is in charge of managing the loans in the system (representing, e.g., a database that stores and manages them) and thus contains a realizing classifier (the **LoanManager** «focus» class) which specifies its behaviour, and that owns the set of **Loans** of the systems (that represent the elements of the database). The structure and contents of such **Loans** are specified in the **DataType** package, which is shown in Figure A.32. These data types have been derived from the corresponding *information object types* (which in turn came from the *enterprise artefacts, roles and objects*).

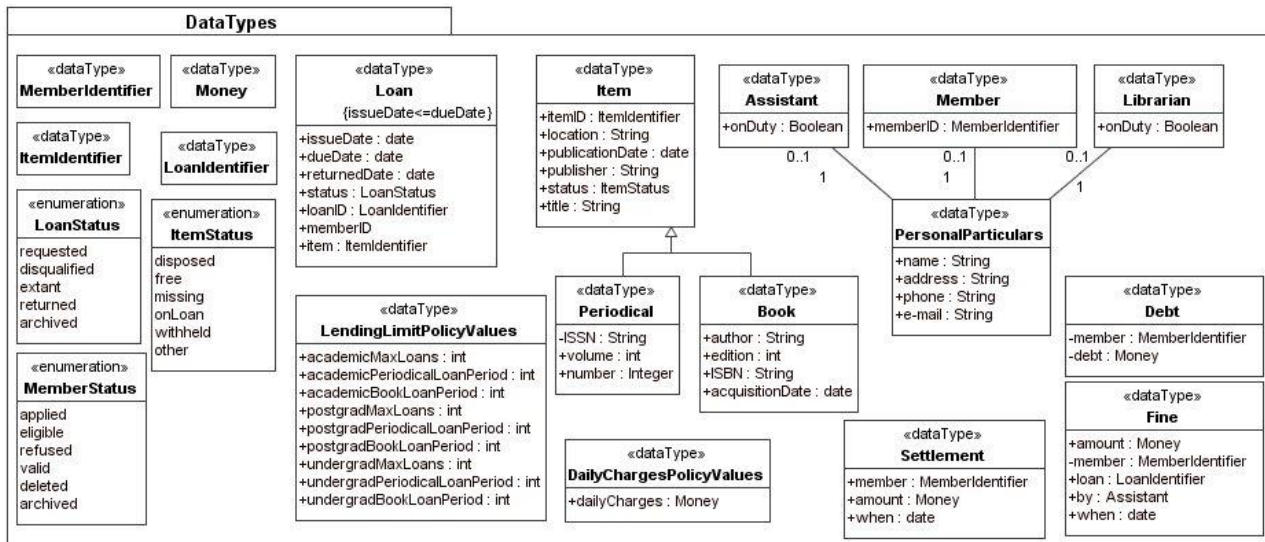

Figure A.32 – Data types handled by the computational objects

A.4.3 Behaviour

Apart from the structural aspects, we need to specify the behaviour of the elements of a computational specification. StateMachines can be used to express the internal behaviour of computational elements: ports, components and realizing classifiers. The way to use stateMachines to represent that behaviour has already been illustrated in the enterprise and information specifications.

In case we want to specify object interactions, activities can be useful because they are abstractions of the many ways in which messages are exchanged between objects. Alternatively, UML interaction diagrams are more appropriate when messages and interaction protocols are the focus of design.

For illustration purposes, Figure A.33 shows a sequence diagram with the interactions that occur between the components of the computational specification during the borrowing process. First, an **Assistant** issues a **loanRequest()** operation, which is received by the component that implements it (**BorrowingSystem**). That component asks the **MemberMgr** for the details of the borrower, and then requests a validation. If the validation fails (reply message number 5), the **BorrowingSystem** registers and archives the loan in the system (through the **LoanManager**), and responds to the **InterfaceToAssistant**. Alternatively, i.e., if the member is valid (reply message number 11), the **BorrowingSystem** component asks the **ItemMgr** for details about the item to borrow, and the **LoanMgr** for the current loans of the borrower. Two alternative *behaviours* are possible then, depending on whether the request is valid or not (the conditions correspond to those specified in the information viewpoint: the loan limits are not exceeded, the item is indeed free, etc. – see Figure A.24). If the request is not valid then the loan is registered and archived, and a response is issued to the **InterfaceToAssistant**. Finally, if the loan request is valid then the item is marked as loaned (through the **reserveItem()** operation), the loan is registered in the system, and the **Assistant** is notified.

Please note how it is possible to incorporate *environment contracts* in the specification, expressed by constraints stereotyped «CV_EnvironmentContract». In this case, the duration constraint corresponds to one of the requirements specified in the enterprise viewpoint, which mandated that the operation should not exceed 5 seconds (see Figure A.5).

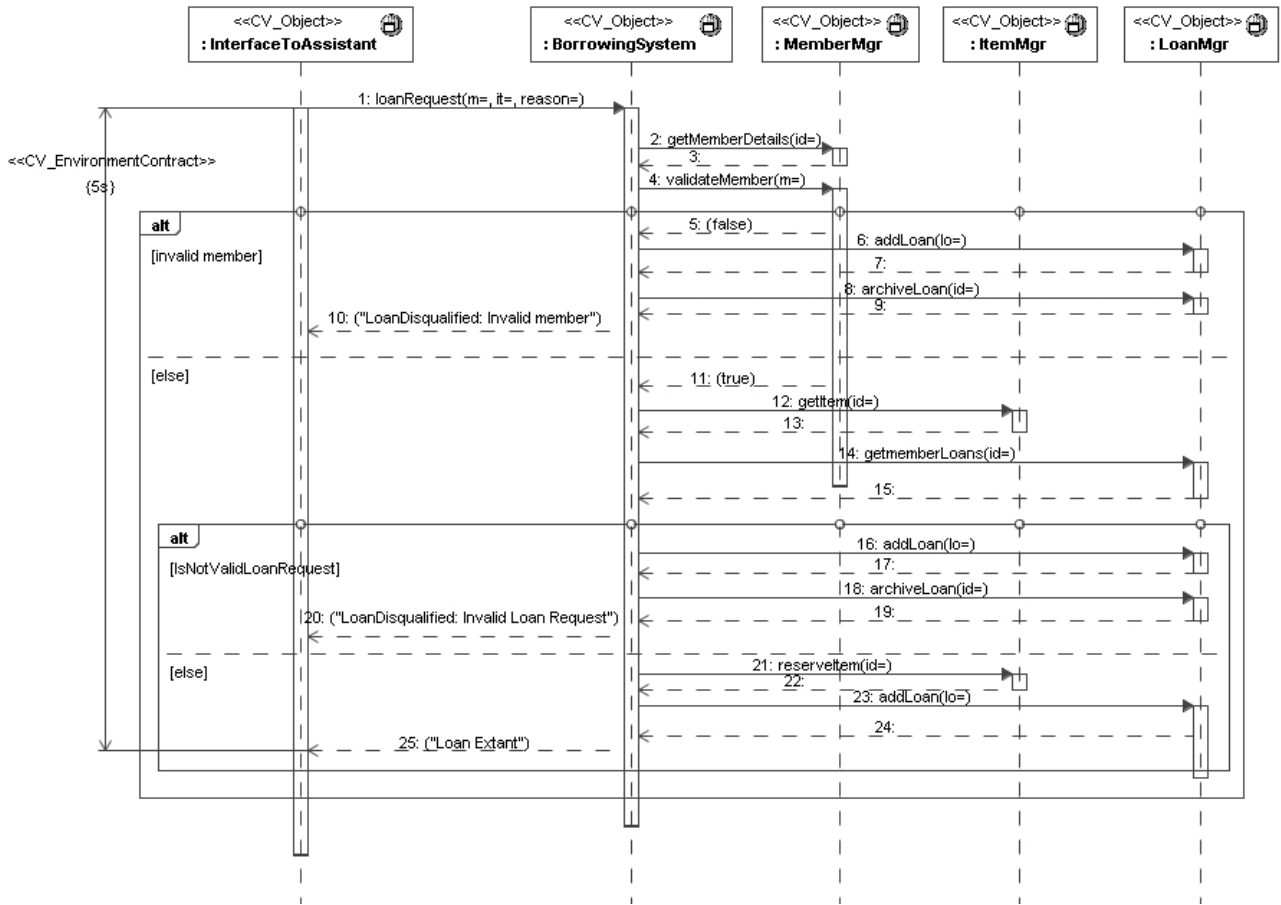

Figure A.33 – Interaction diagram for the borrowing process

A.4.4 Correspondences between the enterprise and computational specifications

Correspondences between the enterprise and computational specifications are expressed in the package **LibrarySystem (E-C Corr)**, as shown in Figure A.1. Correspondences are expressed using the correspondence profile (see [12.2]).

Figure A.34 shows the **LoanRequestDuration** correspondence, that we have mentioned above between the requirement specified in the enterprise viewpoint about the duration of a **loan request**, and the corresponding *environment contract* in the computational specification. The other correspondence shown in this package relates the *enterprise object type* **Loan** with the *computational object type* **Loan**.

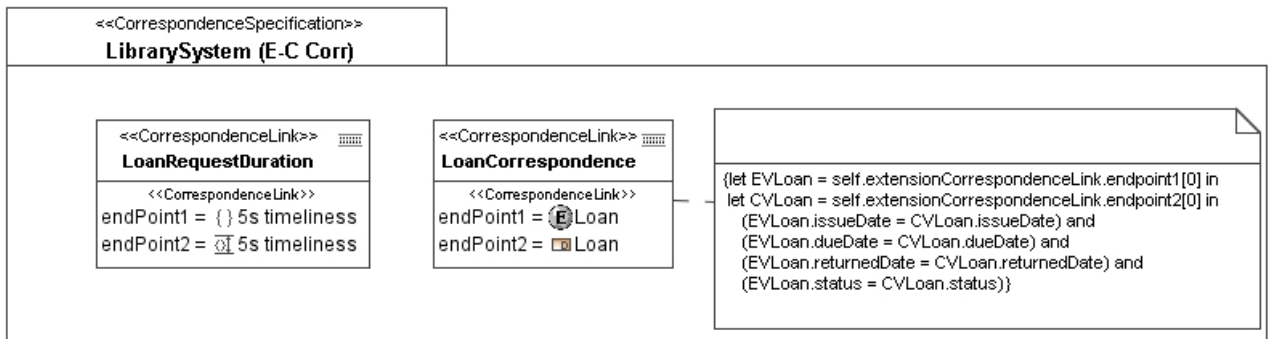

Figure A.34 – Example of correspondence between the enterprise and computational specifications

A.4.5 Correspondences between the information and computational specifications

Correspondences between the information and computational specifications are expressed in the package **LibrarySystem (I-C Corr)**, as shown in Figure A.1. Correspondences are expressed using the correspondence profile (see [12.2]).

Figure A.35 shows an example of a *correspondence* between **Loan** information and *computational objects*: *correspondence* **LoanCorrespondence** links these two types of objects.

The other *correspondence* in that package establishes that the sets of **Loan** instances in the information model should be consistent with the *objects* stored by the **LoanMgr** component (i.e., with the loans stored in the application's database). This is specified by stating that the set of names of the instances of *information object* **loan** should coincide with the set of names of the instances stored by **LoanMgr**.

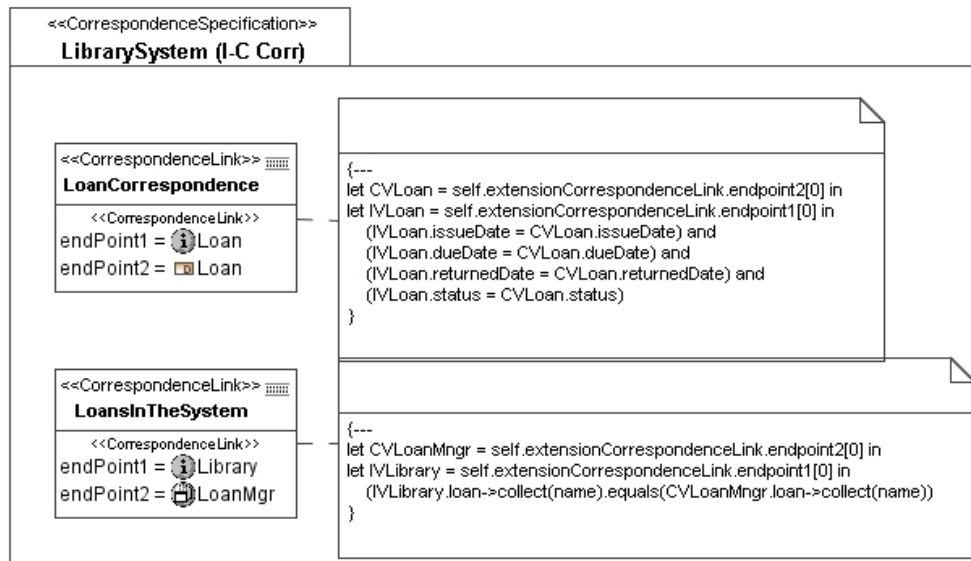

Figure A.35 – Example of correspondence between the information and computational specifications









A.5 Engineering specification in UML

A.5.1 Overview

The engineering viewpoint is concerned with the mechanisms and functions required to support distributed *interaction* between *objects* in the system. An engineering specification defines the structure of *node* (*nucleus*, *capsule*, *cluster*, (*basic*) *engineering objects*), *channel*, and their *management functions*. This clause concentrates on the engineering specification in UML of the borrowing process of the Library system.

In the figures that follow, to improve the clarity of the diagrams, the icons shown in Table A.4 have been used to represent instances of the corresponding stereotypes.

Table A.4 – Engineering language icons

«NV_Object»	
«NV_BEO»	
«NV_TypeObject»	
«NV_TemplateObject»	
«NV_Checkpoint»	
«NV_ClusterCheckpoint»	
«NV_Cluster»	
«NV_Capsule»	
«NV_Node»	
«NV_ClusterManager»	
«NV_CapsuleManager»	
«NV_Nucleus»	
«NV_CommunicationAuthority»	
«NV_Channel»	
«NV_Stub»	
«NV_Binder»	
«NV_Interceptor»	
«NV_ProtocolObject»	
«NV_CommunicationDomain»	
«NV_InterfaceReferenceManagementDomain»	

A.5.2 Computational objects

A set of *computational objects*, which this engineering specification will support, needs to be clarified. In this example, those are the *computational objects* defined in [A.4]: **InterfaceToAssistant**, **InterfaceToLibrarian**, and **LibrarySystemMainFunctionality**, which contains **BorrowingSystem**, **FineSystem**, **LoanMgr**, **ItemMgr**, **MemberMgr**, and **LibraryAdmin**. Those *computational objects* will be supported by corresponding *basic engineering objects*, which are deployed within *clusters* on *nodes*, and by the engineering infrastructure using *nodes*, *nucleus*, *capsules*, *capsule managers*, *clusters*, *cluster managers*, and *channels*.

NOTE – There are several architectural styles to define a physical deployment model, such as client-server, n-tier, model-view-controller (MVC), and service oriented architecture (SOA). In this example, n-tier and MVC architectural style are used. Even with the choice of architectural styles, there will be various types of node configurations, depending on requirements, such as performance, reliability, availability etc.

A.5.3 Node configuration

The basic node configuration model for this example consists of four *nodes*: **ClientTier**, **InteractionTier**, **EnterpriseTier**, and **EISTier** (where EIS stands for enterprise information system) (see Figure A.36). An assistant (i.e., a user of the system) will use a desktop or notebook PC, which serves as **ClientTier**. A request from **ClientTier** node is

sent to a server *node*, which serves as the **InteractionTier**. A functional request is passed to another server *node*, which serves as the **EnterpriseTier**. Finally, data persistence is taken care of by yet another server *node*, which serves as the **EIS_Server**. The following diagram shows an overview of the *node* configuration.

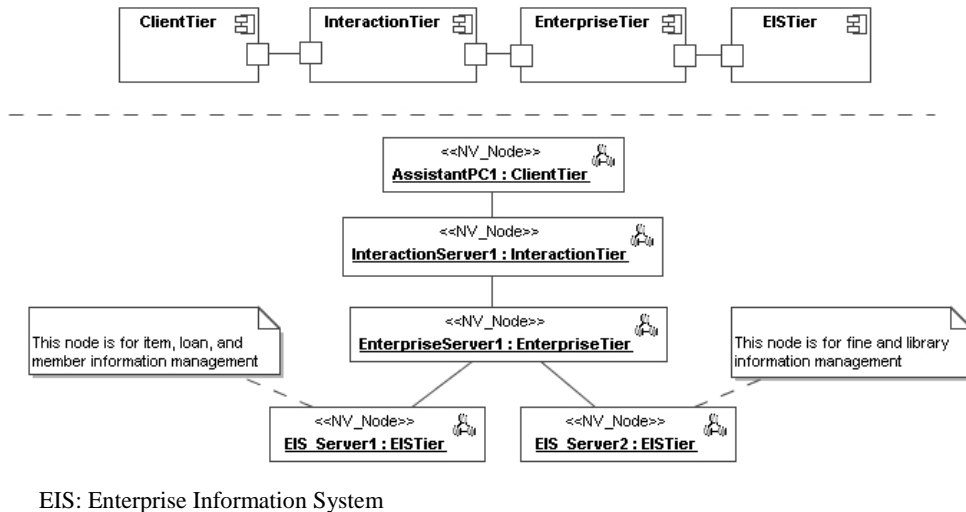

Figure A.36 – Node configuration overview

A.5.4 Node structures

Each *node* consists of the *node* itself, a *nucleus*, and one or more *capsules*, *capsule managers*, *clusters*, *cluster managers*, *BEOs*, *engineering objects*, *stubs*, *binders*, *protocol objects*, and *interceptors*. In the node configuration above, *BEOs* are deployed as follows:

- *BEOs* for graphical user interface to access the system are deployed on the **AssistantPC**;
- *BEOs* to support n-tier and MVC architectural style are deployed on the **InteractionServer** and the **EnterpriseServer**; and
- *BEOs* for application specific computational objects are deployed on the **EnterpriseServer** and the **EIS_Server**.

Figure A.37 shows an example of a configuration of *BEOs* in the engineering specification. *BEOs* are deployed on various *nodes* and within *clusters* in *capsules*. *BEOs* can have interactions between them by using *channels*. For instance, **Browser_APC1** *BEO* on **AssistantPC1** *node* communicates with **Controller** *BEO* on **InteractionServer** *node* via **Channel1**.

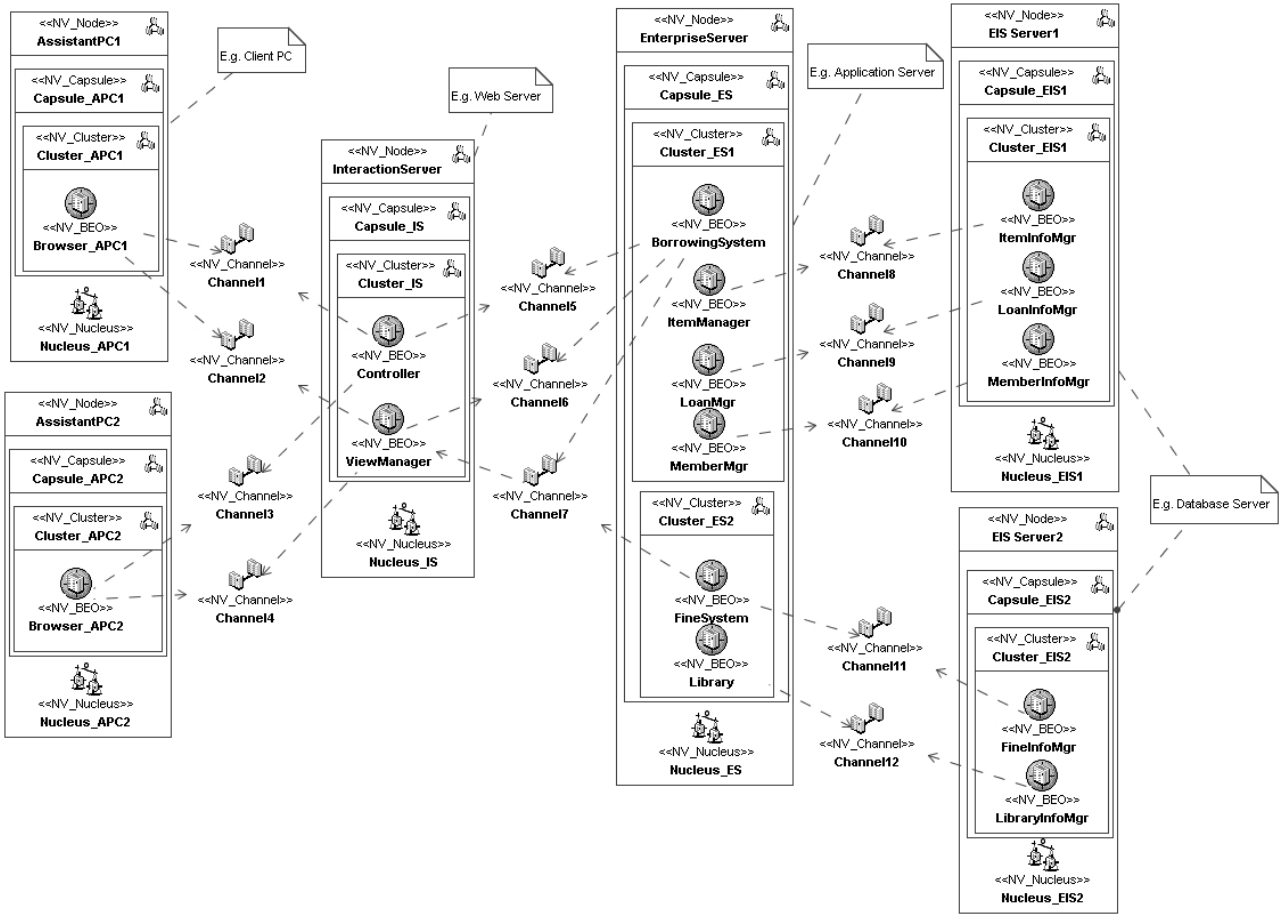

Figure A.37 – Example of BEO configuration

NOTE – Capsule managers and cluster managers are not included, interfaces of various engineering objects are not shown for simplicity, and channels are shown using comments (see Figure A.39 for channel structure example).

As an example of a detailed *node* structure, Figure A.38 shows the internals of the **EnterpriseServer** *node*. In it, **BorrowingSystem** *BEO* makes use of the services provided by locally bound **LoanMgr** *BEO*, **ItemManager** *BEO*, and **MemberMgr** *BEO*. It also makes use of the services provided by **FineSystem** *BEO* in another *cluster* via a local *channel*. **LoanMgr** *BEO* then makes use of an external service (not shown in Figure A.38) via a *channel* to a *BEO* residing on another *node*. All *BEOs* in **Cluster_ES1** are bound to **ClusterMgr_ES1**, and they all are bound to **Nucleus_ES** to have management services provided by the *nucleus*.

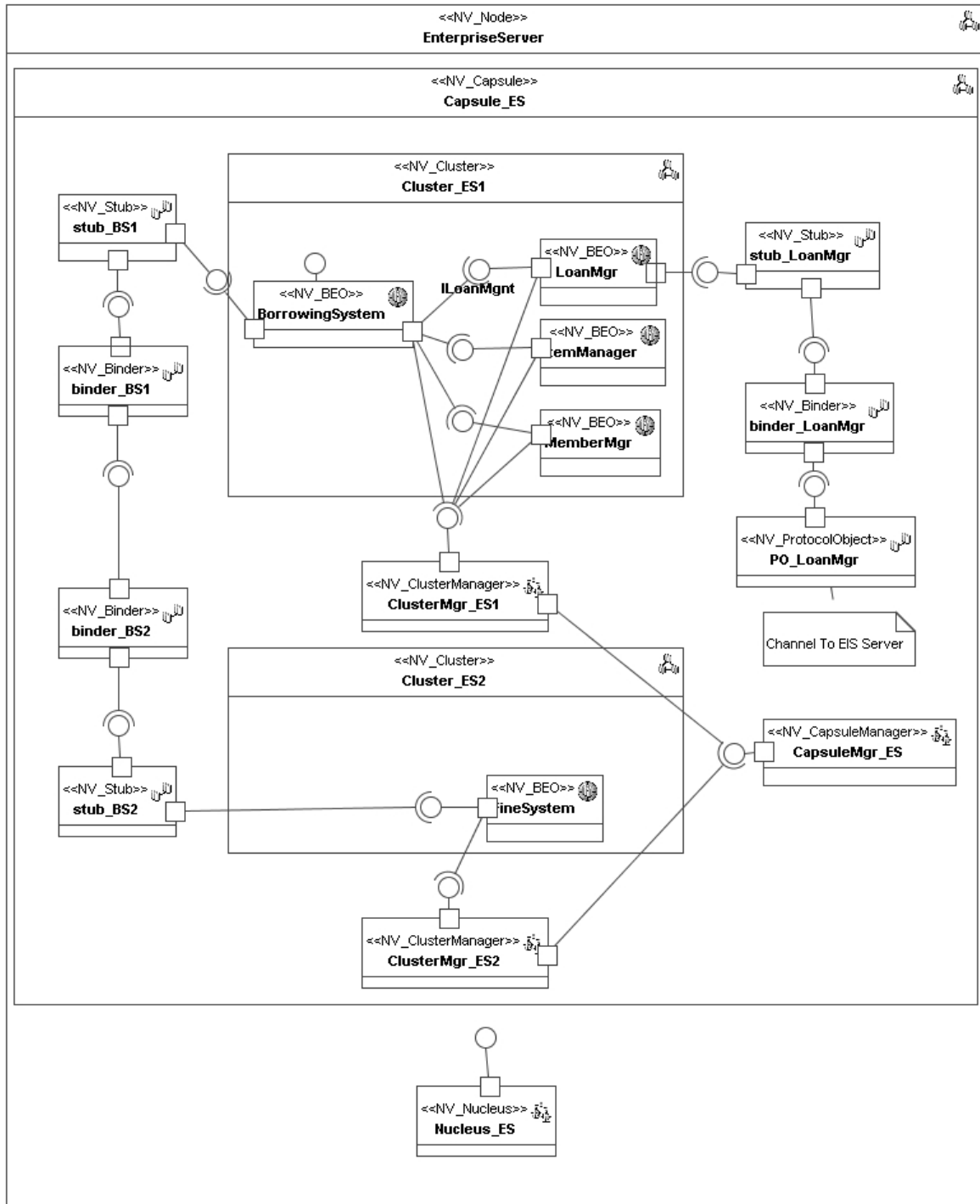

Figure A.38 – Example of EnterpriseServer internals

A.5.5 Channels

In this example, four *channels* exist: one between **AssistantPC** and **InteractionServer**, one between **InteractionServer** and **EnterpriseServer**, and two between **Enterprise Server** and **IntegrationServers**. The first *channel* comprises a *stub*, a *binder*, and a *protocol object* for the **AssistantPC**, and a *stub*, a *binder*, and a *protocol object* for the **InteractionServer**.

Figure A.39 shows an example of a *channel* called **Channel_A**, which allows *binding* and *communication* between a *BEO* of **type2** and a *BEO* of **type3**. To allow both sides to use the *channel*, **Channel_A** provides *interfaces* to both ends.

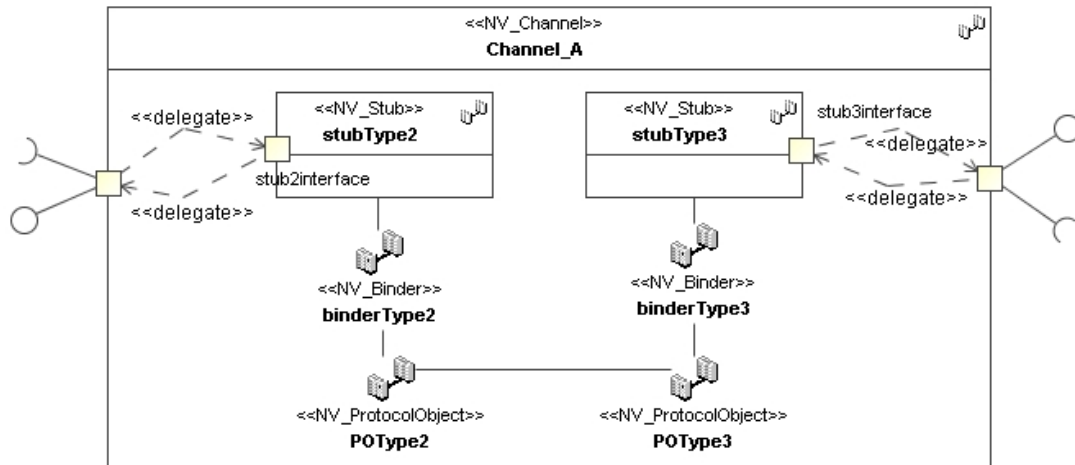

Figure A.39 – Internals of a channel

A.5.6 Communication domain

Figure A.40 shows an example of a *communication domain* specification in UML, using packages that contain *protocol objects* which belong to the same *communication domain*.

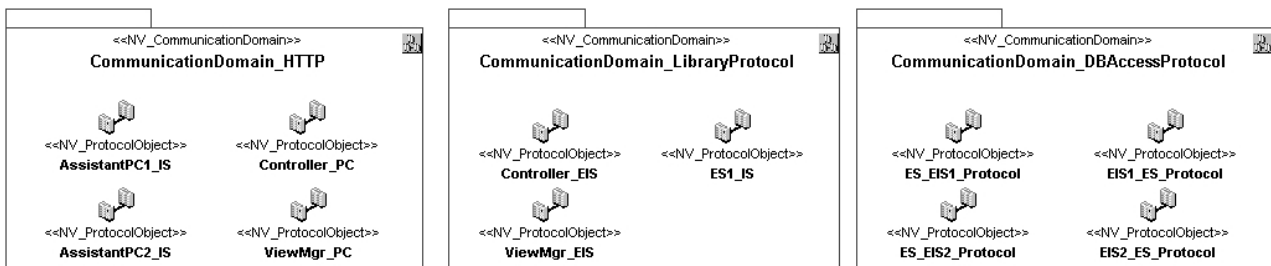

Figure A.40 – Example of a communication domain

A.5.7 Representing functions

Checkpointing, deactivation, cloning, recovery, reactivation, and migration are functions defined in [Part 3 – 8]. Since this Recommendation | International Standard defines stereotypes based on multiple metaclasses, the following is a series of diagrams describing the use of activities and actions to express *functions*. The diagrams are just examples. Users may add more actions or objectNodes to define their extended activity models.

Figure A.41 shows an example of a *checkpointing* process expressed as an activity, which contains a *checkpointing* action inside.

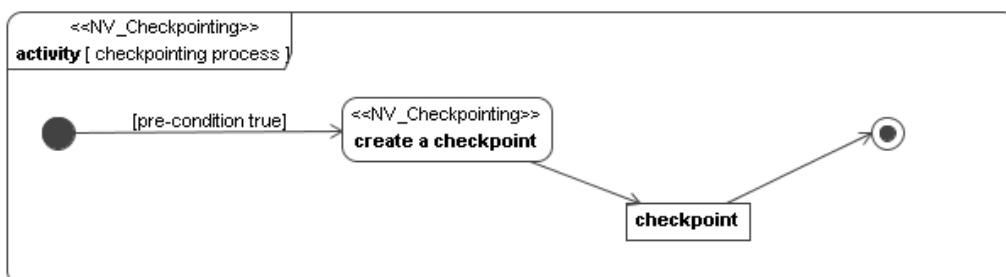

Figure A.41 – Checkpointing process

Figure A.42 shows an example of a *deactivation* process expressed as an activity, which contains a *checkpointing* action inside.

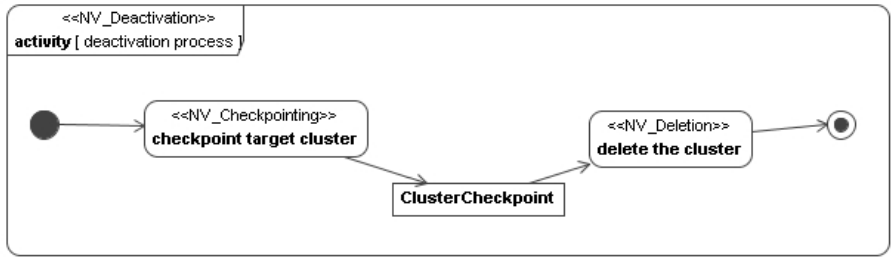

Figure A.42 – Deactivation process

Figure A.43 shows an example of a *cloning* process expressed as an activity.

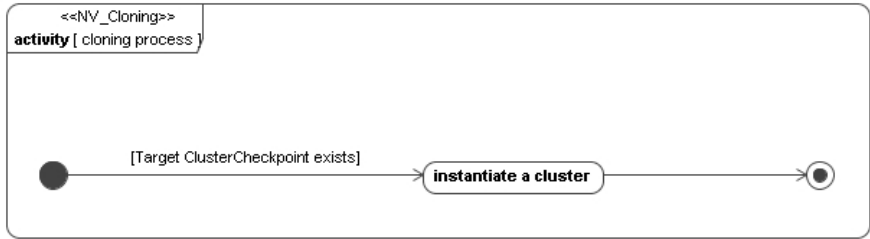

Figure A.43 – Cloning process

Figure A.44 shows an example of a *reactivation* process expressed as an activity, which contains both *deactivation* and *cloning* actions inside.

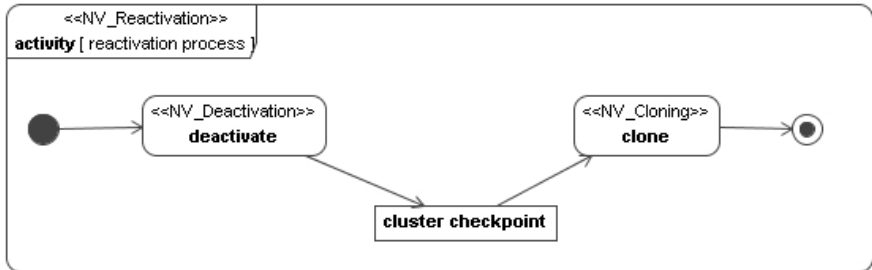

Figure A.44 – Reactivation process

Figure A.45 shows an example of a *recovery* process expressed as an activity, which contains a *cloning* action inside.

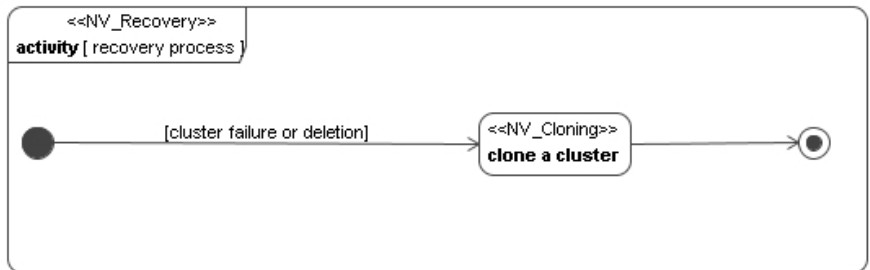

Figure A.45 – Recovery process

Figure A.46 shows an example of a *migration* process expressed as an activity, which contains a *deactivation* action inside.

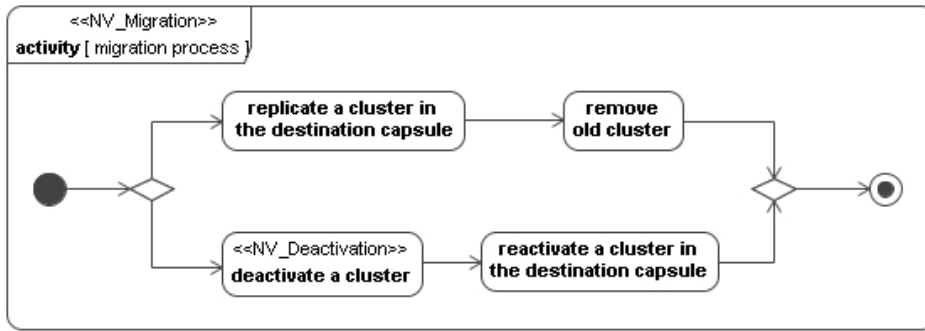

Figure A.46 – Migration process

Finally, Figure A.47 is an example of a diagram showing the use of *functions*, which are represented in terms of an *interface* (**TradingInterface**) that specifies its *signature*, and the specific *engineering object* (**Trader_A**) that realizes or provides the *function*.

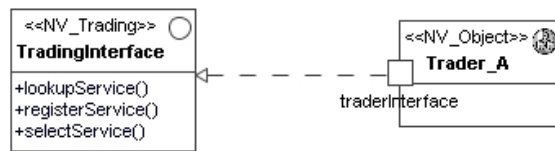

Figure A.47 – Use of functions

A.5.8 Channel creation and interface location

Figure A.48 shows how a *nucleus* provides a *channel* creation and an interface location *interface* to a BEO. Using this *interface*, the BEO can do several operations, such as publish its *interface reference*, bind to a trader, find a target *object* and a *bind object*, and get *channel* type and *communication interface*. The interface is stereotyped as «NV_NodeManagement».

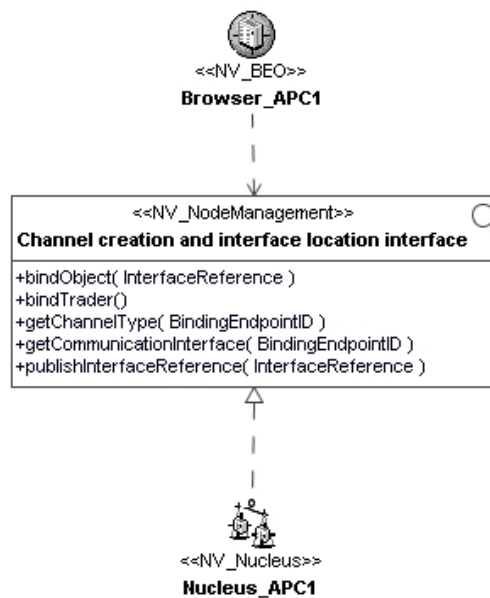

Figure A.48 – Channel creation interface

A.5.9 Interface reference management domain

According to [Part 3 – 8.2.2], "The information within an engineering interface reference can take the form of:

- data;
- identifiers for interfaces giving access to such data;

- a combination of data and identifiers.

The data necessary for binding can include any or all of the following items:

- the interface type of the referenced interface;
- a channel template describing the interceptors, protocol objects, binders and stubs that can be selected when configuring a channel to support the distributed binding;
- the location in space and time (e.g., a network address) of the communication interfaces at which the binding process can be initiated;
- information to enable the detection and repair of distributed bindings invalidated by engineering object relocation."

If necessary, it is possible to show a set of *nodes* belonging to an *engineering interface reference management domain* as in Figure A.49 below.

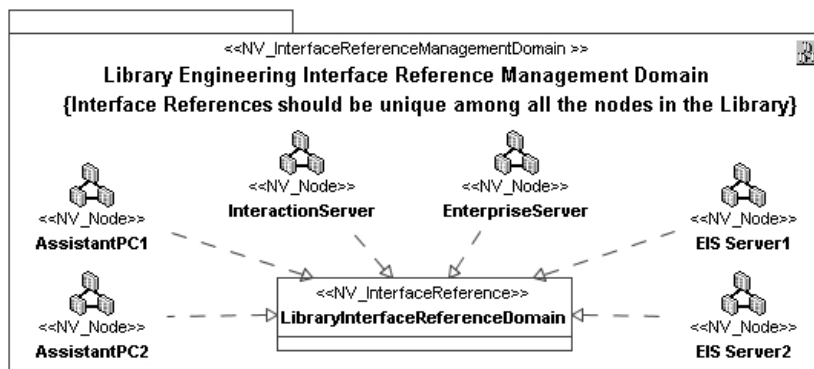

Figure A.49 – Interface reference management domain

A.5.10 Management functions

The diagram in Figure A.50 shows examples of *interfaces* that *objects*, *nucleus*, *cluster manager*, and *capsule manager* can provide. *Interfaces* are stereotyped to show their different *types*, and some *operations* are also stereotyped to show their kind of functionality. More *operations* than those described here can of course be specified, using the stereotypes defined in this Recommendation | International Standard.

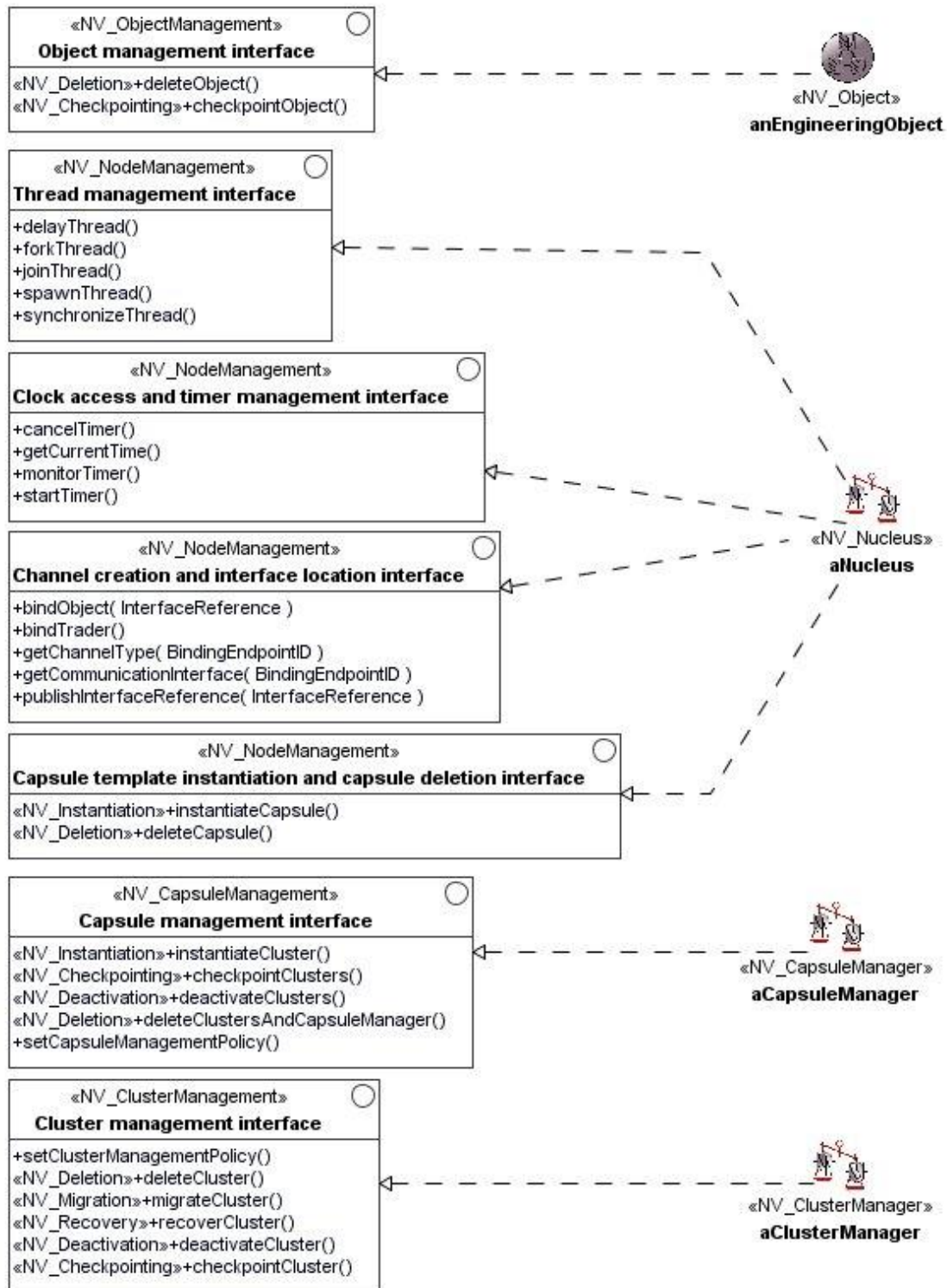

Figure A.50 – Management functions

A.5.11 Correspondences between enterprise and engineering specifications

Correspondences between the enterprise and engineering specifications are expressed in the package **LibrarySystem (E-N Corr)**, as shown in Figure A.1. Correspondences are expressed using the correspondence profile (see [12.2]). Figure A.51 shows the **LibrarySystemCorrespondence** that expresses the *correspondence* between the requirements specified in the enterprise viewpoint about the existence of **Library system**, and the *nodes* supporting the **Library system** in engineering viewpoint.

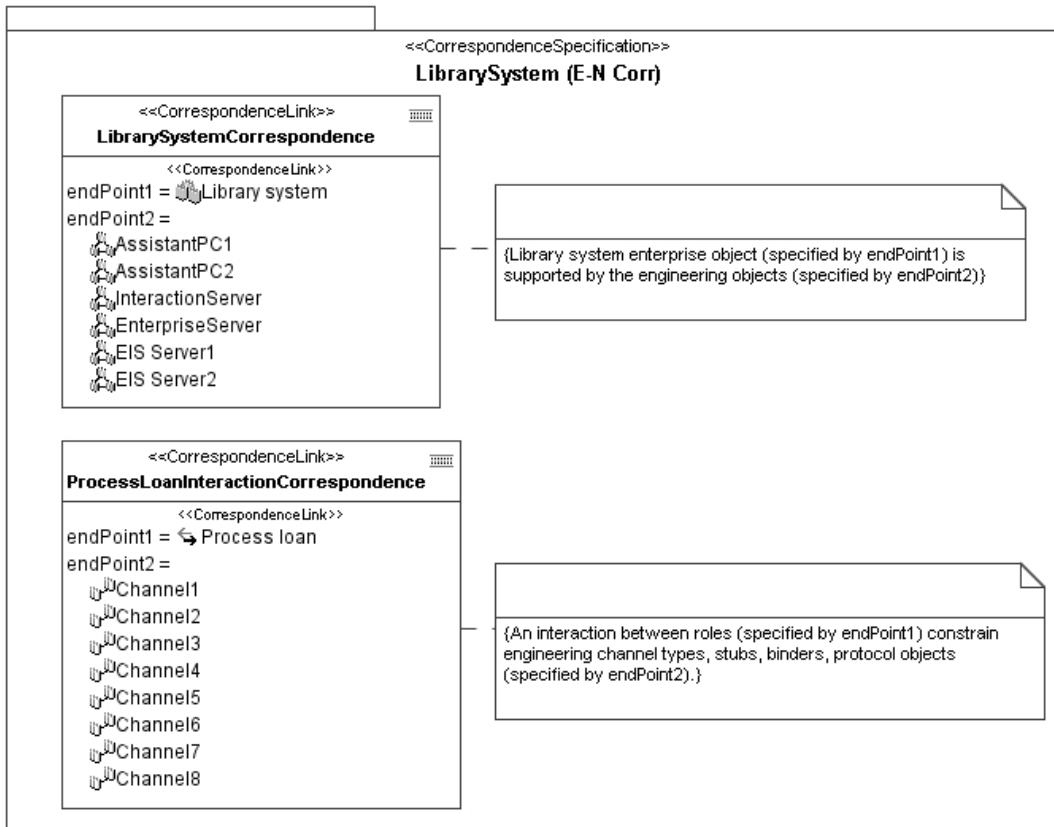

Figure A.51 – Example of correspondences between enterprise and engineering specifications

A.5.12 Correspondences between computational and engineering specifications

Correspondences between the computational and engineering specifications are expressed in the package **LibrarySystem (C-N Corr)**, as shown in Figure A.1. Correspondences are expressed using the correspondence profile (see [12.2]).

Figure A.52 shows the **ObjectCorrespondence** that describes the *correspondence* between the functionality specified in the computational viewpoint, and the *engineering objects* supporting this functionality in the engineering viewpoint.

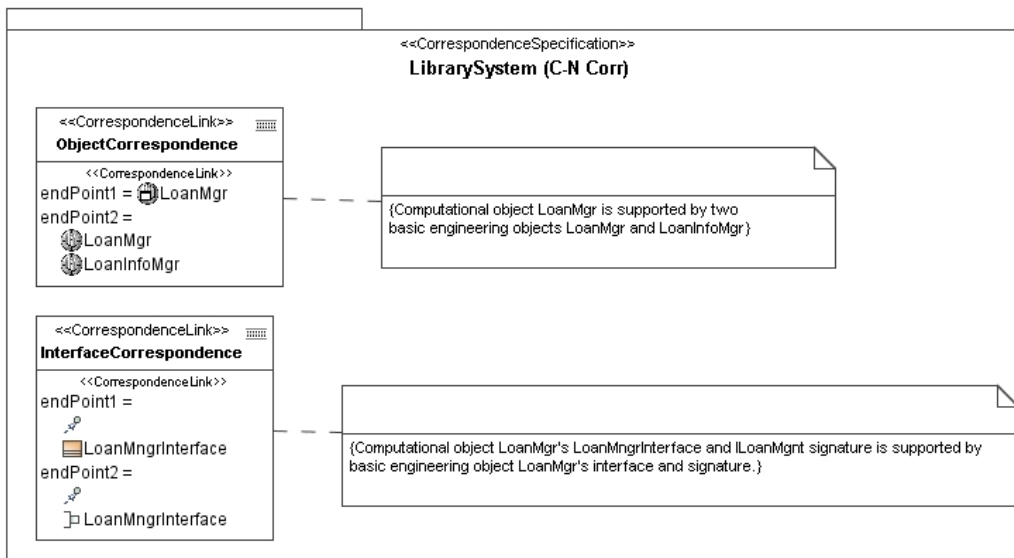

Figure A.52 – Example of correspondences between computational and engineering specifications

NOTE – In this clause [A.5], generic UML constructs are used to complement ODP engineering specifications in UML. For instance, ports are used to represent an *engineering object's interfaces*, and operations are used to represent an *engineering interface's signatures*, since neither are defined in RM-ODP Part 3 engineering language.

A.6 Technology specification in UML

A.6.1 Overview

The technology viewpoint is concerned with the choice of technology to implement the ODP system. A technology specification defines *technology objects* (hardware, software, and network products), which implement *implementable standards* as its templates, *implementation* as a process of instantiation, and *IXIT* as implementation extra information for testing. This clause concentrates on the technology specification in UML of the **borrowing process** of the Library system.

The primary diagram for this specification is a deployment diagram.

In the figures that follow, to improve the clarity of the diagrams, the icons shown in Table A.5 have been used to represent instances of the corresponding stereotypes.

Table A.5 – Technology language icons

«TV_Object»	
«TV_TypeObject»	
«TV_TemplateObject»	
«TV_ImplementableStandard»	
«TV_Implementation»	

A.6.2 Node configuration

In a deployment diagram, a computer *node* is expressed as a node and lines are introduced to express communication links between the nodes. Different types of network can also be depicted as nodes.

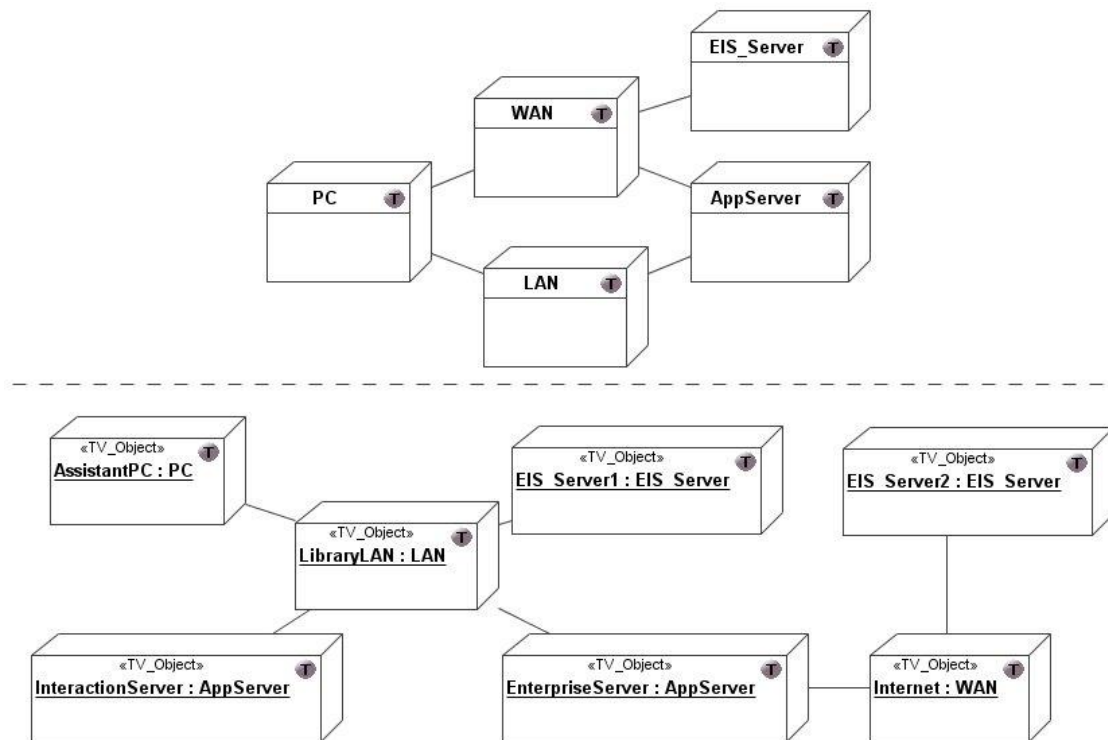

Figure A.53 – Node configuration overview

Figure A.53 shows the node configuration of the Library system, in two parts. The upper part of the figure describes the deployment architecture of the system by showing the different *technology objects* types that will be used, and how they can be connected among themselves. The diagram shows that there will be three different kinds of computing resources (PCs, application servers and enterprise servers) and two different kinds of communication media (LAN and WAN).

PCs and application servers can be connected to LANs and WANs, whilst enterprise servers can only be connected to WANs.

The lower part of Figure A.53 describes the actual system, with concrete instanceSpecifications of the nodes shown in the upper part of the diagram, showing the *technology objects* that will comprise the system, and how they are connected.

A.6.3 Node structure

Technology objects, such as those implementing the corresponding *engineering objects*, are deployed on each *node*. This is shown using a UML deployment diagram with the representation of hardware elements, software elements and network elements. There are cases where both the technology profile and standard profile (e.g., ExecutionEnvironment stereotype) need to be applied to the same element.

In UML, node structures can be specified both at the type level and at the object level. The diagram in Figure A.54 below shows the internal structure of the application servers used in the Library.

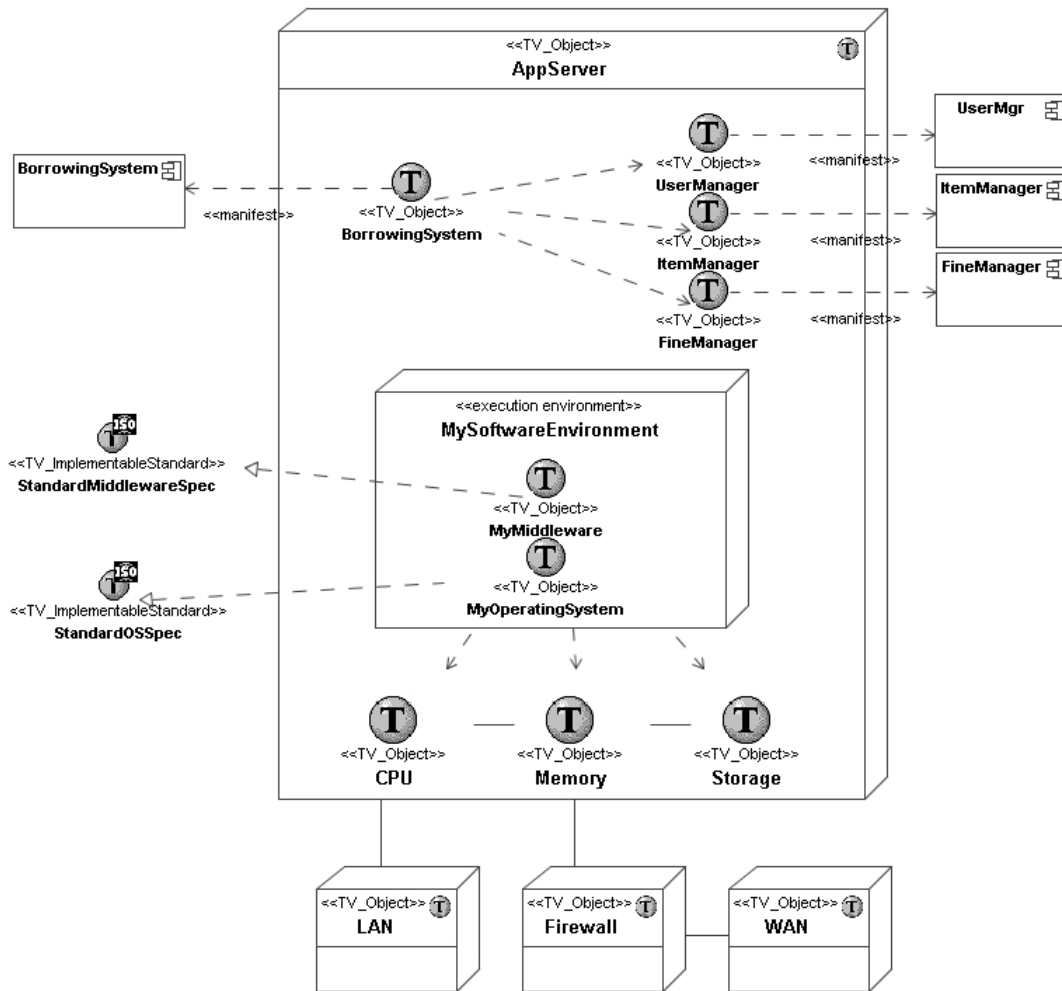

Figure A.54 – Node structure

A.6.4 IXIT

The truth of a statement in an implementation can only be determined by testing, and is based on a mapping from *terms* in the specification to observable aspects of the implementation. A test is a series of observable stimuli and events, performed at prescribed points known as *reference points*, and only at these points. These *reference points* are accessible *interfaces*. Four classes of *reference point* at which conformance tests can be applied are defined, which are *programmatically reference point*, *perceptual reference point*, *interworking reference point*, and *interchange reference point*.

Implementation extra information for testing (IXIT), which means additional information when performing a test against an implementation claiming to implement a defined specification or standard. In this respect, *IXIT* can be attached to any *technology objects* for interaction with a user, other *technology objects* in the same *node*, and other *technology objects* in other *nodes*.

Figure A.55 below shown an example of the addition of this additional information to two *technology objects*.

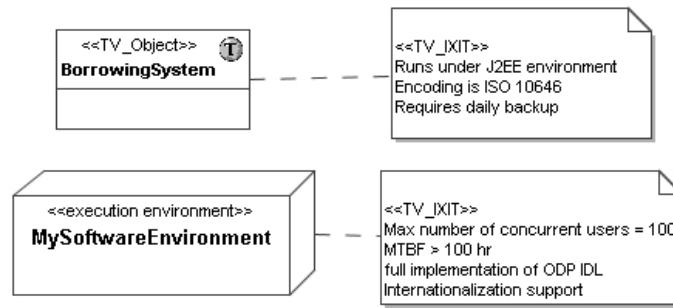

Figure A.55 – IXIT

A.6.5 Implementation

The diagram shown in Figure A.56 below shows an example of an *implementation* process.

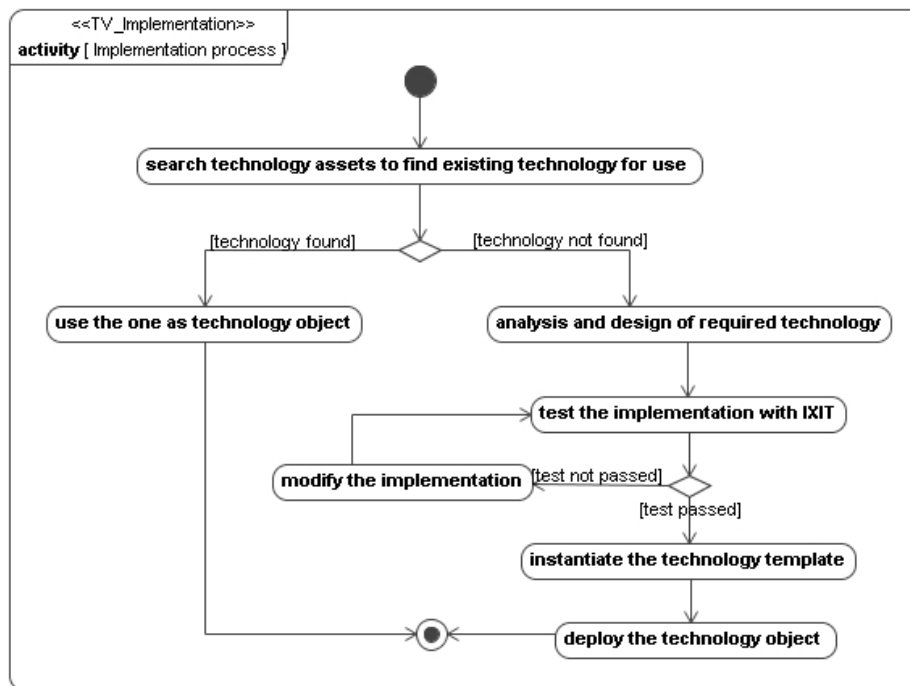

Figure A.56 – Example of implementation process

A.6.6 Correspondences between engineering and technology specifications

Correspondences between the computational and engineering specifications are expressed in the package **LibrarySystem (N-T Corr)**, as shown in Figure A.1. *Correspondences* are expressed using the correspondence profile (see [12.2]).

Figure A.57 shows the **BEO correspondence** that provides a *correspondence* link between an **ItemManager BEO** in the engineering viewpoint and an **ItemManager technology object** in technology viewpoint.

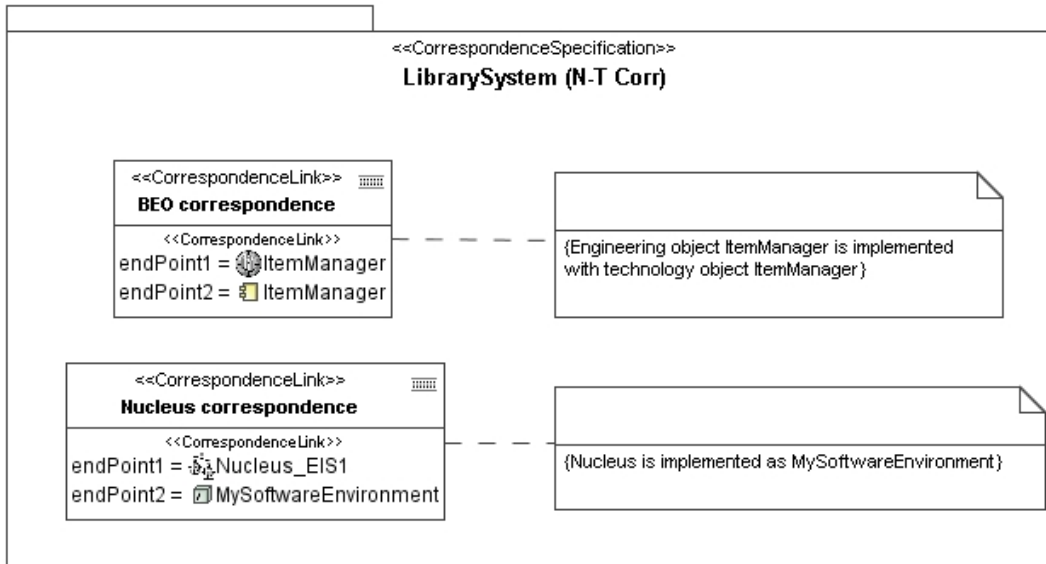

Figure A.57 – Example of correspondences between engineering and technology specifications

Annex B

An example of the representation of deontic concepts

(This annex does not form an integral part of this Recommendation | International Standard.)

This annex illustrates the use of the enterprise language deontic concepts to capture some of the behaviour constraints in a small specification fragment. The example shows how obligations and permissions can be expressed with precision without adding a large amount of detail to the basic enterprise behaviour.

B.1 The scenario

The scenario is concerned with a straightforward commercial situation, and is based on a minimal community (Figure B.1) containing just four roles, describing three active participants: customer, supplier and subcontractor and a role for the goods traded.

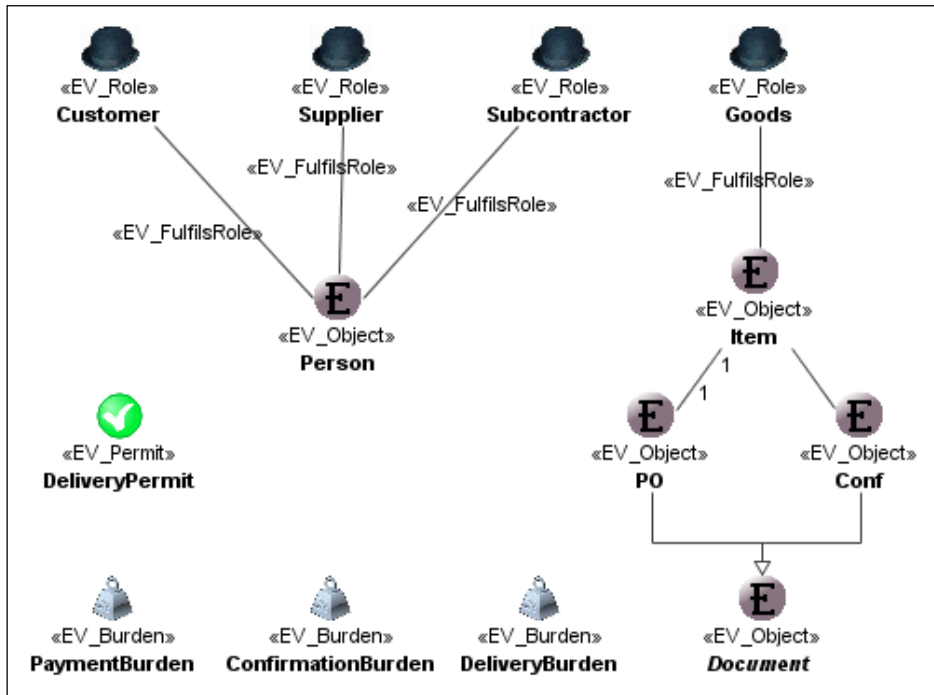

Figure B.1 – The community

The community also defines finer-grain objects to express commercial documents, such as purchase order and confirmation notes, goods items and tokens for the permits and burdens involved.

The broad view of the community behaviour is shown in Figure B.2. The customer places an order with a supplier, and that supplier decides to delegate the execution of the order to a subcontractor who prepares the goods and delivers them. At this point, the subcontractor informs the supplier that delivery is happening. The customer makes payment to the supplier after receipt of the goods.

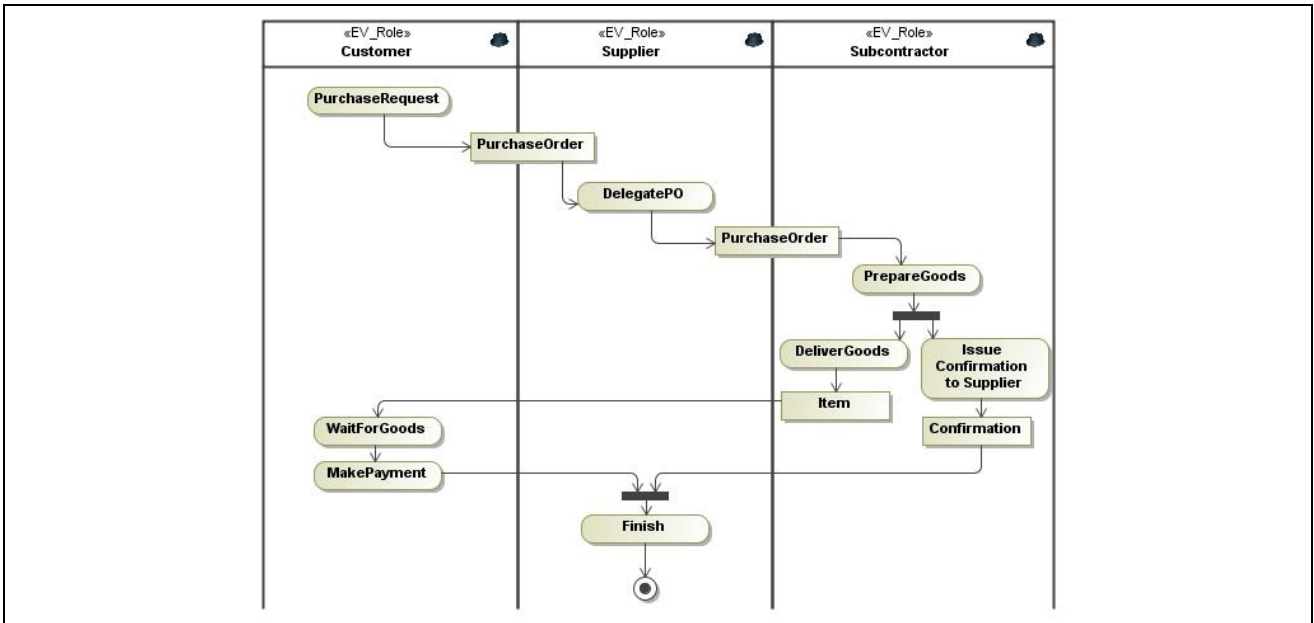

Figure B.2 – Basic behaviour

B.2 Expressing the deontic constraints

To support the expression of the deontic constraints, we refactor this description so as to bring out as separate elements the participants in each significant interaction. These interactions are delineated and emphasized by placing them in distinct activityPartitions, labelled, where appropriate, by the interaction names as an aid to navigation to the details of the interactions (see Figure B.3).

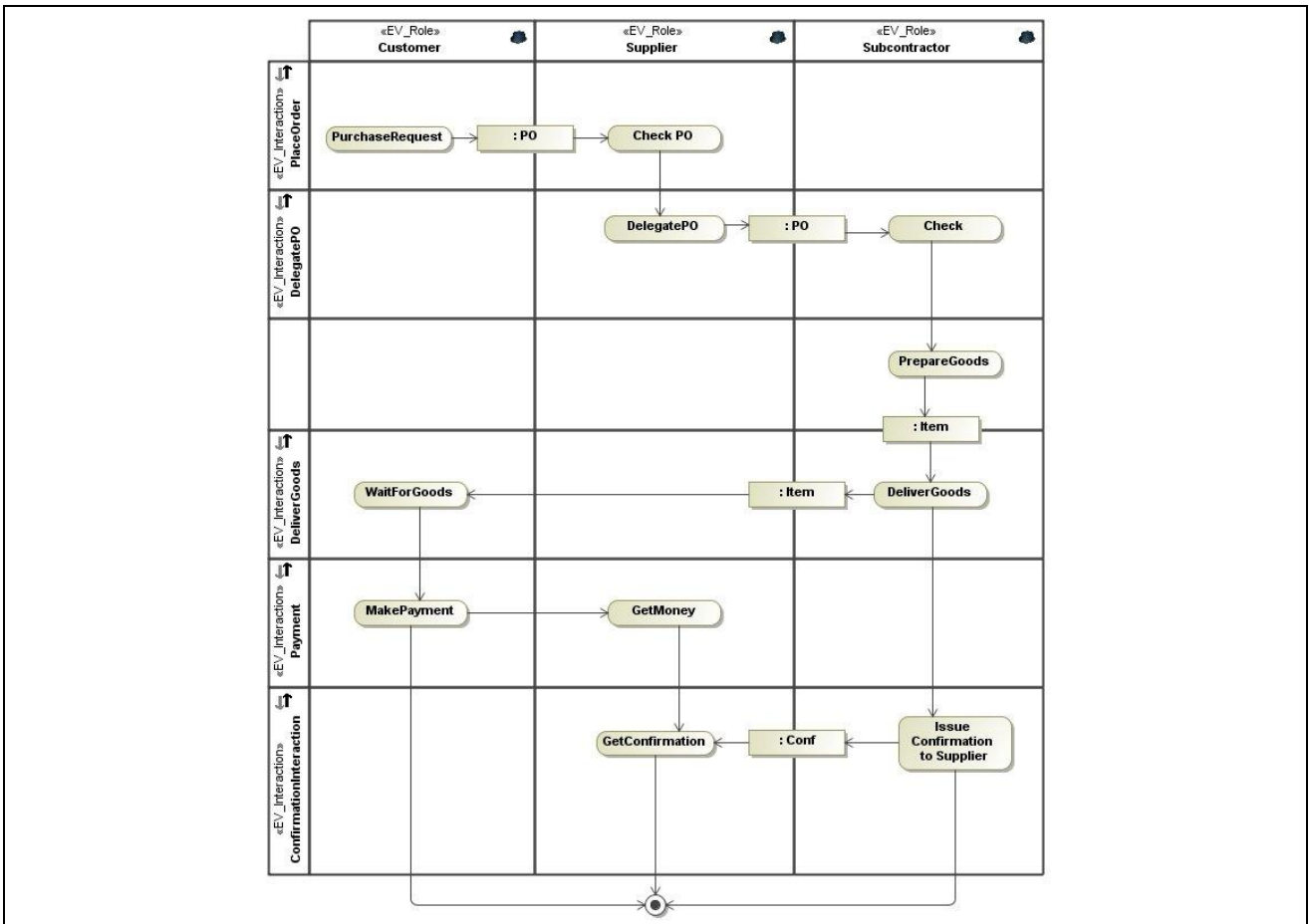

Figure B.3 – Refined basic behaviour

Each of the interactions above is now elaborated in a separate interaction diagram which makes explicit the actor or artefact interaction roles and introduces the deontic tokens being manipulated. The dynamics of the tokens are then expressed in a series of interaction diagrams. These express constraints that take the form of pre- and post-conditions on the occur() operation associated with the interaction (see [7.2.10.3]).

Figure B.4 shows the PlaceOrder interaction. The customer provides a delivery permit that will enable the supplier to gain access to deliver the goods. This is transferred to the supplier when the action occurs. At the same time, an obligation is created at the supplier to deliver the goods in a timely fashion. Throughout this example, the PurchaseOrder (PO) is used as a primary key for identifying the appropriate tokens, since the participants could hold tokens for many other transactions.

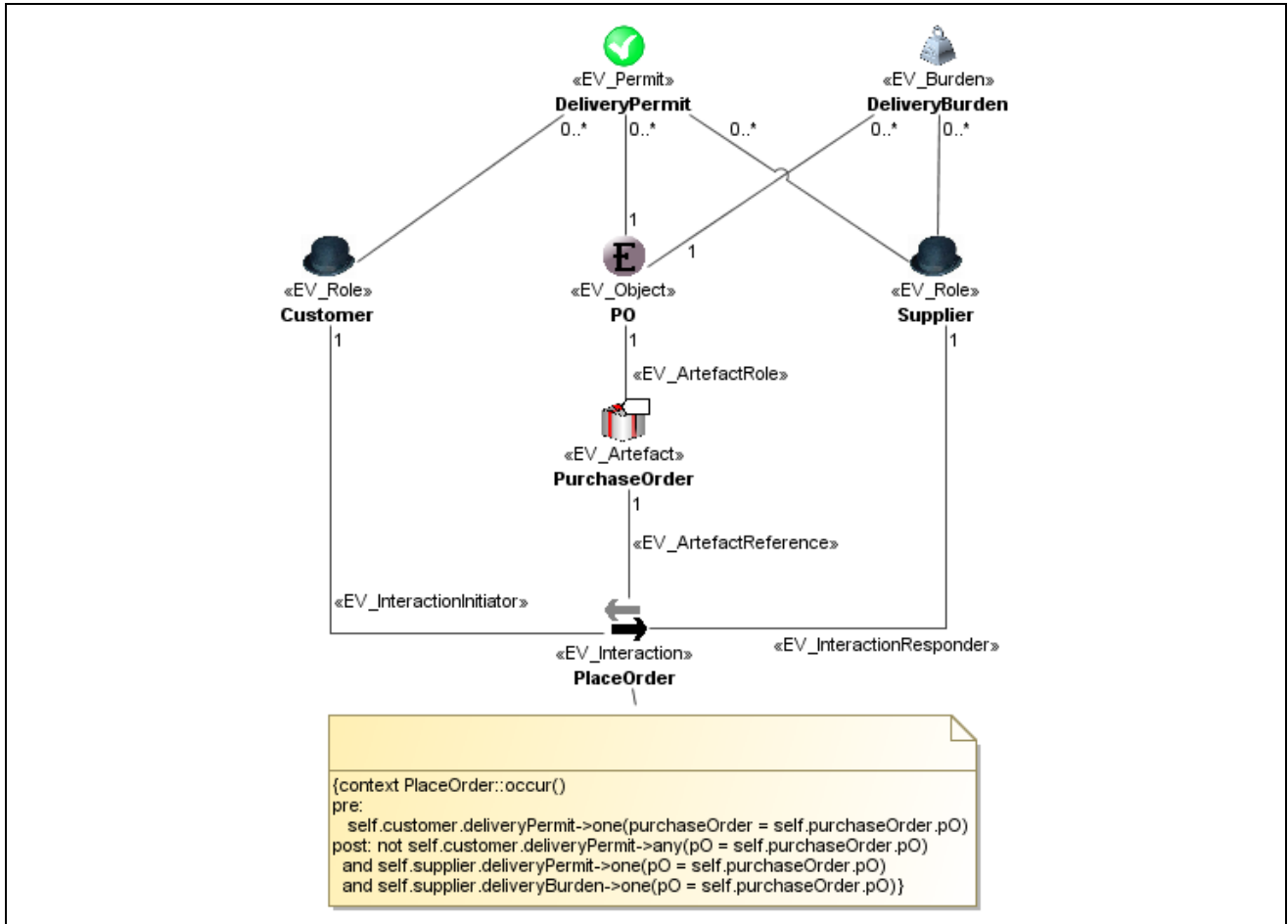

Figure B.4 – The PlaceOrder interaction

We assume that the supplier now decides to delegate the fulfilment of this order to a subcontractor, which it does by performing a DelegatePO interaction (see Figure B.5). This interaction transfers the delivery permit and delivery burden to the subcontractor. It also establishes a burden for the subcontractor to confirm with the supplier when the delivery occurs, so that it is aware the delivery burden has been discharged and payment can be expected.

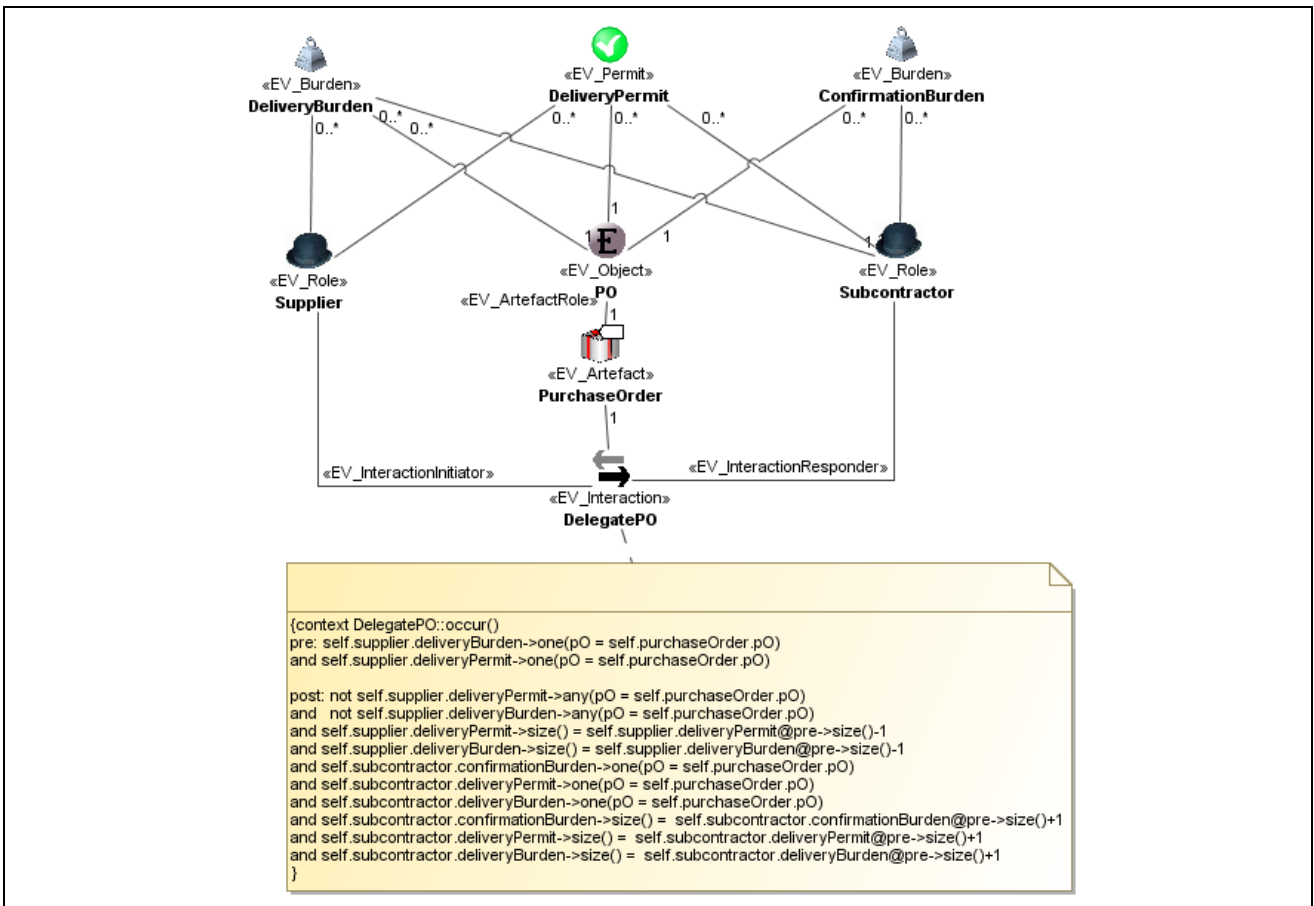

Figure B.5 – The DelegatePO interaction

After preparation of the goods, the specific item requested is delivered, using the interaction shown in Figure B.6. The permit and burdens involved are already in the set held by the subcontractor. The delivery is achieved using the delivery permit and doing so discharges the delivery burden. However, it does create a payment burden on the customer to settle their debts.

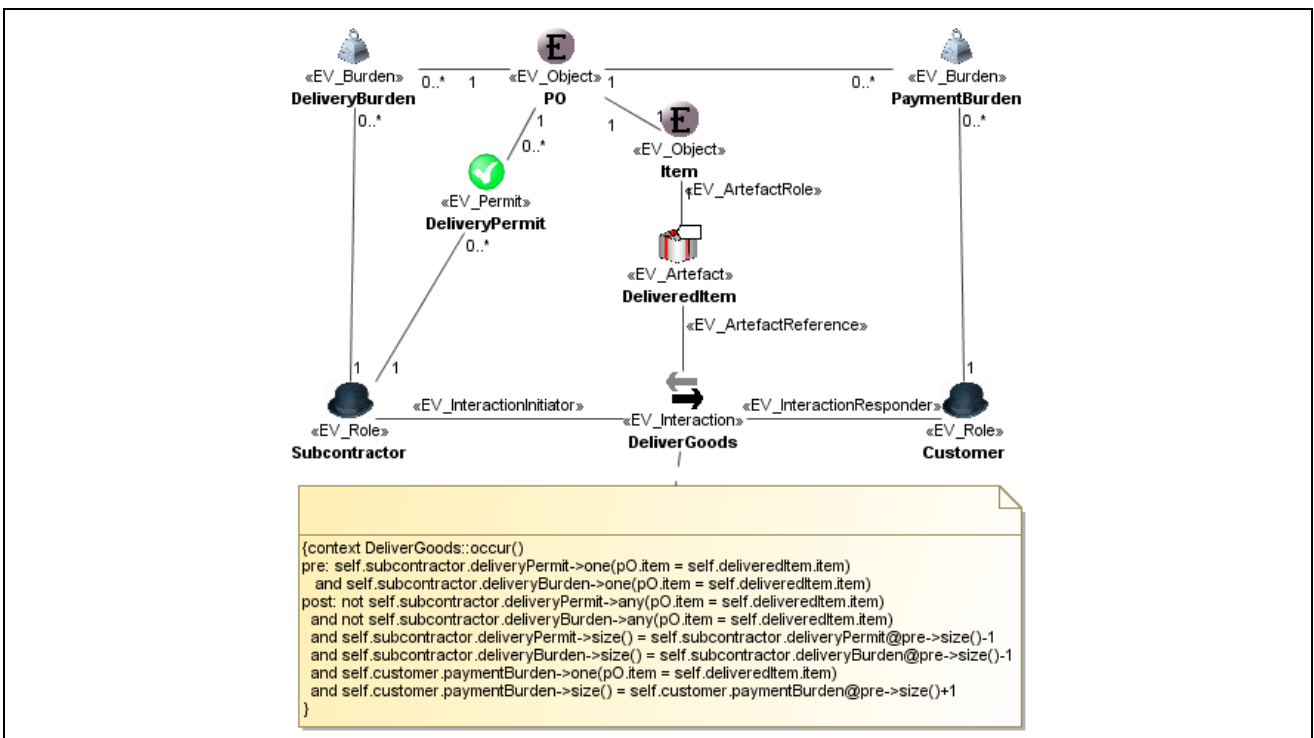

Figure B.6 – The DeliverGoods interaction

The other responsibility of the subcontractor on delivery is to confirm to the supplier that the process has been successful. This is done by the confirmation interaction (Figure B.7) and this interaction satisfies the confirmation burden held by the subcontractor, leaving it without further obligations with respect to this purchase.

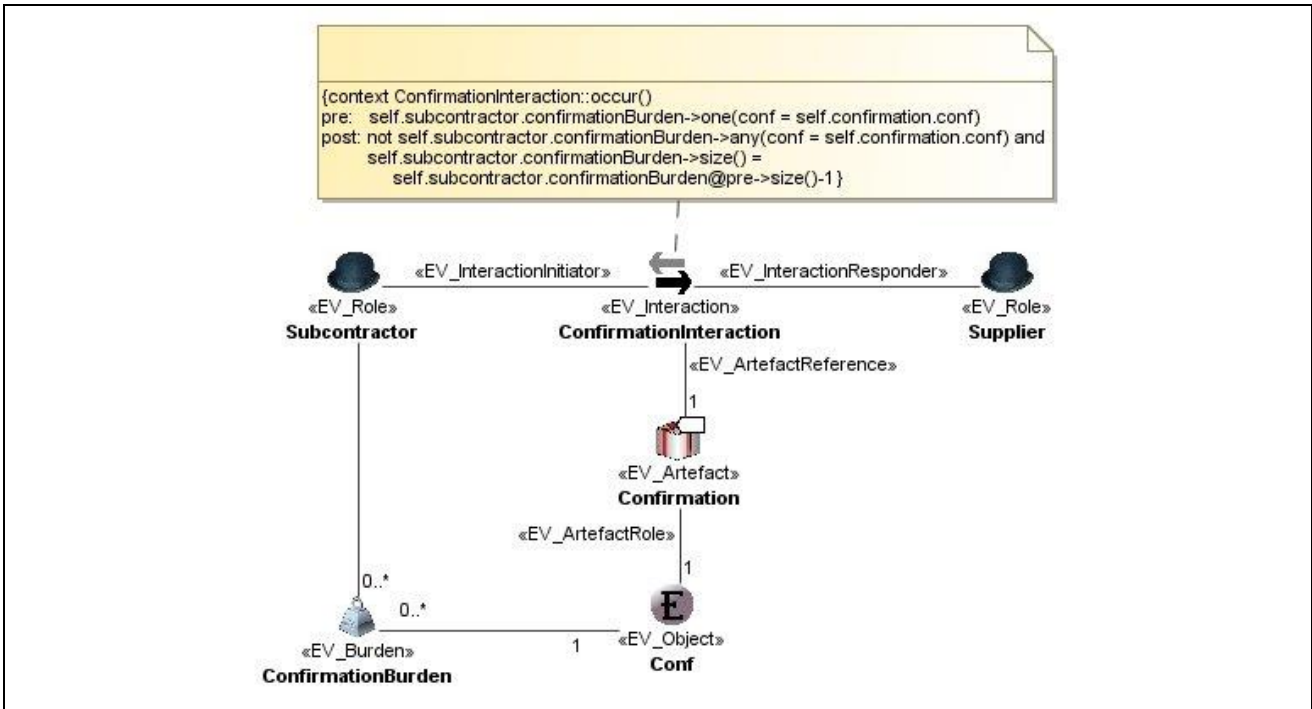

Figure B.7 – The confirmation interaction

The final stage, in Figure B.8, is for the customer to pay the supplier, and so to discharge the payment burden. This completes our simple scenario, although any real system would also have behaviour dealing with violations such as non-payment or slow response in dealing with obligations.

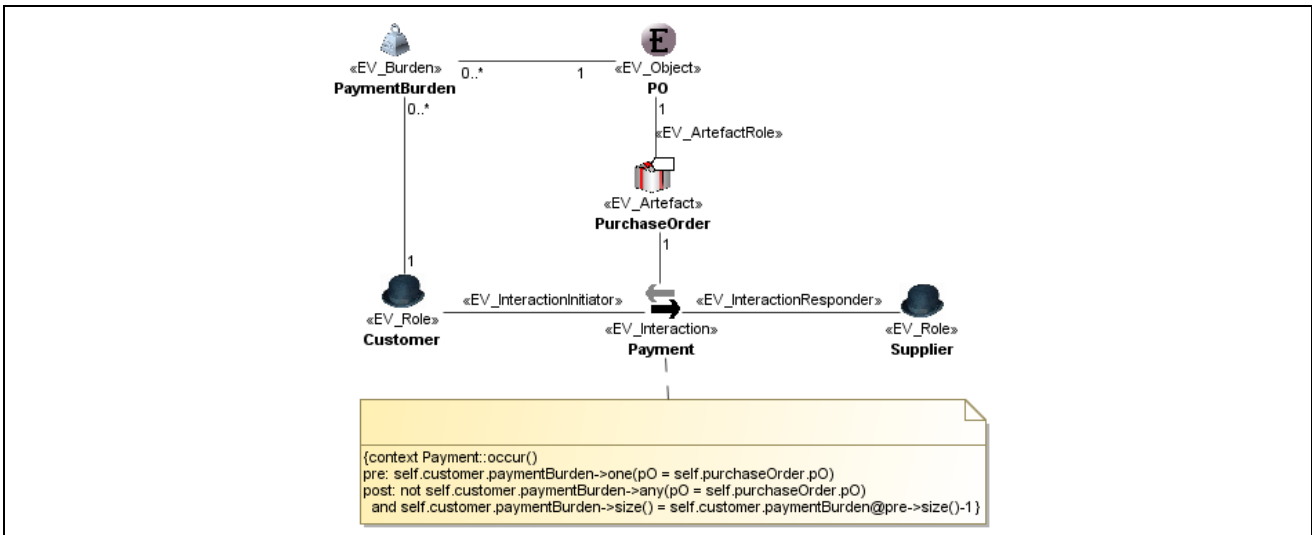

Figure B.8 – The Payment interaction

INDEX

- Abbreviations, 3
- Accountability concepts, 15, 25
- Accountable action, 25, 77
- Action, 7, 13, 15, 21, 31, 39
- Action role, 14, 23
- Actor, 23, 47, 73, 78, 113
- Agent, 25, 83
- Announcement, 37, 42
- Artefact, 23, 47, 63, 78, 113
- Authorization, 25
- Basic engineering object, 47, 49, 57, 62, 98
- Behaviour, 9, 13, 14, 15, 21, 31, 36, 37, 67, 73, 94
- Binder, 49, 58, 98
- Binding, 8, 38, 44, 48, 50, 94, 104
- Binding object, 38, 42
- Burden, 14, 23, 111
- Capsule, 49, 50, 52, 57, 98
- Channel, 47, 49, 53, 57, 58, 100
- Checkpoint, 49, 50, 55, 59, 101
- Cloning, 50, 59, 102
- Cluster, 49, 52, 57, 59, 98
- Commitment, 25, 82
- Communication domain, 50, 58, 101
- Community, 13, 15, 20, 21, 22, 29, 72, 73, 111
- Community object, 13, 15, 21, 22, 72
- Compliance, 68
- Computational interface, 39, 43, 45, 47, 91
- Computational language, 7, 36, 40, 41, 46, 47
- Computational metamodel, 39
- Computational object, 7, 29, 36, 39, 41, 45, 47, 91, 97
- Computational signature, 43, 48
- Computational specification, 7, 29, 36, 39, 41, 47, 91
- Conformance, 6, 30, 67, 68, 108
- Contract, 21, 28, 31, 36, 42, 72, 94
- Conventions, 3
- Correspondence, 35, 47, 66
- Correspondence endpoint, 66
- Correspondence link, 65, 66
- Correspondence metamodel, 66
- Correspondence rule, 65, 66
- Correspondences, 12, 13, 29, 35, 36, 47, 62, 65, 67, 70, 90, 95, 105, 106, 109
- Correspondences specification, 65
- Deactivation, 50, 59, 101
- Declaration, 25, 82
- Delegation, 15, 25, 82, 113
- Deontic concepts, 14, 19, 23, 111
- Distribution transparency, 6
- Domain, 49, 50, 54, 57, 59, 104
- Dynamic schema, 29, 31, 34, 85, 88
- Embargo, 14, 23
- Engineering interface, 47, 48, 58
- Engineering interface reference, 48, 50, 59, 103
- Engineering language, 7, 48, 51, 52, 60, 96
- Engineering metamodel, 51
- Engineering object, 49, 51, 56, 62
- Engineering specification, 8, 29, 48, 56, 62, 96, 105
- Enterprise language, 6, 13, 15, 25, 29, 70, 80, 111
- Enterprise metamodel, 15
- Enterprise object, 6, 13, 14, 20, 29, 35, 72, 78
- Enterprise specification, 6, 13, 19, 28, 29, 35, 70, 72
 - structure of, 15
- Environment contract, 36, 42, 94
- Evaluation, 25, 82
- Field of application, 20, 72
- Flow, 37, 38, 45
- Identifier, 48, 50, 55, 59
- Implementable standard, 8, 63, 64, 107
- Implementation, 63, 64, 67, 108, 109
- Information language, 7, 30, 32, 34
- Information metamodel, 32
- Information object, 7, 29, 30, 32, 47, 84

- class, 30
- template, 31
- type, 30
- Information specification, 7, 30, 31, 32, 83, 90
- Interaction, 7, 21, 22, 29, 31, 33, 36, 37, 49, 77, 88, 112
- Interceptor, 49, 50, 54, 58, 98
- Interface, 7, 29, 31, 36, 37, 39, 43, 44, 47, 49, 50, 52, 58, 91, 103, 104
- Interface role, 22
- Interrogation, 37, 38, 42, 43
- Invariant schema, 29, 31, 33, 35, 86
- Invocation, 38, 42
- IXIT, 63, 64, 108
- Metamodel
 - computational, 39
 - engineering, 51
 - enterprise, 15
 - information, 32
 - technology, 63
- Migration, 51, 59, 102
- Node, 49, 52, 58, 96, 97, 107
 - structure, 52, 98, 108
- Nucleus, 49, 52, 58, 98, 103
- Object modelling, 4
- Object type, 20, 32, 42, 57, 63
- Objective, 13, 15, 21, 72
- ODP functions, 51, 55, 59
- ODP system, 13, 19, 64, 70
- Operation, 30, 37, 38, 42, 43, 48, 91
- Operation interface, 37, 41, 43, 58
- Party, 15, 25, 82
- Permit, 14, 23, 111
- Policy, 14, 24, 29, 80
- Prescription, 25, 82
- Principal, 15, 25, 82
- Protocol object, 50, 58, 98
- Reactivation, 50, 59, 102
- Recovery, 50, 59, 102
- Resource, 13, 23, 47
- Scope, 1, 6, 20, 70
- Signal, 37, 38, 41, 42, 43, 48, 85
- Signal interface, 37, 38, 43, 58
- Signature, 38, 41, 43, 45, 49, 58, 91
- Static schema, 31, 34, 87
- Stream, 38, 43
- Stream interface, 37, 38, 43, 44, 45, 58
- Stub, 49, 58, 98
- System, 4, 6, 11, 13, 14
- Technology language, 8, 63, 64
- Technology metamodel, 63
- Technology object, 8, 62, 63, 107
- Technology specification, 8, 63, 64, 107
- Template, 8, 20, 31, 32, 37, 41, 42, 56, 57, 63
- Term, 12, 65, 66
- Termination, 37, 42, 43
- Transparency, 6, 38, 48
- Transparency schema, 38, 45
- UML, 8, 10, 11, 13, 20
 - Extension mechanisms, 9
- UML profile, 11, 19, 32, 41, 56, 63, 66, 67
- Unified Modelling Language. *See* UML
- Universes of discourse, 10, 13, 20
- Viewpoint specification, 5, 11, 12
- Violation, 22

SERIES OF ITU-T RECOMMENDATIONS

Series A	Organization of the work of ITU-T
Series D	General tariff principles
Series E	Overall network operation, telephone service, service operation and human factors
Series F	Non-telephone telecommunication services
Series G	Transmission systems and media, digital systems and networks
Series H	Audiovisual and multimedia systems
Series I	Integrated services digital network
Series J	Cable networks and transmission of television, sound programme and other multimedia signals
Series K	Protection against interference
Series L	Construction, installation and protection of cables and other elements of outside plant
Series M	Telecommunication management, including TMN and network maintenance
Series N	Maintenance: international sound programme and television transmission circuits
Series O	Specifications of measuring equipment
Series P	Terminals and subjective and objective assessment methods
Series Q	Switching and signalling
Series R	Telegraph transmission
Series S	Telegraph services terminal equipment
Series T	Terminals for telematic services
Series U	Telegraph switching
Series V	Data communication over the telephone network
Series X	Data networks, open system communications and security
Series Y	Global information infrastructure, Internet protocol aspects and next-generation networks
Series Z	Languages and general software aspects for telecommunication systems