



# VT520/VT525 Video Terminal

---

## Programmer Information

Order Number: EK-VT520-RM. A01

---

**July 1994**

Digital Equipment Corporation makes no representations that the use of its products in the manner described in this publication will not infringe on existing or future patent rights, nor do the descriptions contained in this publication imply the granting of licenses to make, use, or sell equipment or software in accordance with the description.

DEC, OpenVMS, VT, and the DIGITAL logo are trademarks of Digital Equipment Corporation.

ADDS is a trademark of Applied Digital Data Systems, Inc.

IBM, ProPrinter, and PS/2 are registered trademarks of International Business Machines Corporation.

MS-DOS is a registered trademark and Windows is a trademark of Microsoft Corporation.

SCO is a trademark of Santa Cruz Operations, Inc.

TVI is a trademark of TeleVideo, Inc.

UNIX is a registered trademark of UNIX System Laboratories, Inc.

WY and WYSE are registered trademarks of Wyse Technologies.

All other trademarks and registered trademarks are the property of their respective holders.

The Energy Star emblem does not represent EPA endorsement of any product or service.

Copyright © Digital Equipment Corporation 1994. All Rights Reserved.

Printed in U.S.A.

For copies of manuals, contact your local sales office.

This document was prepared using VAX DOCUMENT Version 2.1.

## Introduction

This manual provides detailed information for advanced users, consultants, and programmers. This manual has the following parts, chapters, and appendices:

- Part I, VT520 Video Terminal
  - Chapter 1, Overview
  - Chapter 2, Set-Up
  - Chapter 3, Desktop Features
- Part II, VT520 ANSI Mode
  - Chapter 4, ANSI Control Functions Summary
  - Chapter 5, ANSI Control Functions
  - Chapter 6, SCO Console Emulation
  - Chapter 7, Character Sets
  - Chapter 8, Keyboard Processing
  - Chapter 9, Communications
  - Chapter 10, Printer Port
- Part III, VT520 ASCII Emulation
  - Chapter 11, ASCII Emulations and Control Functions
  - Chapter 12, ASCII Escape Sequences
  - Chapter 13, Defining and Loading ASCII Character Fonts
- Appendix A, VT Keyboard Legend Data
- Appendix B, Enhanced PC Keyboards
- Appendix C, ASCII Keycodes and Local Functions
- Appendix D, VT520 Termcap Data
- Appendix E, ANSI Control Function Index

## Conventions

The following conventions are used in this manual:

### Set-Up features

`Alt/Ctrl/Print Screen`

Terminal Set-Up menu selections appear in **boldface** type.

Multiple keys are separated by a slash (/) and should be pressed in combination. That is, all three keys `Alt`, `Ctrl`, and `Print Screen` are pressed down at the same time.

Characters in control functions

Control function characters are in **boldface** type. Below each character is a column/row number that indicates the character's position in a standard code table. For example:

<b>ESC</b>	#	<b>6</b>	←	Control function
1/11	2/3	3/6	←	Column/row numbers

*Parameters*

Parameters appear in italic type.

**Note**

Provides general information.

## How to Use This Manual

The *VT520 Video Terminal Programmer Information* is written for four audiences: an advanced user, who needs to know more about the terminal Set-Up features; a programmer, who develops application programs; a software product support person, who provides assistance to application programmers and users; and a hardware systems engineer, who need more information on terminal connections.

### Advanced User

If you have read the *VT520 Video Terminal Installation and Operating Information* manual and need more information on the the terminal Set-Up features, you may wish to refer to the following:

- **Index**
- **Chapter 1—Overview**—Provides a brief summary of the product.
- **Chapter 2—Set-Up**—Describes each entry in the Set-Up menus in the order that is displayed in the terminal.
- **Chapter 3—Desktop Features**—Provides a more in-depth description of the desktop features of the terminal.
- **Chapter 6—Keyboard Processing**—Describes the differences in the types of keyboard layouts supported, local functions, and accessibility aids.

### Programmer

If you are using ANSI control functions for your program, then you may wish to start with Part II of the manual:

- **Chapter 4—ANSI Control Function Summary**— Provides a tutorial section on Control Functions and information on designing and down-line loading a Soft Character set (soft font). In this chapter, the Control Functions are grouped according to the task to be performed. The information on each Control Function is very brief. If you need more information, the mnemonic at the end of the line item refers to a command section in Chapter 5.
- **Chapter 5—ANSI Control Functions**—Provides in-depth information on each control function listed in alphabetic order according to the mnemonic.
- **Chapter 2—Set-Up**—Lists the Set-Up factory defaults at the end of this chapter, with their host control code mnemonic.

- **Chapter 6—Keyboard Processing**—Describes the keyboard layouts, keyboard-to-host interface, keypad sequences, local functions, LEDs controls, languages, accents, scan codes, and control codes.
- **Chapter 9—Communications**—Describes the serial communications from the terminal to the host ports and the hardware and software handshaking.
- **Chapter 10—Printer Port**—Describes the parallel printer port and the switching sequences for the modes supported.
- **Appendix A—VT Keyboard Legend Data**
- **Appendix B—Enhanced PC Keyboard Legend Data**
- **Appendix D—VT500 Termcap Data**

If you are developing an application program for a SCO Console, then you may wish to refer to:

- **Chapter 6—SCO Console Emulation**—Describes the SCO Console mode, including the Control Functions relative to the SCO Console applications.

If you are using ASCII control functions for your program, then you may wish to start with Part III of the manual:

- **Chapter 11—ASCII Emulations and Control Functions**— Provides an overview of the ASCII emulation, the coding notation, and the symbols used in the ASCII sequence tables.
- **Chapter 12—ASCII Escape Sequences**—Summarizes the ASCII escape and control sequences for the various ASCII emulation modes, according to the task to be performed.
- **Chapter 13—Defining and Loading ASCII Character Fonts** – Provides specific information on loading font banks and designing an ASCII character font.
- **Appendix C—ASCII Keycodes and Local Functions**

#### Software Product Support

If you are helping a user or programmer with an application, then you may wish to refer to the following:

- **Appendix E—ANSI Control Function Index**—Lists the control functions by their final character, which makes them easier to find in a program. The mnemonic at the end of the line item refers to a command in Chapter 5, listed in alphabetic order.
- **Index**—Lists control functions by mnemonic or by name and lists other subjects by topic.
- **Chapter 5—ANSI Control Functions**—Provides in-depth information on specific control functions.
- **Chapter 6—Keyboard Processing**—Lists the scan codes Make and Break sequences.
- **Appendix D—VT500 Termcap Data**—Provides the Termcap information for ANSI emulations.

## Hardware Systems Engineer

If you are helping a user to install the terminal or to operate within a specific environment, then you may wish to refer to the following:

- **Index**—Search by topic.
- **Chapter 1—Overview** Provides a brief summary of the product.
- **Chapter 2—Set-Up** Describes each entry in the order that is displayed in the terminal, starting with the **Actions** menu and lists the modes supported. Also lists the Set-Up factory defaults.
- **Chapter 9—Communications**—Describes the serial communications from the terminal to the host ports, pin numbers and signals, and the hardware and software handshaking.
- **Chapter 10—Printer Port**—Describes the parallel printer port, pin numbers and signals, and modes supported.

---

# Contents

<b>Preface</b> .....	iii
----------------------	-----

## **Part I VT520 Video Terminal**

### **1 Overview**

1.1	Introduction .....	1-1
1.2	Communications Features .....	1-1
1.3	Keyboard Features .....	1-2
1.4	Printer Port Features .....	1-3
1.5	Display and Text Capabilities .....	1-3
1.5.1	ANSI .....	1-3
1.5.2	ASCII .....	1-3
1.6	Enhanced Set-Up .....	1-4
1.7	Desktop Productivity Features .....	1-4
1.8	Character Set Support .....	1-4
1.9	Ergonomics (Human Factors) Features .....	1-4
1.10	Field-Upgradable Firmware .....	1-5
1.11	Comparison with previous VT Terminals .....	1-6

### **2 Set-Up**

2.1	Entering Set-Up .....	2-1
2.1.1	Effects of Entering Set-Up .....	2-2
2.1.2	Set-Up Languages .....	2-2
2.1.3	Power-On Settings and Defaults .....	2-2
2.1.4	Self-test Error Messages .....	2-3
2.1.5	Context Sensitivity .....	2-3
2.1.6	Set-Up Summary Line .....	2-5
2.1.7	Set-Up Status Messages .....	2-5
2.1.8	Status Line .....	2-6
2.1.9	Keyboard Indicator Line .....	2-6
2.2	Set-Up Screen Text .....	2-7
2.3	Main Menu .....	2-8
2.3.1	On-Line .....	2-8
2.3.2	Save Settings .....	2-9
2.3.3	Restore Settings .....	2-9
2.3.4	Exit Set-Up .....	2-9
2.4	Actions Menu .....	2-9
2.4.1	Clear Display .....	2-9
2.4.2	Clear Communications .....	2-9
2.4.3	Reset this Session .....	2-10
2.4.4	Restore Factory Defaults .....	2-10
2.4.5	Clock, Calculator, Show Character Sets .....	2-11

2.4.6	Banner Message . . . . .	2-11
2.5	Multiple Sessions . . . . .	2-11
2.5.1	Enabling and Controlling the Session Configuration . . . . .	2-12
2.5.2	Multiple Sessions using a Terminal Server with TD/SMP . . . . .	2-12
2.5.3	Multiple Sessions using SSU Host Software . . . . .	2-12
2.5.4	Opening Another Session . . . . .	2-12
2.5.5	Restoring an Interrupted Session . . . . .	2-13
2.5.6	Session Management . . . . .	2-13
2.6	Session Menu . . . . .	2-13
2.6.1	Select Session . . . . .	2-14
2.6.2	Session Name . . . . .	2-14
2.6.3	Pages per Session . . . . .	2-14
2.6.4	Soft Character Sets/Session . . . . .	2-16
2.6.5	Save Settings for All and Restore Settings for All . . . . .	2-16
2.6.6	Copy Settings from Menu . . . . .	2-17
2.6.7	Update Session . . . . .	2-17
2.7	Resetting and Restoring Defaults . . . . .	2-18
2.7.1	Reset Session . . . . .	2-18
2.7.2	Restore Factory Defaults . . . . .	2-18
2.8	Display Menu . . . . .	2-19
2.8.1	Lines per Screen . . . . .	2-20
2.8.1.1	Auto Resize . . . . .	2-20
2.8.2	Lines per Page . . . . .	2-20
2.8.3	Review Previous Lines Buffer . . . . .	2-21
2.8.4	Columns per Page, Clear on Change . . . . .	2-22
2.8.5	Status Display . . . . .	2-22
2.8.6	Scrolling Mode . . . . .	2-22
2.8.7	Screen Background . . . . .	2-22
2.8.8	Cursor Display . . . . .	2-22
2.8.9	Cursor Coupling . . . . .	2-22
2.8.10	Writing Direction . . . . .	2-23
2.8.11	Zero . . . . .	2-23
2.8.12	Auto Wrap . . . . .	2-23
2.8.13	New Line Mode . . . . .	2-23
2.8.14	Lock User Preferences . . . . .	2-23
2.8.15	Show Control Characters . . . . .	2-24
2.8.16	CRT Saver . . . . .	2-24
2.8.17	Energy Saver . . . . .	2-24
2.8.17.1	Warning Bell . . . . .	2-25
2.8.18	Overscan . . . . .	2-25
2.8.19	Framed Windows . . . . .	2-25
2.8.20	Screen Alignment . . . . .	2-27
2.9	Color Set-Up . . . . .	2-28
2.9.1	Assign Colors . . . . .	2-28
2.9.2	Alternate Text Colors . . . . .	2-30
2.9.3	Define Colors Dialog Box . . . . .	2-31
2.9.4	Select Color Mode . . . . .	2-32
2.9.5	ASCII Color Mode . . . . .	2-32
2.9.6	Bold and Blink Style . . . . .	2-32
2.9.7	Erase Color . . . . .	2-32
2.9.8	Reverse and Blank Attributes . . . . .	2-33
2.9.9	Intensity Attributes . . . . .	2-33
2.10	Terminal Type Menu . . . . .	2-33
2.10.1	Emulation Mode . . . . .	2-33



2.10.2	Terminal ID to Host . . . . .	2-34
2.10.3	VT Default Character Set . . . . .	2-34
2.10.4	PCTerm Character Set . . . . .	2-34
2.10.5	7-Bit NRCS Characters . . . . .	2-34
2.10.6	Transmit 7-Bit Controls . . . . .	2-34
2.11	ASCII Emulation Menu . . . . .	2-35
2.12	Keyboard Menu . . . . .	2-36
2.12.1	Keyboard Language . . . . .	2-37
2.12.2	Define Key Editor . . . . .	2-37
2.12.2.1	Copy of Key Default—Moving a Standard Function . . . . .	2-38
2.12.2.2	Customization . . . . .	2-39
2.12.2.3	Modifier Keys . . . . .	2-39
2.12.2.4	Creating a New Function . . . . .	2-39
2.12.2.5	Examples of Creating New Functions . . . . .	2-39
2.12.2.6	Correcting a Mistake . . . . .	2-40
2.12.2.7	Creating A New Alphanumeric Key or Keyboard Layout . . . . .	2-40
2.12.2.8	Examples of Creating New Alphanumeric Keys . . . . .	2-40
2.12.2.9	User-Defined Keys . . . . .	2-41
2.12.2.10	Programming Notes . . . . .	2-41
2.12.3	Save Key Definitions . . . . .	2-42
2.12.4	Recall Key Definitions . . . . .	2-42
2.12.5	Lock Key Definitions . . . . .	2-42
2.12.6	Caps Lock Function . . . . .	2-42
2.12.7	Keyclick, Warning Bell, and Margin Bell Volume . . . . .	2-42
2.12.7.1	Visible Bell . . . . .	2-43
2.12.8	Keyboard Encoding . . . . .	2-43
2.12.9	Auto Repeat . . . . .	2-43
2.12.10	Data Processing Keys . . . . .	2-43
2.12.11	Application Cursor Keys . . . . .	2-43
2.12.12	Application Keypad Mode . . . . .	2-44
2.12.13	Map PC Keyboard to VT . . . . .	2-44
2.12.14	Ignore Missing Keyboard . . . . .	2-44
2.13	Communication Menu . . . . .	2-45
2.13.1	Communication Port Select . . . . .	2-46
2.13.2	Word Size . . . . .	2-47
2.13.3	Parity . . . . .	2-47
2.13.4	Stop Bits . . . . .	2-47
2.13.5	Transmit Speed . . . . .	2-48
2.13.6	Receive Speed . . . . .	2-48
2.13.7	Transmit Flow Control . . . . .	2-48
2.13.8	Receive Flow Control . . . . .	2-49
2.13.9	Flow Control Threshold . . . . .	2-49
2.13.10	Transmit Rate Limit, Fkey Rate Limit . . . . .	2-49
2.13.11	Ignore Null Character . . . . .	2-50
2.13.12	Local Echo . . . . .	2-50
2.13.13	Half Duplex . . . . .	2-50
2.13.14	Auto Answerback . . . . .	2-50
2.13.15	Answerback Message . . . . .	2-50
2.13.16	Answerback Concealed . . . . .	2-51
2.14	Modem Menu . . . . .	2-52
2.14.1	Enable Modem Control . . . . .	2-52
2.14.2	Disconnect Delay . . . . .	2-52
2.14.3	Modem High Speed . . . . .	2-53
2.14.4	Modem Low Speed . . . . .	2-53

2.15	Printer Menu . . . . .	2-54
2.15.1	Port Select . . . . .	2-54
2.15.2	Print Mode . . . . .	2-54
2.15.3	Printer Type . . . . .	2-55
2.15.4	Printer Character Sets . . . . .	2-55
2.15.4.1	DEC/ISO Character Sets . . . . .	2-56
2.15.4.2	PC Character Sets . . . . .	2-56
2.15.5	Print Extent . . . . .	2-56
2.15.6	Print Terminator . . . . .	2-56
2.15.7	Serial Print Speed . . . . .	2-56
2.15.8	2-Way Communication . . . . .	2-57
2.15.9	Transmit Flow Control . . . . .	2-57
2.15.10	Receive Flow Control . . . . .	2-57
2.15.11	Word Size . . . . .	2-57
2.15.12	Parity . . . . .	2-58
2.15.13	Stop Bits . . . . .	2-58
2.15.14	Same as Receive . . . . .	2-58
2.16	Tabs . . . . .	2-58
2.17	Sound . . . . .	2-59
2.18	Set-Up Factory Defaults . . . . .	2-61

### 3 Desktop Features

3.1	Introduction . . . . .	3-1
3.2	Invoking Desktop Features . . . . .	3-1
3.3	Calculator . . . . .	3-2
3.4	Clock . . . . .	3-5
3.5	Review Previous Lines . . . . .	3-7
3.6	Character Set Tables . . . . .	3-7
3.6.1	Show Character Sets feature . . . . .	3-7
3.6.2	Banner message . . . . .	3-8
3.7	Keyboard Summary . . . . .	3-8

## Part II VT520 ANSI Mode

### 4 ANSI Control Functions Summary

4.1	Introduction . . . . .	4-1
4.2	Control Characters . . . . .	4-1
4.3	Control Functions . . . . .	4-5
4.3.1	Sequence Format . . . . .	4-5
4.3.2	Escape Sequences . . . . .	4-6
4.3.3	Control Sequences . . . . .	4-6
4.3.3.1	Control Sequence Introducer . . . . .	4-6
4.3.3.2	Parameters . . . . .	4-7
4.3.3.3	Intermediate Characters . . . . .	4-8
4.3.3.4	Final Character . . . . .	4-8
4.3.4	Device Control Strings . . . . .	4-8
4.3.5	Using Control Characters in Sequences . . . . .	4-9
4.3.6	7-Bit Code Extension Technique . . . . .	4-9
4.4	Working with 7-Bit and 8-Bit Environments . . . . .	4-10
4.4.1	Conventions for Codes Received by the Terminal . . . . .	4-10
4.4.2	Conventions for Codes Sent by the Terminal . . . . .	4-10
4.5	Showing Control Characters . . . . .	4-11

4.6	Terminal Management Functions . . . . .	4-15
4.7	ANSI Control Function Tables . . . . .	4-16
4.7.1	Sessions Management Control Functions . . . . .	4-16
4.7.2	Window Management Control Functions . . . . .	4-17
4.7.3	Audible Attributes Control Functions . . . . .	4-18
4.7.4	Color Selection Control Functions . . . . .	4-18
4.7.5	Visual Attributes Control Functions . . . . .	4-20
4.7.6	Editing Control Functions . . . . .	4-21
4.7.7	Text Processing Control Functions . . . . .	4-22
4.7.8	Graphic Character Sets Control Functions . . . . .	4-25
4.7.9	Keyboard Processing Control Functions . . . . .	4-27
4.7.10	Printer Control Functions . . . . .	4-33
4.7.11	Terminal Management Control Functions . . . . .	4-34
4.7.12	Terminal Management—Communications Control Functions . . . . .	4-39
4.7.13	Terminal Synchronization Control Functions . . . . .	4-41
4.7.14	Reports Control Functions . . . . .	4-42
4.8	VT52 Mode Escape Sequences . . . . .	4-45

## 5 ANSI Control Functions

ANSI Conformance Levels . . . . .	5-1
CBT—Cursor Backward Tabulation . . . . .	5-3
CHA—Cursor Horizontal Absolute . . . . .	5-3
CHT—Cursor Horizontal Forward Tabulation . . . . .	5-4
CNL—Cursor Next Line . . . . .	5-4
CPL—Cursor Previous Line . . . . .	5-5
CPR—Cursor Position Report . . . . .	5-5
CRM—Show Control Character Mode . . . . .	5-6
CUB—Cursor Backward . . . . .	5-7
CUD—Cursor Down . . . . .	5-7
CUF—Cursor Forward . . . . .	5-7
CUP—Cursor Position . . . . .	5-8
CUU—Cursor Up . . . . .	5-8
DA1—Primary Device Attributes . . . . .	5-9
DA2—Secondary Device Attributes . . . . .	5-11
DA3—Tertiary Device Attributes . . . . .	5-12
DCH—Delete Character . . . . .	5-13
DDD1, DDD2, DDD3 . . . . .	5-14
DECAAM—Set/Reset Auto Answerback Mode . . . . .	5-15
DECAC—Assign Color . . . . .	5-16
DECALN—Screen Alignment Pattern . . . . .	5-17
DECANM—ANSI Mode . . . . .	5-18
DECANM Exit—Exiting ANSI (VT52) Mode . . . . .	5-19
DECARM—Autorepeat Mode . . . . .	5-19
DECARR—Select Auto Repeat Rate . . . . .	5-20
DECARSM—Set/Reset Auto Resize Mode . . . . .	5-21
DECATC—Alternate Text Color . . . . .	5-22
DECATCBM—Set/Reset Alternate Text Color Blink Mode . . . . .	5-23
DECATCUM—Set/Reset Alternate Text Color Underline Mode . . . . .	5-23
DECAUPSS—Assigning User-Preferred Supplemental Sets . . . . .	5-24

DECAWM—Autowrap Mode	5-25
DECBBSM—Bold and Blink Style Mode	5-25
DECBI—Back Index	5-26
DECBKM—Backarrow Key Mode	5-26
DECCANSM—Conceal Answerback Message Mode	5-27
DECCAPSLK—Caps Lock Mode	5-28
DECCARA—Change Attributes in Rectangular Area	5-28
DECCIR—Cursor Information Report (Terminal to Host)	5-30
DECCKD—Copy Key Default	5-31
DECCKM—Cursor Keys Mode	5-32
DECCKSR—Memory Checksum Report	5-33
DECCOLM—Selecting 80 or 132 Columns per Page	5-34
DECCRA—Copy Rectangular Area	5-35
DECCRTST—CRT Saver Timing	5-36
DECCRTSM—Set/Reset CRT Save Mode	5-37
DECDC—Delete Column	5-37
DECDHL—Double-Width, Double-Height Line	5-38
DECULD—Dynamically Redefinable Character Sets Extension	5-39
DECDMAC—Define Macro	5-45
DECDLDA—Down Line Load Allocation	5-47
DECDWL—Double-Width, Single-Height Line	5-48
DECECM—Erase Color Mode	5-48
DECEKBD—Extended Keyboard Report	5-49
DESELF—Enable Local Functions	5-51
DECERA—Erase Rectangular Area	5-52
DECES—Enable Session	5-53
DECESKM—Enable Secondary Keyboard Language Mode	5-53
DECFI—Forward Index	5-54
DECFRA—Fill Rectangular Area	5-55
DECFWM—Set/Reset Framed Windows Mode	5-56
DECHDPXM—Set/Reset Half-Duplex Mode	5-56
DECHEM—Hebrew Encoding Mode	5-57
DECHEBM—Hebrew/N-A Keyboard Mapping Mode	5-58
DECHWUM—Host Wake-Up Mode (CRT and Energy Saver)	5-59
DECIC—Insert Column	5-59
DECID—Identify Device	5-60
DECINVM—Invoke Macro	5-61
DECIPEM—Enter/Return from IBM ProPrinter Emulation Mode	5-62
DECKBD—Keyboard Language Selection	5-63
DECKBUM—Typewriter or Data Processing Keys	5-65
DECKLHIM—Keyboard LED's Host Indicator Mode	5-65
DECKPAM—Keypad Application Modes	5-66
DECKPM—Key Position Mode	5-66
DECKPNM—Keypad Numeric Modes	5-67
DECLANS—Load Answerback Message	5-68
DECLBAN—Load Banner Message	5-69
DECLFKC—Local Function Key Control	5-70

DECLL—Load LEDs . . . . .	5-71
DECLRMM—Left Right Margin Mode . . . . .	5-72
DECLTOD—Load Time of Day . . . . .	5-72
DECMCM—Modem Control Mode . . . . .	5-73
DECMSR—Macro Space Report . . . . .	5-73
DECNAKB—Greek/N-A Keyboard Mapping Mode . . . . .	5-74
DECNCSM—No Clearing Screen On Column Change Mode . . . . .	5-74
DECNKM—Numeric Keypad Mode . . . . .	5-75
DECNRCM—National Replacement Character Set Mode . . . . .	5-75
DECNULM—Null Mode . . . . .	5-76
DECNUMLK—Num Lock Mode . . . . .	5-76
DECOM—Origin Mode . . . . .	5-77
DECOSCNM—Set/Reset Overscan Mode (VT520 only) . . . . .	5-77
DECPAK—Program Alphanumeric Key . . . . .	5-78
DECPCCM—Page Cursor-Coupling Mode . . . . .	5-80
DECPCTERM—Enter/Exit PCTerm or Scancode Mode . . . . .	5-81
DECPEX—Print Extent Mode . . . . .	5-83
DECPFF—Print Form Feed Mode . . . . .	5-83
DECPFK—Program Function Key . . . . .	5-84
DECPKA—Program Key Action . . . . .	5-87
DECPKFM—Program Key Free Memory Report . . . . .	5-88
DECPS—Play Sound . . . . .	5-89
DECRARA—Reverse Attributes in Rectangular Area . . . . .	5-90
DECRC—Restore Cursor . . . . .	5-92
DECRLCM—Right-to-Left Copy Mode . . . . .	5-92
DECRLM—Right-to-Left Mode . . . . .	5-93
DECRPAK—Report All Modifiers/Alphanumeric Key State . . . . .	5-94
DECRPDE—Report Displayed Extent . . . . .	5-95
DECRPFK - Report Function Key Definition . . . . .	5-96
DECRPKT—Report Key Type . . . . .	5-96
DECRPL—Review Previous Lines Mode . . . . .	5-97
DECRPM—Report Mode - Terminal To Host . . . . .	5-98
DECRPSS—Report Selection or Setting . . . . .	5-102
DECRPTUI—Report Terminal Unit ID . . . . .	5-104
DECRQCRA—Request Checksum of Rectangular Area . . . . .	5-105
DECRQDE—Request Displayed Extent . . . . .	5-105
DECRQKD—Request Key Definition . . . . .	5-106
DECRQKT—Request Key Type . . . . .	5-107
DECRQM—Request Mode - Host To Terminal . . . . .	5-108
DECRQPKFM—Request Program Key Free Memory . . . . .	5-111
DECRQPSR—Request Presentation State Report . . . . .	5-111
DECRQSS—Request Selection or Setting . . . . .	5-112
DECRQTSR—Request Terminal State Report . . . . .	5-113
DECCTR—Color Table Request . . . . .	5-114
DECRQUPSS—Request User-Preferred Supplemental Set . . . . .	5-115
DECRSPS—Restore Presentation State . . . . .	5-116
DECRSTS—Restore Terminal State . . . . .	5-117

DECRSTS—Restore Terminal Color Table State	5-118
DECSACE—Select Attribute Change Extent	5-119
DECSASD—Select Active Status Display	5-120
DECSC—Save Cursor	5-120
DECSCA—Select Character Protection Attribute	5-121
DECSCCL—Select Conformance Level	5-122
DECSCCLM—Scrolling Mode	5-123
DECSCNM—Screen Mode: Light or Dark Screen	5-123
DECSCP—Select Communication Port	5-124
DECSCPP—Select Columns Per Page	5-125
DECSCS—Select Communication Speed	5-126
DECSCUSR—Set Cursor Style	5-127
DECSDDT—Select Disconnect Delay Time	5-128
DECSDPT—Select Digital Printed Data Type	5-129
DECSED—Selective Erase in Display	5-129
DECSEST—Energy Saver Timing	5-130
DECSEL—Selective Erase in Line	5-131
DECSERA—Selective Erase Rectangular Area	5-132
DECSEFC—Select Flow Control	5-133
DECSIN—Set Icon Name	5-134
DECSKCV—Set Key Click Volume	5-135
DECSLCK—Set Lock Key Style	5-135
DECSLPP—Set Lines Per Page	5-136
DECSLRM—Set Left and Right Margins	5-137
DECSMBV—Set Margin Bell Volume	5-138
DECSMKR—Select Modifier Key Reporting	5-139
DECSNLS—Set Number of Lines Per Screen	5-140
DECSPMA—Session Page Memory Allocation	5-141
DECSPP—Set Port Parameters	5-142
DECSPPCS—Select ProPrinter Character Set	5-143
DECSPRTT—Select Printer Type	5-144
DECSR—Secure Reset	5-144
DECSRC—Secure Reset Confirmation	5-146
DECSSCLS—Set Scroll Speed	5-146
DECSSDT—Select Status Display (Line) Type	5-147
DECSSL—Select Set-Up Language	5-148
DECST8C—Set Tab at Every 8 Columns	5-149
DECSTBM—Set Top and Bottom Margins	5-149
DECSTR—Soft Terminal Reset	5-150
DECSTGLT—Select Color Look-Up Table	5-151
DECSTRM—Set Transmit Rate Limit	5-152
DECSTUI—Setting Terminal Unit ID	5-153
DECSWBV—Set Warning Bell Volume	5-154
DECSWL—Single-Width, Single-Height Line	5-154
DECSZS—Select Zero Symbol	5-155
DECSWT—Set Window Title	5-156
DECTABSR—Tab Stop Report	5-157

DECTCEM—Text Cursor Enable Mode	5-157
DECTID—Select Terminal ID	5-158
DECTME—Terminal Mode Emulation	5-159
DECTSR—Terminal State Report—Terminal to Host	5-160
DECTSR—Terminal State Report (Color Table Report)	5-161
DECTST—Invoke Confidence Test	5-162
DECUDK—User Defined Keys	5-163
DECUS—Update Session	5-169
DECVCCM—Vertical Cursor-Coupling Mode	5-170
DECXCPR—Extended Cursor Position Report	5-170
DECXRLM—Transmit Rate Limiting	5-171
DL—Delete Line	5-172
DSR—Device Status Reports	5-173
DSR—Cursor Position Report (CPR)	5-173
DSR—Data Integrity Report	5-174
DSR—Extended Cursor Position Report (DECXCPR response)	5-174
DSR—Keyboard Report	5-175
DSR—Macro Space Report	5-176
DSR—Memory Checksum Report (DECCKSR)	5-177
DSR—Operating Status Report	5-177
DSR—Printer Port Report	5-178
DSR—User-Defined Keys Report (VT Level 4 or higher)	5-179
ECH—Erase Character	5-179
ED—Erase in Display	5-180
EL—Erase in Line	5-180
HPA—Horizontal Position Absolute	5-181
HPR—Horizontal Position Relative	5-181
HT—Horizontal Tab	5-182
HTS—Horizontal Tab Set	5-182
HVP—Horizontal and Vertical Position	5-183
ICH—Insert Character	5-183
IL—Insert Line	5-184
IND—Index	5-184
IRM—Insert/Replace Mode	5-185
KAM—Keyboard Action Mode	5-185
LNLM—Line Feed/New Line Mode	5-186
LS—Locking Shift	5-187
MC—Media Copy	5-188
NEL—Next Line	5-191
NP—Next Page	5-191
PP—Preceding Page	5-192
PPA—Page Position Absolute	5-192
PPB—Page Position Backward	5-193
PPR—Page Position Relative	5-193
RIS—Reset to Initial State	5-194
RM—Reset Mode	5-195
S7C1T—Send C1 Control Character to the Host	5-196

S8C1T—Send C1 Control Character to the Host	5-196
SCS—Select Character Set	5-197
Designating Character Sets (SCS Sequences)	5-197
SD—Pan Up	5-200
SGR—Select Graphic Rendition	5-201
SRM—Local Echo: Send/Receive Mode	5-204
SS—Single Shifts	5-205
SM—Set Mode	5-206
SU—Pan Down	5-207
TBC—Tab Clear	5-207
VPA—Vertical Line Position Absolute	5-208
VPR—Vertical Position Relative	5-208

## 6 SCO Console Emulation

6.1	SCO Console Emulation Mode	6-1
6.1.1	Keyboard	6-2
6.1.1.1	Local Function Keys in SCO Console Mode	6-2
6.1.1.2	PC Keyboard	6-2
6.1.1.3	VT Keyboard Key Mapping	6-6
6.2	VT520 SCO Console Control Sequences	6-7
	SCODFK—Define Function Key	6-7
	SCODPCC—Display PC Characters	6-8
	SCORC—Restore Saved Cursor Position	6-9
	SCOSC—Save Current Cursor Position	6-9

## 7 Character Sets

7.1	Overview	7-1
7.2	Character Sets Supported	7-1
7.2.1	VT Graphic Character Sets	7-1
7.2.2	PCTerm Graphic Character Sets	7-2
7.2.3	Control Character Sets	7-3
7.2.4	Character Set Structure	7-3
7.2.5	Characters Not in a Character Set	7-3
7.3	VT Mode	7-4
7.3.1	Selecting Character Sets	7-4
7.3.2	Character Set Mappings	7-4
7.4	PCTerm Mode	7-4
7.4.1	Selecting Character Sets	7-4
7.4.2	Character Set Mappings	7-5
7.5	SCO Console Mode	7-5
7.6	Soft Character Sets	7-5
7.6.1	Designing a Soft Character Set	7-6
7.6.2	Coding the Soft Character Set	7-9
7.6.3	Downloading Soft Characters	7-13
7.6.4	Designating the Soft Character Set	7-14
7.6.5	Soft Character Set Example	7-15
7.6.6	Clearing a Soft Character Set	7-16



## 8 Keyboard Processing

8.1	Overview—Keyboard Layout	8-1
8.2	DEC VT Layout	8-2
8.3	VT Layout - PC Term Mode	8-2
8.4	Enhanced PC Layout - PCTerm Mode	8-3
8.5	Enhanced PC Layout - VT Mode	8-3
8.5.1	DEC VT Style	8-3
8.5.2	IBM PC Style	8-4
8.6	Main Key Array	8-4
8.6.1	Character Sets	8-4
8.6.2	Tab Key	8-4
8.6.3	Modifier Keys	8-4
8.6.4	Caps Lock	8-5
8.6.5	Left Alt	8-5
8.6.6	Right Alt	8-6
8.6.7	Alt Gr	8-6
8.7	Top Row Function Keys	8-6
8.8	Editing Keypad Keys	8-6
8.9	Cursor Keypad Keys	8-7
8.10	Numeric Keypad Keys	8-7
8.11	Local Function Key Defaults	8-9
8.11.1	Numeric Keypad Compose	8-14
8.11.2	Accessibility Aids	8-15
8.12	Controlling Keyboard LEDs	8-16
8.13	Keyboard Languages	8-17
8.14	Switching Between Keyboard Languages	8-18
8.14.1	Keystroke Processing	8-20
8.14.2	Non-Spacing Accent Marks	8-20
8.14.3	German	8-21
8.14.4	Hebrew	8-21
8.15	Keystation Numbers	8-21
8.16	Scan Codes Sent in PCTerm Mode for EPC Keyboards	8-23
8.17	Scan Codes Sent in PCTerm Mode for VT Keyboards	8-27
8.18	Control Codes and Keystrokes	8-28

## 9 Communications

9.1	Introduction to Communications	9-1
9.2	Physical Link Layer	9-2
9.2.1	25-Pin Connectors	9-2
9.2.2	DEC Corporate Modular Jacks (MMJ)	9-3
9.2.3	Connector Pins Description	9-3
9.2.3.1	Transmitted Data—TXD L	9-4
9.2.3.2	Received Data—RXD L	9-4
9.2.3.3	Request to Send—RTS	9-4
9.2.3.4	Clear to Send—CTS	9-4
9.2.3.5	Data Terminal Ready—DTR	9-5
9.2.3.6	Data Set Ready—DSR	9-5
9.2.3.6.1	Modem Initiated Disconnect	9-5
9.2.3.6.2	Terminal Initiated Disconnect	9-5
9.2.3.6.3	Modem off line	9-6
9.2.3.7	Receive Line Signal Detector—RLSD	9-6
9.2.3.8	Speed Indicator—SPDI	9-6
9.2.3.9	Speed Select—SPDS	9-7

9.2.4	Half-Duplex Mode . . . . .	9-7
9.2.5	Supported Modem Configurations . . . . .	9-7
9.2.5.1	CCITT Public Switched Telephone Network (2-wire only) . . . . .	9-7
9.2.5.2	CCITT Dedicated Line (2-Wire / 4-Wire) Data Network . . . . .	9-7
9.2.5.3	European Public Circuit Switched Data Network . . . . .	9-8
9.2.5.4	European Public Packet Switched Data Network (PSDN) . . . . .	9-8
9.3	Data Link Layer . . . . .	9-9
9.3.1	7- /8-Bit VT100/VT520 Operation . . . . .	9-9
9.3.2	Flow Control . . . . .	9-10
9.3.2.1	Receive Buffer . . . . .	9-10
9.3.2.2	Flow Control Selection . . . . .	9-10
9.3.2.2.1	No Flow Control . . . . .	9-11
9.3.2.2.2	XOFF/XON or XPC Flow Control . . . . .	9-11
9.3.2.2.3	DSR/DTR Flow Control . . . . .	9-12
9.3.2.2.4	Software and Hardware Combined Flow Control . . . . .	9-12
9.3.2.2.5	Flow Control Threshold . . . . .	9-12
9.3.2.3	Show Control Character Mode . . . . .	9-13
9.3.2.4	Set-Up on Flow Control Handling . . . . .	9-13
9.3.2.5	When Disconnect Occurs . . . . .	9-13
9.4	Features that Affect Communications . . . . .	9-13
9.4.1	Clear Communications . . . . .	9-14
9.4.2	Connection . . . . .	9-14
9.4.3	Line Disconnection . . . . .	9-14
9.4.4	Break . . . . .	9-15
9.4.4.1	Received Break . . . . .	9-15

## 10 Printer Port

10.1	Overview . . . . .	10-1
10.2	Serial Port . . . . .	10-1
10.2.1	Serial Port Flow Control . . . . .	10-1
10.3	Parallel Port . . . . .	10-2
10.3.1	Parallel Port Flow Control . . . . .	10-3
10.4	Print Modes . . . . .	10-3
10.4.1	Printer Controller Mode . . . . .	10-4
10.5	Print Operation . . . . .	10-4
10.6	Transmitting Print Data . . . . .	10-4
10.6.1	DEC ANSI . . . . .	10-4
10.6.2	IBM ProPrinter or Compatible Printer . . . . .	10-5
10.6.2.1	Data Transmission . . . . .	10-5
10.6.3	DEC ANSI with IBM ProPrinter Emulation . . . . .	10-6
10.6.3.1	Data Transmission . . . . .	10-7
10.7	Printer Status . . . . .	10-7
10.8	Suspending Print Operations . . . . .	10-7
10.9	Aborting Print Operations . . . . .	10-7

## Part III VT520 ASCII Emulation

## 11 ASCII Emulations and Control Functions

11.1	Overview	11-1
11.2	ASCII Emulations	11-1
11.2.1	Enhanced Mode	11-2
11.3	Coding Notation	11-2
11.3.1	Communication Flow Control with PCTerm Mode	11-3
11.3.2	Protecting Data	11-3

## 12 ASCII Escape Sequences

12.1	ASCII Communications	12-1
12.2	Terminal Management	12-4
12.3	Keyboard Processing	12-5
12.4	Screen Processing	12-10
12.4.1	Rectangular Area Operations	12-28
12.4.1.1	Draw Rectangle	12-31
12.4.1.2	Swap/Copy/Move	12-31
12.5	Printing/Sending Data	12-32
12.5.1	Sending Data	12-32
12.5.2	Graphics Characters	12-36

## 13 Defining and Loading ASCII Character Fonts

13.1	Character Sets	13-1
13.1.1	PCTerm on US Keyboard	13-1
13.1.2	WYSE and ADDS Enhanced Personalities	13-1
13.2	Loading, Defining, and Selecting Character Sets	13-3
13.3	Designing a Character Font	13-5

## A VT Keyboard Legend Data

A.1	Compose Processing and Non-spacing Diacritical Marks	A-1
A.2	VT Keyboards	A-1

## B Enhanced PC Keyboards

B.1	Summary of Non-Spacing Diacritical Marks	B-1
B.2	Enhanced PC Keyboards	B-2

## C ASCII Keycodes and Local Functions

C.1	PC Keyboard	C-1
C.2	DEC VT Keyboard	C-6
C.3	ASCII Local Functions	C-9

## D VT520 Termcap Data

D.1	Termcap Emulations	D-1
D.1.1	Termcap Data:	D-1
D.1.2	Terminfo Data:	D-2

## E ANSI Control Function Index

E.1	ANSI Index by Final Character . . . . .	E-1
-----	---	-----

### Glossary

### Index

### Figures

1-1	Sample VT Keyboard Layout . . . . .	1-2
1-2	Sample PC Keyboard Layout . . . . .	1-2
2-1	Set-Up . . . . .	2-1
2-2	Set-Up Language Selection . . . . .	2-2
2-3	Set-Up Summary Line . . . . .	2-5
2-4	Main and Terminal Actions Menu . . . . .	2-7
2-5	Session Menu . . . . .	2-13
2-6	Session Page Memory Allocation . . . . .	2-15
2-7	Lines per Page . . . . .	2-21
2-8	Framed Windows . . . . .	2-26
2-9	Screen Alignment Display . . . . .	2-27
2-10	Color Set-Up Menu . . . . .	2-28
2-11	Assign Colors . . . . .	2-29
2-12	Alternate Colors . . . . .	2-30
2-13	Define Colors . . . . .	2-31
2-14	ASCII Emulation Menu . . . . .	2-35
2-15	Keyboard Menu . . . . .	2-36
2-16	Define Key Editor, Select Function . . . . .	2-38
2-17	Communication Menu . . . . .	2-45
2-18	Communications—Port Select . . . . .	2-46
2-19	Communication Transmit Speed Menu . . . . .	2-48
2-20	Communication Fkey Rate Limit Menu . . . . .	2-49
2-21	Communication Answerback Dialog Box . . . . .	2-51
2-22	Modem Menu . . . . .	2-52
2-23	Modem High Speed Menu . . . . .	2-53
2-24	Printer Menu . . . . .	2-54
2-25	DEC/ISO Character Sets Menu . . . . .	2-56
2-26	PC Character Sets Menu . . . . .	2-57
2-27	Tab Set-Up Dialog Box . . . . .	2-59
3-1	Calculator with VT Keyboard Layout . . . . .	3-3
3-2	Calculator with PC Keyboard Layout . . . . .	3-4
3-3	Clock Function . . . . .	3-6
4-1	7-bit ASCII Code Table with C0 Control Characters Font (Left Half) . . . . .	4-14
4-2	8-bit ASCII Code Table with C1 Control Characters Font (Right Half) . . . . .	4-15
7-1	Character Cell Sizes for 24-Line by 80- and 132-Column Fonts . . . . .	7-6

7-2	Character Body Sizes for 24-Line by 80- and 132-Column Fonts . . . . .	7-8
7-3	Example of an Uppercase D (24-Line by 80-Column Font) . . . . .	7-10
7-4	Sixel-to-ASCII Conversion . . . . .	7-13
8-1	VT Keyboard Layout . . . . .	8-1
8-2	PC Keyboard Layout . . . . .	8-1
8-3	Editing Keypad Legends on DEC and PC Layouts . . . . .	8-7
8-4	VT Layout - Keystation Numbers . . . . .	8-21
8-5	VT Layout - Typical North American Key Legends . . . . .	8-22
8-6	Enhanced PC Layout - Map Numbers . . . . .	8-22
8-7	Enhanced PC Layout - Typical North American Key Legends . . . . .	8-22
9-1	25-Pin Port Pin Numbers . . . . .	9-2
9-2	MMJ Modular Jack Pin Numbers . . . . .	9-3
10-1	Parallel Printer Port . . . . .	10-2
13-1	Process of Selecting Character Sets . . . . .	13-2
A-1	Austrian/German VT Keyboard . . . . .	A-2
A-2	Belgian/French VT Keyboard . . . . .	A-3
A-3	British/U.K./North American VT Keyboard . . . . .	A-4
A-4	Canadian-French VT Keyboard . . . . .	A-5
A-5	Czech VT Keyboard . . . . .	A-6
A-6	Danish VT Keyboard . . . . .	A-7
A-7	Dutch VT Keyboard . . . . .	A-8
A-8	Finnish VT Keyboard . . . . .	A-9
A-9	Flemish VT Keyboard . . . . .	A-10
A-10	Greek VT Keyboard . . . . .	A-11
A-11	Hebrew VT Keyboard . . . . .	A-12
A-12	Hungarian VT Keyboard . . . . .	A-13
A-13	Italian VT Keyboard . . . . .	A-14
A-14	Norwegian VT Keyboard . . . . .	A-15
A-15	Polish VT Keyboard . . . . .	A-16
A-16	Portuguese VT Keyboard . . . . .	A-17
A-17	Romanian VT Keyboard . . . . .	A-18
A-18	Russian VT Keyboard . . . . .	A-19
A-19	SCS VT Keyboard . . . . .	A-20
A-20	Slovak VT Keyboard . . . . .	A-21
A-21	Spanish VT Keyboard . . . . .	A-22
A-22	Swedish VT Keyboard . . . . .	A-23
A-23	Swiss-French VT Keyboard . . . . .	A-24
A-24	Swiss-German VT Keyboard . . . . .	A-25
A-25	Turkish-F VT Keyboard . . . . .	A-26
A-26	Turkish-Q VT Keyboard . . . . .	A-27
B-1	Austrian/German Enhanced PC Keyboard . . . . .	B-3
B-2	Belgian Enhanced PC Keyboard . . . . .	B-4
B-3	British/U.K. Enhanced PC Keyboard . . . . .	B-5
B-4	Canadian-English/North American Enhanced PC Keyboard . . . . .	B-6
B-5	Canadian-French Enhanced PC Keyboard . . . . .	B-7
B-6	Czech Enhanced PC Keyboard . . . . .	B-8
B-7	Danish Enhanced PC Keyboard . . . . .	B-9

B-8	Dutch Enhanced PC Keyboard . . . . .	B-10
B-9	Finnish Enhanced PC Keyboard . . . . .	B-11
B-10	French Enhanced PC Keyboard . . . . .	B-12
B-11	Greek Enhanced PC Keyboard . . . . .	B-13
B-12	Hebrew Enhanced PC Keyboard . . . . .	B-14
B-13	Hungarian Enhanced PC Keyboard . . . . .	B-15
B-14	Italian Enhanced PC Keyboard . . . . .	B-16
B-15	Latin American Enhanced PC Keyboard . . . . .	B-17
B-16	Norwegian Enhanced PC Keyboard . . . . .	B-18
B-17	Polish Enhanced PC Keyboard . . . . .	B-19
B-18	Portuguese Enhanced PC Keyboard . . . . .	B-20
B-19	Romanian Enhanced PC Keyboard . . . . .	B-21
B-20	Russian Enhanced PC Keyboard . . . . .	B-22
B-21	SCS Enhanced PC Keyboard . . . . .	B-23
B-22	Slovak Enhanced PC Keyboard . . . . .	B-24
B-23	Spanish Enhanced PC Keyboard . . . . .	B-25
B-24	Swedish Enhanced PC Keyboard . . . . .	B-26
B-25	Swiss-French Enhanced PC Keyboard . . . . .	B-27
B-26	Swiss-German Enhanced PC Keyboard . . . . .	B-28
B-27	Turkish Enhanced PC Keyboard . . . . .	B-29

## Tables

1-1	VT520/25 Font Sizes . . . . .	1-5
2-1	Error Messages . . . . .	2-3
2-2	Context Sensitive Set-Up Features . . . . .	2-4
2-3	Display Set-Up Features and Control Functions . . . . .	2-19
2-4	Lines per Page vs. Lines per Screen When Auto Resize is Set . . . . .	2-20
2-5	Default Graphic Renditions . . . . .	2-32
2-6	ASCII Emulation Features . . . . .	2-35
2-7	Keyboard Features and Control Functions . . . . .	2-36
2-8	Communication and Modem Features and Control Functions . . . . .	2-45
2-9	Printer Features and Control Functions . . . . .	2-55
2-10	Set-Up Factory Defaults . . . . .	2-61
3-1	ASCII Emulation Character Sets . . . . .	3-7
4-1	C0 (7-Bit) Control Characters Recognized . . . . .	4-2
4-2	C1 (8-Bit) Control Characters Recognized . . . . .	4-3
4-3	8-Bit Control Characters and Their 7-Bit Equivalents . . . . .	4-4
4-4	Control Character Displayed on Screen . . . . .	4-11
4-5	VT52 Mode Escape Sequences . . . . .	4-45
5-1	VT52 Escape Sequences . . . . .	5-18
5-2	DECDDL Parameter Characters . . . . .	5-41
5-3	Settings Supported by DECRQM, DECRPM, RM, and SM . . . . .	5-100
5-4	ANSI Modes for DECRQM, DECRPM, SM, and RM . . . . .	5-109
5-5	DEC Private Modes for DECRQM, DECRPM, SM, and RM . . . . .	5-110
5-6	Terminal's Default Settings . . . . .	5-150
5-7	Terminal Emulation Modes . . . . .	5-159

5-8	VT Keyboards .....	5-165
5-9	PC Keyboards .....	5-166
5-10	VT and PC Keyboard Function Keys Compared .....	5-167
5-11	Keyboard Languages .....	5-175
5-12	Mapping Character Sets with Locking Shifts .....	5-187
5-13	Designating a Character Set .....	5-198
5-14	Character Set Codes .....	5-198
5-15	Visual Character Attribute Values .....	5-201
6-1	SCO Console Mode with ASCII Keycodes and Scancodes .....	6-1
6-2	Local Functions on VT and Enhanced PC Layouts .....	6-2
6-3	SCO Console Mode Function Key Default Codes .....	6-3
6-4	SCO Console Mode Main Keypad Default Codes .....	6-3
6-5	SCO Console Mode Numeric Keypad Default Codes, Num Lock Off..	6-5
6-6	SCO Console Mode Numeric Keypad Default Codes, Num Lock On...	6-5
6-7	SCO Console Mode Editing Keypad Default Codes .....	6-6
6-8	SCO Console Mode Cursor Keypad Default Codes .....	6-6
7-1	Character Cell Sizes .....	7-7
7-2	Guidelines for Designing Soft Characters .....	7-8
7-3	Converting Binary Code to an ASCII Character .....	7-11
8-1	Scan Codes for VT Layout in PCTerm Mode .....	8-2
8-2	VT Style Layout vs. Enhanced PC Style Layout Modifier Keys .....	8-5
8-3	Editing Keypad Sequences for Enhanced PC Layout .....	8-7
8-4	PC Layout Numeric Keypad Sequences - VT Style .....	8-8
8-5	PC Layout Numeric Keypad Sequences - PC Style, Numeric Mode ...	8-9
8-6	Local Functions .....	8-9
8-7	VT Keyboard Languages .....	8-17
8-8	Enhanced PC Keyboard Languages .....	8-17
8-9	8-bit Character Set Initialization when Keyboard Language is Changed .....	8-18
8-10	7-bit Character Set Initialization .....	8-19
8-11	Non-spacing Accent Marks .....	8-20
8-12	Control Codes and Keystrokes .....	8-28
9-1	EIA Interface Signals and Functions .....	9-2
9-2	MMJ Interface Signals .....	9-3
9-3	Flow Control Threshold Points .....	9-13
10-1	Parallel Connector Signals .....	10-2
11-1	Symbols Used in ASCII Terminal Escape Sequences .....	11-2
11-2	Commands that may Carry Protect Mode Features through Pages ...	11-4
11-3	Commands that Can Move the Cursor to Protected Area .....	11-5
11-4	Commands that Cannot Move Cursor into Protected Area .....	11-5
12-1	Serial Port Control Functions .....	12-1
12-2	Terminal Management Control Functions .....	12-4
12-3	Keyboard Processing Control Functions .....	12-5
12-4	Redefinable Keys .....	12-9
12-5	Screen Processing Control Functions .....	12-10
12-6	Data Protection Control Functions .....	12-20
12-7	Cursor Control Functions .....	12-21

12-8	ASCII Editing Control Functions . . . . .	12-25
12-9	Local Edit Mode Function Keys . . . . .	12-25
12-10	Tab Stop Control Functions . . . . .	12-26
12-11	Page Edit Control Functions . . . . .	12-27
12-12	Rules for Locating Rectangle . . . . .	12-29
12-13	Rectangle Area Control Functions . . . . .	12-30
12-14	Send Data Delimiters . . . . .	12-32
12-15	Delimiters for Other Personalities . . . . .	12-33
12-16	Print/Send Control Functions . . . . .	12-33
12-17	Printing Data Control Functions . . . . .	12-35
12-18	Graphic Characters . . . . .	12-36
13-1	Display and Load Character Sets . . . . .	13-1
13-2	Loading Font Bank . . . . .	13-3
13-3	Design a Character Font . . . . .	13-5
A-1	VT Keyboard Non-Spacing Diacritical Marks . . . . .	A-1
B-1	Enhanced PC Keyboard Non-Spacing Diacritical Marks . . . . .	B-1
C-1	WYSE and TVI Modes Function Keys for PC Keyboard . . . . .	C-1
C-2	WYSE and TVI Modes Function Keys for PC Keyboard . . . . .	C-1
C-3	WYSE and TVI Modes Editing Keys for PC Keyboard . . . . .	C-2
C-4	WYSE and TVI Modes Cursor Keys on PC Keyboard . . . . .	C-2
C-5	WYSE and TVI Modes Numeric Keys for PC Keyboard, NumLock = Off . . . . .	C-2
C-6	WYSE 160 and TVI Modes Numeric Keys for PC Keyboard, NumLock = On . . . . .	C-3
C-7	ADDS A2 Function Keys on PC Keyboard . . . . .	C-3
C-8	ADDS A2 Editing Keys on PC Keyboard . . . . .	C-4
C-9	ADDS A2 Cursor Keys on PC Keyboard . . . . .	C-4
C-10	ADDS A2 Mode Numeric Keypad Keys on PC Keyboard; NumLock = Off . . . . .	C-4
C-11	ADDS A2 Mode Numeric Keypad Keys on PC Keyboard; NumLock = On . . . . .	C-5
C-12	WYSE and TVI Modes Function Keys for DEC VT Keyboard . . . . .	C-6
C-13	WYSE and TVI Modes Editing Keys on DEC VT Keyboard . . . . .	C-6
C-14	WYSE and TVI Modes Cursor Keys on DEC VT Keyboard . . . . .	C-7
C-15	WYSE and TVI Modes Numeric Keypad PF Keys on DEC VT Keyboard . . . . .	C-7
C-16	ADDS A2 Function Keys on DEC VT Keyboard . . . . .	C-7
C-17	ADDS A2 Editing Keys on DEC VT Keyboard . . . . .	C-8
C-18	ADDS A2 Cursor Keys on DEC VT Keyboard . . . . .	C-8
C-19	ADDS A2 Numeric Keypad PFKeys on DEC VT Keyboard . . . . .	C-8
C-20	Local Functions in ASCII Code Mode . . . . .	C-9
C-21	Local Functions in PC Scancode Mode . . . . .	C-11
E-1	ANSI Control Functions Index by Final Character . . . . .	E-1



# Part I

---

## VT520 Video Terminal

This part includes the following chapters:

- Chapter 1, Overview
- Chapter 2, Set-Up
- Chapter 3, Desktop Features



## 1.1 Introduction

The VT520 is a low-cost, multi-session, text video terminal featuring enhanced keyboard and communications flexibility, providing up to four sessions at a time. Two or more sessions can be assigned to the same communication port when Terminal Device/Session Management Protocol (TD/SMP) is used to multiplex the sessions. Each session has its own framed window, window title, and icon name.

The VT520 has a define key editor that allows you to reprogram any key on the keyboard.

The VT525 color terminal allows you to assign different colors to the various windows and to combinations of character attributes. You can select colors from color look-up tables or create your own color combinations. Unless specifically mentioned in this manual the term VT520 also refers to the VT525 color model.

The product has a 25-pin stacked male/female RS-232 connector (EIA-232), two 6-pin EIA-423 (MMJ) connectors, and a Centronics parallel connector. The RS-232 and the EIA-423 ports are used.

The VT520 also has power management features that exceed the Environmental Protection Agency (EPA) Energy Star requirements for saving energy.

## 1.2 Communications Features

The terminal provides:

- Three bidirectional, asynchronous serial communication ports; one of which (Comm 3) can be used for a local printer.
- Baud rates from 300 to 115.2K baud
- Centronics parallel printer port
- 25-pin serial connectors
- Two MMJ serial connectors
- Expanded flow control options:
  - Software flow control using XON/XOFF or XPC
  - Hardware flow control using DTR/DSR

# Overview

## 1.3 Keyboard Features

### 1.3 Keyboard Features

The VT520 offers a choice of two keyboard layouts—a VT keyboard layout (LK411) or an enhanced PC keyboard layout (PCXAL). The VT keyboard (Figure 1–1) and the PC keyboard (Figure 1–2) differ in the placement of some of the keys, like the Control key. A VT keyboard has 20 function keys, **F1** through **F20**, above the main keypad, while a PC keyboard has 12 function keys, **F1** through **F12**.

Figure 1–1 Sample VT Keyboard Layout

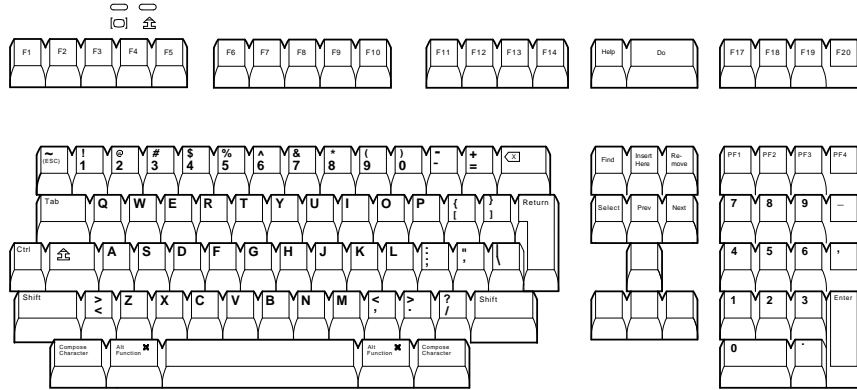

MA-1520a-92.PS

Figure 1–2 Sample PC Keyboard Layout

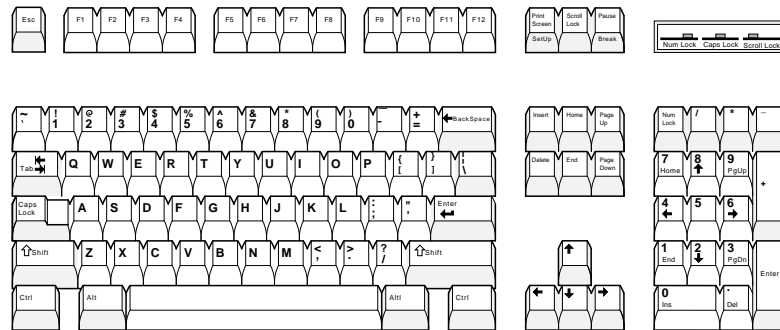

LJ-00226a-T10.PS

The keyboard has the following features:

- An IBM PS/2-compatible 6-pin mini DIN connector.
- Keyboard keys that can be reprogrammed to send single characters, to send character sequences, or to invoke local functions (Hold, Copy and Paste, Remove, Insert, Print Page, Toggle Autoprint, Set-Up, Break, and so on).
- A local user-defined key editor. Key definitions can be saved in nonvolatile memory.
- Eight levels of user-defined function keys using any combination of Shift, Control, and Alt.
- 971 bytes of nonvolatile memory available for custom user-defined keys (UDKs)/Session, which cannot be reallocated. The maximum length for a UDK definition is 255 bytes.

## **1.4 Printer Port Features**

The terminal has the following printer port features:

- A Centronics parallel printer port.
- IBM ProPrinter support.
- Bidirectional serial communication ports.
- Baud rates from 300 to 115.2K baud.
- Null characters that can pass as data to the printer port.

## **1.5 Display and Text Capabilities**

The terminal has both ANSI and ASCII display and text processing capabilities. The features of each are listed below.

### **1.5.1 ANSI**

- Macro capability
- Display: 26, 42, or 53 data lines
- Selectable page size: 24, 25, 36, 42, 48, 50, or 72 lines
- Full status line (occupies one data line)
- Separate keyboard indicator line
- Three pages of 24 lines
- SCO Console mode

### **1.5.2 ASCII**

- Terminal emulations:  
WYSE: 325 (color model only), 50, 50+, 60 native, 160 text only, 120, 150, PCTerm  
Teletype: TVI 950, 925, 910+  
Applied Digital Data Systems: ADDS A2
- Dim and invisible character attributes

## Overview

### 1.6 Enhanced Set-Up

#### 1.6 Enhanced Set-Up

The terminal provides an enhanced menu-based Set-Up, allowing common features to be accessed easily from a single screen. All Set-Up features are host controllable to allow remote configuration. The terminal also has a means to lock out the local setup key.

Set-Up menus are available in English, French, German, Italian, or Spanish. For details, see Chapter 2, Set-Up.

#### 1.7 Desktop Productivity Features

The terminal has the following desktop productivity features:

- Local copy and paste (not available in PCTerm mode)
- Time of day clock (host or locally set, no battery back up)
- Desktop calculator with decimal, octal, and hex conversions
- Display character set tables.
- Review previous data lines.

For details, see Chapter 3, Desktop Features.

#### 1.8 Character Set Support

In addition to the traditional Digital graphic character sets (DEC Multinational, NRCS, and so on), the VT520 supports Cyrillic, Greek, Hebrew, Turkish, most Eastern European languages, and PC character sets. For details, see Chapter 7, Character Sets.

#### 1.9 Ergonomics (Human Factors) Features

The terminal is designed to provide a high-quality human interface and long-term reliability at low cost. The VT520 offers 72 Hz refresh, full overscan. The terminal has the following features:

- 35.5 cm (14 in) flat face, antiglare CRT screen
- Improved resolution of 802 × 480 pixels. (The mono VT520 also has 800 × 432 with overscan.)
- 72 Hz refresh
- Overscan<sup>1</sup>
- Additional fonts (see Table 1-1)
- Tilt/swivel base
- Choice of keyboards
- Accessibility aids

---

<sup>1</sup> Not available in color model.

Table 1–1 VT520/25 Font Sizes

80 Columns	132 Columns	Maximum Number of Lines
10 × 16	6 × 16	26 lines + keyboard indicator line
10 × 10	6 × 10	42 lines + keyboard indicator line
10 × 8	6 × 8	53 lines + keyboard indicator line

## 1.10 Field-Upgradable Firmware

All VT520 models include support for a 4 Mbit (512 KByte) ROM cartridge option. The base unit comes with a factory-installed ROM. The ROM cartridge connector is protected by a ROM cartridge cover. To install new code, the ROM cartridge cover is removed, and a ROM cartridge with attached cover is plugged into the ROM connector. The new code completely supersedes the factory-installed ROM code. It does not overlay or extend the factory code.

---

### Note

---

If you service the terminal with a ROM cartridge installed, turn the power Off, and remove and save the ROM cartridge to put it on the new terminal.

---

To install a ROM cartridge with new firmware, use the following steps:

1. Turn the power off before installing the ROM cartridge.
2. Turn the power on and press **F3**.
3. Select **Actions** > **Restore factory defaults** and press **Return**.
4. Select **Sessions** > **Save all sessions** and press **Return**.

The installation is now complete. When you power-on the terminal, the message “ROM card active” is displayed in the upper-left corner of the display. Note that steps 3 and 4 are necessary to initialize the terminal’s non-volatile memory for use with the ROM cartridge firmware. Failure to perform these steps may cause the terminal to report an NVR error.

## Overview

### 1.11 Comparison with previous VT Terminals

#### 1.11 Comparison with previous VT Terminals

The VT520 is functionally compatible with other ANSI products with the following exceptions:

- **Terminal ID**

The Primary Device Attributes can report additional extensions to cover new features. See Chapter 4 for a summary of the control functions. The Secondary Device Attributes are different.

```
VT520    CSI > 64 ; Pv ; 0 c  
VT525    CSI > 65 ; Pv ; 0 c
```

Where Pv is the firmware version number.

- **Dynamically Redefinable Character Set (DRCS) Fonts**

The VT520 has four buffers, which can load up to two dynamically redefinable character sets, each with an 80-column font and a 132-column font.

- **Keyboards**

VT420 keyboards cannot be used on the VT520; however, the VT520 can emulate the VT420 keyboard behavior when configured accordingly.

- **Four Sessions**

The VT520 is a multi-session terminal. You can have up to four sessions enabled. More than one session can be established on the same communication port.

- **PC Character Sets**

PC character sets are available in PC Term and SCO Console mode only.



This chapter describes VT520 Set-Up features. Set-Up is used to examine or change terminal operating features, such as transmit/receive speeds, type of cursor, or key definitions.

## 2.1 Entering Set-Up

You enter Set-Up by pressing the key designated as the Set-Up key. Pressing this key alternately places the terminal in Set-Up mode or returns it to the operating mode.

On a ...	The Set-Up key is ...
VT keyboard	<b>F3</b> on the top row.
SCO Console mode	<b>Caps Lock F3</b>
PC keyboard	<b>Caps Lock Print Screen</b> or <b>Alt Print Screen</b> .

Figure 2-1 Set-Up

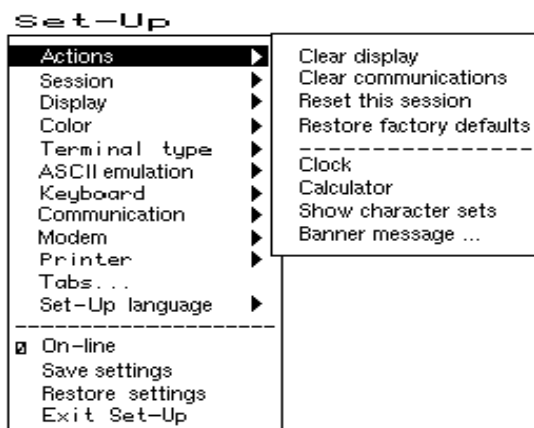

MA049193.GRA

The Set-Up display consists of pull-right menus. You can move back and forth with the arrow keys. Pressing **Enter**, **Return**, **Do**, or **Select** invokes the action or setting for the current menu item.

The Set-Up function may be reassigned to other key combinations or can be disabled it for local entry into Set-Up. When you press **F3** as the first key after the terminal is powered on, you always enter Set-Up, regardless of which keyboard you use or how **F3** is defined.

## Set-Up

### 2.1 Entering Set-Up

#### 2.1.1 Effects of Entering Set-Up

Placing the terminal in Set-Up mode causes no loss of data if a Flow Control protocol is in use on the communications port. The first Set-Up menu is displayed on the screen. Upon exiting Set-Up, the previous text is restored.

Entering Set-Up has the following side effects:

- Any compose sequence in progress is aborted and the keyboard is unlocked.
- A Set-Up Summary Line is displayed.
- Press **[Shift]** to show the Indicator Status Line.
- Printer operations are suspended and are resumed upon exiting Set-Up.

#### 2.1.2 Set-Up Languages

The VT520 Set-Up menus can be displayed in five languages using a Set-Up feature. A menu allows you to choose the language in which all subsequent Set-Up menus and displays are written. Selections from this Set-Up language menu (Figure 2-2) take effect immediately. This feature can also be invoked by DECSSL.

Figure 2-2 Set-Up Language Selection

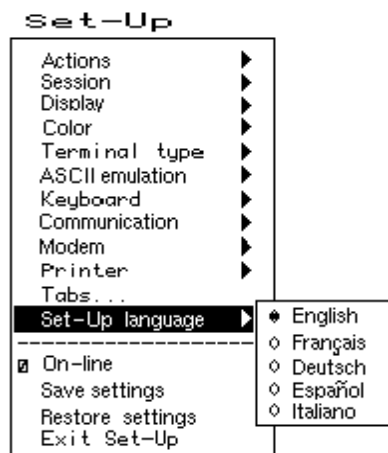

#### 2.1.3 Power-On Settings and Defaults

The VT520 terminal stores many of its feature settings in nonvolatile memory (NVM). Nonvolatile memory retains these settings even when power is shut off. In addition to storing operator-selected features, the terminal retains the factory default settings in permanent memory. By using Set-Up, you can modify individual terminal features, recall the feature settings stored in nonvolatile memory, or recall the factory default settings.

In this chapter, the defaults are shown with a solid bullet (●) in lists and in **boldface** in text.

### 2.1.4 Self-test Error Messages

At power-up, the VT520 terminal executes a series of self-tests, displays a message indicating whether the self-tests were successful, and displays a banner message. (To change the banner message, see Section 2.4.6.)

If the self-tests detect an error, one of the following messages is displayed on the terminal in place of "Selftest OK."

**Table 2–1 Error Messages**

Message	Meaning
NVR Error - 1	A firmware update, or loss of power while writing to the NVR during a <b>Save settings</b> process may cause this error. Try <b>Actions</b> ▸ <b>Recall factory defaults</b> followed by <b>Session</b> ▸ <b>Save settings for all</b> .
RS-232 Port Data Error - 2	Communications problem inside terminal. Call for service.
RS-232 Port Controls Error - 3	Communications problem inside terminal. Call for service.
DEC-423 Port Error - 5	Communications problem inside terminal. Call for service.
Parallel Port Error - 6	Communications problem inside terminal. Call for service.
ROM Cartridge Error - 7	Turn the terminal off, and make sure the ROM cartridge is seated firmly on its connector pins. Turn the terminal on. If the problem continues, try another ROM cartridge. If the new ROM cartridge does not work, the problem is inside the terminal; in which case, call for service.
Keyboard Error - 8	Turn the terminal off, and make sure the keyboard cable is plugged in. Turn the terminal on. If the problem continues, try another keyboard. If the new keyboard does not work, the problem is inside the terminal; in which case, call for service.

### 2.1.5 Context Sensitivity

On the screen, a check box  or radio button (●) indicates the current user selection and normally reflects the operating state of the terminal.

Certain feature selections overlap and could contradict each other, so they cannot be active at the same time. These are called *context sensitive* features, which are displayed with the dim video attribute in Set-Up. Example:

You cannot select *Comm3* as a printer port if it is selected as a communications port.

Table 2–2 lists the set-up features that are context sensitive.

## Set-Up

### 2.1 Entering Set-Up

Table 2–2 Context Sensitive Set-Up Features

	Menu Item	Dimmed when . . .
<b>Session</b> ▷	<b>Pages per session</b> Page memory allocation	Page selection exceed the number of unassigned pages available.
<b>Display</b> ▷	<b>Lines per screen</b> <b>Lines per page</b>	Sizes are not available based on the current page memory allocation. WYSE is selected; use <b>ASCII emulation</b> ▷ <b>Data lines</b> and <b>Pages</b> .
	<b>Cursor direction</b>	<b>Keyboard language</b> is not Hebrew.
	<b>Energy saver</b>	<b>CRT saver</b> = never is selected.
	<b>Overscan</b>	Terminal is a color terminal.
<b>Color</b> ▷	<b>ASCII color mode, Reverse and blank attributes, and Intensity attributes</b>	<b>Emulation mode</b> is set to other than an ASCII terminal emulation.
	<b>Alternate text colors...</b>	<b>Select color mode</b> is other than <b>Alternate color</b> .
	<b>Select color mode</b>	<b>Terminal type</b> ▷ <b>Emulation mode</b> is other than a VT or SCO console.
<b>Terminal type</b> ▷	<b>Terminal ID to host</b>	<b>Terminal type</b> ▷ <b>Emulation mode</b> is other than a VT or SCO console.
	<input type="checkbox"/> <b>7-bit NRCS characters</b>	<b>Emulation mode</b> is set to VT100/VT52; or <b>Communication</b> ▷ <b>Word size</b> is 7-bits; or no 8-bit NRC set exists for the keyboard language.
<b>ASCII emulation</b> ▷		<b>Terminal type</b> ▷ <b>Emulation mode</b> is set to VT or SCO console.
	<b>TVI page-flip</b>	<b>Terminal type</b> ▷ <b>Emulation mode</b> is other than TVI.
<b>Keyboard</b> ▷	<b>Key encoding</b> ▷ <b>Character, Scan code and Key position</b>	<b>ASCII emulation</b> is selected, or a PC keyboard is connected.
	<b>Data processing keys</b>	A PC keyboard is connected.
	<b>Map PC keyboard to VT</b>	The keyboard is not a PC keyboard.
<b>Communication</b> ▷	<b>Port select</b> Comm3	Comm3 is selected as a communications port. (It can be either a comm port or a printer port but not both.)
	<b>Half duplex</b>	The host <b>Communication</b> ▷ <b>Port select</b> is set to <b>S1=comm2</b> .
	<b>Transmit flow control</b> ▷ <b>DSR and Both</b>	The <b>Modem</b> ▷ <b>Enable modem control</b> is selected.
	<b>Receive flow control</b> ▷ <b>DTR and Both</b>	The <b>Modem</b> ▷ <b>Enable modem control</b> is selected.
<b>Modem</b> ▷	<b>Disconnect delay and Modem speed</b>	The <b>Modem</b> ▷ <b>Enable modem control</b> is not selected.
<b>Printer</b> ▷	<b>Serial print speed, 2-way communication, Transmit flow control, Receive flow control, Word size, Parity, and Stop bits</b>	The <b>Communication</b> ▷ <b>Port select</b> is set to one of the <b>Print = parallel</b> selections.
	<b>DEC/ISO char sets</b>	<b>IBM ProPrinter</b> is selected.
	<b>PC character sets</b>	<b>DEC ANSI</b> printer is selected.
	<b>Print mode</b> ▷ <b>Controller</b>	<b>Display</b> ▷ <b>Show control characters</b> is selected.

### 2.1.6 Set-Up Summary Line

The Set-Up Summary Line (Figure 2-3) shows the important set-up features that affect whether the terminal can successfully communicate with the host. If the terminal is not working, the Set-Up Summary Line allows you to quickly verify if the communication features are set appropriately. The summary line is displayed below the last data line, where the status line would normally appear.

**Figure 2-3 Set-Up Summary Line**

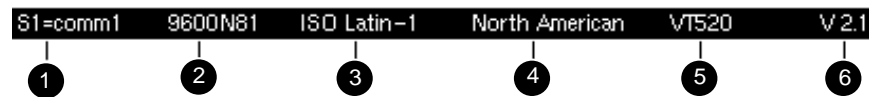

The Set-Up Summary Line contains the following set-up information extracted from the Set-Up displays.

Item	Information Displayed	Communication Feature
❶	S1=comm1	Port selected: comm1, comm2, or comm3
❷	9600 N 8 1	Transmit speed: 9600 baud Parity: N=none, E=even, O=odd, M=mark, S=space Word size: 7 or 8 bits Stop bits: 1 or 2 bits
❸	ISO Latin-1	Default character set or PC set in PCTerm mode
❹	North American	Keyboard language
❺	VT520	Emulation mode
❻	V2.1	Firmware version

The summary line is visible whenever the terminal is in Set-Up, except under the following conditions:

- You press a **[Shift]** key. Pressing either **[Shift]** key causes the normal Indicator Status Line to replace the Set-Up Summary Line.
- The Set-Up Summary line is temporarily replaced by an error or status message from the terminal. In this case, the error or status message is shown in place of the Set-Up Summary line until you type another key.

The Set-Up Summary Line appears in the currently selected set-up language.

### 2.1.7 Set-Up Status Messages

The Status or Set-Up Summary line is sometimes replaced by a Set-Up status message until the next user keystroke. Set-Up status messages are displayed whenever the effect of a set-up action would not otherwise be apparent. Example: "Done" is displayed after the Reset terminal action has completed.

The following are set-up status messages:

- Done
- NVR Error
- Incompatible settings not restored - check pages per session and lines per page

## Set-Up

### 2.1 Entering Set-Up

- Incompatible settings not restored - check comm port selection
- Page memory reallocated
- Sessions not enabled - No Session Management response from host
- Session # terminated abnormally
- Insufficient terminal resources to open Session
- Sessions not enabled - Unable to run with host Session Management version
- Session open request pending
- Session opened
- No response from host for Session Management
- Data overrun occurred on Session #
- Sessions not enabled - Sessions not selected
- Session # terminated normally
- Insufficient host resources to open Session
- Sessions disabled
- Sessions enabled - Restoring previous sessions

Set-Up functions that require additional time to process display the message "Please wait" until they have completed. **Save settings for all** and **Restore settings for all** display this message.

#### 2.1.8 Status Line

The VT520 terminal has a status display with the following features:

- The clock time appears on the status display if the local clock has been initialized since the terminal was last powered on.
- In the ASCII emulation modes, the host-writable status line becomes the WYSE Editing status line.
- When enabled, the Accessibility Aids feature ("sticky keys") displays icons in the Keyboard Indicator line. For details, see Section 8.11.2.

The VT520 Indicator status line includes the Active Position Indicator, Printer Status Indicator, Modem Status Indicator, and local clock time in the desired format. Example:

```
1(24,008) Printer: None Modem: DSR 3:15 PM
```

#### 2.1.9 Keyboard Indicator Line

The Keyboard Indicator Line has the following features:

- It is displayed in the Set-Up language.
- It has active keyboard layout. Nothing is displayed for Group 1. "G2" is displayed for Group 2, along with a small icon representing the right side of the top of the keycap. (To see this icon, press `Ctrl/Alt/F2`. To return from Group 2, press `Ctrl/Alt/F1`.)
- For Greek, Hebrew, and Russian, "G2" is replaced by "Grk", "Heb", and "Rus", respectively.

- Visible bell—This feature flashes a bell ringing font whenever a sound is generated.
- When the Num Lock state is active on an EPC keyboard, "Num Lock" is displayed.
- When an EPC keyboard is operating in VT style, "VT" is displayed in place of the Num Lock indicator.
- In French and Spanish, an icon replaces the word "Lock" on the indicator line.

Example:

```

Heb          Num Lock   Copy Hold Lock Compose Wait
  
```

## 2.2 Set-Up Screen Text

The main menu, shown in Figure 2–4, is the first menu displayed whenever you enter Set-Up. As the first menu, it holds the main directory of Set-Up features and those features which are commonly accessed and must be easy to find at all times. The Actions submenu is also displayed, since the Actions menu item is currently selected.



Unless stated otherwise, the following general descriptions apply:

- Changes to feature settings do not take effect until you exit Set-Up. Only net changes have an effect—a change to a new value and back to an old value has no effect.
- The setting choices for some features are shown in the corresponding Set-Up displays. Where all the choices could not be displayed, additional choices are listed immediately under the figure.

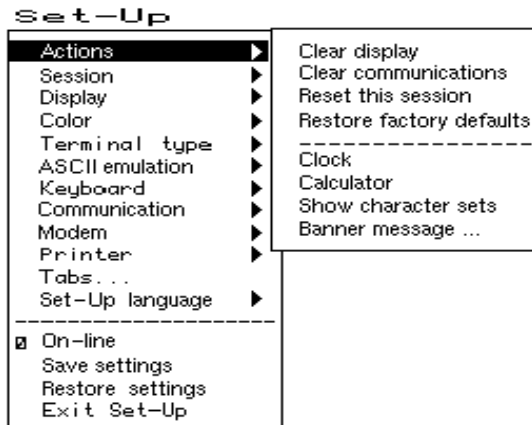
**Figure 2–4 Main and Terminal Actions Menu**



MA049193.GRA

Pressing  moves the cursor to the next item in the main menu. Pressing  moves the cursor right to the first item of the submenu, making it the active menu.

## Set-Up

### 2.3 Main Menu

## 2.3 Main Menu

The following descriptions refer to Figure 2–4.

The items above the dividing line in the main menu form a directory to the major functional areas of set-up features. Each item has a corresponding submenu or dialog box.

Pressing the Set-Up key from within a dialog box will flash the OK button as if it were pressed and accept the corresponding changes before exiting Set-Up.

Below the dividing line are features that need to be easy to find from any menu.

### 2.3.1 On-Line

The **On-line** feature allows you to select whether the terminal directs keyboard input to its host port UART to communicate with a remote host (On-Line), or directs keyboard input directly to the screen (receive character parser) without sending to a remote host (off-line or local).

---

#### Note

---

The **On-line** selection is different from the Local echo mode in the Communications Set-Up submenu. When **On-line** is disabled (local mode), nothing is sent to the host. Any keyboard input is directed to the receive character parser, which updates the screen.

In contrast, **Local echo** causes characters sent to the host port to also be directed back to the receive character parser, as if they had been received (echoed) from the host. Local echo is temporarily disabled when the terminal is in either Local mode or Local Controller mode, because keyboard input is already being redirected to the screen or printer port.

If an NVR error occurs during power-up, the terminal switches to Local mode.

---

Terminal reports, such as Answerback, DA, CPR, DECTSR, DECRPM, DECRPSS, DECAUPSS, DECCIR, DECTABSR and DSR, are not directed to the display. While in "local", host communications are put on "hold": All data received is buffered. If necessary, an XOFF is sent (or DTR is deasserted) to prevent buffer overflow. This buffered data is directed to the display when On-line mode is reentered. Note that the received character buffer (silo) is responsible for sending XON and XOFF when needed, not the On-line/Local state.

When in Local mode, modem signals, including DTR, are unaffected. No disconnect is performed. The functions of the printer port remain unchanged in Local mode. They function the same as in On-line mode.

When in Local mode and Printer To Host mode is selected, data from the printer port is displayed on the video terminal.

When both Local mode and Printer Controller mode are selected, the terminal is in Local Controller mode. Keyboard characters are sent to the printer port. Note that in "regular local" mode, any keyboard output is directed to the screen, but in "regular controller" mode, the keyboard output is directed at the host port. When Local Controller mode is exited to Local mode, the terminal redirects keyboard output from the printer to the screen (and parser). When you change from Local Controller mode to Printer Controller mode, the terminal transmits the characters accumulated in the receive silo to the printer.



### 2.3.2 Save Settings

The **Save settings** menu item, when invoked by pressing `[Return]` or `[Enter]`, causes the settings for most Set-Up controlled operating features to be saved in nonvolatile memory, where they become the power-on settings.

The following settings are not saved.

- **Keyboard encoding mode**
- **Application cursor keys** when set by a host control function.
- **Application keypad mode** when set by a host control function.

### 2.3.3 Restore Settings

**Restore settings** is an action field that is used to replace all saved Set-Up parameters with the values stored in the NVR. As a side effect, this feature performs a disconnect sequence, clears the screen, reinitializes the user-definable keys (as saved), clears the soft character set, returns the cursor to the upper left corner, aborts any print operation in progress, aborts ESC, CSI, and DCS sequences (and control strings), and shows "Done" on the status line. This action can also be invoked by the RIS control function.

### 2.3.4 Exit Set-Up

The **Exit Set-Up** menu item, when invoked by pressing `[Enter]`, causes the terminal to exit Set-Up. The effect is identical to pressing the Set-Up key while in Set-Up.

## 2.4 Actions Menu

The following descriptions refer to Figure 2-4. Certain Set-Up features instruct the terminal to perform an immediate action when they are invoked. These features are grouped in the terminal Actions menu.

### 2.4.1 Clear Display

The **Clear display** feature clears the active page (including the lines which have temporarily disappeared while the you are in Set-Up).

### 2.4.2 Clear Communications

This feature is used to clear communication buffers and flags. It does not affect the On-Line/Local state. It is not invoked by any control functions.

**Clear communications:**

- Aborts any print operation in progress
- Aborts any escape sequence, control sequence, control string, or character string processing (ESC, CSI, DCS, APC, OSC, PM, SOS)
- Clears the keyboard buffers
- Clears the receive silo
- Clears the transmit silo
- Takes the terminal out of Printer Controller mode
- Sends XON on to the host port
- Sends XON to the printer port if Printer To Host and XOFF are enabled

## Set-Up

### 2.4 Actions Menu

- Resets XOFF received flags on both ports
- Does not clear the screen
- Clears KAM locked condition
- Clears the "printer port has seen DSR since power up" flag. When in Set-Up, **Ctrl|Enter** disables sessions and clears TD/SMP.

#### 2.4.3 Reset this Session

The **Reset this session** menu selection only resets the active session.

To ...	Press ...
Reset all four sessions,	<b>Control</b> <b>Reset this session.</b>
Perform a power-up reset,	<b>Control</b> <b>Set-Up</b> from within Set-Up.

The **Reset this session** Set-Up feature resets the terminal to a "known state." This function is like Soft Terminal Reset (DECSTR), except DECSTR resets the Character Set mode to "8-bit Characters" and **Reset terminal** does not.

Additions:

- Keyboard encoding is reset to "character."
- PCTerm mode is not selected.

#### Note

From Set-Up, a soft reset using **Reset terminal** always works regardless of the terminal mode; but using mode changing control functions (DECSCS, S8C1T, S7C1T, DECANM), the soft reset is sometimes not performed.

#### 2.4.4 Restore Factory Defaults

The **Restore factory defaults** menu selection restores the factory default settings for all four sessions. There is no provision to restore factory defaults to a single session. Restore settings on the main menu only restores the active session's settings from NVM.

As a side effect, Restore factory defaults does the following:

- Performs a disconnect sequence
- Clears the screen
- Reinitializes the user-definable keys
- Clears the soft font
- Returns the cursor to upper-left corner
- Aborts print operations in progress
- Aborts ESC, CSI and DCS sequences
- Displays the "Done" message on the status line

### 2.4.5 Clock, Calculator, Show Character Sets

The **Clock**, **Calculator**, and **Show character sets** menu items are used to invoke the corresponding desktop productivity features. Refer to Chapter 3.

### 2.4.6 Banner Message

The **Banner message** menu item invokes a dialog box with a 30-character limit. When this feature is selected, a dialog box is displayed with a reverse video text entry area 30 characters long. If a **Banner message** is currently defined, the message is displayed in the text entry area. The **<X|** or **Delete** key can then be used to delete backwards and enter a new **Banner message**.

All characters that can be generated by the keyboard are legal in this field (including primary and secondary keyboard language characters). As such, no errors are reported, except when trying to enter more than 30 characters. In this case, the bell rings (if enabled), and no more characters are accepted. The factory default message is no message at all (a blank field).

From the **Actions** menu, select **Banner message...**

1. Press **Return** or **Enter** to display a dialog box.
2. Enter your banner message.
3. Press the **↓** to select **OK** button.
4. Press **Return** or **Enter** to return to the Set-Up menu.
5. Use the **Save settings** menu item to save the Banner message.

## 2.5 Multiple Sessions

Multiple sessions extends the VT520 to act like four terminals in one. A *session* is an active connection between the terminal and a host system. The Session Set-Up menu controls the use of more than one session. See Figure 2–18.

The VT520 supports up to four sessions using virtual terminals. Each virtual terminal maintains the full keyboard and display state of a real physical terminal but shares a single keyboard and display with other virtual terminals. Before you can login using a virtual terminal, it must be connected to a host computer.

VT520 session virtual terminals can be connected directly to a host computer through any of the three serial communication ports on the back of the terminal. Since there are only three comm ports, this method alone can only support three sessions.

To use a fourth session or reduce the number of serial comm lines needed, more than one session must be connected through a single comm port. The VT520 allows this using a session management protocol, called TD/SMP (Terminal Device/Session Management Protocol). TD/SMP allows two or more sessions to share a single comm line, as long as the other end of the comm line supports the protocol. To enable TD/SMP at the terminal, you simply assign more than one session virtual terminal to the same comm port in Set-Up.

TD/SMP is standard on most terminal servers. If you are using a terminal server, check with its documentation to determine if it can run TD/SMP.

## Set-Up

### 2.5 Multiple Sessions

#### 2.5.1 Enabling and Controlling the Session Configuration

The VT520 provides three serial communication ports which may be assigned to session virtual terminals in any combination. When only one virtual terminal is assigned to a communications port, the terminal functions as a single session terminal. The other three session selections are dimmed. The single session may be allocated 8 pages of 25 lines each by 80 or 132 columns. The color terminal supports 9 pages.

As session virtual terminals are assigned to physical communication ports, the terminal's firmware allocates the necessary structures to create the virtual terminals up to a maximum of four. When more than one virtual terminal is assigned to a single communication port, the Terminal Device/Session Management Protocol (TD/SMP) is used.

#### 2.5.2 Multiple Sessions using a Terminal Server with TD/SMP

**Procedure:**

1. At the Local> prompt, enter the following command:

```
Local> set port multi enable 
```

2. Continue with your login procedure.

To permanently set a terminal server port to use TD/SMP, you would type:

```
Local> define port multi enable 
```

#### 2.5.3 Multiple Sessions using SSU Host Software

If your VT520 is connected directly to a host computer without a terminal server, use can still use TD/SMP by running the Session Support Utility (SSU) on your host computer. On a system that has SSU software, such as OSF or OpenVMS, open the first session as follows:

```
$ mcr ssu 
```

On an UNIX-style system, open the first using:

```
% ssu
```

#### 2.5.4 Opening Another Session

Once TD/SMP is enabled, you can open a new session and switch between them as follows:

1. Press the  (Session) key on a VT keyboard; or press   on the numeric keypad on a PC keyboard.

F4 is used as the Session key on the VT keyboard (factory default). For consistency,   also works on the VT keyboard.

On Enhanced PC layout keyboards (PC style),   or   are used as the Session keystroke and may be substituted for the VT Session key (F4) anywhere it is used.

2. To go directly to a particular session, press  , ,  or  on the numeric keypad.

The currently selected session is indicated on the Set-Up Summary line along with its corresponding communications port assignment (S1=comm1 for example).

### 2.5.5 Restoring an Interrupted Session

When a session is interrupted, the VT520 or the host system may lose the context of the current session. After the terminal and system regain communication, you can restore the context of the interrupted session without canceling the session and starting over again.

To restore a session, press the **F4** key; or press **[Caps Lock] 0** on the numeric keypad. Or you can enter Set-Up **Communications** ▸ **Port Select** and assign the session to a comm port.

### 2.5.6 Session Management

Assigning more than one session virtual terminal to a single comm port automatically allows session management.

Reducing the number of session virtual terminals assigned to a single comm port from two to one automatically disables session management if it was enabled.

When **Display** ▸ **Framed windows** is selected in Set-Up, you can assign a name for each session up to 30 characters for the window title. The first 12 characters become the default icon name, which you can change in Set-Up.

## 2.6 Session Menu

The Session Set-Up (Figure 2-5) controls the use of the more than one session.

Figure 2-5 Session Menu

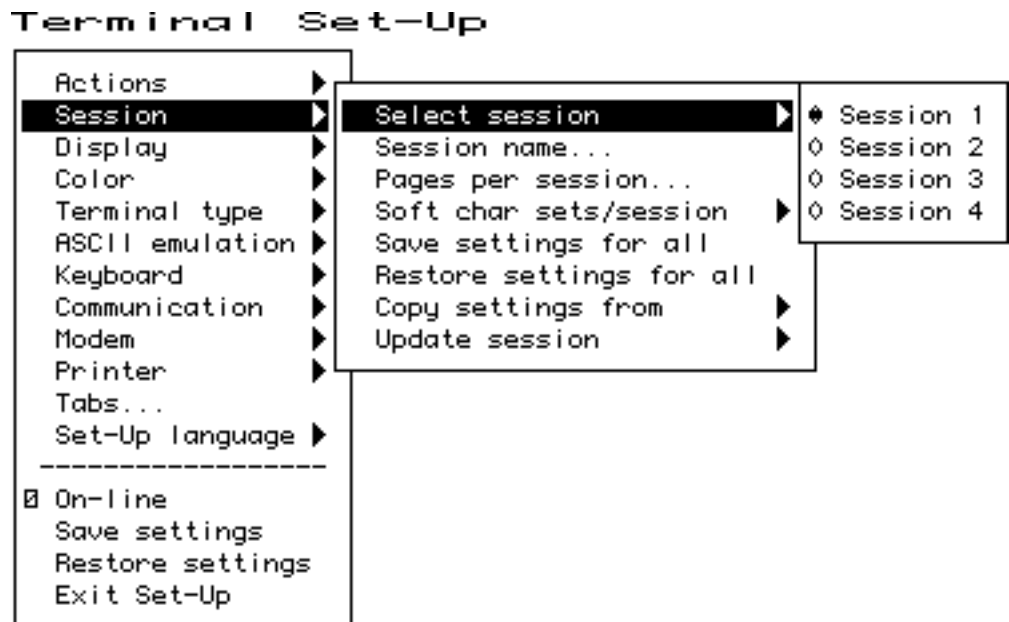

On a VT keyboard, **F4** is used as the Session key (factory default). On a PC keyboard, **[CapsLock] 0 kpd** is used as the Session keystroke and may be substituted in this text for VT Session key (F4) anywhere it is used. For consistency, **[CapsLock] 0 kpd** also works on the VT keyboard.

## Set-Up

### 2.6 Session Menu

#### 2.6.1 Select Session

The **Select session** submenu is used to select the active session. All Set-Up selections apply to the currently active session. Most settings are kept independently for each session and may be saved in non-volatile memory. Exceptions are made for settings that control the physical hardware that is shared between sessions. Example:

A single communications port cannot be used for both a session connection and a printer port simultaneously.

The terminal ensures that conflicts like this do not happen by disabling (displaying as dim) or resetting certain selections. All such exceptions are noted explicitly.

A disabled session has its session selection dimmed but can still be configured in Set-Up if it was active when Set-Up was entered. At least one session is always enabled. If the currently active session is disabled, the previous enabled session becomes the active session when you exit Set-Up.

While the terminal is in Set-Up, the Session key can be used to cycle between sessions in order. You can also use `[CapsLock] 1 kpd` through `[CapsLock] 4 kpd` to select enabled sessions explicitly. The currently selected session is indicated on the Set-Up Summary line along with its corresponding communications port assignment (S1=comm1 for example).

Selecting a different session within Set-Up does not affect the active session at the host until you exit Set-Up.

#### 2.6.2 Session Name

The **Enter session name** dialog box allows a 30 character descriptive name to be entered for the active session. Depending on the windowing option selected, this name is displayed with the corresponding session window to help you identify each session. See also Section 2.8.19.

Entering a session name is similar to entering an answerback message. A session name is not saved automatically; you must use the **Save settings** menu item.

**Icon name** — The first 12 characters of the session name is used as the icon name, but this name may be overwritten if a separate icon name is specified by a host control function. The session name is included as the "application\_parameter" in the TD/SMP OPEN\_SESSION command and may be used to select a desired service.

#### 2.6.3 Pages per Session

The **Pages per session** dialog box displays a Session Page Memory Allocation screen (Figure 2-6), which allows you to control how the terminal's page memory is allocated among the enabled sessions. The VT520 provides 8 pages of 25 lines by 80 or 132 columns as standard (9 pages on the color terminal). A disabled session (Comm = session off) is dimmed and does not use any page memory.

Page selections which are not available in the current configuration are dimmed and cannot be selected. Thus, you may have to decrease the number of pages assigned to one session before you can increase the number of pages assigned to another. Any data on these pages is erased.

Figure 2-6 Session Page Memory Allocation

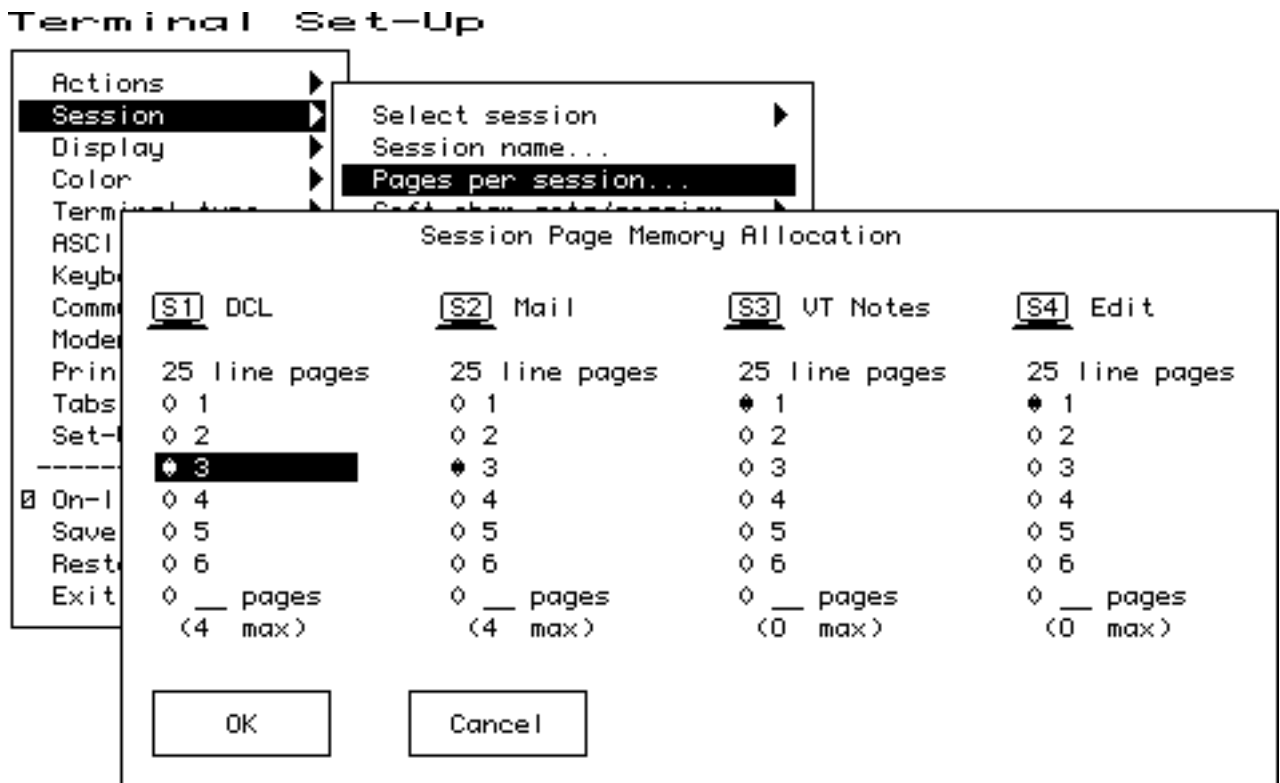

The “0 \_\_pages” selections in Figure 2-6 allow you to enter a number of pages not shown as one of the other choices. The number in parenthesis below these selections is maximum number of pages available to each session. When you select this radio button, this maximum number is used as the number of pages for this session unless you enter a new value. Pressing Enter selects the radio button and maximum number of pages in a single operation. Alternatively, any number up to the maximum number of pages available can be typed in directly.

The maximum number of pages available to each session change as the allocation to other sessions changes. If only one session is enabled, the maximum number of pages in a standard VT520 is 8.

A session that is currently disabled (Comm = session off) is dimmed and shows Max pages as zero to remind you that it is not using any page memory. (Zero is the factory default for S3 and S4.) A disabled session can be re-enabled at any time by assigning it to a communications port. When a disabled session is re-enabled, its initial page memory allocation is the previous allocation for that session if available from the free resource pool; otherwise, it is one page of 25 lines. If all pages are currently assigned, the terminal reduces by one the allocation to the highest numbered session with more than one page. This automatic adjustment of page allocation ensures that you can always enable another session without worrying about memory management. If a session requires a fixed number of pages for compatibility, you can assign that number to S1 and S2. We recommend that you allocate page memory for the number of sessions to be used ahead of time to avoid losing data in an existing session when creating a new one.

## Set-Up

### 2.6 Session Menu

In case you cause the terminal to re-assign page memory while sessions are in use, the pages assigned to a new session is first erased. If the cursor was on that page, it goes to page one. The terminal issues a warning message to indicate what may have changed for you to check, such as:

"Page memory reallocated, check pages per session and lines per page."	The terminal created a new session forcing page memory to be re-allocated.
"Incompatible settings not restored, check pages per session and lines per page."	The terminal is unable to copy or restore a requested setting.

#### 2.6.4 Soft Character Sets/Session

The **Soft char sets/session** submenu allows you to specify the allocation of DRCS character set buffers to multiple sessions on the VT520 mono terminal only.

- **Two each S1 and S2** allocates two character set buffers each to S1 and S2 making S1 and S2 compatible with terminals, like the VT510, VGB10, or WS510 video terminals. In this case, S3 and S4 do not support the DRCS extension, which is reported in their primary device attributes response.
- **One each** gives each session a single DRCS character set buffer making each session compatible with terminals, like the VT420.

This submenu is not included in the color terminal since it has enough memory to give all four sessions **Two each**.

#### 2.6.5 Save Settings for All and Restore Settings for All

The **Save settings for all** and **Restore settings for all** menu items are like the Save settings and Restore settings items in the main menu except that they operate on all four sessions at once.

Since restoring settings for four sessions can take some time, the screen is cleared and a "Please wait" message is displayed in the center of the screen for one second to begin the restore operation. A "Done" or "Incompatible setting not restored" message is displayed upon completion.

When restoring settings saved in non-volatile memory, it is possible that the number of pages saved for a session is larger than the number of pages available in the free resource pool. In this case, the same approach is used as when a session is newly enabled. The process can be summarized as follows:

1. When restoring settings for more than one session, settings for each session are restored in order (S1, S2, S3, S4).
2. The saved page memory allocation is restored if that number of pages is available from the free resource pool, otherwise the page memory allocation is set to one page of 25 lines.
3. If no pages are available from the free resource pool, the terminal reduces by one the allocation to the highest numbered session with more than one page.
4. If a previously saved setting is not restored, the terminal displays the information message "Incompatible setting not restored, check pages per session and lines per page" on the error line. The message is cleared on the next keystroke.



The principle used is to restore all the settings possible, replace those individual settings that can't be restored with some reasonable default, and display the information message "Incompatible setting not restored..." if necessary. This same principle is used in all cases where settings cannot be copied or restored due to resource limitations or conflicts with other settings.

The active session number is not saved in NVM. Restore settings for all does not change the active session.

### 2.6.6 Copy Settings from Menu

The **Copy settings from** menu allows you to copy settings from another session to the current one. The currently active or in-use settings are copied so it is not necessary to save settings in one session before copying them to another.

The communications port selection and print port selection are not copied. The VT520 conceptual model is four terminals sitting on your desk. Copying settings from one terminal to another does not transfer the communication cables. Copying settings to a disabled session does not automatically enable it since the "Comm = session off" setting is not changed.

The session name if any is not copied. Since the conceptual model is four terminals, copying settings does not copy the label on each terminal. The page memory allocation is copied unless there are not sufficient pages available in the free resource pool. In this case, the page memory allocation remains unchanged, and the information message "Incompatible settings not restored, check pages per session and lines per page" is displayed.

### 2.6.7 Update Session

The **Update session** menu controls how a session is updated when it is not the active session.

- **Only when active** prevents the session from being updated unless it is the active session.
- **When available** allows the page memory of this session to be updated when the VT520 is not otherwise busy with the active session (factory default).
- **At regular intervals** ensures that the page memory of this session is updated on a regular basis. Updating an inactive session at regular intervals slows down the active session as necessary.

---

#### Note

---

Increasing the number of sessions assigned to a communication port from 1 to 2 causes the terminal to send the TD/SMP ENABLE\_SESSIONS command. Conversely reducing the number of sessions from 2 to 1 sends a TD/SMP DISABLE\_SESSIONS command. Pressing Control while selecting "Clear comm" in Set-Up also sends DISABLE\_SESSIONS.

---

## Set-Up

### 2.7 Resetting and Restoring Defaults

## 2.7 Resetting and Restoring Defaults

### 2.7.1 Reset Session

The **Reset this session** menu selection only resets the active session. To reset all four sessions, press the Control key while you select Reset this session. Pressing Control/Set- Up from within Set-Up initiates a power-up reset.

### 2.7.2 Restore Factory Defaults

The **Restore factory defaults** menu selection restores the factory default settings for all four sessions. There is no provision to restore factory defaults to a single session. Restore settings on the main menu only restores the active session's settings from NVM.

## 2.8 Display Menu

Many of the features in the Display menu can be controlled by the host control functions listed in Table 2–3. The control functions listed by function in Chapter 4 and are described fully in Chapter 5.

**Table 2–3 Display Set-Up Features and Control Functions**

Display Set-Up Feature	Factory Default	Host Control Code
Lines per screen	24, 25 or 26	DECSNLS
<input type="checkbox"/> Auto resize		DECARSM
Lines per page	24 lines x 3 pages	DECSLPP
<input type="checkbox"/> Review previous lines		-
Columns per page	80 Columns	DECCOLM
<input checked="" type="checkbox"/> Clear on change		DECNCSM
Status display	Local status	DECSSDT
Scrolling mode	Jump	DECSCLM DECSSCLS
Screen background	Dark	DECSCNM
Cursor display	Block	DECSCUSR
<input checked="" type="checkbox"/> Blink		-
<input checked="" type="checkbox"/> Enable cursor		DECTCEM
Cursor coupling		-
<input checked="" type="checkbox"/> Vertical coupling		DECVCCM
<input checked="" type="checkbox"/> Page coupling		DECPCCM
Cursor direction	Left to right	DECRLM
Copy direction	Left to right	DECRLCM
Zero	0	DECSZS
<input type="checkbox"/> Auto wrap		DECAWM
<input type="checkbox"/> New line mode		LNLM
<input type="checkbox"/> Lock user preferences		-
<input type="checkbox"/> Show control characters		CRM
CRT saver	15 minutes	DECCRTSM
<input checked="" type="checkbox"/> Host wake-up		-
Energy saver	15 minutes	DECEST
<input type="checkbox"/> Overscan		DECOSCNM (mono model only)
<input type="checkbox"/> Framed windows		-
Screen alignment...		DECALN

## Set-Up

### 2.8 Display Menu

#### 2.8.1 Lines per Screen

This menu chooses a font that enables the selected number of lines to be viewed. Note that you cannot view more lines than the number of lines on a page (**Lines per page**).

If the **Status display** is enabled, it is displayed using one of the same **Lines per screen** as the text for the corresponding session.

This is an operator preference feature and cannot be changed by control functions if the operator preference is set to **Lock user preferences**; however, if **Auto resize** is enabled at the same time, then the number of **Lines per screen** changes when the page size changes.

This feature can be changed from the host using the DECSNLS control function. Or, it may be changed indirectly from the host if **Auto resize** is selected and the page configuration is changed using DECSLPP.

##### 2.8.1.1 Auto Resize

When **Auto resize** is enabled, the number of lines per screen changes automatically each time the page arrangement changes, either by the host or through Set-Up. Table 2-4 shows how the screen size changes whenever the page size changes when Auto Resize is set.

Table 2-4 Lines per Page vs. Lines per Screen When Auto Resize is Set

Lines per Page	Lines per Screen
24	26
25	26
36	43
42	43
43	43
48	52
52	52
72	52

If **Auto resize** is enabled in Display Set-Up, switching to two windows will set **lines per screen** to 48 and switching to one window will set **lines per screen** to correspond with the most recent lines per page setting, as if DECSLPP had been received. This applies to all sessions with auto-resize enabled.

#### 2.8.2 Lines per Page

This menu allows you to select the page size in lines and number of pages. The page size determines the addressing range for cursor positioning and scroll regions. The number of lines that can be displayed depends on the current setting of the **Lines per screen** feature.

Lines per page sizes not available based on the current page memory allocation are dimmed. If the page memory allocation is changed such that the currently selected number of lines per page is not available, the factory default page size is used (24 lines per page for the VT emulations).

When the **Review previous lines** feature is selected, the **Lines per page** selections show the corresponding number of lines by only one page (Figure 2-7).

Figure 2-7 Lines per Page

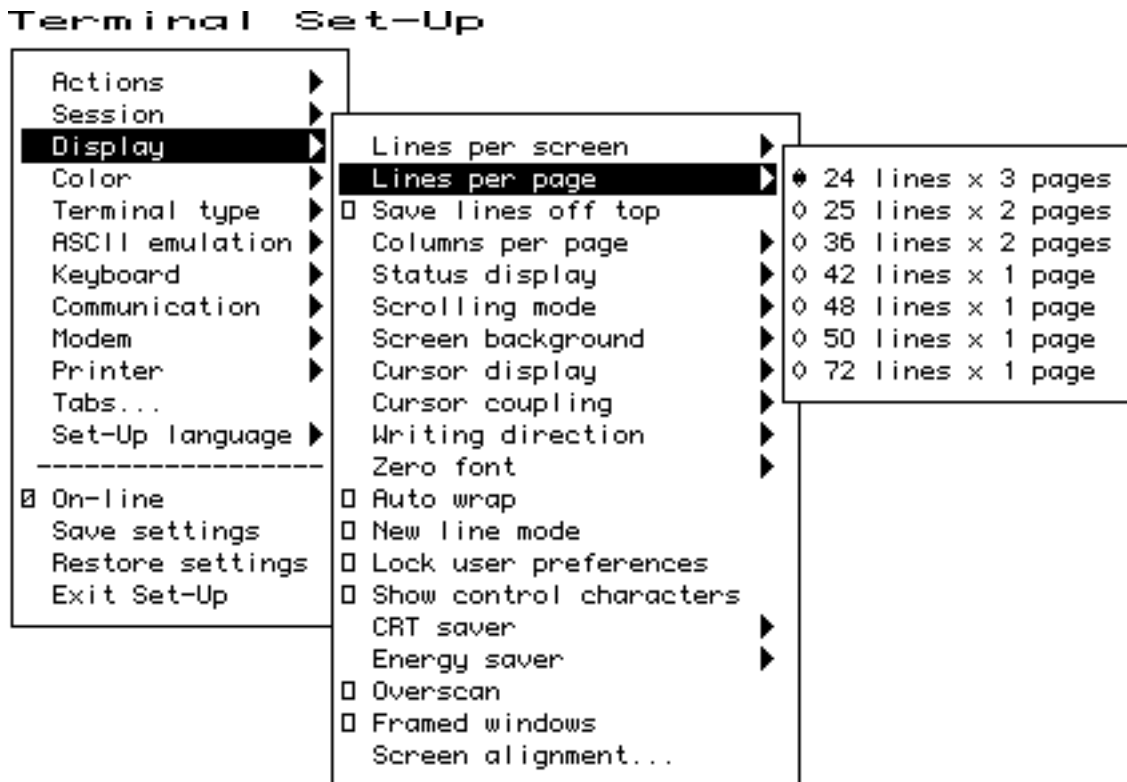

This field is also invoked by the DECSLPP control function.

### 2.8.3 Review Previous Lines Buffer

The **Review previous lines** feature when selected re-arranges page memory into a single page and a scroll back buffer (transcript). Lines of text scrolled up from the first line of the page are saved in the scroll back buffer (replacing the oldest lines saved if any). Pressing Control with the up or down arrow keys pans the screen window up or down allowing you to view lines previously scrolled off the top of the page up to the number of lines saved in the scroll back buffer. If the page size is larger than the window size, pressing Control with the up arrow key first pans to the top of the page and then pans into the scroll back buffer.

Any time lines in the scroll back buffer are available, a small down and/or up arrow appears at the lower right position of the status line to indicate there are additional unseen lines of the page below or above. When any text is received from the host for this session, the screen window is automatically repositioned to show the single page before the display is updated. Switching sessions does not automatically reposition the screen allowing you to view the scroll back data in one window while working in another. The number of lines that can be saved in the scroll back buffer is one page less than the total number of lines (in 25 line pages) allocated to the session virtual terminal. The factory default for Review previous lines is *disabled*.

You cannot copy and paste from the scroll back buffer.

## Set-Up

### 2.8 Display Menu

#### 2.8.4 Columns per Page, Clear on Change

This menu allows you to select an 80- or 132-column display for text. If **Clear on change** is disabled, changing this feature does not clear page memory, except when changing from 132 columns to 80 columns; then, columns 81 through 132 of each page are cleared. Changes to this field take effect immediately.

This field is also invoked by the DECSCPP and DECCOLM control functions. The **Clear on change** feature affects the behavior of the DECCOLM sequence or 80/132 column mode setting only. *It does not erase page memory.* The factory default is "clear on change" for backward compatibility with previous terminals.

#### 2.8.5 Status Display

The **Status display** can be enabled in the following selections:

- Local status
- Host writable or editing
- None

#### 2.8.6 Scrolling Mode

The **Scrolling mode** menu allows you to select how fast lines appear on the screen.

Scroll Selection	Scroll Rate
<b>Slow smooth</b>	Smooth steady scroll at approximately 9 lines per second (two scan lines per frame time).
Fast smooth	Smooth scrolls at approximately 18 lines per second.
Jump	Displays new lines as fast as they are received, causing a jump scroll on the screen.

This is a user-preference feature. If **Lock user preferences** is set, then this field is not invoked by any control functions.

#### 2.8.7 Screen Background

The **Screen background** can be either dark or light, with **dark** as the default.

#### 2.8.8 Cursor Display

The **Cursor display** can be enabled in the following selections:

- Block
- Underline
- ▯ Blink
- ▯ Enable cursor

#### 2.8.9 Cursor Coupling

**Cursor coupling** can be **Vertical** and/or Page coupling selectable from a single submenu.

### Vertical Coupling

Vertical coupling selects whether the user window automatically pans to follow the cursor when the cursor is moved vertically to a part of the page that is not in the currently displayed user window. Panning does not occur until the input buffer becomes empty and the cursor is displayed.

When **Vertical coupling** is disabled, the user window does not follow the cursor. If the cursor moves above or below the visible portion of the page, the cursor is no longer visible.

### Page Coupling

**Page** coupling selects whether the user window automatically follows the cursor when the cursor is moved to a page that is not currently in the user window. When page coupling is enabled, moving the cursor to a page that is not currently displayed causes that page to be displayed. Panning does not occur until the input buffer becomes empty and the cursor is displayed.

When **Page** coupling is disabled, the user window does not follow the cursor. If the cursor moves to a page that is not currently displayed, the cursor is no longer visible.

## 2.8.10 Writing Direction

The **Writing direction** and copy direction defaults are **left to right**. If a Hebrew keyboard is connected to the terminal, a selection is available for advancing or copying right to left.

The writing direction and the copy direction should be matched.

## 2.8.11 Zero

A **Zero** feature allows you to select the style of the zero character: oval, zero with a slash, or zero with a dot.

## 2.8.12 Auto Wrap

**Auto wrap** selects where a received character is displayed when the cursor is at the right margin.

This is not a user-preference feature, so you cannot lock this feature.

This field can be invoked by the DECAWM control function. The **Auto wrap** setting can be saved in NVM.

## 2.8.13 New Line Mode

When enabled, **New line mode** selects the characters transmitted by Return, CR, or CR+LF. It also determines the action taken by the terminal when receiving line feed, form feed, and vertical tab, LF, or CR+LF.

**New line mode** is not a user-preference feature, so you cannot lock it. This feature can be invoked by the DECNLM (SM/RM) control function.

## 2.8.14 Lock User Preferences

The **Lock user preferences** feature allows you to prevent the host from modifying user-preference features. If set to lock, the user-preference features cannot be changed by host control functions.

The following user-preference features are locked and unlocked by this feature and when locked, cannot be changed by control functions:

- Auto repeat

## Set-Up

### 2.8 Display Menu

- Scrolling mode
- Screen background
- Tab stops
- Keyboard definitions
- Lines per screen
- Auto resize
- Overscan

#### 2.8.15 Show Control Characters

**Show control characters** allows you to select a normal display or a display called Control Representation mode or CRM. This "monitor and show all" display includes graphic representation of control characters,

When **Show control characters** is enabled, special CRM symbols are used for the C0 and C1 control areas of ISO 2022 conforming character sets. Other characters are displayed using the current user preference supplemental set (DEC default character set).

#### 2.8.16 CRT Saver

If the **CRT saver** feature is enabled the screen goes blank after the specified interval of no keyboard activity or receive character activity. This feature is intended to prevent phosphor aging and prolong the useful life of the CRT. When the CRT saver is active, the monitor goes into *stand by mode*.

Any keystroke instantly restores the display to show its previous contents.

If **Host wake-up** is enabled, any character received from the host also restores the display.

The factory default setting is **CRT saver** enabled.

If **CRT saver = Never** is selected, the Energy saver is dimmed and not available.

Monitor Mode	VT520 Terminal	Color Terminal
On	Normal operation	Normal operation
Stand by	Screen saver (~4 W)	Video blank, no horizontal sync
Suspend	Energy saver (<15 W)	Video blank, no vertical sync
Off	Same as Suspend	Video blank, no sync

#### 2.8.17 Energy Saver

The **Energy saver** feature switches the monitor to **suspend mode** after the specified interval of CRT saver active. Monitor suspend mode blanks the screen like CRT saver but also switches off the synchronization and deflection circuits of the monitor significantly reducing the terminal's power consumption. A keystroke may take several seconds to restore the display from suspend mode.

On the color model, **Energy saver** switches the monitor to **off mode** after 30 minutes in suspend mode. The monitor off mode is like suspend mode but also turns off the CRT cathode (heater) further reducing power consumption. From the monitor off mode, it can take 15 to 30 seconds to restore the display upon



detecting a keystroke. The color model follows the VESA convention for driving Energy Star<sup>1</sup> compliant PC monitors.

Received characters power the monitor back on from the Energy saver suspend or monitor off state only if CRT Saver **Host wake-up** is selected. Otherwise it is necessary to press a key to power the monitor back on.

#### 2.8.17.1 Warning Bell

The terminal's warning bell still operates normally in all energy saver states. Many host systems ring the warning bell to indicate new mail has arrived or to draw attention to an important system message. Upon hearing the bell, press any key to see the corresponding host message.

**Energy saver = Never** allows power to continue to be supplied to the monitor.

#### 2.8.18 Overscan

**Overscan** can be enabled for the monochrome VT520. It is dimmed and not available for the color model.

#### 2.8.19 Framed Windows

When the **Framed windows** check box is selected in the Display menu, window frames with title bars are added to each displayed window. The VT520 has a flip screen and a two-window style with adjustable split. Window frames with titles and icons help you keep track of up to four sessions.

On the mono VT520, the Framed windows check box controls whether session windows are displayed with title bars and session icons.

802 × 480 no overscan, or  
800 × 432 with optional overscan.

When Framed windows is selected, the overscan check box is dimmed. Framed windows is the factory default.

On the color terminal, only the 802 x 480 no overscan format is available. The Framed windows check box controls whether session windows are displayed with title bars and session icons (802 x 480 no overscan), or the window frame and icon scan lines are left blank. There is no overscan selection on the color terminal.

When the Framed windows check box is selected in the Display menu, window frames with title bars are added to each displayed window. The title bar shows the previously entered session name if any and is highlighted (filled in) when the session is active. A row of icons is presented across the top of the screen to help you to keep track of the other sessions.

An icon is displayed for each session in the cycle order followed by the icon name which consists of the first 12 characters of the session name unless overwritten by host control function. The icon for the active session is displayed with the reverse video attribute. If the page memory of a session that is not currently visible is updated so that it contains new data which has not yet been seen, the corresponding session icon is displayed with the blink video attribute until the session is made active.

---

<sup>1</sup> The Energy Star emblem does not represent EPA endorsement of any product or service.

## Set-Up

### 2.8 Display Menu

When one session window is displayed, pressing the Session key alone cycles the active session in forward sequence by session number (S1, S2, S3, S4, S1,...). Pressing Shift/Session cycles the active session in reverse sequence by session number (S4, S3, S2, S1, S4,...). A session that is not assigned to a comm port (communications port select "Comm = session off") is omitted from the cycle order.

Control Session (F4) toggles the display between one window or two windows (Figure 2-8).

Figure 2-8 Framed Windows

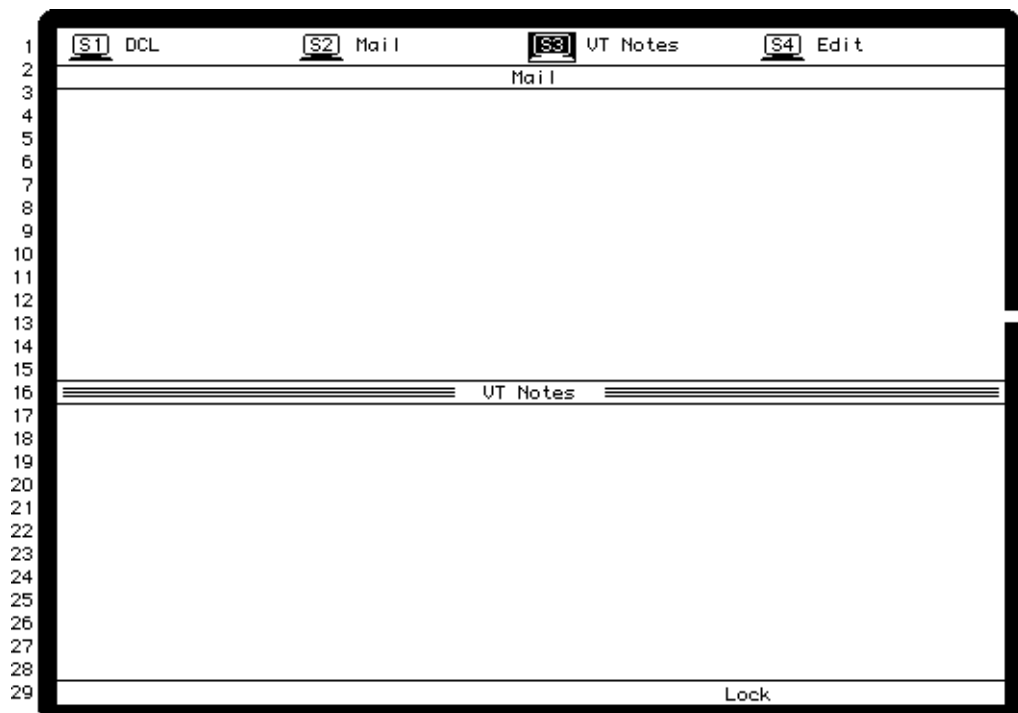

A maximum of two of the possible four session windows can be displayed at a time. One of these must be the active session. When switching to two windows, the active session is displayed on top. When two windows are displayed, pressing the session key toggles the active session between the two sessions displayed. To activate a session not currently displayed, you can use `CapsLock 1 kpd` through `CapsLock 4 kpd` to select the corresponding session 1 through 4 making it active. If the new active session's window was not previously visible, it replaces the previously active session's window. Alternatively, you can select any session through the Set-Up Session submenu. *Note: CapsLock/F1 is a synonym for F11 on the PC keyboards.*

When two windows are displayed, the relative size of each window is adjustable by pressing Control and Shift with the up or down arrow keys to move the border between the windows up or down.

You cannot display the same session in both windows at the same time. Activating a session already displayed makes it the active session. If **auto-resize** is enabled in Display Set-Up, switching to two windows will set **lines per screen** to 48, and switching to one window will set **lines per screen** to correspond with the most recent lines per page setting as if DECSLPP had been received. This applies to all sessions with auto-resize enabled.

## 2.8.20 Screen Alignment

### Screen Alignment on the VT520 Monitor

The **Screen alignment** menu item is used to invoke a screen alignment display (Figure 2-9) for the monochrome monitor only. With the screen alignment display, you can:

- Center the border using **Shift** and arrow keys.
- Rotate the border using **Ctrl**← and **Ctrl**→.

Screen rotation compensates for any magnetic field in the area.

Figure 2-9 Screen Alignment Display

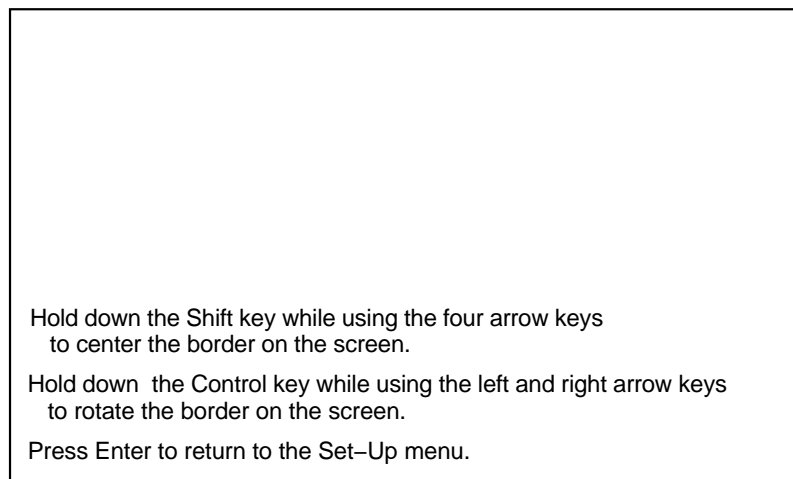

MA-0022-93.GRA

### Screen Alignment on the VT525 Color Monitor

For VT525 color monitors, **Display** ▸ **screen alignment** . . . displays gray scale bars and color bars for the monitor alignment.

1. Press **Enter** to display the gray scale bars.
2. Press **Enter** again to display the color bars.

## Set-Up

### 2.9 Color Set-Up

## 2.9 Color Set-Up

The **Color** Set-Up allows you to control the use of color by the terminal.

The **ASCII color mode**, **Reverse and blank attributes**, and **Intensity attributes** are only available in ASCII terminal emulation modes.

**Select color mode** is only available in the non-ASCII terminal emulation modes besides SCO Console mode which always uses ANSI SGR color.

**Alternate text colors...** is only available when **Select color mode = Alternate color**.

Figure 2-10 Color Set-Up Menu

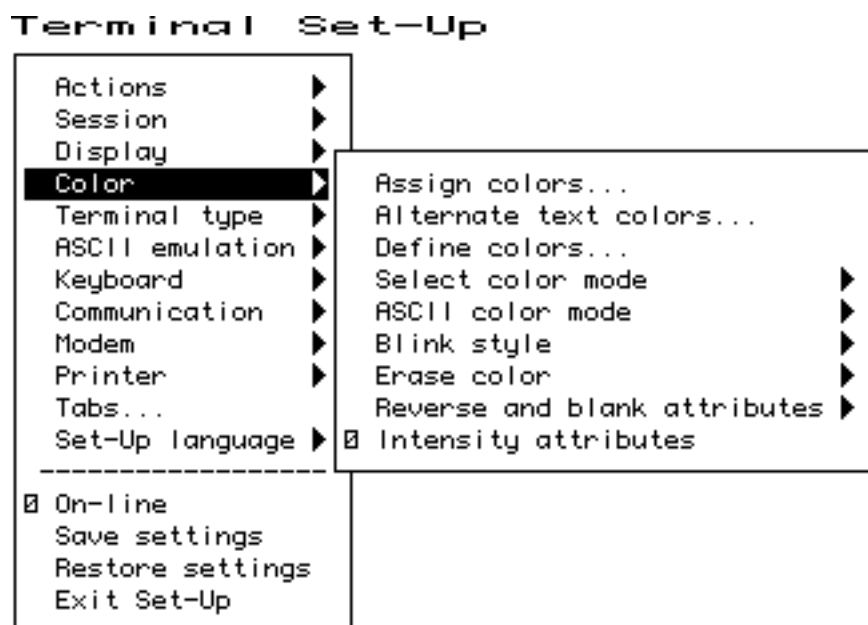

### 2.9.1 Assign Colors

The **Assign colors** dialog box allows you to select normal display colors for text and windowing features. As the slider moves to select a color within the select color box, the corresponding item is displayed using that color. Changing the normal text background only re-writes the "Normal text" caption. It does not otherwise affect the color of text already displayed.

Figure 2-11 Assign Colors

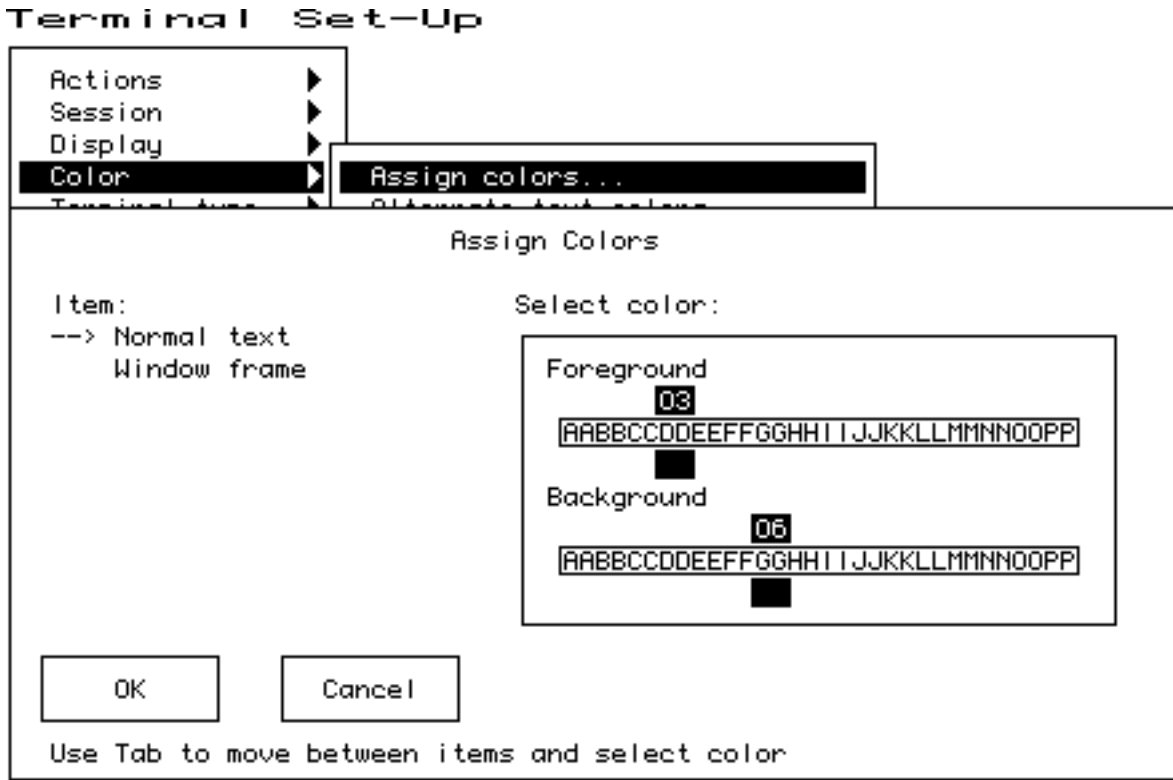

The normal text background and foreground selections determine the writing color used when all SGR attributes are turned off. The other ANSI color SGR attributes are "hard wired" to corresponding color indexes. Each session maintains its own color assignments for normal text and other data within its window.

The window frame colors are global affecting all session windows and icons. The window frame includes the title bar and adjacent separator lines, the sides, and the bottom separator line.

The session icons and keyboard indicator line foreground are displayed using the Window frame foreground color (or background color when dark text on a light background is selected). The icon and keyboard indicator line background uses the screen background color to merge with the screen border rather than the window title bar.

New color assignments do not take affect until you press OK. Color assignments can be saved in NVM or restored to their factory defaults the same as other Set-Up features.

It is possible to assign text foreground and background colors that make subsequent text difficult to read. Set-Up is displayed using the factory default colors with the exception of those dialog boxes that affect color selections. This ensures that Set-Up is always usable.

## Set-Up

### 2.9 Color Set-Up

#### 2.9.2 Alternate Text Colors

Figure 2-12 Alternate Colors

#### Terminal Set-Up

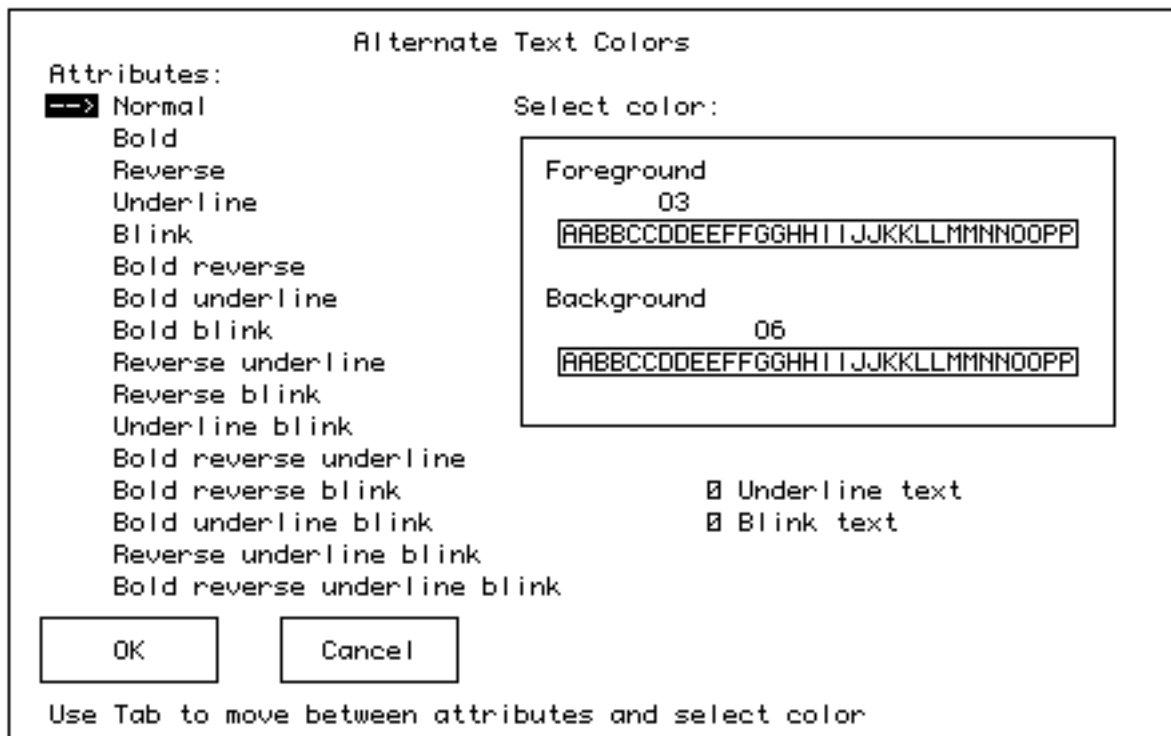

The **Alternate Text Colors** dialog box allows you to specify colors for any combination of text renditions (bold, reverse, underline, blink) when the Color mode is set to Alternate text colors. Operation of the dialog box is similar to the Assign Colors dialog box described above. If Underline text is selected, text with the underline attribute will be underlined as well as displayed using the specified color. If Blink text is selected, text with the blink attribute will blink as well as appearing in the specified colors.

- The attributes are displayed in the selected colors allowing you to see the effect desired.
- All combinations can be specified, providing backward compatibility with other video terminals.
- The foreground color of text with the invisible attribute becomes the background color.

### 2.9.3 Define Colors Dialog Box

Figure 2-13 Define Colors

Terminal Set-Up

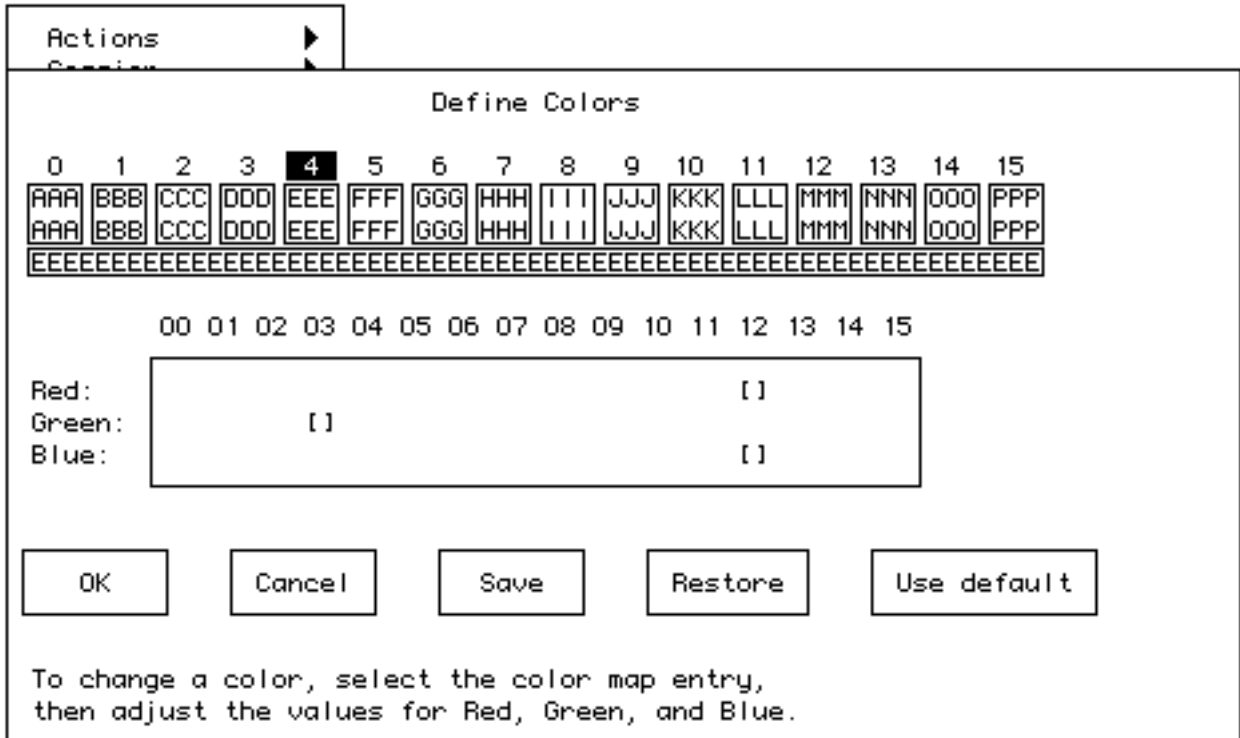

The **Define colors** dialog box allows you to define the terminal's color map with 16 colors from a palette of 4096 colors. This dialog box is intended for adjusting the appearance of individual colors. Radical changes to the terminal's color map may adversely affect the appearance of ANSI color SGR parameters. In the VT520, each session uses its own independent color map which is not affected by the others.

The boxed areas containing capital letters A-P represent the 16 colors currently defined. The selected color number (0-15) remains highlighted in reverse video while the highlighting cursor moves to the RGB sliders and then down to the labeled buttons.

Color definition changes become visible immediately since the terminal has a single active color map. Cancel restores the color map to the settings in effect when the OK or Save button was last pressed. The OK and Cancel buttons exit this dialog box. Pressing Save is similar to pressing OK but also writes the settings to NVM to be used as the power-on settings. Restore recalls the power-on settings from NVM. Use default recalls the factory default settings.

It is possible to define colors that make subsequent text difficult to read. Set-Up is displayed using the factory default colors with the exception of those dialog boxes that affect color selections. This ensures that Set-Up is always usable.

## Set-Up

### 2.9 Color Set-Up

#### 2.9.4 Select Color Mode

The **Select color mode** feature allows you to select how applications will display text colors.

- When **ANSI SGR color** is selected, color text is specified using the ANSI defined SGR color parameters. The terminal uses factory default renditions for text attributes as defined in Table 2–5.
- When **Alternate color** is selected, the terminal displays text renditions as defined in the Alternate Text Colors dialog box.
- When **Mono** is selected, the terminal uses a default monochrome or gray level map designed to maintain the appearance of applications that were not designed to use color.

**Table 2–5 Default Graphic Renditions**

Graphic Rendition	Factory Default Display
Normal text background	Color index 0
Normal text foreground	Color index 7
Bold text foreground	Color index + 8
Bold text background	Color index (unchanged)
Reverse text	Write text foreground with background color and background with foreground color.

The **Color** selection maintains a current graphic rendition that includes a text background color and text foreground color. Reverse text does not exchange the foreground and background colors stored as part of the graphic rendition, rather, it causes the text foreground to be written with the background color and vice versa. Specifying a new foreground color always modifies the "foreground rendition." Subsequent text written with the Reverse attribute will write this color as its background.

#### 2.9.5 ASCII Color Mode

The **ASCII color mode** determines the use of color in the ASCII terminal emulation modes. Color emulates WYSE 325 color. Mono uses a default monochrome or gray level map designed to maintain the appearance of ASCII terminals using applications that were not designed to use color.

#### 2.9.6 Bold and Blink Style

**Bold and blink style** selects whether the bold and blink attributes bold and blink the text foreground only, or both foreground and background. By default, bold adds 8 to the corresponding color index value to select a brighter or dimmer color, and blink cycles the text color between its non-blink rendition and a dimmer less saturated shade of the non-blink rendition.

#### 2.9.7 Erase Color

The **Erase color** selection controls the background color used when text is erased or new text is scrolled on to the screen. **Screen background** causes newly erased areas or scrolled text to be written using color index zero, the screen background. This is VT and DECterm compatible. **Text background** causes erased areas or scrolled text to be written using the current text background color. This is PC console compatible and is the factory default.



## 2.9.8 Reverse and Blank Attributes

The **Reverse and blank attributes** selection controls whether the reverse or blank text attributes are mapped to different colors in WYSE 325 emulation.

**When Map reverse attribute is selected:**

1. The characters with reverse attribute are displayed by the color which is assigned to the REVERSE/BLANK map in the color palette.
2. The characters with blank attribute are displayed by the color which is assigned to the NORMAL map in the color palette.

**When Map blank attribute is selected:**

1. The characters with reverse attribute are displayed by exchanging the foreground and background of the NORMAL map in the color palette.
2. The characters with blank attribute are invisible; that is, the foreground falls back to the background of the REVERSE/BLANK map in the color palette.

## 2.9.9 Intensity Attributes

The Intensity attributes check box operates in WYSE 325 color mode.

When Enabled:

1. The characters with dim attribute are displayed in a lower intensity.
2. The characters without dim attribute, but were written in intensity disabled mode are displayed in a lower intensity when intensity mode is changed to enable.

When Disabled:

All characters are displayed with their normal intensity.

## 2.10 Terminal Type Menu

You can select terminal type and emulation modes using this menu.

### 2.10.1 Emulation Mode

**Emulation mode** is the primary means of selecting different terminal modes or emulations. Changing terminal modes or emulations usually performs some initialization of the terminal state.

Changes to the terminal emulation mode take effect immediately (as soon the emulation mode submenu is exited). Other Set-Up parameters are updated accordingly based on the new emulation mode without exiting Set-Up.

Example: Selecting a VT mode performs a soft terminal reset (DECSTR).

PCTerm mode can be selected or deselected independently from the other emulations. The ASCII modes use WYSE PCTerm. The ANSI modes use VT PCTerm. The ASCII color mode uses WYSE 325 emulation.

This feature corresponds to the DECPCTERM, DECTME, DECANM, and DECSCL control functions described in Chapter 5.

Changing the conformance level (DECSCL) does not change the operating level reported to identify the terminal to the host. It only changes the way extensions are reported.

## Set-Up

### 2.10 Terminal Type Menu

---

#### Notes

---

- Printer operations are not affected or halted by a change in mode.
  - A soft reset is always performed as a result of a mode change from Set-Up.
  - Changes resulting from most, but not all, of the above sequences also cause a soft reset. Exception: Entering VT52 mode (via DECANM) does not cause a soft reset from VT100 mode, but does cause a soft reset from VT500 mode.
- 

#### 2.10.2 Terminal ID to Host

**Terminal ID to host** selects how the terminal identifies itself to host software, specifically the Primary Device Attributes response (DA). The default ID is "VT520."

For a list of the responses, see the Device Attributes sections in Chapter 5. This field has no effect when the terminal is in VT52 mode. The feature corresponds to the DECTID control function described in Chapter 5.

#### 2.10.3 VT Default Character Set

This feature selects the default international character set to use for output as initialized in G0-G3 and GL/GR. It corresponds to the DECAUPSS (Assign User Preference Supplemental Set) control function described in Chapter 5.

Only ISO Latin-1 and DEC Multinational are available on the North American terminal.

#### 2.10.4 PCTerm Character Set

This feature selects the PC code page, ISO character set, or DEC character set to be used in PCTerm mode and SCO Console mode. This feature is also invoked by the DECPCTERM control function described in Chapter 5.

#### 2.10.5 7-Bit NRCS Characters

This feature enables National Replacement Character Set mode (DECNRCM), as described in Chapter 5. When **7-bit NRCS characters** are selected, a corresponding 7-bit NRC set is used depending on the keyboard language. See Chapter 8 for details. Group 2 or secondary keyboard language characters may still be used if they are in the 7-bit character set. This feature is dimmed unless there is a corresponding NRC set available. This feature is not available on the North American terminal.

#### 2.10.6 Transmit 7-Bit Controls

**Transmit 7-bit controls** selects whether C1 control codes are sent in their original 8-bit form (disabled) or converted to their 7-bit ESC Fe form.

This field is invoked by a parameter to the DECSCL control function and by the S7C1T and S8C1T control functions.

## 2.11 ASCII Emulation Menu

Figure 2–14 ASCII Emulation Menu

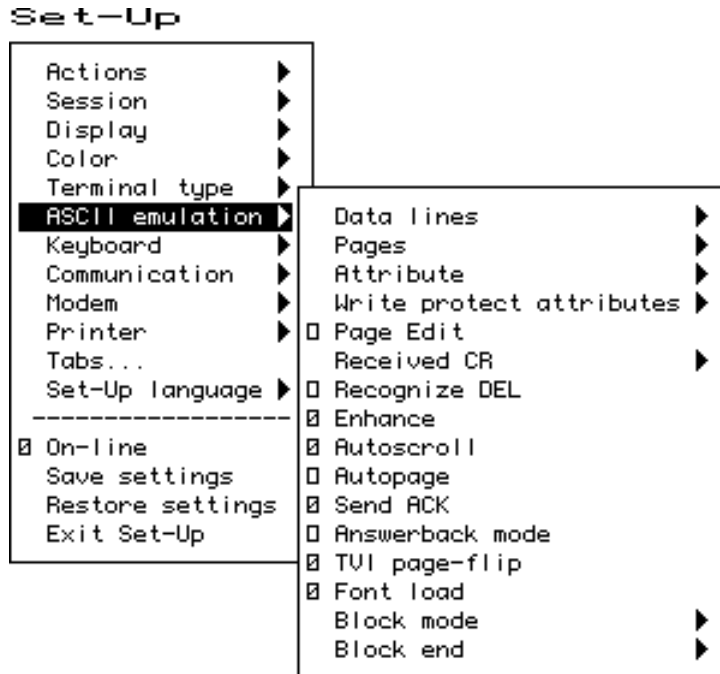

The features, shown in Figure 2–14 and listed in Table 2–6, are specific to the ASCII emulation modes supported in the VT520. The default is shown in **boldface** type. Refer to Part III for details.

Table 2–6 ASCII Emulation Features

Feature	Selections	Determine...
Data lines	<b>24</b> , 25, 42, 43 lines	The number of data display lines visible, not counting any status lines.
Pages	<b>1 × lines</b> 2 × lines 4 × lines *	The page size and number of pages. 1 × lines selects each page to be the number of data lines visible on the screen. The * makes the display of a single page invisible.
Attribute	<b>Character</b> , line, or page	How visual attributes are applied per character, line, or page.
Write protect attributes	<b>Dim</b> , blank, reverse, underline, and/or blink.	The visual attributes used to highlight and specify write protected data.
Received CR	<b>CR</b> or CRLF	Carriage return or carriage return line feed.
Block Mode	<b>Conversation</b> or Block	Transfer method.
Block End	<b>US/CR</b> or CRLF/ETX	At the end of a block transfer, transmit a carriage return or an end-of-text character.

## Set-Up 2.12 Keyboard Menu

### 2.12 Keyboard Menu

Figure 2–15 Keyboard Menu

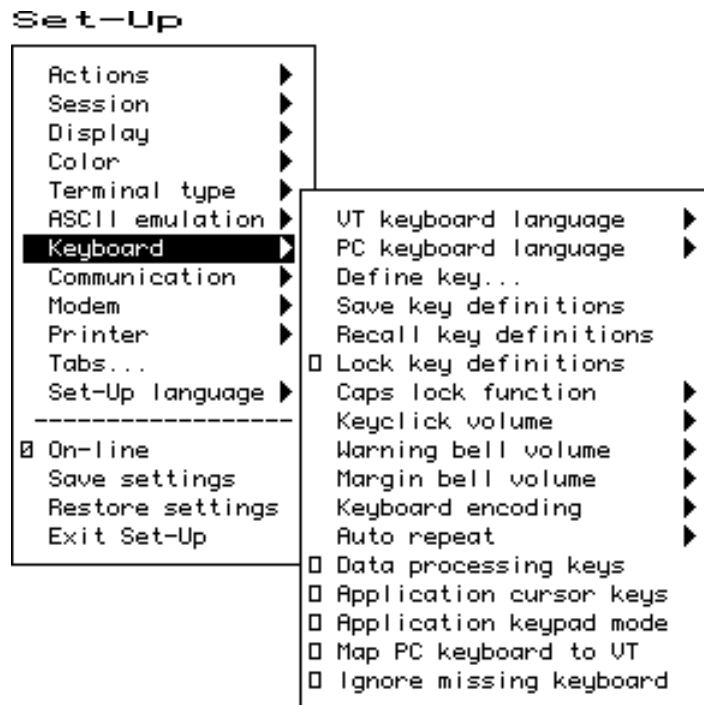

Several of the features shown in Figure 2–15 are self-explanatory and correspond directly to control functions listed in Table 2–7. For additional information, see Chapters 4 and 5.

Table 2–7 Keyboard Features and Control Functions

Set-Up Feature	Control Function
Keyboard language	DECKBD
Switch between primary and secondary keyboard language	DECESKM (general), DECHEBM (Hebrew), DECNAKB (Greek), DECCYRM (Cyrillic)
Caps lock function	DECLCK
Keyclick volume	DEKCV
Warning bell volume	DECWBV
Margin bell volume	DECMBV
Keyboard encoding	DECKPM
Auto repeat	DECARM
Data processing keys	DECKBUM
Application cursor keys	DECCKM
Application keypad mode	DECKPNM, DECKPAM, DECNKM

### 2.12.1 Keyboard Language

Some keyboards allow you to select two different keyboard layouts and easily switch between them (English and Hebrew, for example). This feature allows the VT520 to support both existing conventions and emerging standards for extending the graphic input and/or switching between languages in dual language environments. (The North American keyboard has only one keyboard language, English.)

The primary keyboard language corresponds to Group 1 (per DIN 2137) and generally references the legends on the left half of the keytops.

The secondary keyboard language corresponds to Group 2 (Group Shift per DIN 2137) and generally references the legends on the right half of the keytops.

Unless overridden, `Ctrl/Alt/F1` makes the primary keyboard language active, and `Ctrl/Alt/F2` makes the secondary keyboard language active. (These are factory defaults, standard on PCs.)

Selecting a new keyboard language in Set-Up automatically initializes the keyboard character set, as described in Chapter 8.

Changes to this field take effect immediately. Changing this field to North American or Dutch and then exiting Set-Up or going to another menu resets the **7-bit NRCS characters** feature to disabled. There is no "7-bit characters" mode for the North American or Dutch keyboards. This field affects the language of the keyboard indicator line.

### 2.12.2 Define Key Editor

The Define Key Editor is an advanced function that allows the terminal to adapt to environments that do not match the preprogrammed settings.

---

**Caution**

---

This function is designed to be easy to use; however, unless you understand the consequences of remapping various key combinations, use caution when using this feature.

---

The **Define key** menu invokes the Define Key Editor.

To ensure consistent access to Set-Up features, the following rules apply for interpreting keystrokes.

- Within Set-Up and the Define Key Editor, the four arrow keys along with `Enter`, `Return`, `Do`, `Select` and delete key `<X>` are interpreted according to their standard definitions, regardless of how they may be redefined at other times. The delete key will erase a field when defining an alphanumeric key. The one exception is when pressing the key to be defined.
- When you press `F3` as the first key after the terminal is powered on, you always enter Set-Up, regardless of which keyboard you use or how `F3` is defined.
- When copying one key definition to another, the standard key definition for a key is copied, not the current definition. This copy method ensures that keyboard functions are not lost within the Define Key Editor.

## Set-Up

### 2.12 Keyboard Menu

Figure 2–16 Define Key Editor, Select Function

Define Key Editor  
Available memory: 971

Press key to be defined: F6 Key number: 117

Define key as  
 UDK  Function  Alphanumeric  Copy of key default: \_\_\_

-----  
Modifiers: Definition: Select function:

Unshifted	UDK Sequence	No function
Shifted	UDK Sequence	Hold
<b>Control</b>	UDK Sequence	Print Page
Shift ctrl	No function	Set-Up
Alt	No function	Break
Alt-shift	No function	Hard Reset
Alt sh ctrl	No function	<b>UDK Sequence</b>

UDK: { 2;1 SP }

UDK direction:  Normal  Terminal only  Host only

OK Apply Cancel

MA-0324-93.GRA

#### 2.12.2.1 Copy of Key Default—Moving a Standard Function

The simplest way to reprogram a key is to copy the behavior of another key. You can use **Copy of key default** to copy the factory default for a key to be defined to any position on the keyboard. You cannot, however, use this feature to edit the code transmitted by individual keys. To move factory default key functions:

1. From the **Keyboard** menu item, select the **Define key ...** function and press **[Return]**; the **Define Key Editor** menu will appear.
2. Press the key for which you want to assign a new behavior. If the key is a function key, a screen similar to Figure 2–16 is displayed. Names are displayed in the Set-Up language selected (not according to keyboard language). The ± symbol indicates a toggle feature. Names are truncated to 12 characters in the definition field.
3. Press **[⇒]** to highlight the **Copy of key default** radio button (●) and press **[Enter]**.
4. Press the key whose factory default behavior is what you want your defined key to do.
5. Press **[↓]** to highlight the OK or Apply button and press **[Enter]**.

### 2.12.2.2 Customization

If you want to program a key to behave differently than one of the factory defined keys, then you will need to know about the following key categories:

- Function: Keys such as the arrow keys (↑, ↓, ←, →), the **Shift** modifier key, or the Set-Up key, used to transmit function key sequences or to perform local terminal functions.
- Alphanumeric: Keys used to transmit alphanumeric characters.

### 2.12.2.3 Modifier Keys

Modifier keys vary from within the Function and Alphanumeric categories. A modifier key is a key that modifies the behavior of other keys when it is pressed and held down. For example, pressing an alphanumeric key in combination with the **Shift** modifier key will normally send the shifted or uppercase characters for that key.

Modifier keys are treated as a special kind of local terminal function. The VT520 function modifier keys are: **Shift**, **Ctrl**, and **Alt**. VT520 alphanumeric keys can also be modified by pressing **Group Shift** (**Alt Gr** on enhanced PC keyboards) and **Alt/Shift** (**Shift-2**). Modifier keys themselves cannot normally be modified by other keys. A key assigned to act as the **Shift** modifier, for example, cannot transmit a function sequence when pressed in combination with **Alt**. Defining a key as a modifier key makes all assignable combinations of that key act as a modifier.

### 2.12.2.4 Creating a New Function

To define a new function key:

1. From the **Keyboard** menu item, select the **Define key . . .** function and press **Return**; the **Define Key Editor** menu will appear.
2. Press the key for which you want to assign a new behavior.
3. Press the **←** or **⇒** key to highlight the **Function** radio button (●) and press **Enter**.
4. Press the **↑** and **↓** keys to highlight the modifier combination that you want to define (Unshifted, Shifted, Control, and so on) and press **Enter**.
5. Press the **⇒** key to move to the **Select function** scroll box. Press the **↑** and **↓** keys to highlight the desired keystroke function from the list and press **Enter**.
6. Press the **←** key to return to the **Modifiers**.
7. Repeat steps 4 through 6 to define other modifier combinations as desired.
8. Use the arrow keys (↑, ↓, ←, →) to highlight the OK or Apply button and press **Enter**.

### 2.12.2.5 Examples of Creating New Functions

Examples of when to create new functions include:

- Changing the **<X>** or **Delete** key to delete when unshifted and to backspace when shifted.
- Disabling the **Compose**, **Break**, and Set-Up keys by assigning them to have no function.

## Set-Up

### 2.12 Keyboard Menu

#### 2.12.2.6 Correcting a Mistake

If you make a mistake or want to start over, choose the **Cancel** button. Use **Actions** ▸ **Restore factory defaults** to restore the factory default settings.

#### 2.12.2.7 Creating A New Alphanumeric Key or Keyboard Layout

The method for creating a new alphanumeric key is similar to that for function keys, except that you can define different modifier combinations and you enter alphanumeric values differently.

If the key was previously programmed as a function key, the function definition will be empty. Once any function definition is applied, all the alphanumeric definitions for that key are lost. *A single key cannot act as both a function key and an alphanumeric key simultaneously.*

To define a new alphanumeric key:

1. From the **Keyboard** menu item, select the **Define key . . .** function and press ; the **Define Key Editor** menu will appear.
2. Press the key for which you want to assign a new behavior.
3. Press the  or  key to highlight the **Alphanumeric** radio button (●) and press . The character transmitted when this key is unshifted is highlighted.
4. To select a different character, press the corresponding key on the keyboard, or use the numeric compose key to generate a new character.
5. If desired, press the  key to move to the **Non-spacing accent** scroll box. Press the  and  keys to highlight any non-spacing accent from the list and press .
6. The code transmitted by the unshifted alphanumeric key when pressed in combination with the Control key is calculated automatically and displayed in the **Definition** column. If desired, you may redefine this function.
7. If desired, select an Alt Function modifier combination for the alphanumeric key from the **Select Function** scroll box. You may choose a function, including a user-defined key (UDK) sequence. The default for the Alt Function is **None**.
8. Press the  key to return to the modifier selection.
9. Use the arrow keys (↑, ↓, ←, ⇒) to highlight the OK or Apply button and press .

To enter alphanumeric values you can type the desired character or numeral, you can compose the desired character including numeric keypad compose, or you can select a nonspacing accent from the nonspacing accent scroll box.

#### 2.12.2.8 Examples of Creating New Alphanumeric Keys

Examples of when to create new alphanumeric keys include:

- Making the comma and period keys send comma and period instead of angle brackets when shifted.
- Changing the keyboard from a QWERTY to QWERTZ layout.
- Defining an alternate key layout to match your own preference or local typing conventions (Dvorak, or Russian Cyrillic, instead of Bulgarian Cyrillic).



### 2.12.2.9 User-Defined Keys

The **UDK** radio button allows any key to be programmed with a user-defined sequence. UDKs are a subset of function keys. A separate UDK dialog box is provided for simplicity. Selecting **UDK** causes a **UDK:** text field to be displayed so you can enter a key sequence. This text field can scroll left or right as needed to allow longer strings to be entered.

Enter control codes by holding the **Compose** or **Alt** key down and entering the decimal value for the code on the Numeric keypad. Codes may also be entered on the Numeric keypad in column/row format as follows:

**Compose** **1** **.** **1** **1**

Press **↓** again to move the highlighting cursor to select one of the following UDK directions:

- Normal            The sequence is sent to the host and/or to the screen depending on the communication settings (On-line, Local echo, Half duplex, and so on).
- Terminal only    The sequence is sent only to the screen, as if it had just been received from the host.
- Host only        The sequence is sent only to the host, regardless of the communication settings.

Press **↓** again to select one of the following buttons:

**OK**            **Apply**            **Cancel**

When you select Cancel, you only cancel the changes to the currently selected modifier combination.

### 2.12.2.10 Programming Notes

- When you press **F3** as the first key after the terminal is powered on, you always enter Set-Up, regardless of how **F3** is defined.
- The factory default Break function (unshifted F5) cannot be reprogrammed by host control sequence. This is necessary to support secure attention. If the sequence is received, the factory default keystroke table entry for Break is not overwritten.
- If a key is programmed to act as a modifier key, it operates as a modifier with any combination of **Shift**, **Alt**, or **Control**.
- If a key is programmed to be a modifier key and modifier key reporting is enabled using DECSMKR, the key sends the VT sequence for the left modifier key when there is more than one.
- **Caps Lock** combinations such as **Caps Lock/Print Screen** are local keyboard extensions and cannot be reprogrammed by DECPFK. The **Caps Lock** key acts as a modifier. The **Caps Lock** function can be moved to another key, but **Pause** must still send the Break.
- Use of the Define Key Editor to redefine keys on the numeric keypad affects only the Num Lock off state of these keys. When Num Lock is engaged, these keys will always send their factory default ASCII numerals (and related characters) intended for numeric input. The Num Lock behavior of these keys cannot be reprogrammed. (This Num Lock behavior does not apply to numeric keypad mode on the VT keyboard or PC keyboard in VT style.)

## Set-Up

### 2.12 Keyboard Menu

- The toggle Num Lock function can be assigned to any single key combination. Although the Num Lock state modifies other keys, the toggle Num Lock function is not a modifier key. This means modifier combinations of `[Num Lock/Key]` can be assigned to any other function or user-defined sequence.
- Use of the numeric keypad to compose characters by entering their decimal code in combination with `[Alt Gr]` or `[Compose]` (held down) should continue to work regardless of any reprogramming of keys on the numeric keypad, unless such reprogramming directly conflicts with use of the keypad in this manner. Example: A numeric keypad key has been defined as `[Compose]` or `[Alt Gr]`.
- Function keys also work in VT100 mode.

#### 2.12.3 Save Key Definitions

To save your key definitions so they will be available the next time you turn the power on, select the **Save key definitions** menu item from the **Keyboard** menu.

This action field on the keyboard menu (Figure 2–15) causes the **Define key** modifications to be saved to nonvolatile memory independently from any other Set-Up features. Key definitions are saved on a first-come first-served basis and are limited by the total amount of nonvolatile memory available.

This feature cannot be invoked by a host control function.

#### 2.12.4 Recall Key Definitions

This action field causes previously saved **Define key** modifications to be recalled from nonvolatile memory independently from any other Set-Up features.

#### 2.12.5 Lock Key Definitions

The **Lock key definitions** menu item operates as a check box. When key definitions are locked, they cannot be reprogrammed from the host.

#### 2.12.6 Caps Lock Function

This function allows you to enable the `[Lock]` or `[Caps Lock]` key to do the following:

- Caps lock                      Lock alpha keys on main keypad in uppercase setting.
- Shift lock                      Lock alpha and numeric keys on main keypad in shifted setting.
- Reverse lock                    Works the same as Caps Lock, except that pressing the `[Shift]` key will send the lowercase or unshifted character assigned to a key.

#### 2.12.7 Keyclick, Warning Bell, and Margin Bell Volume

The volume of these settings can be set to high, low, or off, with **high** as the default.

**Suppress repeated warnings** causes the terminal to ignore Control-G warning bells encountered within two seconds of a previously sounded warning bell. When using multiple sessions, this feature prevents broadcast messages sent to more than one session from sounding the warning bell repeatedly for each session. Alternatively, if several broadcast messages are pending in an inactive session, the warning bell sounds once when the session is made active.

### 2.12.7.1 Visible Bell

The terminal provides a **Visible bell** feature, which flashes a bell ringing font whenever a sound is generated. The fonts will flash six times and disappear in 2 seconds automatically. In ANSI mode, the bell is displayed at column 16 of the keyboard indicator line (same place as the sticky keys indicator). In ASCII mode, the bell is displayed at column 23 of the status line. These bell fonts may temporarily replace another indicator on the screen.

## 2.12.8 Keyboard Encoding

The **Keyboard encoding** menu allows you to select from the following:

- Character (ASCII)      The keyboard uses normal ANSI/ISO character encoding.
- Scancode              The terminal transmits make and break codes for each keystroke corresponding to the hardware scan codes used by PC keyboards (scan set 1).
- Key position          The keyboard transmits key position codes for each down transition. This menu allows alternate keyboard layouts to be supported by application software.

This feature corresponds to the DECKPM (key position mode) control function described in Chapter 5.

## 2.12.9 Auto Repeat

The **Auto repeat** feature selects whether keys begin auto repeating if still held down after a delay interval:

- Fast (30/sec)
- Slow (10/sec)
- Off

The repeat rate is the number of "keystrokes" per second, not characters per second. Changes to this field take effect immediately.

This is a user-preference feature. When it is unlocked, this feature can be invoked by the DECARM control function.

## 2.12.10 Data Processing Keys

This feature corresponds to the DECKBUM control function described in Chapter 5. Changes to this field take effect immediately.

## 2.12.11 Application Cursor Keys

This feature corresponds to the DECCKM control function described in Chapter 5. This feature is reset to the factory default setting by DECSTR.

Changes to this field take effect immediately.

Settings for **Application cursor keys** (AppCK) and **Application keypad mode** (AppKM) selected in Set-Up can be saved to NVM and used as the power-on settings. Settings for AppCK and AppKM selected by host control functions affect the current operating state, as shown by the check boxes, but are not saved in the NVM.

## Set-Up

### 2.12 Keyboard Menu

#### 2.12.12 Application Keypad Mode

This feature selects whether the numeric keypad sends ASCII numerals or application function sequences. It corresponds to the DECKPNM, DECKPAM, and DECNKM control functions described in Chapter 5.

This field is reset to the power-up setting when a soft reset occurs (Reset Session or receipt of DECSTR).

Changes to this field take effect immediately so you can use the keypad to enter an Answerback message.

#### 2.12.13 Map PC Keyboard to VT

**Map PC keyboard to VT** causes the terminal to treat a PC layout keyboard as if it were a VT keyboard. F1-F5 behave as local function keys (Hold, Print, Set-Up, Session, Break). Editing and numeric keypad keystrokes work the same as the corresponding keys on a VT keyboard (PF1-PF4 are recognized instead of NumLock and other PC legends).

This feature is only available when a PC keyboard is used and can be toggled on or off by pressing CapsLock/NumLock.

#### 2.12.14 Ignore Missing Keyboard

When selected, **Ignore missing keyboard** causes the terminal to ignore a missing keyboard during power-up selftest instead of displaying a "Keyboard error" message.

## 2.13 Communication Menu

Figure 2-17 Communication Menu

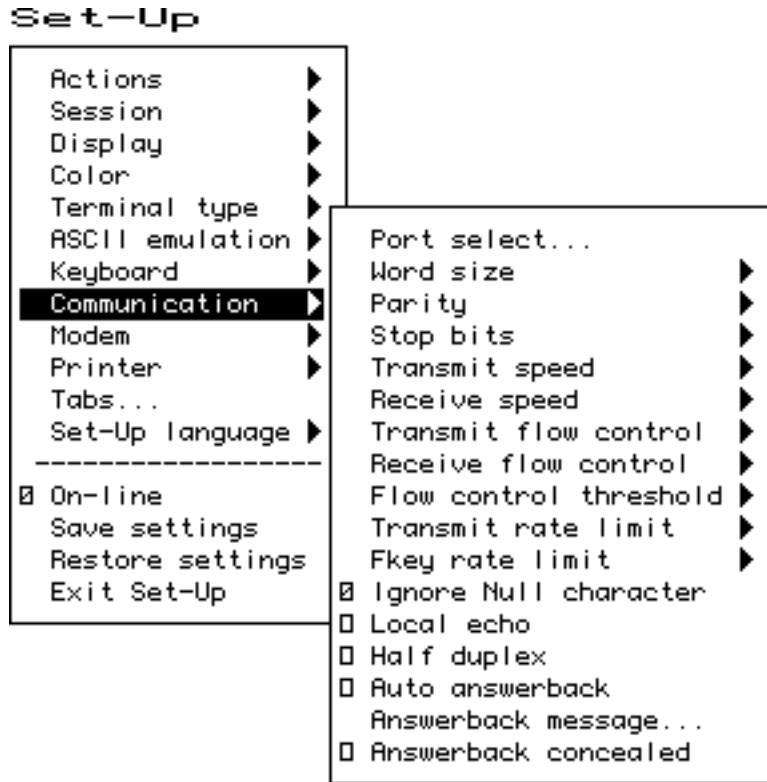

Several of the Communication features shown in Figure 2-17 are self-explanatory and correspond directly to control functions listed in Table 2-8. These functions are described in Chapter 5.

Table 2-8 Communication and Modem Features and Control Functions

Set-Up Feature	Factory Default	Host Control Code
<b>Communication &gt;</b>		
Port select	S1=comm1, S2=comm2, Print=comm3	DECSCP
Word size	8 bits	DECSP
Parity	None	DECSP
Stop bits	1 bit	DECSP
Transmit speed	9600	DECSCS
Receive speed	Transmit speed	DECSCS
Transmit flow control	XON/XOFF	DECSCF
Receive flow control	XON/XOFF or XPC	DECSCF
Flow control threshold	Low (64)	-

(continued on next page)

## Set-Up

### 2.13 Communication Menu

Table 2–8 (Cont.) Communication and Modem Features and Control Functions

Set-Up Feature	Factory Default	Host Control Code
Transmit rate limit	150 cps	DECXRLM DECSTRL
Fkey rate limit	150 cps	DECSTRL
[/] Ignore Null character		DECNULM
[ ] Local echo		SRM
[ ] Half duplex		DECCHDPXM
[ ] Auto answerback		-
Answerback message...		DECLANS
[ ] Answerback concealed		DECCANSM
<b>Modem &gt;</b>		
[ ] Enable modem control		DECMCM
Disconnect delay	2 seconds	DECSDDT
Modem high speed	Ignore	-
Modem low speed	Ignore	-

#### 2.13.1 Communication Port Select

The **Communication > Port Select** dialog box (Figure 2–18) allows you to specify which of the VT520's serial communication ports (comm1..comm3) are used by each session. The sessions are identified across the top of the dialog box with the session icon name.

Figure 2–18 Communications—Port Select

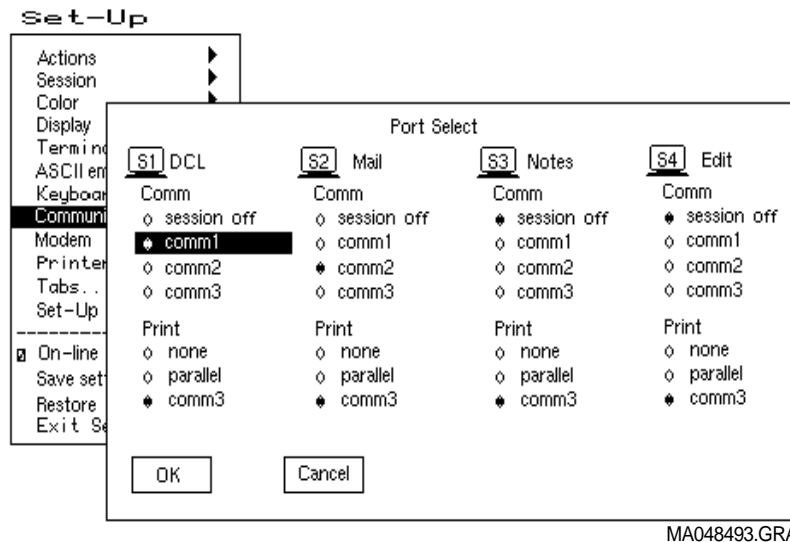

MA048493.GRA

If more than one session is assigned to a single communications port, the Terminal Device/Session Management Protocol (TD/SMP) is used. Pressing the Session key (F4) cycles through each session 1 through 4 in order making it the active session and establishing the corresponding connection as needed.

If sessions are not yet enabled on the corresponding port, the TD/SMP enable sessions command is issued and the first session connection on this port is established. If the corresponding session connection has not yet been established or the session is not the active session on this port, the TD/SMP open session or select session command is sent. If opening a new session fails, the terminal reverts back to the previous session.

#### Comm Radio Buttons

Selecting **Comm = session off** completely disables the corresponding session virtual terminal such that it can no longer be made active, it is not included in the switch session cycle order, and its icon does not appear in the framed windows display. Resources previously assigned to this virtual terminal become available to the others. At least one session must always be enabled. The terminal does not allow "Comm = session off" to be set for the last remaining session. Notice that selecting "Comm = session off" does not dim the corresponding session selection in this dialog box.

#### Print Radio Buttons

This set of radio buttons control the printer port assignments. They are described below with the Printer Port Select dialog box. This same dialog box appears in both Communications and Printer Set-Up and affects all sessions. If comm3 is assigned as the printer port for one or more sessions, it is dimmed and is not available as a comm selection. Alternatively, if comm3 is assigned as the comm port for any session, it is dimmed and is not available as a printer port selection. The factory default is "Print=none" for all four sessions.

The **Printer Port Select** dialog box allows you to specify which port is to be used for local print operations: serial port comm3 or the Centronics parallel port. If more than one session is assigned to use a single printer port, the printer will be shared on a first-come-first-served basis. The Print Page operation and Printer Controller Mode can not be interrupted. If a session is using the printer for either of these, other sessions attempting to use this printer port are forced to wait (printer status: busy) until the previous operation completes. A session assigned "Print = none" will have "printer status: no printer". Any print operations attempted from this session will be ignored.

### 2.13.2 Word Size

The communication word size can be **8 bits** (default) or 7 bits.

### 2.13.3 Parity

You can select any of the following parity checks:

- None
- Even
- Odd
- Even, unchecked
- Odd, unchecked
- Mark
- Space

### 2.13.4 Stop Bits

For communication, **1** (default) or 2 stop bits can be enabled.

## Set-Up

### 2.13 Communication Menu

#### 2.13.5 Transmit Speed

The communication **Transmit speed** is set to 9600 baud. You can select transmit speeds from the menu shown in Figure 2–19.

Figure 2–19 Communication Transmit Speed Menu

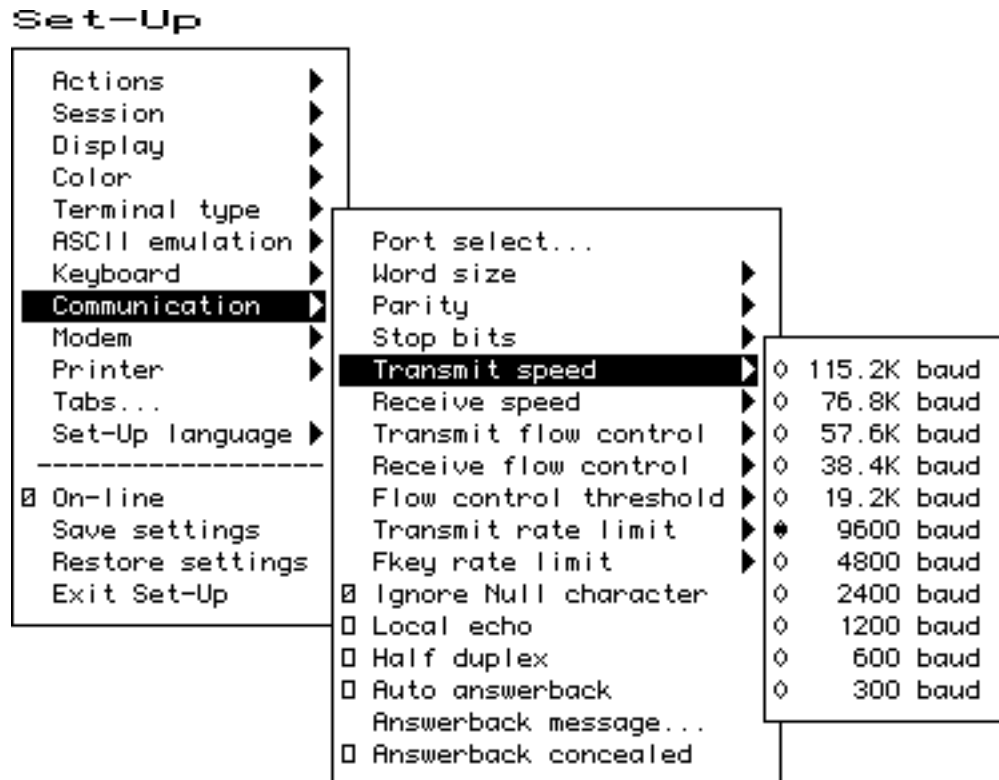

#### 2.13.6 Receive Speed

Like the communication **Transmit speed**, you can select the **Receive speed** from 300 to 115.2K baud. The default receive speed matches the transmit speed selection.

#### 2.13.7 Transmit Flow Control

The **Transmit flow control** method can be one of the following:

- None
- XON/XOFF
- DSR (Data Send Ready)
- Both

---

**Note**

---

When an ASCII emulation is selected, the default **Transmit flow control** is **None**.

---



### 2.13.8 Receive Flow Control

The **Receive flow control** method can be one of the following:

- None
- XON/XOFF or XPC
- DTR (Data Transmit Ready)
- Both

### 2.13.9 Flow Control Threshold

You can set the **Flow control threshold** to Low (64 characters) or to High (768 characters).

### 2.13.10 Transmit Rate Limit, Fkey Rate Limit

The **Transmit rate limit** choice limits the character rate from the keyboard to between 30 and 150 characters per second (selectable with fairly uniform separation), regardless of baud rate. This is fast enough to allow any keystroke to auto repeat at 30 Hz (baud rate permitting). The default is **150**.

This feature allows you to limit the transmit rate from the terminal so as to reduce the interrupt burden on the operating system.

You can select a different transmit rate for graphic keys and function keys using **Fkey rate limit**. The F keys transmit more than 1 byte per key press. This function may be selected through the DECXRLM and DECTRL control function. Refer to Chapter 5, for details.

Figure 2–20 Communication Fkey Rate Limit Menu

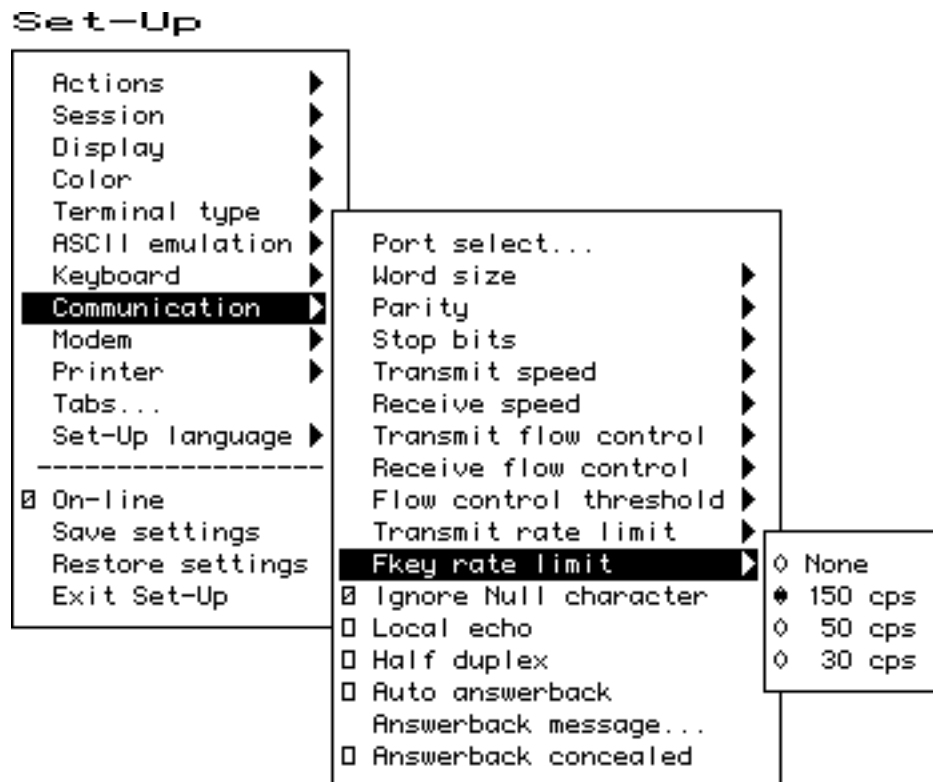

## Set-Up

### 2.13 Communication Menu

#### 2.13.11 Ignore Null Character

The Ignore Null setting causes the terminal to discard Null characters immediately without buffering them. This allows NUL to be used as a time fill character to pace terminal output without overflowing the receive character buffer. To pass NUL control codes to a printer, you must deselect the **Ignore Null character** check box.

#### 2.13.12 Local Echo

With **Local echo** enabled, most characters sent from the keyboard to the host are also displayed on the screen. The answerback message and XON/XOFFs are not echoed locally. Everything else is.

This feature corresponds to the SRM control function described in Chapter 5.

---

#### Note

---

**Local echo** is different from the "Local" setting of **On-line** in the main menu of the Set-Up directory. **Local echo** causes keystrokes to be echoed on the screen, but it does not direct keyboard input to the ANSI parser, which also updates the screen. **Local echo** is temporarily disabled when the terminal is in either Local mode or Local Controller mode, because the keyboard input is already being redirected to the screen through the parser or to the printer.

---

#### 2.13.13 Half Duplex

You can enable or disable **Half duplex** communication. The default is **disabled**. Half duplex communication is available only on the Comm1 communications port. If communication is set for the Comm2 port, this feature is disabled (dimmed).

#### 2.13.14 Auto Answerback

This item is used to enable or disable **Auto answerback** on power-up or upon connection. The factory default is **disabled**.

#### 2.13.15 Answerback Message

Each session can have an answerback message. The **Answerback message . . .** menu item invokes a dialog box with a 30-character limit. All characters that can be generated by the keyboard are legal in this field (including primary and secondary keyboard language characters). As such, no errors are reported, except when trying to enter more than 30 characters. In this case, the bell rings (if enabled), and no more characters are accepted. The factory default message is no message at all (a blank field).

If an Answerback message is currently defined, the message is displayed in the text entry area. The <X> or Delete key can then be used to delete backwards and enter a new Answerback message.

Figure 2-21 Communication Answerback Dialog Box

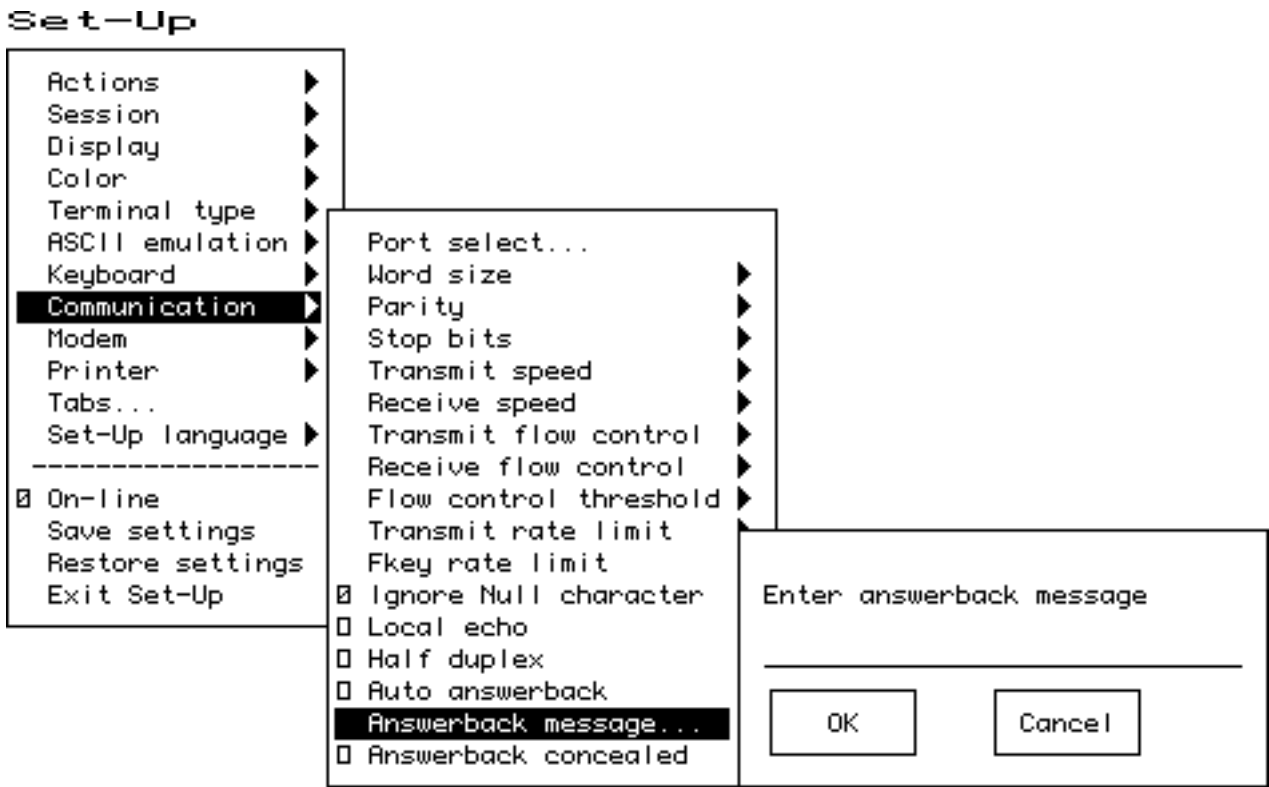

Control characters are displayed using the CRM font. Pressing  enters a return character in the Answerback message. Pressing  with the highlighting cursor in the Answerback text field moves to the OK button.

The current Answerback message is displayed in the answerback dialog box unless **Answerback concealed** is selected. In this case, the previous Answerback message is not shown. Choosing the OK button to enter a new Answerback message clears the Answerback concealed check box.

### 2.13.16 Answerback Concealed

Changes to this field take effect immediately. The factory default is **disabled**.

If disabled, the Answerback message is visible in Set-Up. If enabled, the message is not visible and the text "<concealed>" replaces the message. The only way to return this field to disabled (visible) is to enter a new message.

## Set-Up

### 2.14 Modem Menu

## 2.14 Modem Menu

Figure 2-22 Modem Menu

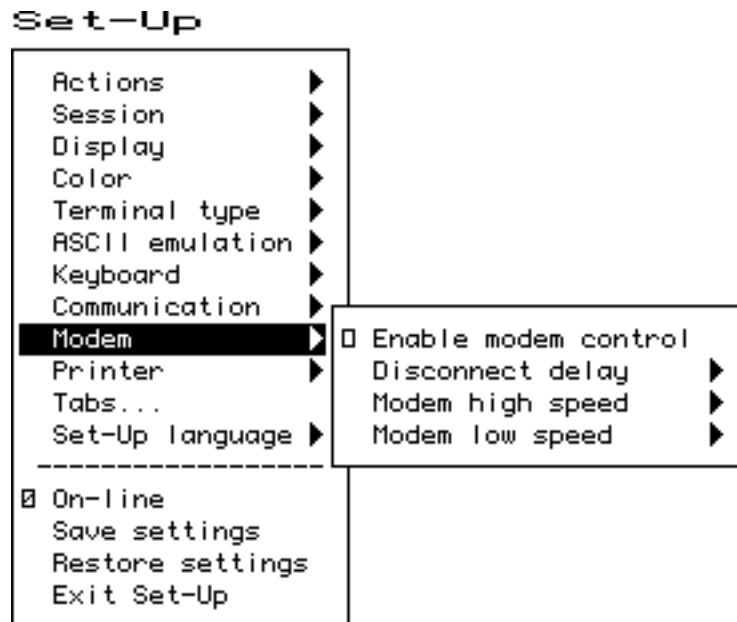

### 2.14.1 Enable Modem Control

The field allows you to select whether the additional hardware control signals at the interface connector are used for modem control. Modem control disabled is also referred to as "Data leads only." Refer to Chapter 9 for details on modem control signals.

This feature corresponds to DECMCM in Chapter 5.

### 2.14.2 Disconnect Delay

When modem control is enabled, the **Disconnect delay** feature determines the time allowed before the terminal disconnects from the communications line when the received line signal detect (RLSD) is lost. Disconnect delay is in effect only when RLSD (CD) is lost. If DSR is lost, the terminal performs a disconnect immediately. The following selections are available:

- 2 seconds
- 60 ms
- No disconnect

All countries except the United Kingdom should use a delay of 2 seconds. The 60 ms delay is for use in the United Kingdom.

If the VT520 detects a loss of carrier and you selected No disconnect, the VT520 ignores RLSD (CD) after the beginning of the connection.

If you try to disconnect and reconnect the line, the VT520 checks to "see" if RLSD is asserted before granting the connection. Once it is connected, the terminal ignores the loss of carrier.

You can select disconnect delay through Set-Up or through control function DECDDT. Refer to Chapter 9 for details on the connect and disconnect process.

### 2.14.3 Modem High Speed

Figure 2-23 Modem High Speed Menu

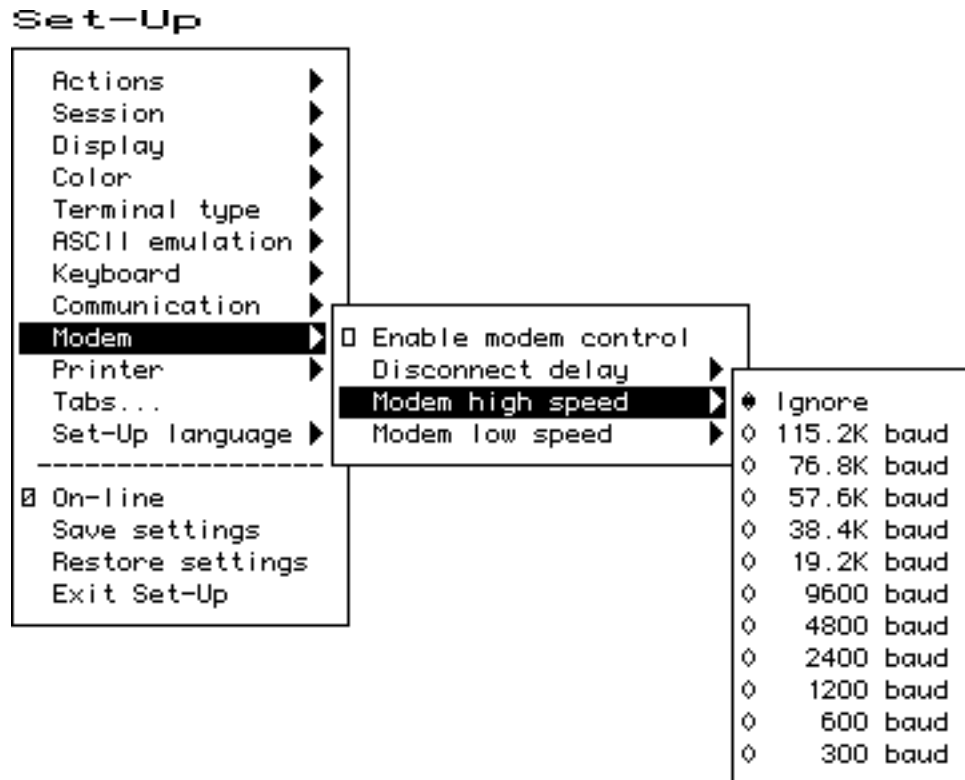

When modem control is enabled, the speed indicator signal (SI) from the modem may be used to select the communication rate. This feature sets the communication rate to be used when the speed indicator line is "on." Selecting Ignore causes the terminal to use its regular transmit and receive speeds as it would when modem control is disabled.

This feature can be invoked by DECSCS.

### 2.14.4 Modem Low Speed

These selections are the same as the modem high speed selections shown in Figure 2-23. When modem control is enabled, the speed indicator (SI) signal from the modem may be used to select the communication rate. This feature sets the communication rate to be used when the speed indicator line is "off." Selecting Ignore causes the terminal to use its regular transmit and receive speed as it would when modem control is disabled. This feature can be invoked by DECSCS.

## Set-Up

### 2.15 Printer Menu

### 2.15 Printer Menu

Figure 2-24 Printer Menu

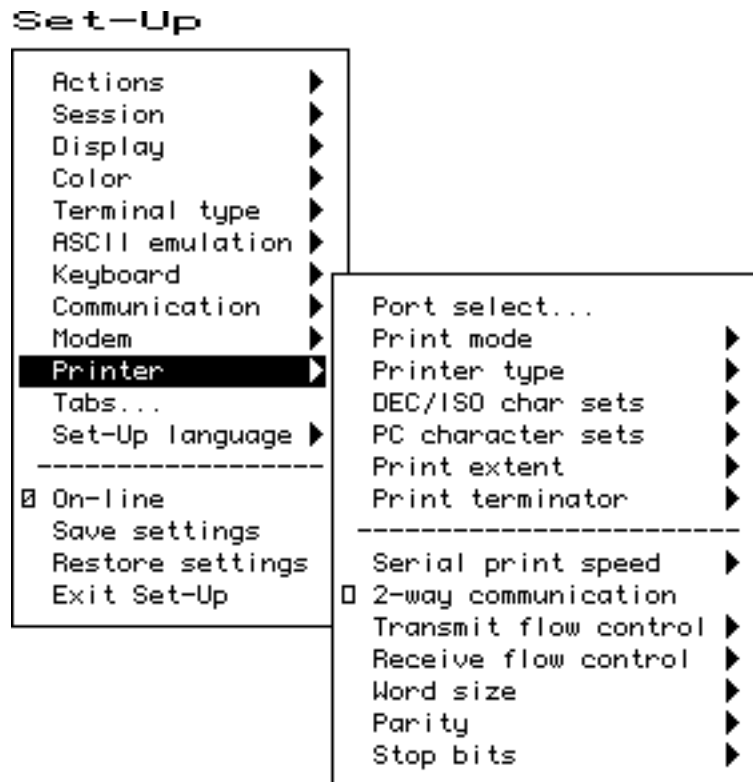

Printer features shown in Figure 2-24 correspond to the control functions listed in Table 2-9. These functions are described in Chapter 5 and Chapter 10.

#### 2.15.1 Port Select

The **Port select** menu is the same one that appears in the **Communication** menu (see Figure 2-18). It is displayed in both areas to be easy to find whether you are selecting the printer port or the host port. Having a single feature avoids complex interactions between printer port and host port selections.

#### 2.15.2 Print Mode

The **Print mode** menu allows you to select the printer operating mode as follows:

- Normal
- Autoprint
- Controller

**Note**

We recommend that you do not save the Controller mode selection in NVR because this may result in a "hung" terminal if the printer does not have DTR asserted.

Local echo is temporarily disabled when the terminal is in either Local mode or Local Controller mode, because the keyboard input is already being redirected to the screen through the parser or to the printer.

**Table 2–9 Printer Features and Control Functions**

Set-Up Feature	Factory Default	Host Control Code
<b>Printer</b> ▶		
Port select	S1=comm1, S2=comm2, Print=comm3	DECSCP
Print mode	Normal	MC
Printer type	DEC ANSI	DECSPRTT DECSDPT
DEC/ISO char sets	National only	DECSDPT
PC character sets	PC International (437)	DECSPPCS
Same as receive		
Print extent	Full page	DECPEX
Print terminator	None	DECPPF
<hr/>		
Serial print speed	4800 baud	DECSCS
[ ] 2-way communication		MC
Transmit flow control	XON/XOFF	DECSCFC
Receive flow control	XON/XOFF	DECSCFC
Word size	8 bits	DECSPS
Parity	None	DECSPS
Stop bits	1 bit	DECSPS

### 2.15.3 Printer Type

You can select the printer type as follows:

- DEC ANSI
  - IBM ProPrinter
  - DEC + IBM

### 2.15.4 Printer Character Sets

The printer character set menus allow you to match the characters printed to the character sets the printer is capable of supporting.

## Set-Up

### 2.15 Printer Menu

#### 2.15.4.1 DEC/ISO Character Sets

You can enable the character set categories shown in Figure 2–25.

Figure 2–25 DEC/ISO Character Sets Menu

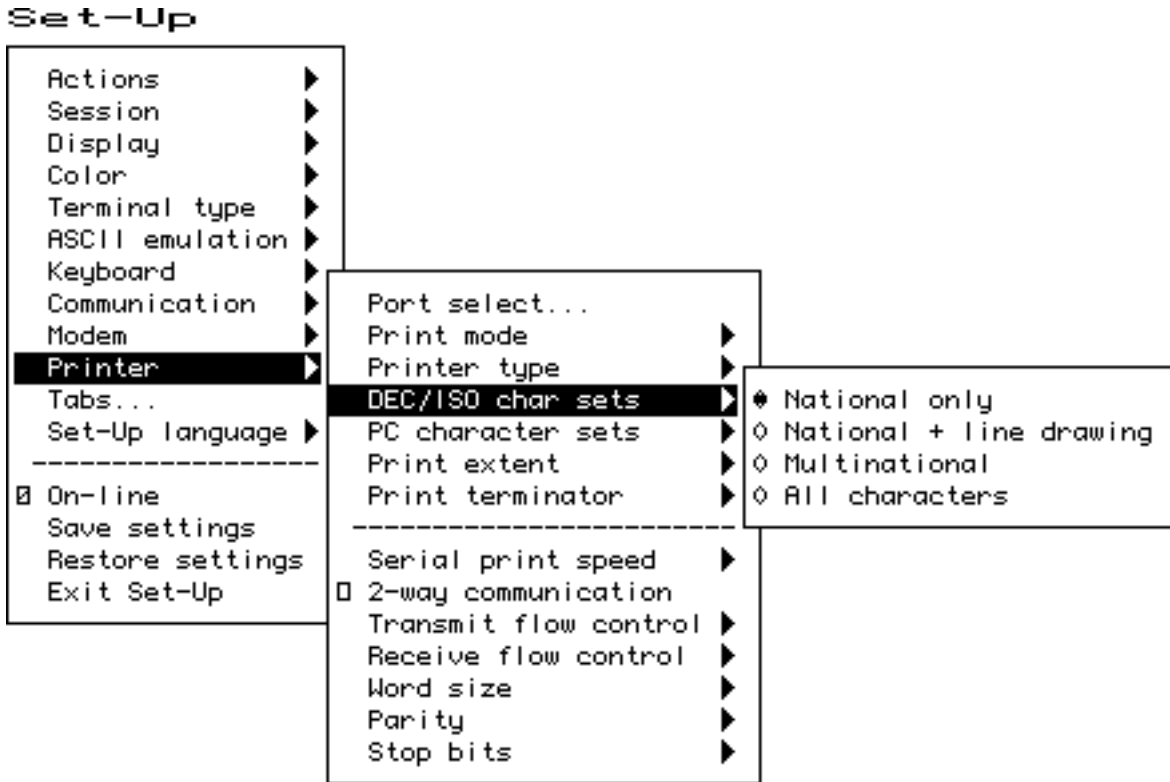

#### 2.15.4.2 PC Character Sets

The numbers in parentheses in this menu refer to standard PC code pages. Refer to Chapter 10 for a listing of the PC character sets.

**Same as receive**—Use IBM ProPrinter sequences with control codes or without host control codes.

#### 2.15.5 Print Extent

This selection allows you to print a **full page** or just the scroll region.

#### 2.15.6 Print Terminator

The print terminator can be **None** or FF (form feed).

#### 2.15.7 Serial Print Speed

Like the **Communication** menu speed selection (see Figure 2–19), you can select the serial printer speed from 300 to 115.2K baud. The default is **4800** baud.



Figure 2–26 PC Character Sets Menu

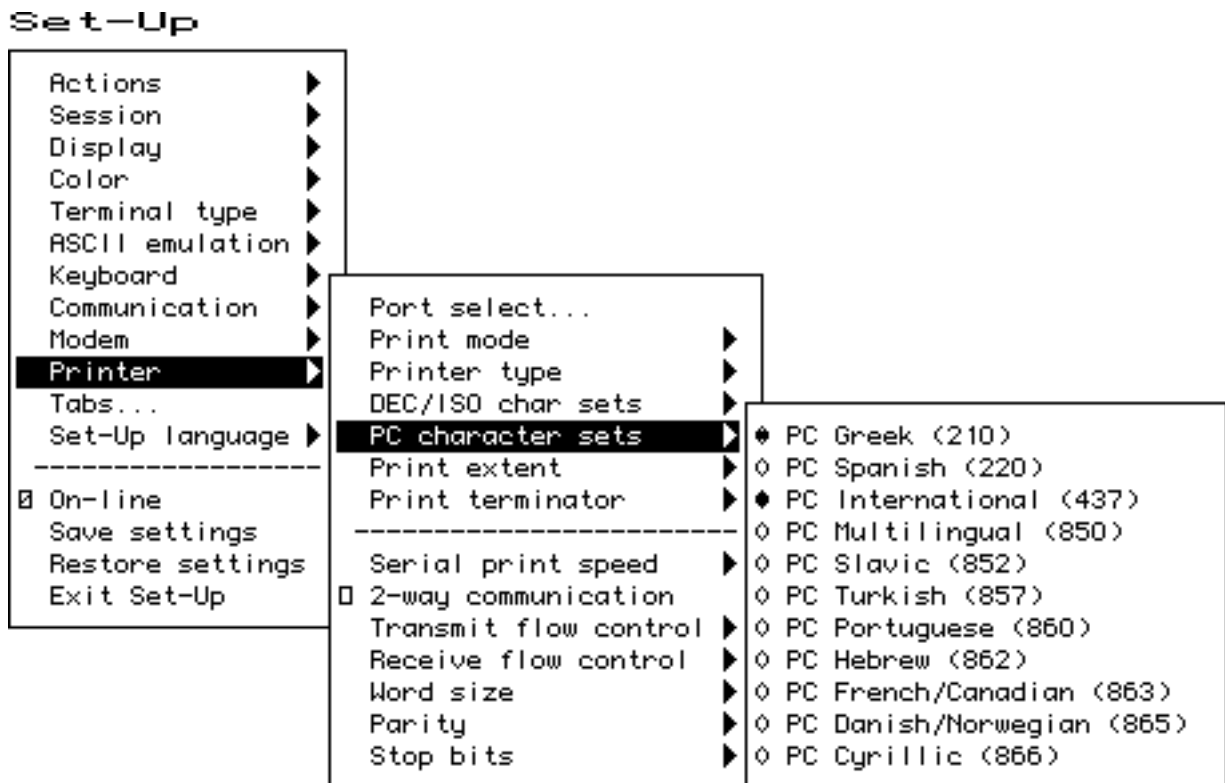

### 2.15.8 2-Way Communication

This item allows you to enable and disable bidirectional communications on the *serial* printer port. The default is 2-way communication **disabled**.

### 2.15.9 Transmit Flow Control

The printer transmit flow control method can be one of the following:

- None
- XON/XOFF
- DSR (Data Send Ready)
- Both

### 2.15.10 Receive Flow Control

The printer receive flow control method can be one of the following:

- None
- XON/XOFF
- DTR (Data Terminal Ready)
- Both

### 2.15.11 Word Size

The printer word size can be **8 bits** (default) or 7 bits.

## Set-Up

### 2.15 Printer Menu

#### 2.15.12 Parity

You can select any of the following parity checks to the printer:

- None
- Even
- Odd
- Mark
- Space

#### 2.15.13 Stop Bits

For the printer, **1** (default) or 2 stop bits can be enabled.

#### 2.15.14 Same as Receive

This item allows you to set the transmit speed to be the same as the receive speed on the printer port.

### 2.16 Tabs . . .

The **Tabs . . .** menu item is used to invoke the Tab Set-Up dialog box, displaying a 132-column tab ruler. Figure 2-27 shows that tab stops are indicated by the letter T.

The highlighting cursor is initially displayed over the entire tab field. The normal character cursor appears in column 1 of the tab field.

The  and  keys move the cursor within the tab field. Pressing  advances the cursor to the next tab stop in the tab field (if any). The character cursor automatically wraps between the end of the first row and the beginning of the second row in the tab field.

Figure 2-27 Tab Set-Up Dialog Box

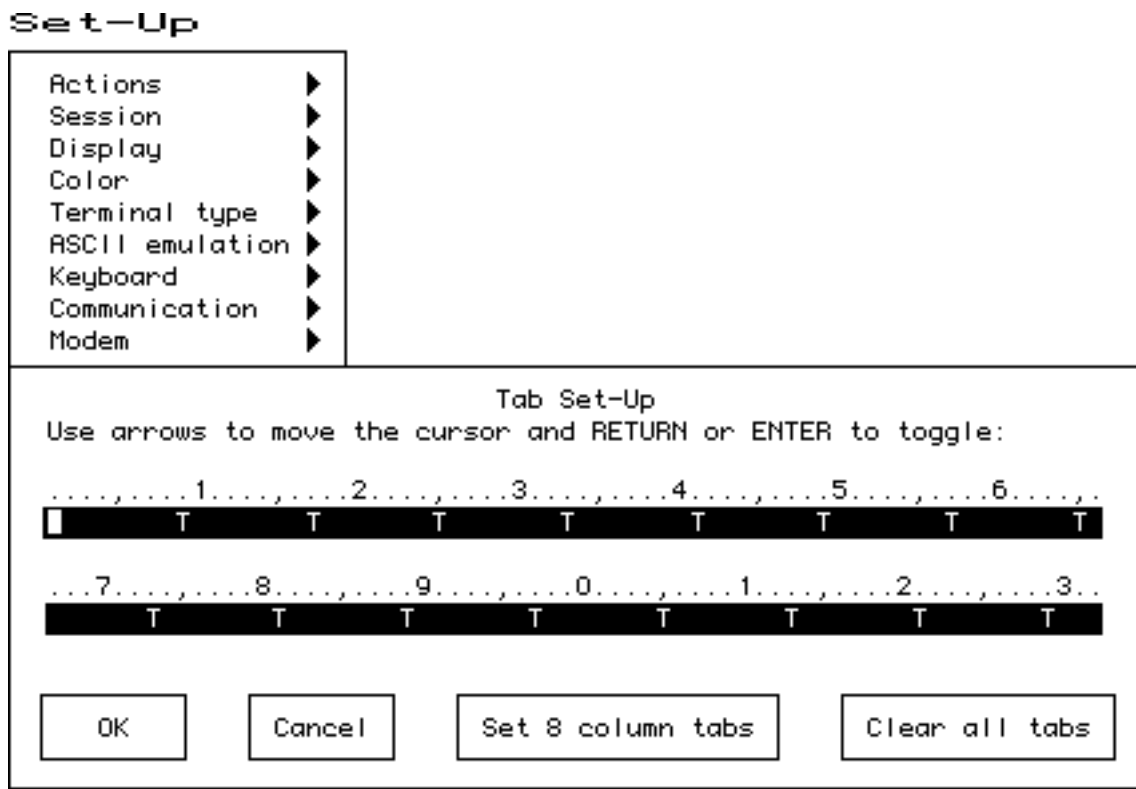

The labeled buttons allow you to clear all tabs or to set 8-column tabs directly. To set individual tabs:

1. Position the cursor in the desired column.
2. Press  to set or clear a tab in that column.

Tab setting can also be invoked by the HTS and DECCTS control functions.

## 2.17 Sound

The VT520 is capable of producing a range of sound frequencies. Examples:

To communicate . . .	Sound used
Power on	125 ms beep
Attention warning (also ^G)	125 ms beep
Programmable Alarm	Four short beeps in rapid succession, pause 0.5 seconds repeat. Alarm 1 uses C. Alarm 2 uses Eb.
Sticky keys on	Series of three rising notes (short beeps Eb Ab C)
Sticky keys off	Series of three falling notes (C Ab Eb)
Hourly chime	125 ms beep
Keyclick	2 ms beep
Margin bell	125 ms beep

## Set-Up

### 2.17 Sound

<i>Pnote</i>	Note	~F (Hz)	<i>Pnote</i>	Note	~F (Hz)
1	C5		14	C#6	1047
2	C#5		15	D6	
3	D5		16	D#6	
4	D#5(Eb)	632	17	E6	
5	E5		18	F6	
6	F5		19	F#6	
7	F#5		20	G6	
8	G5		21	G#6	
9	G#5	847	22	A6	
10	A5		23	A#6	
11	A#5	944	24	B6	
12	B5		25	C7	
13	C6				

There is no local sound editor or customize dialog box as the terminal's sound capability is rather simple and does not justify sophisticated editing features. A control function is defined to allow applications to generate custom sounds. The general form is

```
ESC [ Pvolume ; Pduration ; Pnote ; ... FINAL
```

Where:

Pvolume specifies the sound volume (0=off, 1-3=low, 4-7=high).

Pduration specifies the note duration in 1/32 of a second.

Pnote;...Pnote specifies one or more notes to sound at the specified volume and duration (0=silent, 1=Eb, 2=Ab, 3=Bb, 4=C).

The final characters of the sequence are ,~ (2/12 7/14).

The terminal's sound buffer can store 16 notes of specified volume and duration. Additional sound controls are held in the communications input buffer invoking receive data flow control as needed.

## 2.18 Set-Up Factory Defaults

Table 2–10 lists the default for the features in the Set-up Menu and their corresponding host control code if available.

**Table 2–10 Set-Up Factory Defaults**

Set-Up Feature	Factory Default	Host Control Code
<b>Actions</b> ▶		
Clear display		ED
Clear communications		
Reset this session		DECSTR RIS
Restore factory defaults		
-----		
Clock		DECLTOD
Calculator		
Show character sets		
Banner message		DECLBAN
<b>Session</b> ▶		
Select session		
Session name		DECSWT DECSIN
Pages per session	S1=3,S2=3	DECSPMA
Save settings for all		
Restore settings for all		
Copy settings from		
Update session	When available	DECUS
<b>Display</b> ▶		
Lines per screen	24, 25 or 26	DECSNLS
<input type="checkbox"/> Auto resize		DECARSM
Lines per page	24 lines x 3 pages	DECSLPP
<input type="checkbox"/> Review previous lines		DECRPL
Columns per page	80 Columns	DECCOLM
<input type="checkbox"/> Clear on change		DECNCSM
Status display	Local status	DECSSDT
Scrolling mode	Jump	DECSCLM DECSSCLS
Screen background	Dark	DECSCNM
Cursor display	Block	DECSCUSR
<input type="checkbox"/> Blink		
<input type="checkbox"/> Enable cursor		DECTCEM
Cursor coupling		
<input type="checkbox"/> Vertical coupling		DECVCCM
<input type="checkbox"/> Page coupling		DECPCCM

(continued on next page)

## Set-Up

### 2.18 Set-Up Factory Defaults

Table 2–10 (Cont.) Set-Up Factory Defaults

Set-Up Feature	Factory Default	Host Control Code
Cursor direction	Left to right	DECRLM
Copy direction	Left to right	DECRLCM
Zero	0	DECSZS
<input type="checkbox"/> Auto wrap		DECAWM
<input type="checkbox"/> New line mode		LNLM
<input type="checkbox"/> Lock user preferences		
<input type="checkbox"/> Show control characters		CRM
CRT saver	15 minutes	DECCRTSM
<input type="checkbox"/> Host wake-up		DECHWUM
Energy saver	15 minutes	DECEST
<input type="checkbox"/> Overscan		DECOSCNM (mono model only)
<input type="checkbox"/> Framed windows		
Screen alignment...		DECALN
<b>Color</b> ▶		
Assign colors		DECAC DECCTR
Alternate text colors		DECATC
Define colors		DECRSTS
Select color map	ANSI SGR color	DECSTGLT SGR
ASCII color mode	Color	
Blink and Bold style	Foreground	DECBBSM
Erase color	Text background	DECECM
Reverse and Blank attributes		
<input type="checkbox"/> Intensity attributes		
<b>Terminal type</b> ▶		
Emulation mode	VT520...	DECTME
Terminal ID to host	VT520	DECTID
VT default char set	ISO Latin-1	SCS
PCTerm character set	PC International (437)	DECPCTERM
<input type="checkbox"/> 7-bit NRCS characters		DECNRCM
<input type="checkbox"/> Transmit 7-bit controls		S7C1T
<b>ASCII emulation</b> ▶		
Data lines	24 Lines	
Pages	1 x Lines	
Attribute	Char	
Write protect attributes		
<input type="checkbox"/> Blank		
<input type="checkbox"/> Underline		

(continued on next page)

**Table 2–10 (Cont.) Set-Up Factory Defaults**

Set-Up Feature	Factory Default	Host Control Code
<input type="checkbox"/> Reverse		
<input type="checkbox"/> Blink		
<input type="checkbox"/> Dim		
<input type="checkbox"/> Page edit		
Received CR		
<input type="checkbox"/> Recognize DEL		
<input type="checkbox"/> Enhance		
<input type="checkbox"/> Autoscroll		
<input type="checkbox"/> Autopage		
<input type="checkbox"/> Send ACK		
<input type="checkbox"/> Answerback mode		
<input type="checkbox"/> TVI page-flip		
<input type="checkbox"/> Font load		
Block mode	Conversation	
Block end	US/CR	
<b>Keyboard &gt;</b>		
VT Keyboard language	North American	DECKBD
PC Keyboard language	North American	DECKBD
Define key...		DECPFK DECPAK DECUDK DECNUMLK DECCAPSLK DECKLHIM DECLL
Save key definitions		
Recall key definitions		
<input type="checkbox"/> Lock key definitions		DECPKA
Caps lock function	Caps Lock	DECSLCK
Keyclick volume	High	DECSKCV
Warning bell volume	High	DECSWBV
Suppress repeated warnings		
Margin bell volume	Off	DECSMBV
Keyboard encoding	Character (ASCII)	DECPCTERM
Auto repeat	Fast (30/sec)	DECARM
<input type="checkbox"/> Data processing keys		DECBUM
<input type="checkbox"/> Application cursor keys		DECCKM
<input type="checkbox"/> Application keypad mode		DECPAM DECKPNM
<input type="checkbox"/> Map PC keyboard to VT		
<input type="checkbox"/> Ignore missing keyboard		

(continued on next page)

## Set-Up

### 2.18 Set-Up Factory Defaults

Table 2–10 (Cont.) Set-Up Factory Defaults

Set-Up Feature	Factory Default	Host Control Code
<b>Communication</b> >		
Port select	S1=comm1, S2=comm2, Print=comm3	DECSCP
Word size	8 bits	DECSP
Parity	None	DECSP
Stop bits	1 bit	DECSP
Transmit speed	9600	DECSCS
Receive speed	Transmit speed	DECSCS
Transmit flow control	XON/XOFF	DECSCF
Receive flow control	XON/XOFF or XPC	DECSCF
Flow control threshold	Low (64)	
Transmit rate limit	150 cps	DECXRLM DECSTRL
Fkey rate limit	150 cps	DECSTRL
<input type="checkbox"/> Ignore Null character		DECNULM
<input type="checkbox"/> Local echo		SRM
<input type="checkbox"/> Half duplex		DECCHDPXM
<input type="checkbox"/> Auto answerback		
Answerback message...		DECLANS
<input type="checkbox"/> Answerback concealed		DECCANSM
<b>Modem</b> >		
<input type="checkbox"/> Enable modem control		DECMCM
Disconnect delay	2 seconds	DECSDDT
Modem high speed	Ignore	
Modem low speed	Ignore	
<b>Printer</b> >		
Port select	S1=comm1, S2=comm2, Print=comm3	DECSCP
Print mode	Normal	MC
Printer type	DEC ANSI	DECSPRTT DECSDPT
DEC/ISO char sets	National only	DECSDPT
PC character sets	PC International (437)	DECSPPCS
Same as receive		
Print extent	Full page	DECPEX
Print terminator	None	DECPFF
-----		
Serial print speed	4800 baud	DECSCS

(continued on next page)



**Table 2–10 (Cont.) Set-Up Factory Defaults**

Set-Up Feature	Factory Default	Host Control Code
[ ] 2-way communication		MC
Transmit flow control	XON/XOFF	DECSFC
Receive flow control	XON/XOFF	DECSFC
Word size	8 bits	DECSPP
Parity	None	DECSPP
Stop bits	1 bit	DECSPP
<b>Tabs... &gt;</b>		DECST8C HTS
<b>Set-Up language &gt;</b>	English	DECSSL
-----		
<b>[/] On-line &gt;</b>		
<b>Save settings &gt;</b>		
<b>Restore settings &gt;</b>		
<b>Exit set-Up &gt;</b>		



## 3.1 Introduction

To enhance productivity, the VT520 provides local desktop features that can be used at any time the terminal is powered up, even when the terminal is not connected to a host. These features are:

- Calculator
- Clock
- Show character sets
- Banner message
- Copy and paste

This chapter describes these desktop features and their interaction with the terminal.

## 3.2 Invoking Desktop Features

### Overview

The local functions can be accessed through Set-Up or through a user-programmable key combination. Chapter 2, Set-Up, describes how to invoke these desktop features and how to assign a key combination to a specific feature. When one is invoked, the screen is partially obscured by that feature. Pressing `Ctrl/Z`, `F10` (Exit), or `ESC` exits the current desktop feature and reveals the entire screen contents.

From the **Actions** menu, you can invoke **Clock**, **Calculator**, **Show character sets** and the **Banner message**. When the feature is highlighted (displayed in reverse video), press `Enter` or `Return` to enable the feature. A quick start summary of some keyboard features is provided, as well as how to implement the **Copy and Paste** function. You can copy and paste within a session and between sessions.

## Desktop Features

### 3.2 Invoking Desktop Features

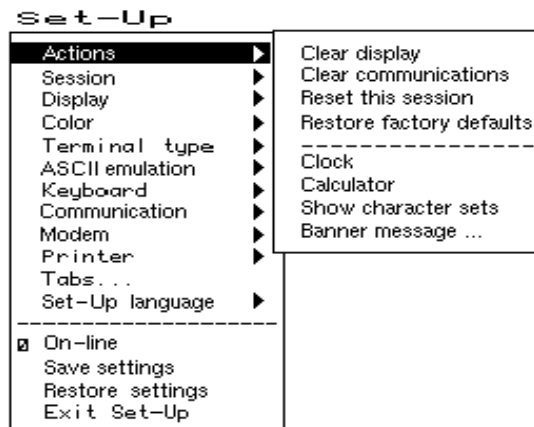

MA049193.GRA

While these desktop features are enabled, other terminal functions are disabled. Press **Ctrl****Z**, **F10**, **Exit**, or **Esc** to exit the feature.

### 3.3 Calculator

You can enable the **Calculator** function in Set-Up by pressing **Caps Lock** **Alt/F12** if you are not in an ASCII emulation mode.

When you select the Calculator function, the terminal displays a simple calculator. See the leftmost layout in Figures 3-1 and 3-2. The keypad keys map directly to the calculator keys. The layout depends on whether a VT or Enhanced PC keyboard is attached, and whether a modifier key (**Shift** or **Alt**) is currently held down.

When a keypad key is pressed, the corresponding key is highlighted (shown in reverse video) on the screen. If a modifier key is pressed down, the display changes to show the new keypad assignment. See the two rightmost layouts in Figures 3-1 and 3-2. All keys not associated with the calculator are ignored.

Figure 3–1 Calculator with VT Keyboard Layout

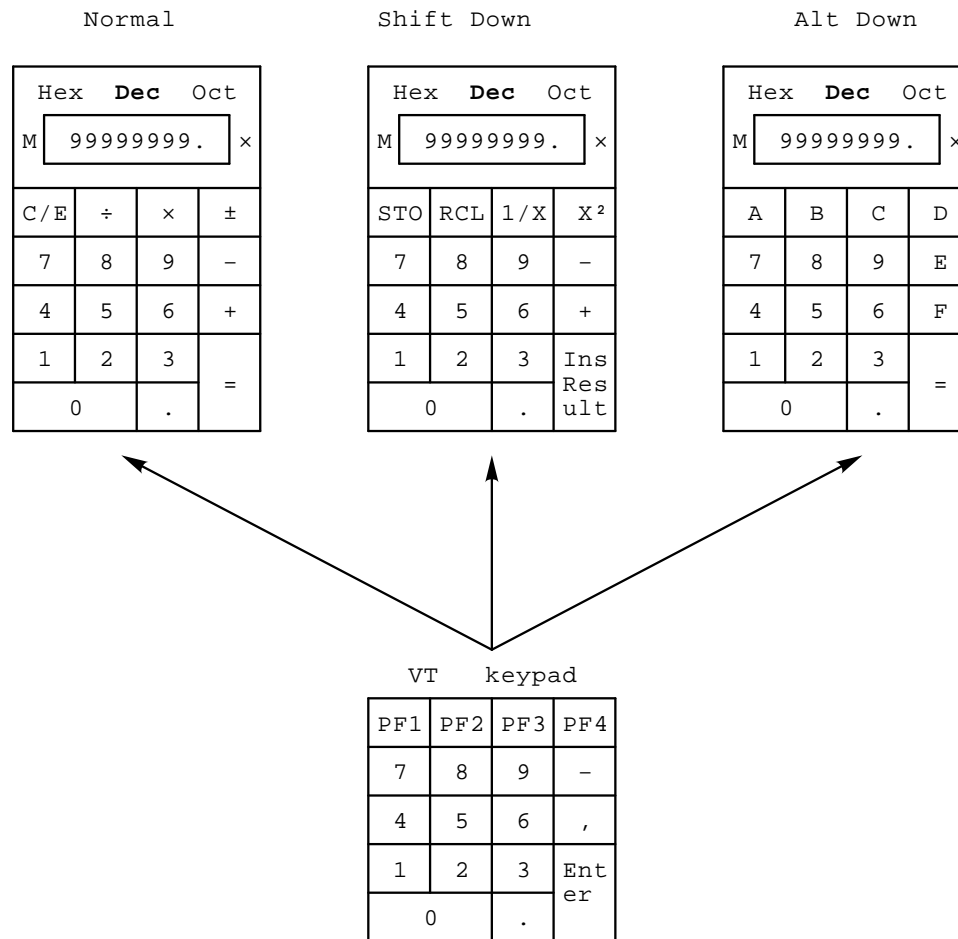

In addition to the numbers on the numeric keypad, you can use the following keys with the calculator:

Key	Function
[H], [O], or [D]	Select hexadecimal, octal, or decimal modes, respectively. The radix is indicated by a radio button. The first letter of each choice is underlined to remind the user of how to select it.
Arrow keys	Move the position of the calculator on the screen.
[Shift]	Changes the keypad display to allow you to select [STO], [RCL], [1/x], [X²], and Insert Result ([Shift/Enter]).
[Alt]	Changes the keypad display to hexadecimal and allows you to select keys [A] through [F] on the numeric keypad.
[C/E]	Clears the entry.
[STO]	Stores the number from the display in memory.
[RCL]	Recalls the number from memory and places it in the display.
[Shift/Enter] (Insert Results)	Inserts the result at the current cursor position after exiting the calculator feature.

Some keys on the main keypad can also be used for calculator functions:

## Desktop Features

### 3.3 Calculator

Main Keypad Key	Calculator Function
<b>+</b>	<b>[,]</b> (VT keyboard); <b>[+]</b> (PC keyboard)
<b>-</b>	<b>-</b>
<b>*</b>	<b>[X]</b>
<b>/</b>	<b>[÷]</b>
<b>=</b>	same as <b>[Enter]</b>
<b>.</b>	<b>[.]</b>
<b>&lt;X</b>	<b>[C/E]</b>

Figure 3-2 Calculator with PC Keyboard Layout

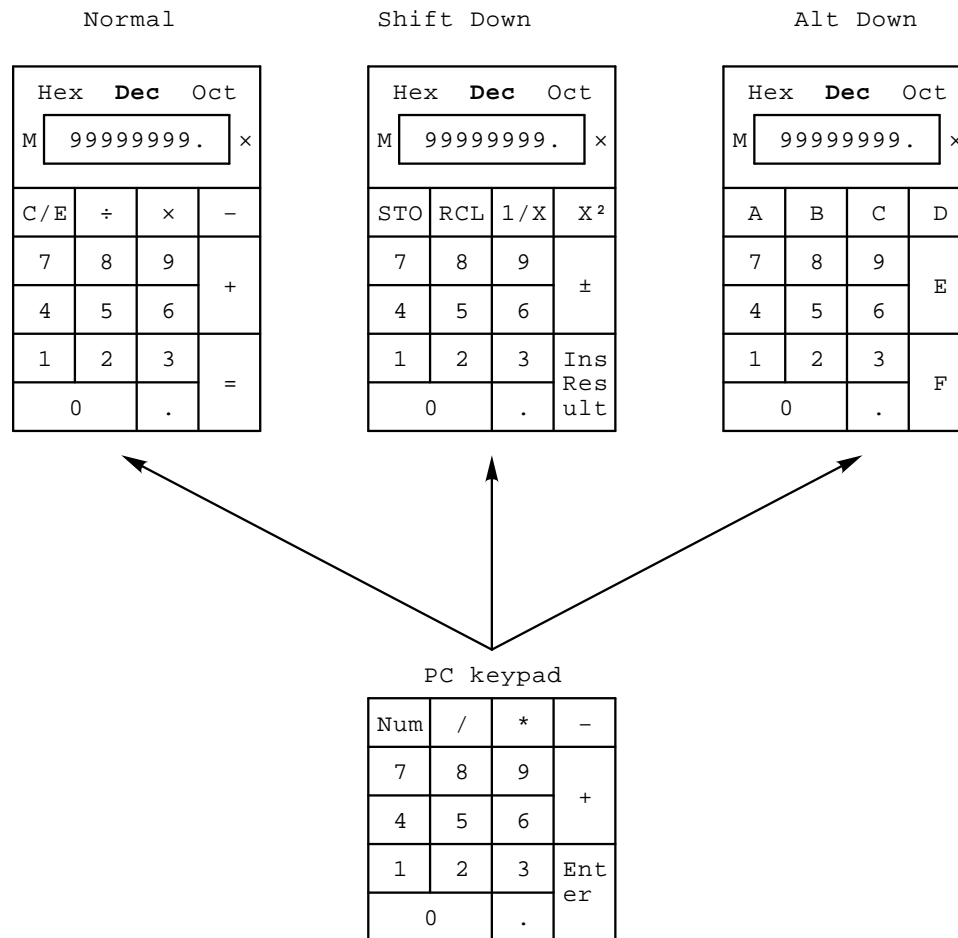

While the calculator is on the screen, all other terminal operations are suspended. The first time the calculator is invoked after the terminal is powered on, the display and memory registers contain 0. The display is eleven characters wide: eight characters are used to display the number's digits, one is used for the decimal point, one for the leading sign bit, and the one in the rightmost position is left blank.

The calculator allows the user to add, subtract, multiply, and divide real numbers in the range [-99,999,999. through +99,999,999.]. While one of these operations is in progress, the calculator displays the corresponding symbol [+ - × ÷] to the right of the display. (See the × in the figures.) You can also compute the reciprocal or the square of a number by pressing the  $\boxed{1/X}$  or  $\boxed{X^2}$  keys, respectively.

All calculator math operations have equal priority except 1/X and X<sup>2</sup>. If a result is wider than the display, then a rounded number will be displayed. The unrounded result will continue to be used in subsequent calculations.

The calculator has a memory register in which an intermediate result can be stored. When you press  $\boxed{STO}$ , you replace the content of this register with the number in the display. When you press  $\boxed{RCL}$ , you place the number from memory in the display. If any value is stored in memory, the calculator displays the letter M to the left of the display.

The number in the display (usually the last result) can be inserted at the current cursor position by pressing  $\boxed{\text{Shift/Enter}}$  (Insert Result), which exits the calculator and transmits the data to the host.

The calculator can also be used with hexadecimal and octal numbers in addition to the default (decimal). The  $\boxed{H}$ ,  $\boxed{O}$ , or  $\boxed{D}$  keys put the calculator in hexadecimal, octal, or decimal modes, respectively. The current mode is in plain text and the other two modes are displayed with the dim attribute. In hexadecimal mode, the numbers A through F are entered by holding down  $\boxed{\text{Alt}}$  and typing the corresponding keypad key. See Figures 3-1 and 3-2. The decimal point cannot be used in the hexadecimal or octal modes, and any fractional part is truncated in these two modes.

## 3.4 Clock

You can enable the **Clock** feature without entering Set-Up by pressing  $\boxed{\text{Caps Lock | Alt|F11}}$  if you are either in a VT or an SCO console emulation mode.

The current time is displayed in the status line, if this feature is enabled. If the 12-hour format is selected, an A or P is displayed after the minutes.

The **Clock** function allows the current time to be set, the hourly chime to be enabled or disabled, and the alarms to be set and armed or disarmed. The current time can also be set from the host through an escape sequence. When the clock function is selected, the window shown in Figure 3-3 is displayed on the screen.

## Desktop Features

### 3.4 Clock

Figure 3–3 Clock Function

Time	<input type="text" value="12:34P"/>	<input type="checkbox"/> 24 hour format
<input checked="" type="checkbox"/> Alarm1	<input type="text" value="12:00"/>	<input type="text" value="Message 1"/>
<input type="checkbox"/> Alarm2	<input type="text" value="12:00"/>	<input type="text" value="Message 2"/>
<input type="checkbox"/> Hourly chime		
<input type="checkbox"/> Request time at power-up		

MA-0325-93.GRA

The following keys have these functions:

Key(s)	Function
<input type="button" value="↓"/> and <input type="button" value="Tab"/>	Move the cursor to the next text field or check box.
<input type="button" value="↑"/> and <input type="button" value="Shift/Tab"/>	Move the cursor to the previous text field or check box.
<input type="button" value="←"/> and <input type="button" value="→"/>	Move the cursor inside a text field.
<input type="button" value="Return"/> and <input type="button" value="Enter"/>	Toggle the state of the check box.
<input type="button" value="←"/> and <input type="button" value="→"/>	Move the cursor inside the current input field. To change the contents of a field, type in the new information.
<input type="button" value="A"/> or <input type="button" value="P"/>	If the 24-hour time format is selected, these keys are ignored. If the 12-hour time format is selected, sets the time to either AM or PM.
<input type="button" value="Caps Lock"/> <input type="button" value="Enter"/>	Input the clock time at the cursor position and exit the clock.

You do not need to type the colon (:) character in the time field; the cursor skips over that character position. The check boxes next to the alarms are used to enable or disable the alarms. When an alarm time comes due and the alarm is enabled, the terminal sounds the alarm for 5 seconds or until you type any key.

The terminal also flashes "Alarm1" or "Alarm2" in the error line and the corresponding message associated with the alarm. The maximum size of the alarm messages is 20 characters. When the alarm is cleared (either by typing a key or after the 5 second timeout), the error line also disappears, revealing the status line if it was enabled.

If the hourly chime check box is enabled, the terminal emits a double beep every hour on the hour.

The state of the alarms, the alarm times, and the alarm messages are saved in NVM if the user chooses **Save settings** from Set-Up. The clock feature is disabled when the terminal is turned off.



## 3.5 Review Previous Lines

In Set-Up or through software, you can allocate the pages that are assigned to each session, up to a total of eight pages or nine pages on the color model. When **Review previous lines** is selected, the page memory allocation for a session becomes a *single page* and a *scroll back buffer*. You can then use **Ctrl↑** and **Ctrl↓** keys to scroll up or down to review lines previously scrolled off the screen. (Note: When this feature is enabled, the host cannot write to specific pages, and control codes from the host are ignored.)

## 3.6 Character Set Tables

### 3.6.1 Show Character Sets feature

When you select **Show character sets**, the current character set is shown on the screen. Nonprinting characters are shown in control representation mode wherever possible.

If you are in either a VT or an SCO console emulation mode, you can enable the **Show character sets** desktop feature without entering Set-Up by using **Caps Lock Alt|F10**. When the character set is displayed, you can use the following keys with this feature:

Key	Function
<b>Next</b> or <b>Prev</b> <b>Page Up</b> or <b>Page Down</b>	Looks through the available character sets.
<b>Shift A</b>	Restores the ASCII character set (when the Line Drawing set is displayed.)
<b>Shift L</b>	Displays the line drawing character set, if you are using a VT character set.
<b>Shift T</b>	Displays the technical character set.
<b>Shift Enter</b>	For the current character set, inserts the highlighted character into text at the current cursor position, if you are using a VT character set.

ASCII terminal emulations support the character sets listed in Table 3–1. They do not support any 8-bit or ISO standard character sets.

**Table 3–1 ASCII Emulation Character Sets**

Emulation Mode	Character Set
WYSE 325	Native/WY-50+
WYSE 160/60 Native	Native/WY-50+
WYSE PCTerm	PC Multilingual (Code Page 850)
WYSE 50+, 150/120	Native/WY-50+
TVI 950, 925, 910+	Native/WY-50+
ADDS A2	Native/WY-50+

## Desktop Features

### 3.6 Character Set Tables

#### 3.6.2 Banner message

The Banner message is the message that is displayed when you turn the terminal on. You can change this message as desired. From the **Actions** menu, select **Banner message...**

1. Press **Return** or **Enter** to display a dialog box.
2. Enter your banner message.
3. Press the **↓** to select the **OK** button.
4. Press **Return** or **Enter** to return to the Set-Up menu.

### 3.7 Keyboard Summary

The following table provides a quick start summary of some keyboard features.

To ...	VT Keyboard, press ...	PC Keyboard, press ...
Hold the screen	<b>F1</b>	<b>Scroll Lock</b>
Print the screen	<b>F2</b>	<b>Print Screen</b>
Enter/Exit Set-Up	<b>F3</b>	<b>Caps Lock</b>   <b>Print Screen</b>
Switch session	<b>F4</b> or <b>Caps Lock</b>   <b>KP0</b>	<b>Caps Lock</b>   <b>KP0</b>
Select specific session	<b>Caps Lock</b>   <b>KP1, 2, 3, or 4</b>	<b>Caps Lock</b>   <b>KP1, 2, 3, or 4</b>
Break	<b>F5</b>	<b>Caps Lock</b>   <b>Pause</b>
Toggle split screen	<b>Ctrl</b>   <b>F4</b>	<b>Ctrl</b>   <b>Caps Lock</b>   <b>0</b>   <i>kpd</i>
Adjust window size	<b>Ctrl</b>   <b>Shift</b>   <b>↑</b> or <b>↓</b>	<b>Ctrl</b>   <b>Shift</b>   <b>↑</b> or <b>↓</b>
Pan previous lines	<b>Ctrl</b>   <b>↑</b> or <b>↓</b>	<b>Ctrl</b>   <b>↑</b> or <b>↓</b>
Review previous lines	<b>Ctrl</b>   <b>↑</b> or <b>↓</b>	<b>Ctrl</b>   <b>↑</b> or <b>↓</b>
<b>Copy and paste:</b>		
Start copy	Hold down <b>F1</b> †	Hold down <b>Scroll Lock</b>
Move to beginning of text	<b>←</b> , <b>⇒</b> , <b>↑</b> , or <b>↓</b>	<b>←</b> , <b>⇒</b> , <b>↑</b> , or <b>↓</b>
Select beginning of text	<b>Select</b> ‡	<b>Home</b> ‡
Select end of text	<b>Remove</b>	<b>End</b>
Finish copy	Release <b>F1</b>	Release <b>Scroll Lock</b>
Move to different session if desired.		
Paste	<b>F1</b>   <b>Insert Here</b>	<b>Scroll Lock</b>   <b>Insert</b>

†For SCO console, press **Caps Lock** | **F1**.

‡If you press the **Select** key (or **Home** key) twice, the keyboard will toggle the copy direction between left-to-right and right-to-left directions for use with right-to-left scripts.

#### Note

The copy and paste buffer is limited to 6K bytes, which is about 24 lines × 132 columns of data. You also cannot copy and paste from the scroll back buffer.

# Part II

---

## VT520 ANSI Mode

This part includes the following chapters:

- Chapter 4, ANSI Control Functions Summary
- Chapter 5, ANSI Control Functions
- Chapter 6, SCO Console Emulation
- Chapter 7, Character Sets
- Chapter 8, Keyboard Processing
- Chapter 9, Communications
- Chapter 10, Printer Port



---

## ANSI Control Functions Summary

### 4.1 Introduction

This chapter provides a general description of ANSI control functions. This chapter provides information on working with 7- and 8-bit environments and the conventions used in each, and it describes the **Show control characters** Set-Up feature. In addition, this chapter provides summary tables of the ANSI control functions.

<b>For . . .</b>	<b>See page . . .</b>
Control characters	4-1
Control functions	4-5
Working with 7-Bit and 8-Bit environments	4-10
Showing control characters	4-11
ASCII code tables	4-14,15
<b>ANSI control function tables</b>	<b>4-16</b>
VT52 mode escape sequences	4-45

### 4.2 Control Characters

The purpose of a control character is to control an action such as line spacing, paging, or data flow. The terminal does not display control characters unless you select **Show control characters** from the **Display** Set-Up menu. There are two groups of control characters.

- C0 7-bit control characters, in columns 0 and 1 of the 8-bit code table
- C1 8-bit control characters, in columns 8 and 9 of the 8-bit code table

Table 4-1 lists the C0 control characters the VT520 recognizes. Table 4-2 lists the C1 control characters the VT520 recognizes. You can also code C1 control characters as 7-bit escape sequences. Table 4-3 lists the equivalent 7-bit sequences for 8-bit control characters. All three tables give column/row locations as an unambiguous character representation.

## ANSI Control Functions Summary

### 4.2 Control Characters

Table 4–1 C0 (7-Bit) Control Characters Recognized

Name	Mnemonic Column/Row	Function
Null	<b>NUL</b> 0/0	NUL has no function (ignored by the terminal). May be used as a fill character.
Enquire	<b>ENQ</b> 0/5	Sends the answerback message. (Communications Set-Up)
Bell	<b>BEL</b> 0/7	Sounds the bell tone if the bell is enabled in Keyboard Set-Up.
BS	<b>BS</b> 0/8	Moves the cursor one character position to the left. If the cursor is at the left margin, no action occurs.
Horizontal tab	<b>HT</b> 0/9	Moves the cursor to the next tab stop. If there are no more tab stops, the cursor moves to the right margin. HT does not cause text to auto wrap.
Line feed	<b>LF</b> 0/10	Causes a line feed or a new line operation, depending on the setting of line feed/new line mode.
Vertical tab	<b>VT</b> 0/11	Treated as LF.
Form feed	<b>FF</b> 0/12	Treated as LF.
Carriage return	<b>CR</b> 0/13	Moves the cursor to the left margin on the current line.
Shift out (locking shift 1)	<b>SO</b> (LS1) 0/14	Maps the G1 character set into GL. You designate G1 by using a select character set (SCS) sequence.
Shift in (locking shift 0)	<b>SI</b> (LS0) 0/15	Maps the G0 character set into GL. You designate G0 by using a select character set (SCS) sequence.
Device control 1 (XON)	<b>DC1</b> 1/1	Also known as XON. If XON/XOFF flow control is enabled in Communications Set-Up, DC1 clears DC3 (XOFF). This action causes the VT520 to continue sending characters.
Device control 3 (XOFF)	<b>DC3</b> 1/3	Also known as XOFF. If XON/XOFF flow control is enabled in Communications Set-Up, DC3 causes the VT520 to stop sending characters. The terminal cannot resume sending characters until it receives a DC1 control character.
Cancel	<b>CAN</b> 1/8	Immediately cancels an escape sequence, control sequence, or device control string in progress. In this case, the VT520 does not display any error character.
Substitute	<b>SUB</b> 1/10	Immediately cancels an escape sequence, control sequence, or device control string in progress, and displays a reverse question mark as an error character.

(continued on next page)

## ANSI Control Functions Summary 4.2 Control Characters

**Table 4–1 (Cont.) C0 (7-Bit) Control Characters Recognized**

Name	Mnemonic Column/Row	Function
Escape	<b>ESC</b> 1/11	Introduces an escape sequence. ESC also cancels any escape sequence, control sequence, or device control string in progress.
Delete	<b>DEL</b> 7/15	Ignored when received, unless a 96-character set is mapped into GL. DEL is not used as a fill character. Digital does not recommend using DEL as a fill character. Use NUL instead.

**Table 4–2 C1 (8-Bit) Control Characters Recognized**

Name	Mnemonic Column/Row	Function
Index	<b>IND</b> 8/4	Moves the cursor down one line in the same column. If the cursor is at the bottom margin, the page scrolls up.
Next line	<b>NEL</b> 8/5	Moves the cursor to the first position on the next line. If the cursor is at the bottom margin, the page scrolls up.
Horizontal tab set	<b>HTS</b> 8/8	Sets a horizontal tab stop at the column where the cursor is.
Reverse index	<b>RI</b> 8/13	Moves the cursor up one line in the same column. If the cursor is at the top margin, the page scrolls down.
Single shift 2	<b>SS2</b> 8/14	Temporarily maps the G2 character set into GL, for the next graphic character. You designate the G2 set by using a select character set (SCS) sequence.
Single shift 3	<b>SS3</b> 8/15	Temporarily maps the G3 character set into GL, for the next graphic character. You designate the G3 set by using a select character set (SCS) sequence.
Device control string	<b>DCS</b> 9/0	Introduces a DCS control string. DCS control strings are used for loading function keys or a soft character set.
Start of string	<b>SOS</b> 9/8	Ignored.
DEC private identification	<b>DECID</b> 9/10	Makes the terminal send its device attributes response to the host (same as an ANSI device attributes (DA) sequence). Programs should use the ANSI DA sequence instead. If the printer is in controller mode, the terminal sends the sequence to the printer.
Control sequence introducer	<b>CSI</b> 9/11	CSI introduces a control sequence.

(continued on next page)

## ANSI Control Functions Summary

### 4.2 Control Characters

**Table 4–2 (Cont.) C1 (8-Bit) Control Characters Recognized**

Name	Mnemonic Column/Row	Function
String terminator	<b>ST</b> 9/12	Ends a control string. ST is normally used in combination with DCS, OSC, PM, or APC.
Operating system command	<b>OSC</b> 9/13	OSC introduces an OSC control string.
Privacy message	<b>PM</b> 9/14	PM introduces a PM control string. The VT520 ignores all PM control strings.
Application program command	<b>APC</b> 9/15	APC introduces an application program command. The VT520 ignores all APC control strings.

**Table 4–3 8-Bit Control Characters and Their 7-Bit Equivalents**

Name	8-Bit Character	7-Bit Sequence	
Index	<b>IND</b> 8/4	<b>ESC</b> 1/11	<b>D</b> 4/4
Next line	<b>NEL</b> 8/5	<b>ESC</b> 1/11	<b>E</b> 4/5
Horizontal tab set	<b>HTS</b> 8/8	<b>ESC</b> 1/11	<b>H</b> 4/8
Reverse index	<b>RI</b> 8/13	<b>ESC</b> 1/11	<b>M</b> 4/13
Single shift 2	<b>SS2</b> 8/14	<b>ESC</b> 1/11	<b>N</b> 4/14
Single shift 3	<b>SS3</b> 8/15	<b>ESC</b> 1/11	<b>O</b> 4/15
Device control string	<b>DCS</b> 9/0	<b>ESC</b> 1/11	<b>P</b> 5/0
Start of string	<b>SOS</b> 9/8	<b>ESC</b> 1/11	<b>X</b> 5/8
DEC private identification	<b>DECID</b> 9/10	<b>ESC</b> 1/11	<b>Z</b> 5/10
Control sequence introducer	<b>CSI</b> 9/11	<b>ESC</b> 1/11	<b>[</b> 5/11
String terminator	<b>ST</b> 9/12	<b>ESC</b> 1/11	<b>\</b> 5/12
Operating system command	<b>OSC</b> 9/13	<b>ESC</b> 1/11	<b>]</b> 5/13
Privacy message	<b>PM</b> 9/14	<b>ESC</b> 1/11	<b>^</b> 5/14
Application program	<b>APC</b> 9/15	<b>ESC</b> 1/11	<b>_</b> 5/15



## 4.3 Control Functions

You use control functions to make the terminal perform special actions in your applications. Examples:

- Move the cursor.
- Delete a line of text.
- Select bold or underlined text.
- Change character sets.
- Make the terminal emulate a VT52 or VT100 terminal.

There are single-character and multiple-character control functions.

The single-character functions are the C0 and C1 control characters. You can use C0 characters in a 7-bit or 8-bit environment. C1 characters provide a few more functions than C0 characters, but you can only use C1 characters directly in an 8-bit environment.

Multiple-character control functions provide many more functions than the C0 and C1 characters. Multiple-character functions can use control characters and graphic characters. There are three basic types of multiple-character control functions.

- Escape sequences
- Control sequences
- Control strings

The structure of control functions are defined by ANSI and ISO standards. Many individual sequences are defined by these same standards and are used throughout the industry. Others are private sequences, created by manufacturers in accordance with ANSI and ISO standards for use in their own products.

In this manual, control functions created by Digital have the prefix DEC in their mnemonic name. For example, column mode has the mnemonic DECCOLM. All other control functions used in the ANSI VT emulations are standardized by ISO.

The following sections describe the format for escape sequences, control sequences, and device control strings.

### Programming Tip

When you use control functions, remember that the binary codes define a function—not the graphic characters. This manual uses graphic characters from the DEC Multinational character set to show control functions. If you use another character set, the graphic characters for control functions may change, but the code is always the same.

### 4.3.1 Sequence Format

This manual shows escape and control sequences in their 8-bit format. You can also use equivalent 7-bit sequences (Table 4–3).

The 8-bit format uses the C0 and C1 control characters and ASCII characters from the DEC Multinational character set. The sequences also show each character's column/row position in the character set table, below the character. The column/row code eliminates confusion over similar-looking characters such as 0 (3/0) and O (4/15).

## ANSI Control Functions Summary

### 4.3 Control Functions

---

#### Note

---

Spaces appear between characters in a sequence for clarity. These spaces are not part of the sequence. If a space is part of the sequence, the SP (2/0) character appears.

---

#### 4.3.2 Escape Sequences

An escape sequence uses two or more bytes to define a specific control function. Escape sequences do not include variable parameters, but may include intermediate characters. Here is the format for an escape sequence.

<b>ESC</b>	<b>I</b>	<b>F</b>
1/11	2/0 to 2/15	3/0 to 7/14
Escape character	Intermediate characters (zero or more characters)	Final character (one character)

**ESC** introduces escape sequences. After receiving the ESC control character, the terminal interprets the next received characters as part of the sequence.

**I** represents zero or more *intermediate characters* that can follow the ESC character. Intermediate characters come from the 2/0 through 2/15 range of the code table.

**F** is the *final character*. This character indicates the end of the sequence. The final character comes from the 3/0 through 7/14 range of the code table. The intermediate and final characters together define a single control function.

For example, the following escape sequence changes the current line of text to double-width, single-height characters:

<b>ESC</b>	<b>#</b>	<b>6</b>
1/11	2/3	3/6

#### 4.3.3 Control Sequences

A control sequence uses two or more bytes to define a specific control function. Control sequences usually include variable parameters. Here is the format for a control sequence.

<b>CSI</b>	<b>P...P</b>	<b>I...I</b>	<b>F</b>
9/11	3/0 to 3/15	2/0 to 2/15	4/0 to 7/14
Control sequence introducer	Parameter (zero or more characters)	Intermediate (zero or more characters)	Final (one character)

##### 4.3.3.1 Control Sequence Introducer

**CSI** is the *control sequence introducer*. You can also use the equivalent 7-bit sequence, ESC (1/11) [ (5/11), as a substitute for CSI. After receiving CSI, the terminal interprets the next received characters as part of the sequence.

**4.3.3.2 Parameters**

**P...P** are *parameter characters* received after CSI. These characters are in the 3/0 to 3/15 range in the code table. Parameter characters modify the action or interpretation of the sequence. You can use up to 16 parameters per sequence. You must use the ; (3/11) character to separate parameters.

All parameters are unsigned, positive decimal integers, with the most significant digit sent first. Any parameter greater than 9999 (decimal) is set to 9999 (decimal). If you do not specify a value, a 0 value is assumed. An omitted parameter indicates a *default value* for the sequence. For most sequences, the default value is 1.

---

**Note**

---

All parameters must be positive decimal integers. Do not use a decimal point in a parameter—the terminal will ignore the command.

---

If the first character in a parameter string is the ? (3/15) character, it indicates that DEC private parameters follow. The terminal interprets private parameters according to ANSI X3.64 and ISO 6429.

The VT520 processes two types to parameters, numeric and selective.

**Numeric Parameters**

A numeric parameter indicates a number value such as a margin location. In this manual, numeric parameters appear as actual values or as *Pn, Pn1, Pn2*, and so on. The following is an example of a control sequence with numeric parameters:

<b>CSI</b>	<b>5</b>	<b>;</b>	<b>2 0</b>	<b>r</b>
9/11	3/5	3/11	3/2 3/0	7/2
Control sequence introducer	First numeric parameter	Delimiter	Second numeric parameter	Final character

This sequence sets the top and bottom margins of the current page. The top margin is at line 5, the bottom is at line 20. The ; (3/11) separates the two parameters.

**Selective Parameters**

A selective parameter selects an action associated with the specific parameter. In this manual, selective parameters usually appear as *Ps, Ps1, Ps2*, and so on. The following is an example of a control sequence using selective parameters:

<b>CSI</b>	<b>1</b>	<b>;</b>	<b>4</b>	<b>m</b>
9/11	3/1	3/11	3/4	6/13
Control sequence introducer	First selective parameter	Delimiter	Second selective parameter	Final character

This control sequence turns on the bold and underline attribute at the cursor position. The parameters are 1 (indicating the bold attribute) and 4 (indicating the underline attribute). The ; (3/11) delimiter separates the two parameters.

## ANSI Control Functions Summary

### 4.3 Control Functions

#### 4.3.3.3 Intermediate Characters

**I...I** are zero or more *intermediate characters* received after CSI. These characters are in the 2/0 to 2/15 range.

#### 4.3.3.4 Final Character

**F** is the *final character* from the 4/0 to 7/14 range. The final character indicates the end of the sequence. The intermediate and final characters together define a control function. If there are no intermediate characters, the final character defines the function.

#### 4.3.4 Device Control Strings

Device control strings (DCS), like control sequences, use two or more bytes to define specific control functions. However, a DCS also includes a data string. Here is the format for a device control string.

<b>DCS</b> 9/0	<b>P...P</b> 3/0 to 3/15	<b>I...I</b> 2/0 to 2/15	<b>F</b> 4/0 to 3/15	<b>Data string</b> *****	<b>ST</b> 9/12
Device control string introducer	Zero or more parameters	Zero or more intermediates	Final	String	String terminator

**DCS** is the *device control string introducer*. DCS is the C1 control character at position 9/0. You can also use the equivalent 7-bit sequence, ESC (1/11) P (5/0). After receiving DCS, the terminal processes the next received characters as part of the string function.

**P...P** are *parameter characters* received after DCS. The use of parameter characters in a device control string is a Digital extension to the ANSI syntax. According to ANSI standards, any elements included after DCS are part of the data string.

Parameter characters are in the 3/0 to 3/15 range. They modify the action or interpretation of the device control string. You can use up to 16 parameters per string. Each parameter is separated with a ; (3/11) character. These characters follow the same rules as in a control sequence. See the “Section 4.3.3” section in this chapter.

**I...I** are zero or more intermediate characters received after CSI. These characters are in the 2/0 to 2/15 range.

**F** is the final character in the 4/0 to 7/14 range. The final character indicates the end of the string. The intermediate and final characters define the string. If there are no intermediates, the final character defines the string.

**Data string** follows the final character and usually includes several definition strings. Each definition string can be several characters in length. Individual strings are separated by the ; (3/11) delimiter.

**ST** is the *string terminator*. ST (9/12) indicates the end of a string. You can also use the equivalent 7-bit sequence, ESC (1/11) \ (5/12).

The following is an example of a device control string:

<b>DCS</b>	<b>0</b>	<b>!</b>	<b>u</b>	<b>%</b>	<b>5</b>	<b>ST</b>
9/0	3/0	2/1	7/5	2/5	3/5	9/12
Device control string introducer	Parameter	Inter-mediate	Final	Data string		String terminator

This device control string assigns the DEC Supplemental Graphic set as the user-preferred supplemental set.

### 4.3.5 Using Control Characters in Sequences

You can use control characters—ESC, CAN, and SUB—to interrupt or recover from errors in escape sequences, control sequences, and device control strings.

- You can send ESC (1/11) to cancel a sequence in progress and begin a new sequence.
- You can send CAN (1/8) to indicate the present data is in error or to cancel a sequence in progress. The VT520 interprets the characters following CAN as usual.
- You can send SUB (1/10) to cancel a sequence in progress. The VT520 interprets the characters following SUB as usual.

The VT520 does not lose data when errors occur in escape or control sequences and device control strings. The terminal ignores unrecognized sequences and strings, unless they end a current escape sequence.

### 4.3.6 7-Bit Code Extension Technique

ANSI and ISO standards define a means whereby all 8-bit data interchange can also be transmitted using 7-bits. ANSI calls this technique “7-bit code extension.” To achieve this code extension, the 8-bit C1 control characters each have a corresponding 7-bit representation. 8-bit graphic characters from the right half of the 8-bit code table (GR) can be transmitted in 7-bits by encapsulating them with the SO and SI control functions. Here are some examples.

<b>8-Bit C1 Character</b>	<b>7-Bit Code Extension Escape Sequence</b>	
<b>CSI</b>	<b>ESC</b>	<b>[</b>
9/11	1/11	5/11
<b>SS3</b>	<b>ESC</b>	<b>O</b>
8/15	1/11	4/15
<b>IND</b>	<b>ESC</b>	<b>D</b>
8/4	1/11	4/4
<b>DCS</b>	<b>ESC</b>	<b>P</b>
9/0	1/11	5/0

In general, you can use the 7-bit code extension technique in two ways.

- You can represent any C1 control character as a 2-character escape sequence. The second character of the sequence has a code that is 40<sub>16</sub> or 64<sub>10</sub> less than the code of the C1 character.
- You can make any escape sequence whose second character is in the range of 4/0 through 5/15 one byte shorter by removing the ESC character and adding 40<sub>16</sub> to the code of the second character. This generates an 8-bit control character. For example, you can change **ESC [** to **CSI** with this method.

## ANSI Control Functions Summary

### 4.4 Working with 7-Bit and 8-Bit Environments

#### 4.4 Working with 7-Bit and 8-Bit Environments

There are three requirements for using one of the terminal's 8-bit character sets.

- Your program and communication environment must be 8-bit compatible.
- The terminal cannot be in national replacement character set mode (DECNRCM).
- The terminal must operate in VT level 4 (or higher) or PC TERM mode. When the terminal operates in VT level 1 mode or VT52 mode, you are limited to working in a 7-bit environment.)

The following sections describe conventions that apply in VT level 4 or higher.

##### 4.4.1 Conventions for Codes Received by the Terminal

The terminal expects to receive character codes in a form compatible with 8-bit coding. Your application can use the C0 and C1 control characters, as well as the 7-bit C1 code extensions, if necessary. The terminal always interprets these codes correctly.

When your program sends GL or GR codes, the terminal interprets the character codes according to the graphic character sets in use. When you turn on or reset the terminal, you automatically select the ASCII character set in GL and the current user-preferred character set in GR. You select the user-preferred set in the **Terminal type, VT default character set** Set-Up menu. This mapping assumes the current terminal mode is VT level 4.

##### 4.4.2 Conventions for Codes Sent by the Terminal

The terminal can send data to an application in two ways.

- Directly from the keyboard
- In response to commands from the host (application or operating system)

Most function keys on the keyboard send multiple-character control functions. Many of these functions start with CSI (9/11) or SS3 (8/15), which are C1 characters. If your application cannot handle 8-bit characters, you can make the terminal automatically convert all C1 characters to their equivalent 7-bit code extensions before sending them to the application. To convert C1 characters, you use the DECSCL commands.)

By default, the terminal is set to automatically convert all C1 characters sent to the application to 7-bit code extensions. However, to ensure the correct mode of operation, always use the appropriate DECSCL commands.

---

#### Note

---

In VT level 4, the terminal can send GR graphic characters to an application, even if the application cannot handle 8-bit codes. However, in a 7-bit environment, the terminal sends C1 controls as 7-bit escape sequences and does not send 8-bit graphic characters.

New programs should accept both 7-bit and 8-bit forms of the C1 control characters.

---

## 4.5 Showing Control Characters

The VT520 lets you display control characters as graphic characters, when you want to debug your applications. With this mode enabled, the terminal does not perform all control functions.

To enable this mode, use the **Display** Set-Up menu and enable the check box for **Show control characters**; or you can use the **control representation mode (CRM)** control sequence. (You cannot select this mode with an escape sequence.)

### VT level 5 mode

The terminal uses new control sequences developed for the VT500 series terminals. This level includes all other levels.

### VT level 4 mode

The terminal uses new control sequences developed for the VT400 series terminals. This level includes all lower levels. The terminal temporarily loads a special graphic character set into C0, GL, C1, and GR. Figures 4-1 and 4-2 shows this special set, called the display controls font. The terminal uses this font to display control characters on the screen.

### VT level 1 or VT52 mode

The terminal uses new control codes and escape sequences developed for the VT100 series terminals, include those developed for the VT52 terminal. The terminal temporarily loads the left half of the display controls font into C0 and GL. The terminal uses this half of the font to display all C0 and GL characters. (C1 and GR are meaningless in VT52 or VT100 emulations.)

### Displaying 36 or more lines on the screen

When you display 36 or more lines on the screen (DECSNLS), the terminal uses a smaller font to display control characters. The smaller font represents each control character as a two-character symbol instead of a three-character symbol. Figures 4-1 and 4-2 show what the control characters look like when displaying 24 or 25 lines on the screen. Table 4-4 shows the abbreviation for the control characters in the smaller font.

Table 4-4 Control Character Displayed on Screen

Control Character in Large Font	Control Character in Small Font	Name
NUL	NL	Null
SOH	SH	Start of heading
STX	SX	Start of text
ETX	EX	End of text
EOT	ET	End of transmission
ENQ	EN	Enquire
ACK	AK	Acknowledge
BEL	BL	Bell
BS	BS	Backspace
HT	HT	Horizontal tab
LF	LF	Line feed
VT	VT	Vertical tab

(continued on next page)

## ANSI Control Functions Summary

### 4.5 Showing Control Characters

Table 4–4 (Cont.) Control Character Displayed on Screen

Control Character in Large Font	Control Character in Small Font	Name
FF	FF	Form feed
CR	CR	Carriage return
SO	SO	Shift out
SI	SI	Shift in
DLE	DE	Data link escape
DC1	D1	Device control 1 (XON)
DC2	D2	Device control 2
DC3	D3	Device control 3 (XOFF)
DC4	D4	Device control 4
NAK	NK	Negative acknowledge
SYN	SY	Synchronous idle
ETB	EB	End of transmission block
CAN	CA	Cancel
EM	EM	End of medium
SUB	SB	Substitute
ESC	EC	Escape
FS	FS	Field separator
GS	GS	Group separator
RS	RS	Record separator
US	US	Unit separator
IND	IN	Index
NEL	NE	Next line
SSA	SA	Start selected area
ESA	EA	End selected area
HTS	HS	Horizontal tab set
HTJ	HJ	Horizontal tab with justify
VTS	VS	Vertical tab set
PLD	PD	Partial line down
PLU	PU	Partial line up
RI	RI	Reverse index
SS2	S2	Single shift 2
SS3	S3	Single shift 3
DCS	DC	Device control string
PU1	P1	Private use 1
PU2	P2	Private use 2
STS	SS	Set transmit state
CCH	CC	Cancel character
MW	MW	Message waiting
SPA	SP	Start protected area
EPA	EP	End protected area
CSI	CS	Control sequence introducer
ST	ST	String terminator
OSC	OS	Operating system command

(continued on next page)



## ANSI Control Functions Summary

### 4.5 Showing Control Characters

Table 4–4 (Cont.) Control Character Displayed on Screen

Control Character in Large Font	Control Character in Small Font	Name
PM	PM	Private message
APC	AP	Application program command
NS	NS	No-break space

#### *Exceptions*

Some control functions still work in this mode.

- LF, FF, and VT cause a carriage return and line feed (CR LF) that move the cursor to a new line. The terminal displays the LF, FF, or VT character before performing the new line function.
- XOFF (DC3) and XON (DC1) maintain flow control, if enabled in set-up. The terminal displays the DC1 or DC3 character after performing the control function.
- The terminal does not display SSU session management commands.

# ANSI Control Functions Summary

## 4.5 Showing Control Characters

Figure 4-1 7-bit ASCII Code Table with C0 Control Characters Font (Left Half)

Column	0	1	2	3	4	5	6	7	
b8 Bits	0	0	0	0	0	0	0	0	
b7	0	0	0	0	1	1	1	1	
b6	0	0	1	1	0	0	1	1	
b5	0	1	0	1	0	1	0	1	
b4	0	0	0	0	0	0	0	0	
b3	0	0	0	0	0	0	0	0	
b2	0	0	0	0	0	0	0	0	
b1	0	0	0	0	0	0	0	0	
0	0 0 0 0	NUL 0 0 0	DLO 20 16 10	SP 40 32 20	0 60 48 30	@ 100 64 40	P 120 80 50	' 140 96 60	p 160 112 70
1	0 0 0 1	SOH 1 1 1	DC1 21 17 11	! 41 33 21	1 61 49 31	A 101 65 41	Q 121 81 51	a 141 97 61	q 161 113 71
2	0 0 1 0	STX 2 2 2	DC2 22 18 12	" 42 34 22	2 62 50 32	B 102 66 42	R 122 82 52	b 142 98 62	r 162 114 72
3	0 0 1 1	ETX 3 3 3	DC3 23 19 13	# 43 35 23	3 63 51 33	C 103 67 43	S 123 83 53	c 143 99 63	s 163 115 73
4	0 1 0 0	EOT 4 4 4	DC4 24 20 14	\$ 44 36 24	4 64 52 34	D 104 68 44	T 124 84 54	d 144 100 64	t 164 116 74
5	0 1 0 1	ENQ 5 5 5	NAK 25 21 15	% 45 37 25	5 65 53 35	E 105 69 45	U 125 85 55	e 145 101 65	u 165 117 75
6	0 1 1 0	ACK 6 6 6	SYN 26 22 16	& 46 38 26	6 66 54 36	F 106 70 46	V 126 86 56	f 146 102 66	v 166 118 76
7	0 1 1 1	BEL 7 7 7	ETB 27 23 17	' 47 39 27	7 67 55 37	G 107 71 47	W 127 87 57	g 147 103 67	w 167 119 77
8	1 0 0 0	BS 10 8 8	CAN 30 24 18	( 50 40 28	8 70 56 38	H 110 72 48	X 130 88 58	h 150 104 68	x 170 120 78
9	1 0 0 1	HT 11 9 9	EM 31 25 19	) 51 41 29	9 71 57 39	I 111 73 49	Y 131 89 59	i 151 105 69	y 171 121 79
10	1 0 1 0	LF 12 10 A	? 32 26 1A	* 52 42 2A	:	J 112 74 4A	Z 132 90 5A	j 152 106 6A	z 172 122 7A
11	1 0 1 1	VT 13 11 B	ESC 33 27 1B	+ 53 43 2B	;	K 113 75 4B	[ 133 91 5B	k 153 107 6B	{ 173 123 7B
12	1 1 0 0	FF 14 12 C	FS 34 28 1C	, 54 44 2C	<	L 114 76 4C	\ 134 92 5C	l 154 108 6C	174 124 7C
13	1 1 0 1	CR 15 13 D	GS 35 29 1D	- 55 45 2D	=	M 115 77 4D	] 135 93 5D	m 155 109 6D	} 175 125 7D
14	1 1 1 0	SO 16 14 E	RS 36 30 1E	. 56 46 2E	>	N 116 78 4E	^ 136 94 5E	n 156 110 6E	~ 176 126 7E
15	1 1 1 1	SI 17 15 F	US 37 31 1F	/ 57 47 2F	?	O 117 79 4F	_ 137 95 5F	o 157 111 6F	D_T 177 127 7F



Key

Character	ESC	33	Octal
		27	Decimal
		1B	Hex

GSF\_0647\_89.DG

# ANSI Control Functions Summary

## 4.5 Showing Control Characters

Figure 4–2 8-bit ASCII Code Table with C1 Control Characters Font (Right Half)

8		9		10		11		12		13		14		15		Column	
1	0	1	0	1	0	1	0	1	1	1	0	1	1	1	1	b8	
	0		0		1		1		0		1		0		1	b7	
	0		0		0		1		0		0		1		0	b6	
	0		0		0		0		0		0		0		1	b5	
	0		0		0		0		0		0		0		0	b4	
	0		0		0		0		0		0		0		0	b3	
	0		0		0		0		0		0		0		0	b2	
	0		0		0		0		0		0		0		0	b1	
																Row	
8 <sub>0</sub>	200 128 80	D <sub>CS</sub>	220 144 90	N <sub>SP</sub>	240 160 A0	°	260 176 B0	À	300 192 C0	Ɔ	320 208 D0	à	340 224 E0	ÿ	360 240 F0	0 0 0 0	0
8 <sub>1</sub>	201 129 81	P <sub>U1</sub>	221 145 91	í	241 161 A1	±	261 177 B1	Á	301 193 C1	Ñ	321 209 D1	á	341 225 E1	ñ	361 241 F1	0 0 0 1	1
8 <sub>2</sub>	202 130 82	P <sub>U2</sub>	222 146 92	φ	242 162 A2	2	262 178 B2	Â	302 194 C2	Ò	322 210 D2	â	342 226 E2	ò	362 242 F2	0 0 1 0	2
8 <sub>3</sub>	203 131 83	S <sub>TS</sub>	223 147 93	í	243 163 A3	3	263 179 B3	Ã	303 195 C3	Ó	323 211 D3	ã	343 227 E3	ó	363 243 F3	0 0 1 1	3
I <sub>ND</sub>	204 132 84	C <sub>RH</sub>	224 148 94	α	244 164 A4	'	264 180 B4	Ä	304 196 C4	Ô	324 212 D4	ä	344 228 E4	ô	364 244 F4	0 1 0 0	4
N <sub>E_L</sub>	205 133 85	M <sub>W</sub>	225 149 95	Ÿ	245 165 A5	μ	265 181 B5	Å	305 197 C5	Õ	325 213 D5	å	345 229 E5	õ	365 245 F5	0 1 0 1	5
S <sub>S_A</sub>	206 134 86	S <sub>P_A</sub>	226 150 96	ı	246 166 A6	¶	266 182 B6	Æ	306 198 C6	Ö	326 214 D6	æ	346 230 E6	ö	366 246 F6	0 1 1 0	6
E <sub>S_A</sub>	207 135 87	E <sub>P_A</sub>	227 151 97	§	247 167 A7	·	267 183 B7	Ç	307 199 C7	×	327 215 D7	ç	347 231 E7	·	367 247 F7	0 1 1 1	7
H <sub>T_S</sub>	210 136 88	9 <sub>8</sub>	230 152 98	"	250 168 A8	,	270 184 B8	È	310 200 C8	Ø	330 216 D8	è	350 232 E8	ø	370 248 F8	1 0 0 0	8
H <sub>T_J</sub>	211 137 89	9 <sub>9</sub>	231 153 99	©	251 169 A9	1	271 185 B9	É	311 201 C9	Ù	331 217 D9	é	351 233 E9	ù	371 249 F9	1 0 0 1	9
V <sub>T_S</sub>	212 138 9A	9 <sub>A</sub>	232 154 9A	à	252 170 AA	ó	272 186 BA	Ê	312 202 CA	Ú	332 218 DA	ê	352 234 EA	ú	372 250 FA	1 0 1 0	10
P <sub>L_D</sub>	213 139 9B	C <sub>S_I</sub>	233 155 9B	«	253 171 AB	»	273 187 BB	Ë	313 203 CB	Û	333 219 DB	ë	353 235 EB	û	373 251 FB	1 0 1 1	11
P <sub>L_U</sub>	214 140 9C	S <sub>T</sub>	234 156 9C	⌋	254 172 AC	1/4	274 188 BC	Ì	314 204 CC	Ü	334 220 DC	ì	354 236 EC	ü	374 252 FC	1 1 0 0	12
R <sub>I</sub>	215 141 9D	O <sub>S_C</sub>	235 157 9D	—	255 173 AD	1/2	275 189 BD	Í	315 205 CD	Ý	335 221 DD	í	355 237 ED	ý	375 253 FD	1 1 0 1	13
S <sub>S_2</sub>	216 142 9E	P <sub>M</sub>	236 158 9E	®	256 174 AE	3/4	276 190 BE	Î	316 206 CE	ÿ	336 222 DE	î	356 238 EE	ÿ	376 254 FE	1 1 1 0	14
S <sub>S_3</sub>	217 143 9F	A <sub>P_C</sub>	237 159 9F	—	257 175 AF	¿	277 191 BF	Ï	317 207 CF	ß	337 223 DF	ï	357 239 EF	ÿ	377 255 FF	1 1 1 1	15

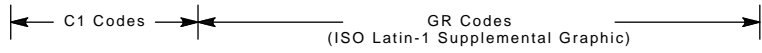

GSF\_0648\_89.DG

### 4.6 Terminal Management Functions

Terminal management functions are control functions not intended for use by applications software. Rather, they are intended to allow the user, the system administrator, or the host software to configure the terminal for use in the desired application environment.

## ANSI Control Functions Summary

### 4.7 ANSI Control Function Tables

#### 4.7 ANSI Control Function Tables

The tables in this section summarize the ANSI Control Functions for ANSI-compatible VT mode and VT PCTerm mode. Default conditions are in boldface type. If you need additional information on a particular function, refer the the mnemonic in Chapter 5, which describes all the ANSI control functions in alphabetical order by mnemonic.

Refer to the following sections for a brief summary of the control for a particular function.

Control Functions	Refer to . . .	Page
Session management	Section 4.7.1	4-16
Window management	Section 4.7.2	4-17
Audible attributes	Section 4.7.3	4-18
Color selection	Section 4.7.4	4-18
Visual attributes	Section 4.7.5	4-20
Editing	Section 4.7.6	4-21
Text processing	Section 4.7.7	4-22
Graphic character sets	Section 4.7.8	4-25
Keyboard processing	Section 4.7.9	4-27
Program keys		4-30
Printer	Section 4.7.10	4-33
Terminal management	Section 4.7.11	4-34
Desktop features		4-34
Energy saver functions		4-34
Terminal communications	Section 4.7.12	4-39
Terminal synchronization	Section 4.7.13	4-41
Reports	Section 4.7.14	4-42

In these tables, the word “same” signifies the same control sequences as in the VT520 column.

#### 4.7.1 Sessions Management Control Functions

Sessions Management	Control Function				Mnemonic
	VT520	VT420	VT100		
Enable Session	CSI & x	n/a	n/a		DECES
Session Page Memory Allocation	CSI <i>Pn1</i> ; <i>Pn2</i> ; <i>Pn3</i> ; <i>Pn4</i> ; , x	n/a	n/a		DECSPMA
<i>Pn</i> Pages per session (1...4)					
Update Session	CSI <i>Ps</i> , y	n/a	n/a		DECUS
<i>Ps</i>	<u>Item</u>				
1	Only when active				
2	When available				
3	At regular intervals				

## ANSI Control Functions Summary 4.7 ANSI Control Function Tables

### 4.7.2 Window Management Control Functions

WINDOW MANAGEMENT		Control Function		
Coupling Mode	VT520	VT420	VT100	Mnemonic
Auto Resize Mode		n/a	n/a	DECARSM
Set (enable):	CSI ? 98 h			
<b>Reset (disable):</b>	<b>CSI ? 98 I</b>			
Horizontal Cursor Coupling		n/a	n/a	DECHCCM†
Set:	CSI ? 60 h			
<b>Reset:</b>	<b>CSI ? 60 I</b>			
Page Cursor Coupling		same	n/a	DECPCCM
<b>Set:</b>	<b>CSI ? 64 h</b>			
Reset:	CSI ? 64 l			
Vertical Cursor Coupling		same	n/a	DECVCCM
<b>Set:</b>	<b>CSI ? 61 h</b>			
Reset:	CSI ? 61 l			
<b>Display Extent</b>				
Request Displayed Extent	CSI " v	same	n/a	DECRQDE
Report Displayed Extent	CSI Ph;Pw;Pml;Pmt;Pmp; " w	same	n/a	DECRPDE
Select number of lines per screen	CSI Pn *	same	same	DECSNLS
<b>Windows</b>				
Framed Windows Mode		same	same	DECFWM
Set:	CSI ? 111 h			
Reset:	CSI ? 111 l			
Review Previous Lines		same	same	DECRPL
Set:	CSI ? 112 h			
Reset:	CSI ? 112 l			
Set ICON Name	OSC 2 D...D ST	n/a	n/a	DECSIN
where D...D is L ; <name> (up to 12 char)				
Set Window Title	OSC 2 D...D ST	n/a	n/a	DECSWT
where D...D is 1 ; <name> (up to 30 char)				
<b>Pan Direction</b>				
Pan Down	CSI P/ S	same	same	SU
Pan Up	CSI P/ T	same	same	SD

†Mode is always Reset and cannot be changed.

# ANSI Control Functions Summary

## 4.7 ANSI Control Function Tables

### 4.7.3 Audible Attributes Control Functions

Audible Attributes	Control Function				Mnemonic
	VT520	VT420	VT100		
Bell	BEL	same	same		BEL
Set Margin Bell Volume	CSI <i>Ps</i> SP u	same	n/a		DECSMBV
<u><i>Ps</i></u> <b>none,0,1</b>	<u>Volume</u> <b>Off</b>				
2,3,4	Low				
5,6,7,8	High				
Set Warning Bell Volume	CSI <i>Ps</i> SP t	n/a	n/a		DECSWBV
<u><i>Ps</i></u> 1	<u>Volume</u> Off				
2,3,4	Low				
<b>none,0,</b>	<b>High</b>				
5,6,7,8					
Play Sound	CSI <i>Pvol</i> , <i>Pduration</i> ; <i>Pnote</i> , ~ <i>Pduration</i>	n/a	n/a		DECPS
<u><i>Pvol</i></u> 0..7 (0 = silent)	0..255 (1/32nd of a sec)				
	<u><i>Pnote</i></u>	<u>Selection</u>	<u><i>Pnote</i></u>	<u>Selection</u>	<u><i>Pnote</i></u>
	0	silent	9	G#5	18
	1	C5	10	A5	19
	2	C#5	11	A#5	20
	3	D5	12	B5	21
	4	D#5(Eb)	13	C6	22
	5	E5	14	C#6	23
	6	F5	15	D6	24
	7	F#5	16	D#6	25
	8	G5	17	E6	

### 4.7.4 Color Selection Control Functions

The VT525 and VGB25 can display 16 colors from a palette of 4096. These functions allow you to define the color map and select colors for different display uses and text attributes.

Color Selection	Control Function				Mnemonic
	VT520	VT420	VT100		
Assign Color	CSI <i>Ps1 Ps2 Ps3</i> ,	n/a	n/a		DECAC
<u><i>Ps1</i></u> 1	<u>Item</u> Normal text				
2	Window frame				
<u><i>Ps2</i></u> 0-15	<u>Foreground</u> color index				
<u><i>Ps3</i></u> 0-15	<u>Background</u> color index				
Alternate Text Color	CSI <i>Ps1 Ps2 Ps3</i> , }	n/a	n/a		DECATC
<u><i>Ps1</i></u> 0	<u>Attribute</u> Normal text	<u><i>Ps1</i></u> 8			
1	Bold	9			
					Reverse underline
					Reverse blink

## ANSI Control Functions Summary 4.7 ANSI Control Function Tables

Color Selection	Control Function				Mnemonic
	VT520	VT420	VT100		
2	Reverse	10	Underline blink		
3	Underline	11	Bold reverse underline		
4	Blink	12	Bold reverse blink		
5	Bold reverse	13	Bold underline blink		
6	Bold underline	14	Reverse underline blink		
7	Bold blink	15	Bold reverse underline blink		
<u>Ps2</u>	<u>Foreground</u>				
0-15	color map entry				
<u>Ps3</u>	<u>Background</u>				
0-15	color map entry				
Alternate Text Color Blink Mode			n/a	n/a	DECATCBM
Set (blink):	CSI ? 115 h				
<b>Reset:</b>	<b>CSI ? 115 I</b>				
Alternate Text Color Underline Mode			n/a	n/a	DECATCUM
Set (underline):	CSI ? 114 h				
<b>Reset:</b>	<b>CSI ? 114 I</b>				
Bold and Blink Style Mode			n/a	n/a	DECBBSM
Set (ForeGnd & BkGnd):	CSI ? 116 h				
<b>Reset (ForeGnd only):</b>	<b>CSI ? 116 I</b>				
Color Table Request/Report/Restore			n/a	n/a	DECCTR
Request:	CSI 2 ; Pu \$ u				
Reply to Host:	DCS 2 \$ s D...D ST				
Restore format:	DCS 2 \$ p D...D ST				
<i>D...D</i>	A group of 5 parameters: <i>Pc; Pu; Px; Py; Pz/</i>				
<i>Pc</i>	Color number 0-255				
<u><i>Pu</i></u>	<u>Color coordinate system</u>				
0	illegal				
1	HLS (hue, lightness, saturation)				
2	RGB (red, green, blue)				
	<u>If <i>Pu</i>=1 . . .</u>	<u>If <i>Pu</i>=2 . . .</u>			
<i>Px</i>	Hue 0-360	Red 0-100			
<i>Py</i>	Lightness 0-100;	Green 0-100			
<i>Pz</i>	Saturation 0-100;	Blue 0-100			
Erase Color Mode			n/a	n/a	DECECM
Set (erase to screen):	CSI ? 117 h				
<b>Reset (erase to text):</b>	<b>CSI ? 117 I</b>				
Select Color Look-Up Table	CSI <i>Ps</i> {		n/a	n/a	DECSTGLT
<u><i>Ps</i></u>	<u>Selection</u>				
0	Mono				
1	Alternate color (use text attributes)				
2	Alternate color				
3	ANSI SGR color				

# ANSI Control Functions Summary

## 4.7 ANSI Control Function Tables

### 4.7.5 Visual Attributes Control Functions

Visual Attributes	Control Function			
	VT520	VT420	VT100	Mnemonic
Double Height Line Top	ESC # 3	same	same	DECDHL
Double Height Line Bottom	ESC # 4	same	same	DECDHL
Single Width Line	ESC # 5	same	same	DECSWL
Double Width Line	ESC # 6	same	same	DECDWL
Screen Mode – Light/Dark		same	same	DECSNM
Set (light background):	CSI ? 5 h			
<b>Reset (dark background):</b>	<b>CSI ? 5 l</b>			
Select Graphic Rendition	CSI <i>Ps</i> ; <i>Ps m</i>	same	same	SGR
<u><i>Ps</i></u> <u>Attribute</u>				
<b>0</b>	<b>All attributes off</b>			
	<u>VT Level 1 or higher</u>	<u><i>Ps</i></u>	<u>VT Level 2 or higher</u>	
1	Bold	22	Normal (bold off)	
4	Underline	24	Underline off	
5	Blink	25	Blinking off	
7	Negative (reverse) image	27	Positive image (negative off)	
<u><i>Ps</i></u> <u>Attribute (DA1 Reports - VT525 only)</u>			<u>Default Color</u>	
30	Foreground Color 0		Black	
31	Foreground Color 1		Red	
32	Foreground Color 2		Green	
33	Foreground Color 3		Yellow	
34	Foreground Color 4		Blue	
35	Foreground Color 5		Magenta	
36	Foreground Color 6		Cyan	
37	Foreground Color 7		White	
39	Default Foreground Color		White	
40	Background Color 0		Black	
41	Background Color 1		Red	
42	Background Color 2		Green	
43	Background Color 3		Yellow	
44	Background Color 4		Blue	
45	Background Color 5		Magenta	
46	Background Color 6		Cyan	
47	Background Color 7		White	
49	Default Background Color		Black	



## ANSI Control Functions Summary

### 4.7 ANSI Control Function Tables

#### 4.7.6 Editing Control Functions

EDITING	Control Function			
	VT520	VT420	VT100	Mnemonic
Delete Character <i>Pn</i> Number of characters to delete (default = 1).	CSI <i>Pn</i> P	same	same	DCH
Delete Column <i>Pn</i> Number of columns to delete (default = 1).	CSI <i>Pn</i> '~	same	n/a	DECDC
Delete Line <i>Pn</i> Number of lines to delete (default = 1).	CSI <i>Pn</i> M	same	same	DL
Erase Character <i>Pn</i> Number of characters to erase ( <i>Pn</i> = 0 or 1 (default) = 1 character).	CSI <i>Pn</i> X	same	n/a	ECH
Erase in Display <i>Ps</i> Erase from . . . <b>0</b> <b>Cursor to end of display</b> 1      Top of display through cursor 2      Top to bottom of display	CSI <i>Ps</i> J	same	same	ED
Erase in Line <i>Ps</i> Erase from . . . <b>0</b> <b>Cursor to end of line</b> 1      Start of line through cursor 2      Start to end of line	CSI <i>Ps</i> K	same	same	EL
Insert Character	CSI <i>Pn</i> @	same	n/a	ICH
Insert Column <i>Pn</i> Number of columns to insert (default = 1). <i>Pn</i> Number of lines to insert (default = 1).	CSI <i>Pn</i> ' }	same	n/a	DECIC
Insert Line <i>Pn</i> Number of lines to insert (default = 1).	CSI <i>Pn</i> L	same	same	IL
Insert/Replace Mode Set (insert): <b>Reset (replace):</b>	CSI 4 h <b>CSI 4 I</b>	same	same	IRM
Select Character Attribute <sup>1</sup> <i>Ps</i> Meaning <b>0</b> <b>DECSED and DECSEL can erase characters.</b> 1      DECSED and DECSEL cannot erase characters. 2      Same as 0.	CSI <i>Ps</i> " q	same	n/a	DECSCA
Selective Erase in Display <i>Ps</i> Erase from . . . <b>0</b> <b>Cursor to end of display</b> 1      Top of display through cursor 2      Top to bottom of display	CSI ? <i>Ps</i> J	same	n/a	DECSED
Selective Erase in Line <i>Ps</i> Erase from . . . <b>0</b> <b>Cursor to end of line</b> 1      Start of line through cursor 2      Start to end of line	CSI ? <i>Ps</i> K	same	n/a	DECSEL

<sup>1</sup>DECSCA does not affect visual character attributes set by the select graphic rendition (SGR) function.

## ANSI Control Functions Summary

### 4.7 ANSI Control Function Tables

Rectangle Area Processing	Control Function			Mnemonic
	VT520	VT420	VT100	
Change Attribute in Rectangle	CSI <i>Pt;Pl;Pb;Pr; Ps1;...Psn</i> \$ r		n/a	DECCARA
<u><i>Ps</i></u> <u>Attribute</u>				
<b>0</b> <b>Off</b>				
1      Bold		<i>Pt</i> Top line		
4      Underline		<i>Pl</i> Left column		
5      Blink		<i>Pb</i> Bottom line		
7      Negative image		<i>Pr</i> Right column		
22      No bold				
24      No underline				
25      No blink				
27      Positive image				
Copy Rectangular Area	CSI <i>Pts;Pls;Pbs;Prs;Pps;Ptd;Pld;Ppd</i> \$v	same	n/a	DECCRA
		<u>Destination</u>		
<i>Pts</i> <u>Source</u>		<i>Ptd</i> Top line border		
<i>Pls</i> Left column border		<i>Pld</i> Left column border		
<i>Pbs</i> Bottom line border		<i>Ppd</i> Page number		
<i>Prs</i> Right column border				
<i>Pps</i> Page number				
Erase Rectangular Area	CSI <i>Pt;Pl;Pb;Pr</i> \$ z	same	n/a	DECERA
Fill Rectangular Area	CSI <i>Pch; Pt;Pl;Pb;Pr</i> \$ x	same	n/a	DECFRA
<i>Pch</i> Character				
Reverse Attribute in Rectangle	CSI <i>Pt;Pl;Pb;Pr Ps1;...Psn</i> \$ t	same	n/a	DECRARA
<u><i>Ps</i></u> <u>Reverse Attributes</u>				
<b>0</b> <b>All</b>				
1      Bold				
4      Underline				
5      Blink				
7      Negative image				
Select Attribute Change Extent	CSI <i>Ps</i> * x	same	n/a	DECSACE
Selective Erase Rectangular Area	CSI <i>Pt;Pl;Pb;Pr</i> \$ {	same	n/a	DECSERA

#### 4.7.7 Text Processing Control Functions

Cursor Position	Control Function			Mnemonic
	VT520	VT420	VT100	
Autowrap mode		same	n/a	DECAWM
Set (enable):	CSI ? 7 h			
Reset (disable):	CSI ? 7 I			
Backspace	BS	same	same	BS
Carriage Return	CR	same	same	CR
Cursor Backward	CSI <i>Pc</i> D	same	same	CUB
Cursor Backward Tabulation	CSI <i>Pn</i> Z	n/a	n/a	CBT
Cursor Down	CSI <i>Pl</i> B	same	same	CUD
Cursor Forward	CSI <i>Pc</i> C	same	same	CUF
Cursor Horizontal Absolute	CSI <i>Pn</i> G	n/a	n/a	CHA
Cursor Horizontal Forward Tab	CSI <i>Pn</i> I	n/a	n/a	CHT
Cursor Information Report	DCS 1\$u D.....D ST	same	n/a	DECCIR
Cursor Next Line	CSI <i>Pn</i> E	n/a	n/a	CNL

## ANSI Control Functions Summary 4.7 ANSI Control Function Tables

Cursor Position	Control Function				Mnemonic
	VT520	VT420	VT100		
Cursor Previous Line	CSI <i>Pn</i> F	n/a	n/a		CPL
Cursor Position	CSI <i>Pl</i> ; <i>Pc</i> H	same	same		CUP
Cursor Position Report (Also see DECCIR, DEXCPR, and DSR.)	CSI 6 n	same	same		CPR
	Response: <i>Pl</i> No. of lines <i>Pc</i> No. of columns	CSI <i>Pl</i> ; <i>Pc</i> R			
Cursor Up	CSI <i>Pl</i> A	same	same		CUU
Extended Cursor Position Report	CSI ? 6 n	same	n/a		DEXCPR
	Response: <i>Pl</i> Line <i>Pc</i> Column <i>Pp</i> Page	CSI <i>Pl</i> ; <i>Pc</i> ; <i>Pp</i> R			
Restore Cursor	ESC 8	same	same		DECRC
Restore Saved Cursor (SCO)	CSI u	n/a	n/a		SCORC
Right-to-Left Copy		n/a	n/a		DECRLCM
	Set: <b>Reset:</b>	CSI ? 96 h <b>CSI ? 96 l</b>			
Right-to-Left Mode		n/a	n/a		DECRLM
	Set: <b>Reset:</b>	CSI ? 34 h <b>CSI ? 34 l</b>			
Save Cursor	ESC 7	same	same		DECSC
Save Cursor Position (SCO)	CSI s	n/a	n/a		SCOSC
Set Cursor Style	CSI <i>Ps</i> SP q	n/a	n/a		DECSCUSR
	<i>Ps</i> <b>none,0,1</b> <b>Blinking block</b> 2 Steady block 3 Blinking underline 4 Steady underline				
Text Cursor Enable Mode		same	n/a		DECTCEM
	<b>Set (visible):</b> Reset (invisible):	<b>CSI ? 25 h</b> CSI ? 25 l			
<b>Horizontal and Vertical Position</b>					
Form Feed	FF	same	same		FF
Horizontal Tab	HT	same	same		HT
Horizontal/Vertical Position	CSI <i>Pl</i> ; <i>Pc</i> f	same	same		HVP
	<i>Pl</i> No. of lines to move to <i>Pc</i> No. of columns to move to				
Horizontal Position Absolute	CSI <i>Pn</i> '	same	same		HPA
Horizontal Position Relative	CSI <i>Pn</i> a	same	same		HPR
Line Feed	LF	same	same		LF
Line Feed/New Line Mode		same	same		LNLM
	Set (NL): <b>Reset (LF):</b>	CSI 20 h <b>CSI 20 l</b>			
Next Line	ESC E	same	same		NEL
Vertical Line Position Absolute	CSI <i>Pn</i> d	n/a	n/a		VPA
Vertical Line Position Relative	CSI <i>Pn</i> e	n/a	n/a		VPR
Vertical Tab	VT	same	same		VT

## ANSI Control Functions Summary

### 4.7 ANSI Control Function Tables

Horizontal Tabs—Set/Clear	Control Function				Mnemonic
	VT520	VT420	VT100		
Set Horizontal Tab	ESC H	same	same	HTS	
Set Tab at every 8 columns	CSI ? 5 W	n/a	n/a	DECST8C	
Clear Tabs	CSI <i>Ps</i> g	same	same	TBC	
<i>Ps</i> none, 0 3	Clear . . . <b>tab at cursor</b> all tabs				
<b>Margins and Scrolling</b>					
Back Index	ESC 6	same	n/a	DECBI	
Forward Index	ESC 9	same	n/a	DECFI	
Index	ESC D	same	same	IND	
Origin Mode		same	same	DECOM	
	Set (in margins): <b>Reset (upper-left):</b>	CSI ? 6 h <b>CSI ? 6 l</b>			
Reverse Index	ESC M	same	same	RI	
Scrolling Mode		same	same	DECSCLM	
	<b>Set (smooth):</b> Reset (jump):	<b>CSI ? 4 h</b> CSI ? 4 l			
Set Scroll Speed	CSI <i>Ps</i> SP p	n/a	n/a	DECSSCLS	
<i>Ps</i> none, 0, 1, 2, 3 4, 5, 6, 7, 8 9	<b>Smooth 2</b> Smooth 4 Jump			DECSCLM	
Left Right Margin Mode		same	n/a	DECLRMM	
	Set (enable): <b>Reset (disable):</b>	CSI 69 h <b>CSI 69 l</b>			
Set Left and Right Margin	CSI <i>Pl</i> ; <i>Pr</i> s	same	same	DECSLRM	
<i>Pl</i> <i>Pr</i>	Left column margin (default = 1) Right column margin (default = <b>80</b> or <b>132</b> , depending on page width)				
Set Top and Bottom Margin	CSI <i>Pt</i> ; <i>Pb</i> r	same	same	DECSTBM	
<i>Pt</i> <i>Pb</i>	Top margin (default = 1) Bottom margin				
<b>Page Arrangement and Size <sup>1</sup></b>					
Column Mode		same	same	DECCOLM	
	Set (132 columns): <b>Reset (80 columns):</b>	CSI ? 3 h <b>CSI ? 3 l</b>			
No clear screen on column change	Do not clear: <b>Clear screen:</b>	CSI ? 95 h <b>CSI ? 95 l</b>	n/a	n/a	
Select Columns per Page	CSI <i>Ps</i> \$	same	n/a	DECSCPP	
<i>Ps</i> 0 or 80 132	Set each page to . . . 80 columns 132 columns				
Set Lines Per Page	CSI <i>Pn</i> t	same	same	DEC SLPP	

<sup>1</sup>The page size can be 24, 25, 36, 42, 48, 52, and 72 lines with 80 or 132 columns.

## ANSI Control Functions Summary 4.7 ANSI Control Function Tables

Page Movement	Control Function			
	VT520	VT420	VT100	Mnemonic
Next Page <i>Pn</i> Number of pages to move <b>(0 or 1 = 1 page)</b>	CSI <i>Pn</i> U	same	same	NP
Preceding Page <i>Pn</i> Number of pages to move <b>(0 or 1 = 1 page)</b>	CSI <i>Pn</i> V	same	same	PP
Page Position Absolute	CSI <i>Pn</i> SP P	same	same	PPA
Page Position Backward	CSI <i>Pn</i> SP R	same	same	PPB
Page Position Relative	CSI <i>Pn</i> SP Q	same	same	PPR

### 4.7.8 Graphic Character Sets Control Functions

GRAPHIC CHARACTER SETS	Control Function			
	VT520	VT420	VT100	Mnemonic
Assign User-Preferred Supp Set <u><i>Ps</i></u> <b>0</b> <b>94-Character Set</b> <b>1</b> <b>96-Character Set</b> <u><i>Dscs</i></u> <b>Default 94-Character Set</b> <b>% 5</b> <b>DEC Supplemental</b> " ?      DEC Greek " 4      DEC Hebrew % 0      DEC Turkish & 4      DEC Cyrillic <      User-preferred supplemental	DCS <i>Ps</i> ! u <i>Dscs</i> ST	same	n/a	DECAUPSS
Down-line Load <sup>1</sup>	DCS <i>Pfn</i> ; <i>Pcn</i> ; <i>Pe</i> ; <i>Pcmw</i> ; <i>Pss</i> ; <i>Pu</i> ; <i>Pcmh</i> ; <i>Pcss</i> { < <i>Dscs</i> ><sixel-font-patterns> ST	same	n/a	DECDLD
Down-Line Load Allocation <u><i>Ps</i></u> <b>1</b> <b>One each</b> <b>2</b> <b>Two each S1 and S2</b>	CSI <i>Ps</i> , z	n/a	n/a	DECDLDA
Select Character Set <u><i>I</i></u> ( <b>94-Character G-set</b> G0 )      G1 *      G2 +      G3 <u><i>Dscs</i></u> & 4 <b>Default 94-Character Set</b> A      Cyrillic (DEC) A      British/U.K. NRCS  <u><i>Dscs</i></u> 5 or C <b>Default 94-Character Set</b> R      Finnish NRCS 9 or Q    French NRCS K      French Canadian NRCS K      German NRCS " ?      Greek (DEC)	ESC <i>I</i> <i>Dscs</i>  <u><i>I</i></u> - <b>96-Character G-set</b> G1 .      G2 /      G3  <u><i>Dscs</i></u> A <b>Default 96-Character Set</b> B      ISO Latin-1 Supplemental B      ISO Latin-2 Supplemental  <u><i>Dscs</i></u> F <b>Default 96-Character Set</b> H      ISO Greek Supplemental H      ISO Hebrew Supplemental M      ISO Latin-5 Supplemental L      ISO Latin-Cyrillic <      User-preferred Supplemental	same	n/a	SCS

<sup>1</sup>The VT520 DRCS follows the same DECDLD sequence with the exceptions noted in reference.

## ANSI Control Functions Summary

### 4.7 ANSI Control Function Tables

GRAPHIC CHARACTER SETS	VT520	Control Function			Mnemonic
		VT420	VT100		
" >	Greek NRCS				
<u>Dscs</u>	<u>Default 94-Character Set</u>				
" 4	Hebrew (DEC)				
% =	Hebrew NRCS				
Y	Italian NRCS				
' , E, or 6	Norwegian/Danish NRCS				
% 6	Portuguese NRCS				
& 5	Russian NRCS				
% 3	SCS NRCS				
Z	Spanish NRCS				
7 or H	Swedish NRCS				
=	Swiss NRCS				
% 0	Turkish (DEC)				
% 2	Turkish NRCS				
0	DEC Special Graphic				
% 5	DEC Supplemental				
>	DEC Technical Character Set				
<	User-preferred Supplemental				
Select Zero Symbol	CSI <i>Ps</i> , {	n/a	n/a	DECSZS	
<u><i>Ps</i></u>	<u>Selection</u>				
<b>1</b>	<b>oval zero - 0</b>				
2	zero with slash - Ø				
3	zero with dot				
Supplemental Character Set	VT520	VT420	VT100	Mnemonic	
National Replacement Character Set Mode		same	n/a	DECNRCM	
Set (National):	CSI ? 42 h				
(7-bit characters)					
<b>Reset (Multinational):</b>	<b>CSI ? 42 I</b>				
(8-bit characters)					
Request User-Preferred Supplemental Set	CSI & u	same	n/a	DECRQUPSS	
Response:	DEC <i>Ps</i> ! u <i>Dscs</i> ST			See	
Parameters:				DECAUPSS	

## ANSI Control Functions Summary

### 4.7 ANSI Control Function Tables

Control Characters and Code Extension Functions	Control Function			
	VT520	VT420	VT100	Mnemonic
Display CO controls as PC Characters (SCO)	ESC xx	n/a	n/a	SCODPCC
Show Control Character Mode		same	same	CRM
Set (show):	CSI 3 h			
<b>Reset (interpret):</b>	<b>CSI 3 I</b>			
Send Control Character to Host				
7-bit controls	ESC SP F	n/a	n/a	S7C1T
8-bit controls	ESC SP G	n/a	n/a	S8C1T
Single Shift 2	ESC N	same	same	SS
Single Shift 3	ESC O	same	same	SS
Locking Shift				LS
<b>LSO Map G0 into GL</b>	SI	same	same	
LS1 Map G1 into GL	SO	same	same	
LS1R Map G1 into GR	ESC ~	same	n/a	
LS2 Map G2 into GL	ESC n	same	n/a	
LS2R Map G2 into GR	ESC }	same	na/	
LS3 Map G3 into GL	ESC o	same	n/a	
LS3R Map G3 into GR	ESC	same	n/a	
Locking Shift Zero	SI	same	same	LS0
Locking Shift One	SO	same	same	LS1
Locking Shift Two	ESC n	same	n/a	LS2
Locking Shift Three	ESC o	same	n/a	LS3
Locking Shift One Right	ESC ~	same	n/a	LS1R
Locking Shift Two Right	ESC }	same	n/a	LS2R
Locking Shift Three Right	ESC	same	n/a	LS3R
Single Shift Two	ESC N	same	same	SS2
Single Shift Three	ESC O	same	same	SS3
Send 7-bit C1 control character to host	ESC SP F	same	n/a	S7C1T
Send 8-bit C1 control character to host	ESC SP G	same	n/a	S8C1T

#### 4.7.9 Keyboard Processing Control Functions

Keyboard Function	Control Function			
	VT520	VT420	VT100	Mnemonic
Autorepeat Mode		same	same	DECARM
<b>Set (repeat):</b>	<b>CSI ? 8 h</b>			
Reset (disabled):	CSI ? 8 l			
Auto Repeat Rate	CSI <i>Ps</i> - p	n/a	n/a	DECARR
<i>Ps</i>	Rate			
0-5	Off			
6-15	Slow (10 cps)			
16-30	Fast (30 cps)			
Backarrow Key Mode		same	same	DECBKM
Set (backspace):	CSI ? 67 h			
<b>Reset (delete):</b>	<b>CSI ? 67 I</b>			
Copy Key Default	DCS " z <i>D...D</i> ST	n/a	n/a†	DECCKD
<i>D...D</i>	Key-s/Key-d;Key-s/Key-d...;			
Key-s	Source key			
Key-d	Destination key			

†You can exchange keys in Set-Up.

# ANSI Control Functions Summary

## 4.7 ANSI Control Function Tables

Keyboard Function	Control Function				Mnemonic
	VT520	VT420	VT100		
Cursor Keys Mode		same	same		DECCKM
Set (application):	CSI ? 1 h				
<b>Reset (cursor):</b>	<b>CSI ? 1 I</b>				
Define Function Key (SCO)	ESC Q <i>Fn string</i>	n/a	n/a		SCODFK
Device Status Report (keyboard status)					DSR
Request Keyboard Report:	CSI ? 26 n	same	same		
Reply to Keyboard Request:	CSI ? 27 ; <i>Pn; Pst; Ptyp</i> n				
		same	same		
<u><i>Pn</i></u>	<u>Keyboard Language (VT/PC)</u>	<u><i>Pn</i></u>	<u>Keyboard Language (VT or PC)</u>		
0	Unknown	15	Spanish		
1	North American	16	Portuguese		
2	British	19	Hebrew		
3	Belgian (Flemish)	22	Greek		
4	French Canadian	28	Canadian English		
5	Danish	29	Turkish Q/Turkish		
6	Finnish	30	Turkish F/Turkish		
7	German/German	31	Hungarian		
8	Dutch	33	Slovak		
9	Italian	34	Czech		
10	Swiss French	35	Polish		
11	Swiss German	36	Romanian		
12	Swedish	38	SCS		
13	Norwegian	39	Russian		
14	French	40	Latin American		
<u><i>Pst</i></u>	<u>Keyboard Status</u>	<u><i>Ptyp</i></u>	<u>Keyboard Type</u>		
0	Keyboard Ready	4	LK411		
3	No Keyboard	5	PCXAL		
8	Keyboard Busy				
Extended Keyboard Report	APC : <i>ppp mm ST</i>	same	n/a		DECEKBD
Enable Local Functions	CSI <i>Pf1;Pc1;...Pfn;Pcn</i> + q		n/a		DECELF
Enable Secondary Keyboard Language Mode		same	n/a		DECESKM
Set (secondary):	CSI ? 104 h				
<b>Reset (primary):</b>	<b>CSI ? 104 I</b>				
Hebrew Encoding Mode <sup>1</sup>		same	n/a		DECHEM
<b>Set (8-bit char):</b>	<b>CSI ? 36 h</b>				
Reset (7-bit char):	CSI ? 36 l				
Hebrew Keyboard Map Mode		same	n/a		DECHEBM
Set (Hebrew keyboard):	CSI ? 35 h				
<b>Reset (North American):</b>	<b>CSI ? 35 I</b>				
Keyboard Action Mode		same	same		KAM
Set (lock):	CSI 2 h				
<b>Reset (unlock):</b>	<b>CSI 2 I</b>				
Keypad Application Mode	ESC =	same	same		DECKPAM
Keyboard Language Selection	CSI <i>Ps1; Ps2</i> SP }	same	n/a		DECKBD
<u><i>Ps1</i></u>	<u>Keyboard Type</u>				
1,0	DEC keyboard layout				
2	Enhanced PC keyboard layout				

<sup>1</sup> DECHEM is opposite in action to DECNRCM; that is, setting DECHEM has the same result as resetting DECNRCM.



## ANSI Control Functions Summary 4.7 ANSI Control Function Tables

Keyboard Function		Control Function			
		VT520	VT420	VT100	Mnemonic
<i>Ps2</i>	<u>Keyboard Language (VT/PC)</u>	<i>Ps2</i>	<u>Keyboard Language (VT or PC)</u>		
<b>none,</b>	<b>North American</b>	15	Spanish		
0 or 1		16	Portuguese		
2	British	19	Hebrew		
3	Belgian	22	Greek		
4	French Canadian	28	Canadian English		
5	Danish	29	Turkish Q/Turkish		
6	Finnish	30	Turkish F/Turkish		
7	German	31	Hungarian		
8	Dutch	33	Slovak		
9	Italian	34	Czech		
10	Swiss French	35	Polish		
11	Swiss German	36	Romanian		
12	Swedish	38	SCS		
13	Norwegian	39	Russian		
14	French	40	Latin American		
Keypad Numeric Mode		ESC >	same	same	DECKPNM
Key Position Mode			same	n/a	DECKPM
	Set (key position):	CSI ? 81 h			
	<b>Reset (char codes):</b>	<b>CSI ? 81 I</b>			
Keyboard Usage Mode			same	n/a	DECKBUM
	Set (data processing):	CSI ? 68 h			
	<b>Reset (typewriter):</b>	<b>CSI ? 68 I</b>			
Local Function Key Control		CSI Pk1; Pf1; Pk2; Pf2...*}	same	n/a	DECLFKC
<i>Pk</i>	<u>Function</u>	<u>VT Keyboard</u>	<u>Enhanced PC Keyboard</u>		
1	Hold	F1	Scroll Lock		
2	Print	F2	Print Screen		
3	Set-Up	F3	Cap Lock/Print Screen		
North American/Greek Selection			same	n/a	DECNAKB
	<b>Set (North American):</b>	<b>CSI ? 57 h</b>			
	Reset (Greek keyboard):	CSI ? 57 I			
Numeric Keypad Mode			same	n/a	DECNKM
	Set (application):	CSI ? 66 h			
	<b>Reset (numeric):</b>	<b>CSI ? 66 I</b>			

# ANSI Control Functions Summary

## 4.7 ANSI Control Function Tables

Program Keys	Control Function				
	VT520	VT420	VT100	Mnemonic	
Program Alphanumeric Key	DCS " y <i>D...D</i> ST	n/a	n/a	DECPAK	
Program Function Key	DCS " x <i>D...D</i> ST	n/a	n/a	DECPFK	
<i>D...D</i>	<i>Key1/Mod1/Function n/UDS/UDS Dir; Key1/Mod1/Function n/UDS/UDS Dir;</i>				
<u><i>Keyn</i></u>	<u>VT Keyboard</u>	<u>PC Keyboard</u>			
11	F1	F1			
12	F2	F2			
13	F3	F3			
14	F4	F4			
15	F5	F5			
17	F6	F6			
18	F7	F7			
19	F8	F8			
20	F9	F9			
21	F10	F10			
23	F11	F11			
24	F12	F12			
25	F13				
26	F14				
28	F15				
29	F16				
31	F17				
32	F18				
33	F19				
34	F20				
<u><i>Modn</i></u>	<u>Modifier Key</u>	<u><i>Function n</i></u>	<u>Local function number</u>		
<b>0,none</b>	<b>Normal</b>	<u><i>UDS</i></u>	<u>User-defined sequence</u>		
1	Normal	<u><i>UDS Dir</i></u>	<u>UDS Direction</u>		
2	Shift	<b>0,none</b>	<b>Normal</b>		
3	Alt	1	Local		
4	Alt + Shift	2	Remote		
5	Control				
6	Shift + Control				
7	Alt + Control				
8	Alt + Control + Shift				
Program Key Action		CSI <i>Ps</i> + z	n/a	n/a	DECPKA
<u><i>Ps1</i></u>	<u>Program Key Action</u>				
<b>none,0</b>	<b>None</b>				
1	Lock Keys and Modifiers				
2	Restore Factory Defaults				
3	Recall Key Definitions				
Program Key Free Memory Report <sup>2</sup>		CSI <i>Ps1</i> ; <i>Ps2</i> + y	n/a	n/a	DECPKFMR
<i>Ps1</i>	Total memory (bytes)				
<i>Ps2</i>	Free memory				
Request Program Key Free Memory Response: DECPKFMR		CSI + x	n/a	n/a	DECRQPKFM

<sup>2</sup>The VT520 reports this sequence upon receiving DECRQPKFM from the host. See reference for limitations.

## ANSI Control Functions Summary

### 4.7 ANSI Control Function Tables

Key Type, Click, Lock, LEDs	Control Function			Mnemonic
	VT520	VT420	VT100	
Request Key Definition <i>Ps1</i> Key station number <i>Ps2</i> Modifier Key <b>0,none</b> <b>Normal</b> 1 Normal 2 Shift 3 Alt 4 Alt + Shift 5 Control 6 Shift + Control 7 Alt + Control 8 Alt + Control + Shift	CSI <i>Ps1</i> ; <i>Ps2</i> , w	n/s	n/a	DECRQKD
Request Key Type	CSI <i>Ps</i> , u	n/a	n/a	DECRQKT
Report Key Type	CSI <i>Ps1</i> ; <i>Ps2</i> , v	n/s	n/a	DECRPKT
Report Function Key Definition	DCS " } <i>D...D</i> ST	n/a	n/a	DECRPFK
Report Modifiers/Key State	DCS " ~ <i>D...D</i> ST	n/a	n/a	DECRPAK
Set Key Click Volume <i>Ps</i> <u>Volume</u> 1 Off 2,3,4 Low <b>none,0,5,6,7,8.</b> <b>High</b>	CSI <i>Ps</i> SP r	same	n/a	DECSKCV
Set Lock Key Style <i>Ps</i> <u>Lock Style</u> <b>none,0,1</b> <b>Caps Lock</b> 2 Shift Lock 3 Reverse Lock	CSI <i>Ps</i> SP v	n/a	n/a	DECSLCK
Num Lock Mode Set: Reset:	CSI ? 108 h CSI ? 108 l	same	same	DECNUMLK
Caps Lock Mode Set: Reset:	CSI ? 109 h CSI ? 109 l	same	same	DECCAPSLK
Keyboard LEDs Host Indicator Mode Set: <b>Reset:</b>	CSI ? 110 h <b>CSI ? 110 l</b>	same	same	DECKLHIM
Load LEDs <i>Ps</i> <u>Volume</u> <b>0</b> <b>Clear all LEDs</b> 1 Light Num Lock 2 Light Caps Lock 3 Light Scroll Lock 21 Extinguish Num Lock 22 Extinguish Caps Lock 23 Extinguish Scroll Lock	CSI <i>Ps</i> q	n/a	n/a	DECLL
Select Modifier Key Reporting (See reference.)	CSI <i>Pm1</i> ; <i>Pf1...Pmn</i> ; <i>Pfn</i> + r	same	n/a	DECSMKR

# ANSI Control Functions Summary

## 4.7 ANSI Control Function Tables

User-Defined Keys	Control Function			Mnemonic	
	VT520	VT420	VT100		
User Defined Keys	DCS <i>Ps1; Ps2; Ps3</i>   <i>D...D</i> ST same			n/a	DECUDK <sup>3</sup>
<u><i>Ps1</i></u>	<u>Clear . . .</u>				
none,0	All UDKs before loading new values				
1	Old UDKs only when redefined; load new UDK values.				
<u><i>Ps2</i></u>	<u>Lock . . .</u>				
none,0	UDKs against future redefinition				
1	Don't lock the UDKs against future redefinition.				
<u><i>Ps3</i></u>	<u>Define . . .</u>				
none, 0	Shifted function key				
1	Unshifted function key				
2	Shifted function key				
3	Alt unshifted function key				
4	Alt shifted function key				
<i>D...D</i>	<i>Key1/St1/Dir;Key2/St2/Dir;.....Keyn/Stn/Dir;</i>				
<i>Stn</i>	Sequence user-defined key (UDK)				
<u><i>Keyn</i></u>	<u>VT Keyboard</u>	<u>PC Keyboard</u>			
11	F1	F1			
12	F2	F2			
13	F3	F3			
14	F4	F4			
15	F5	F5			
17	F6	F6			
18	F7	F7			
19	F8	F8			
20	F9	F9			
21	F10	F10			
23	F11	F11			
24	F12	F12			
25	F13				
26	F14				
28	F15				
29	F16				
31	F17				
32	F18				
33	F19				
34	F20				
<u><i>Dir</i></u>	<u>Direction<sup>4</sup></u>				
0, <b>none</b>	<b>Normal</b>				
1	Local				
2	Remote				
DSR - User-Defined Key Request		same	n/a	DSR-UDK	
Request UDK lock:	CSI ? 25 n				
Reply to UDK locked status:	CSI ? 20 n				
Reply to UDK unlocked status:	CSI ? 21 n				

<sup>3</sup>CAUTION: Local Function keys may be disabled by redefining them with DECUDK.

<sup>4</sup>See DECPFK for direction definitions.

## ANSI Control Functions Summary

### 4.7 ANSI Control Function Tables

#### 4.7.10 Printer Control Functions

Printer Port Function	Control Function				
	VT520	VT420	VT100	Mnemonic	
DSR - Printer Port Report			same	same	DSR-Print
Request:	CSI ? 15 n				
Response:	CSI ? Ps n				
<u>Ps</u>	<u>Printer . . .</u>				
<u>10</u>	Ready				
11	Not ready				
13	Off line				
18	Busy				
19	On another session.				
Media Copy - Send Screen Data through Host Port	CSI 2 i	n/a	n/a		-
Media Copy - Start/Stop Printer-to-Host Session					MC
ANSI:	CSI Pa i	same	same		
DEC:	CSI ? Pd i	same	CSI ?8i		
<b>ANSI Mode</b>					<b>DEC Mode</b>
<u>Pa</u>	<u>Function</u>				<u>Pd</u>
0,none	Print page				1
4	Reset printer controller mode				4
5	Set printer controller mode				5
6	Start printer to host session				8
7	Stop printer to host session				9
					10
					11
					18
					19
Print Extent Mode			same	same	DECPEX
Set (entire page):	CSI ? 19 h				
<b>Reset (scroll region):</b>	<b>CSI ? 19 l</b>				
Print Form Feed Mode		same	same		DECPFF
Set (FF):	CSI ? 18 h				
<b>Reset (no FF):</b>	<b>CSI ? 18 l</b>				
Select Digital Printed Data Type <sup>1</sup>	CSI Ps ) p	n/a	n/a		DECSDPT
<u>Ps</u>	<u>Printed Data Type</u>				
<b>none,0,1</b>	<b>Print National Only</b>				
2	National and Line Drawing				
3	Print Multinational				
4	Print All Characters				
Select Printer Type	CSI Ps \$ s	n/a	n/a		DECSPRTT
<u>Ps</u>	<u>Printer Type</u>				
<b>none,0,1</b>	<b>DEC ANSI</b>				
2	IBM ProPrinter				
3	DEC + IBM				
Select ProPrinter Character Set	CSI Pn * p	n/a	n/a		DECSPPCS
<u>Pn</u>	<u>Printer</u>				
<u>210</u>	PC Greek				
220	PC Spanish				
437	PC International				
850	PC Multilingual				
852	PC Slavic (Latin 2)				
857	PC Turkish				
860	PC Portuguese				

<sup>1</sup> This sequence takes effect only when a ProPrinter or Digital printer with ProPrinter emulation mode is attached.

## ANSI Control Functions Summary

### 4.7 ANSI Control Function Tables

862	PC Hebrew
863	PC French-Canadian
865	PC Danish/Norwegian
866	PC Cyrillic

Start/stop printer; see Media Copy.

---

#### DEC Printers with ProPrinter Emulation

---

Enter/Return from IBM ProPrinter Emulation Mode	n/a	n/a	DECIPEM
Enter:                    CSI ? 58 h			
Return:                   CSI ? 58 l			

---

#### 4.7.11 Terminal Management Control Functions

Desktop Feature	Control Function			
	VT520	VT420	VT100	Mnemonic
Select Set-Up Language <i>Ps</i> <b>none,0,1 English</b> 2 French 3 German 4 Spanish 5 Italian	CSI <i>Ps</i> p	n/a	n/a	DECSSL
Load Time of Day <i>Ps1</i> Hour (decimal number between 00 and 23) <i>Ps2</i> Minutes (decimal number between 00 and 59)	CSI <i>Ps1</i> ; <i>Ps2</i> , p	n/a	n/a	DECLTOD

---

#### CRT/Energy Saver Functions

---

CRT Save Mode <b>Set (enable CRT saver 15 min):</b> Reset (disable CRT saver):	<b>CSI 97 h</b> CSI 97 l	n/a	n/a	DECCRTSM
CRT Saver Timing <i>Ps</i> <u>Selection</u> 0 Never 5 5 min <b>15 15 min</b> 30 30 min 60 60 min	CSI <i>Ps</i> - q	n/a	n/a	DECCRTST
Energy Saver Timing <i>Ps</i> <u>Selection</u> 0 Never 5 5 min <b>15 15 min</b> 30 30 min	CSI <i>Ps</i> - r	n/a	n/a	DECSEST
Host Wake-Up mode (CRT and Energy saver) Set: Reset:	CSI ? 113 h CSI ? 113 l	same	same	DECHWUM

## ANSI Control Functions Summary

### 4.7 ANSI Control Function Tables

Device Attributes		Control Function			
		VT520	VT420	VT100	Mnemonic
Device Attributes or Primary Device Attributes		CSI c or CSI 0 c	same	same	DA1
	<u>Model</u>	<u>Response</u>			
	-	CSI ? <i>Psc</i> ; <i>PS1</i> ; ... <i>Psn</i> c			
	VT520	CSI ? 65;1;2;7;8;9;12;18;19;21;23;24;42;44;45;46 c			
	VT525	CSI ? 65;1;2;7;9;12;18;19;21;22;23;24;42;44;45;46 c			
<u>Ext</u>	<u>Description</u>	<u>Ext</u>	<u>Description</u>		
1	132 columns	18	Windowing capability		
2	Printer port extension	21	Horizontal scrolling		
6	Selective erase	23	Greek extension		
7	DRCS	24	Turkish extension		
8	UDK	42	ISO Latin-2 character set		
9	NRCS	44	VT PCTerm		
12	Serbo-Croatian (SCS)	45	Soft key mapping		
15	Technical character set	46	ASCII terminal emulation		
Secondary Device Attributes		CSI > c or CSI > 0 c	same	n/a	DA2
	<u>Keyboard</u>	<u>Response</u>			
	VT520 VT keyboard	CSI > 64; <i>Pv</i> ; 0 c			
	VT525 VT keyboard	CSI > 65; <i>Pv</i> ; 0 c			
	VT520 PC keyboard	CSI > 64; <i>Pv</i> ; 1 c			
	VT525 PC keyboard	CSI > 65; <i>Pv</i> ; 1 c			
Tertiary Device Attributes		CSI = c or CSI = 0 c	same	same	DA3
<b>Terminal ID</b>					
Identify Device		ESC Z	n/a	same	DECID <sup>1</sup>
Report Terminal Unit ID		DCS !   <i>D...D</i> ST <i>Pv</i> Firmware version	same	n/a	DECRTUI
Select Terminal ID <sup>2</sup>		CSI <i>Ps</i> , q	same	same	DECTID
<u><i>Ps</i></u>	<u>ID Type</u>	<u>Response</u>			
0	VT100	ESC [ ? 1; 2 c			
1	VT101	ESC [ ? 1; 0 c			
2	VT102	ESC [ ? 6 c			
5	VT220	CSI ? 62; 1; 2; 7; 8 c			
		CSI ? 62; 1; 2; 7; 8; 9 c			
7	VT320	CSI ? 63; 1; 2; 7; 8 c			
		CSI ? 63; 1; 2; 7; 8; 9 c			
9	VT420	CSI ? 64; 1; 2; 7; 8; 9; 15; 18; 21 c			
		CSI ? 64; 1; 2; 7; 8; 9; 15; 18; 21 c			
<b>10</b>	<b>VT520/VT525</b>	Refer to DA1 for response.			
Set Terminal Unit ID		DCS ! { <i>D...D</i> ST	n/a	n/a	DECSTUI

<sup>1</sup>DECID may not be supported; use primary device attributes (DA1) instead.

<sup>2</sup>DECTID has no effect when the terminal is in VT52 mode.





## ANSI Control Functions Summary 4.7 ANSI Control Function Tables

Mode Description	ANSI Mode		DEC Mode	
	<i>Pa</i>	Mnemonic <sup>4</sup>	<i>Pd</i>	Mnemonic Mode
Guarded area transfer	1	GATM *	?1	DECCKM Cursor keys
Keyboard action	2	KAM	?2	DECANM ANSI
Control representation	3	CRM	?3	DECCOLMColumn
Insert/replace	4	IRM	?4	DECSCLMScrolling
Status reporting transfer	5	SRTM *	?5	DECSCNMScreen
			?6	DECOM Origin
Vertical editing	7	VEM *	?7	DECAWM Autowrap
Horiz editing	10	HEM *	?8	DECARM Autorepeat
Positioning unit	11	PUM *		
Send/receive	12	SRM		
Format effector action	13	FEAM *		
Format effector transfer	14	FETM *		
Multiple area transfer	15	MATM *		
Transfer termination	16	TTM *		
Selected area transfer	17	SATM *		
Tabulation stop	18	TSM *	?18	DECPFF Print form
Editing boundary	19	EBM *	?19	DECPEX Print extent
Linefeed/New line	20	LNМ		
Text cursor enable			?25	DECTCEM
Right-to-left			?34	DECRLM
Hebrew keyboard map			?35	DECHEBM
Hebrew encoding			?36	DEHCEM
NRCS characters			?42	DECNRCM
Greek/N.A.			?57	DECNAKB
Horiz cursor coupling			?60	DEHCCM *
Vertical cursor coupling			?61	DECVCCM
Page cursor coupling			?64	DECPCCM
Numeric keypad			?66	DECNKM
Backarrow key			?67	DECBKM
Keyboard usage			?68	DECKBUM
Vertical split screen			?69	DECVSSM
Transmit rate limiting			?73	DECXRLMM
No clear screen			?95	DECNCSM
Right-to-left copy			?96	DECRLCM
CRT save			?97	DECCRTSM
Auto resize			?98	DECARSM
Modem control			?99	DECMCM
Auto answerback			?100	DECAAM
Conceal answerback			?101	DECCANSM
Null			?102	DECNULM
Half-duplex			?103	DECHDPXM
Enable secondary keyboard language			?104	DECESKM
Overscan			?106	DECOSCNM
Framed windows mode			?111	DECFWM
Review previous lines			?112	DECRPL
Host Wake-Up			?113	DECHWUM
Alternate text color underline			?114	DECATCUM
Alternate text color blink			?115	DECATCBM
Bold and blink style mode			?116	DECBBSM
Erase color mode			?117	DECECM

<sup>4</sup>The \* means this mode is always Reset in the terminal and cannot be changed.

# ANSI Control Functions Summary

## 4.7 ANSI Control Function Tables

Terminal Modes	Control Function				Mnemonic
	VT520	VT420	VT100		
Report Mode (ANSI) or (DEC)	CSI <i>Pa</i> ; <i>Ps</i> \$ <i>y</i> CSI ? <i>Pd</i> ; <i>Ps</i> \$ <i>y</i>	same same	n/a n/a		DECRPM
Reset Mode	CSI <i>P1</i> .... <i>Pn</i> <i>l</i>	same	same		RM
<b>Set/Reset Parameters</b>	<b>ANSI Mode</b>				<b>DEC Mode</b>
	<i>Ps</i>				
Not recognized	0		same		
Set	1		same		
Reset	2		same		
Set permanently	3		same		
Reset permanently	4		same		
Set Mode/Reset Mode (See also DECRQM.)					SM/RM
Send/Receive Mode (Local Echo)		same	same		SRM
<b>Set (Local echo off):</b>	<b>CSI 12 h</b>				
Reset (Local echo on):	CSI 12 l				
<b>Tests</b>					
Invoke Confidence Test <sup>5</sup>	CSI 4 ; <i>Ps</i> ; ... ; <i>Ps</i> <i>y</i>	same	n/a		DECTST <sup>6</sup>
<i>Ps</i>	Test				
0	"All Tests" (1,2,3,6)				
1	Power-Up Self Test				
2	RS-232 Port Data Loopback				
3	Printer Port Loopback				
4	Speed Select and Indicator				
5	Reserved - No action				
6	Modem Loopback Test				
7	EIA-423 Port Loopback				
8	Parallel Port Loopback				
9	Repeat other tests				
<b>Messages</b>					
Auto Answerback Mode		same	same		DECAAM
Set:	CSI ? 100 h				
Reset:	<b>CSI ? 100 l</b>				
Conceal Answerback Message Mode		n/a	n/a		DECCANSM
Set:	CSI ? 101 h				
Reset:	<b>CSI ? 101 l</b>				
Load Answerback Message	DCS <i>Ps</i> v <i>D</i> ... <i>D</i> ST	n/a	n/a		DECLANS
Load Banner Message	DCS <i>Ps</i> r <i>D</i> ... <i>D</i> ST	n/a	n/a		DECLBAN
<i>Ps1</i>	Printer Port				
1	Parallel port				
2	Comm1				
3	Comm2				
<i>Ps2</i>	Session 1				
1	Comm1				
2	Comm2				

<sup>5</sup>"ESC # 8" invokes the Screen Alignment test (all Es).

<sup>6</sup>DECTST causes a disconnect; therefore, it should not be used in conjunction with a modem.

## ANSI Control Functions Summary 4.7 ANSI Control Function Tables

Reset Terminal	Control Function			
	VT520	VT420	VT100	Mnemonic
Reset to Initial state	ESC c	same	same	RIS
Secure Reset	ESC [ Pr + p	same	n/a	DECSR
Secure Reset Confirmation	ESC [ Pr * q	same	same	DECSRC
Soft Terminal Reset	CSI ! p	same	n/a	DECSTR

Terminal Status Display				
Select Active Status Display	CSI Ps \$ }	same	n/a	DECSASD
<u>Ps</u> 0	Send data to . . . <b>Main display only</b>			
1	Status line only			
Select Status Display (Line) Type	CSI Ps \$ ~	n/a	n/a	DECSSDT
<u>Ps</u> 0	Status Line Selected No status line			
1	<b>Indicator status line</b>			
2	Host-writable status line			

### 4.7.12 Terminal Management—Communications Control Functions

Terminal Management – Communication Function	Control Function			
	VT520	VT420	VT100	Mnemonic
Select Communication Port	CSI Ps1; Ps2 * u	n/a	n/a	DECSCP
<u>Ps1</u> 0	Printer Port None			
1	Centronics			
4	Comm3			
<u>Ps2</u> 1	Host port Comm1			
2	Comm2			
3	Comm3			
Select Communication Speed	CSI Ps1; Ps2 * r	n/a	n/a	DECSCS
<u>Ps1</u> none,0,1	Comm Line Host Transmit	<u>Ps2</u> none,0	<u>Communication Speed</u> Use default speed.	
2	Host Receive	1	300	
3	Printer	2	600	
4	Modem Hi	3	1200	
5	Modem Lo	4	2400	
		5	4800	
		6	9600	
		7	19200	
		8	38400	
		9	57600	
		10	76800	
		11	115200	
<u>Communication Line</u> Host Transmit	<u>Default Communication Speed</u> 9600			
Host Receive	Receive=transmit			
Printer	4800			
Modem Hi	Ignore			
Modem Lo	Ignore			

## ANSI Control Functions Summary

### 4.7 ANSI Control Function Tables

Terminal Management – Communication Function		VT520	Control Function		Mnemonic
			VT420	VT100	
Set Port Parameters		CSI <i>Ps1</i> ; <i>Ps2</i> ; <i>Ps3</i> ; <i>Ps4</i> + w		n/a	DECSPP
<u><i>Ps1</i></u> <b>none</b> , 0 or 1 2	<u>Port</u> <b>Comm Port</b> Printer Port		<u><i>Ps3</i></u> <b>none</b> , 0 or 1 2 3 4† 5† 6 7	<u>Parity</u> <b>No parity</b> Even Odd Even Odd, unchecked Mark Space	
<u><i>Ps2</i></u> 1,0 or none 2	<u>Data</u> 8 bits 7 bits				
<u><i>Ps4</i></u> <b>none</b> , 0 or 1 2	<u>Stop Bit</u> <b>1 bit</b> 2 bits				
Set Transmit Rate Limit		CSI <i>Ps1</i> ; <i>Ps2</i> " u	n/a	n/a	DECSTRL
<u><i>Ps</i></u> <b>none</b> , 0 or 1 2 3	<u>Key Type</u> <b>All keys</b> Graphic key Function key				
<u><i>Ps</i></u> <b>none</b> ,0,1 2 3	<u>Characters Per Second</u> <b>150 cps</b> 50 cps 30 cps				
Transmit Rate Limiting Mode			same	n/a	DECXRLM
Set (limited):		CSI ? 73 h			
<b>Reset (unlimited):</b>		<b>CSI ? 73 I</b>			

† Not available for the printer port. If specified in the sequence to configure the printer port, the Ps3 value is ignored.

## ANSI Control Functions Summary 4.7 ANSI Control Function Tables

### 4.7.13 Terminal Synchronization Control Functions

Terminal Synchronization	Control Function				Mnemonic
	VT520	VT420	VT100		
Device Control 1 (XON) Device Control 3 (XOFF)	DC1 DC3	same same	same same		
Disconnect Delay Time <u>Ps</u> 1 2 <b>none,0,3</b>	CSI <i>Ps</i> \$ q   <b>2 s</b>	same	same		DECSDDT
Flow Control	CSI <i>Ps1</i> ; <i>Ps2</i> ; <i>Ps3</i> ; <i>Ps4</i> * s				
<u>Ps1</u> <b>none,0,1</b>  2	<u>Port Type</u> <b>Comm Port</b>  Printer Port	<u>Ps3</u> <b>none,</b> 0 or 1 2 3 4	n/a n/a <u>Flow Control Type</u> <b>XON/XOFF</b> or XPC (for receive only) DTR Both None		DECSFC
<u>Ps2</u> 1,0 or none 2 <b>3</b>	<u>Transmit or Receive</u> Transmit Receive <b>Transmit and Receive</b>	<u>Ps4</u> <b>none</b> 0 or 1 2	<u>Flow Control Threshold</u> <b>Low (64)</b> High (768)		
Half-Duplex Mode Set: <b>Reset:</b>	CSI ? 103 h <b>CSI ? 103 l</b>	n/a	n/a		DECHDPXM
Modem Control Mode Set: <b>Reset:</b>	CSI ? 99 h <b>CSI ? 99 l</b>	n/a	n/a		DECMCM
Null Mode <b>Set (ignore NUL):</b> Reset (accept NUL):	<b>CSI ? 102 h</b> CSI ? 102 l	n/a	n/a		DECNULM

## ANSI Control Functions Summary

### 4.7 ANSI Control Function Tables

#### 4.7.14 Reports Control Functions

Macros	Control Function				Mnemonic
	VT520	VT420	VT100		
Define Macro	DCS <i>Pid;Pdt;Pen ! z D...D ST</i>	same	n/a		DECDMAC
DSR - Macro Space	CSI ? 62 n	same	n/a		DSR-MSR
Invoke Macro	CSI <i>Pid * z</i>	same	n/a		DECINVM
Macro Space Report	CSI <i>Pn * {</i>	same	n/a		DECMSR, DSR-MSR
$Pn = \frac{\text{number of bytes}}{16}$					
<b>Reports</b>					
Device Status Report – ANSI:	CSI <i>Ps n</i>	same	same		DSR
– DEC:	CSI ? <i>Ps n</i>	same	same		DSR
DSR - Data Integrity Report	CSI ? 75 n	same	n/a		DSR-Data
Response:	CSI ? <i>Ps n</i>				
<i>Ps</i>	<u>Meaning</u>				
70	Ready, no power loss or comm errors.				
71	Malfunction, comm error.				
73	No reported data loss since last power up.				
Memory Checksum Report or DSR-Memory Checksum	CSI ? 63; <i>Pid n</i>	same	n/a		DECCKSR or DSR-Mem
Response:	DCS <i>Pid ! ~ D...D ST</i>				
Request Checksum of Rect Area	CSI <i>Pid;Pp;Pt;Pl;Pb;Pr * y</i>	same	n/a		DECRQCRA
Response:	DCS <i>Pid ! ~ D...D ST</i>				
Presentation State Report (See DECRQPSR.)		n/a	n/a		DECPSR
Report Mode (DECRPM) (See Report Mode (ANSI) below.)		same	n/a		DECRPM
Request Mode (ANSI)	CSI <i>Pa \$ p</i>	same	n/a		DECRQM <sup>1</sup>
Request Mode (DEC)	CSI ? <i>Pd \$ p</i>	same	n/a		DECRQM
Request Presentation State Report	CSI <i>Ps \$ w</i>	same	n/a		DECRQPSR
<i>Ps</i>	<u>Report Requested</u>				
0	Error, restore ignored.				
1	Cursor information report (DECCIR)				
2	Tab stop report (DECTABSR)				

<sup>1</sup>A DECRQM sequence can only ask about one mode at a time. When the terminal is set to VT52 mode, DECRQM provides no report.

## ANSI Control Functions Summary 4.7 ANSI Control Function Tables

Reports	Control Function				Mnemonic
	VT520	VT420	VT100	Mnemonic	
Report Selection or Setting (See DECRQSS.)		same	n/a	DECRPSS	
Request Selection or Setting		same	n/a	DECRQSS	
Request (DECRQSS):	DCS \$ q <i>D...D</i> ST				
Report (DECRPSS):	DCS <i>Ps \$ r D...D</i> ST				
	<u>Setting Control Sequence</u>	<u>Final Characters</u>		<u>Mnemonic</u>	
	Assign Color	,		DECAC	
	Alternate Text Color	, }		DECATC	
	Select Active Status Display	\$ }		DECSAD	
	Select Attribute Change Extent	* x		DECSACE	
	Set Character Attribute	" q		DECSCA	
	Set Columns Per Page	\$		DECS CPP	
	Select Communication Speed	* r		DECS CS	
	Select Communication Port	* u		DECS CP	
	Set Conformance Level	" p		DECS CL	
	Set Cursor Style	SP q		DECS CUSR	
	Select Digital Printed Data Type	) p		DECS DPT	
	Select Disconnect Delay Time	\$ q		DECS DDT	
	Select Flow Control Type	* s		DECS FC	
	Set Graphic Rendition	m		SGR	
	Set Key Click Volume	SP r		DECS KCV	
	Set Left and Right Margins	s		DECS LRM	
	Set Lines Per Page	t		DECS LPP	
	Set Lock Key Style	SP v		DECS LCK	
	Set Margin Bell Volume	SP u		DECS MBV	
	Set Number of Lines per Screen	*		DECS NLS	
	Session Page Memory Allocation	, x		DECS PMA	
	Set Port Parameter	+ w		DECS PP	
	Select Printer Type	\$ s		DECS PR TT	
	Select ProPrinter Character Set	* p		DECS PPCS	
	Set Scroll Speed	SP p		DECS SCLS	
	Select Set-Up Language	p		DECS SL	
	Set Status Line Type	\$ ~		DECS SDT	
	Set Top and Bottom Margins	r		DECS TBM	
	Set Transmit Rate Limit	" u		DECS TR L	
	Set Warning Bell Volume	SP t		DECS WBV	
	Select Zero Symbol	, {		DECS ZS	
Request Terminal State Report		same	n/a	DECR QTSR	
Request:	CSI 1 \$ u				
Reply to Host:	DCS 1 \$ s <i>D...D</i> ST				
Effects					
DDD1	DECRLM, DECHEBM, and DEHCEM are set. <sup>2</sup>			DDD1	
DDD2	DECRLM is reset. ASCII is designated in G1.			DDD2	
DDD3	ASCII is designated in G0.			DDD3	

<sup>2</sup> DDD1, DDD2, and DDD3 only work in VT100 mode when the Hebrew keyboard is selected.

## ANSI Control Functions Summary

### 4.7 ANSI Control Function Tables

Reports	Control Function			Mnemonic
	VT520	VT420	VT100	
Restore Presentation State	DCS <i>Ps \$ t D...D</i> ST	same	n/a	DECRSPS
<u><i>Ps</i></u>	<u>Data String Format</u>			
0	Error, restore ignored.			
1	Selects the format of the cursor information report (DECCIR).			
2	Selects the format of the tab stop report (DECTABSR).			
<i>D...D</i>	Data string of tab stops or cursor position.			
Color Table Request/Report/Restore		n/a	n/a	DECCTR
	Request:	CSI 2 ; <i>Pu \$ u</i>		
	Reply to Host:	DCS 2 \$ s <i>D...D</i> ST		
	Restore format:	DCS 2 \$ p <i>D...D</i> ST		
<i>D...D</i>	A group of 5 parameters: <i>Pc; Pu; Px; Py; Pz/</i>			
<i>Pc</i>	Color number 0-255			
<u><i>Pu</i></u>	<u>Color coordinate system</u>			
0	illegal			
1	HLS (hue, lightness, saturation)			
2	RGB (red, green, blue)			
	<u>If <i>Pu=1</i> . . .</u>	<u>If <i>Pu=2</i> . . .</u>		
<i>Px</i>	Hue 0-360	Red 0-100		
<i>Py</i>	Lightness 0-100;	Green 0-100		
<i>Pz</i>	Saturation 0-100;	Blue 0-100		
Restore Terminal State	DCS <i>Ps \$ p D...D</i> ST	same	n/a	DECRSTS
<u><i>Ps</i></u>	<u>Data String Format</u>			
0	Error, restore ignored.			
1	Selects the format of the terminal state report (DECTSR).			
<i>D...D</i>	Data string of restored information.			
Tabulation Stop Report	DCS @ \$ u <i>D...D</i> ST	same	n/a	DECTABSR
<i>D...D</i>	Column numbers of tab stops.			
Terminal State Report (See DECRQTSR.)		same	n/a	DECTSR



## 4.8 VT52 Mode Escape Sequences

Table 4–5 shows the escape sequences that the terminal recognizes when the VT52 Emulation Mode is selected.

**Table 4–5 VT52 Mode Escape Sequences**

Sequence	Action
ESC A	Cursor up.
ESC B	Cursor down.
ESC C	Cursor right.
ESC D	Cursor left.
ESC F	Enter graphics mode.
ESC G	Exit graphics mode.
ESC H	Move the cursor to the home position.
ESC I	Reverse line feed.
ESC J	Erase from the cursor to the end of the screen.
ESC K	Erase from the cursor to the end of the line.
ESC =	Enter alternate keypad mode.
ESC >	Exit alternate keypad mode.
ESC <	Exit VT52 mode.
ESC ^	Enter autoprint mode.
ESC _	Exit autoprint mode.
ESC V	Print the line with the cursor.
ESC W	Enter printer controller mode.
ESC X	Exit printer controller mode.
ESC ]	Print the screen.
ESC Y <i>Pn</i>	Move the cursor to column <i>Pn</i> .
ESC Z	Identify (host to terminal).
ESC / Z	Report (terminal to host).



---

## ANSI Control Functions

This chapter describes the ANSI escape and control sequences in detail, whereas the previous chapter provides only a brief summary of these sequences.

Each command in this chapter is formatted in such a way that you can refer to the command by either the mnemonic, name, or control function.

---

### ANSI Conformance Levels

This control function lets an application map certain character sets into the terminal's in-use table as default sets. The character sets are based on ANSI conformance levels.

#### Format

```
ESC   sp   Final
1/11  2/0  4/**
```

#### Parameters

##### Final

indicates the ANSI conformance level for the subsequent data exchange.

Final	ANSI Conformance Level
<b>L</b>	Level 1
<b>M</b>	Level 2
<b>N</b>	Level 3

#### Description

ANSI conformance levels represent an agreement between the sender and receiver for compatible data exchange. The control function:

1. Acts as an *announcer* for the data exchange that follows between the terminal and application software.
2. Selects which character sets the terminal uses by default in the data exchange.

## ANSI Conformance Levels

The VT520 supports three ANSI conformance levels.

### ANSI Levels 1 and 2

- ASCII designated as G0.
- ISO Latin-1 supplemental designated as G1.
- G0 mapped into GL.
- G1 mapped into GR.

### ANSI Level 3

- ASCII designated as G0.
- G0 mapped into GL.

## Notes

- If the terminal is reset, turned off, or changed with a set conformance level (DECSCL) sequence, then the software must send another announcer sequence to the terminal. Otherwise, the terminal uses the default character sets (ASCII in GL, DEC Supplemental or ISO Latin-1 supplemental in GR).
- The announcer sequence is available in VT Level 4 or higher modes only.
- Do not confuse ANSI conformance levels with VT Levels.

---

## CBT—Cursor Backward Tabulation

Move the active position *n* tabs backward.

**Default:** 1.

### Format

<b>CSI</b>	<i>P<sub>n</sub></i>	<b>Z</b>
9/11	3/ <i>n</i>	5/10

### Parameters

**P<sub>n</sub>**

is the number of active position tabs to move backward.

### Description

The active position is moved to the character position corresponding to the *n*-th preceding horizontal tabulation stop. If an attempt is made to move the active position past the first character position on the line, then the active position stays at column one.

---

## CHA—Cursor Horizontal Absolute

Move the active position to the *n*-th character of the active line.

**Default:** 1.

### Format

<b>CSI</b>	<i>P<sub>n</sub></i>	<b>G</b>
9/11	3/ <i>n</i>	4/7

### Parameters

**P<sub>n</sub>**

is the number of active positions to the *n*-th character of the active line.

### Description

The active position is moved to the *n*-th character position of the active line.

## CHT—Cursor Horizontal Forward Tabulation

---

### CHT—Cursor Horizontal Forward Tabulation

Move the active position  $n$  tabs forward.

**Default:** 1.

#### Format

CSI	$P_n$	I
9/11	3/ $n$	4/9

#### Parameters

**$P_n$**

is the number of active position tabs to move forward.

#### Description

The active position is moved to the character position corresponding to the following  $n$ -th horizontal tabulation stop.

---

## CNL—Cursor Next Line

Move the cursor to the next line.

**Default:** 1.

#### Format

CSI	$P_n$	E
9/11	3/ $n$	4/5

#### Parameters

**$P_n$**

is the active position to the first character of the  $n$ -th following line.

#### Description

The active position is moved to the first character of the  $n$ -th following line.

---

## CPL—Cursor Previous Line

Move the cursor to the preceding line.

**Default:** 1.

### Format

<b>CSI</b>	<i>Pn</i>	<b>F</b>
9/11	3/ <i>n</i>	4/6

### Parameters

**Pn**

is the number of active position moved to the first character of the n-th preceding line.

### Description

The active position is moved to the first character of the n-th preceding line.

---

## CPR—Cursor Position Report

The host asks the terminal for a cursor position report.

### Format

<b>CSI</b>	<b>6</b>	<b>n</b>			Request cursor position.
9/11	3/6	6/14			
<b>CSI</b>	<i>Pl</i>	<b>;</b>	<i>Pc</i>	<b>R</b>	Report cursor position.
9/11	3/ <i>n</i>	3/11	3/ <i>n</i>	5/2	

### Parameters

**Pl**

indicates what line the cursor is on.

**Pc**

indicates what column the cursor is at.

## CRM—Show Control Character Mode

---

### CRM—Show Control Character Mode

Enable or disable control characters to be displayed.

**Default:** Interpret

#### Format

<b>CSI</b>	<b>3</b>	<b>h</b>	Set: show control character.
9/11	3/3	6/8	
<b>CSI</b>	<b>3</b>	<b>I</b>	Reset: interpret control character.
9/11	3/3	6/12	

#### Description

When CRM mode is set, all characters (graphic or control) are displayed in the CRM font. All control functions are displayed as graphic characters. No control functions are executed, except LF, FF, and VT, which are represented in the CRM font before a CRLF (new line) is executed. XOFF (DC3) and XON (DC1) are used for flow control (if enabled). DC1 and DC3 are displayed after execution.

This function affects data received in the data stream following the change to CRM mode. Characters already displayed are not affected. Entering Control Representation mode temporarily causes G0 and GL to be loaded with ASCII. G2 and GR are loaded with user-selected Supplemental Graphic characters if in 8-bit Multinational Character mode.

#### Notes on CRM

- CRM mode works in all terminal modes (VT52, VT100, and VT500).
- NUL is displayed and is not useful as a fill character.
- CRM mode overrides Printer Controller mode. When in CRM, Printer Controller mode is temporarily off.
- In local mode and CRM (or local echo and CRM), ESC Fe sequences may be represented as either ESC Fe sequences or as C1 controls. Conversely, C1 controls may be represented as either C1 controls or as ESC Fe sequences.
- In CRM mode, auto-wrap always occurs at the right margin. Sending a sequence or disabling auto-wrap in Set-Up is ignored.
- Terminal Device Protocol commands are not affected if Control Representation mode is entered.



---

## CUB—Cursor Backward

This control function moves the cursor to the left by a specified number of columns. The cursor stops at the left border of the page.

### Format

<b>CSI</b>	<i>P<sub>n</sub></i>	<b>D</b>
9/11	3/ <i>n</i>	4/4

### Parameters

**P<sub>n</sub>**  
is the number of columns to move the cursor to the left.

---

## CUD—Cursor Down

This control function moves the cursor down a specified number of lines in the same column. The cursor stops at the bottom margin. If the cursor is already below the bottom margin, then the cursor stops at the bottom line.

### Format

<b>CSI</b>	<i>P<sub>n</sub></i>	<b>B</b>
9/11	3/ <i>n</i>	4/2

### Parameters

**P<sub>n</sub>**  
is the number of lines to move the cursor down.

---

## CUF—Cursor Forward

This control function moves the cursor to the right by a specified number of columns. The cursor stops at the right border of the page.

### Format

<b>CSI</b>	<i>P<sub>n</sub></i>	<b>C</b>
9/11	3/ <i>n</i>	4/3

### Parameters

**P<sub>n</sub>**  
is the number of columns to move the cursor to the right.

## CUP—Cursor Position

---

### CUP—Cursor Position

This control function moves the cursor to the specified line and column. The starting point for lines and columns depends on the setting of origin mode (DECOM). CUP applies only to the current page.

#### Format

<b>CSI</b>	<i>Pl</i>	;	<i>Pc</i>	<b>H</b>
9/11	3/ <i>n</i>	3/11	3/ <i>n</i>	4/8

#### Parameters

##### **Pl**

is the number of the line to move to. If *Pl* is 0 or 1, then the cursor moves to line 1.

##### **Pc**

is the number of the column to move to. If *Pc* is 0 or 1, then the cursor moves to column 1.

---

## CUU—Cursor Up

Moves the cursor up a specified number of lines in the same column. The cursor stops at the top margin. If the cursor is already above the top margin, then the cursor stops at the top line.

#### Format

<b>CSI</b>	<i>Pn</i>	<b>A</b>
9/11	3/ <i>n</i>	4/1

#### Parameters

##### **Pn**

is the number of lines to move the cursor up.

---

## DA1—Primary Device Attributes

In this DA exchange, the host asks for the terminal's architectural class and basic attributes.

### Host Request

The host uses the following sequence to send this request:

<b>CSI</b>	<b>c</b>	or	<b>CSI</b>	<b>0</b>	<b>c</b>
9/11	6/3		9/11	3/0	6/3

### Terminal Response

The terminal responds by sending its architectural class and basic attributes to the host. This response depends on the terminal's current operating VT level.

#### Response from VT520

<b>CSI</b>	<b>?</b>	<b>6</b>	<b>5</b>	<b>;</b>	<i>Ps1</i>	<b>;</b>	<b>...</b>	<i>Psn</i>	<b>c</b>
9/11	3/15	3/6	3/5	3/11	3/n	3/11	...	3/n	6/3

### Parameters

**Ps1 ; . . . Psn**  
reports device attributes.

The value of the first parameter is encoded so a simple range check can be performed to determine the basic service class and level of the device. VT520 is a level 5 terminal so its service class code is 65. The following extensions to levels 4 and 5 are provided:

## DA1—Primary Device Attributes

Ps	Meaning
1	132 columns
2	Printer port
6	Selective erase
7	Soft character set (DRCS)
8	User-defined keys (UDKs)
9	National replacement character sets (NRCS)
12	Serbo-Croatian (SCS)
15	Technical character set
18	Windowing capability
19	Sessions
21	Horizontal scrolling
22	Color
23	Greek
24	Turkish
42	ISO Latin-2
44	PCTerm
45	Soft key mapping
46	ASCII terminal emulation

### Primary DA Example

Here is a typical primary DA exchange.

Exchange	Sequence	Meaning
Request (Host to VT520)	<b>CSI c</b> or <b>CSI 0 c</b>	The host asks for the terminal's architectural class code and supported extensions.
Response (VT520 to host)	<b>CSI ? 65; 1; 2; 7; 9; 12; 18; 19; 21; 23; 24; 42; 44; 45; 46 c</b>	The terminal is a level 5 device (65) and supports the Ps parameters listed above. The DA1 response above is used when the "Terminal ID to host" is set to VT520 and the conformance level is set to Level 5 (factory default). Extensions: 6 (selective erase); 8 (UDK); and 15 (technical character set) are not reported explicitly at Level 5.

---

## DA2—Secondary Device Attributes

In this DA exchange, the host requests the terminal's identification code, firmware version level, and hardware options.

### Host Request

The host uses the following sequence to send this request:

```
CSI > c or CSI > 0 c
9/11 3/14 6/3 9/11 3/14 3/0 6/3
```

### Terminal Response

The terminal with a VT keyboard uses the following sequence to respond:

```
CSI > 6 4 ; Pv ; 0 c DA2R for terminal
9/11 3/14 3/6 3/4 3/11 3/n 3/11 3/0 6/3 with STD keyboard.

CSI > 6 4 ; Pv ; 1 c DA2R for terminal
9/11 3/14 3/6 3/4 3/11 3/n 3/11 3/1 6/3 with PC keyboard.
```

### Parameters

#### 64

indicates the identification code for the terminal. The VT520 has an identification code of 64 (65 for color terminal).

#### Pv

indicates the version level of the firmware implementing the terminal management functions, as shown in the following table.

Pv	Version
10	V1.0 (released version 1.0)
20	V2.0 (released version 2.0)

### Secondary DA Example

The following is a typical secondary DA exchange:

Exchange	Sequence	Meaning
Request (Host to VT520)	<b>CSI &gt; c</b> or <b>CSI &gt; 0 c</b>	The host asks for the terminal's identification, firmware version, current hardware options.
Response (VT520 to host)	<b>CSI &gt; 64; 20; 1</b> <b>c</b>	The terminal identifies itself as a VT520 that uses version 2.0 firmware, and has a PC keyboard option.

## DA3—Tertiary Device Attributes

---

### DA3—Tertiary Device Attributes

In this DA exchange, the host asks for the terminal unit identification code. This ID code serves as a way to identify each terminal in a system. The unit ID code is preset at the factory.

#### Host Request

The host uses the following sequence to send this request:

**CSI = c** or **CSI = 0 c**  
9/11 3/13 6/3 or 9/11 3/13 3/0 6/3

#### Terminal Response

The terminal responds by sending a report terminal unit ID (DECRPTUI) control string to the host.

**Available in:** VT Level 4 or higher mode only.

**DCS ! | D...D ST**  
9/0 2/1 7/12 ... 9/12

#### Parameters

##### D...D

is the unit ID of the terminal, consisting of four hexadecimal pairs. The first pair represents the manufacturing site code. This code can be any hexadecimal value from 00 through FF.

The last three hexadecimal pairs are the terminal ID number. This number is unique for each terminal manufactured at that site.

#### Tertiary DA Example

Here is a typical tertiary DA exchange.

Exchange	Sequence	Meaning
Request (Host to Terminal)	<b>CSI = c</b> or <b>CSI = 0 c</b>	The host asks for the terminal unit ID.
DECRPTUI Response (Terminal to host)	<b>DCS !   00</b> <b>01 02 05 ST</b>	The terminal was manufactured at site 00 and has a unique ID number of 010205.

---

## DCH—Delete Character

This control function deletes one or more characters from the cursor position to the right.

### Format

CSI	<i>Pn</i>	P
9/11	3/ <i>n</i>	5/0

### Parameters

#### ***Pn***

is the number of characters to delete. If *Pn* is greater than the number of characters between the cursor and the right margin, then DCH only deletes the remaining characters.

Default: *Pn* = 1.

### Description

As characters are deleted, the remaining characters between the cursor and right margin move to the left. Character attributes move with the characters. The terminal adds blank spaces with no visual character attributes at the right margin. DCH has no effect outside the scrolling margins.

## DDD1, DDD2, DDD3

---

### DDD1, DDD2, DDD3

DDD2 and DDD3 only work in VT100 mode when the Hebrew keyboard, DDD1, is selected.

#### Format

**ESC**    **)**    **1**    DDD1  
1/7    2/9    3/1

**ESC**    **)**    **B**    DDD2  
1/7    2/9    4/2

**ESC**    **(**    **1**    DDD3  
1/7    2/8    3/1

#### Description

These escape sequences have the follow effects:

Escape Sequence	Effect
DDD1	DECRLM is set. DECHEBM is set. DECHEM is set
DDD2	DECRLM is reset. ASCII is designated in G1.
DDD3	ASCII is designated in G0.



---

## DECAAM—Set/Reset Auto Answerback Mode

Selects whether the terminal automatically sends (enables) or does not send (disables) the answerback message to the host computer after a communication line connection.

**Default:** Auto answerback disabled.

### Format

<b>CSI</b>	<b>?</b>	<b>1</b>	<b>0</b>	<b>0</b>	<b>h</b>	
9/11	3/15	3/1	3/0	3/0	6/8	Set: enables auto answerback.

<b>CSI</b>	<b>?</b>	<b>1</b>	<b>0</b>	<b>0</b>	<b>l</b>	
9/11	3/15	3/1	3/0	3/0	6/12	Reset: disables auto answerback.

### Description

When modem control is enabled, the answerback message is sent 500 ms after the connection is made.

## DECAC—Assign Color

---

### DECAC—Assign Color

Selects the colors used for normal text.

**Default:** ANSI SGR color

#### Format

CSI    Ps1   Ps2   Ps3   '   |  
9/11   2/12   7/12

#### Parameters

**Ps1**  
Item

---

Ps1	Color Item
1	Normal text
2	Window frame

---

**Ps2**  
Foreground color index  
0...15

**Ps3**  
Background color index  
0...15

#### Description

DECAC selects the foreground and background colors used for normal text in ANSI SGR color mode and the window frame colors. The normal text colors are used in ANSI SGR color mode as the default foreground and background colors. The window frame foreground color is also used for the session icons and keyboard indicator line.

DECAC can be reported using DECRQSS and DECRPSS. Use **Ps1** in DECRQSS to select the item to be reported.

---

### DECALN—Screen Alignment Pattern

This control function fills the complete screen area with a test pattern used for adjusting screen alignment. Normally, only manufacturing and service personnel would use DECALN.

#### Format

<b>ESC</b>	<b>#</b>	<b>8</b>
1/11	2/3	3/8

#### Notes on DECALN

DECALN sets the margins to the extremes of the page, and moves the cursor to the home position.

Also see the screen alignment in Chapter 2.

## DECANM—ANSI Mode

---

## DECANM—ANSI Mode

DECANM changes the terminal to the VT52 mode of operation. In VT52 mode, the terminal acts like a VT52 terminal. This mode lets you use applications designed for the VT52 terminal.

### Format

CSI	?	2	I
9/11	3/15	3/2	6/12

### Description

**Table 5–1 VT52 Escape Sequences**

Sequence	Action
ESC A	Cursor up.
ESC B	Cursor down.
ESC C	Cursor right.
ESC D	Cursor left.
ESC F	Enter graphics mode.
ESC G	Exit graphics mode.
ESC H	Cursor to home position.
ESC I	Reverse line feed.
ESC J	Erase from cursor to end of screen.
ESC K	Erase from cursor to end of line.
ESC Y Pn	Move cursor to column Pn.
ESC Z	Identify (host to terminal).
ESC /Z	Report (terminal to host).
ESC =	Enter alternate keypad mode.
ESC >	Exit alternate keypad mode.
ESC <	Exit VT52 mode. Enter VT100 mode.
ESC ^	Enter autoprint mode.
ESC _	Exit autoprint mode.
ESC W	Enter printer controller mode.
ESC X	Exit printer controller mode.
ESC	Print screen.
ESC V	Print the line with the cursor.

## DECANM Exit—Exiting ANSI (VT52) Mode

When the terminal exits VT52 mode, it returns to the previous mode before entering VT52 mode. The terminal exits VT52 mode with the following escape sequence:

### Format

```
ESC  <
1/11 3/12
```

## DECARM—Autorepeat Mode

This control function determines whether or not keys automatically repeat their character when held down. If DECARM is set, then most keys you press for more than 0.5 seconds send a character repeatedly until you release the key.

**Default:** Repeat (set)

### Format

```
CSI  ?      8      h      Set: keys autorepeat when pressed
9/11 3/15   3/8   6/8   for more than 0.5 seconds.

CSI  ?      8      l      Reset: keys do not autorepeat.
9/11 3/15   3/8   6/12
```

### Notes on DECARM

- The following keys on the VT keyboard do not repeat:

<b>F1</b> (Hold)	<b>F5</b> (Break)	Return
<b>F2</b> (Print)	Compose Character	Lock
<b>F3</b> (Set-Up)	Shift	Ctrl
<b>F4</b> (Session)	Alt Function	Extend

- The following keys on the PC keyboard do not repeat:

Alt	AltGr
Caps Lock	Pause
Ctrl	Print Screen
Enter	Scroll Lock
Num Lock	Shift

## DECARR—Select Auto Repeat Rate

---

### DECARR—Select Auto Repeat Rate

Controls the keystroke auto repeat rate.

**Default:** Fast (30/sec)

#### Format

CSI      Ps      -      p  
9/11      2/13      7/0

#### Parameters

**Ps**  
Auto Repeat Rate

---

<b>Ps</b>	<b>Selection</b>
0...5	Off
6...15	Slow (10 cps)
16...30	Fast (30 cps)

---

#### Description

DECARR controls the keystroke auto-repeat rate. Values for **Ps** outside the defined range are ignored.

DECARR can be reported using DECRPSS.

---

## DECARSM—Set/Reset Auto Resize Mode

Enable or disable changing the lines per screen automatically when the page arrangement changes.

**Default:** Auto resize disabled

### Format

**CSI** ? **9** **8** **h**    Set: enable auto resize.  
9/11 3/15 3/9 3/8 6/8

**CSI** ? **9** **8** **l**    Reset: disable auto resize.  
9/11 3/15 3/9 3/8 6/12

### Description

When **Auto Resize** is enabled, the number of Lines/Screen changes automatically each time the page arrangement changes.

**Auto Resize** and **Number of lines per screen** are user features that can be locked from being redefined by the host if the **User Feature Lock** in Set-Up is enabled.

The following table indicates how the lines/screen changes when the page size changes, assuming **Auto Resize** is set.

Page size	Lines/Screen
24	26 (24 data lines, 1 status line, 1 blank line)
25	26 (25 data lines, 1 status line)
36	42 (36 data lines, 1 status line, 5 blank lines)
41	42 (41 data lines, 1 status line)
42	42 (42 data lines, no status line)
48	53 (48 data lines, 1 status line, 4 blank lines)
52	53 (52 data lines, 1 status line)
53	53 (53 data lines, 0 status line)
72	53 (53 data lines, 0 status line)

## DECATC—Alternate Text Color

---

## DECATC—Alternate Text Color

Selects the colors used for text attribute combinations.

### Format

```
CSI  Ps1  Ps2  Ps3  '  }  
9/11      2/12 7/13
```

### Parameters

**Ps1**  
Attribute combinations

<b>Ps1</b>	<b>Attributes</b>
0	Normal text
1	<b>Bold</b>
2	Reverse
3	Underline
4	Blink
5	<b>Bold reverse</b>
6	<b>Bold underline</b>
7	<b>Bold blink</b>
8	Reverse underline
9	Reverse blink
10	Underline blink
11	<b>Bold reverse underline</b>
12	<b>Bold reverse blink</b>
13	<b>Bold underline blink</b>
14	Reverse underline blink
15	<b>Bold reverse underline blink</b>

**Ps2**  
Foreground color index  
0...15

**Ps3**  
Background color index  
0...15

### Description

DECATC can be reported using DECRQSS and DECRPSS. Use **Ps1** in DECRQSS to select the attribute combination to be reported.



---

## DECATCBM—Set/Reset Alternate Text Color Blink Mode

Allows text with blink attributes to blink.

### Format

<b>CSI</b>	<b>?</b>	<b>1</b>	<b>1</b>	<b>5</b>	<b>h</b>	Set: enables blink text mode
9/11	3/15	3/1	3/1	3/5	6/8	

<b>CSI</b>	<b>?</b>	<b>1</b>	<b>1</b>	<b>5</b>	<b>l</b>	Reset: disables blink text mode
9/11	3/15	3/1	3/1	3/5	6/12	

### Description

If **blink text** is selected, text with the blink attribute will blink, as well as displayed using the specified alternate text colors. See **Alternate Text Colors in Set-Up** for details.

DECATCBM can be reported using DECRQM and DECRPM.

---

## DECATCUM—Set/Reset Alternate Text Color Underline Mode

Allows text with underline attributes to be displayed in alternate color.

### Format

<b>CSI</b>	<b>?</b>	<b>1</b>	<b>1</b>	<b>4</b>	<b>h</b>	Set: enables underline text mode
9/11	3/15	3/1	3/1	3/4	6/8	

<b>CSI</b>	<b>?</b>	<b>1</b>	<b>1</b>	<b>4</b>	<b>l</b>	Reset: disables underline text mode
9/11	3/15	3/1	3/1	3/4	6/12	

### Description

If **underline text** is selected, text with the underline attribute will be underlined, as well as displayed using the specified alternate text colors. See **Alternate Text Colors in Set-Up** for details.

DECATCUM can be reported using DECRQM and DECRPM.

## DECAUPSS—Assigning User-Preferred Supplemental Sets

---

## DECAUPSS—Assigning User-Preferred Supplemental Sets

You can assign the supplemental character set you use most often as a special standby set. This standby set is called the user-preferred supplemental set. This feature provides applications with an easy way to access the user's preferred supplemental set.

**Default:** DEC Supplemental Graphic

### Format

<b>DCS</b>	<i>Pn</i>	<b>!</b>	<b>u</b>	<i>Dscs</i>	<b>ST</b>
9/0	3/n	2/1	7/5	3/n	9/12

### Parameters

**Pn**  
represents a character set designator.

---

<b>Pn</b>	<b>Meaning</b>
0	DEC, ISO Latin-1, ISO Latin-2
1	ISO Latin-5, ISO Latin-7, ISO Cyrillic, ISO Hebrew

---

**Dscs**  
represents a character set.

---

<b>Dscs</b>	<b>Character Set</b>
% 5	DEC Supplemental
" ?	DEC Greek
" 4	DEC Hebrew
% 0	DEC Turkish
& 4	DEC Cyrillic
<	User-preferred Supplemental
A	ISO Latin-1 Supplemental
B	ISO Latin-2 Supplemental
F	ISO Greek Supplemental
H	ISO Hebrew Supplemental
M	ISO Latin-5 Supplemental
L	ISO Latin-Cyrillic

---

### Description

You can assign any supplemental or ISO Latin supplemental set as the standby set. See SCS—Select Character Set for more information.

After you assign a set:

1. Designate the set as G1, G2, or G3.
2. Map the set into GR.

---

## DECAWM—Autowrap Mode

This control function determines whether or not received characters automatically wrap to the next line when the cursor reaches the right border of a page in page memory.

**Default:** No autowrap

### Format

**CSI** ? 7 h Set: autowrap.  
9/11 3/15 3/7 6/8

**CSI** ? 7 l Reset: no autowrap.  
9/11 3/15 3/7 6/12

### Description

If the DECAWM function is set, then graphic characters received when the cursor is at the right border of the page appear at the beginning of the next line. Any text on the page scrolls up if the cursor is at the end of the scrolling region.

If the DECAWM function is reset, then graphic characters received when the cursor is at the right border of the page replace any previous characters there.

---

## DECBBSM—Bold and Blink Style Mode

Selects whether the bold and blink attributes affect the text foreground only or both the foreground and background.

### Format

**CSI** ? 1 1 6 h Set: foreground and background  
9/11 3/15 3/1 3/1 3/6 6/8

**CSI** ? 1 1 6 l Reset: foreground only - default  
9/11 3/15 3/1 3/1 3/6 6/12

### Description

This setting selects whether the bold and blink attributes affect the text foreground only, or both foreground and background. See the Set-Up chapter for details.

DECBBSM can be reported using DECRQM and DECRPM.

## DECBI—Back Index

---

### DECBI—Back Index

This control function moves the cursor backward one column. If the cursor is at the left margin, then all screen data within the margin moves one column to the right. The column that shifted past the right margin is lost.

**Available in:** VT Level 4 or higher mode only

#### Format

ESC	6
1/11	3/6

#### Description

DECBI adds a new column at the left margin with no visual attributes. DECBI is not affected by the margins. If the cursor is at the left border of the page when the terminal receives DECBI, then the terminal ignores DECBI.

---

## DECBKM—Backarrow Key Mode

This control function determines whether the `<X` key works as a backspace key or delete key.

---

#### Note

To be compatible with some software, DECBKM should be reset (delete key setting).

---

**Default:** Delete key

#### Format

CSI	?	6	7	h	Set: backspace key.
9/11	3/15	3/6	3/7	6/8	

CSI	?	6	7	l	Reset: delete key.
9/11	3/15	3/6	3/7	6/12	

#### Description

If DECBKM is set, `<X` works as a backspace key. When you press `<X`, the terminal sends a BS character to the host.

If DECBKM is reset, `<X` works as a delete key. When you press `<X`, the terminal sends a DEL character to the host.

---

## DECCANSM—Conceal Answerback Message Mode

Conceal the answerback message.

**Default:** Answerback message is not concealed

### Format

<b>CSI</b>	<b>?</b>	<b>1</b>	<b>0</b>	<b>1</b>	<b>h</b>	Conceal answerback message
9/11	3/15	3/1	3/0	3/1	6/8	
<b>CSI</b>	<b>?</b>	<b>1</b>	<b>0</b>	<b>1</b>	<b>l</b>	Answerback message is not concealed
9/11	3/15	3/1	3/0	3/1	6/12	

### Description

Setting	Function
Not concealed	The answerback message is visible in Set-Up.
Concealed	<p>The text "concealed" replaces the answerback message.</p> <p>The answerback message cannot be set back to "not concealed" either through a host control function or Set-Up. Only entering a new message returns this field to "not concealed."</p> <p>If the user or host requests the terminal to reset to the default setting (answerback message not concealed (CSI ? 101 l)) when the answerback message is set to "concealed," then the terminal will not reset the answerback message to "not concealed."</p>

## DECCAPSLK—Caps Lock Mode

---

## DECCAPSLK—Caps Lock Mode

DECCAPSLK controls the CapsLock state of the keyboard as if the CapsLock key had been pressed.

### Format

<b>CSI</b>	<b>?</b>	<b>1</b>	<b>0</b>	<b>9</b>	<b>h</b>	Set: Lock on.
9/11	3/15	3/1	3/0	3/9	6/8	

<b>CSI</b>	<b>?</b>	<b>1</b>	<b>0</b>	<b>9</b>	<b>l</b>	Reset: Lock off.
9/11	3/15	3/1	3/0	3/9	6/12	

---

## DECCARA—Change Attributes in Rectangular Area

This control function lets you change the visual character attributes (bold, blink, reverse video, and underline) of a specified rectangular area in page memory. The select attribute change extent (DECSACE) control function determines the stream or rectangular area. DECCARA does NOT change the values of characters just the visual attributes of those characters.

**Available in:** VT Level 4 or higher mode only

### Format

<b>CSI</b>	<i>Pt; Pl; Pb; Pr;</i>	<i>Ps1; . . . Psn</i>	<b>\$</b>	<b>r</b>
9/11	<i>area to be changed</i>	<i>attributes to change</i>	2/4	7/2

### Parameters

#### **Pt; Pl; Pb; Pr;**

define the rectangular area to be changed. A semicolon (3/11) separates parameters.

#### **Pt**

is the top-line border. *Pt* must be less than or equal to *Pb*.

Default: *Pt* = 1.

#### **Pl**

is the left-column border. *Pl* must be less than or equal to *Pr*. Default: *Pl* = 1.

#### **Pb**

is the bottom-line border.

Default: *Pb* = last line of the active page.

#### **Pr**

is the right-column border.

Default: *Pr* = last column of the active page.

#### **Ps1; . . . Psn**

select the visual character attributes to change. These values correspond to the values used in the select graphic rendition.

## DECCARA—Change Attributes in Rectangular Area

Psn	Meaning
0 (default)	Attributes off (no bold, no underline, no blink, positive image)
1	Bold
4	Underline
5	Blink
7	Negative image
22	No bold
24	No underline
25	No blink
27	Positive image

DECCARA ignores all other parameter values. When you use more than one parameter in a command, DECCARA executes them cumulatively in sequence.

### Examples

The following sequence changes the video attributes of the complete screen to blink and underscore:

```
CSI ; ; ; ; 0; 4; 5; $ r
```

The following sequence turns off the blinking character attribute from position line 10, column 2 to position line 14, column 45 on the current page:

```
CSI 10; 2; 14; 45; 25 $ r
```

### Notes on DECCARA

- The coordinates of the rectangular area are affected by the setting of origin mode (DECOM).
- DECCARA is not affected by the page margins.
- If the value of *Pt*, *Pl*, *Pb*, or *Pr* exceeds the width or height of the active page, then the value is treated as the width or height of that page.
- DECCARA does not change the active cursor position.
- DECCARA does not change the current rendition set by the select graphic rendition (SGR) function.
- The exact character positions affected by DECCARA depend on the current setting of the select attribute change extent (DECSACE) function.

## DECCIR—Cursor Information Report (Terminal to Host)

---

### DECCIR—Cursor Information Report (Terminal to Host)

The terminal sends this sequence in response to a request presentation state report (DECRQPSR) sequence. DECCIR reports the status of the cursor position, including visual attributes and character protection attributes. DECCIR also reports the status of origin mode (DECOM) and the current active character sets.

#### Format

```
DCS  1  $  u  D ... D  ST
9/0  3/1  2/4  7/5  D ... D  9/12
```

#### Description

DECCIR reports all the character sets if they are assigned to one of the G0, G1, G2, or G3 sets. Refer to SCS—Select Character Set for all character set designators.



---

## DECCKD—Copy Key Default

Copies the default states of a key and its key/modifier combination to another key and its key/modifier combination.

### Format

DCS	"	z	D ... D	ST
9/0	2/2	7/10	D ... D	9/12

### Description

This control function copies the default states of a key and all its modifier combinations to another key and its modifier combinations. The source key may have been reprogrammed to perform a non-default function when copy operation is executed. Only the default states of the source key are copied.

The source key and the destination key can be two different keys or the same key. If they are different keys, then the copy operation occupies the memory space that is reserved for the operations of control functions, DECPFK, DECPAK, and DECUDK and their equivalent functions in Set-Up. (Refer to DECPFK—Program Function Key for details.) If they are the same key, then the function of the copy operation is to restore the key's default. In this state, the terminal does not allocate new memory space. The terminal frees up the space by deleting the non-default functions of the destination key and its modifier combinations.

A function key can copy the default state from a function key or a graphic key. When a graphic key's default is copied, the function key operates as a graphic key. Only the modifiers that are suitable for a graphic key operate with the key. This logic is used when a graphic key copies the default from a function key.

Multiple keys can be copied in one sequence.

The data string D...D format is:

*Key-s/Key-d;Key-s/Key-d.....;*

Where:

- Key-s is the keystation number of the key to be copied.
- Key-d is the keystation number of the destination key.

Once programmed, the key states are not affected by the terminal mode changes. Refer to DECPFK—Program Function Key for the list of terminal mode changes.

This function works in all the VT modes except in VT52 mode.

## DECCKM—Cursor Keys Mode

---

### DECCKM—Cursor Keys Mode

This control function selects the sequences the arrow keys send. You can use the four arrow keys to move the cursor through the current page or to send special application commands.

**Default:** Cursor

#### Format

<b>CSI</b>	<b>?</b>	<b>1</b>	<b>h</b>	Set: application sequences.
9/11	3/15	3/1	6/8	

<b>CSI</b>	<b>?</b>	<b>1</b>	<b>l</b>	Reset: cursor sequences.
9/11	3/15	3/1	6/12	

#### Description

If the DECCKM function is set, then the arrow keys send application sequences to the host.

If the DECCKM function is reset, then the arrow keys send ANSI cursor sequences to the host.

---

## DECCKSR—Memory Checksum Report

The host asks for a memory checksum report of current text macro definitions.

### Programming Tip

Enter your macro definitions, then request and save a memory checksum. After this procedure, you can request another checksum to determine if the checksum has changed.

### Format

<b>CSI</b>	<b>?</b>	<b>6</b>	<b>3</b>	<b>;</b>	<i>Pid</i>	<b>n</b>	Request memory checksum.
9/11	3/15	3/6	3/3	3/11	3/n	6/14	
<b>DCS</b>	<i>Pid</i>	<b>!</b>	<b>~</b>	<i>D . . . D</i>	<b>ST</b>		Response with checksum.
9/0	3/n	2/1	7/14	. . .	9/12		

### Parameters

#### **Pid (request)**

is an optional numeric parameter that provides a label to identify the particular checksum request. The checksum report returns the label. This label lets you distinguish between multiple checksum reports.

#### **Pid (response)**

is a label indicating which DSR request the report is for.

#### **D . . . D**

is the data string consisting of four hexadecimal digits indicating the checksum. The digits can be in the range of 3/0 through 3/9 and 4/0 through 4/6.

## DECCOLM—Selecting 80 or 132 Columns per Page

---

## DECCOLM—Selecting 80 or 132 Columns per Page

There are two control functions that can set the page width to 80 or 132 columns, DECSCPP (DECSCPP—Select Columns Per Page ) and DECCOLM.

---

### NOTE

---

It is recommended that new applications use DECSCPP rather than DECCOLM. DECCOLM resets the cursor position to 1;1. DECSCPP does not clear page memory or reset the scrolling regions, as does DECCOLM. If DECNCSM is set, the page is not erased by DECCOLM. DECCOLM is provided mainly for compatibility with previous products.

---

**Default:** 80 columns

### Format

CSI	?	3	h	Set: 132-column font.
9/11	3/15	3/3	6/8	
CSI	?	3	l	Reset: 80-column font.
9/11	3/15	3/3	6/12	

### Notes on DECCOLM

- DECCOLM sets the number of columns on the page to 80 or 132 and selects the corresponding 80- or 132-column font.
- If you change the DECCOLM setting, the terminal:
  - Sets the left, right, top and bottom scrolling margins to their default positions.
  - Erases all data in page memory, unless DECNCSM is set; then, the page is not erased.
- DECCOLM resets vertical split screen mode (DECLRMM) to unavailable.
- DECCOLM clears data from the status line if the status line is set to host-writable.

---

## DECCRA—Copy Rectangular Area

This control function copies a rectangular area of characters from one section to another in page memory. The copied text retains its character values and attributes.

**Available in:** VT Level 4 or higher mode only

### Format

<b>CSI</b>	<i>Pts; Pls; Pbs; Prs; Pps;</i>	<i>Ptd; Pld; Ppd</i>	<b>\$</b>	<b>v</b>
9/11	<i>area to be copied</i>	<i>destination</i>	2/4	7/6

### Parameters

**Pts; Pls; Pbs; Prs; Pps;**

define the rectangular area to be copied (the source). A semicolon (3/11) separates parameters.

**Pts**

is the top-line border. *Pts* must be less than or equal to *Pbs*. Default: *Pts* = 1.

**Pls**

is the left-column border. *Pls* must be less than or equal to *Prs*. Default: *Pls* = 1.

**Pbs**

is the bottom-line border.

Default: *Pbs* = the last line of the page.

**Prs**

is the right-column border.

Default: *Prs* = the last column of the page.

**Pps**

is the number of the page where the rectangular area is located.

Default: *Pps* = 1.

**Ptd; Pld; Ppd;**

define the destination of the copied rectangular area.

**Ptd**

is the top-line border.

Default: *Ptd* = 1.

**Pld**

is the left-column border.

Default: *Pld* = 1.

**Ppd**

is the number of the page.

Default: *Ppd* = 1.

## DECCRA—Copy Rectangular Area

### Notes on DECCRA

- If *Pbs* is greater than *Pts*, or *Pls* is greater than *Prs*, the terminal ignores DECCRA.
- The coordinates of the rectangular area are affected by the setting of origin mode (DECOM).
- DECCRA is not affected by the page margins.
- The copied text takes on the line attributes of the destination area.
- If the value of *Pt*, *Pl*, *Pb*, or *Pr* exceeds the width or height of the active page, then the value is treated as the width or height of that page.
- If a page value exceeds the number of pages available in the current page arrangement, then the value is treated as the last available page number.
- If the destination area is partially off the page, then DECCRA clips the off-page data.
- DECCRA does not change the active cursor position.

---

## DECCRTST—CRT Saver Timing

Controls the timing of the CRT screen saver.

**Default:** 15 minutes

### Format

CSI    *Ps*    -    *q*  
9/11       2/13    7/1

### Parameters

**Ps**  
Screen saver timing

<b>Ps</b>	<b>Selection</b>
0	Never
5	5 minutes
15	15 minutes
30	30 minutes
60	60 minutes

### Description

The **CRT saver** feature causes the screen to go blank after the specified interval of no keystroke or receive character activity. Refer to Set-Up for details.

DECCRTSM remains functional (set = 15 min; reset = never).

DECCRTST can be reported using DECRPSS.

---

## DECRTSM—Set/Reset CRT Save Mode

Enable or disable CRT saver.

**Default:** Enable CRT saver.

### Format

<b>CSI</b>	<b>?</b>	<b>9</b>	<b>7</b>	<b>h</b>	Set: enable CRT saver.
9/11	3/15	3/9	3/7	6/8	

<b>CSI</b>	<b>?</b>	<b>9</b>	<b>7</b>	<b>l</b>	Reset: disable CRT saver.
9/11	3/15	3/9	3/7	6/12	

### Description

If CRT saver is enabled and the terminal is inactive for 15 minutes (no keyboard activity or input from a host computer), then the monitor screen goes blank to prolong the life of the CRT. No data is lost when CRT saver is active. Keyboard activity or input from the host computer re-activates the monitor.

When the monitor goes blank, the keyboard LEDs flash.

---

## DECDC—Delete Column

This control function deletes one or more columns in the scrolling region, starting with the column that has the cursor.

**Available in:** VT Level 4 or higher mode only.

### Format

<b>CSI</b>	<b><i>P<sub>n</sub></i></b>	<b>'</b>	<b>~</b>
9/11	3/?	2/7	7/14

### Parameters

***P<sub>n</sub>***

is the number of columns to delete.

Default: *P<sub>n</sub>* = 1.

### Description

As columns are deleted, the remaining columns between the cursor and the right margin move to the left. The terminal adds blank columns with no visual character attributes at the right margin. DECDC has no effect outside the scrolling margins.

## DECDHL—Double-Width, Double-Height Line

---

### DECDHL—Double-Width, Double-Height Line

These two control functions make the line with the cursor the top or bottom half of a double-height, double-width line. You must use these sequences in pairs on adjacent lines. In other words, the same display characters must appear in the same positions on both lines to form double-height characters. If the line was single width and single height, then all characters to the right of the screen center are lost.

#### Format

<b>ESC</b>	<b>#</b>	<b>3</b>	Top Half
1/11	2/3	3/3	
<b>ESC</b>	<b>#</b>	<b>4</b>	Bottom Half
1/11	2/3	3/4	

#### Description

The following sequences make the phrase “VT520 Video Terminal” a double-height, double-width line.

**ESC#3** VT520 Video Terminal

**ESC#4** VT520 Video Terminal

This control does not operate when DECLRMM (left right margin mode) is set.



---

## DECDDL—Dynamically Redefinable Character Sets Extension

DECDDL loads your soft character set into dynamically redefinable character set (DRCS) font buffers. The terminal supports two each S1 and S2 buffers for soft character sets.

The terminal arranges the DRCS font buffers into sets. Each DRCS set has two font buffers: one for 80-column fonts and one for 132-column fonts. These buffers also allow you to load two different font heights or character sets in both 80- and 132-column widths.

Although the terminal allows you to use two different soft character sets at one time, it only allows you to use one DRCS set at one time.

### Format

DCS *Pfn* ; *Pcn*; *Pe*; *Pcmw*; *Pss*; *Pt*; *Pcmh*; *Pcss* { *<Dscs><sixel-font-pattern>* ST

### Description

DCS is the *DCS control string introducer*. DCS is an 8-bit C1 character. You can use the equivalent 7-bit sequence, ESC P (1/11, 5/0), when coding for a 7-bit environment.

ST is the *string terminator*. ST is an 8-bit C1 character. You can use the equivalent 7-bit sequence, ESC \ (1/11, 5/12), when coding for a 7-bit environment.

### Parameters

**Pfn; Pcn; Pe; Pcmw; Pss; Pu; Pcmh; Pcss**

are *parameter characters*, separated by semicolons (3/11). Table 5–2 describes these parameters and lists their possible values.

{  
is the *final character*. It marks the end of the parameter characters and indicates that this string is a DECDDL function.

**Dscs**

defines the name for the soft character set. You use this name in the select character set (SCS) escape sequence. You use the following format for the *Dscs* name:

*I F*

*I* is 0, 1, or 2 intermediate characters from the 2/0 to 2/15 range in the ASCII character set.

*F* is a final character in the 3/0 to 7/14 range.

---

## NOTES

---

- If two downline loaded soft character sets have the same *Dscs*, then the most recently loaded set is used. The terminal looks for a matching *Dscs* in reverse load order (last loaded first).
  - If the terminal receives a DRCS control string for a given font number with a different *Dscs* (designating sequence), *Pcmh* (height) or *Pcss* (character set size), then the terminal erases the previously downline loaded set (if any) in both 80- and 132-column mode.
  - If there is no DRCS available that is compatible with the current number of lines per screen (font height), then the terminal displays a reverse question mark in place of any characters.
- 

### Examples of Dscs Names

Name			Function
<b>sp</b> 2/0	<b>@</b> 4/0		Defines the character set as an unregistered soft set. <b>This value is the recommended default for user-defined sets.</b> The value of <i>Pcss</i> defines whether this set has 94 or 96 characters.
<b>A</b> 4/2			If <i>Pcss</i> is 0, then A defines the soft character set as the U.K. national replacement character set. If <i>Pcss</i> is 1, then A defines the soft character set as the ISO Latin-1 supplemental set.
<b>&amp;</b> 2/6	<b>%</b> 2/5	<b>C</b> 4/3	Defines the soft character set as % C, which is currently an unregistered set. The value of <i>Pcss</i> defines whether this set has 94 or 96 characters.

## DECDDL—Dynamically Redefinable Character Sets Extension

Table 5–2 DECDDL Parameter Characters

Parameter	Name	Description
<i>Pfn</i>	Font number	<p>Selects the DRCS (soft character set) to load. The previous set (if any), that you load with that font number, is erased or overwritten as specified by the control sequence.</p> <p>You can assign a value of 0, 1, and 2 to <i>Pfn</i>. Other values cause the terminal to ignore the entire sequence. <i>Pfn</i> = 0 defaults to the first empty font buffer, or, if none are empty, to font buffer 1.</p>
<i>Pcn</i>	Starting character	<p>Selects where to load the first character in the DRCS font buffer. The location corresponds to a location in the ASCII code table. For example, a <i>Pcn</i> value of 0 means that the first soft character is loaded into position 2/0 of the character table. A <i>Pcn</i> value of 1 means position 2/1 in the table, and so on, up to <i>Pcn</i> = 95 (position 7/15).</p> <p><i>Pcn</i> is affected by the character set size. See <i>Pcss</i> below.</p>
<i>Pe</i>	Erase control	<p>Selects which characters to erase from the DRCS buffer before loading the new font.</p> <p>0 = Erases all characters in the DRCS buffer with this number, width, and rendition.</p> <p>1 = Erases only characters in locations being reloaded.</p> <p>2 = Erases all renditions of the soft character set (normal, bold, 80-column, 132-column).</p>

**Note**

Erased characters are undefined (not blank). The terminal displays these characters as the error character (reverse question mark).

(continued on next page)

# DECDDL—Dynamically Redefinable Character Sets Extension

Table 5–2 (Cont.) DECDDL Parameter Characters

Parameter	Name	Description
<i>Pcmw</i>	Character matrix width	<p>Selects the maximum character cell width. When <i>Pss</i> specifies 80 columns, <i>Pu</i> specifies font usage full cell as follows:</p> <ul style="list-style-type: none"> <li><b>0</b> = <b>10 pixels wide for 80 columns, 6 pixels wide for 132 columns. (default).</b></li> <li>0 = device default</li> <li>2 = 5 × 10 pixel cell (width × height).</li> <li>3 = 6 × 10 pixel cell (width × height).</li> <li>4 = 7 × 10 pixel cell (width × height).</li> <li>5 = 5 pixels wide.</li> <li>6 = 6 pixels wide.</li> <li>7 = 7 pixels wide.</li> <li>8 = 8 pixels wide.</li> <li>9 = 9 pixels wide.</li> <li>10 = 10 pixels wide.</li> </ul> <p>When <i>Pss</i> specifies 80 columns, <i>Pu</i> specifies font usage text as follows:</p> <ul style="list-style-type: none"> <li><b>0</b> = <b>10 pixels wide for 80 columns, 6 pixels wide for 132 columns. (default)</b></li> <li>0 = device default</li> <li>2 = 5 × 10 pixel cell (width × height).</li> <li>3 = 6 × 10 pixel cell (width × height).</li> <li>4 = 7 × 10 pixel cell (width × height).</li> <li>5 = 5 pixels wide.</li> <li>.</li> <li>.</li> <li>.</li> <li>9 = 9 pixels wide.</li> </ul> <p>When <i>Pss</i> specifies 132 columns, <i>Pu</i> specifies font usage full cell as follows:</p> <ul style="list-style-type: none"> <li><b>0</b> = <b>10 pixels wide for 80 columns, 6 pixels wide for 132 columns. (default)</b></li> <li>2 = 5 × 10 pixel cell (width × height).</li> <li>3 = 6 × 10 pixel cell (width × height).</li> <li>4 = 7 × 10 pixel cell (width × height).</li> <li>5 = 5 pixels wide.</li> <li>6 = 6 pixels wide.</li> </ul>

(continued on next page)

## DECDDL—Dynamically Redefinable Character Sets Extension

Table 5–2 (Cont.) DECDDL Parameter Characters

Parameter	Name	Description
		<p>When <i>Pss</i> specifies 132 columns, <i>Pu</i> specifies font usage text as follows:</p> <p><b>0 = 10 pixels wide for 80 columns, 6 pixels wide for 132 columns. (default)</b></p> <p>2 = 5 × 10 pixel cell (width × height).            3 = 6 × 10 pixel cell (width × height).            4 = 7 × 10 pixel cell (width × height).            5 = 5 pixels wide.</p> <p>If you omit a <i>Pcmw</i> value, the terminal uses the default character width. If the <i>Pe</i> parameter is 0, <i>Pcmw</i> must be less than 10. Any <i>Pcmw</i> value over 10 is illegal. For illegal values of <i>Pcmw</i>, the terminal ignores the rest of the load sequence.</p> <p><b>For VT200 compatible software:</b> Use a <i>Pcmw</i> value of 0=device default, 8 . . . 16 pixel high matrix.</p>
<i>Pss</i>	Font set size	<p>Defines the screen width and screen height for this font.</p> <p><b>0,1 = 80 columns, 24 lines. (default)</b></p> <p>0 = 80 columns, 24 lines            1 = 80 columns, 24 (25 or 26) lines            2 = 132 columns, 24 lines            11 = 80 columns, 36 (40 or 42) lines            12 = 132 columns, 36 lines            21 = 80 columns, 48 (50 or 52) lines            11 = 132 columns, 48 lines</p> <p>For illegal values of <i>Pss</i>, the terminal ignores the rest of the load sequence.</p> <p>If the number of columns or lines/screen changes, then the terminal uses the appropriate variation of the soft set. If you try to display a DRCS character when there is no soft set defined for the current number of lines and columns, then the terminal displays the error character (reverse question mark).</p>

---

### Note

---

For VT220 compatibility, you must use a soft font of 80 or 132 columns (not both). The VT220 allows a single font to be used for 80 and 132 columns.

---

(continued on next page)

## DECDDL—Dynamically Redefinable Character Sets Extension

Table 5–2 (Cont.) DECDDL Parameter Characters

Parameter	Name	Description
		You can load a font for any of the six sizes at any time. When a new soft set is loaded, any characters from the previous soft set are lost. Characters currently displayed from the old set become reverse question marks.
<i>Pu</i>	Text or full cell	<p>Defines the font as a text font or <i>full-cell font</i>.</p> <p><b>0</b> = <b>text. (default)</b>  <b>1</b> = text.  <b>2</b> = full cell.</p> <p>Full-cell fonts can individually address all pixels in a cell.  Text fonts cannot individually address all pixels. If you specify a text cell, then the terminal automatically performs spacing and centering of the characters.</p>
<i>Pcmh</i>	Character matrix height	<p>Selects the maximum character cell height.</p> <p><b>0 or omitted = 16 pixels high. (default)</b>  <b>1</b> = 1 pixel high.  <b>8</b> = 8 pixels high.  <b>9</b> = 9 pixels high.  .  .  .  <b>16</b> = 16 pixels high.</p> <p><i>Pcmh</i> values over 16 are illegal. If the value of <i>Pcmw</i> is 2, 3, or 4, then <i>Pcmh</i> is ignored.</p>

## DECDMAC—Define Macro

This device control string lets you define a macro consisting of a string of ANSI text and control functions. After you define the macro, you can execute it by using the invoke macro control function (DECINVM). The terminal processes the macro as normal input.

**Available in:** VT Level 4 or higher mode only.

### Programming Tip

You can find how much memory space you have available for macros by using a device status report sequence.

### Format

```
DCS  Pid ; Pdt ; Pen ! z  D...D  ST
9/0  3/? 3/11 3/? 3/11 3/? 2/1 7/10  ... 9/12
```

### Parameters

#### Pid

is the macro ID number. *Pid* can be any number between 0 and 63, otherwise the terminal ignores the command. If you give a macro an ID that already exists, then DECDMAC deletes the old macro definition before using the new one.

#### Pdt

defines how the terminal treats new macro definitions.

Pdt	Meaning
0 or omitted	DECDMAC deletes the old macro with the same ID number before defining this new macro.
1	DECDMAC deletes all current macro definitions before defining this macro.
Other	The terminal ignores the macro.

#### Pen

selects the encoding format for the text of the macro definition.

Pen	Meaning
0 or omitted	Uses standard ASCII characters in the macro.
1	Uses hex pairs in the macro. Each pair of characters in the macro is the hex value for a single ASCII character.
Other	The terminal ignores the macro.

#### D...D

is the data of the control string. This data is the string of text and control functions performed when an application invokes the macro. The data can consist of ASCII text or hex pairs.

## DECDMAC—Define Macro

**When you use ASCII text (Pen = 0 or omitted)**, the macro consists of the graphic characters that appear in the device control string. Only characters from positions 2/0 through 7/14 and 10/00 through 15/15 in the code table are valid.

**When you use hex pairs (Pen = 1)**, the macro consists of pairs of hex numbers, each of which represents an ASCII character. When using hex pairs, you can also use a repeat introducer in the data string. The repeat introducer is the ! (2/1) character. The repeat introducer lets you repeat any hex pair within the definition string any number of times. You embed repeat sequences within the data string of the macro definition.

### Notes on DECDMAC

- If ASCII text is specified as the encoding format, then you cannot use the repeat sequence.
- ! is the repeat sequence introducer. The format of the hex string with the repeat introducer is as follows:
  - ! *Pn*; *D...D* ;
  - Pn* is a numeric parameter that specifies the number of times to repeat the sequence. If *Pn* is omitted, then the macro repeats the sequence once.
  - D...D* is the sequence of hex pairs to repeat *Pn* times.
  - A semicolon ; (3/11) separates the repeat count from the sequence of hex pairs. Another semicolon ends the sequence. If any characters are included before the first semicolon, then the terminal ignores the macro. If a string terminator is placed before the final semicolon, then the repeat string ends normally.
- The VT520 has 6 Kbytes of memory available for the storage of macros. The terminal ignores any macro definitions that cannot fit into this space.
- A reset to initial state (RIS) or secure reset (DECSR) operation clears all macro definitions. A soft terminal reset (DECSTR) has no effect on stored macro definitions.
- You can include characters from positions 0/8 through 0/13 to format the device control string, but these characters cannot be part of the macro definition.



---

## DECDLDA—Down Line Load Allocation

This control function controls the number of soft character sets (DECS) allowed per session.

**Available for:** monochrome terminals only; not available for color terminals.

### Format

CSI *Ps* , **z**  
 9/11 3/s 2/12 7/10

### Parameters

**Ps**  
 is the number of soft character sets allowed:  
 Default: *Ps* = 2.

<b>Ps</b>	<b>Description</b>	<b>Compatible with terminals such as . . .</b>
1	One each	VT420 video terminal.
2	Two each for sessions S1 and S2	VT510 video terminal.

### Description

For the monochrome monitor, you can use these commands to set up one or two soft character sets for sessions S1 and S2. You can also use the **Session ▸ Soft character sets/session** to perform this same function. Also see 2.6.4.

The color terminal does not use this command because it has enough memory to give all four sessions **Two each**.

DECDLDA can be reported using DECRPSS.

## DECDWL—Double-Width, Single-Height Line

---

### DECDWL—Double-Width, Single-Height Line

This control function makes the line with the cursor a double-width, single-height line. If the line was single width and single height, then all characters to the right of the screen's center are lost.

#### Format

ESC	#	6
1/11	2/3	3/6

#### Note on DECDWL

DECDWL control does not operate when DECLRMM (left right margin mode) is set.

---

## DECECM—Erase Color Mode

Controls the background color used when text is erased or new text is scrolled on to the screen.

**Default:** Erase to text background

#### Format

CSI	?	1	1	7	h	Set: erase to screen background (VT)
9/11	3/15	3/1	3/1	3/7	6/8	

CSI	?	1	1	7	l	Reset: erase to text background (PC)
9/11	3/15	3/1	3/1	3/7	6/12	

#### Description

The **erase color** selection controls the background color used when text is erased or new text is scrolled onto the screen. Refer to Set-Up for details.

DECECM can be reported using DECRQM and DECRPM.

---

## DECEKBD—Extended Keyboard Report

This control function is a report that provides applications with more complete keystroke information. Each report consists of an ISO key position code and the current state of the eight modifier keys—pressed or released.

### Format

```
APC      :      ppp  mm  ST
9/15     3/10    ***   **   9/12
```

### Parameters

#### ppp

is a three-character ISO key position name, for example C01. For keys that occupy more than one position in the ISO key position map, the VT520 uses the largest lower-left position. The position for the space bar is A02; Return is C13.

#### mm

are two ASCII hexadecimal digits that represent the state of the modifier keys.

The terminal represents the state of each modifier key as a bit in an 8-bit binary number. A bit value of 1 means the key is pressed, and a bit value of 0 means the key is not pressed. *mm* is the hexadecimal equivalent of the resulting 8-bit binary number.

The following table shows the order in which keys are represented in the binary number, and their corresponding hexadecimal values when pressed. The least significant bit represents the left Shift key. The most significant bit represents the right Compose Character key.

For example,  $00000010_2$  means that the right Shift key is pressed. The hexadecimal value for  $00000010_2$  is  $02_{16}$ .

mm	Key
01	left <span style="border: 1px solid black; padding: 0 2px;">Shift</span> (Least significant bit)
02	right <span style="border: 1px solid black; padding: 0 2px;">Shift</span>
04	<span style="border: 1px solid black; padding: 0 2px;">Lock</span>
08	<span style="border: 1px solid black; padding: 0 2px;">Ctrl</span>
10	left <span style="border: 1px solid black; padding: 0 2px;">Alt Function</span>
20	right <span style="border: 1px solid black; padding: 0 2px;">Alt Function</span>
40	left <span style="border: 1px solid black; padding: 0 2px;">Compose Character</span>
80	right <span style="border: 1px solid black; padding: 0 2px;">Compose Character</span> (Most significant bit)

## DECEKBD—Extended Keyboard Report

### Description

The terminal only sends extended key position reports when key position mode (DECKPM) is set.

The terminal uses the following rules when sending extended key reports:

- A single report may contain more than one keystroke. In this case, each keystroke is separated by a slash (/). The terminal sends the control string (APC ... ST) when a modifier key changes, or to separate keystroke data from other terminal reports.
- The terminal only sends the modifier key state when it changes in the first keystroke after an APC character.
- The terminal sends repeated key position reports as a single repeat character, period (.).

### Examples

The following sequence reports an **a** key with no modifier keys, four **⇒** keys, one **⇐** key, and a **b** key:

```
APC : C01 00 / B18.../ B16 / B05 ST
```

The following sequence reports a left **Shift** key and an **A** key:

```
APC : B99 01 / C01 ST
```

---

## DECELF—Enable Local Functions

This control function lets you enable or disable the keys used to perform several local terminal functions: cutting and pasting text, panning, and resizing windows. DECELF is useful for:

- Simplifying the keyboard for novice users
- Letting the corresponding keys send position codes to the host when key position mode (DECKPM) is set
- Disabling features that are not compatible with the application

### Format

```
CSI  Pfn ; Pc1 ; ... Pfn; Pcn + q
9/11 3/n 3/11 3/n 3/11 ... 3/n 3/n 2/11 7/1
```

### Parameters

#### Pfn

is a number that specifies the local function affected.

Pfn	Local Functions Affected	Default Setting
0 (default)	All local functions listed for 1, 2, and 3.	
1	Copy and paste keys, including <b>F1</b> (Hold), <b>Select</b> , <b>Remove</b> , and <b>Insert Here</b> .	The keys are enabled.
2	Panning keys, including <b>Ctrl</b> with <b>↑</b> , <b>↓</b> , <b>←</b> , or <b>→</b> .	The keys are enabled.
3	Window resizing keys, including: <b>Control</b> and <b>Shift</b> with <b>↑</b> or <b>↓</b> keys.	The keys are enabled.

#### Pcn

controls the action of the local function specified by the corresponding *Pfn* value.

Pcn	Meaning
0	Selects the default setting of the local function. In VT mode, the default setting is enabled. In PC Term mode, the default setting is disabled.
1	Enables the local function. The associated keys perform the local function and cannot send position codes to the host.
2	Disables the local function. The associated keys do not perform the local function and may send position codes to the host.

### Description

DECELF can accept any number of parameter pairs. The terminal executes the parameters in the order in which it receives them.

## DECERA—Erase Rectangular Area

---

## DECERA—Erase Rectangular Area

This control function erases characters from the specified rectangular area in page memory. When an area is erased, DECERA replaces all character positions with the space character (2/0). DECERA erases character values and visual attributes from the specified area. DECERA does not erase line attributes.

**Available in:** VT Level 4 or higher mode only.

### Format

<b>CSI</b>	<i>Pt</i>	<b>;</b>	<i>Pl; Pb; Pr</i>	<b>\$</b>	<b>z</b>
9/11	3/ <i>n</i>	3/11	*****	2/4	7/10

### Parameters

#### **Pt, Pl, Pb, and Pr**

define the rectangular area to be erased:

**Pt** is the top-line border. *Pt* must be less than or equal to *Pb*.

Default: *Pt* = 1.

**Pl** is the left-column border. *Pl* must be less than or equal to *Pr*. Default: *Pl* = 1.

**Pb** is the bottom-line border.

Default: *Pb* = the last line of the active page.

**Pr** is the right-column border.

Default: *Pr* = the last column of the active page.

### Notes on DECERA

- The coordinates of the rectangular area are affected by the setting of origin mode (DECOM).
- DECERA is not affected by the page margins.
- If the value of *Pt*, *Pl*, *Pb*, or *Pr* exceeds the width or height of the active page, then the value is treated as the width or height of that page.
- DECERA does not change the active cursor position.

---

## DECES—Enable Session

Make the session receiving this command the active session.

### Format

```
CSI  &  x
9/11 2/6 7/8
```

### Description

This command makes the session receiving this command the active session for keyboard input. Normally the active session for keyboard input is controlled by the user pressing the Session key.

---

## DECESKM—Enable Secondary Keyboard Language Mode

Select a secondary or primary keyboard language.

### Format

```
CSI  ?  1  0  4  h  Secondary keyboard mapping.
9/11 3/15 3/1 3/0 3/4 3/8

CSI  ?  1  0  4  l  Primary keyboard mapping.
9/11 3/15 3/1 3/0 3/4 6/12
```

### Description

When enabled, a secondary keyboard mapping (Group 2) replaces the primary keyboard mapping. To use the secondary keyboard mapping, a secondary keyboard language has to be defined for the currently selected keyboard language, such as Hebrew, Greek, or Cyrillic.

## DECFI—Forward Index

---

### DECFI—Forward Index

This control function moves the cursor forward one column. If the cursor is at the right margin, then all screen data within the margins moves one column to the left. The column shifted past the left margin is lost.

**Available in:** VT Level 4 or higher mode only.

#### Format

ESC	9
1/11	3/6

#### Description

DECFI adds a new column at the right margin, with no visual attributes. DECFI is not affected by the margins. If the cursor is at the right border of the page when the terminal receives DECFI, then the terminal ignores DECFI.



---

## DECFRA—Fill Rectangular Area

This control function fills a rectangular area in page memory with a specified character. DECFRA replaces the rectangular area's character positions and attributes with the specified fill character. The fill character assumes the visual character attributes set by the last select graphic rendition (SGR) command. DECFRA does not change the current line attributes.

**Available in:** VT Level 4 or higher mode only

### Format

```
CSI  Pch ; Pt; Pl; Pb; Pr $ x
9/11 3/n 3/11 3/n 2/4 7/8
```

### Parameters

#### **Pch**

is the decimal value of the fill character. *Pch* can be any value from 32 to 126 or from 160 to 255. If *Pch* is not in this range, then the terminal ignores the DECFRA command. The decimal value refers to the character in the current GL or GR in-use table.

#### **Pt; Pl; Pb; Pr**

define the rectangular area to be filled:

**Pt** is the top-line border. *Pt* must be less than or equal to *Pbs*.

Default: *Pt* = 1.

**Pl** is the left-column border. *Pl* must be less than or equal to *Pr*.

Default: *Pl* = 1.

**Pb** is the bottom-line border.

Default: *Pb* = the last line of the active page.

**Pr** is the right-column border.

Default: *Pr* = the last column of the active page.

### Notes on DECFRA

- The coordinates of the rectangular area are affected by the setting of origin mode (DECOM).
- DECFRA is not affected by the page margins.
- If the value of *Pt*, *Pl*, *Pb*, or *Pr* exceeds the width or height of the active page, the value is treated as the width or height of that page.
- DECFRA does not change the active cursor position.

## DECFWM—Set/Reset Framed Windows Mode

---

### DECFWM—Set/Reset Framed Windows Mode

Selects whether or not session windows are displayed with window frames with frame borders and icons.

**Default:** Framed windows enabled

#### Format

<b>CSI</b>	<b>?</b>	<b>1</b>	<b>1</b>	<b>1</b>	<b>h</b>	Set: enables framed windows
9/11	3/15	3/1	3/1	3/1	6/8	

<b>CSI</b>	<b>?</b>	<b>1</b>	<b>1</b>	<b>1</b>	<b>l</b>	Reset: disables framed windows
9/11	3/15	3/1	3/1	3/1	6/12	

#### Description

When **framed windows** is selected, window frames with title bars are added to each displayed window. Refer to Set-Up chapter for details.

DECFWM can be reported using DECRQM and DECRPM.

---

## DECHDPXM—Set/Reset Half-Duplex Mode

Enables half-/full-duplex communication.

#### Format

<b>CSI</b>	<b>?</b>	<b>1</b>	<b>0</b>	<b>3</b>	<b>h</b>	Set to half-duplex mode.
9/11	3/15	3/1	3/0	3/3	6/8	

<b>CSI</b>	<b>?</b>	<b>1</b>	<b>0</b>	<b>3</b>	<b>l</b>	Set to full-duplex mode.
9/11	3/15	3/1	3/0	3/3	6/12	

#### Description

Full-duplex mode allows simultaneously two-way communication; half-duplex mode is limited to one-way communication at any given time. Half-duplex mode is available only in an RS232 line. Refer to Chapter 9 for details about half-duplex mode communication protocol.

---

## DECHEM—Hebrew Encoding Mode

This control function sets the terminal's character set mode to DEC (8-bit) multinational mode. On a reset, the sequence resets the terminal's character set mode to (7-bit) national mode (NRC sets).

The terminal maintains DECHEM for the main display and status line separately in the same way as it maintains National Replacement Character Set Mode (DECNRCM).

### Format

<b>CSI</b>	<b>?</b>	<b>3</b>	<b>6</b>	<b>h</b>	Set
9/11	3/15	3/3	3/6	6/8	
<b>CSI</b>	<b>?</b>	<b>3</b>	<b>6</b>	<b>I</b>	Reset
9/11	3/15	3/3	3/6	6/12	

## DECHEBM—Hebrew/N-A Keyboard Mapping Mode

---

### DECHEBM—Hebrew/N-A Keyboard Mapping Mode

This control function sets the keyboard mapping to Hebrew/N-A and resets the mapping to North American.

#### Format

<b>CSI</b>	<b>?</b>	<b>3</b>	<b>5</b>	<b>h</b>	Set
9/11	3/15	3/3	3/5	6/8	
<b>CSI</b>	<b>?</b>	<b>3</b>	<b>5</b>	<b>I</b>	Reset
9/11	3/15	3/3	3/5	6/12	

#### Description

When 8-bit characters are selected, DECHEBM switches between the Group 1 and the Group 2 character set mappings. It does not affect the keyboard character set selection or the processing of received characters.

When 7-bit characters are selected or the terminal is set to VT100 mode, setting DECHEBM does the following:

- Switches keyboard map to Group 2.
- Makes DEC 7-bit Hebrew the keyboard character set.
- Causes received characters in the range of 60 to 7A (hex) to be displayed using the DEC 7-bit Hebrew when ASCII is designated or invoked and keyboard Group 2 is active.

Receiving DECHEBM does the following:

- Switches keyboard map to Group 1.
- Makes ASCII the keyboard character set.
- Causes received characters to be displayed using the graphic left (GL) table of characters in use at the time.

---

#### Note

---

DECHEBM is only valid when a Hebrew keyboard language is selected. Also it does not convert ASCII or Hebrew characters already on the display.

---

## DECHWUM—Host Wake-Up Mode (CRT and Energy Saver)

---

### DECHWUM—Host Wake-Up Mode (CRT and Energy Saver)

When the Host wake-up feature is selected, any character received from the host will also restore the display.

#### Format

<b>CSI</b>	<b>?</b>	<b>1</b>	<b>1</b>	<b>3</b>	<b>h</b>	Set: enables host wake-up mode
9/11	3/15	3/1	3/1	3/3	6/8	

<b>CSI</b>	<b>?</b>	<b>1</b>	<b>1</b>	<b>3</b>	<b>l</b>	Reset: disables host wake-up mode
9/11	3/15	3/1	3/1	3/3	6/12	

#### Description

This command allows any character received from the host to restore the display when either the CRT or Energy saver is in effect. Refer to Set-Up chapter for details.

DECHWUM can be reported using DECRPM.

---

### DECIC—Insert Column

This control function inserts one or more columns into the scrolling region, starting with the column that has the cursor.

**Available in:** VT Level 4 or higher mode only

#### Format

<b>CSI</b>	<i>P<sub>n</sub></i>	<b>'</b>	<b>}</b>
9/11	3/?	2/7	7/13

#### Parameters

**P<sub>n</sub>**  
is the number of columns to insert.  
Default: *P<sub>n</sub>* = 1.

#### Description

As columns are inserted, the columns between the cursor and the right margin move to the right. DECIC inserts blank columns with no visual character attributes. DECIC has no effect outside the scrolling margins.

## DECID—Identify Device

---

### DECID—Identify Device

This control function is similar to a primary device attributes (DA) request from the host.

---

**Note**

---

Using DECID is not recommended. DECID may not be supported in the manufacturers terminals. You should use the primary device attributes request for this purpose. In VT400 or higher mode, the terminal ignores DECID.

---

### Format

<b>ESC</b>	<b>Z</b>
1/11	5/10

### Terminal Response

The terminal uses the same response as for a primary DA request for all operating levels (1 or 4). See DA1, DA2, and DA3.

---

## DECINVM—Invoke Macro

This control function lets you execute a stored macro. You store macros with the define macro (DECDMAC) control string. The terminal substitutes the DECINVM sequence with the contents of the macro definition and executes the macro.

**Available in:** VT Level 4 or higher mode only.

### Format

CSI	<i>Pid</i>	*	<b>z</b>
9/11	3/ <i>n</i>	2/10	7/10

### Parameters

#### **Pid**

is the macro ID number. If the *Pid* is not associated with a particular macro, the terminal ignores the command.

### Notes on DECINVM

Any functions executed with a macro invocation remain in affect after the terminal executes the macro.

### Examples

Suppose you want to create a macro that clears all pages in page memory, writes the word "top" at the top of each page, and leaves the cursor on page 1.

First, you would write the string with ASCII characters as follows:

```
DCS 1 ; 0 ; 1 ! z CSI 6 sp P ! 6 ; CSI 1 ; 1 H CSI 2 J TOP
CSI 1 V ; ST
```

Then, you must convert the string into hexadecimal code because the string uses the repeat (!) character. You can only use the repeat character with hexadecimal sequences. The following example is the same string written in hex:

```
DCS 1 ; 0 ; 1 ! z 9B 36 20 50 ! 6 ; 9B 31 3B 48 9B 32 49 54
4F 50 9B 31 56 ; ST
```

To invoke the macro, use the following sequence:

```
CSI 1 * z
```

## DECIPEM—Enter/Return from IBM ProPrinter Emulation Mode

---

## DECIPEM—Enter/Return from IBM ProPrinter Emulation Mode

Exit from DEC protocol and interpret subsequent data according to the IBM ProPrinter protocol syntax. This sequence also resets IBM ProPrinter mode to its initial state.

### Format

<b>CSI</b>	<b>?</b>	<b>5</b>	<b>8</b>	<b>h</b>	Set: Enter ProPrinter Emulation mode.
9/11	3/15	3/5	3/8	6/8	
<b>CSI</b>	<b>?</b>	<b>5</b>	<b>8</b>	<b>l</b>	Reset: Return from ProPrinter Emulation mode.
9/11	3/15	3/5	3/8	6/12	

### Description

DECIPEM works the same as the IBM SOCS and ROCS control functions.



---

**DECKBD—Keyboard Language Selection**

Select a national keyboard language on either a VT keyboard or an Enhanced PC keyboard.

**Format**

```
CSI  Ps1  ;   Ps2  SP  }
9/11 3/n  3/   3/n  2/0 7/13
```

**Parameters****Ps1**

denotes a keyboard type (layout): VT or enhanced PC.

<b>Ps1</b>	<b>Keyboard Layout</b>
0, 1, or None	VT
2	Enhanced PC

**Ps2**

indicates the national keyboard language.

<b>Ps2</b>	<b>Keyboard Language (VT/PC)</b>
0, 1 or None	North American
2	British
3	Belgian (Flemish)
4	French Canadian
5	Danish
6	Finnish
7	German
8	Dutch
9	Italian
10	Swiss French
11	Swiss German
12	Swedish
13	Norwegian
14	French
15	Spanish
16	Portuguese
19	Hebrew
22	Greek
28	Canadian (English)
29	Turkish Q/Turkish
30	Turkish F

## DECKBD—Keyboard Language Selection

Ps2	Keyboard Language (VT/PC)
31	Hungarian
33	Slovak
34	Czech
35	Polish
36	Romanian
38	SCS
39	Russian
40	Latin American

### Description

The first selective parameter, Ps1, denotes a keyboard type, VT layout or Enhanced PC keyboard layout. The second parameter, Ps2, indicates the national keyboard language.

Selecting a new keyboard language automatically initializes the keyboard character set. Refer to Chapter 8 for more details.

---

## DECKBUM—Typewriter or Data Processing Keys

You can select whether the main keyboard keys act as data processing keys or typewriter keys by using the keyboard usage mode (DECKBUM) function.

**Default:** Typewriter keys

### Keyboard Usage Mode (DECKBUM)

<b>CSI</b>	<b>?</b>	<b>6</b>	<b>8</b>	<b>h</b>	Set: data processing keys.
9/11	3/15	3/6	3/8	6/8	

<b>CSI</b>	<b>?</b>	<b>6</b>	<b>8</b>	<b>l</b>	Reset: typewriter keys.
9/11	3/15	3/6	3/8	6/12	

### Description

If DECKBUM is set, then data processing keys send the characters on the right half of their keycaps.

If DECKBUM is reset, then data processing keys send the characters on the left half of their keycaps.

### Notes on DECKBUM

- DECKBUM changes the characters that the main keyboard keys send. Make sure you are aware of this change if you use DECKBUM in an application.
- If you use the North American language, then DECKBUM should always be reset (typewriter). For all other languages, you can use either mode.

---

## DECKLHIM—Keyboard LED's Host Indicator Mode

DECKLHIM controls the state of the keyboard LED's host indicator mode.

**Default:** Reset.

### Format

<b>CSI</b>	<b>?</b>	<b>1</b>	<b>1</b>	<b>0</b>	<b>h</b>	Set: keyboard LED's host indicator mode.
9/11	3/15	3/1	3/1	3/0	6/8	

<b>CSI</b>	<b>?</b>	<b>1</b>	<b>1</b>	<b>0</b>	<b>l</b>	Reset: The keyboard LED's act as local indicators.
9/11	3/15	3/1	3/1	3/0	6/12	

### Description

See DECLL for the implications of using DECLL to control the keyboard LEDs independently of any keyboard state.

## DECKPAM—Keypad Application Modes

---

### DECKPAM—Keypad Application Modes

DECKPAM enables the numeric keypad to send application sequences to the host.

See DECKPNM—Keypad Numeric Modes , which enables the numeric keypad to send keypad characters.

DECKPAM and DECKPNM function the same as numeric keypad mode (DECNKM).

#### Format

ESC = Sends application sequences.  
1/11 3/13

#### Note on DECKPAM

When you turn on or reset the terminal, it automatically selects numeric keypad mode.

---

### DECKPM—Key Position Mode

This control function selects whether the keyboard sends character codes or key position reports to the host. DECKPM lets new applications take full control of the keyboard including single shifts, locking shifts, and compose character processing.

**Default:** Send character codes

#### Format

CSI 8 1 h Set: send key position reports.  
9/11 3/8 3/1 6/8

CSI 8 1 I Reset: send character codes.  
9/11 3/8 3/1 6/12

#### Description

If the DECKPM function is set, then all keyboard keys send extended reports that include the key position and the state of modifier keys when pressed. A *modifier key* is pressed in combination with another key to modify the code sent by that key. The Ctrl key is a modifier key.

If the DECKPM function is reset, then the keyboard keys send character codes.

#### Note on DECKPM

DECKPM only affects keyboard input; it does not affect how the terminal interprets data from the host.

---

## DECKPNM—Keypad Numeric Modes

DECKPNM enables the numeric keypad to send keypad characters to the host.

See DECKPAM—Keypad Application Modes , which enables the keypad to send application sequences.

DECKPNM and DECKPAM function the same as numeric keypad mode (DECNKM).

**Default:** Send keypad characters.

### Format

ESC	>	Send keypad characters.
1/11	3/14	

### Description

DECKPNM enables the numeric keypad to send the characters shown on each key—number, comma, period, or minus sign. Keys **PF1** to **PF4** send application sequences. See DECKPAM—Keypad Application Modes for more information.

### Note on DECKPNM

When you turn on or reset the terminal, it automatically selects numeric keypad mode.

## DECLANS—Load Answerback Message

---

### DECLANS—Load Answerback Message

This sequence loads an answerback message into the terminal's memory.

#### Format

DCS	Ps	v	D ... D	ST
9/0	ps	7/6	...	9/12

#### Description

The answerback data string may consist of from 0 to 30, 7- or 8-bit characters, which are hex pairs in the range:

3/0 - 3/9 (0 through 9),  
4/1 - 4/6 (A through F), and  
6/1 - 6/6 (a through f).

Once defined, the message may be stored in the non-volatile memory if **Save settings** is executed in the Set-Up.

The selective parameter denotes the encoding of the answerback message. A "1" is always used for the VT520 indicating answerback is encoded as hex pairs. The sequence is ignored if any number other than "1" is specified in the Ps field.

Pressing Ctrl/Break or receiving ENQ code causes the VT520 to transmit the answerback message. In on-line mode, the answerback message is transmitted to the appropriate host port. The answerback is not echoed in local echo and is not "sent" in local mode.

The answerback message is transmitted as keyboard data. Any speed restrictions (as set in limited transmit) apply.

---

## DECLBAN—Load Banner Message

DECLBAN loads a banner message to be displayed.

### Format

```
DCS  Ps  r  D...D  ST
9/0  3/s  7/2  ...  9/12
```

### Parameters

#### Ps

denotes the encoding of the message.

Ps	Description
0	Zero or omitted, default to Ps=2.
1	Interprets as ASCII hexadecimal pairs. See DECLANS.
2	Loads as text in the VT default character set.

#### D . . . D

is a 30-character string. If a matching *Ps* value is selected as an encoding method, then you can select to define the string by the characters in the default character set or by hexadecimal pairs.

### Description

DECLBAN loads a banner message to be displayed at terminal power-on. Once defined, the user must store the banner message in non-volatile memory by invoking **Save settings** in order for it to be available at power-on. The terminal displays the banner message in double size characters above the Selftest OK message.

## DECLFKC—Local Function Key Control

---

### DECLFKC—Local Function Key Control

This control function lets you select the action performed by some of the local function keys on the top row of the keyboard:

Pk	Function	VT Keyboard	Enhanced PC Keyboard
1	Hold	<b>F1</b>	Scroll Lock
2	Print	<b>F2</b>	Print Screen
3	Set-Up	<b>F3</b>	Caps Lock/Print Screen

You can have the key perform its local function, send a function key sequence to the host, or do nothing.

This control function is useful for:

- Simplifying the keyboard for novice users
- Disabling features that are not compatible with the application, such as local printing

#### Format

```
CSI  Pk1  ;   Pfn  ...  Pkn  ;   Pfn  *   }  
9/11 3/n  3/11 3/n  ... 3/n  3/11 3/n  2/10 7/13
```

#### Parameters

##### Pkn

is a number from 0 to 4 that corresponds to the local function key affected (**F1** to **F4**). A *Pkn* value of 0 means that all four keys (**F1** through **F4**) are affected.

##### Pfn

controls the action of the local function key specified by the corresponding *Pkn* value.

Pfn	Meaning	VT Mode	PCTerm Mode
0	Selects the default function of the key.	Local print	Scan code
1	The key performs its local function either shifted, unshifted, or with the <b>Ctrl</b> key.	Print	Local Print
2	The unshifted key sends its function key sequence to the host. The key sends nothing when pressed with <b>Shift</b> or <b>Ctrl</b> .	Function Key	Scan Code
3	The key is disabled.	Disabled	Does not exist



**Description**

DECLFKC can accept any number of parameter pairs. The terminal executes the parameters in the order in which it receives them.

**Note on DECLFKC**

Applications cannot disable the **⏏** (Break) key. This restriction is required for secure systems, which ensures that the operator has control of the communication line.

**DECLL—Load LEDs**

Load the programmable LEDs on the keyboard according to its parameters.

**Format**

```
CSI   Ps   q
9/11  3/n  7/1
```

**Parameters****Ps**

selects the state of the **Num Lock**, **Caps Lock**, and **Scroll Lock** LEDs as follows:

Ps	LED	Light Condition
0	Num Lock	Off
	Caps Lock	Off
	Scroll Lock	Off
1	Num Lock	On
2	Caps Lock	On
3	Scroll Lock	On
21	Num Lock	Off
22	Caps Lock	Off
23	Scroll Lock	Off

## DECLRMM—Left Right Margin Mode

---

### DECLRMM—Left Right Margin Mode

This control function defines whether or not the set left and right margins (DECSLRM) control function can set margins.

**Available in:** VT Level 4 or higher mode only.

**Default:** DECSLRM cannot set margins.

#### Format

<b>CSI</b>	<b>?</b>	<b>6</b>	<b>9</b>	<b>h</b>	Set: DECSLRM can set margins.
9/11	3/15	3/6	3/9	6/8	

<b>CSI</b>	<b>?</b>	<b>6</b>	<b>9</b>	<b>l</b>	Reset: DECSLRM cannot set margins.
9/11	3/15	3/3	3/9	6/12	

#### Description

When DECLRMM is set, DECSLRM can set the left and right margins. All line attributes currently in page memory for the session are set to single width, single height. The terminal ignores any sequences to change the line attributes to double width or double height (DECDDL or DECDDL).

When DECLRMM is reset, DECSLRM cannot set the left and right margins. The margins are set to the page borders for every page. The terminal can process sequences to change the line attributes to double width or double height (DECDDL or DECDDL).

---

## DECLTOD—Load Time of Day

Down-line load the time of day on the terminal. This sequence loads the time of day into the terminal's memory.

#### Format

<b>CSI</b>	<i>Ps1</i>	<b>;</b>	<i>Ps2</i>	<b>,</b>	<b>p</b>
9/11	3/n	3/11	3/n	2/12	7/0

#### Parameters

##### **Ps1**

specifies the hour, which is a 2-digit decimal number between 00 and 23.

The default value is 8, indicating 8:00 a.m.

##### **Ps2**

specifies the minutes, which is a 2-digit decimal number between 00 and 59.

The default value is 00, indicating 8:00 a.m.

## DECMMCM—Modem Control Mode

Enables (set) or disables (reset) modem control.

### Format

<b>CSI</b>	<b>?</b>	<b>9</b>	<b>9</b>	<b>h</b>	Enable Modem Control
9/11	3/15	3/6	3/6	6/8	
<b>CSI</b>	<b>?</b>	<b>9</b>	<b>9</b>	<b>l</b>	Disable modem control - default
9/11	3/15	3/6	3/6	6/12	

### Description

When enabled for the Comm2 or Comm3 connector, no data is transmitted or received unless DSR is asserted. Assertion of DSR alone is sufficient to establish a connection. Loss of DSR causes a disconnect. When DSR is not asserted, no data is transmitted, and incoming receive data is ignored. When DSR is again asserted, the communications state is re-initialized to prepare for the new connection.

When enabled for the Comm1 (25-pin EIA) connector, the terminal does not transmit unless CTS is asserted. If a connection has not been established (DSR is deasserted), RLSD is ignored. Transmission and reception may still occur if CTS is asserted. Assertion of CTS with DSR and RLSD asserted indicates a connection has been established. (CTS is checked last.)

When Modem Control is disabled, transmission and reception occur regardless of the state of the modem control signal. The terminal communicates using data leads only. DTR and RTS are always asserted except during an operator initiated disconnect sequence, or the input buffer reaches the 64-byte threshold when DTR flow control scheme is selected.

## DECMSR—Macro Space Report

DECMSR is the terminal's response to a DSR from the host. DECMSR indicates the number of bytes available for macro definitions.

### Format

<b>CSI</b>	<b><i>P<sub>n</sub></i></b>	<b>*</b>	<b>{</b>
9/11	3/ <i>n</i>	3/10	7/11

### Parameters

***P<sub>n</sub>***  

$$P_n = \frac{\text{number of bytes}}{16} \text{ rounded down.}$$

## DECNAKB—Greek/N-A Keyboard Mapping Mode

---

### DECNAKB—Greek/N-A Keyboard Mapping Mode

This control function sets the keyboard mapping to North American and resets the mapping to Greek/N-A.

#### Format

<b>CSI</b>	<b>?</b>	<b>5</b>	<b>7</b>	<b>h</b>	Set.
9/11	3/15	3/5	3/7	6/8	
<b>CSI</b>	<b>?</b>	<b>5</b>	<b>7</b>	<b>I</b>	Reset.
9/11	3/15	3/5	3/7	6/12	

---

### DECNCM—No Clearing Screen On Column Change Mode

Set/reset the following condition: do not clear the screen whenever the column mode changes.

#### Format

<b>CSI</b>	<b>?</b>	<b>9</b>	<b>5</b>	<b>h</b>	Set: do not clear screen when column mode changes.
9/11	3/15	3/9	3/5	6/8	
<b>CSI</b>	<b>?</b>	<b>9</b>	<b>5</b>	<b>I</b>	Reset: clear the screen when column mode changes.
9/11	3/15	3/9	3/5	6/12	

#### Description

When enabled, a column mode change (either through Set-Up or by the escape sequence DECCOLM) does not clear the screen. When disabled, the column mode change clears the screen as a side effect.

This sequence does not affect the column mode change caused by the sequence, DECSCPP.

---

## DECNKM—Numeric Keypad Mode

This control function works like the DECKPAM and DECKPNM functions. DECNKM is provided mainly for use with the request and report mode (DECRQM/DECRPM) control functions.

**Available in:** VT Level 4 or higher mode only

**Default:** Numeric

### Format

<b>CSI</b>	<b>?</b>	<b>6</b>	<b>6</b>	<b>h</b>	Set: application sequences.
9/11	3/15	3/6	3/6	6/8	
<b>CSI</b>	<b>?</b>	<b>6</b>	<b>6</b>	<b>I</b>	Reset: keypad characters.
9/11	3/15	3/6	3/6	6/12	

---

## DECNRCM—National Replacement Character Set Mode

Enable operation in 7-bit or 8-bit character mode.

### Format

<b>CSI</b>	<b>?</b>	<b>4</b>	<b>2</b>	<b>h</b>	Set: 7-bit characters.
9/11	3/15	3/4	3/2	6/8	
<b>CSI</b>	<b>?</b>	<b>4</b>	<b>2</b>	<b>I</b>	Reset: 8-bit characters (default)
9/11	3/15	3/4	3/2	6/12	

### Description

On the VT520, the character set mode is reset to 8-bit characters. In 8-bit mode, the terminal operates as a normal level 5 terminal allowing 8-bit controls and using the default character set, which is user-selectable for transmission and reception.

## DECNUM—Null Mode

---

## DECNUM—Null Mode

Discard NUL characters upon receipt, or pass them on to the printer.

### Format

<b>CSI</b>	<b>?</b>	<b>1</b>	<b>0</b>	<b>2</b>	<b>h</b>	Set: discard NUL characters (default).
9/11	3/15	3/1	3/0	3/2	6/8	

<b>CSI</b>	<b>?</b>	<b>1</b>	<b>0</b>	<b>2</b>	<b>l</b>	Reset: pass NUL characters to printer.
9/11	3/15	3/1	3/0	3/2	6/12	

### Description

If enabled, the NUL character is discarded upon receipt and may be used as a time fill character. If disabled, then the NUL character is accepted and stored in the input buffer so it may be passed on to the printer port.

---

## DECNUMLK—Num Lock Mode

Controls the keyboard Num Lock state as if the Num Lock key had been pressed.

### Format

<b>CSI</b>	<b>?</b>	<b>1</b>	<b>0</b>	<b>8</b>	<b>h</b>	Set: Num lock ON.
9/11	3/15	3/1	3/0	3/8	6/8	

<b>CSI</b>	<b>?</b>	<b>1</b>	<b>0</b>	<b>8</b>	<b>l</b>	Reset: Num lock OFF.
9/11	3/15	3/1	3/0	3/8	6/12	

---

## DECOM—Origin Mode

This control function sets the origin for the cursor. DECOM determines if the **cursor position** is restricted to inside the page margins. When you power up or reset the terminal, you reset origin mode.

**Default:** Origin is at the upper-left of the screen, independent of margins.

### Format

<b>CSI</b>	<b>?</b>	<b>6</b>	<b>h</b>	Set: within margins.
9/11	3/15	3/6	6/8	

<b>CSI</b>	<b>?</b>	<b>6</b>	<b>l</b>	Reset: upper-left corner.
9/11	3/15	3/3	6/12	

### Description

When DECOM is set, the home cursor position is at the upper-left corner of the screen, within the margins. The starting point for line numbers depends on the current top margin setting. The cursor *cannot* move outside of the margins.

When DECOM is reset, the home cursor position is at the upper-left corner of the screen. The starting point for line numbers is independent of the margins. The cursor *can* move outside of the margins.

---

## DECOSCNM—Set/Reset Overscan Mode (VT520 only)

Sets or resets overscan mode for monochrome terminal. (This feature is not available for color terminals.)

**Default:** Overscan disabled (reset).

### Format

<b>CSI</b>	<b>?</b>	<b>1</b>	<b>0</b>	<b>6</b>	<b>h</b>	Set: Enable overscan
9/11	3/15	3/1	3/0	3/6	6/8	

<b>CSI</b>	<b>?</b>	<b>1</b>	<b>0</b>	<b>6</b>	<b>l</b>	Reset: Disable overscan (Default)
9/11	3/15	3/1	3/0	3/6	6/12	

## DECPAK—Program Alphanumeric Key

---

## DECPAK—Program Alphanumeric Key

Allow users to reprogram keys to transmit user-preferred alphanumeric codes or to perform user-preferred functions.

### Format

DCS	"	y	D . . . D	ST
9/0	2/2	7/9	...	9/12

### Description

This sequence programs one or more keys (and their modifier combinations) `[Key]` or `[Alt/Key]` from the current state to:

- Transmit desired alphanumeric codes
- Perform a local function or send user-defined sequence

This function works in all the VT modes except in VT52 mode.

The memory allocation and deallocation processes (program key lock and unlock process) on the DECPAK are the same as on the DECPFK. Refer to DECPFK—Program Function Key for details.

The data string D...D format is:

```
Key1/HEX Code String/Function #/UDS/UDS Direction;  
Key2/HEX Code String/Function #/UDS/UDS Direction;.....;
```

Where, Key<sub>n</sub> is the key station number and slash "/" is a delimiter.

“HEX code string” is the hex character code to be transmitted with each of the seven modifier states. The hex code represents a valid code in the current character set (either 7-bit or 8-bit). Use a period "." as a place holder if a modifier combination is not to be defined. Use a minus "-" preceding the hex representation of a diacritical sign if a diacritical mark is to be defined.

The VT520 always allows the ISO character set to be used for specifying accent marks to DECPAK even when:

1. 7-bit NRCS characters are selected
2. The ISO character set is not the user-preferred supplemental character set

The corresponding ISO character set would be based on the keyboard language. Refer to Chapter 8 for more information on the keyboard language and character sets.

The position of the diacritical marks within the ISO Latin character sets is as follows:



## DECPAK—Program Alphanumeric Key

Diacritical Sign	Position	Available ISO Character Set(s)
Circumflex	5/14	ASCII
Grave	6/0	ASCII
Tilde	7/14	ASCII
Dieresis (umlaut)	10/8	Latin 1, Latin 2, Latin Greek, Latin Turkish
Degree (ring)	11/0	Latin 1, Latin 2, Latin Greek, Latin Turkish
Acute	11/4	Latin 1, Latin 2, Latin Greek, Latin Turkish
Cedilla	11/8	Latin 1, Latin 2, Latin Turkish
Macron	10/15	Latin 1
Breve	10/2	Latin 2
Ogonek	11/2	Latin 2
Caron	11/7	Latin 2
Double Acute Accent	11/13	Latin 2
Dot Above	15/15	Latin 2

You should program the Hex string according in the following order of modifier states:

1. Group 1 unshifted
2. Group 1 shifted
3. Group 1 alternate shifted (Shift 2)
4. Group 2 (Group Shift or Alt Gr) unshifted
5. Group 2 shifted
6. Group 2 alternate shifted
7. Control (if omitted, use default)

If the control state is not redefined in this sequence, then the Key/Ctrl combination generates the control code based on the "Group 1 unshifted" state.

A graphic key transmits alphanumeric codes only when pressed with the above modifiers. When pressed with Alt key, the graphic key performs either of these two functions:

- Local terminal function
- User-defined sequence (same as UDK)

"Function #" corresponds to a local function to be performed when the key is pressed in combination with the Alt function. Example: Function number "0" is used to make the Key/Alt combination inoperative. Function number "100" indicates a user-defined sequence (UDS), and a UDS direction is defined for the Key/Alt combination following the "/" delimiter.

The UDS and UDS direction operations on DECPAK are the same as on DECPFK. Refer to DECPFK—Program Function Key for the details.

Once programmed, the key states are not affected by the terminal mode changes. Refer to DECPFK—Program Function Key for the list of terminal mode changes.

## DECPCCM—Page Cursor-Coupling Mode

---

### DECPCCM—Page Cursor-Coupling Mode

This control function determines if a new page appears in the display when the cursor moves to a new page. DECPCCM is only useful with a multiple-page format.

#### Format

<b>CSI</b>	<b>?</b>	<b>6</b>	<b>4</b>	<b>h</b>	Set: couples the cursor to the display.
9/11	3/15	3/6	4/4	6/8	

<b>CSI</b>	<b>?</b>	<b>6</b>	<b>4</b>	<b>l</b>	Reset: uncouples the cursor.
9/11	3/15	3/6	4/4	6/12	

#### Description

When DECPCCM is set, the cursor is coupled to the display when the cursor moves to a new page. The new page appears in the display to keep the cursor in view.

When DECPCCM is reset, the cursor is uncoupled from the display. If the cursor moves to a new page, then the cursor disappears.

---

## DECPCTERM—Enter/Exit PCTerm or Scancode Mode

DECPCTERM enables you to switch the terminal between VT mode and PCTerm mode, while the terminal is in VT mode. It also enables you to switch the terminal between ASCII character and scancode keycode mode, while the terminal is in SCO Console mode.

### Format

```
CSI ? Ps1 ; Ps2 r
9/11 3/15 3/n 3/11 3/n 7/2
```

### Parameters

#### Ps1

selects VT mode or PCTerm mode. In SCO console mode, this parameter selects ASCII characters or scancode keycode mode. When the mode changes, some operating features are changed to reflect the characteristics of the selected emulation mode.

Ps1	VT Emulation Mode	SCO Console Mode
0 or none	VT Mode	ASCII characters
1	PCTerm Mode	Scancodes

#### Ps2

indicates the character set selection.

There are two kinds of character set values in this parameter. Values "0" through "7" are reserved for VT520 backward compatibility. Value "8" copies the VT character set as the PCTerm character set. The rest of the parameter values are enhanced in the VT520 to denote the code page numbers that are associated with the PC character sets.

All 8-bit DEC and ISO character sets are available for both VT mode and PCTerm mode. PC character sets are available only in PCTerm mode or SCO console emulation. (SCO console uses the PCTerm character set.)

If you select a DEC or ISO character set for use in PCTerm mode, then the SCS invocation sequences can be used to modify the PCTerm character set. If you select a PC character set, then the SCS invocation sequences are ignored.

## DECPCTERM—Enter/Exit PCTerm or Scancode Mode

Ps2	Character Set
0 or none	No Change
1	PC Multilingual
2	PC International
3	PC Danish/Norwegian
4	PC Spanish
5	PC Portuguese
6	DEC Supplemental
7	ISO Latin 1
8	VT character set
210	PC Greek
220	PC Spanish
437	PC International
850	PC Multilingual
852	PC Slavic (Latin 2)
857	PC Turkish
860	PC Portuguese
862	PC Hebrew
863	PC French Canadian
865	PC Danish
866	PC Cyrillic

---

## DECPEX—Print Extent Mode

This control function selects how much data you can print when you use the print page function.

**Default:** Scrolling region

### Format

<b>CSI</b>	<b>?</b>	<b>1</b>	<b>9</b>	<b>h</b>	The print function prints the complete page.
9/11	3/15	3/1	3/9	6/8	
<b>CSI</b>	<b>?</b>	<b>1</b>	<b>9</b>	<b>l</b>	The print function prints the scrolling region only (data inside the margins).
9/11	3/15	3/1	3/9	6/12	

---

## DECPFF—Print Form Feed Mode

This control function selects whether or not the terminal sends a form feed (FF) character to the printer at the end of a printing function. DECPFF does not affect the print cursor line function described in the next section.

**Default:** No form feed

### Format

<b>CSI</b>	<b>?</b>	<b>1</b>	<b>8</b>	<b>h</b>	The terminal sends a form feed (FF) to the printer at the end of a printing function.
9/11	3/15	3/1	3/8	6/8	
<b>CSI</b>	<b>?</b>	<b>1</b>	<b>8</b>	<b>l</b>	The terminal sends nothing to the printer at the end of a printing function.
9/11	3/15	3/1	3/8	6/12	

---

## DECPFK—Program Function Key

Allows users to program keys to perform user-preferred functions.

### Format

DCS	"	x	D . . . D	ST
9/0	2/2	7/8	. . .	9/12

### Description

This sequence programs one or more keys (and their modifier combinations) from the current state to perform user-desired functions. The type of the function programmed must be either:

- a local terminal function
- a user-defined sequence (same as UDK)

This sequence is ignored when the program key function is locked through DECPKA, DECUDK, or Set-Up.

There are 768 bytes reserved for programmable key operations. This memory is shared by the following four functions:

- Program keys through DECPFK or through Set-Up
- Program keys through DECPAK or through Set-Up
- Copy other key default through DECCKD or Set-Up
- Program user-defined keys through DECUDK

Space is supplied on a first-come, first-serve basis. Once the 768 bytes are used, no more keys may be redefined unless space is made available. Space may be made available by restoring keys back to their default states. There are four ways to do this:

- Execute a **Restore factory defaults** from the Set-Up main menu. All the terminal parameters, including the keys, return to their default states.
- Execute a “Restore factory defaults of all keys and key definitions” either through DECPKA (Program Key Action) or **Recall key definitions** in Set-Up. This action also releases the 768 bytes.
- Execute a **Copy key default** to copy a key’s own default either through DECCKD or in Set-Up to free the space occupied by the destination key.
- Clear UDKs by issuing a clear function in DECUDK.

The free bytes left for key programming can be seen using the **Define Key Editor** in Set-Up.

The format of data string D...D is:

```
Key1/Mod1/Function #/UDS/UDS Direction; Key2/Mod2/Function #/UDS/UDS Direction;  
.....i
```

- *Keyn* is the key station number and a slash "/" is a delimiter.

Refer to Chapter 8 for the key station number map.

- *Modn* denotes the modifier key that is to be pressed at the same time as the defined key.

Modn	Modifier Key
0 or None	Normal
1	Normal
2	Shift
3	Alt
4	Alt + Shift
5	Control
6	Shift + Control
7	Alt + Control
8	Alt + Control + Shift

- “*Function #*” represents a number associated with a local function. For example, function number "0" is used to make the key or key/modifier inoperative. Function number "100" indicates a user-defined sequence (UDS) and UDS direction is defined following the slash "/" delimiter. Refer to Chapter 8.
- *UDS* is a user-defined sequence with a maximum length of 255 bytes, which must be written in Hex format for DEC/ANSI terminals. Each hex code in this string represents a value transmitted by the defined key combined with the modifiers.
  - *UDS* in DECPFK is functionally equivalent to the string *Stn* in the DECUDK control function.
  - DECUDK is reserved in this terminal for backward compatibility with previous VT terminals. See DECUDK—User Defined Keys.
- *UDS Direction* indicates the direction of the UDS transmission.

Direction	UDS is sent to the . . .
Remote	Host only.
Local	Terminal screen only.
Normal	Host and/or the terminal, depending on the setting of the COMM mode parameter. For full-duplex mode, the key sequence is directed to the host. For local mode, the sequence is sent to the screen only.

UDS Direction	Direction
0 or None	Normal (Default)
1	Local
2	Remote

## DECPFK—Program Function Key

Any of the following four methods may be used to define a key to transmit a user-defined sequence (either single byte or multiple bytes):

- Control function DECPFK
- Control function DECPAK
- Control function DECUDK
- In Set-Up, **Define key** . . .

Once programmed, the key state is not effected by the terminal mode changes listed below:

- Keyboard mode change, such as switching between Data Processing mode and Typewriter mode
- Character Mode change, such as switching between 7-bit character and 8-bit character
- Keyboard Layout change, such as switching between PC layout and VT layout
- Keyboard Style change, such as switching between PC-style and VT-style
- Terminal Mode change, such as switching between VT100 and VT500

### **Redefining Keys on the Numeric Keypad**

Using **Define key..** to redefine keys on the numeric keypad will affect only the Num Lock off state of these keys. When Num Lock is on, these keys will always send their factory default ASCII numerals and characters. The Num Lock behavior of these keys cannot be reprogrammed.

*Scenario:* Imagine the keyboard having two numeric keypads: one for Num Lock Off, and the other for Num Lock On. Only the Num Lock Off keypad can be reprogrammed. The Num Lock On keypad retains the factory defaults.

This function works in all the ANSI VT modes except VT52 mode.



---

## DECPKA—Program Key Action

Allow changes to programmable keys, which affects all the keys on the keyboard in all the VT modes except in VT52 mode.

### Format

**CSI**    *Ps*    **+**    **z**  
 9/11    3/*n*    2/11    7/10

### Parameters

#### Ps

This sequence has two functions:

1. Lock the keys from redefinition.
2. Restore the definitions of the keys either from the factory default or the NVR.

If set to "1," the parameter determines whether the keys will be locked. Any attempt to program keys will be invalid.

If the keys are not locked, then the keys are available for further definition either through Set-Up or control functions DECPFK, DECPAK, DECKD, and DECUDK. But if "Lock UDK" is enabled by DECUDK, then the attempt to program the keys does not take effect. (Refer to DECUDK—User Defined Keys for details.)

Once locked, keys can only be unlocked through Set-Up. There is no host control function that can unlock the keys.

If the parameter Ps is set to 2, then all the keys and keys/modifiers combination restore to their factory default states. Refer to DECKD—Copy Key Default if restoring defaults for a single key and key/modifier combination.

If the parameter Ps is set to 3, all saved settings of the keys and keys/modifiers combination are recalled from the NVR.

If the keys are locked for further definition, then restore and recall operations are not valid.

Ps1	Program Key Action
0 or none	None
1	Locks keys and keys/modifiers from further definition
2	Restores factory defaults of all the keys and their keys/modifiers
3	Recalls saved keys definition

### Note on DECPKA

The factory default **F5** key is assigned as a BREAK key. It cannot be programmed from the host even if the program key is unlocked. This restriction is required for a secure system to ensure that the operator has control of the communication line.

## DECPKFMR—Program Key Free Memory Report

---

### DECPKFMR—Program Key Free Memory Report

Report the free memory space for program key operations.

#### Format

CSI	Ps1	;	Ps2	+	y
9/11	3/n	3/11	3/n	2/11	7/9

#### Parameters

##### Ps1

denotes the total memory space in bytes that is reserved for the programmable keys. The total memory available is 768 bytes, hence the Ps1 value is "768."

##### Ps2

denotes the memory space that is available at the time DECRQPKFM is received, depending on the number of bytes left in decimal format. An "0" indicates that no memory is left for any key programming operation; in which case, any attempt to program the keys will fail.

#### Description

The VT520 reports this sequence upon receiving DECRQPKFM from the host.

#### Note on DECPKFMR

The VT520 firmware data structure uses some memory to program the key definitions; therefore, the free bytes reported by Ps2 do not represent the exact bytes available for users. A program to enter a definition that has the same byte count as reported by Ps2 may not be valid.

---

## DECPS—Play Sound

Controls the sound frequency or notes (one at a time).

### Format

CSI Pvolume; Pduration; Pnote , ~  
9/11 2/12 7/14

### Parameters

#### Pvolume

Sound volume

0 = off

1...3 (low)

4...7 (high)

#### Pduration

Duration of note in 1/32 of a second

#### Pnote

Note

<i>Pnote</i>	<b>Note</b>	<b>~F (Hz)</b>	<i>Pnote</i>	<b>Note</b>	<b>~F (Hz)</b>
1	C5		14	C#6	1047
2	C#5		15	D6	
3	D5		16	D#6	
4	D#5(Eb)	632	17	E6	
5	E5		18	F6	
6	F5		19	F#6	
7	F#5		20	G6	
8	G5		21	G#6	
9	G#5	847	22	A6	
10	A5		23	A#6	
11	A#5	944	24	B6	
12	B5		25	C7	
13	C6				

### Description

The terminal's sound buffer can store 16 notes of specified volume and duration. Additional sound controls are held in the communications input buffer invoking receive data flow control as needed.

There is no TSI report for sounds played.

## DECRARA—Reverse Attributes in Rectangular Area

---

### DECRARA—Reverse Attributes in Rectangular Area

This control function lets you reverse the visual character attributes (bold, blink, reverse video, and underline) of a specified rectangular area in page memory. The select attribute change extent (DECSACE) control function determines whether all or some of the character positions in the rectangle are affected.

Reversing a visual attribute means changing the attribute to its opposite setting, on or off. For example, DECRARA can change characters from bold and not underlined to characters that are underlined and not bold. DECRARA does not change the values of characters, just the visual attributes of those characters.

**Available in:** VT Level 4 or higher mode only

#### Format

```
CSI   Pt; Pl; Pb; Pr;      Ps1; . . . Psn      $   t
9/11  area to be reversed  attributes to reverse  2/4  7/4
```

#### Parameters

##### **Pt, Pl, Pb, and Pr**

define the rectangular area to be reversed.

**Pt** is the top-line border. *Pt* must be less than or equal to *Pb*.  
Default: *Pt* = 1.

**Pl** is the left-column border. *Pl* must be less than or equal to *Pr*.  
Default: *Pr* = 1.

**Pb** is the bottom-line border.  
Default: *Pb* = last line of the active page.

**Pr** is the right-column border.  
Default: *Pr* = last column of the active page.

##### **Ps1; . . . Psn**

select the visual character attributes to reverse. These values correspond to the values used in the select graphic rendition (SGR) function.

---

<b>Ps</b>	<b>Meaning</b>
0	Reverse all attributes (default).
1	Reverse the bold attribute.
4	Reverse the underline attribute.
5	Reverse the blink attribute.
7	Reverse the negative-image attribute.

---

DECRARA ignores all other parameter values.

When you use more than one parameter in a command, DECRARA executes them cumulatively in sequence.

## DECRARA—Reverse Attributes in Rectangular Area

### Examples

The following sequence reverses the blink and underscore attributes of the complete screen:

```
CSI ; ; ; ; 0; 4; 5; $ t
```

The following sequence reverses all attributes except the blink attribute, from position line 10, column 2 to position line 14, column 45 on the current page:

```
CSI 10; 2; 14; 45; 1; 4; 7 $ t
```

### Notes on DECRARA

- The coordinates of the rectangular area are affected by the setting of origin mode (DECOM).
- DECRARA is not affected by the page margins.
- If the value of *Pt*, *Pl*, *Pb*, or *Pr* exceeds the width or height of the active page, then the value is treated as the width or height of that page.
- DECRARA does not change the active cursor position.
- DECRARA does not change the current rendition set by the select graphic rendition (SGR) function.
- The exact character positions affected by DECRARA depend on the current setting of the select attribute change extent (DECSACE) function.

## DECRC—Restore Cursor

---

### DECRC—Restore Cursor

Restores the terminal to the state saved by the save cursor (DECSC) function.

#### Format

ESC	8
1/11	3/8

#### Description

If nothing was saved by DECSC, then DECRC performs the following actions:

- Moves the cursor to the home position (upper left of screen).
- Resets origin mode (DECOM).
- Turns all character attributes off (normal setting).
- Maps the ASCII character set into GL, and the DEC Supplemental Graphic set into GR.

#### Notes on DECSC and DECRC

The terminal maintains a separate DECSC buffer for the main display and the status line. This feature lets you save a separate operating state for the main display and the status line.

---

### DECRLCM—Right-to-Left Copy Mode

Perform a copy/paste from right-to-left or from left-to-right.

**Default:** Disable right-to-left-copy.

#### Format

CSI	?	9	6	h	Enable right-to-left copy.
9/11	3/15	3/9	3/6	6/8	
CSI	?	9	6	l	Disable right-to-left copy (default).
9/11	3/15	3/9	3/6	6/12	

#### Description

This function is only recognized when the keyboard language is set to Hebrew. When operating in Copy/Paste, you can paste the copied text according to the direction assigned in this command sequence.

If right-to-left copy is selected, then the text is stored in the paste buffer starting from right-to-left. For example if "ABCD" is to be copied right-to-left, when a Paste key is pressed, the string is saved in the paste buffer as "DCBA." Thus, the text is displayed as "DCBA".

---

## DECRLM—Right-to-Left Mode

This control function starts/stops the right-to-left cursor direction.

### Format

<b>CSI</b>	<b>?</b>	<b>3</b>	<b>4</b>	<b>h</b>	Set.
9/11	3/15	3/3	4/4	6/8	
<b>CSI</b>	<b>?</b>	<b>3</b>	<b>4</b>	<b>l</b>	Reset.
9/11	3/15	3/3	4/4	6/12	

### Description

DECRLM state is common to both the main display and the status line display. The status line is effected only when you set it to Host Writable Status Display in the Display Set-Up screen. DECRLM does not affect column numbering within the line. The first line column is always at the left side of the display window. The last column is always at the right side of the display window.

The next character position is defined as the current cursor position minus 1.

If the terminal is in Replace mode (IRM is reset), then:

- The new character is inserted in the current cursor position.
- The cursor moves to the next character position.

If terminal is in Insert mode (IRM is set), then:

- All characters from the current cursor position to the left margin inclusively are shifted one position towards the left.
- The character previously displayed at the left margin disappears.
- The new character is inserted in the current cursor position.
- The cursor moves to the next character position.

The following escape sequences are affected by the DECRLM setting:

ICH - Insert Character	DECSED - Selective Erase in Display
DCH - Delete Character	DECSEL - Selective Erase in Line
ED - Erase in Display	ECH - Erase Character
EL - Erase in Line	

The following escape sequences are not affected by the DECRLM setting:

CUP - Cursor Position  
 HVP - Horizontal and Vertical Position  
 CUF - Cursor Forward  
 CUB - Cursor Backward

## DECRLM—Right-to-Left Mode

### Notes on DECRLM

- The BS control character increases the current cursor position by one, thus moving the cursor on the screen one position to the right.
- When new line mode (LNM) is set and the terminal receives one of the control codes LF, VT, or FF, the cursor moves to the last right-most column of the next line.
- When control code CR is received, the cursor moves to the last right-most column of the current line.
- When control code SUB is received, a number of cancellation activities result within the terminal and the terminal displays an error character, according to the current DECRLM setting.
- When control code NEL is received, the cursor moves to the last right-most column of the next line. If the cursor is at the bottom margin, then the page scrolls up.
- If auto-wrap is enabled (DECAWM is set), then a graphic character received when the cursor is at column number one appears at the right margin column of the next line. If the cursor is at the end of the scrolling region, then any text already on the page scrolls up.

---

## DECRLM—Report All Modifiers/Alphanumeric Key State

This control string is in response to a Request Key Definition (DECRLM).

### Format

DCS	"	~	D . . . D	ST
9/0	2/2	7/14	...	9/12

### Description

String D...D has a format same as DECPAK.

### Parameters

**D . . . D**

See DECPAK for a description of parameters.



---

## DECRPDE—Report Displayed Extent

The terminal sends this control function in response to a request displayed extent (DECRQDE) sequence. DECRPDE indicates how much of the current page is displayed on the screen.

DECRPDE indicates how much of the screen has to display the current page.

### Format

```
CSI  Ph  ;   Pw  ;   Pml ;   Pmt ;   Pmp  ;   "   w
9/11 3/n  3/11 3/n  3/11 3/n  3/11 3/n  3/11 3/n  3/11 2/2 7/7
```

### Parameters

**Ph**

is the number of lines of the current page displayed excluding the status line.

**Pw**

is the number of columns of the current page displayed.

**Pml**

is the column number displayed in the left-most column.

**Pmt**

is the line number displayed in the top line.

**Pmp**

is the page number displayed.

## DECRPFK - Report Function Key Definition

---

### DECRPFK - Report Function Key Definition

The terminal reports a function key's definition when it receives a DECRQKD. DECRPFK denotes a local function number or a defined sequence, that the target key, which is combined with a specific modifier key, performs or transmits.

#### Format

```
DCS    "    }    D ... D    ST
9/0    2/2  7/13  ...      9/12
```

#### Parameters

##### **D ... D**

uses the same format as DECPFK, Key/Modifier/Function#/UDS/UDS Direction. Function# is skipped in the report, if the function key has not been redefined and is transmitting the default escape sequence as its UDS.

---

### DECRPKT—Report Key Type

DECRPKT (from the terminal) is a response to a key type inquiry (DECRQKT).

#### Format

```
CSI    Ps1    ;    Ps2    ,    v
9/11   3/n    3/11   3/n    2/12   7/6
```

#### Parameters

##### **Ps1**

indicates is the target key's station number.

##### **Ps2**

indicates

---

Ps2	Key Type
0	Alphanumeric
1	Function

---

---

## DECRL—Review Previous Lines Mode

Allows user to view lines previously scrolled off the top of the page.

**Default:** Review previous lines disabled

### Format

<b>CSI</b>	<b>?</b>	<b>1</b>	<b>1</b>	<b>2</b>	<b>h</b>	Set: enables review previous lines
9/11	3/15	3/1	3/1	3/2	6/8	

<b>CSI</b>	<b>?</b>	<b>1</b>	<b>1</b>	<b>2</b>	<b>l</b>	Reset: disables review previous lines
9/11	3/15	3/1	3/1	3/2	6/12	

### Description

This command rearranges page memory into a single page and a scroll back buffer (transcript). Refer to Set-Up chapter for details.

DECRL can be reported using DECRLM and DECRLP.

## DECRPM—Report Mode - Terminal To Host

---

## DECRPM—Report Mode - Terminal To Host

Reports the terminal mode in response to a request mode (DECRQM) function. In the response DECRPM informs the host if a certain mode is set (SM—Set Mode) or reset (RM—Reset Mode).

### Programming Tip

Applications can use the information in the DECRPM report to save the current mode settings. Later, the application can restore the mode settings that were saved.

This operation is useful for applications that need to temporarily change some of the terminal's mode settings. When the application is finished, it can restore the mode settings that were in effect before the application changed them. You use the set mode (SM) and reset mode (RM) functions to restore mode settings. SM and RM are described later in this chapter.

There are two versions of DECRPM, for ANSI and DEC private modes.

### Reporting ANSI Modes

CSI	<i>Pa</i>	;	<i>Ps</i>	\$	<i>y</i>
9/11	3/n	3/11	3/n	2/4	7/9

### Reporting DEC Private Modes

CSI	?	<i>Pd</i>	;	<i>Ps</i>	\$	<i>y</i>
9/11	3/15	3/n	3/11	3/n	2/4	7/9

### Parameters

#### Pa

Table 5–3 lists the values for *Pa*.

#### Pd

indicates which DEC private mode the terminal is reporting on. Table 5–3 lists the values for *Pd*.

#### Ps

indicates the setting of the mode. The *Ps* values are the same for the ANSI and DEC private versions.

---

Ps	Mode Setting
0	Mode not recognized
1	Set
2	Reset
3	Permanently set
4	Permanently reset

---

## Examples

The following sequence reports the setting of a DEC private mode:

VT520 Report	Meaning
<b>CSI ? 57; h</b>	(Greek) Keyboard mapping is currently set. (57 = DECNAKB, h = set)

The following sequences report the setting for some modes:

```

CSI Ps $ p (or CSI Ps $ p for DEC private) (Request Mode)
CSI Ps1; Ps2 $ y (or CSI ? Ps1; Ps2 $ y) (Report Mode)
CSI P1.....Pn l (Reset Mode)
CSI P1.....Pn h (Set Mode)

```

## Notes on DECRPM

The terminal can only report on one mode at a time.

## DECRPM—Report Mode - Terminal To Host

### Description

DECRQM, DECRPM, SM, and RM support all the mode settings as follows:

**Table 5–3 Settings Supported by DECRQM, DECRPM, RM, and SM**

Pa	ANSI-Specified Mode		DEC-Private Mode	
	Mnemonic	Pd	Mnemonic	
1	GATM*	?1	DECCKM	
2	KAM	?2	DECANM†	
3	CRM	?3	DECOLM	
4	IRM	?4	DECSCLM	
5	SRTM*	?5	DECSCNM	
		?6	DECOM	
7	VEM*	?7	DECAWM	
		?8	DECARM	
10	HEM*	–	–	
11	PUM*	–	–	
12	SRM			
13	FEAM*	–	–	
14	FETM*	–	–	
15	MATM*	–	–	
16	TTM*	–	–	
17	SATM*	–	–	
18	TSM*	?18	DECPFF	
19	EBM*	?19	DECPEX	
20	LNМ	–	–	
–	–	?25	DECTCEM	
–	–	?34	DECRLM	
–	–	?35	DECHEBM	
–	–	?36	DECHEM	
–	–	?42	DECNRCM	
–	–	?57	DECNAKB	
–	–	?60	DECHCCM *	
–	–	?61	DECVCCM	
–	–	?64	DECPCCM	
–	–	?66	DECNKM	
–	–	?67	DECBKM	
–	–	?68	DECKBUM	
–	–	?69	DECLRMM (DECVSSM)	
–	–	?73	DECXRLMM	

\*This mode is always reset in the terminal and cannot be changed.

†When the terminal is set to VT52 mode, DECRQM provides no report.

(continued on next page)

Table 5-3 (Cont.) Settings Supported by DEC RQM, DEC RPM, RM, and SM

Pa	ANSI-Specified Mode		DEC-Private Mode	
		Mnemonic	Pd	Mnemonic
-	-		?95	DECNCSM
-	-		?96	DECRLCM
-	-		?97	DECCRTSM
-	-		?98	DECARSM
-	-		?99	DECMCM
-	-		?100	DECAAM
-	-		?101	DECCANSM
-	-		?102	DECNULM
-	-		?103	DECHDPXM
-	-		?104	DECESKM
-	-		?106	DECOSCNM
-	-		?111	DECFWM
-	-		?112	DECRPL
-	-		?113	DECHWUM
-	-		?114	DECATCUM
-	-		?115	DECATCMB
-	-		?116	DECBSM
-	-		?117	DECECM

## DECRPSS—Report Selection or Setting

---

### DECRPSS—Report Selection or Setting

The terminal sends the host this sequence in response to a request selection or setting (DECRQSS) sequence. The terminal sends DECRPSS to report the setting of a particular control function.

#### Programming Tip

Applications can use the information in the DECRPSS report to save the current selections or settings of some control functions. Later, the application can restore the control functions to their saved state.

This operation is useful for applications that need to temporarily change the settings of some of the terminal's control functions. When the application is finished, it can restore the control functions to their previous state.

#### Format

```
DCS  Ps  $   r   D...D  ST
9/0  3/n  2/4  7/2  ...      9/12
```

#### Parameters

##### Ps

indicates whether or not the request from the host is valid.

Ps	Host Request
0	Host's request is valid.
1	Host's request is invalid.

##### D...D

indicates the current setting of a valid control function that the host asked about. *D...D* consists of all the characters in the control function, except the CSI (9/11) or ESC [ (1/11, 5/11) introducer characters.

#### Examples

The host requests the setting of the select graphic rendition (SGR) function. If the current graphic rendition is underline, blinking, and reverse, then the terminal responds with the following DECRPSS sequence:

```
DCS 0 $ r 0 ; 4 ; 5 ; 7 m ST
```

**0; 4 ; 5 ; 7 m** are all the characters in the SGR sequence, except CSI.

The host requests the setting of the set top and bottom margin function (DECSTBM). If the current top and bottom margins are set to include the complete screen area (24 lines/screen), then the terminal responds with the following DECRPSS sequence:

```
DCS 0 $ r 1 ; 24 r ST
```

**1 ; 24 r** are all the characters in the DECSTBM sequence, except CSI.



## DECRPSS—Report Selection or Setting

The host requests the setting of a function that the terminal does not recognize. The terminal responds with the following DECRPSS sequence:

```
DCS 1 $ r ST
```

The terminal does not send a data string (*D...D*) to the host when the terminal receives an invalid request.

DECRPSS (and DECRQSS) support the following settings or selections:

Setting	Mnemonic	Final Character(s)
Alternate Text Color	DECATC	, }
Assign Color	DECAC	,
CRT Saver Timing	DECCRTST	- q
Down Line Load Allocation	DECDLDA	, z
Energy Save Timing	DECSEST	-r
Select Active Status Display	DECSASD	\$ }
Select Attribute Change Extent	DECSACE	* x
Select Auto Repeat Rate	DECARR	- p
Select Color Lookup Table	DECSTGLT	) {
Select Communication Port	DECSCP	* u
Select Communication Speed	DECSCS	* r
Select Digital Printed Data Type	DECSDPT	( p
Select Disconnect Delay Time	DECSDDT	\$ q
Select Flow Control Type	DECSFC	* s
Select Printer Type	DECSPRTT	\$ s
Select ProPrinter Character Set	DECSPPCS	* p
Select Set-Up Language	DECSSL	p
Select Zero Symbol	DECSZS	, {
Session Page Memory Allocation	DECSPPMA	, x
Set Character Attribute	DECSCA	" q
Set Columns Per Page	DECSCPP	\$
Set Conformance Level	DECSCCL	" p
Set Cursor Style	DECSCUSR	SP q
Set Graphic Rendition	SGR	m
Set Key Click Volume	DECSKCV	SP r
Set Left and Right Margins	DECSLRM	s
Set Lines Per Page	DECSLPP	t
Set Lock Key Style	DECSLCK	SP v
Set Margin Bell Volume	DECSMBV	SP u
Set Number of Lines per Screen	DECSNLS	*
Set Port Parameter	DECSPP	+ w
Set Scroll Speed	DECSSCLS	SP p
Set Status Line Type	DECSSDT	\$ ~

## DECRPSS—Report Selection or Setting

Setting	Mnemonic	Final Character(s)
Set Top and Bottom Margins	DECSTBM	r
Set Transmit Rate Limit	DECSTRL	" u
Set Warning Bell Volume	DECSWBV	SP t
Terminal Mode Emulation	DECTME	SP ~

---

## DECRPTUI—Report Terminal Unit ID

DECRPTUI is a response from the terminal to a tertiary DA (DA3) request from the host.

**Available in:** VT Level 4 or higher mode only. See DA3 for more information.

### Format

```
DCS  !  |  D...D  ST
9/0  2/1  7/12  ...  9/12
```

### Parameters

#### D...D

is the unit ID of the terminal, consisting of four hexadecimal pairs. The first pair represents the manufacturing site code. This code can be any hexadecimal value from 00 through FF.

The last three pairs are the terminal ID number. This number is unique for each terminal manufactured at that site.

---

## DECRCRA—Request Checksum of Rectangular Area

This control function requests a checksum of the specified rectangular area in the specified page. The terminal returns a checksum report (DECCKSR) in response to this request.

### Format

```
CSI  Pid  ;   Pp;  Pt;Pl;Pb;Pr  *   y
9/11 3/n  3/11 3/n  3/n . . . 3/n  2/10 7/9
```

### Parameters

#### Pid

is a numeric label you can provide to identify the checksum request. The checksum report returns this number. The number serves to differentiate between multiple checksum reports.

#### Pp

is the page number that has the rectangular area. If *Pp* is 0 or omitted, then the terminal ignores the following parameters and reports a checksum for all pages in page memory. If *Pp* is a higher number than the number of pages available, then the terminal reports on the last page.

#### Pt;Pl;Pb;Pr

are the top, left, bottom, and right borders of the rectangular area. *Pt* and *Pb* are line numbers. *Pt* must be less than or equal to *Pb*. *Pl* and *Pr* are column numbers. *Pl* must be less than or equal to *Pr*.

Defaults are *Pt* = 1, *Pb* = current page length, *Pr* = current page width. If these parameters are omitted, then the terminal returns a checksum of page *Pp*.

### Note on DECRCRA

The coordinates of the rectangular area are affected by the setting of origin mode (DECOM).

---

## DECRCDE—Request Displayed Extent

The host sends a DECRCDE to the terminal requesting how much of the current page is displayed on the screen for the active session.

### Format

```
CSI  "  v
9/11 2/2 7/6
```

## DECQRKD—Request Key Definition

---

## DECQRKD—Request Key Definition

DECQRKD allows you to inquire about the terminal's definition of:

- A function key or a function key combined with a single modifier key.
- An alphanumeric key combined with all of its available modifier keys.

The terminal reports the function key definition with DECRRPK, and the alphanumeric key definition with DECRRPAK.

### Format

```
CSI  Ps1 ; Ps2 , w
9/11 3/n 3/11 3/n 2/12 7/7
```

### Parameters

#### Ps1

indicates is the target key's station number. When inquiring for an alphanumeric key definition, *Ps2* is ignored by the terminal. DECRRPAK always reports a hexadecimal string in which each code represents a value transmitted by pressing a combination of the target key and a modifier key. See DECRRPAK.

#### ps

When inquiring for a function key definition, *Ps2* represents:

Ps2	Description
0, 1 or none	Normal
2	Shift
3	Alt
4	Alt + Shift
5	Control
6	Shift + Control
7	Alt + Control
8	Alt + Control + Shift

If you enter an invalid key/modifier, the entire sequence is ignored .

---

## DECQRKT—Request Key Type

The host issues a DECQRKT to the terminal for the key definition of a function or alphanumeric key. Upon receiving the request, the terminal reports using DECRPKT.

### Format

<b>CSI</b>	<i>Ps</i>	,	<b>u</b>
9/11	3/ <i>n</i>	2/12	7/5

### Parameters

**Ps**

is a decimal number representing the target key's station number.

## DECRQM—Request Mode - Host To Terminal

---

### DECRQM—Request Mode - Host To Terminal

The host sends this control function to find out if a particular mode is set or reset. The terminal responds with a report mode function (DECRPM—Report Mode - Terminal To Host).

DECRQM functions in ANSI and DEC private modes.

#### Requesting ANSI Modes

<b>CSI</b>	<b>Pa</b>	<b>\$</b>	<b>p</b>
9/11	3/n	2/4	7/0

#### Requesting DEC Private Modes

<b>CSI</b>	<b>?</b>	<b>Pd</b>	<b>\$</b>	<b>p</b>
9/11	3/15	3/n	2/4	7/0

#### Parameters

##### Pa

indicates the ANSI mode that the host is asking about. Table 5–4 lists the values for Pa.

##### Pd

indicates the DEC private mode the host is asking about. Table 5–5 lists the values for Pd.

#### Examples

The following sequences request the setting of some ANSI modes:

Host	Meaning
<b>CSI 2 \$ p</b>	What is the current state of keyboard action mode (KAM)? (KAM = 2)
<b>CSI 4 \$ p</b>	What is the current state of insert/replace mode (IRM)? (IRM = 4)

The following sequences request the setting of some DEC private modes:

Host	Meaning
<b>CSI ? 36 \$ p</b>	What is the current state of Hebrew encoding mode (DECHEM)? (DECHEM = 36)
<b>CSI ? 6 \$ p</b>	What is the current state of origin mode (DECOM)? (DECOM = 6)

Notes on DECRCM

- The terminal does not respond to a DECRCM sequence when in VT52 mode.
- A DECRCM sequence can only ask about one mode at a time.

Table 5–4 ANSI Modes for DECRCM, DECRCM, SM, and RM

Mode	Mnemonic	Pa
Guarded area transfer	GATM*	1
Keyboard action	KAM	2
Control representation	CRM†	3
Insert/replace	IRM	4
Status reporting transfer	SRTM*	5
Vertical editing	VEM*	7
Horizontal editing	HEM*	10
Positioning unit	PUM*	11
Send/receive	SRM	12
Format effector action	FEAM*	13
Format effector transfer	FETM*	14
Multiple area transfer	MATM*	15
Transfer termination	TTM*	16
Selected area transfer	SATM*	17
Tabulation stop	TSM*	18
Editing boundary	EBM*	19
Line feed/new line	LNМ	20

\*This control function is permanently reset.

†The host cannot change the setting of CRM. You can only change CRM from Set-Up. If CRM is set, then the terminal ignores DECRCM and most other control functions.

## DEC RQM—Request Mode - Host To Terminal

**Table 5-5 DEC Private Modes for DEC RQM, DEC RPM, SM, and RM**

Mode	Mnemonic	Pd
Cursor keys	DECCKM	1
ANSI	DECANM	2
Column	DECCOLM	3
Scrolling	DECSCLM	4
Screen	DECSCNM	5
Origin	DECOM	6
Autowrap	DECAWM	7
Autorepeat	DECARM	8
Print form feed	DECPFF	18
Printer extent	DECPEX	19
Text cursor enable	DECTCEM	25
Cursor direction, right to left	DECRLM	34
Hebrew keyboard mapping	DECHEBM	35
Hebrew encoding mode	DECHEM	36
National replacement character set	DECNRCM	42
Greek keyboard mapping	DECNAKB	57
Horizontal cursor coupling	DECHCCM	60
Vertical cursor coupling	DECVCCM	61
Page cursor coupling	DECPCCM	64
Numeric keypad	DECNKM	66
Backarrow key	DECBKM	67
Keyboard usage	DECKBUM	68
Vertical split screen	DECVSSM /DECLRMM	69
Transmit rate limiting	DECXRLM	73
Key position mode	DECNCSM	95
Key position mode	DECRLCM	96
Key position mode	DECCRTSM	97
Key position mode	DECARSM	98
Key position mode	DECMCM	99
Key position mode	DECAAM	100
Key position mode	DECCANSM	101
Key position mode	DECNULM	102
Key position mode	DECHDPXM	103
Key position mode	DECESKM	104
Key position mode	DECOSCNM	106



---

## DECQRPKFM—Request Program Key Free Memory

Inquire as to the amount of free memory for programmable key operations.

### Format

CSI + x  
9/11 2/11 7/8

### Description

Upon receiving of this sequence, the terminal responds with DECPKFMR.

---

## DECQRPSR—Request Presentation State Report

The host sends this sequence to request a cursor information report (DECCIR) or tabulation stop report (DECTABSR).

### Format

CSI Ps \$ w  
9/11 3/n 2/4 7/7

### Parameters

**Ps**  
indicates which report the host requests.

<b>Ps</b>	<b>Report Requested</b>
0	Error. Request ignored
1	Cursor information report (DECCIR)
2	Tab stop report (DECTABSR)

## DECRQSS—Request Selection or Setting

---

## DECRQSS—Request Selection or Setting

The host requests the terminal setting. See DECRPSS for the terminal's response.

### Format

<b>DCS</b>	<b>\$</b>	<b>q</b>	<b>D . . . D</b>	<b>ST</b>
9/0	2/4	7/1	...	9/12

### Parameters

#### **D . . . D**

indicates the current setting of a valid control function that the host asked about. D . . . D consists of all the characters in the control function, except the CSI (9/11) or ESC [(1/11, 5/11) introducer characters.

### Description

DECRQSS (and DECRPSS) support the following settings or selections:

<b>Setting</b>	<b>Mnemonic</b>	<b>Final Characters</b>
Alternate Text Color	DECATC	, }
Assign Color	DECAC	,
CRT Saver Timing	DECCRTST	- q
Down Line Load Allocation	DECDLDA	, z
Energy Save Timing	DECSEST	-r
Select Active Status Display	DECSASD	\$ }
Select Attribute Change Extent	DECSACE	* x
Select Auto Repeat Rate	DECARR	- p
Select Color Lookup Table	DECSTGLT	) {
Select Communication Port	DECSCP	* u
Select Communication Speed	DECSCS	* r
Select Digital Printed Data Type	DECSDPT	( p
Select Disconnect Delay Time	DECSDDT	\$ q
Select Flow Control Type	DECSFC	* s
Select Printer Type	DECSPRTT	\$ s
Select ProPrinter Character Set	DECSPPCS	* p
Select Set-Up Language	DECSSL	p
Select Zero Symbol	DECSZS	, {
Session Page Memory Allocation	DECSPMA	, x
Set Character Attribute	DECSCA	" q
Set Columns Per Page	DECSCPP	\$
Set Conformance Level	DECSCCL	" p

## DECRQSS—Request Selection or Setting

Setting	Mnemonic	Final Characters
Set Cursor Style	DECSCUSR	SP q
Set Graphic Rendition	SGR	m
Set Key Click Volume	DECSKCV	SP r
Set Left and Right Margins	DECSLRM	s
Set Lines Per Page	DECSLPP	t
Set Lock Key Style	DECSLCK	SP v
Set Margin Bell Volume	DECSMBV	SP u
Set Number of Lines per Screen	DECSNLS	*
Set Port Parameter	DECSPP	+ w
Set Scroll Speed	DECSSCLS	SP p
Set Status Line Type	DECSSDT	\$ ~
Set Top and Bottom Margins	DECSTBM	r
Set Transmit Rate Limit	DECSTRL	" u
Set Warning Bell Volume	DECSWBV	SP t
Terminal Mode Emulation	DECTME	SP ~

## DECRQTSR—Request Terminal State Report

The host requests the terminal to report its state. The terminal reports (DECTSR) by indicating the setting of many device attributes. See DECTSR.

### Format

```
CSI  Ps  $  u
9/11 3/n 2/4 7/5
```

### Parameters

#### Ps

indicates the type of report the host requests from the terminal.

Ps	Report Requested
0 or none	Ignored. No report sent.
1	Terminal state report (DECTSR)

### Response

**DCS 1 \$ s D . . . D ST**

D . . . D

See Device Attributes (DA1, DA2, DA3).

## DECCTR—Color Table Request

---

## DECCTR—Color Table Request

The host requests a color table report from the terminal. The terminal responds with a DECTSR control with parameter 2 and each color table entry.

### Format

```
CSI 2 ; Pu $ u
9/11 3/2 3/11 3/u 2/4 7/5
```

### Parameters

#### **Pu**

is a parameter to select the type of color coordinate system that the terminal uses to report the color map.

<b>Pu</b>	<b>Report Requested</b>
0	Illegal
1	HLS (hue 0-360, lightness 0-100, saturation 0-100)
2	RGB (red 0-100, green 0-100, blue 0-100)

### Response

**DCS 2 \$ p D . . . D ST**

D . . . D

See (DECTSR - Terminal State Report (Color Table Report)).

---

## DECRQUPSS—Request User-Preferred Supplemental Set

Applications can ask for the current user-preferred supplemental set. The terminal responds with the user-preferred supplemental set (DECAUPSS) sequence.

### Host Request (DECRQUPSS)

The host requests the current user-preferred supplemental set by sending the following sequence:

### Format

```
CSI   &   u
9/11  2/6  7/5
```

### Terminal Responses

The terminal uses the DECAUPSS device control string to report the current user-preferred supplemental set (UPSS). The terminal sends DECAUPSS in response to a DECRQUPSS sequence. As examples, the terminal can send the following reports:

Control Sequence	UPSS
<b>DCS 0 ! u % 5 ST</b>	The user-preferred supplemental set is DEC Supplemental Graphic.
<b>DCS 1 ! u A ST</b>	The user-preferred supplemental set is ISO Latin-1 supplemental.

For a complete listing of combinations, see DECAUPSS—Assign User-Preferred Supplemental Character Set.

## DECRSPS—Restore Presentation State

---

### DECRSPS—Restore Presentation State

This control function restores the terminal to a previous state based on one of the presentation state reports. There are two presentation state reports.

**Available in:** VT Level 4 or higher mode only.

Cursor information report (DECCIR)

Tab stop report (DECTABSR)

A DECRSPS sequence can only restore the information from one report at a time, cursor information, or tab stop.

#### Programming Tip

Applications can use DECRSPS to restore the terminal to a previous state specified in a presentation state report. See the previous "Cursor Information Report (DECCIR)" section in this chapter.

#### Format

```
DCS  Ps  $  t  D . . . D  ST
9/0  3/n  2/4  7/4  . . .  9/12
```

#### Parameters

##### Ps

indicates the format of the data string (D . . . D). You can use one of the two following formats for the data string. These formats correspond to the formats used in the two presentation state reports (DECPSR). Make sure you use the format of the report you are restoring.

Ps	Data String Format
0	Error, restore ignored.
1	Selects the format of the cursor information report (DECCIR).
2	Selects the format of the tab stop report (DECTABSR).

##### D . . . D

is a data string that contains the restored information. This string is identical to the data string used in the report you are restoring— Cursor Information Report (DECCIR) or Tab Stop Report (DECTABSR).

#### Examples

The following DECRSPS sequence restores tab stops according to the tab stop report (DECTABSR):

```
DCS 2 $ t 9/ 17/ 25/ 33/ 41/ 49/ 57/ 65/ 73 ST
```

Note that the data string format above is exactly the same as the format for the tab stop report (DECTABSR). If there is an invalid value in the DECRSPS sequence, then the terminal ignores the rest of the sequence. This action may leave the terminal in a partially restored state.

---

## DECRSTS—Restore Terminal State

This sequence restores the terminal to a previous state specified in a terminal state report (DECTSR).

**Available in:** VT Level 4 or higher mode only.

### Programming Tip

Applications can use DECRSTS to restore the terminal to a previous operating state specified in a terminal state report.

### Format

```
DCS  Ps  $  p  D...D  ST
9/0  3/n  2/4  7/0  ...  9/12
```

### Parameters

#### Ps

indicates the format of the data string (D . . . D).

Ps	Data String Format
0	Error, restore ignored
1	Selects the format of the terminal state report (DECTSR)

#### D . . . D

is a data string that contains the restored information. This string is identical to the data string used by the report you are restoring.

### Notes on DECRSTS

- If there is an invalid value in the DECRSTS sequence, then the terminal ignores the rest of the sequence. This action may leave the terminal in a partially restored state.
- Software should not expect the format of the terminal state report (DECTSR) to be the same for all VT400 family members.

## DECRSTS—Restore Terminal Color Table State

---

### DECRSTS—Restore Terminal Color Table State

A host request to restore a color table.

#### Format

```
DCS 2 $ p D...D ST
9/0 3/2 2/4 7/0 ... 9/12
```

#### Parameters

##### **D . . . D**

is a data string that contains the groups of five parameters for each color map to restore as follows:

```
Pc; Pu; Px; Py; Pz / Pc; Pu; Px; Py; Pz / ...
```

where:

*Pc* is the color number 0 -255.

*Pu* is the color coordinate system.

1—HLS (hue 0-360, lightness 0-100, saturation 0-100)

2—RGB (red 0-100, green 0-100, blue 0-100)

*Px*, *Py*, *Pz* are values in the color coordinate system.

; is the semicolon (3/11).

/ is the slash character (2/15).

#### Description

To load a previously reported color map, the host transmits a DECRSTS control with parameter 2 and the desired color map definitions in the data string. When loading a color map, only the index entries specified are changed. Also see DECRQTSR and DECTSR for requesting color maps and the terminal's report.



---

## DECSACE—Select Attribute Change Extent

Selects which character positions within a rectangle are affected by an attribute change.

**Available in:** VT Level 4 or higher mode only

### Format

<b>CSI</b>	<i>Ps</i>	*	<b>x</b>
9/11	3/ <i>n</i>	2/10	7/8

### Parameters

**Ps**

selects the area of character positions affected.

<b>Ps</b>	<b>Area Effected</b>
0 (default)	DECCARA or DECRARA affect the stream of character positions that begins with the first position specified in the DECCARA or DECRARA command, and ends with the second character position specified.
1	Same as 0.
2	DECCARA and DECRARA affect all character positions in the rectangular area. The DECCARA or DECRARA command specifies the top-left and bottom-right corners.

## DECSASD—Select Active Status Display

---

### DECSASD—Select Active Status Display

DECSASD selects whether the terminal sends data to the main display or the status line.

**Available in:** VT Level 4 or higher mode only

**Default:** Main display

#### Format

```
CSI  Ps  $  }  
9/11 3/n 2/4 7/13
```

#### Parameters

##### Ps

indicates the display to which the terminal sends data.

Ps	Action
0 (default)	Selects the main display. The terminal sends data to the main display only.
1	Selects the status line. The terminal sends data to the status line only.

---

## DECSC—Save Cursor

#### Format

```
ESC  7  
1/11 3/7
```

#### Description

Saves the following items in the terminal's memory:

- Cursor position
- Character attributes set by the SGR command
- Character sets (G0, G1, G2, or G3) currently in GL and GR
- Wrap flag (autowrap or no autowrap)
- State of origin mode (DECOM)
- Selective erase attribute
- Any single shift 2 (SS2) or single shift 3 (SS3) functions sent

---

## DECSCA—Select Character Protection Attribute

DECSCA defines the characters that come after it as erasable or not erasable from the screen. The selective erase control functions (DECSED and DECSEL) can only erase characters defined as erasable.

**Available in:** VT Level 4 or higher mode only

### Format

```
CSI   Ps   "   q
9/11  3/n  2/2  7/1
```

### Parameters

#### Ps

defines all characters that follow the DECSCA function as erasable or not erasable.

Ps	Meaning
0 (default)	DECSED and DECSEL can erase characters.
1	DECSED and DECSEL cannot erase characters.
2	Same as 0.

### Note on DECSCA

DECSCA does *not* effect visual character attributes set by the select graphic rendition (SGR) function.

## DECSCSCL—Select Conformance Level

---

### DECSCSCL—Select Conformance Level

Using DECSCSCL, you can select the terminal's conformance level. The factory default for the VT500 family is level 5 (VT Level 5 mode, 8-bit controls).

---

**Note**

---

When you change the operating level, the terminal performs a hard reset (RIS).

---

#### Format

Sequence		Level Selected					
		<i>Level 1</i>					
<b>CSI</b> 9/11	<b>6</b> 3/6	<b>1</b> 3/1	<b>"</b> 2/2	<b>p</b> 7/0			VT100 mode
							<i>Level 5†</i>
<b>CSI</b> 9/11	<b>6</b> 3/6	<i>n</i> 3/ <i>n</i>	<b>"</b> 2/2	<b>p</b> 7/0			VT Level 5 mode, 8-bit controls
<b>CSI</b> 9/11	<b>6</b> 3/6	<i>n</i> 3/ <i>n</i>	<b>;</b> 3/11	<b>0</b> 3/0	<b>"</b> 2/2	<b>p</b> 7/0	VT Level 5 mode, 8-bit controls
<b>CSI</b> 9/11	<b>6</b> 3/6	<i>n</i> 3/ <i>n</i>	<b>;</b> 3/11	<b>1</b> 3/2	<b>"</b> 2/2	<b>p</b> 7/0	VT Level 5 mode, 7-bit controls
<b>CSI</b> 9/11	<b>6</b> 3/6	<i>n</i> 3/ <i>n</i>	<b>;</b> 3/11	<b>2</b> 3/2	<b>"</b> 2/2	<b>p</b> 7/0	VT Level 5 mode, 8-bit controls

---

†Level 5 includes levels 2, 3, and 4. In these sequences, *n* can be 2, 3, 4, or 5.

---

---

## DECSCLM—Scrolling Mode

This control function selects the way the terminal scrolls lines. You can select one of two scroll settings, smooth or jump.

**Default:** Smooth scroll.

### Format

<b>CSI</b>	<b>?</b>	<b>4</b>	<b>h</b>	Set: smooth scroll.
9/11	3/15	3/4	6/8	

<b>CSI</b>	<b>?</b>	<b>4</b>	<b>l</b>	Reset: jump scroll.
9/11	3/15	3/4	6/12	

### Description

When DECSCLM is set, the terminal adds lines to the screen at a moderate, smooth rate. You can select a slow rate or fast rate in Display Set-Up.

When DECSCLM is reset, the terminal can add lines to the screen as fast as it receives them.

---

## DECSCNM—Screen Mode: Light or Dark Screen

This control function selects a dark or light background on the screen.

**Default:** Dark background.

### Format

<b>CSI</b>	<b>?</b>	<b>5</b>	<b>h</b>	Set: reverse video.
9/11	3/15	3/5	6/8	

<b>CSI</b>	<b>?</b>	<b>5</b>	<b>l</b>	Reset: normal display.
9/11	3/15	3/5	6/12	

### Description

When DECSCNM is set, the screen displays dark characters on a light background.

When DECSCNM is reset, the screen displays light characters on a dark background.

### Note on DECSCNM

Screen mode only effects how the data appears on the screen. DECSCNM does not change the data in page memory.

## DECSCP—Select Communication Port

---

## DECSCP—Select Communication Port

Select the port to be used for printer or host connection.

### Format

```
CSI  Ps1  ;   Ps2  *   u
9/11 3/n  3/11 3/n  2/10 7/5
```

### Parameters

#### Ps1

indicates the port selection for a printer connection. The VT520 enables you to select from a Centronics parallel port.

Ps1	Printer Port
0	None
1	Centronics
4	Comm3

#### Ps2

indicates the port selection for a host connection. The host session can connect to the Comm1, Comm2, or Comm3 port.

Ps2	Session 1
1	Comm1
2	Comm2
3	Comm3

### Description

The VT520 provides three serial ports and a parallel port. Any of the serial ports can be used as a host communication port, but only Comm3 and the parallel printer port can be a printer port.

The VT520 provides up to four session virtual terminals. When a session virtual terminal is assigned to a communication port, it is said to exist. You cannot create or destroy a session virtual terminal from the host since no communication is possible with a virtual terminal that does not exist.

If you assign two or more session virtual terminals to the same communication port, the Terminal Device/Session Management Protocol (TD/SMP) is used to multiplex the sessions. The host can open or close session connections with any currently existing virtual terminal.

DECSCP can be reported using DECRPSS.

---

## DECSCPP—Select Columns Per Page

There are two control functions that can set the page width to 80 or 132 columns, DECSCPP and DECCOLM (DECCOLM—Selecting 80 or 132 Columns per Page ).

---

**NOTE**

---

It is recommended that new applications use DECSCPP rather than DECCOLM. DECSCPP does not clear page memory or reset the scrolling regions as does DECCOLM. DECCOLM is provided mainly for compatibility with previous products.

---

**Default:** 80 columns

### Format

Sequence		Sets Each Page to . . .				
<b>CSI</b>	<b>\$</b>	<b> </b>				80 columns.
9/11	2/4	7/12				
<b>CSI</b>	<b>0</b>	<b>\$</b>	<b> </b>			80 columns.
9/11	3/0	2/4	7/12			
<b>CSI</b>	<b>8</b>	<b>0</b>	<b>\$</b>	<b> </b>		80 columns.
9/11	3/8	3/0	2/4	7/12		
<b>CSI</b>	<b>1</b>	<b>3</b>	<b>2</b>	<b>\$</b>	<b> </b>	132 columns.
9/11	3/1	3/3	3/2	2/4	7/12	

### Notes on DECSCPP

- DECSCPP changes the font to match the current number of columns on the page.
- DECSCPP does not move the cursor. If, however, the cursor is beyond the width of the new page when DECSCPP executes, then the cursor moves to the right column of the new page.
- If you switch from 132-column to 80-column pages, then you can lose data from page memory. Columns no longer present in page memory are lost. Make sure you set page columns *before* you enter data into page memory.

## DECSCS—Select Communication Speed

---

## DECSCS—Select Communication Speed

Select a communication speed for a communication line.

### Format

**CSI** *Ps1* ; *Ps2* \* **r**  
9/11 3/n 3/11 3/n 2/10 7/2

### Parameters

#### Ps1

indicates the communication line.

Ps1	Comm Line Type
1, 0 or none	Host Transmit
2	Host Receive
3	Printer
4	Modem Hi
5	Modem Low

#### Ps2

indicates the communication speed.

Ps2	Speed	Ps2	Speed
0 or none	default	6	9600
1	300	7	19200
2	600	8	38400
3	1200	9	57600
4	2400	10	76800
5	4800	11	115200

The default value depends on the type of communication line.

Communication Line	Default Communication Speed
Host Transmit	9600
Host Receive	Receive=transmit
Printer	4800
Modem Hi	Ignore
Modem Low	Ignore



---

## DECSCUSR—Set Cursor Style

Select the style of the cursor on the screen.

### Format

```
CSI  Ps  SP  q
9/11 3/n 2/0 7/1
```

### Parameters

**Ps**  
indicates the style of the cursor.

<b>Ps</b>	<b>Cursor Style</b>
0, 1 or none	Blink Block (Default)
2	Steady Block
3	Blink Underline
4	Steady Underline

This sequence causes the cursor to be displayed in a different style when the cursor is enabled.

### Note on DECSCUSR

The escape sequence DECTCEM can enable or disable the cursor display.

## DECSDDT—Select Disconnect Delay Time

---

### DECSDDT—Select Disconnect Delay Time

Select an appropriate disconnect delay time.

#### Format

<b>CSI</b>	<i>Ps</i>	<b>\$</b>	<b>q</b>
9/11	3/n	2/4	7/1

#### Parameters

##### **Ps**

indicates the selection for the disconnect delay time.

<b>Ps</b>	<b>Disconnect Delay Time</b>
1	None
2	60 ms
3, 0 or none	2 seconds

#### Description

The disconnect delay feature determines the time allowed before the terminal disconnects from the communications line when the Received Line Signal Detect (RLSD) is lost.

All countries except the United Kingdom should use the 2 seconds delay. The 60 ms delay is for use in the United Kingdom.

If the terminal detects a loss of carrier and if the user has selected "no disconnect," then the terminal ignores RLSD (CD) after the beginning of the connection.

If the user tries to disconnect and reconnect the line, then the terminal checks if RLSD is asserted before granting the connection. Once it is connected, the terminal ignores the loss of carrier. In this case, the disconnect should be done on DSR going off.

---

## DECSDPT—Select Digital Printed Data Type

Allow users to match the characters printed to the character sets the DEC ANSI conforming printer is capable of supporting.

### Format

```
CSI  Ps  )  p
9/11 3/n 2/9 7/0
```

### Parameters

**Ps**  
denotes the selection for printed data type.

Ps	Printed Data Type
1, 0 or none	Print National Only (Default)
2	National and Line Drawing
3	Print Multinational
4	Print All Characters

---

## DECSED—Selective Erase in Display

This control function erases some or all of the erasable characters in the display. DECSED can only erase characters defined as erasable by the DECSCA control function. DECSED works inside or outside the scrolling margins.

**Available in:** VT Level 4 or higher mode only

### Format

```
CSI  ?  Ps  J
9/11 3/15 3/n 4/10
```

### Parameters

**Ps**  
represents the area of the display to erase, as follows:

Ps	Area Erased
0 (default)	From the cursor through the end of the display
1	From the beginning of the display through the cursor
2	The complete display

## DECSEST—Energy Saver Timing

---

### DECSEST—Energy Saver Timing

Selects the energy saver timing.

**Default:** 15 minutes

#### Format

CSI      Ps      -      r  
9/11      2/13      7/2

#### Parameters

**Ps**  
Energy Saver Timing

---

Ps	Selection
0	Never
5	5 minutes
15	15 minutes
30	30 minutes

---

#### Description

The **Energy saver** feature switches the monitor to suspend mode after the specified interval of CRT saver active. The energy saver is disabled if the CRT saver is set to never. Refer to the Set-Up chapter for details.

DECSEST can be reported using DECRPSS.

---

## DECSEL—Selective Erase in Line

This control function erases some or all of the erasable characters in a single line of text. DECSEL erases only those characters defined as erasable by the DECSCA control function. DECSEL works inside or outside the scrolling margins.

**Available in:** VT Level 4 or higher mode only

### Format

```
CSI  ?   Ps  K
9/11 3/15 3/n 4/11
```

### Parameters

#### **Ps**

represents the section of the line to erase, as follows:

<b>Ps</b>	<b>Section Erased</b>
0 (default)	From the cursor through the end of the line
1	From the beginning of the line through the cursor
2	The complete line

## DECSERA—Selective Erase Rectangular Area

---

### DECSERA—Selective Erase Rectangular Area

This control function erases all erasable characters from a specified rectangular area in page memory. The select character protection attribute (DECSCA) control function defines whether or not DECSERA can erase characters.

When an area is erased, DECSERA replaces character positions with the space character (2/0). DECSERA does not change:

- Visual attributes set by the select graphic rendition (SGR) function
- Protection attributes set by DECSCA
- Line attributes

**Available in:** VT Level 4 or higher mode only

#### Format

```
CSI  Pt  ;  Pl  ;  Pb  ;  Pr  $  {  
9/11 3/n 3/11 3/n 3/11 3/n 3/11 3/n 2/4 7/11
```

#### Parameters

##### **Pt, Pl, Pb, and Pr**

define the rectangular area to be selectively erased:

**Pt** is the top-line border. *Pt* must be less than or equal to *Pb*.

Default: *Pt* = 1.

**Pl** is the left-column border. *Pl* must be less than or equal to *Pr*.

Default: *Pl* = 1.

**Pb** is the bottom-line border.

Default: *Pb* = the last line of the active page.

**Pr** is the right-column border.

Default: *Pr* = the last column of the active page.

#### Notes on DECSERA

- The coordinates of the rectangular area are affected by the setting of origin mode (DECOM).
- DECSERA is not affected by the page margins.
- If the value of *Pt*, *Pl*, *Pb*, or *Pr* exceeds the width or height of the active page, then the value is treated as the width or height of that page.
- DECSERA does not change the active cursor position.

## DECSFC—Select Flow Control

Select a flow control scheme for the communication port or printer port.

### Format

```
CSI  Ps1 ; Ps2 ; Ps3 ; Ps4 * s
9/11 3/n 3/11 3/n 3/11 3/n 3/11 3/n 2/10 7/3
```

### Parameters

#### Ps1

determines which port is to be assigned the flow control scheme.

Ps1	Port Type
1, 0 or none	Comm Port
2	Printer Port

#### Ps2

indicates the flow method. On the VT520, the transmit side or the receive side of the communication line can select different or the same flow control methods.

Ps2	Transmit or Receive
1, 0 or none	Transmit
2	Receive
3	Transmit and Receive

#### Ps3

is for the flow control type. When the terminal is in PCTerm mode, XPC replaces XON/XOFF on the receive side.

Ps3	Flow Control Type
1, 0 or none	XON/XOFF or XPC (XPC is for receive only)
2	DTR
3	Both
4	None

## DECSFC—Select Flow Control

### Ps4

sets the flow control threshold.

---

Ps4	Flow Control Threshold
1, 0 or none	Low (64)
2	High (768)

---

The terminal uses "low" and "high" to denote the flow control threshold.

- If Low is selected, then the terminal sends an XOFF (if in software flow control) or lower DTR (in hardware flow control) to notify the host of holding transmission when the input buffer reaches 64 bytes.
- If High is selected, then 768 bytes is the flow control threshold.

"High" flow control threshold is not available for the printer port, which always uses low (64 bytes) as the flow control threshold.

---

## DECSIN—Set Icon Name

Specifies a descriptive name, up to 12 characters, for this session's icon, using an OSC string.

### Format

```
OSC  2   D...D  ST
9/13 3/2          9/12
```

Where D...D is:

```
L   ;   <name>
4/12 3/11
```

### Description

DECSIN specifies a descriptive name, up to 12 characters, for this session's icon.

There is no TSI report for the session icon name.



---

## DECSKCV—Set Key Click Volume

Set the keyclick volume.

### Format

```
CSI  Ps  SP  r
9/11 3/n 2/0 7/2
```

### Parameters

**Ps**  
indicates the selection of the click volume.

Ps	Key Click Volume
1	Off
2, 3, 4	Low
5, 6, 7, 8, 0 or none	High (Default)

---

## DECSLCK—Set Lock Key Style

Allow the host to control the Caps Lock key.

### Format

```
CSI  Ps  SP  v
9/11 Ps  2/0 7/6
```

### Parameters

**Ps**  
indicates the selection of the Caps Lock key.

Ps	Lock Style	Meaning
1, 0 or None	Caps Lock (Default)	Lock alpha keys on main keypad in uppercase.
2	Shift Lock	Lock alpha and numeric keys on main keypad in shifted setting.
3	Reverse Lock	Works the same as Caps Lock, except that pressing Shift while Reverse Lock is active will send the lowercase or unshifted character assigned to a key. Thus, the lock state is reversible.

## DECSLPP—Set Lines Per Page

---

### DECSLPP—Set Lines Per Page

This control function sets the number of lines for each page in page memory.

**Default:** One session—6 pages of 24 lines

#### Format

CSI	<i>Pn</i>	t
9/11	<i>n</i>	7/4

#### Parameters

##### **Pn**

Sets the lines per page according to the numeric parameter.

#### Description

If the number of lines specified is not one of the values supported by the implementation, then the next higher supported number of lines per page is assumed. If the number of lines specified exceeds the maximum number supported, then the maximum number supported is used. The valid *Pn* values are 24, 25, 36, 41, 42, 48, 52, 53, and 72.

The VT520 supports three pages of off-screen memory in the following configurations:

- 3 pages × 24 lines (default)
- 2 pages × 25 lines
- 2 pages × 36 lines
- 1 pages × 41 lines
- 1 pages × 42 lines
- 1 pages × 48 lines
- 1 pages × 52 lines
- 1 pages × 53 lines
- 1 pages × 72 lines

#### Notes on DECSLPP

- If you switch to a smaller page size, then data that was on the larger page may be split across the smaller pages. To avoid confusion, make sure you set the lines/page *before* you enter data into page memory.
- DECSLPP usually does not change the top and bottom scrolling margins. If, however, you change the page size so that the current scrolling margins exceed the new page size, then the terminal resets the margins to the page limits.

---

## DECSLRM—Set Left and Right Margins

This control function sets the left and right margins to define the scrolling region. DECSLRM only works when vertical split screen mode (DECLRMM) is set.

**Available in:** VT Level 4 or higher mode only

**Default:** Margins are at the left and right page borders.

### Format

```
CSI  Pl  ;   Pr  s
9/11 3/n 3/11 3/n 7/3
```

### Parameters

#### Pl

is the column number for the left margin.

Default:  $Pl = 1$ .

#### Pr

is the column number for the right margin.

Default:  $Pr = 80$  or  $132$  (depending on the page width).

### Notes on DECSLRM

- The value of the left margin ( $Pl$ ) must be less than the right margin ( $Pr$ ).
- The maximum size of the scrolling region is the page size, based on the setting of set columns per page (DECSCPP).
- The minimum size of the scrolling region is two columns.
- The terminal only recognizes this control function if vertical split screen mode (DECLRMM) is set.
- DECSLRM moves the cursor to column 1, line 1 of the page.
- If the left and right margins are set to columns other than 1 and 80 (or 132), then the terminal cannot scroll smoothly.

## DECSMBV—Set Margin Bell Volume

---

### DECSMBV—Set Margin Bell Volume

Set the margin bell volume.

#### Format

<b>CSI</b>	<i>Ps</i>	<b>SP</b>	<b>u</b>
9/11	Ps	2/0	7/5

#### Parameters

**Ps**  
indicates the selection of the bell volume.

---

<b>Ps</b>	<b>Key Click Volume</b>
1, 0 or none	Off (default)
2, 3, 4	Low
5, 6, 7, 8	High

---

#### Description

This sequence is used to adjust the margin bell volume, which sounds as the current position nears the right margin.

---

## DECSMKR—Select Modifier Key Reporting

Program the modifier keys to send extended keyboard reports when pressed or released. DECSMKR only works when key position mode (DECKPM) is set. Applications can use DECSMKR to gain more control over the keyboard by monitoring the action of each modifier key.

### Format

```
CSI  Pm1 ; Pf1 ... Pmn ; Pfn + r
9/11 3/n 3/11 3/n ... *** 3/11 *** 2/11 7/2
```

### Parameters

#### Pmn

is the key number that corresponds to the modifier key affected. A *Pmn* value of 0 selects all modifier keys.

Pmn	Key	Default Function
1	left <span style="border: 1px solid black; padding: 0 2px;">Shift</span>	Local shift.
2	right <span style="border: 1px solid black; padding: 0 2px;">Shift</span>	Local shift.
3	<span style="border: 1px solid black; padding: 0 2px;">Lock</span>	Local lock.
4	<span style="border: 1px solid black; padding: 0 2px;">Ctrl</span>	Local control.
5	left <span style="border: 1px solid black; padding: 0 2px;">Alt Function</span>	Report up or down transitions.
6	right <span style="border: 1px solid black; padding: 0 2px;">Alt Function</span>	Report up or down transitions.
7	left <span style="border: 1px solid black; padding: 0 2px;">Compose Character</span>	Local compose.
8	right <span style="border: 1px solid black; padding: 0 2px;">Compose Character</span>	Local compose.

#### Pfn

controls the action of the modifier key specified by the corresponding *Pmn* value.

Pfn	Meaning
0	Selects the default function of the key.
1	The key performs its default modifier function.
2	The key sends an extended keyboard report when pressed or released. The key does not modify other keystrokes or perform its default function.
3	The key is disabled.

### Description

DECSMKR can accept any number of parameter pairs. The terminal executes the parameters in the order in which it receives them. Applications cannot change the function of the F5 (Break) key. This restriction is required for secure systems to ensure that the operator has control of the communication line.

## DECSNLS—Set Number of Lines Per Screen

---

## DECSNLS—Set Number of Lines Per Screen

Set the maximum lines that can be displayed on the screen.

### Format

```
CSI   Pn   *   |  
9/11  ... 2/10 7/12
```

### Description

The terminal supports three different font heights, which allows 26, 42, or 53 data lines to be displayed on the screen or 25, 41, or 52 data lines to be displayed on the screen, plus a status line. The different character fonts are:

	80/26	132/26	80/42	132/42	80/53	132/53
Cell Width	10	6	10	6	10	6
Cell Height	16	16	10	10	8	8

### Valid Combinations

The terminal has the following valid combinations:

Lines Per Screen	Refresh Rate	Overscan
26	72 Hz	No
26	72 Hz	Yes
26	60 Hz	No
26	60 Hz	Yes
42	72 Hz	No
42	60 Hz	No
42	60 Hz	Yes
53	72 Hz	No
53	60 Hz	No
53	60 Hz	Yes

If an invalid combination is selected, the terminal automatically returns to a valid combination according to the following priority order:

1. Lines Per Screen
2. Refresh Rate
3. Overscan

### Examples

The current combination is 26 lines/72 Hz/Overscan. If you attempt to assign 42 lines per screen, then the terminal becomes 42 lines/72 Hz/No Overscan.

The current combination is 42 lines/60 Hz/Overscan. If you attempt to assign 72 Hz refresh rate, then the terminal becomes 42 lines/72 Hz/No Overscan.

The current combination is 53 lines/72 Hz/No Overscan. Any attempt to enable Overscan is invalid.

---

## DEC SPMA—Session Page Memory Allocation

Allocates 25 line pages to each session according to the corresponding parameters.

### Format

CSI Pn1; Pn2; Pn3; Pn4; , x  
9/12 2/12 7/8

### Description

Pages are allocated for each session in order (1 through 4). An omitted parameter leaves the previous allocation unchanged. A parameter larger than the number of pages available leaves the previous allocation for that session unchanged. No actual pages are allocated to disabled sessions, but the allocation is changed the next time the session is enabled.

DEC SPMA can be reported using DECRPSS.

## DECSP—Set Port Parameters

---

## DECSP—Set Port Parameters

Configures communication parameters for either a communication port or a printer port.

### Format

```
CSI  Ps1 ; Ps2 ; Ps3 ; Ps4 + W
9/11 3/n 3/11 3/n 3/11 3/n 3/11 3/n 2/11 7/7
```

### Parameters

#### Ps1

determines which port is to be configured.

Ps1	Port Selection
1, 0 or none	Comm Port
2	Printer Port

#### Ps2

determines the data bit.

Ps2	Data Bit
1, 0 or none	8 bits
2	7 bits

#### Ps3

determines the parity.

Ps3	Parity	Ps3	Parity
1, 0 or none	No Parity	5	Odd Parity, Unchecked
2	Even Parity	6	Mark Parity
3	Odd Parity	7	Space Parity
4	Even Parity, Unchecked		

Ps3 selections 4 and 5 are not available for the printer port.

#### Ps4

determines the stop bit.

Ps4	Stop Bit
1, 0 or none	1 bit
2	2 bits



---

## DECSPPCS—Select ProPrinter Character Set

Allow users to match the characters printed to the character sets the IBM ProPrinter is capable of supporting.

### Format

```
CSI  Pn  *  p
9/11 3/n 2/10 7/0
```

### Parameters

#### **Pn**

denotes the code page numbers for ProPrinter supported character sets.

<b>Pn</b>	<b>Printer</b>
210	PC Greek
220	PC Spanish
437	PC International
850	PC Multilingual
852	PC Slavic (Latin 2)
857	PC Turkish
860	PC Portuguese
862	PC Hebrew
863	PC French-Canadian
865	PC Danish
866	PC Cyrillic

### Description

This sequence takes affect only when the printer type (DECSPRTT) is set to "IBM ProPrinter" or "DEC + IBM."

## DECSPRTT—Select Printer Type

---

### DECSPRTT—Select Printer Type

Allow users to select a printer type that matches their environment.

#### Format

CSI    *Ps*    \$    s  
9/11    3/*n*    2/4    7/3

#### Parameters

**Ps**  
indicates the selection of the printer type.

Ps	Printer Type
1, 0 or none	DEC ANSI (default)
2	IBM ProPrinter
3	DEC + IBM

#### Description

Printer type "DEC ANSI" indicates a printer type that is capable of recognizing Digital ANSI conforming escape sequences.

"ProPrinter" indicates an attached printer type that recognizes the IBM ProPrinter escape sequences.

If the attached printer is an ANSI-compatible printer that has the IBM ProPrinter emulation feature, then select "DEC + IBM."

---

## DECSR—Secure Reset

This control function sets the terminal to its power-up state. DECSR lets applications know the exact state of the terminal before any attempted operations. You can use DECSR to guarantee the terminal state for secure connections. DECSR is similar to RIS, but does not perform a disconnect from the host.

#### Format

CSI    *Pr*    +    p  
9/11    3/*n*    2/11    7/0

#### Parameters

**Pr**  
is an optional random number from 0 to 16383. If *Pr* is included, then the terminal sends a confirmation (DECSRC) with this number.

## DECSR Actions

- Clears user-defined keys.
- Clears soft character sets.
- Clears the screen and all off-screen page memory.
- Returns the cursor to the upper-left corner of the first page.
- Resets the scrolling margins.
- Resets origin mode (DECOM) to absolute.
- Sets visual character attributes to normal.
- Sets the selective erase (DECSCA) attribute to not selectively erasable.
- Sets all character sets to the defaults (G0, G1, G2, G3, GL, GR).
- Erases macro memory.
- Erases the paste buffer.
- Reinitializes the keyboard state by:
  - Clearing the keyboard input buffer
  - Canceling compose sequences
  - Resetting the keyboard to send its default codes (in NVR)
  - Unlocking the keyboard (resetting KAM)

DECSR replaces all set-up parameters to their saved settings or power-up default values. If you include the optional *Pr* parameter, then the terminal returns a secure reset report to the host.

## Notes on DECSR

- DECSR works in all conformance levels (level 1 or higher).
- DECSR works in display controls mode (CRM) and causes the terminal to exit this mode.
- DECSR does not work in VT52 mode or printer controller mode. The host software must explicitly exit these modes. You can send DECSR to an attached printer if the terminal is in printer controller mode.
- The terminal buffers DECSR like any other incoming data.

## DECSRC—Secure Reset Confirmation

---

### DECSRC—Secure Reset Confirmation

The terminal returns this report to the host if the *Pr* parameter was included in the last secure reset (DECSR) control function. DECSRC report indicates that the secure reset operation was successful.

#### Format

<b>CSI</b>	<i>Pr</i>	*	<b>q</b>
9/11	3/ <i>n</i>	2/10	7/1

#### Parameters

##### **Pr**

is the number from 0 to 16383 that was included in the corresponding secure reset sequence.

---

### DECSSCLS—Set Scroll Speed

Select how fast lines appear on the screen.

#### Format

<b>CSI</b>	<i>Ps</i>	<b>SP</b>	<b>p</b>
9/11	<i>Ps</i>	2/0	7/0

#### Parameters

##### **Ps**

indicates the scroll speed and lines per second.

<b>Ps</b>	<b>Scroll Speed</b>	<b>Lines per Second</b>
0, 1, 2, 3 or none	Smooth 2 (default)	9
4, 5, 6, 7, 8	Smooth 4	18
9	Jump	As fast as received

#### Description

This is a user preference feature. If the **User Features Locked** is enabled, then the scroll speed cannot be changed by this control function.

The escape sequence DECSCLM can change the scroll speed between Smooth 2 and Jump scroll.

---

## DECSSDT—Select Status Display (Line) Type

This control function lets the host select the type of status line displayed.

**Available in:** VT Level 4 or higher mode only

**Default:** Indicator status display

### Format

```
CSI  Ps  $  ~
9/11 3/n 2/4 7/14
```

### Parameters

#### Ps

indicates which status line the host selects:

Ps	Status Line Selected
0 (default)	No status line
1	Indicator status line
2	Host-writable status line

### Notes on DECSSDT

- If you select no status line ( $Ps = 0$ ), then the terminal uses the line as an additional user window line to display data.
- If you change from an indicator to a host-writable status line, then the new host-writable status line is empty.
- When you select the host-writable status line, most of the control functions that affect the main display also affect the status line. The following list describes the exceptions to the rule:

Control Function	Action
Select character set (SCS)	Both the main display and status line use the same character set.
Cursor position controls	Only the column parameters in cursor-positioning commands operate in the status line.
ANSI mode (DECANM)	Ignored if received in the status line.
Set conformance level (DECSCCL)	Exits the status line.
Scrolling mode (DECSCCLM)	Affects the main display and the status line.
Soft terminal reset (DECSTR)	Exits the status line.

## DECSSDT—Select Status Display (Line) Type

Control Function	Action
Insert/replace mode (IRM)	Affects the main display and the status line.
Hard terminal reset (RIS)	Erases and exits the status line.
Tab stops	Affect the main display and status line.
Autowrap mode (DECAWM)	Affects the main display and status line.

- DECSSDT does not affect the status line type displayed in Set-Up. In Set-Up, the terminal always uses the indicator status line.

## DECSSL—Select Set-Up Language

Select one of several languages for Set-Up display menus.

### Format

CSI    *Ps*    p  
9/11   3/*n*   5/0

### Parameters

**Ps**  
indicates the set-up language.

Ps	Set-Up Language
0, 1 or none	English
2	French
3	German
4	Spanish
5	Italian

---

## DECST8C—Set Tab at Every 8 Columns

Set a tab stop at every eight columns starting with column 9.

### Format

CSI	?	5	W
9/11	3/15	3/5	5/7

### Description

Any tab stop setting before this command is executed is cleared automatically. Control function TBC clears the tab stops on the display; HTS sets a horizontal tab stop at the active column.

---

## DECSTBM—Set Top and Bottom Margins

This control function sets the top and bottom margins for the current page. You cannot perform scrolling outside the margins.

**Default:** Margins are at the page limits.

### Format

CSI	Pt	;	Pb	r
9/11	3/n	3/11	3/n	7/2

### Parameters

**Pt**  
is the line number for the top margin.  
Default:  $Pt = 1$ .

**Pb**  
is the line number for the bottom margin.  
Default:  $Pb =$  current number of lines per screen.

### Notes on DECSTBM

- The value of the top margin ( $Pt$ ) must be less than the bottom margin ( $Pb$ ).
- The maximum size of the scrolling region is the page size.
- DECSTBM moves the cursor to column 1, line 1 of the page.

## DECSTR—Soft Terminal Reset

---

## DECSTR—Soft Terminal Reset

Perform a soft reset to the default values listed in Table 5–6.

### Format

```
CSI  !  p
9/11 2/1 7/0
```

### Description

Table 5–6 lists the terminal's default settings:

**Table 5–6 Terminal's Default Settings**

Mode	Mnemonic	State after DECSTR
Text cursor enable	DECTCEM	Cursor enabled.
Insert/replace	IRM	Replace mode.
Origin	DECOM	Absolute (cursor origin at upper-left of screen. )
Autowrap	DECAWM	No autowrap.
National replacement character set	DECNRCM	Multinational set.
Keyboard action	AM	Unlocked.
Numeric keypad	DECNKM	Numeric characters.
Cursor keys	DECCKM	Normal (arrow keys).
Set top and bottom margins	DECSTBM	Top margin = 1; bottom margin = page length.
All character sets	G0, G1, G2, G3, GL, GR	Default settings.
Select graphic rendition	SGR	Normal rendition.
Select character attribute	DECSCA	Normal (erasable by DECSEL and DECSER).
Save cursor state	DECSC	Home position.
Assign user preference supplemental set	DECAUPSS	Set selected in Set-Up.
Select active status display	DECSASD	Main display.
Keyboard position mode	DECKPM	Character codes.
Cursor direction	DECRLM	Reset (Left-to-right), regardless of NVR setting.
PC Term mode	DECPCTERM	Always reset.



---

## DECSTGLT—Select Color Look-Up Table

Selects the color mode or mapping.

**Default:** ANSI SGR color

### Format

```
CSI  Ps  )  {
9/11 2/9 7/11
```

### Parameters

**Ps**  
Look-Up Table

Ps	Selection	To select colors, the terminal uses . . .
0	Mono	Monochrome or gray level color map
1	Alternate color	Text attributes (bold, blink, underline, reverse)
2	Alternate color	-
3	ANSI SGR color	ANSI SGR color parameters

### Description

DECSTGLT selects the color mode or mapping used to display text colors and attributes. Refer to **Color** ▸ **Select color mode** in Set-Up chapter for details.

DECSTGLT can be reported using DECRPSS.

## DECSTRL—Set Transmit Rate Limit

---

### DECSTRL—Set Transmit Rate Limit

Limit the rate of character transmission according to the selected rate.

#### Format

```
CSI  Ps1 ; Ps2 " u
9/11 3/n 3/11 3/n 2/2 7/5
```

#### Parameters

##### Ps1

indicates the key type.

Ps1	Key Type
1, 0 or none	All Keys
2	Graphic Key
3	Function Key

##### Ps2

indicates the characters per second.

Ps2	Characters Per Second
1, 0 or none	150 CPS
2	50 CPS
3	30 CPS

#### Description

When enabled, the terminal limits the rate at which it transmits the answerback, CPR, DA, TSI, and DSR messages, as well as the keyboard keys, and any other characters transmitted from the terminal. All messages and keystrokes are transmitted according to the selected "character per second" rate.

You can select different transmit rates for graphic keys and function keys, which usually transmit more than one byte at a time.

The transmit rate limit function can be enabled and disabled through the DECXRLM control function. When disabled, all messages and keystrokes are transmitted as fast as possible without any delay between characters.

---

## DECSTUI—Setting Terminal Unit ID

DECSTUI writes the terminal unit ID into the terminal's NVR. The host can read the ID with the tertiary device attribute (DA3).

### Format

DCS	!	{	<i>D ... D</i>	ST
9/0	2/1	7/11	...	9/12

### Parameters

#### **D...D**

is the terminal's unit ID, consisting of four hexadecimal pairs. The first pair represents the manufacturing site code. The last three pairs represent an ID, which is unique for all terminals manufactured at a specific site. See tertiary DA (DA3) for more information.

### Description

DECSTUI writes the terminal unit ID into the terminal's nonvolatile random access memory (NVR).

**Available in:** VT Level 4 or higher mode only.

### Note on DECSTUI

Under normal operations the terminal ignores DECSTUI. DECSTUI works only when the non-volatile memory checksum is invalid or a small jumper inside the terminal is activated, and the terminal is set to VT Level 4 mode.

## DECSWBV—Set Warning Bell Volume

---

### DECSWBV—Set Warning Bell Volume

Set the warning bell volume.

#### Format

<b>CSI</b>	<i>Ps</i>	<b>SP</b>	<b>t</b>
9/11	Ps	2/0	7/4

#### Parameters

**Ps**  
indicates the selection of the click volume.

<b>Ps</b>	<b>Bell Volume</b>
1	Off
2, 3, 4	Low
5, 5, 7, 8, 0 or none	High (default)

#### Description

This sequence is used to adjust the warning bell volume (for errors and receipt of **Ctrl G**).

---

### DECSWL—Single-Width, Single-Height Line

DECSWL makes the line with the cursor a single-width, single-height line. This line attribute is the standard for all new lines on the screen.

#### Format

<b>ESC</b>	<b>#</b>	<b>5</b>
1/11	2/3	3/5

---

## DECSZS—Select Zero Symbol

Selects the style of the zero displayed in text.

**Default:** 0

### Format

```
CSI 9/11 Ps ' 2/12 { 7/11
```

### Parameters

**Ps**  
Zero Font

Ps	Selection
1	oval zero - default 0
2	zero with slash - Ø
3	zero with dot

### Description

DECSZS can be reported using DECRPSS.

## DECSWT—Set Window Title

---

### DECSWT—Set Window Title

Specifies a descriptive name, up to 30 characters, for this session.

#### Format

```
OSC      2      D...D      ST
9/13     3/2    9/12
```

Where D...D is:

```
1      ;      <name>
3/1    3/11
```

#### Description

The session name is used in three places:

1. As the window title when framed windows mode is enabled.
2. As the icon name, using the first 12 characters of the session name, when a session icon name is not otherwise specified. Session icons are displayed when framed windows mode is enabled.
3. As the application parameter of the TD/SMP enable session command, the session name is transmitted to the host, where it can be used to select a desired service.

There is no TSI report for the window title.

---

## DECTABSR—Tab Stop Report

The terminal sends this sequence to the host in response to a request presentation state report (DECRQPSR) sequence. DECTABSR informs the host of the terminal's current tab settings.

### Programming Tip

Applications can use information in the tab stop report to save the current tab stops. Later, the application can restore the saved tab stops.

This operation is useful for applications that need to temporarily change the terminal's tab stops. When the application is finished, it can restore the tab stops that were in effect before the application changed them. You use the restore presentation state (DECRSPS) function to restore tab stops. Refer to DECRSPS—Restore Presentation State for additional information.

### Format

```
DCS 2 $ u D...D ST
9/0 3/2 2/4 7/5 ... 9/12
```

### Parameters

#### D...D

is a data string indicating the column number location of each tab stop.

### Example

The following is an example of a DECTABSR sequence:

```
DCS 2 $ u 9/ 17/ 25/ 33/ 41/ 49/ 57/ 65/ 73 ST
```

**9, 17, 25, 33, 41, 49, 57, 65, and 73** are the column numbers for tab stops.

---

## DECTCEM—Text Cursor Enable Mode

This control function makes the cursor visible or invisible.

**Default:** Visible

### Format

```
CSI ? 2 5 h Set: makes the cursor visible.
9/11 3/15 3/2 3/5 6/8

CSI ? 2 5 l Reset: makes the cursor invisible.
9/11 3/15 3/2 3/5 6/12
```

## DECTID—Select Terminal ID

---

## DECTID—Select Terminal ID

Select a terminal ID.

### Format

CSI *Ps* , **q**  
9/11 3*n* 2/12 7/1

### Parameters

**Ps**  
denotes the ID type.

<b>Ps</b>	<b>ID Type</b>
0	VT100
1	VT101
2	VT102
5	VT220
7	VT320
9	VT420
10	VT520

### Description

This sequence selects the Primary DA Response ("Terminal ID") transmitted by the terminal in either VT100 or VT500 mode. DECTID has no effect when the terminal is in VT52 mode.

The VT520 supports the following DA1 responses:

VT100 ID	ESC [ ? 1; 2 c
VT101 ID	ESC [ ? 1; 0 c
VT102 ID	ESC [ ? 6 c
VT220 ID (N.A.)	CSI ? 62; 1; 2; 7; 8 c
VT220 ID (Intl)	CSI ? 62; 1; 2; 7; 8; 9 c
VT320 ID (N.A.)	CSI ? 63; 1; 2; 7; 8 c
VT320 ID (Intl)	CSI ? 63; 1; 2; 7; 8; 9 c
VT420 ID (N.A.)	CSI ? 64; 1; 2; 7; 8; 9; 15; 18; 21 c
VT420 ID (Intl)	CSI ? 64; 1; 2; 7; 8; 9; 15; 18; 21 c
VT520 ID	Reference function DA1

The default ID is "VT520."



---

## DECTME—Terminal Mode Emulation

Select a terminal emulation mode.

### Format

```
CSI  Ps  SP  ~
9/11 3/n 2/0 7/17
```

### Parameters

#### Ps

The Ps parameter selects the terminal emulation mode as follows:

**Table 5–7 Terminal Emulation Modes**

Ps	Terminal Mode
1	VT520 (VT Level 5)
2	VT100
3	VT52
4	VT PCTerm
5	WYSE 60/160
6	WYSE PCTerm
7	WYSE 50/50+
8	WYSE 150/120
9	TVI 950
10	TVI 925
11	TVI 910+
12	ADDS A2
13	SCO Console
14	WYSE 325

### Description

This sequence allows you to select the terminal emulation mode. After any mode change is made, a soft reset is performed.

The VT520 is functionally equivalent to the architectural level 5 terminal. VT Level 5 provides level 2, 3, 4, and 5 compatibility. compatibility.

## DECTME—Terminal Mode Emulation

### Notes on DECTME

- Printer operations are not affected or halted by a change in mode.
- A soft reset is always performed as a result of a mode change between VT modes.  
Exception: Entering VT52 mode using DECANM does not cause a soft reset from VT100 mode, but does cause a soft reset from VT500 Mode.
- DECANM and DECSCL can also change the VT operating modes.

DECTME can be reported using DECRPSS from the VT modes. All WYSE emulations report like the WYSE 325.

---

## DECTSR—Terminal State Report—Terminal to Host

Requests and reports the state of the terminal.

### Format

<b>CSI</b>	<i>Ps</i>	<b>\$</b>	<b>u</b>
9/11	Ps	2/4	7/5

### Parameters

#### **Ps**

indicates the type of report the host requests from the terminal.

---

<b>Ps</b>	<b>Report Requested</b>
0 or none	Ignored. No report sent.
1	Terminal state report (DECTSR)

---

#### **Response**

**DCS 1 \$ s D . . . D ST**

D . . . D

See Device Attributes (DA1, DA2, DA3).

### Description

DECRQTSR and DECTSR requests and reports the state of the terminal.

---

## DECTSR—Terminal State Report (Color Table Report)

A response to a host request (DECRQTSR) for a color table report. The terminal responds with each color table entry given as a group of five parameters in the data string.

### Format

```
DCS  2  $  s  D...D  ST
9/0  3/2  2/4  7/3  ...  9/12
```

### Parameters

#### D . . . D

is a data string that contains the groups of five parameters as follows:

```
Pc; Pu; Px; Py; Pz / Pc; Pu; Px; Py; Pz / ...
```

where:

*Pc* is the color number 0 -255.

*Pu* is the color coordinate system.

1—HLS (hue 0-360, lightness 0-100, saturation 0-100)

2—RGB (red 0-100, green 0-100, blue 0-100)

*Px*, *Py*, *Pz* are values in the color coordinate system.

; is the semicolon (3/11).

/ is the slash character (2/15).

### Description

The DECRQTSR control with parameter 2 request the terminal color map. The terminal responds with the DECTSR control with parameter 2. To load a previously reported color map, the host transmits a DECRSTS control with parameter 2 and the desired color map definitions in the data string. When loading a color map, only the index entries specified are changed.

## DECTST—Invoke Confidence Test

---

## DECTST—Invoke Confidence Test

Select tests to be performed.

### Format

```
CSI  4  ;  Ps  ...  ;  Ps  y
9/11 3/4 3/11 3/n ... 3/11 3/n 7/9
```

### Parameters

#### Ps

is the parameter indicating a test to be done.

---

Ps	Test
0	"All Tests" (1,2,3,6)
1	Power-Up Self Test
2	RS-232 Port Data Loopback Test
3	Printer Port Loopback Test
4	Speed Select and Speed Indicator Test
5	Reserved - No action
6	RS-232 Port Modem Control Line Loopback Test
7	DEC-423 Port Loopback Test
8	Parallel Port Loopback Test
9	Repeat (Loop On) Other Tests In Parameter String

---

### Description

After the first parameter, "4", the parameters each select one test. Several tests may be invoked at once by chaining the parameters together separated by semicolons. The tests are not necessarily executed in the order in which they are entered in the parameter string.

"ESC 8" invokes the Screen Alignment test for the VT520. Additionally, after executing the power-up selftest, the terminal displays either the diagnostic messages in the upper left corner of the screen or the "VT520 OK" message in the center of the screen and within a box. Upon receipt of any character except XON or if the user types a keystroke, the screen is cleared. If the terminal is in local mode, then characters from the host are ignored and the message remains visible even if characters are received from the host. DECTST causes a disconnect; therefore, it should not be used in conjunction with a modem.

---

## DECUDK—User Defined Keys

DECUDK downloads definitions for user-defined keys.

### Format

<b>DCS</b>	<i>Ps1 ; Ps2 ; Ps3</i>		<i>D . . . D</i>	<b>ST</b>
9/0	Clear,	7/12	Final	9/12
Device	Lock, and	Character	Key Definition String	String
Control	Modifier			Terminator
String	Parameters			
Introducer				

### Parameters

#### Ps1

is the *clear parameter*. *Pc* selects how to clear key definitions.

Ps1	Meaning
0 (default) or none	Clear all keys before loading new values.
1	Load new UDK values; clear old values only when redefined.

When *Ps1* is 1, the terminal only clears the keys you are loading. By using a *Ps1* value of 1, you can redefine some keys without redefining them all.

---

#### Note

---

There are 768 bytes of memory for all user-defined keys. A key definition can only use the number of bytes available when that key is loaded.

---

#### Programming Tip

If *Ps1* is 1, a key load may fail because no memory space is available. The reason for this is as follows:

With *Ps1* set to 1, keys are cleared and loaded sequentially. If the new definition for a key is larger than the old one, then you may exceed the 768 byte limit.

For example, suppose  $\overline{F6}$  contains 412 bytes,  $\overline{F7}$  contains 330 bytes, and  $\overline{F8}$  contains 20 bytes. You try to load  $\overline{F8}$  with 40 bytes,  $\overline{F6}$  with one byte, and  $\overline{F7}$  with one byte, in that order. This works if all keys are cleared first (*Ps1* is 0), but not if keys are cleared one at a time (*Ps1* is 1). When you try to load  $\overline{F8}$  with 40 bytes, the load fails because only 26 bytes are free at that time.

$$768 \text{ (maximum)} - 412 (\overline{F6}) - 330 (\overline{F7}) = 26$$

#### Ps2

is the *lock parameter*. *Pl* determines whether the key definitions are locked or unlocked after you load them.

## DECUDK—User Defined Keys

Ps2	Action
0 or none	Lock the keys. If you want to load new values into the keys, then you must unlock the keys by using Set-Up.
1	Do not lock the keys against future redefinition.

If *Ps2* is 1 and the keys are already locked, then nothing happens.

The terminal uses a special lock to prevent or allow the programming of user-defined keys. You can turn on this lock from Set-Up or from the host (with a DECUDK device control string). The lock affects all programmable keys. When you use the lock, you should follow these guidelines:

- **Unlock the keys to define them.**

The keys must be unlocked before you can define them. You can only unlock the keys from set-up. If a key is locked and an application tries to redefine the key with a DECUDK sequence, then the terminal ignores the sequence.

- **Lock the keys to prevent redefinition.**

You can lock the keys from Set-Up or from the host by sending a DECUDK sequence. New key definitions are locked by default.

### Ps3

is the *modifier parameter*. *Ps3* designates whether the key is shifted or unshifted.

Ps3	Action
0, 2, or none	Defines the shifted function key.
1	Defines the unshifted function key.
3	Defines the alternate unshifted function key.
4	Defines the alternate shifted function key.

|  
is the *final character*. The vertical bar (7/12) identifies this control string as a DECUDK.

### D . . . D

are the *key definition strings*. You include these strings between the final character (|) and the string terminator (ST). Each string consists of a key selector number (*Kyn*) and a string parameter (*Stn*), separated by a slash (/) (2/15). A semicolon (;) (3/11) separates different strings.

- The key selector number (**Kyn**) indicates which key you are defining. Tables 5–8 and 5–9 list the definable keys and their identifying values. Table 5–10 compares the function keys on the VT keyboard to equivalent keys on the PC keyboard.

## Description

Table 5–8 VT Keyboards

Kyn	Pm = 1	Pm = none, 0, or 2
	Key	Key
11	F1	Shift/F1
12	F2	Shift/F2
13	F3	Shift/F3
14	F4	Shift/F4
15	F5	Shift/F5
17	F6	Shift/F6
18	F7	Shift/F7
19	F8	Shift/F8
20	F9	Shift/F9
21	F10	Shift/F10
23	F11	Shift/F11
24	F12	Shift/F12
25	F13	Shift/F13
26	F14	Shift/F14
28	F15	Shift/F15
29	F16	Shift/F16
31	F17	Shift/F17
32	F18	Shift/F18
33	F19	Shift/F19
34	F20	Shift/F20

---

**Note**

---

Pm values of 3 and 4 are specific to the PC keyboard. They are ignored when you use a VT keyboard.

---

## DECUDK—User Defined Keys

**Table 5–9 PC Keyboards**

Kyn	Pm Value			
	1	None, 0, or 2	3	4
11	F1	Shift/F1	Alt/F1	Alt/Shift/F1
12	F2	Shift/F2	Alt/F2	Alt/Shift/F2
13	F3	Shift/F3	Alt/F3	Alt/Shift/F3
14	F4	Shift/F4	Alt/F4	Alt/Shift/F4
15	F5	Shift/F5	Alt/F5	Alt/Shift/F5
17	F6	Shift/F6	Alt/F6	Alt/Shift/F6
18	F7	Shift/F7	Alt/F7	Alt/Shift/F7
19	F8	Shift/F8	Alt/F8	Alt/Shift/F8
20	F9	Shift/F9	Alt/F9	Alt/Shift/F9
21	F10	Shift/F10	Alt/F10	Alt/Shift/F10
23	F11	Shift/F11	Alt/F11	Alt/Shift/F11
24	F12	Shift/F12	Alt/F12	Alt/Shift/F12
25	Alt/F3	Alt/Shift/F3	–	–
26	Alt/F4	Alt/Shift/F4	–	–
28	Alt/F5	Alt/Shift/F5	–	–
29	Alt/F6	Alt/Shift/F6	–	–
31	Alt/F7	Alt/Shift/F7	–	–
32	Alt/F8	Alt/Shift/F8	–	–
33	Alt/F9	Alt/Shift/F9	–	–
34	Alt/F10	Alt/Shift/F10	–	–
35	Alt/F11	Alt/Shift/F11	–	–
36	Alt/F12	Alt/Shift/F12	–	–



Table 5–10 VT and PC Keyboard Function Keys Compared

Kyn	Keyboard	
	VT	PC
11	F1	F1
12	F2	F2
13	F3	F3
14	F4	F4
15	F5	F5
17	F6	F6
18	F7	F7
19	F8	F8
20	F9	F9
21	F10	F10
23	F11	F11
24	F12	F12
25	F13	–
26	F14	–
28	F15	–
29	F16	–
31	F17	–
32	F18	–
33	F19	–
34	F20	–

- The string parameters (**Stn**) are the encoded definition of the keys. String parameters consist of hex pairs in the following ranges:

3/0 through 3/9 (0 through 9)

4/1 through 4/6 (A through F)

6/1 through 6/6 (a through f)

When you combine these hex values, they represent an 8-bit quantity.

This method lets you use any of the 256 character codes in the key string.

You can enter key definition strings in any order.

Default: Empty. The key is undefined.

## Description

DCS (9/0) indicates the beginning of a device control string. DCS is an 8-bit C1 character. You can use ESC P (1/11 5/0) for a 7-bit environment.

ST is the *string terminator*. ST (9/12) is a C1 8-bit character. You can use ESC \ (1/11, 5/12) for a 7-bit environment.

## DECUDK—User Defined Keys

### General Guidelines When Loading UDKs

- Clear UDK memory space before loading new definitions.  
Use a DECUDK string to clear keys without locking them. Then you can use another DECUDK string to redefine the keys and lock them.
- If you redefine a key, then the old definition is lost. This clears space if the new definition uses less bytes than the old one.
- There is only one way to unlock UDKs.  
To unlock a UDK, use Set-Up.
- When you clear a UDK, the key definition is empty.
- An invalid hex pair in a DECUDK string stops a UDK sequence.  
When a load sequence stops (error or other cause), the terminal saves keys already loaded and sends the rest of DECUDK to the screen.
- You can disable the local function keys by redefining them with DECUDK.
- DECUDK works in all VT modes except VT52 mode.

### Examples of DECUDK Device Control Strings

The following sequence clears unshifted UDKs:

```
DCS 0 ; 1 ; 1 | ST
```

The following sequence locks unshifted UDKs:

```
DCS 1 ; 0 ; 1 | ST
```

Suppose you want to define the unshifted **F20** key to be “PRINT”, without clearing or locking any other keys. The first part of your sequence would look like this:

```
DCS 1 ; 1 ; 1 | 3 4 /
```

**34** is the code for the **F20** key.

After the slash character (/) (2/15), you include the definition. The rest of the sequence after the slash character would look like this:

```
5 0 5 2 4 9 4 E 5 4 ST
```

The hex encoding for “PRINT” is as follows:

50	=	P
52	=	R
49	=	I
4E	=	N
54	=	T

The ST character (9/12) marks the end of the control string:

```
DCS 1 ; 1 ; 1 | 34 / 50 52 49 4E 54 ST
```

---

## DECUS—Update Session

Controls how display memory is updated for this session when it is not active.

**Default:** Update when available

### Format

```
CSI      Ps      '      y
9/11    2/12    7/9
```

### Description

Update session according to the parameter Ps as follows:

Ps	Update Session . . .	Description
1	Only when active	Prevents the session from being updated until it is explicitly made active by the user or the host.
2	When available	Allows the session to be updated when the terminal is not otherwise busy with the active session.
3	At regular intervals	Ensures session will continue to be updated even when not active.

DECUS can be reported using DECRPSS.

## DECVCCM—Vertical Cursor-Coupling Mode

---

### DECVCCM—Vertical Cursor-Coupling Mode

This control function determines whether the user window pans with the cursor when the cursor moves past the top or bottom border of the user window. DECVCCM is only useful when the height of the current user window is smaller than the page. The cursor must stay on the current page.

**Default:** Coupled

#### Format

**CSI ? 6 1 h** Set: couples the cursor to the display.  
9/11 3/15 3/6 3/1 6/8

**CSI ? 6 1 I** Reset: uncouples the cursor.  
9/11 3/15 3/6 3/1 6/12

#### Description

When DECVCCM is set, the cursor is coupled to the display for vertical movement. When the cursor moves past the top or bottom border of the user window, the window pans to keep the cursor in view.

If the cursor moves past the top of the display, the user window pans up. New lines appear at the top of the screen, while lines at the bottom move out of view.

When DECVCCM is reset, the cursor is uncoupled from the display. If the cursor moves past the top or bottom border of the user window, the cursor disappears.

---

## DECXCPR—Extended Cursor Position Report

The host asks the terminal for the current cursor position, including the current page number.

#### Format

**CSI ? 6 n**  
9/11 3/15 3/16 6/14

#### Response

**CSI *Pl* ; *Pc* ; *Pp* R**

#### Parameters

***Pl*; *Pc*; *Pp***

The terminal indicates that the cursor is currently at line *Pl*, column *Pc*, on page *Pp*.

---

## DECXRLM—Transmit Rate Limiting

Applications can control the transmit rate limiting feature through the DECXRLM control function.

**Default:** Unlimited

### Format

<b>CSI</b>	<b>?</b>	<b>7</b>	<b>3</b>	<b>h</b>	Set: limited transmit rate.
9/11	3/15	3/7	3/3	6/8	

<b>CSI</b>	<b>?</b>	<b>7</b>	<b>3</b>	<b>l</b>	Reset: unlimited transmit rate.
9/11	3/15	3/7	3/3	6/12	

### Modem Connection and Disconnections

When the terminal makes a connection to the host system through a modem, the terminal performs the following operations to ensure it is ready to send and receive.

- Unlocks the keyboard (if it was locked).
- Clears any transmission in progress.
- Clears the keyboard buffer and all message buffers.
- Clears the input buffer.
- Clears XOFF sent and XOFF received.

Any of the following conditions will disconnect the connection to the host system in VT mode:

- You press **Shift** **F5** (**Shift** **Break**).
- You use the **Recall** or **Default** fields in the Set-Up Directory.
- You change the host port you are using (from the RS-232 port to the DEC-423 port, or from the DEC-423 port to the RS-232 port).
- The terminal loses the data set read (DSR) signal.
- The terminal loses the received line signal detect (RLSD) signal for a period of time you defined in set-up. See the **disconnect delay** feature in the Communications Set-Up screen.
- The terminal does not receive an RLSD signal within 30 seconds after DSR.
- The terminal receives a self-test command from the host system.

The usual way to disconnect communications is to type **Shift** **F5** (**Shift** **Break**). The host system's response to the disconnect signal depends on the system and the software.

### Terminal-to-Printer Data Flow Control

The terminal sends only data characters to the printer. The terminal does not send XON and XOFF characters. The terminal recognizes only XON and XOFF characters from the printer. Any other characters from the printer are ignored.

When the terminal receives XOFF from the printer, the terminal stops sending data. The terminal starts sending data again when it receives an XON, or when a clear comm operation is performed.

## DECXRLM—Transmit Rate Limiting

### Using C1 Control Characters

Using an 8-bit setting for the printer port implies the use of 8-bit C1 control characters. Using a 7-bit setting implies the use of the 7-bit ESC form of C1 control characters. You select the setting by using the **data bits/parity** feature in the Printer Set-Up screen.

### Note on DECXRLM

Older printers may not recognize the 8-bit form of C1 control characters. With these printers, you must set the printer port to 7-bits for correct operation.

---

## DL—Delete Line

This control function deletes one or more lines in the scrolling region, starting with the line that has the cursor.

### Format

CSI	<i>Pn</i>	M
9/11	3/ <i>n</i>	4/13

### Parameters

**Pn**  
is the number of lines to delete.  
Default:  $Pn = 1$ .

### Description

As lines are deleted, lines below the cursor and in the scrolling region move up. The terminal adds blank lines with no visual character attributes at the bottom of the scrolling region. If  $Pn$  is greater than the number of lines remaining on the page, DL deletes only the remaining lines. DL has no effect outside the scrolling margins.

---

## DSR—Device Status Reports

The host computer and terminal exchange DSR sequences to provide the host with the operating status of the following features:

Operating status	User-defined keys
Keyboard status - language	Macro space report
Cursor position report	Memory checksum
Cursor position with page	Data integrity report
Printer port	-

DSR requests and reports follow one of two formats, ANSI standard or DEC private. The format for each is as follows:

### Format

<b>CSI</b>	<i>Ps</i>	<b>n</b>		ANSI standard
9/11	3/?	6/14		
<b>CSI</b>	?	<i>Ps</i>	<b>n</b>	DEC private
9/11	3/15	3/?	6/14	

### Parameters

#### **Ps**

indicates the type of DSR requested. See the following individual DSR reports for specific parameters within each report.

### Description

There is a different DSR request for each feature. The following sections describe the possible DSR reports. If the terminal is in printer controller mode, then the printer receives the DSR request. The printer can respond through the bidirectional printer port.

---

## DSR—Cursor Position Report (CPR)

The host asks the terminal for a cursor position report.

### Format

Exchange	Sequence	Meaning
Request (Host to terminal)	<b>CSI 6 n</b>	The host asks for a cursor position report (CPR).
CPR response (Terminal to host)	<b>CSI <i>Pl</i>; <i>Pc</i> R</b>	The terminal indicates that the cursor is currently at line <i>Pl</i> , column <i>Pc</i> .

## DSR—Data Integrity Report

---

### DSR—Data Integrity Report

The host asks for the status of the data integrity flag. The data integrity flag indicates the integrity of the data flow between the terminal and host. This flag is reset each time the terminal sends a data integrity report.

#### Programming Tip

Applications using the flag should always reset the flag before sending data to the terminal. You can reset the flag with a DSR request (**CSI ? 75 n**) sequence. After the application sends data, the application should send another request to find out if a parity error has occurred.

#### Format

Exchange	Sequence	Meaning
Request (Host to terminal)	<b>CSI ? 75 n</b>	The host asks for the status of the data integrity flag.
Possible responses (Terminal to host)	<b>CSI ? 70 n</b>	Ready, no communication errors or power-ups have occurred since last report.
	<b>CSI ? 71 n</b>	Malfunction, a communication error has occurred since the last report.
	<b>CSI ? 73 n</b>	The terminal has not reported data integrity since the last power-up or hard reset (RIS).

---

### DSR—Extended Cursor Position Report (DECXCPR response)

The host asks the terminal for the current cursor position, including the current page number.

#### Format

Exchange	Sequence	Meaning
Request (Host to Terminal)	<b>CSI ? 6 n</b>	The host asks for an extended cursor position report (DECXCPR).
DECXCPR response (Terminal to host)	<b>CSI <i>Pl</i>; <i>Pc</i>; <i>Pp</i> R</b>	The terminal indicates that the cursor is currently at line <i>Pl</i> , column <i>Pc</i> , on page <i>Pp</i> .



---

## DSR—Keyboard Report

The host asks for the current keyboard language, operating status, and type.

### Format

Exchange	Sequence	Meaning
Request (Host to terminal)	<b>CSI ? 26 n</b>	The host asks for the keyboard status.
Response (Terminal to host)	<b>CSI ? 27; Pn; Pst; Ptyp n</b>	The keyboard language is <i>Pn</i> , the keyboard status is <i>Pst</i> , and the keyboard type is <i>Ptyp</i> .

### Parameters

#### Pn

Table 5–11 is a complete list of keyboards and keyboard languages.

**Table 5–11 Keyboard Languages**

Pn	VT/PC Language
0	Keyboard language cannot be determined.
1	North American
2	British
3	Belgian (Flemish)
4	French Canadian
5	Danish
6	Finnish
7	German
8	Dutch
9	Italian
10	Swiss French
11	Swiss German
12	Swedish
13	Norwegian
14	French
15	Spanish
16	Portuguese
19	Hebrew
22	Greek
28	Canadian (English)
29	Turkish-Q/Turkish
30	Turkish-F/Turkish
31	Hungarian
33	Slovak
35	Polish
36	Romanian
38	SCS
39	Russian
40	Latin American

## DSR—Keyboard Report

### Pst

indicates the keyboard status.

Pst	Keyboard Status‡	
0	Keyboard Ready	The terminal sends typed characters to the current session.
3	No Keyboard	The terminal does not detect the keyboard.
8	Keyboard Busy	The other session is currently using the keyboard.

‡The terminal only sends *Pst* in VT level 4 or 5 mode.

### Ptyp

indicates the keyboard type.

Ptyp	Keyboard Type
4	LK411
5	PCXAL

## DSR—Macro Space Report

The host asks for the available macro space in the form of a macro space report (DECMSR).

### Format

Exchange	Sequence	Meaning
Request (Host to terminal)	CSI ? 62 n	The host asks for a macro space report (DECMSR).
DECMSR response (Terminal to host)	CSI Pn * {	The terminal indicates the number of bytes available for macro definitions.

### Parameters

#### Pn

$Pn = \frac{\text{number of bytes}}{16}$  rounded down.

## DSR—Memory Checksum Report (DECCKSR)

---

### DSR—Memory Checksum Report (DECCKSR)

The host asks for a memory checksum report of current text macro definitions.

#### Programming Tip

Enter your macro definitions, then request and save a memory checksum. Later, you can request another checksum and see if it has changed.

#### Format

Exchange	Sequence	Meaning
Request (Host to terminal)	<b>CSI ? 63; Pid n</b>	The host asks for a memory checksum report of current text macro definitions (DECCKSR).  <i>Pid</i> is an optional numeric parameter that provides a label to identify the particular checksum request. The checksum report returns the label. This label lets you differentiate between multiple checksum reports.
DECCKSR response (Terminal to host)	<b>DCS Pid ! ~ D..D ST</b>	<i>Pid</i> is a label indicating which DSR request the report is for.  <i>D..D</i> is the data string consisting of four hexadecimal digits indicating the checksum. The digits can be in the range of 3/0 through 3/9 and 4/0 through 4/6.

---

### DSR—Operating Status Report

The host requests the terminal's operating status.

#### Format

Exchange	Sequence	Meaning
Request (Host to terminal)	<b>CSI 5 n</b>	The host requests the terminal's operating status. The host asks if the terminal is in good operating condition.
Responses (Terminal to host)	<b>CSI 0 n</b>	The terminal indicates that it is in good operating condition.
	or	
	<b>CSI 3 n</b>	The terminal indicates that it has a malfunction.

## DSR—Printer Port Report

---

### DSR—Printer Port Report

The host asks for the status of the terminal's printer.

---

**Note**

---

Host software should check the printer status before entering any print mode or starting any printing function.

---

#### Format

Exchange	Sequence	Meaning
Request (Host to terminal)	<b>CSI ? 15 n</b>	The host asks for the current printer status.
Possible responses (Terminal to host)	<b>CSI ? 13 n</b>	No printer. The data terminal ready (DTR) signal has not been asserted on the printer port since the last power-up or reset.
	<b>CSI ? 10 n</b>	Printer ready. DTR is asserted on the printer port.
	<b>CSI ? 11 n</b>	Printer not ready. DTR is not currently asserted on the printer port.
	<b>CSI ? 18 n</b>	Printer busy. DTR is asserted on the printer port, but the other session is using the printer.  In VT Level 1, the terminal sends the <i>printer not ready</i> sequence above.
	<b>CSI ? 19 n</b>	Printer assigned to other session. DTR is asserted on the printer port, but the printer is assigned to the other session. The printer is not available to this session.  In VT100 mode, the terminal sends the <i>no printer</i> sequence above.

---

## DSR—User-Defined Keys Report (VT Level 4 or higher)

The host asks if the user-defined keys (UDKs) are locked or unlocked.

### Format

Exchange	Sequence	Meaning
Request (Host to terminal)	CSI ? 25 n	The host asks if UDKs are locked or unlocked.
Possible responses (Terminal to host)	CSI ? 20 n	UDKs are unlocked.
	CSI ? 21 n	UDKs are locked.

---

## ECH—Erase Character

This control function erases one or more characters, from the cursor position to the right. ECH clears character attributes from erased character positions. ECH works inside or outside the scrolling margins.

**Available in:** VT Level 4 or higher mode only

### Format

CSI    *Pn*    X  
 9/11   3/*n*    5/8

### Parameters

**Pn**  
 is the number of characters to erase. A *Pn* value of 0 or 1 erases one character.  
 Default: *Pn* = 1.

## ED—Erase in Display

---

### ED—Erase in Display

This control function erases characters from part or all of the display. When you erase complete lines, they become single-height, single-width lines, with all visual character attributes cleared. ED works inside or outside the scrolling margins.

#### Format

```
CSI  Ps  J
9/11 3/n 4/10
```

#### Parameters

**Ps**  
represents the amount of the display to erase.

<b>Ps</b>	<b>Area Erased</b>
0 (default)	From the cursor through the end of the display
1	From the beginning of the display through the cursor
2	The complete display

#### Programming Tip

Use a *Ps* value of 2 to erase the complete display in a fast, efficient manner.

---

## EL—Erase in Line

This control function erases characters on the line that has the cursor. EL clears all character attributes from erased character positions. EL works inside or outside the scrolling margins.

#### Format

```
CSI  Ps  K
9/11 3/n 4/11
```

#### Parameters

**Ps**  
represents the section of the line to erase.

<b>Ps</b>	<b>Section Erased</b>
0 (default)	From the cursor through the end of the line
1	From the beginning of the line through the cursor
2	The complete line

---

## HPA—Horizontal Position Absolute

Move the active position to the n-th horizontal position of the active line.

### Format

CSI	$P_n$	'
9/11	3/n	6/0

### Parameters

**P<sub>n</sub>**  
indicates horizontal position.

### Description

HPA causes the active position to be moved to the n-th horizontal position of the active line. If an attempt is made to move the active position past the last position on the line, then the active position stops at the last position on the line.

---

## HPR—Horizontal Position Relative

Move the active position to the n-th column following the current horizontal position of the active line.

### Format

CSI	$P_n$	a
9/11	3/n	6/1

### Parameters

**P<sub>n</sub>**  
indicates horizontal position.

### Description

HPR causes the active position to be moved to the n-th following horizontal position of the active line. If an attempt is made to move the active position past the last position on the line, then the active position stops at the last position on the line.

## HT—Horizontal Tab

---

### HT—Horizontal Tab

HT moves the active position forward in the display to the next horizontal tab stop in the active line.

#### Format

HT  
0/9

#### Description

- If the active position does not reach a tab stop before reaching the right margin of the active line within the scroll area, then the terminal will set the active position to the right margin of the active line.
- If the active column is beyond the right margin or the active line is outside the scroll area because of absolute cursor positioning, then the active position will move to the next tab stop or the last column of the active line, whichever comes first.

---

### HTS—Horizontal Tab Set

HTS sets a horizontal tab stop at the column position indicated by the value of the active column when the terminal receives an HTS.

You can use either one of the following formats:

#### Format

HTS      or      ESC    H  
8/8            1/11    4/8

#### Description

Executing an HTS does not effect the other horizontal tab stop settings.



---

## HVP—Horizontal and Vertical Position

This control function works the same as the cursor position (CUP) function. New applications should use CUP instead of HVP. HVP is provided for compatibility with earlier VT products.

### Format

<b>CSI</b>	<b>f</b>				Cursor moves to home position selected by DECOM
9/11	6/6				
<b>CSI</b>	<i>Pl</i>	<b>;</b>	<i>Pc</i>	<b>f</b>	Moves cursor to line <i>Pl</i> , column <i>Pc</i>
9/11	3/ <i>n</i>	3/11	3/ <i>n</i>	6/6	

### Parameters

#### PI; PC

If *PI* or *Pc* is not selected or selected as 0, then the cursor moves to the first line or column, respectively. Origin mode (DECOM) selects line numbering and the ability to move the cursor into margins.

---

## ICH—Insert Character

This control function inserts one or more space (SP) characters starting at the cursor position.

**Available in:** VT Level 4 or higher mode only

### Format

<b>CSI</b>	<i>Pn</i>	<b>@</b>
9/11	3/ <i>n</i>	4/0

### Parameters

#### *Pn*

is the number of characters to insert.

Default: *Pn* = 1.

### Description

The ICH sequence inserts *Pn* blank characters with the normal character attribute. The cursor remains at the beginning of the blank characters. Text between the cursor and right margin moves to the right. Characters scrolled past the right margin are lost. ICH has no effect outside the scrolling margins.

## IL—Insert Line

---

### IL—Insert Line

This control function inserts one or more blank lines, starting at the cursor.

#### Format

CSI	<i>Pn</i>	L
9/11	3/ <i>n</i>	4/12

#### Parameters

**Pn**  
is the number of lines to insert.  
Default:  $Pn = 1$ .

#### Description

As lines are inserted, lines below the cursor and in the scrolling region move down. Lines scrolled off the page are lost. IL has no effect outside the page margins.

---

## IND—Index

IND moves the cursor down one line in the same column. If the cursor is at the bottom margin, then the screen performs a scroll-up.

#### Format

ESC	D
1/11	4/4

---

## IRM—Insert/Replace Mode

This control function selects how the terminal adds characters to page memory. The terminal always adds new characters at the cursor position.

**Default:** Replace.

### Format

<b>CSI</b>	<b>4</b>	<b>h</b>	Set: insert mode.
9/11	3/4	6/8	

<b>CSI</b>	<b>4</b>	<b>l</b>	Reset: replace mode.
9/11	3/4	6/12	

### Description

If IRM mode is set, then new characters move characters in page memory to the right. Characters moved past the page's right border are lost.

If IRM mode is reset, then new characters replace the character at the cursor position.

---

## KAM—Keyboard Action Mode

This control function locks or unlocks the keyboard.

**Default:** Unlocked

### Format

<b>CSI</b>	<b>2</b>	<b>h</b>	Set: locks the keyboard.
9/11	3/2	6/8	

<b>CSI</b>	<b>2</b>	<b>l</b>	Reset: unlocks the keyboard.
9/11	3/2	6/12	

### Description

If KAM is set, then the keyboard cannot send characters to the host. The `Wait` indicator appears on the keyboard indicator line at the bottom of the screen. The terminal ignores all keystrokes that send characters to the host. KAM does not affect the `F3` (Set-Up) or `F4` (Session) keys.

If KAM is reset, then the terminal unlocks the keyboard. The keyboard can send characters to the host.

## LNМ—Line Feed/New Line Mode

---

### LNМ—Line Feed/New Line Mode

This control function selects the characters sent to the host when you press the `Return` key. LNМ also controls how the terminal interprets line feed (LF), form feed (FF), and vertical tab (VT) characters.

---

#### Note

---

For compatibility with Digital's software, you should keep LNМ reset (line feed).

---

**Default:** Line feed

#### Format

<b>CSI</b>	<b>2</b>	<b>0</b>	<b>h</b>	Set: new line.
9/11	3/2	3/0	6/8	

<b>CSI</b>	<b>2</b>	<b>0</b>	<b>l</b>	Reset: line feed
9/11	3/2	3/0	6/12	

#### Description

If LNМ is set, then the cursor moves to the first column on the next line when the terminal receives an LF, FF, or VT character. When you press `Return`, the terminal sends both a carriage return (CR) and line feed (LF).

If LNМ is reset, then the cursor moves to the current column on the next line when the terminal receives an LF, FF, or VT character. When you press `Return`, the terminal sends only a carriage return (CR) character.

#### Note on LNМ

When the auxiliary keypad is in keypad numeric mode (DECKPNM), the `Enter` key sends the same characters as the `Return` key.

---

## LS—Locking Shift

When you use a locking shift, the character set remains in GL or GR until you use another locking shift. Table 5–12 lists all locking shifts available.

### Format

**Table 5–12 Mapping Character Sets with Locking Shifts**

Locking Shift	Code	Function
<b>LS0</b> (locking shift 0)	<b>SI</b> (Ctrl/o) 0/15	<b>Map G0 into GL.(default)</b>
<b>LS1</b> (locking shift 1)	<b>SO</b> (Ctrl/n) 0/14	Map G1 into GL.
<b>The following locking shift functions are available only in VT Level 4 mode.</b>		
<b>LS1R</b> (locking shift 1, right)	<b>ESC</b> ~ 1/11 7/14	Map G1 into GR.
<b>LS2</b> (locking shift 2)	<b>ESC</b> n 1/11 6/14	Map G2 into GL.
<b>LS2R</b> (locking shift 2, right)	<b>ESC</b> } 1/11 7/13	Map G2 into GR.
<b>LS3</b> (locking shift 3)	<b>ESC</b> o 1/11 6/15	Map G3 into GL.
<b>LS3R</b> (locking shift 3, right)	<b>ESC</b>   1/11 7/12	Map G3 into GR.

### Examples

The following sequence designates the DEC Technical character set as G1, then maps G1 into GL:

```
ESC ) >      SO
Designate as G1.  Map G1 into GL.
```

The following sequences designate the ISO Latin-1 supplemental character set as G2, then map G2 into GR:

```
ESC . A      ESC }
Designate as G2.  Map G2 into GR.
```

## MC—Media Copy

---

## MC—Media Copy

MC is the control sequence that enables the terminal to control all print functions.

### Format

CSI *Pn* *i*    ANSI standard.  
9/11 3/*n* 6/9

CSI ? *Ps* *i*    DEC private.  
9/11 3/15 3/*n* 6/9

### Parameters

#### **Pn (ANSI standard)**

indicates the following ANSI standard print functions:

Pn	Action	Notes on Print Page
0	Prints the page that has the cursor.	<ul style="list-style-type: none"><li>The terminal stores data from the keyboard until printing is complete.</li><li>If printer extent mode (DECPEX) is currently reset, then the print page function only prints the scrolling region.</li></ul>
2	Sends screen data through host port.	
4	Turns off printer controller mode.	<ul style="list-style-type: none"><li>Printer controller mode lets the host control printer operation. The terminal sends characters and control sequences directly to the printer, without displaying them on the screen.</li><li>The terminal sends all characters and control sequences except NUL, XON, XOFF, and the printer controller mode sequences.</li><li>Printer controller mode cancels autoprnt mode. When the terminal leaves printer controller mode, it returns to the normal method for printing operations.</li><li>The printer's active column position should always be on the left margin before the terminal leaves printer controller mode.</li></ul>

Pn	Action	Notes on Printer Controller Mode
5	Turns on printer controller mode.	
6	Start a printer-to-host session.	
7	Stop a printer-to-host session.	

**Pn (DEC private)**

indicates the following DEC private print functions:

Pn	Action	Note on Print Cursor Line
1	Prints the line that has the cursor.	The cursor does not move.

Pn	Action	Notes on Autoprint Mode
4	Turns off autoprint mode.	
5	Turns on autoprint mode.	<ul style="list-style-type: none"> <li>The printer prints a line from the screen when you move the cursor off that line with an LF, FF, or VT character, or an autowrap occurs.</li> <li>The printed line ends with a CR and the character (LF, FF, or VT) that moved the cursor off the previous line.</li> </ul>
8	Disables communication from the printer port to the host.	
9	Enables communication from the printer port to the host.	

Pn	Action	Note on Print Composed Main Display
10	Prints the data on the screen.	Printer extent mode (DECPEX) does not affect this function.

## MC—Media Copy

Pn	Action	Notes on Print All Pages
11	Prints all pages in page memory.	<ul style="list-style-type: none"><li>• If the current page format is 3 pages of 24 lines each, the printer prints 3 pages of 24 lines.</li><li>• The terminal stores new data from the keyboard until printing is complete.</li><li>• If print form feed mode (DECPFF) is set, then the terminal sends a form feed (FF) to the printer after each page.</li></ul>
18	Lets the terminal accept printer commands.	

### Description

Escape Sequence **CSI 6 i** and **CSI 7 i** are functionally equivalent to **CSI ? 9 i** and **CSI ? 8 i**. Also, **CSI ? 9 i** and **CSI ? 8 i** are media copy commands used in VT terminals to set/reset printer to host mode.



---

## NEL—Next Line

Moves cursor to first position on next line. If cursor is at bottom margin, then screen performs a scroll-up.

### Format

ESC	E
033	105

---

## NP—Next Page

This control function moves the cursor forward to the home position on one of the following pages in page memory. If there is only one page, then the terminal ignores NP.

**Default:** Move to the next page.

### Format

CSI	<i>Pn</i>	U
9/11	3/ <i>n</i>	5/5

### Parameters

#### **Pn**

indicates how many pages to move the cursor forward.

Default:  $Pn = 0$ .

If  $Pn$  is 0 or 1, then the cursor moves to the next page in page memory. If  $Pn$  tries to move the cursor past the last page in memory, then the cursor stops at the last page.

## PP—Preceding Page

---

### PP—Preceding Page

This control function moves the cursor backward to the home position on one of the preceding pages in page memory. If there is only one page, then the terminal ignores PP.

**Default:** Move to the preceding page.

#### Format

CSI	<i>Pn</i>	V
9/11	3/ <i>n</i>	5/6

#### Parameters

##### **Pn**

indicates how many pages to move the cursor backward.

Default:  $Pn = 0$ .

If  $Pn$  is 0 or 1, then the cursor moves to the preceding page. If  $Pn$  tries to move the cursor back farther than the first page in memory, then the cursor stops at the first page.

---

## PPA—Page Position Absolute

This control function can move the cursor to the corresponding row and column on any page in page memory. You select the page by its number. If there is only one page, then the terminal ignores PPA.

**Default:** Move to page 1.

#### Format

CSI	<i>Pn</i>	sp	P
9/11	3/ <i>n</i>	2/0	5/0

#### Parameters

##### **Pn**

is the number of the page to move the cursor to. If  $Pn$  is greater than the number of the last page in memory, then the cursor stops at the last page. If  $Pn$  is less than the number of the first page, then the cursor stops at the first page.

---

## PPB—Page Position Backward

This control function moves the cursor backward to the corresponding row and column on one of the preceding pages in page memory. If there is only one page, then the terminal ignores PPB.

**Default:** Move backward one page.

### Format

CSI	<i>Pn</i>	sp	R
9/11	3/ <i>n</i>	2/0	5/2

### Parameters

#### **Pn**

indicates the number of pages to move the cursor backward. If *Pn* tries to move the cursor back farther than the first page in memory, then the cursor stops at the first page.

---

## PPR—Page Position Relative

This control function moves the cursor forward to the corresponding row and column on one of the following pages in page memory. If there is only one page, then the terminal ignores PPR.

**Default:** Move to the next page.

### Format

CSI	<i>Pn</i>	sp	Q
9/11	3/ <i>n</i>	2/0	5/1

### Parameters

#### **Pn**

indicates how many pages to move the cursor forward. If *Pn* tries to move the cursor beyond the last page in memory, then the cursor stops at the last page.

## RIS—Reset to Initial State

---

### RIS—Reset to Initial State

This control function causes a nonvolatile memory (NVR) recall to occur. RIS replaces all set-up features with their saved settings.

The terminal stores these saved settings in NVR memory. The saved setting for a feature is the same as the factory-default setting, unless you saved a new setting.

---

#### Note

---

It is recommended that you not use RIS to reset the terminal. You should use a soft terminal reset (DECSTR) instead. RIS usually causes a communication line disconnect and may change the current baud rate settings. When performing a RIS, the terminal sends XOFF to the host to stop communication. When the RIS is complete, the terminal sends XON to resume communication.

---

### Format

ESC	c
1/11	6/3

### RIS Actions

- Sets all features listed on set-up screens to their saved settings.
- Causes a communication line disconnect.
- Clears user-defined keys.
- Clears the screen and all off-screen page memory.
- Clears the soft character set.
- Clears page memory. All data stored in page memory is lost.
- Clears the screen.
- Returns the cursor to the upper-left corner of the screen.
- Sets the select graphic rendition (SGR) function to normal rendition.
- Selects the default character sets (ASCII in GL, and DEC Supplemental Graphic in GR).
- Clears all macro definitions.
- Erases the paste buffer.

---

## RM—Reset Mode

There are two versions of this control function. You use the ANSI version to reset one or more ANSI modes. You use the DEC private version to reset one or more DEC private modes. You *cannot* reset ANSI and DEC private modes with the same RM sequence.

### Resetting DEC Private Modes

```
CSI ? Pd ; ... ; Pd |
9/11 3/15 3/n 3/11 ... 3/11 3/n 6/12
```

### Parameters

#### **Pd**

indicates a DEC private mode to reset. Table 5–5 lists the *Pd* values for DEC private modes. You can use more than one *Pd* value in a sequence.

### Examples

#### **DEC Private Modes**

The following sequence resets (Hebrew) keyboard mapping (DECHEBM) and Hebrew encoding mode (DECHEM):

```
CSI ? 34; 36 |
```

**34** indicates (Hebrew) keyboard mapping.

**36** indicates Hebrew encoding mode.

#### **Programming Tip**

Applications can use the SM and RM functions to restore any number of VT520 modes to a desired state. See the Report Mode (DECRPM) section in this chapter for details.

## S7C1T—Send C1 Control Character to the Host

---

### S7C1T—Send C1 Control Character to the Host

The VT520 can send C1 control characters to the host as single 8-bit characters or as 7-bit escape sequences. You should select the format that matches the operating level you are using.

The following sequence causes the terminal to send all C1 control characters as 7-bit escape sequences or single 8-bit characters:

#### Format

<b>ESC</b>	<b>sp</b>	<b>F</b>
1/11	2/0	4/7

#### Description

This sequence changes the terminal mode as follows:

<b>Mode Before</b>	<b>Mode After</b>
VT Level 4 mode, 8-bit controls	VT Level 4 mode, 7-bit controls.
VT Level 4 mode, 7-bit controls	Same. Terminal ignores sequence.
VT Level 1 or VT52 mode, 7-bit controls	Same. Terminal ignores sequence.

---

## S8C1T—Send C1 Control Character to the Host

The following sequence causes the terminal to send C1 control characters to the host as single 8-bit characters:

#### Format

<b>ESC</b>	<b>sp</b>	<b>G</b>
1/11	2/0	4/6

#### Description

This sequence changes the terminal mode as follows:

<b>Mode Before</b>	<b>Mode After</b>
VT Level 4 mode, 8-bit controls	Same. Terminal ignores sequence.
VT Level 4 mode, 7-bit controls	VT Level 4 mode, 8-bit controls.
VT Level 1 mode	Same. Terminal ignores sequence.

---

## SCS—Select Character Set

Designate character sets to G-sets.

To understand how to select character sets, you must first understand the function of the terminal's *in-use table*. The in-use table contains the character sets the terminal can currently access. You can place any two character sets in the terminal's in-use table. The in-use table consists of the *graphic left* (GL) and *graphic right* (GR) logical tables.

Each time you turn on the terminal, the terminal places the following default character sets in the in-use table:

ASCII in GL

Supplemental Graphic (or ISO Latin-1 supplemental) in GR

Together, the ASCII and Supplemental Graphic sets make up the Multinational set. The ASCII and ISO Latin-1 supplemental sets make up the ISO Latin-1 set, which is the worldwide standard.

You can select a different character set by following these two steps:

1. **Designate the set as G0, G1, G2, or G3.**

G0 through G3 are logical sets that the terminal uses to access character sets. You can designate up to four character sets and have them ready for use in the in-use table.

2. **Map the designated set into the in-use table.**

After you map the set into the in-use table, you can display or send any character from that set by using 8-bit codes.

---

## Designating Character Sets (SCS Sequences)

You designate a hard character set as G0 through G3 by using a select character set (SCS) escape sequence. You cannot designate a 96-character set as G0.

SCS sequences use the following format. Table 5–14 lists the code used to select each available character set.

### Format

<b>ESC</b>	$I_1$	$I_2$	...	$I_n$	$F$
1/11	***	***	...	***	***

### Parameters

$I_1$ , **intermediate character**

Designates the character set as G0, G1, G2, or G3.

## Designating Character Sets (SCS Sequences)

**Table 5–13 Designating a Character Set**

<b>I<sub>1</sub> Character</b>	<b>Code</b>	<b>Set Selection</b>
<b>94-Character Sets</b>		
( left parenthesis	2/8	G0 (initial setting for GL)
) right parenthesis	2/9	G1
* asterisk	2/10	G2 (initial setting for GR)
+ plus sign	2/11	G3
<b>96-Character Sets*</b>		
- hyphen	2/13	G1
. period	2/14	G2
/ slash	2/15	G3

\*You cannot designate a 96-character set into G0.

### **I<sub>2</sub>...I<sub>n</sub> F, intermediate and final characters**

Selects one of the standard character sets. The following table lists the characters used to select standard sets.

**Table 5–14 Character Set Codes**

<b>Character Set</b>	<b>I<sub>2</sub>...I<sub>n</sub> F Characters</b>	<b>Code</b>
<b>94-Character Sets</b>		
<b>ASCII</b> (initial setting for G1 and G0)	<b>B</b>	<b>4/2</b>
<b>DEC Supplemental Graphic</b> (initial setting for G2 and G3)	<b>%5</b>	<b>2/5, 3/5</b>
DEC Special Graphic Set	0	3/0
DEC Technical Character Set	>	3/14
User-preferred Supplemental Set	<	3/12
<b>NRC Sets</b>		
DEC Supplemental	% 5	2/5, 3/5
DEC Greek	" ?	2/2, 3/15
DEC Hebrew	" 4	2/2, 3/4
DEC Turkish	% 0	2/5, 3/0
DEC Cyrillic	& 4	2/6, 3/4
U.K. NRCS	A	4/1
French NRCS	R	5/2
French Canadian NRCS†	9 or Q	3/9 or 5/1
Norwegian/Danish NRCS†	‘, E, or 6	6/0, 4/5, or 3/6
Finnish NRCS†	5 or C	3/5 or 4/3
German NRCS	K	4/11

†We recommend using the first code shown.

(continued on next page)



## Designating Character Sets (SCS Sequences)

Table 5–14 (Cont.) Character Set Codes

Character Set	I <sub>2</sub> ...I <sub>n</sub> F Characters	Code
Italian NRCS	Y	5/9
Swiss NRCS	=	3/13
Swedish NRCS†	7 or H	3/7 or 4/8
Spanish NRCS	Z	5/10
Portuguese NRCS	% 6	2/5, 3/6
Greek NRCS	" >	2/2, 3/14
Hebrew NRCS	% =	2/5, 3/13
Turkish NRCS	% 2	2/5, 3/2
SCS NRCS	% 3	2/5, 3/3
Russian NRCS	& 5	3/6, 3/5
<b>96-Character Sets</b>		
ISO Latin-1 Supplemental	A	4/1
ISO Latin-2 Supplemental	B	4/2
ISO Greek Supplemental	F	4/6
ISO Hebrew Supplemental	H	4/8
ISO Latin-Cyrillic	L	4/12
ISO Latin-5 Supplemental	M	4/13
User-preferred Supplemental	<	3/12

†We recommend using the first code shown.

### Examples

The following sequence designates the Special Graphic character set as the G1 logical set:

ESC ) 0

The following sequence designates the ISO Latin-1 supplemental character set as the G3 logical set:

ESC / A

---

### Mapping Character Sets

---

After you designate a character set as G0, G1, G2, or G3, you must map the set into the in-use table as GL or GR. To map a set, you use *locking-shift* or *single-shift* control functions. See **LS-Locking Shift** or **SS-Single Shift** commands.

---

## SD—Pan Up

---

## SD—Pan Up

This control function moves the user window up a specified number of lines in page memory.

### Format

CSI	<i>Pn</i>	T
9/11	3/ <i>n</i>	5/4

### Parameters

#### **Pn**

is the number of lines to move the user window up in page memory. *Pn* new lines appear at the top of the display. *Pn* old lines disappear at the bottom of the display. You cannot pan past the top margin of the current page.

---

## SGR—Select Graphic Rendition

This control function selects one or more character attributes at the same time.

**Default:** Clear all attributes.

### Format

```
CSI  Ps  ;   Ps  ...  m
9/11 3/n 3/11 3/n  ... 6/13
```

### Parameters

#### Ps

is a number representing a certain visual attribute. You can use more than one *Ps* value to select different character attributes. Table 5–15 lists *Ps* values and the attributes they select.

Default: *Ps* = 0 (clears all attributes).

**Table 5–15 Visual Character Attribute Values**

Ps	Attribute (VT Level 1 or higher)
0	All attributes off
1	Bold
4	Underline
5	Blinking
7	Negative image
8	Invisible image
Ps	Attribute (VT Level 2 or higher)
10	The ASCII character set is the current 7-bit display character set (default).
11	Hex 00-7F of the PC character set codes are mapped to the current 7-bit display character set.
12	Hex 80-FF of the current character set are mapped to the current 7-bit display character set.
22	Bold off
24	Underline off
25	Blinking off
27	Negative image off
28	Invisible image off

(continued on next page)

## SGR—Select Graphic Rendition

Table 5–15 (Cont.) Visual Character Attribute Values

Ps	Attribute (VT Level 5, VT525 only) <sup>1</sup>	Default Color
30	Foreground Color 0	Black
31	Foreground Color 1	Red
32	Foreground Color 2	Green
33	Foreground Color 3	Yellow
34	Foreground Color 4	Blue
35	Foreground Color 5	Magenta
36	Foreground Color 6	Cyan
37	Foreground Color 7	White
39	Default Foreground Color	White
40	Background Color 0	Black
41	Background Color 1	Red
42	Background Color 2	Green
43	Background Color 3	Yellow
44	Background Color 4	Blue
45	Background Color 5	Magenta
46	Background Color 6	Cyan
47	Background Color 7	White
49	Default Background Color	Black

<sup>1</sup>ANSI color text extension (DA1 reports 22 for VT525 and VGB25 only).

### Examples

When you select more than one attribute in an SGR sequence, then they are executed in order. For example, you can use the following sequence to display text that is bold, blinking, and underlined:

```
CSI 0 ; 1 ; 5 ; 4 m
```

The following sequence displays the negative image of text:

```
CSI 7 m
```

### Notes on SGR

- After you select an attribute, the terminal applies that attribute to all new characters received. If you move characters by scrolling, then the attributes move with the characters.
- If you display control characters, then the terminal ignores the bold attribute for displayed control characters.
- Color renditions may be selected in any combination. Selecting additional renditions do not affect the setting of previously selected renditions or characters already on the display unless all renditions are turned off (parameter value 0).

## SGR—Select Graphic Rendition

When a PC character set is selected:

Command	(Hexadecimal) Display Character
Executing "CSI 10 m"	00-1F: control codes 20-7F: ASCII characters 80-FF: 8 bit PC characters
Executing "CSI 11 m"	00-1F: PC characters, except the following codes when XON/XOFF is enabled: 1B (ESC) 11 (DC1) 13 (DC3) 20-7F: ASCII characters (or PC 7 bit character) 80-FF: 8 bit PC characters
Executing "CSI 12 m"	00-1F: PC characters that are located in 80 - 9F in PC character set, except the following codes when XON/XOFF is enabled: 9B (ESC) 91 (DC1) 93 (DC3) 20-7F: PC characters located in A0-FF 80-FF: 8 bit PC characters.

For ISO/ANSI character set:

Command	(Hexadecimal) Display Character
Executing "CSI 10 m"	00-1F: control codes 20-7F: ASCII characters 80-9F: control code A0-FF: GR characters
Executing "CSI 12 m"	00-1F: control codes 20-7F: ISO/ANSI characters located in A0-FF 80-9F: control code A0-FF: GR characters

Commands "CSI 10-12 m" affect only the Hex 00-7F portion of the display character set. The hex 80-FF region of the display character set is left intact.

The ASCII character set with control codes residing in Hex 00 to 1F region is the default 7-bit display character set. This is true regardless of the ISO/ANSI or PC character set. When in an ISO/ANSI character set, issuing "CSI 10 m" is equivalent to "designating and invoking ASCII to G0 and GL."

## SGR—Select Graphic Rendition

When "ESC 11 m" is executed, the display character set is loaded with codes in the Hex 00 to 7F region of a PC character set. PC characters whose code values are less than 1F can be displayed through this sequence except 1B (ESC) and 11(DC1), 13(DC3) when XON/XOFF is enabled. 1B is always executed as an ESC to allow the application to execute the command to go back to the default character set. Hex 11 and 13 can be displayed only when XON/XOFF is disabled. This command does not work when the ISO/ANSI character set is selected.

Command "ESC 12 m" toggles the high bit of the current 8-bit character set. All the characters in Hex 80-FF region can be displayed as 7-bit codes except 9B (ESC) and 91(DC1), 93(DC3) when XON/XOFF is enabled. After the command is executed, 1B is executed as an ESC. Hex 11 and 13 can be displayed only when XON/XOFF is disabled.

When in an ISO/ANSI character set, issuing "CSI 12 m" is equivalent to "designating and invoking current 8 bit char set to G2 and GL."

---

## SRM—Local Echo: Send/Receive Mode

This control function turns local echo on or off. When local echo is on, the terminal sends keyboard characters to the screen. The host does not have to send (echo) the characters back to the terminal display. When local echo is off, the terminal only sends characters to the host. It is up to the host to echo characters back to the screen.

**Default:** No local echo

### Format

<b>CSI</b>	<b>1</b>	<b>2</b>	<b>h</b>	Set: local echo off.
9/11	3/1	3/2	6/8	

<b>CSI</b>	<b>1</b>	<b>2</b>	<b>l</b>	Reset: local echo on.
9/11	3/1	3/2	6/12	

### Description

When the SRM function is set, the terminal sends keyboard characters to the host only. The host can echo the characters back to the screen.

When the SRM function is reset, the terminal sends keyboard characters to the host and to the screen. The host does have to echo characters back to the terminal.

---

## SS—Single Shifts

You use a single shift when you want to display the next character from a different character set. A single shift maps the G2 or G3 set into GL. The character set is active for only one character, then the terminal returns to the previous character set in GL.

The terminal has two single-shift control functions available.

### Format

Single-Shift Control	8-Bit Character	7-Bit Equivalent Sequence		Function
Single shift 2	<b>SS2</b> 8/14	<b>ESC</b> 1/11	<b>N</b> 4/14	Maps G2 into GL for the next character.
Single shift 3	<b>SS3</b> 8/15	<b>ESC</b> 1/11	<b>O</b> 4/15	Maps G3 into GL for the next character.

### Example

Suppose the ASCII character set is in GL. You want to display the alpha character from the DEC Technical character set, already designated as G3. You do not want to replace the ASCII set just to display one character. Instead, you can use single shift 3 to temporarily map the DEC Technical set (G3) into GL.

```
SS3      a
single shift 3  alpha character
```

After displaying the alpha character, the terminal maps the ASCII set (G1) back into GL, replacing the DEC Technical set (G3).

## SM—Set Mode

---

### SM—Set Mode

This control function has two versions. You use the ANSI version to set one or more ANSI modes. You use the DEC private version to set one or more DEC private modes. You *cannot* set ANSI and DEC private modes with the same SM sequence.

#### Setting DEC Private Modes

CSI	?	<i>Pd</i>	;	...	<i>Pd</i>	h
9/11	3/15	3/ <i>n</i>	3/11	...	3/ <i>n</i>	6/8

#### Parameters

##### **Pd**

indicates a DEC private mode to set. Table 5–5 lists the *Pd* values for DEC private modes. You can use more than one *Pd* value in a sequence.

#### Examples

##### **DEC Private Modes**

The following sequence sets (Hebrew) keyboard mapping (DECHEBM) and Hebrew encoding mode (DECHEM):

```
CSI ? 34; 36 h
```

**34** indicates (Hebrew) keyboard mapping.

**36** indicates Hebrew encoding mode.

##### **Programming Tip**

Applications can use the SM and RM functions to restore any number of VT520 modes to a desired state. See the Report Mode (DECRPM) section in this chapter for details.



---

## SU—Pan Down

This control function moves the user window down a specified number of lines in page memory.

### Format

<b>CSI</b>	<i>Pn</i>	<b>S</b>
9/11	3/ <i>n</i>	5/3

### Parameters

#### **Pn**

is the number of lines to move the user window down in page memory. *Pn* new lines appear at the bottom of the display. *Pn* old lines disappear at the top of the display. You cannot pan past the bottom margin of the current page.

---

## TBC—Tab Clear

This control function clears tab stops.

### Format

<b>CSI</b>	<i>Ps</i>	<b>g</b>
9/11	3/ <i>n</i>	6/7

### Parameters

#### **Ps**

indicates the tab stops to clear. There are only two values for *Ps*, 0 and 3.

0 or none      The terminal only clears the tab stop at the cursor.  
(default)

3              The terminal clears all tab stops.

## VPA—Vertical Line Position Absolute

---

### VPA—Vertical Line Position Absolute

Move to the corresponding vertical position (line  $P_n$ ) of the current column.

The default value is 1.

#### Format

CSI	$P_n$	d
9/11	3/n	6/4

#### Parameters

**$P_n$**   
is line number.

#### Description

Move cursor to line  $P_n$ . VPA causes the active position to be moved to the corresponding vertical position on line  $P_n$ . If an attempt is made to move the active position beyond the last line, then the active position stops at the last line.

---

### VPR—Vertical Position Relative

Move vertically  $P_n$  lines in the current column.

The default value is 1.

#### Format

CSI	$P_n$	e
9/11	3/n	6/5

#### Parameters

**$P_n$**   
is number of lines to move.

#### Description

VPR causes the active position to be moved to vertically corresponding  $P_n$  lines following the current position of the active line. If an attempt is made to move the active position beyond the last line, the active position stops at the last line.

## SCO Console Emulation

This chapter describes the SCO Console mode.

### 6.1 SCO Console Emulation Mode

SCO Console mode is a terminal emulation mode. It uses ANSI sequences with minor modifications to act like a SCO UNIX operating system console on a PC.

Depending on the terminal status, SCO Console mode for the VT520 transmits ASCII characters (default) or scancode to the host when keys are pressed. Users can specify a keycode mode by issuing an escape sequence (DECPCTERM) or by keyboard encoding of Set-Up. When in SCO Console mode with the ASCII keycode selected, the terminal behavior is similar to VT mode. When in SCO Console mode with scancode selected, the terminal behavior is similar to VT PCTerm mode. Table 6–1 shows the similarities and differences.

**Table 6–1 SCO Console Mode with ASCII Keycodes and Scancodes**

Default	SCO Console Mode with			
	ASCII Keycodes	Scancodes	VT Mode	VT PCTerm
Screen display	25×80	25×80	24×80	25×80
Autowrap	On	On	Off	On
Autowrap behavior	Like WYSE	Like WYSE	Like VT	Like VT
Status line	None	None	Local	None
Cursor position while switching pages	Saved	Saved	Not saved	Not saved
Character set	PCTerm (including PC, ISO/ANSI character sets)		VT character set (ISO/ANSI)	PCTerm character set
CSI 10-12 m	Supported	Supported	Not supported	Not supported
SU SD	Acts like IND Acts like RI	Acts like IND Acts like RI	Acts like SU Acts like SD	Acts like SU Acts like SD
CSI s and CSI u DECSC and DECRC	Supported Supported	Supported Supported	Only DECSC and DECRC are supported.	
CSI Pn z (switch pages)	Supported	Supported	Not supported	Not supported
ESC Q Fn String (Define Function)	Supported	Supported	Not supported	Not supported
Transmit flow control	None	None	XON/XOFF	None

## SCO Console Emulation

### 6.1 SCO Console Emulation Mode

#### 6.1.1 Keyboard

SCO Console mode works with either a PC keyboard or a VT keyboard attached.

##### 6.1.1.1 Local Function Keys in SCO Console Mode

The keys used to perform local functions in SCO Console mode are similar to those used for VT mode (see Chapter 8, Keyboard Processing. Table 6–2 shows the exceptions).

**Table 6–2 Local Functions on VT and Enhanced PC Layouts**

Fn#	Function	VT Layout	EPC Layout
1	Hold	CapsLock/F1	Scroll CapsLock
2	Print	CapsLock/F2	Print Screen
3	Set-Up	CapsLock/F3	CapsLock/Print Screen Alt/Print Screen
5	Break	CapsLock/F5	CapsLock/Pause
7	Hard Reset	CapsLock/Ctrl/F3	Ctrl/CapsLock/Print Screen
8	Toggle Autoprint	CapsLock/Ctrl/F2	Ctrl/Print Screen
9	Disconnect	CapsLock/Shift/F5	Shift/CapsLock/Pause
10	Send Answerback	CapsLock/Ctrl/F5	Ctrl/CapsLock/Pause
11	Print Composed Main Display	Not supported	
20	Pan Up	Not supported	
21	Pan Down	Not supported	
24	Pan Prev Page	Not supported	
25	Pan Next Page	Not supported	
30	Copy and Paste	CapsLock/F1	Scroll Lock
47	Primary KB language	CapsLock/Ctrl/Alt/F1	CapsLock/Ctrl/Alt/F1
48	Secondary KB language	CapsLock/Ctrl/Alt/F2	CapsLock/Ctrl/Alt/F2
53	±DEC/IBM PC Style	Not supported	

##### 6.1.1.2 PC Keyboard

Tables 6–3 through 6–6 list the default codes sent by keys in ASCII character code mode.

The keys that can be affected by Caps Lock or Num Lock send a shifted value when in Lock state. If **[Shift]** is pressed when Caps Lock or Num Lock is in effect, the key sends its unshifted value. This "Reverse Lock" is the default for a Caps Lock function.

**[Alt]** has no effect on the key pressed unless otherwise indicated. A blank in any column means the keystroke is not defined.

## SCO Console Emulation 6.1 SCO Console Emulation Mode

**Table 6–3 SCO Console Mode Function Key Default Codes**

Key	Unmodified	Shift	Ctrl	Ctrl/Shift
F1	ESC[M	ESC[Y	ESC[k	ESC[w
F2	ESC[N	ESC[Z	ESC[l	ESC[x
F3	ESC[O	ESC[a	ESC[m	ESC[y
F4	ESC[P	ESC[b	ESC[n	ESC[z
F5	ESC[Q	ESC[c	ESC[o	ESC[@
F6	ESC[R	ESC[d	ESC[p	ESC[[
F7	ESC[S	ESC[e	ESC[q	ESC[<
F8	ESC[T	ESC[f	ESC[r	ESC[ ]
F9	ESC[U	ESC[g	ESC[s	ESC[^
F10	ESC[V	ESC[h	ESC[t	ESC[_
F11	ESC[W	ESC[i	ESC[u	ESC['
F12	ESC[X	ESC[j	ESC[v	ESC[{
Print Screen	Print Screen	ESC[0i		
Scroll Lock	Scroll Lock	Scroll Lock	N/A	N/A
Pause	Break	Break	N/A	N/A

**Table 6–4 SCO Console Mode Main Keypad Default Codes**

Key	Unmodified	Shift	Ctrl	Ctrl/Shift
ESC	ESC	ESC	ESC	ESC
1	1	!	1	!
2	2	@	Nul	Nul
3	3	#	ESC	ESC
4	4	\$	FS	FS
5	5	%	GS	GS
6	6	^	RS	RS
7	7	&	US	US
8	8	*	DEL	DEL
9	9	(		
0	0	)		
-	-	_	US	US
=	=	+		
Backspace	BS	BS	DEL	DEL
Tab	HT	ESC[Z		
q	q	Q	DC1	DC1
w	w	W	ETB	ETB
e	e	E	ENQ	ENQ
r	r	R	DC2	DC2

(continued on next page)

## SCO Console Emulation

### 6.1 SCO Console Emulation Mode

Table 6–4 (Cont.) SCO Console Mode Main Keypad Default Codes

Key	Unmodified	Shift	Ctrl	Ctrl/Shift
t	t	T	DC4	DC4
y	y	Y	EM	EM
u	u	U	NAK	NAK
i	i	I	HT	HT
o	o	O	SI	SI
p	p	P	DLE	DLE
[	[	{	ESC	ESC
]	]	}	GS	GS
\	\		FS	FS
Return	CR	CR	LF	LF
Ctrl	Ctrl	Ctrl	Ctrl	Ctrl
a	a	A	SOH	SOH
s	s	S	DC3	DC3
d	d	D	EOT	EOT
f	f	F	ACK	ACK
g	g	G	BEL	BEL
h	h	H	BS	BS
j	j	J	LF	LF
k	k	K	VT	VT
l	l	L	FF	FF
;	;	:		
'	'	"		
z	z	Z	SUB	SUB
x	x	X	CAN	CAN
c	c	C	ETX	ETX
v	v	V	SYN	SYN
b	b	B	STX	STX
n	n	N	SO	SO
m	m	M	CR	CR
,	,	<		
.	.	>		
/	/	?	US	US

## SCO Console Emulation 6.1 SCO Console Emulation Mode

**Table 6–5 SCO Console Mode Numeric Keypad Default Codes, Num Lock Off**

Keypad Key	Unmodified	Shift	Ctrl	Ctrl/Shift
Num Lock	Num Lock	Num Lock	DC3	DC3
/	/	/		
*	*	*		
7	ESC[H	7	ESC[H	7
8	ESC[A	8	ESC[A	8
9	ESC[I	9	ESC[I	9
-	-	-	-	-
4	ESC[D	4	ESC[D	4
5	ESC[E	5	ESC[E	5
6	ESC[C	6	ESC[C	6
+	+	+	+	+
1	ESC[F	1	ESC[F	1
2	ESC[B	2	ESC[B	2
3	ESC[G	3	ESC[G	3
0	ESC[L	0	ESC[L	0
.	DEL	.	DEL	DEL
Enter	CR	CR	LF	LF

**Table 6–6 SCO Console Mode Numeric Keypad Default Codes, Num Lock On**

Keypad Key	Unmodified	Shift	Ctrl	Ctrl/Shift
Numlock	Numlock	Numlock	DC3	DC3
/	/	/		
*	*	*		
7	7	ESC[H		
8	8	ESC[A		
9	9	ESC[I		
-	-	-	-	-
4	4	ESC[D		
5	5	ESC[E		
6	6	ESC[C		
+	+	+		
1	1	ESC[F		
2	2	ESC[B		
3	3	ESC[G		
0	0	ESC[L		
.	.	DEL		
Enter	CR	CR		

## SCO Console Emulation

### 6.1 SCO Console Emulation Mode

#### Note

Pressing **Alt/.** on the numeric keypad sends DEL, not a period.

**Table 6–7 SCO Console Mode Editing Keypad Default Codes**

Key	Unmodified, <b>Shift</b> , <b>Ctrl</b> , or <b>Ctrl/Shift</b>
<b>Insert</b>	ESC[L
<b>Home</b>	ESC[H
<b>Page Up</b>	ESC[I
<b>Delete</b>	DEL
<b>End</b>	ESC[F
<b>Page Down</b>	ESC[G

**Table 6–8 SCO Console Mode Cursor Keypad Default Codes**

Key	Unmodified, <b>Shift</b> , <b>Ctrl</b> , or <b>Ctrl/Shift</b>
<b>↑</b>	ESC[A
<b>↓</b>	ESC[B
<b>⇒</b>	ESC[C
<b>⇐</b>	ESC[D

#### 6.1.1.3 VT Keyboard Key Mapping

More key mapping information is provided in Chapter 8, Keyboard Processing.

- On the main keypad, 8-bit codes are allowed for keyboard input.
- Function keys **F1** through **F12** send the same codes as **F1** through **F12** on a PC keyboard. Function keys **F13** through **F20** send the same codes as **F13** through **F20** in VT mode, except **Do** sends an ESC code.
- For Autowrap, On is the default.
- On the editing keypad, VT keyboard keys send the same sequences as the corresponding PC keyboard keys:

PC Keyboard	VT Keyboard
<b>Insert</b>	<b>Insert Here</b>
<b>Home</b>	<b>Find</b>
<b>PageUp</b>	<b>Prev</b>
<b>Delete</b>	<b>Remove</b>
<b>End</b>	<b>Select</b>
<b>PageDown</b>	<b>Next</b>



## 6.2 VT520 SCO Console Control Sequences

---

### SCODFK—Define Function Key

Programs function key to send a defined string in SCO Console mode.

#### Format

```
ESC   Q   Fn   string
1/11  5/1  ...  ...
```

#### Parameters

##### Fn

is an ASCII code representing the function key being defined. F1, the first key, is represented by "0"; each following key has an ASCII value that increments 1 from the previous key's ASCII value as follows:

Key	Function Key	Fn ASCII Character
1 - 12	F1 through F12	0 - ;
13 - 24	Shift/F1 through Shift/F12	< - G
25 - 36	Ctrl/F1 through Ctrl/F12	H - S
37 - 48	Ctrl/Shift/F1 through Ctrl/Shift/F12	T - -
49	Kpd 7	'
50	Kpd 8	a
51	Kpd 9	b
52	Kpd -	c
53	Kpd 4	d
54	Kpd 5	e
55	Kpd 6	f
56	Kpd +	g
57	Kpd 1	h
58	Kpd 2	i
59	Kpd 3	j
60	Kpd 0	k

##### String

is the programmed key definition which is enveloped by two characters as the delimiters.

## SCODFK—Define Function Key

### Description

The first character after the ASCII character representing a function key becomes the delimiter. It looks for an identical character as the second and final delimiter. If string is too long and no memory is available, then the command string is aborted and remaining characters are displayed on screen. The character becomes the final character. All the following characters are displayed on the screen.

#### Example:

Executing "ESC Q 0 'abcdefghij'klmnopq" when 100 bytes of memory is available defines the string "abcdefghij" into F1 function key and displays "klmnopq" on the screen.

If you execute the same sequence when only a 4 byte string is allowed, then the whole sequence is aborted.

A "^" character causes any following character to subtract 32 from its ASCII value. For example, "^e" in the string sends "E" when the key is pressed.

Any code in the 00-7F region can be defined. An 8-bit code entered is stripped of its eighth bit and defined as a corresponding 7-bit code.

For example, executing ESCQ0'F1KEY' defines string F1KEY for function key F1; ESC1aF2KEYa defines string F2key for F2.

The maximum string length for a defined key is 255 characters.

---

## SCODPCC—Display PC Characters

Displays C0 controls (lower 32 bytes) as PC characters for SCO Console mode.

### Format

ESC	xx
1/11	hex value

### Description

SCO Console allows "ESC xx" to work when the PC character set is selected and displayable characters are mapped in the 00-1F region (when either "CSI 11 m" or "CSI 12 m" is executed). The command allows the character in 1B location to be displayed; 1B is always executed as an ESC control code under "CSI 11 or 12 m" (See SGR).

---

## SCORC—Restore Saved Cursor Position

Moves cursor to the position saved by save cursor command in SCO console mode.

### Format

CSI	u
9/11	7/5

### Description

This command acts the same as the DECRC command, except that the cursor stays at the same page instead of moving to a page where the cursor was saved.

---

## SCOSC—Save Current Cursor Position

Saves current cursor position for SCO console mode.

### Format

CSI	s
9/11	7/3

### Description

This command acts the same as the DECSC command, except that the page number where the cursor is located is not saved as a result of executing the command.



---

# Character Sets

This chapter describes the character sets supported by the VT520 video terminal.

## 7.1 Overview

The VT520 video terminal supports most character sets for Eastern Europe, Cyrillic, Greek, Hebrew, and Turkish character sets. In addition to traditional DEC and ISO character sets the VT520 supports a number of IBM PC *code pages* (which refer to page numbers in IBM's standard character set manual) in PCTerm mode to emulate the console terminal of industry-standard PCs.

Each code page defines both the exact repertoire (set of characters) and the assignment of code positions in the 0 - 255 range. Once configured, the code page is not usually changed within a single application.

## 7.2 Character Sets Supported

The following sections list the characters sets supported by the VT520 terminal.

### 7.2.1 VT Graphic Character Sets

The VT520 supports the following VT 8-bit multinational character sets:

- ISO Latin-1
- ISO Latin-2
- ISO Latin-Cyrillic
- ISO Latin-Greek
- ISO Latin-Hebrew
- ISO Latin-5
- KOI-8 Cyrillic
- DEC Multinational
- DEC Greek
- DEC Hebrew
- DEC Turkish

The VT520 also supports the following character sets:

- DEC Special Graphics (VT100 Line Drawing set)
- DEC Technical Character set

## Character Sets

### 7.2 Character Sets Supported

When **7-bit NRCS Characters** is selected, a corresponding 7-bit or NRC set is used depending on the keyboard language selected. (See Chapter 8 for details.)

- U.K. NRC (ISO)
- French NRC (ISO)
- DEC French Canadian NRC
- Norwegian/Danish NRC (ISO)
- DEC Finnish NRC
- German NRC (ISO)
- Italian NRC (ISO)
- DEC Swiss NRC
- Swedish NRC (ISO)
- Spanish NRC (ISO)
- DEC Portuguese NRC
- SCS NRC
- Russian 7-bit (KOI-7)
- DEC 7-bit Greek
- DEC 7-bit Hebrew
- DEC 7-bit Turkish

#### 7.2.2 PCTerm Graphic Character Sets

When **PCTerm mode** is selected, the terminal can still use all the VT 8-bit character sets listed in Section 7.2.1. Additionally, the following PC code pages are supported:

- PC International (437)
- PC Multilingual (850)
- PC Slavic (852)
- PC Greek (210)
- PC Spanish (220)
- PC Turkish (857)
- PC Portuguese (860)
- PC Hebrew (862)
- PC French/Canadian (863)
- PC Danish/Norwegian (865)
- PC Cyrillic (866)

---

**Note**

---

7-bit NRC sets are not available in PCTerm mode.

---

### 7.2.3 Control Character Sets

The following control character sets are defined in the terminal. ASCII C0 and C1 control sets have corresponding fonts for graphic representation in control representation mode.

- ASCII C0 Control Set (32 characters)
- 8-bit ASCII C1 Control Set (32 characters)

The control representation mode font includes C0 and C1 control character set graphic representations plus DELETE (7/15), non-breaking space - NBS (10/0), and 15/15 (total of 67 characters).

### 7.2.4 Character Set Structure

The VT 8-bit multinational character sets are formed from two 7-bit character set "halves." ASCII is used as the left half (GL), and the corresponding named supplemental set is used as the right half (GR). Although the character set "halves" can be designated and invoked independently, in practice, they are almost always used together. It is simpler and more convenient to think of them as a single 8-bit multinational set, although technically they are also separate 7-bit sets.

Many characters appear in more than one of the mentioned sets, so the total number of characters is far less than the sum of the individual totals. There is also a down-line loadable portion of character RAM provided for a custom *soft font*, a Dynamically Redefinable Character Set (DRCS). This character RAM can contain up to  $2 \times 96$  characters.

### 7.2.5 Characters Not in a Character Set.

The following characters are not technically part of any of character set. They are like "control characters," but they are not in the C0 or C1 control sets.

Name	Description	Code	Keystroke	Action on Receipt
SP	SPACE	32	Space Bar	Treated as space
DEL	DELETE	127	Delete Ctrl-8	Ignored (unless in CRM)
	Reserved	160	None	Error character generated
	Reserved	255	None	Ignored (unless in CRM)

---

**Notes**

---

NULL is the only fill character. (DEL and 255 are not usable as fill characters.)

If a 96-character character set is invoked into GL, then the receipt of codes 32 and 127 are part of that character set, and their graphic characters are displayed from the 96-character set. In this case, the codes 32 and 127 are not treated as SP or DEL.

If a 96-character character set is invoked into GR, the receipt of codes 160 and 255 are part of that character set, and their graphic characters are displayed from the 96-character character set. In this case, the codes 160 and 255 are not treated as an error condition or ignored, respectively.

---

## Character Sets

### 7.3 VT Mode

### 7.3 VT Mode

All DEC character sets are supported in VT500 mode with either a VT keyboard or an attached Enhanced PC keyboard.

In VT100 mode, VT52 mode, or when **7-bit NRCS characters** is selected (through Set-Up or DECNRCM), only ASCII, NRC sets, and DEC Special Graphic characters are available.

#### 7.3.1 Selecting Character Sets

Character sets are designated with the select character set (SCS) control function. Refer to Chapter 5 for more details.

#### 7.3.2 Character Set Mappings

The following table lists the character set mappings.

Character Set	Mapped onto decimal . . .
C0 controls	0 to 31
Space	32
ASCII, all other NRC sets, Line Drawing, DEC Technical set, DEC 7-Bit Greek, DEC 7-Bit Hebrew, or DEC 7-Bit Turkish	33 to 126
DEL	127
C1 controls	128 to 159
10/0	160
DEC Multinational Graphic, 15/15	161 to 254 255
ISO Latin-1 Supplemental Graphic, ISO Latin-2 Supplemental Graphic, ISO Latin-Cyrillic, ISO Latin-Greek, ISO Latin-Hebrew, or ISO Latin-5.	160 to 255

These are typical assignments. By appropriate designating and invoking sequences, other mappings are possible for the graphic character sets.

## 7.4 PCTerm Mode

This section describes how to select character sets in PCTerm mode.

#### 7.4.1 Selecting Character Sets

If a **PC character set** is selected, then all the SCS sequences used to designate and invoke character sets into G0, G1, G2, G3, GL, and GR (including single and locking shifts) are ignored. You select the character set through a Set-Up field or an escape sequence, DECPCTERM. You can use only one code page containing 256 characters at a time.

If you use a DEC character set, all the SCS and invocation sequences continue to work normally.



## 7.4.2 Character Set Mappings

If DEC character sets are in use, all the character set mappings follow the VT mode convention. C0 and C1 regions are all control codes.

In PC character sets, the conventional ISO C1 region, (80 hex through 9F hex) are all displayable character codes. The VT520 does not recognize control sequences that have 8-bit control codes; therefore, the 8-bit control mode becomes invalid.

The C0 region (00 hex through 1F hex) in a PC character set is mixed with control characters and graphic characters. Among them, 11 locations can have both *control characters* and *displayable characters* in the same locations; other locations are occupied by displayable characters only. The 11 C0 locations include 0/5, 0/7, 0/8, 0/9, 0/A, 0/B, 0/C, 0/D, 1/1, 1/3, and 1/B.

Control codes are used for ENQ, BEL, BS, HT, LF, VT, FF, CR, DC1, DC3, and ESC operations.

You access the *displayable characters* by preceding the C0 control code with ESC to form a 2-byte pair (1Bh XXh). These 2-byte pairs, such as ESC C0, are only recognized in PCTerm mode.

## 7.5 SCO Console Mode

SCO console mode can use both VT character sets and PC character sets. You select a **VT character set** through the **PCTerm character set** field in Set-Up, or you can use an SCS invocation sequence. You can select a PC character set through the same Set-Up field, or you can use the DECPCTERM escape sequence.

---

**Note**

All the character sets can be displayed on the screen.

---

## 7.6 Soft Character Sets

You can download soft character set from the host system into the terminal. This feature lets you design your own soft character sets for use with the terminal. You can only load soft character sets in VT Level 4 or higher.

The control string command to down-line load the soft character sets is DECDLD. The DECDLD command down-line loads one or more characters of a specified 94- or 96-character dynamically redefinable character set (DRCS) with a specified logical pixel pattern. The affected characters in the DRCS set also change the presentation of characters from the set currently being displayed on the screen. The DECDLD control does not clear the screen.

See Chapter 5 for a description of the DECDLD—Dynamically Redefinable Character Sets Extension command.

---

**Note**

VT220 or VT320 fonts may appear different on a VT520 terminal, because the character cell sizes are different from those terminals. See the Pcmw parameter in DECDLD—Dynamically Redefinable Character Sets Extension.

---

## Character Sets

### 7.6 Soft Character Sets

The soft character set is also known as a *dynamically redefinable character set (DRCS)*. The terminal stores the soft characters in its DRCS buffer.

---

#### Note

---

The terminal does not store the soft character set in nonvolatile RAM. When you turn off the terminal, the soft characters are lost.

---

The next section describes the guidelines for designing a soft set. The sections that follow describe how to code, load, designate, and clear a soft set.

#### 7.6.1 Designing a Soft Character Set

Your terminal displays each character by turning on a series of pixels. A **pixel** (picture element) is the smallest displayable unit on the screen. Each character must fit in a limited area, called the character cell. The size of the character cell depends on the number of lines and columns on the screen. The screen can display 24, 36, or 48 lines in 80 or 132 columns. With 24 lines on the screen, the terminal uses a default character cell size of 10 by 16 pixels for 80 columns and 6 by 16 pixels for 132 columns (Figure 7-1).

**Figure 7-1 Character Cell Sizes for 24-Line by 80- and 132-Column Fonts**

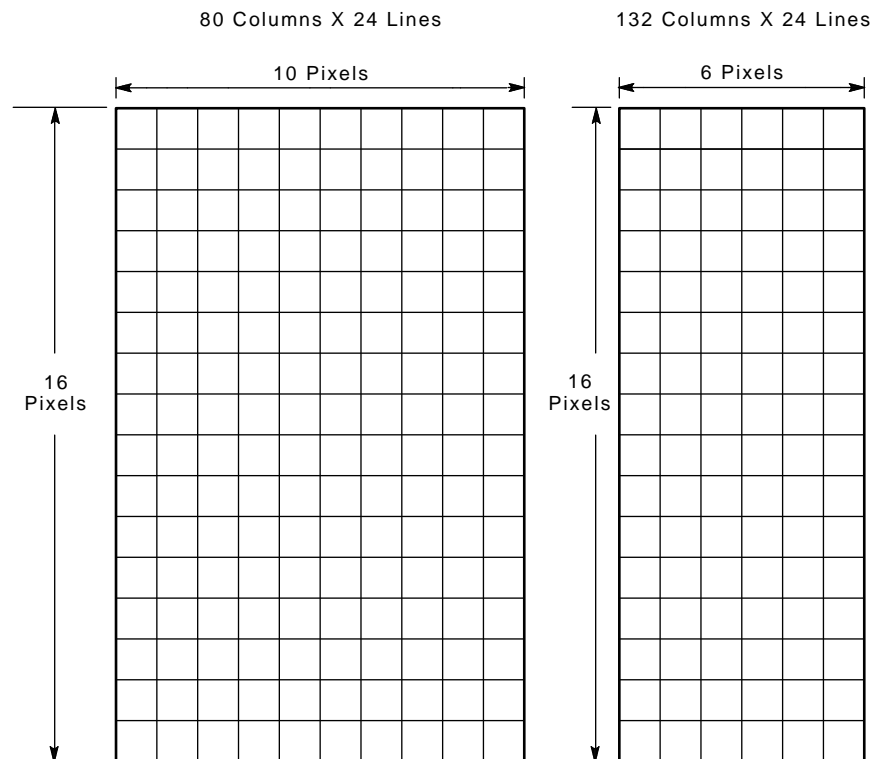

GSF\_0598\_89\_R.DG

Table 7–1 shows the default character cell widths and heights based on the number of lines and columns on the screen.

**Table 7–1 Character Cell Sizes**

Cell Size	80 Columns	132 Columns
<b>24 Lines/Screen</b>		
Width	10 pixels	6 pixels
Height	16	16
<b>36 Lines/Screen</b>		
Width	10	6
Height	10	10
<b>48 Lines/Screen</b>		
Width	10	6
Height	8	8

When you design a character, you should lay out a character cell on grid paper. The little boxes on the grid paper represent pixels. You fill in the pixels that make up the character. The next section shows an example of a character design.

You should design six versions of your character set to fit six different character cell sizes. This means that there will be a version of your soft character set to fit any combination of lines and columns available on the terminal:

- 24 lines × 80 columns
- 24 lines × 132 columns
- 36 lines × 80 columns
- 36 lines × 132 columns
- 48 lines × 80 columns
- 48 lines × 132 columns

Design your character set, then load six versions of the set, one for each possible line/column combination. The terminal automatically selects which version of the set to use, based on the current number of lines and columns on the screen.

The terminal's built-in fonts follow the guidelines in Table 7–2, which lists the different guidelines for characters displayed with 24 lines, 36 lines, or 48 lines on the screen. In all cases, the screen resolution is 800 by 400 pixels for 80 columns, 792 by 400 pixels for 132 columns. The pixel aspect ratio is 1:1.4.

You must design your characters to fit the cell. The terminal ignores any pixels that are defined outside the cell. Also, you should include empty pixels on the left or right side of the character cell to allow for space between characters. Figure 7–2 shows an example of spacing for an uppercase D character with 24 lines on the screen. In this example, the character for the 80-column font has two pixel columns reserved for spacing.

# Character Sets

## 7.6 Soft Character Sets

Figure 7-2 Character Body Sizes for 24-Line by 80- and 132-Column Fonts

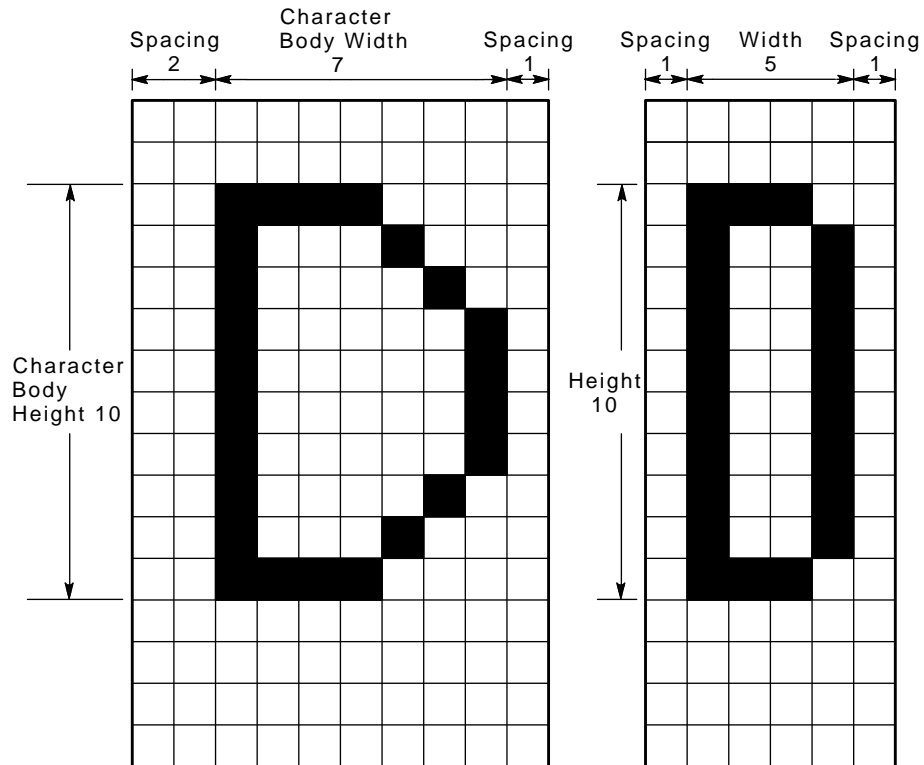

All values are in pixels.

GSF\_0599\_89\_R.DG

Table 7-2 Guidelines for Designing Soft Characters

Character Dimension	80-Column Font	132-Column Font
<b>24 Lines/Screen</b>		
Cell width	10 pixels	6 pixels
Cell height	16	16
Body width	8	4
Body height	10	9
Ascender height	3	3
Descender height	3	3
Spacing before character	1	1
Spacing after character	1	1

(continued on next page)

**Table 7–2 (Cont.) Guidelines for Designing Soft Characters**

Character Dimension	80-Column Font	132-Column Font
<b>36 Lines/Screen</b>		
Cell width	10 pixels	6 pixels
Cell height	10	10
Body width	7	5
Body height	7	7
Ascender height	2	1
Descender height	1	2
Spacing before character	2	1
Spacing after character	1	0
<b>48 Lines/Screen</b>		
Cell width	10 pixels	6 pixels
Cell height	8	8
Body width	7	4
Body height	6	7
Ascender height	1	1
Descender height	1	1
Spacing before character	2	1
Spacing after character	1	1

### 7.6.2 Coding the Soft Character Set

After you design your characters, you must code them for the terminal. This section describes how to code soft characters. The next section describes how to load the character codes into the terminal.

Each pixel of a soft character cell receives a binary value of 0 or 1. A 1 bit indicates the pixel is on, and a 0 bit indicates the pixel is off.

The terminal receives the code for a soft character in sections, called **sixels**. A sixel is a 6-bit binary code that represents a vertical column of 6 pixels on the screen. Each bit in a sixel corresponds to a pixel on the screen. The following example describes how to design and code a soft character.

#### Example

Suppose you want to design an uppercase D for a 24-line by 80-column font.

- 1. Draw your design on a grid.**

Use the grid for an 80-column character cell to draw your design. Mark which pixels will be on and which pixels will be off. Your design may look like Figure 7–2.

- 2. Divide the character cell into columns of 6 bits each.**

## Character Sets

### 7.6 Soft Character Sets

Use the format shown in Figure 7-3. Each 6-bit pattern represents 6 pixels, or a sixel. The least significant bit is at the top, and the most significant bit is at the bottom. The terminal would receive the sixel columns in order (1 to 10), starting with Group A.

Figure 7-3 Example of an Uppercase D (24-Line by 80-Column Font)

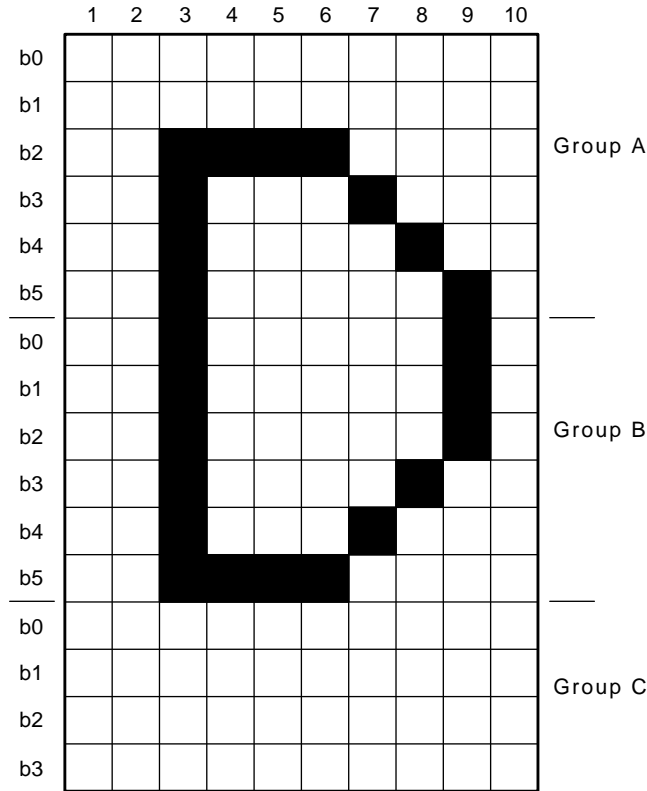

GSF\_0600\_89.DG

Because the character cell height (16 pixels) is not a multiple of 6, the columns on the bottom of the character cell (Group D) have only 4 bits each, b0 through b3. Bits b4 and b5 in the bottom cell do not affect the character's appearance, so they have been excluded from Figure 7-3.

#### 3. Convert the binary value of each sixel to its hexadecimal value.

Sixel codes are restricted to characters in the range of ? (3F<sub>16</sub>) to ~ (7E<sub>16</sub>), so you must add an offset of 3F<sub>16</sub> to the hexadecimal value of each column. For example:

$$\begin{array}{rcl}
 000000_2 & = & 00_{16} \\
 + 3F_{16} & & \\
 \hline
 & & 3F_{16}
 \end{array}
 \qquad
 \begin{array}{rcl}
 110101_2 & = & 35_{16} \\
 + 3F_{16} & & \\
 \hline
 & & 74_{16}
 \end{array}
 \qquad
 \begin{array}{rcl}
 111111_2 & = & 3F_{16} \\
 + 3F_{16} & & \\
 \hline
 & & 7E_{16}
 \end{array}$$

**4. Use Table 7-3 to convert each binary number to the equivalent ASCII character.**

Table 7-3 lists the results of steps 3 and 4 for each possible binary value. All you have to do is find the 6-digit binary number for each sixel bit pattern in your character design.

Figure 7-4 shows this conversion for the uppercase D in this example.

You use this procedure to convert each character of your soft character set into a string of sixel bit patterns. Then you can download your DRCS characters into the terminal, using the DECDLD device control string described in Chapter 5.

**Table 7-3 Converting Binary Code to an ASCII Character**

Binary Value	Hex. Value	Hex. Value + 3F Offset	Character Equivalent
000000	00	3F	?
000001	01	40	@
000010	02	41	A
000011	03	42	B
000100	04	43	C
000101	05	44	D
000110	06	45	E
000111	07	46	F
001000	08	47	G
001001	09	48	H
001010	A	49	I
001011	B	4A	J
001100	C	4B	K
001101	D	4C	L
001110	E	4D	M
001111	F	4E	N
010000	10	4F	O
010001	11	50	P
010010	12	51	Q
010011	13	52	R
010100	14	53	S
010101	15	54	T
010110	16	55	U
010111	17	56	V
011000	18	57	W
011001	19	58	X
011010	1A	59	Y
011011	1B	5A	Z
011100	1C	5B	[
011101	1D	5C	\
011110	1E	5D	]
011111	1F	5E	^
100000	20	5F	-

(continued on next page)

## Character Sets

### 7.6 Soft Character Sets

Table 7–3 (Cont.) Converting Binary Code to an ASCII Character

Binary Value	Hex. Value	Hex. Value + 3F Offset	Character Equivalent
100001	21	60	'
100010	22	61	a
100011	23	62	b
100100	24	63	c
100101	25	64	d
100110	26	65	e
100111	27	66	f
101000	28	67	g
101001	29	68	h
101010	2A	69	i
101011	2B	6A	j
101100	2C	6B	k
101101	2D	6C	l
101110	2E	6D	m
101111	2F	6E	n
110000	30	6F	o
110001	31	70	p
110010	32	71	q
110011	33	72	r
100100	34	73	s
110101	35	74	t
110110	36	75	u
110111	37	76	v
111000	38	77	w
111001	39	78	x
111010	3A	79	y
111011	3B	7A	z
111100	3C	7B	{
111101	3D	7C	
111110	3E	7D	}
111111	3F	7E	~



Figure 7-4 Sixel-to-ASCII Conversion

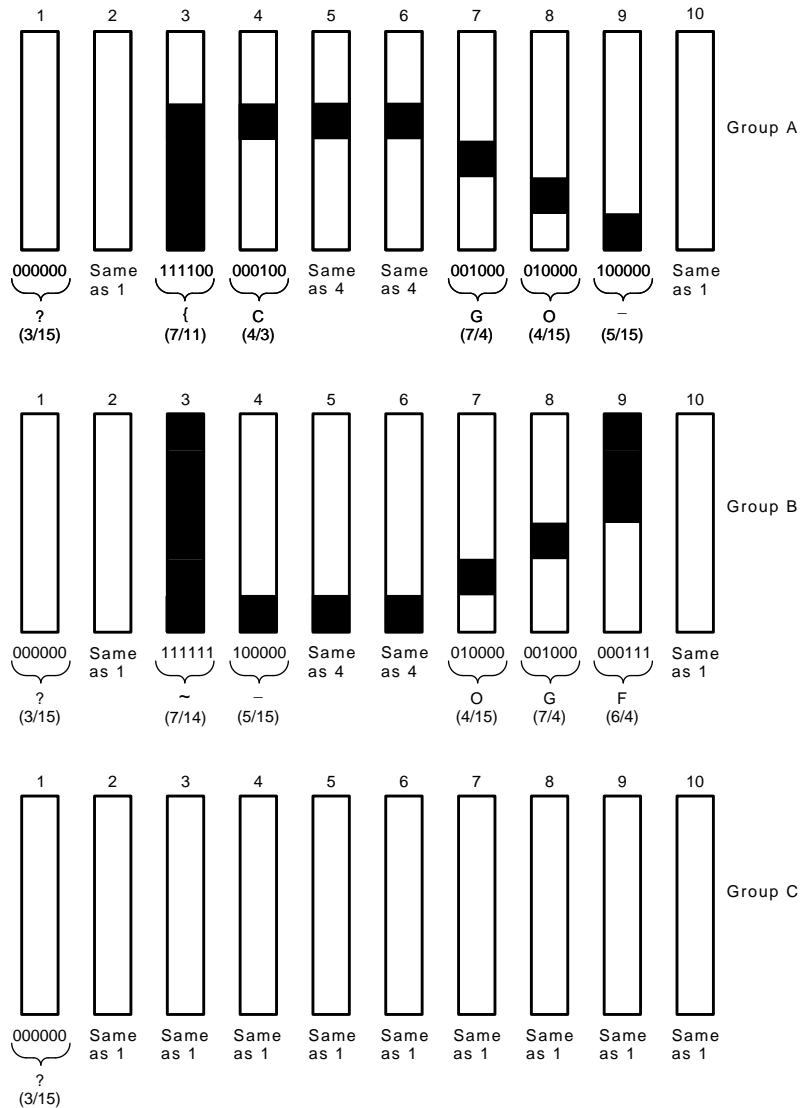

GSF\_0601\_89\_R.DG

### 7.6.3 Downloading Soft Characters

The terminal lets you load up to six variations of the same soft character set for each session. These six variations correspond to the six different combinations of character width and character height available.

#### Character Width

For 80 columns: 10 pixels

For 132 columns: 6 pixels

#### Character Height

For 24 lines/screen: 16 pixels

For 36 lines/screen: 10 pixels

For 48 lines/screen: 8 pixels

## Character Sets

### 7.6 Soft Character Sets

You can adjust the screen size by using the select number of lines/screen (DECSNLS) control function. The terminal automatically selects the appropriate soft set for the screen size.

When loading a soft set, you specify which of the six width/height variations the set is intended for. Your set replaces any soft set already loaded for that width/height variation.

You should load six variations of your set to correspond to the six variations of character width and height available in the terminal (80 or 132 columns by 24, 36, or 48 lines). Do not confuse the font rendition with the actual character set. You cannot load six different soft sets. However, you can load six different renditions of the same soft set.

#### 7.6.4 Designating the Soft Character Set

You designate your soft character set the same way you designate the hard character sets—using a select character set (SCS) sequence. You also use the same format for the SCS sequence.

<b>ESC</b>	<i>Intermediate(s)</i>	<i>Final</i>
1/11	*****	****

##### **Intermediate(s)**

are one or more characters that designate the soft character set as one of the logical sets, G0 through G3. You use the same intermediate characters that you use for SCS select character set function (Table 5–13).

The intermediate character(s) also indicates whether the soft character set is a 94- or 96-character set. Make sure you use an intermediate character that matches the setting of the character set size parameter (*Pcss*) in the DECDLD string (Table 5–2).

##### **Final**

is the *Dscs* name you used for the soft character set in the DECDLD string.

##### **Notes on Designating Soft Character Sets**

- **Replacing a soft set with a new soft set**

If you use a new *Dscs* name when you replace the current soft set with another soft set, then the following occurs:

- Characters from the old soft set are undefined. If you redefine the soft set, characters currently on the screen may change.
- Any logical sets (G0, G1, G2, G3) used to designate the old soft set are undefined. The in-use table is also undefined.

After you load a new soft set, use a select character set (SCS) sequence to designate the soft set. Using SCS eliminates the confusion involved with undefined characters.

- **Replacing a hard set with a soft set**

You can define a soft set that replaces one of the hard sets (such as ASCII or DEC Special Graphic).

A soft set that replaces a hard set remains in effect until you perform one of the following actions:

- Clear the soft set by:
  - Recalling saved settings or factory-default settings with the Save or Default fields in the Set-Up Directory.
  - Running the power-up self-test.
- Redefine the soft set (using another DECDDL string).

### 7.6.5 Soft Character Set Example

Suppose you want to create a soft character set containing a solid rectangle, a blank, a rectangular box, and a striped rectangle. You decide to use a font that is 24 lines by 80 columns with a character cell size of 8 by 16 pixels. This example shows how you would

1. Download the set.
2. Designate the set as G1.
3. Map the G1 set into GL.

---

**Note**

---

Make sure the terminal is in a VT Level 4 or higher mode before you try to load a soft character set. You cannot load soft sets in VT Level 1 mode.

---

1. You could use the following DECDDL string to load your character set. The string is shown divided into sections for clarity.

```
DCS
 1 ; 1 ; 0 ; 12 ; 1 ; 1 ; 12 ; 0 { sp @
-----/-----/-----;
????????/????????/????????;
~@@@@@~/~?????~/~GGGGG~/;
TTTTTTTT/TTTTTTTT/TTTTTTTT;
ST
```

**DCS (9/0)**

introduces the device control string.

**1 ; 1 ; 0 ; 12 ; 1 ; 1 ; 12 ; 0**

is the parameter string specifying the following functions. See Table 5-2 for parameter definitions.

<b>Parameter</b>	<b>Function</b>
<i>Pfn</i> = 1	Loads this soft set into the DRCS font buffer.
<i>Pcn</i> = 1	Selects the character at row 2/ column 1 in the ASCII table (Figure 4-1) as the first character to load.
<i>Pe</i> = 0	Erases all characters in the font buffer for that rendition.
<i>Pcmw</i> = 12	Selects a maximum character width of 12 pixels.
<i>Pss</i> = 1	Selects a font set size of 80 columns, 24 lines.
<i>Pt</i> = 1	Defines the set as a text font.
<i>Pcmh</i> = 12	Selects a maximum character height of 12 pixels.
<i>Pcss</i> = 0	Defines the set as a 94-character set.

## Character Sets

### 7.6 Soft Character Sets

{ (7/11)

indicates the end of the parameter characters and specifies that this sequence is a DECDLD string.

**sp @**

defines the character set as an unregistered soft set. This value is the recommended default value for user-defined sets. The sp represents one space. You can use other values to define other specific character sets.

\_\_\_\_/\_\_\_\_/\_\_\_\_

represents the first character (a solid rectangle).

; separates the soft characters.

???????/???????/???????

represents the second character (a blank).

~@@@@@~/~????~/~GGGGG~

represents the third character (a hollow rectangle).

**TTTTTTT/TTTTTTT/TTTTTTT**

represents the fourth character (a set of horizontal stripes).

**ST** (9/12) indicates the end of the DECDLD string.

2. Now you are ready to designate the character set as G1. You can use the following SCS escape sequence:

```
ESC ) sp @
```

**ESC** (1/11) introduces the SCS sequence.

) (2/9)

designates the character set as G1.

**sp @** (2/0, 4/0)

selects the soft set as the set to designate as G1. Remember, sp @ was the name used for the soft set in the DECDLD string.

3. Finally, you want to map the G1 set into the in-use table as GL. You can map the set by sending a shift out (SO) control character. To send (load) the SO character, you hold down the **Ctrl** key and press the **↵** key.

---

#### Note

---

For information on using shift characters, see **LS-Locking Shift** or **SS-Single Shift** commands.

---

#### 7.6.6 Clearing a Soft Character Set

You can clear a soft character set that you loaded into the terminal by using the following DECDLD control string:

```
DCS 1;1;2 { sp @ ST
```

Any of the following actions also clear the soft character set:

- Performing the power-up self-test.
- Selecting the Recall or Default set-up fields from the Set-Up Directory.
- Using a reset to initial state (RIS) sequence.

## Keyboard Processing

This chapter describes the physical keyboards and keyboard-to-host interface supported by the VT520 video terminal.

### 8.1 Overview—Keyboard Layout

The term **keyboard layout** describes the physical layout of a keyboard, specifically, the number of keys and their positions on the keyboard. The VT520 supports two keyboard layouts: **VT layout** and **PC layout**.

Figure 8–1 VT Keyboard Layout

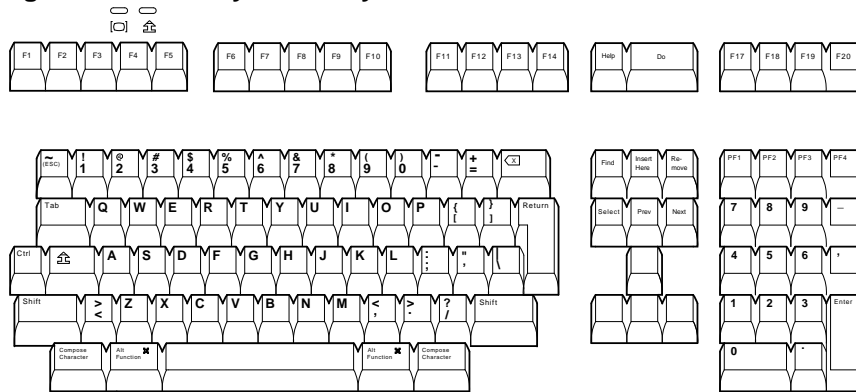

MA-1520a-92.PS

Figure 8–2 PC Keyboard Layout

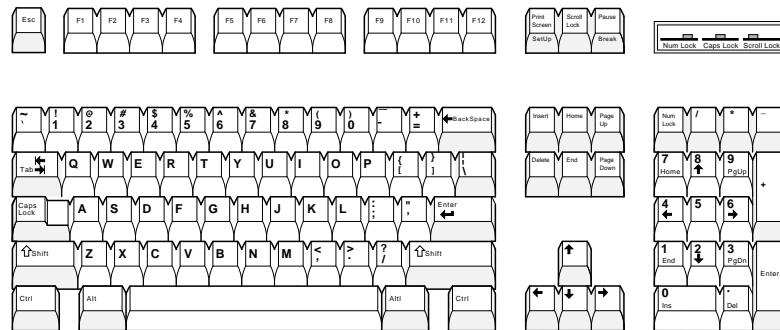

LJ-00226a-T10.PS

## Keyboard Processing

### 8.2 DEC VT Layout

### 8.2 DEC VT Layout

When a DEC VT Layout keyboard is used, only characters from the currently selected keyboard character set may be generated. All other graphic character keystrokes are ignored. See Chapter 8 for a list of the character sets supported.

The numeric keypad compose feature works as follows. Pressing and holding the Compose (Alt-Gr on EPC keyboards) while typing a number on the numeric keypad sends the corresponding decimal character code. The character code will be sent when the Compose key is release. If the keypad period is typed while entering the number, the previously entered value is multiplied by 16 and added to the value entered subsequently. This feature supports the column/row entry used commonly in character coding tables.

### 8.3 VT Layout - PC Term Mode

PCTerm mode using a VT layout keyboard is the same as PCTerm mode with an Enhanced PC layout keyboard with the following exceptions:











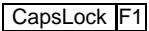
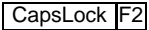
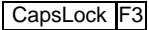
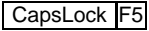





- All keystrokes send scan codes, except:
  -  performs Hold,
  -  forms Print,
  -  enters Set-Up, and
  -  send Break.
- Keystations 107, 124 - 126, and 130 send the corresponding scan codes generated by the LK411 VT layout. Keystations 131 - 133 act as Print Screen, Scroll Lock, and Pause.
- Keystations 42, (VT ), sends the scan code of keystation 29 of Enhanced PC layout (EPC ).
- Keystations 127 (VT ), sends the scan code of keystation 110 (EPC .

Table 8–1 shows the make/break scan codes for the VT layout in PCTerm mode.

**Table 8–1 Scan Codes for VT Layout in PCTerm Mode**

Key No.	VT Legend (U.S.)	Scan Code (Make / Break)
42		2B/AB
107		7E / FE
124		E0 3D / E0 BD
125		E0 3E / E0 BE
126		E0 3F / E0 BF
127		01 / 81
130		E0 41 / E0 C1
131		E0 2A E0 37 / E0 B7 E0 AA Ctrl or Shift 37 / E0 B7 E0 AA
131		Alt 54 / D4
132		46 / C6
133		E1 1D 45 E1 9D C5
		Ctrl E0 46 E0 C6

## 8.4 Enhanced PC Layout - PCTerm Mode

In PCTerm mode, each press or release keystroke causes a unique scan code or sequence of scan codes to be sent to the host, corresponding to the keystation that was pressed or released. There is no keyboard character set. It is left to the host to translate scan codes into the desired display character set.

The one exception to the rule above is that Caps Lock combinations that involve local functions still work.

- `[CapsLock][Print Screen]` enters Set-Up,
- `[CapsLock][Pause]` send Break,
- `[CapsLock][F1]` performs Hold,
- `[CapsLock][F2]` forms Print,
- `[CapsLock][F3]` enters Set-Up, and
- `[CapsLock][F5]` send Break.

The make code for Caps Lock is sent when the Caps Lock key is released, before another key is pressed, or when another key is pressed that is not defined as a local function above.

All keys, including `[Shift]`, `[Alt]`, and `[Ctrl]` send make codes immediately upon being depressed, EXCEPT `[Caps Lock]`, whose make code is deferred as described above. If a modifier combination other than CapsLock is defined to invoke a local function (such as Alt/F3), a make code is sent for the modifier before the local function is invoked. When the local function is recognized, the corresponding break code is sent to cancel the modifier.

DEC and ISO multinational character sets are available in PCTerm mode. The 7-bit NRC sets are not included.

## 8.5 Enhanced PC Layout - VT Mode

The Enhanced PC layout can be used as an alternate to the VT Layout in VT mode. In this mode, the VT520 still operates as a traditional video terminal to communicate with conventional terminal applications. Since the Enhanced PC Layout does not correspond key-for-key to the VT Layout, some adaptation is necessary. Two styles are provided to support different users:

- DEC VT Style for traditional DEC VT users.
- IBM PC Style for IBM PC or ASCII terminal users

Pressing `[Caps Lock][Num Lock]` toggles between these two styles. When DEC VT Style is selected, "VT" is displayed on the keyboard indicator line. Either style can be saved in NVM.

### 8.5.1 DEC VT Style

In this style, all keys send the same function sequences as the similarly named key on the VT Layout. The missing keys from the VT Layout are accessed by Caps Lock key combinations, where you press and hold `[Caps Lock]` while you type another key.

- Local terminal functions, "Print Screen," "Scroll Lock," and "Pause," are top row F keys.
- Left `[Alt/Space]` functions as compose key.

## Keyboard Processing

### 8.5 Enhanced PC Layout - VT Mode

#### 8.5.2 IBM PC Style

In this style (the default style), the keys are mapped to behave as they would on an IBM PC. The differences in the IBM PC Style are:

- Editing keypad keys, `[Home]` and `[Delete]`, send sequences corresponding to these functions.
- Numeric keypad keys send different sequences when the keypad is in numeric mode to accommodate the “Num Lock” feature. With Num Lock off, the numeric keypad sends editing key sequences.
- `[F1]` through `[F5]` send function key sequences in PC style. Local terminal functions, “Print Screen,” “Scroll Lock,” and “Pause,” are located as they would be on an Enhanced PC layout.
- Keys to operate copy and paste are different. See 3.7.
- Left `[Alt/Space]` does not work as compose key.

## 8.6 Main Key Array

This section describes the main keys on the keyboard.

### 8.6.1 Character Sets

Only characters from the currently selected keyboard character set may be generated. All other graphic character keystrokes are ignored. The following keyboard character sets are supported: ISO Latin 1, ISO Latin 2, ISO Latin Cyrillic, ISO Latin Greek, ISO Latin Hebrew, ISO Latin 5 (Turkish), DEC Multinational, DEC Cyrillic, DEC Greek, DEC Hebrew and DEC Turkish. When **7-bit NRCS characters** is selected, a corresponding 7-bit NRC set is supported based on the Keyboard Dialect.

PC character sets are not supported in VT modes since the terminal is being used as a conventional video terminal that happens to have a PC keyboard attached. New applications should be written to use ISO character sets. (PC character sets are available in PCTerm and SCO console mode.)

Characters corresponding to the right side of the key top are typed by pressing the key in combination with `[Alt Gr]`, the right Alt key.

### 8.6.2 Tab Key

With an Enhanced PC Layout keyboard, pressing `[Shift/Tab]` causes a CBT sequence, CSI Z, to be transmitted. A horizontal tabulation code (HT, 0/9) is transmitted when a VT Layout keyboard is used.

### 8.6.3 Modifier Keys

Table 8–2 shows the corresponding modifier keys for the VT and the Enhanced PC layouts.



Table 8–2 VT Style Layout vs. Enhanced PC Style Layout Modifier Keys

VT Style Keyboard	PC Style Keyboard
Left <b>Shift</b>	Left <b>Shift</b>
Right <b>Shift</b>	Right <b>Shift</b>
<b>Caps Lock</b>	<b>Caps Lock</b>
<b>Ctrl</b>	Left <b>Ctrl</b>
none	Right <b>Ctrl</b>
Left <b>Compose</b> character	<b>Alt Gr</b>
Right <b>Compose</b> character	none
Left <b>Alt</b>	Left <b>Alt</b>
Right <b>Alt</b>	none or Right <b>Alt</b>

There is no **Ctrl** key on the right side of the VT keyboard. Left and right **Ctrl** keys on the Enhanced PC layout generates the single control function the same as on the VT Layout.

There is no key labeled "compose" on the Enhanced PC layout. **Alt Gr** (Right Alt) accesses the supplemental characters on the top right half of the key tops on some Enhanced PC layout keyboards. **Alt Gr** can be used with the numeric keypad to enter character codes directly. Left **Alt Space** can be used to initiate compose sequences when VT Style is selected.

### 8.6.4 Caps Lock

The Lock function may operate in three ways:

Caps Lock	Alphabetic keys send their shifted character.
Shift Lock	All keys on the main key array send their shifted character.
Reverse Lock	Pressing <b>Shift</b> temporarily reverses the effect of <b>Caps Lock</b> ; that is, unshifted or lowercase alphabetic characters are transmitted.

Pressing and releasing the **Caps Lock** key toggles the lock state on or off.

The **Caps Lock** key is also used to generate keystrokes for keys that are not present on the keyboard. Known as keyboard extension, this is done by pressing and holding the **Caps Lock** key and then pressing the extension key. The lock state is not toggled when an extension keystroke is pressed. The following Extension keystrokes are defined:

- **Caps Lock Print Screen** acts as the Set-Up key.
- **Caps Lock Pause** acts as the Break key.
- **Caps Lock F1**—**Caps Lock F10** on the Enhanced PC Layout generates F11—F20. **Caps Lock KP+** acts as **KP-** (DEC keypad minus) in application mode.

### 8.6.5 Left Alt

Left **Alt** on the PC layout corresponds to the Alt function on the VT layout. Depressing the left **Alt** key performs the following functions (unless re-programmed):

- Left **Alt Space** acts as the compose key in VT Style.

## Keyboard Processing

### 8.6 Main Key Array

- On the United States Enhanced PC layout, the left **Alt** acts the same as **Alt Gr** when pressed and held in combination with keys from the numeric keypad. This feature keeps the two **Alt** keys equivalent to each other.

#### 8.6.6 Right Alt

The right **Alt** key appears on the United States Enhanced PC layout. On other country layouts, the right **Alt** key appears as **Alt Gr**. Depressing the right **Alt** key performs the following functions (unless re-programmed):

- Right **Alt Space** acts as the compose key in VT Style. This feature keeps the two **Alt** keys equivalent.
- Right **Alt** key acts the same as the **Alt Gr** key when pressed and held in combination with keys from the numeric keypad.
- The right **Alt** key is the same as the Right Alt function on the VT layout with the exceptions listed previously.

#### 8.6.7 Alt Gr

The right **Alt** key is marked as **Alt Gr** on all but the United States Enhanced PC layout. The words Alt Gr are short for alternate graphic and corresponds roughly to the function of the compose key.

- **Alt Gr** in combination with graphic character keys generate the character corresponding to the right side of the key tops.
- **Alt Gr** is used for numeric keypad compose.

### 8.7 Top Row Function Keys

There are 20 top row function keys on the VT layout and 12 on the Enhanced PC layout. **Caps Lock/F1** through **Caps Lock/F10** keys on the Enhanced PC layout transmit the same sequences as **F11** through **F20** in the VT layout. Additional unique function sequences are transmitted by pressing function keys in combination with **Shift**, **Alt**, or **Ctrl** keys. See DECFNK and DECPAK for details.

In VT Style, the **F1** through **F5** keys operate the same as on the VT layout and can be used for local functions to send function sequences or to be ignored. In VT Style, **F13** (Print Screen), **F14** (Scroll Lock), and **F15** (Pause) send their corresponding function key sequences. In PC Style, the **F1** through **F5** keys send function sequences (unless re-programmed) while **Print Screen**, **Scroll Lock**, and **Pause** default to local functions.

### 8.8 Editing Keypad Keys

Figure 8-3 shows the layout for the DEC VT and Enhanced PC editing keypads.

Figure 8–3 Editing Keypad Legends on DEC and PC Layouts

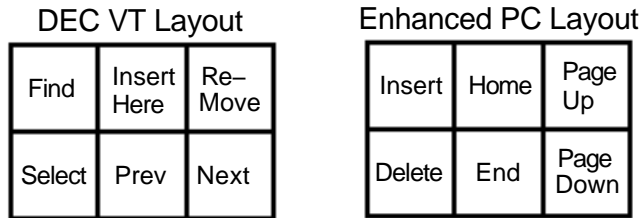

MA-0028-93.GRA

When DEC VT Style is selected, the Enhanced PC layout editing keys transmit the same function sequences as the similarly legend editing keys in the VT layout. In IBM PC Style, the **Home** key sends a Cursor Up (CUP) sequence to move the cursor home and the **Delete** key transmits a DEL (7/15).

Table 8–3 lists the key sequences for Enhanced PC editing keypads.

Table 8–3 Editing Keypad Sequences for Enhanced PC Layout

Enhanced PC Legend	VT Legend	VT Style Sequence	PC Style Sequence
<b>Insert</b>	<b>Insert Here</b>	CSI 2 ~	CSI 2 ~
<b>Delete</b>	<b>Remove</b>	CSI 3 ~	DEL
<b>Home</b>	<b>Find</b>	CSI 1 ~	CSI H
<b>End</b>	<b>Select</b>	CSI 4 ~	CSI 4 ~
<b>Page Up</b>	<b>Prev Screen</b>	CSI 5 ~	CSI 5 ~
<b>Page Down</b>	<b>Next Screen</b>	CSI 6 ~	CSI 6 ~

In addition to these unshifted sequences, the editing keys can send unique sequences when pressed in combination with **Shift**, **Alt**, or **Ctrl**. See DECFNK for details.

## 8.9 Cursor Keypad Keys

The cursor keypad keys send the same sequences as the VT layout. Additional unique sequences can be sent when pressed in combination with **Shift**, **Alt**, or **Ctrl**. See DECFNK for details.

## 8.10 Numeric Keypad Keys

The Enhanced PC layout numeric keypad has three differences from the VT layout:

1. The four keys at the top of the keyboard are labeled **Num Lock**, **/**, **\***, and **-** instead of **PF1** through **PF4**.
2. The **Num Lock** key toggles the keypad keys, sending either numerals or function sequences.
3. A two unit **+** key occupies the **-** and **.** positions so there is no keypad comma.

## Keyboard Processing

### 8.10 Numeric Keypad Keys

In VT Style, with **Application Mode** enabled, the numeric keypad keys send the same sequences as the corresponding keys on a VT layout. When the numeric keypad is in numeric mode, the four keys at the top of the keyboard still operates as **PF1** through **PF4**, and the **+** key sends an ASCII "+" character.

Table 8-4 shows the numeric keypad sequences in VT Style.

**Table 8-4 PC Layout Numeric Keypad Sequences - VT Style**

PC Key	DEC Key	Numeric Mode	Application Mode
Num Lock	PF1	SS3 P	SS3 P
/	PF2	SS3 Q	SS3 Q
*	PF3	SS3 R	SS3 R
-	PF4	SS3 S	SS3 S
Caps Lock/+	-		SS3 m
+	,	"+"	SS3 l
.	.	". "	SS3 n
Enter	Enter	CR	SS3 M
0	0	"0"	SS3 p
1	1	"1"	SS3 q
2	2	"2"	SS3 r
3	3	"3"	SS3 s
4	4	"4"	SS3 t
5	5	"5"	SS3 u
6	6	"6"	SS3 v
7	7	"7"	SS3 w
8	8	"8"	SS3 x
9	9	"9"	SS3 y

In IBM PC Style, when the numeric keypad is in **Application Mode**, the numeric keypad keys send the same sequences as the corresponding keys on the VT layout as shown in Table 8-4.

In IBM PC Style, when the numeric keypad is in **Numeric Mode**, the keypad keys send either editing keypad sequences corresponding to the gray legend in the lower part of the key tops, or the numerals corresponding to the black legend in the upper part of the key tops. The numerals are sent when **Shift** or the **Num Lock** has been depressed. The Num Lock state can be toggled on or off by pressing the **Num Lock** key. "Num Lock" appears on the keyboard indicator line when this feature is activated. If Num Lock is on and "Reverse Lock" is activated, pressing **Shift** temporarily reverses the effect of Num Lock.

#### Redefining Num Lock Key

Using **Define key...** to redefine keys on the numeric keypad will affect only the Num Lock off state of these keys. When Num Lock is on, these keys will always send their factory default ASCII numerals and characters. The Num Lock behavior of these keys cannot be reprogrammed.

*Scenario:* Imagine the keyboard having two numeric keypads: one for Num Lock Off, and the other for Num Lock On. Only the Num Lock Off keypad can be reprogrammed. The Num Lock On keypad retains the factory defaults.

Table 8–5 lists the numeric keypad sequences in PC Style Numeric mode.

**Table 8–5 PC Layout Numeric Keypad Sequences - PC Style, Numeric Mode**

Keys	Num Lock Off unshifted, or Num Lock On with <b>[Shift]</b>	Num Lock On unshifted, or Num Lock Off with <b>[Shift]</b>
<b>Num Lock</b>		
<b>[/]</b>	/	/
<b>[*]</b>	*	*
<b>[-]</b>	-	-
<b>[+]</b>	+	+
<b>[.]</b> <i>Del</i>	DEL	.
<b>[Enter]</b>	CR	CR
<b>[0]</b> <i>Insr</i>	CSI 2 ~	0
<b>[1]</b> <i>End</i>	CSI 4 ~	1
<b>[2]</b> <i>↓</i>	CSI B	2
<b>[3]</b> <i>FgDn</i>	CSI 6 ~	3
<b>[4]</b> <i>←</i>	CSI D	4
<b>[5]</b>		5
<b>[6]</b> <i>→</i>	CSI C	6
<b>[7]</b> <i>Home</i>	CSI H	7
<b>[8]</b> <i>↑</i>	CSI A	8
<b>[9]</b> <i>FgUp</i>	CSI 5 ~	9

Several of the Enhanced PC layout keyboards use a comma instead of a period on key 104, sending the corresponding code for a comma instead of a period shown in Table 8–5.

## 8.11 Local Function Key Defaults

The keys used to perform local terminal functions differ between the VT keyboard, PC keyboard, and the mode selection. Table 8–6 shows the corresponding keys for the default local functions. The function number in Table 8–6 is used in the DECPFK host sequence or DECPAK's alternate function to specify a change to that local function key.

**Table 8–6 Local Functions**

Function Number	Function	VT Keyboard	SCO Console	PC Keyboard VT-Style	PC Keyboard PC-Style	PC Keyboard SCO
0	no function					
1	Hold	<b>[F1]</b>	<b>[CapsLk/F1]</b>	<b>[F1]</b>	<b>[Scroll Lock]</b>	

± means the function switches alternately between on and off.  
C&P means Copy and Paste.  
**[CapsLk]** means the **[Lock]** key, **[Caps Lock]** key, or key with lock icon.

(continued on next page)

# Keyboard Processing

## 8.11 Local Function Key Defaults

Table 8–6 (Cont.) Local Functions

Function Number	Function	VT Keyboard	SCO Console	PC Keyboard VT-Style	PC Keyboard PC-Style	PC Keyboard SCO
2	Print	F2	CapsLk/F2	F2	Print Screen	
3	Set-Up	F3	CapsLk/F3	F3	CapsLk/Print Screen	
					CapsLk/Sys Rq	
					or	
					Alt/Print Screen	
4	Session Forward	F4, CapsLk KP0		F4, CapsLk KP0	F4, CapsLk KP0	
5	Break	F5	CapsLk/F5	F5	CapsLk/Pause	
7	Hard Reset	Ctrl/F3	CapsLk/Ctrl/F3	Ctrl/F3	Ctrl/CapsLk/Print Screen	
8	Toggle Autoprint	Ctrl/F2	CapsLk/Ctrl/F2	Ctrl/F2	Ctrl/Print Screen	
9	Disconnect	Shift/F5	CapsLk/Shift/F5	Shift/F5	Shift/CapsLk/Pause	
10	Send Answerback	Ctrl/F5	CapsLk/Ctrl/F5	Ctrl/F5	Ctrl/CapsLk/Pause	
11	Print Composed Main Display	Shift/F2	n/a <sup>4</sup>	Shift/F2	Shift/Print Screen	n/a
12	Session Backward	Shift F4, Shift CapsLk KP0		Shift F4, Shift CapsLk KP0	Shift F4, Shift CapsLk KP0	
20	Pan Up	Ctrl/ ↑	n/a	Ctrl/ ↑	Ctrl/ ↑	n/a
21	Pan Down	Ctrl/ ↓	n/a	Ctrl/ ↓	Ctrl/ ↓	
24	Pan Prev Page	Ctrl/Prev	n/a	Ctrl/Page Up	Ctrl/Page Up	
25	Pan Next Page	Ctrl/Next	n/a	Ctrl/ Page Down	Ctrl/Page Down	
30	Copy & Paste Mode	F1 (hold down)	CapsLk/F1	F1	Scroll Lock	
31	C&P Cursor Left	←		←	←	
32	C&P Cursor Down	↓		↓	↓	
33	C&P Cursor Up	↑		↑	↑	
34	C&P Cursor Right	⇒		⇒	⇒	
35	C&P Start Selection	Select		Home	Home	
36	C&P Copy	Remove		End	End	
37	C&P Paste	Insert Here		Insert	Insert	
38	C&P ± Left-to-Right	Select		Home	Home	
41	Shift Modifier	Left or right Shift		Left or right Shift	Left or right Shift	

<sup>4</sup> n/a means the function is not available in the default SCO state. If there is no "n/a" in the **SCO Console** column, then this means that the key sequence is the same as the **VT Keyboard** column. If there is no "n/a" in the **PC Keyboard SCO** column, then this means that the key sequence is the same as the **PC Keyboard PC-Style** column.

± means the function switches alternately between on and off.  
C&P means Copy and Paste.

CapsLk means the Lock key, Caps Lock key, or key with lock icon.

(continued on next page)

## Keyboard Processing 8.11 Local Function Key Defaults

**Table 8–6 (Cont.) Local Functions**

Function Number	Function	VT Keyboard	SCO Console	PC Keyboard VT-Style	PC Keyboard PC-Style	PC Keyboard SCO
42	Control Modifier	<b>Ctrl</b>		Left or right <b>Ctrl</b>	Left or right <b>Ctrl</b>	
43	Alt Function Modifier	Left or right <b>Alt</b>		Left or right <b>Alt</b>	Left or right <b>Alt</b>	
44	Start Compose	Left or right <b>Compose</b>		Left <b>Alt/Space</b>	Left <b>Alt/Space</b>	
45 <sup>1</sup>	Group Shift Modifier	<b>Group Shift</b>		<b>Alt/Gr</b>	<b>Alt/Gr</b>	
46 <sup>2</sup>	Shift2 Modifier	<b>Alt/Shift</b>				
47	Primary KB language	<b>Ctrl/Alt/F1</b>	<b>CapsLk/Alt/Ctrl/F1</b>	<b>Ctrl/Alt/F1</b>	<b>Ctrl/Alt/F1</b>	See SCO Console
48	Secondary KB language	<b>Ctrl/Alt/F2</b>	<b>CapsLk/Alt/Ctrl/F2</b>	<b>Ctrl/Alt/F2</b>	<b>Ctrl/Alt/F2</b>	See SCO Console
49 <sup>3</sup>	± KB language					
51	± Caps Lock State	<b>CapsLk</b>		<b>CapsLk</b>	<b>CapsLk</b>	
52	± Num Lock State			<b>Num Lock</b>	<b>Num Lock</b>	
53	± VT/IBM Style		n/a	<b>CapsLk</b> <b>Num Lock</b>	<b>CapsLk</b> <b>Num Lock</b>	n/a
54	Extend Kbd Modifier			<b>CapsLk</b>	<b>CapsLk</b>	
61	Screen saver					
62	± Calculator	<b>CapsLk/Alt/F12</b>		<b>CapsLk/Alt/F12</b>	<b>CapsLk/Alt/F12</b>	
63	± Clock	<b>CapsLk/Alt/F11</b> or <b>CapsLk/Enter</b>		<b>CapsLk/Alt/F11</b>	<b>CapsLk/Alt/F11</b>	
64	± Show character sets	<b>CapsLk/Alt/F10</b>		<b>CapsLk/Alt/F10</b>	<b>CapsLk/Alt/F10</b>	
65	Transfer result	<b>Shift/Enter</b>		<b>Shift/Enter</b>	<b>Shift/Enter</b>	
91	BS					
92	CAN					
93	ESC					
94	DEL					
100	UDK sequence					

<sup>1</sup>The Group Shift Modifier is assigned to the **Group Shift** key (German "Left **Compose**") when it appears on the corresponding keyboard (German, Czech, Hungarian, Polish, and Slovak).

<sup>2</sup>The Shift2 Modifier is assigned to the **Alt Shift** key (German "right **Compose**") when it appears on the corresponding keyboard (German).

<sup>3</sup>Toggle KB language is assigned to the named language key when it appears on the corresponding keyboard (Greek, Hebrew, and Russian).

± means the function switches alternately between on and off.

C&P means Copy and Paste.

**CapsLk** means the **Lock** key, **Caps Lock** key, or key with lock icon.

(continued on next page)

## Keyboard Processing

### 8.11 Local Function Key Defaults

Table 8–6 (Cont.) Local Functions

Function Number	Function	VT Keyboard	SCO Console	PC Keyboard VT-Style	PC Keyboard PC-Style	PC Keyboard SCO
105	Soft reset (WY) <sup>5</sup>	Shift F3		Shift F3	Shift F3	
106	±Show controls	Shift Ctrl KP1		Shift Ctrl KP1	Shift Ctrl KP1	
111	±Status display (WY)	Ctrl ←		Ctrl ←	Ctrl ←	
112	±Split screen					
113	Raise page split (WY)	Ctrl KP -		Ctrl KP -	Ctrl KP -	
114	Lower page split (WY)	Ctrl KP +		Ctrl KP +	Ctrl KP +	
115	Adjust window to show cursor (WY)	Ctrl Find		Ctrl Find	Ctrl Home	
116	±Cursor drag (WY)	Ctrl Shift KP `				
117	±Insert mode (WY)	Ctrl PF4 Ctrl Shift PF4		Ctrl PF4 Ctrl Shift Insert	Ctrl PF4 Ctrl Shift Insert	
119	Home & Clear (WY)	Ctrl Shift Prev			Ctrl Shift Home	
120	Page 0 (WY mono)	Ctrl KP0		Ctrl KP0	Ctrl KP0	
121	Page 1 (WY mono)	Ctrl KP1		Ctrl KP1	Ctrl KP1	
122	Page 2 (WY mono)	Ctrl KP2		Ctrl KP2	Ctrl KP2	
123	Page 3 (WY mono)	Ctrl KP3		Ctrl KP3	Ctrl KP3	
124	Page 4 (WY mono)	Ctrl KP4		Ctrl KP4	Ctrl KP4	
125	Page 5 (WY mono)	Ctrl KP5		Ctrl KP5	Ctrl KP5	
126	Page 6 (WY mono)	Ctrl KP6		Ctrl KP6	Ctrl KP6	
127	Page 7 (WY mono)	Ctrl KP7		Ctrl KP7	Ctrl KP7	
128	Page 8 (WY mono)	Ctrl KP8		Ctrl KP8	Ctrl KP8	
129	Page 9 (WY mono)	Ctrl KP9		Ctrl KP9	Ctrl KP9	
138	Prev Page	Ctrl Prev Ctrl Shift Prev			Ctrl PageUp Ctrl Shift PageUp	

<sup>5</sup>(WY) indicates that this function is available in the ASCII emulation modes only. “WY color” indicates that this function is available only in the WYSE color emulation mode. “WY mode”, only in the WYSE mono emulation mode.

± means the function switches alternately between on and off.

C&P means Copy and Paste.

⌘ means the ⌘ key, ⌘ key, or key with lock icon.

(continued on next page)



## Keyboard Processing 8.11 Local Function Key Defaults

**Table 8–6 (Cont.) Local Functions**

Function Number	Function	VT Keyboard	SCO Console	PC Keyboard VT-Style	PC Keyboard PC-Style	PC Keyboard SCO
139	Next Page	Ctrl Next Ctrl Shift Next			Ctrl PageDn Ctrl Shift PageDn	
142	Slow Scroll	Ctrl Shift ↓			Ctrl Shift ↓	
143	Fast Scroll	Ctrl Shift ↑			Ctrl Shift ↑	
151	±Keyclick	Shift Enter			Shift Enter	
155	±Block mode (WY)	Shift Ctrl F5 or F4		Shift Ctrl Pause	Shift Ctrl Pause	
156	Block mode on (WY scan mode)	Alt PF1		Alt NumLock	Alt NumLock	
157	Block mode off (WY scan mode)	F4		Pause	Pause	
159	Palette soft (WY325) <sup>5</sup>	Ctrl KP .		Ctrl KP .	Ctrl KP .	
160	Palette 0 (WY color)	Ctrl KP0		Ctrl KP0	Ctrl KP0	
161	Palette 1 (WY color)	Ctrl KP1		Ctrl KP1	Ctrl KP1	
162	Palette 2 (WY color)	Ctrl KP2		Ctrl KP2	Ctrl KP2	
163	Palette 3 (WY color)	Ctrl KP3		Ctrl KP3	Ctrl KP3	
164	Palette 4 (WY color)	Ctrl KP4		Ctrl KP4	Ctrl KP4	
165	Palette 5 (WY color)	Ctrl KP5		Ctrl KP5	Ctrl KP5	
166	Palette 6 (WY color)	Ctrl KP6		Ctrl KP6	Ctrl KP6	
167	Palette 7 (WY color)	Ctrl KP7		Ctrl KP7	Ctrl KP7	
168	Palette 8 (WY color)	Ctrl KP8		Ctrl KP8	Ctrl KP8	
169	Palette 9 (WY color)	Ctrl KP9		Ctrl KP9	Ctrl KP9	
170	± Framed windows					
171	± Window configuration	Ctrl F4 Ctrl CapsLk KP0		Ctrl F4 Ctrl CapsLk KP0	Ctrl F4 Ctrl CapsLk KP0	
172	Raise window border	Ctrl Shift ↑		Ctrl Shift ↑	Ctrl Shift ↑	

<sup>5</sup>(WY) indicates that this function is available in the ASCII emulation modes only. “WY color” indicates that this function is available only in the WYSE color emulation mode. “WY mode”, only in the WYSE mono emulation mode.

± means the function switches alternately between on and off.

C&P means Copy and Paste.

CapsLk means the Lock key, Caps Lock key, or key with lock icon.

(continued on next page)

## Keyboard Processing

### 8.11 Local Function Key Defaults

Table 8–6 (Cont.) Local Functions

Function Number	Function	VT Keyboard	SCO Console	PC Keyboard VT-Style	PC Keyboard PC-Style	PC Keyboard SCO
173	Lower window border	Ctrl Shift ↓		Ctrl Shift ↓	Ctrl Shift ↓	
181	Session 1	CapsLk KP1		CapsLk KP1	CapsLk KP1	
182	Session 2	CapsLk KP2		CapsLk KP2	CapsLk KP2	
183	Session 3	CapsLk KP3		CapsLk KP3	CapsLk KP3	
184	Session 4	CapsLk KP4		CapsLk KP4	CapsLk KP4	

± means the function switches alternately between on and off.

C&P means Copy and Paste.

CapsLk means the Lock key, Caps Lock key, or key with lock icon.

#### Note

See Chapter 2 to re-define keys using the Define Key Editor.

#### 8.11.1 Numeric Keypad Compose

Pressing and holding Compose, Alt or Alt Gr while typing a decimal number on the numeric keypad sends the corresponding decimal character code when the compose key is released. If the . key on the keyboard is pressed while entering a number, then the value entered before pressing the . key is multiplied by 16 and added to the value entered next. This supports column/row entry commonly used in character coding tables.

### 8.11.2 Accessibility Aids

**Accessibility aids** allow the user with limited motor skills to use modifier key combinations in a sequential manner rather than a simultaneous manner (default). All modifier key combinations are supported.

The Accessibility aids option is enabled by depressing the **Shift** key five times in succession. This option can be disabled by pressing and holding a modifier key while pressing another key.

Once enabled, this option provides two levels of assistance known as Latch and Lock. The Latch state is achieved by pressing a modifier key once and affects the next key pressed. The Lock state is achieved by pressing a modifier key twice. All keys pressed are affected by the modifier until they are unlocked by either depressing the modifier key again or depressing another modifier key twice. Once any modifier is in the Locked state, pressing other modifier keys adds those modifiers to the Locked state.

A small icon appears on the Keyboard Indicator Line or Status Line to provide user feedback on the changing modifier state.

The icons for each state are as follows:



Accessibility Aid Keys Enabled

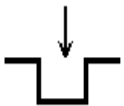

Modifier Latched (Cleared on Next Keystroke)

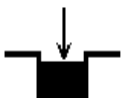

Modifier Locked

When Accessibility aid keys are disabled, no icon is displayed on the Keyboard Indicator Line or Status Line.

## Keyboard Processing

### 8.12 Controlling Keyboard LEDs

#### 8.12 Controlling Keyboard LEDs

The following sequences allow the host to control keyboard modifier states for `Caps Lock`, `Scroll Lock`, and `Num Lock` or keyboard LEDs to indicate program status. They are as follows:

ESC [ ? 108 h - Set NumLock mode (DECNUMLK)

ESC [ ? 108 l - Reset NumLock mode

ESC [ ? 109 h - Set CapsLock mode (DECCAPSLK)

ESC [ ? 109 l - Reset CapsLock mode

"Scroll Lock" or "Hold Screen" cannot be controlled from the host because it suspends transmission from the host and there is no way to release it.

DECLL controls keyboard LEDs independently of any keyboard state. The use of LEDs for this purpose conflicts with their use as keyboard state indicators. The host control selects a mode of how the keyboard LEDs are to be used: as keyboard indicators; or host indicators. If host indicators is selected, then the DECLL sequence can be used to control the keyboard LEDs.

The following control sequences are used to control keyboard LEDs.

ESC [ ? 110 h - Set Keyboard LEDs—Host Indicator Mode (DECKLHIM)

ESC [ ? 110 l - Reset Keyboard LEDs—Local Indicator Mode (default)

---

#### Note

---

See Chapter 2 to re-define keys using the Define Key Editor.

---

## 8.13 Keyboard Languages

**Table 8–7 VT Keyboard Languages**

---

Austrian/German	Greek	Russian
Belgian/French	Hebrew	SCS
British	Hungarian	Slovak
Canadian-French/English	Italian	Spanish
Czech	North American	Swedish
Danish	Norwegian	Swiss-French
Dutch	Polish	Swiss-German
Finnish	Portuguese	Turkish F
Flemish	Romanian	Turkish Q

---

**Table 8–8 Enhanced PC Keyboard Languages**

---

Belgian	Greek	Romanian
British	Hebrew	Russian
Czech	Hungarian	SCS
Danish	Italian	Slovak
Dutch	Latin American	Spanish
Finnish	North American	Swedish
French	Norwegian	Swiss-French
French-Canadian	Polish	Swiss-German
German	Portuguese	Turkish

---

## Keyboard Processing

### 8.14 Switching Between Keyboard Languages

#### 8.14 Switching Between Keyboard Languages

The VT520 allows the user to easily switch between two different keyboard layouts for several languages (English and Hebrew, for example). This feature allows the VT520 to support both existing conventions and emerging standards for extending the graphic input repertoire and/or switching between languages in dual language environments.

The primary keyboard language corresponds to "Group 1" and generally references the legends on the left portion of the key tops.

The secondary keyboard language corresponds to "Group 2" and generally references the legends on the right portion of the key tops.

Unless otherwise overridden, **Ctrl/Alt/F1** activates the primary keyboard language (locking shift), and **Ctrl/Alt/F2** activates the secondary keyboard language. These factory defaults are standard on PCs.

Selecting a new Keyboard Dialect in Set-Up resets the keyboard group shift state to Group 1 and automatically initializes the keyboard character set and VT default character set as shown in table Table 8–9. The keyboard character set is initialized to match the VT default character set.

**Table 8–9 8-bit Character Set Initialization when Keyboard Language is Changed**

New Keyboard Language	If VT Default Character Set is not . . .	Change to . . .
Austrian/German, Belgian/French, British, Canadian-English, Canadian-French, Flemish, Danish, Dutch, Finnish, Italian, Portuguese, North American, Norwegian, Spanish, Swedish, Swiss-French, Swiss-German.	DEC Multinational character set or ISO Latin-1	ISO Latin-1
Czech, Hungarian, Polish, Romanian, SCS, or Slovak	ISO Latin-2	ISO Latin-1
Greek	DEC Greek or ISO Latin-Greek	ISO Latin-Greek
Hebrew	DEC Hebrew or ISO Latin-Hebrew	ISO Latin-Hebrew
Russian	KOI-8 Cyrillic or ISO Latin-Cyrillic	ISO Latin-Cyrillic
Turkish	DEC Turkish or ISO Latin-Turkish	ISO Latin-Turkish

## Keyboard Processing

### 8.14 Switching Between Keyboard Languages

If 7-bit NRCS characters is selected, then the following corresponding NRC sets are used.

**Table 8–10 7-bit Character Set Initialization**

Keyboard	VT Keyboard	Default Character Set
		Enhanced PC Keyboard
Austrian/German	German NRC	Austrian/German NRC
Belgian/French	French NRC	French NRC
British (U.K.)	U.K. NRC	U.K. NRC
Canadian-English	French Canadian NRC	French Canadian NRC
Canadian-French	French Canadian NRC	French Canadian NRC
Czech	N/A	N/A
Danish	Norwegian/Danish NRC	Norwegian/Danish NRC
Dutch (Netherlands)	N/A <sup>1</sup>	N/A <sup>1</sup>
Finnish <sup>2</sup>	Finnish NRC	Finnish NRC
Flemish	French NRC	N/A
Greek	DEC Greek NRC	DEC Greek NRC
Hebrew	DEC 7-bit Hebrew	DEC 7-bit Hebrew
Hungarian	N/A	N/A
Italian	Italian NRC	Italian NRC
North American (U.S.) <sup>3</sup>	N/A	N/A
Norwegian	Norwegian/Danish NRC	Norwegian/Danish NRC
Polish	N/A	N/A
Portuguese	Portuguese NRC	Portuguese NRC
Romanian	N/A	N/A
Russian	DEC Russian NRC	DEC Russian NRC
SCS	SCS NRC	SCS NRC
Slovak	N/A	N/A
Spanish	Spanish NRC	Spanish NRC
Swedish	Swedish NRC	Swedish NRC
Swiss-French	Swiss NRC	Swiss NRC <sup>4</sup>
Swiss-German	Swiss NRC	Swiss NRC
Turkish-F	DEC 7-bit Turkish	N/A <sup>5</sup>
Turkish-Q	DEC 7-bit Turkish	DEC Turkish NRC

<sup>1</sup>Same as North American (U.S.) keyboard.

<sup>2</sup>Same as Swedish keyboard.

<sup>3</sup>7-bit character mode is not available.

<sup>4</sup>Swiss French/German is a single PC keyboard.

<sup>5</sup>The VT keyboard is available in both the Turkish-F and Turkish-Q keyboard layouts. The EPC keyboard is only available in the Turkish-Q layout.

## Keyboard Processing

### 8.14 Switching Between Keyboard Languages

#### 8.14.1 Keystroke Processing

Any time the terminal is operating, a keyboard encoding is being used to translate graphic character keystrokes into character codes, called the keyboard character set. The Keyboard Character set is a function of:

1. Keyboard language
2. Keyboard group (Hebrew only)
3. Default character set
4. The 7-bit or 8-bit characters setting
5. Any keyboard customization defined in Set-Up.

When the graphic character assigned to a keystroke (which usually corresponds to the legend appearing on the keycap) has a corresponding character in the Keyboard Character set, the terminal transmits the corresponding character code for that keystroke. The code transmitted for any given keystroke can vary depending on the Keyboard Character set. If the graphic character assigned to a keystroke does not have a corresponding character in the Keyboard Character set, then that keystroke does not transmit any code.

#### 8.14.2 Non-Spacing Accent Marks

Accented characters that do not appear directly on a keyboard can often be entered by typing a non-spacing diacritical mark followed by a base character. While most diacritical marks have stand-alone forms (not in combination with another character), the non-spacing interpretation of these marks are similar to characters but are actually a special internal keystroke representation.

**Table 8–11 Non-Spacing Accent Marks**

Symbol	Non-Spacing Accent Name
´	Acute accent
˘	Breve
ˇ	Hacek (caron)
¸	Cedilla
ˆ	Circumflex accent
¨	Diaeresis (umlaut)
˙	Dot above
˝	Double acute accent
ˋ	Grave accent
ˊ	Greek Tonos
ˉ	Macron
˛	Ogonek
˚	Ring above
˜	Tilde

Keystrokes assigned non-spacing accent marks do not send any character code immediately, but are used instead to modify the code transmitted by the subsequent keystroke. If a keystroke that has been assigned a non-spacing accent mark is followed immediately by a graphic character, then this forms a valid



## Keyboard Processing

### 8.14 Switching Between Keyboard Languages

character in the keyboard character set, and the corresponding character code is transmitted.

When a non-spacing diacritical key is pressed, "Compose" appears on the keyboard indicator line until the next subsequent keystroke.

If the keystroke immediately following the non-spacing diacritical keystroke does not form a valid character in the keyboard character set, then the non-spacing diacritical mark is converted to the corresponding character, if any, and transmitted from the current keyboard character set. The second keystroke is then processed normally. This "error recovery" is different from previous VT auto-compose processing; however, this process follows the emerging standard used on personal computers.

#### 8.14.3 German

For German keyboards, the Group Shift (left Compose) key functions as the keyboard repertoire extension mechanism. Group 1 and Group 2 are defined within the German keyboard dialect and are used whenever the keyboard language is set to German. Group Shift operates as a single shift prefix if pressed and released or as a modifier key if pressed and held.

#### 8.14.4 Hebrew

When Hebrew is selected as the Keyboard Dialect, the Ctrl/Hebrew key toggles between the primary and secondary keyboard language.

When switching into 7-bit Hebrew, lowercase English letters are swapped with their corresponding Hebrew characters throughout the display. The Shift/Hebrew key also performs this swapping function at any time.

## 8.15 Keystation Numbers

Figure 8-4 shows the keystation numbers for a VT keyboard.

**Figure 8-4 VT Layout - Keystation Numbers**

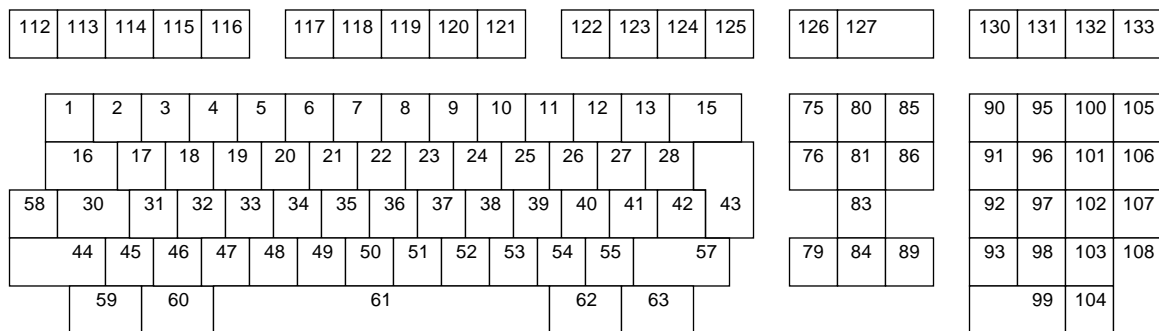

# Keyboard Processing

## 8.15 Keystation Numbers

Figure 8-5 shows a typical legend for a North American VT keyboard.

Figure 8-5 VT Layout - Typical North American Key Legends

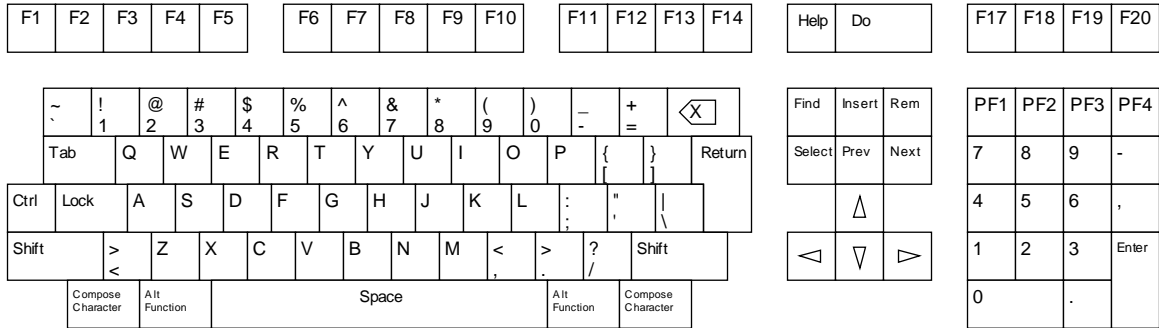

Figure 8-6 Enhanced PC Layout - Map Numbers

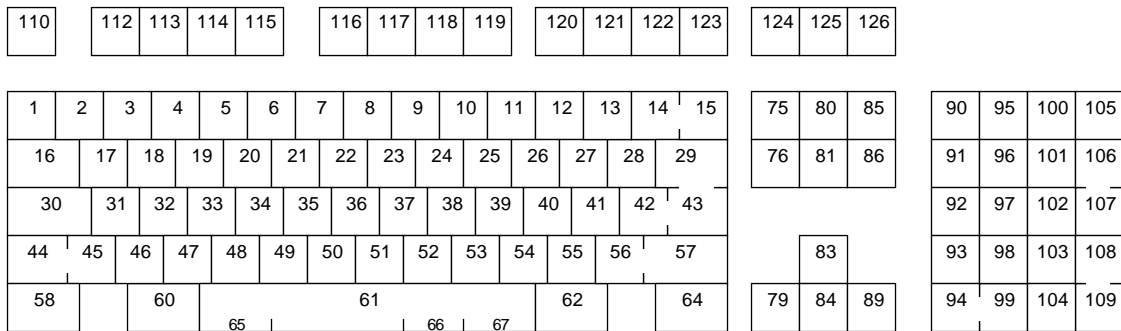
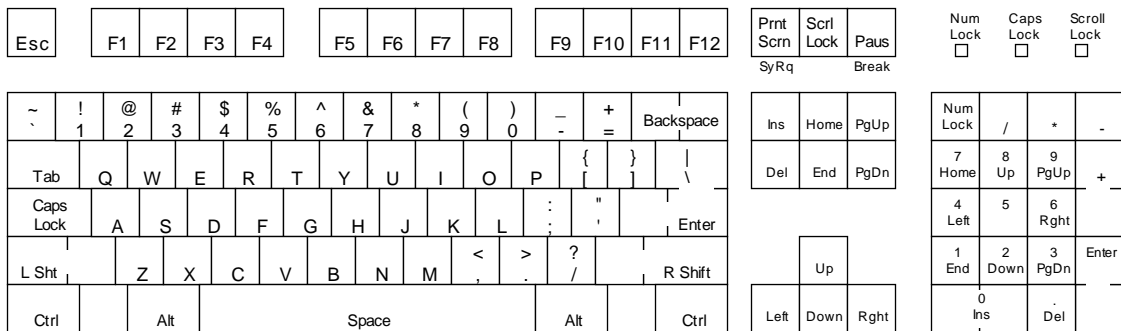

Figure 8-7 Enhanced PC Layout - Typical North American Key Legends



## 8.16 Scan Codes Sent in PCTerm Mode for EPC Keyboards

The following keys send the corresponding scan codes, regardless of any modifiers that may be in effect.

Key #	Legend (U.S.)	Scan Code Make/Break <sup>1</sup>
1	'	29/A9
2	1	02/82
3	2	03/83
4	3	04/84
5	4	05/85
6	5	06/86
7	6	07/87
8	7	08/88
9	8	09/89
10	9	0A/8A
11	0	0B/8B
12	-	0C/8C
13	=	0D/8D
14		7D/FD <sup>2</sup>
15	Backspace	0E/8E
16	Tab	0F/8F
17	Q	10/90
18	W	11/91
19	E	12/92
20	R	13/93
21	T	14/94
22	Y	15/95
23	U	16/96
24	I	17/97
25	O	18/98
26	P	19/99
27	[	1A/9A
28	]	1B/9B
29	\	2B/AB <sup>†</sup>
30	Caps Lock	3A/BA
31	A	1E/9E
32	S	1F/9F
33	D	20/A0
34	F	21/A1

<sup>1</sup>Make means when the key is pressed; Break means when the key is released.

<sup>2</sup>Not used on 101/102 keyboard layout.

<sup>†</sup>101 keyboard layout only

## Keyboard Processing

### 8.16 Scan Codes Sent in PCTerm Mode for EPC Keyboards

Key #	Legend (U.S.)	Scan Code Make/Break <sup>1</sup>
35	G	22/A2
36	H	23/A3
37	J	24/A4
38	K	25/A5
39	L	26/A6
40	;	27/A7
41	'	28/A8
42		2B/AB‡
43	Return	1C/9C
44	Left Shift	2A/AA
45		56/D6‡
46	Z	2C/AC
47	X	2D/AD
48	C	2E/AE
49	V	2F/AF
50	B	30/B0
51	N	31/B1
52	M	32/B2
53	,	33/B3
54	.	34/B4
55	/	35/B5
56		73/F3 <sup>2</sup>
57	Right Shift	36/B6
58	Left Ctrl	1D/9D
60	Left Alt	38/B8
61	Space	39/B9
62	Right Alt	E0 38/E0 B8
64	Right Ctrl	E0 1D/E0 9D
90	Num Lock	45/C5
91	<sup>7</sup> Home	47/C7
92	<sup>4</sup> ←	4B/CB
93	<sup>1</sup> End	4F/CF
94		7C/FC <sup>2</sup>
96	<sup>8</sup> ↑	48/C8
97	KP5	4C/CC
98	<sup>2</sup> ↓	50/D0
99	<sup>0</sup> Ins	52/D2



















<sup>1</sup>Make means when the key is pressed; Break means when the key is released.

<sup>2</sup>Not used on 101/102 keyboard layout.

‡102 keyboard layout only

## Keyboard Processing

### 8.16 Scan Codes Sent in PCTerm Mode for EPC Keyboards

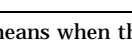
Key #	Legend (U.S.)	Scan Code Make/Break <sup>1</sup>
100	Keypad *	37/B7
101		49/C9
102		4D/CD
103		51/D1
104		53/D3
105	Keypad -	4A/CA
106	Keypad +	4E/CE
107		7E/FE <sup>2</sup>
108		E0 1C/E0 9C
109		78/F8 <sup>2</sup>
110		01/81
112		3B/BB
113		3C/BC
114		3D/BD
115		3E/BE
116		3F/BF
117		40/C0
118		41/C1
119		42/C2
120		43/C3
121		44/C4
122		57/D7
123		58/D8
125		46/C6

<sup>1</sup>Make means when the key is pressed; Break means when the key is released.

<sup>2</sup>Not used on 101/102 keyboard layout.

The keys in the following table send different series of scan codes depending on the modifier state in effect (Shift, Control, Alt, and/or Num Lock). Many of them have a base scan code that is identical to another key. To make each key unique, some have an extra byte hex 'E0' or hex 'E1' added to their scan code sequence.

## Keyboard Processing

### 8.16 Scan Codes Sent in PCTerm Mode for EPC Keyboards

Key #	Legend (U.S.)	Base Case Make/Break	Shift Case Make/Break	Num Lock ON Make/Break
75		E0 52/E0 D2	E0 AA E0 52/E0 D2 E0 2A*	E0 2A E0 52/E0 D2 E0 AA
76		E0 53/E0 D3	E0 AA E0 53/E0 D3 E0 2A*	E0 2A E0 53/E0 D3 E0 AA
79		E0 4B/E0 CB	E0 AA E0 4B/E0 CB E0 2A*	E0 2A E0 4B/E0 CB E0 AA
80		E0 47/E0 C7	E0 AA E0 47/E0 C7 E0 2A*	E0 2A E0 47/E0 C7 E0 AA
81		E0 4F/E0 CF	E0 AA E0 4F/E0 CF E0 2A*	E0 2A E0 4F/E0 CF E0 AA
83		E0 48/E0 C8	E0 AA E0 48/E0 C8 E0 2A*	E0 2A E0 48/E0 C8 E0 AA
84		E0 50/E0 D0	E0 AA E0 50/E0 D0 E0 2A*	E0 2A E0 50/E0 D0 E0 AA
85		E0 49/E0 C9	E0 AA E0 49/E0 C9 E0 2A*	E0 2A E0 49/E0 C9 E0 AA
86		E0 51/E0 D1	E0 AA E0 51/E0 D1 E0 2A*	E0 2A E0 51/E0 D1 E0 AA
89		E0 4D/E0 CD	E0 AA E0 4D/E0 CD E0 2A*	E0 2A E0 4D/E0 CD E0 AA

\*When the left key is pressed, the AA-2A shift break and make should envelope the base codes as shown in the previous table. When the right key is pressed, the code B6 (right shift break) is sent in place of AA and the code 36 (right shift make) is sent in place of 2A. If both right and left keys are pressed, then both B6 and AA are sent where AA is shown, and both 36 and 2A are sent where 2A is shown.

Key #	Legend (U.S.)	Scan Code Make/Break	Shift Case Make/Break
95	Keypad	E0 35/E0 B5	E0 AA E0 35/E0 B5 E0 2A *

The marker code Hex 'E0' precedes shift codes that are artificially produced by the keyboard logic. These artificially produced shift codes are not repeated during typamatic (auto repeat) operation of the corresponding key. Only the unique base code is repeated at the auto repeat rate. The terminal must ensure that both shift states are restored when all shift-dependent keys are released.

Key #	Legend (U.S.)	Scan Code Make/Break	Ctrl Case and Shift Case Make/Break	Alt Case Make/Break
124	PrtSc SysRq	E0 2A E0 37/E0 B7 E0 AA	E0 37/E0 B7	54/D4

Notice there are two base scan codes associated with keystation 124. To ensure the make/break sequence, the code associated with the break must reflect the make code regardless of the Alt state at the time of the break.

Key #	Legend (U.S.)	Scan Code Make	Ctrl down Make
126	Pause Break	E1 1D 45 E1 9D C5	E0 46 E0 C6







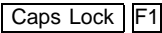
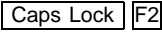
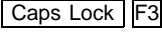
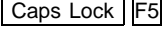





The Pause/Break key is a make-only key, meaning it generates a code when pressed, not when released. All scan codes or actions associated with this key occur with the make of the key.

## 8.17 Scan Codes Sent in PCTerm Mode for VT Keyboards

All keystrokes send scan codes except:

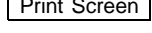
Key	Which sends . . .
	Hold
	Print
	Enter Set-Up
	Send Break

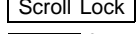
All keys including Shift, Alt, and Ctrl send make codes immediately upon being pressed, except the Caps Lock key. The make code for the Caps Lock key is sent after the Caps Lock key is released. The following keys send the corresponding scan codes, regardless of any modifiers that may be in effect.

Key #	Legend (U.S.)	Scan Code Make/Break
42		2B/AB
107	 <sup>1</sup>	7E/FE
124		E0 3D/E0 BD
125		E0 3E/E0 BE
126		E0 3F/E0 BF
127		01/81 (Like  key on PC keyboard)
130		E0 41/E0 C1
131		E0 2A E0 37/E0 B7 E0 AA Ctrl or Shift E0 37/E0 B7
		Alt 54/D4
132		46/C6
133	 <sup>2</sup>	E1 1D 45 E1 9D C5
	 <sup>2</sup>	Ctrl E0 46 E0 C6

<sup>1</sup>On Numeric keypad.

<sup>2</sup>This is a make-only key; code is sent only when key is pressed.

## Keyboard Processing

### 8.18 Control Codes and Keystrokes

## 8.18 Control Codes and Keystrokes

The following codes are transmitted when the **Ctrl** key is depressed simultaneously with another key.

**Table 8–12 Control Codes and Keystrokes**

Legend	HEX Code Transmitted	Name
<b>Ctrl</b> Space	00	NUL
<b>Ctrl</b> 2	00	NUL
<b>Ctrl</b> A	01	SOH
<b>Ctrl</b> B	02	STX
<b>Ctrl</b> C	03	ETX
<b>Ctrl</b> D	04	EOT
<b>Ctrl</b> E	05	ENQ
<b>Ctrl</b> F	06	ACK
<b>Ctrl</b> G	07	BEL
<b>Ctrl</b> H	08	BS
<b>Ctrl</b> I	09	HT
<b>Ctrl</b> J	0A	LF
<b>Ctrl</b> K	0B	VT
<b>Ctrl</b> L	0C	FF
<b>Ctrl</b> M	0D	CR
<b>Ctrl</b> N	0E	SO
<b>Ctrl</b> O	0F	SI
<b>Ctrl</b> P	10	DLE
<b>Ctrl</b> Q	11	DC1†
<b>Ctrl</b> R	12	DC2
<b>Ctrl</b> S	13	DC3†
<b>Ctrl</b> T	14	DC4
<b>Ctrl</b> U	15	NAK
<b>Ctrl</b> V	16	SYN
<b>Ctrl</b> W	17	ETB
<b>Ctrl</b> X	18	CAN
<b>Ctrl</b> Y	19	EM
<b>Ctrl</b> Z	1A	SUB
<b>Ctrl</b> 3	1B	ESC
<b>Ctrl</b> [	1B	ESC
<b>Ctrl</b> 4	1C	FS
<b>Ctrl</b> \	1C	FS
<b>Ctrl</b> 5	1D	GS
<b>Ctrl</b> ]	1D	GS

†Code is transmitted if XON/XOFF handling is disabled.

(continued on next page)



## Keyboard Processing 8.18 Control Codes and Keystrokes

Table 8–12 (Cont.) Control Codes and Keystrokes

Legend	HEX Code Transmitted	Name
Ctrl 6	1E	RS
Ctrl ~	1E	RS
Ctrl 7	1F	US
Ctrl ?	1F	US
Ctrl 8	7F	DEL
Ctrl Tab	09	HT
Ctrl Enter	Same as Enter alone.	
Ctrl Return	Same as Return alone.	
Ctrl Delete	18	CAN



This chapter describes the serial asynchronous communications through the host ports.

## 9.1 Introduction to Communications

This chapter describes the physical layer and data link layer. The physical layer is comprised of the mechanical, electrical, and functional arrangements necessary for a physical connection, including cables and telephone lines. The physical layer applies to both ANSI and ASCII terminal emulations.

The data link layer is the electronic protocol used to convey a unit of information from the VT520 to a host computer. This layer includes flow control, character conversions, and some forms of error control.

The asynchronous character format consists of a start bit (space), the data bits (1=mark, 0=space), the parity bit (if present), and one or two stop bits (mark). The data bits represent a character with the least significant bit leading. The parity bit may be enabled as either none, odd, even, space, or mark. Received parity may be checked or ignored. When transmitting odd or even parity, the received parity must be set to the same parity as the transmitted data. These parameters can be selected through Set-Up or by using the escape sequence, DECSPP.

For further information on the asynchronous character format, refer to ANSI X3.15-1976, *American National Standard for bit sequencing of the American National Standard Code for Information Interchange in Serial-By-Bit Data Transmission*.

The VT520 supports the following:

- Full-duplex mode
- Half-duplex mode

Full-duplex mode allows simultaneous two-way communication, while half-duplex mode limits communication to one way at any given time. The VT520 always supports full duplex (two wires) at the physical layer. Half-duplex mode is a simple data link layer protocol intended to support half-duplex modems. It is common to view the terminal and attached modem as a single system. Refer to Section 9.2.4 for details on half-duplex mode. This feature can be selected from Set-Up or by the control function, DECHDPXM.

The VT520 does not support synchronous communications.

# Communications

## 9.2 Physical Link Layer

### 9.2 Physical Link Layer

Communications lines may be connected to the comm ports without interaction between the two lines. You can use the Set-Up menu **Communication - Port select** to select the communications port. The port selection can also be programmed through the escape sequence, DECSCP.

#### 9.2.1 25-Pin Connectors

Figure 9–1 shows the typical 25-pin EIA 232 ports.<sup>1</sup> You can only use one connector at a time.

Figure 9–1 25-Pin Port Pin Numbers

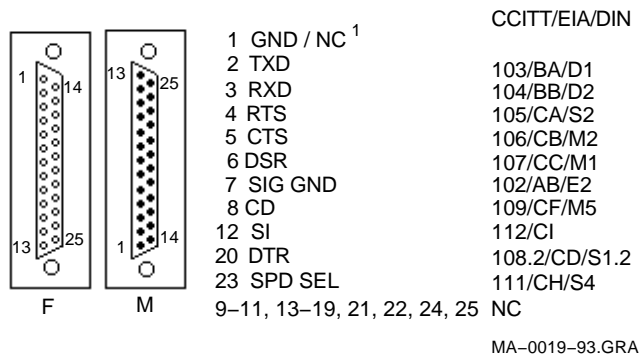

Comm1, a DB-25P serial port, has full modem control, accepting a variety of modems that meet national and international standards.

Comm2 has data lead only and RS-423 drivers.

Table 9–1 shows the interface signals and functions. Interface signals are labeled with both EIA and CCITT designations.

Table 9–1 EIA Interface Signals and Functions

Pin	Signal Name	Source	Function	CCITT/EIA/DIN
1	GND	Ground		
2	TXD L	Terminal	Transmitted Data	103/BA/D1
3	RXD L	Modem	Received Data	104/BB/D2
4	RTS	Terminal	Request to Send	105/CA/S2
5	CTS	Modem	Clear to Send	106/CB/M2
6	DSR	Modem	Data Set Ready	107/CC/M1
7	SGND		Signal Ground	102/AB/E2
8	RLSD	Modem	Rec Line Signal Detector	109/CF/M5
9-11, 13-19, 21, 22, 24, 25			No connection	

(continued on next page)

<sup>1</sup> Normally grounded on the VT520. NC = no connection.

**Table 9–1 (Cont.) EIA Interface Signals and Functions**

Pin	Signal Name	Source	Function	CCITT/EIA/DIN
12	SPDI	Modem	Speed Mode Indication	112/CI/M4
20	DTR	Terminal	Data Term. Ready	108.2/CD/S1.2
23	SPD SEL L	Terminal	Speed Select	111/CH/S4

### 9.2.2 DEC Corporate Modular Jacks (MMJ)

The modular jacks provide DEC-423 compatible levels with the intent of allowing greater length between terminal and host. Limited modem support is also provided. The DTR output and DSR input are supported on this connector. DEC-423 signals provide separate ground lines for TXD and RXD signals. Transmit ground for transmit data and DTR are isolated from receive ground used for receive data and DSR. Figure 9–2 shows the MMJ port signals.

**Figure 9–2 MMJ Modular Jack Pin Numbers**

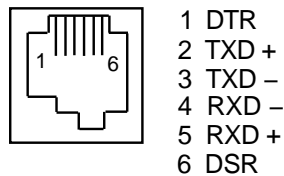

MA-0020-93.GRA

Table 9–2 describes the function of each MMJ interface signal.

**Table 9–2 MMJ Interface Signals**

Pin	Signal Name	Source	Function
1	DTR	Terminal	Data Terminal Ready*
2	TXD +	Terminal	Transmitted Data
3	RXD -	Terminal	Transmit Signal Ground
4	RXD -	Modem	Receive Signal Ground
5	RXD +	Modem	Received Data
6	DSR	Modem	Data Set Ready†

\*Pin 1 is a terminal output signal and uses pin 3 as a reference.

†Pin 6 is a terminal input signal and uses pin 4 as a reference.

### 9.2.3 Connector Pins Description

This section describes the function of full-duplex mode connector pins. Half-duplex mode connector pins have different functions than the full-duplex mode connector pins as mentioned in Section 9.2.4.

## Communications

### 9.2 Physical Link Layer

#### 9.2.3.1 Transmitted Data—TXD L

The TXD L signal is supported on the 25-pin D-sub and the Corporate Modular Connector.

Data on this circuit represents the serially encoded characters that are transmitted from the VT520. This circuit is held at the mark state (-) during stop bits between characters and also at times when no data is being transmitted.

On the 25-pin connector when modem control is enabled, no data is transmitted unless Clear to Send is asserted from the modem. Assertion of DSR or RLSD from the modem is not required. This is specific to the 25-pin EIA connector and is intended to allow the VT520 to communicate with intelligent modems (like the DF224) before a connection has been established.

#### 9.2.3.2 Received Data—RXD L

The RXD L signal is supported on the 25-pin D-sub as well as on the Corporate Modular Connector.

Data on this circuit represents the serially encoded characters to be received by the VT520.

When modem control is not enabled, received data is processed regardless of the state of the control lines.

On a 25-pin EIA connector, when modem control is enabled and a connection has been established (DSR from the modem is asserted), the received characters are ignored if RLSD is unasserted, except when Disconnect Delay in Set-up is selected as **No disconnect**. This is an implementation in firmware of mark carrier clamping.

If a connection has not been established (DSR from the modem is not asserted), then received characters are processed even if RLSD is unasserted. This is an implementation that permits V.25 bis compatible autodial modems to be used without the user having to set "data leads only" to access the autodial functions.

#### 9.2.3.3 Request to Send—RTS

The RTS signal is supported on the 25-pin D-sub but not on the Corporate Modular Connector.

For modems with this function, asserting RTS may put the modem in the transmit mode. When the modem is in the transmit mode, it then asserts CTS.

---

#### Note

---

For full-duplex modems without RTS inputs, CTS is asserted by the modem whenever it is capable of transmission.

---

#### 9.2.3.4 Clear to Send—CTS

The CTS signal is supported on the 25-pin D-sub but not on the Corporate Modular Connector.

Assertion of CTS indicates that the modem is ready to receive data (that is, the terminal is clear to send data to the modem).

The data can be either a command to the modem if "off line" (DSR de-asserted) or transmitted data to the host if "on line" (DSR asserted).

### 9.2.3.5 Data Terminal Ready–DTR

The DTR signal is supported on the 25-pin D-sub as well as the Corporate Modular Connector.

The VT520 asserts DTR whenever it is ready to transmit and/or receive on the port to which it is associated with.

The VT520 de-asserts DTR when:

- Recalling saved settings
- Recalling factory defaults
- Pressing Shift/Break
- Powering up self-test
- Resetting to Initial State (RIS)–hard reset
- DTR is being used for hardware flow control and the receive buffer has reached the flow control threshold

The VT520 does not de-assert DTR when:

- Resetting session
- Clearing comm

### 9.2.3.6 Data Set Ready–DSR

The DSR signal is supported on the 25-pin D-sub as well as the Corporate Modular Connector.

When the DTR/DSR is not the selected flow control scheme, the assertion of DSR indicates the following:

- That the modem is in the data mode
- That the modem is connected to the communications channel
- The answer tone is finished
- The user is being charged by the PTT
- That the modem is ready to exchange the appropriate control signals to initiate data transmission/reception

When DTR/DSR is the selected hardware flow control scheme only, refer to Section 9.3.2.2.3.

**9.2.3.6.1 Modem Initiated Disconnect** When DSR is unasserted during the progress of a call but before DTR is unasserted, the terminal interprets this condition as a lost or aborted call and disconnects. Any subsequent assertion of DSR is considered a new call. If connected to a modem and the modem's power is turned off or if DSR becomes an open circuit, then the VT520 interprets these conditions as a de-assertion. The state of the DSR input is shown on the indicator status line display.

**9.2.3.6.2 Terminal Initiated Disconnect** The terminal disconnects itself from the modem by dropping DTR.

## Communications

### 9.2 Physical Link Layer

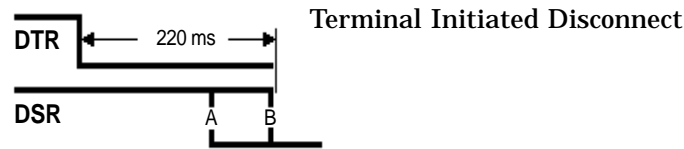

If DSR is de-asserted 220 ms after DTR goes de-asserted, then do nothing, since the modem has already done a disconnect. If DSR is still asserted 220 ms after DTR goes deasserted, then DTR must remain deasserted for greater than 2 seconds to assure that the modem does a disconnect.

**9.2.3.6.3 Modem off line** When DSR is unasserted and modem control is enabled on the 25-pin EIA connector, the system is in a transitory "off line" state. In this state, the user may interact with a dial-up modem to enter numbers, change modem set-up, and so on.

When DSR is asserted and modem control is being used, the modem, terminal, and host system are ready for communication to a remote host.

#### 9.2.3.7 Receive Line Signal Detector—RLSD

This signal is supported on the 25-pin D-sub but not on the Corporate Modular Connector.

RLSD is also called Carrier Detect. The modem asserts RLSD when the received signal is of sufficient amplitude or in the case of "training modems," when both modems have adjusted and equalized to the prevailing line conditions, to ensure demodulation of Received Data. The unasserted condition of RLSD indicates that there is neither a received signal nor that it is unsuitable for demodulation.

#### 9.2.3.8 Speed Indicator—SPDI

The SPDI signal is supported on the 25-pin D-sub but not on the Corporate Modular Connector. This signal comes from the modem. When **Modem Control** is enabled in Set-Up, the transmit and receive speed is set as follows:

State	Transmit and Receive Speed
Unasserted	Modem Low Speed
Asserted	Modem High Speed (default)

The user should set these Set-Up fields so that the fast speed (2400 baud, for example) is exactly twice the slow (1200 baud, in the following example) if V.25 bis compatibility is desired. Otherwise, the user may set the two speeds as applicable (1200/300 baud, in the following example).

	Assert	De-assert
Bell 212	1200	300
Bell 103	300	n/a
V.22	1200	600
V.22 bis	2400	1200
V.26 ter	2400	1200
V.32	4800	2400
V.32	9600	4800



### **9.2.3.9 Speed Select–SPDS**

The SPDS signal is supported on the 25-pin D-sub but not on the Corporate Modular Connector.

If the speed is greater or equal to 1200 baud, then Speed Select will be high. If the speed is below 1200 baud, then Speed Select will be low. This signal comes from the terminal.

### **9.2.4 Half-Duplex Mode**

Half-duplex mode works in EIA 232-E line only. It uses the pin signals to control the data traffic to one direction at any given time.

In this mode, Data Terminal Ready (DTR) is always asserted. The terminal checks the assertion of Data Set Ready (DSR) constantly. The terminal disconnects once DSR is dropped. Ready to Send (RTS) is asserted only if the terminal intends to transmit.

Before transmitting, the terminal checks for the presence of Carrier Detect (CD). If CD is still detected for five seconds, then the terminal disconnects. Otherwise, the terminal asserts the Request to Send (RTS) signal and starts detecting the Clear to Send (CTS) signal. Transmission starts if CTS is detected within five seconds. If CTS is not monitored within five seconds, then the terminal disconnects. After transmission, RTS is de-asserted from the terminal. If CTS is still detected within the next five seconds, then the terminal disconnects.

### **9.2.5 Supported Modem Configurations**

This section describes the supported modem configurations.

#### **9.2.5.1 CCITT Public Switched Telephone Network (2-wire only)**

- V.21 Modem (V.24/V.28)  
Async, FDX, up to 200/300 bit/s
- V.22 Modem (V.24/V.28)  
Async, FDX, up to 1200 bit/s
- V.22 bis Modem (V.24/V.28)  
Async, FDX, up to 2400 bit/s
- V.23 Modem (V.24/V.28)  
Async, Asymmetric FDX  
Receive = 600 or 1200 bit/s,  
Transmit = Reverse channel at 75 bit/s
- V.25 bis Auto Dial Protocol Modem and Hayes

#### **9.2.5.2 CCITT Dedicated Line (2-Wire / 4-Wire) Data Network**

- V.21 Modem (V.24/V.28, 2-W)  
Async, FDX, 200/300 B
- V.23 Modem (V.24/V.28)  
FDX, Async, 1200 B, 4-W
- V.25 bis compatible Modem  
Async, FDX, any standard speed from 300 baud up.
- X.20 bis Full-Duplex asynchronous 300 baud data service unit

## Communications

### 9.2 Physical Link Layer

#### 9.2.5.3 European Public Circuit Switched Data Network

D1200S (Germany)  
 VC-DCE (Nordic Network)  
 VPC-DCE (Nordic Network)  
 X.20bis (V.21) Data Service Unit (V.28)  
 Async, FDX, up to 300 B

#### 9.2.5.4 European Public Packet Switched Data Network (PSDN)

Germany: DATEX-P  
 Basic Datex P10-Service (X.25): Not supported  
 Additional Datex-P20 Service:  
 Fixed Connections to PAD facility with X.28 procedure:

Service	DCE
DATEX-P20 H300	DFG300(X.20 bis), D300S (V.21)
DATEX-P20 H1200	D1200S12(V.22), D1200S (V.23,4-W)
DATEX-P20 H1200/75	D1200S (V.23 with sec. channel, 75 baud Transmit / 1200 Baud Receive)
DATEX-P20 H2400	

Access to DATEX-P PAD facility from other public switched networks with X.28 procedure:

Service	Access	DCE
DATEX-P20 L300	DATEX-L	DFG300 (X.20bis)
DATEX-P20 F300	PSTN	D300S (V.21)
DATEX-P20 F1200	PSTN	D1200S12 (V.22)
DATEX-P20 F1200/75	PSTN	D1200S (V.23 with sec channel, 75 baud Transmit, 1200 baud Receive)
DATEX-P20 F2400		

## 9.3 Data Link Layer

This section describes the data link layer.

### 9.3.1 7- /8-Bit VT100/VT520 Operation

The VT520 supports three broad classes of application requirements:

- Strict compatibility for existing VT100 applications:
  - No 8-bit control codes
  - No 8-bit data Function keys are not limited to the VT100 set as in previous terminals.
- A migration path that allows most applications to run without modification:
  - No 8-bit control codes
  - 8-bit graphic data allowable
  - VT400 function keys are allowable (but not immediately useful) and can be integrated into the application over time.
- Full VT520 mode (VT level 5) functionality:
  - 8-bit data allowable
  - 8-bit controls allowable
  - All VT500 function and modifier keys

The VT520 application requirements are possible through the following VT terminal modes:

- VT52 Mode (7-bit characters, 7-bit controls)
- VT100 Mode (7-bit characters, 7-bit controls)
- VT500 Mode, 8-bit characters, 7-bit controls
- VT500 Mode, 8-bit characters, 8-bit controls
- VT500 Mode, 7-bit characters (Keyboard restricted to keys that generate 7-bit codes, 7-bit graphics, 7-bit controls, for NRC sets, worldwide version only).

These modes are the only supported modes. 8-bit characters are temporarily disabled when in VT100 mode.

The following are certain limitations within these modes:

- The terminal accepts both C0 and C1 controls when 8-bit characters are selected (7-bit NRCS Characters is not selected).
- The terminal accepts both GL and GR characters when 8-bit Characters are selected.
- In VT52 mode, VT100 mode, or VT500 mode, when 7-bit characters is selected, the terminal sets the high bit of all received characters to zero. This action results in compatible character handling. The received characters, therefore, have only seven significant bits. This is applicable to both graphics characters and control characters.

## Communications

### 9.3 Data Link Layer

- If the user needs to restrict the controls to 7 bits, but still needs 8-bit graphic characters and new function keys, then the user can select **Transmit 7-bit controls** with an 8-bit host line. To get full efficiency out of new applications, select 8-bit controls and an 8-bit host line. The **7-bit NRCS Characters** selection is compatible with 7-bit NRC-based applications.
- C1 controls are never available directly from the default keyboard, although they may be available indirectly through the function keys or numeric compose.
- When the terminal is in printer controller mode and the 7-bit character mode, upon receiving 8-bit graphic characters, the terminal immediately retransmits them through the printer port to the printer. The highest bit is not stripped off.
- In printer controller mode when the terminal is receiving 8-bit characters and immediately retransmitting them on a 7-bit line, the high bit is stripped off.
- When the screen contains 8-bit (GR) characters and is being printed on a 7-bit printer, the characters are subject to constraints, which are described in Chapter 10.
- Keyboard operation guidelines are described in Chapter 8.

#### 9.3.2 Flow Control

Flow control is a means to alternately suspend and resume the flow of characters over serial asynchronous point-to-point communication lines.

Depending on the type of flow control selected, the stop/resume transmission signal is different. Users can select a software flow control scheme, a hardware flow control scheme, or a combination software and hardware flow control scheme to meet their communication environment.

##### 9.3.2.1 Receive Buffer

The VT520 operates at a transmission speed of up to 115.2K baud. To prevent loss of data, the receive buffer is 1024 byte. The substitute (SUB) character is substituted in the input buffer for any character with detected receive parity errors or framing errors. If the input buffer overflows, a SUB character is placed in the buffer in place of the lost characters. The SUB character is displayed as a reverse question mark.

##### 9.3.2.2 Flow Control Selection

The VT520 supports bidirectional flow control. The flow control scheme can be selected independently for the transmit and receive direction. The user has the following choices for transmit data flow control:

- No Flow Control
- XON/XOFF
- DTR
- Both

The user has the following choices for receive flow control:

- No Flow Control
- XON/XOFF in VT mode or XPC in PC term mode
- DSR

- Both

You can select flow control methods from Set-Up or through the escape sequences, DECSFC.

**9.3.2.2.1 No Flow Control** If **No Flow Control** is selected, then when the receive buffer is full, it does not send any signal; therefore, the **Hold** key is disabled. Ctrl/S and Ctrl/Q will be transmitted as typed. It is left to the application and user to prevent buffer overflow.

Software that does not support flow control may use all the features of the VT520 by treating NUL as a fill character. If **Ignore NUL** is selected in Set-Up, then NUL is discarded upon receipt. All other received characters are stored in the input buffer for further processing. **Ignore NUL** or **Accept NUL** can be selected from Set-Up or through the escape sequence, DECNUML.

The VT520 can be used without flow control or fill characters, when the:

- Software never sends ESC sequences to the terminal
- Baud rate is limited to 19200 baud or less
- Software does not use smooth scrolling

#### 9.3.2.2.2 XOFF/XON or XPC Flow Control

In the XOFF/XON flow control, two characters establish flow control. In VT mode, these two characters are DC1(11H) (XON) and DC3(13H) (XOFF). In VT mode, the VT520 sends XOFF to suspend the host transmission of data and XON to resume that transmission. Receipt of XOFF inhibits the host from transmitting any code except XOFF and XON. Once the keyboard buffer becomes full, no more keystrokes are accepted. The keyboard locks and "wait" is displayed in the keyboard indicator line. Transmission resumes when the host receives an XON.

In PC Term mode, the terminal receives from the host 11H(DC1) and 13H(DC3) for flow control; but the terminal sends 65H and 67H to the host to resume/stop the communication, known as XPC flow control.

VT520 sends XOFF to indicate halt of transmission when:

1. The number of characters in the input buffer reaches the first XOFF point since the last XON was sent.
2. The number of characters in the input buffer reaches the second XOFF point since the last XON was sent.
3. The input buffer is full.
4. Entering a hold state.

Entering a Hold state causes an XOFF to be sent by the VT520. A Hold state can be generated by pressing the **Hold** key or entering **Ctrl/S**. When exiting from the hold state either by depressing the **Hold** key or entering **Ctrl/Q**, the terminal sends XON to the host unless the input buffer is filled up to or beyond the first XOFF point (flow control threshold).

With the exception of exiting from the hold state, the VT520 sends an XON when the input buffer is emptied to the XON point and when XOFF was the last flow control sent.

Refer to the Section 9.3.2.2.5 for more information on the thresholds.

## Communications

### 9.3 Data Link Layer

The VT520 re-initializes the XON/XOFF(XPC) state under the following conditions:

1. The Clear Comm function is performed.
2. The completion of the NVR recall after the RECALL function is performed.
3. The completion of all tests in a self-test sequence is performed.
4. Successful completion of a connection - generally, DSR assertion.
5. The reception of RIS.

#### 9.3.2.2.3 DSR/DTR Flow Control

When **Hardware flow control** is selected, DTR is asserted any time the terminal is not in self-test and the terminal's input buffer is below the flow control threshold; DTR is de-asserted when the input buffer is filled up to or beyond the threshold.

If the terminal is a sending device, then it polls DSR before transmitting each character. If DSR is not being asserted by the receiving device, then transmission of the character is suspended until DSR is asserted.

As in the XON/XOFF software flow control, VT520 deasserts DTR when:

1. The number of characters in the input buffer is greater than or equal to the flow control threshold (first XOFF point).
2. Entering the Hold state.

As in the XON/XOFF flow control, entering a Hold state causes a deassertion of DTR. When exiting from the hold state either by depressing the **Hold** key or by entering **Ctrl/Q**, the terminal asserts DTR unless the input buffer is filled up to or beyond the flow control threshold (first XOFF point).

With the exception of exiting from the hold state, the VT520 reasserts DTR when the input buffer is emptied to the "resume transmission" (XON) point.

DSR/DTR can be used for hardware flow control when they are not needed for modem control functions. When **Modem Control** is enabled, DST/DTR should not be selectable.

#### 9.3.2.2.4 Software and Hardware Combined Flow Control

For software and hardware flow control, both DTR/DSR and XON/XOFF(XPC) are used to control the data flow. When the receive input buffer reaches the flow control threshold, XOFF is sent and DTR is deasserted. When transmitting, the terminal must be in the XON state with DSR asserted to transmit the next character, except in the case of (XON/XOFF).

#### 9.3.2.2.5 Flow Control Threshold

Table 9-3 shows the flow control threshold points available for the VT520.

Table 9–3 Flow Control Threshold Points

1st Flow Control Threshold	Resume Transmission Point	2nd Flow Control Threshold
64	32	896
768	128	896

#### 9.3.2.3 Show Control Character Mode

While in show control character mode, all characters are temporarily stored in the input buffer and eventually displayed on the screen in the CRM font. XON and XOFF can serve both as data (to be displayed) and flow control. Note that this circumstance is unique to show control character mode.

#### 9.3.2.4 Set-Up on Flow Control Handling

Entering Set-Up leaves the received character processing in the state it was in before entering Set-Up. Characters continue to fill the silo, depending on the flow control type selected. A signal (XOFF or lower DTR) will be sent when the silo gets to the first flow control threshold.

#### 9.3.2.5 When Disconnect Occurs

If a disconnect occurs while the VT520's silo contains characters that have not been displayed or printed, then the characters may be discarded in order to prepare for the next call. XON is sent when a new connection is established.

## 9.4 Features that Affect Communications

The following features described in Chapter 2 affect communication:

- Clear communications
- On-Line/Local
- Transmit speed
- Receive speed
- Transmit rate limiting
- Word size
- Parity
- Stop bits
- Modem control
- Modem high speed
- Modem low speed
- Disconnect delay
- Local echo

## Communications

### 9.4 Features that Affect Communications

#### 9.4.1 Clear Communications

If the terminal appears to be "locked" in Set-Up, then select **Clear communications** to clear the current session. This action:

1. Aborts any print operation in progress if the printer is allocated to the active session.
2. Aborts any escape sequence, control sequence, or device control string (DCS) processing.
3. Clears the keyboard buffer.
4. Clears the receive buffer.
5. Clears the transmit buffer.
6. Takes the terminal out of printer controller mode.
7. Sends XON to the host port if software flow control is in use. Asserts DTR if hardware flow control is in use.
8. Resets XOFF received flags on the printer and host ports if software flow control is in use.

The communications has been cleared when "Done" appears on the terminal status line.

---

**Note**

---

**Clear communications** does not cause a disconnect and does not clear the screen.

---

#### 9.4.2 Connection

If XON/XOFF flow control is enabled, then a single XON will be transmitted after the connection is made. When a connection is made, the VT520 performs the following operations to ensure that it is ready to send and receive:

1. Unlock the keyboard, if it is locked.
2. Clear any transmit in progress on this port.
3. Clear all buffers associated with this port.
4. Clear the "XOFF sent" and "XOFF received" state of this port.
5. At the reception of the carrier tone, the modem asserts CD, and data transmission/reception may begin.

#### 9.4.3 Line Disconnection

A disconnect sequence occurs on the following conditions:

- Operator initiates a disconnect by pressing Shift/Break (note that the BREAK can be disabled through Keyboard Set-Up).
- Doing a RECALL, or DEFAULT. (If a terminal supports more than one session, this only disconnects the active session's line.)
- Loss of DSR.
- Switching to the EIA 232-E port from the DEC423 port or to the DEC423 port from the EIA232-E port.



## Communications

### 9.4 Features that Affect Communications

- With the 25-pin connector and modem control enabled, after a connection has been established, loss of RLSD for greater than 2 seconds (or 60 ms) on host line 1.
- Receipt of a DECTST or RIS sequence (Except the keyboard test in DECTST that leaves the terminal on line).
- Turning off the terminal.

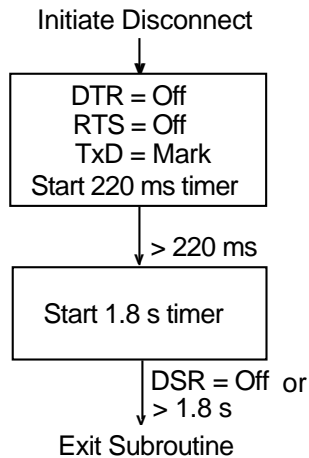

MA-0029-93.GRA

Normally DTR and RTS are asserted by the VT520 whenever power is applied except:

- During a disconnect sequence
- When hardware flow control DTR/DSR is being used and the receive buffer reaches 64 bytes threshold

#### 9.4.4 Break

The **Break** key operates as described in Chapter 8.

A break consists of a  $275 \pm 25$  ms space condition on the transmit data line if transmission is enabled. The break (space) condition is separated from any subsequent mark-to-space transition by at least 100 ms.

##### 9.4.4.1 Received Break

If a break is detected on the received data circuit, then it is ignored. One or more error characters (reverse question mark) may be displayed because the framing errors were generated.



## 10.1 Overview

The VT520 expands the traditional printer port extension to include support for IBM ProPrinter and compatible low-cost parallel interface printers. In Set-Up, you specify the type of printer attached and the terminal automatically selects the correct printing commands and character sets.

The VT520 printer port has the following features:

- Centronics parallel port (25-pin, female, D-type connector)
- IBM ProPrinter mode
- Ability to transparently pass all characters (including the NUL character) through to the printer in printer controller mode

You can connect both a serial and a parallel printer to the VT520 at the same time, and both printer ports can be active at the same time if used by different sessions.

## 10.2 Serial Port

The VT520 uses Comm3 and the serial printer port with speeds of 300 to 115.2K baud. Comm 3 is a 6-pin MMJ connector with EIA 423 levels.

The interface signals are the same as those previously described in Chapter 9.

### 10.2.1 Serial Port Flow Control

The VT520 serial printer port is fully bi-directional when **Printer To Host** communications is enabled in Set-Up or by a Media Copy (MC) control sequence. The printer port has two buffers: one is for output, which is 16 bytes long; and the other is for input, which is 254 bytes long.

The firmware supports bi-directional flow control on the printer port. Transmit and receive flow control protocols can be set independently to one of four choices through Set-Up or by the control sequence, DECSFC.

- None
- XON/XOFF
- DTR/DSR
- Both

**XON/XOFF:** For the 254-character receive input buffer, the XON point is 32. The first XOFF point is 64 characters, and the second is 220 characters.

## Printer Port

### 10.2 Serial Port

**DTR/DSR:** If enabled, the terminal polls DSR before transmitting each character. The terminal asserts DTR until the buffer fills up to or beyond the first XOFF point. When the buffer empties to the XON point, the terminal again asserts DTR. When not used for hardware flow control, DTR is asserted whenever the firmware is active and not in its self-test.

When the input buffer is full and receives another character byte, it overflows. In the event of an input buffer overflow, the last byte in the buffer is replaced with the SUB character.

### 10.3 Parallel Port

The Centronics parallel interface is considered to be industry standard and is not explained in this chapter. This port uses a 25-pin D-type connector with pin assignments shown in Figure 10–1 and listed in Table 10–1.

**Figure 10–1 Parallel Printer Port**

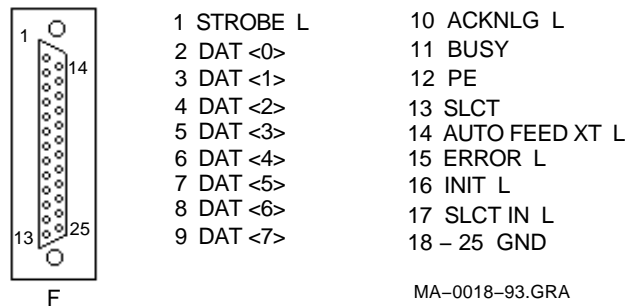

**Table 10–1 Parallel Connector Signals**

Pin	Signal Name	Source	Function
1	STROBE L	Terminal	Strobe
2	DATA0	Terminal	Data Bit 1
3	DATA1	Terminal	Data Bit 2
4	DATA2	Terminal	Data Bit 3
5	DATA3	Terminal	Data Bit 4
6	DATA4	Terminal	Data Bit 5
7	DATA5	Terminal	Data Bit 6
8	DATA6	Terminal	Data Bit 7
9	DATA7	Terminal	Data Bit 8
10	ACKNLG L	Printer	Acknowledge
11	BUSY	Printer	Printer cannot receive data.
12	PE	Printer	Printer is out of paper.
13	SLCT	Printer	Printer is on-line.
14	AUTO FEED XT L	Terminal	Feed 1 line automatically after printing.

(continued on next page)

**Table 10–1 (Cont.) Parallel Connector Signals**

Pin	Signal Name	Source	Function
15	ERROR L	Printer	Paper end, printer off-line, or printer error
16	INIT L	Terminal	Resets the printer to power-on defaults
17	SLCT IN L	Terminal	The VT520 monitors SLCT to determine if a parallel printer is attached and on-line.
18	GROUND	N/A	
19	GROUND	N/A	
20	GROUND	N/A	
21	GROUND	N/A	
22	GROUND	N/A	
23	GROUND	N/A	
24	GROUND	N/A	
25	GROUND	N/A	

The VT520 uses the eight data lines along with control signals STROBE, ACKNLG, and BUSY to transfer data to the printer. All other interface signals are ignored.

### 10.3.1 Parallel Port Flow Control

Characters are transferred to the printer in 8-bit bytes. A parallel printer port is not duplex; data can only go from the terminal to the printer.

The terminal and the printer use interface signals STROBE, ACKNLG, and BUSY to synchronize the data transfer as follows:

1. When the terminal is ready to send data to the printer, the terminal puts the data on the data lines and then generates a STROBE pulse to the printer.
2. When the printer senses the STROBE, it responds with a BUSY signal.
3. When printer receives the data, it pulses ACKNLG to signal the terminal that data has been read into memory.
4. If the printer buffer is full, the printer keeps the BUSY signal asserted.

The parallel printer port does not recognize XON/XOFF flow control.

## 10.4 Print Modes

There are five modes that affect the control of printing operations:

- Printer Controller mode
- Local Controller mode
- Auto Print mode
- Print Form Feed mode
- Print Extent mode

These print modes follow standard terminal transmission except for Printer Controller mode.

## Printer Port

### 10.4 Print Modes

#### 10.4.1 Printer Controller Mode

When printer controller mode is enabled, all data received at the host port is passed through to the printer port, except for:

XON/XOFF when XON/XOFF flow control is enabled at either the host port or the printer port

NUL when **Ignore NUL characters** is selected in the communication setup.

If printer-to-host communication is enabled, then all data received at the printer port is passed through to the host port with the exceptions listed previously.

### 10.5 Print Operation

The VT520 supports the following print operations:

- Print Line
- Print Page or Scrolling Region
- Print Screen

Print Screen prints the screen as it appears, including the status lines if enabled. Print Screen, however, does not print the keyboard indicator line.

### 10.6 Transmitting Print Data

Users have three choices for a printer type:

- DEC ANSI
- IBM ProPrinter
- DEC + IBM emulation mode

Depending on the printer type selected, the terminal transmits different control functions to the printer. You can select the printer type in Set-Up or by using the escape sequence, DECSPPRT.

#### 10.6.1 DEC ANSI

The DEC ANSI protocol supports the following printed data types:

- When in 8-bit mode:
  - ASCII only
  - ASCII + Line Drawing
- When in 7-bit mode:
  - National only
  - National + Line Drawing

You select a printed data type based on the 7- or 8-bit printer port setting and the character set capability of the attached printer. The VT520 sends initialization, transmission, and closing sequences according to the printed data type selected.

If IBM PC characters are displayed, then the terminal translates the corresponding characters in the ISO Latin-1 character set and transmits them based on the current printed data type selected. If there is no corresponding character in ISO Latin-1, then the Space character is used instead.

### 10.6.2 IBM ProPrinter or Compatible Printer

When an IBM ProPrinter is attached, the terminal sends IBM ProPrinter sequences. You can neither designate, nor invoke the ANSI sequence or any other operating sequences in this mode.

The VT520 supports the following printer character sets for the IBM printer: PC Multilingual, PC Latin 2 (PC Slavic), PC International, PC Spanish, PC Portuguese, PC Danish, PC French Canadian, PC Hebrew, PC Greek, PC Turkish, and PC Cyrillic.

During initialization, the VT520 sends a control sequence to the printer to select the same code page as the printer character set selected in the terminal. You must select the appropriate printer character set for the correct data to be printed either in Set-Up or by the escape sequence, DECSPPCS.

In an IBM ProPrinter, each code page has the following character sets:

- Character Set 1
- Character Set 2
- Same as receive
- All Characters

The character sets are identical, except for the interpretation of C0 (0/0 through 1/15) and C1 (8/0 through 9/15) characters.

In Character Set 1, the controls in C0 are identical to those in C1, except that 80 (hex) is ignored instead of being interpreted as NUL.

Character Set 2 uses the same controls as C0, except that some printable characters are added to unused character code spaces. The C1 region is all printable characters.

**Same as receive** uses IBM ProPrinter sequences with control codes or without host control codes.

The “All Characters” set only has printable characters. No control codes are allocated to this character set.

The VT520 initializes the printer to use Character Set 2 at the start of a print screen operation. When a C0 printable character is encountered, the VT520 sends the appropriate sequence to print from the “All Characters” set. See the Set-Up chapter for detailed description on selecting these character sets.

#### 10.6.2.1 Data Transmission

The printer is either an IBM personal printer or a compatible printer. It recognizes the IBM ProPrinter mode escape sequences and supports the terminal's code pages. The printer should support a software-selectable code page switching sequence. If it does not, then you need to take appropriate action to set the correct code page before a printing operation takes place.

## Printer Port

### 10.6 Transmitting Print Data

Each time a print operation is requested, the VT520 sends the following escape sequences:

Escape Sequence	Meaning
ERSCS	Selects code page
ERC02	Selects Character Set 2

Characters are sent to the printer along with their display attributes. If a C0 printable character is encountered, the VT520 sends the escape sequence, ERSSACS or ERC0ACS, to print from the "All Characters" set. If a character that is not in the selected code page is encountered, then a Space character is sent instead.

The VT520 supports the following display attributes sequences:

Display Attribute Sequence	Meaning
EREDHW	Sets double-height and width
EREBD	Enables bold
ERDBD	Disables bold
EREUL	Sets underline
ERDUL	Resets underline

The VT520 supports the following character set switching sequences:

Switching Sequence	Meaning
ERSSACS	Prints a single character from "All Characters" set
ERC0ACS	Prints multiple characters from "All Characters" set

If the terminal has DEC Supplemental or ISO Latin 1 characters on the screen, then the VT520 translates the characters to corresponding characters in the code page indicated by the printer character set before the transmission takes place. If there is no corresponding character in the selected IBM code page, then the Space character is used instead.

The line and display attributes of the printer should be switched back to the default state when printing is completed.

#### 10.6.3 DEC ANSI with IBM ProPrinter Emulation

You can specify both DEC ANSI printed data types and IBM ProPrinter PC character sets in Set-Up when this type of printer is selected. If the terminal is set to display DEC or ISO character sets, then the VT520 treats the printer as a DEC ANSI printer and transmits data to the attached printer using ANSI protocols.

If the terminal is set to display PC character sets, then the VT520 transmits data to the attached printer using the IBM ProPrinter protocol. During initialization, the VT520 sends a Select Other Coding System (SOCS) sequence followed by DECIPEM sequence to the printer to force the printer into IBM ProPrinter emulation mode. The terminal sends all other sequences just as in the IBM ProPrinter mode.



### 10.6.3.1 Data Transmission

The printer is a DEC ANSI printer with IBM ProPrinter emulation. The printer is in its default ANSI mode state. The printer recognizes IBM ProPrinter mode escape sequences and supports the IBM code pages. The printer supports the software selectable code page switching sequence. If it does not, then you must take appropriate action to set the correct code page before a printing operation takes place.

Each time a print operation is requested, the VT520 sends the following escape sequences to initialize the attached printer to a known state:

Escape Sequences	Function
SOCS	Enters IBM ProPrinter mode
DECIPEM	Enters IBM ProPrinter mode
ERSCS	Selects code page
ERC02	Selects Character Set 2

The line and display attributes of the printer return to the default state when printing is completed by sending the following sequences:

Sequence	Function
ROCS	Returns from other coding system
DECIPEM	Returns from IBM emulation mode

## 10.7 Printer Status

The Session Management Extension is supported, so the terminal responds with "Printer Busy" and "Printer Not Assigned."

If the printer stalls, the word "Printer" flashes continuously in the Indicator Status Line.

## 10.8 Suspending Print Operations

Entering Set-Up can suspend, but not abort, printing operations. Upon exit from Set-Up, all unfinished printing operations resume unless an explicit action has been taken in Set-Up to abort the print operation, such as **Clear communications**, **Reset terminal**, or **Restore factory defaults**.

## 10.9 Aborting Print Operations

The **Clear communications** function from Set-up, aborts the current print operation, clears the output silo, and re-initializes the printer port UART. This function may be used to get out of a "hung" state.

---

### Note

---

After a **Clear communications** command, printing may not stop immediately because characters may still be in the printer's input buffer.

---



# Part III

---

## VT520 ASCII Emulation

This part contains the following chapters:

- Chapter 11, ASCII Emulations and Control Functions
- Chapter 12, ASCII Escape Sequences
- Chapter 13, Defining and Loading ASCII Character Fonts



---

## ASCII Emulations and Control Functions

This chapter describes the ASCII emulations and control functions.

### 11.1 Overview

The VT520 video terminal includes emulations for several popular ASCII video terminals. ASCII terminals represent the other major class of serial asynchronous video terminals in widespread use today. Like the VT100, these terminals communicate with a host computer by transmitting and receiving a data stream of 7-bit or 8-bit coded characters. To communicate successfully, the computer and the terminal use a convention for interpreting this data stream. This convention specifies how to recognize characters in the data stream as well as how to recognize control information, such as formatting or editing commands. ASCII terminals support the ASCII character set, *American Standard Code for Information Interchange, ANSI X3.4*; however, they do not follow other ANSI standards that define controls for use with the ASCII character set. The original ASCII terminal protocol pre-dates the ANSI standards. These early protocols have since been widely copied and extended to form the ASCII terminal market.

### 11.2 ASCII Emulations

The VT520 includes a protocol emulation for the WYSE 325 color mode, WYSE 160 Native mode, WYSE 60 Native mode, and many of its popular emulations of other ASCII terminals:

- WYSE 325
- WYSE 160/60 Native mode
- WYSE PCTerm
- WYSE 50/50+
- WYSE 150/120
- Televideo 950
- Televideo 925
- Televideo 910+
- ADDS VP A2

Emulation means that virtually all host application programs designed for these terminals will function correctly.

Note that the VT520 video terminal cannot be identical to all of these terminals simultaneously, and the VT520 includes enhancements in its user interface and character handling ability. The VT520 can handle additional languages and keyboards that extend beyond the original terminals being emulated.

## ASCII Emulations and Control Functions

### 11.2 ASCII Emulations

The VT520 does not emulate the graphics modes of the WYSE 160, such as the TEK 4010/4014 personality.

#### 11.2.1 Enhanced Mode

WYSE 160 Native mode includes function sequences for almost all features supported by the WYSE 160 terminal, including those supported by individual sub-emulations, such as Televideo or ADDS. When one of these sub-emulations is selected, WYSE Enhanced mode (EnH) allows WYSE Native mode sequences to be used from within a sub-emulation to access features that are not normally supported by the physical terminal being emulated. This capability allows existing applications, for one of these emulated terminals, to be enhanced to take advantage of WYSE Native mode features. This enhanced mode does not apply to the VT or ANSI modes, which follow the corresponding ANSI standards.

### 11.3 Coding Notation

Since ASCII control functions do not follow a structured syntax, the notation used to describe function sequences and parameters is important to avoid confusion. Escape sequences are shown with a space between each character to make them easier to read. These spaces are not part of the Escape sequence.

**Words in all caps:** Strings of two or more capital letters, such as ESC or SPACE, are used as symbols, usually to represent a single character within an Escape sequence.

**Words in italics:** Words or abbreviations of two or more characters in *italics* represent sequence parameters that are described subsequently.

**Single characters:** Single characters, such as "E" or "8", represent the corresponding ASCII character in the sequence.

**Regular text (upper- and lowercase):** Regular text is sometimes used to describe sequences that are similar or related to other sequences.

Table 11–1 lists the symbols used in the ASCII control functions.

**Table 11–1 Symbols Used in ASCII Terminal Escape Sequences**

Symbol	Meaning	Symbol	Meaning
Ctrl-	Ctrl immediately followed by a single character represents a control character in the range of 0/0 to 1/15.	EnH	Enhance Mode: This is the same as the WYSE native code when Enhance Mode is on.
Same	Same as the WYSE native code (code is native to this emulation).	Wyse	Same as the WYSE native code (code is <i>not</i> native to this emulation, but is a WYSE enhancement).
n/a	Not available in this emulation.		

(continued on next page)

**Table 11–1 (Cont.) Symbols Used in ASCII Terminal Escape Sequences**

Symbol	Code	Symbol	Code
NUL	0/0	DLE	1/0
SOH	0/1	DC1 (XON)	1/1
STX	0/2	DC2	1/2
ETX	0/3	DC3 (XOFF)	1/3
EOT	0/4	DC4	1/4
ENQ	0/5	NAK	1/5
ACK	0/6	SYN	1/6
BEL	0/7	ETB	1/7
BS	0/8	CAN	1/8
HT	0/9	EM	1/9
LF	0/10	SUB	1/10
VT	0/11	ESC	1/11
FF	0/12	FS	1/12
CR	0/13	GS	1/13
SO	0/14	RS	1/14
SI	0/15	US	1/15
SPACE	4/0		

### 11.3.1 Communication Flow Control with PCTerm Mode

XON/XOFF transmit flow control is disabled while in PCTerm mode. This means XON and XOFF characters received from the host are ignored or displayed as characters from a PC character set. In PCTerm mode, the keyboard generates scan codes. There are no multi-character reports (escape sequences or paste data) sent from the terminal. The terminal can still send XPC as receive flow control.

When switching out of PCTerm mode, the XON/XOFF state of the communications link is unknown. If XON/XOFF flow control is enabled, then the terminal shall transmit a single XON and clear the XOFF received state.

### 11.3.2 Protecting Data

Turning on Write-Protect mode does not start protecting the data. It only defines the range of data that needs to be protected. Not until Protect mode is turned on does the data become protected. Changing emulation does not change the Write-Protect mode. Characters range from 1/0 to 1/15, and embedded attributes are automatically write-protected even when Write-Protect mode is off.

To protect a certain area of data in the screen, users should:

1. Turn on Write-Protect mode.
2. Turn off Write-Protect mode, if the protected area has been defined.
3. Turn on Protect mode.

## ASCII Emulations and Control Functions

### 11.3 Coding Notation

**Protect Mode On:** The protect condition usually is valid for the current page only. The exception is when Autopage mode is on, if a cursor movement command causes the cursor to move from one protected page to an unprotected page, the unprotected page becomes protected. If a cursor movement command causes the cursor to move from an unprotected page to a protected page, then the protected page becomes unprotected. Table 11–2 lists these commands.

**Table 11–2 Commands that may Carry Protect Mode Features through Pages**

Command	Sequence
Cursor left (backspace)	Ctrl/H
Cursor left (delete)	DEL
Cursor right	Ctrl/L
Cursor up; Scroll	ESC j
Cursor down; Scroll (linefeed)	Ctrl/J
Cursor to start of next line	Ctrl/_
Tabulate cursor	ESC i or Ctrl/I
Backtab	ESC I

- Turning on Protect mode enables Line Edit mode. The terminal ignores the command to enable Page Edit mode. Editing command activities are limited to the unprotected data. Any protected line can neither be inserted nor be deleted.
- No cursor movement commands can cause data, protected or unprotected, to scroll off the page.
- The tabulation cursor becomes the field tab.
- Changing emulation turns off Protect mode, except when changing the terminal to a TVI emulation; in which case, the Protect mode does not change.
- Some cursor commands can move the cursor into the protected area, some cannot.

Table 11–3 lists the commands that can move the cursor to the protected area. Even if the cursor can be moved into the protected area by executing these commands, no data can be written into the area. The cursor jumps to the first unprotected position when data started writing into the screen.

Table 11–4 lists the commands that cannot move the cursor to the protected area. Any attempt to move the cursor to the protected area by executing these commands, moves the cursor up, down, left, or right into the first unprotected position.



## ASCII Emulations and Control Functions

### 11.3 Coding Notation

**Table 11–3 Commands that Can Move the Cursor to Protected Area**

<b>Move Cursor . . .</b>	<b>Sequence</b>
Up; scroll (reverse linefeed)	ESC j
Down; no scroll	Ctrl/V
To specific line	ESC [ <i>line</i>
To a specific column	ESC <i>_column</i>
In current page	ESC = <i>line col</i>
To a specific page	ESC h <i>page</i>
In specific 80-column page	ESC w @ <i>page line col</i>
In specific 80-column window	ESC - <i>wnd/page line col</i>
In 80/132-column current page	ESC a <i>ll R ccc C</i>

**Table 11–4 Commands that Cannot Move Cursor into Protected Area**

<b>Move Cursor . . .</b>	<b>Sequence</b>
Left (backspace)	Ctrl/H †
Left (delete)	DEL
Right	Ctrl/L
Up; No scroll	Ctrl/K †‡
Down; Scroll (linefeed)	Ctrl/J
To start of line	Ctrl/M
To start of next line	Ctrl/_
Home	ESC { or Ctrl/^

†The cursor can be moved to a protected field under certain conditions. Refer to the specific cursor command section for details.

‡Cursor can be moved to a protected field for TVI personalities.



## ASCII Escape Sequences

This chapter summarizes the ASCII escape and control Sequences that the VT520 recognizes when it is operating in its ASCII emulation modes.

### 12.1 ASCII Communications

Table 12–1 lists the serial port control functions for each mode. The word “same” in Table 12–1 signifies the same control sequence as the WYSE 325/160/60 column.

**Table 12–1 Serial Port Control Functions**

ACK Mode	WYSE				TVI			ADDS
	325/160/60	PCTerm	150/120	50/50+	950	925	910+	A2
ACK Mode On (default)	ESC e 7	n/a	same	same	EnH	EnH	EnH	EnH
ACK Mode Off	ESC e 6	n/a	same	same	EnH	EnH	EnH	EnH
<b>Answerback Mode</b>								
Answerback Off (default)	ESC e Sp	n/a		same	n/a	n/a	n/a	EnH
Answerback On	ESC e !	n/a	same	same	n/a	n/a	n/a	n/a
Answerback Message	ESC c ; <i>answer</i> Ctrl/Y							
			ESC ] <i>answer</i> Ctrl/M					
			same	same	n/a	n/a	n/a	EnH
Send Answerback message – Format 1:	ESC c <	n/a	same	same	n/a	n/a	n/a	EnH
Format 2:	Ctrl/E	same	same	same	same	same	same	EnH
Conceal Answerback	ESC c =	n/a	same	same	n/a	n/a	n/a	EnH
<b>Assign Serial Ports</b>								
S1=comm1 (host)	ESC e 8	n/a	same	same	EnH	EnH	EnH	EnH
S1=comm2 (host)	ESC e 9	n/a	same	same	EnH	EnH	EnH	EnH
<b>Monitor Mode</b>								
Monitor Mode Off (default)	ESC u or ESC X	same	same	same	same	same	same	EnH on or off
Monitor Mode On	ESC U	same	same	same	same	same	same	EnH

(continued on next page)

# ASCII Escape Sequences

## 12.1 ASCII Communications

Table 12–1 (Cont.) Serial Port Control Functions

Receive Null	WYSE				TVI			ADDS
	325/160/60	PCTerm	150/120	50/50+	950	925	910+	A2
Ignore Null Characters from Host (default)	ESC e R	n/a	same	same	EnH	EnH	EnH	EnH
Accept Null Characters from Host	ESC e S	n/a	same	same	EnH	EnH	EnH	EnH
<b>Set Serial Port Parameters</b>								
Set Comm1 parameters	ESC c 0	<i>Baud Stop Parity Word</i>			ESC { <i>Baud Stop Parity Word</i>			
		n/a	same	same		n/a	n/a	EnH
Set Comm2 parameters	ESC c 1	<i>Baud Stop Parity Word</i>			ESC } <i>Baud Stop Parity Word</i>			
		n/a	same	same		n/a	n/a	EnH
		<u>Baud (Comm1)</u>	<u>Baud (Comm2)</u>		<u>Description</u>			
		D	N/A		115200			
		B	N/A		76800			
		C	N/A		56700			
		0	@ (4/0)		38400			
		1	0 (3/0)		19200			
		2	1 (3/1)		9600			
		3	3 (3/3)		4800			
		4	5 (3/5)		2400			
		7	8 (3/8)		1200			
		8	9 (3/9)		600			
		9	: (3/10)		300			
		<u>Stop</u>	<u>Description</u>					
		0 (3/0)	1 Stop Bit (default)					
		1 (3/1)	2 Stop Bits					
		<u>Word</u>	<u>Description</u>					
		0 (3/0)	7 bits					
		1 (3/1)	8 bits (default)					
		<u>Parity</u>	<u>Description</u>					
		0 (3/0)	No Parity (default)					
		1 (3/1)	Odd Parity					
		2 (3/2)	Mark Parity					
		3 (3/3)	Even Parity					
		4 (3/4)	Space Parity					

(continued on next page)

## ASCII Escape Sequences 12.1 ASCII Communications

**Table 12–1 (Cont.) Serial Port Control Functions**

	WYSE				TVI			ADDS	
	325/160/60	PCTerm	150/120	50/50+	950	925	910+	A2	
<b>Serial Port Handshaking</b>									
Set Comm1 Receive	ESC c 2 <i>Handshaking</i>								
	n/a		same	same	n/a	n/a	n/a	EnH	
Set Comm2 Receive	ESC c 3 <i>Handshaking</i>								
	n/a		same	same	n/a	n/a	n/a	EnH	
Set Comm1 Transmit	ESC c 4 <i>Handshaking</i>								
	n/a		same	same	n/a	n/a	n/a	EnH	
Set Comm2 Transmit	ESC c 5 <i>Handshaking</i>								
	n/a		same	same	n/a	n/a	n/a	EnH	
	<u>Handshaking</u>		<u>Receive Flow Control</u>		<u>Transmit Flow Control</u>				
	0		None		None (default)				
	1		XON-XOFF/XPC (default)		XON/XOFF				
	2		DTR		DSR				
	3		XON-XOFF/XPC and DTR		XON/XOFF and DSR				
Set Host port Receive to DTR	n/a	Ctrl/N	n/a	n/a	Ctrl/N	Ctrl/N	Ctrl/N	n/a	
Set Host port Receive to XON/XOFF or XPC	n/a	Ctrl/O	n/a	n/a	Ctrl/O	Ctrl/O	Ctrl/O	n/a	
<b>Set Duplex Mode</b>									
Full-Duplex On (default)	ESC D F	ESC }	same	same	same	same	same	EnH	
Half-Duplex On	ESC D H	ESC {	same	same	same	same	same	EnH	
<b>Set Block Mode</b>									
Block Mode Off (default)	ESC C	same	same	same	Wyse	Wyse	Wyse	EnH	
Block Mode On	ESC B	same	same	same	same	same or ESC c	same or ESC c	EnH	
<b>Set Local Mode</b>									
Set Local Mode	n/a	n/a	n/a	n/a	ESC c	n/a	n/a	n/a	
<b>Set Maximum Transmit Rate Limit</b>									
Transmit Speed	ESC c 6 <i>Max</i>								
Function Keys	ESC c 7 <i>Max</i>								
	<u>Max</u>		<u>Characters Per Second</u>						
	0		30						
	1		50						
	2		No Limit (default)						
	3		150						

# ASCII Escape Sequences

## 12.2 Terminal Management

### 12.2 Terminal Management

Table 12–2 lists the terminal management control functions. The word “same” in Table 12–2 signifies the same control sequence as in the WYSE 325/160/60 column.

**Table 12–2 Terminal Management Control Functions**

Select Terminal	WYSE				TVI			ADDS	
	325/160/60	PCTerm	150/120	50/50+	950	925	910+	A2	
ADD5 VP A2	ESC ~ %	ESC v %	same as 325/160/60	same	Wyse	Wyse	Wyse	Wyse	
TVI 950	ESC ~ (	ESC v (	same	same	Wyse	Wyse	Wyse	Wyse	
TVI 925	ESC ~ \$	ESC v \$	same	same	Wyse	Wyse	Wyse	Wyse	
TVI 910	ESC ~ #	ESC v #	same	same	Wyse	Wyse	Wyse	Wyse	
VT520, 7-bit	ESC ~ <	ESC v <	same	same	Wyse	Wyse	Wyse	Wyse	
VT520, 8-bit	ESC ~ =	ESC v =	same	same	Wyse	Wyse	Wyse	Wyse	
VT100	ESC ~ ;	ESC v ;	same	same	Wyse	Wyse	Wyse	Wyse	
VT52	ESC ~ 6	ESC v 6	same	same	Wyse	Wyse	Wyse	Wyse	
WYSE 160/60	ESC ~ 4	ESC v 4	same	same	Wyse	Wyse	Wyse	Wyse	
WYSE 160/60 PCTerm	ESC ~ 5	ESC v 5	same	same	Wyse	Wyse	Wyse	Wyse	
WYSE 150/120	ESC ~ 4	ESC v 4	same	same	Wyse	Wyse	Wyse	Wyse	
WYSE 50+	ESC ~ "	ESC v "	same	same	Wyse	Wyse	Wyse	Wyse	
<b>Send Terminal ID</b>									
Inquire emulation ID	ESC Sp <u>Emulation</u> WYSE 160/60 WYSE 150/120 WYSE 50+ ADD5 VPA2 TVI 910+ TVI 925 TVI 950	n/a	same <u>Response</u> 160 160 50 160 925 REV I 925 REV I 1.0	same	ESC M <u>Response in Column/Row Format</u> (3/1 3/6 3/0 0/13) (3/1 3/6 3/0 0/13) (3/5 3/0 0/13) (3/1 3/6 3/0 0/13) (3/9 3/2 3/5 2/0 5/2 4/5 5/6 2/0 4/9 0/13) (3/9 3/2 3/5 2/0 5/2 4/5 5/6 2/0 4/9 0/13) (3/1 2/14 3/0 2/0 0/13)	ESC M	ESC M	ESC M	EnH
<b>Set Enhanced Mode</b>									
Enhanced Mode On (default)	ESC ~ !	ESC v !	same	same	Wyse	Wyse	Wyse	Wyse	
Enhanced Mode Off	ESC ~ Sp	ESC v Sp	same	same	Wyse	Wyse	Wyse	Wyse	
<b>Save Set-Up Modes</b>									
To NVM (except Tabs)	ESC c V	n/a	same	same	n/a	n/a	n/a	EnH	
To NVM with Tabs	ESC c W	n/a	same	same	n/a	n/a	n/a	EnH	

(continued on next page)

**Table 12–2 (Cont.) Terminal Management Control Functions**

	WYSE				TVI			ADDS
	325/160/60	PCTerm	150/120	50/50+	950	925	910+	A2
<b>Select Terminal Defaults</b>								
PCTerm Mode Group <sup>1</sup>	n/a	ESC m	n/a	n/a	n/a	n/a	n/a	n/a
All Modes <sup>2</sup>	ESC c T	n/a	same	same	n/a	n/a	n/a	EnH
Power On Reset	ESC c X	n/a	same	same	n/a	n/a	n/a	EnH
<b>Load/Send Time of Day</b>								
Load Time of Day <sup>3</sup>	ESC c 8 Hr Min				ESC Sp 1 a/p Hr Min			EnH
			same	same				
Send Time of Day	n/a	ESC Sp 2	n/a	n/a	ESC Sp 2	ESC Sp 2	ESC Sp 2	n/a

<sup>1</sup>Sets the following parameters for PCTerm mode:

- Autscroll = On
- Received CR = CR
- Communication Mode = Full Duplex
- Enhanced Mode = Off
- Wrap EOL = Off
- Attribute = Char

<sup>2</sup>Sets the parameters shown in Table 11-2.

<sup>3</sup>Hour ranges from 00 to 23; Minute ranges from 00 to 59 decimal. Entering "00" in hour is displayed as 12 AM. The a/p is a single character—a = AM, p = PM.

## 12.3 Keyboard Processing

Table 12–3 lists the keyboard processing control functions. The word “same” in Table 12–3 signifies the same control sequences as in the WYSE 325/160/60 column.

**Table 12–3 Keyboard Processing Control Functions**

	WYSE				TVI			ADDS
	325/160/60	PCTerm	150/120	50/50+	950	925	910+	A2
<b>Locking the Keyboard</b>								
Unlock keyboard (default)	Ctrl/N or ESC "	ESC "	same	same	ESC "	ESC "	ESC "	Ctrl/B ESC 6
Lock keyboard	Ctrl/O or ESC #	ESC #	same	same	ESC #	ESC #	ESC #	Ctrl/D ESC 5
<b>Enable/Disable Key Repeat</b>								
Key Repeat On (default)	ESC e -	n/a	same	same	EnH	EnH	EnH	EnH
Key Repeat Off	ESC e ,	n/a	same	same	EnH	EnH	EnH	EnH

(continued on next page)

## ASCII Escape Sequences

### 12.3 Keyboard Processing

Table 12–3 (Cont.) Keyboard Processing Control Functions

	WYSE				TVI			ADDS
	325/160/60	PCTerm	150/120	50/50+	950	925	910+	A2
<b>Caps Lock</b>								
Caps Lock off	ESC e ´	ESC Sp M	same	same	EnH	EnH	EnH	EnH
Caps Lock on	ESC e &	ESC Sp L	same	same	EnH	EnH	EnH	EnH
Lock key=Caps Lock (default)	ESC e T	n/a	same	same	EnH	EnH	EnH	EnH
Lock key=Shift Lock	ESC e V	n/a	same	same	EnH	EnH	EnH	EnH
Lock key=Reverse Lock	ESC e U	n/a	same	same	EnH	EnH	EnH	EnH
<b>Num Lock</b>								
Num Lock off	ESC e @	ESC Sp K	same	same	EnH	EnH	EnH	EnH
Num Lock on	ESC e A	ESC Sp J	same	same	EnH	EnH	EnH	EnH
<b>Scroll Lock</b>								
Scroll Lock off	ESC e B	ESC Sp O	same	same	EnH	EnH	EnH	EnH
Scroll Lock on	ESC e C	ESC Sp N	same	same	EnH	EnH	EnH	EnH
<b>Keycode Mode</b>								
ASCII Key Codes <sup>1</sup>	ESC e H	ESC c	same	same	EnH	EnH	EnH	EnH
PC Scan Codes	ESC e I	ESC H	same	same	EnH	EnH	EnH	EnH
<b>Request Modifier Keys Status</b>								
Inquiry	n/a	ESC [	n/a	n/a	n/a	n/a	n/a	n/a
		Report: 81(Hex) + <i>a</i>						
		where <i>a</i> indicates the modifier key being pressed as follows:						
		<u>Bit</u>	<u>Modifier Key</u>					
		0	Caps lock					
		1	Always 0					
		2	Always 0					
		3	Scroll lock On					
		4	Alt					
		5	Ctrl					
		6	Num lock On					
		7	Shift key					
<b>Margin Bell</b>								
	325/160/60	PCTerm	150/120	50/50+	950	925	910+	A2

<sup>1</sup>Default for all but PCTerm mode.

(continued on next page)



## ASCII Escape Sequences 12.3 Keyboard Processing

**Table 12–3 (Cont.) Keyboard Processing Control Functions**

	WYSE				TVI			ADDS
	325/160/60	PCTerm	150/120	50/50+	950	925	910+	A2
<b>Margin Bell</b>								
Sound Bell	Ctrl/G	same	same	same	same	same	same	same
Select Bell tone	ESC c \ <i>Tone</i>	n/a	same	Wyse	n/a	n/a	n/a	EnH
	<u><i>Tone</i></u>	<u>Description</u>						
	0	Off						
	1	Low pitch						
	2	High pitch						
	3	High pitch						
Margin Bell off (default)	ESC e L	ESC n	same	same	EnH	EnH	EnH	EnH
Margin Bell on <sup>2</sup>	ESC e M	ESC o	same	same	EnH	EnH	EnH	EnH
Set Margin Bell at cursor	ESC ` J	n/a	same	same	n/a	n/a	n/a	EnH
Set Margin Bell on and set position	n/a	ESC o	n/a	n/a	n/a	n/a	n/a	n/a
<b>Keyclick</b>								
On (default)	ESC e %	ESC >	same	same	ESC >	ESC >	ESC >	EnH
Off	ESC e \$	ESC <	same	same	ESC <	ESC <	ESC <	EnH
	WYSE				TVI			ADDS
	325/160/60	PCTerm	150/120	50/50+	950	925	910+	A2
<b>Redefining Keys<sup>3</sup></b>								
Program Function keys <sup>4</sup>	ESC z <i>Fkey Seq</i> DEL	n/a	same	same	Wyse	Wyse	Wyse	EnH
	<u>Fkey Unshifted</u>		<u>Fkey Shifted</u>	<u>VT Keyboard</u>		<u>Enhanced PC Keyboard</u>		
	@		`		F1			
	A		a		F2			
	B		b		F3			
	C		c		F4			
	D		d		F5			
	E		e	F6		F6		
	F		f	F7		F7		
	G		g	F8		F8		
	H		h	F9		F9		
	I		i	F10		F10		
	J		j	F11		F11		
	K		k	F12		F12		
	L		l	F13				
	M		m	F14				
	N		n	F15				
	O		o	F16				

<sup>2</sup>Default = 72 for 80-column mode; 124 for 132-column mode.

<sup>3</sup>See Table 12–4 for redefinable keys.

<sup>4</sup>*Seq* is an ASCII character data string sequence. Any 7-bit character except "DEL" (Hex 7F) is legal for the sequence.

(continued on next page)

## ASCII Escape Sequences

### 12.3 Keyboard Processing

Table 12–3 (Cont.) Keyboard Processing Control Functions

	WYSE				TVI			ADDS	
Program Key Direction	325/160/60	PCTerm	150/120	50/50+	950	925	910+	A2	
Program Key Direction	325/160/60	PCTerm	150/120	50/50+	950	925	910+	A2	
Program Key Direction	ESC Z <i>Dir Key Seq</i>	DEL	same	same	ESC   <i>FKey Dir Seq</i>	Wyse	Wyse	EnH	
<b>Key-Sent direction</b>	<b>Communication Mode</b>		<b>Key Definition is Sent to . . .</b>						
	Local		Terminal screen only						
	Remote		Host only						
	Normal		Depending on Comm mode:						
	Full-duplex		Host only						
	Half-duplex		Both the host and the terminal screen						
	Block		Terminal screen only						
	Half Block		Both the host and the terminal screen						
	<u>Dir</u>	<u>Key Transmission Direction</u>							
	0	Normal							
	1	Remote (default)							
	2	Local							
	3	Normal (TVI950 and WYSE 325/160/60 PCTerm only)							
	WYSE				TVI			ADDS	
Inquire Key Direction	325/160/60	PCTerm	150/120	50/50+	950	925	910+	A2	
Inquiry:	ESC Z ~ <i>Key</i>	n/a	same	same	n/a	Wyse	Wyse	EnH	
Response:	<i>Dir Key Sequence</i> DEL								
<b>Clear Key Definitions</b>									
Clear Function key direction and definition	ESC z <i>Fkey</i>	DEL	n/a	same	same	Wyse	Wyse	Wyse	EnH
Set key direction and Clear key definition	ESC Z <i>Dir Key</i> DEL								
Clear all redefinable key definitions	ESC c U	n/a	same	same	n/a	Wyse	Wyse	EnH	
		n/a	same	same	n/a	n/a	n/a	EnH	

## ASCII Escape Sequences 12.3 Keyboard Processing

Table 12-4 lists the redefinable keys.

**Table 12-4 Redefinable Keys**

Emulation	Redefinable Keys			
	<u>Unshifted</u>	<u>Shifted</u>	<u>VT Keyboard</u>	<u>EPC Keyboard</u>
WYSE 325/160/60, WYSE 150/120, WYSE 50+, TVI925, and TVI 910	SP	%		ESC
	!	&	Tab	Tab
	"	'	Backspace	Backspace
	#	(	Remove	
	\$	)	Return	Enter
	*	/	Select	Home
	+	0	↑	↑
	,	1	↓	↓
	-	2	←	←
	.	3	→	→
	s	4	Enter	Enter (keypad)
	q	p	PF4	Insert
	r	w		Page Down
	}	z	PF3	
	5	6	PF2	Delete
	7	8	PF1	
	R	X		Print Screen
	:	;		Page Up
	\	]		End
	Q	W	F17	
S	Y	F18		
T	Z	F19		
P	V	F20		
<hr/>				
WYSE 325/160/60 PCTerm	<u>Fkey Unshifted</u>		<u>VT Keyboard</u>	<u>EPC Keyboard</u>
	1	!	F1	F1
	2	@	F2	F2
	3	#	F3	F3
	4	\$	F4	F4
	5	%	F5	F5
	6	^	F6	F6
	7	&	F7	F7
	8	*	F8	F8
	9	(	F9	F9
	0	)	F10	F10

(continued on next page)

## ASCII Escape Sequences

### 12.3 Keyboard Processing

Table 12–4 (Cont.) Redefinable Keys

Emulation	Redefinable Keys			
TVI 950	<u>Fkey</u>	<u>Fkey</u>	<u>VT Keyboard</u>	<u>Enhanced PC Keyboard</u>
	1	<	F1	F1
	2	=	F2	F2
	3	>	F3	F3
	4	?	F4	F4
	5	@	F5	F5
	6	A	F6	F6
	7	B	F7	F7
	8	C	F8	F8
	9	D	F9	F9
	:	E	F10	F10
	;	F	F11	F11
	G	L	F12	F12
	H	M	F13	
	I	N	F14	
	J	O	F15	
	K	P	F16	

## 12.4 Screen Processing

Table 12–5 lists the screen processing control functions. The word “same” in this table signifies the same control sequences as in the WYSE 325/160/60 column.

Table 12–5 Screen Processing Control Functions

Video Display Features	WYSE				TVI			ADDS
	325/160/60	PCTerm	150/120	50/50+	950	925	910+	A2
Border Display (Overscan On/Off)	ESC c   <i>Intensity</i>							
		n/a	same	same	n/a	n/a	n/a	EnH
<b>Parameters:</b>	<u><i>Intensity</i></u>	<u>Overscan</u>						
	0	Off (default)						
	1	On						
Screen Display On (default)	ESC ` 9	ESC N	same	same	ESC n	ESC n	ESC n	EnH
Screen Display Off	ESC ` 8	ESC O	same	same	ESC o	ESC o	ESC o	EnH
Normal background <sup>1</sup>	ESC ^ 0	ESC d	same	same	ESC d	ESC d	ESC d	EnH
Reverse background	ESC ^ 1	ESC b	same	same	ESC b	ESC b	ESC b	EnH
Screen Saver on (default)	ESC e Q	n/a	same	same	EnH	EnH	EnH	EnH
Screen Saver off	ESC e P	n/a	same	same	EnH	EnH	EnH	EnH

<sup>1</sup>Assigning parameters "6," "7" or "A" clears previously defined write-protected attributes. "B" through "G" add on top of previous attribute(s) and display a combination of new and old display attributes.

(continued on next page)

Table 12–5 (Cont.) Screen Processing Control Functions

Scroll Type	WYSE				TVI			ADDS
	325/160/60	PCTerm	150/120	50/50+	950	925	910+	A2
WYSE Mode	ESC ` <i>Scroll</i>	n/a	same	same	n/a	n/a	n/a	EnH
<b>Parameters:</b>	<i>Scroll</i> @ <, = >, ?	<b>Scrolling Type</b> <sup>2</sup> Jump Scroll (default) Slow Smooth Scroll Fast Smooth Scroll						
TVI - Smooth scroll off	n/a	n/a	n/a	n/a	ESC 9	ESC 9	ESC 9	n/a
TVI - Smooth scroll on	n/a	n/a	n/a	n/a	ESC 8	ESC 8	ESC 8	n/a
<b>Character Cell</b>								
Select 10 × 16 size (def)	ESC e >	n/a	same	Wyse	EnH	EnH	EnH	EnH
Select 10 × 13 size	ESC e ?	n/a	same	Wyse	EnH	EnH	EnH	EnH
<b>Column Display</b>								
Select 80-column display (default)	ESC ` :	n/a	same	same	n/a	n/a	n/a	EnH
Select 132-column display	ESC ` ;	n/a	same	same	n/a	n/a	n/a	EnH
<b>Display Data Lines</b>								
24 data lines (default)	ESC e (	n/a	same	same	EnH	EnH	EnH	EnH
25 data lines	ESC e )	ESC ^	same as 325/160 /60	same as 325/160 /60	EnH	EnH	EnH	EnH
42 data lines	ESC e *	n/a	same	same	EnH	EnH	EnH	EnH
43 data lines	ESC e +	ESC _	same as 325/160 /60	same as 325/160 /60	EnH	EnH	EnH	EnH

In ASCII emulation mode, the VT520 displays four types of data lines:

- 24 data lines, 1 status line, and 2 label lines
- 25 data lines, 1 status line, and 1 label line
- 42 data lines, 1 status line, and 2 label lines<sup>4</sup>
- 43 data lines, 1 status line, and 1 label line

<sup>2</sup> Users can change the scrolling rate by entering keys from the keyboard. Pressing Ctrl/Shift/ ↑ to increase the rate and Ctrl/Shift/ ↓ to decrease it.

<sup>4</sup>Because of hardware limitations, selecting 42 or 43 data lines forces the screen size to be 53 lines.

(continued on next page)

## ASCII Escape Sequences

### 12.4 Screen Processing

Table 12–5 (Cont.) Screen Processing Control Functions

Fill Page with "H"s in PCTerm Mode	WYSE				TVI			ADDS
	325/160/60	PCTerm	150/120	50/50+	950	925	910+	A2
Fill page with "H"s	n/a	ESC F	n/a	n/a	n/a	n/a	n/a	n/a
<b>Width-Change-Clear Mode</b>								
Width-change-clear off	ESC e .	n/a	same	same	EnH	EnH	EnH	EnH
Width-change-clear on (default)	ESC e /	n/a	same	same	EnH	EnH	EnH	EnH
<b>Page Size</b>								
Set Page Size <sup>5</sup>	ESC w <i>Length</i>		same	same	ESC \ <i>Length</i> <sup>6</sup>			EnH
<b>WYSE 325/160/60, WYSE 50+ Parameters:</b>	<u>Length</u>	<u>Size of a Page</u>		<u>Description</u>				
	G	1*lines		Page number = current screen data lines				
	H	2*lines		Page number = current screen data lines * 2				
	I	4*lines		Page number = current screen data lines * 4				
	J	*		One page number = screen data lines; the other contains rest of lines in memory.				
<b>WYSE 325/160/60 PCTerm and TVI Parameters:</b>	<u>Length</u>	<u>Size of a Page</u>		<u>Description</u>				
	1	1*lines		Page number = current screen data lines				
	2	2*lines		Page number = current screen data lines * 2				
	3	4*lines		Page number = current screen data lines * 4				
	4	*		One page number = screen data lines; the other contains rest of lines in memory.				
<b>Display Page</b>								
Display Previous Page <sup>7</sup>	ESC w B or ESC J	n/a	same	same	ESC J	ESC J	ESC J	EnH
Display Next Page <sup>8</sup>	ESC w C or ESC K	n/a	same	same	ESC K	ESC K	ESC K	n/a
Display Specific Page	ESC w <i>Page</i>	n/a	same	same	n/a	n/a	n/a	EnH

<sup>5</sup> Upon receipt of the Set Page Size command, the terminal:

- Clears the display memory to NUL (0/0) characters.
- Displays first page "page 0."
- Moves the cursor to its home position.
- Changes the split screen to a full screen format.
- Turns off the Protect mode.
- Unlocks the locked line.

<sup>6</sup> Enhanced Mode off.

<sup>7</sup> In WYSE mode, command "ESC J" works only when the screen is not split. If the screen is split, refer to "Activate Other Window or Page" command. Command "ESC w B" in WYSE modes works when the screen is not split or the split screen is caused by an adjustable split. It does not work when the split screen is a result of a simple split. Users can use local function keys to display the previous page. On a VT keyboard, press **Ctrl/Prev**; on an Enhanced PC keyboard, press **Ctrl/Page Up**.

<sup>8</sup> Users can use a local function key to display the next page. Press **Ctrl/N**, where N is a number on the numeric keypad key equivalent to the page number, on both VT and Enhanced PC keyboard.

(continued on next page)

## ASCII Escape Sequences 12.4 Screen Processing

**Table 12–5 (Cont.) Screen Processing Control Functions**

	WYSE				TVI			ADDS
	325/160/60	PCTerm	150/120	50/50+	950	925	910+	A2
<b>Split Screen</b>								
Split screen horizontally	ESC x A <i>Line</i>	n/a	same	same	n/a	n/a	n/a	n/a
Adjustable horiz split	ESC x C <i>Line</i>	n/a	same	same	n/a	n/a	n/a	n/a
Split screen horizontally and Clear data	ESC x 1 <i>Line</i>	n/a	same	same	n/a	n/a	n/a	n/a
Adjustable horiz split screen and Clear data	ESC x 3 <i>Line</i>	n/a	same	same	n/a	n/a	n/a	n/a
Lower horiz split	ESC x P	n/a	same	same	n/a	n/a	n/a	n/a
Raise horiz split	ESC x R	n/a	same	same	n/a	n/a	n/a	n/a
<b>Windows</b>								
Activate upper window	ESC ]	n/a	same	same	n/a	n/a	n/a	n/a
Activate lower window	ESC }	n/a	same	same	n/a	n/a	n/a	n/a
Activate other window or page	ESC J or ESC K	n/a	same	same	n/a	n/a	n/a	n/a
Roll window up in page	ESC w E	n/a	same	same	n/a	n/a	n/a	n/a
Roll window down in page	ESC w F	n/a	same	same	n/a	n/a	n/a	n/a
Redefine screen as one window	ESC x @	n/a	same	same	n/a	n/a	n/a	n/a
Redefine screen as one window and Clear page	ESC x 0	n/a	same	same	n/a	n/a	n/a	n/a
<b>Cursor Drag Mode</b>								
Cursor drag mode on (default)	ESC d )	n/a	same	same	n/a	n/a	n/a	n/a
Cursor drag mode off	ESC d (	n/a	same	same	n/a	n/a	n/a	n/a
<b>Status Line Display</b>								
Editing Status line on	ESC ` a	n/a	same	same	n/a	n/a	n/a	EnH
Standard Status line on (default)	ESC ` b	n/a	same	same	n/a	n/a	n/a	EnH
Status line off	ESC ` c	n/a	same	same	n/a	n/a	n/a	EnH
	<u>Starts at Column</u>		<u>Standard Status Line</u>			<u>Editing Status Line</u>		
	26		HH:MM AM (or PM)			PROT (Protect mode is on)		
	31					WRPT (Write protect is on)		
	35		Column-Row (Cursor)					
	36					INS (Insert mode is on)		
<b>Messages:</b>	<u>Message</u>		<u>Description</u>					
	LOCK		Keyboard locked					
	COMP		In compose process					
	NUM		NUM LOCK state					
	CAPS		The <span style="border: 1px solid black; padding: 0 2px;">Caps Lock</span> key is on					
	1...		Page indication (No message displayed for page 0)					
	*		Monitor mode state					
	FDX		Full-duplex mode					
	HDX		Half-duplex mode					

(continued on next page)

# ASCII Escape Sequences

## 12.4 Screen Processing

Table 12–5 (Cont.) Screen Processing Control Functions

Status Line Display								
<b>Messages:</b>	BLK	Block mode						
	HBLK	Half-duplex block mode						
	<u>Message</u>	<u>Description</u>						
	LCL	Local mode						
	HLD	Hold state						
	%	Page Printing						
	>	Autoprint mode						
	=	Controller print mode						
	PBSY	Printer is busy or no printer is attached.						
	PTR	Printer is ready.						
<AUX	Terminal is in auxiliary receive mode.							
Function Key Label Display								
Computer Message	WYSE				TVI			ADDS
	325/160/60	PCTerm	150/120	50/50+	950	925	910+	A2
Program/Display computer message	ESC F <i>Message</i> CR							
Clear computer message	ESC F CR	n/a	same	same	Wyse	Wyse	Wyse	EnH
Function Key Label Display	ESC z <i>Field Label</i> CR	n/a	same	same	Wyse <sup>9</sup>	Wyse	Wyse	EnH
		ESC z <i>Field</i> CR	n/a	same	same	Wyse	Wyse	Wyse
<b>Field Parameters:</b>	<u>Key</u>	<u>Unshifted</u>	<b>Field</b>	<u>Shifted</u>	<u>Key</u>	<u>Unshifted</u>	<u>Shifted</u>	
	F1	0		P	F9	8	X	
	F2	1		Q	F10	9	Y	
	F3	2		R	F11	:	Z	
	F4	3		S	F12	;	[	
	F5	4		T	F13	<	\	
	F6	5		U	F14	=	]	
	F7	6		V	F15	>	^	
	F8	7		W	F16	?	-	
<b>Label Parameters:</b>	<u>Emulation Mode</u>	<u>Column Mode</u>		<u>Maximum Length</u>				
	Hidden	80		9				
	Hidden	132		7				
	Embedded	80		8				
	Embedded	132		7				
Function Key Label Display								
Label Line Display	WYSE				TVI			ADDS
	325/160/60	PCTerm	150/120	50/50+	950	925	910+	A2
Program/Display computer message on unshifted Label line.	ESC z ( <i>Text</i> CR		same	same as	ESC f <i>text</i> CR or ESC f <i>text</i> Ctrl-M			EnH
Program/Display computer message on	ESC z ) <i>text</i> CR		n/a	same	same	n/a	n/a	EnH

<sup>9</sup>Unshifted key label only; the Shifted Key label is not available for TVI modes.

(continued on next page)



**Table 12–5 (Cont.) Screen Processing Control Functions**

Label Line Display	WYSE				TVI			ADDS
	325/160/60	PCTerm	150/120	50/50+	950	925	910+	A2
shifted Label line.								
Clear unshifted Label line.	ESC z ( CR	ESC f CR or ESC f Ctrl-M	same	same as 325/160/60	ESC f CR or ESC f Ctrl-M			EnH
Clear shifted Label line.	ESC z ) CR	n/a	same	same	n/a	n/a	n/a	EnH
Disable shifted Label line.	ESC z DEL	n/a	same	same	n/a	n/a	n/a	EnH

**WYSE and ADDS Enhanced Modes:**

There are two distinct label lines when the terminal is using 24 or 42 data lines:

- The upper one is for shifted label line (shifted function key label line).
- The lower one is for unshifted label line (unshifted function key label line).

When using the 25 or 43 data line configuration mode, only one label line is available at a time. By default, it displays the unshifted label line (or unshifted function key label line). This line becomes a shifted label line (or shifted function key label) whenever the Shift key is pressed. Releasing the Shift key returns the line to be the unshifted display line.

**TVI and PCTerm Modes:**

Only an unshifted label line (unshifted function label line) is available. To be visible, the label line must be explicitly turned on by the command "Turn on User Line."

For TVI personalities, the label line is displayed only when data line is set to 24 or 42 data lines.

For PCTerm mode, turning on the display line forces the terminal to 24 or 42 data lines. If the cursor is at the 25th or 43rd line before the line is set, then the cursor moves to the same column at line 24 or 42, and the entire data area scrolls up one line. The label line is displayed at the 25th or 43rd line, respectively.

**Text Parameter:**

The parameter *text* is a character string to be entered in the label line. The allowable size of *text* varies among emulation modes and column modes. In embedded emulation mode, the first character shown on the user line is an attribute space.

<u>Emulation Mode</u>	<u>Column Mode</u>	<u>Maximum Number</u>	<u>Column Position</u>
Hidden	80	80	1–80
Hidden	132	132	1–132
Embedded	80	79	2–80
Embedded	132	131	2–132

(continued on next page)

# ASCII Escape Sequences

## 12.4 Screen Processing

Table 12–5 (Cont.) Screen Processing Control Functions

Color	WYSE					TVI		ADDS
	325	160/60	PCTerm	150/120	50+/50	925	910+	VP A2
Select ASCII Color Mode	ESC d z Ctrl/B	same	ESC Sp # Ctrl/B	same	same	same	same	EnH
Select Mono Mode	ESC d z Ctrl/C	same	ESC Sp # Ctrl/C	same	same	same	same	EnH
Select Color Palette	ESC d z <i>Palette</i>	same	ESC Sp # <i>Palette</i>	same	EnH	EnH	EnH	EnH
	## <i>Palette</i> numbers run from 0 to 9 and <input type="checkbox"/> <i>kpd</i> .							
Customize Color Palette	ESC d y <i>F-Color B-Color Attribute</i>					EnH	EnH	EnH
	ESC Sp # <i>F-Color B-Color Attribute</i>							
<b>Parameters:</b>	<u><i>F- or B-Color</i></u>	<u>Description</u>			<u>Attribute</u>	<u>Description</u>		
	1	Black			1	Normal		
	2	Blue			2	Reverse/Blank		
	3	Green			3	Dim		
	4	Cyan			4	Dim, Reverse/Blank		
	5	Red			5	Underline		
	6	Magenta			6	Underline, Reverse/Blank		
	7	Yellow			7	Underline, Dim		
	8	White			8	Underline, Dim, Reverse /Blank		
<b>Enable/Disable Intensity Attribute</b>								
Dim intensity attribute On (default)	ESC e }	same	ESC SP !	same	n/a	n/a	n/a	n/a
Dim intensity attribute Off	ESC e	same	ESC SP "	same	n/a	n/a	n/a	n/a
<b>Reverse and Blank Attribute</b>								
Map the Reverse attribute (default)	ESC d	same	ESC SP &	same	n/a	n/a	n/a	n/a
Map the Blank attribute	ESC d {	same	ESC SP %	same	n/a	n/a	n/a	n/a

(continued on next page)

Table 12–5 (Cont.) Screen Processing Control Functions

User Label Line Display for TVI Mode	WYSE				TVI			ADDS
	325/160/60	PCTerm	150/120	50/50+	950	925	910+	A2
Turn off User line (default)	n/a	ESC e or ESC h	same	n/a	ESC h	ESC h	ESC h	n/a
Turn on User line	n/a	ESC g	n/a	n/a	ESC g	ESC g	ESC g	n/a
<b>Character Attributes</b>								
Assign character attribute (main display area)	ESC G <i>Attr</i>	ESC G <i>Attribute</i>	same	same	same	same	same	EnH
<b>Parameters:</b> Wyse 325, <sup>10</sup> 160/60, 150 /120, 50+, and ADDS	<u><i>Attr</i></u>	<u>Display Attributes</u>					<u>TVI <i>Attr</i></u>	
	SP	Space character					SP	
	0	Normal					0, p	
	1	Invisible <sup>10</sup>					1, q	
	2	Blink					2, r	
	3	Invisible and blink					3, s	
	4	Reverse					4, t	
	5	Reverse and invisible					5, u	
	6	Reverse and blink					6, v	
	7	Reverse, blink, invisible					7, w	
	8	Underline					8, x	
	9	Underline and invisible					9, y	
	:	Underline and blink					:, z	
	;	Underline, blink, invisible					;, {	
	<	Underline and reverse					<,	
	=	Underline, reverse, invisible					=, }	
	>	Underline, reverse, blink					>, ~	
	?	Underline, reverse, blink, invisible					?, DEL	
	p	Dim						
	q	Dim and invisible						
	r	Dim and blink						
	s	Dim, blink, invisible						
	t	Dim and reverse						
	u	Dim, reverse, invisible						
	v	Dim, reverse, blink						
	w	Dim, reverse, blink, invisible						
	x	Dim and underline						
	y	Dim, underline, invisible						
	z	Dim, underline, blink						
	{	Dim, underline, blink, invisible						
		Dim, underline, reverse						
	}	Dim, underline, reverse, invisible						
	~	Dim, underline, reverse, blink						
	DEL	Dim, underline, reverse, blink, invisible						

† All the 7-bit ASCII codes are legal in this sequence. Example: "A" turns on the dim attribute, "T" turns on the reverse attribute, "S" turns on dim, blink and reverse attributes.

(continued on next page)

# ASCII Escape Sequences

## 12.4 Screen Processing

Table 12–5 (Cont.) Screen Processing Control Functions

PCTerm Mode	Attribute	Display Attributes
	0, @, P, `, p	Normal
	1, A, Q, a, q	Invisible
	2, B, R, b, r	Blink
	3, C, S, c, s	Invisible and blink
	4, D, T, d, t	Reverse
	5, E, U, e, u	Reverse and invisible
	6, F, V, f, v	Reverse and blink
	7, G, W, g, w	Reverse, blink, invisible
	8, H, X, h, x	Underline
	9, I, Y, i, y	Underline and invisible
	;, J, Z, j, z	Underline and blink
	;, K, [, k, {	Underline, blink, invisible
	<, L \, l,	Underline and reverse
	=, M, ], }	Underline, reverse, invisible
	>, N, ^, n, ~	Underline, reverse, blink
	?, O, _, o, DEL	Underline, reverse, blink, invisible

Selecting	WYSE				TVI			ADDS
	325/160/60	PCTerm	150/120	50/50+	950	925	910+	A2
Char attribute mode on <sup>11</sup>	ESC e 1	n/a	same	n/a	n/a	n/a	n/a	n/a
Char attribute mode off	ESC e 0	n/a	same	n/a	n/a	n/a	n/a	n/a
Page attribute mode on <sup>12</sup>	ESC e 2	n/a	same	same	EnH	EnH	EnH	EnH
Line attribute mode on	ESC e 3	n/a	same	same	EnH	EnH	EnH	EnH
Assign display attribute to a message field	ESC A <i>Area Attr</i>	n/a	same	same	ESC \ <i>Area Attr</i> (EnH)			EnH
<b>Parameters:</b>	<u>Area</u>		<u>Description</u>					
	0		Data Area					
	1		Label Line					
	2		Terminal message field on Status Line					
	3		Computer message field on Status Line					

Assign write-protect character attribute	ESC ` <i>Wpca</i>	n/a	same	same	n/a	n/a	n/a	EnH or ESC 0 <i>Spca</i>
<b>Parameters using WYSE sequences:</b>	<u>Wpca</u>	<u>Description</u>	<b>Parameters - ADDS mode</b> †	<u>Spca</u>	<u>Description</u>			
	6	Reverse		0	Dim			
	7	Dim (default)		1	Blink			
	A	Normal		2	Invisible			
	B	Blink		3	Normal			
	C	Invisible		4	Reverse			
	E	Underline		5	Underline			
	F	Reverse						
	G	Dim						

\*Assigning parameters "6," "7" or "A" clears previously defined write-protected attributes. "B" through "G" add on top of previous attribute(s) and display a combination of new and old display attributes.

† All the 7-bit ASCII codes are legal in this sequence. Example: "A" turns on the dim attribute, "T" turns on the reverse attribute, "S" turns on dim, blink and reverse attributes.

‡ Example: Dim + Reverse + Invisible reports VTS (8AH) + a.

<sup>12</sup>Default for embedded emulation.

(continued on next page)

Table 12–5 (Cont.) Screen Processing Control Functions

Selecting	WYSE				TVI			ADDS
	325/160/60	PCTerm	150/120	50/50+	950	925	910+	A2
Clear unprotected page to display attribute	n/a	n/a	n/a	ESC ! <i>Attr</i>	n/a	Wyse	Wyse	EnH
Request attribute under cursor	n/a	ESC D	n/a	n/a	n/a	n/a	n/a	n/a
<b>Response:‡</b>	Two bytes—the <u>Bit</u> for attribute under the cursor, then "a".							
	<u>Bit</u>	<u>Attribute</u>	<u>Bit</u>	<u>Attribute</u>				
	0	Underline	4	Always 0				
	1	Reverse	5	Always 0				
	2	Blink	6	Always 0				
	3	Invisible	7	Dim				
<b>Assign Line Attributes</b>								
Assign line attributes	ESC G <i>LineAttr</i>	n/a	same	same	n/a	n/a	n/a	EnH
<b>Parameters:</b>	<u>LineAttr</u>	<u>Line Attribute</u>						
	@	Single height, single width (default)						
	A	Single height, double width						
	B	Top-half of double height, single width						
	C	Bottom-half of double height, single width						
	D	Top-half of double height, double width						
	E	Bottom-half of double height, double width						
‡ Example: Dim + Reverse + Invisible reports VTS (8AH) + a.								

## ASCII Escape Sequences

### 12.4 Screen Processing

Table 12–6 lists the data protection control functions. The word “same” in Table 12–6 signifies the same control sequences as in the WYSE 325/160/60 column.

**Table 12–6 Data Protection Control Functions**

	WYSE				TVI			ADDS
	325/160/60	PCTerm	150/120	50/50+	950	925	910+	A2
<b>Write-Protect Mode</b>								
Write-protect mode off (default)	ESC (	same	same	same	same	same	same	EnH or Ctrl/O
Write-protect mode on <sup>1</sup>	ESC )	same	same	same	same	same	same	EnH or Ctrl/N
<b>Protect Mode</b>								
Protect mode off (default)	ESC `	same	same	same	same	same	same	EnH
Protect mode on	ESC &	same	same	same	same	same	Wyse	EnH

<sup>1</sup> Turning on Write-Protect mode does not start protecting the data. It only defines the range of data that needs to be protected. Not until Protect mode is turned on does the data become protected. Changing personality does not change the Write-Protect mode. Graphic characters range from 1/0 to 1/15, and embedded attributes are automatically write-protected even when Write-Protect mode is off.

## ASCII Escape Sequences 12.4 Screen Processing

Table 12–7 lists the cursor control functions. The word “same” in Table 12–7 signifies the same control sequences as in the WYSE 325/160/60 column.

**Table 12–7 Cursor Control Functions**

	WYSE				TVI			ADDS
	325/160/60	PCTerm	150/120	50/50+	950	925	910+	A2
<b>Autopage Mode</b>								
On	ESC d +	n/a	same	same	ESC v	ESC v	ESC v	EnH
Off (default)	ESC d *	n/a	same	same	ESC w	ESC w	ESC w	EnH
<b>Autoscrolling Mode</b>								
On (default)	ESC O	n/a	same	same	n/a	n/a	n/a	EnH
Off	ESC N	n/a	same	same	n/a	n/a	n/a	EnH
<b>Cursor Display Feature</b>								
Set cursor appearance	ESC ` <i>Cursor</i>	ESC . <i>Cursor</i>	same as 325/160 /60	same as 325/160 /60	ESC . <i>Cursor</i>			EnH <sup>1</sup>
<b>Parameters:</b>	<u>Cursor</u>	<u>Description</u>						
	0	Cursor Display Off						
	1	Cursor Display On						
	2	Steady Block Cursor						
	3	Blinking Line Cursor						
	4	Steady Line Cursor						
	5	Blinking Block Cursor						
<b>End-of-Line Wrap Mode</b>								
On (default)	ESC d /	ESC ~	same as 325/160 /60	same as 325/160 /60	n/a	n/a	n/a	EnH
Off	ESC d .	ESC 0	same as 325/160 /60	same as 325/160 /60	n/a	n/a	n/a	EnH
When the cursor position is located at the bottom and right margin position of the current page with wrap flag on, any displayable character received has the following effect:								
	<u>Autopage</u>	<u>Autoscroll</u>		<u>Page Mode</u>	<u>Cursor Moves to . . .</u>			
	On	-		Single	Home position of the active page.			
				Multiple	Home position of the next page.			
	Off	On		Multiple	Left margin of bottom line after a scroll is performed.			
	Off	Off		Multiple	Home position of the active page.			

<sup>1</sup> [Ctrl/W] = Cursor off; [Ctrl/X] = Cursor on.

(continued on next page)

## ASCII Escape Sequences

### 12.4 Screen Processing

Table 12–7 (Cont.) Cursor Control Functions

	WYSE				TVI			ADDS
	325/160/60	PCTerm	150/120	50/50+	950	925	910+	A2
<b>Received CR Mode</b>								
CR (default)	ESC e 4	ESC 9	same as 325/160/60	same as 325/160/60	EnH	EnH	EnH	EnH
CRLF	ESC e 5	ESC 8	EnH	same as 325/160/60	EnH	EnH	EnH	EnH
<b>Lock Cursor Line Mode</b>								
On	ESC ` H	n/a	same	same	ESC ! 1	n/a	n/a	EnH
Off (default)	ESC ` I	n/a	same	same	ESC ! 2	n/a	n/a	EnH
<b>Recognize DEL Mode</b>								
On (default)	ESC e E	EnH	same	same	EnH	EnH	EnH	EnH
Off	ESC e D	EnH	same	same	EnH	EnH	EnH	EnH
<b>Cursor Movement</b>								
Cursor Left (Back Space)	Ctrl/H	same	same	same	same	same	same	Wyse or Ctrl/U
	<u>Autopage</u> On	<u>Page Mode</u> Multiple		<u>Cursor Moves to . . .</u> Bottom right margin of the preceding page (if any) even though the bottom right margin is protected. Under this command, the Protect mode feature carries through all pages. Refer to Protect Mode for details.				
	Off	Single		Bottom right margin of the active page even though the right margin is protected.				
Cursor Left (Delete)	DEL	same	same	same	same	same	same	same
Cursor Right	Ctrl/L	same	same	same	same	same	same	Ctrl/F
	<u>Autopage</u> On	<u>Autoscroll</u> -	<u>Page</u> Multiple	<u>Cursor Moves to . . .</u> Home position or the first unprotected position (when Protect mode is on) of the next page (if any). Under this command, the Protect mode feature carries through all pages. Refer to Protect mode for details.				
	Off	On	Single <sup>2</sup>	Left margin of the bottom margin line after a scroll is performed.				
	Off	Off	Single <sup>3</sup>	Home position of the active page.				

<sup>2</sup>Autopage mode is either set to off, or the terminal is in Single Page mode and Autoscroll mode is on.

<sup>3</sup>Autopage mode is either set to off, or the terminal is in Single Page mode and Autoscroll mode is off.

(continued on next page)



**Table 12–7 (Cont.) Cursor Control Functions**

	WYSE				TVI			ADDS
	325/160/60	PCTerm	150/120	50/50+	950	925	910+	A2
<b>Cursor Up</b>								
Cursor Up—No Scroll	Ctrl/K	same	same	same	same	same	same	Ctrl/Z
Cursor Up—Scroll (Reverse Linefeed)	ESC j	same	same	same	same	same	Wyse	EnH
	This command moves the cursor as follows:							
	<u>Autopage</u>	<u>Autoscroll</u>	<u>Page</u>	<u>Protect</u>	<u>Cursor Moves to . . .</u>			
	-	-	Single	-	(Command is ignored.)			
	On	-	Multiple	On or Off	Bottom line of the previous page. Under this command, the Protect mode feature carries through all pages.			
	Off	On	Multiple	Off	Top margin of the active page after a reverse scroll is performed.			
	Off	On	Multiple	On	(Command is ignored.)			
	Off	Off	Multiple	-	(Command is ignored.)			
<hr/>								
<b>Cursor Down</b>								
Cursor Down—No Scroll	Ctrl/V	same	same	same	same	same	same	same
Cursor Down—Scroll (Linefeed)	Ctrl/J	same	same	same	same	same	same	same
	<u>Autopage</u>	<u>Autoscroll</u>	<u>Page Mode</u>		<u>Cursor Moves to . . .</u>			
	Off	Off	-		Top margin line of the active page. If the destination position is protected, the cursor moves right to the first unprotected position.			
	On	-	Single		Top margin line of the active page. If the destination position is protected, the cursor moves right or down to the first unprotected position.			
	On	-	Multiple		Top margin line of the next page. Under this command, the Protect mode feature carries through all pages. Refer to Protect Mode for details.			
	Off	On	Multiple		Bottom line of the active page after a scroll is performed.			
<hr/>								
<b>Cursor to Start</b>								
Cursor to start of line	Ctrl/M	same	same	same	same	same	same	same
Cursor to start of next line	Ctrl/_	same	same	same	same	same	same	EnH
	<u>Autopage</u>	<u>Page</u>	<u>Cursor Moves to . . .</u>					
	Off	Single <sup>4</sup>	Home position of the current page or the first unprotected position of the current page if Protect mode is on.					
	On	Multiple	Home position of the next page or the first unprotected position of the next page if Protect mode is on. Under this command, the Protect mode feature carries through all pages. Refer to Protect Mode for details.					

<sup>4</sup>Either Autopage mode or Single Page mode is enabled.

(continued on next page)

## ASCII Escape Sequences

### 12.4 Screen Processing

Table 12–7 (Cont.) Cursor Control Functions

Address Cursor	WYSE				TVI			ADDS
	325/160/60	PCTerm	150/120	50/50+	950	925	910+	A2
Cursor to Home	Ctrl/^ or ESC {	Ctrl/^	same	same	Ctrl/^	same	same	EnH or Ctrl/A
Address Cursor to a specific column ( <i>Col</i> )	ESC _ <i>Col</i>	n/a	same	same	ESC ] <i>Col</i>			EnH or Ctrl/P <i>Col</i>
Address Cursor to a specific line	ESC [ <i>Line</i>	n/a	same	same	same	same	same	EnH or Ctrl/K <i>Line</i>
Address Cursor in Current Page	ESC = <i>Line Col</i>	same	same	same	same	same	same	EnH or ESC Y
Address Cursor in specific page	ESC h <i>page</i>	n/a	same	same	n/a	n/a	n/a	EnH  <i>Line Col</i>
Address Cursor in specific page, line, and column	ESC w @ <i>Page Line Col</i>	n/a	same	same	ESC - <i>Page Line Col</i> <sup>5</sup>			EnH
Address Cursor in specific Window/Page	ESC - <i>Window/Page Line Col</i> <sup>6</sup>	same	same	same	EnH	EnH	EnH	EnH
Address Cursor in 80/132 column current Page	ESC a <i>Line R Col C</i>	n/a	same	same	ESC d <i>Line R Col C</i>			EnH
<b>Read Cursor</b>								
Read Cursor address in current Page	ESC ?	same	same	same	same	same	same	EnH
Read Window, Page no., and Cursor address	ESC /	same	same	same	same	same	same	EnH
Read Cursor address in Current 80/132-col page	ESC b	n/a	same	same	n/a	n/a	n/a	EnH
Read Page number and Cursor address	ESC w `	n/a	same	same	n/a	n/a	n/a	EnH
	ESC w .							
	ESC w ,							
	ESC w ´							

<sup>5</sup>Enhanced Mode off.

<sup>6</sup>When screen is split, "0" = upper window; "1" = lower window.

#### Note

The terminal responds to the Read Cursor command in the following format: III R ccc C

The two parameter values, III and ccc, are the 3-byte decimal values for the line/column location of the cursor. For example, "019R010C" indicates the cursor is at line 19, column 10. The sequence with parameters "001" (3/0)(3/0)(3/1) and "001" (3/0)(3/0)(3/1) indicates the cursor is at the home position.

## ASCII Escape Sequences 12.4 Screen Processing

Table 12–8 lists the ASCII editing control functions. The word “same” in Table 12–8, Table 12–10, and Table 12–11 signify the same control sequences as in the WYSE 325/160/60 column.

**Table 12–8 ASCII Editing Control Functions**

Local Edit Mode	WYSE				TVI			ADDS
	325/160/60	PCTerm	150/120	50/50+	950	925	910+	A2
Off <sup>1</sup> (default)	ESC l	n/a	same	same	same	same	same	n/a
On <sup>2</sup>	ESC k	n/a	same	same	same	same	same	n/a

<sup>1</sup>Duplex Edit Mode On.

<sup>2</sup>Duplex Edit Mode Off.

In local edit mode, instead of sending keycodes to the host, some function keys send codes directly to the terminal to speed up the editing process. Table 12–9 lists these local edit functions and their operating keys for both the VT keyboard and the Enhanced PC keyboard.

**Table 12–9 Local Edit Mode Function Keys**

Function	VT Keyboard	EPC Keyboard	Sequence
Insert Character	<b>PF1</b>		ESC Q
Insert Line	Shifted <b>PF1</b>		ESC E
Delete Character	<b>PF2</b>	<b>Delete</b>	ESC W
Delete Line	Shifted <b>PF2</b>	Shifted <b>Delete</b>	ESC R
Clear Line	<b>PF3</b>	<b>End</b>	ESC T
Clear Screen	Shifted <b>PF3</b>	Shifted <b>End</b>	ESC Y
Insert		<b>Insert</b>	ESC q
Replace		Shifted <b>Insert</b>	ESC r
Next Page		<b>Page Down</b>	ESC K
Previous Page		<b>Page Up</b>	ESC J
Send			ESC 7
Print		<b>Print</b>	ESC P
Home		Shift <b>Home</b>	ESC {
Tab		Shift <b>Tab</b>	ESC I

## ASCII Escape Sequences

### 12.4 Screen Processing

Table 12–10 lists the tab stop control functions.

**Table 12–10 Tab Stop Control Functions**

Tab Stop Function	WYSE				TVI			ADDS
	325/160/60	PCTerm	150/120	50/50+	950	925	910+	A2
Clear All Tab Stops	ESC 0	ESC 3	same as 325/160 /60	same as 325/160 /60	ESC 3	ESC 3	ESC 3	n/a
Clear Tab Stop	ESC 2	same	same	same	same	same	same	EnH
Set Tab Stop	ESC 1	same	same	same	same	same	same	EnH
Tabulate Cursor or Field Tab <sup>1</sup>	ESC i or Ctrl/I	same	same	same	same	same	same	EnH
The cursor moves as follows:								
	<u>Autopage</u>	<u>Autoscroll</u>		<u>Page Mode</u>	<u>Cursor Moves to . . .</u>			
	On	-		Single	Top margin line of the active page			
	On	-		Multiple	Top margin line of the other page.			
	Off	On		Multiple	Bottom margin of the active page after a scroll is performed.			
	Off	Off		Multiple	Top margin line of the active page.			
Backtab or Field Tab <sup>2</sup>	ESC I	same	same	same	same	same	same	EnH
The cursor moves as follows:								
	<u>Autopage</u>	<u>Autoscroll</u>		<u>Page Mode</u>	<u>Cursor Moves to . . .</u>			
	On	-		Single	Home			
	On	-		Multiple	Bottom margin line of the previous page if any.			
	Off	On		Multiple	Bottom margin line of the active page.			
	Off	Off		Multiple	Bottom margin line of the active page.			

<sup>1</sup>Executes "tabulate cursor" when protect mode is off.

<sup>2</sup>If protect mode is on, this command executes a "field tab" to move the cursor left to the first unprotected character position after the nearest protect field. The tab stop setting is completely ignored. The cursor moves backward from the first position of an unprotected area to the first position of another unprotected area.

Executing a Backtab from an unprotected page to a previous protected page changes its protect mode to "unprotected."

Table 12–11 lists the page edit control functions.

**Table 12–11 Page Edit Control Functions**

Page Edit Mode	WYSE				TVI			ADDS
	325/160/60	PCTerm	150/120	50/50+	950	925	910+	A2
Off (default)	ESC e "	n/a	same	same	ESC O	ESC O	ESC O	EnH
On	ESC e #	n/a	same	same	ESC N	ESC N	ESC N	EnH
<b>Insert/Replace Mode</b>								
Replace mode On (default)	ESC r	same	same	same	same	Wyse	Wyse	EnH
Insert mode On	ESC q	ESC z	same as 325/160 /60	same as 325/160 /60	same as 325/160 /60	Wyse	Wyse	EnH
<b>Insert Characters</b>								
Insert Space Character	ESC Q	same	same	same	same	same	same	EnH
Insert Line of Spaces	ESC E	same	same	same	same	same	same	EnH or ESC M
Insert Column of NULs	ESC c M	n/a	same	same	n/a	n/a	n/a	EnH
<b>Deleting Data on Current Page Only</b>								
Delete Cursor Character	ESC W	same	same	same	same	same	same	EnH
Delete Cursor Line	ESC R	same	same	same	same	same	same	EnH
Delete Cursor Column	ESC c J	n/a	same	same	n/a	n/a	n/a	EnH
<b>Erasing Data on Page Function</b>								
Clear Page to NULs	ESC *	same	same	same	same	same	same	EnH
Clear Page to spaces	ESC +	n/a	same	same	n/a	n/a	n/a	EnH or Ctrl/L
Clear page to write-protected spaces	ESC ,	n/a	same	same	n/a	n/a	n/a	EnH
Clear unprotected page to write-protected spaces	n/a	ESC ,	n/a	n/a	ESC ,	ESC ,	ESC ,	n/a
Clear unprotected page to NULs	ESC :	same	same	same	same	same	same	ESC : (EnH)
Clear unprotected page to spaces	ESC ; or Ctrl/Z	same or ESC +	same as 325/160 /60	same as 325/160 /60	same or ESC+	same or ESC+	same or ESC+	EnH
Clear unprotected page to a specific character <sup>1</sup>	ESC . <i>Char</i>	n/a	same	same	n/a	n/a	n/a	EnH
Clear unprotected page to NULs from cursor	ESC y	same	same	same	same	same	same	EnH
Clear unprotected page to spaces from cursor	ESC Y	same	same	same	same	same	same	ESC k
Clear unprotected page foreground to NULs from cursor position	ESC c Q	n/a	same	same	n/a	n/a	n/a	EnH

<sup>1</sup>"*Char*" is an ASCII character. Any 8-bit code is treated as a 7-bit code since the most significant bit of the code is stripped off.

(continued on next page)

## ASCII Escape Sequences

### 12.4 Screen Processing

Table 12–11 (Cont.) Page Edit Control Functions

Erasing Data on Page Function (cont.)	WYSE				TVI			ADDS
	325/160/60	PCTerm	150/120	50/50+	950	925	910+	A2
Clear unprotected page foreground to spaces from cursor position	ESC c P	n/a	same	same	n/a	n/a	n/a	EnH
Clear unprotected area to end of line with NULs	ESC c L	n/a	same	same	n/a	n/a	n/a	EnH
Clear unprotected area to end of line with spaces	ESC c O	n/a	same	same	n/a	n/a	n/a	EnH
Clear unprotected line from cursor position to NULs	ESC t	same	same	same	same	same	same	EnH
Clear unprotected line from cursor position to spaces	ESC T	same	same	same	n/a	n/a	n/a	ESC K
Clear unprotected line foreground from cursor position to NULs	ESC c S	n/a	same	same	n/a	n/a	n/a	EnH
Clear unprotected line foreground from cursor position to spaces	ESC c R	n/a	same	same	n/a	n/a	n/a	EnH
Clear unprotected position to NULs	ESC c K	n/a	same	same	n/a	n/a	n/a	EnH
Clear unprotected column to a specific character <sup>1</sup>	ESC c I <i>Char</i>	n/a	same	same	n/a	n/a	n/a	EnH
Clear column to write-protected space	ESC V	same	same	same	same	same	same	EnH

<sup>1</sup>"*Char*" is an ASCII character. Any 8-bit code is treated as a 7-bit code since the most significant bit of the code is stripped off.

#### 12.4.1 Rectangular Area Operations

Upon execution, a rectangle that is drawn with line drawing characters and normal attributes is displayed on the screen. If the four lines that form the rectangle are occupied with data before the command execution, then the data is replaced.

The parameters *Line*, *Column*, and the line, column number of the cursor decide where the rectangle will be located. See Table 12–12.

The parameters *Line* and *Column* in format 1 are ASCII characters whose decimal values are the desired numbers plus 31.

The parameter *Column* in format 2 is an ASCII character whose decimal value is the desired column number plus 31 and minus 80.

The symbol "~" in escape sequences indicates number "80" to be added to the "Column" value. The result of executing this command draws a rectangle 80 columns wider than the rectangle drawn by the command without the "~" symbol. Therefore, this command is not recommended for 80-column mode.

*Char* is an ASCII character. If an 8-bit code is entered as a parameter value, then the most significant bit of the code is stripped off.

Table 12–12 lists the rules for locating the rectangle.

Table 12–12 Rules for Locating Rectangle

If <i>Line</i> value is...	And <i>Column</i> value is...	Then, the rectangle is located from the cursor...	And...
<b>Larger</b> than the cursor line	<b>Larger</b> than the cursor column	<b>Down</b> to the line number indicated by <i>Line</i>	<b>Right</b> to column number indicated by <i>Column</i> .
<b>Larger</b> than the cursor line	<b>Smaller</b> than the cursor column	<b>Down</b> to the line number indicated by <i>Line</i>	<b>Left</b> to column number indicated by <i>Column</i> .
<b>Smaller</b> than the cursor line	<b>Larger</b> than the cursor column	<b>Up</b> to the line number indicated by <i>Line</i>	<b>Right</b> to column number indicated by <i>Column</i> .
<b>Smaller</b> than the cursor line	<b>Smaller</b> than the cursor column	<b>Up</b> to the line number indicated by <i>Line</i>	<b>Left</b> to column number indicated by <i>Column</i> .
<b>Equal</b> to the cursor line	<b>Equal</b> to the cursor column	At the same location	A single box character is displayed.

The rectangle extends to the bottom of the screen only. If an out of range line parameter is entered, then the bottom line of the rectangle is located at the bottom margin. The command is ignored if the rectangle covers a locked line.

In 80-column mode, if the entered parameter extends the rectangle to over 80 columns but within the 132-column area, then the over 80 column part is not displayed. Changing to 132-column mode displays the whole rectangle.

In 132-column mode, if an out of range column number is entered, then the right line of the rectangle is located at the right margin.

Whether or not the protect mode is on when the command executes, the rectangle line is drawn write protected.

## ASCII Escape Sequences

### 12.4 Screen Processing

Table 12–13 lists the rectangle area control functions. The word “same” signifies the same control sequences as in the WYSE 325/160/60 column.

**Table 12–13 Rectangle Area Control Functions**

Draw Rectangle in 80/132 column Current Page	WYSE				TVI			ADDS
	325/160/60	PCTerm	150/120	50/50+	950	925	910+	A2
Format 1	ESC c G <i>Line Col</i>	n/a	same	same	n/a	n/a	n/a	EnH
Format 2 <sup>1</sup>	ESC c G <i>Line ~ Col</i>	n/a	same	same	n/a	n/a	n/a	EnH
<b>Fill Rectangle with a Specific Character in 80/132-column Cursor Page</b>								
Format 1	ESC c H <i>Line Col Char</i>	n/a	same	same	n/a	n/a	n/a	EnH
Format 2 <sup>1</sup>	ESC c H <i>Line ~ Col Char</i>	n/a	same	same	n/a	n/a	n/a	EnH
<b>Fill unprotected Rectangle with a specific character</b>								
Format 1	ESC c F <i>Line Col Char</i>	n/a	same	same	n/a	n/a	n/a	EnH
Format 2 <sup>1</sup>	ESC c F <i>Line ~ Col Char</i>	n/a	same	same	n/a	n/a	n/a	EnH
<b>Draw Rectangle<sup>2</sup></b>								
Draw rectangle area to right and below cursor.	ESC c N <i>Width Height</i>	n/a	same	same	n/a	n/a	n/a	EnH
<b>Swap/Copy/Move<sup>3</sup></b>								
Swap, copy, or move the data in a rectangle to another rectangle.	ESC c ^ <i>Action S_page P S_n1 R S_n2 C S_n3 R S_n4 C D_page P D_n1 R D_n2 C</i>							
<b>Parameters:</b>	<u>Action</u>	<u>Description</u>						
	0	Swaps data between the source and the destination rectangles.						
	1	Copies the content of the source rectangle to a destination rectangle, preserving the contents of the source rectangle.						
	2	Moves the contents of the source rectangle to destination rectangle, clearing the source rectangle.						
	<u>Parameter</u>	<u>Description</u>						
	<i>S_page</i>	Page number of the source rectangle						
	<i>S_n1</i>	Starting line number of the source rectangle (top left corner)						
	<i>S_n2</i>	Starting column number of the source rectangle (top left corner)						
	<i>S_n3</i>	Ending line number of the source rectangle (bottom right corner)						
	<i>S_n4</i>	Ending column number of the source rectangle (bottom right corner)						
	<i>D_page</i>	Page number of the destination rectangle						

<sup>1</sup>Not recommended for 80-column mode.

<sup>2</sup>Parameters *Line* and *Column* are ASCII characters whose decimal values are the desired numbers plus 31. See Section 12.4.1.1.

<sup>3</sup>See Section 12.4.1.2.

(continued on next page)



Table 12–13 (Cont.) Rectangle Area Control Functions

Swap/Copy/Move <sup>3</sup>	WYSE 325/160/60							
	<i>D_n1</i>	Starting line number of the destination rectangle (top left corner)						
	<i>D_n2</i>	Starting column number of the destination rectangle (top left corner)						
Swap/Copy/Move	PCTerm	150/120	50/50+	950	925	910+	A2	
Swap, copy, or move the data in a rectangle.	n/a	same as 325/160 /60	same as 325/160 /60	n/a	n/a	n/a	EnH	

<sup>3</sup>See Section 12.4.1.2.

### 12.4.1.1 Draw Rectangle

The rectangle extends to the bottom of the screen only. If an out of range line parameter is entered, then the bottom line of the rectangle is located at the bottom margin.

- In 80-column mode, if the entered parameter extends the rectangle to over 80 columns but within a 132-column area, the over 80-column part is not displayed. After changing to 132-column mode, the entire rectangle is displayed.
- In 132-column mode, if an out of range column number is entered, then the right line of the rectangle is located at the right margin.

Whether or not protect Mode is turned on, the rectangle line is drawn write protected. This command is ignored if the targeted rectangle covers a locked line.

### 12.4.1.2 Swap/Copy/Move

In the Swap/Copy/Move command, the parameters *s\_n1*, *s\_n2*, *s\_n3*, *s\_n4*, *d\_n1* and *d\_n2* are screen coordinates, expressed as decimal numbers. The first four parameters define the two diagonal corners of the source rectangle; the later two define the top-left corner of the destination rectangle.

Only data, not its attribute, is moved in any of the rectangular actions. The protect mode and the line lock mode are ignored during the movement.

This command sequence is ignored when the column parameters (*s\_n2*, *s\_n4*, *d\_n2*) are beyond the right margin of the page.

An out of range of the row parameters (*s\_n1*, *s\_n3*, *d\_n1*) causes the rectangle to be limited to the bottom margin line.

An out of range of the action parameter causes the command sequence to be aborted.

An out of range of the page parameter causes the command to be ignored.

## 12.5 Printing/Sending Data

This section describes commands to print and send data.

### 12.5.1 Sending Data

This section describes commands to send a defined area of data on the screen through the main communication port (Comm1) using ASCII control functions. Individual commands address the specific data to be sent.

In send operations, delimiter characters are sent along with data to mark a line end, transfer complete, or the protect data and its area. Table 12–14 lists the possible delimiter types. Depending on the scope of data (line, page) and the type of data (protected, unprotected) that has been sent, different delimiter characters are enclosed. The individual commands explain which delimiter should be sent with each command.

Table 12–14 lists the types of delimiters to send data.

**Table 12–14 Send Data Delimiters**

Delimiter Type	Sent . . .
End of the line	At the end of each line but not at the end of the page (block).
Transfer complete	After each Send Data action, except for a "Send the Cursor Character" command.
Field separator	To take the position of the protected field data when "Send Unprotected" command is executed and Protect mode is on.
Start protect field and End protect field	To mark the beginning and the ending of a write-protected field of data when Protect mode is on.

All the send data actions in this section, except "Send the Cursor Character" command, use the following rules:

- The attributes are not sent along with their data. But a Space character (Hex 20) is inserted between two distinct attribute data to indicate the attribute difference.
- During the process of sending characters, the cursor moves to the location of the character being sent.
  - **Protect mode on:** The cursor does not move.
  - **Protect mode off:** The cursor moves to the left margin of the next line.
- Null characters on the screen are not sent.
- Delimiter characters:
  - **TVI modes and WYSE 325/160/60 PCTerm modes:** Defined by command "Define Delimiters" (Refer to the command for details.)
  - **Other personalities:** See Table 12–15.

**Table 12–15 Delimiters for Other Personalities**

Delimiter	Terminal sends...
End of line	Either "US" or "CRLF" depending on the Set-Up Block End selection.
End of transmission	Either "CR" or "ETX" depending on the Set-Up Block End selection.
Protected field	A single FS (Hex 1C).
Protected field separator	<b>Native mode:</b> "ESC )" and "ESC (" when the protect field attribute is Dim or Normal; "ESC )sp" and "ESC (sp" when the protect field attribute is any other combination.  <b>Other modes:</b> "ESC )" and "ESC ("

- If any line on the screen is locked, then the line is not sent; however, the end of line delimiter is still sent to indicate a line has been skipped.
- If the first character sent is a protected character, then the ESC ) sequence is not sent before the first character; if the last character sent is a protected character, then the ESC ( sequence is not sent before the terminator.
- If the cursor position is located at the right margin of the bottom margin line and the Protect mode is off:

Autopage	Autoscroll	Page Mode	Cursor moves to . . .
On	-	Single	Home position of the active page.
On	-	Multiple	Home position of the other page.
Off	On	Multiple	Left margin of the bottom line after a scroll is performed.
Off	Off	Multiple	Home position of the active page.

Table 12–16 lists the print/send control functions.

**Table 12–16 Print/Send Control Functions**

Function	WYSE				TVI			ADDS
	325/160/60	PCTerm	150/120	50/50+	950	925	910+	A2
Define delimiters	n/a	ESC x <i>Dlmtr Char1 Char2</i>		n/a	n/a	ESC x <i>Dlmtr Char1 Char2</i>		n/a
<b>Parameters:</b>	<u>Dlmtr</u>	<u>Description</u>						
	0	Protected Field separator						
	1	Start protect field						
	2	End protect field						
	3	End of the line						
	4	Termination						
	Parameters <i>Char1</i> and <i>Char2</i> are ASCII characters.							
	<u>Delimiter</u>	<u>Default ASCII Character</u>						
	Field separator	FS NUL (1/12 0/0)						
	Start protect field	ESC ) (1/11 2/9)						

(continued on next page)

## ASCII Escape Sequences

### 12.5 Printing/Sending Data

Table 12–16 (Cont.) Print/Send Control Functions

Function	WYSE				TVI			ADDS
	325/160/60	PCTerm	150/120	50/50+	950	925	910+	A2
End protect field			ESC ( (1/11 2/8)					
End of the line			US NUL (1/15 0/0)					
Termination			CR NUL (1/13 0/0)					
A NUL character that is defined in a delimiter is not sent out.								
<b>Begin Print/Send</b>								
Begin Print/Send at Top of Page	ESC d `	n/a	same	same	n/a	n/a	n/a	EnH
Begin Print/Send at Top of Screen	ESC d &	n/a	same	same	n/a	n/a	n/a	EnH
<b>Sending a Character or Line</b>								
Send the Cursor Character	ESC M	n/a	same	same	n/a	n/a	n/a	n/a
Send the Cursor Line	ESC 6	same	same	same	same	same	same	n/a
Send unprotected Cursor Line	ESC 4	same	same	same	same	same	same	n/a
<b>Sending a Page</b>								
Send Page	ESC 7	same	same	same	same	same	same	EnH
Send an unprotected Page	ESC 5	same	same	same	same	same	same	n/a
<b>Sending a Block</b>								
Mark Block Beginning	ESC 8	n/a	same	same	n/a	n/a	n/a	EnH
Mark Block Ending <sup>1</sup>	ESC 9	n/a	same	same	n/a	n/a	n/a	EnH
Send Block <sup>2</sup>	ESC s	same	same	same	same	same	same	EnH
Send an unprotected Character in a Block	ESC S	same	same	same	same	same	same	EnH

<sup>1</sup>

• **Replace mode on:** "STX" or "ETX" replaces the existing character at the active position and moves the cursor right one position.

• **Insert mode on:** Writing "STX" or "ETX" moves all characters and their attributes one position to the right of the cursor position (inclusive) in the current line without wraparound.

<sup>2</sup>

• **Protect mode on:** Unprotected data is sent as is; protected data, enveloped between "start of protect field" and "end of protect field" delimiters, is sent.

• **Protect mode off:** All the data in the range, protected or unprotected, is sent.

ASCII emulations do not send:

- Initialization codes
- Ending sequences to designated character sets and display attributes
- "Fallbacks" to represent data that cannot be printed by the attached printer

## ASCII Escape Sequences 12.5 Printing/Sending Data

The only factors that affect printing data are data and parity settings.

Data/Parity Setting	Characters are printed . . .
8-bit	As is
7-bit	After stripping off the most significant bit

Table 12–17 lists the printing data control functions.

**Table 12–17 Printing Data Control Functions**

	WYSE				TVI			ADDS
	325/160/60	PCTerm	150/120	50/50+	950	925	910+	A2
<b>Autoprint Mode<sup>1</sup></b>								
Off (default)	Ctrl/T	ESC A	Ctrl/T	Ctrl/T	ESC A or Ctrl/T			Ctrl/T
On	Ctrl/R	ESC @	Ctrl/R	Ctrl/R	ESC @ or Ctrl/R			Ctrl/R
<b>Control Print Mode<sup>3</sup></b>								
Off	Ctrl/T	ESC a	Ctrl/T	Ctrl/T	ESC a	ESC a	ESC a	ESC 4
On	ESC d # or Ctrl/X <sup>2</sup>	ESC ´	same as 325/160 /60	same as 325/160 /60	ESC `	ESC `	ESC `	ESC 3 ESC d# (EnH)
<b>Aux Receive Mode</b>								
Off (default)	ESC d Sp	n/a	same	same	n/a	n/a	n/a	EnH
On	ESC d !	n/a	same	same	n/a	n/a	n/a	EnH
<b>Bidirectional Mode<sup>4</sup></b>								
Off (default)	ESC d \$	Ctrl/T	same as 325/160 /60	same as 325/160 /60	Ctrl/T	Ctrl/T	Ctrl/T	EnH
On	ESC d %	Ctrl/R	same as 325/160 /60	same as 325/160 /60	Ctrl/R	Ctrl/R	Ctrl/R	EnH
<b>Print Page to the Cursor Position</b>								
Formatted Page <sup>5</sup>	ESC P	same	same	same	same	same	Wyse	EnH
Formatted Page (unprotected)	ESC @	n/a	same	same	n/a	n/a	n/a	EnH
Unformatted Page <sup>5</sup>	ESC p or ESC L	n/a	same	same	ESC L	n/a	n/a	ESC p

<sup>1</sup> The symbol ">" is displayed in the status line when in Autoprint mode.

<sup>2</sup> Enhanced mode is off.

<sup>3</sup> The symbol "=" is displayed in the status line when in Autoprint mode.

<sup>4</sup> Turning off Bidirectional mode turns off Aux Receive mode and forces a normal print mode.

<sup>5</sup> The time prints out in a format such as "TIME AM/PM 00:00." At the end of the time message, the following is sent to the printer port: **NUL Ctrl/F NUL**. The page prints as formatted data. The terminal sends an "ACK" to the host at the end of a print operation if ACK mode is on.

(continued on next page)

## ASCII Escape Sequences

### 12.5 Printing/Sending Data

Table 12–17 (Cont.) Printing Data Control Functions

Print the Page with Time Message <sup>5</sup>	WYSE				TVI			ADDS
	325/160/60	PCTerm	150/120	50/50+	950	925	910+	A2
	n/a	ESC L	n/a	n/a	n/a	ESC L	ESC L	n/a
<b>Pass a Character to the Printer Port</b>								
	Ctrl/P <i>Char</i>	Wyse	same	same	Wyse	Wyse	Wyse	n/a
<b>Define the Page Print Terminator</b>								
	n/a	ESC p Ps <i>Char</i>		n/a	ESC p <i>Char</i>		n/a	

<sup>5</sup> The time prints out in a format such as "TIME AM/PM 00:00." At the end of the time message, the following is sent to the printer port: **NUL Ctrl/F NUL**. The page prints as formatted data. The terminal sends an "ACK" to the host at the end of a print operation if ACK mode is on.

### 12.5.2 Graphics Characters

Table 12–18 lists the graphic characters.

Table 12–18 Graphic Characters

Graphics Mode	WYSE				TVI			ADDS
	325/160/60	PCTerm	150/120	50/50+	950	925	910+	A2
On	ESC H or Ctrl/B	ESC \$	same as 325/160 /60	same as 325/160 /60	ESC \$ or Wyse	ESC \$ or Wyse	ESC \$ or Wyse	EnH
Off (default)	ESC H or Ctrl/C	ESC %	same as 325/160 /60	same as 325/160 /60	ESC % or Wyse	ESC % or Wyse	ESC % or Wyse	EnH
<b>Display Graphic Character</b>								
Display character from the first 32 character set. <sup>1</sup>	ESC H <i>Char</i>	n/a	same	same	n/a	n/a	n/a	EnH

<sup>1</sup>The parameter *Char* is an ASCII character in the range of Hex 20 to Hex 7E.

With Graphics mode on, all received codes in the range of 00 to 7E are displayed as characters in the range of Hex 00 to Hex 1F in the same character set.

This is done by stripping off the highest 3 bits of the code. For example:

Receiving . . .	Displays . . .
21, 41, or 61 (Hex)	01 (Hex) character
2C, 4C, or 6C (Hex)	0C (Hex) character
31, 51, or 71 (Hex)	11 (Hex) character

## ASCII Escape Sequences

### 12.5 Printing/Sending Data

Most character sets in ASCII emulation contain characters in the range of Hex 00 and Hex 1F. For example, the Native character set contains 16 line-drawing graphics characters from Hex 10 to Hex 1F and 16 CRM characters from Hex 00 to 0F. But in most of the cases, Hex codes 00 to 1F are treated as control codes. To display these graphic characters, Graphic mode has to be turned on.

When the Graphic mode is on, new characters entered have normal attributes regardless of the state of the Write-Protect mode attribute. With Protect mode on, all the entered characters, except CRM characters, are protected.

To design a character font, see Chapter 13.





## Defining and Loading ASCII Character Fonts

This chapter defines the ASCII character fonts and describes how to load the fonts.

### 13.1 Character Sets

In WYSE mode and ADDS Enhanced mode, desired characters can be acquired by loading them from various built-in character sets or by designing them using a pixel pattern\*.

#### 13.1.1 PCTerm on US Keyboard

The default and only character set supported for PCTerm on the US Keyboard is the PC International character set. This is a 256-character set, of which the first 128 characters form the PC Standard character set\*.

#### 13.1.2 WYSE and ADDS Enhanced Personalities

WYSE mode and ADDS enhanced mode support ten built-in ROM character sets and four *font banks*, which are physical locations in memory. Each character set has 128 characters (Hex 00 to Hex 7F), thus each font bank has the same space allocation.

The character set must be loaded into a font bank to become an "active" character set. Characters cannot be displayed directly by calling their physical locations; they can only be displayed through a series of steps to make them active. First, the primary and secondary logical character sets are defined by pointing to the desired font banks. Then, the active character set is defined for the terminal to display and receive codes. See Table 13–1 on how to display and load character sets.

**Table 13–1 Display and Load Character Sets**

Step	Description
1. Load font bank with built-in character set or Define and load character	Load a target character set from one of the ten built-in character sets into a font bank. Design a character and load it into a font bank.
2. Define logical character set	Define primary or secondary character set to point to the font bank.
3. Select active character set	Set active character set to point to either a primary or a secondary character set.

#### Notes

**WYSE 160:** You can display all 512 characters in the four font banks on the screen at the same time.

\* Refer to the IBM Code Page 437.

# Defining and Loading ASCII Character Fonts

## 13.1 Character Sets

**WYSE 50+:** You can only display one font bank on the screen at a time.

Figure 13-1 shows the process for selecting character sets.

**Figure 13-1 Process of Selecting Character Sets**

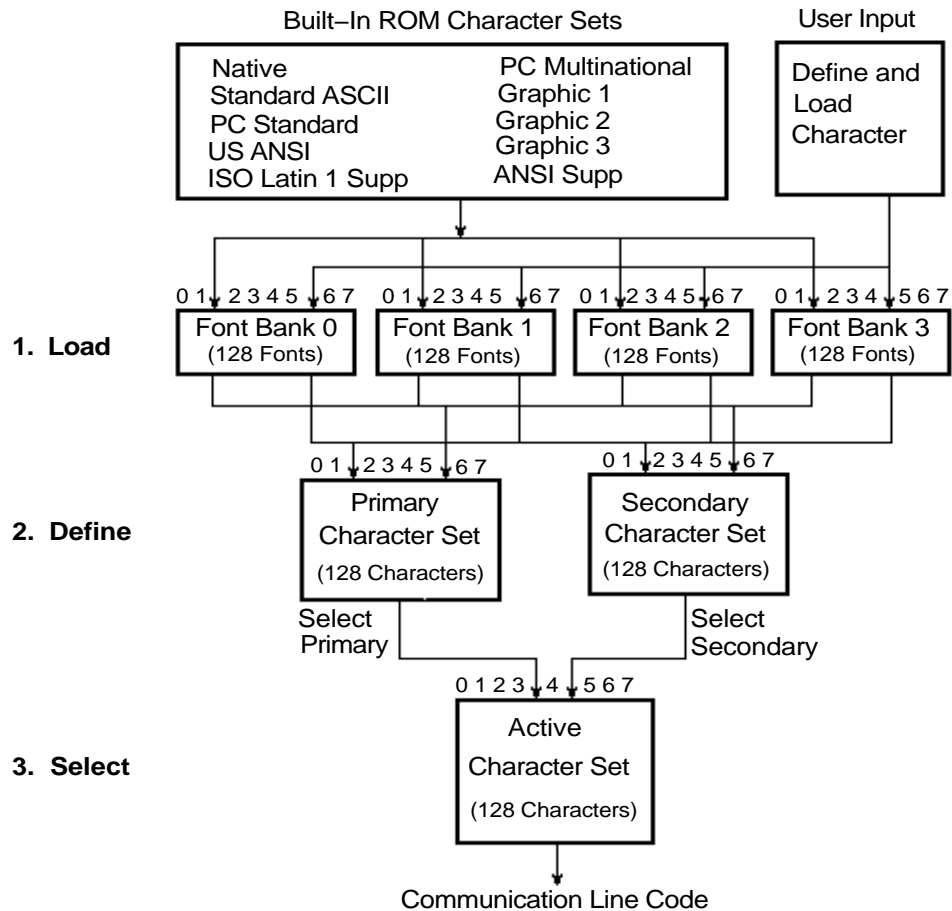

MA-0027-93.GRA

The VT520 selects a character set from one of the built-in character sets by the following process. Refer to Table 13-1 for details.

1. Load the character sets into the font banks.
2. Define the primary and secondary character set from the font buffers.
3. Select which character set will be the active characters set.

## Defining and Loading ASCII Character Fonts

### 13.1 Character Sets

#### Note

Changing a character set in a font bank may change the active character set if the active character set and primary/secondary character set happen to point to the same font bank.

## 13.2 Loading, Defining, and Selecting Character Sets

Table 13–2 shows how to load, define, and select the character sets. The word “same” in Table 13–2 signifies the same control sequences as in the WYSE 160/60 column.

**Table 13–2 Loading Font Bank**

	WYSE				TVI			ADDS
	160/60	PCTerm	150/120	50/50+	950	925	910+	A2
<b>Load Font Bank<sup>1</sup></b>	<b>160/60</b>	<b>PCTerm</b>	<b>150/120</b>	<b>50/50+</b>	<b>950</b>	<b>925</b>	<b>910+</b>	<b>A2</b>
Load ROM-resident character set into one of the four font banks. <sup>2</sup>	ESC c @ <i>Bank Charset</i>							
<b>Parameters:</b>	<u>Bank</u>	<u>Description</u>						
	0	Font Bank 0	n/a	same	same	n/a	n/a	n/a
	1	Font Bank 1						EnH
	2	Font Bank 2						
	3	Font Bank 3						
	<u>Charset</u>	<u>Character Set Selected</u>						
	@ (4/0) or ` (6/0)	Native						
	A (4/1) or a (6/1)	PC Multinational						
	B (4/2) or c (6/3) or d (6/4)	Standard ASCII						
	C (4/3)	Graphics 1						
	D (4/4) or b (6/2)	PC standard						
	E (4/5)	Graphics 2						
	F (4/6)	Graphics 3						
	G (4/7) or H (4/8) or g (6/7)	US ANSI						
	N (4/14) or j (6/10)	ISO Latin-1 Supplemental						
	I (4/9) or e (6/5)	ANSI Supplemental						
<b>Define Logical Character Set</b>								
Primary Character Set	ESC c B <i>Bank</i>	n/a	same	same	n/a	n/a	n/a	EnH
Secondary Character Set	ESC c C <i>Bank</i>	n/a	same	same	n/a	n/a	n/a	EnH
<b>Select Active Character Set<sup>3</sup></b>								
Primary Character Set (default)	ESC c D	n/a	same	same	n/a	n/a	n/a	EnH

<sup>1</sup> If not redefined, the default primary character set is Native/Wyse 50+ in Font Bank 0; the secondary character set is PC Multinational in Font Bank 1.

<sup>2</sup> Example: To load Bank 1 with the Multinational character set, enter: ESC c @ 1 A  
This sequence is sent to the terminal. If ACK mode is on, the terminal returns an ACK to indicate that the font has loaded successfully.

<sup>3</sup>The default active character set, including that for TVI mode, is Native/Wyse 50+.

(continued on next page)

## Defining and Loading ASCII Character Fonts

### 13.2 Loading, Defining, and Selecting Character Sets

Table 13–2 (Cont.) Loading Font Bank

Select Active Character Set <sup>3</sup>								
Secondary Character Set	ESC c E	n/a	same	same <sup>4</sup>	n/a	n/a	n/a	EnH
Automatic Font Loading								
On (default)	ESC e O	n/a	same	same	n/a	n/a	n/a	n/a
Off	ESC e N	n/a	same	same	n/a	n/a	n/a	n/a
		WYSE			TVI			ADDS
Clear Font Bank	160/60	PCTerm	150/120	50/50+	950	925	910+	A2
Erase a character set from one of the four font banks. <sup>1</sup>	ESC c ? <i>Bank</i>	n/a	same	same	n/a	n/a	n/a	EnH

<sup>1</sup> If not redefined, the default primary character set is Native/Wyse 50+ in Font Bank 0; the secondary character set is PC Multinational in Font Bank 1.

<sup>3</sup>The default active character set, including that for TVI mode, is Native/Wyse 50+.

<sup>4</sup>See Note on the following page.

#### Note

**Wyse 50+ Mode:** Because Wyse 50+ can only display one font bank at any given time, executing the sequence has a side effect of converting the existing screen characters into new characters that have equivalent positions as the old characters in the original character sets.

For example, a screen full of "!" characters are displayed when the active character set is Native/Wyse 50+. Executing **Select Secondary Character Set** to select the PC Multinational as the active character set causes the "!" on the screen to be converted to "í ". The character "!" occupies Hex 21 in Native/Wyse 50+ character set; whereas, "í " occupies Hex 21 in the PC Multinational character set.

## 13.3 Designing a Character Font

Table 13–3 shows how to design a character font.

**Table 13–3 Design a Character Font**

Define and	WYSE				TVI			ADDS
	Load a Character	160/60	PCTerm	150/120	50/50+	950	925	910+
Design a character font	ESC c A Bank Pp bb..bb Ctrl/Y							
		n/a	same	same	n/a	n/a	n/a	EnH

The sequence in Table 13–3 defines the *bb..bb* string and loads it in the *Pp* position of the *Bank* font bank.

*Bank* is the font bank that holds a defined character set. Refer to Table 13–2.

*Pp* is a 2-byte Hex code in the range of 00 to 7F specifying a position in that font bank.

*bb...bb* is a Hex code string defining the bit pattern of the defined character. The string contains one of the following:

- 16 2-byte Hex codes for a 10 × 16 cell size character
- 13 2-byte Hex codes for a 10 × 13 cell size character
- 10 2-byte Hex codes for a 10 × 10 cell size character

The command aborts if Ctrl/Y in the sequence is received before the expected number of Hex codes in *bb...bb* is received.

Perform the following steps to draw a graphic character in a 10 × 16 cell:

1. Divide the cell into 10 × 16 pixels and draw the desired font pattern. Observe the following rules:
  - a. Start the pattern from the left column in the cell.
  - b. For an alphanumeric character, the pattern should occupy only the left seven columns; for other graphic characters, the pattern can extend to the eighth column. (The ninth and tenth column follow whatever you place in the eighth column.)
  - c. If possible, leave some space at both the top and bottom pixels to allow for spacing.
2. Turn the font pattern into a value represented as 1s and 0s; where "1" represents a filled pixel, and "0" represents an empty pixel.
3. Encode the bit pattern, 4 bits (a *nibble*) at a time, row by row, into hexadecimal numbers 0 to F. (Do not encode the right two columns.)
4. Form the two nibbles per row into a 2-byte Hex code.
5. Feed the 16 Hex codes into the *bb...bb* string. See the following example.

## Defining and Loading ASCII Character Fonts

### 13.3 Designing a Character Font

Load the the following character into position 31 (Hex) in Font Bank 3.

Bit -->	MSB				LSB				Hex Code		
	7	6	5	4	3	2	1	0		A	B
1											00
2											00
3	X	X	X	X	X	X	X	X			FF
4	X								X		81
5	X								X		81
6	X								X		81
7	X								X		81
8	X	X	X	X	X	X	X	X			FF
9	X								X		81
10	X								X		81
11	X								X		81
12	X								X		81
13	X	X	X	X	X	X	X	X			FF
14											00
15											00
16											00

Use the following sequence to load this graphic character:

```
ESC c A 3 31 00 00 FF 81 81 81 81 FF 81 81 81 81 81 FF 00 00 Ctrl/Y
```

Once loaded, the font remains in the font bank until:

- The terminal is powered off
- This font bank is explicitly re-loaded or cleared
- This font bank is implicitly re-loaded by changing the terminal's personality or the terminal changes between a 24-line and a 44-line display while Automatic Font Load is on. Refer to Table 13-2.

---

## VT Keyboard Legend Data

This appendix describes the Compose processing, non-spacing diacritical marks, and keyboard layouts for the VT keyboard layouts.

### A.1 Compose Processing and Non-spacing Diacritical Marks

Of the new keyboard dialects added to the VT520, only Hebrew and SCS allows three-stroke compose sequences. Pressing "Hebrew" (the `[Compose]` key) initiates a compose sequence. `[Ctrl/Hebrew]` is used to switch between Group 1 and Group 2.

The other new keyboard dialects employ a Group Shift mechanism to access additional characters so there is no `[Compose]` key and no three-stroke compose sequences. Three keyboards have non-spacing diacritical marks in Group 1 or Group 2. These keystrokes initiate a two-stroke "auto-compose" sequence.

Table A-1 lists the VT keyboard non-spacing diacritical marks. The brackets in Table A-1 are not part of the non-spacing diacritical marks.

**Table A-1 VT Keyboard Non-Spacing Diacritical Marks**

VT Keyboard <sup>1</sup>	Acute	Caron	Circumflex	Dieresis	Ring	Tonos
Czech VT	[']	[ˇ]	[^] <sup>2</sup>	[¨]	[°] <sup>3</sup>	
Greek VT				[¨] <sup>4</sup>		[ˆ] <sup>4</sup>
Slovak VT	[']	[ˇ]	[^] <sup>2</sup>	[¨]	[°] <sup>3</sup>	

<sup>1</sup>Hebrew, Hungarian, Polish, Romanian, Russian, SCS, Turkish-Q and Turkish-F keyboards have no non-spacing diacritical marks.

<sup>2</sup>Circumflex over O/o can be produced with caron and O/o.

<sup>3</sup>Ring over U/u can also be produced with caron and U/u.

<sup>4</sup>Greek iota with diaeresis and accent can be produced by pressing diaeresis, accent, then iota. Greek upsilon with diaeresis and accent can be produced by pressing diaeresis, accent, then upsilon.

### A.2 VT Keyboards

The VT keyboard layouts are shown in the figures that follow:

---

**Note**

The keyboards shipped with the product may not look exactly like those illustrated here. Different fonts may be used, and some characters may not look the same.

---

# VT Keyboard Legend Data

## A.2 VT Keyboards

Figure A-1 Austrian/German VT Keyboard

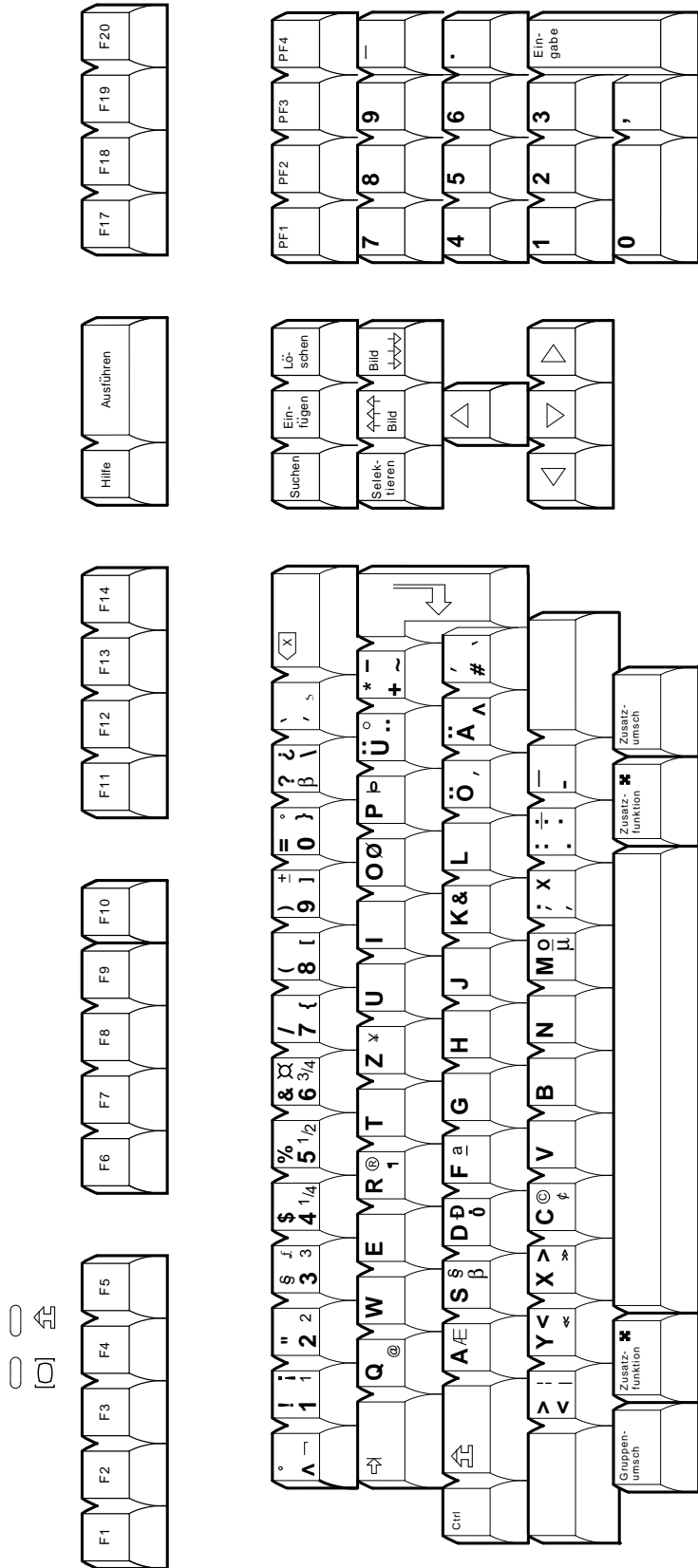

LJ-03232-T10



Figure A-2 Belgian/French VT Keyboard

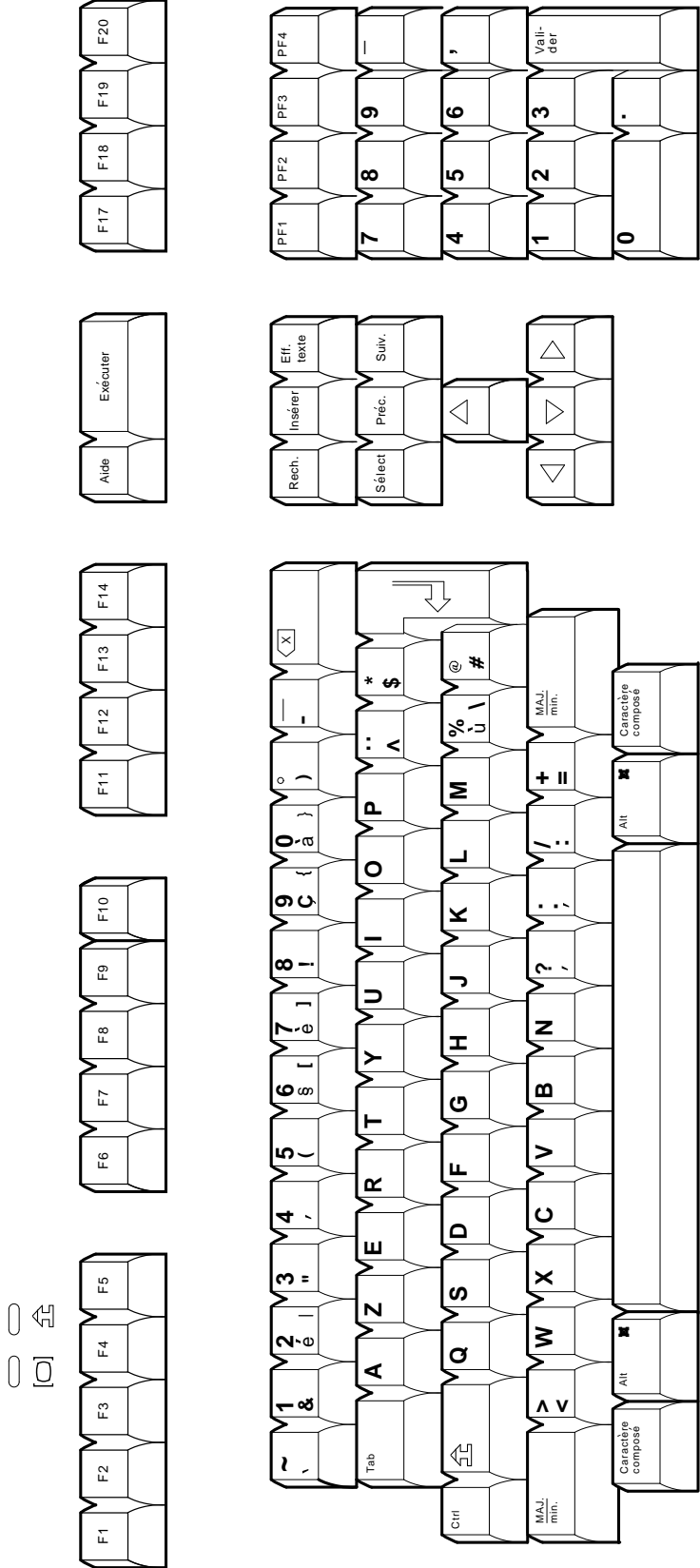

LJ-03277-T10

# VT Keyboard Legend Data

## A.2 VT Keyboards

Figure A-3 British/U.K./North American VT Keyboard

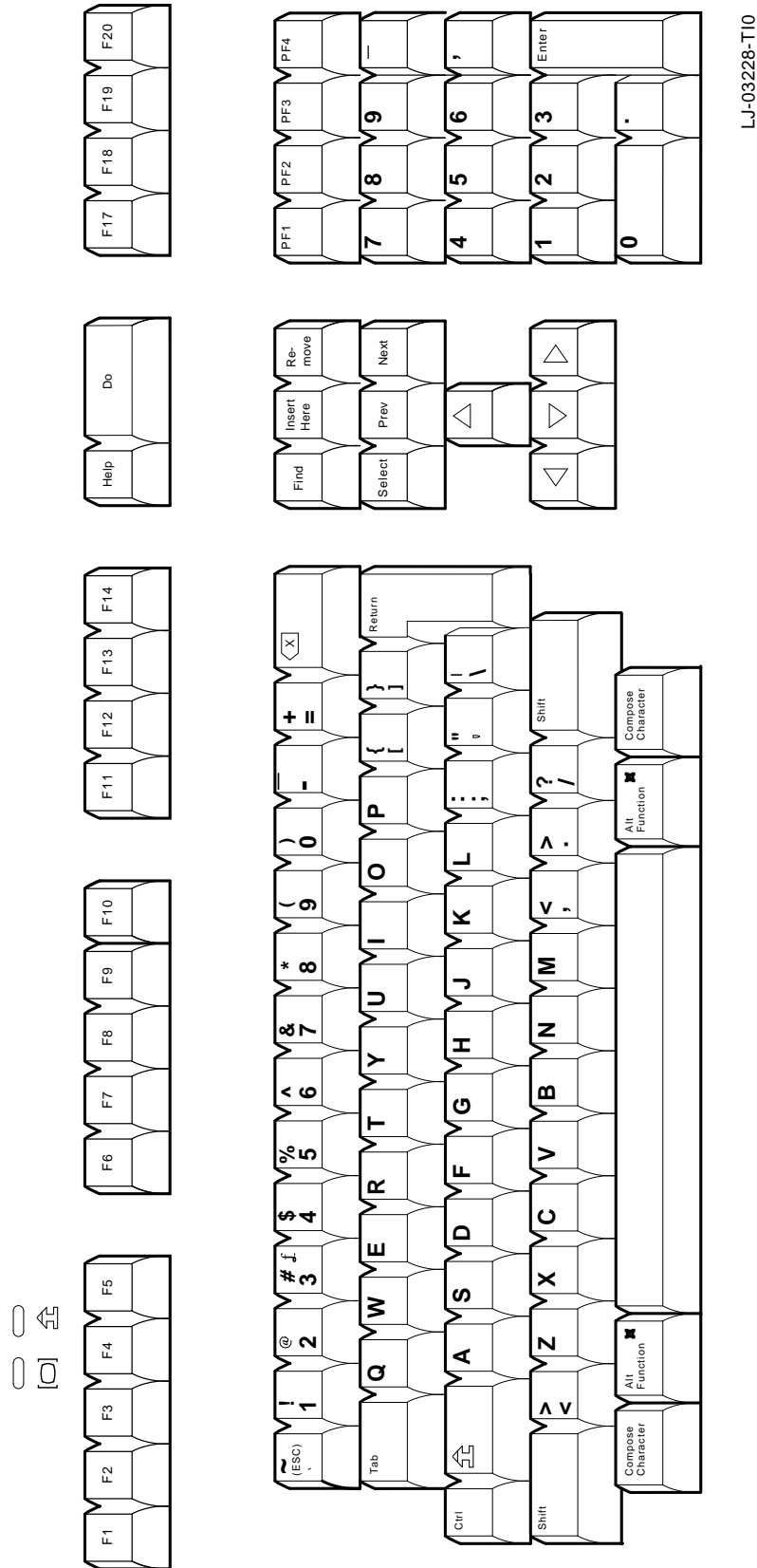
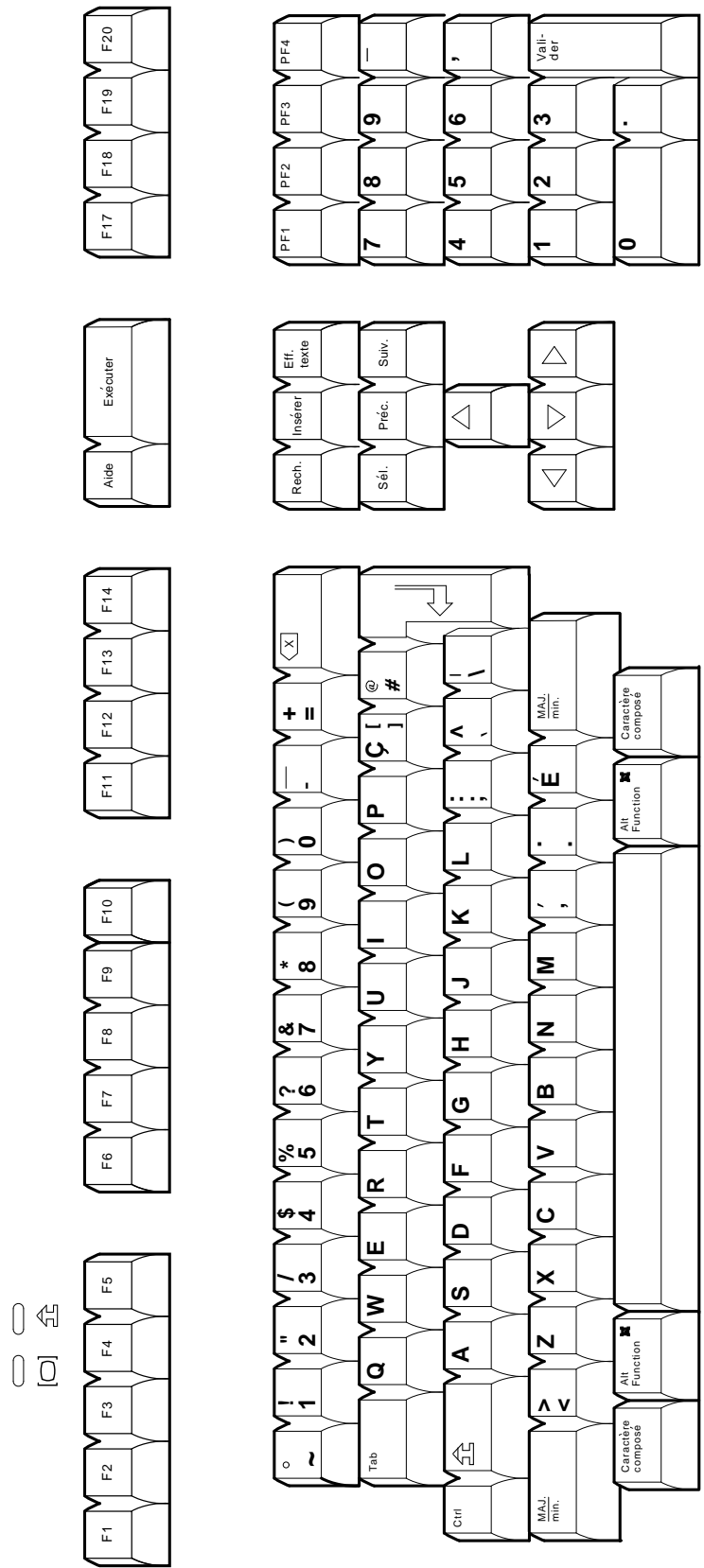

Figure A-4 Canadian-French VT Keyboard



LJ-03230-T10

# VT Keyboard Legend Data

## A.2 VT Keyboards

Figure A-5 Czech VT Keyboard

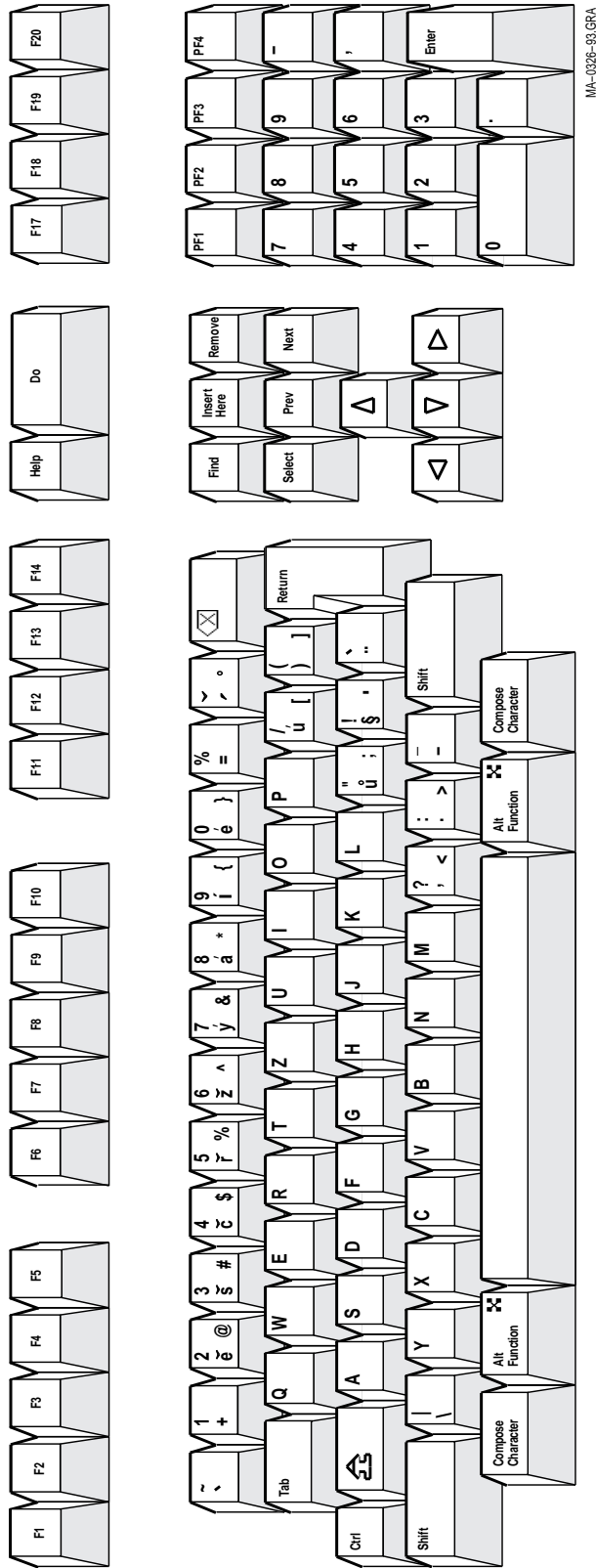
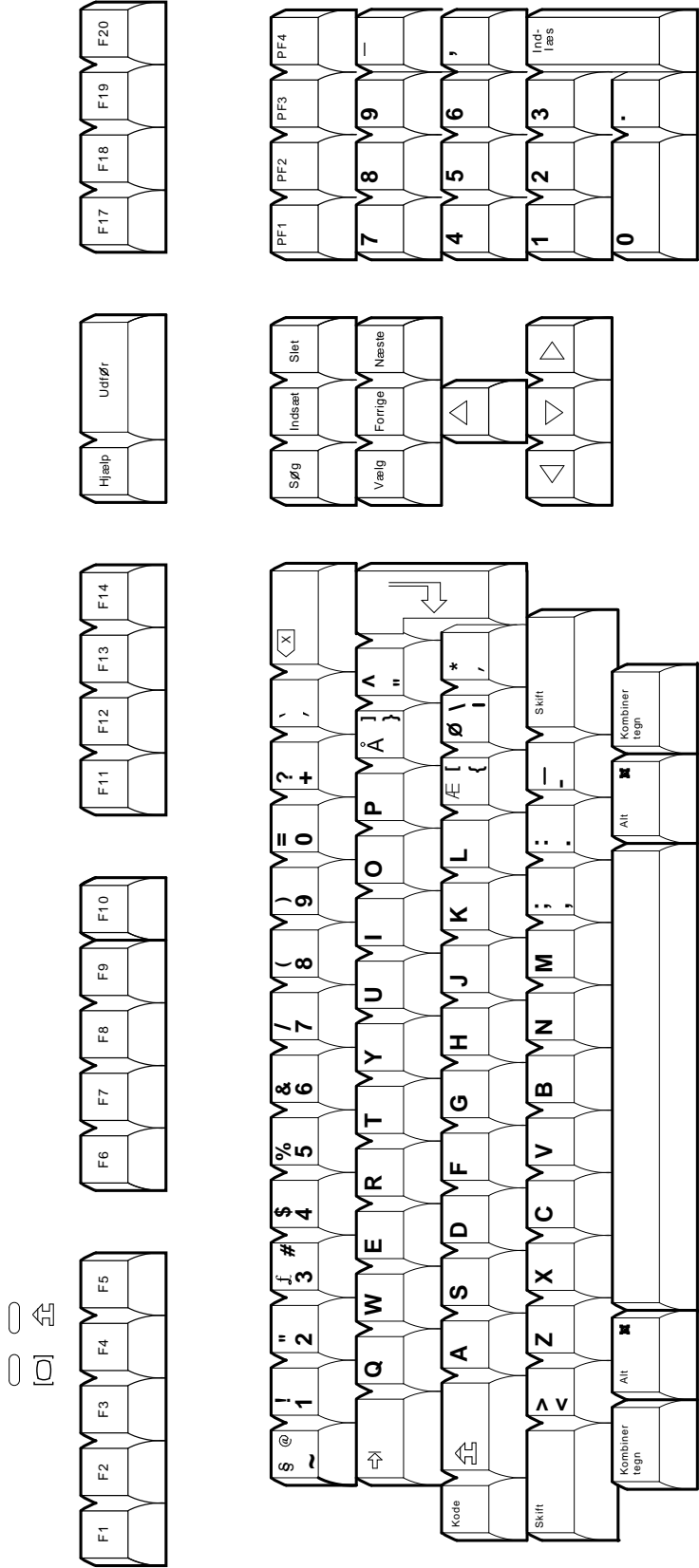

Figure A-6 Danish VT Keyboard



LJ-03278-T10

# VT Keyboard Legend Data

## A.2 VT Keyboards

Figure A-7 Dutch VT Keyboard

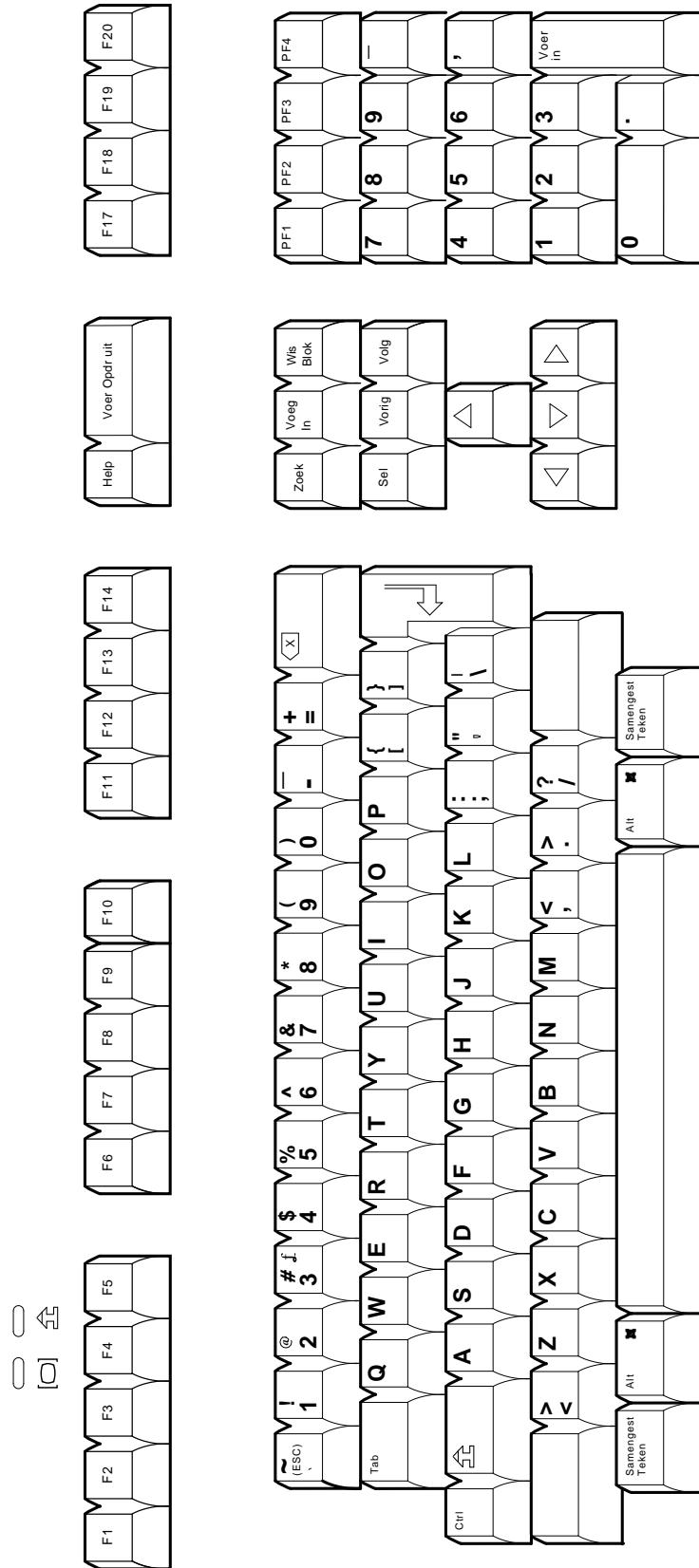

LJ-03229-T10



# VT Keyboard Legend Data

## A.2 VT Keyboards

Figure A-9 Flemish VT Keyboard

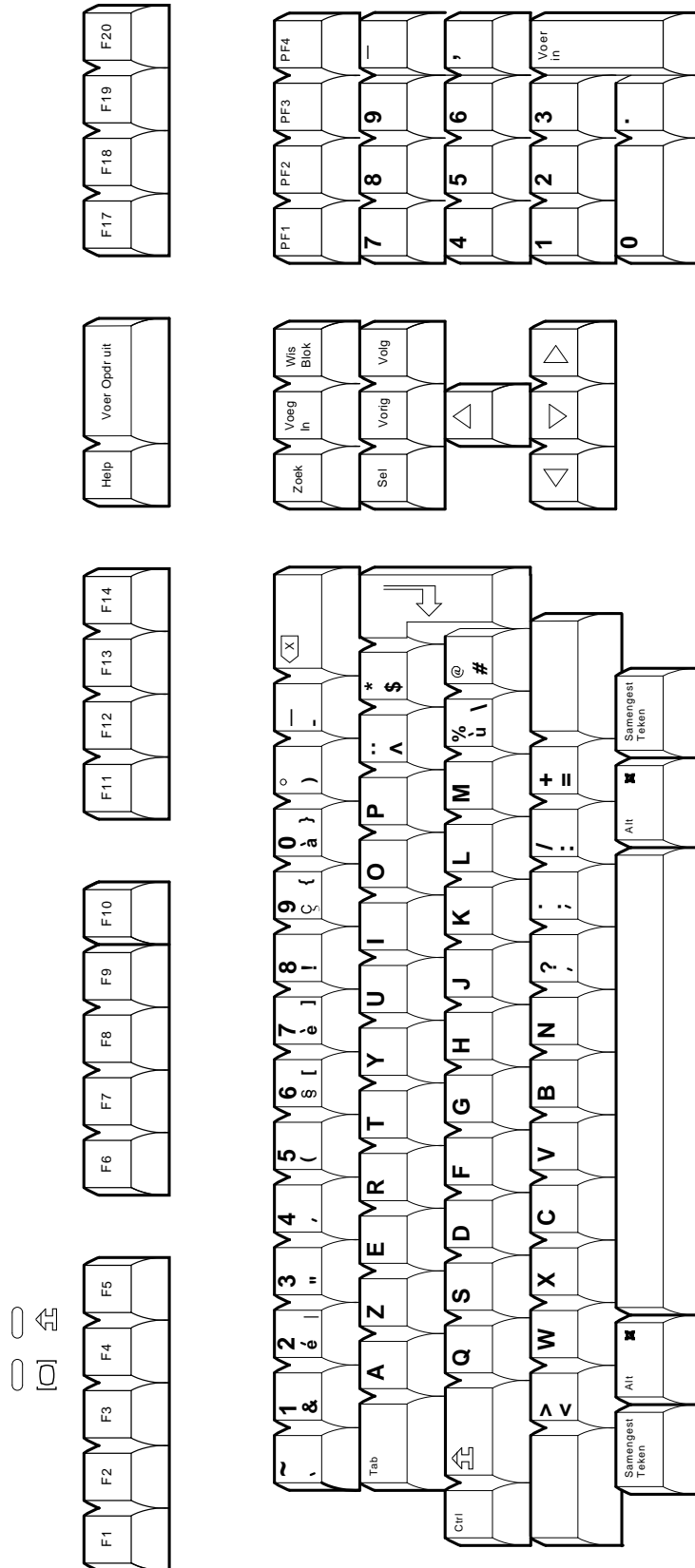

LJ-03229-T10



Figure A-10 Greek VT Keyboard

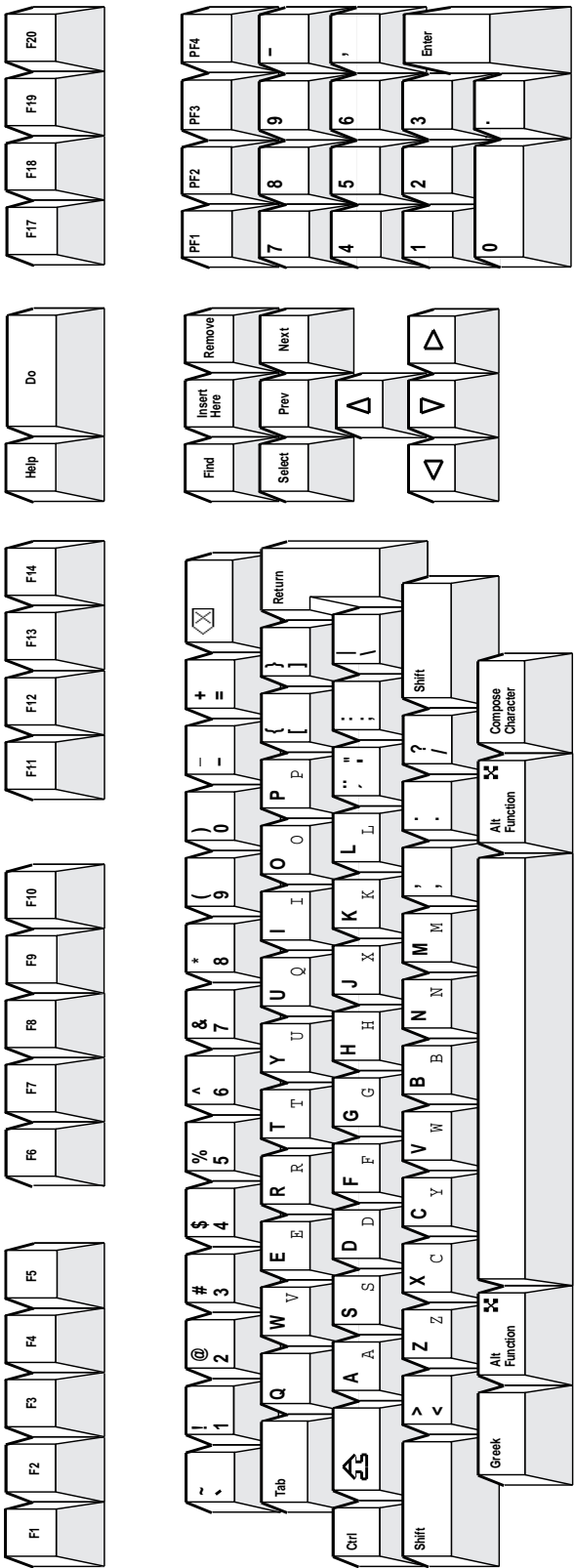

# VT Keyboard Legend Data

## A.2 VT Keyboards

Figure A-11 Hebrew VT Keyboard

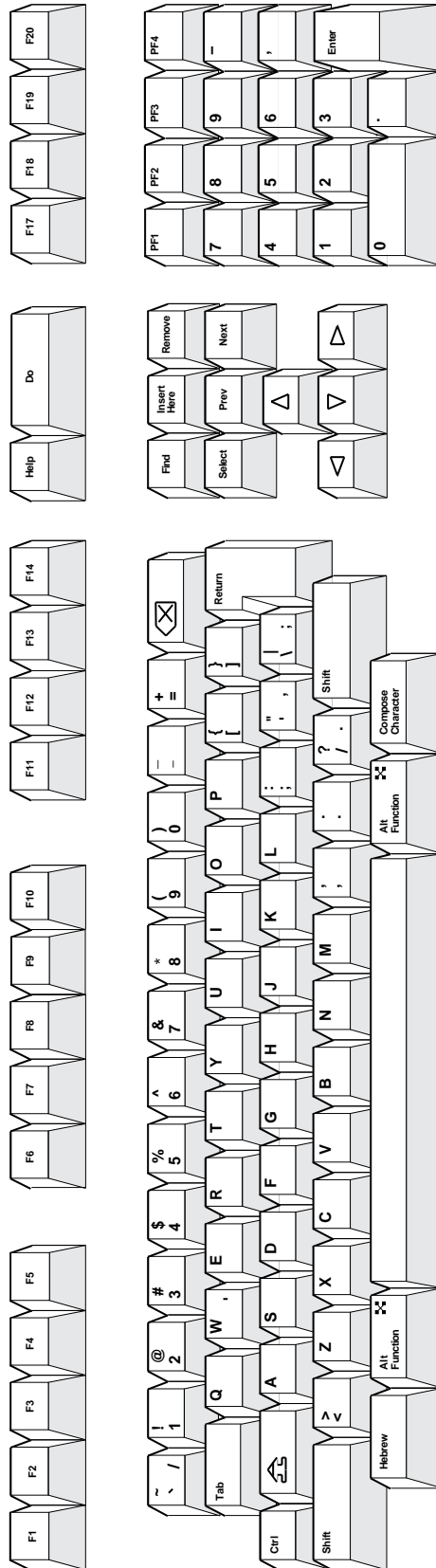

Figure A-12 Hungarian VT Keyboard

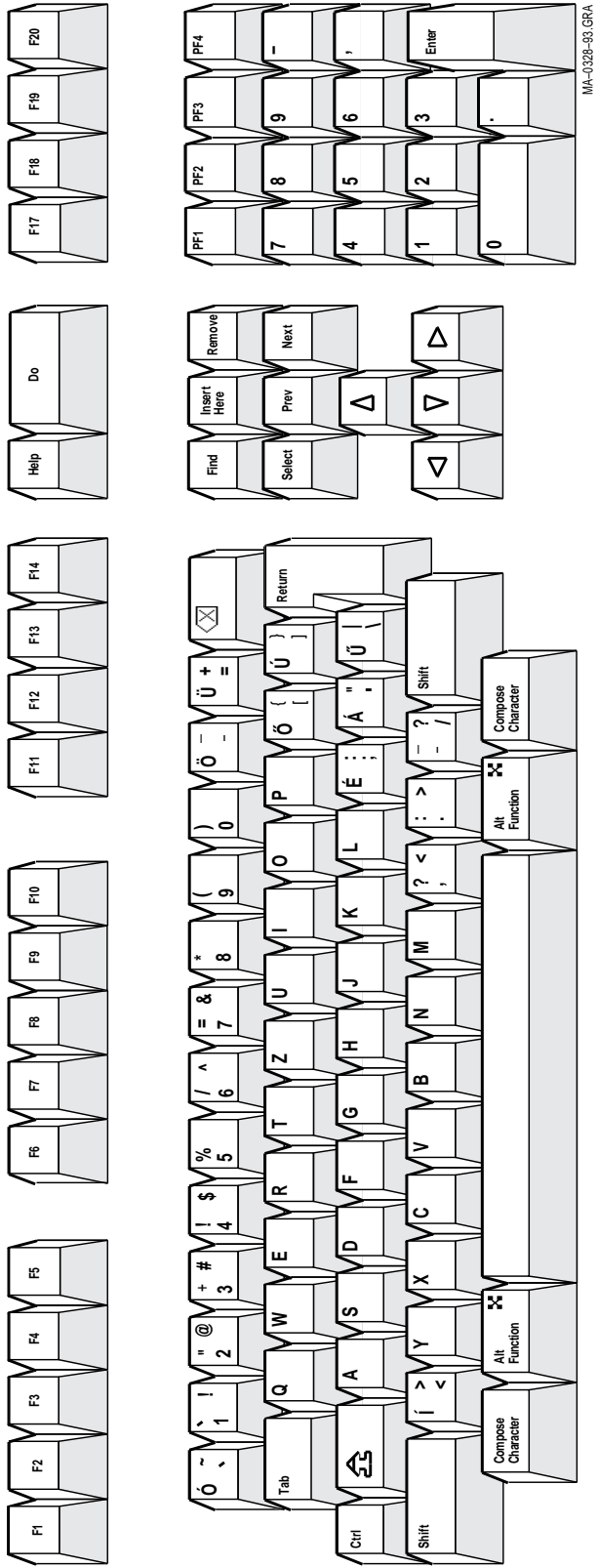
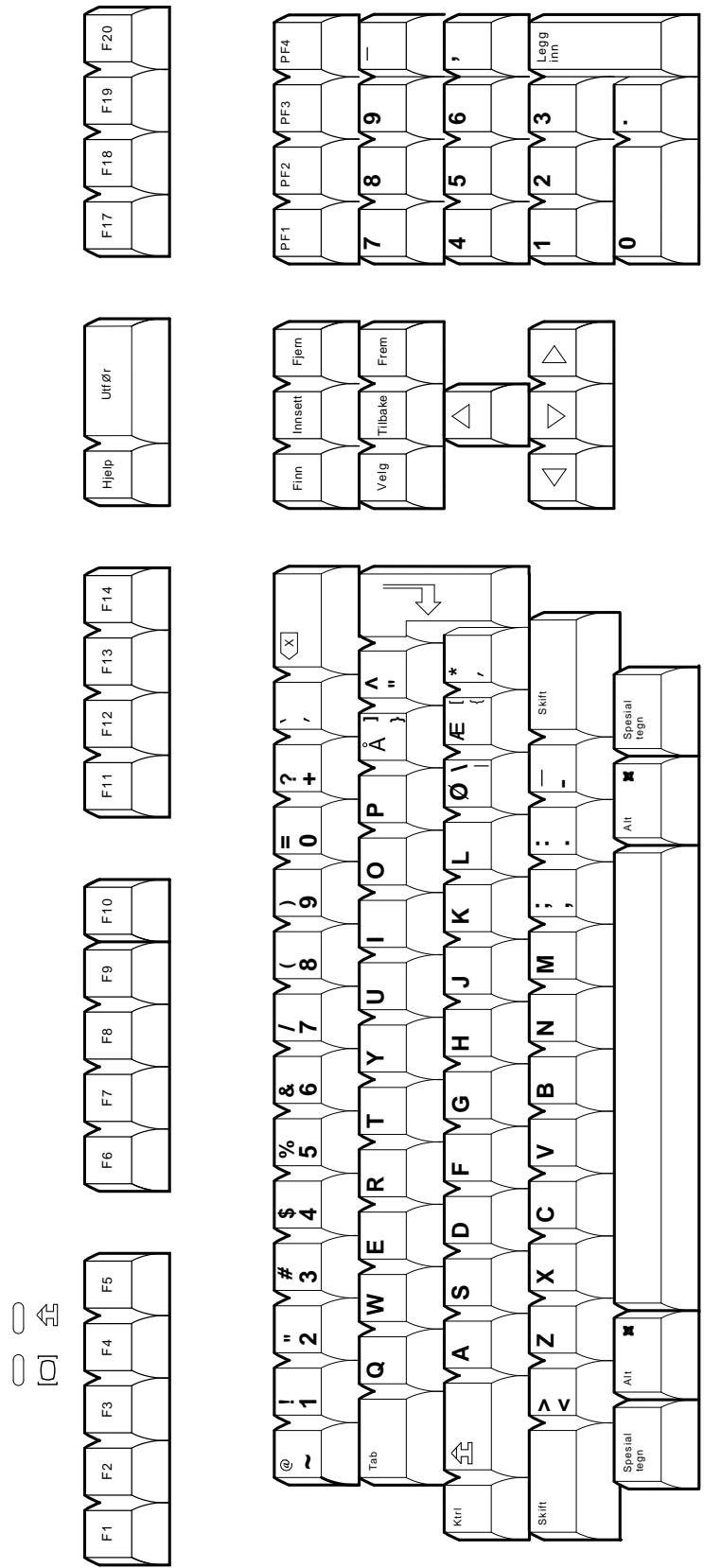



Figure A-14 Norwegian VT Keyboard



LJ-03327-T10

# VT Keyboard Legend Data

## A.2 VT Keyboards

Figure A-15 Polish VT Keyboard

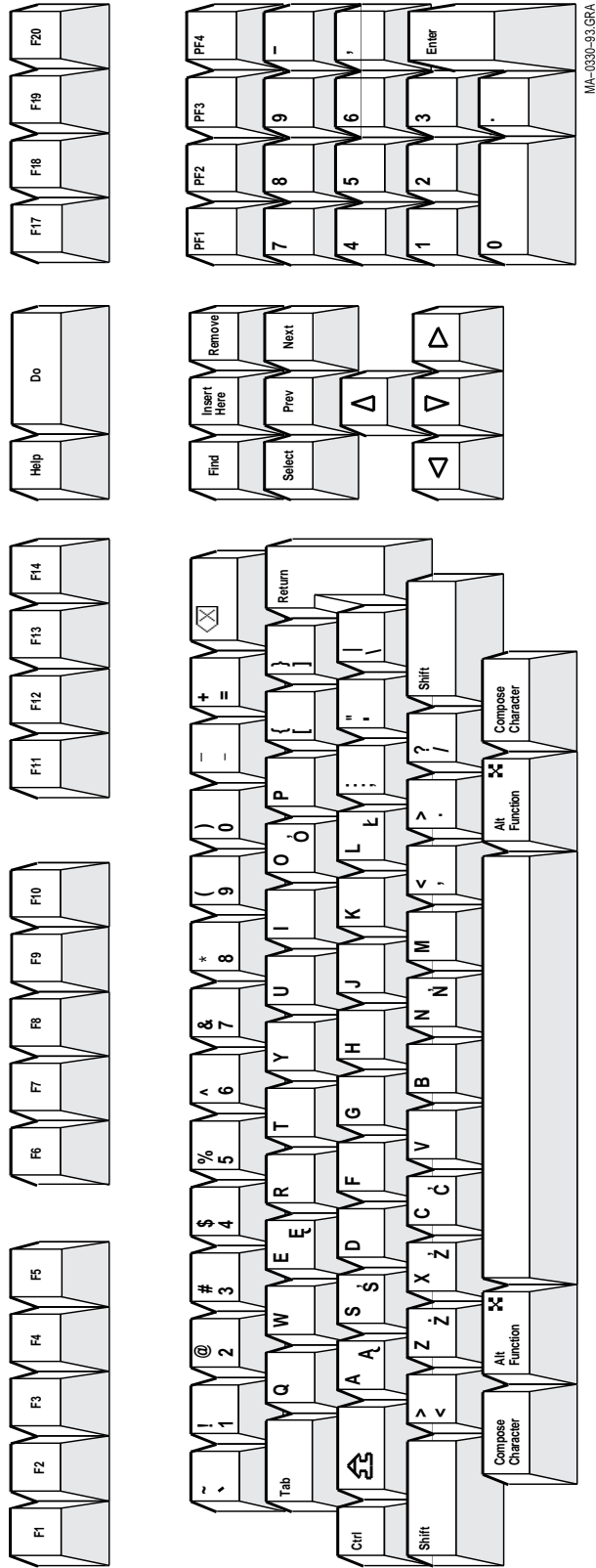
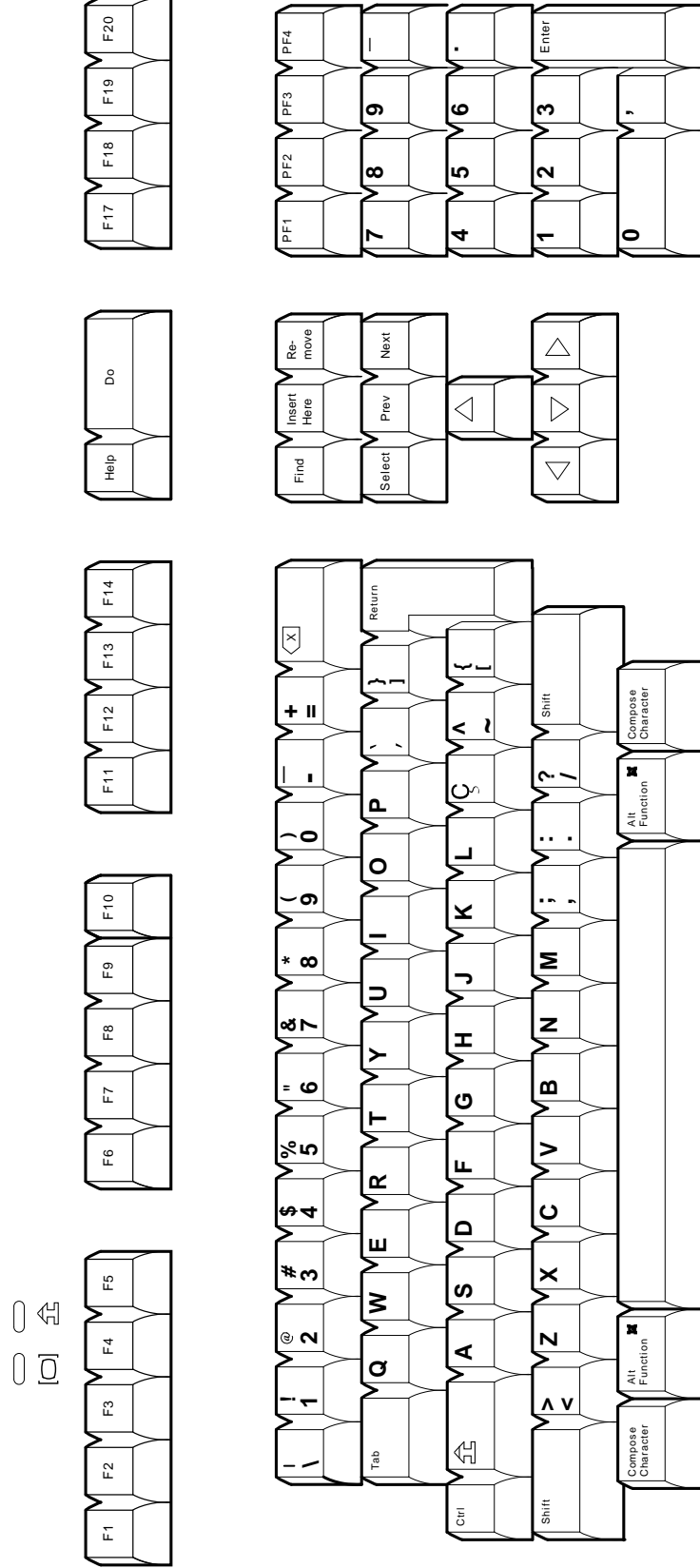

Figure A-16 Portuguese VT Keyboard



LJ-03328-T10

# VT Keyboard Legend Data

## A.2 VT Keyboards

Figure A-17 Romanian VT Keyboard

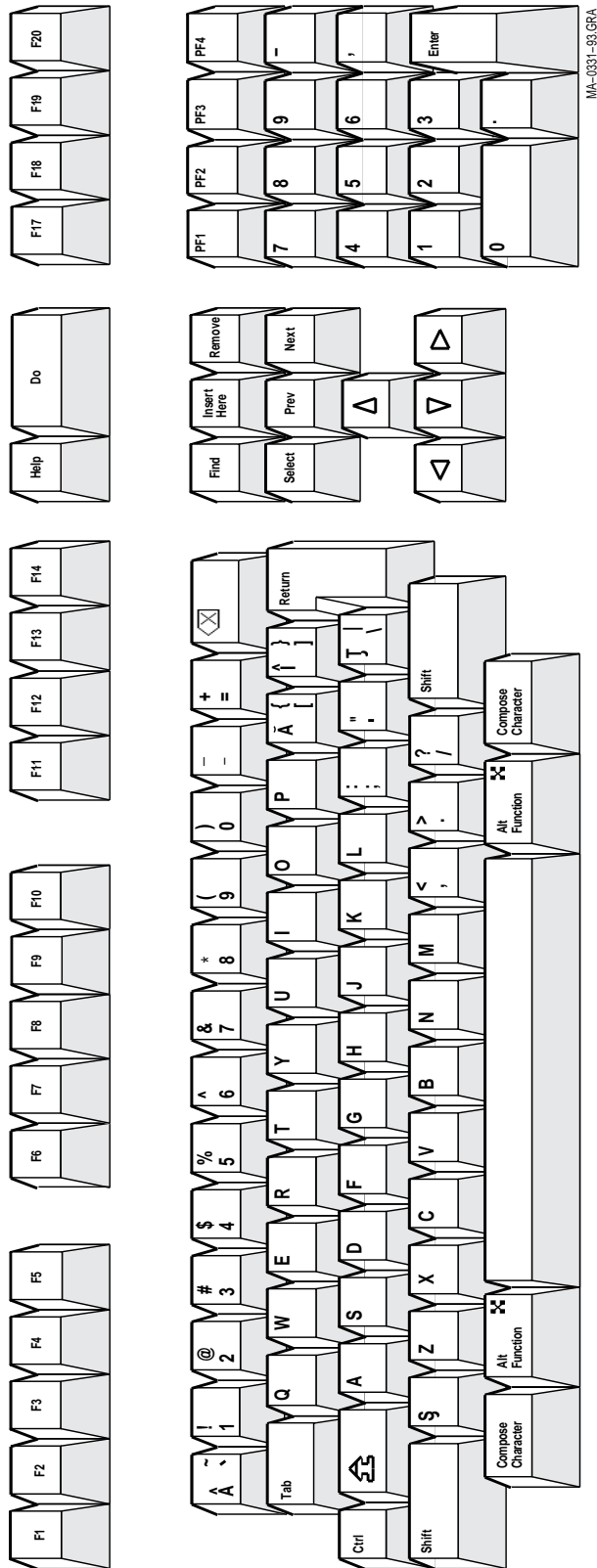
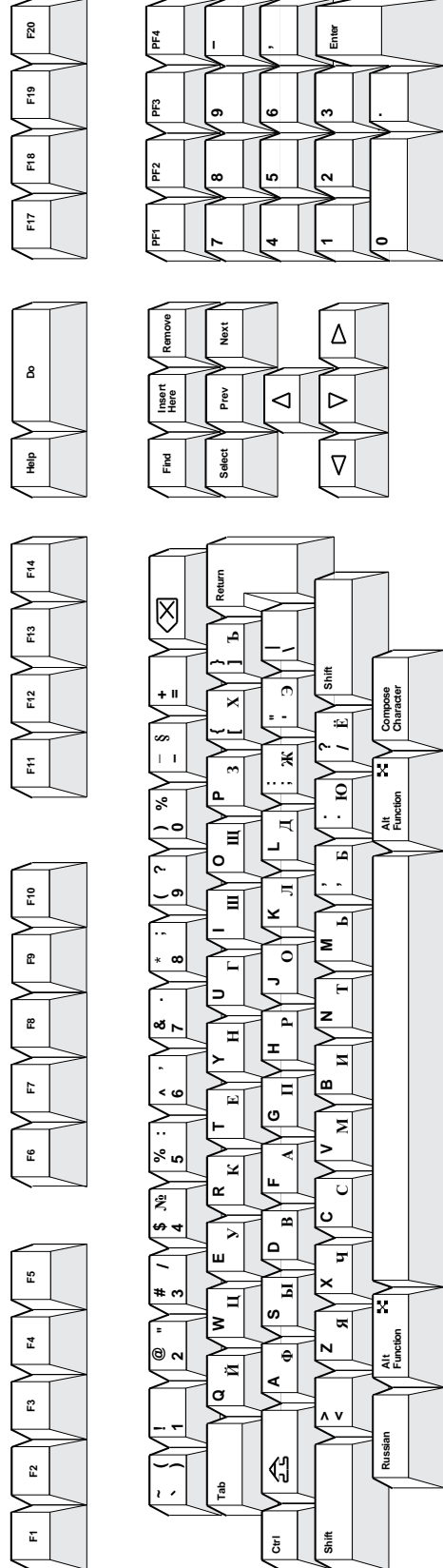



Figure A-18 Russian VT Keyboard



# VT Keyboard Legend Data

## A.2 VT Keyboards

Figure A-19 SCS VT Keyboard

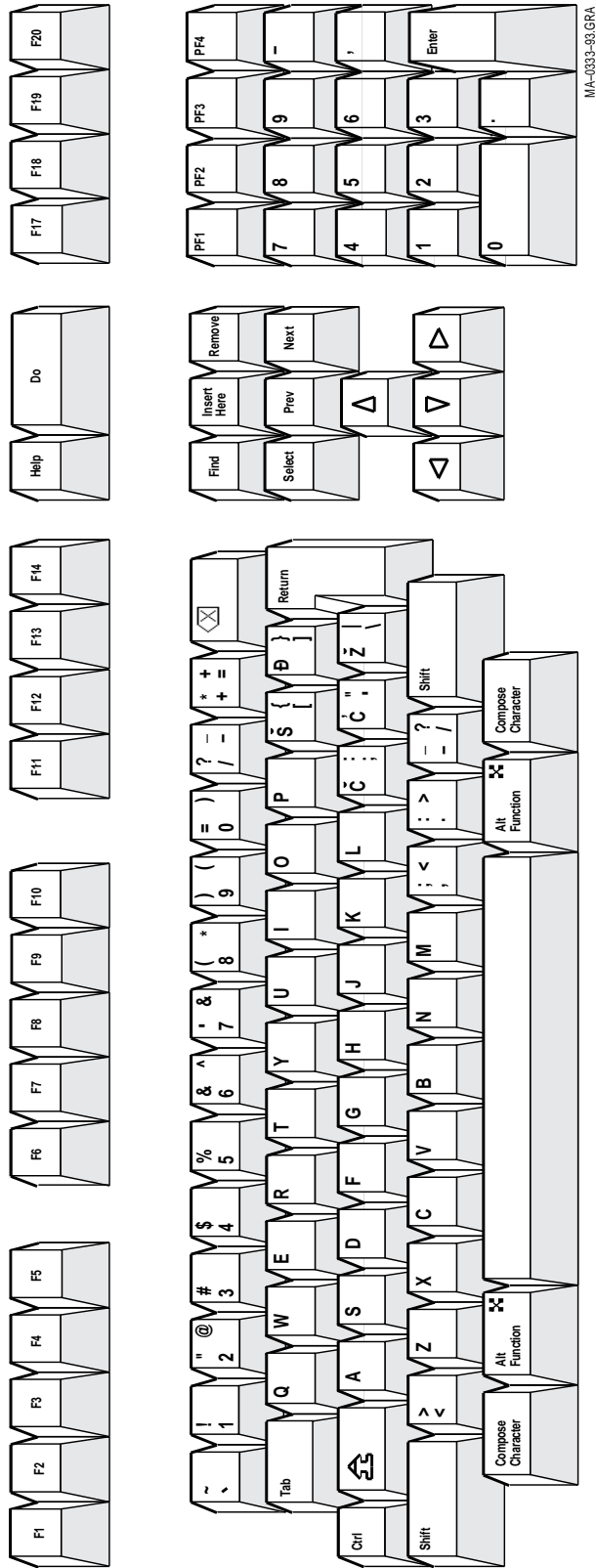
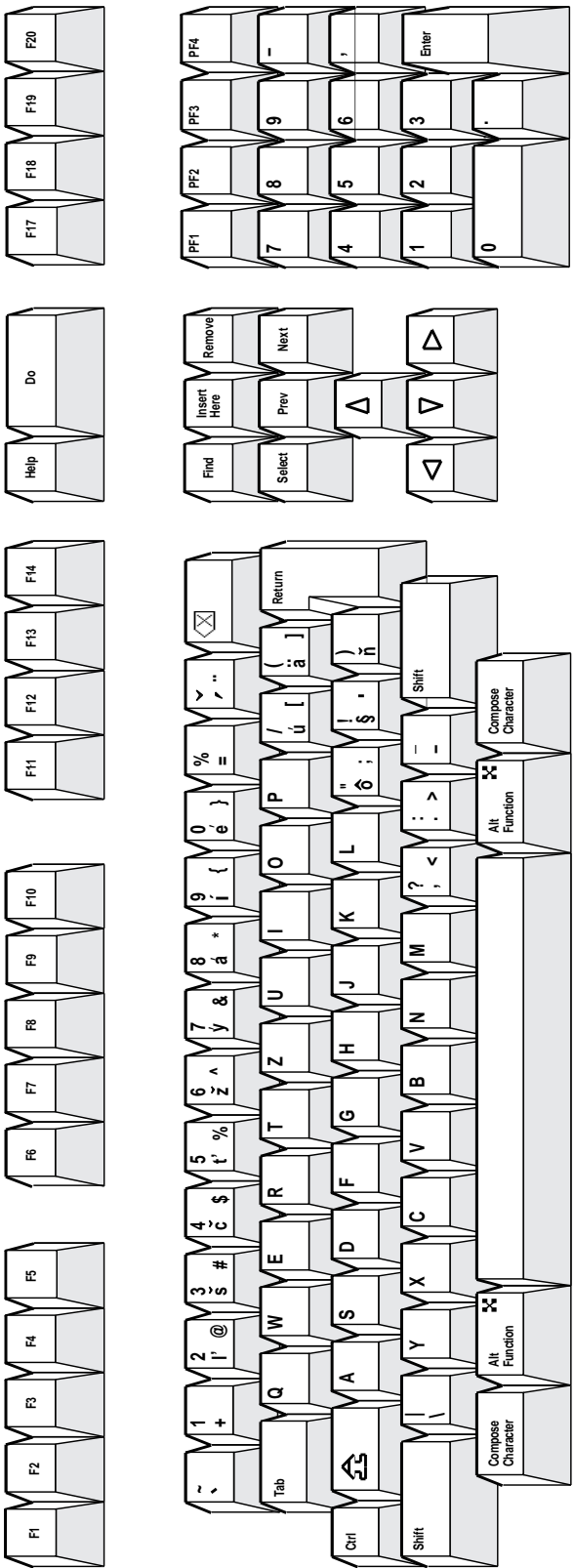

Figure A-20 Slovak VT Keyboard



# VT Keyboard Legend Data

## A.2 VT Keyboards

Figure A-21 Spanish VT Keyboard

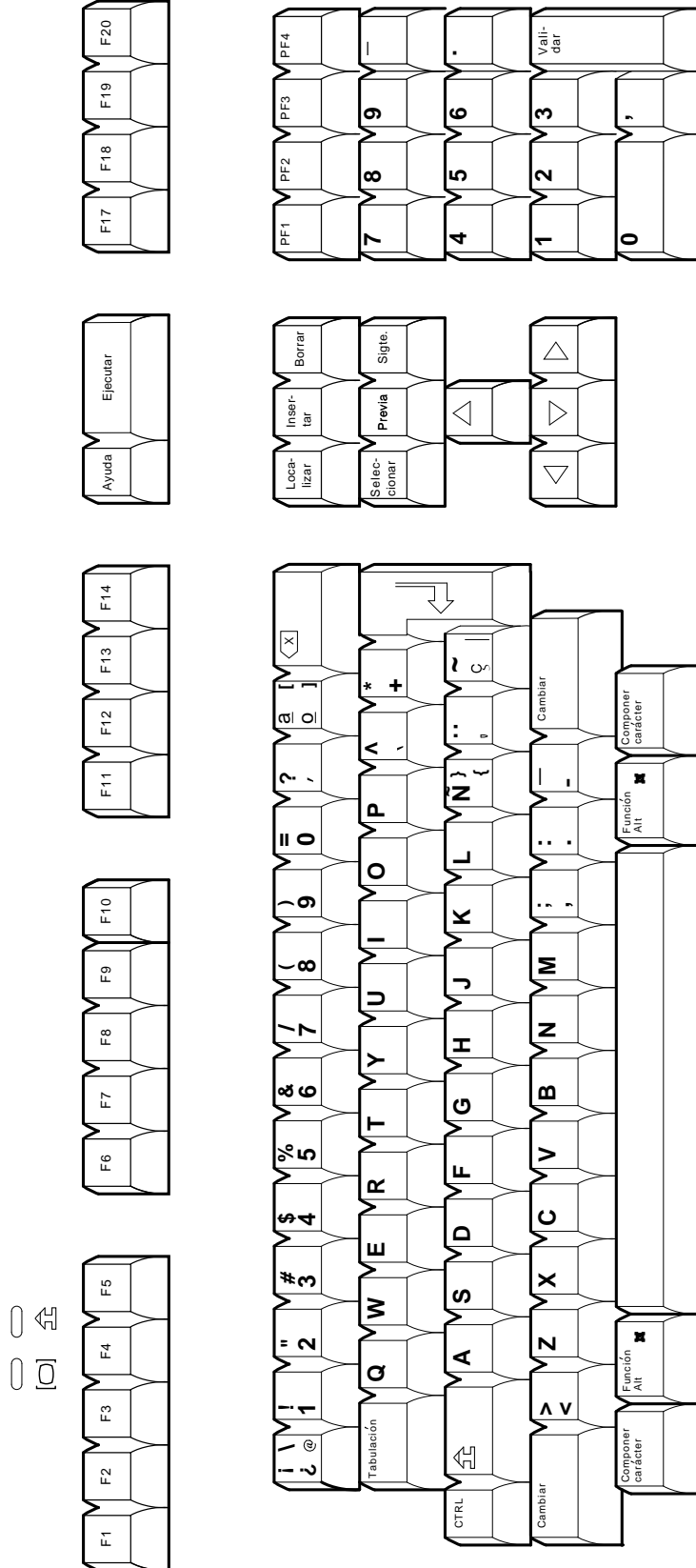

LJ-03276-T10

Figure A-22 Swedish VT Keyboard

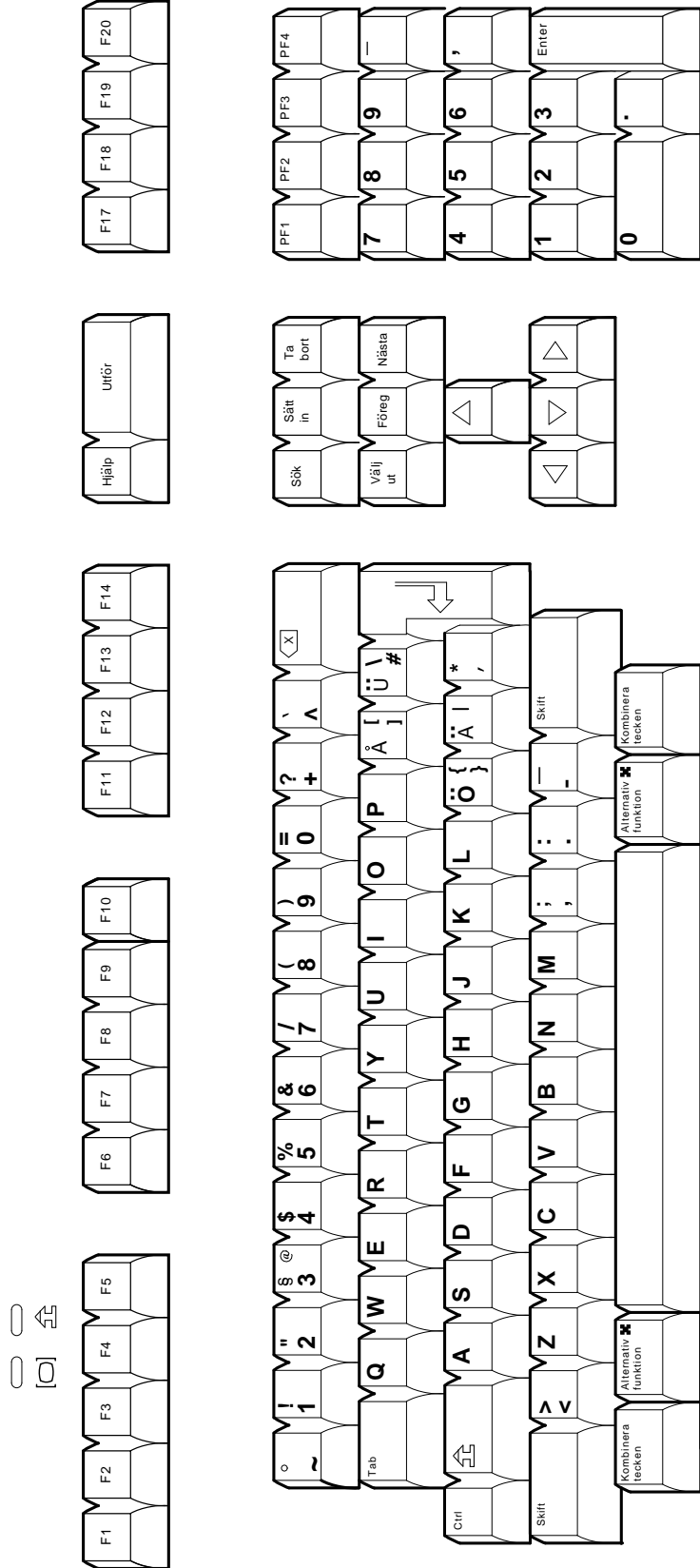

LJ-09233-T10

# VT Keyboard Legend Data

## A.2 VT Keyboards

Figure A-23 Swiss-French VT Keyboard

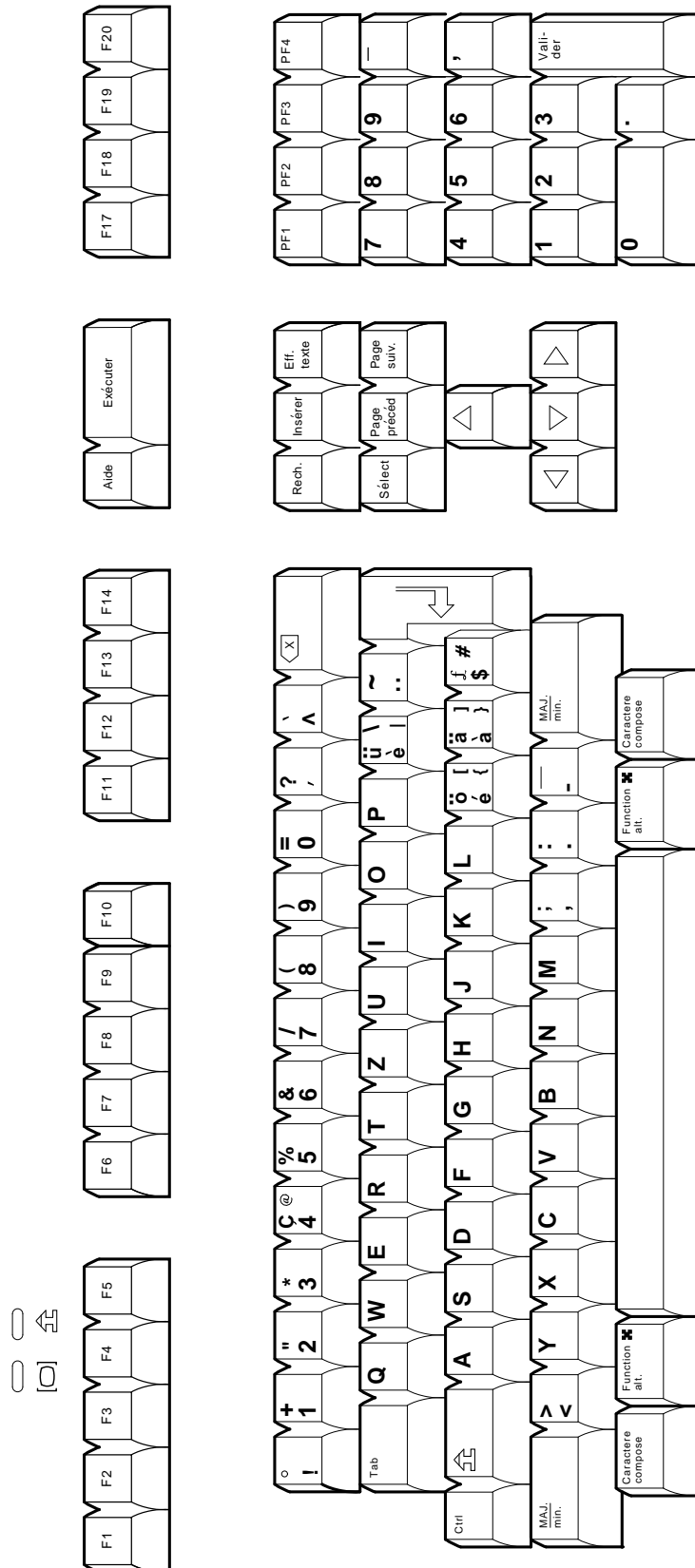

LJ-03275-T10

Figure A-24 Swiss-German VT Keyboard

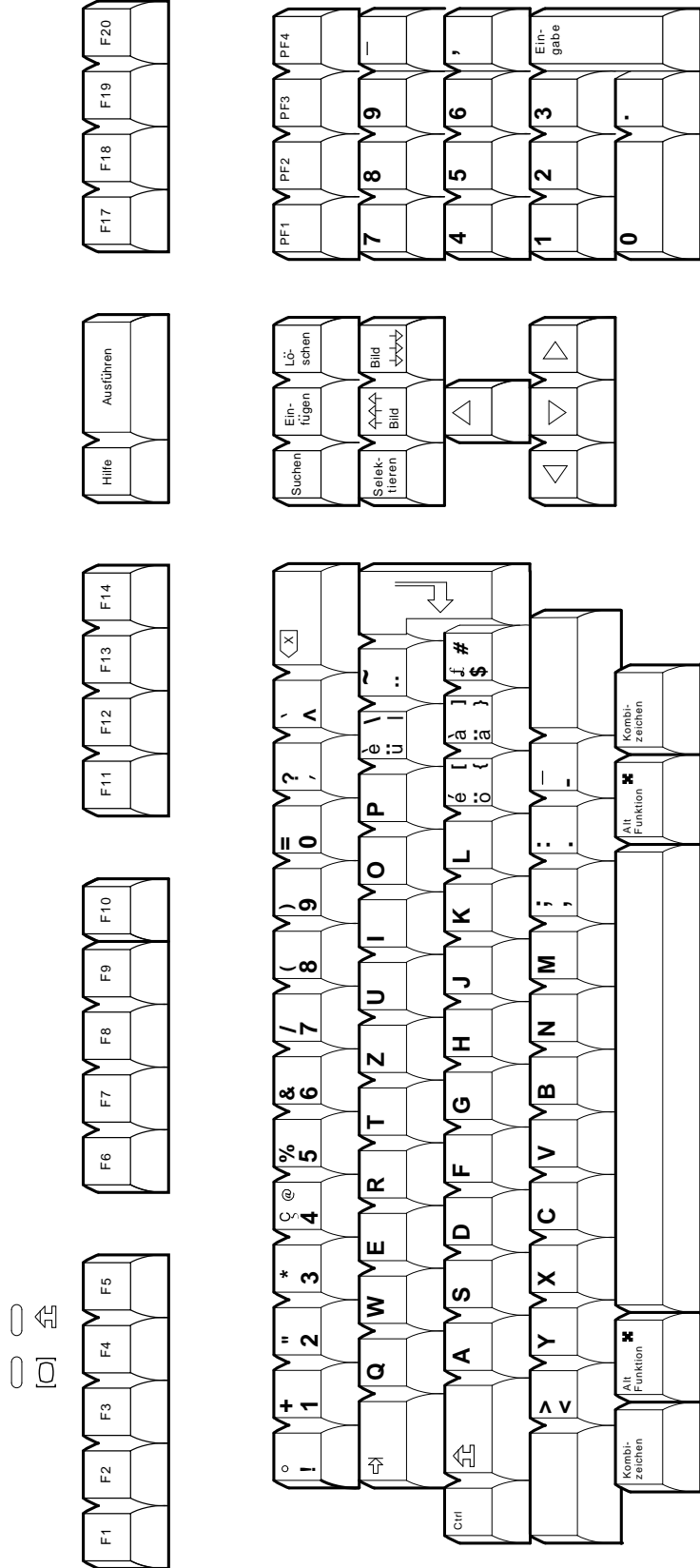

LJ-09234-T10

# VT Keyboard Legend Data

## A.2 VT Keyboards

Figure A-25 Turkish-F VT Keyboard

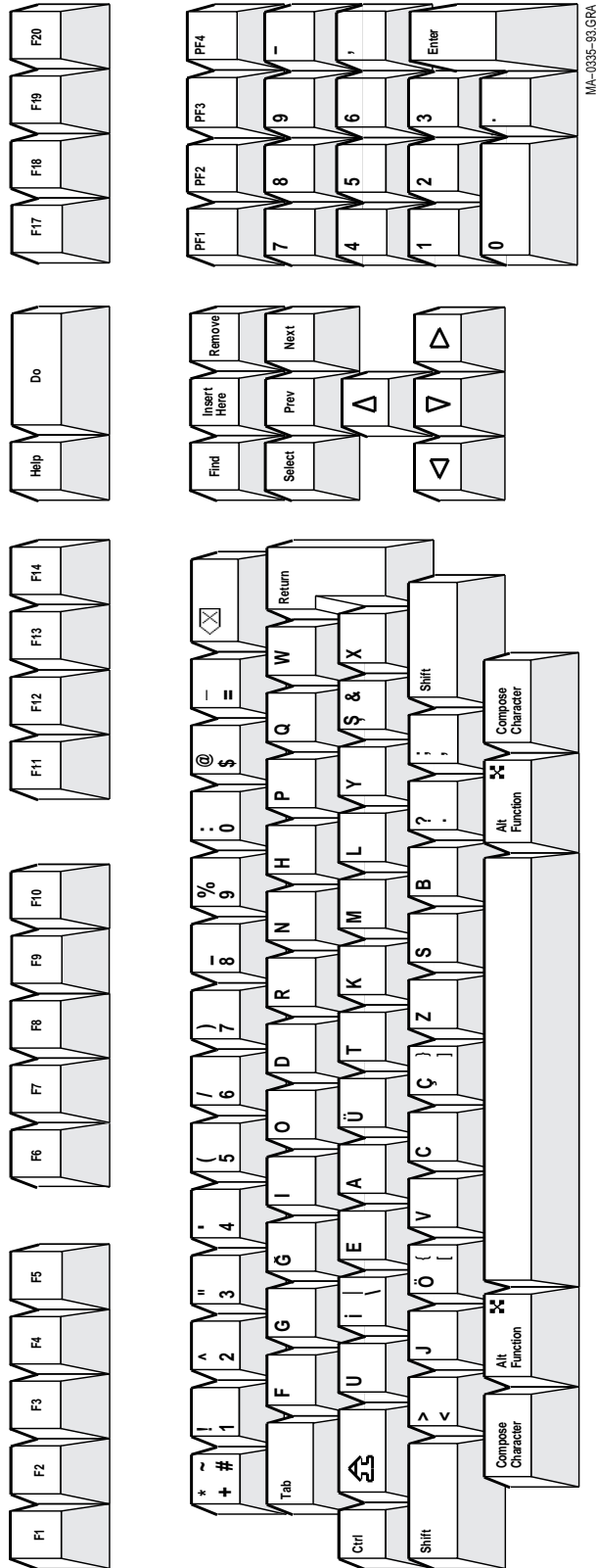
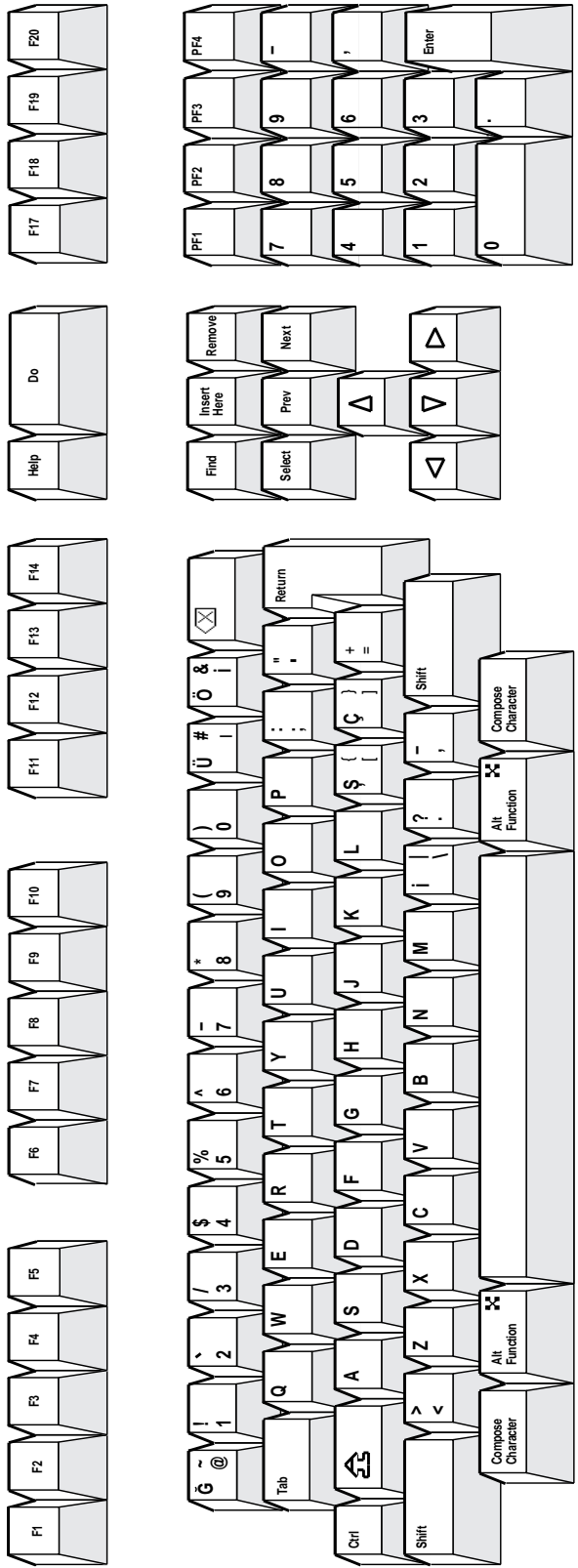



Figure A-26 Turkish-Q VT Keyboard





# B

## Enhanced PC Keyboards

This appendix shows the non-spacing diacritical marks and the keyboard layouts for VT520 Enhanced PC keyboards.

### B.1 Summary of Non-Spacing Diacritical Marks

Table B-1 lists the non-spacing diacritical marks within square brackets [].

**Table B-1 Enhanced PC Keyboard Non-Spacing Diacritical Marks**

EPC Keyboard	Acute	Breve	Caron	Cedilla	Circumflex	Dieresis	Dot
Austrian/German	[ ]				[^]		
Belgian	[ ]				[^]	[ ]	
Canadian (French)	[ ]			[ ]	[^]	[ ]	
Czech	[ ]		[ ˇ]			[ ]	
Danish	[ ]				[^]	[ ]	
Dutch	[ ]			[ ]	[^]	[ ]	
Finnish	[ ]				[^]	[ ]	
French					[^]	[ ]	
Greek						[ ]	
Hebrew (none)							
Hungarian	[ ]	[ ˘]	[ ˇ]	[ ]	[^]	[ ]	[ ]
Italian (none)							
Latin American	[ ]				[^]	[ ]	
Norwegian	[ ]				[^]	[ ]	
Polish	[ ]						
Portuguese	[ ]				[^]	[ ]	
Romanian	[ ]	[ ˘]	[ ˇ]	[ ]	[^]	[ ]	[ ]
Russian (none)							
SCS (none)							
Slovak	[ ]		[ ˇ]			[ ]	
Spanish	[ ]				[^]	[ ]	
Swedish	[ ]				[^]	[ ]	
Swiss-French	[ ]				[^]	[ ]	
Swiss-German	[ ]				[^]	[ ]	
Turkish-Q							

(continued on next page)

## Enhanced PC Keyboards

### B.1 Summary of Non-Spacing Diacritical Marks

Table B-1 (Cont.) Enhanced PC Keyboard Non-Spacing Diacritical Marks

EPC Keyboard	Double acute	Grave	Ogonek	Ring	Tilde	Tonos
German		[ ]				
Belgian		[ ]			[~]	
Canadian (French)		[ ]				
Czech		[ ]				
Danish		[ ]			[~]	
Dutch		[ ]			[~]	
Finnish		[ ]			[~]	
French						
Greek						[ ]
Hebrew (none)						
Hungarian	[ ]	[ ]	[ ]	[°]	[~]	
Italian (none)						
Latin American		[ ]				
Norwegian		[ ]			[~]	
Polish			[ ]			
Portuguese		[ ]			[~]	
Romanian	[ ]	[ ]	[ ]	[°]	[~]	
Russian (none)						
SCS (none)						
Slovak		[ ]				
Spanish		[ ]				
Swedish		[ ]			[~]	
Swiss-French		[ ]			[~]	
Swiss-German		[ ]			[~]	
Turkish-Q		[ ]				

## B.2 Enhanced PC Keyboards

The Enhanced PC keyboards for use with the VT520 video terminal are shown in the figures that follow. In the figures, the shading on the keycaps indicates a non-spacing diacritical character. Exceptions: Hebrew, Hungarian, Polish, Romanian, and Russian.

### Note

The keyboards shipped with the product may not look exactly like those illustrated here. Different fonts may be used, and some characters may not look the same.

Figure B-1 Austrian/German Enhanced PC Keyboard

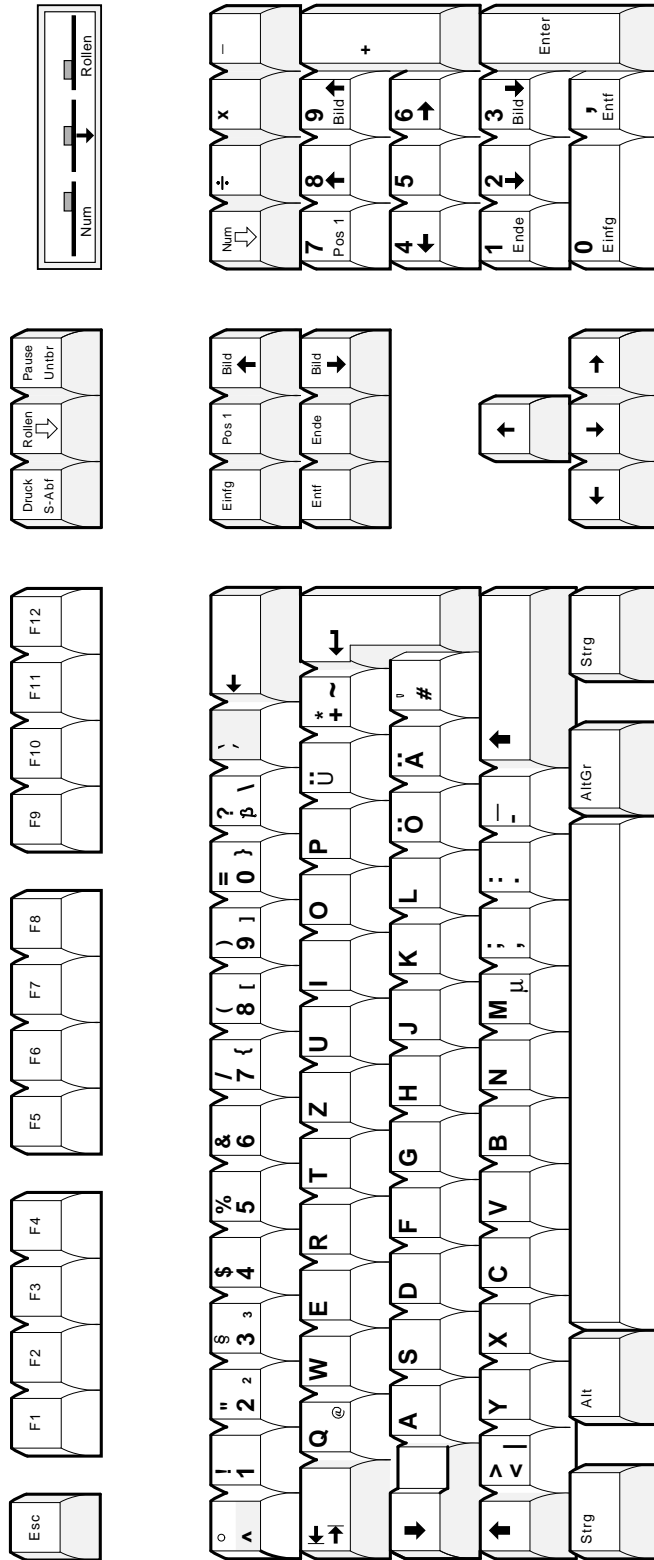

LJ-03212-T10

# Enhanced PC Keyboards

## B.2 Enhanced PC Keyboards

Figure B-2 Belgian Enhanced PC Keyboard

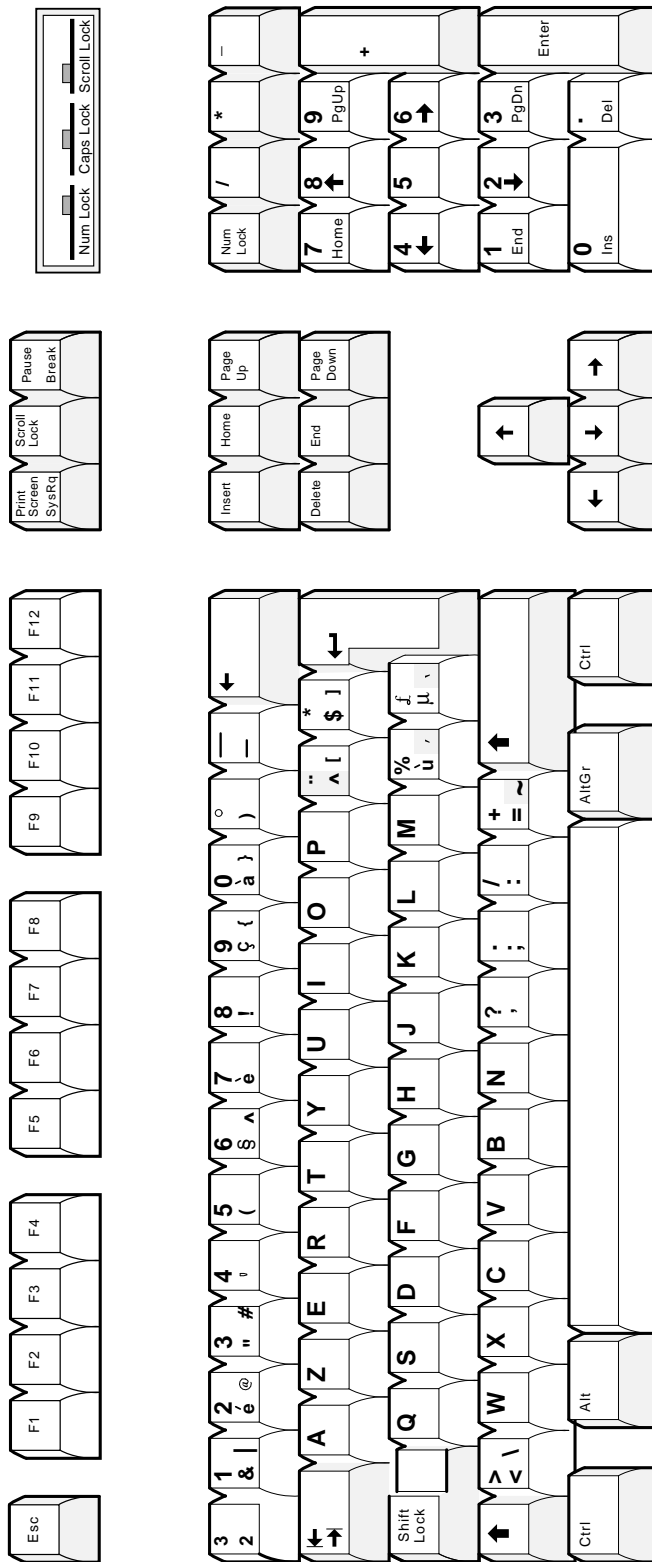

LJ-03221-T10

Figure B-3 British/U.K. Enhanced PC Keyboard

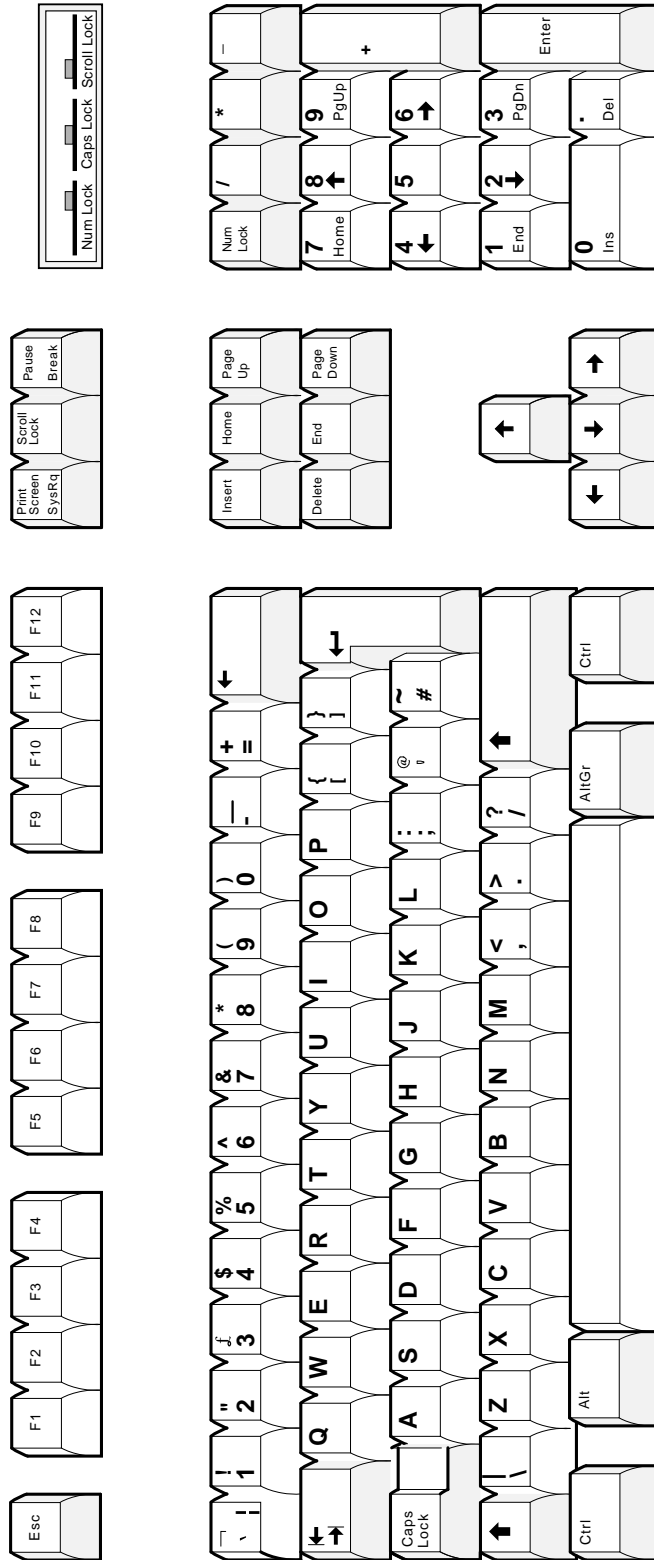

LJ-03219-T10

# Enhanced PC Keyboards

## B.2 Enhanced PC Keyboards

Figure B-4 Canadian-English/North American Enhanced PC Keyboard

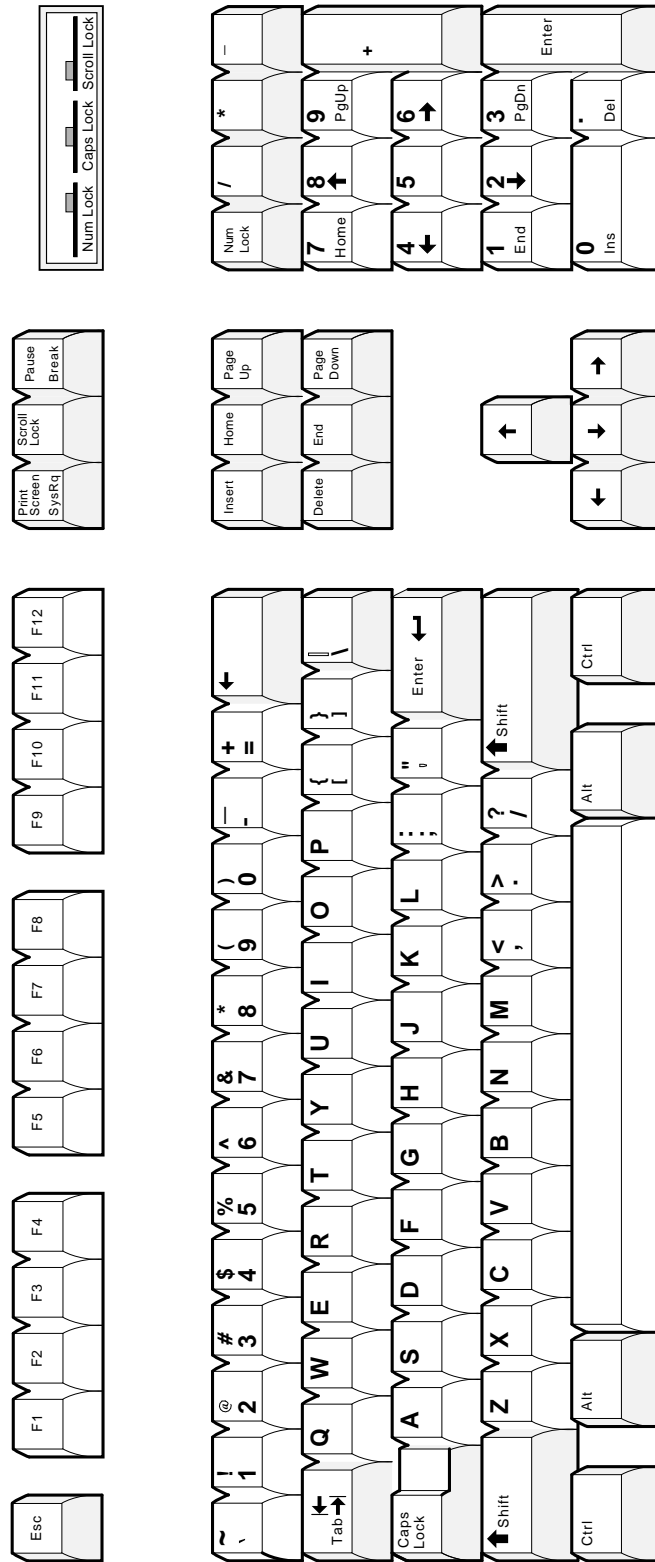

LJ-03218-T10



Figure B-5 Canadian-French Enhanced PC Keyboard

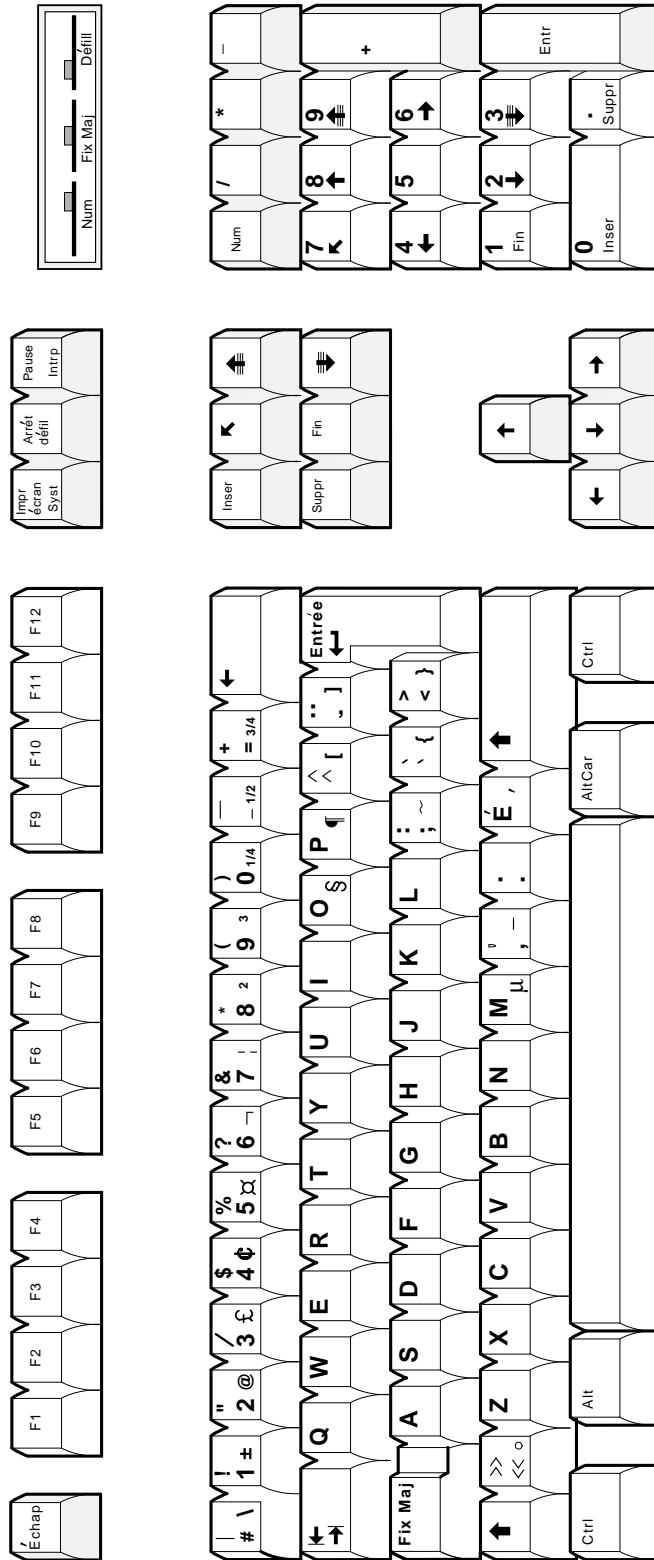

LJ-03225-T10

# Enhanced PC Keyboards

## B.2 Enhanced PC Keyboards

Figure B-6 Czech Enhanced PC Keyboard

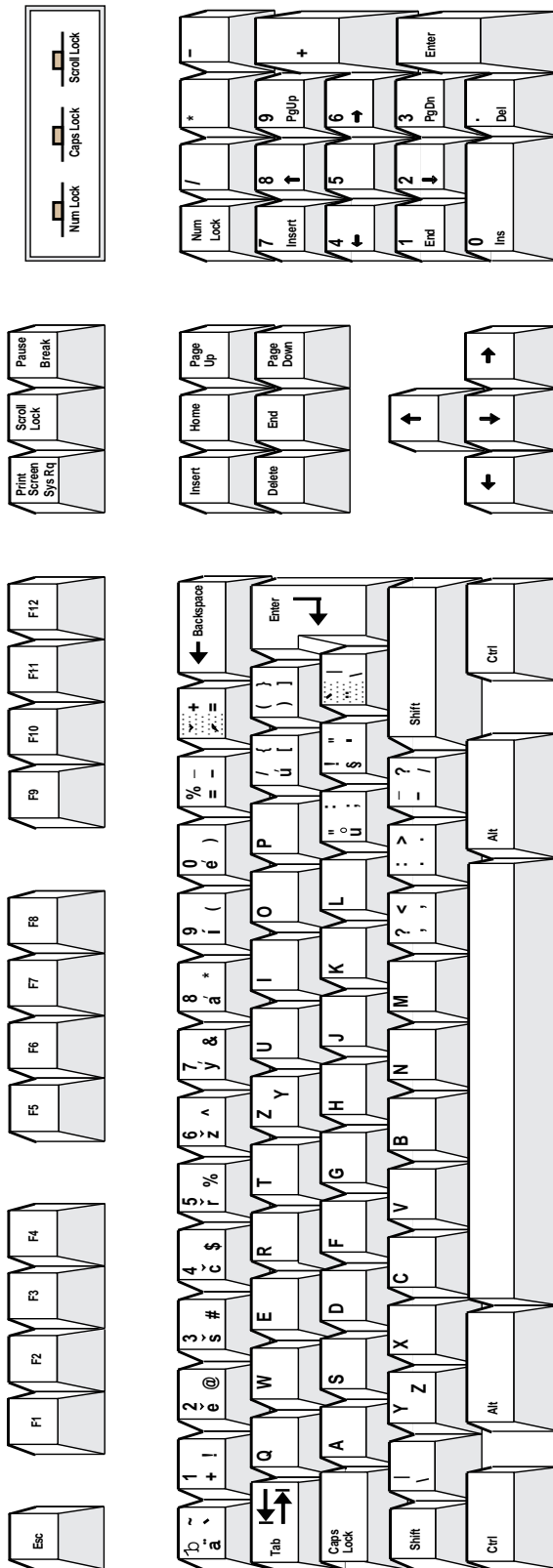

MA-0300-93.GRA

Figure B-7 Danish Enhanced PC Keyboard

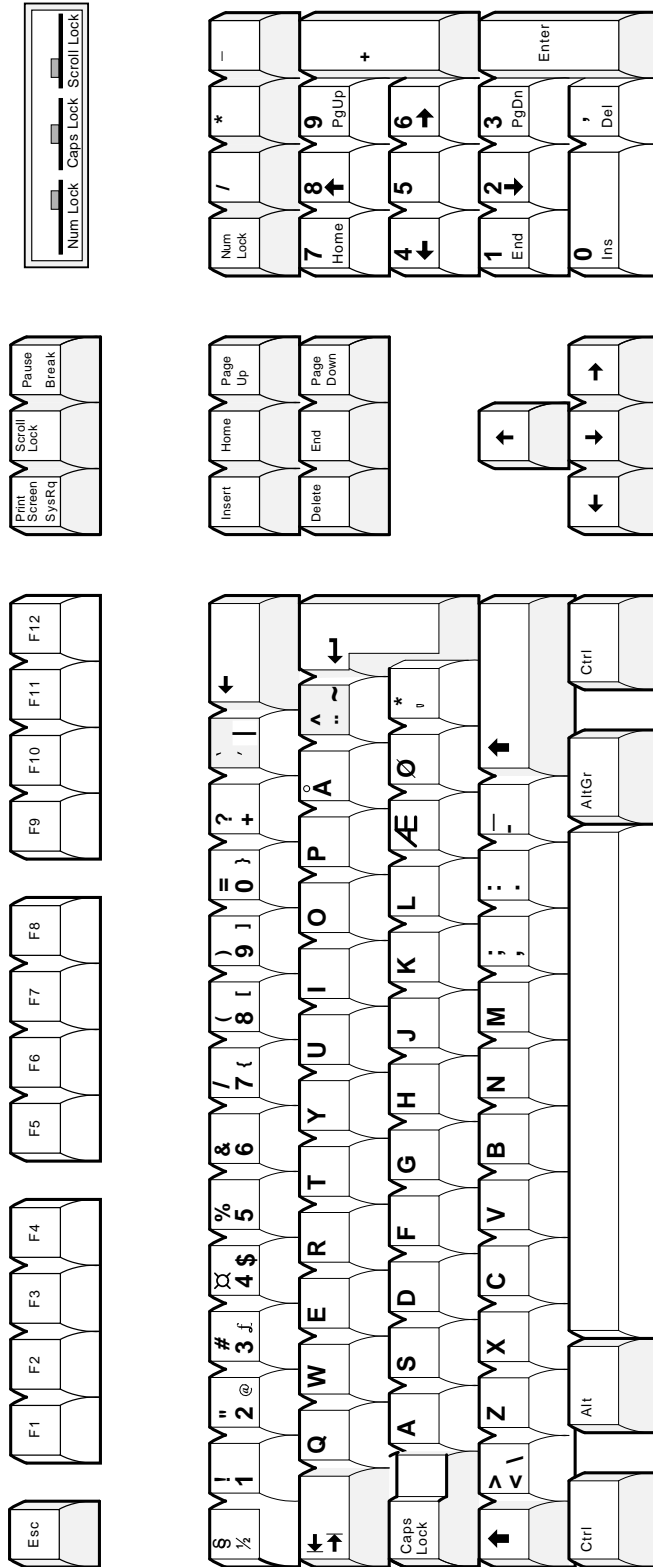

LJ-03222-T10



Figure B-9 Finnish Enhanced PC Keyboard

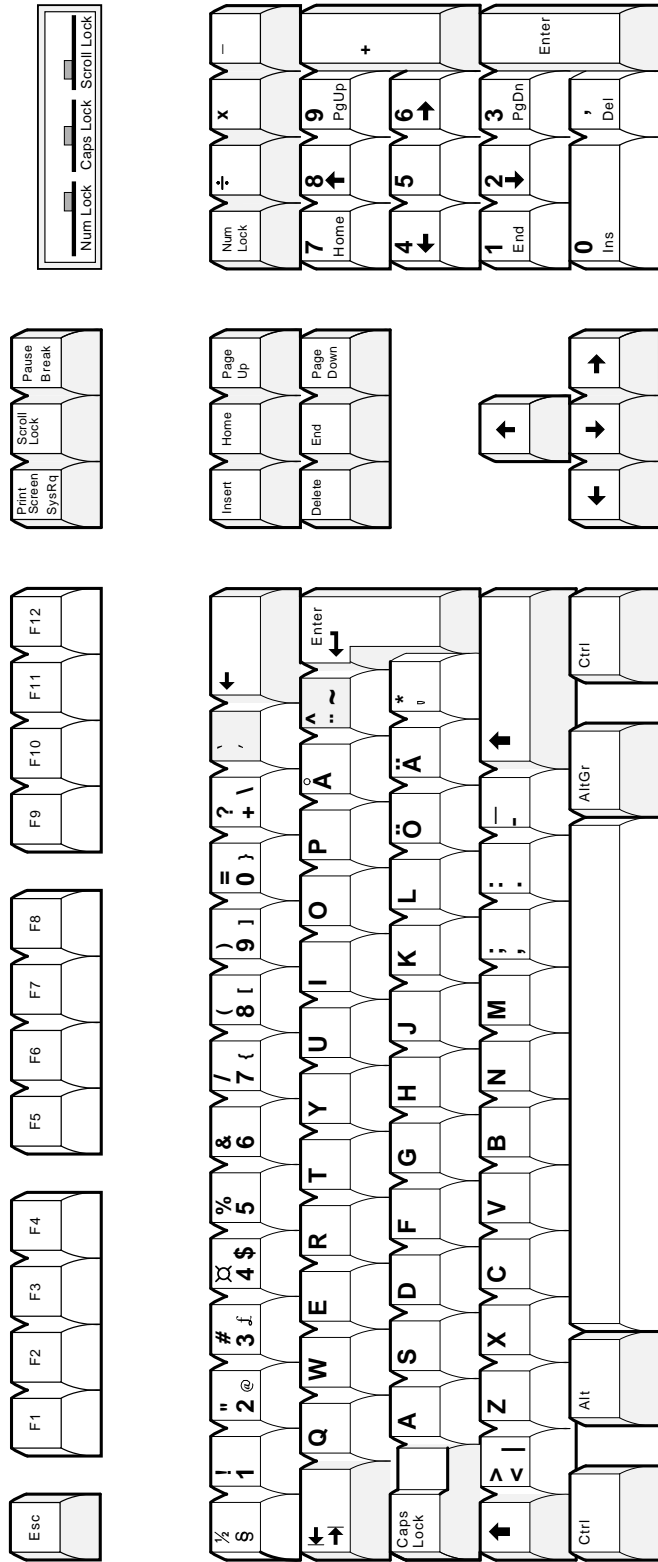

LJ-03210-T10

# Enhanced PC Keyboards

## B.2 Enhanced PC Keyboards

Figure B-10 French Enhanced PC Keyboard

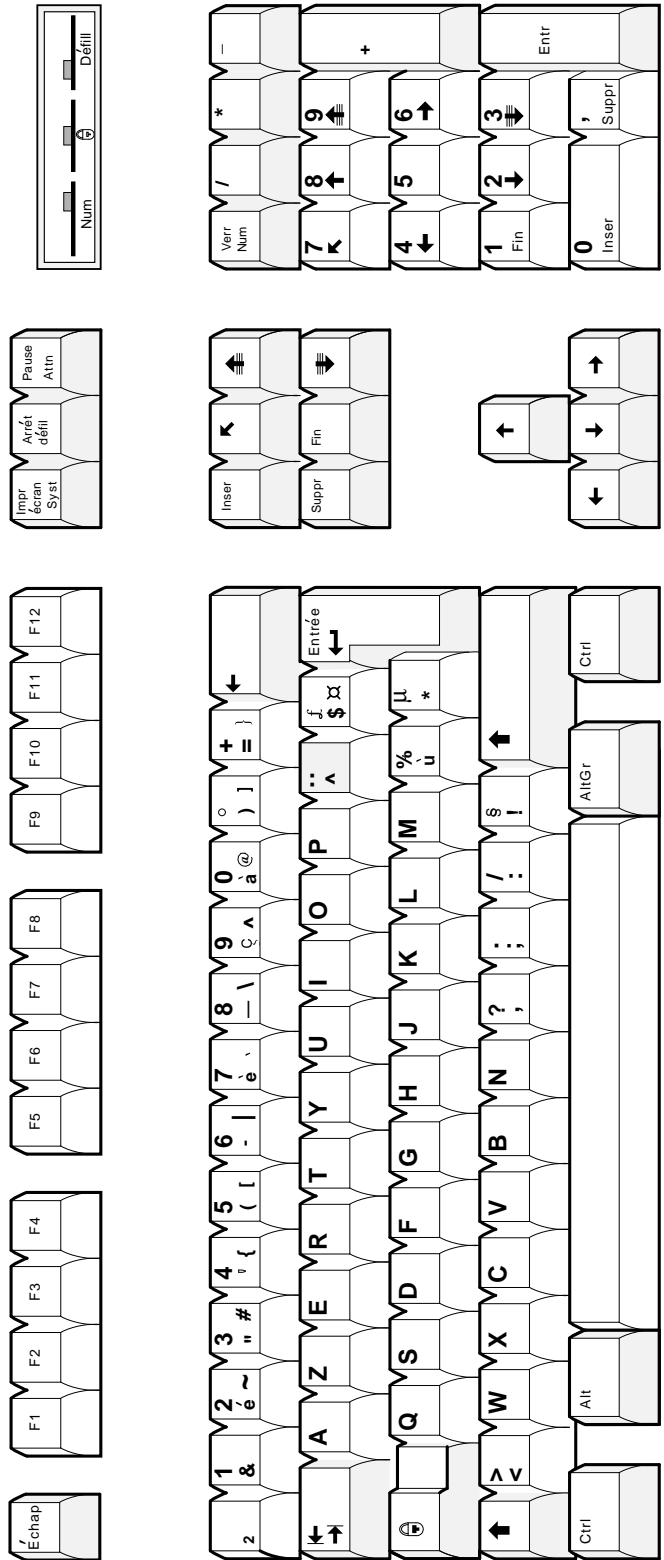

LJ-03211-T10

Figure B-11 Greek Enhanced PC Keyboard

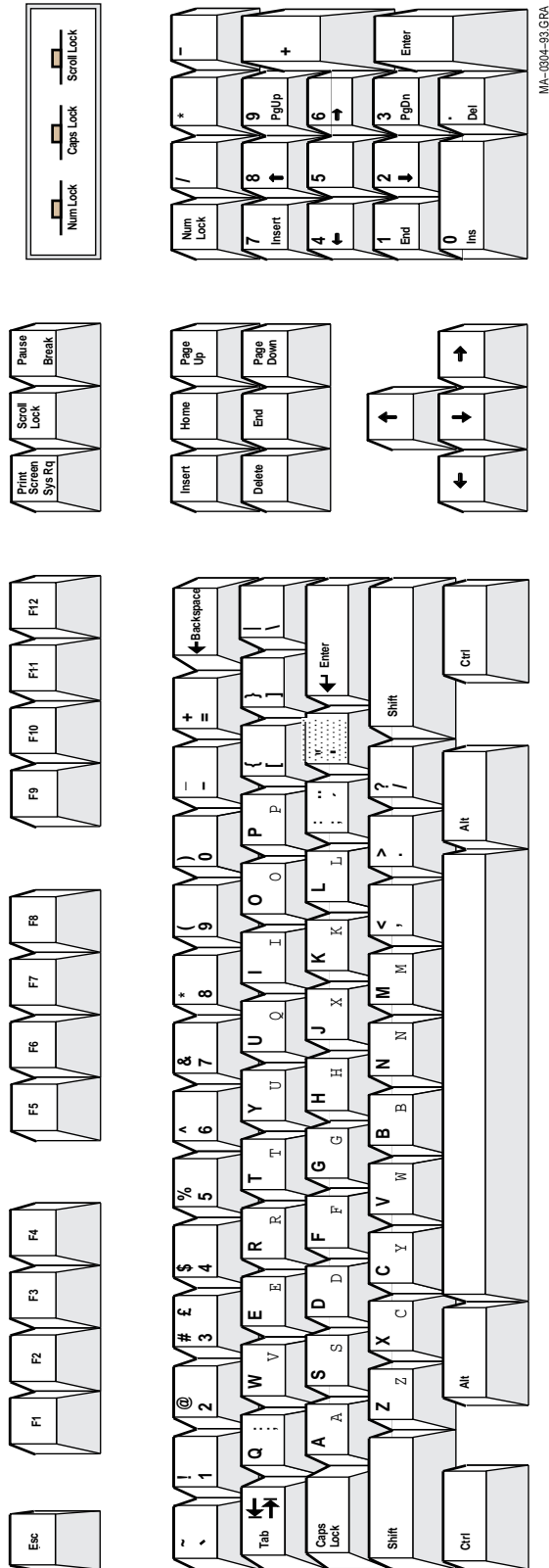

# Enhanced PC Keyboards

## B.2 Enhanced PC Keyboards

Figure B-12 Hebrew Enhanced PC Keyboard

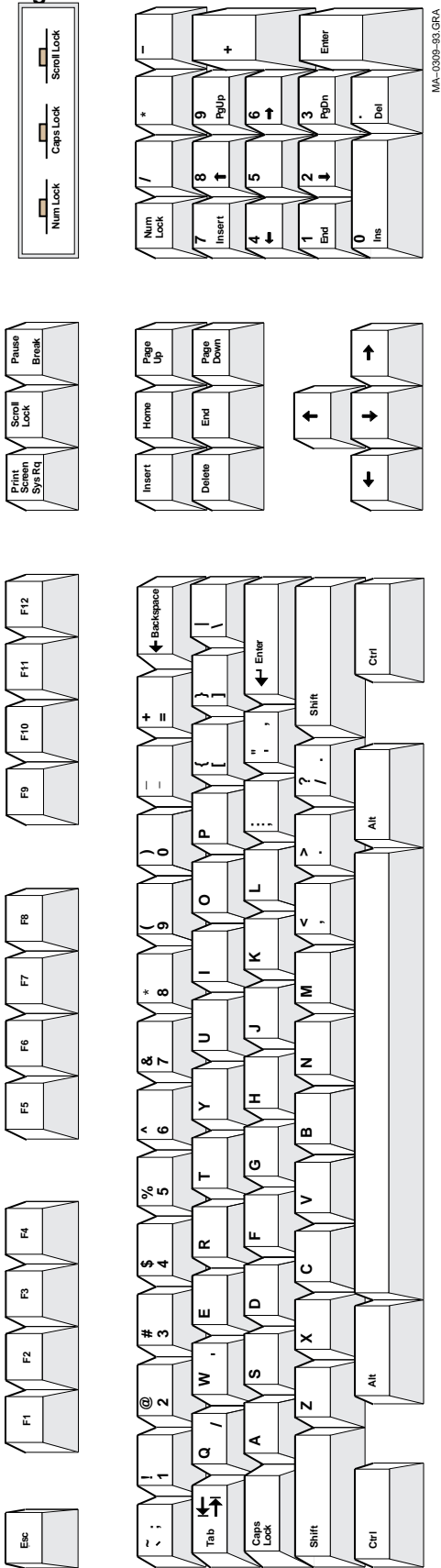
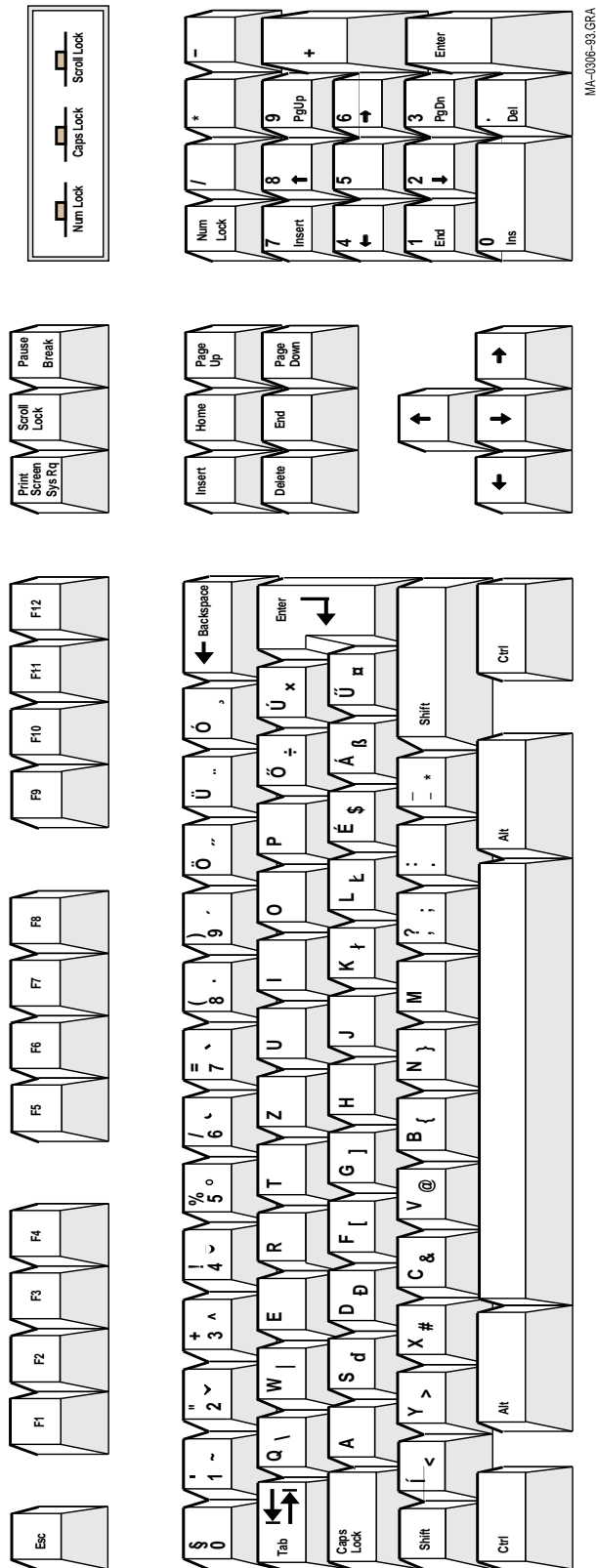



Figure B-13 Hungarian Enhanced PC Keyboard



# Enhanced PC Keyboards

## B.2 Enhanced PC Keyboards

Figure B-14 Italian Enhanced PC Keyboard

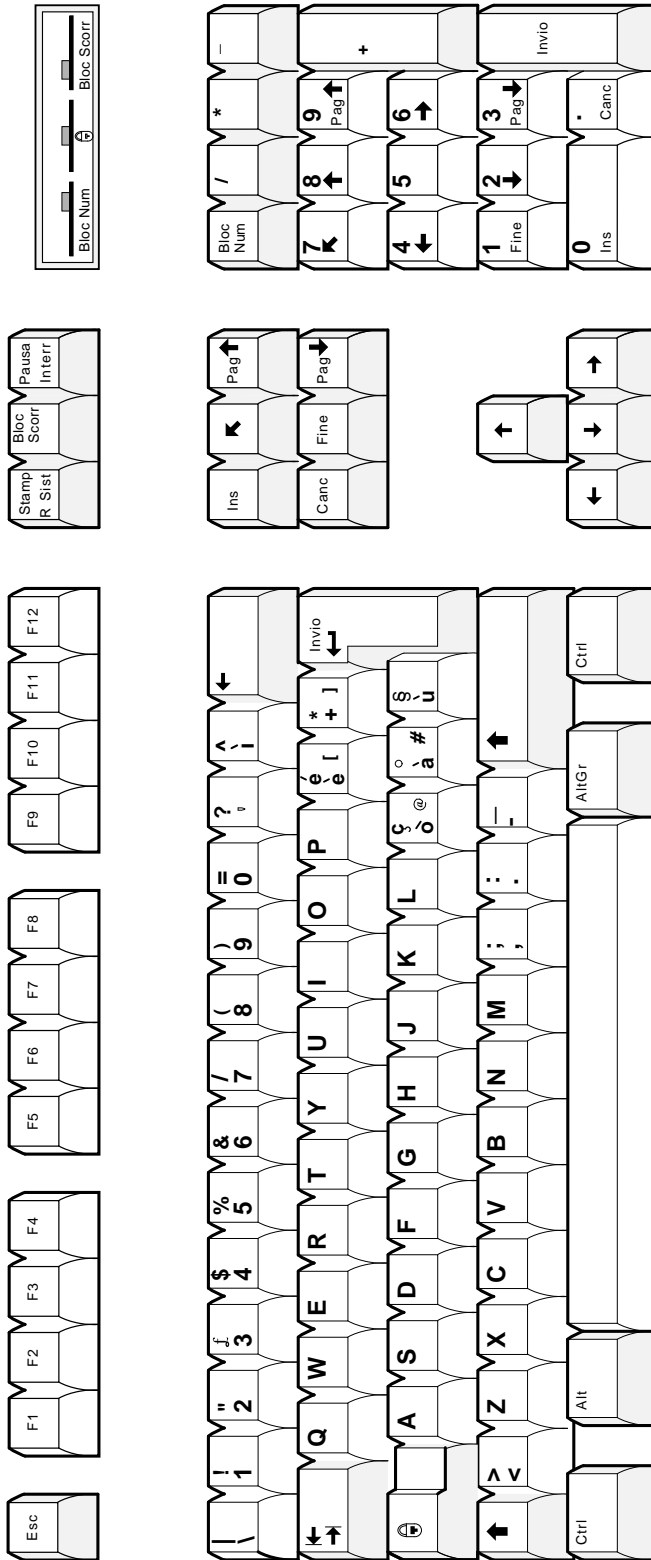

LJ-03213-T10

Figure B-15 Latin American Enhanced PC Keyboard

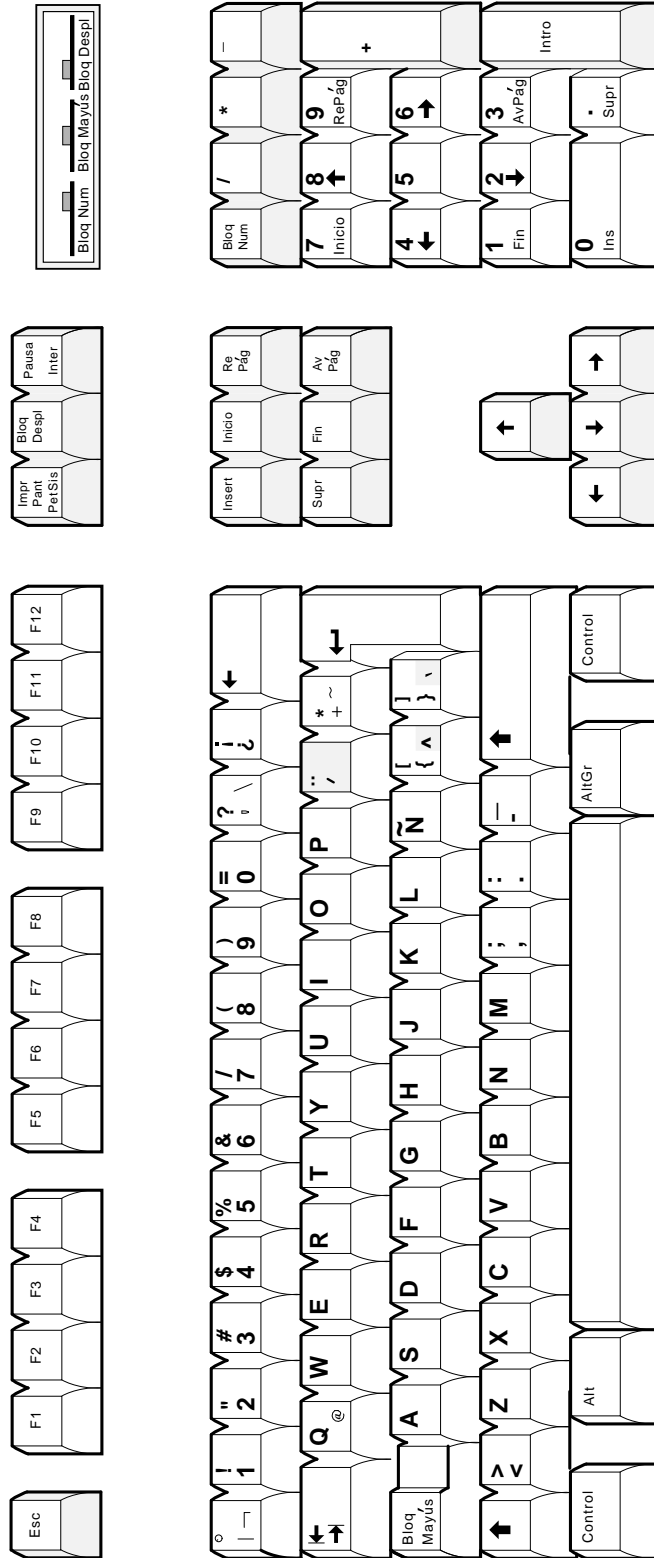

LJ-03216-T10

# Enhanced PC Keyboards

## B.2 Enhanced PC Keyboards

Figure B-16 Norwegian Enhanced PC Keyboard

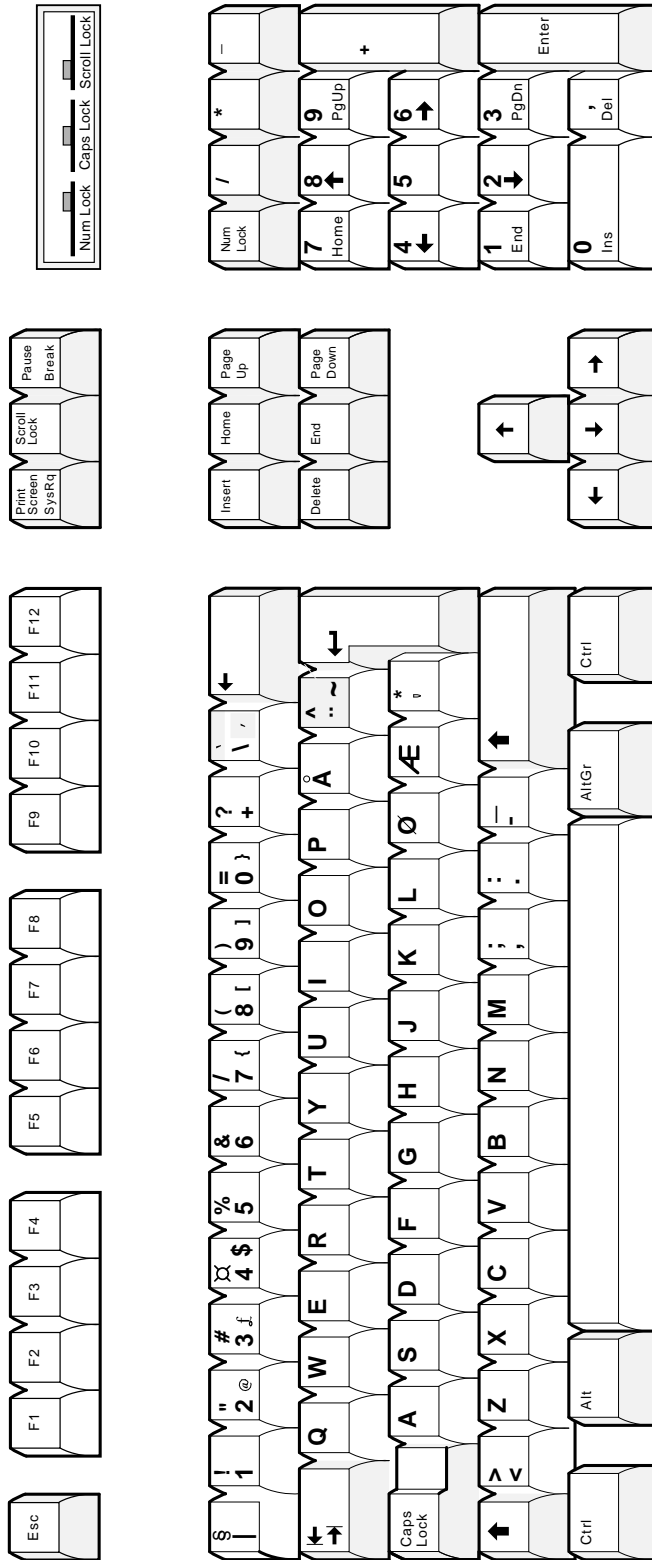

LJ-03214-T10

Figure B-17 Polish Enhanced PC Keyboard

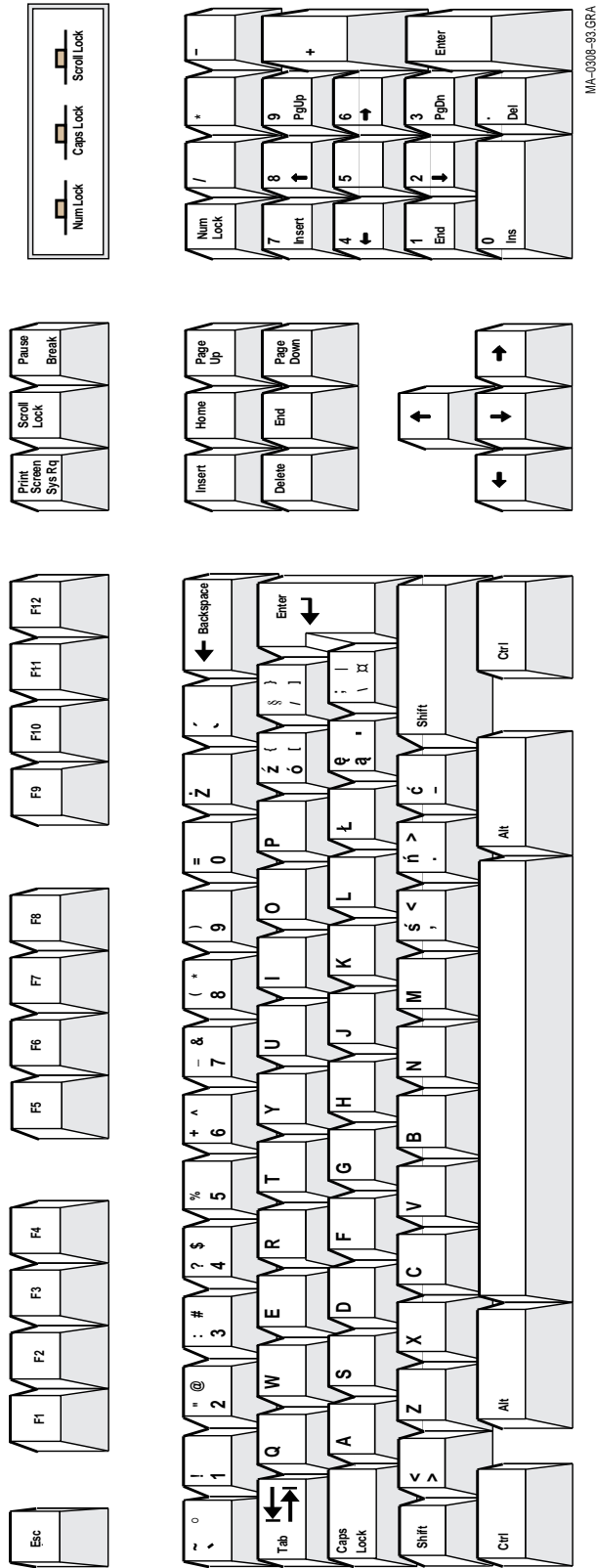

MA-0308-93.GRA



Figure B-19 Romanian Enhanced PC Keyboard

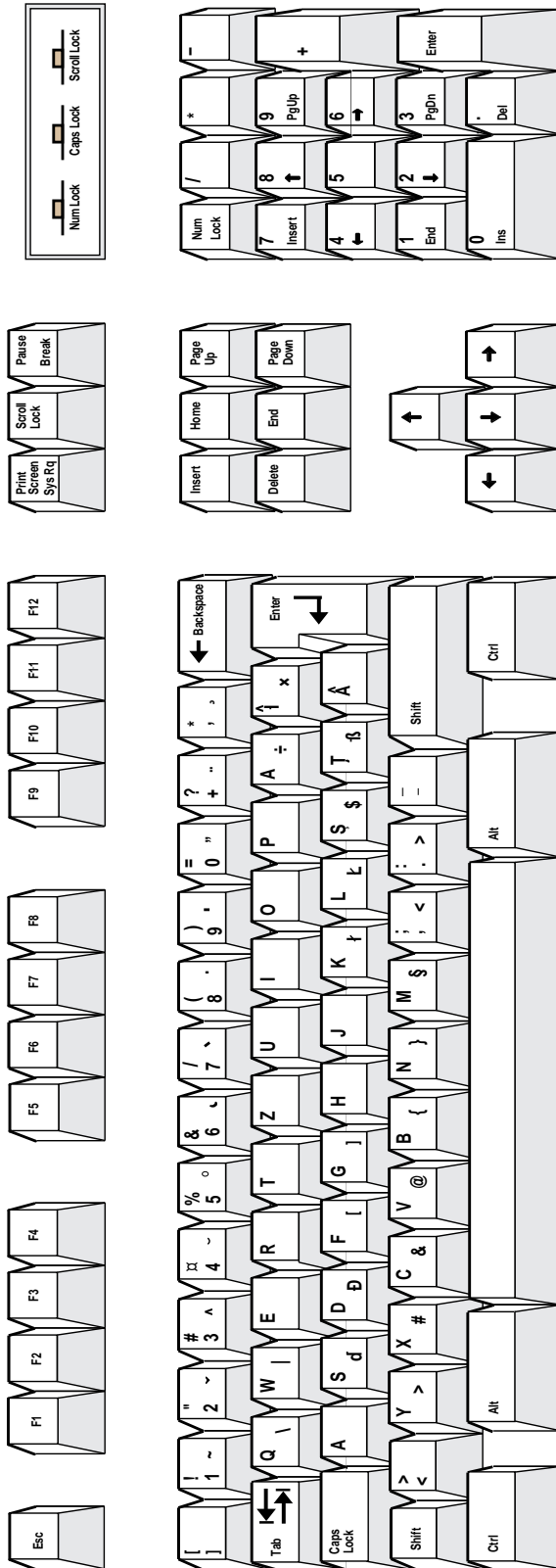

MA-0001-93.GRA





Figure B-21 SCS Enhanced PC Keyboard

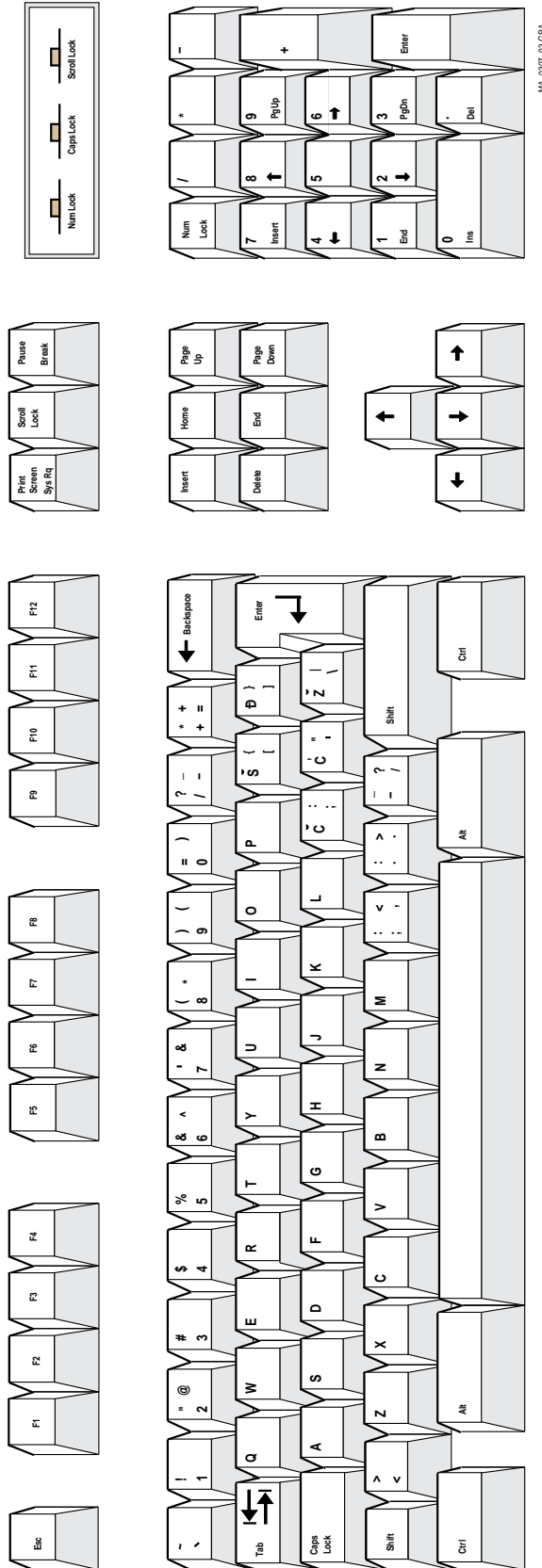

# Enhanced PC Keyboards

## B.2 Enhanced PC Keyboards

Figure B-22 Slovak Enhanced PC Keyboard

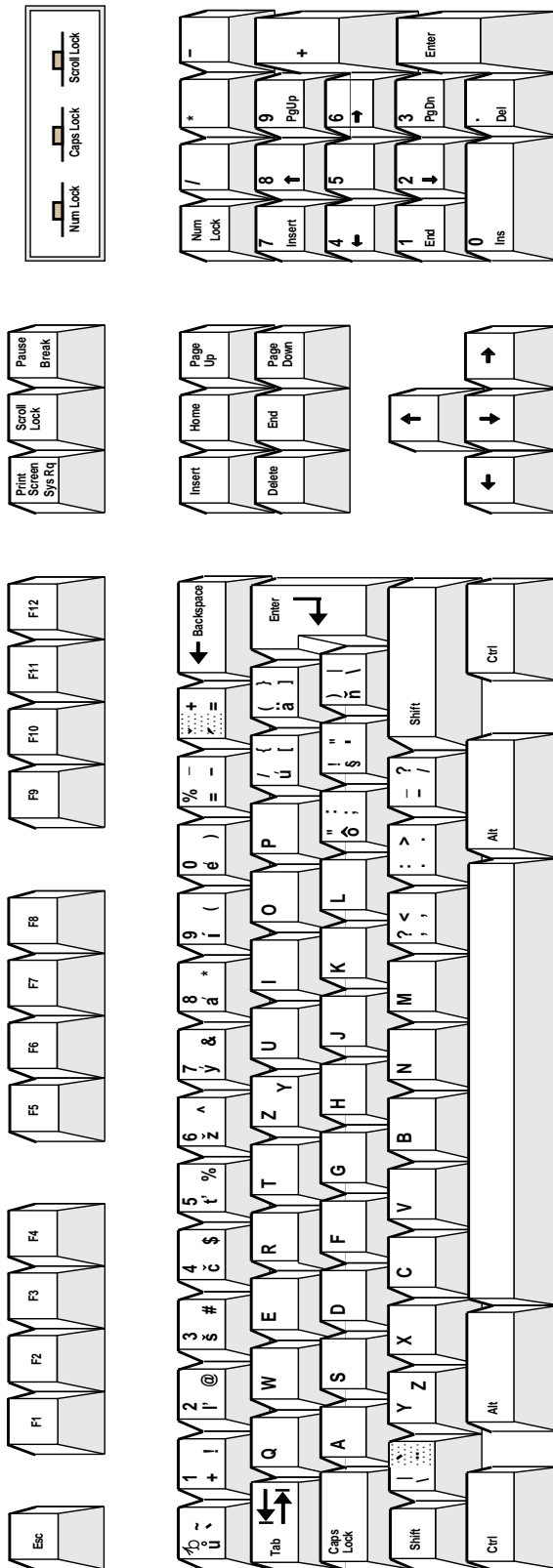

MA-0302-93.GFA

Figure B-23 Spanish Enhanced PC Keyboard

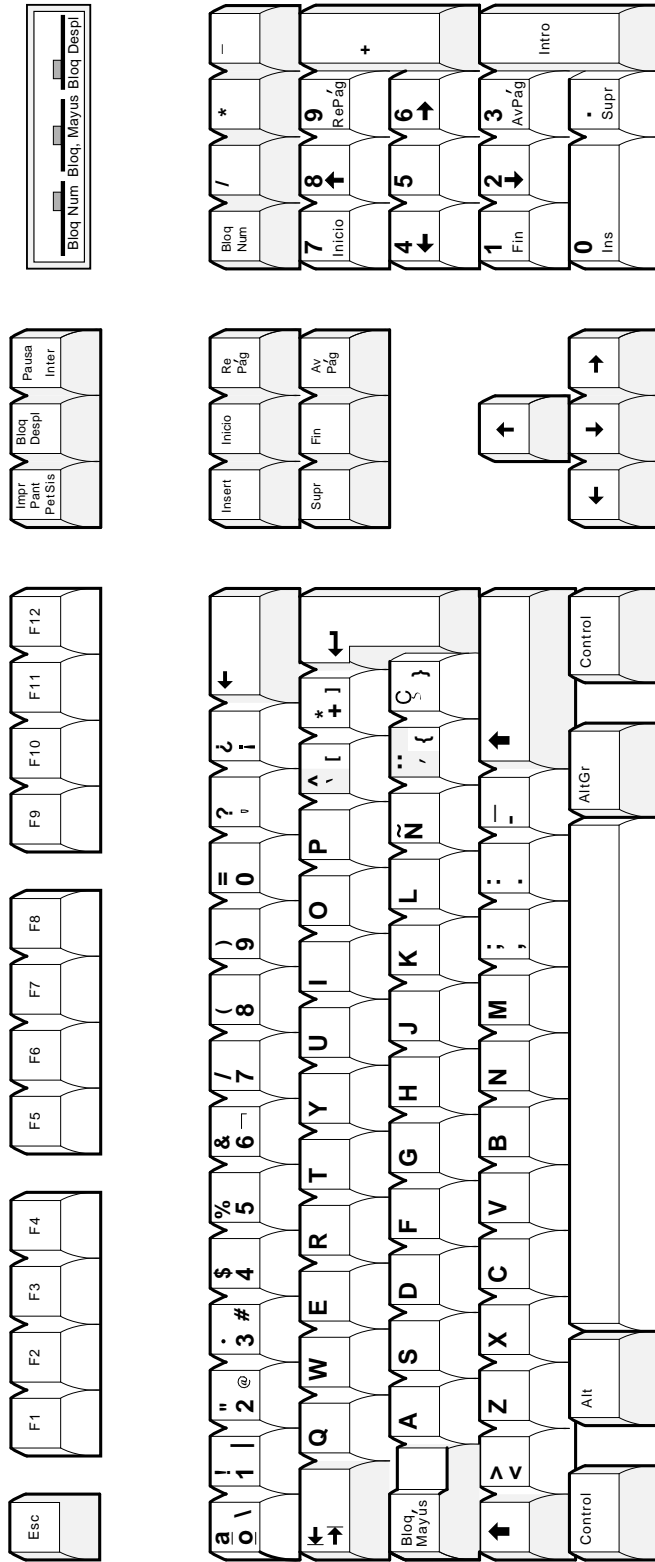

LJ-03217-T10

# Enhanced PC Keyboards

## B.2 Enhanced PC Keyboards

Figure B-24 Swedish Enhanced PC Keyboard

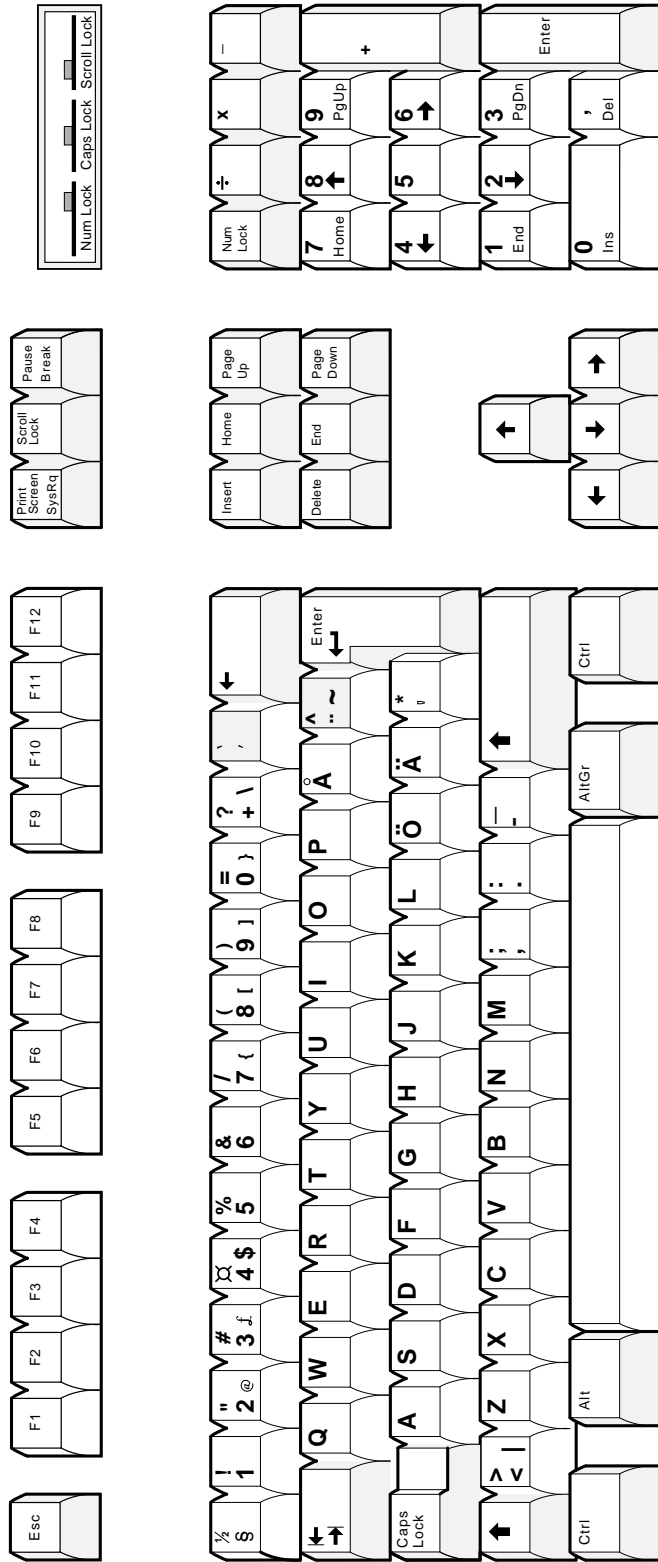

LJ-03210-T10

Figure B-25 Swiss-French Enhanced PC Keyboard

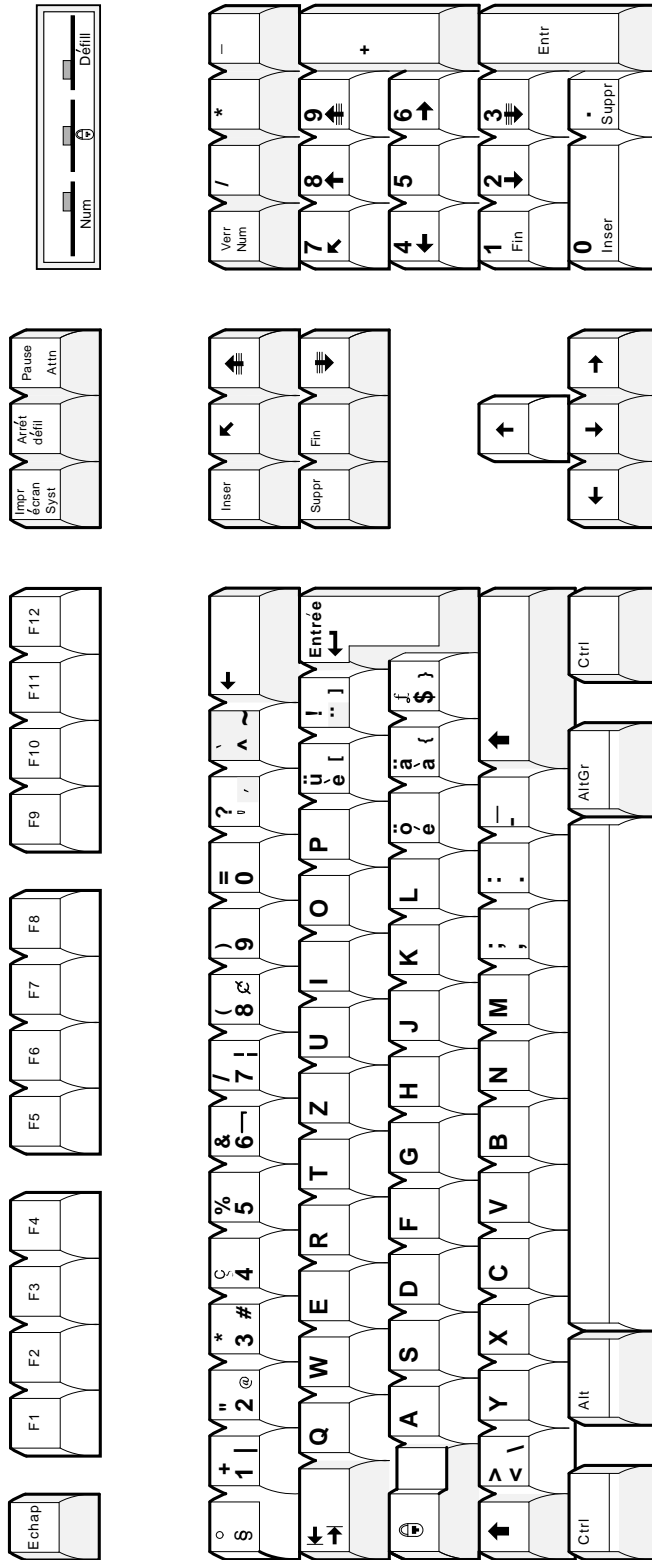

LJ-03224-T10

# Enhanced PC Keyboards

## B.2 Enhanced PC Keyboards

Figure B-26 Swiss-German Enhanced PC Keyboard

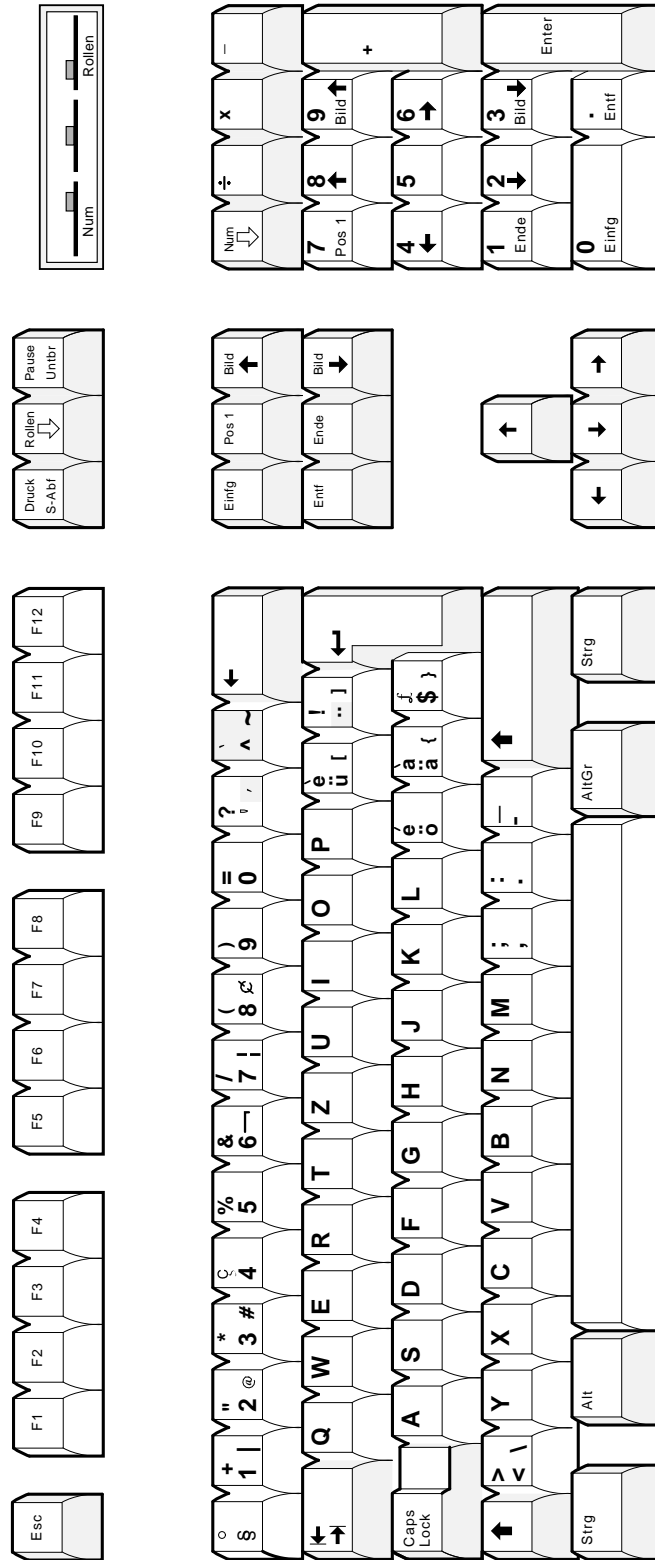

LJ-03220-T10







## ASCII Keycodes and Local Functions

### C.1 PC Keyboard

Table C-1 through Table C-11 list the keycodes sent by individual keys in each mode for the PC keyboard. The **Alt** key does not effect the keycode sent unless specified.

**Table C-1 WYSE and TVI Modes Function Keys for PC Keyboard**

Key	Unmodified	Shift	Ctrl	Shift/Ctrl
F1	SOH @ CR	SOH ' CR	80 (Hex)	90 (Hex)
F2	SOH A CR	SOH a CR	81 (Hex)	91 (Hex)
F3	SOH B CR	SOH b CR	82 (Hex)	92 (Hex)
F4	SOH C CR	SOH c CR	83 (Hex)	93 (Hex)
F5	SOH D CR	SOH d CR	84 (Hex)	94 (Hex)
F6	SOH E CR	SOH e CR	85 (Hex)	95 (Hex)
F7	SOH F CR	SOH f CR	86 (Hex)	96 (Hex)
F8	SOH G CR	SOH g CR	87 (Hex)	97 (Hex)
F9	SOH H CR	SOH h CR	88 (Hex)	98 (Hex)
F10	SOH I CR	SOH i CR	89 (Hex)	99 (Hex)
F11	SOH J CR	SOH j CR	8A (Hex)	9A (Hex)
F12	SOH K CR	SOH k CR	8B (Hex)	9B (Hex)
Print Screen	ESC P	ESC P	Toggle Autoprint	Toggle Autoprint
Scroll Lock	Hold	Hold	Hold	Hold
Pause	Disconnect	Send Answerback	Break	Toggle Block Mode

**Table C-2 WYSE and TVI Modes Function Keys for PC Keyboard**

Key	Alt	Alt/Shift	Alt/Ctrl	Alt/Shift/Ctrl
Print Screen	Set-Up	Soft Reset	ESC P	Toggle Autoprint (Note)
Pause	SOH N CR	SOH n CR	Break	9E (Hex) (Note)

## ASCII Keycodes and Local Functions

### C.1 PC Keyboard

**Table C-3 WYSE and TVI Modes Editing Keys for PC Keyboard**

Key	Unmodified	Shift	Ctrl	Shift/Ctrl
Insert	ESC q	ESC r	Toggle Insert Mode	Toggle Insert Mode
Home	1E (Hex)	ESC {	Toggle Auto Panning	Home Cursor and Clear Page
Page Up	ESC J	ESC J	Display Previous Page	Display Previous Page
Delete	ESC W	ESC R	ESC W	ESC R
End	ESC T	ESC Y	ESC T	Screen Saver
Page Down	ESC K	ESC K	Display Next Page	Display Next Page

**Table C-4 WYSE and TVI Modes Cursor Keys on PC Keyboard**

Key	Unmodified	Shift	Ctrl	Shift/Ctrl
↑	VT	VT†	Roll Active Page Up	Speed Scrolling Rate
↓	LF‡	LF	Roll Active Page Down	Slow Scrolling Rate
⇒	FF	FF	Change Status Line Type	Change Status Line Type
⇐	BS	BS	BS	BS

†"ESC j" for TVI 925 and TVI 950 emulations.

‡"16 (Hex)" for TVI 925 and TVI 950 emulations.

**Table C-5 WYSE and TVI Modes Numeric Keys for PC Keyboard, NumLock = Off**

Key	Unmodified	Shift	Ctrl	Shift/Ctrl
0	ESC r	ESC q	Display Page 0	ESC q
1	ESC T	ESC Y	Display Page 1	Toggle Monitor Mode
2	LF <sup>1</sup>	LF	Display Page 2	LF
3	ESC K	ESC K	Display Page 3	ESC K
4	BS	BS	Display Page 4	BS
5	5	5	Display Page 5	5
6	FF	FF	FF	6
7	1E (Hex)	ESC {	1E (Hex)	ESC {
8	VT	VT <sup>2</sup>	VT	VT
9	ESC J	ESC J	ESC J	ESC J
/	/	/	/	/
*	*	*	*	*
-	-	-	Raise Split Line	Toggle Split Screen Mode
+	+	+	+	+
.	7F (Hex)	7F (Hex)	7F (Hex)	Print Page
Enter	CR	Toggle Keyclick	CR	CR

<sup>1</sup>"16 (Hex)" for TVI 925 and TVI 950 emulations.

<sup>2</sup>"ESC j" for TVI 925 and TVI 950 emulations.

## ASCII Keycodes and Local Functions C.1 PC Keyboard

**Table C-6 WYSE 160 and TVI Modes Numeric Keys for PC Keyboard, NumLock = On**

Key	Unmodified	Shift	Ctrl	Shift/Ctrl
0	0	0	0	0
1	1	1	1	1
2	2	2	2	2
3	3	3	3	3
4	4	4	4	4
5	5	5	5	5
6	6	6	6	6
7	7	7	7	7
8	8	8	8	8
9	9	9	9	9
/	/	/	/	/
*	*	*	*	*
-	-	-	-	-
+	+	+	+	+
.	.	.	.	-
Enter	CR	CR	CR	CR

**Table C-7 ADDS A2 Function Keys on PC Keyboard**

Key	Unmodified	Shift	Ctrl (Hex)	Shift/Ctrl (Hex)
F1	STX 1 CR	STX ! CR	80	90
F2	STX 2 CR	STX " CR	81	91
F3	STX 3 CR	STX # CR	82	92
F4	STX 4 CR	STX \$ CR	83	93
F5	STX 5 CR	STX % CR	84	94
F6	STX 6 CR	STX & CR	85	95
F7	STX 7 CR	STX ' CR	86	96
F8	STX 8 CR	STX ( CR	87	97
F9	STX 9 CR	STX ) CR	88	98
F10	STX : CR	STX * CR	89	99
F11	STX ; CR	STX + CR	8A	9A
F12	STX < CR	STX , CR	8B	9B

## ASCII Keycodes and Local Functions

### C.1 PC Keyboard

**Table C–8 ADDS A2 Editing Keys on PC Keyboard**

Key	Unmodified	Shift	Ctrl	Shift/Ctrl
Insert	ESC q	ESC r	Toggle Insert Mode	Toggle Insert Mode
Home	SOH	SOH	Toggle Auto Panning	Home Cursor and Clear Page
Page Up	ESC J	ESC J	Display Previous Page	Display Previous Page
Delete	ESC W	ESC I	ESC W	ESC I
End	ESC K	ESC k	ESC K	Screen Saver
Page Down	ESC J	ESC J	Display Next Page	Display to Next Page

**Table C–9 ADDS A2 Cursor Keys on PC Keyboard**

Key	Unmodified	Shift	Ctrl	Shift/Ctrl
↑	1A (Hex)	1A (Hex)	Roll Active Page Up	Speed Scrolling Rate
↓	LF	LF	Roll Active Page Down	Speed Scrolling Rate
⇒	ACK	ACK	Change Status Line Type	Change Status Line Type
←	15 (Hex)	15 (Hex)	15 (Hex)	15 (Hex)

**Table C–10 ADDS A2 Mode Numeric Keypad Keys on PC Keyboard; NumLock = Off**

Key	Unmodified	Shift	Ctrl	Shift/Ctrl
0	ESC r	ESC q	Display Page 0	ESC q
1	ESC K	ESC K	Display Page 1	Toggle Monitor Mode
2	LF	LF	Display Page 2	LF
3	ESC J	ESC J	Display Page 3	ESC J
4	15(Hex)	15(Hex)	Display Page 4	15(Hex)
5	5	5	Display Page 5	5
6	ACK	ACK	ACK	6
7	SOH	SOH	SOH	SOH
8	1A(Hex)	1A(Hex)	1A(Hex)	1A(Hex)
9	ESC J	ESC J	ESC J	ESC J
/	/	/	/	/
*	*	*	*	*
-	-	-	Raise Split Line	Toggle Split Screen Mode
+	+	+	+	+
.	7F (Hex)	7F (Hex)	7F (Hex)	Print Page
Enter	CR	Toggle Keyclick	CR	CR

## ASCII Keycodes and Local Functions C.1 PC Keyboard

**Table C-11 ADDS A2 Mode Numeric Keypad Keys on PC Keyboard; NumLock = On**

Key	Unmodified	Shift	Ctrl	Shift/Ctrl
0	0	0	0	0
1	1	1	1	1
2	2	2	2	2
3	3	3	3	3
4	4	4	4	4
5	5	5	5	5
6	6	6	6	6
7	7	7	7	7
8	8	8	8	8
9	9	9	9	9
/	/	/	/	/
*	*	*	*	*
-	-	-	-	-
+	+	+	+	+
.	.	.	.	.
Enter	CR	CR	CR	CR

## ASCII Keycodes and Local Functions

### C.2 DEC VT Keyboard

### C.2 DEC VT Keyboard

Table C–12 through Table C–19 list the keycodes sent by individual keys in each mode for VT keyboards. The Alt key does not effect the keycode sent unless specified.

**Table C–12 WYSE and TVI Modes Function Keys for DEC VT Keyboard**

Key	Unmodified	Shift	Ctrl	Shift/Ctrl
F1	Toggle Hold Screen	Toggle Hold Screen	Toggle Hold Screen	Toggle Hold Screen
F2	ESC P	ESC P	Toggle AutoPrint	Toggle AutoPrint
F3	Setup	Soft Reset	82 (Hex)	92 (Hex)
F4	Toggle Block Mode	ESC 7	Toggle Block Mode	ESC 7
F5	Break	Disconnect	Send Answerback	Toggle Block Mode
F6	SOH E CR	SOH e CR	85 (Hex)	95 (Hex)
F7	SOH F CR	SOH f CR	86 (Hex)	96 (Hex)
F8	SOH G CR	SOH g CR	87 (Hex)	97 (Hex)
F9	SOH H CR	SOH h CR	88 (Hex)	98 (Hex)
F10	SOH I CR	SOH i CR	89 (Hex)	99 (Hex)
F11	SOH J CR	SOH j CR	8A (Hex)	9A (Hex)
F12	SOH K CR	SOH k CR	8B (Hex)	9B (Hex)
F13	SOH L CR	SOH l CR	8C (Hex)	9C (Hex)
F14	SOH M CR	SOH m CR	8D (Hex)	9D (Hex)
F15	SOH N CR	SOH n CR	8E (Hex)	9E (Hex)
F16	SOH O CR	SOH o CR	8F (Hex)	9F (Hex)
F17	SOH P CR	SOH p CR	SOH P CR	SOH p CR
F18	SOH Q CR	SOH q CR	SOH Q CR	SOH q CR
F19	SOH R CR	SOH r CR	SOH R CR	SOH r CR
F20	SOH S CR	SOH s CR	SOH S CR	SOH s CR

**Table C–13 WYSE and TVI Modes Editing Keys on DEC VT Keyboard**

Key	Unmodified	Shift	Ctrl	Shift/Ctrl
Find	n/a	n/a	n/a	n/a
Insert	ESC Q	ESC E	ESC Q	ESC E
Remove	7F (Hex)	7F (hex)	7F (Hex)	7F (Hex)
Select	n/a	n/a	n/a	n/a
Prev	ESC J	ESC J	Move to Previous Page	Move to Previous Page
Next	ESC K	ESC K	Move to Next Page	Move to Next Page

## ASCII Keycodes and Local Functions C.2 DEC VT Keyboard

**Table C–14 WYSE and TVI Modes Cursor Keys on DEC VT Keyboard**

Key	Unmodified	Shift	Ctrl	Shift/Ctrl
↑	VT	VT <sup>1</sup>	Roll Active Page Up	Speed Scrolling Rate
↓	LF <sup>2</sup>	LF	Roll Active Page Down	Speed Scrolling Rate
⇒	FF	FF	Change Status Line Type	Change Status Line Type
⇐	BS	BS	BS	BS

<sup>1</sup>"ESC j" for TVI 925 and TVI 950 emulations.

<sup>2</sup>"16 (Hex)" for TVI 925 and TVI 950 emulations.

**Table C–15 WYSE and TVI Modes Numeric Keypad PF Keys on DEC VT Keyboard**

Key	Unmodified	Shift	Ctrl	Shift/Ctrl
PF1	ESC Q	ESC E	ESC Q	ESC E
PF2	ESC W	ESC R	ESC W	ESC R
PF3	ESC T	ESC Y	ESC T	Screen Saver
PF4	ESC r	ESC q	Toggle Insert Mode	Toggle Insert Mode
0	0	0	Display Page 0	0
1	1	1	Display Page 1	Toggle Monitor Mode
2	2	2	Display Page 2	2
3	3	3	Display Page 3	3
4	4	4	Display Page 4	4
5	5	5	Display Page 5	5
6	6	6	6	6
7	7	7	7	7
8	8	8	8	8
9	9	9	9	9
-	-	-	Raise Split Line	Toggle Split Screen Mode
,	,	,	Lower Split Line	Cursor Drag Mode
.	.	.	.	Print Page
Enter	CR	Toggle Keyclick	CR	CR

**Table C–16 ADDS A2 Function Keys on DEC VT Keyboard**

Key	Unmodified	Shift	Ctrl	Shift/Ctrl
F1	Toggle Hold Screen	Toggle Hold Screen	Toggle Hold Screen	Toggle Hold Screen
F2	ESC P	ESC P	Toggle AutoPrint	Toggle AutoPrint
F3	Setup	Soft Reset	82 (Hex)	92 (Hex)
F4	Toggle Block Mode	ESC 7	Toggle Block Mode	ESC 7
F5	Break	Disconnect	Send Answerback	Toggle Block Mode
F6	STX 6 CR	STX & CR	85 (Hex)	95 (Hex)

(continued on next page)

## ASCII Keycodes and Local Functions

### C.2 DEC VT Keyboard

**Table C-16 (Cont.) ADDS A2 Function Keys on DEC VT Keyboard**

Key	Unmodified	Shift	Ctrl	Shift/Ctrl
F7	STX 7 CR	STX ' CR	86 (Hex)	96 (Hex)
F8	STX 8 CR	STX ( CR	87 (Hex)	97 (Hex)
F9	STX 9 CR	STX ) CR	88 (Hex)	98 (Hex)
F10	STX : CR	STX * CR	89 (Hex)	99 (Hex)
F11	STX ; CR	STX + CR	8A (Hex)	9A (Hex)
F12	STX < CR	STX , CR	8B (Hex)	9B (Hex)
F13	STX = CR	STX - CR	8C (Hex)	9C (Hex)
F14	STX > CR	STX . CR	8D (Hex)	9D (Hex)
F15	STX ? CR	STX / CR	8E (Hex)	9E (Hex)
F16	STX @ CR	STX 0 CR	8F (Hex)	9F (Hex)
F17	STX A CR	STX 1 CR	STX A CR	STX 1 CR
F18	STX B CR	STX 2 CR	STX B CR	STX 2 CR
F19	STX C CR	STX 3 CR	STX C CR	STX 3 CR
F20	STX D CR	STX 4 CR	STX D CR	STX 4 CR

**Table C-17 ADDS A2 Editing Keys on DEC VT Keyboard**

Key	Unmodified	Shift	Ctrl	Shift/Ctrl
Find	n/a	n/a	n/a	n/a
Insert	ESC Q	ESC M	ESC Q	ESC M
Remove	7F (Hex)	7F (Hex)	7F (Hex)	7F (Hex)
Select	n/a	n/a	n/a	n/a
Prev	ESC J	ESC J	Move to Previous Page	Move to Previous Page
Next	ESC J	ESC J	Move to Next Page	Move to Next Page

**Table C-18 ADDS A2 Cursor Keys on DEC VT Keyboard**

Key	Unmodified	Shift	Ctrl	Shift/Ctrl
↑	1A (Hex)	1A (Hex)	Roll Active Page UP	Speed Scrolling Rate
↓	LF	LF	Roll Active Page Down	Speed Scrolling Rate
⇒	ACK	ACK	Change Status Line Type	Change Status Line Type
⇐	15 (Hex)	15 (Hex)	15 (Hex)	15 (Hex)

**Table C-19 ADDS A2 Numeric Keypad PFKeys on DEC VT Keyboard**

Key	Unmodified	Shift	Ctrl	Shift/Ctrl
PF1	ESC Q	ESC M	ESC Q	ESC M
PF2	ESC W	ESC I	ESC W	ESC I

(continued on next page)



## ASCII Keycodes and Local Functions C.2 DEC VT Keyboard

**Table C–19 (Cont.) ADDS A2 Numeric Keypad PFKeys on DEC VT Keyboard**

Key	Unmodified	Shift	Ctrl	Shift/Ctrl
PF3	ESC K	ESC k	ESC K	Screen Saver
PF4	ESC r	ESC q	Toggle Insert Mode	Toggle Insert Mode
0	0	0	Display Page 0	0
1	1	1	Display Page 1	Toggle Monitor Mode
2	2	2	Display Page 2	2
3	3	3	Display Page 3	3
4	4	4	Display Page 4	4
5	5	5	Display Page 5	5
6	6	6	6	6
7	7	7	7	7
8	8	8	8	8
9	9	9	9	9
-	-	-	Raise Split Line	Toggle Split Screen Mode
,	,	,	Lower Split Line	Cursor Drag Mode
.	.	.	.	Print Page
Enter	CR	Toggle Keyclick State	CR	CR

### C.3 ASCII Local Functions

Table C–20 and Table C–21 list the local functions in ASCII code mode and PC scancode mode. In the tables, keypad is abbreviated as (kpd).

**Table C–20 Local Functions in ASCII Code Mode**

Function	DEC VT Layout	EPC Layout
±Hold Screen	F1	Scroll Lock
Print page	Ctrl/Shift/ . (kpd)	Ctrl/Shift/ . (kpd)
Set-Up	F3 Caps Lock/F3	Alt/Print Screen Caps Lock/Print Screen
Break	F5	Ctrl/Pause
Hard Reset	Ctrl/F3 in Set-Up	
Soft Reset	Shift/F3	Alt/Shift/Print Screen
±Autoprint Mode	Ctrl/F2 Ctrl/Shift/F2	Ctrl/Print Screen Ctrl/Shift/Print Screen Alt/Ctrl/Shift/Print Screen
Disconnect	Shift/F5	Pause
Send Answerback	Ctrl/F5	Shift/Pause
Display Next Page	Ctrl/Next	Ctrl/Page Down

(continued on next page)

## ASCII Keycodes and Local Functions

### C.3 ASCII Local Functions

Table C–20 (Cont.) Local Functions in ASCII Code Mode

Function	DEC VT Layout	EPC Layout
Active Other Window	Shift/Ctrl/Next	Ctrl/Shift/Page Down
	Ctrl/Next or Ctrl/Prev	Ctrl/Page Down or Ctrl/Shift/Page Down or Ctrl/Page Up or Ctrl/Shift/Page Up
Display Prev. Page	Ctrl/Prev	Ctrl/Page Up
	Shift/Ctrl/Prev	Ctrl/Shift/Page Up
Display Page 0	Ctrl/0 (kpd)	Ctrl/0 (kpd)
Display Page 1	Ctrl/1 (kpd)	Ctrl/1 (kpd)
Display Page 2	Ctrl/2 (kpd)	Ctrl/2 (kpd)
Display Page 3	Ctrl/3 (kpd)	Ctrl/3 (kpd)
Display Page 4	Ctrl/4 (kpd)	Ctrl/4 (kpd)
Display Page 5	Ctrl/5 (kpd)	Ctrl/5 (kpd)
±Block Mode	F4	Ctrl/Shift/Pause
	Ctrl/F4	
	Shift/Ctrl/F5	
Change Status Line Display	Ctrl/⇒	Ctrl/⇒
	Ctrl/Shift/⇒	Ctrl/Shift/⇒
±Insert Mode	Ctrl/PF4	Ctrl/Insert
	Ctrl/Shift/PF4	Ctrl/Shift/Insert
±Monitor Mode	Ctrl/Shift/1 (kpd)	Ctrl/Shift/1 (kpd)
Screen Saver	Ctrl/Shift/PF3	Ctrl/Shift/End
Speed Scroll Rate	Ctrl/Shift/↑	Ctrl/Shift/↑
Slow Scroll Rate	Ctrl/Shift/↓	Ctrl/Shift/↓
Home cursor and Clear Display		Ctrl/Shift/Home
Roll Active Window Up In Page	Ctrl/↑	Ctrl/↑
Roll Active Window Down In Page	Ctrl/↓	Ctrl/↓
±Toggle Split screen	Ctrl/Shift/ - (kpd)	Ctrl/Shift/ - (kpd)
Raise Split Line	Ctrl/ - (kpd)	Ctrl/ - (kpd)
Lower Split Line	Ctrl/ , (kpd)	n/a
Adjust Window to Include Cursor		Ctrl/Home
±Cursor Drag Mode	Ctrl/Shift/ , (kpd)	n/a
±Caps Lock State	Lock	Caps Lock
±Num Lock State	n/a	NumLock
±Keyclick State	Shift/Enter (kpd)	Shift/Enter (kpd)

## ASCII Keycodes and Local Functions

### C.3 ASCII Local Functions

**Table C-21 Local Functions in PC Scancode Mode**

Function	DEC VT Layout	EPC Layout
Set-Up	Alt/Print Screen	Caps Lock/Print Screen or Caps Lock/F3
Hard Reset	Ctrl/Shift/F3	Ctrl/Shift/Select
Turn On Block Mode	Compose/PF1	L Alt/NumLock
Turn Off Block Mode	Compose/PF1	Shift/Ctrl/Pause



## VT520 Termcap Data

### D.1 Termcap Emulations

The VT520 and the VT525 terminals have multiple terminal emulations. The following “termcap” and “terminfo” data is for use with the ANSI VT emulations. The ASCII emulations use existing termcap and terminfo data commonly found on UNIX systems.

The VT525 is a color version of the VT520. Color capabilities are not standardized across UNIX and are not included here. Except for color, VT525 emulations are the same as the VT520. In the Termcap Data and Termcap Info code examples, you may change the “vt520” entry names to vt525 if desired.

#### D.1.1 Termcap Data:

```
# VT100
d1|vt100|vt-100|pt100|pt-100|dec vt100:\
:am:co#80:li#24:cl=50\E[;H\E[2J:bs:cm=5\E[%i%d;%dH:nd=2\E[C:up=2\E[A:\
:ce=3\E[K:cd=50\E[J:so=2\E[7m:se=2\E[m:us=2\E[4m:ue=2\E[m:\
:is=\E>\E[?11\E[?31\E[?41\E[?51\E[?7h\E[?8h:\
:if=/usr/lib/tabset/vt100:ku=\E[A:kd=\E[B:kr=\E[C:kl=\E[D:\
:kh=\E[H:kl=\EOP:k2=\EOQ:k3=\EOR:k4=\EOS:pt:xn:sr=5\EM:\
:mb=\E[5m:md=\E[1m:me=\E[0m:\
:GS=\E(0:GE=\E(B:\
:GV=x:GH=q:G1=k:G2=l:G3=m:G4=j:GU=v:\
:GD=w:GC=n:GL=u:GR=t:\
:CL=\EOP:CR=\EOQ:WL=\EOR:WR=\EOS:\
:UK=\E[A:DK=\E[B:LK=\E[D:RK=\E[C:\
:PN=\E[5i:PS=\E[4i:\
:cs=%i\E[%2;%2r:
d0|vt100n|vt100 w/no init:\
:is@if@:tc=vt100:
# vt100 entry for use without automargins set
dn|vt100nam|vt100-nam|pt100nam|pt-100nam|DEC VT100 without automargins:\
:am@:tc=vt100:
ds|vt100s|vt-100s|pt100s|pt-100s|dec vt100 132 cols 14 lines:\
:li#14:tc=vt100w:
dt|vt100w|vt-100w|pt100w|pt-100w|dec vt100 132 cols:\
:co#132:li#24:is=\E>\E[?3h\E[?41\E[?51\E[?7h\E[?8h:\
:vs=\E[?3h:tc=vt100:
#
d6|vt420|DEC VT420 :\
:am:mi:xn:xo:bs:pt:\
:co#80:li#24:kn#3:\
:ae=4\E(B:al=\E(L:as=2\E(0:cd=50\E(J:ce=3\E(K:\
:cl=50\E[;H\E[2J:cm=10\E[%i%d;%dH:cs=\E[%i%d;%dr:\
:dc=\E(P:dl=\E(M:ei=\E[4l:ho=\E(H:\
:if=/usr/lib/tabset/vt100:\
:im=\E[4h:\
```

## VT520 Termcap Data

### D.1 Termcap Emulations

```
:is=\E[1;24r\E[24;1H:\
:r3=\E[?67h\E[64;1"p:\
:i3=\E[?67h\E[64;1"p:\
:k0=\E[29~:\
      :k1=\EOP:k2=\EOQ:k3=\EOR:k4=\EOS:\
      :k5=\E[17~:k6=\E[18~:k7=\E[19~:k8=\E[20~:k9=\E[21~:\
      :kb=\b:kd=\E[B:ke=\E>:kl=\E[D:\
:kr=\E[C:ks=\E=:ku=\E[A:nd=\E[C:\
:rc=\E8:rf=/usr/lib/tabset/vt100:\
      :se=\E[m:so=\E[7m:\
:sr=\EM:ue=\E[m:up=\E[A:us=\E[4m:nl=\E[B:ko=do,nd,up:
#
d6|vt520|DEC VT520 :\
:tc=vt420:
df|vt520nam|vt520-nam|v520n|DEC VT520 with no automargins:\
:am@:tc=vt520:
```

#### D.1.2 Terminfo Data:

```
vt420|DEC VT420 ,
  am, mir, xenl, xon,
  cols#80, lines#24, vt#3,
  bel=^G, blink=\E[5m$<2>,
  acsc=`aaffggjjkkllmmnooppqrrssttuuvvwxxyzz{|||}~`,
  bold=\E[1m$<2>, clear=\E[H\E[2J$<50>, cr=\r,
  csr=\E[%i%p1$d;%p2%dr, cubl=\b, cudl=\E[B, cuf1=\E[C,
  cup=\E[%i%p1$d;%p2%dH$<10>, cuul=\E[A, dch1=\E[P,
  dll=\E[M, ed=\E[J$<50>, el=\E[K$<3>, home=\E[H, ht=\t,
  if=/usr/lib/tabset/vt100, ill=\E[L, ind=\ED,
  is2=\E[1;24r\E[24;1H, is3=\E[?67h\E[64;1"p,
  kbs=^H, kcubl=\E[D, kcucl=\E[B, kcufl=\E[C, kcuul=\E[A,
  kf0=\E[29~, kf1=\EOP, kf2=\EOQ, kf3=\EOR, kf4=\EOS, kf5=\E[17~,
  kf6=\E[18~, kf7=\E[19~, kf8=\E[20~, kf9=\E[21~, kf10=\E[29~,
  rc=\E8, rev=\E[7m$<2>, rf=/usr/lib/tabset/vt100, ri=\EM,
  rmacs=\E(B$<4>, rmir=\E[4l, rmso=\E[m, rmul=\E[m,
  rs3=\E[?67h\E[64;1"p,
  rmsc=\E[?0;0r\E>\E[?31\E[?41\E[?51\E[?7h\E[?8h,
  kfnd=\E[1~, kich1=\E[2~, kdch1=\E[3~,
  knp=\E[6~, kpp=\E[5~, ks1t=\E[4~,
  sgr=\E[0%?%p6%t;1%;%?%p2%t;4%;%?%p4%t;5%;%?%p1%p3%|%t;7%;m%?%p9%t
    \E(0%e\E(B%;,
  sgr0=\E[m$<2>, smacs=\E(0$<2>, smir=\E[4h, smso=\E[7m,
  smul=\E[4m,
#
vt420nam|vt420-nam|v420n|DEC VT420 in vt100 emul. mode with NO AUTO WRAP mode,
  am@, use=vt420,
#
vt420pc|DEC VT420 w/PC keyboard,
  pctrm=USR_TERM:vt420pcdos:,
  kdch1=^?, khome=\E[H, kend=\E[4~,
  kf1=\E[11~, kf2=\E[12~, kf3=\E[13~, kf4=\E[14~, kf5=\E[15~,
  kf6=\E[17~, kf7=\E[18~, kf8=\E[19~, kf9=\E[20~, kf10=\E[21~,
  kf11=\E[23~, kf12=\E[24~,
#
  kf13=\E[11;2~, kf14=\E[12;2~, kf15=\E[13;2~, kf16=\E[14;2~,
  kf17=\E[15;2~, kf18=\E[17;2~, kf19=\E[18;2~, kf20=\E[19;2~,
  kf21=\E[20;2~, kf22=\E[21;2~, kf23=\E[23;2~, kf24=\E[24;2~,
#
  kf25=\E[23~, kf26=\E[24~, kf27=\E[25~, kf28=\E[26~,
  kf29=\E[28~, kf30=\E[29~, kf31=\E[31~, kf32=\E[32~,
  kf33=\E[33~, kf34=\E[34~, kf35=\E[35~, kf36=\E[36~,
#
  kf37=\E[23;2~, kf38=\E[24;2~, kf39=\E[25;2~, kf40=\E[26;2~,
  kf41=\E[28;2~, kf42=\E[29;2~, kf43=\E[31;2~, kf44=\E[32;2~,
  kf45=\E[33;2~, kf46=\E[34;2~, kf47=\E[35;2~, kf48=\E[36;2~,
#
```

## VT520 Termcap Data

### D.1 Termcap Emulations

```
# DECUDK
#         if (key < 16) then value = key;
#         else if (key < 21) then value = key + 1;
#         else if (key < 25) then value = key + 2;
#         else if (key < 27) then value = key + 3;
#         else if (key < 30) then value = key + 4;
#         else value = key + 5;
#
pfx=\EPI;1|%%?%{16}%p1%>t%{0}%e%{21}%p1%>t%{1}%e%{25}%p1%>t
%{2}%e%{27}%p1%>t%{3}%e%{30}%p1%>t%{4}%e%{5};%p1%+d/%p2%s\E\\,
use=vt420,
#
vt420pcdos|DEC VT420 w/PC for DOS Merge,
pctrm@,
smcsc=\E[?1;2r\E[34h,
rmcsc=\E[?0;0r\E>\E[?31\E[?41\E[?51\E[?7h\E[?8h,
u0=eg,
dispc=%?%p2%{19}%=%t\E\023\021%e%p2%{32}%<%t\E%p2%c%e%p2%{127}%=%t
\E\177%e%p2%c%;,
sgr@,
sgr0=\E[0m,
lines#25,
use=vt420pc,
#
vt420f|DEC VT420 with VT kbd; VT400 mode; F1-F5 used as Fkeys,
kdch1=^?, khome=\E[H,
kf1=\E[11~, kf2=\E[12~, kf3=\E[13~, kf4=\E[14~, kf5=\E[15~,
kf6=\E[17~, kf7=\E[18~, kf8=\E[19~, kf9=\E[20~, kf10=\E[21~,
kf11=\E[23~, kf12=\E[24~, kf13=\E[25~, kf14=\E[26~, kf15=\E[28~,
kf16=\E[29~, kf17=\E[31~, kf18=\E[32~, kf19=\E[33~, kf20=\E[34~,
lf1=\EOP, lf2=\EQQ, lf3=\EOR, lf4=\EOS,
use=vt420,
#
# Use v420fn and v420pcn for LYRIX
#
vt420f-nam|v420fn|DEC VT420 no auto margins,
am@, use=vt420f,
vt420pc-nam|v420pcn|DEC VT420 PC keyboard no auto margins,
am@, use=vt420pc,
#
# vt520:
##
vt520|DEC VT520,
use=vt420,
vt520nam|vt520-nam|v520n|DEC VT520 in vt100 emul. mode with NO AUTO WRAP mode,
use=vt420nam,
vt520pc|DEC VT520 w/PC keyboard,
use=vt420pc,
vt520pc-nam|v520pcn|DEC VT520 PC keyboard no auto margins,
am@, use=vt420pc,
vt520pcdos|DEC VT520 w/PC for DOS Merge,
use=vt420pcdos,
```





---

## ANSI Control Function Index

### E.1 ANSI Index by Final Character

This index lists the ANSI host interface commands according to their final character for reference in software programs. Each command has a mnemonic reference, which is in Chapter 5.

**Table E-1 ANSI Control Functions Index by Final Character**

Control Function	Description	Reference
BEL	Bell	
BS	Backspace	
OSC 2 1 ; <name>	Set Window Title	DECSWT
OSC 2 L ; <name>	Set Icon Name	DECSIN
ESC # 3	Double Height Line Top	DECDHL
ESC # 4	Double Height Line Bottom	DECDHL
ESC # 5	Single Width Line	DECSWL
ESC # 6	Double Width Line	DECDWL
ESC 6	Back Index	DECBI
ESC 7	Save Cursor	DECSC
ESC 8	Restore Cursor	DECRC
ESC # 8	Screen Alignment Pattern	DECALN
ESC 9	Forward Index	DECFI
ESC xx	Display PC character xx (hex) (SCO Console)	SCODPCC
ESC ) 1	DDD1 - Set DECRLM, DECHEBM, and DEHCCEM	DDD1
ESC ) B	DDD2 - ASCII to G1; reset DECRLM2	DDD2
ESC ( 1	DDD3 - ASCII to G0	DDD3
<hr/>		
<b>A</b>		
<hr/>		
CSI <i>PI</i> A	Cursor Up	CUU
CSI <i>Pn</i> a	Horizontal Position Relative	HPR
<hr/>		
<b>B</b>		
<hr/>		
CSI <i>PI</i> B	Cursor Down	CUD

(continued on next page)

# ANSI Control Function Index

## E.1 ANSI Index by Final Character

Table E-1 (Cont.) ANSI Control Functions Index by Final Character

Control Function	Description	Reference
<b>C</b>		
CSI <i>Pc C</i>	Cursor Forward	CUF
CSI <i>c</i> or CSI <i>0 c</i>	Device Attributes	DA1
CSI ? <i>Psc ; PSl ; ... Psn c</i>	Response to Device Attributes	DA1
CSI <i>&gt; c</i> or CSI <i>&gt; 0 c</i>	Secondary Device Attributes	DA2
CSI <i>&gt; 64; Pv; 0 c</i>	VT520 response to Sec Device Attributes (VT keyboard)	DA2
CSI <i>&gt; 64; Pv; 1 c</i>	VT520 response to Sec Device Attributes (PC keyboard)	DA2
CSI <i>&gt; 65; Pv; 0 c</i>	VT525 response to Sec Device Attributes (VT keyboard)	DA2
CSI <i>&gt; 65; Pv; 1 c</i>	VT525 response to Sec Device Attributes (PC keyboard)	DA2
CSI <i>= c</i> or CSI <i>= 0 c</i>	Tertiary Device Attributes	DA3
CSI ? <i>1; 2 c</i>	VT100 terminal ID	DECTID
CSI ? <i>1; 0 c</i>	VT101 terminal ID	DECTID
CSI ? <i>6 c</i>	VT102 terminal ID	DECTID
CSI ? <i>62; 1; 2; 7; 8 c</i>	VT220 North American	DECTID
CSI ? <i>62; 1; 2; 7; 8; 9 c</i>	VT220 International	DECTID
CSI ? <i>63; 1; 2; 7; 8 c</i>	VT320 North American	DECTID
CSI ? <i>63; 1; 2; 7; 8; 9 c</i>	VT320 International	DECTID
CSI ? <i>64; 1; 2; 6; 7; 8; 9; 15; 18; 21 c</i>	VT420	DECTID
CSI ? <i>65;1;2;6;7;8;9;12;23;24;46 c</i>	VT520 level 1	DECTID
CSI ? <i>65;1;2;6;7;8;9;12;15;18;19; 21;23;24;42;44;45;46 c</i>	VT520 level 2-4	DECTID
CSI ? <i>65;1;2;7;9;12;18;19;21;23;24; 42;44;45;46 c</i>	VT520 level 4	DECTID
CSI ? <i>65;1;2;6;7;8;9;12;15;18;19;21; 22;23;24;42;44;45;46 c</i>	VT525 level 2-4	DECTID
CSI ? <i>65;1;2;7;9;12;18;19;21;22;23; 24;42;44;45;46 c</i>	VT525 level 5	DECTID
ESC <i>c</i>	Reset to Initial state	RIS
<b>D</b>		
CSI <i>Pc D</i>	Cursor Backward	CUB
CSI <i>Pn d</i>	Vertical Line Position Absolute	VPA
ESC <i>D</i>	Index	IND
<b>E</b>		
CSI <i>Pn E</i>	Cursor Next Line	CNL
CSI <i>Pn e</i>	Vertical Position Relative	VPR
ESC <i>E</i>	Next Line	NEL

(continued on next page)

## ANSI Control Function Index E.1 ANSI Index by Final Character

**Table E-1 (Cont.) ANSI Control Functions Index by Final Character**

Control Function	Description	Reference
<b>F</b>		
CSI <i>Pl</i> ; <i>Pc</i> f	Horizontal/Vertical Position	HVP
CSI <i>Pn</i> F	Cursor Previous Line	CPL
ESC SP F	Send 7-bit C1 Control character to host	S7C1T
<b>G</b>		
CSI <i>Pn</i> G	Cursor Horizontal Absolute	CHA
CSI <i>Ps</i> g	Clear Tabs	TBC
ESC SP G	Send 8-bit C1 Control character to host	S8C1T
<b>H</b>		
CSI <i>Pl</i> ; <i>Pc</i> H	Cursor Position	CUP
CSI <i>Pl...Pn</i> h	Set Mode	SM
CSI ? 1 h	Set Cursor Keys mode (application)	DECCKM
CSI 2 h	Set Keyboard Action Mode	KAM
CSI 3 h	Set Show Control Character Mode	CRM
CSI ? 3 h	Set Column Mode (132 columns)	DECCOLM
CSI 4 h	Set Insert Mode	IRM
CSI ? 4 h	Set Scrolling Mode (smooth)	DECSCLM
CSI ? 5 h	Set Screen Mode (light)	DECSCNM
CSI ? 6 h	Set Origin Mode (in margins)	DECOM
CSI ? 7 h	Set Autowrap Mode	DECAWM
CSI ? 8 h	Set Autorepeat mode	DECARM
CSI 12 h	Set Send/Receive mode (Local echo off)	SRM
CSI ? 18 h	Set Print Form Feed Mode	DECPFF
CSI ? 19 h	Set Printer Extent Mode	DECPEX
CSI 20 h	Set Line Feed/New Line (NL)	LMN
CSI ? 25 h	Set Text Cursor Enable Mode (visible)	DECTCEM
CSI ? 34 h	Set Right-to-Left Mode	DECRLM
CSI ? 35 h	Set Hebrew Keyboard Map Mode	DECHEBM
CSI ? 36 h	Set Hebrew Encoding Mode to 8-bit characters	DECHEM
CSI ? 42 h	Set National 7-bit character	DECNRCM
CSI ? 57 h	Set N.A./Greek Selection to N.A.	DECNAKB
CSI ? 58 h	Set (enter) ProPrinter Emulation Mode	DECIPEM
CSI ? 60 h	Set Horizontal Cursor	DECHCCM
CSI ? 61 h	Set Vertical Cursor Coupling	DECVCCM
CSI ? 64 h	Set Page Cursor Coupling	DECPCCM
CSI ? 66 h	Set Numeric Keypad Mode	DECNKM
CSI ? 67 h	Set Backarrow key mode (BS)	DECBKM
CSI ? 68 h	Set Data Processing Keys	DECKBUM
CSI ? 69 h	Set Vertical Split Screen Mode	DECVSSM
CSI ? 73 h	Set Transmit Rate Limiting	DECXRLM
CSI ? 81 h	Set Key Position Mode	DECKPM

(continued on next page)

# ANSI Control Function Index

## E.1 ANSI Index by Final Character

Table E-1 (Cont.) ANSI Control Functions Index by Final Character

Control Function	Description	Reference
<b>H</b>		
CSI ? 95 h	Set no clear screen on column change	DECNCM
CSI ? 96 h	Set Right-to-Left Copy	DECRLCM
CSI 97 h	Set CRT Save Mode	DECCRTSM
CSI ? 98 h	Set Auto Resize	DECARSM
CSI ? 99 h	Set Modem Control Mode	DECMCM
CSI ? 100 h	Set Auto Answerback Mode	DECAAM
CSI ? 101 h	Set Conceal Answerback Message	DECCANSM
CSI ? 102 h	Set Ignore Null Mode	DECNULM
CSI ? 103 h	Set Half-Duplex Mode	DECHDPXM
CSI ? 104 h	Set Enable Secondary Keyboard Language Mode	DECESKM
CSI ? 106 h	Set Overscan Mode	DECOSCNM
CSI ? 108 h	Set Num Lock Mode	DECNUMLK
CSI ? 109 h	Set Caps Lock Mode	DECCAPSLK
CSI ? 110 h	Set Keyboard LED's Host Indicator Mode	DECKLHIM
CSI ? 111 h	Set Framed Windows Mode	DECFWM
CSI ? 112 h	Set Review Previous Lines	DECRPL
CSI ? 113 h	Set Host Wake-Up Mode	DECHWUM
CSI ? 114 h	Set Alternate Text Color Underline Mode	DECATCUM
CSI ? 115 h	Set Alternate Text Color Blink Mode	DECATCBM
CSI ? 116 h	Set Bold and Blink Style Mode	DECBBSM
CSI ? 117 h	Set Erase Color Mode	DECECM
ESC H	Set Horizontal Tabs	HTS
<b>I</b>		
CSI <i>Pn</i> I	Cursor Horizontal Forward Tab	CHT
CSI <i>Ps</i> i	Media Copy	MC
CSI 6 i	Start Printer-to-Host Session	MC
CSI 7 i	Stop Printer-to-Host Session	MC
CSI ? <i>Ps</i> i	Media Copy (DEC)	MC
CSI ? 8 i	Stop Printer-to-Host Session	MC
CSI ? 9 i	Start Printer-to-Host Session	MC
ESC I Dscs	Designate Character Set	SCS
<b>J</b>		
CSI <i>Ps</i> J	Erase in Display	ED
CSI ? <i>Ps</i> J	Selective Erase in Display	DECSER
<b>K</b>		
CSI <i>Ps</i> K	Erase in Line	EL
CSI ? <i>Ps</i> K	Selective Erase in Line	DECSEL

(continued on next page)

## ANSI Control Function Index E.1 ANSI Index by Final Character

**Table E-1 (Cont.) ANSI Control Functions Index by Final Character**

Control Function	Description	Reference
<b>L</b>		
CSI <i>Pn</i> L	Insert Line	IL
CSI <i>P1...Pn</i> l	Reset Mode	RM
CSI ? 1 l	Reset Cursor Keys mode (Cursor)	DECCKM
CSI 2 l	Reset Keyboard Action Mode	KAM
CSI ? 2 l	ANSI Mode	DECANM
CSI 3 l	Reset Show Control Character Mode	CRM
CSI ? 3 l	Reset Column Mode (80 columns)	DECCOLM
CSI 4 l	Reset Insert Mode (Replace)	IRM
CSI ? 4 l	Reset Scrolling Mode (jump)	DECSCLM
CSI ? 5 l	Reset Screen Mode (dark)	DECSCNM
CSI ? 6 l	Reset Origin Mode (upper left)	DECOM
CSI ? 7 l	Reset Autowrap Mode	DECAWM
CSI ? 8 l	Reset Autorepeat mode	DECARM
CSI 12 l	Reset Send/Receive mode (Local echo on)	SRM
CSI ? 18 l	Reset Print Form Feed Mode	DECPFF
CSI ? 19 l	Reset Printer Extent Mode	DECPEX
CSI 20 l	Reset Line Feed (LF)/New Line	LNLM
CSI ? 25 l	Reset Text Cursor Enable Mode (invisible)	DECTCEM
CSI ? 34 l	Reset Right-to-Left Mode	DECRLM
CSI ? 35 l	Reset Hebrew Keyboard Map Mode to N.A.	DECHEBM
CSI ? 36 l	Reset Hebrew Encoding Mode to 7-bit characters	DEHCEM
CSI ? 42 l	Reset Multinational 8-bit characters	DECNRCM
CSI ? 57 l	Reset N.A./Greek Selection to Greek	DECNAKB
CSI ? 58 l	Reset (return from) ProPrinter Emulation Mode	DECIPEM
CSI ? 60 l	Reset Horizontal Cursor	DECHCCM†
CSI ? 61 l	Reset Vertical Cursor Coupling	DECVCCM
CSI ? 64 l	Reset Page Cursor Coupling	DECPCCM
CSI ? 66 l	Reset Numeric Keypad Mode	DECNKM
CSI ? 67 l	Reset Backarrow key mode (DEL)	DECBKM
CSI ? 68 l	Reset to Typewriter Keys	DECKBUM
CSI ? 69 l	Reset Vertical Split Screen Mode	DECVSSM
CSI ? 73 l	Reset Transmit Rate Limiting	DECXRLM
CSI ? 81 l	Reset Key Position Mode	DECKPM
CSI ? 95 l	Reset no clear screen on column change	DECNCSM
CSI ? 96 l	Reset Right-to-Left Copy	DECRLCM
CSI 97 l	Reset CRT Save Mode	DECRTSM
CSI ? 98 l	Reset Auto Resize	DECARSM
CSI ? 99 l	Reset Modem Control Mode	DECMCM
CSI ? 100 l	Reset Auto Answerback Mode	DECAAM
CSI ? 101 l	Reset Conceal Answerback Message Mode	DECCANSM
CSI ? 102 l	Reset Ignore Null Mode	DECNULM
CSI ? 103 l	Reset Half-Duplex Mode	DECHDPXM
CSI ? 104 l	Reset Enable Secondary Keyboard Language Mode to Primary keyboard mapping	DECESKM
CSI ? 106 l	Reset Overscan Mode	DECOSCNM
CSI ? 108 l	Reset Num Lock Mode	DECNUMLK
CSI ? 109 l	Reset Caps Lock Mode	DECCAPSLK
CSI ? 110 l	Reset Keyboard LED's Host Indicator Mode	DECKLHIM
CSI ? 111 l	Reset Framed Windows Mode	DECFFWM
CSI ? 112 l	Reset Review Previous Lines	DECRPL

(continued on next page)

## ANSI Control Function Index

### E.1 ANSI Index by Final Character

Table E-1 (Cont.) ANSI Control Functions Index by Final Character

Control Function	Description	Reference
<b>L</b>		
CSI ? 113 l	Reset Host Wake-Up Mode	DECHWUM
CSI ? 114 l	Set Alternate Text Color Underline Mode	DECATCUM
CSI ? 115 l	Reset Alternate Text Color Blink Mode	DECATCBM
CSI ? 116 l	Reset Bold and Blink Style Mode	DECBBSM
CSI ? 117 l	Reset Erase Color Mode	DECECM
<b>M</b>		
CSI <i>Pn</i> M	Delete Line(s)	DL
CSI <i>Ps</i> ; . . . ; <i>Ps</i> m	Select Graphic Rendition	SGR
ESC M	Reverse Index	RI
<b>N</b>		
CSI 0 n	DSR—Operating Status Response	DSR—Op
CSI 3 n	DSR—Operating Status Response	DSR—Op
CSI 5 n	DSR—Operating Status Request	DSR—Op
CSI 6 n	Cursor Position Report Request or DSR—CPR	CPR or DSR—CPR
CSI ? 6 n	Extended Cursor Position Request, or DSR—Extended CPR	DECXCPR, DSR—ExCPR
CSI ? 10 n	DSR—Printer Port Response	DSR—Print
CSI ? 11 n	DSR—Printer Port Response	DSR—Print
CSI ? 13 n	DSR—Printer Port Response	DSR—Print
CSI ? 15 n	DSR—Printer Port Request	DSR—Print
CSI ? 18 n	DSR—Printer Port Response	DSR—Print
CSI ? 19 n	DSR—Printer Port Response	DSR—Print
CSI ? 20 n	DSR—User-Defined Keys Response	DSR—UDK
CSI ? 21 n	DSR—User-Defined Keys Response	DSR—UDK
CSI ? 25 n	DSR—User-Defined Keys Request	DSR—UDK
CSI ? 26 n	DSR—Keyboard Status Request	DSR—KeyBd
CSI ? 27 ; <i>Prr</i> ; <i>Pst</i> ; <i>Ptyp</i> n	DSR—Keyboard Response	DSR—KeyBd
CSI ? 62 n	DSR—Macro Space Report Request	DECDMAC, DSR—MSR
CSI ? 63; <i>Pid</i> n	Memory Checksum Report Request or DSR—Memory Checksum Request	DECCKSR, DSR—Mem
CSI ? 70 n	DSR—Data Integrity Report Response	DSR—Data
CSI ? 71 n	DSR—Data Integrity Report Response	DSR—Data
CSI ? 73 n	DSR—Data Integrity Report Response	DSR—Data
CSI ? 75 n	DSR—Data Integrity Report Request	DSR—Data
CSI ? <i>Ps</i> n	Response to Device Status Report	DSR
ESC N	Single Shift Two	SS
ESC n	Locking Shift Two	LS
<b>O</b>		
ESC O	Single Shift Three	SS
ESC o	Locking Shift Three	LS

(continued on next page)

## ANSI Control Function Index E.1 ANSI Index by Final Character

**Table E-1 (Cont.) ANSI Control Functions Index by Final Character**

Control Function	Description	Reference
<b>P</b>		
CSI <i>Pn</i> P	Delete Character	DCH
CSI <i>Pn</i> SP P	Page Position Absolute	PPA
CSI <i>Pr</i> + p	Secure Reset	DECSR
CSI <i>Ps</i> p	Select Set-Up Language	DECSSL
CSI <i>Ps</i> - p	Auto Repeat Rate	DECARR
CSI <i>Ps</i> SP p	Set Scroll Speed	DECSSCLS
CSI <i>Pa</i> \$ p	Request Mode (ANSI) Host to Terminal	DECRRQM
CSI ? <i>Pd</i> \$ p	Request Mode (DEC) Host to Terminal	DECRRQM
CSI ! p	Soft Terminal Reset	DECSTR
CSI <i>Ps</i> * p	Select ProPrinter Character Set	DECSPPCS
CSI <i>Ps</i> ) p	Select Digital Printed Data Type	DECSDPT
CSI 6 <i>Ps1</i> ; <i>Ps2</i> ; " p	Select Conformance Level	DECSCLO
CSI <i>Ps1</i> ; <i>Ps2</i> , p	Load Time of Day	DECLTOD
DCS <i>Ps</i> \$ p <i>D...D</i> ST	Restore Terminal State	DECRRSTS
DCS 2 \$ p <i>D...D</i> ST	Color Table Restore	DECCTR
DCS 2 \$ p <i>Pc;Pu;Px;Py;Pz</i> / ST	Color Table Restore	DECCTR
<b>Q</b>		
CSI <i>Pn</i> SP Q	Page Position Relative	PPR
CSI <i>Pr</i> * q	Secure Reset Confirmation	DECSR
CSI <i>Ps</i> - q	CRT Saver Timing	DECRTST
CSI <i>Ps</i> q	Load LEDs	DECLL
CSI <i>Ps</i> SP q	Set Cursor Style	DECSCUSR
CSI <i>Ps</i> " q	Select Character Protection Attribute	DECSCA
CSI <i>Ps1</i> , q	Select Terminal ID	DECTID
CSI <i>Ps</i> \$ q	Select Disconnect Delay Time	DECSDDT
CSI <i>Pf1</i> ; <i>PC1</i> ; ... <i>Pfn</i> ; <i>Pcn</i> + q	Enable Local Functions	DECSELF
DCS \$ q <i>D...D</i> ST	Request Selection or Setting	DECRRQSS
ESC Q <i>Fn String</i>	Define Function Key (SCO Console)	SCODFK
<b>R</b>		
CSI <i>Pl</i> ; <i>Pc</i> R	Response to Cursor Position Report (CSI 6 n) or DSR—CPR	CPR or DSR—CPR
CSI <i>Pl</i> ; <i>Pc</i> ; <i>Pp</i> R	Response to Extended Cursor Position Request (CSI ? 6 n) or DSR—Extended CPR	DECXCPR, DSR—ExCPR
CSI <i>Pn</i> SP R	Page Position Backwards	PPB
CSI <i>Ps</i> * r	Select Communication Speed	DECSCS
CSI <i>Ps</i> - r	Energy Saver Timing	DECSEST
CSI <i>Ps1</i> ; <i>Ps2</i> * r	Select Communication Speed	DECSCS
CSI ? <i>Ps1</i> ; <i>Ps2</i> r	Enter/Exit PCTerm Mode	DECPCTERM
CSI <i>Ps</i> SP r	Set Key Click Volume	DECCLKV
CSI <i>Pt</i> ; <i>Pb</i> r	Set Top and Bottom Margin	DECSTBM
CSI <i>Pt</i> ; <i>Pb</i> ; <i>Pr</i> ; <i>Ps1</i> ; ... <i>Psn</i> \$ r	Change Attribute in Rectangle	DECCARA
CSI <i>Pm1</i> ; <i>Pf1</i> ; ... <i>Pmn</i> ; <i>Pfn</i> + r	Select Modifier Key Reporting	DECCKMR
DCS <i>Ps</i> r <i>D...D</i> ST	Load Banner Message	DECLBAN
DCS <i>Ps</i> \$ r <i>D...D</i> ST	Report Selection or Setting	DECRRQSS

(continued on next page)

## ANSI Control Function Index

### E.1 ANSI Index by Final Character

Table E-1 (Cont.) ANSI Control Functions Index by Final Character

Control Function	Description	Reference
<b>S</b>		
CSI s	Save Current Cursor Position (SCO Console)	SCOSC
CSI Pn S	Pan Down	SU
CSI Pl ; Pr s	Set Left and Right Margin	DECSLRM
CSI Ps \$ s	Select Printer Type	DECSPRTT
CSI Ps * s	Select Flow Control Type	DECSFC
CSI Ps1; Ps2; Ps3; Ps4 * s	Select Flow Control	DECSFC
DCS 1 \$ s D...D ST	Reply to Terminal State Report to Host	DECTSR
DCS 2 \$ s D...D ST	Color Table Report	DECCTR
DCS Ps \$ s D...D ST	Reply to Terminal State Report	DECRQTSR
<b>T</b>		
CSI Pn T	Pan Up	SD
CSI Pn t	Set Lines Per Page	DECSLPP
CSI Ps SP t	Set Warning Bell Volume	DECSWBV
CSI Pt;Pl;Pb;Pr Ps1;...Psn \$ t	Reverse Attribute in Rectangle	DECRARA
DCS Ps \$ t D...D ST	Restore Presentation State	DECRSPS
<b>U</b>		
CSI u	Restore Saved Cursor Position (SCO Console)	SCORC
CSI Pn U	Next Page	NP
CSI & u	Request User-Preferred Supplemental Set	DECRQUPSS
CSI 1 \$ u	Request Terminal State Report	DECTSR
CSI Ps \$ u	Request Terminal State Report	DECRQTSR
CSI 2; Pu \$ u	Color Table Request	DECCTR
CSI Ps , u	Key Type Inquiry	DECRQKT
CSI Ps SP u	Set Margin Bell Volume	DECSMBV
CSI Ps * u	Select Communication Port	DECSCP
CSI Ps1; Ps2 * u	Select Communication Port	DECSCP
CSI Ps " u	Set Transmit Rate Limit	DECSTRL
CSI Ps1; Ps2 " u	Set Transmit Rate Limit	DECSTRL
DCS 1 \$ u D...D ST	Cursor Information Report	DECCIR
DCS 2 \$ u D...D ST	Tab Stop Report	DECTABSR
DCS Ps ! u Dscs ST	Assign User-Preferred Supp Set	DECAUPSS
<b>V</b>		
CSI Pn V	Preceding Page	PP
CSI Ps SP v	Set Lock Key Style	DECSLCK
CSI " v	Request Displayed Extent	DECRQDE
CSI Ps1 ; Ps2 , v	Report Key Type	DECRPKT
CSI Pts;Pls;Pbs;Prs;Pps;Ptd;Pld;Ppd\$ v	Copy Rectangular Area	DECCRA
DCS Ps v D...D ST	Load Answerback Message	DECLANS
<b>W</b>		
CSI ? 5 W	Set Tab at every 8 columns	DECST8C
CSI Ps + w	Set Port Parameter	DECSPP
CSI Ps1 ; Ps2 , w	Key Definition Inquiry	DECRQKD

(continued on next page)



## ANSI Control Function Index E.1 ANSI Index by Final Character

**Table E-1 (Cont.) ANSI Control Functions Index by Final Character**

Control Function	Description	Reference
<b>W</b>		
CSI <i>Ps1; Ps2; Ps3; Ps4</i> + w	Set Port Parameter	DECSPP
CSI <i>Ph; Pw; Pml; Pmt; Pmp;</i> " w	Report Displayed Extent	DECRPDE
CSI <i>Ps</i> \$ w	Request Presentation State Report	DECRQPSR
<b>X</b>		
CSI <i>Pn</i> X	Erase Character(s)	ECH
CSI & x	Enable Session	DECES
CSI <i>Pch; Pt; Pl; Pb; Pr</i> \$ x	Fill Rectangular Area	DECFRA
CSI <i>Pn1; Pn2; Pn3; Pn4</i> , x	Session Page Memory Allocation	DECSPPA
CSI <i>Ps</i> * x	Select Attribute and Change Extent	DECSACE
CSI + x	Program Key Free Memory Inquiry	DECRQPKFM
DCS " x D...D ST	Program Function Key	DECPFK
<b>Y</b>		
CSI <i>Pa; Ps</i> \$ y	Report Mode (ANSI) Terminal to Host	DECRPM
CSI ? <i>Pd; Ps</i> \$ y	Report Mode (DEC) Terminal to Host	DECRPM
CSI <i>Pid; Pp; Pt; Pl; Pb; Pr</i> * y	Request Checksum of Rectangle Area	DECRQCRA
CSI 4 ; <i>Ps</i> ; ... ; <i>Ps</i> y	Invoke Confidence Test	DECTST
CSI <i>Ps1; Ps2</i> + y	Program Key Free Memory Report	DECPKFM
CSI <i>Ps</i> , y	Update Session	DECUS
DCS " y D...D ST	Program Alphanumeric Key	DECPAK
<b>Z</b>		
CSI <i>Pt; Pl; Pb; Pr</i> \$ z	Erase Rectangular Area	DECERA
CSI <i>Pid</i> * z	Invoke Macro	DECINVM
CSI <i>Pn</i> Z	Cursor Backward Tabulation	CBT
CSI <i>Ps</i> , z	Down Line Load Allocation	DECDLDA
CSI <i>Ps</i> + z	Program Key Action	DECPKA
DCS <i>Pid; Pdt; Pen</i> ! z D...D ST	Define Macro	DECDMAC
DCS " z D...D ST	Copy Key Default	DECCKD
ESC Z	Identify Device (Use DA1 instead.)	DECID
<b>Other Characters</b>		
APC : <i>ppp mm</i> ST	Extended Keyboard Report	DECEKBD
CSI <i>Pn</i> @	Insert Character	ICH
CSI <i>Ps1; Ps2; Ps3</i> ,	Assign Color	DECAC
CSI <i>Pn</i> *	Select number of lines per screen	DECSNLS
CSI \$	Set 80 columns per page	DECSPPP
CSI <i>Ps</i> \$	Set <i>Ps</i> columns per page	DECCOLM
CSI 80 \$	Set 80 columns per page	DECSPPP
CSI 132 \$	Set 132 columns per page	DECSPPP
DCS !   D...D ST	Report Terminal Unit ID, response to Tertiary Device Attributes	DA3 and DECRPTUI
DCS <i>Ps1; Ps2; Ps3</i>   D...D ST	User Defined Key	DECUDK
ESC	Locking Shift Three Right	LS

(continued on next page)

# ANSI Control Function Index

## E.1 ANSI Index by Final Character

Table E-1 (Cont.) ANSI Control Functions Index by Final Character

Control Function	Description	Reference
<b>Other Characters</b>		
CSI <i>Pn</i> * {	Macro Space Report Response	DECMSR, DSR-MSR
CSI <i>Ps</i> ) {	Select Color Look-Up Table	DECSTGLT
CSI <i>Ps</i> , {	Select Zero Symbol	DECSZS
CSI <i>Pt;Pl;Pb;Pr</i> \$ {	Selective Erase Rectangular Area	DECSERA
DCS ! { <i>D...D</i> ST	Set Terminal Unit ID	DECSTUI
DCS <i>Pfn; Pcn; Pe; Pcmw; Pss; Pu;</i> <i>Pcmh; Pcss</i> { < <i>Dscs</i> > <sixel-font-patterns> ST	Dynamically Redefinable Character Sets Extension (Down-line Load)	DECDDL
CSI <i>Pn</i> ' }	Insert Column	DECIC
CSI <i>Ps</i> \$ }	Select Active Status Display	DECSASD
CSI <i>Ps1; Ps2; Ps3</i> , }	Alternate Text Colors	DECATC
CSI <i>Ps1; Ps2</i> SP }	Keyboard Language Selection	DECKBD
CSI <i>Pk1; Pf1; Pk2; Pf2.....*</i> }	Local Function Key Control	DECLFKC
DCS " } <i>D...D</i> ST	Report Function Key Definition	DECRPFK
ESC }	Locking Shift Two Right	LS
CSI <i>Pn</i> ' ~	Horizontal Position Absolute	HPA
CSI <i>Pn</i> ' ~	Delete Column(s)	DEDC
CSI <i>Ps</i> SP ~	Terminal Mode Emulation	DECTME
CSI <i>Ps</i> \$ ~	Set Status Display (Line) Type	DECSSDT
CSI <i>Ps1 ; Ps2</i> ~	Function Key	DECFNK
CSI <i>D...D</i> , ~	Play Sound	DECPS
DCS " ~ <i>D...D</i> ST	Report all Modifiers/Alphanumeric Key State	DECRPAK
DCS <i>Pid</i> ! ~ <i>D...D</i> ST	Response to Memory Checksum Report Request	DECRQCRA, DECCKSR, or DSR-Mem
ESC ~	Locking Shift One Right	LS
ESC ( <i>Dscs</i>	G0 94-character set	SCS
ESC ) <i>Dscs</i>	G1 94-character set	SCS
ESC * <i>Dscs</i>	G2 94-character set	SCS
ESC + <i>Dscs</i>	G3 94-character set	SCS
ESC - <i>Dscs</i>	G1 96-character set	SCS
ESC . <i>Dscs</i>	G2 96-character set	SCS
ESC / <i>Dscs</i>	G3 96-character set	SCS
ESC =	Set Keypad Application Mode	DECKPAM
ESC <	Exit ANSI (VT52) Mode	DECANM
ESC >	Reset Keypad to numeric characters	DECKPNM
S0	Locking Shift One	LS

---

# Glossary

## Active Session

The session to which keyboard input is currently directed.

## ANSI

*American National Standards Institute*; ANSI character set.

## ANSI Standard Color

Support for specifying text colors using the Select Graphic Rendition (SGR) command and parameters defined in ANSI X3.64.

## ANSI Terminal

A video terminal that complies with prominent ANSI standards, which usually include:

ANSI X3.4, *ASCII, American Standard Code for Information Exchange*  
ANSI X3.41 *Controls for use with ASCII*  
ANSI X3.64 *Additional Controls for use with ASCII*

## ASCII

*American Standard Code for Information Interchange*; ASCII character set.

## ASCII Terminal

A video terminal that complies with:

ANSI X3.4 *ASCII, American Standard Code for Information Exchange*  
ANSI X3.41 *Controls for use with ASCII*

But an ASCII terminal may not comply with control sequences, the protocol defined by ANSI X3.64, *Additional Controls for use with ASCII*.

## Character Set

A one-to-one mapping between the character codes and the symbols produced. The differences are as follows:

Character Set	Character Codes	Control Codes
ASCII 7-bit	96	32
ASCII 8-bit	192	64
PC	256	0
PCTerm	256	16 (typically)

**Control Codes**

Binary codes representing control data, rather than graphic data, to perform non-printable functions, such as tab, form feed, bell, and so on.

- C0 control codes are defined for 7-bit character sets.
- C0 and C1 control codes are defined for 8-bit character sets.

**Control Function**

A general term for control codes, escape sequences, control sequences, and control strings.

**Control Sequence**

The ANSI standards define the protocol for extending the meaning of character set data to be control data. As such, a control sequence has a prefix called a *control sequence introducer* (CSI) followed by the command and its parameters. For example, **Esc [** is the CSI used for 7-bit ANSI control sequences.

**DRCS**

Dynamically Redefinable Character Set. A feature that allows user specified character sets (soft sets) to be downloaded by host software.

**EPC Keyboard**

An Enhanced PC (PCXAL) 101- or 102-key layout keyboard.

**Function Key**

A key that sends control codes or control sequences that are usually interpreted by a host computer to perform some function. In *PCTerm mode*, a keyboard mapping process in the host computer determines the function to be performed.

**Graphic Key**

An alphanumeric key.

**Keyboard Dialect**

A mapping from keystrokes on the main key array to the characters produced. The names of the *keyboard dialects* are based on the geographical region, country, or language for which the keyboard is primarily intended.

**Keyboard Language**

Another term for a *keyboard dialect*.

**Keyboard Layout**

A physical arrangement of keys and keycap legends on a keyboard.

**Keyboard Scan Codes**

The numeric codes transmitted from a keyboard to a terminal or computer. Within a keyboard, scan codes are generated by scanning a physical key array to detect key switch transitions. Scan codes represent the physical position of the keys in the key matrix. The host defines the meaning of the scan codes, mapping them to alphanumeric, function, or “hot” keys for DOS application use.

**Local Function Key**

A key that invokes a local terminal function (Examples: Print Screen, Set-Up).

**MPR II**

A Swedish standard that sets limits for low frequency magnetic energy emitted from electronic equipment.

**PCTerm**

A terminal mode that emulates the console of an industry-standard PC, while communicating with a host over a serial communications line. PCTerm mode allows you to run an application on a host as if the application was running locally on the terminal. In PCTerm mode, the terminal transmits the same PC keyboard *scan codes* that a console keyboard attached to a PC would send.

**Session**

A connection between a single virtual terminal and a host computer.

**Set-Up Summary Line**

A line of text that appears at the bottom of the screen any time the terminal is in Set-Up. This line summarizes how the terminal is configured. If the terminal is unable to communicate with a host for some reason, the *Set-Up Summary Line* can be used to quickly find any mismatched settings.

**Soft Key Mapping**

The ability to modify the correspondence between keystrokes to character codes or functions for all keys on the keyboard.

**Status Display**

A separate logical display that usually appears as a single line near the bottom or top of the screen to provide status information.

**TD/SMP**

Terminal Device/Session Management Protocol. A communications protocol that allows multiple sessions to share a single comm port.

**User Defined Key**

A *function key* that can be reprogrammed by the user or by a control sequence from the host.

**Virtual Terminal**

A virtual terminal appears to be a real physical terminal to a host computer but may in fact share resources with other virtual terminals (keyboard and display) to create the effect of more than one terminal within a single device. Virtual terminals maintain the full state and context of real physical terminals.

**VT Keyboard**

An LK450 (LK411) 108-key layout keyboard.

**XOFF/XON**

Control codes that the terminal uses to stop and resume transmission when its receive buffer (or the host's receive buffer) is full or empty.

**XPC**

A remapping of transmitted XOFF and XON control codes to unused PC scan codes. While in PCTerm mode, these control codes would interfere with the scan codes that the host expects to receive. The terminal, however, still responds to received XOFF and XON control codes.

## A

---

Aborting  
  print operations, 10–7

Accessibility aids, 2–6, 8–15

Actions menu, 2–7, 2–9  
  banner message, 2–11  
  calculator, 2–11  
  clear communications, 2–9  
  clear display, 2–9  
  clock, 2–11  
  reset this session, 2–10  
  restore factory defaults, 2–10  
  show character sets, 2–11

ADDS mode, 13–1

Alignment, screen, 2–27

Alternate text colors, 2–30

ANSI  
  code summary, 4–1  
  conformance levels, 5–1  
  control characters, 4–1  
  control functions, 5–1  
    audible attributes, 4–18  
    color selection, 4–18  
    communications, 4–39  
    defined, 4–1  
    editing, 4–21  
    graphic character sets, 4–25  
    index by final character, E–1  
    keyboard processing, 4–27  
    printer, 4–33  
    reports, 4–42  
    sessions, 4–16  
    terminal management, 4–34  
      defined, 4–15  
    terminal synchronization, 4–41  
    text processing, 4–22  
    visual attributes, 4–20  
  control sequences, 5–1

ANSI control sequences  
  by Control Function  
    APC : *ppp mm* ST (DECEKBD), 5–49  
    CSI ! p (DECSTR), 5–150  
    CSI " v (DECRQDE), 5–105  
    CSI \$ | (select 80 columns/page), 5–125  
    CSI & u (DECRQUPSS), 5–115  
    CSI & x (enable session), 5–53

ANSI control sequences  
  by Control Function (cont'd)  
    CSI + x (DECRQPKFM), 5–111  
    CSI 0 \$ | (select 80 columns/page), 5–125  
    CSI 0 n (DSR—operating status), 5–177  
    CSI 1 2 h (SRM set), 5–204  
    CSI 1 2 l (SRM reset), 5–204  
    CSI 1 3 2 \$ | (select 132 columns/page),  
      5–125  
    CSI 2 0 h (LNM set), 5–186  
    CSI 2 0 l (LNM reset), 5–186  
    CSI 2 ; *Pu \$ u* (DECCTR), 5–114  
    CSI 2 h (KAM set), 5–185  
    CSI 2 l (KAM reset), 5–185  
    CSI 3 h (CRM set), 5–6  
    CSI 3 l (CRM reset), 5–6  
    CSI 3 n (DSR—operating status: problem),  
      5–177  
    CSI 4 ; *Ps . . . ; Ps y* (DECTST), 5–162  
    CSI 4 h (IRM set), 5–185  
    CSI 4 l (IRM reset), 5–185  
    CSI 5 n (DSR—request operating status),  
      5–177  
    CSI 6 1 " P (VT Level 1 mode), 5–122  
    CSI 6 n " P (VT Level 4 mode, 8-bit  
      controls), 5–122  
    CSI 6 n (CPR request), 5–5, 5–173  
    CSI 6 n ; 0 " P (VT Level 4 mode, 8-bit  
      controls), 5–122  
    CSI 6 n ; 1 " P (VT Level 4 mode, 7-bit  
      controls), 5–122  
    CSI 6 n ; 2 " P (VT Level 4 mode, 8-bit  
      controls), 5–122  
    CSI 8 0 \$ | (select 80 columns/page),  
      5–125  
    CSI 8 1 h (DECKPM set), 5–66  
    CSI 8 1 l (DECKPM reset), 5–66  
    CSI = c or CSI = 0 c (DA3 request), 5–12  
    CSI > 61 ; *Pv ; 0 c* (DA2 request from VT  
      Keyboard), 5–11  
    CSI > 61 ; *Pv ; 1 c* (DA2 request from PC  
      Keyboard), 5–11  
    CSI > c or CSI > 0 c (DA2), 5–11  
    CSI ? 100 h (enable DECAAM), 5–15  
    CSI ? 100 l (disable DECAAM (default)),  
      5–15  
    CSI ? 101 h (DECCANSM), 5–27

## ANSI control sequences

## by Control Function (cont'd)

CSI ? 101 l (DECCANSM), 5-27  
 CSI ? 1 0 2 h (DECNULM set), 5-76  
 CSI ? 1 0 2 l (DECNULM reset), 5-76  
 CSI ? 1 0 3 h (DECHDPXM enabled  
 /half-duplex enabled), 5-56  
 CSI ? 1 0 3 l (DECHDPXM disabled  
 /full-duplex enabled), 5-56  
 CSI ? 1 0 4 h (secondary keyboard mapping  
 - DECESKM), 5-53  
 CSI ? 1 0 4 l (primary keyboard mapping -  
 DECESKM), 5-53  
 CSI ? 1 0 6 h (DECOSCNM set), 5-77  
 CSI ? 1 0 6 l (DECOSCNM reset), 5-77  
 CSI ? 10 n (DSR—printer ready), 5-178  
 CSI ? 111 h (enable (set) framed windows  
 mode - default), 5-56  
 CSI ? 111 l (disable (reset) framed windows  
 mode), 5-56  
 CSI ? 112 h (enable (set) review previous  
 lines mode), 5-97  
 CSI ? 112 l (disable (reset) review previous  
 lines mode - default), 5-97  
 CSI ? 113 h (enable (set) host wake-up),  
 5-59  
 CSI ? 113 l (disable (reset) host wake-up  
 mode), 5-59  
 CSI ? 11 n (DSR—printer assigned to other  
 session), 5-178  
 CSI ? 11 n (DSR—printer not ready),  
 5-178  
 CSI ? 13 n (DSR—no printer), 5-178  
 CSI ? 15 n (DSR—printer port request),  
 5-178  
 CSI ? 1 8 h (DECPFF set), 5-83  
 CSI ? 1 8 l (DECPFF reset), 5-83  
 CSI ? 18 n (DSR—printer busy), 5-178  
 CSI ? 1 9 h (DECPEX set), 5-83  
 CSI ? 1 9 l (DECPEX reset), 5-83  
 CSI ? 1 h (DECCKM set), 5-32  
 CSI ? 1 l (DECCKM reset), 5-32  
 CSI ? 20 n (DSR—UDKs unlocked), 5-179  
 CSI ? 21 n (DSR—UDKs unlocked), 5-179  
 CSI ? 2 5 h (DECTCEM set), 5-157  
 CSI ? 2 5 l (DECTCEM reset), 5-157  
 CSI ? 25 n (DSR—UDK request), 5-179  
 CSI ? 26 n (DSR— keyboard status  
 request), 5-175  
 CSI ? 27 ; Pn ; Pst ; Ptyp n (DSR—keyboard  
 status reply), 5-175  
 CSI ? 2 l (DECANM), 5-18  
 CSI ? 3 4 h (DECPCCM set), 5-80  
 CSI ? 3 4 h (DECRLM set), 5-93  
 CSI ? 3 4 l (DECPCCM reset), 5-80  
 CSI ? 3 4 l (DECRLM reset), 5-93  
 CSI ? 3 5 h (DECHEBM reset), 5-58  
 CSI ? 3 5 l (DECHEBM set), 5-58

## ANSI control sequences

## by Control Function (cont'd)

CSI ? 3 6 h (DECHEM set), 5-57  
 CSI ? 3 6 l (DECHEM reset), 5-57  
 CSI ? 3 h (DECCOLM set), 5-34  
 CSI ? 3 l (DECCOLM reset), 5-34  
 CSI ? 4 2 h (DECNRCM set), 5-75  
 CSI ? 4 2 l (DECNRCM reset), 5-75  
 CSI ? 4 h (DECSCLM set), 5-123  
 CSI ? 4 l (DECSCLM reset), 5-123  
 CSI ? 5 7 h (DECNAKB set), 5-74  
 CSI ? 5 7 l (DECNAKB reset), 5-74  
 CSI ? 58 h (DECIPEM - enter IBM  
 ProPrinter emulation mode), 5-62  
 CSI ? 58 l (DECIPEM - exit IBM ProPrinter  
 emulation mode), 5-62  
 CSI ? 5 h (DECSCNM set), 5-123  
 CSI ? 5 l (DECSCNM reset), 5-123  
 CSI ? 5 W (DECST8C), 5-149  
 CSI ? 6 1 h (DECVCCM set), 5-170  
 CSI ? 6 1 l (DECVCCM reset), 5-170  
 CSI ? 62 n (DSR—macro space request),  
 5-176  
 CSI ? 63; Pid n (DSR—memory checksum  
 request), 5-177  
 CSI ? 65 ; Psl ; ... ; Psn c (DA1 response),  
 5-9  
 CSI ? 6 6 h (DECNKM set), 5-75  
 CSI ? 6 6 l (DECNKM reset), 5-75  
 CSI ? 6 7 h (DECBKM set), 5-26  
 CSI ? 6 7 l (DECBKM reset), 5-26  
 CSI ? 6 8 h (DECKBUM set), 5-65  
 CSI ? 6 8 l (DECKBUM reset), 5-65  
 CSI ? 6 9 h (DECLRMM set), 5-72  
 CSI ? 6 9 l (DECLRMM reset), 5-72  
 CSI ? 6 h (DECOM set), 5-77  
 CSI ? 6 l (DECOM reset), 5-77  
 CSI ? 6 n (CPR request), 5-174  
 CSI ? 70 n (DSR—data integrity report),  
 5-174  
 CSI ? 71 n (DSR—data integrity report),  
 5-174  
 CSI ? 7 3 h (DECXRLM set), 5-171  
 CSI ? 7 3 l (DECXRLM reset), 5-171  
 CSI ? 73 n (DSR—data integrity report),  
 5-174  
 CSI ? 75 n (DSR—data integrity request),  
 5-174  
 CSI ? 7 h (DECAWM set), 5-25  
 CSI ? 7 l (DECAWM reset), 5-25  
 CSI ? 8 h (DECARM set), 5-19  
 CSI ? 8 l (DECARM reset), 5-19  
 CSI ? 9 5 h (DECNCNM set), 5-74  
 CSI ? 9 5 l (DECNCNM reset), 5-74  
 CSI ? 9 6 h (DECRLCM disabled), 5-92  
 CSI ? 9 6 h (DECRLCM enabled), 5-92  
 CSI ? 97 h (CRT saver enabled), 5-37  
 CSI ? 97 l (CRT saver disabled), 5-37



## ANSI control sequences

## by Control Function (cont'd)

CSI ? 98 h (enable DECARSM), 5-21  
 CSI ? 98 l (disable DECARSM), 5-21  
 CSI ? 99 h (DECMCM set), 5-73  
 CSI ? 99 l (DECMCM reset), 5-73  
 CSI ? Pd \$ p (DECRCQM), 5-108  
 CSI ? Pd ; ... ; Pd l (RM), 5-195  
 CSI ? Pd ; . . . ; Pd h (SM), 5-206  
 CSI ? Ps 114 h (enable (set) alternate text color underline mode ), 5-23  
 CSI ? Ps 114 l (disable (reset) alternate text color underline mode), 5-23  
 CSI ? Ps 115 h (enable (set) alternate text color blink mode), 5-23  
 CSI ? Ps 115 l (disable (reset) alternate text color blink mode), 5-23  
 CSI ? Ps 116 h (enable (set) bold and blink style mode ), 5-25  
 CSI ? Ps 116 l (disable (reset) bold and blink style mode), 5-25  
 CSI ? Ps 117 h (enable (set) erase color mode ), 5-48  
 CSI ? Ps 117 l (disable (reset) erase color mode - default), 5-48  
 CSI ? Ps1 ; Ps2 \$ y (DECRCQM), 5-98  
 CSI ? Ps1 ; Ps2 r (DECPCTERM), 5-81  
 CSI ? Ps i (MC), 5-188  
 CSI ? Ps J (DECSED), 5-129  
 CSI ? Ps K (DECSEL), 5-131  
 CSI c or CSI 0 c (DA1), 5-9  
 CSI Pa \$ p (DECRCQM—ANSI mode), 5-108  
 CSI Pch ; Pt ; Pl ; Pb ; Pr \$ x (DECFCRA), 5-55  
 CSI Pfl ; Pc1 ; Pf2 ; Pc2 ; ... + q (DECCLF), 5-51  
 CSI Ph ; Pw ; Pml ; Pmt ; Pmp ; " w (DECRPDE), 5-95  
 CSI Pid \* i (DECINVM), 5-61  
 CSI Pid ; Pp ; Pt ; Pl ; Pb ; Pr ... \* y (DECRCRA), 5-105  
 CSI Pk1 ; Pfl . . . Pkn ; Pfn \* } (DECLFKC), 5-70  
 CSI Pl ; Pc ; Pp R (DECXCPR report), 5-174  
 CSI Pl ; Pc f and CSI f (HVP), 5-183  
 CSI Pl ; Pc H (CUP), 5-8  
 CSI Pl ; Pc R (CPR report), 5-173  
 CSI Pl ; Pc R (CPR response), 5-5  
 CSI Pl ; Pr s (DECCLRM), 5-137  
 CSI Pm1 ; Pfl ; Pmn ; Pfn ; + r, 5-139  
 CSI Pn ' } (DECIC), 5-59  
 CSI Pn ' ~ (DECDC), 5-37  
 CSI Pn \* p (DECSPPCS), 5-143  
 CSI Pn \* { (DECMSR), 5-73  
 CSI Pn \* { (DSR—macro space report), 5-176

## ANSI control sequences

## by Control Function (cont'd)

CSI Pn \* | (DECSNLS), 5-140  
 CSI Pn1 ; Pn2 ; Pn3 ; Pn4, x (session page memory allocation), 5-141  
 CSI Pn @ (ICH), 5-183  
 CSI Pn A (CUU), 5-8  
 CSI Pn a (HPR), 5-181  
 CSI Pn B (CUD), 5-7  
 CSI Pn C (CUF), 5-7  
 CSI Pn D (CUB), 5-7  
 CSI Pn d (VPA), 5-208  
 CSI Pn E (CNL), 5-4  
 CSI Pn e (VPR), 5-208  
 CSI Pn F (CPL), 5-5  
 CSI Pn G (CHA), 5-3  
 CSI Pn I (CHT), 5-4  
 CSI Pn L (IL), 5-184  
 CSI Pn M (DL), 5-172  
 CSI Pn P (DCH), 5-13  
 CSI Pn S (SU), 5-207  
 CSI Pn sp P (PPA), 5-192  
 CSI Pn sp Q (PPR), 5-193  
 CSI Pn sp R (PPB), 5-193  
 CSI Pn t (DECCLPP), 5-136  
 CSI Pn T (SD), 5-200  
 CSI Pn U (NP), 5-191  
 CSI Pn V (PP), 5-192  
 CSI Pn X (ECH), 5-179  
 CSI Pn Z (CBT), 5-3  
 CSI Pn ' (HPA), 5-181  
 CSI Ps " q (DECSCA), 5-121  
 CSI Ps \$ - (DECSSDT), 5-147  
 CSI Ps \$ q (DECSDDT), 5-128  
 CSI Ps \$ s (DECSPRTT), 5-144  
 CSI Ps \$ u (DECRCQTSR), 5-113  
 CSI Ps \$ w (DECRCQPSR), 5-111  
 CSI Ps \$ } (DECASAD), 5-120  
 CSI Ps ) p (DECSDPT), 5-129  
 CSI Ps ) { (select color look-up table), 5-151  
 CSI Ps \* x (DECSACE), 5-119  
 CSI Ps + z (DECPCRA), 5-87  
 CSI Ps , u (DECRCQT), 5-107  
 CSI Ps , y (update session), 5-169  
 CSI Ps , z (DECCLDA), 5-47  
 CSI Ps , { (select zero symbol), 5-155  
 CSI Ps1 , q (DECTID), 5-158  
 CSI Ps1 ; Ps2 " u (DECSTRL), 5-152  
 CSI Ps1 ; Ps2 \$ y (DECRCQM), 5-98  
 CSI Ps1 ; Ps2 \* r (DECSCS), 5-126  
 CSI Ps1 ; Ps2 \* u (DECSCP), 5-124  
 CSI Ps1 ; Ps2 + y (DECPKFRM), 5-88  
 CSI Ps1 ; Ps2 , p (DECLTOD), 5-72  
 CSI Ps1 ; Ps2 , v (DECRCPT), 5-96  
 CSI Ps1 ; Ps2 , w (DECRCQKD), 5-106  
 CSI Ps1 ; Ps2 ; Ps3, | (assign color), 5-16

## ANSI control sequences

## by Control Function (cont'd)

CSI *Ps1*; *Ps2*; *Ps3*, } (alternate text color), 5-22  
 CSI *Ps1* ; *Ps2* ; *Ps3* ; *Ps4* \* s (DECSFC), 5-133  
 CSI *Ps1* ; *Ps2* ; *Ps3* ; *Ps4* + w (DECSPP), 5-142  
 CSI *Ps1* ; *Ps2* SP } (DECKBD), 5-63  
 CSI *Ps* ; *Ps* ; *Ps* m (SGR), 5-201  
 CSI *Ps* g (TBC), 5-207  
 CSI *Ps* i (MC - ANSI standard), 5-188  
 CSI *Ps* J (ED), 5-180  
 CSI *Ps* K (EL), 5-180  
 CSI *Ps* p (DECSSL), 5-148  
 CSI *Ps* - p (select auto repeat rate), 5-20  
 CSI *Ps* - q (CRT saver timing), 5-36  
 CSI *Ps* - r (energy saver timing), 5-130  
 CSI *Ps* SP p (DECSSCLS), 5-146  
 CSI *Ps* SP q (DECSCUSR), 5-127  
 CSI *Ps* SP r (DECSKCV), 5-135  
 CSI *Ps* SP t (DECSWBV), 5-154  
 CSI *Ps* SP u (DECSMBV), 5-138  
 CSI *Ps* SP v (DECSLCK), 5-135  
 CSI *Ps* SP ~ (DECTME), 5-159  
 CSI *Pt* ; *Pb* r (DECSTBM), 5-149  
 CSI *Pt* ; *Pl* ; *Pb* ; *Pr* \$ z (DECERA), 5-52  
 CSI *Pt* ; *Pl* ; *Pb* ; *Pr* \$ { (DECSERA), 5-132  
 CSI *Pt* ; *Pl* ; *Pb* ; *Pr* ; *Ps1* ; ... *Psn* \$ r (DECCARA), 5-28  
 CSI *Pt* ; *Pl* ; *Pb* ; *Pr* ; *Ps1* ; ... *Psn* \$ t (DECRARA), 5-90  
 CSI *Pts* ; *Pls* ; *Pbs* ; *Prs* ; *Pps* ; *Ptd* ; *Pld* ; *Ppd* \$ v (DECCRA), 5-35  
 CSI *Pvolume*; *Pduration*; *Pnote*, ~ (play sound), 5-89  
 CSI s (SCOSC), 6-9  
 CSI u (SCORC), 6-9  
 DCS ! { *D...D* ST (DECSTUI), 5-153  
 DCS ! | *D...D* ST (DA3 response), 5-12  
 DCS ! | *D...D* ST (DECRPTUI), 5-104  
 DCS " x *D...D* ST (DECPFK), 5-84  
 DCS " y *D...D* ST (DECPAK), 5-78  
 DCS " z *D...D* ST (DECCKD), 5-31  
 DCS " } *D...D* ST (DECRPFK), 5-96  
 DCS " ~ *D...D* ST (DECRPAK), 5-94  
 DCS \$ q *D...D* ST (DECRQSS request), 5-112  
 DCS 1 \$ s *D...D* ST (DECTSR), 5-160  
 DCS 1 \$ u *D...D* ST (DECCIR), 5-30  
 DCS 2 \$ p *D...D* ST (DECRSTS), 5-118  
 DCS 2 \$ p *D...D* ST (DECTSR), 5-161  
 DCS 2 \$ u *D...D* ST (DECTABS), 5-157  
 DCS *Dscs* ! u *Pd* ST (DECAUPSS), 5-24  
 DCS *Pfn* ; *Pcn*; *Pe*; *Pcmw*; *Pss*; *Pu*; *Pcmh*; *Pcss* { <*Dscs*><*sixel-font-pattern*> ST (DECILD), 5-39

## ANSI control sequences

## by Control Function (cont'd)

DCS *Pid* ! ~ *D...D* ST (DSR —memory checksum report), 5-177  
 DCS *Pid* ; *Pdt* ; *Pen* ! z *D...D* ST (DECDMAC), 5-45  
 DCS *Ps* \$ p *D...D* ST (DECRSTS), 5-117  
 DCS *Ps* \$ r *D...D* ST (DECRPSS), 5-102  
 DCS *Ps* \$ t *D...D* ST (DECRSPS), 5-116  
 DCS *Ps1* ; *Ps2* ; *Ps3* | *D...D* ST (DECUDK), 5-163  
 DCS *Ps* r *D...D* ST (DECLBAN), 5-69  
 DCS *Ps* v *D...D* ST (DECLANS), 5-68  
 ESC # 3 (top), ESC # 4 (bottom) (DECDHL), 5-38  
 ESC # 5 (DECSWL), 5-154  
 ESC # 6 (DECDWL), 5-48  
 ESC # 8 (DECALN), 5-17  
 ESC ( 1 (DDD3), 5-14  
 ESC ) 1 (DDD1), 5-14  
 ESC ) B (DDD2), 5-14  
 ESC 6 (DECBI), 5-26  
 ESC 7 (DECSC), 5-120  
 ESC 8 (DECRC), 5-92  
 ESC 9 (DECFI), 5-54  
 ESC < (exit DECANM), 5-19  
 ESC = (DECKPAM), 5-66  
 ESC > (DECKPNM), 5-67  
 ESC c (RIS), 5-194  
 ESC I *Dscs* (SCS), 5-197  
 ESC n (locking shift G2), 5-187  
 ESC o (locking shift G3), 5-187  
 ESC Q *Fn String* (SCODFK), 6-7  
 ESC sp F (S7C1T), 5-196  
 ESC sp *final* (ANSI conformance level), 5-1  
 ESC sp G (S8C1T), 5-196  
 ESC Z (DECID), 5-60  
 ESC [ ? 108 h (DECNUMLK set), 5-76  
 ESC [ ? 108 l (DECNUMLK reset), 5-76  
 ESC [ ? 109 h (DECCAPSLK set), 5-28  
 ESC [ ? 109 l (DECCAPSLK reset), 5-28  
 ESC [ ? 110 h (DECKLHIM set), 5-65  
 ESC [ ? 110 l (DECKLHIM reset), 5-65  
 ESC [ *Pr* \* *q* (DECSR), 5-146  
 ESC [ *Pr* + *p* (DECSR), 5-144  
 ESC [ *Ps* *q* (DECLL), 5-71  
 ESC | (locking shift G3 right), 5-187  
 ESC } (locking shift G2 right), 5-187  
 ESC ~ (locking shift G1 right), 5-187  
 HT (HT), 5-182  
 HTS (HTS), 5-182  
 OSC 2 *D...D* ST (set icon name), 5-134  
 OSC 2 *D...D* ST (set window title), 5-156  
 SI (locking shift G0), 5-187  
 SO (locking shift G1), 5-187  
 SS2 (single shift G2), 5-205  
 SS3 (single shift G3), 5-205

## ANSI control sequences (cont'd)

### by Control Sequence

- CSI ? 6 3 ; *Pid n* (DECCKSR request), 5-33
- DCS *Pid ! ~ D . . . D ST* (DECCKSR response), 5-33
- ESC D (IND), 5-184
- ESC E (NEL), 5-191

### by Mnemonic

- CBT (cursor backward tabulation), 5-3
- CHA (cursor horizontal absolute), 5-3
- CHT (cursor horizontal forward tabulation), 5-4
- CNL (cursor next line), 5-4
- CPL (cursor previous line), 5-5
- CPR (cursor position report), 5-5, 5-173
- CRM (show control character mode), 5-6
- CUB (cursor backward), 5-7
- CUD (cursor down), 5-7
- CUF (cursor forward), 5-7
- CUP (cursor position), 5-8
- CUU (cursor up), 5-8
- DA1 (primary device attributes), 5-9
- DA2 (secondary device attributes), 5-11
- DA3 (tertiary device attributes), 5-12
- DCH (delete character), 5-13
- DDD1 (DDD1), 5-14
- DDD2 (DDD2), 5-14
- DDD3 (DDD3), 5-14
- DECAAM (set/reset auto answerback mode), 5-15
- DECAC (Assign color), 5-16
- DECALN (screen alignment pattern), 5-17
- DECANM (ANSI mode), 5-18
- DECANM (exiting ANSI (VT52) mode), 5-19
- DECARM (autorepeat mode), 5-19
- DECARR (Select auto repeat rate), 5-20
- DECARSM (set/reset auto resize mode), 5-21
- DECATC (Alternate text color), 5-22
- DECATCBM (Set/reset alternate text color blink mode), 5-23
- DECATCUM (Set/reset alternate text color underline mode), 5-23
- DECAUPSS (assigning user-preferred supplemental sets), 5-24
- DECAWM (autowrap mode), 5-25
- DECBBSM (bold and blink style mode), 5-25
- DECBI (back index), 5-26
- DECBKM (backarrow key mode), 5-26
- DECCANSM (conceal answerback message mode), 5-27
- DECCAPSLK (caps lock mode), 5-28
- DECCARA (change attributes in rectangular area), 5-28
- DECCIR (cursor information report), 5-30

## ANSI control sequences

### by Mnemonic (cont'd)

- DECCKD (copy key default), 5-31
- DECCKM (cursor keys mode), 5-32
- DECCKSR (memory checksum), 5-33, 5-177
- DECCOLM (column mode), 5-34
- DECCRA (copy rectangular area), 5-35
- DECCRTSM (set/reset CRT save mode), 5-37
- DECCRTST (CRT saver timing), 5-36
- DECCTR (color table request), 5-114
- DECDC (delete column), 5-37
- DECDDL (double-width, double-height line), 5-38
- DECDDL (dynamically redefinable character sets extension), 5-39
- DECDLDA (down-line load allocation), 5-47
- DECDMAC (define macro), 5-45
- DECDWL (double-width, single-height line), 5-48
- DECECM (Erase color mode), 5-48
- DECEKBD (extended keyboard report), 5-49
- DECSELF (enable local functions), 5-51
- DECERA (erase rectangular area), 5-52
- DECES (Enable session), 5-53
- DECESKM (enable secondary keyboard language mode), 5-53
- DECFI (forward index), 5-54
- DECFRA (fill rectangular area), 5-55
- DECFWM (Set/reset framed windows mode), 5-56
- DECHDPXM (set/reset half-duplex mode), 5-56
- DECHEBM (Hebrew/N-A keyboard mapping), 5-58
- DECHEM (Hebrew encoding mode), 5-57
- DECHWUM (Host wake-up mode), 5-59
- DECIC (insert column), 5-59
- DECID (identify device), 5-60
- DECINVM (invoke macro), 5-61
- DECIPEM (enter/return from IBM ProPrinter emulation mode), 5-62
- DECKBD (keyboard language selection), 5-63
- DECKBUM (keyboard usage mode), 5-65
- DECKLHIM (keyboard LEDs host indicator mode), 5-65
- DECKPAM (keypad application mode), 5-66
- DECKPM (key position mode), 5-66
- DECKPNM (keypad numeric mode), 5-67
- DECLANS (load answerback message), 5-68
- DECLBAN (load banner message), 5-69

ANSI control sequences  
by Mnemonic (cont'd)

DECLFKC (local function key control),  
5-70  
DECLL (load LEDs), 5-71  
DECLRMM (vertical split screen mode),  
5-72  
DECLTOD (load time of day), 5-72  
DECMCM (modem control mode), 5-73  
DECMSR (macro space report), 5-73  
DECNAKB (Greek/N-A keyboard mapping),  
5-74  
DECNCSM (no clearing screen on column  
change), 5-74  
DECNKM (numeric keypad mode), 5-75  
DECNRCM (character set mode), 5-75  
DECNULM (null mode), 5-76  
DECNUMLK (Num lock mode), 5-76  
DECOM (origin mode), 5-77  
DECOSCNM (set/reset overscan mode),  
5-77  
DECPAK (program alphanumeric key),  
5-78  
DECPCCM (page cursor-coupling mode),  
5-80  
DECPCTERM (enter/exit PCTerm or  
scancode mode), 5-81  
DECPEX (print extent mode), 5-83  
DECPFF (print form feed mode), 5-83  
DECPFK (program function key), 5-84  
DECPKA (program key action), 5-87  
DECPKFM (program key free memory  
report), 5-88  
DECPS (play sound), 5-89  
DECRARA (reverse attributes in  
rectangular area), 5-90  
DECRC (restore cursor), 5-92  
DECRLCM (right-to-left copy mode), 5-92  
DECRLM (right-to-left mode), 5-93  
DECRPAK (report all modifiers  
/alphanumeric key state), 5-94  
DECRPDE (report displayed extent), 5-95  
DECRPFK (report function key definition),  
5-96  
DECRPKT (report key type), 5-96  
DECRPL (review previous lines mode),  
5-97  
DECRPM (report mode), 5-98  
DECRPSS (report selection or setting),  
5-102  
DECRPTUI (report terminal unit ID),  
5-104  
DECRQCRA (request checksum of  
rectangular area), 5-105  
DECRQDE (request displayed extent),  
5-105  
DECRQKD (request key definition), 5-106  
DECRQKT (request key type), 5-107

ANSI control sequences  
by Mnemonic (cont'd)

DECRQM (request mode), 5-108  
DECRQPKFM (request program key free  
memory), 5-111  
DECRQPSR (request presentation state  
report), 5-111  
DECRQSS (request selection or setting),  
5-112  
DECRQTSR (request terminal state report),  
5-113  
DECRQUPSS (request user-preferred  
supplemental set), 5-115  
DECRSPS (restore presentation state),  
5-116  
DECRSTS (restore terminal state), 5-117  
color table, 5-118  
DECSACE (select attribute change extent),  
5-119  
DECSASD (select active status display),  
5-120  
DECSA (save cursor), 5-120  
DECSCA (select character protection  
attribute), 5-121  
DECSCCL (select conformance level), 5-122  
DECSCLM (scrolling mode), 5-123  
DECSCNM (screen mode: light or dark  
screen), 5-123  
DECSCP (select communication port),  
5-124  
DECSCPP (set columns per page), 5-125  
DECSCS (select communication speed),  
5-126  
DECSCUSR (set cursor style), 5-127  
DECSDDT (select disconnect delay time),  
5-128  
DECSDPT (select Digital printed data  
type), 5-129  
DECSER (selective erase in display),  
5-129  
DECSEL (selective erase in line), 5-131  
DECSERA (selective erase rectangular  
area), 5-132  
DECSEST (Energy saver timing), 5-130  
DECSFC (select flow control), 5-133  
DECSIN (Set icon name), 5-134  
DECSKCV (set key click volume), 5-135  
DECSLCK (set lock key), 5-135  
DECSLPP (set lines per page), 5-136  
DECSLRM (set left and right margins),  
5-137  
DECSMBV (set margin bell volume),  
5-138  
DECSMKR (select modifier key reporting),  
5-139  
DECSNLS (set number of lines per screen),  
5-140

ANSI control sequences  
by Mnemonic (cont'd)

DECSPMA (Session page memory allocation), 5-141  
DECSPP (set port parameters), 5-142  
DECSPPCS (select ProPrinter character set), 5-143  
DECSPRTT (select printer type), 5-144  
DECSR (secure reset), 5-144  
DECSRC (secure reset confirmation), 5-146  
DECSSCLS (set scroll speed), 5-146  
DECSSDT (select status display (line type)), 5-147  
DECSSL (select set-up language), 5-148  
DECST8C (set tab at every 8 columns), 5-149  
DECSTBM (set top and bottom margins), 5-149  
DECSTGLT (Select color look-up table), 5-151  
DECSTR (soft terminal reset), 5-150  
DECSTRL (set transmit rate limit), 5-152  
DECSTUI (set terminal unit ID), 5-153  
DECSWBV (set warning bell volume), 5-154  
DECSWL (single-width, single-height line), 5-154  
DECSWT (Set window title), 5-156  
DECSZS (select zero symbol), 5-155  
DECTABSR (tab stop report), 5-157  
DECTCEM (text cursor enable mode), 5-157  
DECTID (select terminal ID), 5-158  
DECTME (terminal mode emulation), 5-159  
DECTSR (terminal state report), 5-160  
color table report, 5-161  
DECTST (invoke confidence test), 5-162  
DECUDK (user-defined keys), 5-163  
DECUS (Update session), 5-169  
DECVCCM (vertical cursor-coupling mode), 5-170  
DECXCPR (extended cursor position report), 5-170, 5-174  
DECXRLM (transmit rate limiting), 5-171  
DL (delete line), 5-172  
DSR (data integrity report), 5-174  
DSR (device status report, keyboard), 5-175  
DSR (macro space report), 5-176  
DSR (operating status), 5-177  
DSR (printer port), 5-178  
DSR (user-defined keys), 5-179  
ECH (erase character), 5-179  
ED (erase in display), 5-180  
EL (erase in line), 5-180  
HPA (horizontal position absolute), 5-181

ANSI control sequences  
by Mnemonic (cont'd)

HPR (horizontal position relative), 5-181  
HT (horizontal tab), 5-182  
HTS (horizontal tab set), 5-182  
HVP (horizontal and vertical position), 5-183  
ICH (insert character), 5-183  
IL (insert line), 5-184  
IND (index), 5-184  
IRM (insert/replace mode), 5-185  
KAM (keyboard action mode), 5-185  
LNM (line feed/new line mode), 5-186  
Locking shift (LS), 5-187  
LS0 (maps G0 into GL), 5-187  
LS1 (maps G1 into GL), 5-187  
LS1R (maps G1 into GR), 5-187  
LS2 (maps G2 into GL), 5-187  
LS2R (maps G2 into GR), 5-187  
LS3 (maps G3 into GL), 5-187  
LS3R (maps G3 into GR), 5-187  
MC (media copy), 5-188  
NEL (next line), 5-191  
NP (next page), 5-191  
PP (preceding page), 5-192  
PPA (page position absolute), 5-192  
PPB (page position backward), 5-193  
PPR (page position relative), 5-193  
RIS (reset to initial state), 5-194  
RM (reset mode), 5-195  
S7C1T (send 7-bit C1 control character to host), 5-196  
S8C1T (send 8-bit C1 control characters), 5-196  
SCODFK (define function key), 6-7  
SCODFK (save cursor position (SCO)), 6-9  
SCODPCC (display PC character (SCO)), 6-8  
SCORC (SCO) (restore cursor), 6-9  
SCS (select character set), 5-197  
SD (pan up), 5-200  
SGR (select graphic rendition), 5-201  
SM (set mode), 5-206  
SRM (send/receive mode—local echo), 5-204  
SS2 (maps G2 into GL), 5-205  
SS3 (maps G3 into GL), 5-205  
SU (pan down), 5-207  
TBC (tab clear), 5-207  
VPA (vertical line position absolute), 5-208  
VPR (vertical position relative), 5-208  
by Name, 4-16  
Alternate text color (DECATC), 4-18, 5-22  
Alternate text color blink mode (DECATCBM), 4-19, 5-23  
Alternate text color underline mode (DECATCUM), 4-19, 5-23  
ANSI conformance level, 4-36, 5-1

ANSI control sequences  
by Name (cont'd)

ANSI mode (DECANM), 4-36, 5-18  
Assign color (DECAC), 4-18, 5-16  
Assigning user-preferred supplemental sets (DECAUPSS), 4-25, 5-24  
Auto answerback mode (DECAAM), 4-38, 5-15  
Autorepeat mode (DECARM), 4-27, 5-19  
Autorepeat rate (DECARR), 4-27, 5-20  
Auto resize mode (DECARSM), 4-17, 5-21  
Autowrap mode (DECAWM), 4-22, 5-25  
Backarrow key mode (DECBKM), 4-27, 5-26  
Back index (DECBI), 4-24, 5-26  
Bold and blink style mode (DECBBSM), 4-19, 5-25  
Caps lock mode (DECCAPSLK), 4-31, 5-28  
Change attributes in rectangular area (DECCARA), 4-22, 5-28  
Character set mode (DECNRCM), 4-26, 5-75  
Clear tabs (TBC), 4-24  
Color table request/report/restore (DECCTR), 4-19, 4-44, 5-114  
Column mode (DECCOLM), 4-24, 5-34  
Conceal answerback message mode (DECCANSM), 4-38, 5-27  
Copy key default (DECCKD), 4-27, 5-31  
Copy rectangular area (DECCRA), 4-22, 5-35  
CRT save mode (DECCRTSM), 4-34, 5-37  
CRT saver timing (DECCRTST), 4-34, 5-36  
Cursor backward (CUB), 4-22, 5-7  
Cursor backward tabulation (CBT), 4-22, 5-3  
Cursor down (CUD), 4-22, 5-7  
Cursor forward (CUF), 4-22, 5-7  
Cursor horizontal absolute (CHA), 4-22, 5-3  
Cursor horizontal forward tabulation (CHT), 4-22, 5-4  
Cursor information report (DECCIR), 4-22, 5-30  
Cursor keys mode (DECCKM), 4-28, 5-32  
Cursor next line (CNL), 4-22, 5-4  
Cursor position (CUP), 4-23, 5-8  
Cursor position report (CPR), 4-23, 5-5, 5-173  
Cursor previous line (CPL), 4-23, 5-5  
Cursor up (CUU), 4-23, 5-8  
Data integrity report (DSR), 4-42, 5-174  
DDD1 (DDD1), 4-43, 5-14  
DDD2 (DDD2), 4-43, 5-14  
DDD3 (DDD3), 4-43, 5-14

ANSI control sequences  
by Name (cont'd)

Define function key (SCO) (SCODFK), 4-28, 6-7  
Define macro (DECDMAC), 4-42, 5-45  
Delete character (DCH), 4-21, 5-13  
Delete column (DECDC), 4-21, 5-37  
Delete line (DL), 4-21, 5-172  
Device attributes  
  primary (DA1), 4-35, 5-9  
  secondary (DA2), 4-35, 5-11  
  tertiary (DA3), 4-35, 5-12  
Device status report  
  cursor position (CPR), 5-173  
  data integrity (DSR), 4-42, 5-174  
  extended cursor position (DECXCPR), 4-23, 5-174  
  keyboard (DSR), 4-28, 5-175  
  macro (DSR), 4-42, 5-176  
  memory checksum (DSR), 4-42, 5-177  
Device status report (DSR), 4-42, 5-173  
Double-width, double-height line (DECDHL), 4-20, 5-38  
Double-width, single-height line (DECDWL), 4-20, 5-48  
Down-line load (DECDDL), 4-25, 5-39  
Down-line load allocation (DECDDLDA), 4-25, 5-47  
Dynamically redefinable character sets extension (DECDDL), 4-25, 5-39  
Enable local functions (DECELFL), 4-28, 5-51  
Enable secondary keyboard language mode (DECESKM), 4-28, 5-53  
Enable session (DECES), 4-16, 5-53  
Energy saver timing (DECSEST), 4-34, 5-130  
Enter/exit IBM ProPrinter emulation mode (DECIPEM), 4-34, 5-62  
Enter/exit PCTerm mode from VT mode (DECPCTERM), 4-36, 5-81  
Erase character (ECH), 4-21, 5-179  
Erase color mode (DECECM), 4-19, 5-48  
Erase in display (ED), 4-21, 5-180  
Erase in line (EL), 4-21, 5-180  
Erase rectangular area (DECERA), 4-22, 5-52  
Exiting ANSI (VT52) mode (DECANM), 4-36, 5-19  
Extended cursor position report (DECXCPR), 4-23, 5-170, 5-174  
Extended keyboard report (DECEKBD), 4-28, 5-49  
Fill rectangular area (DECFFRA), 4-22, 5-55  
Forward index (DECFFI), 4-24, 5-54  
Framed windows mode (DECFFWM), 4-17, 5-56

ANSI control sequences  
by Name (cont'd)

Greek/N-A keyboard mapping (DECNAKB), 4-29, 5-74  
Half-duplex mode (DECHDPXM), 4-41, 5-56  
Hebrew encoding mode (DECHEM), 4-28, 5-57  
Hebrew/N-A keyboard mapping (DECHEBM), 4-28, 5-58  
Horizontal and vertical position (HVP), 4-23, 5-183  
Horizontal cursor coupling (DECHCCM), 4-17, 5-100  
Horizontal position absolute (HPA), 4-23, 5-181  
Horizontal position relative (HPR), 4-23, 5-181  
Horizontal tab (HT), 4-23, 5-182  
Horizontal tab set (HTS), 4-24, 5-182  
Host wake-up mode (DECHWUM), 4-34, 5-59  
Identify device (DECID), 4-35, 5-60  
Index (IND), 4-24, 5-184  
Insert character (ICH), 4-21, 5-183  
Insert column (DECIC), 4-21, 5-59  
Insert line (IL), 4-21, 5-184  
Insert/replace mode (IRM), 4-21, 5-185  
Invoke confidence test (DECTST), 4-38, 5-162  
Invoke macro (DECINVM), 4-42, 5-61  
Keyboard action mode (KAM), 4-28, 5-185  
Keyboard language selection (DECKBD), 4-28, 5-63  
Keyboard LEDs host indicator mode (DECKLHIM), 4-31, 5-65  
Keyboard usage mode (DECKBUM), 4-29, 5-65  
Keypad application mode (DECKPAM), 4-28, 5-66  
Keypad numeric mode (DECKPNM), 4-29, 5-67  
Key position mode (DECKPM), 4-29, 5-66  
Left right margin mode (DECLRMM), 4-24, 5-72  
Line feed/new line mode (LNM), 4-23, 5-186  
Load answerback message (DECLANS), 4-38, 5-68  
Load banner message (DECLBAN), 4-38, 5-69  
Load LEDs (DECLL), 4-31, 5-71  
Load time of day (DECLTOD), 4-34, 5-72  
Local echo: send/receive mode (SRM), 4-38, 5-204  
Local function key control (DECLFKC), 4-29, 5-70  
Locking shift G0 (LS0), 4-2, 5-187

ANSI control sequences  
by Name (cont'd)

Locking shift G1 (LS1), 4-2, 4-27, 5-187  
Locking shift G1 right (LS1R), 4-27, 5-187  
Locking shift G2 (LS2), 4-27, 5-187  
Locking shift G2 right (LS2R), 4-27, 5-187  
Locking shift G3 (LS3), 4-27, 5-187  
Locking shift G3 right (LS3R), 4-27, 5-187  
Macro space report (DECMSR), 4-42, 5-73  
Macro space report (DSR), 4-42, 5-176  
Media copy (MC), 4-33, 5-188  
Memory checksum (DECCKSR), 4-42, 5-33, 5-177  
Modem control mode (DECMCM), 4-41, 5-73  
National replacement character set mode (DECNRCM), 4-26, 5-75  
Next line (NEL), 4-23, 5-191  
Next page (NP), 4-25, 5-191  
No clearing screen on column change (DECNCM), 4-24, 5-74  
Null mode (DECNULM), 4-41, 5-76  
Numeric keypad mode (DECNKM), 4-29, 5-75  
Num lock mode (DECNUMLK), 4-31, 5-76  
Operating status (DSR), 4-42, 5-177  
Origin mode (DECOM), 4-24, 5-77  
Overscan mode (DECOSCNM), 4-36, 5-77  
Page cursor-coupling mode (DECPCCM), 4-17, 5-80  
Page position absolute (PPA), 4-25, 5-192  
Page position backward (PPB), 4-25, 5-193  
Page position relative (PPR), 4-25, 5-193  
Pan down (SU), 4-17, 5-207  
Pan up (SD), 4-17, 5-200  
Play sound (DECPS), 4-18, 5-89  
Preceding page (PP), 4-25, 5-192  
Presentation state report (DECPSR), 4-42, 5-116  
Primary device attributes (DA1), 4-35, 5-9  
Printer port (DSR), 4-33, 5-178  
Print extent mode (DECPEX), 4-33, 5-83  
Print form feed mode (DECPFF), 4-33, 5-83  
Program alphanumeric key (DECPAK), 4-30, 5-78  
Program function key (DECPFK), 4-30, 5-84  
Program key action (DECPKA), 4-30, 5-87  
Program key free memory report (DECPKFMR), 4-30, 5-88  
Report displayed extent (DECRPDE), 4-17, 5-95  
Report function key definition (DECRPFK), 4-31, 5-96  
Report key type (DECRPKT), 4-31, 5-96  
Report mode (DECRPM), 4-38, 4-42, 5-98

ANSI control sequences  
by Name (cont'd)

Report modifiers/alphanumeric key state (DECRPAK), 4-31, 5-94  
Report selection or setting (DECRPSS), 4-43, 5-102  
Report terminal unit ID (DECRPTUI), 4-35, 5-104  
Request and report selection or setting (DECRQSS), 4-43, 5-112  
Request checksum of rectangular area (DECRQCRA), 4-42, 5-105  
Request displayed extent (DECRQDE), 4-17, 5-105  
Request key definition (DECRQKD), 4-31, 5-106  
Request key type (DECRQKT), 4-31, 5-107  
Request mode (DECRQM), 4-42, 5-108  
Request presentation state report (DECRQPSR), 4-42, 5-111  
Request program key free memory (DECRQPKFM), 4-30, 5-111  
Request terminal state report (DECRQTSR), 4-43, 5-113  
Request user-preferred supplemental set (DECRQUPSS), 4-26, 5-115  
Reset mode (RM), 4-38, 5-195  
Reset to initial state (RIS), 4-39, 5-194  
Restore cursor (DECRC), 4-23, 5-92  
Restore presentation state (DECRSPS), 4-44, 5-116  
Restore saved cursor (SCO) (SCORC), 4-23, 6-9  
Restore terminal state (DECRSTS), 4-44, 5-117  
color table, 5-118  
Reverse attributes in rectangular area (DECRARA), 4-22, 5-90  
Reverse index (RI), 4-24  
Review previous lines (DECRPL), 4-17, 5-97  
Right-to-left copy mode (DECRLCM), 4-23, 5-92  
Right-to-left mode (DECRLM), 4-23, 5-93  
Save cursor (DECSC), 4-23, 5-120  
Save cursor position (SCO) (SCOSC), 4-23, 6-9  
Screen alignment pattern (DECALN), 5-17  
Screen mode: light or dark screen (DECSCNM), 4-20, 5-123  
Scrolling mode (DECSCLM), 4-24, 5-123  
Secondary device attributes (DA2), 4-35, 5-11  
Secure reset (DECSR), 4-39, 5-144  
Secure reset confirmation (DECSR), 4-39, 5-146

ANSI control sequences  
by Name (cont'd)

Select active status display (DECSASD), 4-39, 5-120  
Select attribute change extent (DECSACE), 4-22, 5-119  
Select character protection attribute (DECSA), 4-21, 5-121  
Select character set (SCS), 4-25, 5-197  
Select color look-up table (DECSTGLT), 4-19, 5-151  
Select columns per page (DECSCPP), 4-24, 5-125  
Select communication port (DECSCP), 4-39, 5-124  
Select communication speed (DECSCS), 4-39, 5-126  
Select conformance level (DECSCSCL), 4-36, 5-122  
Select Digital printed data type (DECSDP), 4-33, 5-129  
Select disconnect delay time (DECSDDT), 4-41, 5-128  
Select flow control (DECSFC), 4-41, 5-133  
Select graphic rendition (SGR), 4-20, 5-201  
Selective erase in display (DECSSED), 4-21, 5-129  
Selective erase in line (DECSEL), 4-21, 5-131  
Selective erase rectangular area (DECSERA), 4-22, 5-132  
Select modifier key reporting (DECSMKR), 4-31, 5-139  
Select printer type (DECSPRTT), 4-33, 5-144  
Select ProPrinter character set (DECSPPCS), 4-33, 5-143  
Select set-up language (DECSSL), 4-34, 5-148  
Select status display (line) type (DECSSDT), 4-39, 5-147  
Select terminal ID (DECTID), 4-35, 5-158  
Select zero symbol (DECSZS), 4-26, 5-155  
Send 7-bit C1 control character to host (S7C1T), 4-27, 5-196  
Send 8-bit C1 control characters (S8C1T), 5-196  
Send 8-bit C1 control character to host (S8C1T), 4-27  
Session page memory allocation (DECSPMA), 4-16, 5-141  
Set cursor style (DECSCUSR), 4-23, 5-127  
Set icon name (DECSIN), 4-17, 5-134  
Set key click volume (DECSKCV), 4-31, 5-135  
Set left and right margins (DECSLRM), 4-24, 5-137



ANSI control sequences  
by Name (cont'd)

- Set lines per page (DEC SLPP), 4-24, 5-136
- Set lock key style (DEC SLCK), 4-31, 5-135
- Set margin bell volume (DEC SMBV), 4-18, 5-138
- Set mode (SM), 4-36, 5-206
- Set number of lines per screen (DEC SNLS), 4-17, 5-140
- Set port parameters (DEC SPP), 4-40, 5-142
- Set scroll speed (DEC SSCLS), 4-24, 5-146
- Set tab at every 8 columns (DEC ST8C), 4-24, 5-149
- Set terminal unit ID (DEC STUI), 4-35, 5-153
- Set top and bottom margins (DEC STBM), 4-24, 5-149
- Set transmit rate limit (DEC STRL), 4-40, 5-152
- Set warning bell volume (DEC SWBV), 4-18, 5-154
- Set window title (DEC SWT), 4-17, 5-156
- Show control character mode (CRM), 4-27, 4-36, 5-6
- Single shift (SS), 4-27, 5-205
- Single shift 2 (SS2), 4-27, 5-205
- Single shift 3 (SS3), 4-27, 5-205
- Single-width line (DEC SWL), 4-20, 5-154
- Soft terminal reset (DEC STR), 4-39, 5-150
- Switch between ASCII character and Scancode mode (DEC PCTERM), 4-36, 5-81
- Tab clear (TBC), 4-24, 5-207
- Tab stop report (DEC TABSR), 4-44, 5-157
- Terminal identification (DEC ID), 4-35, 5-60
- Terminal mode emulation (DEC TME), 4-36, 5-159
- Terminal state report
  - color table report (DEC CTR), 4-44, 5-114
- Terminal state report (DEC TSR), 4-44, 5-160
  - color table report, 5-161
- Tertiary device attributes (DA3), 4-35, 5-12
- Text cursor enable mode (DEC TCEM), 4-23, 5-157
- Transmit rate limiting (DEC XRLM), 4-40, 5-171
- Update session (DEC US), 4-16, 5-169
- User-defined keys (DEC UDK), 4-32, 5-163
- User-defined keys (DSR), 4-32, 5-179

ANSI control sequences  
by Name (cont'd)

- User-preferred supplemental set (DEC RQUPSS), 4-26, 5-115
- Vertical cursor-coupling mode (DEC VCCM), 4-17, 5-170
- Vertical line position absolute (VPA), 4-23, 5-208
- Vertical position relative (VPR), 4-23, 5-208
- VT52 mode, 4-45
- Answerback
  - concealed, 2-51
  - enabling, 2-50
  - message, 2-50
- Application
  - cursor keys, 2-43
  - keypad mode, 2-44
- Arrow keys, 5-32
- ASCII
  - boarder display, 12-10
  - character sets
    - defining, 13-1
    - emulation mode, 3-7
    - loading, 13-3
  - code table
    - 7-bit, 4-15
    - 8-bit, 4-15
  - color mode, 2-32
  - communications
    - answerback message, 12-1
    - monitor mode, 12-1
    - serial port, 12-2
    - serial port control, 12-1
  - control functions, 11-1
  - controlling cursor, 12-21
  - defined, Glossary-1
  - display attribute
    - control functions, 12-17
  - editing control functions, 12-25
  - emulation
    - features, 2-35
    - menu, 2-35
  - emulations, 11-1
  - enhanced mode, 11-2
  - graphic characters, 12-36
  - keyboard
    - processing, 12-5
    - program key direction, 12-8
    - redefinable keys, 12-9
    - selections, 11-3
  - local functions
    - ASCII code mode, C-10
    - PC scancode mode, C-11
  - overscan on/off, 12-10
  - page edit, 12-27
  - page memory, 12-12
  - PC keycodes

## ASCII

### PC keycodes (cont'd)

- ADDS mode, C-4
- TVI mode, C-1
- WYSE mode, C-1
- printer selection, 11-3
- printing data, 12-34
- print/send operations, 12-33
- protecting data, 11-3, 12-20
- rectangular area operations, 12-28
- screen processing, 12-10
  - split screen, 12-12
  - windows, 12-13
- selecting character sets, 13-3
- sending data, 12-32, 12-34
- status lines, 12-13
- swap/copy/move, 12-31
- terminal management, 12-4
- VT keycodes
  - ADDS mode, C-8
  - TVI mode, C-6
  - WYSE mode, C-6

### ASCII control functions

- color selection, 12-16
- ESC ! 1 (lock cursor line on), 12-22
- ESC ! 2 (lock cursor line off), 12-22
- ESC ! *attr* (clear page), 12-19
- ESC " (lock keyboard), 12-5
- ESC # (lock keyboard), 12-5
- Esc \$ (graphics mode on), 12-36
- Esc % (graphics mode off), 12-36
- ESC & (protect mode on), 12-20
- ESC ( (write-protect off), 12-20
- Esc ` (control print mode on), 12-35
- ESC ^ (protect mode off), 12-20
- ESC / (read window, page, cursor), 12-24
- ESC ) (write-protect on), 12-20
- Esc \* (clear page to NULs), 12-27
- Esc + (clear page to spaces), 12-27
- Esc , (clear page to protected spaces), 12-27
- Esc . *char* (clear page to character), 12-27
- ESC . *cursor* (set cursor), 12-21
- Esc 0 (clear all tabs), 12-26
- ESC 0 (EOL wrap off), 12-21
- ESC 0 *spca* (write-protect), 12-18
- Esc 1 (set tab stop), 12-26
- Esc 2 (clear tab stop), 12-26
- Esc 3 (clear all tabs), 12-26
- Esc 3 (control print mode on), 12-35
- Esc 4 (control print mode off), 12-35
- Esc 4 (send cursor line), 12-34
- ESC 5 (lock keyboard), 12-5
- Esc 5 (send page), 12-34
- ESC 6 (lock keyboard), 12-5
- Esc 6 (send cursor line), 12-34
- Esc 7 (send page), 12-34
- Esc 8 (mark block beginning), 12-34
- ESC 8 (received CRLF), 12-22

## ASCII control functions (cont'd)

- ESC ` 8 (screen display off), 12-10
- ESC 8 (smooth scroll on, TVI), 12-11
- Esc 9 (mark block ending), 12-34
- ESC 9 (received CR), 12-22
- ESC ` 9 (screen display on), 12-10
- ESC 9 (smooth scroll off, TVI), 12-11
- ESC ` : (80-column display), 12-11
- Esc : (clear page to NULs), 12-27
- ESC ` ; (132-column display), 12-11
- Esc ; (clear page to spaces), 12-27
- ESC < (keyclick off), 12-7
- ESC > (keyclick on), 12-7
- ESC ? (read cursor address), 12-24
- Esc @ (autoprint on), 12-35
- ESC @ (num lock off), 12-6
- Esc @ (print formatted page), 12-35
- Esc A (autoprint off), 12-35
- Esc a (control print mode off), 12-35
- ESC ` a (editing status line on), 12-13
- ESC a *line R col C* (address cursor), 12-24
- ESC \ *area attr* (assign display attribute), 12-18
- ESC B (block mode on), 12-3
- ESC b (read cursor address), 12-24
- ESC b (reverse background), 12-10
- ESC ` b (standard status line on), 12-13
- ESC c (ASCII key codes), 12-6
- ESC C (block mode off), 12-3
- ESC c (set local mode), 12-3
- ESC ` c (status line off), 12-13
- ESC c 0 (serial port parameters), 12-2
- ESC c 1 (set comm2 parameters), 12-2
- ESC c 2 (set comm1 receive), 12-2
- ESC c 3 (set comm2 receive), 12-3
- ESC c 4 (set comm1 transmit), 12-3
- ESC c 5 (set comm2 transmit), 12-3
- ESC c 6 *Max* (transmit speed), 12-3
- ESC c 7 *Max* (function keys), 12-3
- ESC c 8 *hr min* (set time of day), 12-5
- ESC c ; *answer Ctrl/Y* (answerback message), 12-1
- ESC c < (send answerback), 12-1
- ESC c = (conceal answerback), 12-1
- Esc c ? *bank* (clear font bank), 13-4
- Esc c @ *bank charset* (load font bank), 13-3
- Esc c A *bank Pp bb...bb Ctrl-Y* (define & load character), 13-5
- Esc c B *bank* (define primary char. set), 13-3
- Esc c C *bank* (define secondary char. set), 13-3
- Esc c D (select primary char. set), 13-3
- Esc c E (select secondary char. set), 13-3
- Esc c F *line col char* (fill rectangle), 12-30
- Esc c F *line ~ col char* (fill rectangle), 12-30
- Esc c G *line col* (draw rectangle), 12-30
- Esc c G *line ~ col* (draw rectangle), 12-30
- Esc c H *line col char* (fill rectangle), 12-30
- Esc c H *line ~ col char* (fill rectangle), 12-30

## ASCII control functions (cont'd)

Esc c I *char* (clear column to character), 12-28  
 Esc c J (delete cursor column), 12-27  
 Esc c K (clear position to NUL), 12-28  
 Esc c L (clear to EOL with NULs), 12-28  
 Esc c M (insert column of NULs), 12-27  
 Esc c N *width height* (draw rectangle), 12-30  
 Esc c O (clear to EOL with spaces), 12-28  
 Esc c P (clear foreground to spaces), 12-28  
 Esc c Q (clear foreground to NULs), 12-27  
 Esc c R (clear foreground to spaces), 12-28  
 Esc c S (clear foreground to NULs), 12-28  
 ESC c T (set default all modes), 12-5  
 ESC c \ *tone* (select bell), 12-7  
 ESC c U (clear all key definitions), 12-8  
 ESC ` *cursor* (set cursor), 12-21  
 ESC c V (save Set-Up modes), 12-4  
 ESC c W (save Set-Up modes), 12-4  
 ESC c X (power on reset), 12-5  
 ESC c ] *Intensity* (border display), 12-10  
 Esc c ^ (swap, copy, move data), 12-30  
 Esc d ! (aux mode on), 12-35  
 Esc d # (control print mode on), 12-35  
 Esc d \$ (bidirectional mode off), 12-35  
 Esc d % (bidirectional mode on), 12-35  
 Esc d & (begin print), 12-34  
 ESC d ( (cursor drag off), 12-13  
 Esc d ` (begin print), 12-34  
 ESC d / (EOL wrap on), 12-21  
 ESC d (normal background), 12-10  
 ESC D (request attribute under cursor), 12-19  
 ESC d ) (cursor drag on), 12-13  
 ESC d \* (autopage off), 12-21  
 ESC d + (autopage on), 12-21  
 ESC d . (EOL wrap off), 12-21  
 ESC D F (set full-duplex), 12-3  
 ESC D H (set half-duplex), 12-3  
 ESC d *line R col C* (address cursor), 12-24  
 Esc d Sp (aux mode off), 12-35  
 ESC d { (blank attribute), 12-16  
 ESC d | (reverse on), 12-16  
 Esc e ! (answerback on), 12-1  
 Esc e " (page edit off), 12-27  
 Esc e # (page edit on), 12-27  
 ESC e \$ (keyclick off), 12-7  
 ESC e % (keyclick on), 12-7  
 ESC e & (caps lock on), 12-6  
 ESC e ( (set 24 data lines), 12-11  
 ESC e ` (caps lock off), 12-6  
 Esc E (insert line of spaces), 12-27  
 ESC e - (key repeat on), 12-5  
 ESC e (user line off), 12-17  
 ESC e / (width-change-clear on), 12-12  
 ESC e ) (set 25 data lines), 12-11  
 ESC e \* (set 42 data lines), 12-11  
 ESC e + (set 43 data lines), 12-11  
 ESC e , (key repeat off), 12-5  
 ESC e . (width-change-clear off), 12-12

## ASCII control functions (cont'd)

ESC e 0 (char attribute mode off), 12-18  
 ESC e 1 (char attribute mode on), 12-18  
 ESC e 2 (page attribute mode on), 12-18  
 ESC e 3 (line attribute mode on), 12-18  
 ESC e 4 (received CR), 12-22  
 ESC e 5 (received CRLF), 12-22  
 ESC e 6 (ACK mode off), 12-1  
 ESC e 7 (ACK mode on), 12-1  
 ESC e 8 (assign serial ports), 12-1  
 ESC e 9 (s1=comm2), 12-1  
 ESC e > (character cell size), 12-11  
 ESC e ? (character cell size), 12-11  
 ESC e A (num lock on), 12-6  
 ESC e B (scroll lock off), 12-6  
 ESC e C (scroll lock on), 12-6  
 ESC e D (DEL mode off), 12-22  
 ESC e E (DEL mode on), 12-22  
 ESC e H (ASCII key codes), 12-6  
 ESC e I (PC scan codes), 12-6  
 ESC e L (bell off), 12-7  
 ESC e M (bell on), 12-7  
 Esc e N (font loading off), 13-4  
 Esc e O (font loading on), 13-4  
 ESC e P (screen saver off), 12-10  
 ESC e Q (screen saver on), 12-10  
 ESC e R (ignore null characters), 12-1  
 ESC e S (accept null characters), 12-2  
 ESC e Sp (answerback off), 12-1  
 ESC e T (lock key), 12-6  
 ESC e U (lock key), 12-6  
 ESC e V (lock key), 12-6  
 ESC e | (intensity off), 12-16  
 ESC e } (intensity on), 12-16  
 ESC f (clear label line), 12-15  
 ESC F (fill page H's), 12-12  
 ESC F CR (clear computer message), 12-14  
 ESC f CR (clear label line), 12-15  
 ESC F *message* CR (display computer message), 12-14  
 ESC f *text* CR (display computer message), 12-14  
 ESC g (user line on), 12-17  
 ESC G *Attr* (assign character attribute), 12-17  
 ESC G *LineAttr* (assign line attribute), 12-19  
 ESC ` H (lock cursor line on), 12-22  
 ESC H (PC scan codes), 12-6  
 ESC h (user line off), 12-17  
 Esc H *char* (display character), 12-36  
 Esc H Ctrl-B (graphics mode on), 12-36  
 Esc H Ctrl-C (graphics mode off), 12-36  
 ESC h *page* (address cursor), 12-24  
 Esc I (back tab cursor), 12-26  
 ESC ` I (lock cursor line off), 12-22  
 Esc i (tab cursor), 12-26  
 ESC J (activate other window), 12-13  
 ESC j (cursor up), 12-23  
 ESC J (display page), 12-12

## ASCII control functions (cont'd)

ESC ` J (set margin bell), 12-7  
 ESC K (activate other window), 12-13  
 Esc k (clear foreground to NULs), 12-27  
 Esc K (clear to EOL with spaces), 12-28  
 ESC K (display next page), 12-12  
 Esc k (local edit on), 12-25  
 Esc l (local edit off), 12-25  
 Esc L (print page), 12-35  
 Esc L (print page with time), 12-36  
 Esc L (print unformatted page), 12-35  
 ESC \ *length* (page size), 12-12  
 ESC m (select terminal defaults), 12-5  
 Esc M (send cursor character), 12-34  
 ESC M (send terminal ID), 12-4  
 ESC N (autoscroll off), 12-21  
 ESC n (bell off), 12-7  
 Esc N (page edit on), 12-27  
 ESC n (screen display on), 12-10  
 ESC N (screen display on), 12-10  
 ESC O (autoscroll on), 12-21  
 ESC o (bell on), 12-7  
 Esc O (page edit off), 12-27  
 ESC o (screen display off), 12-10  
 ESC O (screen display off), 12-10  
 ESC o (set margin bell), 12-7  
 Esc P (print page to cursor), 12-35  
 Esc p (print unformatted page), 12-35  
 ESC - *page line col* (address cursor), 12-24  
 Esc p *char* (define terminator), 12-36  
 Esc q (insert mode on), 12-27  
 Esc Q (insert space), 12-27  
 Esc R (delete cursor line), 12-27  
 Esc r (replace mode on), 12-27  
 Esc s (send block), 12-34  
 Esc S (send character in block), 12-34  
 ESC ` *Scroll* (scroll type), 12-11  
 ESC Sp (send terminal ID), 12-4  
 ESC Sp 1 (set time of day), 12-5  
 ESC Sp 2 (set time of day), 12-5  
 ESC Sp J (num lock on), 12-6  
 ESC Sp K (num lock off), 12-6  
 ESC Sp L (caps lock on), 12-6  
 ESC Sp M (caps lock off), 12-6  
 ESC Sp N (scroll lock on), 12-6  
 ESC Sp O (scroll lock off), 12-6  
 Esc t (clear to EOL with NULs), 12-28  
 Esc T (clear to EOL with spaces), 12-28  
 ESC u (monitor mode off), 12-1  
 ESC U (monitor mode on), 12-1  
 ESC v ! (set enhanced mode), 12-4  
 ESC v " (set WYSE 50+ personality), 12-4  
 ESC v # (set TVI 910 personality), 12-4  
 ESC v \$ (set TVI 925 personality), 12-4  
 ESC v % (set ADDS personality), 12-4  
 ESC v ( (set TVI 950 personality), 12-4  
 ESC v (autopage on), 12-21  
 Esc V (clear column to spaces), 12-28

## ASCII control functions (cont'd)

ESC v 4 (set WYSE 160/60 personality), 12-4  
 ESC v 5 (set WYSE 160/60 PCTerm), 12-4  
 ESC v 6 (set VT52 personality), 12-4  
 ESC v ; (set VT100 personality), 12-4  
 ESC v < (set VT520, 7-bit), 12-4  
 ESC v = (set VT520, 8-bit), 12-4  
 ESC v Sp (enhanced mode off), 12-4  
 ESC w (autopage off), 12-21  
 Esc W (delete cursor character), 12-27  
 ESC w ` (read page number), 12-24  
 ESC w ` (read page number), 12-24  
 ESC w , (read page number), 12-24  
 ESC w . (read page number), 12-24  
 ESC w @ *page line col* (address cursor), 12-24  
 ESC w B (display page), 12-12  
 ESC w C (display next page), 12-12  
 ESC w E (roll window up), 12-13  
 ESC w F (roll window down), 12-13  
 ESC - *win/page line col* (address cursor),  
 12-24  
 ESC w *length* (page size), 12-12  
 ESC w *page* (display page), 12-12  
 ESC ` *wpca* (write-protect), 12-18  
 ESC X (monitor mode off), 12-1  
 ESC x 0 (redefine screen), 12-13  
 ESC x 1 *line* (horiz split screen), 12-13  
 ESC x 3 *line* (horiz split screen), 12-13  
 ESC x @ (redefine screen), 12-13  
 ESC x A *line* (split screen), 12-13  
 ESC x C *line* (horiz split screen), 12-13  
 Esc x *dlntr c1 c2* (define delimiters), 12-33  
 ESC x P (lower horiz split), 12-13  
 ESC x R (raise horiz split), 12-13  
 ESC Y (address cursor), 12-24  
 Esc y (clear page to NULs from cursor), 12-27  
 Esc Y (clear page to spaces from cursor), 12-27  
 ESC z ( CR (clear label line), 12-15  
 Esc z (insert mode on), 12-27  
 ESC z ) CR (clear shifted label line), 12-15  
 ESC z ) *text* CR (display computer message),  
 12-14  
 ESC z DEL (disable label line), 12-15  
 ESC Z *dir key* DEL (clear key definition), 12-8  
 ESC Z *dir key seq* DEL (program key direction),  
 12-7  
 ESC z *field* CR (display F key label), 12-14  
 ESC z *Fkey* DEL (clear key definition), 12-8  
 ESC z *Fkey seq* DEL (program function keys),  
 12-7  
 ESC Z ~ *Key* (inquire key direction), 12-8  
 ESC [ (request key status), 12-6  
 ESC [ *line* (address cursor), 12-24  
 ESC ] (activate upper window), 12-13  
 ESC ] *answer* Ctrl/M (answerback message),  
 12-1  
 ESC ] *Col* (address cursor), 12-24  
 ESC ^ (set 25 data lines), 12-11

## ASCII control functions (cont'd)

- ESC ^ 0 (normal background), 12-10
  - ESC ^ 1 (reverse background), 12-10
  - ESC \_ (set 43 data lines), 12-11
  - ESC \_ Col (address cursor), 12-24
  - ESC { (cursor home), 12-24
  - ESC { (set half-duplex), 12-3
  - ESC { *baud stop parity word* (serial port parameters), 12-2
  - ESC | *Fkey dir seq* Ctrl-Y (program key direction), 12-8
  - ESC } (activate lower window), 12-13
  - ESC } (set full-duplex), 12-3
  - ESC } *baud stop parity word* (serial port parameters), 12-2
  - ESC ~ ! (set enhanced mode), 12-4
  - ESC ~ " (set WYSE 50+ personality), 12-4
  - ESC ~ # (set TVI 910 personality), 12-4
  - ESC ~ \$ (set TVI 925 personality), 12-4
  - ESC ~ % (set ADDS personality), 12-4
  - ESC ~ ( (set TVI 950 personality), 12-4
  - ESC ~ (EOL wrap on), 12-21
  - ESC ~ 4 (set WYSE 160/60 personality), 12-4
  - ESC ~ 5 (set WYSE 160/60 PCTerm), 12-4
  - ESC ~ 6 (set VT52 personality), 12-4
  - ESC ~ ; (set VT100 personality), 12-4
  - ESC ~ < (set VT520, 7-bit), 12-4
  - ESC ~ = (set VT520, 8-bit), 12-4
  - ESC ~ Sp (enhanced mode off), 12-4
- Assign colors, 2-28
- Audible attributes  
control functions, 4-18
- Austrian  
PC keyboard, B-3  
VT keyboard, A-2
- Auto  
answerback, 2-50  
repeat rate, 2-43  
resize, 2-20  
wrap, 2-23
- Automatic font loading, 13-4
- Autorepeating keys, 5-19
- Autowrapping text, 5-25

## B

---

- Banks, 13-3
- Banner message, 2-11, 3-1
  - power on, 2-3
- Baud rate
  - menu, 2-48
  - receive speed, 2-48
- Belgian
  - PC keyboard, B-4
  - VT keyboard, A-3
- Bell
  - margin, 2-42
  - visible, 2-43

## Bell (cont'd)

- warning, 2-25, 2-42
- 7-bit and 8-bit environments, 4-10
- 7-bit ASCII code table, 4-15
- 8-bit ASCII code table, 4-15
- 7-bit code extension technique, 4-9
- 7-bit NRCS character sets, 7-2
- Blinking, 5-201
- Bold and blink style, 2-32
- Bold display, 5-201
- Break key, 9-15
- British/U.K.
  - PC keyboard, B-5
  - VT keyboard, A-4

## C

---

- C0 control characters, 4-1, **4-15**
- C1 control characters, 4-1, 4-9, **4-15**
- Calculator, 2-11
  - feature, 3-1
  - enabling, 3-2
- Canadian
  - English
    - PC keyboard, B-6
    - VT keyboard, A-4
  - French
    - PC keyboard, B-7
    - VT keyboard, A-5
- CAN character, 4-9
- Carrier detect, 9-6
- Character
  - delete, 7-3
  - NULL, 7-3
  - space, 7-3
- Character attributes, 5-201
- Character encoding, 4-15
- Characters
  - ASCII graphic, 12-36
- Character set codes, 5-198
- Character sets, 2-11, **7-1**
  - ASCII control functions, 13-1
  - ASCII emulation mode, 3-7
  - 7-bit NRCS, 2-34, 7-2
  - control characters, 7-3
  - default
    - PC, 2-34
    - VT, 2-34
  - designing, 7-6
  - downloaded, 7-5
  - downloading, 7-13
  - mappings
    - ANSI, 7-4
    - PCTerm mode, 7-5
  - PCTerm mode, 7-2, 7-4
  - printer, 2-55
    - DEC/ISO, 2-56
    - PC, 2-56

## Character sets (cont'd)

- SCO Console mode, 7-5
- selecting, 7-5
  - ANSI, 7-4
  - designating, 5-197
  - for ProPrinter, 5-143
  - Hebrew encoding mode, 5-57
  - locking shifts (LS), 5-187
  - mapping, 5-187, 5-199, 5-205
  - overview, 5-197
  - PCTerm mode, 7-4
  - SCO Console mode, 7-5
  - single shifts (SS), 5-205
  - user-preferred supplemental sets, 5-24
- show, 3-1, 3-7
- soft, 7-5
- structure, 7-3
- support, 1-4
- VT mode, 7-1, 7-4

## Clear

- communications, 2-9, 9-14, 10-7
- display, 2-9
- on change, 2-22
- printer, 10-7

## Clock, 2-11

- feature, 3-1, 3-5

## Code pages

- defined, 7-1

## Coding conventions, 4-10

## Color

- assigning, 2-28
- selection
  - control functions, 4-18

## Colors

- alternate text, 2-30
- ASCII color mode, 2-32
- bold and blink style, 2-32
- defining, 2-31
- erase, 2-32
- intensity, 2-33
- mode, 2-32
- reverse and blank, 2-33

## Color table request/report/restore (DECCTR), 4-19

## Columns

- per page, 2-22

## Communications

### ASCII

- answerback message, 12-1
- monitor mode, 12-1
- serial port, 12-2
- serial port control, 12-1
- break, 9-15
- carrier detect, 9-6
- clear, 9-14
- clear printer, 10-7
- control functions, 4-39
- CTS, 9-4

## Communications (cont'd)

- data link layer, 9-9
  - disconnect delay, 2-52
  - DSR, 9-5, 9-12
  - DTR, 9-5, 9-12
  - features, 1-1
  - features affected by, 9-13
  - features to control functions, 2-45
  - flow control, 9-10
    - PCTerm mode, 11-3
  - half-duplex, 2-50, 9-7
  - line disconnect, 9-14
  - menu, 2-45
  - MMJ port
    - signals, 9-3
  - modem
    - disconnect, 9-5
    - high speed, 2-53
    - low speed, 2-53
    - off line, 9-6
    - supported types, 9-7
  - no flow control, 9-11
  - parity, 2-47
  - 25-pin ports, 9-1, 9-2
    - signals, 9-2
  - receive buffer, 9-10
  - receive speed, 2-48
  - RLSD, 9-6
  - RTS, 9-4
  - RXD, 9-4
  - select
    - DECSCP, 4-39
  - SPDI, 9-6
  - SPDS, 9-7
  - stop bits, 2-47
  - transmit speed, 2-48
  - two-way, 2-57
  - TXD, 9-4
  - word size, 2-47
  - XOFF/XON, 9-11
  - XPC flow control, 9-11
- ## Compose, 8-2
- ## Context sensitivity, 2-3
- ## Control
- ANSI functions
    - defined, 4-1
  - characters, 7-3
  - functions, 5-1
    - ANSI
      - audible attributes, 4-18
      - color selection, 4-18
      - communications, 4-39
      - editing, 4-21
      - graphic character sets, 4-25
      - keyboard processing, 4-27
      - printer, 4-33
      - reports, 4-42
      - sessions, 4-16

- Control
  - functions
    - ANSI (cont'd)
      - terminal management, 4-34
      - terminal synchronization, 4-41
      - text processing, 4-22
      - visual attributes, 4-20
    - terminal management
      - defined, 4-15
    - sequences, 5-1
  - Control characters
    - ANSI, 4-1 to 4-4
    - 7-bit, 4-1
    - 8-bit, 4-3
    - 7-bit and 8-bit equivalents, 4-4
    - C0, **4-15**
    - C1, **4-15**
    - control one (C1), 4-3 to 4-4, 4-5, 4-9, 4-10
    - control zero (C0), 4-1 to 4-3, 4-5, 4-10
    - displaying, 4-11 to 4-15
    - in control functions, 4-9
    - showing, 2-24
  - Control codes, 8-28
    - for Set-Up functions, 2-61
  - Control functions
    - ASCII, 11-1
    - control characters, 4-9
    - control sequence format, 4-6
    - device control string format, 4-8
    - escape sequence format, 4-6
    - general format, 4-5
    - interrupting, 4-9
    - numeric parameters, 4-7
    - overview, 4-5 to 4-9
    - selective parameters, 4-7
    - VT52 mode, 4-45
  - Control sequences, format of, 4-6
  - Conventions, iv
  - Copy
    - direction, 2-23
    - key default, 2-38
    - settings from menu, 2-17
  - Copy and paste, 3-8
    - limits, 3-8
  - Correcting mistakes
    - Define Key Editor, 2-40
  - Creating new keyboard key output, 2-40
  - CRT
    - saver, 2-24
  - CSI character, 4-6
  - CTS, 9-4
  - Cursor
    - control
      - ASCII control functions, 12-21
    - coupling
      - page, 5-80
      - vertical, 2-22, 5-170
    - display, 2-22

- Cursor (cont'd)
  - invisible, 5-157
  - key codes
    - SCO Console mode, 6-6
  - moving on the page, 5-7
  - right-to-left mode, 5-93
  - to protected area, 11-4
- Czech
  - PC keyboard, B-8
  - VT keyboard, A-6

## D

---

- Danish
  - PC keyboard, B-9
  - VT keyboard, A-7
- Data link layer, 9-9
- Data processing
  - keys, 2-43
- DCS character, 4-8
- DEC-423 port error, 2-3
- DEC ANSI
  - print mode, 10-4
  - with IBM ProPrinter, 10-6
- DECDDL
  - down-line loading, 7-5
- DECSCL, 2-33
- Default
  - character set
    - PC, 2-34
    - VT, 2-34
  - parameters, 2-2
  - Set-Up modes, 2-61
- Define colors, 2-31
- Define Key Editor, 2-37
  - copy of key default, 2-38
  - correcting mistakes, 2-40
- Delay
  - disconnect, 2-52
- Designating character sets, 5-197
- Desktop
  - features
    - banner message, 3-1
    - calculator, 2-11, 3-1, 3-2
    - clock, 2-11, 3-1, 3-5
    - show character sets, 2-11, 3-1, 3-7
  - productivity
    - features, 1-4
- Device
  - attributes, 5-12, 5-104
  - status reports, 5-173 to 5-179
- Device control
  - strings, 4-8
- Diacritical marks
  - PC keyboards, B-1
  - VT keyboard, A-1

- Dim menu items, 2-3
- Dim video, 2-3
- Disconnect delay, 2-52
- Display
  - attribute
    - control functions, 12-17
  - capabilities, 1-3
  - menu, 2-19
- Display C0 controls as PC characters (SCO) (SCODPCC), 4-27
- Displaying control characters, 4-11 to 4-15
- Display menu
  - control functions, 2-19
- Down-line loading
  - allocation, 5-47
  - character sets, 7-5, 7-13
  - DECDLD, 7-5
- DRCS
  - defined, 1-6
- DSR, 9-5
- DTR, 2-49, 9-5
- DTR/DSR, 10-2
  - flow control, 2-48, 2-49, 9-12
    - printer, 2-57
    - threshold, 2-49
- Duplex
  - half, 2-50
- Dutch
  - PC keyboard, B-10
  - VT keyboard, A-8

## E

---

- Echo, local, 2-50
- Editing
  - ASCII control functions, 12-25
  - character protection attribute, 5-121, 5-131
  - control functions, 4-21
  - delete
    - character, 5-13
    - column, 5-37
    - line, 5-172
  - erase
    - character, 5-179
    - in display, 5-180
    - in line, 5-180
  - insert
    - character, 5-183
    - column, 5-59
    - line, 5-184
  - keypad key codes
    - SCO Console mode, 6-6
  - selective erase in display, 5-129
- EIA communications
  - See Communications

- Embedded emulation mode, 12-15
- Emulation
  - mode, 2-33
- Emulations
  - ASCII, 11-1
- Energy saver, 2-24
- Enhanced mode, 11-2
- Entering Set-Up, 2-1
- Erase color, 2-32
- Erasing data
  - ASCII control functions, 12-28
- Ergonomics, 1-4
- Error
  - character, 4-2
  - correcting UDK, 2-40
- Error messages
  - DEC-423 port error, 2-3
  - keyboard error, 2-3
  - NVR error, 2-3
  - parallel port error, 2-3
  - ROM cartridge error, 2-3
  - RS-232 port data error, 2-3
  - self-test, 2-3
- Escape sequences, format of, 4-6
  - VT52 mode, 4-45
- ESC character, 4-6, 4-9
- Exit Set-Up, 2-9

## F

---

- Features
  - affected by communications, 9-13
  - printer port, 10-1
- Final character
  - ANSI index, E-1
- Finnish
  - PC keyboard, B-11
  - VT keyboard, A-9
- Flemish
  - VT keyboard, A-10
- Flow control, 9-10
  - printer, 10-1
  - threshold, 2-49
- Font
  - designing, 13-5
  - loading, 13-4
  - sizes, 1-4
- Framed windows, 2-26
- French
  - PC keyboard, B-12
  - VT keyboard, A-3
- French-Canadian
  - PC keyboard, B-7
  - VT keyboard, A-5
- Full-duplex
  - mode, 9-1



Function keys  
  codes  
    SCO Console mode, 6-2  
  rate limit, 2-49

## G

---

German  
  PC keyboard, B-3  
  VT keyboard, A-2  
Glossary, Glossary-1  
Graphic  
  character sets, 7-1  
    7-bit NRCS, 7-2  
    control characters, 7-3  
  mappings  
    ANSI, 7-4  
    PCTerm mode, 7-5  
  PCTerm mode, 7-2, 7-4  
  selecting  
    ANSI, 7-4  
    PCTerm mode, 7-4  
    SCO Console mode, 7-5  
  soft, 7-5  
  structure, 7-3  
  VT mode, 7-1, 7-4  
Graphic character sets  
  control functions, 4-25  
Greek  
  PC keyboard, B-13  
  VT keyboard, A-11  
Greek/N-A keyboard  
  mapping, 5-74

## H

---

Half-duplex  
  communications, 2-50  
  mode, 9-1  
  signals, 9-7  
Hardware flow control, 1-1  
Hebrew  
  PC keyboard, B-14  
  VT keyboard, A-12  
Hebrew/N-A keyboard  
  mapping, 5-58  
Hidden emulation mode, 12-15  
Hungarian  
  PC keyboard, B-15  
  VT keyboard, A-13

## I

---

IBM ProPrinter  
  mode, 10-5  
  with DEC ANSI, 10-6

Icon name, 2-14  
ID to host, 2-34  
Ignore missing keyboard, 2-44  
Ignore null characters, 2-50  
Inserting and deleting data, 5-183, 5-185, 5-191, 5-195  
Insert/replace mode, 5-185  
In-use table, 5-197  
Invisible attribute, 5-201  
Italian  
  PC keyboard, B-16  
  VT keyboard, A-14

## K

---

Keyboard  
  arrow keys, 5-32  
  ASCII  
    local functions  
      PC scancode mode, C-11  
    processing, 12-5  
    program key direction, 12-8  
    redefinable keys, 12-9  
    terminal, 11-3  
  autorepeating keys, 5-19  
  autowrap mode, 5-25  
  control codes and keystrokes, 8-28  
  control functions, 2-36  
  enabling local functions, 5-51  
  encoding menu item, 2-43  
  error, 2-3  
  extended keyboard report, 5-49  
  features, 1-2, 1-3  
  <X> function, 5-26  
  "hot" keys, Glossary-2  
  indicator line, 2-6  
  language for Set-Up, 2-37  
  layouts  
    PC keyboards, B-2  
    VT keyboards, A-1  
  line feed/new line mode, 5-186  
  local-function key control, 5-70  
  local functions  
    ASCII code mode, C-10  
  locking keyboard, 5-185  
  menu, 2-36  
  numeric keypad, 5-67, 5-75  
  PC  
    Austrian, B-3  
    Belgian, B-4  
    British/U.K., B-5  
    Canadian-English, B-6  
    Canadian-French, B-7  
    Czech, B-8  
    Danish, B-9  
    Dutch, B-10  
    Finnish, B-11  
    French, B-12

## Keyboard

### PC (cont'd)

- German, B-3
  - Greek, B-13
  - Hebrew, B-14
  - Hungarian, B-15
  - Italian, B-16
  - Latin American, B-17
  - North American, B-6
  - Norwegian, B-18
  - Polish, B-19
  - Portuguese, B-20
  - Romanian, B-21
  - Russian, B-22
  - SCS, B-23
  - Slovak, B-24
  - Spanish, B-25
  - Swedish, B-26
  - Swiss-French, B-27
  - Swiss-German, B-28
  - Turkish, B-29
- PC legend data, B-2
- processing control functions, 4-27
- quick start summary, 3-8
- saving key definitions, 2-42
- scan code, defined, Glossary-2
- select modifier key reporting, 5-139
- typewriter or data processing keys, 5-65
- unlocking keyboard, 5-185
- user-defined keys, 5-163

### VT

- Austrian, A-2
- Belgian, A-3
- British/U.K., A-4
- Canadian, A-4
- Canadian-French, A-5
- Czech, A-6
- Danish, A-7
- Dutch, A-8
- Finnish, A-9
- Flemish, A-10
- French, A-3
- German, A-2
- Greek, A-11
- Hebrew, A-12
- Hungarian, A-13
- Italian, A-14
- North American, A-4
- Norwegian, A-15
- Polish, A-16
- Portuguese, A-17
- Romanian, A-18
- Russian, A-19
- SCS, A-20
- Slovak, A-21
- Spanish, A-22
- Swedish, A-23
- Swiss-French, A-24

## Keyboard

### VT (cont'd)

- Swiss-German, A-25
  - Turkish-F, A-26
  - Turkish-Q, A-27
- VT legend data, A-1
- VT vs. PC, 1-2, 8-1
- Keyboard control functions, 5-163
- Keyboard mapping
- Greek/N-A, 5-74
  - Hebrew/N-A, 5-58
- Keyclick, 2-42
- Keycodes
- PC keyboard
    - ADDS mode, C-4
    - TVI mode, C-1
    - WYSE mode, C-1
  - VT keyboard
    - ADDS mode, C-8
    - TVI mode, C-6
    - WYSE mode, C-6
- Key editor, 2-37
- Keypad mode
- application, 2-44
- Keys
- application cursor, 2-43
  - data processing, 2-43

## L

---

### Language

- Set-Up, 2-2

### Language, Set-Up, 2-37

### Latin American

- PC keyboard, B-17

### Lines

- per page, 2-20
- per screen, 2-20

### Local

- controller mode, 2-8
- echo, 2-8, 2-50
- Function keys
  - SCO Console mode, 6-2
- mode, 2-8

### Lock

- caps, 2-42
- keyboard, 5-185
- key definitions, 2-42
- user preferences, 2-23

### Locking-shift (LS) control functions, 5-187

## M

---

### Macro commands, 5-45

- defining, 5-45

### Main keypad key codes

- SCO Console mode, 6-3

- Main menu, 2-8
- Mapping character sets, 5-199
  - locking shifts, 5-187
  - single shifts, 5-205
- Margins
  - left and right, 5-137
  - top and bottom, 5-149
- Mistake
  - correcting using define key editor, 2-40
- MMJ port
  - signals, 9-3
- Mode description, 4-37
- Model differences, 1-1
- Modem
  - control mode
    - reset, 5-73
    - set, 5-73
  - disconnect delay, 2-52
  - features to control functions, 2-45
  - high speed, 2-53
  - low speed, 2-53
  - menu, 2-52
  - supported, 9-7
- Mode settings, 4-36, 5-195
- MPR II, 1-1, Glossary-3
- Multiple sessions
  - enabling and controlling configuration, 2-12
  - management, 2-13
  - pages, 2-14
  - reset, 2-18
  - selection, 2-14
  - session name, 2-14
  - setting up, 2-11
  - updating, 2-17
  - using a terminal server with TD/SMP, 2-12
    - opening another session, 2-12
    - restoring an interrupted session, 2-13
  - using SSU Host software, 2-12

## N

---

- New line mode, 2-23
- North American
  - PC keyboard, B-6
  - VT keyboard, A-4
- Norwegian
  - PC keyboard, B-18
  - VT keyboard, A-15
- NULL characters, 2-50
- Numeric keypad, 5-67
- Numeric parameters, 4-7
- Num lock LED, 2-7, 5-86, 8-8
- NVR error, 2-3

## O

---

- On-line feature, 2-8
- Origin for page addressing, 5-77
- Overscan, 2-25

## P

---

- Page
  - coupling, 2-23
  - edit
    - ASCII control functions, 12-27
  - memory
    - ASCII, 12-12
    - controlling the page format, 5-72
    - left and right margins, 5-137
    - left right margin mode, 5-72
    - lines per page, 5-136
    - moving to a new page, 5-193
    - 80 or 132 columns, 5-34, 5-125
    - page origin, 5-77
    - top and bottom margins, 5-149
- Panning, 5-200, 5-207
- Parallel port
  - error, 2-3
- Parity
  - communication, 2-47
- Paste and copy, 3-8
  - limits, 3-8
- PC keyboard
  - Austrian, B-3
  - Belgian, B-4
  - British/U.K., B-5
  - Canadian-English, B-6
  - Canadian-French, B-7
  - Czech, B-8
  - Danish, B-9
  - Dutch, B-10
  - Finnish, B-11
  - French, B-12
  - German, B-3
  - Greek, B-13
  - Hebrew, B-14
  - Hungarian, B-15
  - Italian, B-16
  - Latin American, B-17
  - legend data, B-2
  - North American, B-6
  - Norwegian, B-18
  - Polish, B-19
  - Portuguese, B-20
  - Romanian, B-21
  - Russian, B-22
  - scan codes, 8-23
  - SCS, B-23
  - Slovak, B-24
  - Spanish, B-25

- PC keyboard (cont'd)
  - Swedish, B-26
  - Swiss-French, B-27
  - Swiss-German, B-28
  - Turkish, B-29
- PCTerm
  - graphic character sets, 7-2
  - mode
    - communications flow control, 11-3
    - on US keyboard, 13-1
  - scan codes
    - EPC keyboards, 8-23
    - VT keyboards, 8-27
  - selecting character sets, 7-4
- 25-pin port, 9-1, 9-2
  - signals, 9-2
- Polish
  - PC keyboard, B-19
  - VT keyboard, A-16
- Portuguese
  - PC keyboard, B-20
  - VT keyboard, A-17
- Power-on
  - banner message, 2-3, 2-11
- Presentation state reports, 5-116
- Print
  - data
    - transmitting, 10-4
  - modes
    - affecting print operations, 10-3
  - operations, 10-4
    - ASCII, 12-33
- Printer
  - aborting operations, 10-7
  - character sets, 2-55
    - DEC/ISO, 2-56
    - PC, 2-56
  - control functions, 4-33
  - controller mode, 10-4
  - data transmission, 10-5
  - features to control functions, 2-55
  - flashes on screen, 10-7
  - ignore null characters, 2-50
  - menu, 2-54
  - parity, 2-58
  - port
    - control functions, 5-83
    - DSR/DTR, 10-2
    - features, 1-3, 10-1
    - flow control, 10-1, 10-3
    - parallel, 10-2
      - signals, 10-2
    - select, 2-54
    - serial, 10-1
  - print
    - extent, 2-56
    - mode, 2-54
    - speed, 2-56

- Printer
  - print (cont'd)
    - terminator, 2-56
    - receive flow control, 2-57
    - receive speed, 2-48
    - same as receive, 2-58
    - stalls, 10-7
    - stop bits, 2-47, 2-58
    - suspending operations, 10-7
    - transmit flow control, 2-57
    - transmit speed, 2-48
    - type, 2-55
    - word size, 2-57
- Printer port control functions, 5-83
- Printing
  - data
    - ASCII control functions, 12-34
    - form feeds, 5-83
    - full screen or scrolling region, 5-83
- ProPrinter
  - enter mode, 5-62
  - exit mode, 5-62
  - selecting
    - character set, 5-143
    - code pages, 5-143
    - printer type, 5-144
- Protecting data
  - ASCII control functions, 12-20
  - description, 11-3

---

## R

- Recall
  - key definitions, 2-42
- Receive
  - buffer
    - communications, 9-10
    - flow control, 2-49
  - Receive speed, 2-48
- Rectangular area operations
  - changing character attributes, 5-90 to 5-91
  - copying, 5-35
  - defined, 12-28
  - erasing, 5-52, 5-132
  - filling, 5-55
- Redefining keys
  - ASCII, 12-9
- Repeat keys, 2-43
- Reports
  - control functions, 4-42
  - cursor information report, 5-30
  - cursor position report, 5-173
  - data integrity report, 5-174
  - extended cursor position report, 5-174
  - macro space report, 5-176
  - memory checksum, 5-177
  - operating status, 5-177
  - primary device attributes (DA1), 5-9

## Reports (cont'd)

- printer port, 5-178
  - report mode, 5-98
  - report selection or setting, 5-102
  - request mode, 5-108
  - reset mode, 5-195
  - restore presentation state, 5-116
  - restore terminal state, 5-117
    - color table, 5-118
  - secondary device attributes (DA2), 5-11
  - set mode, 5-206
  - tab stop report, 5-157
  - terminal state, 5-160
    - color table report, 5-161
  - terminal unit ID, 5-104
  - tertiary device attributes (DA3), 5-12
  - user-defined keys, 5-179
- ## Resetting
- modem control mode, 5-73
  - session, 2-10
  - terminal
    - secure reset, 5-144
    - soft reset, 2-10
- ## Resetting the terminal, 5-207
- clearing tabs, 5-207
  - reset to initial state, 5-194
  - secure reset confirmation, 5-146
- ## Restore
- factory defaults, 2-10, 2-18
  - settings, 2-9
    - for all, 2-16
- ## Restoring an interrupted session, 2-13
- ## Reverse and blank attributes, 2-33
- ## Reverse video, 5-201
- ## Review lines of text, 2-21
- ## Review previous lines, 2-21
- buffer, 2-21
- ## Right-to-left mode
- cursor, 5-93
- ## RI—Reverse index, 4-4
- ## RLSD, 9-6
- ## Romanian
- PC keyboard, B-21
  - VT keyboard, A-18
- ## ROM cartridge
- error, 2-3
- ## RS-232 port data error, 2-3
- ## RTS, 9-4
- ## Russian
- PC keyboard, B-22
  - VT keyboard, A-19
- ## RXD, 9-4

## S

---

### Save

- key definitions, 2-42
- settings, 2-9
  - for all, 2-16

### Scan codes

- sent in PCTerm mode
  - EPC keyboards, 8-23
  - VT keyboards, 8-27

### SCO Console

- cursor key codes, 6-6
- editing keypad key codes, 6-6
- emulation, 6-1
- emulation mode, 5-159
- function key
  - codes, 6-2
- local function keys, 6-2
- main keypad key codes, 6-3
- scancodes, 5-81
- SCODFK (define function key), 6-7
- SCODPCC (display PC characters), 6-8
- SCORC (restore saved cursor position), 6-9
- SCOSC (save cursor position), 6-9
- selecting character sets, 7-5
  - with ASCII keycodes, 6-1
  - with Scancode keycodes, 6-1

### SCO control sequences

- by Control Function
  - CSI s (SCOSC), 6-9
  - CSI u (SCORC), 6-9
  - ESC Q *Fn String* (SCODFK), 6-7
  - ESC xx (SCODPCC), 6-8
- by Mnemonic
  - SCODFK (define function key), 6-7
  - SCODPCC (display PC characters), 6-8
  - SCORC (restore saved cursor position), 6-9
  - SCOSC (save current cursor position), 6-9
- by Name
  - Define function key (SCODFK), 6-7
  - Display PC characters (SCODPCC), 6-8
  - Restore saved cursor position (SCORC), 6-9
  - Save current cursor position (SCOSC), 6-9

### Screen

- alignment, 2-27
- background, 2-22
- display control functions, 5-147 to 5-148
- processing
  - ASCII, 12-10
- saver, 2-24

### Scrolling

- jump, 2-22
- mode, 2-22
- rate, 2-22
- smooth, 2-22

- SCS
  - PC keyboard, B-23
  - VT keyboard, A-20
- Select
  - color mode, 2-32
- Selecting
  - character sets
    - ASCII control functions, 13-3
- Selective parameters, 4-7
- Self-test
  - error messages, 2-3
- Sending data
  - ASCII, 12-32
  - ASCII control functions, 12-34
- Session
  - menu, 2-13
- Sessions, 1-6
  - control functions, 4-16
  - management, 4-16
  - multiple, 2-11
    - enabling and controlling configuration, 2-12
    - management, 2-13
    - pages, 2-14
    - selection, 2-14
    - using a terminal server with TD/SMP, 2-12
      - opening another session, 2-12
      - restoring an interrupted session, 2-13
      - using SSU Host software, 2-12
  - reset, 2-18
  - session name, 2-14
  - switching, 3-8
  - updating, 2-17
- Setting modem control mode, 5-73
- Set-Up, 2-1
  - actions menu, 2-7, 2-9
  - alternate text colors, 2-30
  - ASCII color mode, 2-32
  - ASCII emulation menu, 2-35
  - assign colors, 2-28
  - auto repeat rate, 2-43
  - auto resize, 2-20
  - auto wrap, 2-23
  - banner message, 2-11
  - 7-bit NRCS, 2-34
  - bold and blink style, 2-32
  - calculator, 2-11
  - caps lock, 2-42
  - clear communications, 2-9
  - clear display, 2-9
  - clock, 2-11
  - columns per page, 2-22
  - communications
    - auto answerback, 2-50
    - Fkey rate limit, 2-49
    - half-duplex, 2-50
    - ignore null characters, 2-50
- Set-Up
  - communications (cont'd)
    - local echo, 2-50
    - modem menu, 2-52
    - receive flow control, 2-49
    - receive speed, 2-48
    - select sessions, 2-46
    - stop bits, 2-47
    - transmit flow control, 2-48
    - transmit rate limit, 2-49
    - transmit speed, 2-48
    - word size, 2-47
  - communications menu, 2-45
  - context sensitivity, 2-3
  - control codes to set features, 2-61
  - copy settings from menu, 2-17
  - CRT saver, 2-24
  - cursor coupling
    - vertical, 2-22
  - cursor display, 2-22
  - default character set
    - PC, 2-34
    - VT, 2-34
  - defaults, 2-61
  - define colors, 2-31
  - define key editor, 2-37
    - copy key default, 2-38
    - correcting a mistake, 2-40
    - creating a new function, 2-39
    - creating a new key definition, 2-40
    - user-defined keys, 2-41
  - desktop features
    - banner message, 3-1
    - calculator, 3-1, 3-2
    - clock, 3-1, 3-5
    - show character sets, 3-1, 3-7
  - dim menu items, 2-3
  - display menu, 2-19
  - effects of entering, 2-2
  - emulation mode, 2-33
  - energy saver, 2-24
  - entering, 2-1
  - erase color, 2-32
  - exiting, 2-9
  - framed windows, 2-25
  - keyboard encoding, 2-43
  - keyboard language, 2-37
  - keyboard menu, 2-36
  - keyclick, 2-42
  - languages, 2-2
  - lines per page, 2-20
  - lines per screen, 2-20
  - lock key definitions, 2-42
  - lock out, 2-1
  - lock user preferences, 2-23
  - main menu, 2-7, 2-8
  - margin bell, 2-42
  - modem

## Set-Up

- modem (cont'd)
  - disconnect delay, 2-52
  - enable modem control, 2-52
  - speed, 2-53
- modem menu, 2-52
- multiple sessions, 2-11
  - management, 2-13
  - pages, 2-14
  - reset, 2-18
  - selection, 2-14
  - session name, 2-14
  - updating, 2-17
  - using a terminal server with TD/SMP, 2-12
    - opening another session, 2-12
    - restoring an interrupted session, 2-13
  - using SSU Host software, 2-12
- new line mode, 2-23
- page coupling, 2-23
- power-on settings, 2-2
- printer
  - character sets, 2-55
  - flow control, 2-57
  - ignore null characters, 2-50
  - mode, 2-54
  - parity, 2-58
  - port select, 2-54
  - print extent, 2-56
  - print terminator, 2-56
  - speed, 2-56
  - stop bits, 2-58
  - type, 2-55
  - word size, 2-57
- printer menu, 2-54
- recall key definitions, 2-42
- reset this session, 2-10
- resetting and restoring defaults, 2-18
- restore factory defaults, 2-10, 2-18
- restore settings, 2-9
- restore settings for all, 2-16
- reverse and blank, 2-33
- review previous lines, 2-21
- save key definitions, 2-42
- save settings, 2-9
- save settings for all, 2-16
- screen background, 2-22
- scrolling, 2-22
- select color mode, 2-32
- session menu, 2-13
- show character sets, 2-11
- show control characters, 2-24
- soft character sets, 2-16
- status messages, 2-5
- summary line, 2-5
- tabs, 2-58
- terminal ID to host, 2-34
- terminal type, 2-33

## Set-Up (cont'd)

- transmit 7-bit controls, 2-34
- warning bell, 2-25, 2-42
- writing direction, 2-23
- zero symbol, 2-23
- Show
  - character sets, 2-11
  - control characters, 2-24, 4-11
    - C0 control characters, 4-15
    - C1 control characters, 4-15
- Single-shift (SS) commands, 5-205
- Slovak
  - PC keyboard, B-24
  - VT keyboard, A-21
- Soft character set
  - clearing, 7-16
  - example, 7-15
- Soft character sets, 7-5 to 7-16
  - coding, 7-9
  - designating, 7-14
  - designing, 7-6
  - downloading, 7-13
- Soft key mapping, Glossary-3
- Soft terminal reset, 2-10
- Software flow control, 1-1
- Sound
  - notes available, 2-60
  - types of, 2-59
- Spanish
  - PC keyboard, B-25
  - VT keyboard, A-22
- SPDI, 9-6
- SPDS, 9-7
- Split screen, 12-12
- Status
  - display, 2-22
  - lines
    - ASCII control functions, 12-13
    - messages, 2-5
- Sticky keys, 2-6
  - See Accessibility aids
- Stop bits, 2-47
- SUB character, 4-9
- Supplemental character sets
  - See User-preferred supplemental character sets
- Suspending
  - printer operations, 10-7
- Swedish
  - PC keyboard, B-26
  - VT keyboard, A-23
- Swiss
  - French
    - PC keyboard, B-27
    - VT keyboard, A-24
  - German
    - PC keyboard, B-28
    - VT keyboard, A-25

## T

---

### Tabs

- dialog box, 2-59
- setting, 2-58

### Tabulation

- ASCII control functions, 12-26

### Terminal

- ID, 1-6
- ID to host, 2-34
- management
  - ASCII, 12-4
- type menu, 2-33

### Terminal management

- control functions, 4-34
- defined, 4-15

### Terminal state reports, 5-117

- color table, 5-118

### Terminal synchronization

- control functions, 4-41

### Testing the terminal

- screen alignment pattern, 5-17

### Text

- capabilities, 1-3
- processing, 4-22

### Transmit

- 7-bit controls, 2-34
- flow control, 2-48
- rate limit, 2-49
- speed, 2-48

### Transmitting print data, 10-4

### Turkish-F

- VT keyboard, A-26

### Turkish-Q

- PC keyboard, B-29
- VT keyboard, A-27

### Two-way communications, 2-57

### TXD, 9-4

## U

---

### UDK

- correcting mistakes, 2-40

### Underlining, 5-201

### Unlocking keyboard, 5-185

### Use of VT420 keyboards, 1-6

### User-defined keys, 2-41, 5-163

### User-preferred supplemental character sets, 5-24

## V

---

### Vertical

- coupling, 2-22

### Visible bell, 2-43

### Visual attributes

- control functions, 4-20

### VT52 mode

- escape sequences, 4-45

### VT keyboard

- Austrian, A-2
  - Belgian, A-3
  - British/U.K., A-4
  - Canadian, A-4
  - Canadian-French, A-5
  - Czech, A-6
  - Danish, A-7
  - Dutch, A-8
  - Finnish, A-9
  - Flemish, A-10
  - French, A-3
  - German, A-2
  - Greek, A-11
  - Hebrew, A-12
  - Hungarian, A-13
  - Italian, A-14
  - legend data, A-1
  - North American, A-4
  - Norwegian, A-15
  - Polish, A-16
  - Portuguese, A-17
  - Romanian, A-18
  - Russian, A-19
  - scan codes, 8-27
  - SCS, A-20
  - Slovak, A-21
  - Spanish, A-22
  - Swedish, A-23
  - Swiss-French, A-24
  - Swiss-German, A-25
  - Turkish-F, A-26
  - Turkish-Q, A-27
- VT keyboards, A-1

## W

---

### Warning bell, 2-25

### Window

- adjustment, 3-8
- framed, 2-25

### Windowing, 2-25

- two windows, 2-26

### Windows

- ASCII control functions, 12-13

### Word size, 2-47

### Writing

- direction, 2-23

### WYSE Enhanced mode, 13-1



## **X**

---

XON/XOFF, 9-11

    description, 11-3

XPC flow control, 9-11

## **Z**

---

Zero symbol, 2-23

