

This chapter includes the following sections:

- **A Brief History of Fiber-Optic Communications**—This section discusses the history of fiber optics, from the optical semaphore telegraph to the invention of the first clad glass fiber invented by Abraham Van Heel. Today more than 80 percent of the world’s long-distance voice and data traffic is carried over optical-fiber cables.
- **Fiber-Optic Applications**—Telecommunications applications of fiber-optic cable are widespread, ranging from global networks to desktop computers.
- **The Physics Behind Fiber Optics**—This section discusses the physics behind the operation of fiber-optic cables.
- **Optical-Cable Construction**—This section discusses fiber-optic cable construction. Fiber-optic cables are constructed of three types of materials: glass, plastic, and plastic-clad silica (PCS).
- **Propagation Modes**—There are two main modes of fiber-optic propagation: multimode and single mode. These two modes perform differently with respect to both attenuation and chromatic dispersion.
- **Fiber-Optic Characteristics**—Fiber-optic system characteristics include linear and nonlinear characteristics. Linear characteristics include attenuation and interference. Nonlinear characteristics include single-phase modulation (SPM), cross-phase modulation (XPM), four-wave mixing (FWM), stimulated Raman scattering (SRS), and stimulated Brillouin scattering (SBS).
- **Fiber Types**—This section discusses various multimode and single-mode fiber types currently used for premise, metro, aerial, submarine, and long-haul applications.
- **Fiber-Optic Cable Termination**—Removable and reusable optical termination in the form of metal and plastic connectors plays a vital role in an optical system.
- **Splicing**—Seamless permanent or semipermanent optical connections require fibers to be spliced. Fiber-optic cables might have to be spliced together for a number of reasons.
- **Physical-Design Considerations**—When designing a fiber-optic cable plant, you must consider many factors. First and foremost, the designer must determine whether the cable is to be installed for an inside-plant (ISP) or outside-plant (OSP) application.
- **Fiber-Optic Communications System**—This section discusses the end-to-end fiber-optic system.
- **Fiber Span Analysis**—Optical loss, or total attenuation, is the sum of the losses of each individual component between the transmitter and receiver. Loss-budget analysis is the calculation and verification of a fiber-optic system’s operating characteristics.

Fiber-Optic Technologies

A Brief History of Fiber-Optic Communications

Optical communication systems date back to the 1790s, to the optical semaphore telegraph invented by French inventor Claude Chappe. In 1880, Alexander Graham Bell patented an optical telephone system, which he called the Photophone. However, his earlier invention, the telephone, was more practical and took tangible shape. The Photophone remained an experimental invention and never materialized. During the 1920s, John Logie Baird in England and Clarence W. Hansell in the United States patented the idea of using arrays of hollow pipes or transparent rods to transmit images for television or facsimile systems.

In 1954, Dutch scientist Abraham Van Heel and British scientist Harold H. Hopkins separately wrote papers on imaging bundles. Hopkins reported on imaging bundles of unclad fibers, whereas Van Heel reported on simple bundles of clad fibers. Van Heel covered a bare fiber with a transparent cladding of a lower refractive index. This protected the fiber reflection surface from outside distortion and greatly reduced interference between fibers.

Abraham Van Heel is also notable for another contribution. Stimulated by a conversation with the American optical physicist Brian O'Brien, Van Heel made the crucial innovation of cladding fiber-optic cables. All earlier fibers developed were bare and lacked any form of cladding, with total internal reflection occurring at a glass-air interface. Abraham Van Heel covered a bare fiber or glass or plastic with a transparent cladding of lower refractive index. This protected the total reflection surface from contamination and greatly reduced cross talk between fibers. By 1960, glass-clad fibers had attenuation of about 1 decibel (dB) per meter, fine for medical imaging, but much too high for communications. In 1961, Elias Snitzer of American Optical published a theoretical description of a fiber with a core so small it could carry light with only one waveguide mode. Snitzer's proposal was acceptable for a medical instrument looking inside the human, but the fiber had a light loss of 1 dB per meter. Communication devices needed to operate over much longer distances and required a light loss of no more than 10 or 20 dB per kilometer.

By 1964, a critical and theoretical specification was identified by Dr. Charles K. Kao for long-range communication devices, the 10 or 20 dB of light loss per kilometer standard. Dr. Kao also illustrated the need for a purer form of glass to help reduce light loss.

In the summer of 1970, one team of researchers began experimenting with fused silica, a material capable of extreme purity with a high melting point and a low refractive index.

Corning Glass researchers Robert Maurer, Donald Keck, and Peter Schultz invented fiber-optic wire or “optical waveguide fibers” (patent no. 3,711,262), which was capable of carrying 65,000 times more information than copper wire, through which information carried by a pattern of light waves could be decoded at a destination even a thousand miles away. The team had solved the decibel-loss problem presented by Dr. Kao. The team had developed an SMF with loss of 17 dB/km at 633 nm by doping titanium into the fiber core. By June of 1972, Robert Maurer, Donald Keck, and Peter Schultz invented multimode germanium-doped fiber with a loss of 4 dB per kilometer and much greater strength than titanium-doped fiber. By 1973, John MacChesney developed a modified chemical vapor-deposition process for fiber manufacture at Bell Labs. This process spearheaded the commercial manufacture of fiber-optic cable.

In April 1977, General Telephone and Electronics tested and deployed the world’s first live telephone traffic through a fiber-optic system running at 6 Mbps, in Long Beach, California. They were soon followed by Bell in May 1977, with an optical telephone communication system installed in the downtown Chicago area, covering a distance of 1.5 miles (2.4 kilometers). Each optical-fiber pair carried the equivalent of 672 voice channels and was equivalent to a DS3 circuit. Today more than 80 percent of the world’s long-distance voice and data traffic is carried over optical-fiber cables.

Fiber-Optic Applications

The use and demand for optical fiber has grown tremendously and optical-fiber applications are numerous. Telecommunication applications are widespread, ranging from global networks to desktop computers. These involve the transmission of voice, data, or video over distances of less than a meter to hundreds of kilometers, using one of a few standard fiber designs in one of several cable designs.

Carriers use optical fiber to carry plain old telephone service (POTS) across their nationwide networks. Local exchange carriers (LECs) use fiber to carry this same service between central office switches at local levels, and sometimes as far as the neighborhood or individual home (fiber to the home [FTTH]).

Optical fiber is also used extensively for transmission of data. Multinational firms need secure, reliable systems to transfer data and financial information between buildings to the desktop terminals or computers and to transfer data around the world. Cable television companies also use fiber for delivery of digital video and data services. The high bandwidth provided by fiber makes it the perfect choice for transmitting broadband signals, such as high-definition television (HDTV) telecasts.

Intelligent transportation systems, such as smart highways with intelligent traffic lights, automated tollbooths, and changeable message signs, also use fiber-optic-based telemetry systems.

Another important application for optical fiber is the biomedical industry. Fiber-optic systems are used in most modern telemedicine devices for transmission of digital diagnostic images. Other applications for optical fiber include space, military, automotive, and the industrial sector.

The Physics Behind Fiber Optics

A fiber-optic cable is composed of two concentric layers, called the core and the cladding, as illustrated in Figure 3-1. The core and cladding have different refractive indices, with the core having a refractive index of n_1 , and the cladding having a refractive index of n_2 . The index of refraction is a way of measuring the speed of light in a material. Light travels fastest in a vacuum. The actual speed of light in a vacuum is 300,000 kilometers per second, or 186,000 miles per second.

Figure 3-1 *Cross Section of a Fiber-Optic Cable*

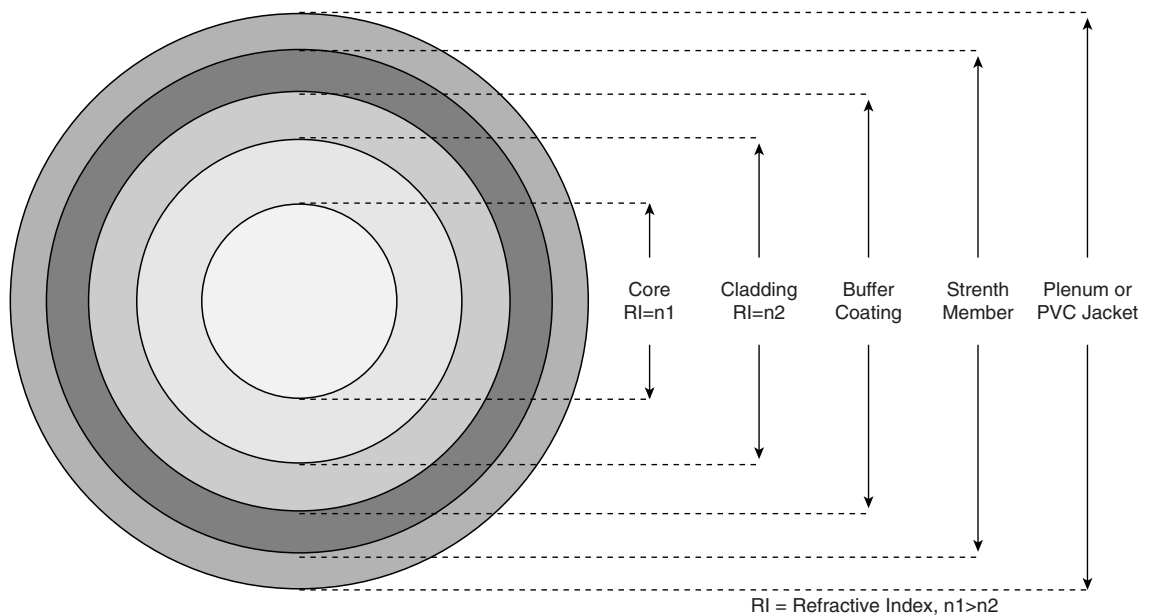

The index of refraction is calculated by dividing the speed of light in a vacuum by the speed of light in another medium, as shown in the following formula:

$$\text{Refractive index of the medium} = \left[\frac{\text{Speed of light in a vacuum}}{\text{Speed of light in the medium}} \right]$$

The refractive index of the core, n_1 , is always greater than the index of the cladding, n_2 . Light is guided through the core, and the fiber acts as an optical waveguide.

Figure 3-2 shows the propagation of light down the fiber-optic cable using the principle of total internal reflection. As illustrated, a light ray is injected into the fiber-optic cable on the left. If the light ray is injected and strikes the core-to-cladding interface at an angle greater than the critical angle with respect to the normal axis, it is reflected back into the core. Because the angle of incidence is always equal to the angle of reflection, the reflected light continues to be reflected. The light ray then continues bouncing down the length of the fiber-optic cable. If the angle of incidence at the core-to-cladding interface is less than the critical angle, both reflection

and refraction take place. Because of refraction at each incidence on the interface, the light beam attenuates and dies off over a certain distance.

Figure 3-2 *Total Internal Reflection*

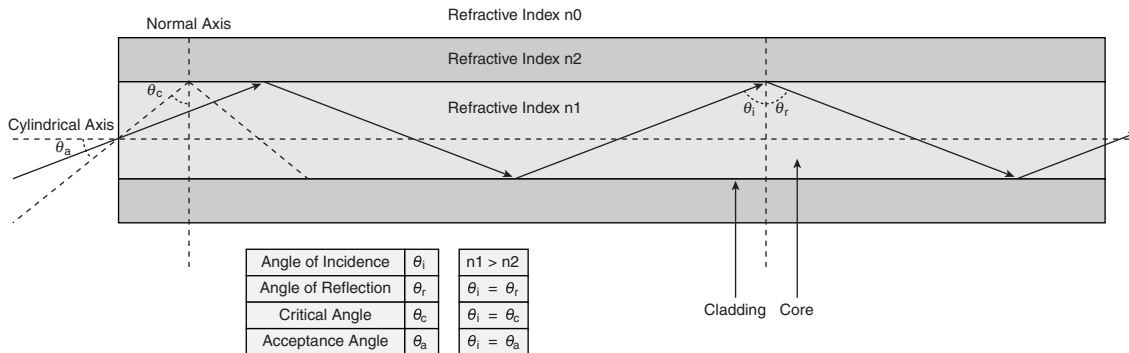

The critical angle is fixed by the indices of refraction of the core and cladding and is computed using the following formula:

$$\theta_c = \cos^{-1} (n_2/n_1)$$

The critical angle can be measured from the normal or cylindrical axis of the core. If $n_1 = 1.557$ and $n_2 = 1.343$, for example, the critical angle is 30.39 degrees.

Figure 3-2 shows a light ray entering the core from the outside air to the left of the cable. Light must enter the core from the air at an angle less than an entity known as the acceptance angle (θ_a):

$$\theta_a = \sin^{-1} [(n_1/n_0) \sin(\theta_c)]$$

In the formula, n_0 is the refractive index of air and is equal to one. This angle is measured from the cylindrical axis of the core. In the preceding example, the acceptance angle is 51.96 degrees.

The optical fiber also has a numerical aperture (NA). The NA is given by the following formula:

$$NA = \sin \theta_a = \sqrt{(n_1^2 - n_2^2)}$$

From a three-dimensional perspective, to ensure that the signals reflect and travel correctly through the core, the light must enter the core through an acceptance cone derived by rotating the acceptance angle about the cylindrical fiber axis. As illustrated in Figure 3-3, the size of the acceptance cone is a function of the refractive index difference between the core and the cladding. There is a maximum angle from the fiber axis at which light can enter the fiber so that it will propagate, or travel, in the core of the fiber. The sine of this maximum angle is the NA of the fiber. The NA in the preceding example is 0.787. Fiber with a larger NA requires less precision to splice and work with than fiber with a smaller NA. Single-mode fiber has a smaller NA than MMF.

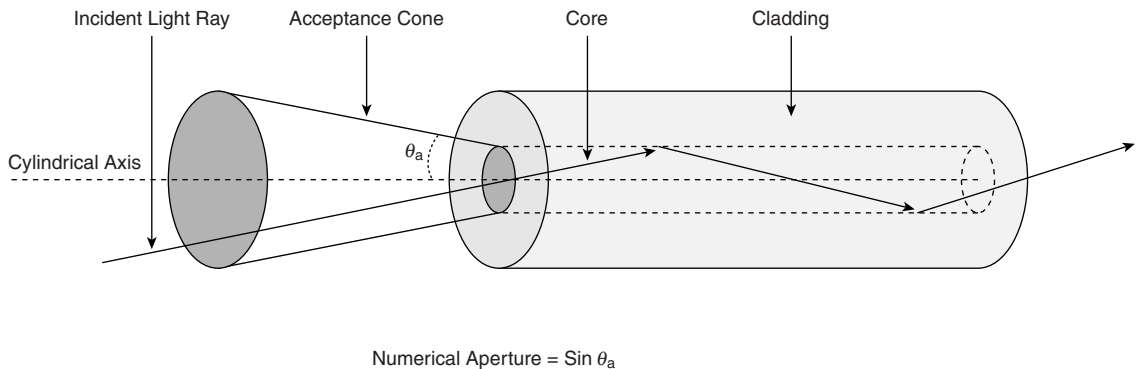
Figure 3-3 *Acceptance Cone*

Performance Considerations

The amount of light that can be coupled into the core through the external acceptance angle is directly proportional to the efficiency of the fiber-optic cable. The greater the amount of light that can be coupled into the core, the lower the bit error rate (BER), because more light reaches the receiver. The attenuation a light ray experiences in propagating down the core is inversely proportional to the efficiency of the optical cable because the lower the attenuation in propagating down the core, the lower the BER. This is because more light reaches the receiver. Also, the less chromatic dispersion realized in propagating down the core, the faster the signaling rate and the higher the end-to-end data rate from source to destination. The major factors that affect performance considerations described in this paragraph are the size of the fiber, the composition of the fiber, and the mode of propagation.

Optical-Power Measurement

The power level in optical communications is of too wide a range to express on a linear scale. A logarithmic scale known as decibel (dB) is used to express power in optical communications.

The wide range of power values makes decibel a convenient unit to express the power levels that are associated with an optical system. The gain of an amplifier or attenuation in fiber is expressed in decibels. The decibel does not give a magnitude of power, but it is a ratio of the output power to the input power.

$$\text{Loss or gain} = 10 \log_{10}(\text{POUTPUT}/\text{PINPUT})$$

The decibel milliwatt (dBm) is the power level related to 1 milliwatt (mW). Transmitter power and receiver dynamic ranges are measured in dBm. A 1-mW signal has a level of 0 dBm.

Signals weaker than 1 mW have negative dBm values, whereas signals stronger than 1 mW have positive dBm values.

$$\text{dBm} = 10 \log_{10}(\text{Power(mW)}/1(\text{mW}))$$

Optical-Cable Construction

The core is the highly refractive central region of an optical fiber through which light is transmitted. The standard telecommunications core diameter in use with SMF is between $8\ \mu\text{m}$ and $10\ \mu\text{m}$, whereas the standard core diameter in use with MMF is between $50\ \mu\text{m}$ and $62.5\ \mu\text{m}$. Figure 3-4 shows the core diameter for SMF and MMF cable. The diameter of the cladding surrounding each of these cores is $125\ \mu\text{m}$. Core sizes of $85\ \mu\text{m}$ and $100\ \mu\text{m}$ were used in early applications, but are not typically used today. The core and cladding are manufactured together as a single solid component of glass with slightly different compositions and refractive indices. The third section of an optical fiber is the outer protective coating known as the *coating*. The coating is typically an ultraviolet (UV) light-cured acrylate applied during the manufacturing process to provide physical and environmental protection for the fiber. The buffer coating could also be constructed out of one or more layers of polymer, nonporous hard elastomers or high-performance PVC materials. The coating does not have any optical properties that might affect the propagation of light within the fiber-optic cable. During the installation process, this coating is stripped away from the cladding to allow proper termination to an optical transmission system. The coating size can vary, but the standard sizes are $250\ \mu\text{m}$ and $900\ \mu\text{m}$. The $250\text{-}\mu\text{m}$ coating takes less space in larger outdoor cables. The $900\text{-}\mu\text{m}$ coating is larger and more suitable for smaller indoor cables.

Figure 3-4 *Optical-Cable Construction*

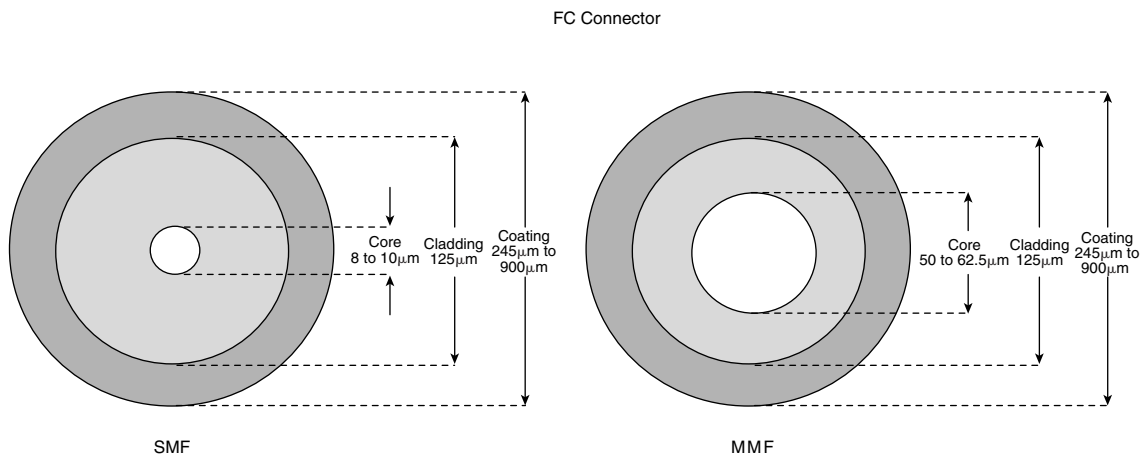

Fiber-optic cable sizes are usually expressed by first giving the core size followed by the cladding size. Consequently, 50/125 indicates a core diameter of 50 microns and a cladding diameter of 125 microns, and 8/125 indicates a core diameter of 8 microns and a cladding diameter of 125 microns. The larger the core, the more light can be coupled into it from the external acceptance angle cone. However, larger-diameter cores can actually allow in too much light, which can cause receiver saturation problems. The 8/125 cable is often used when a fiber-optic data link operates with single-mode propagation, whereas the 62.5/125 cable is often used in a fiber-optic data link that operates with multimode propagation.

Three types of material make up fiber-optic cables:

- Glass
- Plastic
- Plastic-clad silica (PCS)

These three cable types differ with respect to attenuation. Attenuation is principally caused by two physical effects: absorption and scattering. Absorption removes signal energy in the interaction between the propagating light (photons) and molecules in the core. Scattering redirects light out of the core to the cladding. When attenuation for a fiber-optic cable is dealt with quantitatively, it is referenced for operation at a particular optical wavelength, a window, where it is minimized. The most common peak wavelengths are 780 nm, 850 nm, 1310 nm, 1550 nm, and 1625 nm. The 850-nm region is referred to as the *first window* (as it was used initially because it supported the original LED and detector technology). The 1310-nm region is referred to as the *second window*, and the 1550-nm region is referred to as the *third window*.

Glass Fiber-Optic Cable

Glass fiber-optic cable has the lowest attenuation. A pure-glass, fiber-optic cable has a glass core and a glass cladding. This cable type has, by far, the most widespread use. It has been the most popular with link installers, and it is the type of cable with which installers have the most experience. The glass used in a fiber-optic cable is ultra-pure, ultra-transparent, silicon dioxide, or fused quartz. During the glass fiber-optic cable fabrication process, impurities are purposely added to the pure glass to obtain the desired indices of refraction needed to guide light.

Germanium, titanium, or phosphorous is added to increase the index of refraction. Boron or fluorine is added to decrease the index of refraction. Other impurities might somehow remain in the glass cable after fabrication. These residual impurities can increase the attenuation by either scattering or absorbing light.

Plastic Fiber-Optic Cable

Plastic fiber-optic cable has the highest attenuation among the three types of cable. Plastic fiber-optic cable has a plastic core and cladding. This fiber-optic cable is quite thick. Typical dimensions are 480/500, 735/750, and 980/1000. The core generally consists of polymethylmethacrylate (PMMA) coated with a fluropolymer. Plastic fiber-optic cable was pioneered principally for use in the automotive industry. The higher attenuation relative to glass might not be a serious obstacle with the short cable runs often required in premise data networks. The cost advantage of plastic fiber-optic cable is of interest to network architects when they are faced with budget decisions. Plastic fiber-optic cable does have a problem with flammability. Because of this, it might not be appropriate for certain environments and care has to be taken when it is run through a plenum. Otherwise, plastic fiber is considered extremely rugged with a tight bend radius and the capability to withstand abuse.

Plastic-Clad Silica (PCS) Fiber-Optic Cable

The attenuation of PCS fiber-optic cable falls between that of glass and plastic. PCS fiber-optic cable has a glass core, which is often vitreous silica, and the cladding is plastic, usually a silicone elastomer with a lower refractive index. PCS fabricated with a silicone elastomer cladding suffers from three major defects. First, it has considerable plasticity, which makes connector application difficult. Second, adhesive bonding is not possible. And third, it is practically insoluble in organic solvents. These three factors keep this type of fiber-optic cable from being particularly popular with link installers. However, some improvements have been made in recent years.

NOTE

For data center premise cables, the jacket color depends on the fiber type in the cable. For cables containing SMFs, the jacket color is typically yellow, whereas for cables containing MMFs, the jacket color is typically orange. For outside plant cables, the standard jacket color is typically black.

Multifiber Cable Systems

Multifiber systems are constructed with strength members that resist crushing during cable pulling and bends. The outer cable jackets are OFNR (riser rated), OFNP (plenum rated), or LSZH (low-smoke, zero-halogen rated). The OFNR outer jackets are composed of flame-retardant PVC or fluoropolymers. The OFNP jackets are composed of plenum PVC, whereas the LSZH jackets are halogen-free and constructed out of polyolefin compounds. Figure 3-5 shows a multiribbon, 24-fiber, ribbon-cable system. Ribbon cables are extensively used for inside plant and datacenter applications. Individual ribbon subunit cables use the MTP/MPO connector assemblies. Ribbon cables have a flat ribbon-like structure that enables installers to save conduit space as they install more cables in a particular conduit.

Figure 3-5 *Inside Plant Ribbon-Cable System*

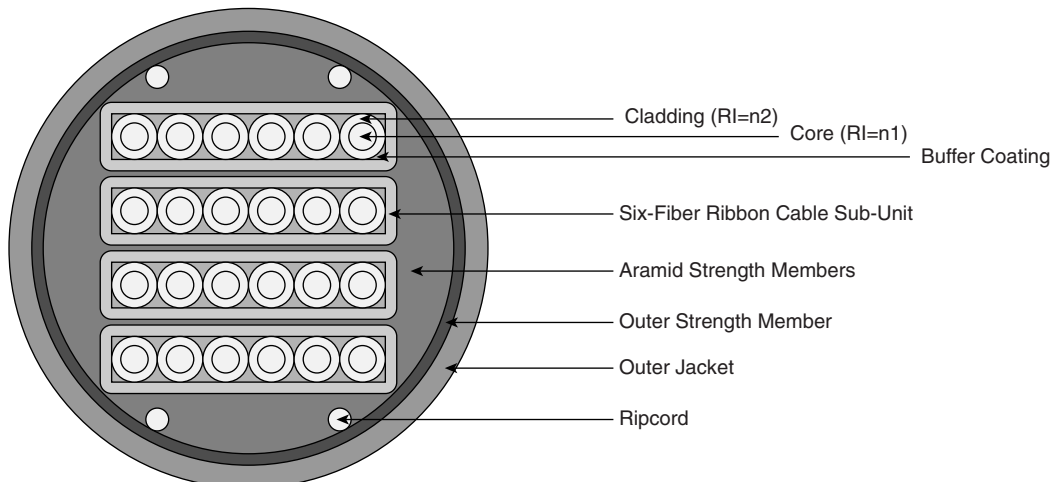

Figure 3-6 shows a typical six-fiber, inside-plant cable system. The central core is composed of a dielectric strength member with a dielectric jacket. The individual fibers are positioned around the dielectric strength member. The individual fibers have a strippable buffer coating. Typically, the strippable buffer is a 900- μm tight buffer. Each individual coated fiber is surrounded with a subunit jacket. Aramid yarn strength members surround the individual subunits. Some cable systems have an outer strength member that provides protection to the entire enclosed fiber system. Kevlar is a typical material used for constructing the outer strength member for premise cable systems. The outer jacket is OFNP, OFNR, or LSZH.

Figure 3-6 *Cross Section of Inside-Plant Cables*

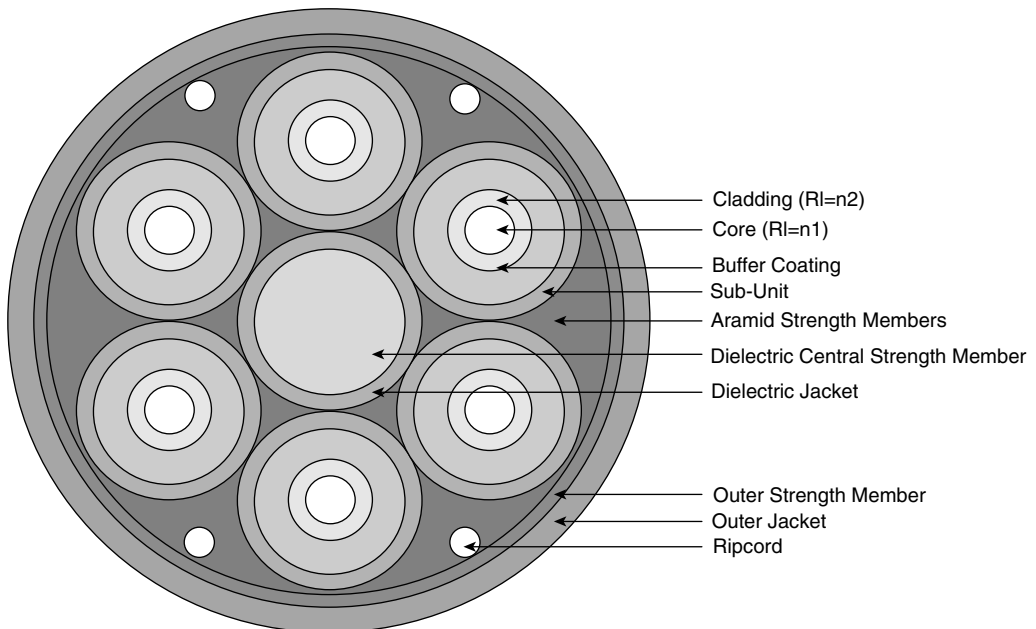
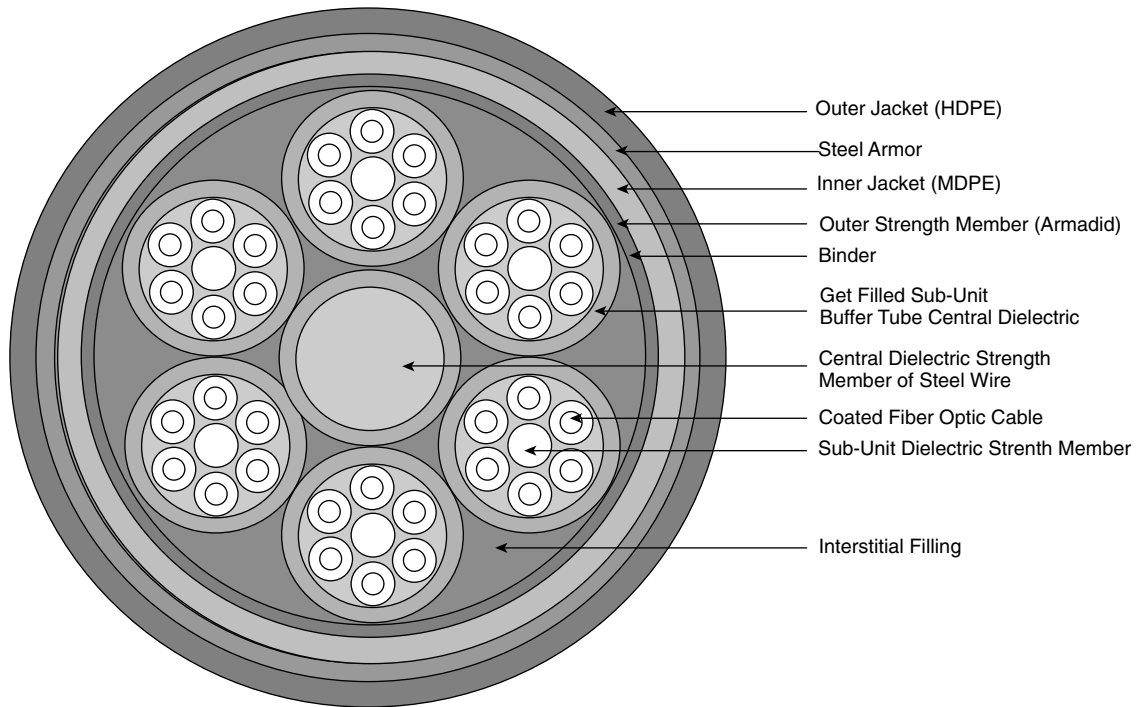

Figure 3-7 shows a typical armored outside-plant cable system. The central core is composed of a dielectric with a dielectric jacket or steel strength member. The individual gel-filled subunit buffer tubes are positioned around the central strength member. Within the subunit buffer tube, six fibers are positioned around an optional dielectric strength member. The individual fibers have a strippable buffer coating. All six subunit buffer tubes are enclosed within a binder that contains an interstitial filling or water-blocking compound. An outer strength member, typically constructed of aramid Kevlar strength members encloses the binder. The outer strength member is surrounded by an inner medium-density polyethylene (MDPE) jacket. The corrugated steel armor layer between the outer high-density polyethylene (HDPE) jacket, and the inner MDPE

jacket acts as an external strength member and provides physical protection. Conventional deep-water submarine cables use dual armor and a special hermetically sealed copper tube to protect the fibers from the effects of deep-water environments. However, shallow-water applications use cables similar to those shown in Figure 3-7 with an asphalt compound interstitial filling.

Figure 3-7 *Cross Section of an Armored Outside-Plant Cable*



Propagation Modes

Fiber-optic cable has two propagation modes: multimode and single mode. They perform differently with respect to both attenuation and time dispersion. The single-mode fiber-optic cable provides much better performance with lower attenuation. To understand the difference between these types, you must understand what is meant by “mode of propagation.”

Light has a dual nature and can be viewed as either a wave phenomenon or a particle phenomenon that includes photons and solitons. Solitons are special localized waves that exhibit particle-like behavior. For this discussion, let’s consider the wave mechanics of light. When the light wave is guided down a fiber-optic cable, it exhibits certain modes. These are variations in the intensity

of the light, both over the cable cross section and down the cable length. These modes are actually numbered from lowest to highest. In a very simple sense, each of these modes can be thought of as a ray of light. For a given fiber-optic cable, the number of modes that exist depends on the dimensions of the cable and the variation of the indices of refraction of both core and cladding across the cross section. The various modes include multimode step index, single-mode step index, single-mode dual-step index, and multimode graded index.

Multimode Step Index

Consider the illustration in Figure 3-8. This diagram corresponds to multimode propagation with a refractive index profile that is called *step index*. As you can see, the diameter of the core is fairly large relative to the cladding. There is also a sharp discontinuity in the index of refraction as you go from core to cladding. As a result, when light enters the fiber-optic cable on the left, it propagates down toward the right in multiple rays or multiple modes. This yields the designation multimode. As indicated, the lowest-order mode travels straight down the center. It travels along the cylindrical axis of the core. The higher modes, represented by rays, bounce back and forth, going down the cable to the left. The higher the mode, the more bounces per unit distance down to the right.

Figure 3-8 *Multimode Step Index*

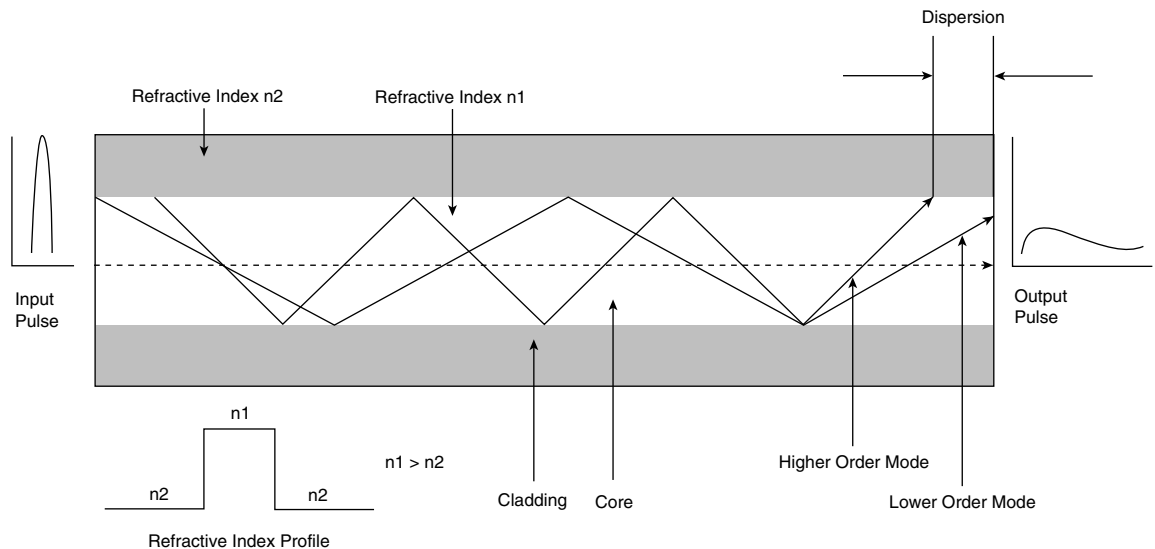

The illustration also shows the input pulse and the resulting output pulse. Note that the output pulse is significantly attenuated relative to the input pulse. It also suffers significant time dispersion. The reasons for this are as follows. The higher-order modes, the bouncing rays, tend to leak into the cladding as they propagate down the fiber-optic cable. They lose some of their

energy into heat. This results in an attenuated output signal. The input pulse is split among the different rays that travel down the fiber-optic cable. The bouncing rays and the lowest-order mode, traveling down the center axis, are all traversing paths of different lengths from input to output. Consequently, they do not all reach the right end of the fiber-optic cable at the same time. When the output pulse is constructed from these separate ray components, the result is chromatic dispersion.

Fiber-optic cable that exhibits multimode propagation with a step index profile is thereby characterized as having higher attenuation and more time dispersion than the other propagation candidates. However, it is also the least costly and is widely used in the premises environment. It is especially attractive for link lengths up to 5 kilometers. It can be fabricated either from glass, plastic, or PCS. Usually, MMF core diameters are 50 or 62.5 μm . Typically, 50- μm MMF propagates only 300 modes as compared to 1100 modes for 62.5- μm fiber. The 50- μm MMF supports 1 Gbps at 850-nm wavelengths for distances up to 1 kilometer versus 275 meters for 62.5- μm MMF. Furthermore, 50- μm MMF supports 10 Gbps at 850-nm wavelengths for distances up to 300 meters versus 33 meters for 62.5- μm MMF. This makes 50- μm MMF the fiber of choice for low-cost, high-bandwidth campus and multitenant unit (MTU) applications.

Single-Mode Step Index

Single-mode propagation is illustrated in Figure 3-9. This diagram corresponds to single-mode propagation with a refractive index profile that is called *step index*. As the figure shows, the diameter of the core is fairly small relative to the cladding. Because of this, when light enters the fiber-optic cable on the left, it propagates down toward the right in just a single ray, a single mode, which is the lowest-order mode. In extremely simple terms, this lowest-order mode is confined to a thin cylinder around the axis of the core. The higher-order modes are absent.

Figure 3-9 *Single-Mode Step Index*

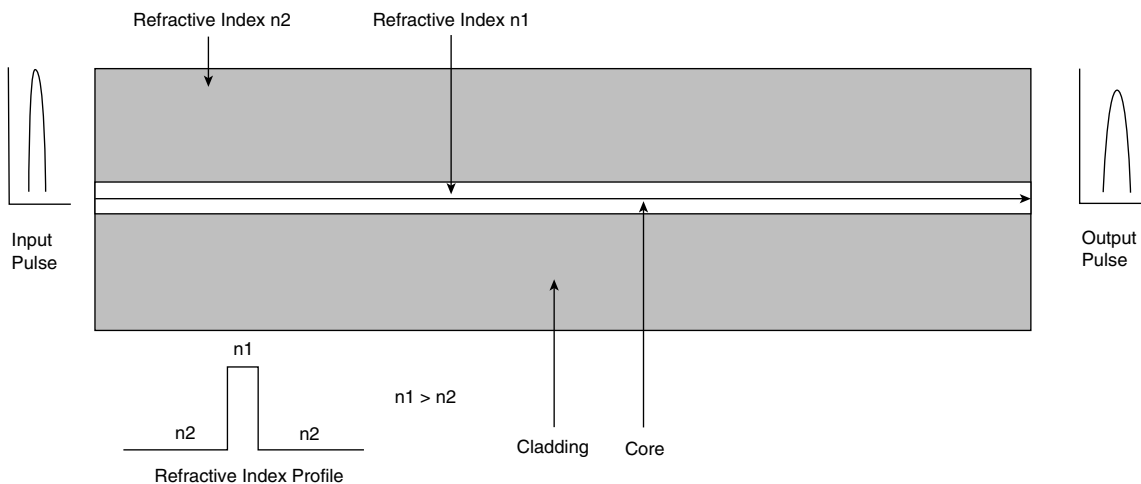

Consequently, extremely little or no energy is lost to heat through the leakage of the higher modes into the cladding, because they are not present. All energy is confined to this single, lowest-order mode. Because the higher-order mode energy is not lost, attenuation is not significant. Also, because the input signal is confined to a single ray path, that of the lowest-order mode, very little chromatic dispersion occurs. Single-mode propagation exists only above a certain specific wavelength called the *cutoff wavelength*.

The cutoff wavelength is the smallest operating wavelength when SMFs propagate only the fundamental mode. At this wavelength, the second-order mode becomes lossy and radiates out of the fiber core. As the operating wavelength becomes longer than the cutoff wavelength, the fundamental mode becomes increasingly lossy. The higher the operating wavelength is above the cutoff wavelength, the more power is transmitted through the fiber cladding. As the fundamental mode extends into the cladding material, it becomes increasingly sensitive to bending loss. Comparing the output pulse and the input pulse, note that there is little attenuation and time dispersion. Lower chromatic dispersion results in higher bandwidth. However, single-mode fiber-optic cable is also the most costly in the premises environment. For this reason, it has been used more with metropolitan- and wide-area networks than with premises data communications. Single-mode fiber-optic cable has also been getting increased attention as local-area networks have been extended to greater distances over corporate campuses. The core diameter for this type of fiber-optic cable is exceedingly small, ranging from 8 microns to 10 microns. The standard cladding diameter is 125 microns.

SMF step index fibers are manufactured using the outside vapor deposition (OVD) process. OVD fibers are made of a core and cladding, each with slightly different compositions and refractive indices. The OVD process produces consistent, controlled fiber profiles and geometry. Fiber consistency is important, to produce seamless spliced interconnections using fiber-optic cable from different manufacturers. Single-mode fiber-optic cable is fabricated from silica glass. Because of the thickness of the core, plastic cannot be used to fabricate single-mode fiber-optic cable. Note that not all SMFs use a step index profile. Some SMF variants use a graded index method of construction to optimize performance at a particular wavelength or transmission band.

Single-Mode Dual-Step Index

These fibers are single-mode and have a dual cladding. Depressed-clad fiber is also known as *doubly clad fiber*. Figure 3-10 corresponds to single-mode propagation with a refractive index profile that is called *dual-step index*. A depressed-clad fiber has the advantage of very low macrobending losses. It also has two zero-dispersion points and low dispersion over a much wider wavelength range than a singly clad fiber. SMF depressed-clad fibers are manufactured using the inside vapor deposition (IVD) process. The IVD or modified chemical vapor deposition (MCVD) process produces what is called *depressed-clad fiber* because of the shape of its refractive index profile, with the index of the glass adjacent to the core depressed. Each cladding

has a refractive index that is lower than that of the core. The inner cladding has a lower refractive index than the outer cladding.

Figure 3-10 *Single-Mode Dual-Step Index*

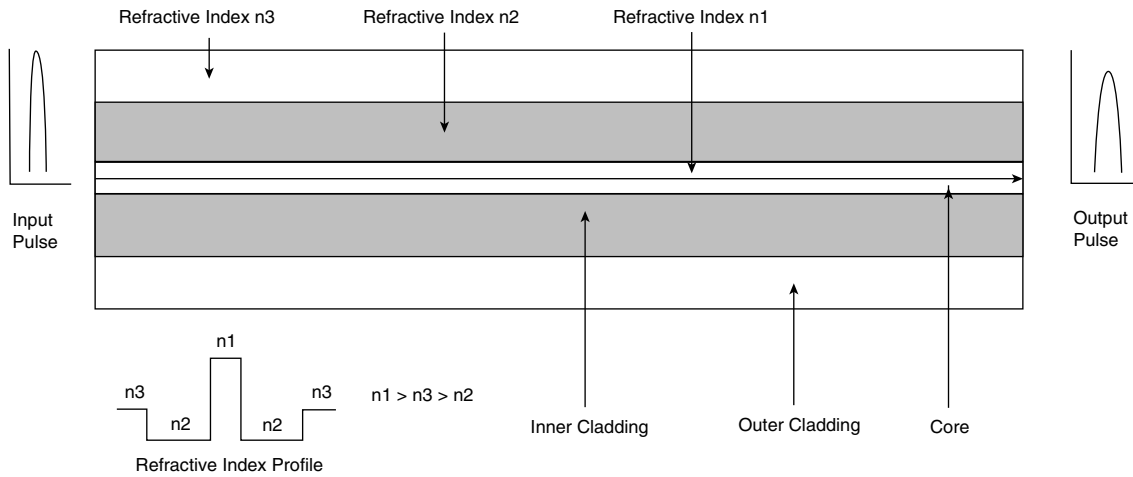

Multimode Graded Index

Multimode graded index fiber has a higher refractive index in the core that gradually reduces as it extends from the cylindrical axis outward. The core and cladding are essentially a single graded unit. Consider the illustration in Figure 3-11. This corresponds to multimode propagation with a refractive index profile that is called *graded index*. Here the variation of the index of refraction is gradual as it extends out from the axis of the core through the core to the cladding. There is no sharp discontinuity in the indices of refraction between core and cladding. The core here is much larger than in the single-mode step index case previously discussed. Multimode propagation exists with a graded index. As illustrated, however, the paths of the higher-order modes are somewhat confined. They appear to follow a series of ellipses. Because the higher-mode paths are confined, the attenuation through them due to leakage is more limited than with a step index. The time dispersion is more limited than with a step index; therefore, attenuation and time dispersion are present, but limited.

In Figure 3-11, the input pulse is shown on the left, and the resulting output pulse is shown on the right. When comparing the output pulse and the input pulse, note that there is some attenuation and time dispersion, but not nearly as much as with multimode step index fiber-optic cable.

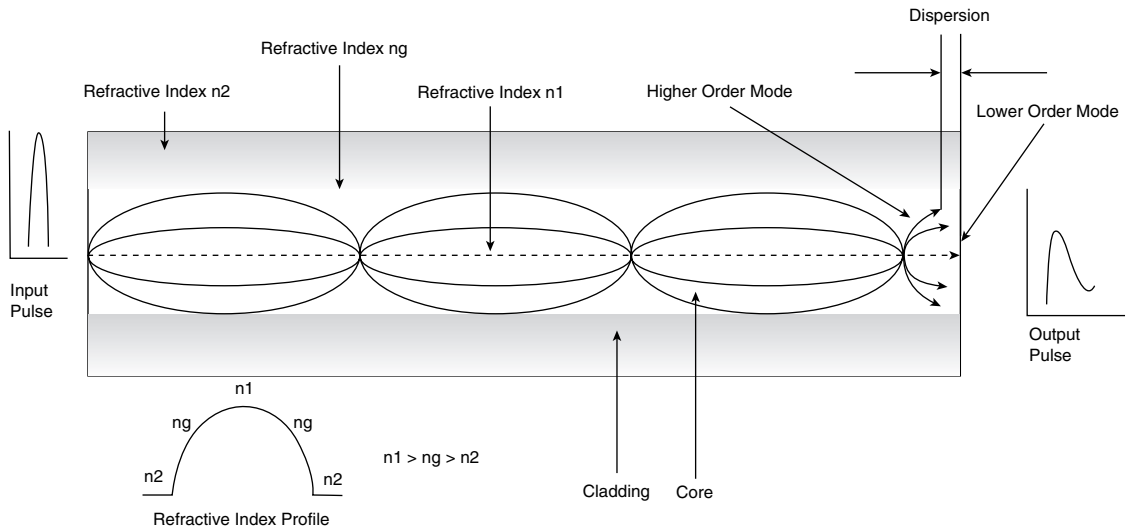
Figure 3-11 *Multimode Graded Index*

Fiber-optic cable that exhibits multimode propagation with a graded index profile is characterized as having levels of attenuation and time-dispersion properties that fall between the other two candidates. Likewise, its cost is somewhere between the other two candidates. Popular graded index fiber-optic cables have core diameters of 50, 62.5, and 85 microns. They have a cladding diameter of 125 microns—the same as single-mode fiber-optic cables. This type of fiber-optic cable is extremely popular in premise data communications applications. In particular, the 62.5/125 fiber-optic cable is the most popular and most widely used in these applications. Glass is generally used to fabricate multimode graded index fiber-optic cable.

Fiber-Optic Characteristics

Optical-fiber systems have many advantages over metallic-based communication systems. These advantages include interference, attenuation, and bandwidth characteristics. Furthermore, the relatively smaller cross section of fiber-optic cables allows room for substantial growth of the capacity in existing conduits. Fiber-optic characteristics can be classified as linear and nonlinear. Nonlinear characteristics are influenced by parameters, such as bit rates, channel spacing, and power levels.

Interference

Light signals traveling via a fiber-optic cable are immune from electromagnetic interference (EMI) and radio-frequency interference (RFI). Lightning and high-voltage interference is also eliminated. A fiber network is best for conditions in which EMI or RFI interference is heavy or safe operation free from sparks and static is a must. This desirable property of fiber-optic cable makes it the medium of choice in industrial and biomedical networks. It is also possible to place fiber cable into natural-gas pipelines and use the pipelines as the conduit.

Linear Characteristics

Linear characteristics include attenuation, chromatic dispersion (CD), polarization mode dispersion (PMD), and optical signal-to-noise ratio (OSNR).

Attenuation

Several factors can cause attenuation, but it is generally categorized as either intrinsic or extrinsic. Intrinsic attenuation is caused by substances inherently present in the fiber, whereas extrinsic attenuation is caused by external forces such as bending. The attenuation coefficient α is expressed in decibels per kilometer and represents the loss in decibels per kilometer of fiber.

Intrinsic Attenuation

Intrinsic attenuation results from materials inherent to the fiber. It is caused by impurities in the glass during the manufacturing process. As precise as manufacturing is, there is no way to eliminate all impurities. When a light signal hits an impurity in the fiber, one of two things occurs: It scatters or it is absorbed. Intrinsic loss can be further characterized by two components:

- Material absorption
- Rayleigh scattering

Material Absorption Material absorption occurs as a result of the imperfection and impurities in the fiber. The most common impurity is the hydroxyl (OH-) molecule, which remains as a residue despite stringent manufacturing techniques. Figure 3-12 shows the variation of attenuation with wavelength measured over a group of fiber-optic cable material types. The three principal windows of operation include the 850-nm, 1310-nm, and 1550-nm wavelength bands. These correspond to wavelength regions in which attenuation is low and matched to the capability of a transmitter to generate light efficiently and a receiver to carry out detection.

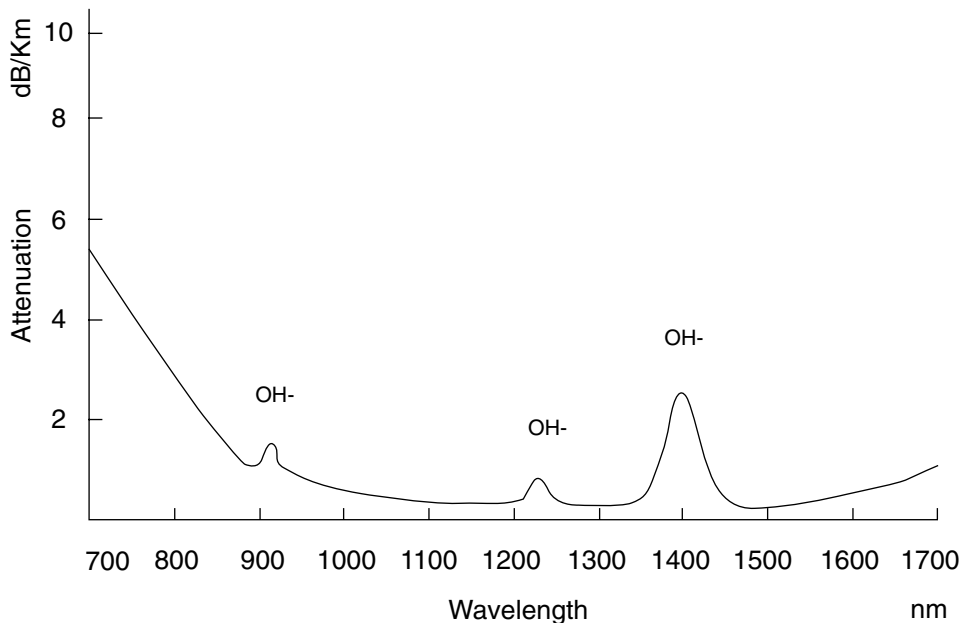
Figure 3-12 Attenuation Versus Wavelength

The OH- symbols indicate that at the 950-nm, 1380-nm, and 2730-nm wavelengths, the presence of hydroxyl radicals in the cable material causes an increase in attenuation. These radicals result from the presence of water remnants that enter the fiber-optic cable material through either a chemical reaction in the manufacturing process or as humidity in the environment. The variation of attenuation with wavelength due to the *water peak* for standard, single-mode fiber-optic cable occurs mainly around 1380 nm. Recent advances in manufacturing have overcome the 1380-nm water peak and have resulted in zero-water-peak fiber (ZWPF). Examples of these fibers include SMF-28e from Corning and the Furukawa-Lucent OFS AllWave. Absorption accounts for three percent to five percent of fiber attenuation. This phenomenon causes a light signal to be absorbed by natural impurities in the glass and converted to vibration energy or some other form of energy such as heat. Unlike scattering, absorption can be limited by controlling the amount of impurities during the manufacturing process. Because most fiber is extremely pure, the fiber does not heat up because of absorption.

Rayleigh Scattering As light travels in the core, it interacts with the silica molecules in the core. Rayleigh scattering is the result of these elastic collisions between the light wave and the silica molecules in the fiber. Rayleigh scattering accounts for about 96 percent of attenuation in optical fiber. If the scattered light maintains an angle that supports forward travel within the core, no attenuation occurs. If the light is scattered at an angle that does not support continued forward travel, however, the light is diverted out of the core and attenuation occurs. Depending

on the incident angle, some portion of the light propagates forward and the other part deviates out of the propagation path and escapes from the fiber core. Some scattered light is reflected back toward the light source. This is a property that is used in an optical time domain reflectometer (OTDR) to test fibers. The same principle applies to analyzing loss associated with localized events in the fiber, such as splices.

Short wavelengths are scattered more than longer wavelengths. Any wavelength that is below 800 nm is unusable for optical communication because attenuation due to Rayleigh scattering is high. At the same time, propagation above 1700 nm is not possible due to high losses resulting from infrared absorption.

Extrinsic Attenuation

Extrinsic attenuation can be caused by two external mechanisms: macrobending or microbending. Both cause a reduction of optical power. If a bend is imposed on an optical fiber, strain is placed on the fiber along the region that is bent. The bending strain affects the refractive index and the critical angle of the light ray in that specific area. As a result, light traveling in the core can refract out, and loss occurs.

A macrobend is a large-scale bend that is visible, and the loss is generally reversible after bends are corrected. To prevent macrobends, all optical fiber has a minimum bend radius specification that should not be exceeded. This is a restriction on how much bend a fiber can withstand before experiencing problems in optical performance or mechanical reliability.

The second extrinsic cause of attenuation is a microbend. Microbending is caused by imperfections in the cylindrical geometry of fiber during the manufacturing process. Microbending might be related to temperature, tensile stress, or crushing force. Like macrobending, microbending causes a reduction of optical power in the glass. Microbending is very localized, and the bend might not be clearly visible on inspection. With bare fiber, microbending can be reversible.

Chromatic Dispersion

Chromatic dispersion is the spreading of a light pulse as it travels down a fiber. Light has a dual nature and can be considered from an electromagnetic wave as well as quantum perspective. This enables us to quantify it as waves as well as quantum particles. During the propagation of light, all of its spectral components propagate accordingly. These spectral components travel at different group velocities that lead to dispersion called *group velocity dispersion (GVD)*. Dispersion resulting from GVD is termed *chromatic dispersion* due to its wavelength dependence. The effect of chromatic dispersion is pulse spread.

As the pulses spread, or broaden, they tend to overlap and are no longer distinguishable by the receiver as 0s and 1s. Light pulses launched close together (high data rates) that spread too much (high dispersion) result in errors and loss of information. Chromatic dispersion occurs

as a result of the range of wavelengths present in the light source. Light from lasers and LEDs consists of a range of wavelengths, each of which travels at a slightly different speed. Over distance, the varying wavelength speeds cause the light pulse to spread in time. This is of most importance in single-mode applications. Modal dispersion is significant in multimode applications, in which the various modes of light traveling down the fiber arrive at the receiver at different times, causing a spreading effect. Chromatic dispersion is common at all bit rates. Chromatic dispersion can be compensated for or mitigated through the use of dispersion-shifted fiber (DSF). DSF is fiber doped with impurities that have negative dispersion characteristics. Chromatic dispersion is measured in ps/nm-km. A 1-dB power margin is typically reserved to account for the effects of chromatic dispersion.

Polarization Mode Dispersion

Polarization mode dispersion (PMD) is caused by asymmetric distortions to the fiber from a perfect cylindrical geometry. The fiber is not truly a cylindrical waveguide, but it can be best described as an imperfect cylinder with physical dimensions that are not perfectly constant. The mechanical stress exerted upon the fiber due to extrinsically induced bends and stresses caused during cabling, deployment, and splicing as well as the imperfections resulting from the manufacturing process are the reasons for the variations in the cylindrical geometry.

Single-mode optical fiber and components support one fundamental mode, which consists of two orthogonal polarization modes. This asymmetry introduces small refractive index differences for the two polarization states. This characteristic is known as *birefringence*. Birefringence causes one polarization mode to travel faster than the other, resulting in a difference in the propagation time, which is called the *differential group delay (DGD)*. DGD is the unit that is used to describe PMD. DGD is typically measured in picoseconds. A fiber that acquires birefringence causes a propagating pulse to lose the balance between the polarization components. This leads to a stage in which different polarization components travel at different velocities, creating a pulse spread as shown in Figure 3-13. PMD can be classified as first-order PMD, also known as DGD, and second-order PMD (SOPMD). The SOPMD results from dispersion that occurs because of the signal's wavelength dependence and spectral width.

PMD is not an issue at low bit rates but becomes an issue at bit rates in excess of 5 Gbps. PMD is noticeable at high bit rates and is a significant source of impairment for ultra-long-haul systems. PMD compensation can be achieved by using PMD compensators that contain dispersion-maintaining fibers with degrees of birefringence in them. The introduced birefringence negates the effects of PMD over a length of transmission. For error-free transmission, PMD compensation is a useful technique for long-haul and metropolitan-area networks running at bit rates greater than 10 Gbps. Note in Figure 3-13 that the DGD is the difference between Z_1 and Z_2 . The PMD value of the fiber is the mean value over time or frequency of the DGD and is represented as ps/ $\sqrt{\text{km}}$. A 0.5-dB power margin is typically reserved to account for the effects of PMD at high bit rates.

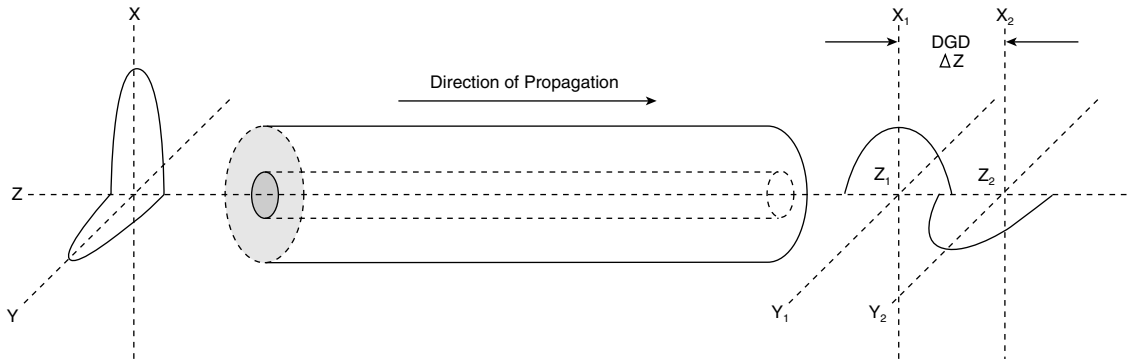
Figure 3-13 Polarization Mode Dispersion

Polarization Dependent Loss

Polarization dependent loss (PDL) refers to the difference in the maximum and minimum variation in transmission or insertion loss of an optical device over all states of polarization (SOP) and is expressed in decibels. A typical PDL for a simple optical connector is less than .05 dB and varies from component to component. Typically, the PDL for an optical add/drop multiplexer (OADM) is around 0.3 dB. The complete polarization characterization of optical signals and components can be determined using an optical polarization analyzer.

Optical Signal-to-Noise Ratio

The optical signal-to-noise ratio (OSNR) specifies the ratio of the net signal power to the net noise power and thus identifies the quality of the signal. Attenuation can be compensated for by amplifying the optical signal. However, optical amplifiers amplify the signal as well as the noise. Over time and distance, the receivers cannot distinguish the signal from the noise, and the signal is completely lost. Regeneration helps mitigate these undesirable effects before they can render the system unusable and ensures that the signal can be detected at the receiver. Optical amplifiers add a certain amount of noise to the channel. Active devices, such as lasers, also add noise. Passive devices, such as taps and the fiber, can also add noise components. In the calculation of system design, however, optical amplifier noise is considered the predominant source for OSNR penalty and degradation.

OSNR is an important and fundamental system design consideration. Another parameter considered by designers is the Q-factor. The Q-factor, a function of the OSNR, provides a qualitative description of the receiver performance. The Q-factor suggests the minimum signal-to-noise ratio (SNR) required to obtain a specific BER for a given signal. OSNR is measured in decibels. The higher the bit rate, the higher the OSNR ratio required. For OC-192 transmissions, the OSNR should be at least 27 to 31 dB compared to 18 to 21 dB for OC-48.

Nonlinear Characteristics

Nonlinear characteristics include self-phase modulation (SPM), cross-phase modulation (XPM), four-wave mixing (FWM), stimulated Raman scattering (SRS), and stimulated Brillouin scattering (SBS).

Self-Phase Modulation

Phase modulation of an optical signal by itself is known as *self-phase modulation (SPM)*. SPM is primarily due to the self-modulation of the pulses. Generally, SPM occurs in single-wavelength systems. At high bit rates, however, SPM tends to cancel dispersion. SPM increases with high signal power levels. In fiber plant design, a strong input signal helps overcome linear attenuation and dispersion losses. However, consideration must be given to receiver saturation and to nonlinear effects such as SPM, which occurs with high signal levels. SPM results in phase shift and a nonlinear pulse spread. As the pulses spread, they tend to overlap and are no longer distinguishable by the receiver. The acceptable norm in system design to counter the SPM effect is to take into account a power penalty that can be assumed equal to the negative effect posed by XPM. A 0.5-dB power margin is typically reserved to account for the effects of SPM at high bit rates and power levels.

Cross-Phase Modulation

Cross-phase modulation (XPM) is a nonlinear effect that limits system performance in wavelength-division multiplexed (WDM) systems. XPM is the phase modulation of a signal caused by an adjacent signal within the same fiber. XPM is related to the combination (dispersion/effective area). CPM results from the different carrier frequencies of independent channels, including the associated phase shifts on one another. The induced phase shift is due to the *walkover* effect, whereby two pulses at different bit rates or with different group velocities walk across each other. As a result, the slower pulse sees the walkover and induces a phase shift. The total phase shift depends on the net power of all the channels and on the bit output of the channels. Maximum phase shift is produced when bits belonging to high-powered adjacent channels walk across each other.

XPM can be mitigated by carefully selecting unequal bit rates for adjacent WDM channels. XPM, in particular, is severe in long-haul WDM networks, and the acceptable norm in system design to counter this effect is to take into account a power penalty that can be assumed equal to the negative effect posed by XPM. A 0.5-dB power margin is typically reserved to account for the effects of XPM in WDM fiber systems.

Four-Wave Mixing

FWM can be compared to the intermodulation distortion in standard electrical systems. When three wavelengths (λ_1 , λ_2 , and λ_3) interact in a nonlinear medium, they give rise to a fourth

wavelength (λ_4), which is formed by the scattering of the three incident photons, producing the fourth photon. This effect is known as *four-wave mixing (FWM)* and is a fiber-optic characteristic that affects WDM systems.

The effects of FWM are pronounced with decreased channel spacing of wavelengths and at high signal power levels. High chromatic dispersion also increases FWM effects. FWM also causes interchannel cross-talk effects for equally spaced WDM channels. FWM can be mitigated by using uneven channel spacing in WDM systems or nonzero dispersion-shifted fiber (NZDSF). A 0.5-dB power margin is typically reserved to account for the effects of FWM in WDM systems.

Stimulated Raman Scattering

When light propagates through a medium, the photons interact with silica molecules during propagation. The photons also interact with themselves and cause scattering effects, such as stimulated Raman scattering (SRS), in the forward and reverse directions of propagation along the fiber. This results in a sporadic distribution of energy in a random direction.

SRS refers to lower wavelengths pumping up the amplitude of higher wavelengths, which results in the higher wavelengths suppressing signals from the lower wavelengths. One way to mitigate the effects of SRS is to lower the input power. In SRS, a low-wavelength wave called *Stoke's wave* is generated due to the scattering of energy. This wave amplifies the higher wavelengths. The gain obtained by using such a wave forms the basis of Raman amplification. The Raman gain can extend most of the operating band (C- and L-band) for WDM networks. SRS is pronounced at high bit rates and high power levels. The margin design requirement to account for SRS/SBS is 0.5 dB.

Stimulated Brillouin Scattering

Stimulated Brillouin scattering (SBS) is due to the acoustic properties of photon interaction with the medium. When light propagates through a medium, the photons interact with silica molecules during propagation. The photons also interact with themselves and cause scattering effects such as SBS in the reverse direction of propagation along the fiber. In SBS, a low-wavelength wave called *Stoke's wave* is generated due to the scattering of energy. This wave amplifies the higher wavelengths. The gain obtained by using such a wave forms the basis of Brillouin amplification. The Brillouin gain peaks in a narrow peak near the C-band. SBS is pronounced at high bit rates and high power levels. The margin design requirement to account for SRS/SBS is 0.5 dB.

Fiber Types

This section discusses various MMF and SMF types currently used for premise, metro, aerial, submarine, and long-haul applications. The International Telecommunication Union (ITU-T),

which is a global standardization body for telecommunication systems and vendors, has standardized various fiber types. These include the 50/125- μm graded index fiber (G.651), Nondispersion-shifted fiber (G.652), dispersion-shifted fiber (G.653), 1550-nm loss-minimized fiber (G.654), and NZDSF (G.655).

Multimode Fiber with a 50-Micron Core (ITU-T G.651)

The ITU-T G.651 is an MMF with a 50- μm nominal core diameter and a 125- μm nominal cladding diameter with a graded refractive index. The attenuation parameter for G.651 fiber is typically 0.8 dB/km at 1310 nm. The main application for ITU-T G.651 fiber is for short-reach optical transmission systems. This fiber is optimized for use in the 1300-nm band. It can also operate in the 850-nm band.

Nondispersion-Shifted Fiber (ITU-T G.652)

The ITU-T G.652 fiber is also known as standard SMF and is the most commonly deployed fiber. This fiber has a simple step-index structure and is optimized for operation in the 1310-nm band. It has a zero-dispersion wavelength at 1310 nm and can also operate in the 1550-nm band, but it is not optimized for this region. The typical chromatic dispersion at 1550 nm is high at 17 ps/nm-km. Dispersion compensation must be employed for high-bit-rate applications. The attenuation parameter for G.652 fiber is typically 0.2 dB/km at 1550 nm, and the PMD parameter is less than 0.1 ps/ $\sqrt{\text{km}}$. An example of this type of fiber is Corning SMF-28.

Low Water Peak Nondispersion-Shifted Fiber (ITU-T G.652.C)

The legacy ITU-T G.652 standard SMFs are not optimized for WDM applications due to the high attenuation around the water peak region. ITU G.652.C-compliant fibers offer extremely low attenuation around the OH peaks. The G.652.C fiber is optimized for networks where transmission occurs across a broad range of wavelengths from 1285 nm to 1625 nm. Although G.652.C-compliant fibers offer excellent capabilities for shorter, unamplified metro and access networks, they do not fully address the needs for 1550-nm transmission. The attenuation parameter for G.652 fiber is typically 0.2 dB/km at 1550 nm, and the PMD parameter is less than 0.1 ps/ $\sqrt{\text{km}}$. An example of this type of fiber is Corning SMF-28e.

Dispersion-Shifter Fiber (ITU-T G.653)

Conventional SMF has a zero-dispersion wavelength that falls near the 1310-nm window band. SMF shows high dispersion values over the range between 1500 nm and 1600 nm (third window band). The trend of shifting the operating transmission wavelength from 1310 nm to 1550 nm initiated the development of a fiber type called *dispersion-shifted fiber (DSF)*. DSF exhibits a zero-dispersion value around the 1550-nm wavelength where the attenuation is minimum. The DSFs are optimized for operating in the region between 1500 to 1600 nm. With

the introduction of WDM systems, however, channels allocated near 1550 nm in DSF are seriously affected by noise induced as a result of nonlinear effects caused by FWM. This initiated the development of NZDSF. Figure 3-14 illustrates the dispersion slope of DSF with respect to SMF and NZDSF. G.53 fiber is rarely deployed any more and has been superseded by G.655.

Figure 3-14 *Fiber Dispersion Slopes*

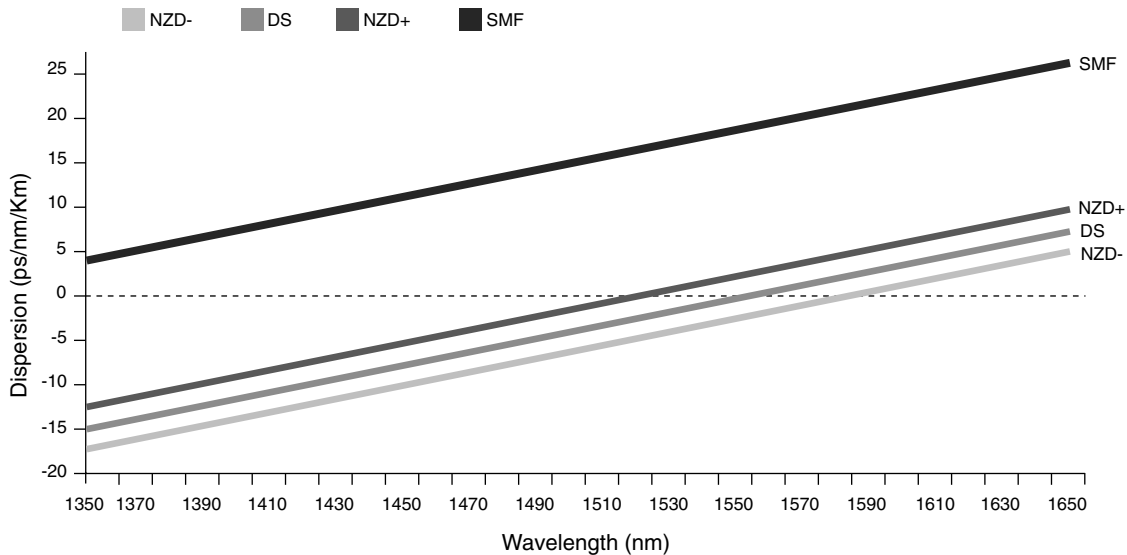

1550-nm Loss-Minimized Fiber (ITU-T G.654)

The ITU-T G.654 fiber is optimized for operation in the 1500-nm to 1600-nm region. This fiber has a low loss in the 1550-nm band. Low loss is achieved by using a pure silica core. ITU-T G.654 fibers can handle higher power levels and have a larger core area. These fibers have a high chromatic dispersion at 1550 nm. The ITU G.654 fiber has been designed for extended long-haul undersea applications.

Nonzero Dispersion Shifted Fiber (ITU-T G.655)

Using nonzero dispersion-shifted fiber (NZDSF) can mitigate nonlinear characteristics. NZDSF fiber overcomes these effects by moving the zero-dispersion wavelength outside the 1550-nm operating window. The practical effect of this is to have a small but finite amount of chromatic dispersion at 1550 nm, which minimizes nonlinear effects, such as FWM, SPM, and XPM, which are seen in the dense wavelength-division multiplexed (DWDM) systems without the need for costly dispersion compensation. There are two fiber families called nonzero dispersion (NZD+ and NZD-), in which the zero-dispersion value falls before and after the 1550-nm

wavelength, respectively. The typical chromatic dispersion for G.655 fiber at 1550 nm is 4.5 ps/nm-km. The attenuation parameter for G.655 fiber is typically 0.2 dB/km at 1550 nm, and the PMD parameter is less than 0.1 ps/ $\sqrt{\text{km}}$. The Corning LEAF fiber is an example of an enhanced G.655 fiber with a 32 percent larger effective area. Figure 3-14 illustrates the dispersion slope of NZDSF with respect to SMF and DSF.

Fiber-Optic Cable Termination

There are many types of optical connectors. The one you use depends on the equipment you are using it with and the application you are using it on. The connector is a mechanical device mounted on the end of a fiber-optic cable, light source, receiver, or housing. The connector allows the fiber-optic cable, light source, receiver, or housing to be mated to a similar device. The connector must direct light and collect light and must be easily attached and detached from equipment. A connector marks a place in the premises fiber-optic data link where signal power can be lost and the BER can be affected by a mechanical connection. Of the many different connector types, those for glass fiber-optic cable and plastic fiber-optic cable are discussed in this chapter. Other considerations for terminations are repeatability of connection and vibration resistance. Physical termination density is another consideration. Commonly used fiber-optic connectors are discussed in the following subsections and are shown in Figure 3-15.

Figure 3-15 *Fiber-Optic Connectors*

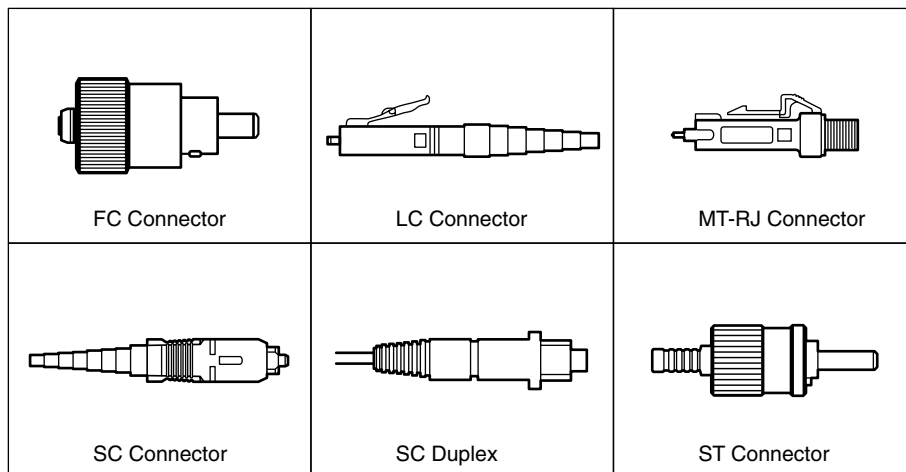

FC Connectors

These connectors are used for single-mode and multimode fiber-optic cables. FC connectors offer extremely precise positioning of the fiber-optic cable with respect to the transmitter's optical source emitter and the receiver's optical detector. FC connectors feature a position

locatable notch and a threaded receptacle. FC connectors are constructed with a metal housing and are nickel-plated. They have ceramic ferrules and are rated for 500 mating cycles. The insertion loss for matched FC connectors is 0.25 dB. From a design perspective, it is recommended to use a loss margin of 0.5 dB or the vendor recommendation for FC connectors.

SC Connectors

SC connectors are used with single-mode and multimode fiber-optic cables. They offer low cost, simplicity, and durability. SC connectors provide for accurate alignment via their ceramic ferrules. An SC connector is a push-on, pull-off connector with a locking tab. Typical matched SC connectors are rated for 1000 mating cycles and have an insertion loss of 0.25 dB. From a design perspective, it is recommended to use a loss margin of 0.5 dB or the vendor recommendation for SC connectors.

ST Connectors

The ST connector is a keyed bayonet connector and is used for both multimode and single-mode fiber-optic cables. It can be inserted into and removed from a fiber-optic cable both quickly and easily. Method of location is also easy. ST connectors come in two versions: ST and ST-II. These are keyed and spring-loaded. They are push-in and twist types. ST connectors are constructed with a metal housing and are nickel-plated. They have ceramic ferrules and are rated for 500 mating cycles. The typical insertion loss for matched ST connectors is 0.25 dB. From a design perspective, it is recommended to use a loss margin of 0.5 dB or the vendor recommendation for ST connectors.

LC Connectors

LC connectors are used with single-mode and multimode fiber-optic cables. The LC connectors are constructed with a plastic housing and provide for accurate alignment via their ceramic ferrules. LC connectors have a locking tab. LC connectors are rated for 500 mating cycles. The typical insertion loss for matched LC connectors is 0.25 dB. From a design perspective, it is recommended to use a loss margin of 0.5 dB or the vendor recommendation for LC connectors.

MT-RJ Connectors

MT-RJ connectors are used with single-mode and multimode fiber-optic cables. The MT-RJ connectors are constructed with a plastic housing and provide for accurate alignment via their metal guide pins and plastic ferrules. MT-RJ connectors are rated for 1000 mating cycles. The typical insertion loss for matched MT-RJ connectors is 0.25 dB for SMF and 0.35 dB for MMF. From a design perspective, it is recommended to use a loss margin of 0.5 dB or the vendor recommendation for MT-RJ connectors.

MTP/MPO Connectors

MTP/MPO connectors are used with single-mode and multimode fiber-optic cables. The MTP/MPO is a connector manufactured specifically for a multifiber ribbon cable. The MTP/MPO single-mode connectors have an angled ferrule allowing for minimal back reflection, whereas the multimode connector ferrule is commonly flat. The ribbon cable is flat and appropriately named due to its flat ribbon-like structure, which houses fibers side by side in a jacket. The typical insertion loss for matched MTP/MPO connectors is 0.25 dB. From a design perspective, it is recommended to use a loss margin of 0.5 dB or the vendor recommendation for MTP/MPO connectors.

Splicing

Fiber-optic cables might have to be spliced together for a number of reasons—for example, to realize a link of a particular length. Another reason might involve *backhoe fade*, in which case a fiber-optic cable might have been ripped apart due to trenching work. The network installer might have in his inventory several fiber-optic cables, but none long enough to satisfy the required link length. Situations such as this often arise because cable manufacturers offer cables in limited lengths—usually 1 to 6 km. A link of 10 km can be installed by splicing several fiber-optic cables together. The installer can then satisfy the distance requirement and avoid buying a new fiber-optic cable. Splices might be required at building entrances, wiring closets, couplers, and literally any intermediate point between a transmitter and receiver.

Connecting two fiber-optic cables requires precise alignment of the mated fiber cores or spots in a single-mode fiber-optic cable. This is required so that nearly all the light is coupled from one fiber-optic cable across a junction to the other fiber-optic cable. Actual contact between the fiber-optic cables is not even mandatory.

There are two principal types of splices: fusion and mechanical. Fusion splices use an electric arc to weld two fiber-optic cables together. The process of fusion splicing involves using localized heat to melt or fuse the ends of two optical fibers together. The splicing process begins by preparing each fiber end for fusion. Fusion splicing requires that all protective coatings be removed from the ends of each fiber. The fiber is then cleaved using the score-and-break method. The quality of each fiber end is inspected using a microscope. In fusion splicing, splice loss is a direct function of the angles and quality of the two fiber-end faces.

The basic fusion-splicing apparatus consists of two fixtures on which the fibers are mounted with two electrodes. An inspection microscope assists in the placement of the prepared fiber ends into a fusion-splicing apparatus. The fibers are placed into the apparatus, aligned, and then fused together. Initially, fusion splicing used nichrome wire as the heating element to melt or fuse fibers together. New fusion-splicing techniques have replaced the nichrome wire with carbon dioxide (CO₂) lasers, electric arcs, or gas flames to heat the fiber ends, causing them to fuse together. Arc fusion splicers can splice single fibers or 12- and 24-fiber-count ribbon fibers at the same time. The small size of the fusion splice and the development of automated fusion-splicing machines have made electric arc fusion one of the most popular splicing techniques

in commercial applications. The splices offer sophisticated, computer-controlled alignment of fiber-optic cables to achieve losses as low as 0.02 dB.

Splices can also be used as optical attenuators if there is a need to attenuate a high-powered signal. Splice losses of up to 10.0 dB can be programmed and inserted into the cable if desired. This way, the splice can act as an in-line attenuator with the characteristic nonreflectance of a fusion splice. Typical fusion-splice losses can be estimated at 0.02 dB for loss-budget calculation purposes. Mechanical splices are easily implemented in the field, require little or no tooling, and offer losses of about 0.5 to 0.75 dB.

Physical-Design Considerations

Many factors must be considered when designing a fiber-optic cable plant. First and foremost, the designer must determine whether the cable is to be installed for an inside-plant (ISP) or outside-plant (OSP) application. The answer to this question usually determines whether a loose buffer or a tight buffer cable will be used. An important factor in fiber-optic cable design and implementation is consideration of the cable's *minimum bend radius* and tensile loading. There are two kinds of submarine cable systems: shallow-water and deep-water systems.

Tight Buffer Versus Loose Buffer Cable Plants

Tight buffer or tight tube cable designs are typically used for ISP applications. Each fiber is coated with a buffer coating, usually with an outside diameter of 900 μm . Tight buffer cables have the following cable ratings:

- **OFNR**—Optical fiber, nonconductive riser rated
- **OFNP**—Optical fiber, nonconductive plenum rated
- **LSZH**—Low smoke, zero halogen rated

The type of ISP tight buffer cable selected usually depends on the application, environment, and building code. Loose-buffer or loose-tube cables mean that the fibers are placed loosely within a larger plastic tube. Usually 6 to 12 fibers are placed within a single tube. These tubes are filled with a gel compound that protects the fibers from moisture and physical stresses that may be experienced by the overall cable. Loose buffer designs are used for OSP applications such as underground installations, lashed or self-supporting aerial installations, and other OSP applications. These cables require additional cleaning, including the removal of the protective compounds when the fibers are to be terminated. Loose-tube cable designs include multifiber armored and non-armored cable systems.

Bend Radius and Tensile Loading

An important consideration in fiber-optic cable installation is the cable's *minimum bend radius*. Bending the cable farther than its minimum bend radius might result in increased attenuation

or even broken fibers. Cable manufacturers specify the minimum bend radius for cables under tension and long-term installation. The ANSI TIA/EIA-568B.3 standard specifies a bend radius of 1.0 inch under no pull load and 2.0 inches when subject to tensile loading up to the rated limit.

For ISP cable other than two-fiber and four-fiber, the standard specifies 10× the cable's outside diameter under no pull load and 15× the cable's outside diameter when subject to tensile load. Cable tensile load ratings, also called cable *pulling tensions* or *pulling forces*, are specified under short-term and long-term conditions. The short-term condition represents a cable during installation and it is not recommended that this tension be exceeded. The long-term condition represents an installed cable subjected to a permanent load for the life of the cable. Typical loose-tube cable designs have a short-term (during installation) tensile rating of 600 pounds (2700 N) and a long-term (post installation) tensile rating of 200 pounds (890 N).

Submarine Cable Systems

Shallow-water systems are similar to their armored loose-buffered terrestrial counterparts, whereas deep-water submarine cables use a special hermetically sealed copper tube to protect the fiber from the effects of deep-water environments. Deep-water and submarine cables also have dual armor and an asphalt compound that is used to fill interstitial spaces and add negative buoyancy. In addition to the significant external physical forces that might be encountered in a submarine environment, the other major concern is the effect of hydrogen on the performance of the optical fiber in cables used in such applications.

The effect of hydrogen on fiber performance depends on specific system characteristics. System attributes include fiber type, system operating wavelength, and cable design and installation method. Hydrogen can chemically react with dopants, such as phosphorus, to produce irreversible absorption peaks, resulting in a significant increase in the attenuation coefficient across various wavelength ranges. This phenomenon, also known as the *Type 1 hydrogen effect*, occurred primarily in early optical-fiber designs that used a phosphorus dopant. Unlike early phosphorus fibers, current fibers using germania dopants are not susceptible to Type 1 hydrogen effects.

The second hydrogen effect arises from the propensity for molecular hydrogen to diffuse readily through most other materials. When diffused into glass optical fiber, hydrogen creates distinct absorption peaks at certain wavelengths. The most predominant of these occurs at 1240 nm and 1380 nm. The tails of these peaks can extend out, depending on the hydrogen concentration, affecting the optical performance at 1310 nm and 1550 nm. Unlike the Type 1 effect, the effect created by molecular hydrogen is reversible and is known as the *Type 2 hydrogen effect*. The major sources are typically understood to be the corrosion of the metal armoring and the presence of bacteria. Proper span design must take into consideration hydrogen safety margins for submarine applications. The attenuation coefficient is proportional to the water depth role because as depth increases, the partial pressure of hydrogen increases, resulting in an increase in the amount of interstitial hydrogen that can be present in the fiber.

Fiber-Optic Communications System

As depicted in Figure 3-16, information (voice, data, and video) from the source is encoded into electrical signals that can drive the transmitter. The fiber acts as an optical waveguide for the photons as they travel down the optical path toward the receiver. At the detector, the signals undergo an optical-to-electrical (OE) conversion, are decoded, and are sent to their destination.

Figure 3-16 *Fiber-Optic Communication System*

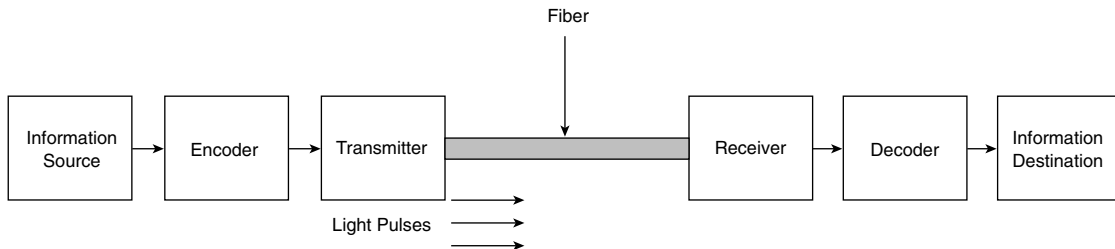

Transmitter

The transmitter component of Figure 3-16 serves two functions. First, it must be a source of the light launched into the fiber-optic cable. Second, it must modulate this light to represent the binary data that it receives from the source. A transmitter's physical dimensions must be compatible with the size of the fiber-optic cable being used. This means that the transmitter must emit light in a cone with a cross-sectional diameter of 8 to 100 microns; otherwise, it cannot be coupled into the fiber-optic cable. The optical source must be able to generate enough optical power so that the desired BER can be met over the optical path. There should be high efficiency in coupling the light generated by the optical source into the fiber-optic cable, and the optical source should have sufficient linearity to prevent the generation of harmonics and intermodulation distortion. If such interference is generated, it is extremely difficult to remove. This would cancel the interference resistance benefits of the fiber-optic cable. The optical source must be easily modulated with an electrical signal and must be capable of high-speed modulation; otherwise, the bandwidth benefits of the fiber-optic cable are lost. Finally, there are the usual requirements of small size, low weight, low cost, and high reliability. The transmitter is typically pulsed at the incoming frequency and performs a transducer electrical-to-optical (EO) conversion. Light-emitting diodes (LEDs) or vertical cavity surface emitting lasers (VCSELs) are used to drive MMF systems, whereas laser diodes are used to drive SMF systems. Two types of light-emitting junction diodes can be used as the optical source of the transmitter. These are the LED and the laser diode (LD). LEDs are simpler and generate incoherent, lower-power light. LEDs are used to drive MMF. LDs generate coherent, higher-power light and are used to drive SMF.

Figure 3-17 shows the optical power output, P , from each of these devices as a function of the electrical current input, I , from the modulation circuitry. As the figure indicates, the LED has a relatively linear P-I characteristic, whereas the LD has a strong nonlinearity or threshold effect. The LD can also be prone to kinks when the power actually decreases with increasing input current. LDs have advantages over LEDs in the sense that they can be modulated at very high speeds, produce greater optical power, and produce an output beam with much less spatial width than an LED. This gives LDs higher coupling efficiency to the fiber-optic cable. LED advantages include a higher reliability, better linearity, and lower cost.

Figure 3-17 LED and LD P-I Characteristics

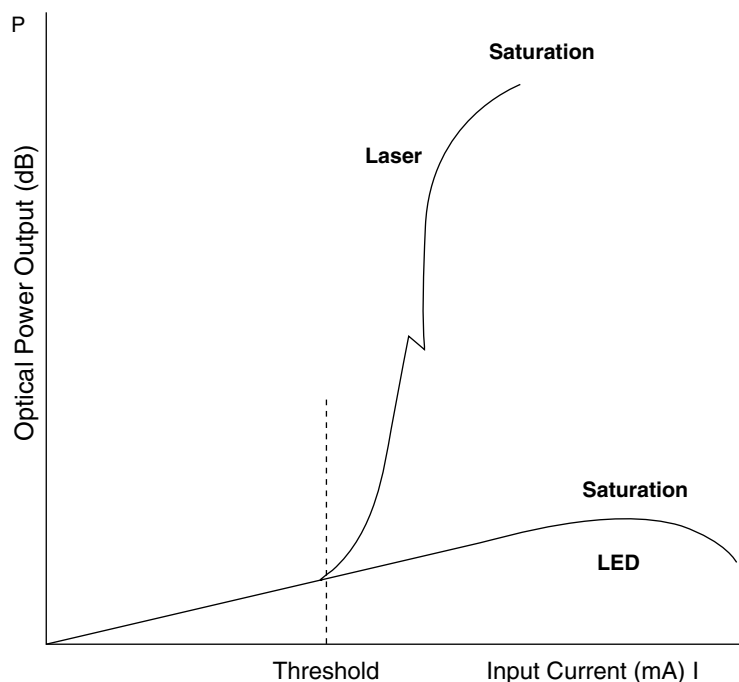

A key difference between the optical output of an LED and a LD is the wavelength spread over which the optical power is distributed. The spectral width, σ , is the 3-dB optical power width (measured in nanometers or microns). The spectral width impacts the effective transmitted signal bandwidth. A larger spectral width takes up a larger portion of the fiber-optic cable link bandwidth. Figure 3-18 shows the spectral width of the two devices. The optical power generated by each device is the area under the curve. The spectral width is the half-power spread. An LD always has a smaller spectral width than an LED. The specific value of the spectral width depends on the details of the diode structure and the semiconductor material. However, typical values for an LED are around 40 nm for operation at 850 nm and 80 nm at 1310 nm. Typical values for an LD are 1 nm for operation at 850 nm and 3 nm at 1310 nm.

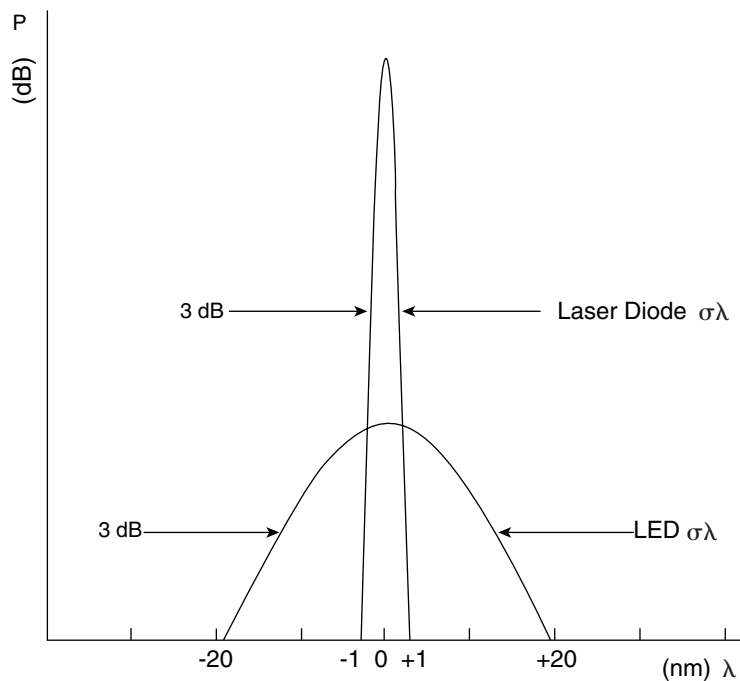
Figure 3-18 LED and LD Spectral Widths

Other transmitter parameters include packaging, environmental sensitivity of device characteristics, heat sinking, and reliability. With either an LED or LD, the transmitter package must have a transparent window to transmit light into the fiber-optic cable. It can be packaged with either a fiber-optic cable pigtail or with a transparent plastic or glass window. Some vendors supply the transmitter with a package having a small hemispherical lens to help focus the light into the fiber-optic cable. Packaging must also address the thermal coupling for the LED or LD. A complete transmitter module can consume more than 1 watt, which could result in significant heat generation. Plastic packages can be used for lower-speed and lower-reliability applications. However, high-speed and high-reliability transmitters need metal packaging with built-in fins for heat sinking.

There are several different schemes for carrying out the modulation function. These include intensity modulation (IM), frequency shift keying (FSK), phase shift keying (PSK), and polarization modulation (PM). Within the context of a premise fiber-optic data link, the only one really used is IM. IM is used universally for premise fiber-optic data links because it is well matched to the operation of both LEDs and LDs. The carrier that each of these sources produces is easy to modulate with this technique. Passing current through them operates both of these devices. The amount of power that they radiate (sometimes referred to as the *radiance*) is proportional to this current. In this way, the optical power takes the shape of the input current. If the input current is the waveform $m(t)$ representing the binary information stream, the resulting optical signal looks like bursts of optical signal when $m(t)$ represents a 1 and the absence of optical signal when $m(t)$ represents a 0. This is also known as *direct modulation* of the LED or LD.

Receiver

Figure 3-19 shows a schematic of an optical receiver. The receiver serves two functions: It must sense or detect the light coupled out of the fiber-optic cable and convert the light into an electrical signal, and it must demodulate this light to determine the identity of the binary data that it represents. The receiver performs the OE transducer function.

Figure 3-19 *Schematic of an Optical Receiver*

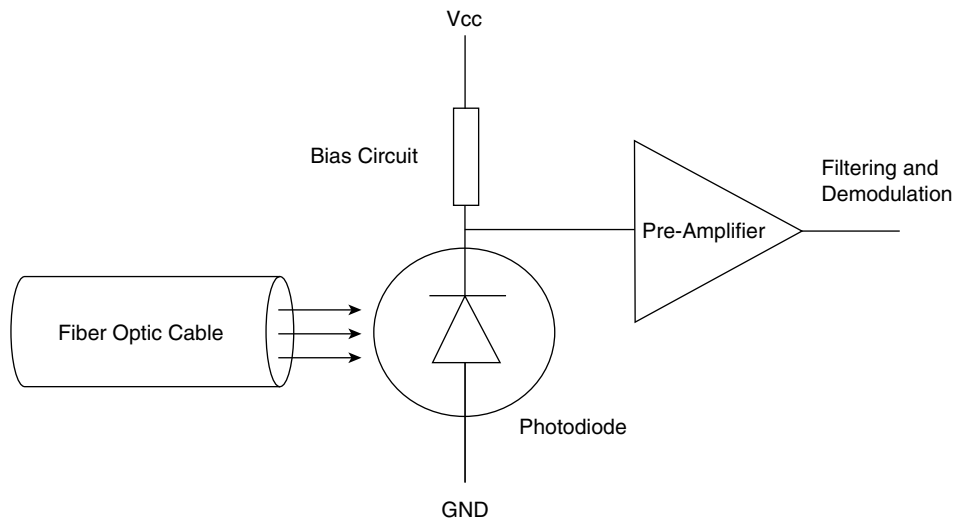

A receiver is generally designed with a transmitter. Both are modules within the same package. The light detection is carried out by a photodiode, which senses light and converts it into an electrical current. However, the optical signal from the fiber-optic cable and the resulting electrical current will have a small amplitude. Consequently, the photodiode circuitry must be followed by one or more amplification stages. There might even be filters and equalizers to shape and improve the information-bearing electrical signal.

The receiver schematic in Figure 3-19 shows a photodiode, bias resistor circuit, and a low-noise pre-amp. The output of the pre-amp is an electrical waveform version of the original information from the source. To the right of this pre-amp is an additional amplification, filters, and equalizers. All of these components can be on a single integrated circuit, a hybrid, or discretely mounted on a printed circuit board.

The receiver can incorporate a number of other functions, such as clock recovery for synchronous signaling, decoding circuitry, and error detection and recovery. The receiver must have high sensitivity so that it can detect low-level optical signals coming out of the fiber-optic cable. The higher the sensitivity, the more attenuated signals it can detect. It must have high bandwidth or a fast rise time so that it can respond fast enough and demodulate high-speed digital data. It must have low noise so that it does not significantly impact the BER of the link and counter the interference resistance of the fiber-optic cable transmission medium.

There are two types of photodiode structures: positive intrinsic negative (PIN) and the avalanche photodiode (APD). In most premise applications, the PIN is the preferred element in the receiver. This is mainly due to fact that it can be operated from a standard power supply, typically between 5 and 15V. APD devices have much better sensitivity. In fact, APD devices have 5 to 10 dB more sensitivity. They also have twice the bandwidth. However, they cannot be used on a 5V printed circuit board. They also require a stable power supply, which increases their cost. APD devices are usually found in long-haul communication links and can increasingly be found in metro-regional networks (because APDs have decreased in cost).

The demodulation performance of the receiver is characterized by the BER that it delivers to the user. The sensitivity curve indicates the minimum optical power that the receiver can detect compared to the data rate, to achieve a particular BER. The sensitivity curve varies from receiver to receiver. The sensitivity curve considers within it the SNR parameter that generally drives all communications-link performance. The sensitivity depends on the type of photodiode used and the wavelength of operation. Figure 3-20 shows sensitivity curve examples.

Figure 3-20 Receiver Sensitivity Curves

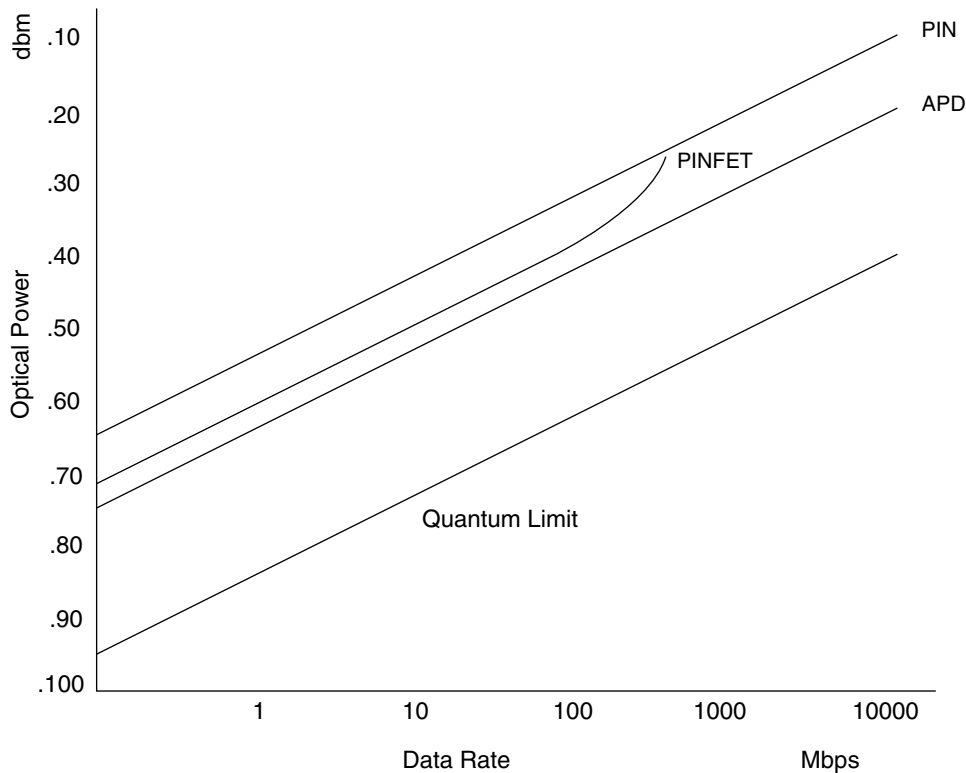

Receiver Sensitivities BER = 10^{-9} , $\lambda = 1.55$ micrometer

The quantum limit curve serves as a baseline reference. In a sense it represents optimum performance on the part of the photodiode in the receiver—that is, performance in which there is 100 percent efficiency in converting light from the fiber-optic cable into an electric current for demodulation. All other sensitivity curves are compared to the quantum limit.

Fiber Span Analysis

Span analysis is the calculation and verification of a fiber-optic system's operating characteristics. This encompasses items such as fiber routing, electronics, wavelengths, fiber type, and circuit length. Attenuation and nonlinear considerations are the key parameters for loss-budget analysis. Before implementing or designing a fiber-optic circuit, a span analysis is recommended to make certain the system will work over the proposed link. Both the passive and active components of the circuit have to be included in the loss-budget calculation. Passive loss is made up of fiber loss, connector loss, splice loss, and losses involved with couplers or splitters in the link. Active components are system gain, wavelength, transmitter power, receiver sensitivity, and dynamic range.

Nonlinear effects occur at high bit rates and power levels. These effects must be mitigated using compensators, and a suitable budget allocation must be made during calculations.

The overall span loss, or *link budget* as it is sometimes called, can be determined by using an optical meter to measure true loss or by computing the loss of system components. The latter method considers the loss associated with span components, such as connectors, splices, patch panels, jumpers, and the optical safety margin. The safety margin sets aside 3 dB to compensate for component aging and repair work in event of fiber cut. Adding all of these factors to make sure their sum total is within the maximum attenuation figure ensures that the system will operate satisfactorily. Allowances must also be made for the type of splice, the age and condition of the fiber, equipment, and the environment (including temperature variations).

NOTE

Considerations for temperature effects associated with most fibers usually yield ± 1 dB that could be optionally included in optical loss-budget calculations.

Transmitter Launch Power

Power measured in dBm at a particular wavelength generated by the transmitter LED or LD used to launch the signal is known as the *transmitter launch power*. Generally speaking, the higher the transmitter launch power, the better. However, one must be wary of receiver saturation, which occurs when the received signal has a very high power content and is not within the receiver's dynamic range. If the signal strength is not within the receiver's dynamic range, the receiver cannot decipher the signal and perform an OE conversion. High launch powers can offset attenuation, but they can cause nonlinear effects in the fiber and degrade system performance, especially at high bit rates.

Receiver Sensitivity and Dynamic Range

Receiver sensitivity and dynamic range are the minimum acceptable value of received power needed to achieve an acceptable BER or performance. Receiver sensitivity takes into account power penalties caused by use of a transmitter with worst-case values of extinction ratio, jitter, pulse rise times and fall times, optical return loss, receiver connector degradations, and measurement tolerances. The receiver sensitivity does not include power penalties associated with dispersion or with back reflections from the optical path. These effects are specified separately in the allocation of maximum optical path penalty. Sensitivity usually takes into account worst-case operating and end-of-life (EOL) conditions. Receivers have to cope with optical inputs as high as -5 dBm and as low as -30 dBm. Or stated differently, the receiver needs an optical dynamic range of 25 dB.

Power Budget and Margin Calculations

To ensure that the fiber system has sufficient power for correct operation, you need to calculate the span's power budget, which is the maximum amount of power it can transmit. From a design perspective, worst-case analysis calls for assuming minimum transmitter power and minimum receiver sensitivity. This provides for a margin that compensates for variations of transmitter power and receiver sensitivity levels.

$$\text{Power budget (P}_B\text{)} = \text{Minimum transmitter power (P}_{TMIN}\text{)} - \text{Minimum receiver sensitivity (P}_{RMIN}\text{)}$$

You can calculate the span losses by adding the various linear and nonlinear losses. Factors that can cause span or link loss include fiber attenuation, splice attenuation, connector attenuation, chromatic dispersion, and other linear and nonlinear losses. Table 3-1 provides typical attenuation characteristics of various kinds of fiber-optic cables. Table 3-2 provides typical insertion losses for various connectors and splices. Table 3-3 provides the margin requirement for nonlinear losses along with their usage criteria. For information about the actual amount of signal loss caused by equipment and other factors, refer to vendor documentation.

$$\text{Span loss (P}_S\text{)} = (\text{Fiber attenuation} * \text{km}) + (\text{Splice attenuation} * \text{Number of splices}) + (\text{Connector attenuation} * \text{Number of connectors}) + (\text{In-line device losses}) + (\text{Nonlinear losses}) + (\text{Safety margin})$$

Table 3-1 *Typical Fiber-Attenuation Characteristics*

Mode	Material	Refractive Index Profile	λ (nm)	Diameter (μm)	Attenuation (dB/km)
Multimode	Glass	Step	800	62.5/125	5.0
Multimode	Glass	Step	850	62.5/125	4.0
Multimode	Glass	Graded	850	62.5/125	3.3
Multimode	Glass	Graded	850	50/125	2.7

Table 3-1 *Typical Fiber-Attenuation Characteristics (Continued)*

Mode	Material	Refractive Index Profile	λ (nm)	Diameter (μm)	Attenuation (dB/km)
Multimode	Glass	Graded	1310	62.5/125	0.9
Multimode	Glass	Graded	1310	50/125	0.7
Multimode	Glass	Graded	850	85/125	2.8
Multimode	Glass	Graded	1310	85/125	0.7
Multimode	Glass	Graded	1550	85/125	0.4
Multimode	Glass	Graded	850	100/140	3.5
Multimode	Glass	Graded	1310	100/140	1.5
Multimode	Glass	Graded	1550	100/140	0.9
Multimode	Plastic	Step	650	485/500	240
Multimode	Plastic	Step	650	735/750	230
Multimode	Plastic	Step	650	980/1000	220
Multimode	PCS	Step	790	200/350	10
Single-mode	Glass	Step	650	3.7/80 or 125	10
Single-mode	Glass	Step	850	5/80 or 125	2.3
Single-mode	Glass	Step	1310	9.3/125	0.5
Single-mode	Glass	Step	1550	8.1/125	0.2
Single-mode	Glass	Dual Step	1550	8.1/125	0.2

Table 3-2 *Component Loss Values*

Component	Insertion Loss
Connector Type	
SC	0.5 dB
ST	0.5 dB
FC	0.5 dB
LC	0.5 dB
MT-RJ	0.5 dB
MTP/MPO	0.5 dB
Splice	
Mechanical	0.5 dB
Fusion	0.02 dB
Fiber patch panel	2.0 dB

NOTE Typical multimode connectors have insertion losses between 0.25 dB and 0.5 dB, whereas single-mode connectors that are factory made and fusion spliced onto the fiber cable will have losses between 0.15 dB and 0.25 dB. Field-terminated single-mode connectors can have losses as high as 1.0 dB.

Table 3-3 *Reference Margin Values*

Characteristic	Loss Margin	Bit Rate	Signal Power
Dispersion margin	1 dB	Both	Both
SPM margin	0.5 dB	High	High
XPM margin (WDM)	0.5 dB	High	High
FWM margin (WDM)	0.5 dB	Both	High
SRS/SBS margin	0.5 dB	High	High
PMD margin	0.5 dB	High	Both

The next calculation involves the power margin (P_M), which represents the amount of power available after subtracting linear and nonlinear span losses (P_S) from the power budget (P_B). A P_M greater than zero indicates that the power budget is sufficient to operate the receiver. The formula for power margin (P_M) is as follows:

$$\text{Power margin } (P_M) = \text{Power budget } (P_B) - \text{Span loss } (P_S)$$

To prevent receiver saturation, the input power received by the receiver, after the signal has undergone span loss, must not exceed the maximum receiver sensitivity specification (P_{RMAX}). This signal level is denoted as (P_{IN}). The maximum transmitter power (P_{TMAX}) must be considered as the launch power for this calculation. The span loss (P_S) remains constant.

$$\text{Input power } (P_{IN}) = \text{Maximum transmitter power } (P_{TMAX}) - \text{Span loss } (P_S)$$

The design equation

$$\text{Input power } (P_{IN}) \leq \text{Maximum receiver sensitivity } (P_{RMAX})$$

must be satisfied to prevent receiver saturation and ensure system viability. If the input power (P_{IN}) is greater than the maximum receiver sensitivity (P_{RMAX}), passive attenuation must be considered to reduce signal level and bring it within the dynamic range of the receiver.

Case 1: MMF Span Analysis

Consider the fiber-optic system shown in Figure 3-21 operating at OC-3 (155 Mbps). The minimum optical transmitter launch power is -12.5 dBm, and the maximum optical transmitter launch power is -2 dBm at 1310 nm. The minimum receiver sensitivity is -30 dBm, and the maximum receiver sensitivity is -3 dBm at 1310 nm. The example assumes inclusion of two

patch panels in the path, two mechanical splices, with the system operating over 2 km of graded index 50/125- μm multimode fiber-optic cable. Refer to Tables 3-1, 3-2, and 3-3 for appropriate attenuation, component, and nonlinear loss values.

Figure 3-21 *MMF Span Analysis*

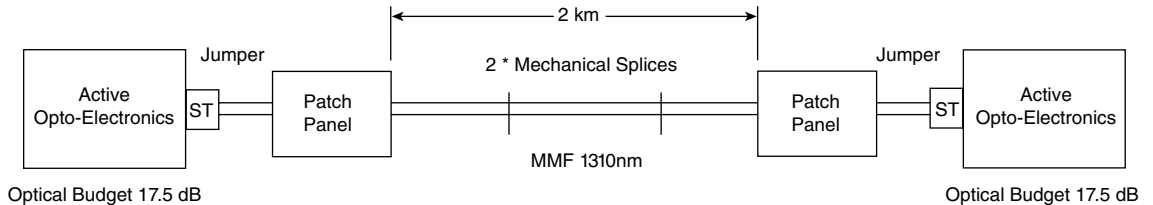

The system operates at 155 Mbps or approximately 155 MHz. At such bit rates, there is no need to consider SPM, PMD, or SRS/SBS margin requirements. Because the link is a single-wavelength system, there is no need to include XPM or FWM margins. However, it is safe to consider the potential for a degree of chromatic dispersion, because chromatic dispersion occurs at all bit rates. The span analysis and viability calculations over the link are computed as follows.

Component	dB Loss
Minimum transmitter launch power (P_{TMIN})	-12.5 dBm
Minimum receiver sensitivity (P_{RMIN})	-30 dBm
Power Budget (P_{B}) = (P_{TMIN} - P_{RMIN})	17.5 dB

Component	dB Loss
MMF graded index 50/125- μm cable at 1310 nm (2 km * 0.7 dB/km)	1.4 dB
ST connectors (2 * 0.5 dB/connector)	1 dB
Mechanical splice (2 * 0.5 dB/splice)	1 dB
Patch panels (2 * 2 dB/panel)	4 dB
Dispersion margin	1 dB
Optical safety and repair margin	3 dB
Total Span Loss (P_{S})	11.4 dB

$$\text{Power margin } (P_{\text{M}}) = \text{Power budget } (P_{\text{B}}) - \text{Span loss } (P_{\text{S}})$$

$$P_{\text{M}} = 17.5 \text{ dB} - 11.4 \text{ dB}$$

$$P_{\text{M}} = 6.1 \text{ dB} > 0 \text{ dB}$$

In the preceding example, notice that the 11.4-dB total span loss is well within the 17.5-dB power budget or maximum allowable loss over the span.

To prevent receiver saturation, the input power received by the receiver, after the signal has undergone span loss, must not exceed the maximum receiver sensitivity specification (P_{RMAX}). This signal level is denoted as (P_{IN}). The maximum transmitter power (P_{TMAX}) must be considered as the launch power for this calculation. The span loss (P_S) remains constant.

$$\text{Input power } (P_{IN}) = \text{Maximum transmitter power } (P_{TMAX}) - \text{Span loss } (P_S)$$

$$P_{IN} = -2 - 11.4$$

$$P_{IN} = -13.4 \text{ dBm}$$

$$-13.4 \text{ dBm } (P_{IN}) \leq -3 \text{ dBm}$$

This satisfies the receiver sensitivity design equation and ensures viability of the optical system at an OC-3 rate over 2 km without the need for amplification or attenuation.

Case 2: SMF Span Analysis

Consider the fiber-optic system in Figure 3-22 operating at OC-192 (9.953 Gbps). The minimum optical transmitter launch power is -7.5 dBm, and the maximum optical transmitter launch power is 0 dBm at 1550 nm. The minimum receiver sensitivity is -30 dBm, and the maximum receiver sensitivity is -3 dBm at 1550 nm. The example assumes inclusion of two patch panels in the path, four fusion splices, with the system operating over 25 km of step index $8.1/125\text{-}\mu\text{m}$ SMF cable. Refer to Tables 3-1, 3-2, and 3-3 for appropriate attenuation, component, and nonlinear loss values.

Figure 3-22 SMF Link-Budget Example

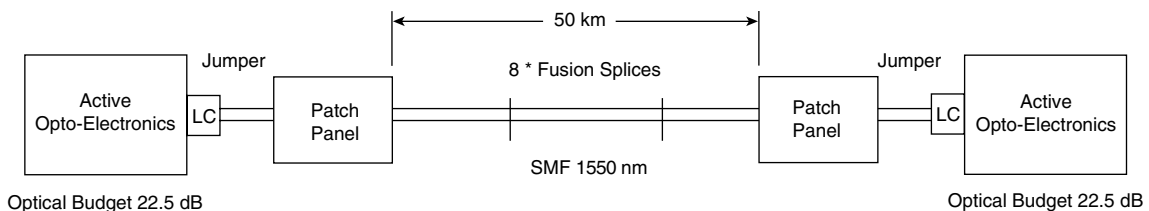

The system is operating at 9.953 Gbps or approximately 10 GHz. At such high bit rates, SPM, PMD, and SRS/SBS margin requirements must be taken into consideration. Also consider the potential for a degree of chromatic dispersion. Because the link is a single-wavelength system, there is no need to include XPM or FWM margins. The link loss and viability calculations over the link are computed as follows.

Component	dB Loss
Minimum transmitter launch power (P_{TMIN})	-7.5 dBm
Minimum receiver sensitivity (P_{RMIN})	-30 dBm
Power Budget (P_B) = (P_{TMIN} - P_{RMIN})	22.5 dB

Component	dB Loss
SMF step index 8.1/125- μ m cable at 1550 nm (50 km * 0.2 dB/km)	10 dB
LC connectors (2 * 0.5 dB/connector)	1.0 dB
Fusion splices (8 * 0.02 dB/splice)	0.16 dB
Patch panels (2 * 2 dB/panel)	4 dB
Dispersion margin	1 dB
SPM margin	0.5 dB
PMD margin	0.5 dB
SRS/SBS margin	0.5 dB
Optical safety and repair margin	3 dB
Total Span Loss (P_S)	20.66 dB

$$\text{Power margin } (P_M) = \text{Power budget } (P_B) - \text{Span loss } (P_S)$$

$$P_M = 22.5 \text{ dB} - 20.66 \text{ dB}$$

$$P_M = 1.84 \text{ dB} > 0 \text{ dB}$$

In the example, notice that the 20.66-dB total span loss is well within the 22.5-dB power budget or maximum allowable loss over the span. To prevent receiver saturation, the input power received by the receiver, after the signal has undergone span loss, must not exceed the maximum receiver sensitivity specification (P_{RMAX}). This signal level is denoted as (P_{IN}). The maximum transmitter power (P_{TMAX}) must be considered as the launch power for this calculation. The span loss (P_S) remains constant.

$$\text{Input power } (P_{IN}) = \text{Maximum transmitter power } (P_{TMAX}) - \text{Span loss } (P_S)$$

$$P_{IN} = 0 - 20.66 \text{ dBm}$$

$$P_{IN} = -20.66 \text{ dBm}$$

$$-20.66 \text{ dBm } (P_{IN}) \leq -3 \text{ dBm } (P_{RMAX})$$

This satisfies the receiver sensitivity design equation and ensures viability of the optical system at an OC-192 rate over 50 km without the need for amplification or attenuation. Note, however, that this example has not considered dispersion calculations or dispersion compensation. Dispersion compensation units insert their own loss component into the overall span.

NOTE

In the preceding example, various margins for nonlinear effects were included in the span loss calculation. This is not necessary if the maximum power on the SMF is kept below +10 dBm to avoid nonlinear effects on the transmission signal. For dispersion-compensated spans, the maximum power on the dispersion compensation module (DCU) must be kept below +4 dBm to avoid nonlinear effects on DCU.

Summary

Fiber optics have become the industry standard for the terrestrial transmission of telecommunication information. Fiber optics will continue to be a major player in the delivery of broadband services. Carriers use optical fiber to carry POTS service across their nationwide networks. Today more than 80 percent of the world's long-distance traffic is carried over optical-fiber cables. Telecommunications applications of fiber-optic cable are widespread, ranging from global networks to desktop computers. These involve the transmission of voice, data, and video over distances of less than a meter to hundreds of kilometers, using one of a few standard fiber designs in one of several cable designs. Carriers use optical fiber to carry analog phone service. Cable television companies also use fiber for delivery of digital video services. Intelligent transportation systems and biomedical systems also use fiber-optic transmission systems. Optical cable is also the industry standard for subterranean and submarine transmission systems.

The principle of total internal reflection is used to propagate light signals. Light is guided through the core, and the fiber acts as an optical waveguide. SMF and MMF cables are constructed differently. MMF has a larger core diameter as compared to SMF. There are two types of propagation for fiber-optic cable: multimode or single mode. These modes perform differently with respect to both attenuation and time dispersion. SMF cable provides better performance than MMF cable. The three primary propagation modes include multimode step index, single-mode step index, and multimode graded index propagation.

In an optical communications system, information from the source is encoded into electrical signals that can drive the transmitter. The transmitter consists of an LED or laser and is pulsed at the incoming frequency. The transmitter performs an EO conversion. The fiber acts as an optical waveguide. At the detector, the signals undergo an OE conversion, are decoded, and are sent to their destination. Fiber-optic system characteristics include attenuation, interference, and bandwidth characteristics. Fiber-optic systems are also secure from data tapping, and tampering can be detected far more easily than with metallic-based transmission medium or free-space propagation. Furthermore, the relatively smaller cross section of fiber-optic cables allows room for substantial growth in the capacity of existing conduits. Attenuation characteristics can be classified as intrinsic and extrinsic. Intrinsic attenuation occurs because of substances inherently present in the fiber, whereas extrinsic attenuation occurs because of external influences such as bending.

Decibel loss at the connector interface is directly proportional to the alignment accuracy and rigidity of the connector. Many types of optical connectors are in use. The one you use depends on the equipment you use it with and the application you use it on. Seamless permanent or semipermanent optical connections require fibers to be spliced. Fiber-optic cables might have to be spliced together for any of a number of reasons. One reason is to realize a link of a particular length. Connecting two fiber-optic cables requires precise alignment of the mated fiber cores or spots in a single-mode fiber-optic cable. This is required so that nearly all the light is coupled from one fiber-optic cable across a junction to the other fiber-optic cable. The two main splicing techniques in use are mechanical and fusion splicing.

Optical loss, or total attenuation, is the sum of the losses of each individual component between a transmitter and receiver. Loss-budget analysis is the calculation and verification of a fiber-optic system's operating characteristics. This encompasses items such as fiber routing, electronics, wavelengths, fiber type, and circuit length. Attenuation and nonlinear fiber characteristics are the key parameters for fiber span analysis. Transmitter launch power, receiver sensitivity, and the dynamic range of the receiver are crucial numbers used in span analysis.