

A summary of Overview of Japan's modern steam locomotives and a brief instruction of the author

This report recounts the story of Japan's modern locomotive from the background to the end including the technical considerations and intangible human aspects. The author, Akira Saito is well fitted to write on this subject. He puts the locomotives in contrast to the international tendency of the era. It had been once revolutionary but changed to conservative even though there was impedance concerning to the industrial level of the country. But the author emphasizes that they were decided by principle of "safety first" or "tracing succeeded model" in order to avoid unforeseen troubles, anxious among the persons in charge.

As the result the basic design criteria did not change for long time since the succeeded locomotive had appeared until the end of the steam locomotives in Japan.

The original was put forward on a journal Rail Magazine published in Japan at May 2000. All pictures were drawn by the author himself in same scale for the report

Mr. Saito was born in 1931 and is the chairman of KRC alumni. After retiring motor car business for long year he wrote two books "The rise and fall of the steam locomotives" and "The challenge of the steam locomotives", the former was given a prize among the books concerned to transportation published in 1997 in Japan.



On the other hand, he is an amateur painter and also a model crafts man. Here we would like to show his portrait with his model, looking forward to meeting him in anywhere rails are.

Overview of Japan's modern steam locomotives

By Akira Saito

An evaluation of the steam locomotive by an enthusiast's eye

The railway has its 200th anniversary in 2004 since it started to be operated by motive power. For three quarters of this history power was by steam locomotive including its best days. Man could get an active power for transportation by steam engine, and the steam locomotive was the flag bearer on the earth for long time. The speed of movement grew explosively from power by horse to power by steam, it affected and changed man's thought and ideology and finally gave birth to strongly centralized modern nations.

The development of the steam locomotive was studied for 150 years simultaneously with construction of the railway, it began from the early 19th and ended in the middle of 20th century when diesel and electric power replaced steam.

The 20th century was the time when the machine civilization, born by the industrial revolution, reached its full growth and gave rise to its second generation by electronics revolution. As we move into the 21st century, the author would like to overview steam locomotives, the flag bearer of the first generation of the machine civilization, and especially to evaluate the locomotives in Japan. The author has loved Japan's steam locomotives as they awakened his interests and is building the models of them. However he is sure that the following overview is cool and unbiased, apart from a little favoritism.

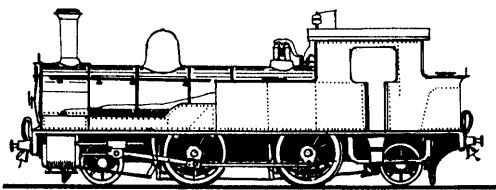

Class 860 The first domestic locomotive was a test machine of a 2-cylinder compound made under the leadership of Trevithick. At that time he probably wanted to be widely recognized in the UK.

Japan's steam locomotive was short life

The first railway opened in 1872 in Japan about 70 years later than in UK. It strongly helped Meiji, the new born government, in building a modern state. Many promising youths were thrown in and learned about those high technologies through supervisors invited from European countries. They shortly succeeded in the region of civil engineering, because the Japanese had already established their own skill by constructing castles, canals and so on, and they had their own surveying technology.

However, the rolling stock was a different matter. There had not existed a so called heavy industry to manufacture products like locomotives, and in addition the locomotive was one of those juicy items for industrialized countries to export. The period of importing had lasted for 40 years although certain persons attempted to design, assemble and manufacture in Japan. During that time, class 860 with a compound engine was manufactured as the first domestic locomotive supervised by Trevithick who also assembled class B6(=2120) using imported main parts. Then the class 6700 appeared as the first domestic locomotive mass produced in Japan in 1911.

The manufacturing technology started by class 6700 bloomed on class 18900(=C51) in 1919, but the main development of the running gear of class C59 finished in 1941 and in 1943 for the boiler of class D52, only thirty two years after the first appearance of class 6700. After this there appeared class C62 in 1947, and E10 in 1948 which applied an already developed design. However including all of them the total span is less than forty years. These years were well known as the last peak of the growth of this technology in the world, and author can not help saying that the technology had grown without straying from the already-improved path, though it had been caused by the industrial level of the country and lack of fundamental engineering power.

It might be unreasonable to try to compare the country a late joiner to the developing race with other countries having already trod a long thorny path, but author would like to do it by presenting an enthusiast's view for acknowledging what position they were in.

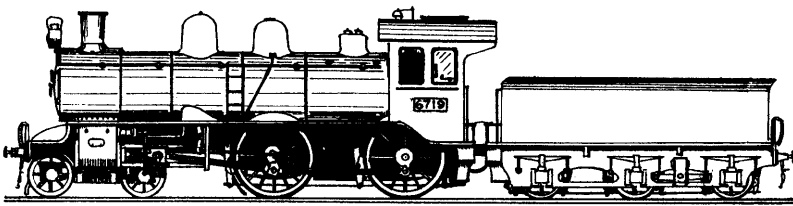

Class 6700 the first domestic locomotive mass produced. Learned Prussian P-4.

The design concept changed from UK/US style to German in this locomotive.

What is Japan's modern locomotive?

It is often said "modern locomotive" but the definition has not been clear. Should it be defined by appearance, by long life or by having the performance equal to it? Or, should it be defined by the new manufacturing methods such as welding and massive castings, or by adopting super heated steam?

In Japan, as mentioned above, the first period was operated by imported locomotives.

However, after the beginning of the 20th century the importation lasted by classes 8700, 8800, 8850, 8900 and theallet types as bank engines. At the same time class 6700 appeared by domestic design. It started by using saturated steam but soon after the next model adopted super heated steam learned from imported locomotive. Therefore author dares to define the domestic locomotives produced after this as the "modern locomotive" on which he would like to make his evaluation.

Illusion of an Atlantic

In 1907 after the Russo-Japanese war, seventeen main railway companies were united as the National Railway and their chief mechanical engineers were called to its technical center. Among them Hikoza Mori, who had been the best disciple of Trevithic and was also the manager of the Shinbashi Works of the National Railway, was assigned to design a locomotive for a rapid train. He designed an enterprising Atlantic type 2-B-1 that had driving wheels of 1676mm(5'6"), which was 101mm(4") bigger than class 6500, it had been the locomotive with the biggest wheel, from Kansai Railway and with trailing wheels to support its big fire box. However, the plan was shelved and not realized by his actual boss Yasujiro Shima who had changed his job moving to the National Railway from Kansai Railway as a chief mechanical engineer to the Ministry of Posts and Transportation

that controlled the National Railway.

Instead a locomotive was designed under supervision of Shima as the first Japanese designed locomotive, designed by Yoshimatsu Ohta, who had been the second disciple of Trevithic

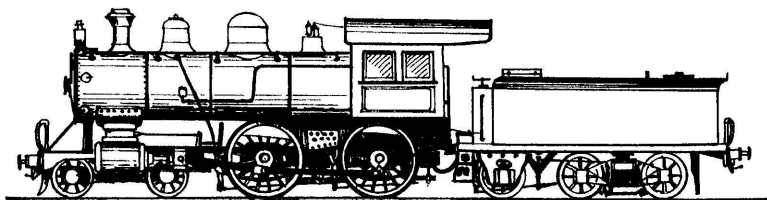

Class 6500 With the biggest wheel in those days for winning the speed race between National Railway and Kansai Rail Road, imported from U.S

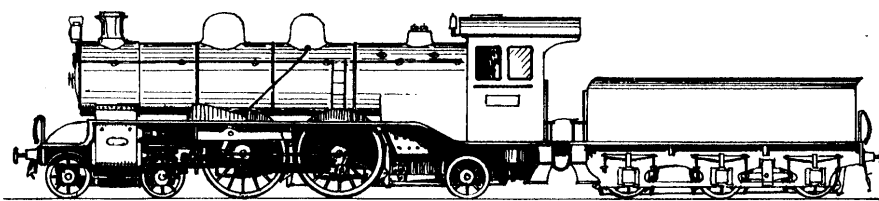

Illusioned Atlantic drawn by the author

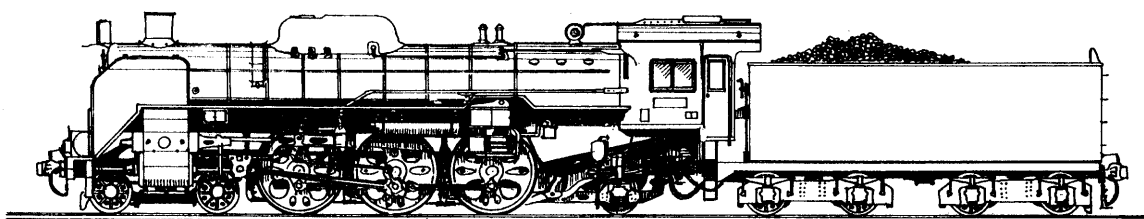

Class C59 Appeared 30 years after the 6700 for the express passenger train of the main trunk line. The last fundamental design for passenger locomotive.

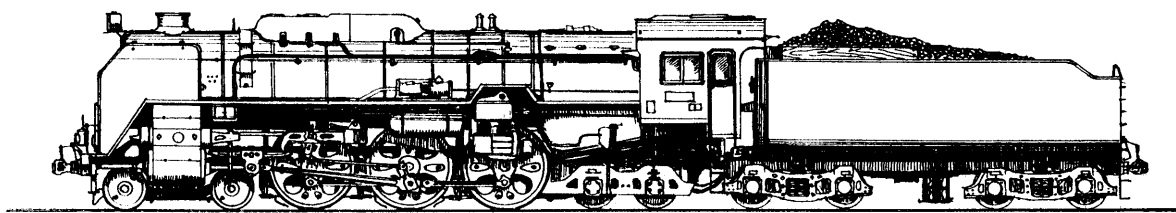

Class C62 appeared after the second world war with combination of running gear from the C59 and the boiler from the D52. It became Japan's representative locomotive for a passenger train. Its style of big boiler on big wheels is a quite different from previous designs.

It was the class 6700 with 2B wheel arrangement and a narrow fire box which had been typical in those days on trunk lines but with a driving wheel of 5'3"(1600mm), 1" larger than the predecessors In addition, the design practice was changed to a German style from the U.K. and U.S. styles until that time. Shima had been in Germany at his own expense to study locomotive design and saw acting class P4 in Prussian State. It was a miniaturized P4.

As a locomotive designer Shima had not experienced much more than Mori, who had been in the main position of the National Railway, and Matsuhiko Iwasaki, who had come from the Sanyo Railway and designed a Vaucrain-compound locomotive. But his advocacy and decision of the dramatic turning to German practice away from U.K. and U.S., which had been dominant in the land until those days, had a big influence on the further development even implicit or explicit. His position became firmly established after that time.

In the same period the National Railway made orders of locomotives for the Japan/Europe express with a view to competing with the U.K., U.S. and Germany. He specified its main dimensions of 2C(Ten wheeler) with a narrow fire box inside the frame referring class P8 of Prussian State. However the U.S. strongly pushed and succeeded in selling 2C1 Pacific class 8900 with a wide fire box though he claimed its cancellation.

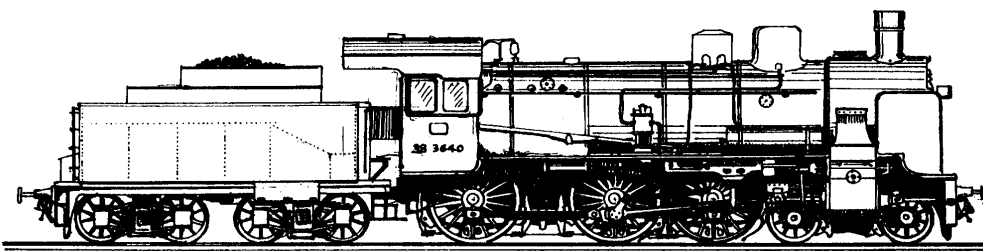

Prussian class P8
For local passenger service.

A plot for future modification to standard gauge

Later while he was staying in Germany as a superintendent for the ordered locomotives, he was increasingly affected by German designs especially by Prussian State's ones. They had a functional and simple structure therefore attaining low cost. It seemed to suit a poor developing country like Japan. The Prussian State Railway had a so-called small engine policy that made a comparably small locomotive work with its full performance. It accorded with his opinion that such a trailing wheel should not be adopted because it was clearly a kind of dead weight.

It is natural to guess that there must be another aim hidden behind the words. It was a provision for preparing the future change to Standard gauge(1435mm) from the 3'6"(1067mm) gauge, which had been adopted from the first locomotive imported from U.K.. Both he and his boss Shinpei Goto, the Minister of Railway were insisting to do so. If the gauge could be changed, the width of the fire box could almost be expanded by the same dimension of 370mm, the difference of two gauges and still be positioned inside the frame, then even the classes 8700 and 8800 could gain same area of the fire box as the later light Pacific, represented by Class 18900(C51).

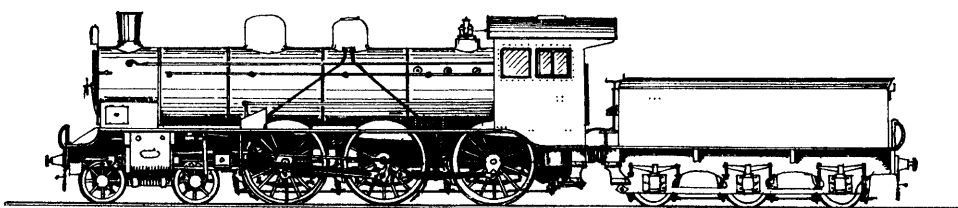

Class 8800
With a design most faithful to Shima's concept among the 4 kinds imported. Looks like a P8 and adopted superheated steam.

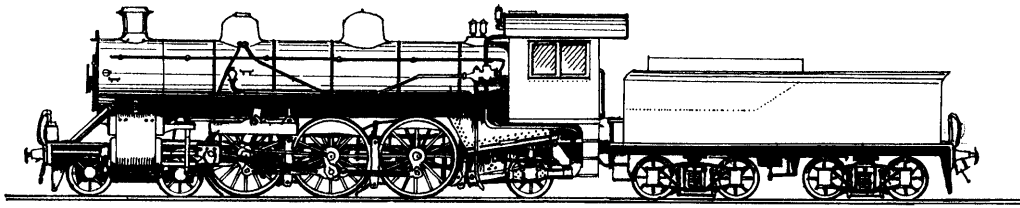

Class 8900
 ALCO succeeded in selling
 2C1
 2C1 arrangement.
 It developed to 18900(C51).

It is supposed that he thought an increase in power would be easily carried out by means of a modification to the boiler or its replacement with the new boiler for future increases in the volume of traffic.

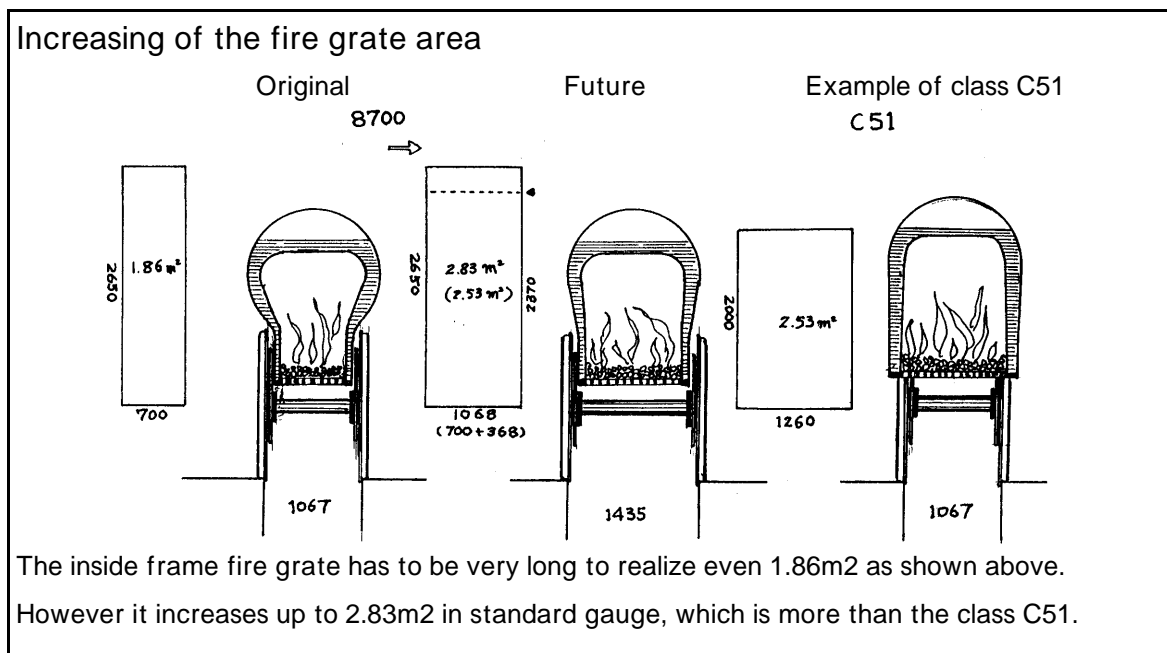

In 1914 class 8620 with de-tuned specifications of the class 8800 started to be manufactured for general purpose work. It had a shorter boiler and consequently one leading and no trailing wheel was sufficient enough to support it. A total of 672 had been launched within nine years for the National Railway, it accounted for 40% of the three driving wheeler passenger locomotives.

During the same period 770 of class 9600 for freight train were manufactured in eight years. It was a 1D arrangement and had, as a matter of course, no trailing wheel.

Shima, as an engineer, ought to have known that South Africa or New Zealand had the same 1067mm gauge. There ran locomotives with the wide fire box supported by a trailing wheel, and they were becoming the leading technique for high power narrow gauge locomotives. However, it would be a good-for-nothing situation on the conditions for a future change to Standard gauge considering the transport demands and the financial condition in those days. Meanwhile it needed an enormous fund to change to standard gauge, it was not a matter of course for them to decide. The gauge of 1067mm had been adopted at the start point for minimizing the cost and at that time it might have been impossible to forecast correctly any future change of Japan. The change of the gauge would be a heavy burden for Japan still under being developed.

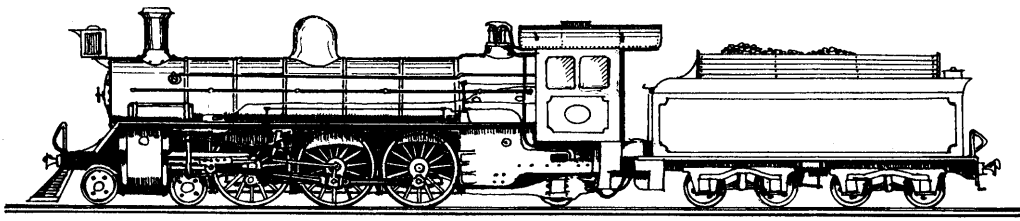

SAR Class 10 adopted 1067mm gauge to overcome sharp curves. Pacific wheel arrangement had been used since 1904 for putting a more powerful one in service than in the U.K.

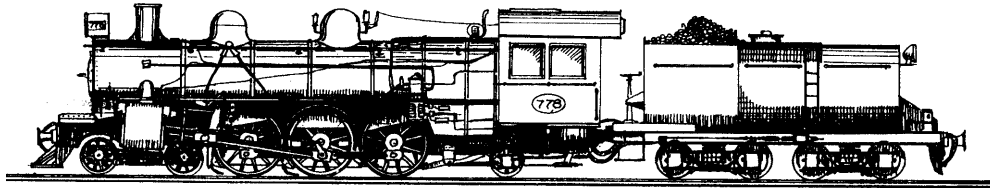

NZGR Class Ab For both the severe height limit and the low calorific coal the first Pacific locomotive in the world was there in 1901. The above drawing is the model of 1915.

What to do for keeping the 1067mm gauge

There were hot arguments among the political parties what should be done: to invest the money in making the gauge wider or in expanding the railway network with the gauge of 1067mm.

The minister of rail, Shinpei Goto, who had supported the standard gauge, was also a politician, least traded it for another policy. Hence the argument without the powerful supporter was discouraged and the National Railway decided to keep the gauge of 1067mm in 1919. Shima presented his resignation in the same year.

However, the situation had also been forecast among them not to change the gauge. The class 18900(later C51) with a trailing wheel was launched at the end of the year. The chief designer was Kiichi Asakura, the best disciple of Shima, but it was obvious Shima had made the basic concept .

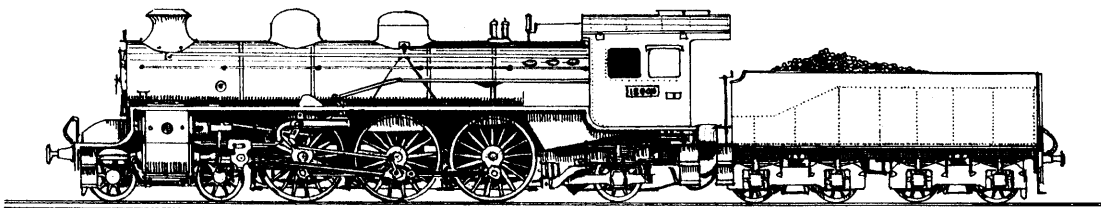

Class C51 A monumental one tacitly to have stipulated further express passenger locomotive. Diameter 1750mm of driving wheel was same as of P8, but an epoch to adopt it to the narrow gauge.

The wheel arrangement of 2C1 Pacific was inevitably understood among them as long as the gauge of 1067mm would continue. It was very regrettable that it came too late even though the performance was epoch-making. The time of no progress continued for ten years as they misread their argument to be realized. They had thought the powerful locomotive could be realized without the trailing wheel for the wide fire grate if the gauge changed to 1435mm.

Classes 8620 and 9600

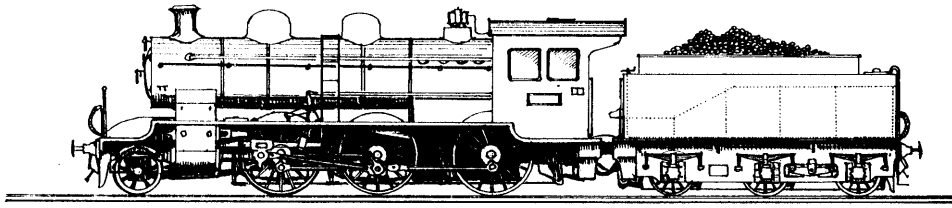

Class 8620 Manufactured for local lines. Based and scaled down on 8800. Link system for support of the leading wheel was a deviation from Krauss Helmholz

The author would like to present more of classes 8620 and 9600 before explaining of class C51. They were, totally manufactured more than 1400 sets within ten years, born with the hope of growing out of the importation current until that period. It was indeed the great first step of their own design and of the locomotive industry in Japan. Some of these types lived on for sixty years until the last steam operation in the country and showed on the other hand that their design was fitted to work there and that their distinguished service could not be ignored. It is no exaggeration to say the design for the most part was a partial improvement or adaptation from the imported locomotives. It is not too much to say that it was a period of no progress even though such a great number were manufactured in the small country, while other countries were developing the new

technology.

The diameter of driving wheel and distances between them of the 8620 was same as of the 8800 and the main dimensions around the engine also followed it. In fundamental part it was inevitable to pay his respects to seniority, which was not only so in locomotives but also in recent cameras, internal combustion engines etc.. In such a condition that had few experience or scope to have the investigation it must have been a matter of course rather than a passive choice.

It adopted a special leading mechanism in the leading wheel. The original design was that the leading wheel was united to the first driving wheel and their center was fixed to the frame. Therefore these two wheels

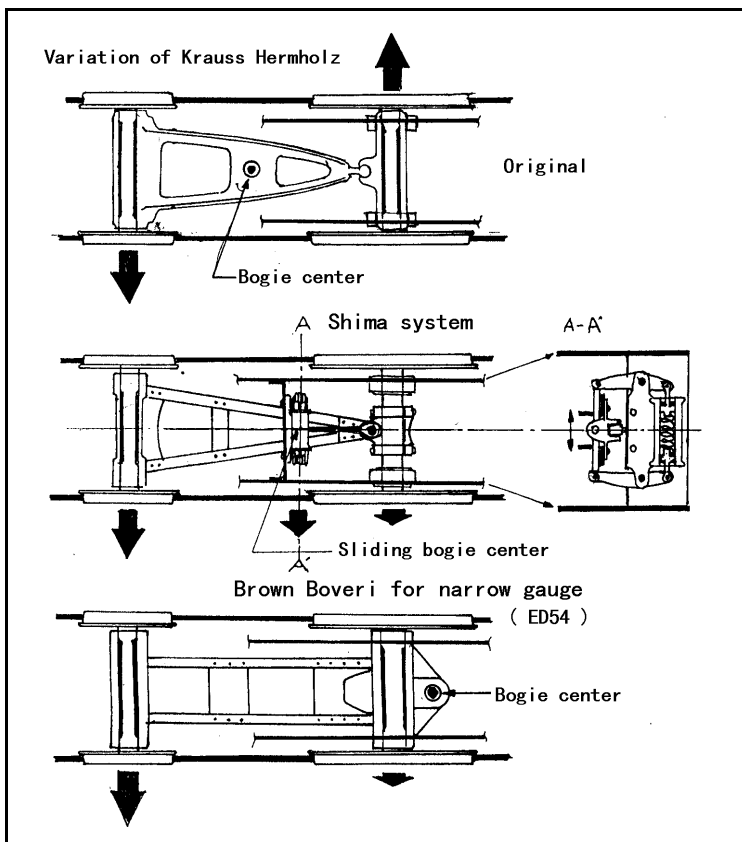

performed like a bogie leading truck and had been adopted by the Austrian National Railway for passing their steep gradient routes with sharp curves. In the 8620, it was called the Shima system, the center was held inside by his elaborate link system to lead the locomotive smoothly even on a small radius curve. However, this system was never adopted by the successors even in this country.

It is supposed the system might have been too complicated to maintain or to not show the remarkable performance. The author thinks there could have been another simple but effective way with the Brown Boveri's Buchli system, which was adopted in the imported electric locomotive class ED54, the bogie center was simply put behind the first driving wheel.

Class 9600 was famous for its structure which put the wide fire box on the driving wheel. This structure had been already adopted in the class 9300, imported by the Nippon Railway from Baldwin by which the wheel arrangement for freight locomotive turned back to 1D Consolidation from 1D1 Mikado. The area of the fire grate was equal to the class 9300.

Comparison of fire box between 9300 and 9600

In both the main frame was cut out for the space for the fire box. Note: 9300 was a bar frame but 9600 was a plate.

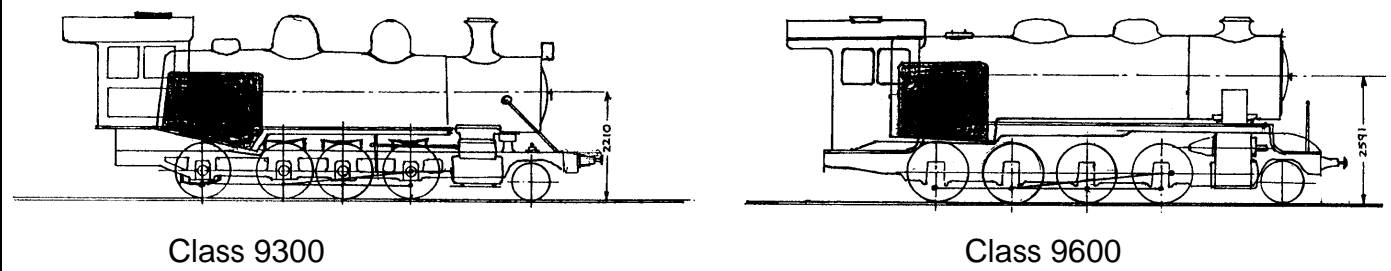

The boiler center was more than 300mm higher compared to the class 9300, this dimension was taken from the Class 8850 passenger locomotive imported from Germany. The frame was made of plate, the driving wheel diameter was 130mm larger than in the 9300 and the steam pressure was raised up a little, but they were improvements with the enlarging of the dimension. The 9600 also stood out by adopting superheated steam and a design of frame and axle box suitable for easy revamping to standard gauge.

The 1750mm driving wheel and the revolution speed

The Class 18900 (the name changed later, hereafter called C51) was, compared with those predecessors, a well balanced locomotive, though there was not any remarkable change in technology. In the words "well balanced" it was an epoch-making appearance and made a masterpiece of passenger locomotive design in Japan. It had the 1750mm diameter of the driving wheel, put forward by Shima's brave attempt, of which there had never before been such an aspect ratio: 1.64 times size of the gauge. It is true there were once big wheels in the U.K.. In the 19th century the maximum ratio was up to 1.8 by 8' 6" (2591mm) wheel, but they were all single drivers designed with the boiler inside the wheel. The modern locomotives required not only speed but also traction force. Therefore it was unavoidable for the boiler to be on the wheels. Even in Germany classes 05 and 61 with a 2300mm wheel that had a record of the maximum diameter except for single drivers the ratio was 1.6. Later SAR class 16E had the driving wheel of 6' (1829mm) diameter, however in those years the diameter was 1600mm max. In Japan their decision to adopt the 1750mm wheel, was remarkable.

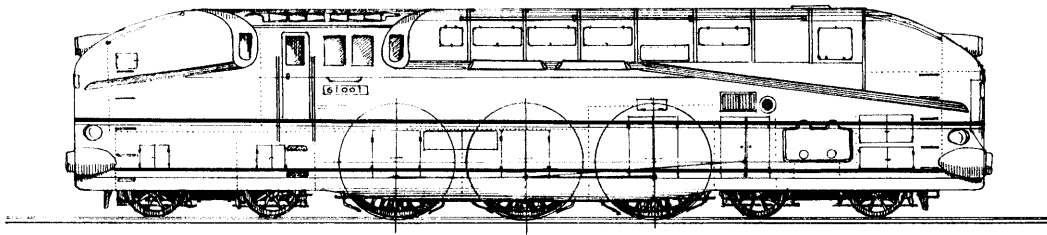

DR Class 61

A high speed tank engine with a 2300mm wheel which succeeded class 05.

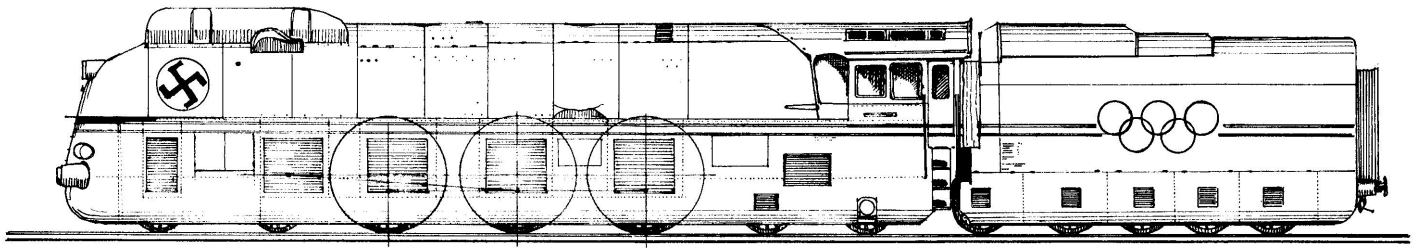

DR Class 05 It was announced as the first steam locomotive to reach the speed record of over 200 Km/h. But the U.K. did not give the acknowledgement. The boiler was too small for practical service.

The first steam engine on earth, built in the U.K., performed with very low pressure steam expanding into a minus pressure (=vacuum) chamber was not considered to revolve in high speed. In fact the volume of low pressure steam is large, therefore the machinery for it had to also be large scale and unsuitable for the purpose. The hard effort for reaching high revolution speeds continued even when the initial pressure was raised up. A reciprocating movement fundamentally generates an unbalanced inertia force and it is not completely muted out except by having a contra arrangement of the same, which is actually impossible. Brunel of Great Western Railway thought, at the end of 1830s, the speed of 60 m/h (96 Km/h) should be realized by having the driving wheel of more than 3000mm diameter on the broad gauge. The plan was not done by less power from the boiler, the revolution speed he aimed for was about 170 rpm. In the 1840s he did more with 8'(2438mm) wheel, in which the revolution speed was 210 rpm. In 1853 the speed of 130 Km/h was recorded with 9'(2743mm) wheel on the broad gauge of 7'1/4"(2140mm), in which the revolution speed was up to 250 rpm.

At the fourth quarter of 19th century when the rail way opened in Japan, the required traction effort for locomotives increased, consequently those single drivers had to be changed to the double drivers (two driving wheels) even in U.K. and the boiler had to be positioned on the driving wheel. Then the diameter of the driving wheel was limited to approx. 7' (2134mm). Meanwhile numerical analysis of the dynamic balance made also progress. It raised the speed up to 120 Km/h by 300 rpm.

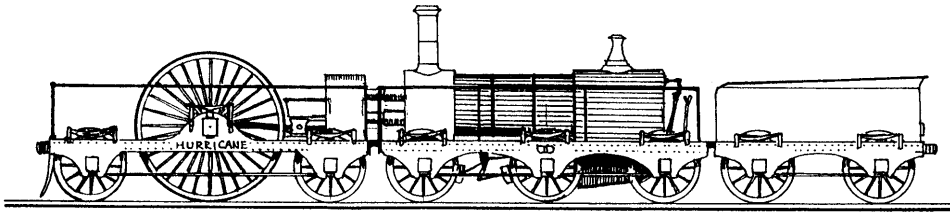

HURRICANE by Brunel He thought the speed of 60 m/h(96 Km/h) should be gotten by 10'(3 m) wheel on 7'(2134 mm) gauge

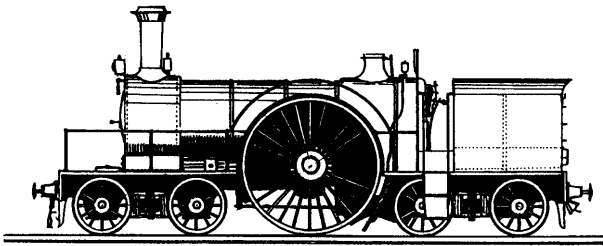

Bristol and Exeter Railway Class 40 130 Km/h recorded in the U.K. with 9' wheel on 7' gauge.

In the U.S. the 2B arrangement had been adopted since early times as the rail condition was poor, then the design practice of the frame was different from that in the U.K., but the level of the speed and the revolutions were similar between them.

Designs rapidly advanced worldwide to get 100 m/h(160 Km/h) in 20th century. In 1904 the GWR City Class 2B arrangement locomotive recorded in the U.K. 164.5 Km/h by 6' 8 1/2''(2045mm) wheel, in which the instantaneous revolution speed was 427 rpm.

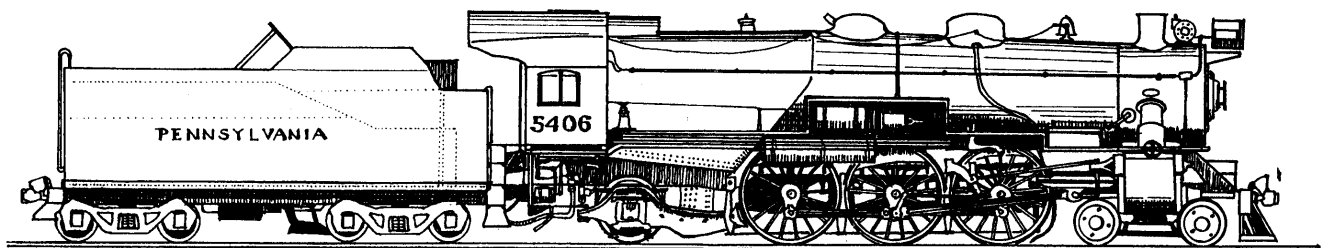

Pennsylvania Railway Class K4, most famous Pacific American standard locomotive adopted 2032mm of diameter.

Meanwhile the balancing up by means of multi cylinders was being observed since the end of 19th century. In 1908 when Shima was in Germany supervising classes 8800 and 8850 ordered by the National Railway, the Bayern State Railway launched class S3/6 . This was a 4-cylinder compound locomotive, each pair of cylinders were united with a crank of 180 deg. differential phase angle which was called a "balanced compound" and the speed was 120Km/h with 1870mm wheel under the revolutions of over 340 rpm.

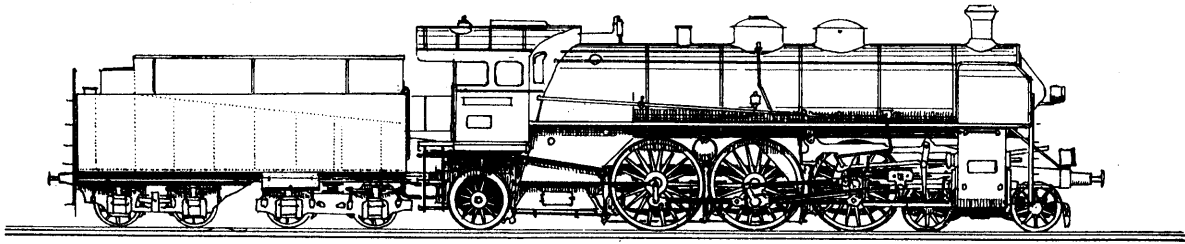

Bayern State Railway Class S3/6 Compound locomotive was standard for passenger trains in the Railway.

In 1907 the adopted 2C1 Pacific wheel arrangement was the first in Europe. After unification of the Railways the production continued with class 01.

Even in the U.S., where two cylinder was the main current, it was said that 1 inch of wheel diameter was equivalent to speed of 1 mile/hour; it was calculated assuming revolution speed of 336 rpm. Among German two cylinder locomotives it was a little conservative, Prussian P8 got the speed up to 100 Km/h with a 1750mm wheel around 300 rpm.

The author believes the concept of a 1750mm wheel of the class C51 was derived from those German locomotives. The revolution speed of 300 rpm. was the value achieved by reference to the recent imported locomotives, in which circumstances 1750mm meant the value to run at the continuous max. speed of 100 Km/h. However the height of its center of gravity was a drastic value decided by operational results and experience on the imported locomotives for nine years. The height by gauge ratio was the top class in the world, not only among narrow gauges but also among standard gauges.

Effort for increasing revolution speed

However it was facing the limit to attain high speed by large wheel. For pulling a heavy train locomotive is required sufficient evaporating capacity, which brings an increase in the boiler diameter. Consequently the wheel diameter is restricted by its dimensional height limit for rolling stock in connection with the boiler diameter. Even on the standard gauge, wheel diameter of high speed locomotives, that appeared after those years, was generally between 2000 and 2100mm. The Class 05 of 2300mm diameter realized a high speed but less power than the Class 01, it was not universal. That super express operated between Berlin and Hamburg by the two 05, consisted of only five passenger cars even though the route was plain. It was understood these big wheelers were concocted for showing Hitler's prestige-the first operation by steam at speed of 200 Km/h. When speed up was not able to depend on wheel diameter, it had to do so on revolution speed for getting both higher speed and power.

Conceptual drawing of balanced compound engine

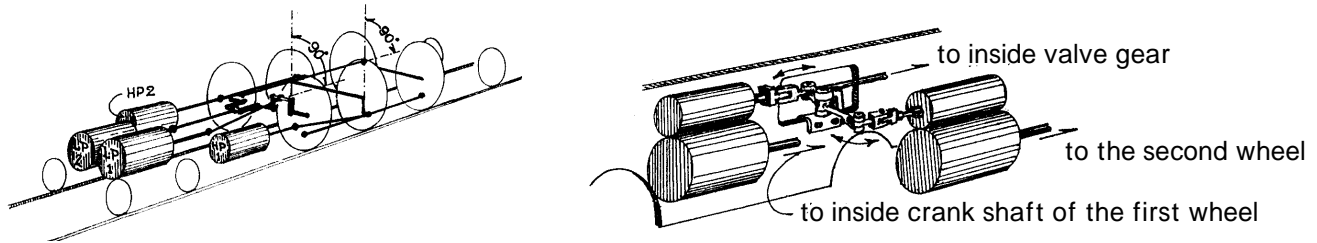

There were two ways to transmit the force among 3 or 4 cylinder balanced compound engines. One was to transmit the power concentrated to one axle and the other divided to two axles. Class S3/6 was the former and the latter was popular in France. The above drawing shows the latter.

For making the revolution speed of reciprocating engines high, it is necessary both to balance the eccentric mass of the rotating parts and to reduce the mass of reciprocating parts. A steam engine was constructed by steel to bear heavy duty, and the mass was heavy. In the early twentieth century in Europe the balanced compound engine came into wide use for high speed locomotives because of less counterweight for eccentric mass and of a better mass balance among subdivided reciprocating parts.

In the mean time, rigidity of the main frame between cylinder and wheel (crank shaft) should be strong enough to bear the reaction force generated by steam pressure. In the U.S. which carried out a thorough investigation of generating high power by two cylinders, the main frame with cylinder block made of mono block cast steel began to be adopted because of its high rigidity. Furthermore the force transmitted by a connecting rod of a two cylinder engine in each stroke was bigger than that of a multi (more than three) cylinder engine. Then the use of roller bearings started in the late 1930's at first for connecting rods, and later for the driving axle. The roller bearing was superior to the traditional plain bearing not only in load capacity but also in lubrication under high speed operation, it contributed highly to the rate of operation. In Manchuria, which was practically a dependency of Japan at that time, the South Manchuria Railway also adopted it for class PA-SI-HA under the influence of the U.S.

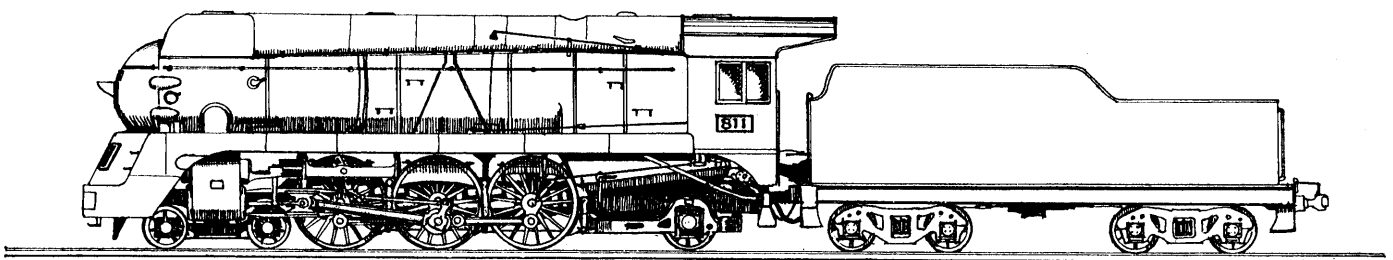

Manchuria Railway Class PA-SI-HA The company was positive to the new technology and adopted a roller bearing for the main shaft.

Turning to the situation of Japan after the appearance of class C51, the main frame changed to a bar frame in the Class D50 in 1923 and Class C53 in 1928. The driving wheel changed to a box type from spoke type in the Class D51 in 1936. But others, except for the multi cylinder, such as the basic mechanism, the wheel base, the diameter of driving wheel, the basic dimension of the

connecting rod and the valve gear were left intact without taking in the new technologies developed in other countries since the 1920's through to the 1940's

Concerning the multi cylinder the Class C53 adopted 3 cylinders in the Gresley system. It had been invented by Sir Nigel Gresley who was the chief mechanical engineer of LNER in the U.K. but Japan imported Class 8200 (late C52) locomotives as a model from ALCO of the U.S. The reason of importing from ALCO was that LNER only manufactured it in their own factory for its own use and ALCO had purchased the license of the basic patent and developed their own design from it, but in Japan it was an easygoing introduction of the technology from ALCO without deeply learning the original philosophy. Further a design change of link lever for the valve gear, when the C53 was designed based on the C52 as a model of the Gresley system, introduced less rigidity which was not enough to keep correct timing among the three valves. It was caused by holes bored in the link lever made for the purpose of reducing the moment of inertia. This one-sided expectation caused an unexpected result different from their original aim. In addition difficult maintenance of the center valve allowed a bad reputation of " failure ". After all, multi cylinder systems finished with the C53, in turn it would grow in other countries though. Their attitude in abandoning the best efforts for improving it and denying progress on the multi cylinder system can not help to be recognized as a reverse move against the rest of the world's progress.

Gresley valve gear in C53

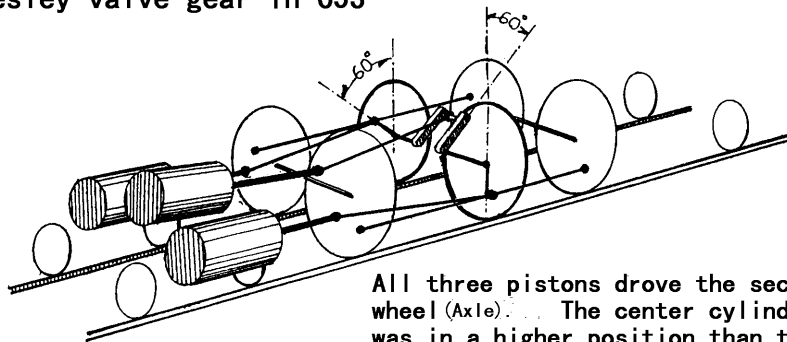

All three pistons drove the second wheel (Axle). The center cylinder was in a higher position than the others to avoid interference the first wheel axle. Movement of the center valve tended to over run by bending the lever, which introduced too much steam into the center cylinder and sometimes caused metal bearing trouble on the center crank.

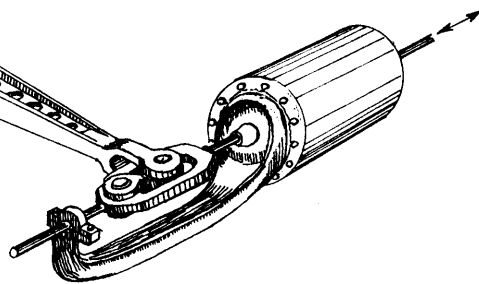
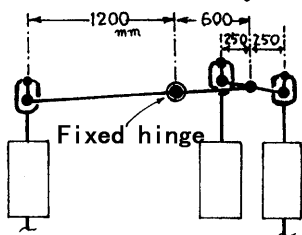
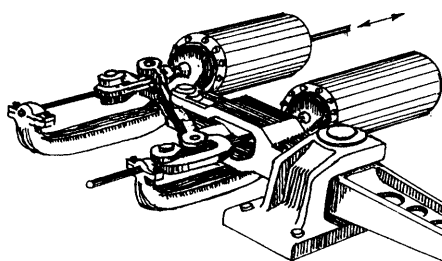

The bar frame is not a style evolved from the plate frame but is like one of design practices. In the U.K. all locomotives adopted a plate frame, and it changed back to a plate frame in the Class 10 of Germany. Also a box wheel came into wide use in the U.S., Russia and Japan but was ignored in Europe. Even in the case of the Class 01-5 manufactured in East Germany, changed to a spoke wheel.

In the common sense of more than 400rpm

In the 1930's France, having bought up a compound system and also in the U.K. a simple expansion with three or four cylinder locomotives was being generalized for high speed passenger trains. Nevertheless their wheels were supported by a plane bearing and the maximum cruising speed of 100 miles/h was not rare. Also in the U.S. it attained more with two cylinders but had a high rigidity frame and roller bearing. Their revolutions got to 420 through 430 rpm, even in Germany a little conservative typical three cylinder locomotive 01-10 with 2000mm wheel reached 370 rpm at the maximum speed of 140 Km/h.

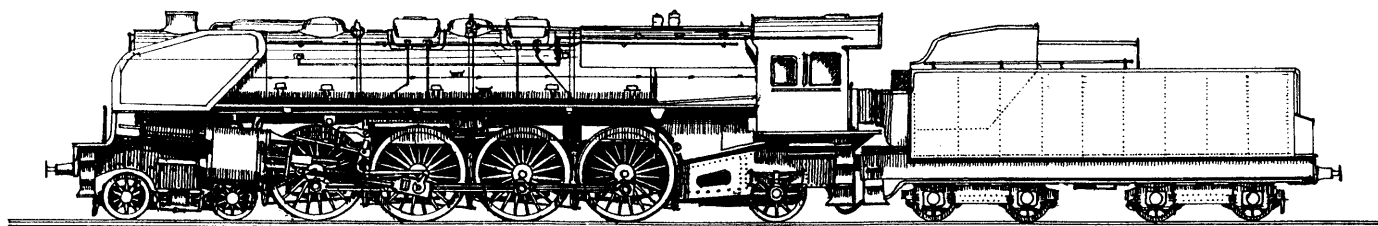

SNCF class 241A It achieved a low fuel consumption rate by pursuing compound expansion in multi cylinder.

Turning to narrow gauge, at the same era as the C51, the Class 1000 of Colonial Indonesia was thrown into service for the special express between Jakarta and Surabaya. The aim was to run the distance of 821 Km in a time of 12 hours. It was important to avoid a shower at night time. This Dutch made locomotive had 2C1 Pacific wheel arrangement and adopted a balanced compound system consisting of four cylinders. The overall style was similar to the C51 but the wheel diameter was 1600mm and all power was transmitted to the first driving wheel. However its average speed was 10Km/h higher than special express "Tsubame" drawn by the C51 that was a pride of Japan's National Railway. Its maximum speed reached 120 Km/h with 400 rpm.

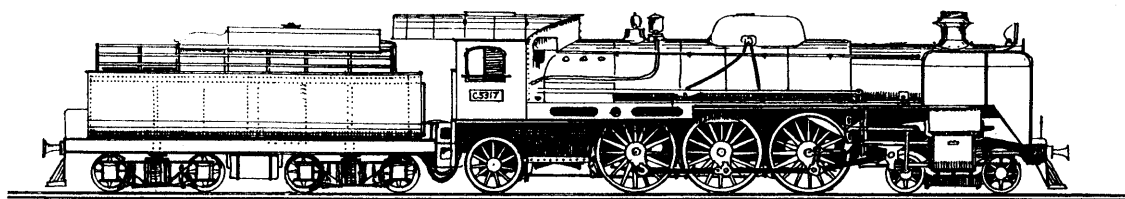

The Colonial Indonesian Railway Class 1000 Balanced compound with four cylinders was rare for narrow gauge. It made most of the function though it was all single track as the pass ways in the stations were constructed straight.

In New Zealand this was the first country in the world to adopt 2C1 Pacific arrangement. The diameter of driving wheel could never be more than 1372mm (4'6") because of the restricted loading height. It was 500mm less than in Japan. In 1932 it changed to the 2D2 Northern arrangement for a growing transport load, it was Class K. In 1939 it was reinforced by Class Ka that adopted roller bearings in all axles though the number of cylinders was the same, two. It could not function well at first because of low calorific fuel coal, however a strike in coal mines forced the railway to burn oil instead. It then gave full performance, the maximum speed reaching 120Km/h. As it can run over 100Km/h in exhibition trips still now, it was sure a revolution speed of 400 rpm was a practical value.

In South Africa in 1935 demand for higher speed by the Union Limited (later The Blue Train) from 60 m/h (96 Km/h) to 70 m/h (113 Km/h) produced the famous Pacific Class 16E with 6' (1829mm) wheel. The concept of a big wheel equivalent to high speed was a traditional practice, and the wheel diameter with 1.71 times the gauge had the highest record in modern locomotives. It made a big impact on Japan, then a superior locomotive with 1850mm wheel was once planned in a company where Shima was the chairman. The Class 16E performed 70 m/h as expected, in which the revolution speed was 330 rpm. However the body of the passenger car changed to steel, it was too heavy for the 2C1 locomotive to draw the express, the Class 16E finally withdrew from its duty two years after.

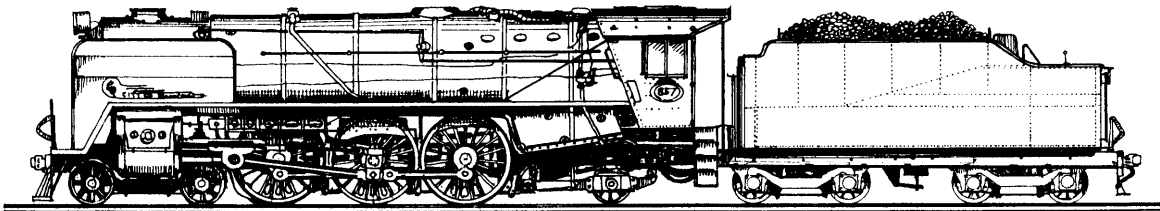

SAR Class 16E Driving wheel diameter of 1829mm is not only the maximum in a modern narrow gauger but also the maximum value of wheel/gauge ratio.

The successor was the Mountain Class 23 with a 1600mm wheel and a 2D1 arrangement made in Germany, but produced no remarkable result because of lower quality of steel material available just before the second world war.

After the war the Northern Class 25 of 2D2 arrangement was launched. Its wheel diameter was 1524mm but all its axles were equipped with the newest American equipment such as roller bearings and a frame and cylinder made of mono block steel casting. The reputation was that it moved like the wind. It was said to accelerate as easily and smoothly to speeds of over 70 m/h as an electric locomotive. Therefore the operation supervisor was occupied every day to warn the engineer to keep it under 70 m/h to avoid overturn. Among other leading countries operation around 400 rpm was no longer out of range.

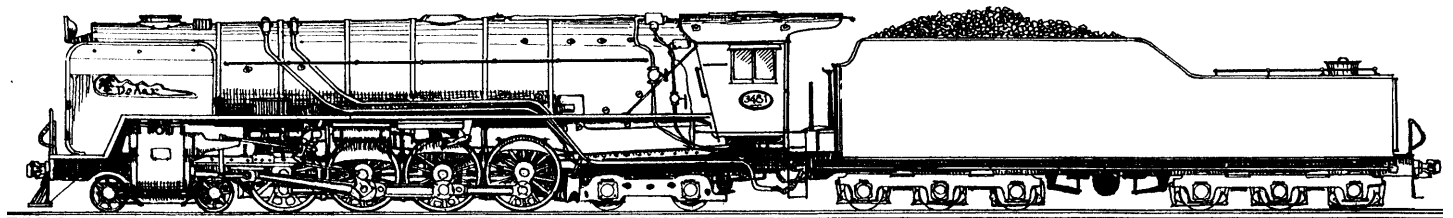

SAR Class 25NC (Non Condensing) The greatest locomotive on narrow gauge designed with the newest American practices. Speed and power are not inferior to that of standard gauge.

Was 300 rpm an inviolable value?

Against the current trend, the maximum speed of 95 Km/h by approx. 300 rpm with 1750mm wheel never changed since the Classes C51 till C62 the last passenger locomotive in Japan. This revolution limit seemed a normative value for design, in fact wheel diameters of 1750, 1600, 1520, 1400 and 1250 coincide with the maximum speed of 100, 90, 85, 80 and 70 Km/h.

It is said that speed limitation is usually caused by the strength of the track. In addition, the voice of the civil engineer must be stronger than of the mechanical engineer as civil engineering in Japan had a longer history, then as a natural result the mechanical engineer might not get sufficient budget but required a limit of axle loading. However it can not be justified they did not accept the challenge to attain high revolution speed. Moreover, there must be another way with high revolutions to overcome any adverse condition required by the condition of the track. High revolutions would make diameter of 1750mm unnecessary, consequently the number of driving axles could be increased, of which total effective load beard by each driving wheel was within a given limitation. It must not only bring much tractive power but also give good effect to keep braking distance within the limit of 600m under emergency conditions.

Higher revolutions directly relates to smaller wheels under the same maximum speed, which decreases the height of center of gravity. The low center of gravity allows for a bigger boiler and a smaller wheel realizes a shorter wheel base, which improves speed limit on a curved track and results in higher acceleration rate. In mountainous circumstances where gradient and curved tracks are common, high acceleration is very effective to keep high average speed. As the weight of the running gear becomes lighter and the total length also shorter than others, if this were realized it would have been welcome by the track keeper. Such a wheel of 1750 mm diameter might be too big except for the two main trunk lines to Tokaido and Sanyo for which the first Shinkansen bullet train service would start later.

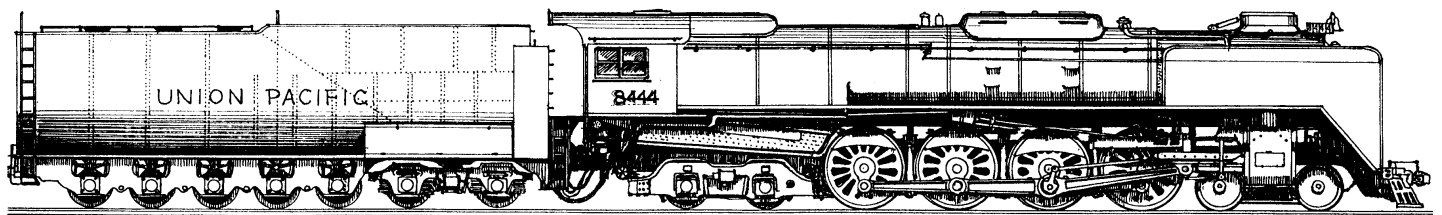

Union Pacific Class FEF It was called the king of passenger locomotives. The heavy body was supported By mono block cast steel frame and roller bearings. It usually ran over 160 Km/h.

Even if the diameter is 10 % less, a maximum speed of 95 Km/h is realized by a 10 % higher revolution speed of 330 rpm. After the retirement of the Class 16E in SAR the heavy express was drawn by the mountain class 15F with 5' wheel till class 25 was thrown in service. Its maximum revolution speed of 330 rpm. using plain bearings was lower than the Class 01 German two cylinder locomotive in the same condition but with revolution speed of 345 rpm.. In any case the level of 330 rpm. was the general concept among world's top-ranking makers in the middle of the 1930's, even in two cylinder locomotives.

Regardless of this tendency, 300 rpm remained as an untouchable criteria for basic design in Japan. Any gain by increasing the revolutions should be thought of against the limitations caused by the strength of the rail. But the countermeasures for it, such as improving rigidity of the main elements, lubrication, machining accuracy, new technologies and etc., were not considered at all but kept as they were. The concept that a big wheel should be the golden rule, though it had been brought by the Class C51 in the early 20th. century, would not change through to the last of steam in Japan. It was followed by a plan for a bullet train of standard gauge, where the diameter of 2300 mm, the same as the Class 05 of DR, was drawn to attain 150 Km/h. In addition to this, the diameter of 2460 mm was at once investigated. It was calculated from the diameter/gauge ratio of the Class 16E. However, what diameter would have been allowed for the boiler on those wheels if this wheel diameter was realized? But no one who claimed his own opinion or decisiveness was there to challenge the golden rule.

Was Japan's own mechanism effective?

There was another technology in addition to the leading wheel mechanism, it was the exhaust expansion chamber. Exhaust steam from the cylinders was lead into a chamber positioned in the middle of the cylinders in order to average the pulsatory ejection of combustion gas. It was developed by Shima junior and adopted to Class C55 and the successors except for small locomotives.

A steam locomotive is a thermal engine, therefore for getting high efficiency many devices had been added to it step by step. And, there were special features only of steam locomotives, it was a big proposition how to evaporate much water under such poor conditions: small grate area, limited height of chimney and many but small diameter horizontal smoke tubes.

For solving this matter a simple but effective measure had been developed and adopted by most of the locomotives. This is to induce combustion gas by utilizing kinetic energy generated by the residual pressure of the exhaust steam from the cylinder. However it is a double edged sword, high back pressure makes good burning but gives less cylinder power. Steam is a fluid and has mass and viscosity. Therefore steam flow generates fluid resistance which reduces effective energy of the steam. Andre Chaplon, the famous French designer of compound locomotives, coined the phrase "Internal stream linearization" and this was taken notice of in the 1930s to minimize energy loss by steam flow.

It was important not to disturb the steam flow not only in the main steam pipe but also for exhaust steam, which was related to ejector design for combustion gases. For expanding exhaust steam not to raise back pressure on the piston, counter measures such as multi passages, ejector nozzles and chimneys were adopted, which became a synonymous with high performance locomotives. Class A4 Mallard holding the speed record by steam in the world had a Kylchap system double blast pipe that had two chimneys each with four nozzles' steam flow induced combustion gases. Class 26 last model in SAR was also the similar design, each four nozzles below chimneys arranged in a "V" formation enabled ejected gas to flow smoothly. Concerning the new exhausting systems in Japan, some of the Class D51 in Hokkaido district adopted the Giesl system developed in Austria with a narrow and long chimney for seven exhaust nozzles in a straight line parallel to boiler center. It might not be appreciated by the center of the Rolling Stock Division because the adoption was limited to a local district, while the exhaust expansion chamber was widely adopted. However the exhaust chamber must obviously throttle (pressure down) exhaust steam from the cylinder when the steam goes into the chamber. It is a loss of steam energy for exhausting, even though it realizes smooth exhausting.

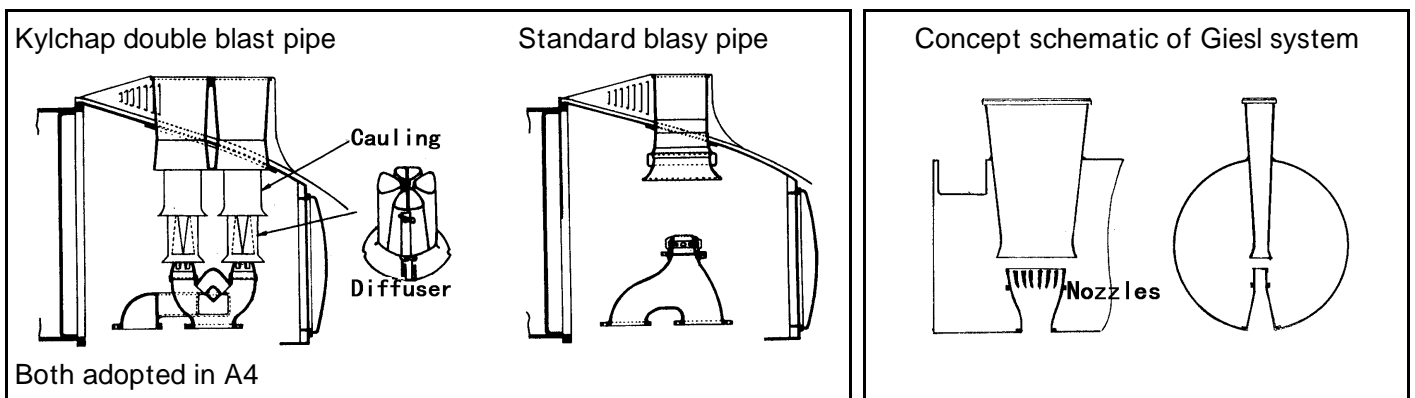
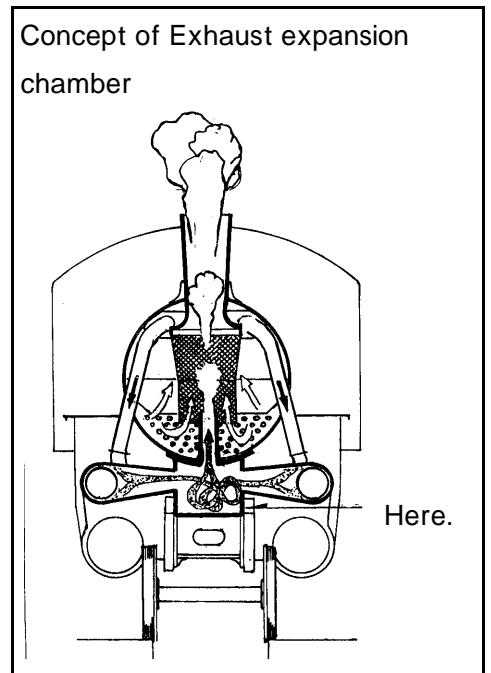

It was a divergence of view which should be the more efficient for total energy balance, smooth and less pulsating flow of combustion gas or minimum energy loss of exhaust steam. The author has no material concerning the matter, but did not hear of other countries adopting such an exhaust expansion chamber.

Another matter neglected in Japan

There was another important matter relating to get high performance, which was not taken into consideration in Japan. In 1925 GWR and LNER competed with each other for the prize of the strongest locomotive in the UK. LNER used a class A1 of simple three cylinder 2C1 wheel arrangement designed by Gresley and GWR used a Castle class of simple four cylinder 2C

arrangement by Collett. A year before at an exhibition in London they were presented as the strongest passenger locomotives, then GWR called for an open test to terminate the argument. Their wheel diameters and axle loads are almost the same but the boiler pressure is a little higher in the Castle. The Castle won the match, it had higher tractive effort and lower coal consumption. LNER did not consent the result but tried to improve its Walschert's valve gear, but this was hardly effective. However LNER soon got a chance to know why. Castle came to Darlington for taking part in the exhibition of hundred year's anniversary of rail. They checked it in full detail and finally found out that the good performance was caused by the difference between the piston valve travel and the steam lap length which governed the time introducing steam. The cause was that the travel of the piston valve of the Gresley's valve gear had been made short because the center one had a tendency to over-run under high speed operation by a rather not rigid valve gear design. The modification was made by Spencer, a subordinate of Gresley, as he did not allow it at first. It brought a big effect to the A1, the fuel consumption became so low that she could make the non stop service of 623 Km between London and Edinburgh where LMS had already done it.

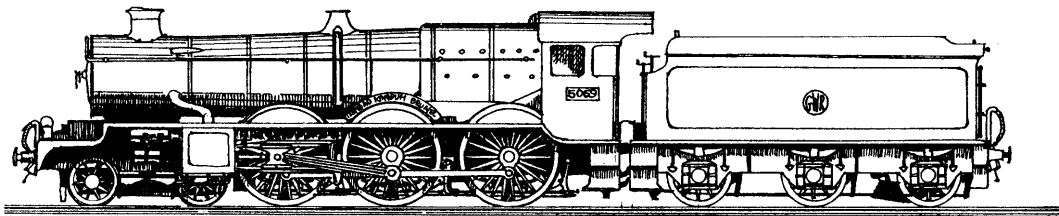

GWR Castle class Two divided drive by four cylinder locomotive with well balanced design and narrow fire box recorded high performance by high calorific coal.

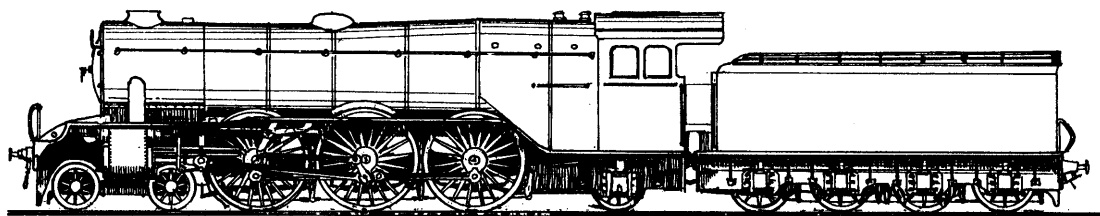

LNER Class A1 Gresley's first Pacific locomotive, which saved the steam hauled limited express of LNER from a German diesel car.

The long lap and long travel of the piston valve were important factors to realize a low cut off for high speed operation. It was not only a norm in UK also in other countries, actually German Class 01 adopted the long lap and travel.

In Japan, the concept was not noticed and a valve dimension of short lap and short travel established for the Class C51 was maintained to the last design. It might be thought unnecessary for 300rpm maximum.

In South Africa using the same gauge as Japan, it was tried to overcome the problem by a poppet valve the fundamental function of which was to adjust the timing of the steam and exhaust valves independently.

Caprotti's poppet valve mechanism

On service 1921 - 1957

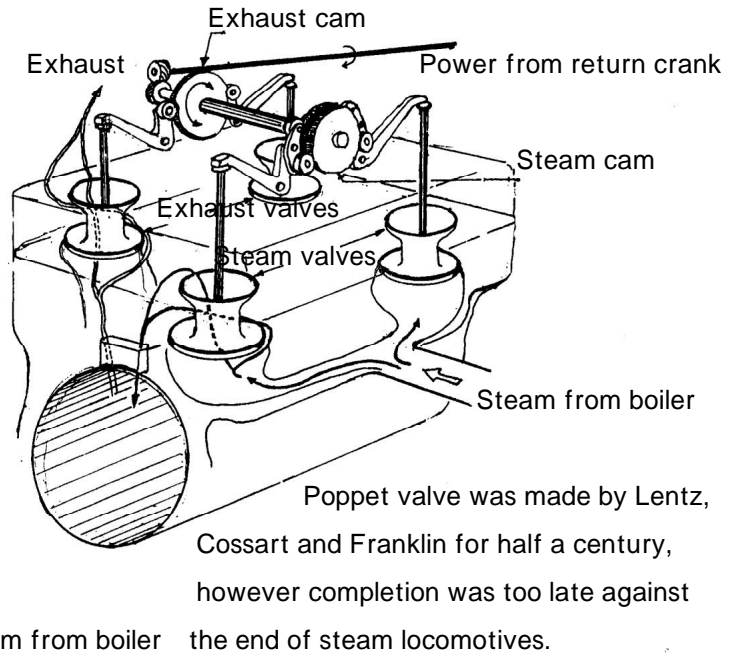
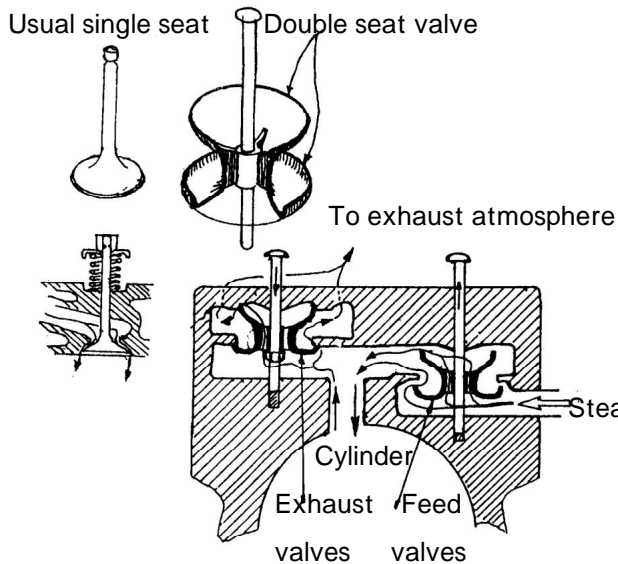

Unfortunately the technology had not been completed at that time to realize the expected performance, then they finally abandoned it and adopted the long lap, long travel piston valve design from 1937 onwards.

Boiler pressure and combustion chamber

The boiler for a steam locomotive must be compact and responsive to sudden load changes, therefore the fire tube boiler had been adopted because of its large water volume compared with the water tube boiler. Then, the pressure was about 21 Kg/Cm² maximum. In the Class 6700 the first domestic locomotive, the imported Class 8700 and so on the pressure was 12.7 Kg/Cm², which level was succeeded through the Classes 8620 and 9600 to C51 made up later to 13 Kg/Cm². In 1928, in the Class C53 it was up to 14, in 1932 in the Class C11 was up to 15 and it was up to 16 for the Class C57 since 1937. This pressure of 16 Kg/Cm² never changed to the last design for the Class D52.

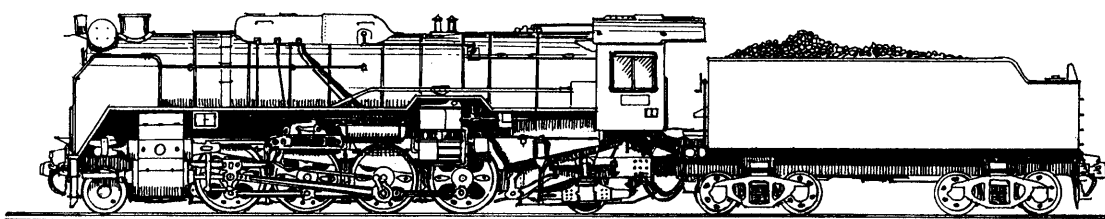

Class D52 National Railway's last and largest freight locomotive, adopted the combustion chamber. Design practice was leaving from the German one but it was the last design as a new boiler.

High pressure is most effective for getting high power under a limited (small) space, but it should be carefully decided by taking account of the cost balance among material, productivity and maintenance. However it was a fact that main locomotives in the world adopted 17.5 through 20 Kg/Cm² since the latter half of the 1930's.

In the UK, LNER's A4 class (famous as the fastest in the world), LMS's most powerful in the UK Pacific Duchess class, SR's Merchant Navy and West Country class drawn "Golden Arrow", National Railway's Britannia 70000 and the last express passenger locomotive 71000, they were all 17.6 Kg/Cm².

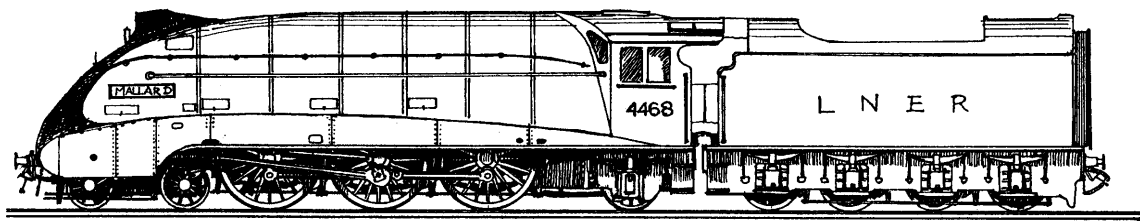

LNER A4 class "The Mallard" Grown from A1 via A3, had the world's highest speed record of 126 miles/h as by steam.

In the U.S. Pency's T1, Union Pacific's FEF, Santa Fe's 2900, Southern Pacific's GS, Milwaukee's A and F7, most of these big high performance locomotives were 21 Kg/Cm² and even Niagara the low one among them was 19.3 Kg/Cm². In France it was also high as compound expansion became adopted.

In Germany 20 Kg/Cm² was tried on 05, 06 and 61 but it did not succeed. Those mass-produced were 16 Kg/Cm² unchanged, but the Class 10 the last locomotive there, adopted 18Kg/Cm².

In Japan Class C63 was also planned with 18 Kg/Cm² but it was regrettable that the plan was too late to be actually manufactured.

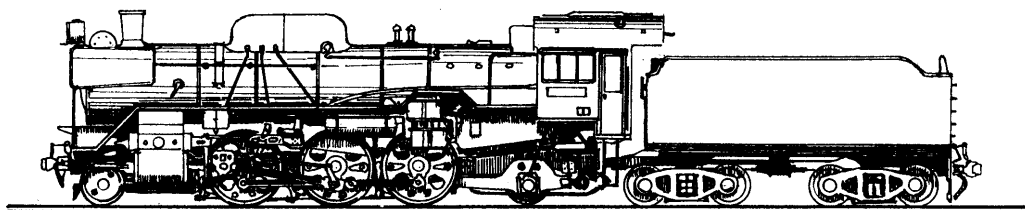

Illusioned Class C63 Planned as an successor to the C58 with 18 Kg/Cm² steam pressure

The locomotive boiler has to be horizontally long caused by its dimensional limits, it makes for difficulty in flue gas flow. Concerning the failure of the Class 06 in Germany, it was said that this was caused by the first adoption of 20 Kg/Cm² boiler pressure and 7.5m long fire tubes. Wagner, a chief mechanical engineer of Reichsbahn, insisted on a big heat transfer area by long smoke tubes, against critical opinions. It not only prevented smooth gas flow but also brought insufficient strength for vibration stress generated by high speed running.

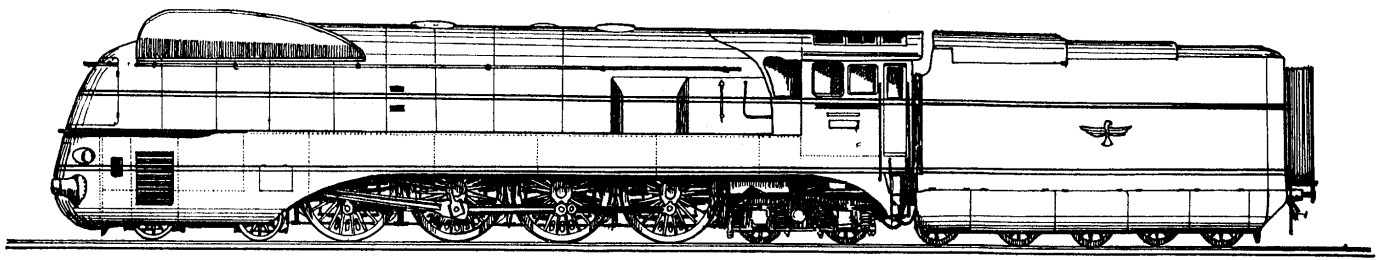

DB class 06 Hopeful German high speed locomotive delayed its debut 4 years because of the boiler trouble.

In contrast to those mentioned above, the middle of the 1900's witnessed a practice of a combustion chamber added to a fire chamber born in the U.S. for big and effective heat transmission by radiation. It was rapidly coming into wide use with the scaling up of the mallet. The fire tube length was 6.7 meters at the very most in "Big Boy".

The combustion chamber was spread to the rest of the world except for Germany.

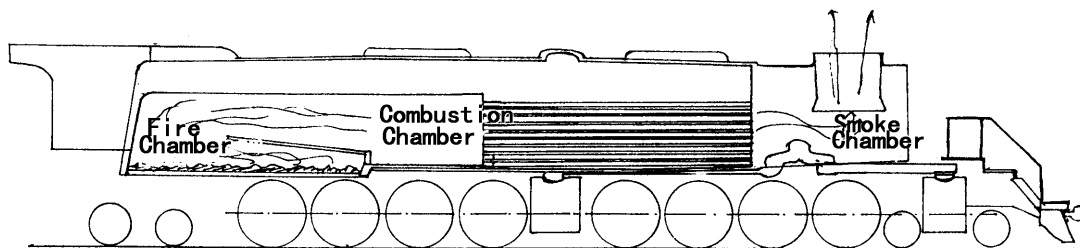

Boiler of Big Boy More than half is occupied by the fire and combustion chambers

The South Manchuria Railway technically under influence of the U.S. had adopted a combustion chamber since 1927 for their Class PA-SI-KO.

In the meantime the adoption in Japan at 1943 for was the Class D52 because of the influence of German technical concepts. In 1942 Hideo Shima, the National Railway's chief designer of the new bullet train, presented in a technical journal that to increase the radiant heat transfer area is preferable to increase the contact heat transfer area with a view to getting much heat transfer. He had to note it but too late. The combustion chamber was not in the Class C59 launched in 1941 but in the Class D52 in 1943, it meant that the combustion chamber was acknowledged as their collective view. It was also the time when the Class 06 faced a rash of boiler troubles in Germany.

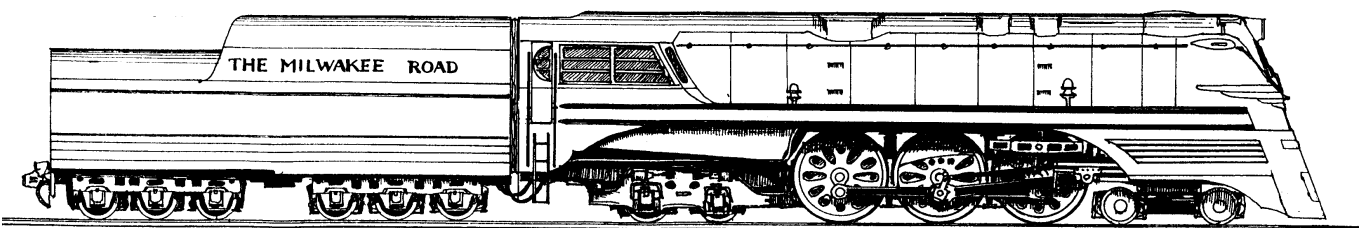

Milwaukee Railway Class F7 Drew the limited express "HIAWATHA", and exceeded the "ZEPHER" driven by the newly risen diesel power.

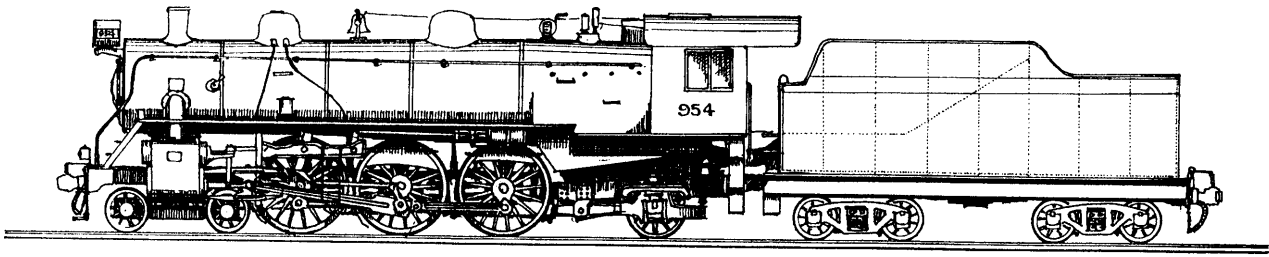

The South Manchurian Railway class PA-SI-KO even though it was not in the national railway.

The first locomotive with a combustion chamber made in Japan

The Mallet, locomotive not correctly evaluated in Japan

In 1904 the Mallet, originally made in France for farm's portable rail, turned into a typical gigantic locomotive once it was manufactured in the U.S., 17 years after its birth. The first Mallet in Japan was a German made class 4500, imported for exhibition in 1903.

Class 4500 imported from Germany when the big Mallet was not yet made in U.S.

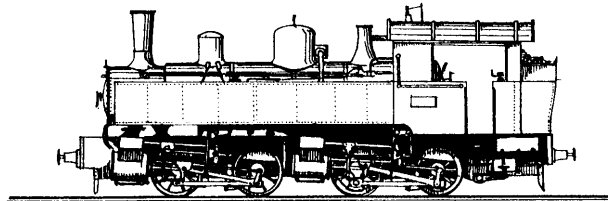

They were really imported at the same period when Classes 8700 and 8800 were imported, the number reached 60 in a very short time from U.S. by the aggressive promotion by sales agents. They were expected to solve a big bottle neck at Hakone-pass, the most important trunk line. The author supposed that Yasujiro Shima would not have liked to accept imports that had not been technically evaluated yet among locomotive engineers, but he was unfortunately in Germany at that time and communication tools were so powerless to overcome the agents working in the Far East.

They were Classes 9750, 9800 and 9850 with C+C driving wheel arrangement, but had neither a leading nor a trailing wheel. This arrangement of wheels (without leading and trailing wheels) had already finished in the U.S. The number of 60 was larger than total of the same arrangement in the U.S. At that time a leading wheel was recognized as fundamentally necessary to minimize wear on the driving wheel flange, while S.A.R. began to test it two years in advance and all the Mallet had leading wheels. Japan was worried soon by the wear of the flange. Did they promote it as if they had not been aware of the defect with an excuse that the length of locomotive was limited by turn table diameter?

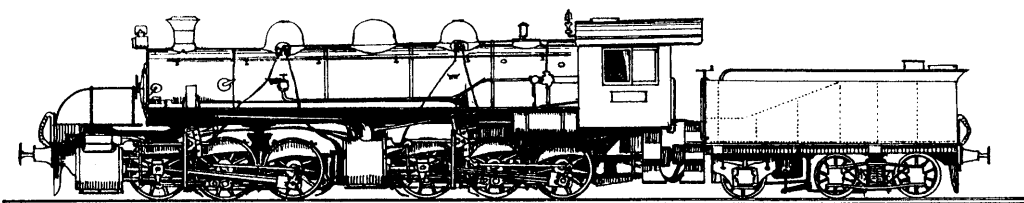

Class 9750 A lot of Mallets, designed by ALCO, were imported from Germany and the U.S

Was Japan taken advantage of the ignorance?

In advance of them, a small Mallet Class 9020 with B+B driving wheel arrangement was imported from the U.S. for a performance test. However it was not applicable for practical use.

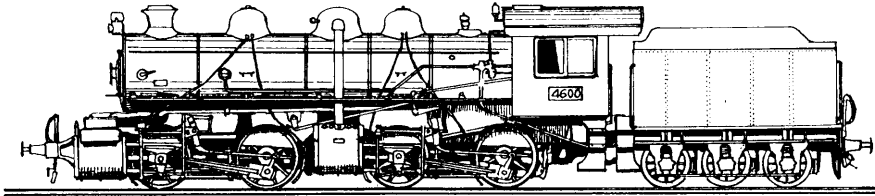

Class 9020 The first Mallet from the U.S. was so small even there had not been.
No use except for as training purpose.

Importation circumstances were really vague, the engineer in charge had neither knowledge of it nor its prospect for the future. Meanwhile in South Africa after the importation they designed Mallets improved by themselves and used nine kinds for more than 60 years. In Japan they were neither remodeled nor developed into a new design, and ended their life in less than 20 years.

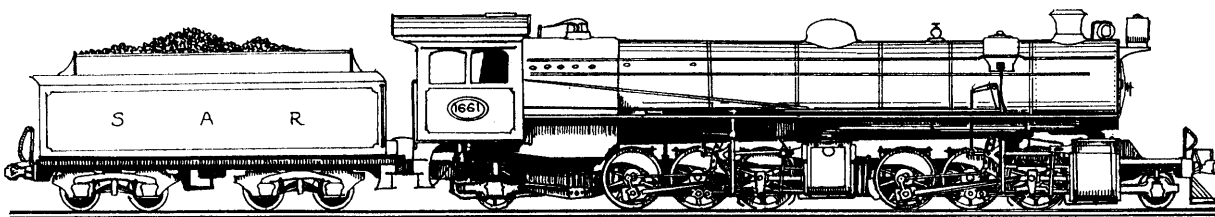

SAR class MH The biggest in SAR launched 1915 was also the strongest in the world at that time except for the U.S.

Tractive effort required for locomotive in Japan was different from that in South Africa because the train units were not the same. However the author supposed it was not expected to take on a challenge of the new technology under the management of Shima. There was rarely a big Mallet in Europe, it might implicitly effect him.

Remarks

It was 130 years ago when Japan abandoned the isolationism and it was also the starting point of the modern machine industry. However the development of the locomotive had to wait until their own engineer grew up. Therefore the net development period was short, which was less than the 40 years of the one for developing the Shinkansen-Japan's famous bullet train. Rome was not built in a day, and the locomotive technology here had to start from zero. Therefore it could not be helped, there was not sufficient time to mature those fundamental matters which had been learned and consequently we could not put forward new technologies applicable to other countries. The eras of

the steam mostly followed the principle of wealth and armament in Japan. Priority of investment and labor was given to war industries, but capital and labor given to locomotive developments were finite. The weapon was developed regardless of expense, but the locomotive was limited by budget, consequently locomotive engineers had to follow in the technology already established on the actual field. Also in Japan there was no cutthroat competition especially in the race for speed among railway companies.

The eminent leadership by Yasujiro Shima established the systematically designed locomotives, however we could not find out any engineer to return it to the drawing board and re-establish it with freedom for new ideas. Rather, new ideas were eliminated. The early extinction of the Mallet and three cylinders was understood by it. His son Hideo Shima, who was also the chief mechanical engineer of the National Railway, never denied the concept but broke new ground through the decentralization of motive power. In Japan where the National Railway was actually the only user, locomotive manufacturers could not intend to develop their proper product.

Under the conditions of limited time, a small number of designers, no competition and a single authority, it is inevitable that a new or odd thing shall not be adopted. Hence the Japanese modern locomotives were monotonous and similar. It was a logical result.

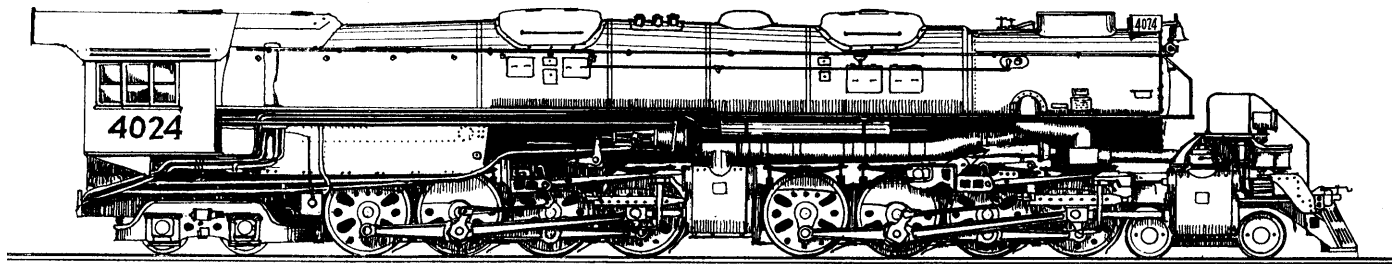

UP Class Big Boy In addition to a big tractive effort, the maximum speed was 80 miles/h.

Appendix. 1									
Main specifications of Japanese locomotives									
Type configuration	Axle load Ton	Driving wheel diameter	Boiler pressure Kg/cm2	Cylinder Nos.xdiameter X stroke	Grate area m2	Weight Ton	Year Manufactured	Number Manufactured	
Heavy express									
C53 4-6-2	15.44	1750	14	3x450x660	3.25	80.98	1928-30	97	
C59 4-6-2	16.19	1750	16	2x520x660	3.27	80.4	1941-47	196	
C62 4-6-2	16.08	1750	16	2x520x660	3.85	88.83	1948-49	49	
C52 4-6-2	15.9	1600	14	3x450x660	3.25	82.47	1926	6	
Express									
C51 4-6-2	14.2	1750	12.7	2x530x660	2.53	66.3	1919-28	289	
C54 4-6-2	13.42	1750	14	2x510x660	2.53	65.3	1931-32	17	
C55 4-6-2	13.62	1750	14	2x510x660	2.53	66.04	1935-37	62	
C57 4-6-2	13.62	1750	16	2x500x660	2.53	66.04	1937-47	201	
8800 4-6-0	12.26	1600	12.7	2x470x610	1.86	50.84	1911	12	
Local and mixed									
6700 4-4-0	14.12	1600	12.7	2x406x610	1.58	43.5	1911-12	46	
6760 4-4-0	13.88	1600	12.7	2x470x610	1.63	45.57	1914-18	88	
8620 2-6-0	13.48	1600	12.7	2x470x610	1.65	46.75	1914-29	672	
C50 2-6-0	14.9	1600	14	2x470x610	1.61	53	1929-33	154	
C58 2-6-2	13.68	1520	16	2x480x610	2.15	58.86	1938-47	427	
Goods and gradient									
9600 2-8-0	13.17	1250	12.7	2x508x610	2.32	59.83	1913-26	770	
D50 2-8-2	14.99	1400	12.7	2x570x660	3.25	78.14	1923-27	380	
D51 2-8-2	14.3	1400	14	2x550x660	3.27	76.8	1937-43	1115	
D52 2-8-2	16.28	1400	16	2x550x660	3.85	84.5	1944-46	285	

E10	2-10-4	14.24	1250	16	2x550x66 0	3.3	102.1	1948	5
-----	--------	-------	------	----	---------------	-----	-------	------	---

Note:

All steam are superheated except for 6700.

C52 and 8800 are imported locomotives, shown for reference.

E10 is tank engine.

Appendix. 2

Numbering and classification rule of old locomotives

It was started to assign the numerical classification .

Forexample:

Class	Numbers	manufactured	
1	1	Bagnall	1903
5	5,6	Baldwin	1898
10	10-32	Krauss	1889-95
40	40,41	Krauss	1896, 1911

However, when the number in the class increased, it became complicated.

For example:

Class	Numbers
8900	8900-8936

The successor of 8900 should have been the class of 8950 or 9000, but the total number were 289 and the class 9000 had already been assigned to another type. Therefore the class 18900 was given, but the numbers were very complicated. Actual numbers were 18900 through 38988, The first, fourth and fifth digits varied. The succeeding number of 18999 was 28900.

Then classification rule was changed. The class C51 was newly assigned instead of 18900,

There a combination of the class and the number was adopted, C511 through C51289 were born.