

Security Level:

OBA000100 GPON Fundamentals

www.huawei.com





References

- ITU-T 984.1
- ITU-T 984.2
- ITU-T 984.3
- ITU-T 984.4

Objectives

- Upon completion of this course, you will be able to:
 - Describe GPON Network Architecture
 - Outline GPON Basic Concepts
 - Outline GPON Applications



Contents

1. Overview of Optical Access Network
2. Basic Concepts of PON
3. GPON Frame Structure
4. GPON Key Technologies
5. GPON Management and Service Provisioning
6. Basic Services over GPON Network



Contents

1. Overview of Optical Access Network
2. Basic Concepts of PON
3. GPON Frame Structure
4. GPON Key Technologies
5. GPON Management and Service Provisioning
6. Basic Services over GPON Network

Architecture of Optical Access Network

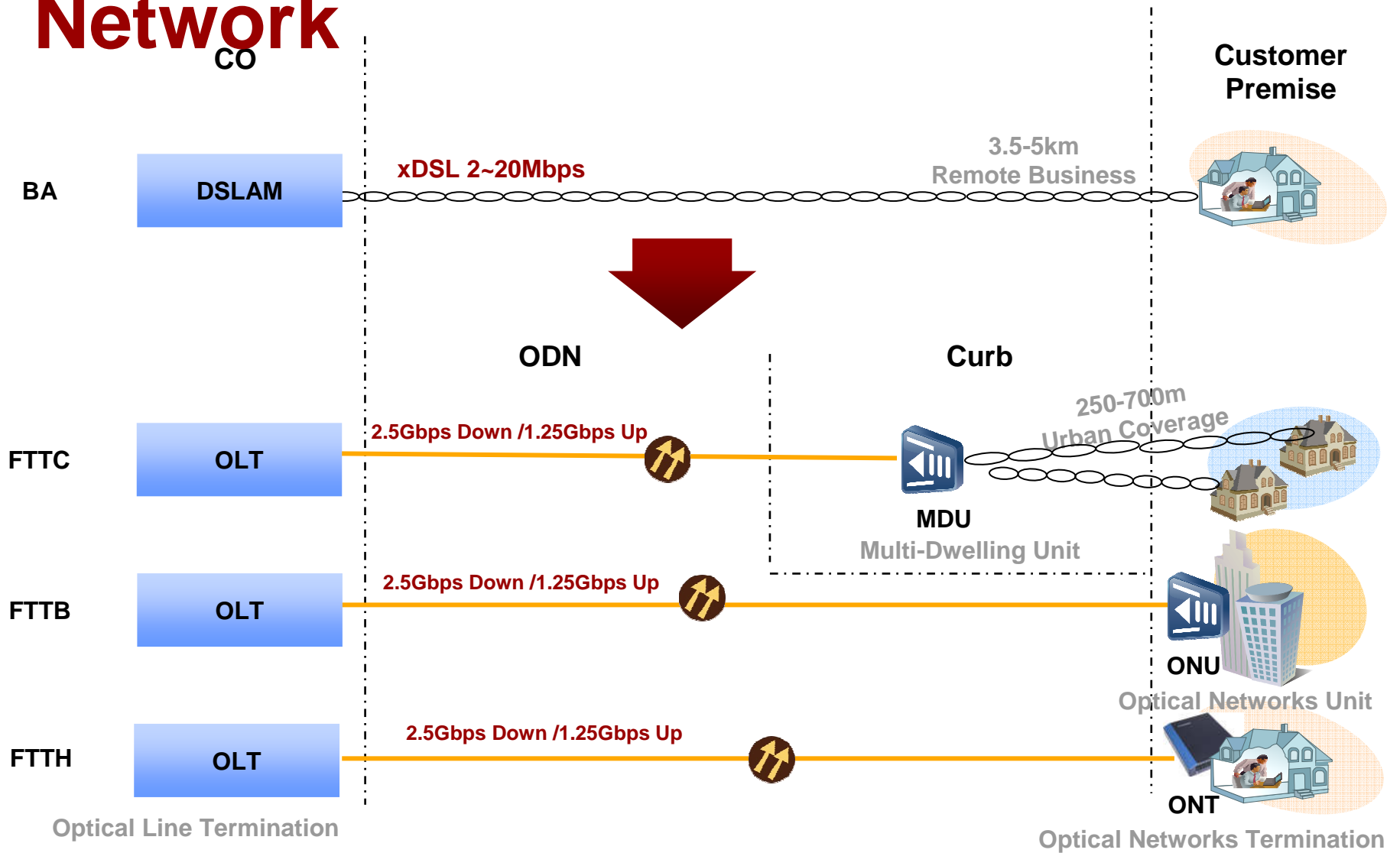

What is Optical Access Network?

From the architecture diagram, the optical access network comprises the following scenarios:

1. FTTB scenario

SBU : Single business unit ; providing a comparatively small number of ports such as 10/100/1000BASE-T, RF, and DS1/T1/E1 ports

MTU :Business Multi-tenant unit ; providing a comparatively larger number of ports, including 10/100/1000BASE-T, RF and DS1/T1/E1 ports., VDSL2, and so on.

2. FTTC & FTTCab scenario

MDU : Multi-dwelling unit ;providing a comparatively larger number of ports, including 10/100/1000BASE-T, RF, VDSL2, and so on.

3. FTTH scenario

SFU : Single family unit , providing a comparatively small number of ports, including following types: POTS, 10/100/1000BASE-T, and RF.



Contents

1. Overview of Optical Access Network
2. **Basic Concepts of PON**
3. GPON Frame Structure
4. GPON Key Technologies
5. GPON Management and Service Provisioning
6. Basic Services over GPON Network

What is PON?

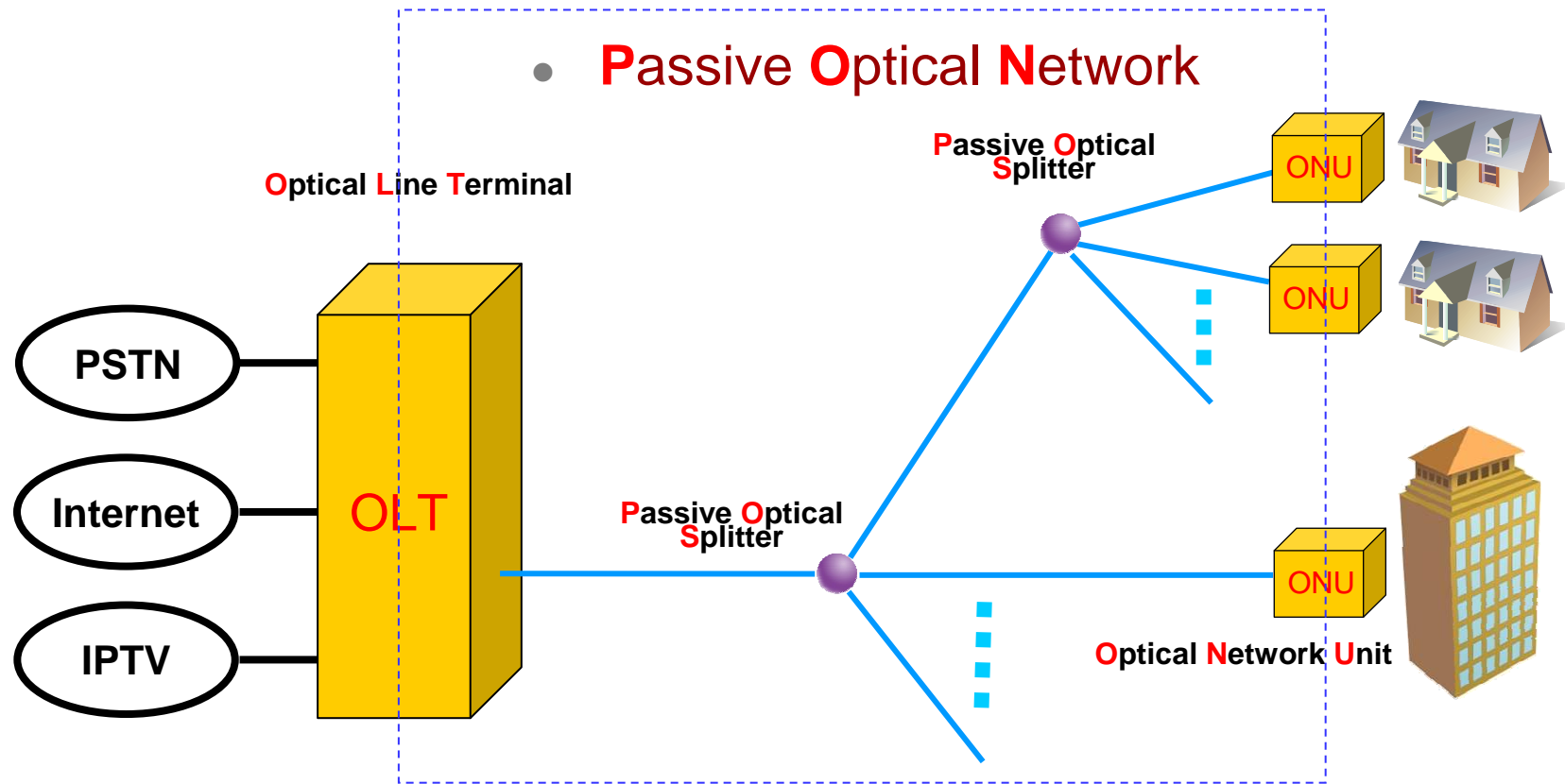

- PON is a kind of passive optical network featuring one-to-multiple-point architecture;
- PON is short for Passive Optical Network ;
- PON consists of Optical Line Terminal (OLT), Optical Network Unit (ONU) and Optical Distribution Network(ODN).

Why GPON?

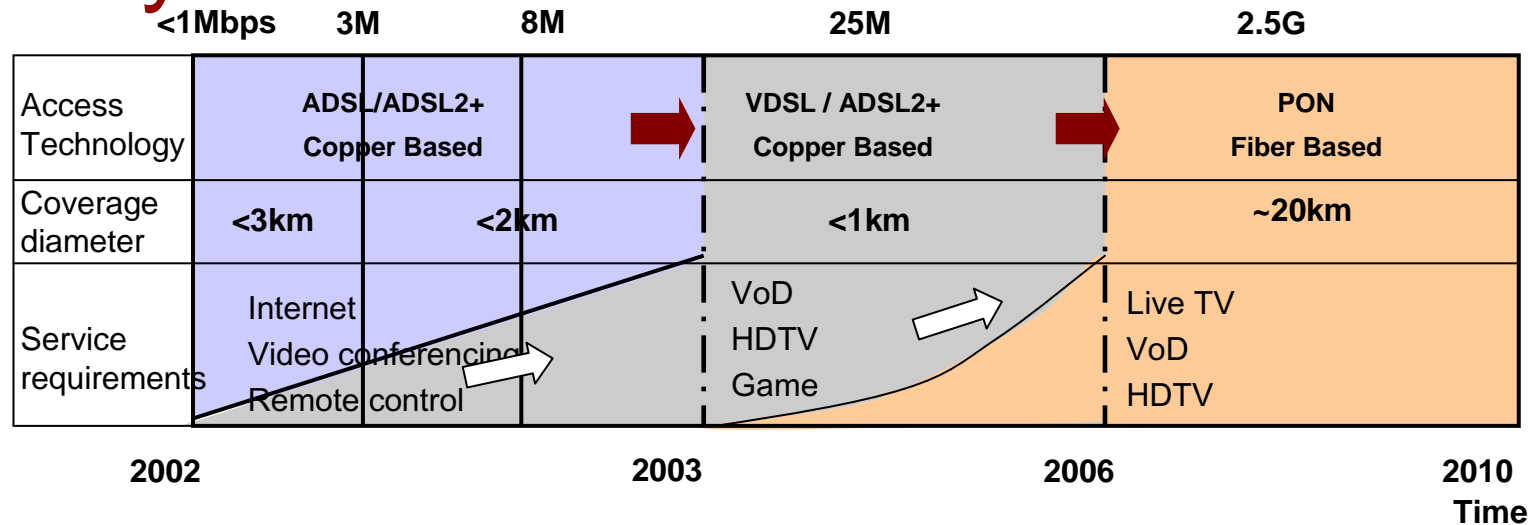

- **GPON (Gigabit-capable Passive Optical Networks)**
- GPON supports :
 - Triple - play service
 - high-bandwidth
 - long-reach (up to 20 km)
- GPON is the choice of large carriers in the international market.

GPON Principle----Data Multiplexing

- GPON adopts Wavelength Division Multiplexing (WDM) technology, facilitating bi-direction communication over a single fiber.

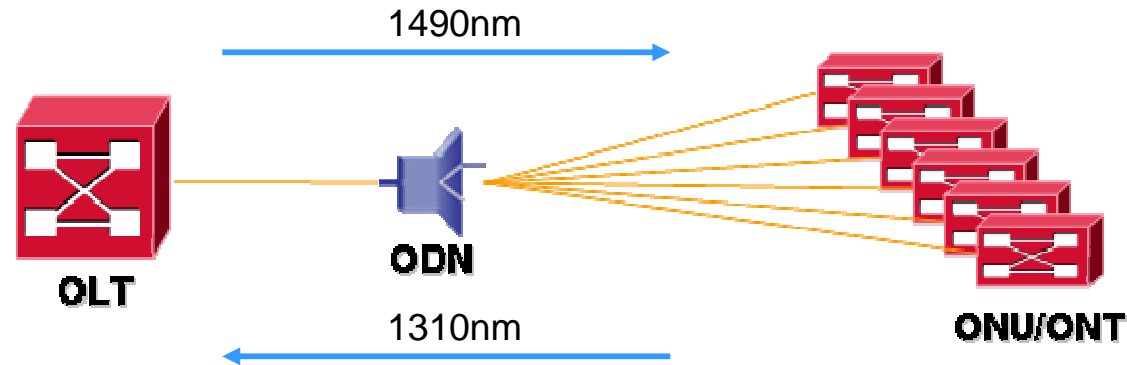

- To separate upstream/downstream signals of multiple users over a single fiber, GPON adopts two multiplexing mechanisms:
 - In downstream direction, data packets are transmitted in a broadcast manner;
 - In upstream direction, data packets are transmitted in a TDMA manner.

GPON Principle----Downstream Data

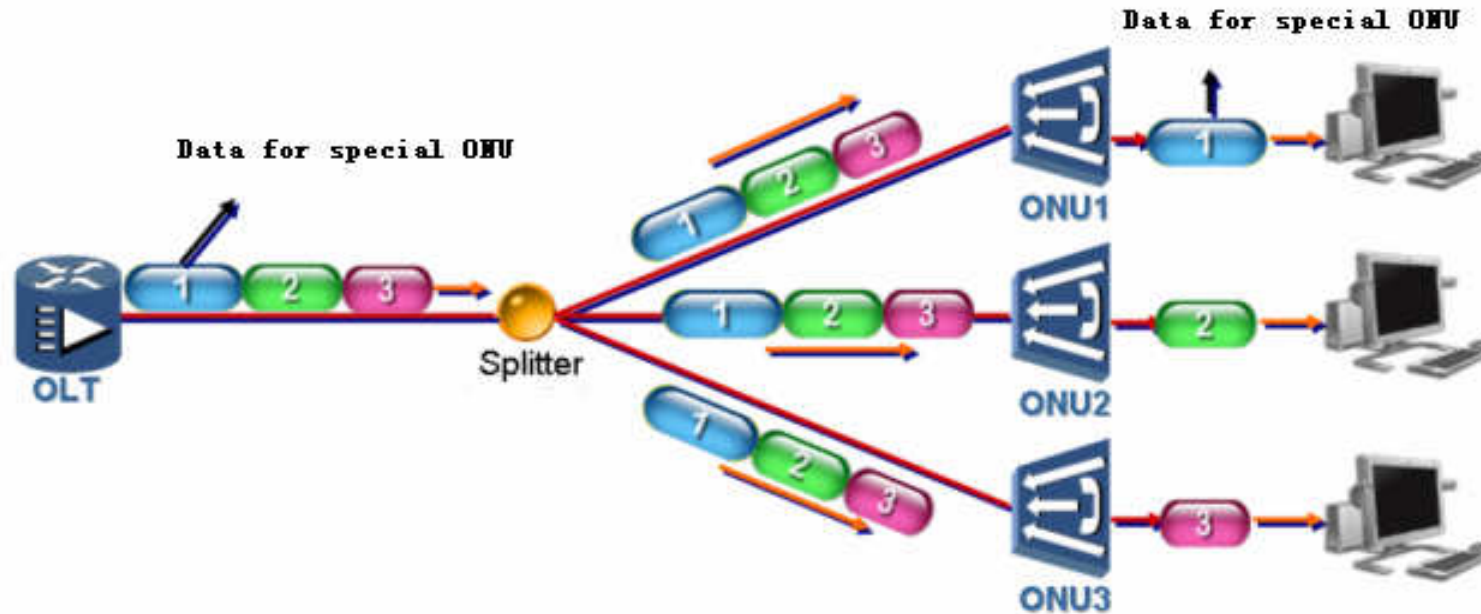

- Broadcast mode

GPON Principle----Upstream Data

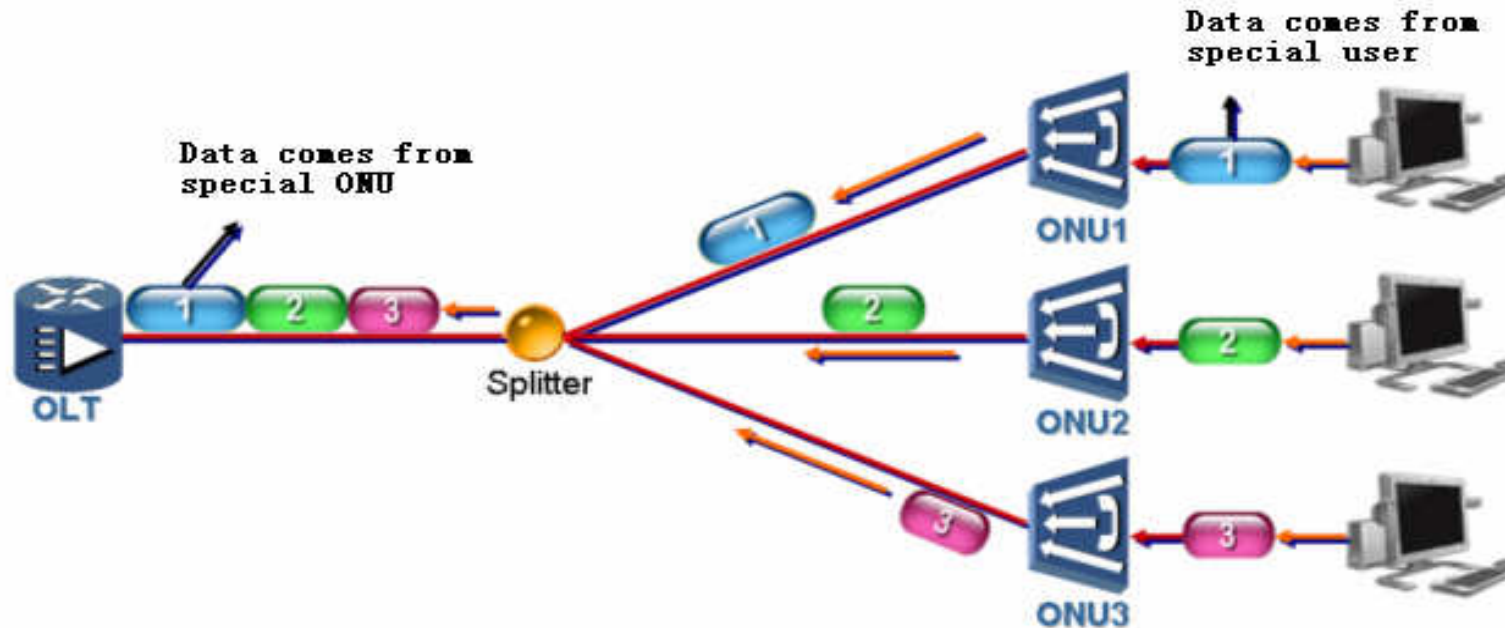

- TDMA mode

GPON Standards

ITU-T G.984.1

- Parameter description of GPON network
- Requirements of protection switch-over networking

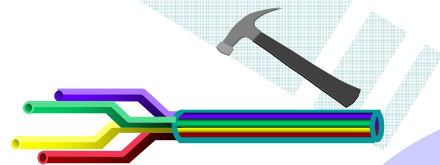

ITU-T G.984.2

- Specifications of ODN parameters
- Specifications of 2.488Gbps downstream optical port
- Specifications of 1.244Gbps upstream optical port
- Overhead allocation at physical layer

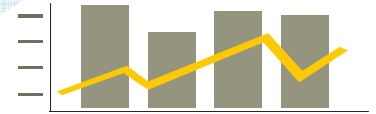

Simple development process
Powerful compatibility



ITU-T G-984.1/2/3/4

ITU-T G.984.3

- Specifications of TC layer in the GPON system
- GTC multiplexing architecture and protocol stack
- GTC frame
- ONU registration and activation
- DBA specifications
- Alarms and performance



ITU-T G.984.4

- OMCI message format
- OMCI device management frame
- OMCI working principle

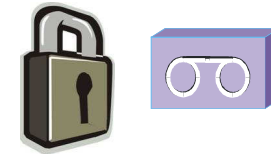

Basic Performance Parameters

Upstream	Downstream
Rate(Gbps) 0.15552	Rate(Gbps) 1.24416
0.62208	1.24416
1.24416	1.24416
0.15552	2.48832
0.62208	2.48832
1.24416	2.48832
2.48832	2.48832

1.24416 Gbit/s up, **2.48832 Gbit/s** down is the mainstream speed combination supported at current time.

Basic Performance Parameters

Maximum logical reach	60 km
Maximum physical reach	20 km
Maximum differential fibre distance	20 km
Split ratio	1 : 64/up to 1 : 128

The distance between nearest and farthest ONTs



Contents

1. Overview of Optical Access Network
2. Basic Concepts of PON
3. **GPON Frame Structure**
4. GPON Key Technologies
5. GPON Management and Service Provisioning
6. Basic Services over GPON Network

GPON Network Model Reference

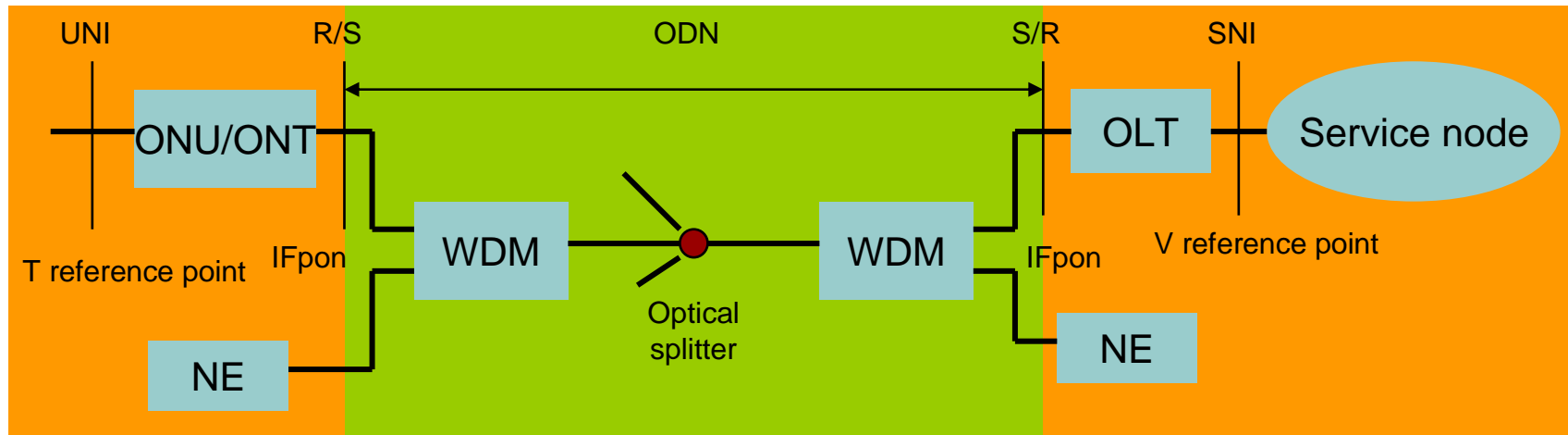

- ONU** Optical Network Unit
- ONT** Optical Network Terminal
- ODN** Optical Distribution Network
- OLT** Optical Line Terminal
- WDM** Wavelength Division Multiplex Module
- NE** Network Element
- SNI** Service Node Interface
- UNI** User Network Interface

GPON Multiplexing Architecture

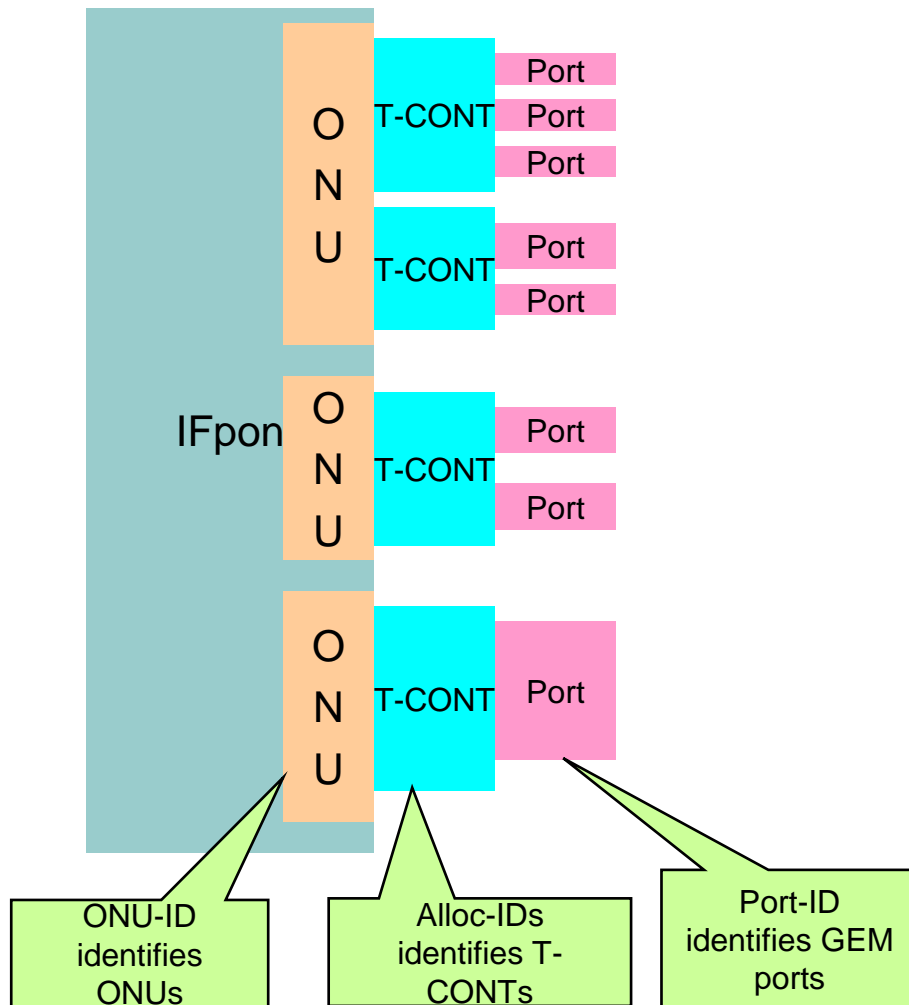

- GEM Port: the minimum unit for carrying services.
- T-CONT: Transmission Containers is a kind of buffer that carries services. It is mainly used to transmit upstream data units. T-CONT is introduced to realize the dynamic bandwidth assignment of the upstream bandwidth, so as to enhance the utilization of the line.
- IF pon: GPON interface.
- Based on the mapping scheme, service traffic is carried to different GEM ports and then to different T-CONTs. The mapping between the GEM port and the T-CONT is flexible. A GEM port can correspond to a T-CONT; or multiple GEM Ports can correspond to the same T-CONT.
- A GPON interface of an ONU contains one or multiple T-CONTs.

GPON Multiplexing Architecture

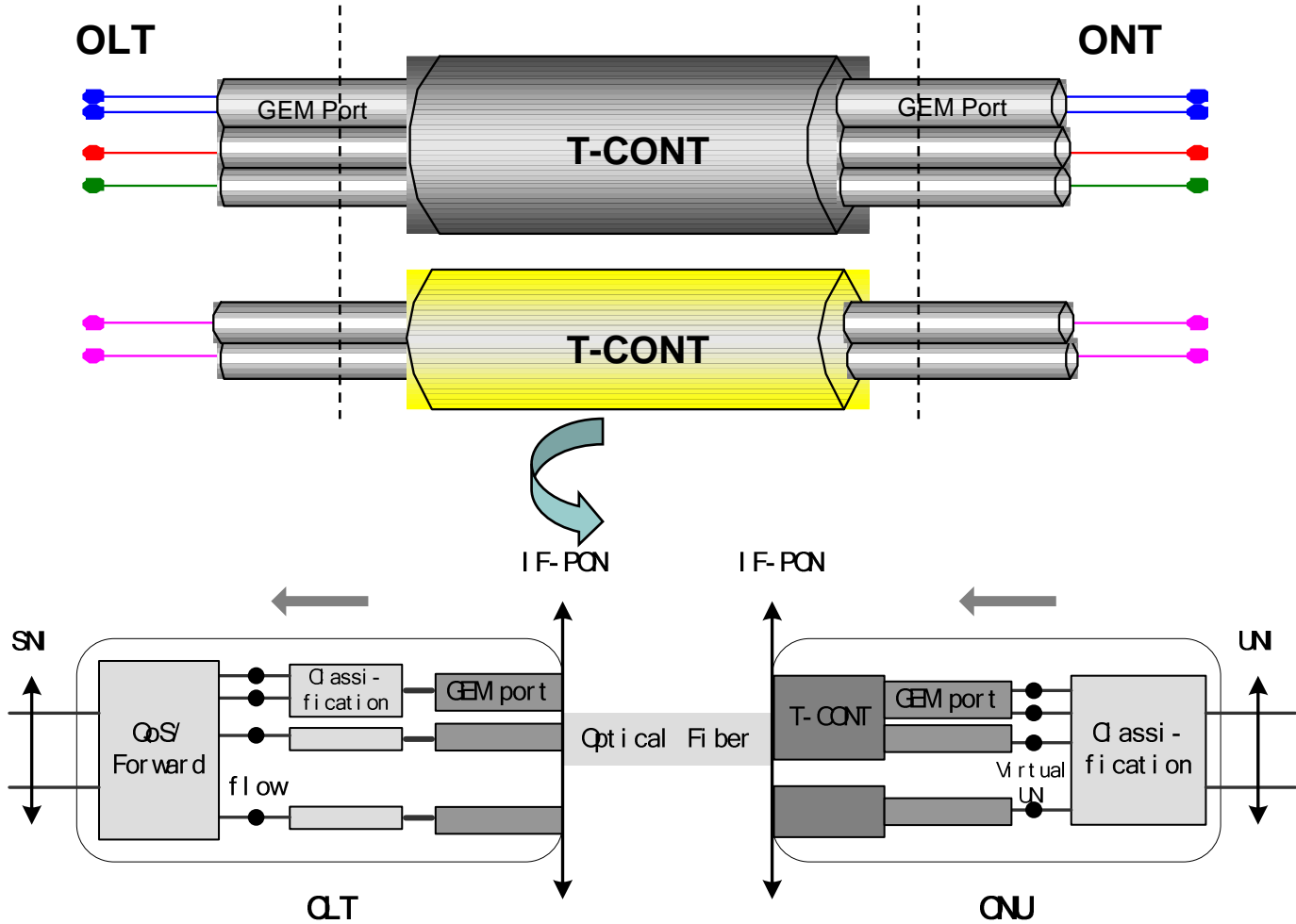

GPON Frame Structure

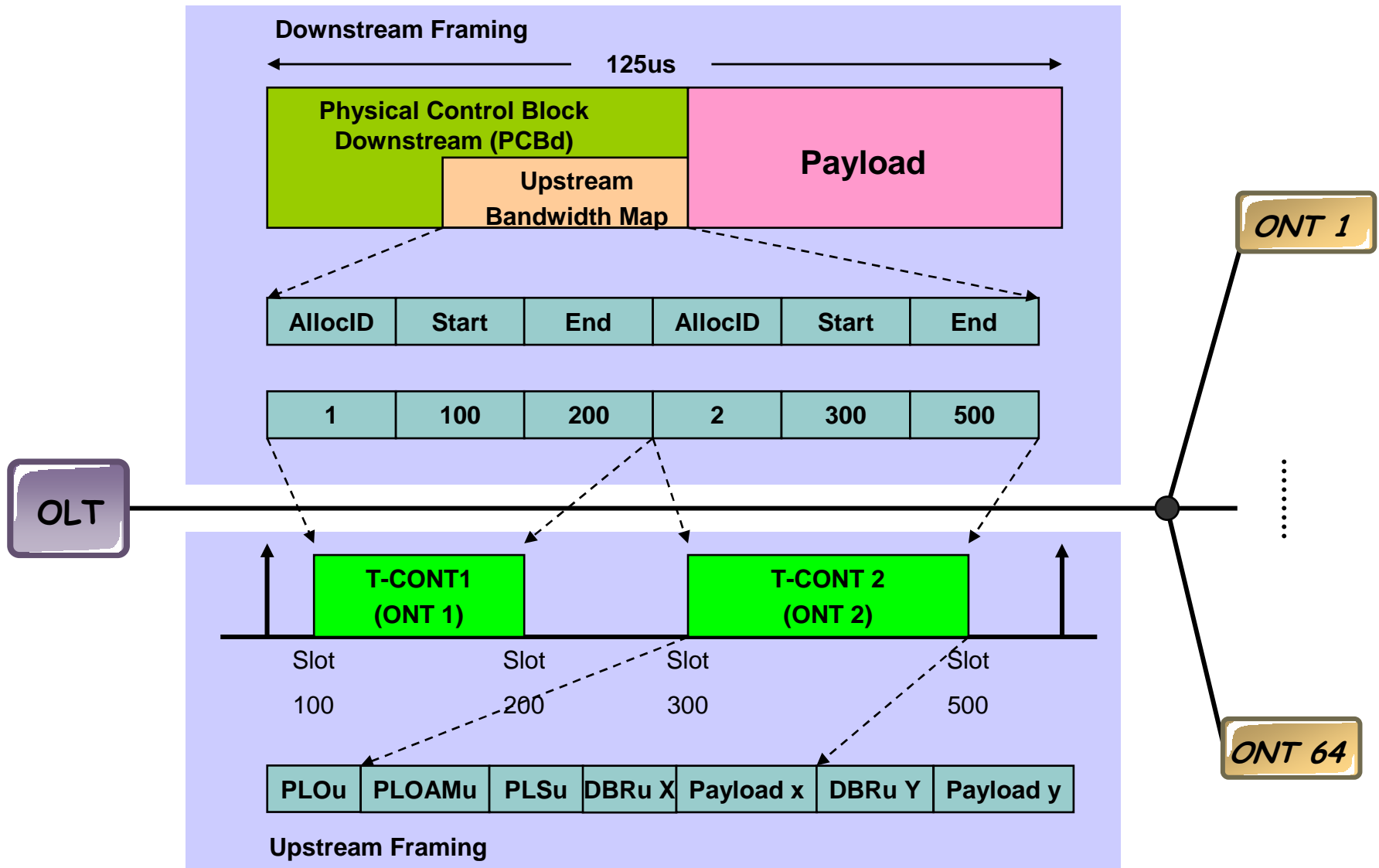

GPON Upstream Frame Structure

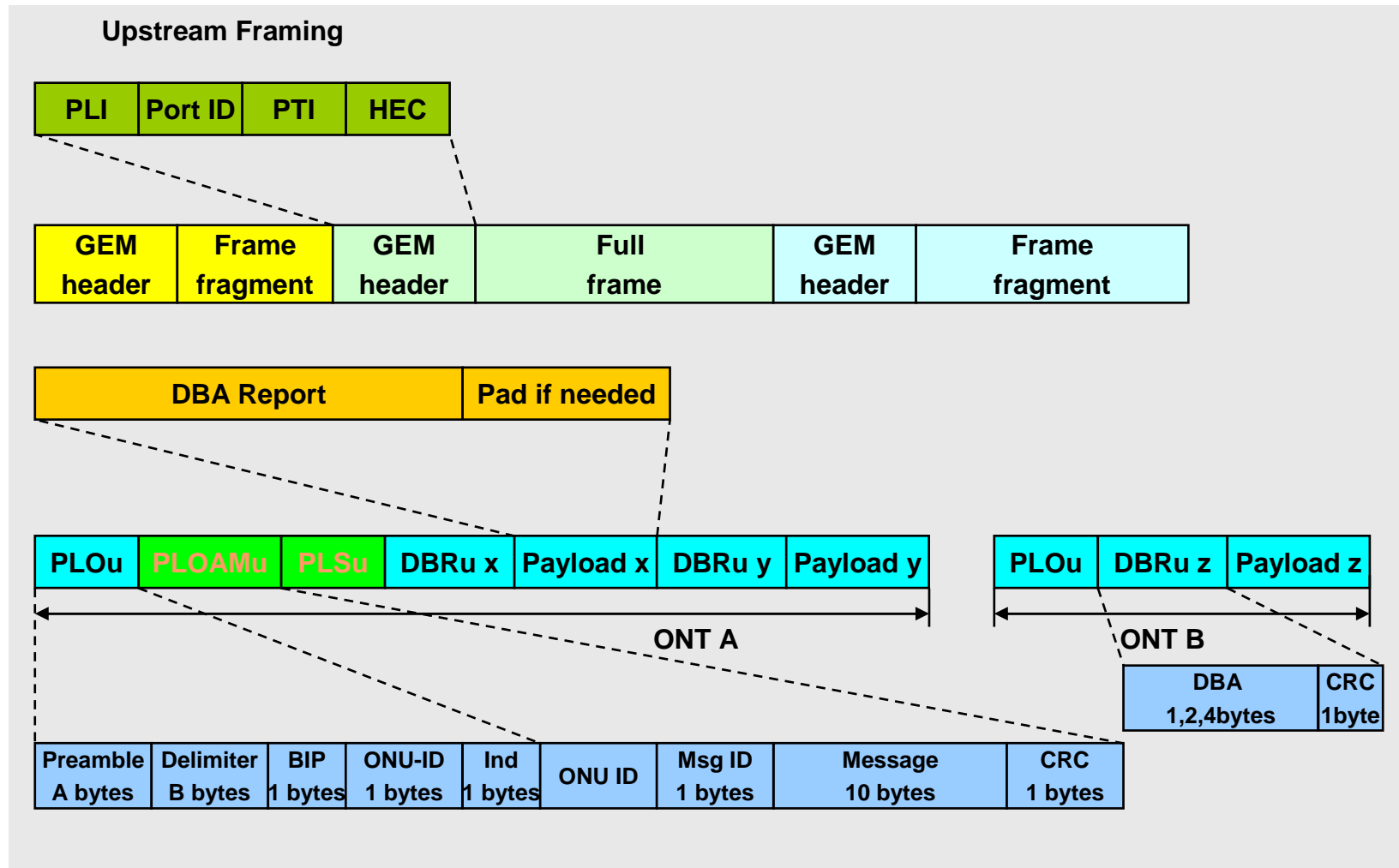

GPON Downstream Frame Structure

Structure

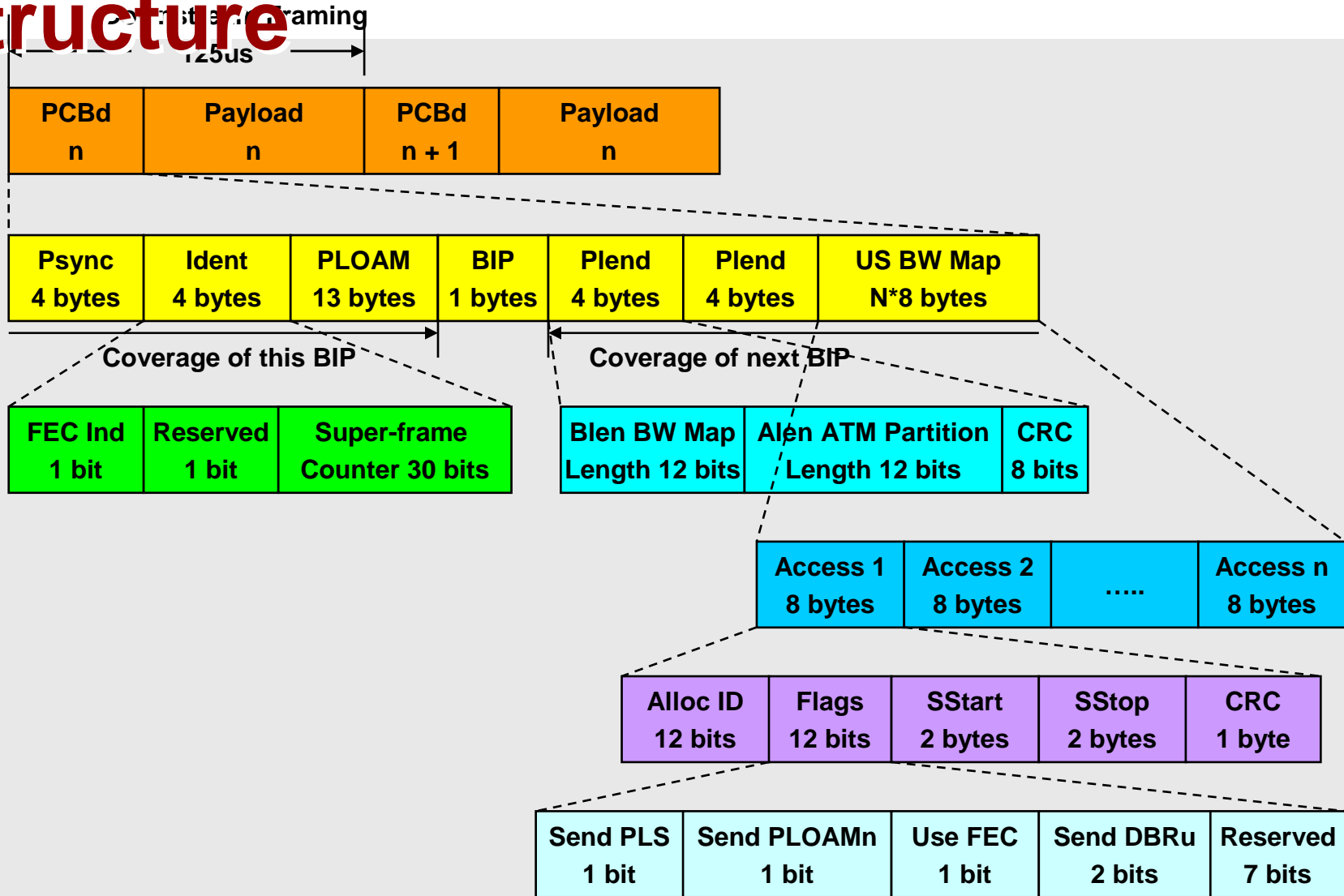

Mapping of TDM Service in GPON

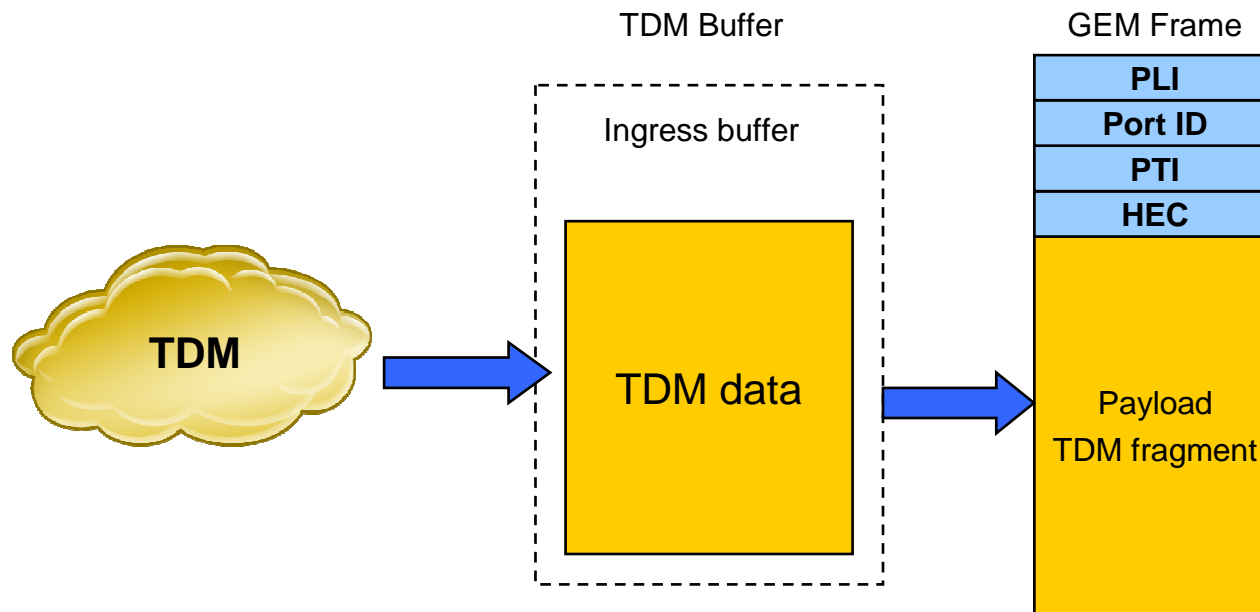

- TDM frames are buffered and queued as they arrive, then TDM data is multiplexed in to fixed-length GEM frames for transmission.
- This scheme does not vary TDM services but transmit TDM services transparently.
- Featuring fixed length, GEM frames benefits the transmission of TDM services .

Mapping of Ethernet Service in GPON

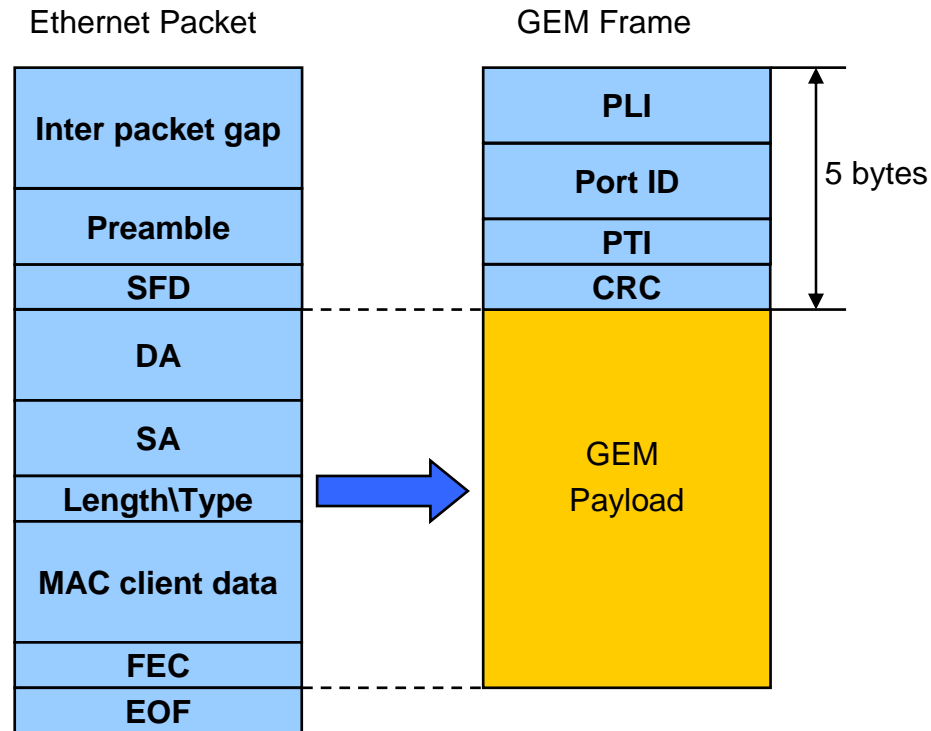

- GPON system resolves Ethernet frames and then directly maps the data of frames into the GEM Payload.
- GEM frames automatically encapsulate header information.
- Mapping format is clear and it is easy for devices to support this mapping. It also boasts good compatibility.



Contents

1. Overview of Optical Access Network
2. Basic Concepts of PON
3. GPON Frame Structure
4. **GPON Key Technologies**
5. GPON Management and Service Provisioning
6. Basic Services over GPON Network

GPON Key Technologies-

- Ranging
- DBA
- T-CONT
- AES
- Attenuation



Ranging

- OLT obtains the Round Trip Delay (RTD) through ranging process, then specifies suitable Equalization Delay (EqD) so as to avoid occurrence of collision on optical splitters.
- To acquire the serial number and ranging, OLT needs open a window, that is, Quiet Zone, and pauses upstream transmitting channels on other ONUs.

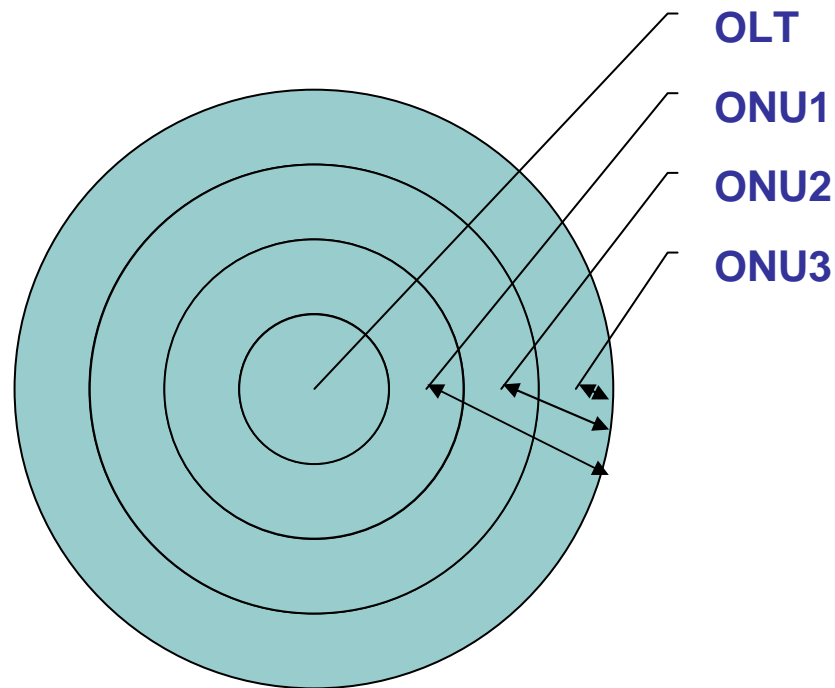

DBA

- What is DBA?
 - DBA, Dynamic Bandwidth Assignment
- Why DBA?
 - It enhances the uplink bandwidth utilization of PON ports.
 - More users can be added on a PON port.
 - Users can enjoy higher-bandwidth services, especially those requiring comparatively greater change in terms of the bandwidth.
- DBA operation modes
 - SR-DBA: status report-DBA
 - NSR-DBA: non status report-DBA

SR-DBA Operation

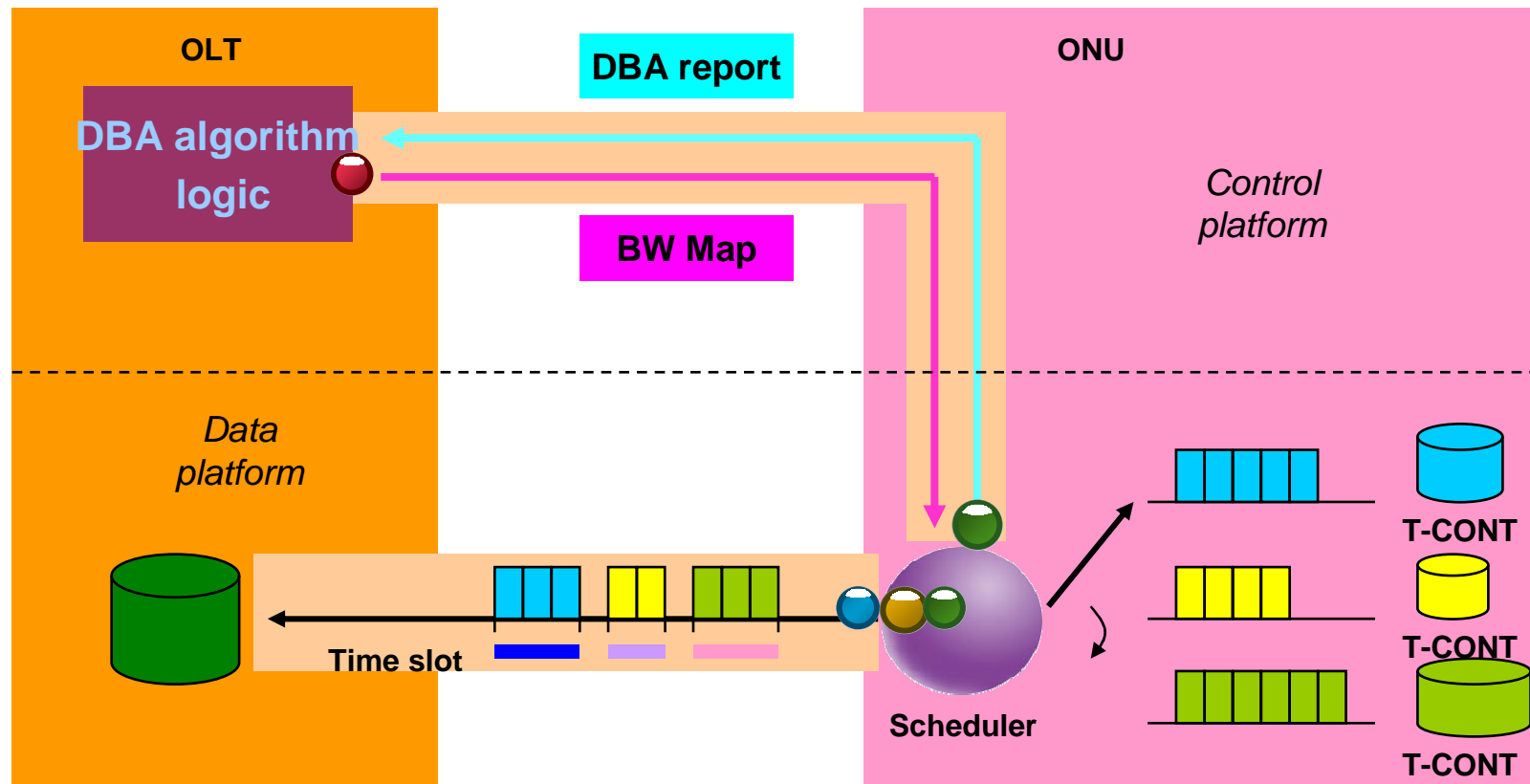

- DBA block in the OLT constantly collects information from DBA reports, and sends the algorithm result in the form of BW Map to ONUs .
- Based on the BW Map, each ONU sends upstream burst data on time slots specified to themselves and utilizes the upstream bandwidth.

SR-DBA Operation

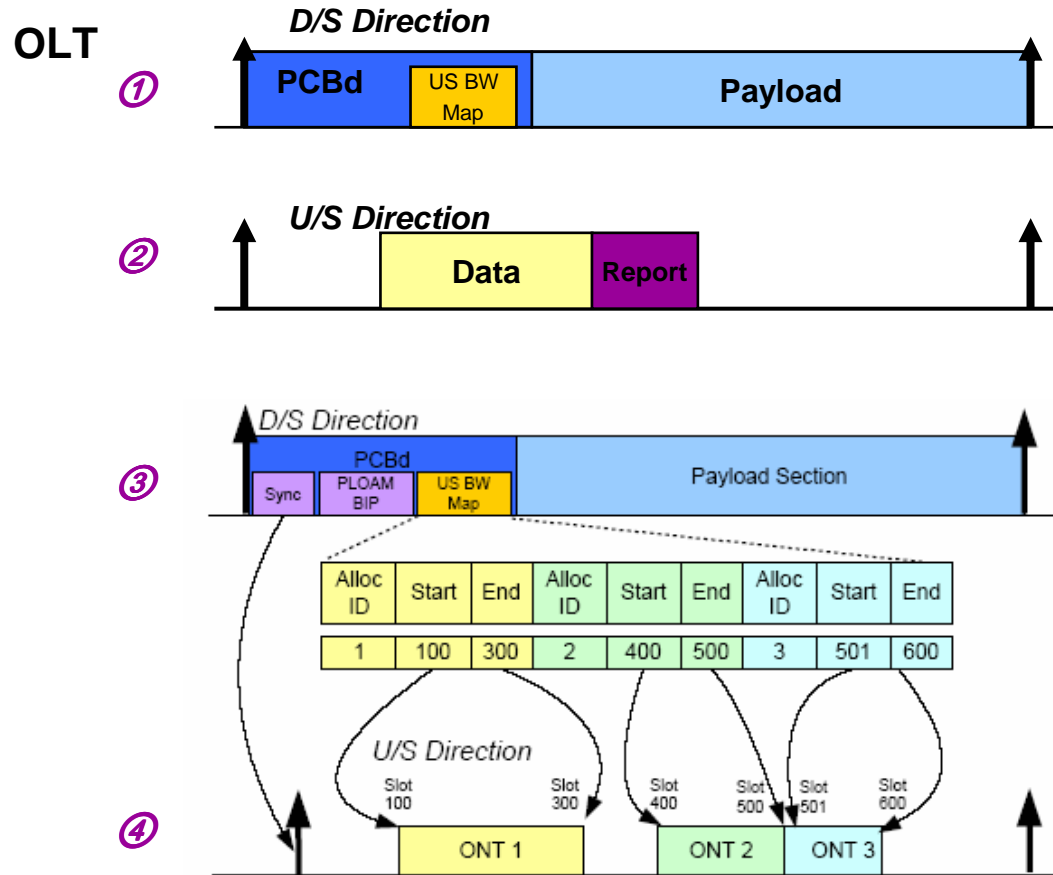

ONT

- Based on the algorithm result of last time, OLT delivers **BW Maps** in the header of downstream frames.
- Based on the bandwidth allocation information, ONU sends the status report of data currently waiting in T-CONTs in the specified time slots.
- OLT receives the status report from the ONU, updates BW Map through DBA algorithm and then delivers the new BW Map in the next frame.
- ONU receives the BW Map from the OLT and sends data in the specified time slots.

NSR-DBA Operation

- **NSR-DBA**

- NSR is an algorithm scheme that realizes DBA. It helps to predict the bandwidth allocated to each ONU based on the traffic from ONUs.

- **Procedure:**

- Step1: Monitor the number of data packets received by OLT within the specified interval.
 - Step2: Use the result of real time monitoring in step 1 to calculate the utilization rate.
 - Step3: Recognize the congestion status by comparing the utilization rate with the specified limits.

DBA Working Principle

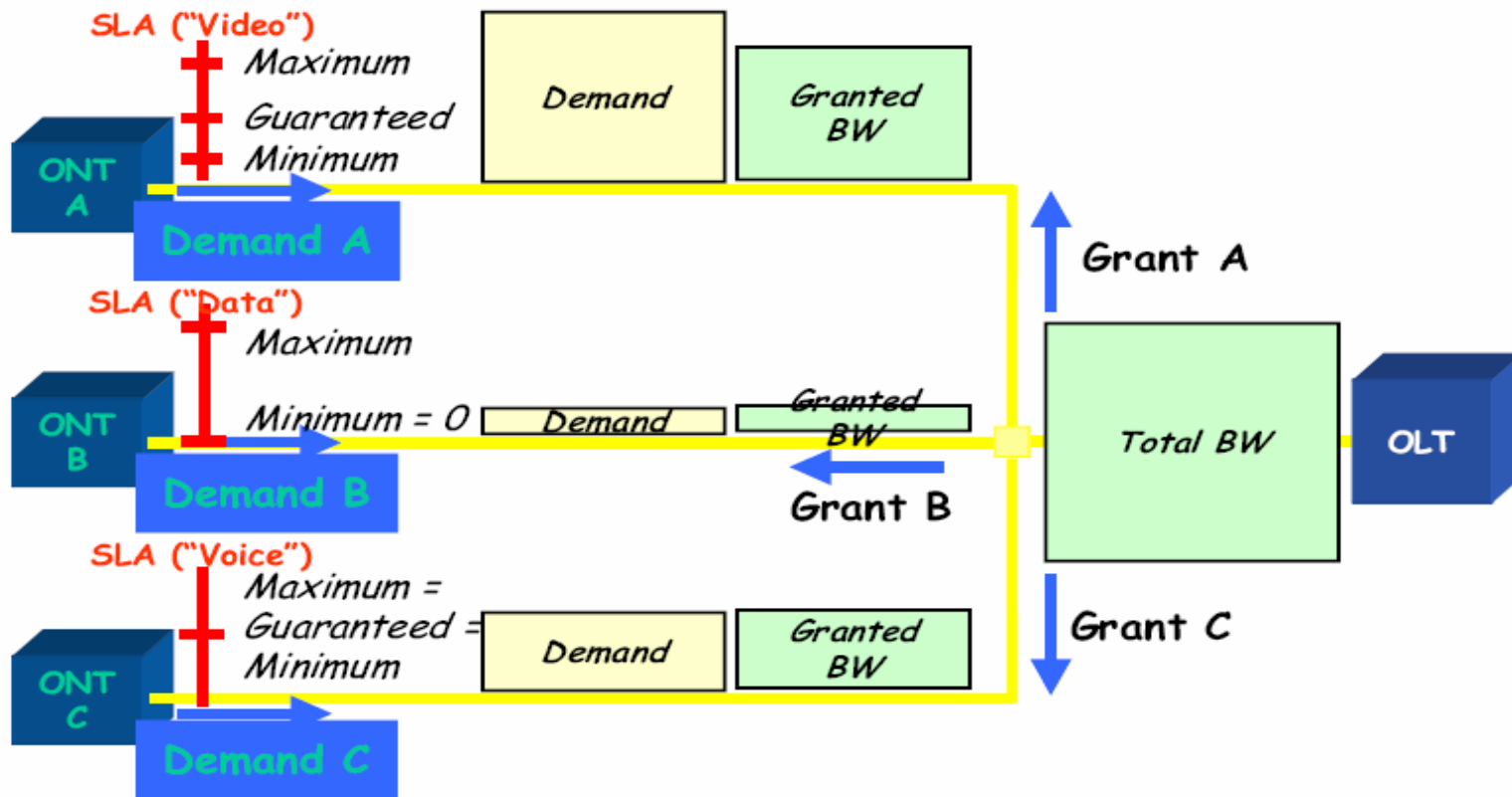

- Based on service priorities, the system sets SLA for each ONU, restricting service bandwidth.
- The maximum bandwidth and the minimum bandwidth pose limits to the bandwidth of each ONU, ensuring various bandwidth for services of different priorities. In general, voice service enjoys the highest, then video service and data service the lowest in terms of service priority.
- OLT grants bandwidth based on services, SLA and the actual condition of the ONU. Services of higher priority enjoy higher bandwidth.

T-CONT Bandwidth Terms

- Transmission Containers (T-CONTs): it dynamically receives grants delivered by OLT. T-CONTs are used for the management of upstream bandwidth allocation in the PON section of the Transmission Convergence layer. T-CONTs are primarily used to improve the upstream bandwidth use on the PON.
- T-CONT BW type falls into FB, AB, NAB, and BE.
- Five T-CONT types: Type1, Type2, Type3, Type4, and Type5.

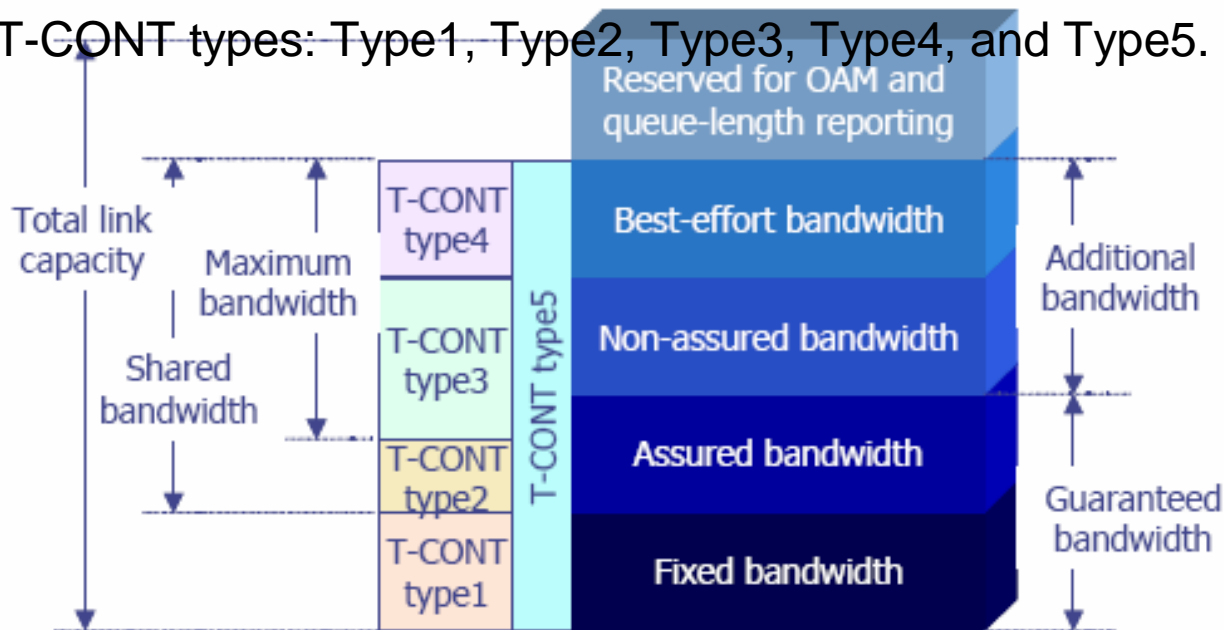

T-CONT Type and Bandwidth Type

BW Type	Delay Sensitive	Applicable T-CONT types				
		Type 1	Type 2	Type 3	Type 4	Type 5
Fixed	Yes	X				X
Assured	No		X	X		X
Non-Assured	No			X		X
Best Effort	No				X	X

- Type1 T-CONT is of the fixed bandwidth type and mainly used for services sensitive to delay and services of higher priorities, such as voice services.
- Type2 and type3 T-CONT is of the guaranteed bandwidth type and mainly used for video services and data services of higher priorities.
- Type4 is of the best-effort type and mainly used for data services (such as Internet and email), and services of lower priorities. These services do not require high bandwidth.
- Type5 is of the mixed T-CONT type, involving all bandwidth types and bearing all services.

QoS Mechanism of ONU in GPON

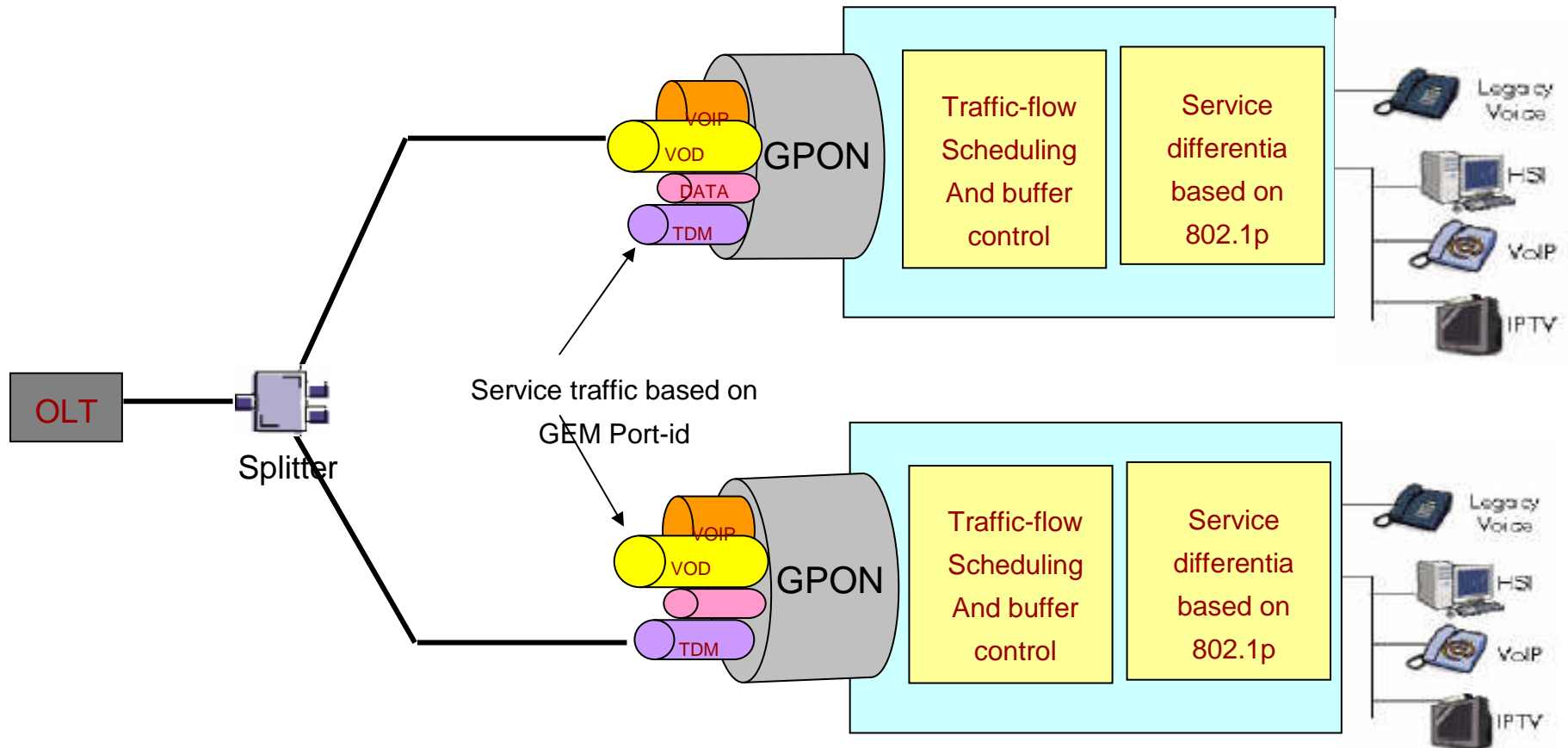

- Traffic classification of services based on LAN/802.1p.
- Service scheduling based on the combination of strict priority (SP) and Weighted Round Robin (WRR) algorithms.
- Service transmission based on service mapping with different T-CONTs, enhancing line utilization and reliability.

QoS Mechanism of OLT in GPON

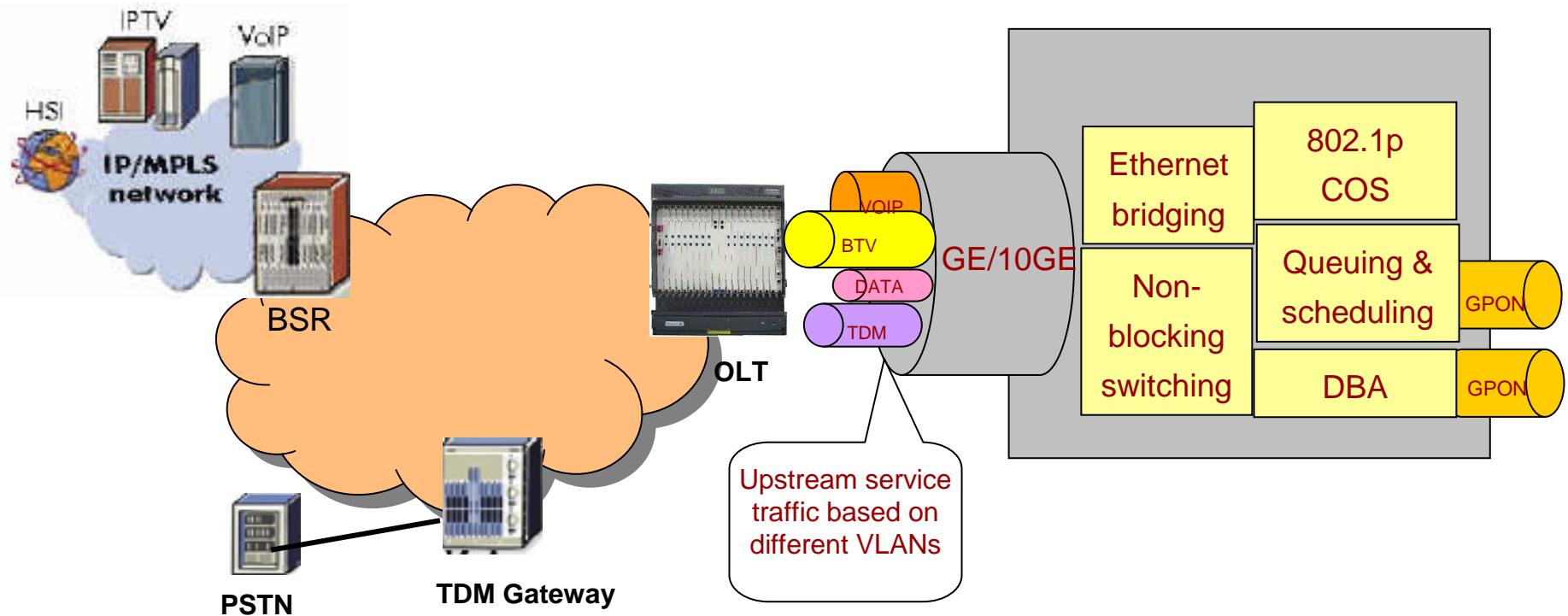

- Traffic classification based on VLAN/802.1p.
- Service scheduling based on combination of strict priority (SP) and Weighted Round Robin (WRR) algorithms.
- DBA algorithm, enhancing uplink bandwidth utilization.
- Access control list (ACL)-based access control on layers above layer-2.

AES Encryption in GPON

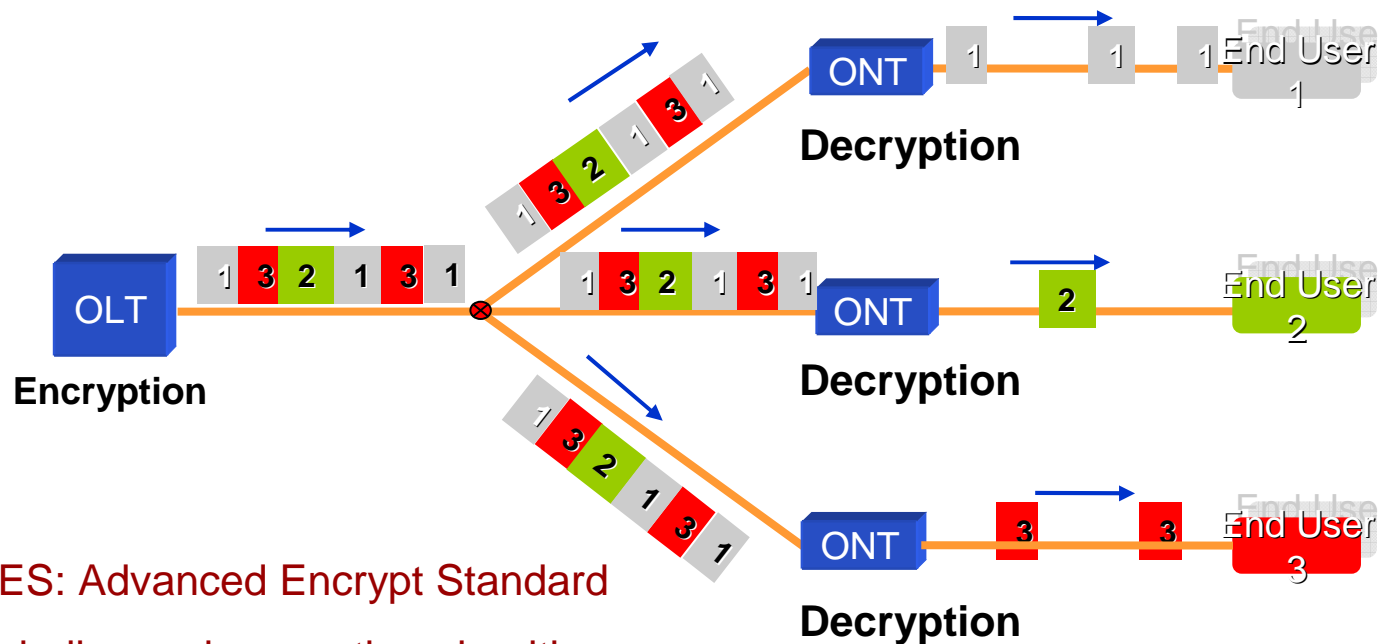

AES: Advanced Encrypt Standard
A globally-used encryption algorithm

- OLT applies Advanced Encryption Standard (AES) 128 encryption.
- GPON supports encrypted transmission in downstream direction, such as AES128 encryption.
- In the case of GEM fragments, only the payload will be encrypted.
- GPON system initiates AES key exchange and switch-over periodically, improving the reliability of the line.

Fibre Attenuation and Power Budget

- Fibre attenuation relates to the fibre length →
- The attenuation of fibre splicing point is
- generally less than 0.2dB
- Other factors may cause attenuation, such
- as fibre bending

**About 0.35 dB per km
for 1310,1490nm**

**Huawei's OLT and ONU
28 dB (Class B+)**

Table G.984.2 – Classes for optical path loss

	Class A	Class B	Class B +	Class C
Minimum loss	5 dB	10 dB	13 dB	15 dB
Maximum loss	20 dB	25 dB	28 dB	30 dB

NOTE – The requirements of a particular class may be more stringent for one system type than for another, e.g. the class C attenuation range is inherently more stringent for TCM systems due to the use of a 1:2 splitter/combiner at each side of the ODN, each having a loss of about 3 dB.



Parameters of GPON (Class B+)

Items	Unit	Single fibre
OLT:		OLT
Mean launched power MIN	dBm	+1.5
Mean launched power MAX	dBm	+5
Minimum sensitivity	dBm	-28
Minimum overload	dBm	-8
ONU:		ONU
Mean launched power MIN	dBm	0.5
Mean launched power MAX	dBm	+5
Minimum sensitivity	dBm	-27
Minimum overload	dBm	-8



Contents

1. Overview of Optical Access Network
2. Basic Concepts of PON
3. GPON Frame Structure
4. GPON Key Technologies
5. **GPON Management and Service Provisioning**
6. Basic Services over GPON Network

Control and Management Plane

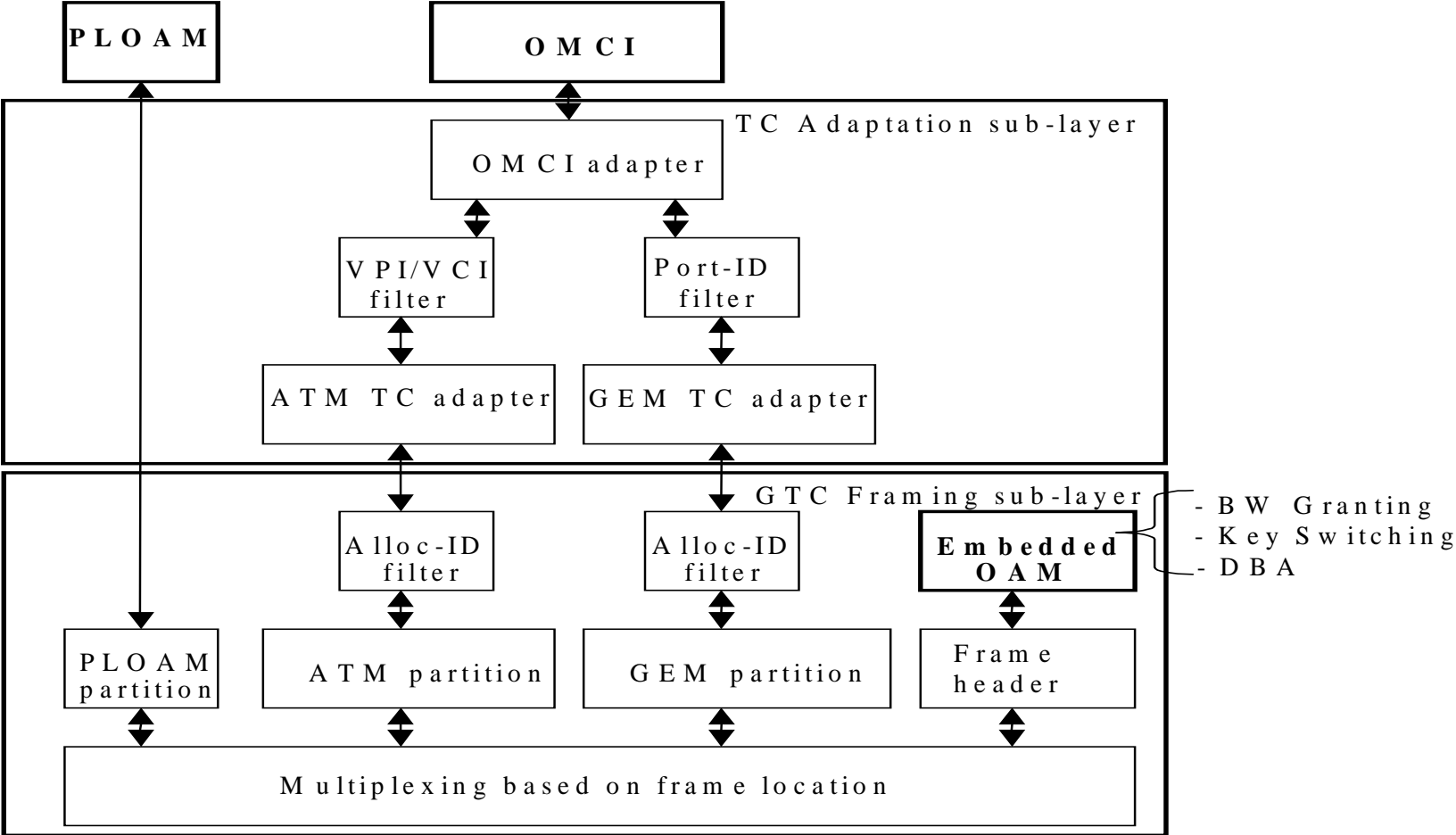

GPON Management

- OAM message at the physical layer falls into three types:
embedded OAM, PLOAM and OMCI .
 - The embedded OAM and PLOAM channels manage the functions of the PMD and the GTC layers. The OMCI provides a uniform system of managing higher (service defining) layers.
 - The embedded OAM channel is provided by field-formatted information (such as BW Map , DBRu) in the header of the GTC frame. The functions that use this channel include: bandwidth granting, Dynamic Bandwidth Assignment signalling and so on.
 - The OMCI channel is used to manage the service defining layers that lay above the GTC.

GPON Service Provisioning

Carriers' nightmare

Initial configurations (such as service system information configuration, data configuration) are required on terminals and then they can be put into use. To finish these configurations, it is not cost-effective to carriers.

Flexible Configuration plan of GPON

GPON supports zero configuration on terminals and plug-and-play of terminals, which is cost-effective.

Application scenario

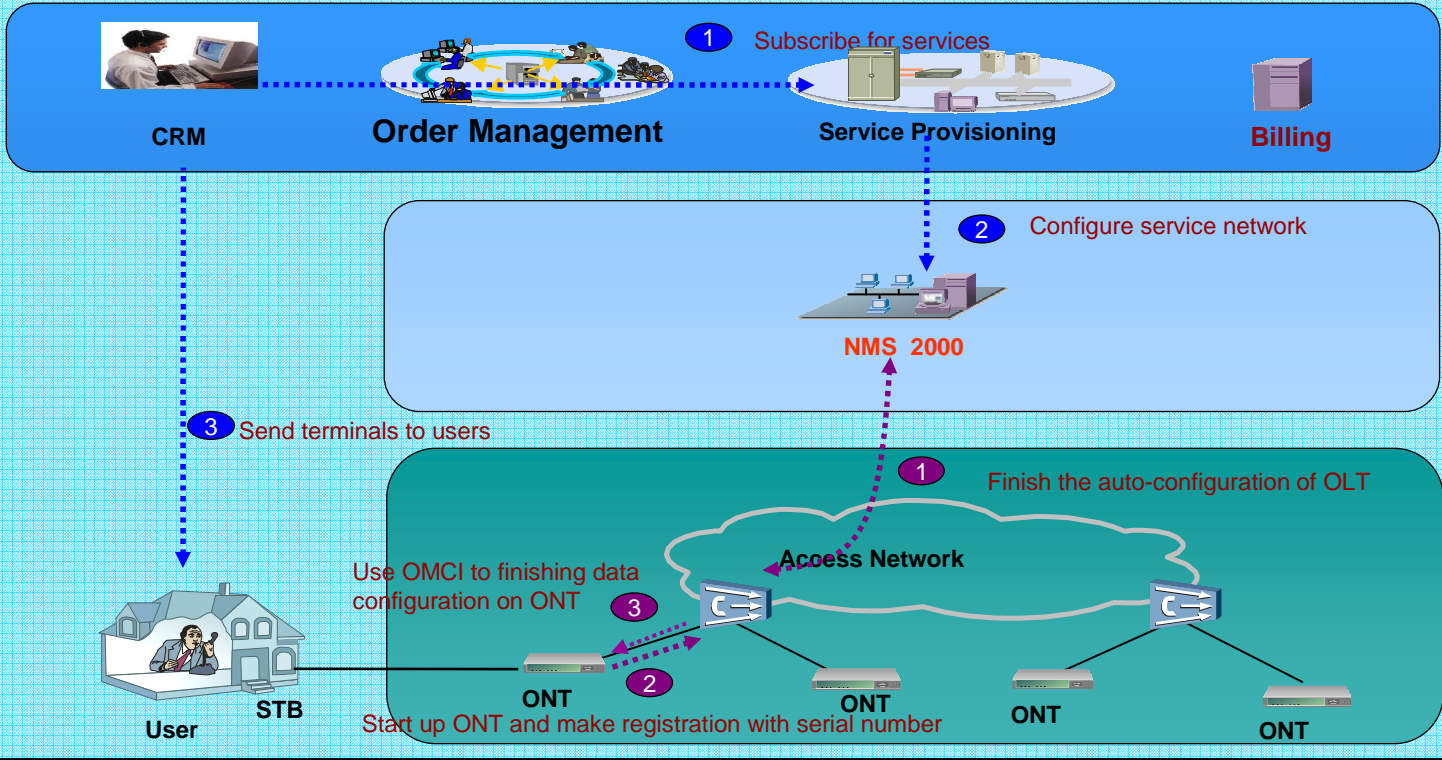



Contents

1. Basic Concepts of PON
2. Overview of Optical Access Network
3. Analysis of GPON Standards
4. GPON Key Technologies
5. GPON Management and Service Provisioning
6. Basic Services over GPON Network

Triple Play Solution in GPON

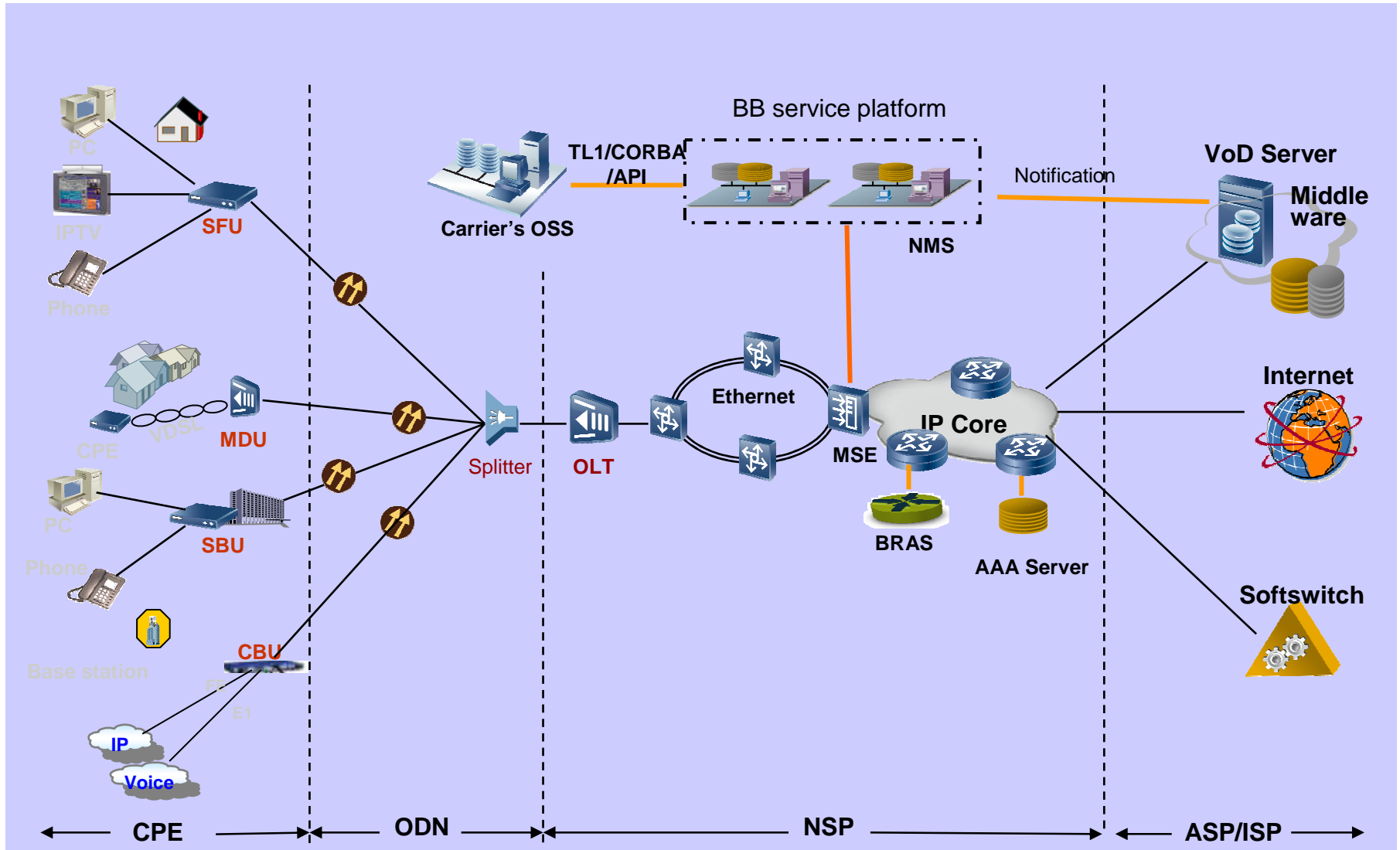



Questions

- GPON network architecture?
- Describe DBA operation mode?
- Describe GPON service provisioning?



Summary

- In this presentation, we introduced GPON basic concept ,architecture ,and principle.
- We also discussed about GPON service provisioning and application.

Thank you

www.huawei.com

