

**Reference Manual**  
**IBM 82, 83, and 84 Sorters**



**Reference Manual**

**IBM 82, 83, and 84 Sorters**

## Preface

This manual will assist the machine operator in learning the most efficient methods for operation of the IBM sorters. It contains diagrams and descriptions of the operating features and principles of sorting card documents.

Because the operation of the sorter is simple, no previous machine experience is necessary.

MINOR REVISION (July, 1962)

This edition, A24-1034-1, is a minor revision of the preceding edition but does not obsolete A24-1034-0. Additions appear on pages 20 and 22.

This edition obsoletes Technical Newsletter N24-0020, No. 1, March 9, 1962.

## Contents

<b>Introduction</b> .....	5
Operating Procedure (IBM 82, 83, 84) .....	5
<b>IBM 82 Sorter</b> .....	6
Operating Features .....	6
Machine Operation .....	8
Operating Suggestions .....	12
<b>IBM 83 Sorter</b> .....	15
Operating Features .....	15
Machine Operation .....	18
<b>IBM 84 Sorter</b> .....	20
Operating Features .....	20
Operating Suggestions .....	22
<b>Special Features (IBM 82, 83, 84)</b> .....	23
<b>Index</b> .....	35

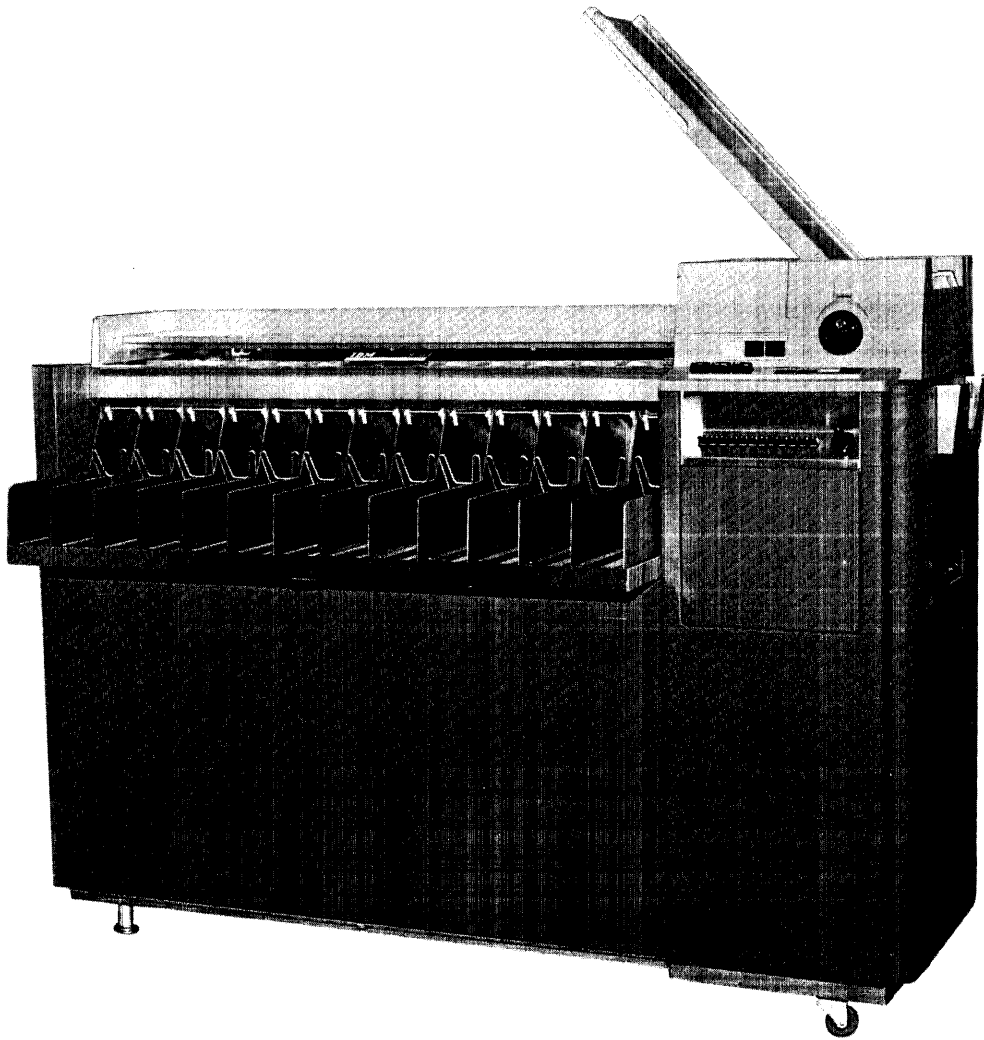

Figure 1. IBM 84 Sorter

The accurate and up-to-the-minute reports that are so essential to a modern competitive business are dependent upon rapid and precise sorting and arranging of unit records.

Manual sorting or rearranging of documents into numerical or alphabetic sequence is a time-consuming and tedious operation. This method, with its delays and errors, is being replaced by the simple-to-operate high-speed IBM sorter.

The IBM system of punched-card records makes it possible to arrange or select card documents at great speed and with little chance of error. The IBM 84 Sorter (Figure 1) operates at a rated speed of 2,000 cards per minute; the IBM 83 Sorter at 1,000 cards per minute; the IBM 82 Sorter at 650 cards per minute; and the IBM 82 Sorter, Series 50, at 450 cards per minute.

Because these IBM sorters are alike in operation and design, the first section of this manual is a discussion of the machines as a group. Each machine, with its individual characteristics, is described in another section.

Special devices that can be installed on the IBM sorters to increase the application possibilities are discussed in the *Special Features* section of this manual.

### **Operating Procedure (IBM 82, 83, 84)**

The operation of the IBM sorter is simple. It is important, however, for an operator to acquire skill in handling the cards properly and to analyze each application to adopt the most efficient routine for completing it.

The operating procedures for the IBM 82, 83, and 84 Sorters are basically the same:

1. Plug the cord to a source of current.
2. Turn on the main-line switch to supply current to the machine.
3. Press the start key (after a 60-second warm-up period for the 82 and 83) to clear the machine of cards.
4. Check the selection switches and/or digit-suppression switches. These switches control both the selection of specific cards and alphabetic sorting.
5. Set the column indicator to the column to be sorted. One column is sorted at a time.
6. Joggle the cards into perfect alignment before placing them in the IBM 82 or 83. The IBM 84 requires a minimum of joggling as does the 83 *with* file feed.
7. Place the cards, face-down, 9-edge toward the throat, in the card-feed hopper, located at the right end of the machine. Cards travel through the IBM sorters from right to left.
8. Place the card weight on top of the cards. This is unnecessary in the IBM 84.
9. Press the start key until the machine starts automatic feeding of the cards from the bottom of the stack. They pass under the brush (or sensing mechanism) that determines which of the 13 pockets or stackers is to accept each card. There is a pocket for each punch position on the card and an R (reject) pocket for cards that have no punching in the column sorted.
10. The machine stops when a pocket is full, when the hopper is empty, when the stop key is pressed, or when the cover over the brush assembly is raised.

## IBM 82 Sorter

The card-feed hopper of the IBM 82 Sorter (Figure 2) holds approximately 1200 cards. The cards pass through the machine at the rate of 650 cards per minute.

### Operating Features

#### Machine Controls

These controls are on the front of the machine, at the right (Figure 3).

##### MAIN-LINE SWITCH

Turn on this switch to supply current to the machine. The machine is ready to operate after a 60-second warm-up period. On some models a red signal light indicates the machine is ready to operate.

##### START KEY

Press this key to start the cards feeding from the hopper. The cards then feed automatically until the hopper is empty, until a pocket (stacker) is full, or until the stop key is pressed.

##### STOP KEY

Press this key to stop card-feeding.

#### Sort Brush and Column Indicator

The sort brush (Figure 4) is mounted in a holder immediately to the left of the card-feed hopper. The brush controls the chute blades that direct the cards to the various pockets. To set the brush on any column, turn the column-selector handle, which is on the front of the machine near the hopper (see Figure 2). The column indicator directly above the brush shows the column on which the brush is set. Each turn of the handle moves the brush one column. To move the brush across several columns at a time, raise the handle to the upper position (so the indicator is between columns), pull down the finger lever on the indicator, and move it to the desired column.

To replace the brush, remove the brush holder from the machine by first raising the column-selector handle to the upper position and then raising the locking lever toward the left. After removing the holder, loosen the

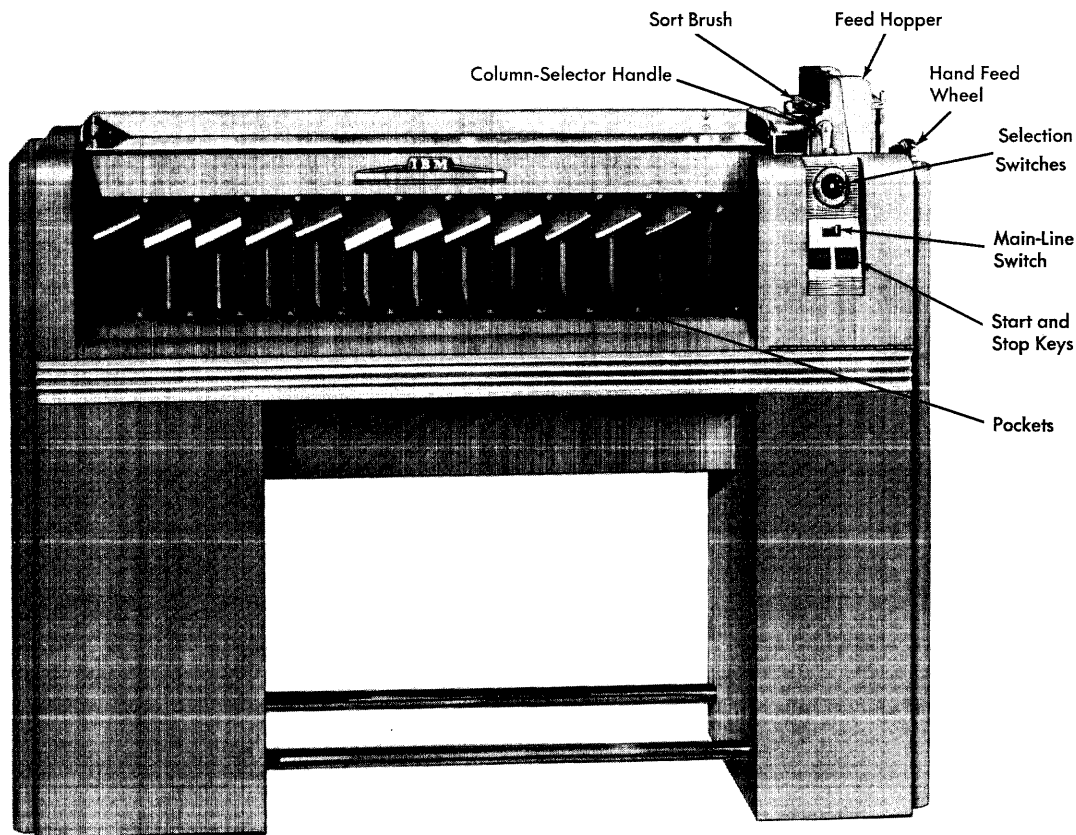

Figure 2. IBM 82 Sorter

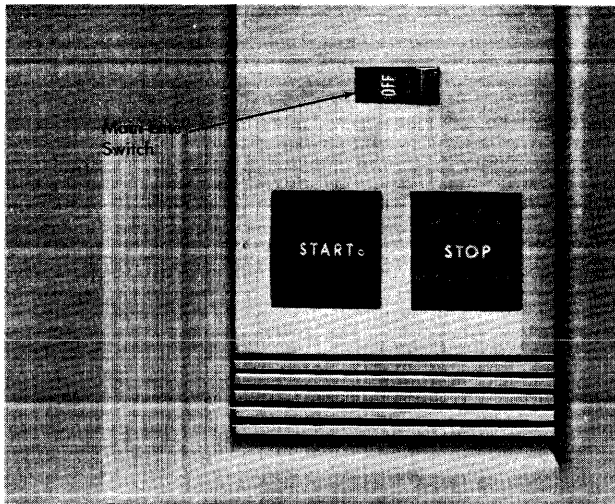

Figure 3. Machine Controls (82)

locking screw to remove the brush. Raising the plastic cover over the brush holder prevents machine operation.

### Selection Switches

Setting the selection switches (Figure 5) located just above the main-line switch makes it possible to select from a file, all cards that have any specified punch or punches in one column, without disturbing the sequence of the rest of the file. The 12 black switches correspond to the 12 punch-positions on the card.

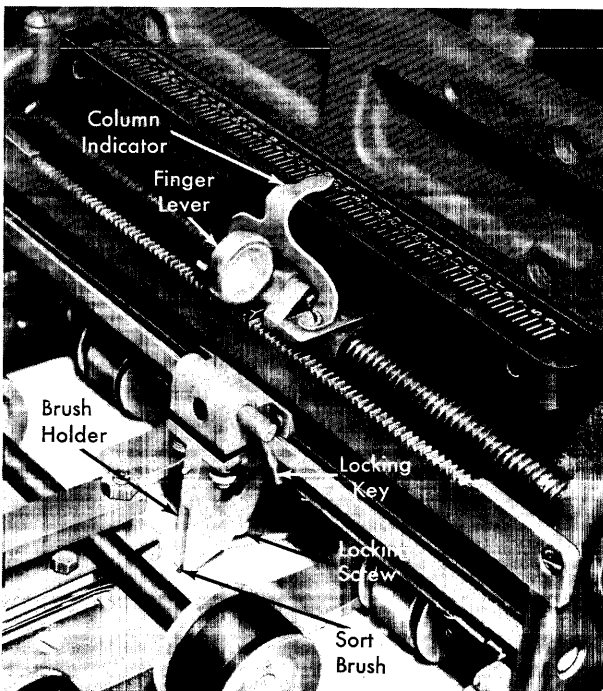

Figure 4. Sort Brush and Column Indicator (82)

In regular numerical sorting without selection, the 13 switches are in the outer position of the circle, away from the center. When pulled toward the center, the selection switches suppress sorting of the corresponding punch positions, and the machine rejects all cards punched in those positions.

The larger red switch in the selection-switch group is the alphabetic-sort switch. Setting this switch toward the center has the same effect as setting toward the center *all* the switches from 1 to 9. It allows sorting on a zone punch only (0, 11, or 12) and rejects cards without a zone punch in the column being sorted. The 11-zone punch is also called an *X-punch*. This red switch is used in alphabetic sorting.

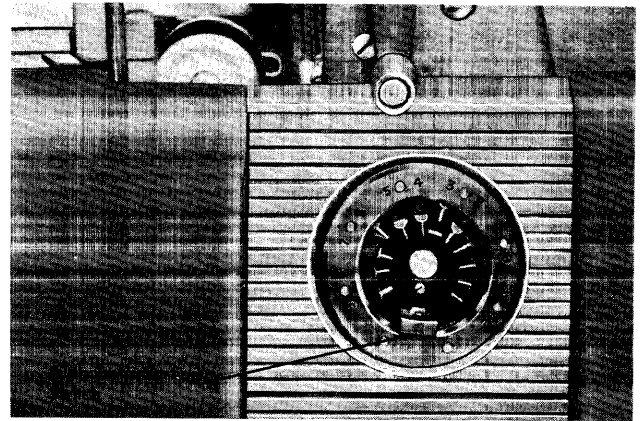

Figure 5. Selection Switches (82)

### Pockets and Pocket Stops

The 13 receiving pockets are arranged from left to right: 9, 8, 7, 6, 5, 4, 3, 2, 1, 0, 11, 12, R (see Figure 2). There is a pocket for each of the 12 punch-positions of a card column, and a reject pocket (R) for cards unpunched in the column being sorted, or cards that are not to be sorted according to the settings of the selection switches.

A pocket-stop lever in each pocket automatically stops card feeding when a pocket reaches its capacity of approximately 550 cards. To resume operation, remove the cards from the pocket and press the start key.

### Hand Feed Wheel

This wheel is on the right side of the IBM 82 Sorter (see Figure 2). To feed cards when testing the machine or removing a card jam, push in the wheel and turn it manually.



### Chute Blades

The 12 chute blades (Figure 6) are bands of metal, varying in length, that guide the cards on their way from the sort brush to the pockets. Each chute blade extends from a point immediately past the sort brush to the opening above one of the numbered pockets. There is no chute blade for the reject pocket.

### Machine Operation

When the start key is pressed, the cards begin entering the machine one at a time, from the bottom of the stack. The cards are advanced between a sorter brush and a metal roller (Figure 6). As each card passes under the brush, the punched hole allows the brush to drop through the card and make contact with the metal roller to close an electric circuit. The chute blades then guide the card automatically to the correct pocket.

Figure 6 is a schematic of the card feed with a card passing under the brush. The card has a 4-punch in the column being sorted. In the first half of the schematic, the 4-punch has not yet reached the brush. At the same time that the card is passing under the brush,

the leading edge (9-edge) of that card is passing beneath the ends of the chute blades.

The second half of the schematic shows how the sorter selects the right chute blade for the card. The tips of the chute blades are spaced so that the sort brush drops through the 4-punch in the card immediately after the leading edge of the card passes under the tip of chute-blade 5. The electric circuit closed by the sort brush energizes the sort magnet. A spring holds the armature up except when the magnet is energized. The magnet pulls down the armature and chute-blades 4, 3, 2, 1, 0, 11, and 12. The card holds up chute-blades 9, 8, 7, 6, and 5. This opens a passage between chute-blades 4 and 5. The carrier rolls convey the card over chute-blade 4 into pocket 4.

Cards without a punch in the column being sorted go into the reject pocket. The brush does not make contact with the metal roll; the sorting magnet is not impulsed; so the armature is not pulled down. When the chute blades are not pulled down, the card goes into the reject pocket.

Cards that have a double punch in the column being sorted go into the pocket corresponding to the punch that is read first (punch nearest the 9-edge of the card).

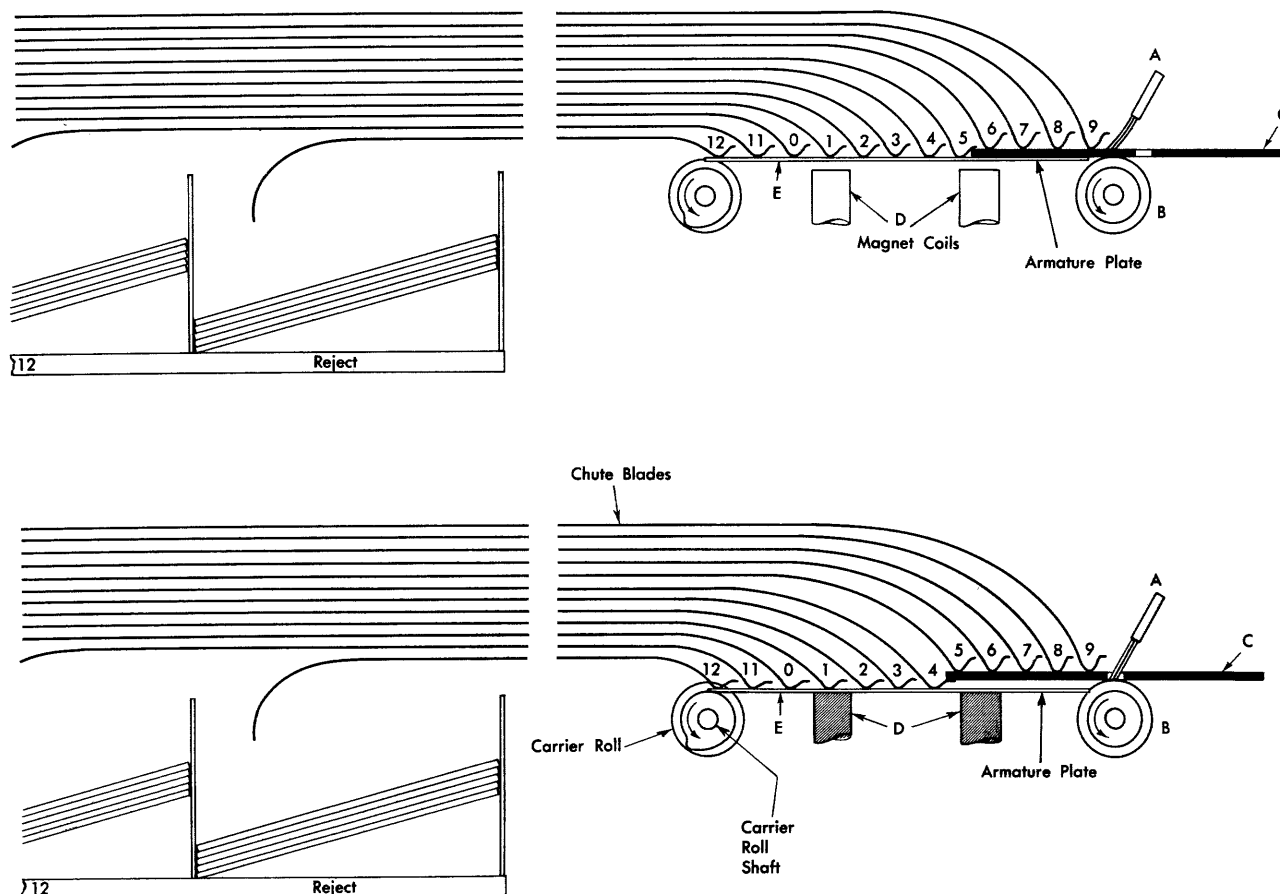

Figure 6. Schematic of Card Feed (82)

## Numerical Sorting

To arrange cards in numerical order, set the selection switches to the outer position. Sort each column separately beginning with the right-hand (units) column of the field and, as you remove the cards from the pockets, stack them so that for the next sort, the cards enter the sorter with the position just punched in numerical order. Repeat this process for each of the other columns in the field, from right to left, until the entire field has been sorted.

Figure 7 shows the path, from hopper to pockets, of 15 cards punched with the numbers 11 to 23. They are in miscellaneous order when placed in the hopper. On the first sort, with the sort brush on the units column of the two-column field, cards punched 1 in the units column (11, 21) fall into pocket 1; cards punched 2 (12, 22) fall into pocket 2; cards punched 3 (13, 23) fall into pocket 3. The normal procedure then follows: remove the cards, sight-checking each group to assure accuracy, and place them in the hopper face-down in ascending sequence so the cards punched 1 are first, followed by cards punched 2 and 3.

On the second sort (Figure 7) with the sort brush on the tens column, cards punched 1 in the tens column (11, 12, 13) fall into pocket 1, and cards punched 2 (21, 22) fall into pocket 2. When removed from the pockets in order, the file is in numerical sequence from 11 to 23.

For larger fields, follow this same procedure for the third and subsequent columns. After each column is sorted, the cards are in order according to the columns already sorted.

Usually numerical fields have no unpunched columns; zeros are punched in columns that precede significant data. In punching 25 in a five-digit field, the three preceding columns are punched with zeros (00025). Therefore, in a strictly numerical sort, no cards should fall into the 11-, 12-, or R-pocket.

*Sorting More Than One Field:* In certain sorting operations, the desired sequence involves more than one field. For instance, a deck of cards is to be arranged in order by state and in order by city within each state. This is known as a major and minor sort. Because a city is a subdivision of a state, first make the minor sort on the field designating the city. After the minor sort is completed, set the sort brush on the units column of the field designating the state and continue sorting in the usual manner.

In other words, for the purpose of sorting you may consider the two fields as one field. This combined field would have the major field as the high-order digits and the minor field as the low-order digits. Any intermediate fields would be sorted in order of importance such as city, county, and then state.

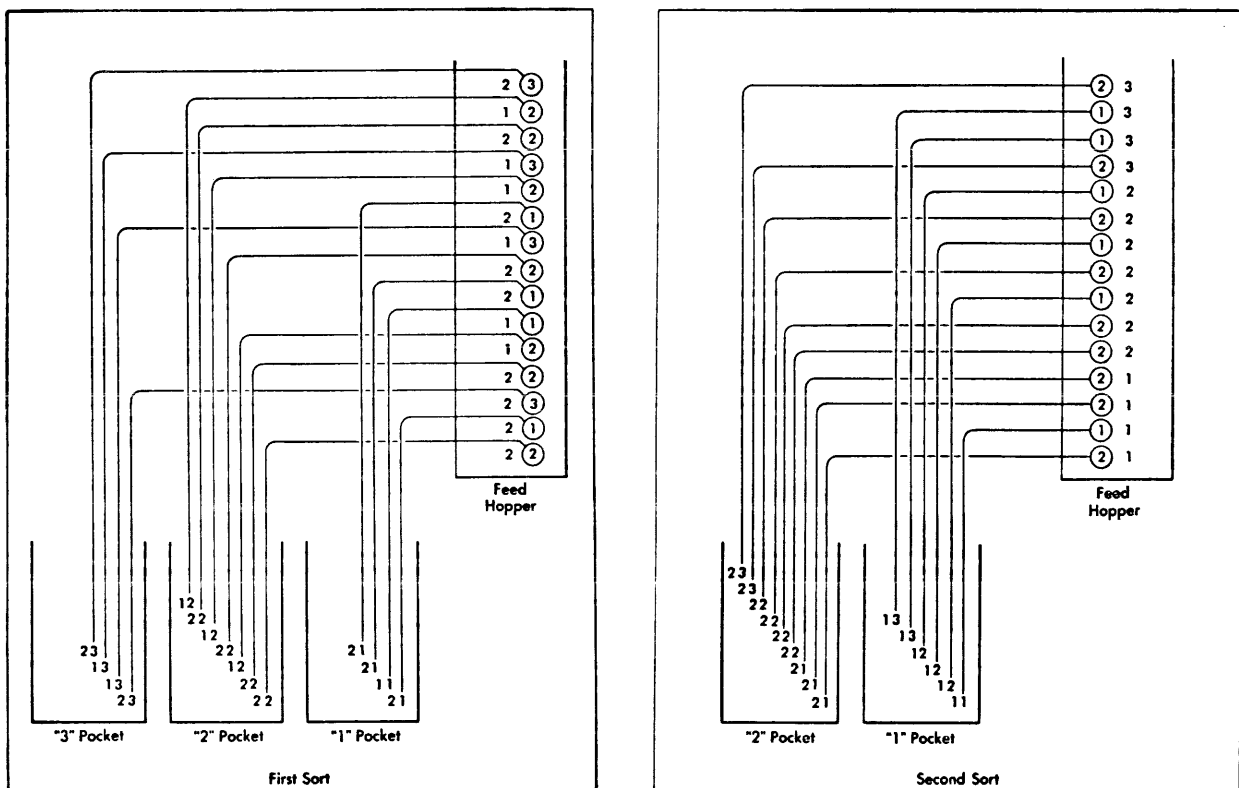

Figure 7. Sorting Principle

**BLOCK SORTING**

Usually cards are sorted beginning with the units column, but when a large quantity is to be handled, you may save time by separating the cards into smaller groups first. To do this, sort the cards on the left-hand column of the field. This separates the cards into ten or fewer blocks of cards in 10 of the pockets in the sorter. Sort each block separately. After each block has been sorted in the usual manner (beginning with units column) it is ready to be processed further.

In operations involving more than one field, block-sort by first sorting the major field (Figure 8). Then treat each major group as a separate unit of the file. In block sorting, as in all sorting operations, sight-check cards as you remove them from each pocket of the sorter.

Block sorting reduces the over-all time required to prepare a report, by permitting the processing of completed blocks through other machines while the remaining blocks are being sorted. Another advantage is that an error in sorting is localized to a particular block, and is easier to correct than if spread through the entire file. Block sorting also permits the use of more than one sorter, not only in establishing the blocks, but in the final sorting as well.

When a peak load of sorting is involved in the preparation of month-end reports, reduce the load by block sorting each day or every few days.

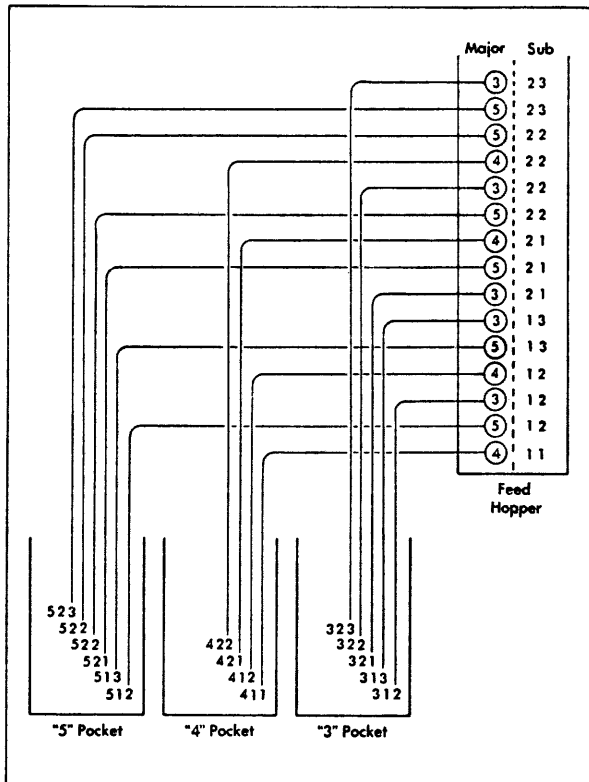

Figure 8. Block Sorting

**SEQUENCE OF SORTING FOR REPORTS**

For greater economy in preparing reports on IBM accounting machines, schedule the reports to minimize the sorting time. The IBM accounting machine senses changes in group classifications of cards to accumulate and print totals for these groups. The cards used in preparing such a report must be sorted according to the minor group classification, and then according to the major group classification.

Different reports are often prepared from the same cards, with the same card fields representing different classifications on two or more of the reports. For example, five reports are to be prepared from the same cards (Figure 9) showing total hours and amounts for each major and minor classification:

1. by employee
2. by part subdivided by operation
3. by operation subdivided by employee
4. by department subdivided by order
5. by order subdivided by part

If the reports are prepared in this sequence, the cards must be run through the sorter 34 times as shown here:

REPORT No.	SORTS REQUIRED
1	4
2	7
3	6
4	7
5	10
	<hr/> 34 sorts

Changing the sequence of reports permits maximum use of previous sorts for reducing sorting of subclassifications. The number of runs through the sorter is cut from 34 to 18 by changing the sequence of reports:

REPORT No.	SORTS REQUIRED
1	4
3	2
2	5
5	5
4	2
	<hr/> 18 sorts

**Alphabetic Sorting**

Figure 10 shows the IBM punching codes for digits, letters, and special characters. The zero position is a digit punch when used alone and a zone punch when used with a digit to form an alphabetic code. Because an alphabetic character is recorded by two punches in the same column (a zone punch with a digit punch) alphabetic sorting requires two sorts on each column.

Each letter A through I is recorded by a zone punch in position 12 with a numerical punch 1 through 9; each letter J through R is recorded by an 11-zone



You can block-sort large files of cards on alphabetic fields using the same method as for numerical fields. To form the blocks sort alphabetically on any desired column of the field. Then sort each block separately.

#### SHORT-CUT METHOD

To save about 16% of the time usually required for alphabetic sorting you may use this short-cut method.

For the first sort on each column, place the cards in the hopper face-up, 12-edge first, with the 9 selection-switch set toward the center. Because the cards are entering the sorter 12-edge first, a 12-zone punch is read as a 9, an 11- as an 8, and so on. But, because the 9 selection-switch is set toward the center, a 12-zone punch is not read. All letters with a 12-zone punch, therefore, sort on numerical coding: the A's (12-1) fall into pocket 6; B's (12-2) fall into pocket 5; C's (12-3) fall into pocket 4, and so on, up to the I's (12-9) which fall into pocket 12. The 11- and 0-zone punches fall into pockets 8 and 7, respectively. Remove the cards from pockets 6 through 12 so the A's (pocket 6) are on top and the rest follow alphabetically.

Reset the 9 selection-switch away from the center. Remove the cards from pockets 7 and 8. Now sort the cards with the 11-zone punch in that column (pocket 8) in the usual manner (face-down, 9-edge first). The letters J through R fall into pockets 1 through 9. File these behind the first group (A through I). Next sort in the same way the cards with the 0-zone punch in that column (from pocket 7 of the original sort) and file these behind the others.

Remember for the first run on each column, run the cards starting from the back of the file to the front, face-up, 12-edge first.

For the second run on each column, run the remaining cards (J through Z) in the usual manner (face-down, 9-edge first).

#### Single-Column Selection

To select all cards that have one or more particular punches in one column, set toward the center of the selection switch group all the *black* selection switches *except* those corresponding to the digit or digits to be selected. The switches that are set toward the center cause the cards punched in those positions to fall into the reject pocket. The switches in the outer setting (those to be selected) cause the cards punched in those positions to fall into their corresponding pockets.

Figure 5 shows the switches arranged to select and sort into their pockets, cards with a 3- and/or 6-punch in the column being sorted. The rest of the cards fall into the reject pocket without changing sequence.

To select cards on a column with a single-digit punch *without* changing their sequence and without regard to the arrangement of the rest of the file, reset

the selection switches so those to be selected are away from center, and set the others toward the center. In this case, switches 3 and 6 are set toward the center with all others remaining in their normal position. Cards punched 3 and/or 6 fall into the reject pocket in their original sequence, and cards punched with other digits sort normally into the corresponding pockets.

Setting the red alphabetic-sort switch toward the center has the same effect as setting the black switches for positions 1 to 9. For numerical selection, the alphabetic-sort switch is ordinarily set away from center.

## Operating Suggestions

### Handling Cards

Improper handling of cards is the cause of most difficulty that occurs in sorting operations. Edges of the cards are sometimes damaged in joggling or in placing them into the feed hopper. Such cards may wrinkle or fold at the throat of the sorter, under the brush, or between the chute blades and rollers of the machine. This may cause a jam as they pass through the machine.

Always check the edges of the cards to be sure that they are not bent or torn. Check the feed hopper to be certain that it contains no dirt, card dust, pieces of paper, or other obstruction that might clog the throat. Always fan cards before putting them into the feed hopper. This removes static electricity, which causes cards to stick together, particularly in damp weather. Fanning also allows any foreign matter to drop out from between cards. Keep the hopper well supplied with cards to assure continuous card-feeding.

When cards are being fed into the sorter, do not:

1. rest a hand on the cards in the hopper,
2. use a heavier-than-normal card weight,
3. drop cards into the hopper, or
4. fill the hopper higher than the side-plates.

The extra weight may cause misfeeding, missorting, and rejecting of cards.

### Protection Against Card Jams

Keep the machine clean. Dirt and other foreign material can cause the machine to jam. Certain tab index cards do not fit in the hopper and may cause a jam.

In the event of a jam, immediately stop card-feeding by pressing the stop key, and turn off the main-line switch. If the jam has occurred at the throat, empty the hopper and raise the brush from the roller by turning the column-selector handle a half turn; that is, until the handle is in the upper position. Turn the locking key and remove the brush holder to prevent damage to the brush while cards are being removed.

If part of the jam is between the chute blades, raise the glass top of the machine by lifting the front. Use the hand feed wheel to move cards to a more accessible position.

In removing jammed cards from the machine:

1. Make every effort to straighten the cards enough so that they can be run into the pockets by turning the hand feed wheel on the right end of the machine.
2. If the jam is severe, it may be necessary to remove the cards under the blades. In doing this, pull from one side of the chute blades, exerting steady pressure on one end of the card. Be careful not to pull the chute blades out of line while removing the cards.
3. Make every effort not to tear damaged cards any more than necessary, because this makes it more difficult to assemble the pieces in order to punch duplicate cards. These must be hand-filed in their proper sequence.
4. Match pieces of torn cards to be certain no torn pieces remain in the machine to cause further jams.
5. When damaged cards have been removed and no pieces remain in the machine, close the top and replace the brush holder in the proper sorting position. Always check to be sure that the wire strands of the brush are not spread or damaged.

### Timing the Brush

When it is necessary to install a new sort brush, see that it is adjusted properly to prevent missorting.

Timing the brush (Figure 11) is a simple operation:

1. Turn on the main-line switch.
2. Punch an 8 in a column at each end of a card, and place it in the feed hopper with the card weight.
3. Set the brush on one of the punched columns.
4. Turn the hand feed wheel so the card moves slowly into the sorter until contact is made by the brush, through the hole in the card.
5. When contact is made, the dropping armature plate makes a sound like a *click*. At this time the card should be about  $\frac{1}{32}$  inch under the end of the first chute blade. Press the start key. The card should fall into the 8-pocket. If it does not, the brush has not been properly timed.
6. Repeat the operation for the punch at the other end of the card. This checks for proper card alignment to assure correct timing for the entire card.

The machine stops automatically when the transparent cover over the brush-holder assembly is raised.

### Checking and Stacking Cards

Often the cause of missorting is off-gage punching (not aligned well enough for the brush to make contact) or it may be caused by cards that are slightly

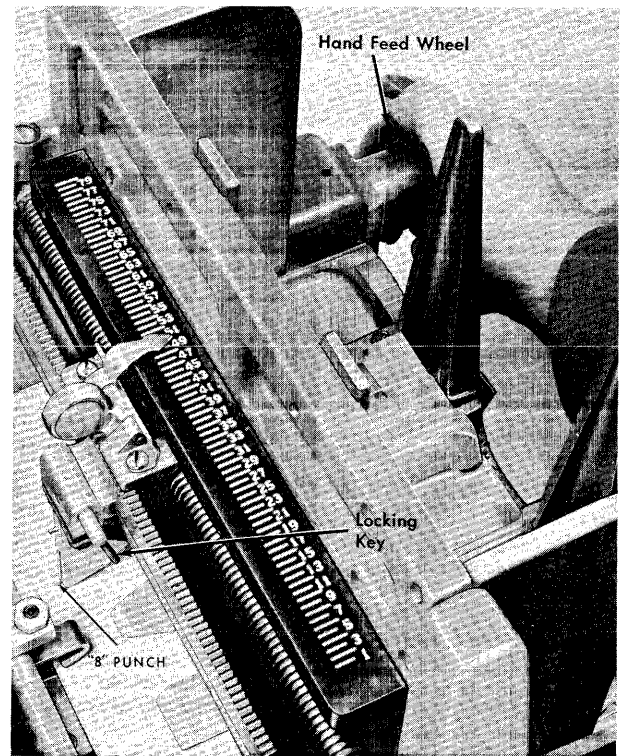

Figure 11. Timing the Brush (82)

damaged. If cards appear to be *off-punched* (off-gage punching) check several of them with a card gage. If damaged cards are causing missorting, have the cards duplicated and use the new cards.

If a card lands vertically in a stacker, straighten it immediately. Otherwise it may get out of sequence or cause a jam as other cards fall into the pocket.

**Sight Checking:** After removing cards from each pocket, check the sorting. Joggle the cards (Figure 12) into perfect alignment. Hold the cards in front



Figure 12. Joggling Cards

of a source of light and look through the hole corresponding to the pocket from which they were removed (Figure 13). If the cards have been sorted properly, the holes form a passage through which light can be seen. If the position you check is not punched in every card of the group, no light can be seen through that position. This indicates that one or more cards have been missorted. Remove the missorted cards and hand-file them in their proper places. In hand-filing remember to consider any columns previously sorted, as well as the column just completed.

*Using a Sorting Needle:* Figure 14 shows how to use a sorting needle to locate missorted cards. A missorted card blocks the needle and can be removed.

Use the sorting needle also for manual sorting of comparatively large groups of cards having the same punching in a given column.

*Stacking Cards Temporarily:* After sight-checking each group of cards, stack them *face-down* in sorter trays. These trays are usually attached to the back of the machine. In the absence of sorter trays, a working table with file drawers or boxes should be located conveniently near the machine.

If the volume of cards to be sorted is small (2,000 or less) use the top of the machine for temporary stacking of cards.

For subsequent sorting, feed the cards into the hopper starting with the card at the *front* of each file (bottom of each stack). If this is not done, previous sequence is destroyed.

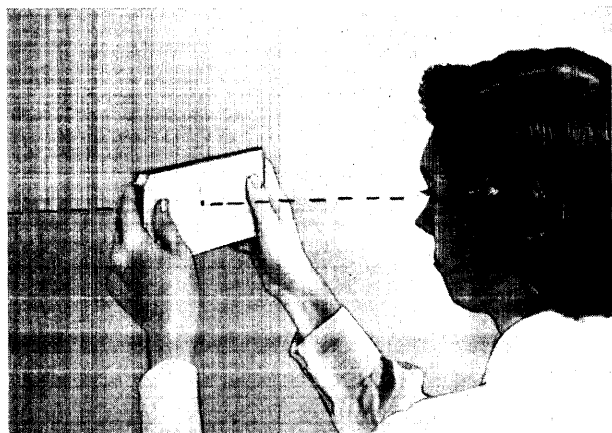

Figure 13. Sight Checking

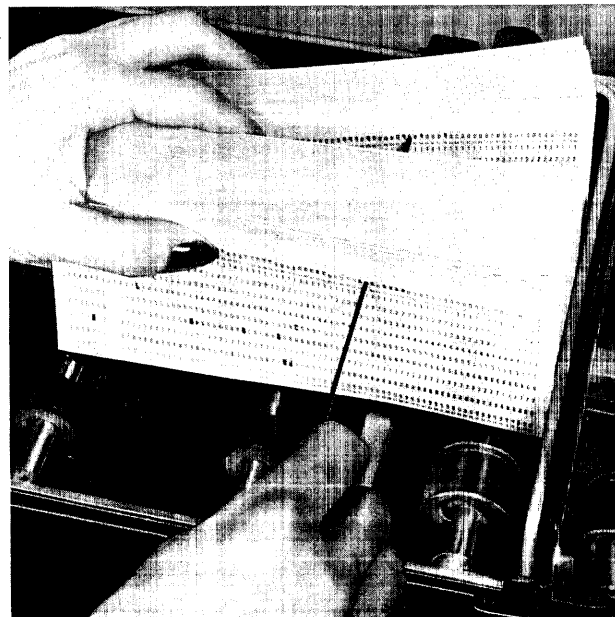

Figure 14. Using a Sorting Needle

With the exception of the differences noted in this section of the manual, the IBM 83 Sorter (Figure 15) operates the same as the IBM 82 Sorter, but at the rate of 1,000 cards per minute.

**Operating Features**

**DIGIT-SUPPRESSION KEYS**

The twelve digit-suppression keys (Figure 16) correspond to the twelve punching positions on an IBM card. To select from a file all cards that have any specified punch or punches in one column, suppress sorting of these punches by pressing the corresponding digit-suppression keys. When pressed, the keys automatically latch down. To unlatch or reset the keys, run a fingertip along the bottom edge of the keys.

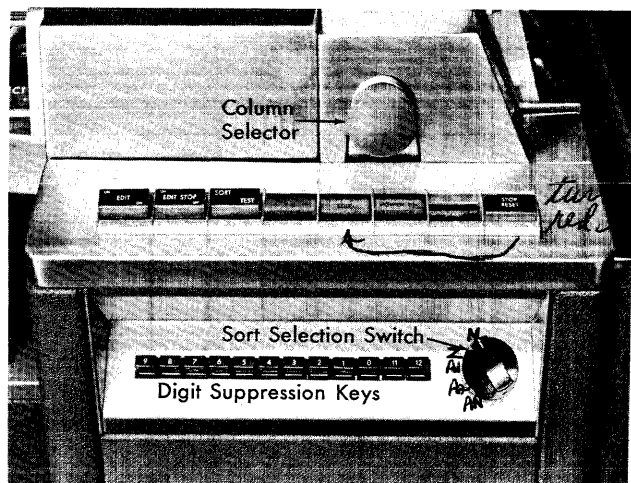

Figure 16. Machine Controls (83)

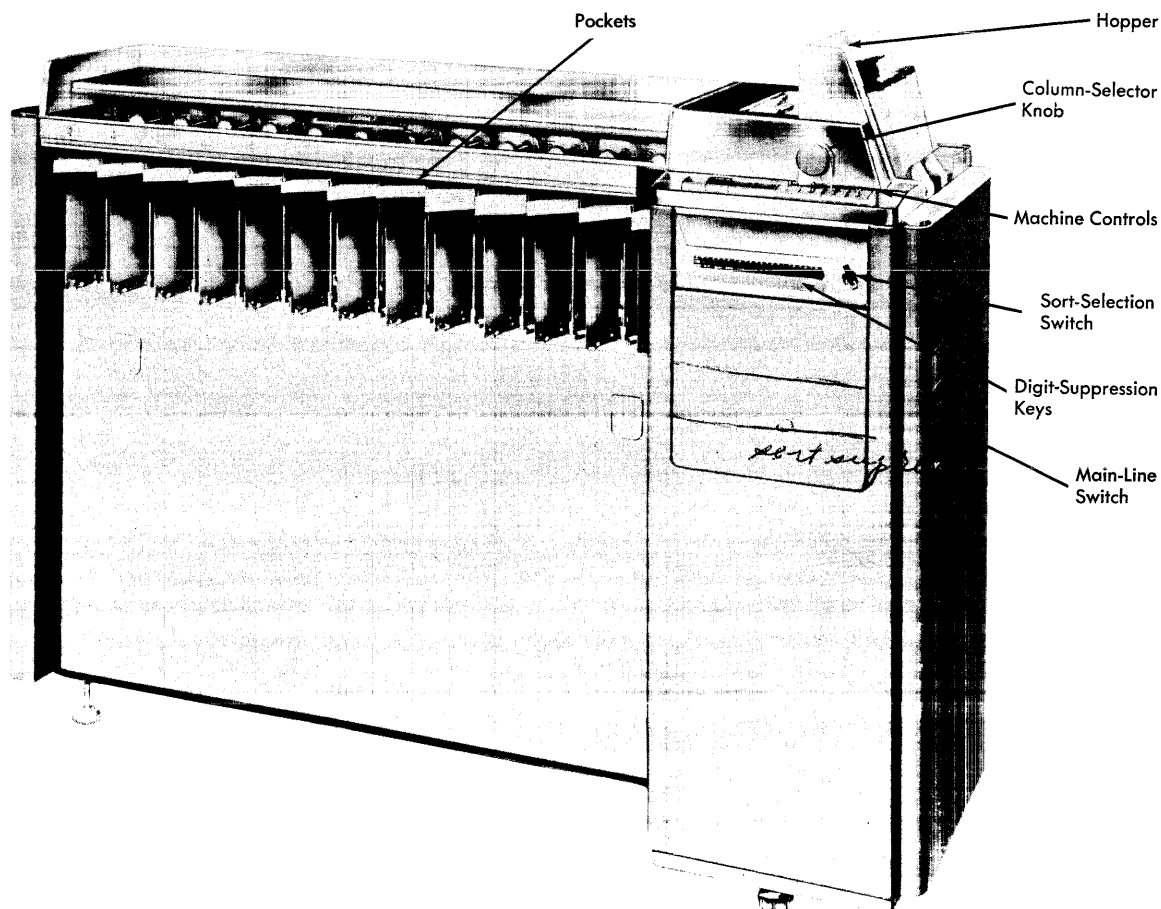

Figure 15. IBM 83 Sorter

*sort suppress = all ones, fives, & 8s will go to the 12 pocket & keep them in sequence.*



### SORT-SELECTION SWITCH

A 5-position rotating switch (Figure 16) determines the sorting pattern: Numerical, Zone, Alphabetic-Sort 1, Alphabetic-Sort 2, or Alpha-Numerical. Figure 17 shows the sorting pattern for each setting of the sort-selection switch. Blanks fall into the reject pocket on every setting.

**Numerical (N):** Cards are sorted on the first punch that is read. Double punches fall into the reject pocket as errors if the edit switch or edit-stop switch is ON.

**Zone (Z):** Cards sort on zone (0, 11, 12) punches only. Cards without a zone punch fall into the reject pocket. Any card with more than one zone punch in the column being sorted falls into the reject pocket as an error if the edit switch or edit-stop switch is ON.

**Alphabetic-Sort 1 (A-1):** Cards punched with a digit and a 12-zone (letters A through I) sort on the digit punches (1 through 9). Cards with an 11-zone punch fall into the 11-pocket. Cards with a zero punch fall into the zero pocket. Cards with only a digit punch and cards with only a 12-zone punch fall into the reject pocket. If the edit switch or edit-stop switch is ON, cards with multiple-digit punches or multiple-zone punches fall into the reject pocket as errors.

**Alphabetic-Sort 2 (A-2):** Cards punched with an 11-zone and a digit (J through R) or a zero-zone and a digit (S through Z) sort on the digit punches.

Cards with a zero or 11-punch only, cards with a digit punch only, and cards punched with letters A through I fall into the reject pocket. The error condition is the same as A-1.

**Alpha-Numerical (A-N):** Cards with a digit punch (0-9) but no zone punch fall into their respective digit pockets. Cards with an 11-zone punch fall into the 11-pocket; cards with a 12-zone punch fall into the 12-pocket; cards with a zero-zone punch fall into the reject pocket. The error condition is the same as A-1.

### EDIT SWITCH

With this switch ON, errors fall into the reject pocket without stopping card-feeding.

### EDIT-STOP SWITCH

With this switch ON, errors fall into the reject pocket, the error light comes on, and card-feeding stops. To reset the error circuits when the machine has stopped and the error light is ON, press the stop-reset key.

### SORT-TEST SWITCH

To check machine timing, the customer engineer sets this switch to TEST. Set the switch to SORT for sorting operations.

### EDIT LIGHT

When the edit-stop switch is ON and the machine senses an error, this light comes on. It also comes on when the test-sort switch is set at TEST and the brush is reading a punch in the card.

SORT SELECTION SWITCH SETTING	POCKETS												REJECTS REGARDLESS OF EDIT	ERRORS (When Edit or Edit-Stop is ON)
	9	8	7	6	5	4	3	2	1	0	11	12		
Numerical (N)	9	8	7	6	5	4	3	2	1	0	11	12	Blanks	Multiple-punched cards (incl. letters)
Zone (Z)										0	11	12	Any card without a zone punch	Any card with more than one zone punch
Alpha-1 (A-1)	I	H	G	F	E	D	C	B	A	0 S-Z	11 J-R		Blanks and cards with a 12-zone punch but no digit punch. Digits 1 to 9.	Any card with more than one zone punch or with more than one digit punch
Alpha-2 (A-2)	R,Z	Q,Y	P,X	O,W	N,V	M,U	L,T	K,S	J 0-1				Cards with 0 or 11-zone only. Blanks. Letters A to I, and 12-zone spec. char. Digits 1 to 9.	Same as A-1
Alpha-Numerical (A-N)	9	8	7	6	5	4	3	2	1	0 (digit)	11 J-R	12 A-I	Blanks, 0-zone (S-Z)	Same as A-1

This pattern is based on cards being fed face down, 9 edge first.

Figure 17. Sorting Pattern for Standard IBM 83

#### POWER-ON LIGHT

This light glows when the main-line switch is ON and the machine is ready to operate.

#### STOP-RESET KEY

Press this key to stop card-feeding or to reset the error circuits when the sorter has stopped with the error light ON.

#### SORT BRUSH

The sort-brush assembly (Figure 18) operates the same as for the IBM 82 Sorter, except that the column-selector knob moves the brush three columns for each full rotation — one-third turn per column.

*Sort-Brush Gage:* The sort-brush gage sets the sort brush for correct projection. By turning the column-selector knob, raise the brush holder; unlock the locking lever; remove the holder from the machine. Place the sort-brush holder on the gage as shown in Figure 19 and adjust the sort brush.

#### POCKET STOPS

Each of the 13 pockets has a pocket-stop lever. To adjust the capacity of the pockets, adjust the control lever on the rear of the sorter. It can be set for approximately 400, 565, 735, or 800 cards per pocket. Figure 20 shows the pocket-stop control lever as seen from the front of the machine. From this position, you may move the lever until it clicks into one of the four positions.

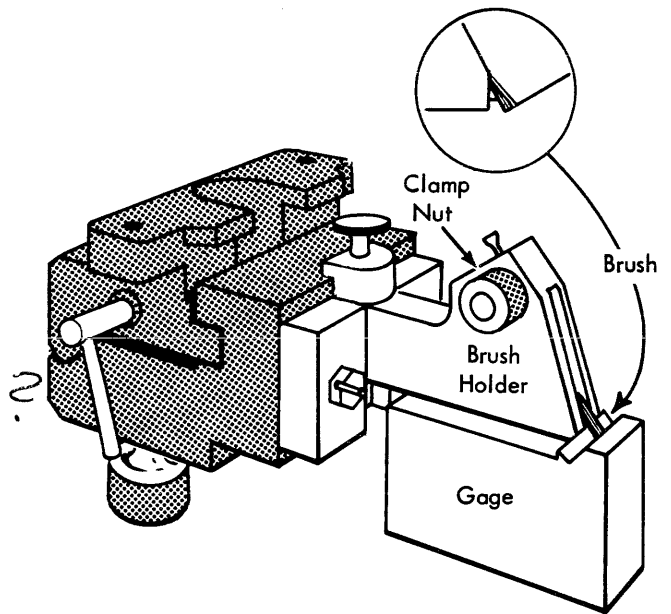

Figure 19. Sort-Brush Holder and Gage (83)

#### CHUTE BLADES

Twelve selector-pins operate the chute blades. Each pin is centered above the exposed portion of its corresponding chute-blade tab. The electric circuit, closed by the sort brush when the brush drops through a hole in the card, attracts a magnet armature, pushes down a selector pin, and separates the chute blades. Figure 21 shows the chute blades separated to provide a path to pocket 3.

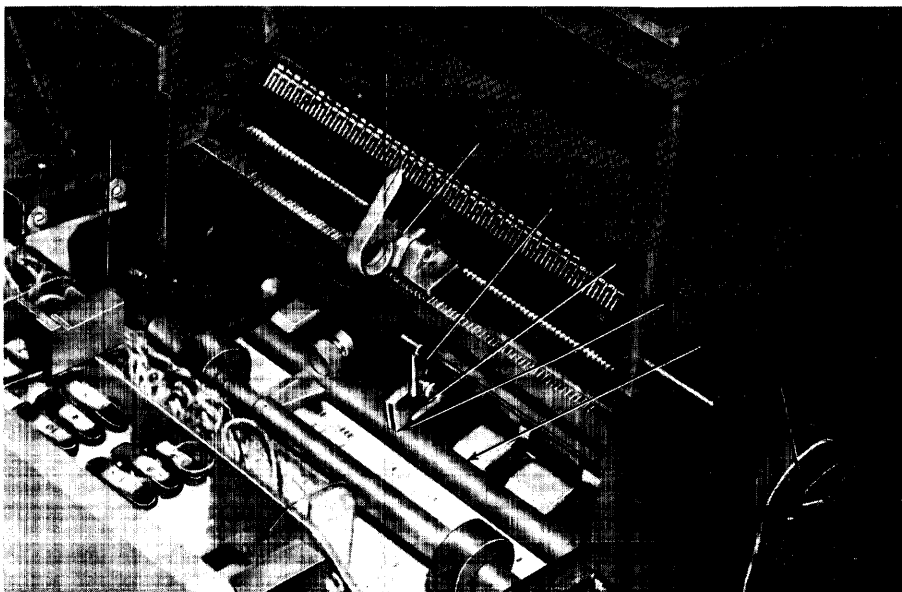

Figure 18. Sort-Brush Assembly (83)

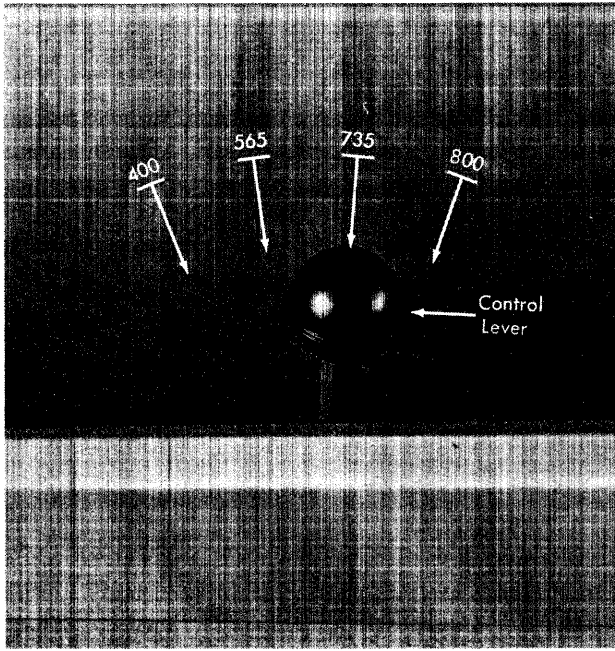

Figure 20. Control Lever for Adjusting Pocket Stop (83)

#### PROTECTION AGAINST CARD JAMS

A damaged card may be fed inadvertently into the sorter. Any card that is bent or distorted enough to cause a jam stops the machine automatically before three to five more cards are fed.

To remove damaged cards that may result from a card jam, follow the procedure described in the IBM

82 Sorter section of this manual. An interlock switch prevents machine operation when either the card deck over the pockets is raised or the cover of the brush is raised.

If a card jam occurs at the sort brush, rotate the locking key (Figure 22) and remove the brush assembly. Remove the jammed cards. Check the brush with the brush gage before replacing it.

If a card jam occurs at the entrance to the chute blades, release the latch (Figure 22) and raise the selector unit. Be careful in handling the selector and the chute blades.

If a card jam occurs in the chute blades above the pockets, raise the cover and remove the damaged cards by a steady pull on the cards. Be careful not to damage the chute blades.

#### Machine Operation

The sorting principle is the same for both the IBM 82 Sorter and the IBM 83 Sorter. The procedure is made even more simple on the 83 by the sort-selection switch and the digit-suppression keys.

#### Numerical Sorting

After setting the sort-selection switch at N (Numerical) proceed as with the IBM 82 Sorter. Block sorting and single-column selection are performed using the digit-suppression keys.

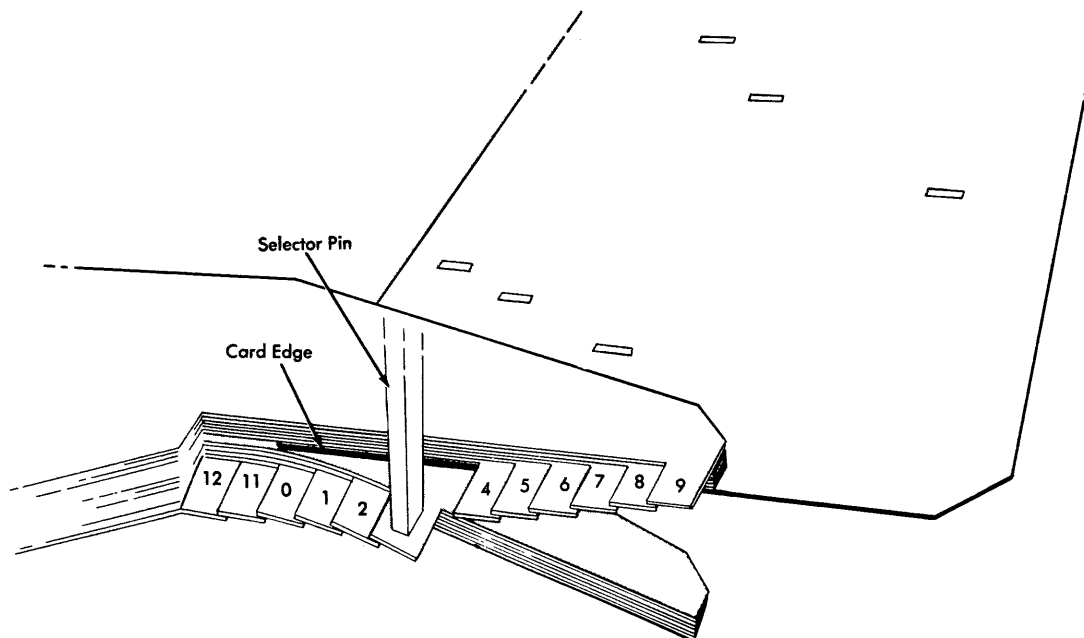

Figure 21. Chute Blades (83)

### Zone Sorting

To select cards with a specific zone punch in a column, set the sort-selection switch at z (Zone) and press the digit-suppression keys corresponding to the other zone positions. For example, in selecting cards punched 11 (X), press digit-suppression keys 12 and zero so that cards with these punches are not selected. All cards without an X-punch then sort into the reject pocket. If multiple-punch zones are to be identified, do not press any digit-suppression keys. Instead, turn on the edit-stop switch so cards with multiple-punched zones fall into the reject pocket and stop the sorter.

### Alphabetic Sorting

Alphabetic sorting with the IBM 83 Sorter is much faster than with the 82 because fewer cards must pass through the machine twice. First, with the sort-selection switch set at A-1 and the edit-stop switch turned on:

1. Letters A through I (12-zone with a digit) are sorted completely on this one pass. They sort into pockets 1 through 9.
2. Letters J through R (11-zone with a digit) sort into the 11-pocket.
3. Letters S through Z (zero-zone with a digit) sort into the zero pocket.
4. Cards that are blank or punched with only a 12-zone or only a digit, sort into the reject pocket.
5. With the edit-stop switch ON, multiple-zone punches and multiple-digit punches reject and stop the sorter.

After sorting on A-1, stack the cards in order from pockets 1 through 9 (A through I). Stack the cards from pockets 11 and zero separately, ready for the second sort on A-2. You may leave the rejects in the reject pocket, or check them for valid punching and hold them for the next-column sort.

Change the sort-selection switch to A-2 but do not change the column setting. Do not sort the rejects or the A-through-I cards on A-2.

Sort the 11-zone cards (J through R), which sort into pockets 1 through 9. Place them behind the A-through-I cards. Next, sort the zero-zone cards (S through Z), which sort into pockets 1 through 9. Place them behind the other cards.

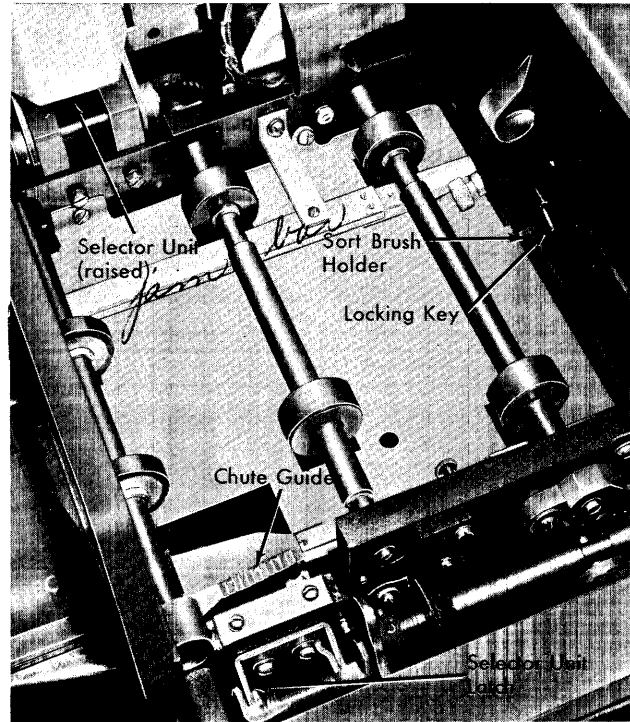

Figure 22. Selector Assembly and Latch (83)

Place valid cards from the reject pocket in front of the file for the next-column sort.

Repeat this A-1 and A-2 sorting procedure for each column progressing from right to left across the field.

### Alpha-Numerical Sorting

If the card columns to be sorted may contain either letters or digits, set the sort-selection switch to A-N. This setting separates the letters from the digit cards. The digits 0-9 sort into the 0-9 pockets. The 12-zones sort into the 12-pocket; 11-zones sort into the 11-pocket; and the zero-zones into the reject pocket. Any digit punch under a zone punch in a column is ignored by the sorter.

The digit cards are now in sequence, and the alphabetic cards are separated into 3 groups that require only one more sort. To complete the alphabetic sort: sort the 12-zone cards on A-1; sort the 11-zone cards on A-2; sort the zero-zone cards on A-2.

## IBM 84 Sorter

The IBM 84 Sorter (see Figure 1) has evolved from the IBM 83 to provide an even faster, more accurate and convenient machine for sorting. For this reason the 84 is similar to the 83 in many ways. With the exception of the differences mentioned in this section of the manual, the IBM 84 operates the same as the 83, but at the rate of 2,000 cards per minute, double the rate of the 83.

The IBM 84 is designed for large volumes of cards. Sorting small groups of cards on the 84 is less economical with reference to card handling time, total sorting time, and operator attendance at the machine.

### Operating Features

The IBM 84 Sorter has many of the same features that are provided on the IBM 83. The 84 has brushless card-sensing, radial stackers, a vacuum-assist feed, and solid-state circuitry, which provide an even faster, more accurate and convenient machine for sorting. Solid-state circuitry makes a warm-up period unnecessary.

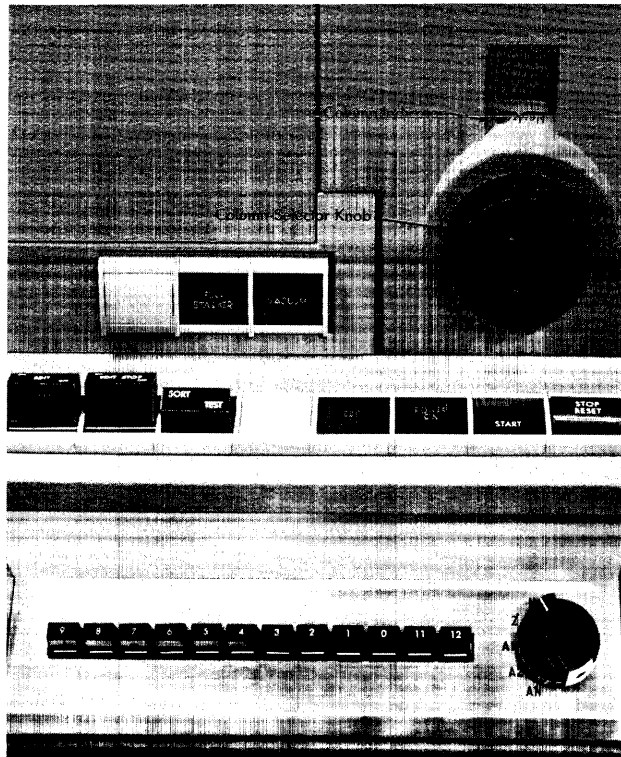

Figure 23. Machine Controls (84)

#### FULL-POCKET LIGHT

When a stacker approaches maximum capacity, this light (Figure 23) comes on. When the maximum capacity of a pocket is reached, the machine stops automatically.

#### VACUUM LIGHT

This light (Figure 23) comes on and card-feeding stops when the vacuum level has fallen too low for assured feeding. When this happens, the condition should be corrected by the IBM customer engineer.

#### File Feed

A file feed (Figure 24) with a 3600-card capacity is standard on the 84. Manual joggling is held to a minimum because the file feed automatically joggles the cards in the hopper. The high-speed vacuum-assisted feed mechanism then feeds the cards surely and accurately. To make the sensing area more accessible, raise the file feed to an upright position without removing the cards. It locks 12 degrees from the vertical. To lower the file feed, raise it slightly and pull up the latch on the back.

Use the plastic card-deck separator to facilitate card feeding from the file feed, if desired.

#### Brushless Card-Sensing and Column Indicator

A photoelectric method of card sensing in the IBM 84 has a maximum reliability and eliminates the need for brush adjustments. The sensing of holes in a particular column is accomplished by a movable one-watt light bulb shining from below the card, through the hole in the card, and onto a light-sensitive diode (Figure 25). Turning the column-selector knob moves the bulb and diode assembly from column to column. The column indicator is directly above the column-selector knob (see Figure 23).

To minimize rejects, clean the light source daily with a dust cloth (after turning off the main-line switch). More frequent cleaning may be necessary if the sorter is running for extended periods, or if conditions cause excessive dust or dirt in the light-source

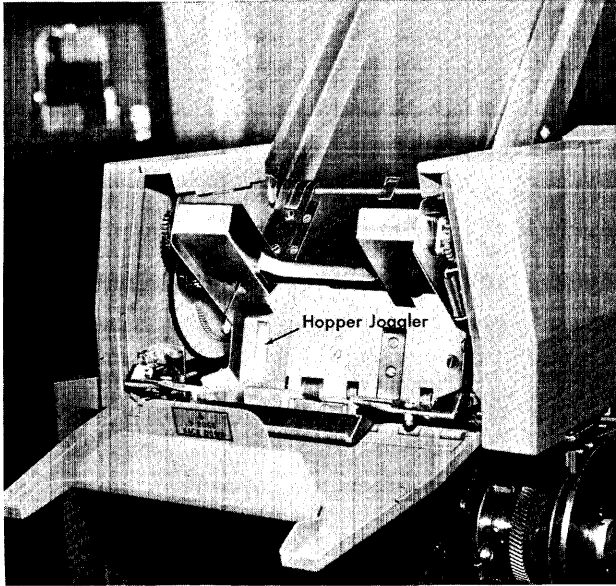

Figure 24. File Feed (84)

area. The IBM customer engineer will make any *adjustments* to the sensing mechanism that may become necessary.

#### Chute Blades

The chute blades are nearly identical to those in the IBM 83. Twelve sort-lever arms operate the chute

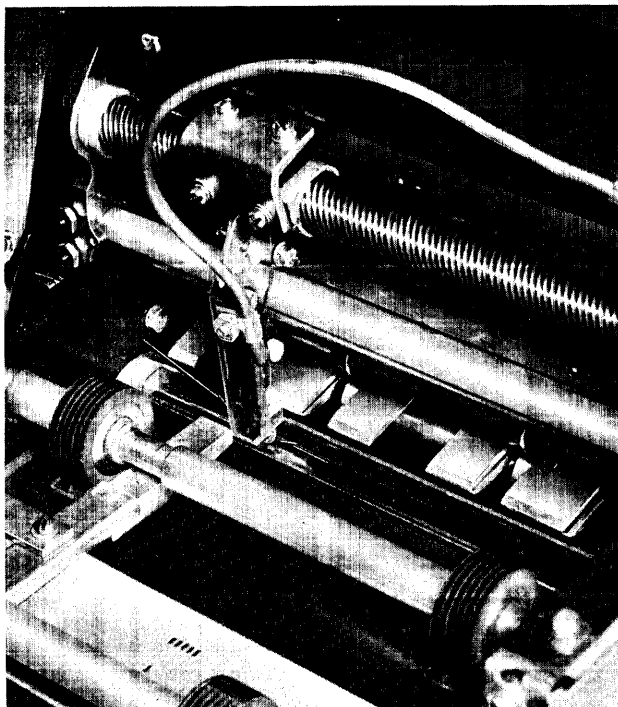

Figure 25. Sensing Mechanism (84)

blades (Figure 26). Each arm is centered above the exposed portion of its corresponding chute-blade tab. When a hole is sensed by the photoelectric sensing mechanism, the corresponding sort-lever arm presses down the chute blade and provides a path to the stacker.

#### Protection Against Card Jams

Any card that is bent or distorted enough to cause a jam stops the machine immediately.

In removing damaged cards that may result from a card jam, do not try to remove the sensing mechanism. The IBM customer engineer will remove it if necessary.

An interlock switch prevents machine operation when any of these covers is raised:

1. card deck (the cover extending over the stackers)
2. selector cover
3. feed cover
4. access cover (the clear plastic cover over the stackers).

Because the stackers place the cards on end, certain types of cards may cause stacking difficulties. These cards are not recommended for sorting in the 84, because they are likely to cause stacking and jamming problems:

1. Cards with internal scores M-2A, M-3, or punched hole score OM-2.

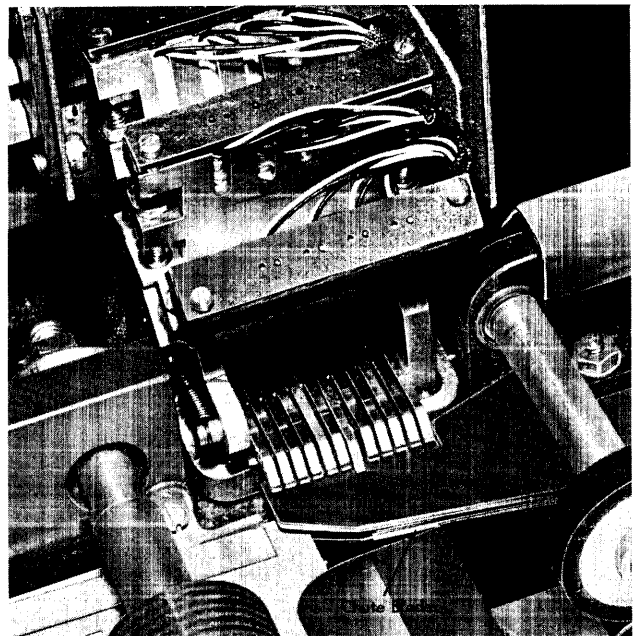

Figure 26. Selector Unit

2. Cards folded or creased (card fold crease S-2).
3. Circulating card documents, such as card checks.
4. Cards with a verifier notch or similar condition on the column-1 end of the feed.
5. Cards that are folded, torn, bent, or creased.

Only these *external* scores (column-1 end of feed) are approved for the IBM 84 Sorter: M-2A, M-3, M-4, M-5, and CF-4.

### Radial Stackers

The 84 has 13 radial-type stackers, each with a capacity of 1650 cards. The stackers place the cards on end facing the front of the machine. This means that the cards are in sequence with the first card at the front of the file. Simply lift the cards out in proper order without stopping the machine. Figure 27 is an exposed view of a radial stacker to show how the cards are stacked. Figure 28 is a schematic of the radial stacker as it would appear from the right end of the machine.

The stacker receives the card from the transport mechanism, while the card is still horizontal. As the card enters the stacker, the front (column-1) end rests on the pivot assembly, while the rear end falls in an arc, guided by the guide assembly. As the rear end approaches the spring-loaded alignment levers, the front end drops off the pivot assembly. At this point the rear end of the card is on the alignment levers and the front end has come to rest against the card-deck support or against the card previously stacked. When

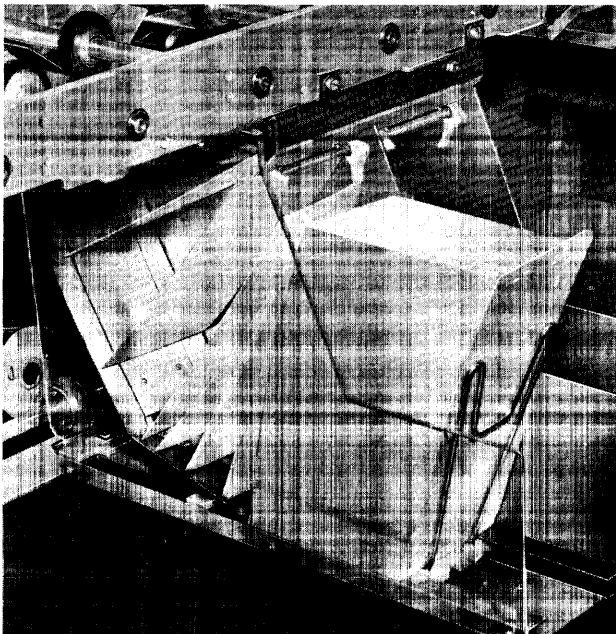

Figure 27. Side View of Radial Stacker

four to six cards accumulate on the aligners, the weight of the cards overcomes the spring tension of the aligners and lowers the cards onto the card pusher. The card pusher oscillates, and step by step it pushes the bottom of the cards to the front.

The card-retaining levers (Figure 28) prevent the cards from falling backward into the stacker. The levers are free to pivot forward to allow a card to pass, but they cannot pivot backward.

As the stacker fills, the card deck is pushed forward until it activates the stacker-stop switch and turns on the full-pocket light. When more cards enter the stacker, this switch stops the machine.

### Operating Suggestions

When sorting cards that have been corrected by placing patches over punches, be sure that the patches are opaque. The photoelectric sensing mechanism of the 84 reads through a translucent patch.

Because the sensing mechanism may read oil spots, staple holes, heavy erasures, or other damage to cards, do not try to sort cards with such defects.

The 84 can be used immediately after the main-line switch is turned on. To conserve the light source and pump, and reduce the power usage, turn off the main-line switch when the sorter is not to be used for an extended period.

The 84 is extremely accurate in sorting. However, compared to other machines, the 84 is more sensitive to off-punched cards. Increasing the tolerance to off-punched cards would decrease overall accuracy. Therefore, for best performance, avoid or correct off-punched cards.

To facilitate card handling, place the card trays in front of, or at the side of, the IBM 84.

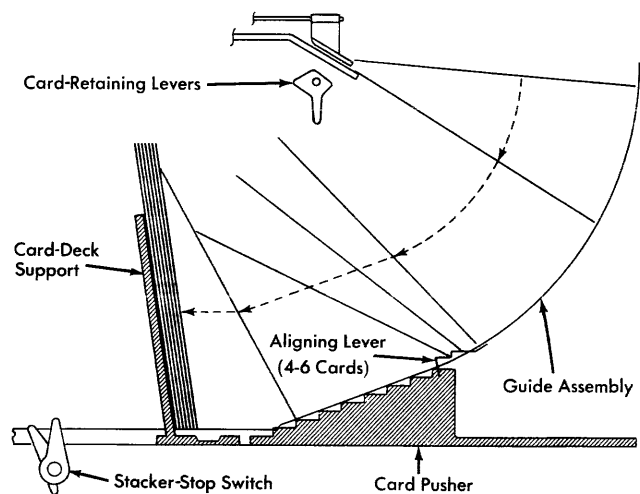

Figure 28. Schematic of Radial Stacker (84)

Special features are available for the IBM 82, 83, and 84 Sorters to extend the application possibilities of the machines. Some features cannot be used simultaneously with certain other features.

**Alphabetic-Sorting Feature (IBM 83, 84)**

With this feature, the sorting patterns for settings A-1, A-2, and A-N are changed permanently. To sort a column alphabetically, feed the cards through the sorter once and part of the cards a second time. Ten letters, including all the vowels, are sorted on the first pass, and it is not necessary to remove the sorted cards from the machine until the remaining cards are sorted.

Figure 29 shows the sorting pattern for a machine with the alphabetic sorting feature. The pattern is based on the frequency of certain letters in proper names.

For the first sort, set the sort-selection switch on A-1. Cards punched A, C, E, G, I, L, O, R, U, and X fall into pockets zero through 9. The letters B, D, F, H, J, M, P, S, V, and Y fall into pocket 12. Letters K, N, Q, T, W, and Z fall into pocket 11. Blanks and cards without letter coding fall into the reject pocket.

Change the switch to A-2. It is not necessary to remove cards from pockets zero to 9. Place the cards from pocket 12 in the hopper followed by the cards from pocket 11. Cards fall into their proper pockets, and the column is completely sorted (Figure 30).

*Alpha-Numerical Sorting with Alphabetic-Sorting Feature:* Set the sort-selection switch on A-N. Digits zero through 9 fall in their respective pockets. The letter K, N, Q, T, W, Z fall into pocket 11. Letters B, D, F, H, J, M, P, S, V, Y fall into pocket 12. Cards with only an 11-zone punch fall into pocket 11, and 12-zone cards fall into pocket 12. All other cards including the letters A, C, E, G, I, L, O, R, U, X and the zero-1 combinations fall into the reject pocket.

**Auxiliary Card Counter (IBM 82, 83, 84)**

This electrically operated card-counting mechanism registers a 1 for each card that passes the brush. It has dials that may be read easily for manual transcription of totals. The counter does not affect the normal speed or method of operation of the machine to which it is attached. The maximum capacity of the counter is 999,999 for the IBM 83 and 84, and 99,999 for the IBM 82.

Normally, it counts the total number of cards passing through the machine. It can count by pockets, however, on a second sort. After a total of all cards has been taken on the regular sorting operation, set aside the largest group of cards from an individual pocket. Run the cards from each of the other pockets for group totals and deduct the total of these groups from the grand total to determine the number of cards in the largest group. This eliminates the necessity of running the latter group through the sorter a second time.

SORT SELECTION SWITCH SETTING	POCKETS												REJECTS REGARDLESS OF EDIT	ERRORS (When Edit or Edit-Stop is ON)
	9	8	7	6	5	4	3	2	1	0	11	12		
A-1	X	U	R	O	L	I	G	E	C	A	KN QT WZ	BD FH JM PS VY	Cards punched with digits only, zones only, 0-1 combination, or blank	Any card with more than one zone punch or more than one digit punch
A-2	Z Y X	W V U	T S R	Q P O	N M L	K J I	H G	F E	D C	B A			Same as A-1	Same as A-1
A-N	9	8	7	6	5	4	3	2	1	0	KN QT WZ 11	BD FH JM PS VY 12	Blanks. A, C, E, G, I, L, O, R, U, X and the combina- tion 0-1.	Same as A-1

This pattern is based on cards being fed face down, 9 edge first.

Figure 29. Sorting Pattern for Alphabetic Sorting Feature



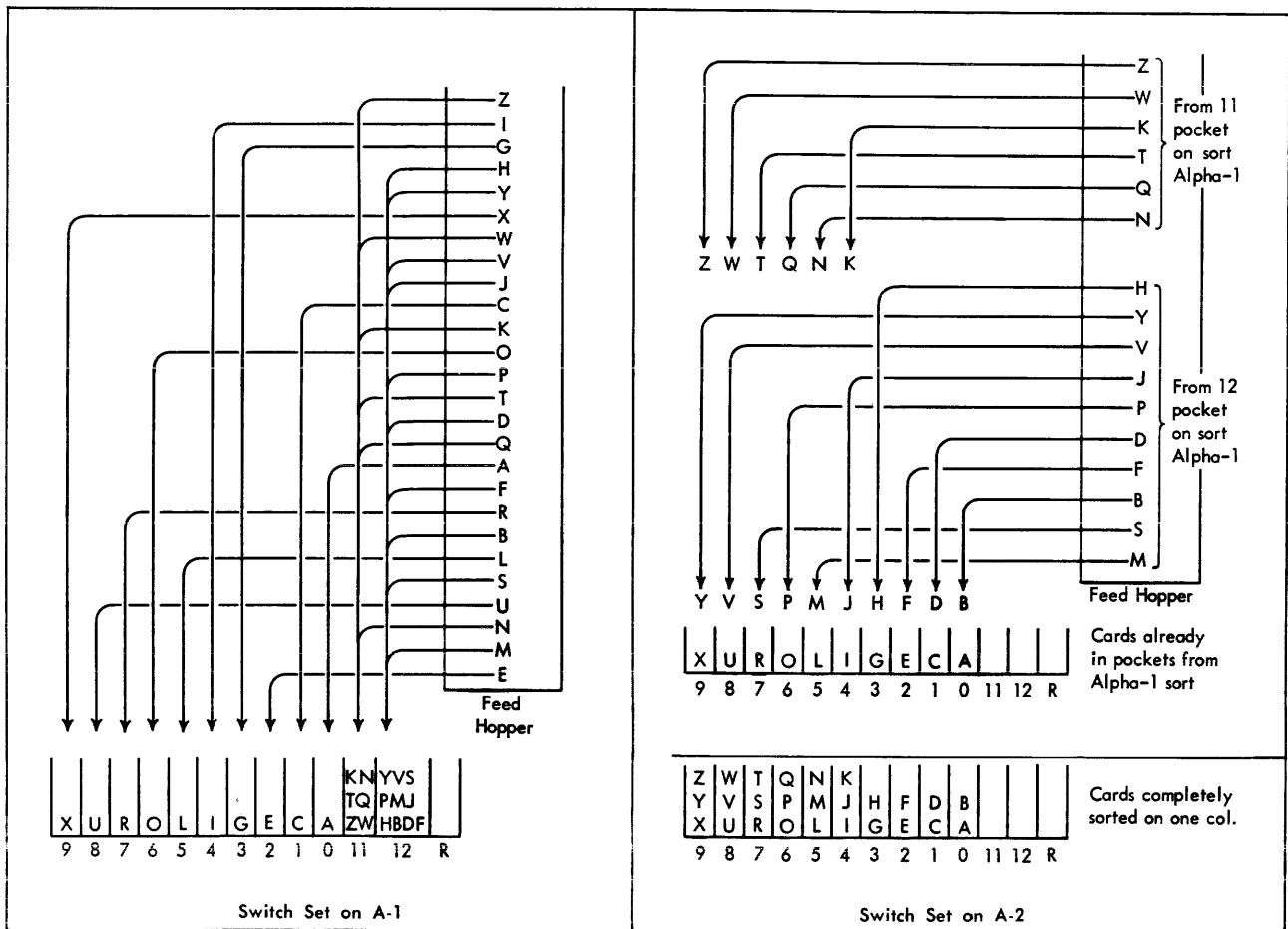

Figure 30. Sorting Principle Using Alphabetic Sorting Feature

**Card-Counting Unit (IBM 82, 83)**

With this feature (Figure 31), turn on the count switch to count all holes in a given column and the number of cards *not* punched in that column. The count switch and count-only switch are located with the machine controls on the sorter. Turn on the count-only switch to suppress sorting while cards are being counted, without disturbing their original sequence.

To simultaneously count and sort cards, turn off the count-only switch and turn on the count switch.

The card-counting unit contains 14 five-digit adding counters: one for each pocket and one for sub-totals. To accumulate a grand total, use the auxiliary card counter.

To clear all counters press the clear lever and rotate the clearing crank two turns to a locked position. If

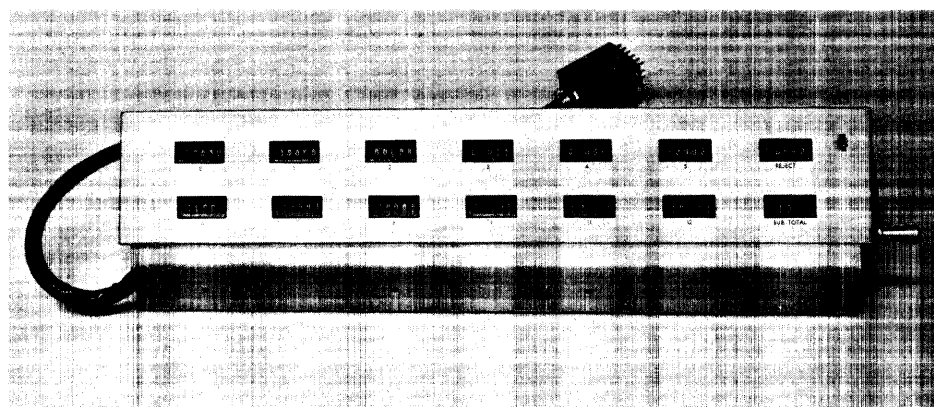

Figure 31. Card Counting Unit

the clear lever is pressed but the clearing crank has not been rotated, the sorter does not operate. If the count switch is ON and the cable is not connected to the sorter, the sorter does not operate.

The card-counting unit is connected to the sorter by a flexible five-foot cable, so the unit can be placed on the sorter or on a nearby desk or table. A record-keeper may sit at the desk or table to record, while the operator handles the cards. When the unit is placed on the sorter, the operator can record without leaving the machine. When an 83 has this feature and the multiple-column selector, the multiple-column selector supersedes the card counter and prevents a pocket count.

### **Card-Matching Feature (IBM 82, 83)**

This feature removes from a file of interspersed detail and master cards, those master cards that are not preceded by matching detail cards. For example, in a file using name-and-address cards as master cards, the inactive name-and-address cards are separated from the file. Unmatched masters fall into the reject pocket, while the matched masters and details fall into pocket 9 (IBM 82 Sorter) or pocket 11 (IBM 83 Sorter). The card-matching feature switch is located with the machine controls on the sorter.

Detail cards must precede the master cards because the chute to pocket 9 or 11 is opened by the details and closed by the master card. Therefore, it may be necessary to feed cards face-up.

To open the chute to pocket 9 or 11, a special rail brush recognizes a leading-edge corner-cut, or 9- or 12-punch in column 1 or 80 of the detail card.

To close the chute to pocket 9 or 11, use either the corner-cut method or the significant-punch method.

*Corner-Cut Method:* A special offset sorting-brush is set to track on the front edge of the card (opposite the rail-brush edge). This brush senses the corner cut of the first master card following the details. This first master card follows its group of detail cards into pocket 9 or 11, while any master cards that follow are rejected until another detail is recognized. Use this method only with groups having single master-cards.

*Significant-Punch Method:* The standard sorting brush senses a distinctive punch in the last master card of each group. No offset brush is necessary. Use this method with groups having single or multiple master-cards.

The sort-selection switch of the 83 is set at n. Suppress sorting to all pockets except the one corresponding to the corner cut (9 or 12) or the one corresponding to the significant punch. If master

cards are fed 12-edge first, the corresponding suppress settings would be in reverse order. For example, the 9-setting controls 12-punches, the 8-setting controls 11-punches.

The master cards must have square corners on the leading edge that passes under the rail brush used for recognizing detail cards. Also, the master cards should never have a 9- or 12-punch in column 1 or 80, when this column is adjacent to a rail brush. When the significant-punch method is used, this punch cannot be in any of the *four* columns adjacent to a rail brush set for corner-cut cards, and cannot be in any of the *six* columns adjacent to a rail brush set to read column 1 or 80.

### **Card Trays**

Two different card trays hold cards during sorting operations involving large volumes of cards. The upper tray, with a capacity of 3000 cards for each pocket, is on a movable stand. The lower tray (IBM 83 only) with a capacity of 2500 cards for each pocket, is in front of and just below the sorter pockets where it is accessible to the operator. Both card trays have the pockets numbered to correspond to the pockets of the sorter.

### **File Feed (IBM 83)**

The file feed triples the IBM 83's hopper capacity from 1200 to approximately 3600 cards. This allows as much as 3½ minutes of continuous running time without reloading. The file feed considerably reduces card handling and card joggling so that one operator can efficiently handle two sorters simultaneously. It takes less operator time to run two file-feed equipped sorters than to run one sorter without this device. If only one sorter is used, the time saved by the file feed can be used to run other equipment.

The file-feed magazine is about 25 inches long and extends at a 45-degree angle from the hopper over the top of the machine (Figure 32). In standard operation, the modified card weight is in the hopper at the start of a job. Cards are loaded on the magazine 9-edge down and the column-1 end toward the operator. Usually, it is not necessary for the operator to fan and joggle the cards because this is automatically accomplished as the cards enter the hopper from the magazine.

Pressing the start key allows about 300 cards to feed on top of the card weight in the hopper. As the cards are fed, the device automatically fans the cards and joggles them at the 12-edge and the column-1 end.

Once the hopper is filled, feeding stops. Swing out the hinged front joggle-plate to allow access to the

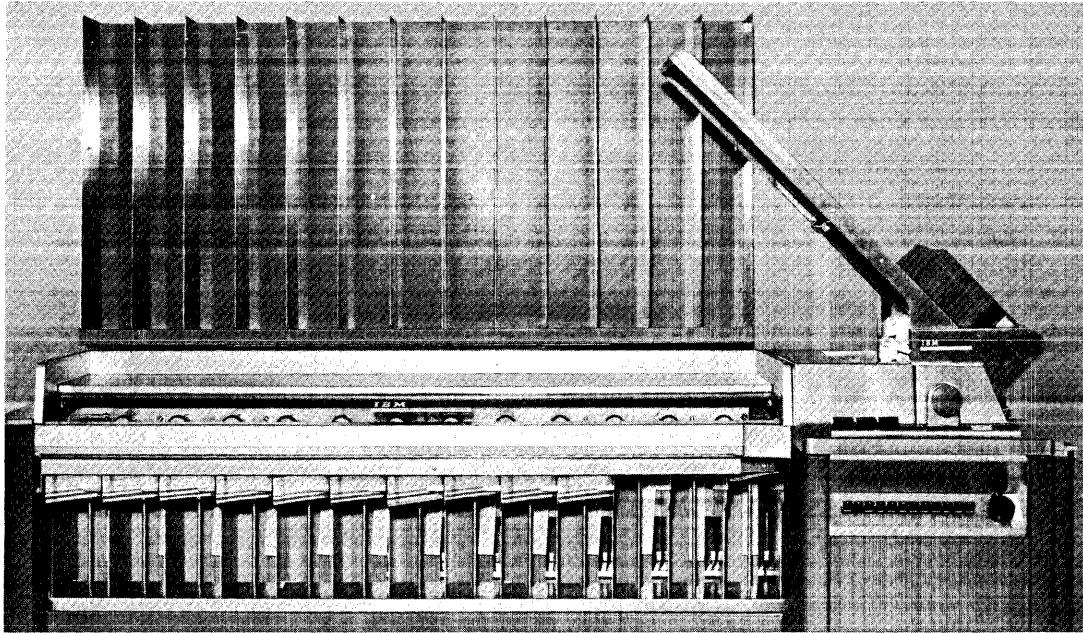

Figure 32. IBM 83 Sorter with File Feed

hopper so the card weight can be removed (Figure 33). Then place the weight on top of the cards in the magazine. Return the joggle plate to its normal position and press the start key again. A constant volume of about 300 cards is maintained in the hopper, except during run-out.

As the cards enter their proper pockets, a pocket joggler (Figure 34) automatically joggles them again. This vibrates against the top half-inch of the stack of cards as they enter the pockets, keeping them stacked evenly. The pocket joggler is easy to raise out of the way when the pockets are emptied, or simply push the cards down below the joggler and remove them. The pocket joggler is included in the file-feed feature of the IBM 83 Sorter.

To prepare for the next-column sort, place the card weight on top of the cards in the file-feed magazine, followed by the cards for the next sort. When the weight reaches the hopper bed and feeding stops, empty the pockets, move the brush to the next desired column, remove the weight, and again press the start key.

To permit access to the brush and feed rolls simply raise the magazine to an almost vertical position. It is not necessary to remove the cards from the magazine before it is raised. When the magazine is at its 45-degree angle, the reject- and 12-pockets in the upper sorting rack are limited to 1400 and 1800 cards, respectively. When the magazine is raised, these pockets are completely accessible.

You may run jobs of 300 cards or fewer without feeding from the magazine. To do this, it is necessary to swing the joggle plate out so that the cards, with

the weight on top, may be inserted directly into the hopper. Then return the joggle plate to its normal position and press the start key. Because this method bypasses the magazine feed, fan and joggle the cards before inserting them directly into the hopper.

The file-feed feature can be installed on an 83 Sorter in the field or at the factory.

#### **Group Sorting (IBM 82, 83)**

The group-sorting feature sorts an entire group of cards according to the punching in a leading master card. A corner cut on the leading edge of this master card is recognized by a special brush mounted on either the front or rear rail of the machine. When a card is recognized as a master, it is sorted according to the holes read by the regular sorting brush. The detail cards, with square corners, sort into the same pocket until the leader card for the next group is recognized. The master card must have a corner cut on the leading edge and on the side read by the special rail brush. Cards with C-3 corner cut should not be sorted using group sorting because the corner cut is too small to be recognized consistently.

#### **TRAILER-CARD FEATURE**

On the IBM 83 a trailer-card feature is available. If used, a rail brush recognizes a corner cut in the trailing edge of the trailer card (last detail card of a group). The rail brush may be either the one used for the master cards or another rail brush that reads the opposite side. When the rail brush recognizes the trailer card, it follows its group into the pocket selected by the preceding master card. All cards following the

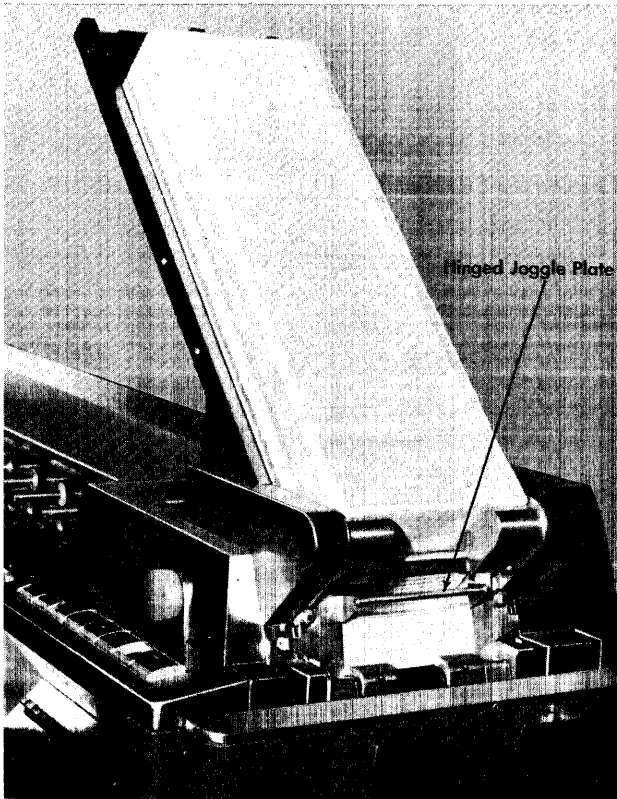

Figure 33. Hinged Joggle Plate

trailer card are rejected until the next master card is recognized. The sort-selection switch, edit switch, and edit-stop switch operate the same as for standard sorting.

On the 83, the standard sort brush cannot be set in the six card-columns nearest the rail brush.

### Multiple-Column Selector (IBM 82, 83)

The operations of multiple-column selection, testing for zeros in the high-order positions of a field, determining blank columns to the right in alphabetic fields, and selecting cards with common digits in any of ten consecutive columns, all depend on this ten-position brush assembly.

*Multiple-Column Selection* selects into a single pocket, on an initial pass through the machine, those cards punched with a predetermined numerical or alphabetic code in ten or less consecutive card-columns. For example, all cards punched *ASDF* can be selected in one pass through the machine.

*Common-Digit Selection* sorts out all cards which have one or more common digit punches. For example, all cards with one or more *X*'s in ten or fewer consecutive columns may be selected in one pass through the machine.

*Zero Elimination* permits greater speed in the completion of sorting operations by rejecting those cards

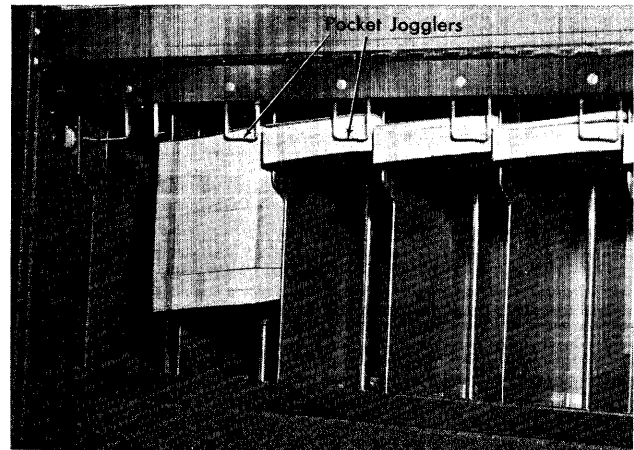

Figure 34. Pocket Jogglers

that require no further sorting (those with all zeros to the left). For example, a card with a part number 000000028 would be rejected on the third sort.

*Length of Field* distributes cards into the pockets as determined by the last significant column punched in the field, regardless of the remaining spaces to the left. For example, short names like Dow and Jones, which require fewer sorting passes, can be separated from longer names like Christianson and Mainbocher on an initial pass through the machine.

The multiple-column selector feature (Figure 35) consists of a ten-position brush assembly inserted by the operator in place of the standard sort-brush assembly. The feature also includes a small control panel on the right end of the sorter, ten column-control keys, and control switches on the front of the sorter.

### MULTIPLE-COLUMN SELECTOR FEATURE FOR THE IBM 82

*Control Panel and Switches:* Each brush of the ten-position brush assembly has two corresponding exit hubs on the control panel (Figure 36) labeled *ZONE PUNCHING* and *LOWER PUNCHING*. When inserted in sorting position, brush number one is toward column 80. Each brush has a brush-selection-for-sorting switch with positions for *select* and for *sort*.

When the switch is set on *SELECT*, the zone-punching hubs for that switch emit the zone (0, 11, 12) read by the corresponding brush unless the zero-elimination switch is on.

The lower punching exit hubs emit numerical impulses (9-1) read by the corresponding brush when the switch for that position is on *SELECT*.

The ten-position brush assembly can sort normally without control-panel wiring. Set the switch for the column being sorted on *SORT*, and all switches to the left on *SELECT*. As sorting proceeds from column to column, each switch is successively set on *SORT*.

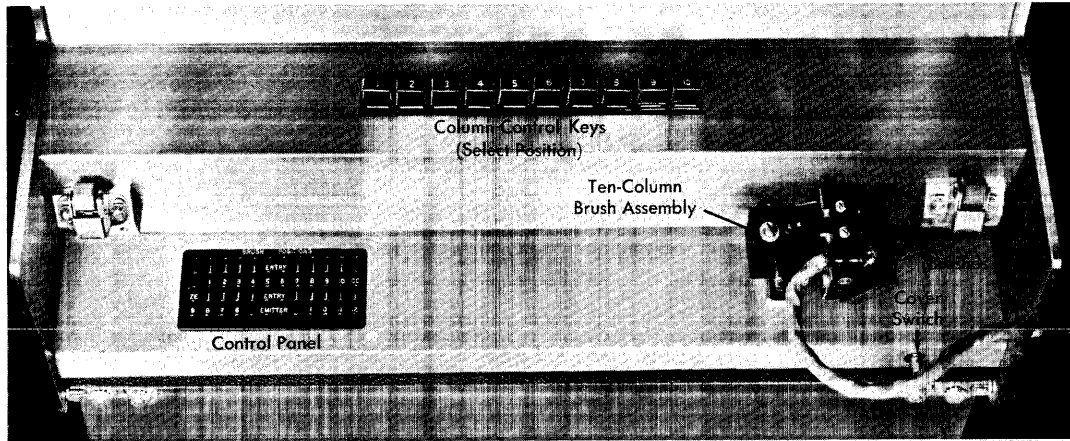

Figure 35. Ten-Column Brush Assembly, Control Panel, Keys, and Switches on the IBM 83 Sorter

The sc (sorting common) entry hub accepts any zone or digit impulse to cause the card to sort into the corresponding pocket, or select into pocket 12. The card sorts into the corresponding pocket when the sort-selection switches are out, as for normal sorting. It selects into pocket 12 when the sort-selection switches are out and the multiple-column selection switch is on.

The selector hubs accept impulses from the zone- and lower-punching hubs.

**Multiple-Column-Selection Switch and Zero-Elimination-Switch:** When the multiple-column selection switch is on:

1. Cards sort into pocket 12 or reject pocket only.
2. If any selector hub is impulsed by a digit other than its own (for example, if the 9-selector hub receives a 5-impulse) the card sorts into pocket 12.
3. If any one of the selector hubs receives an impulse corresponding to its number, and no other selector hubs receive impulses other than their own, the card sorts into the reject pocket. This is the principle used in multiple-column selection.
4. If none of the selector hubs receive an impulse (field is blank) the card sorts into pocket 12.

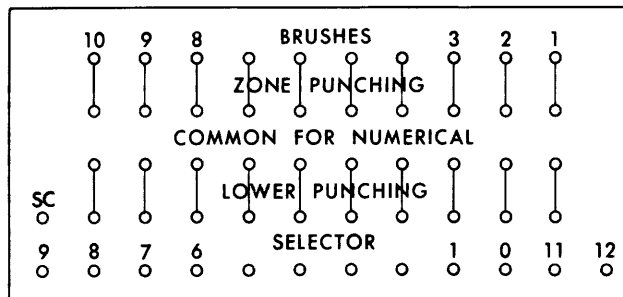

Figure 36. Multiple-Column Selection Feature Control Panel (82)

5. If the sc hub receives any 9-12 impulse, the card sorts into pocket 12 if the sort-selection switches are out.

When the zero-elimination switch is on:

1. The card rejects if the column being sorted is blank or contains a zero, 11, or 12; and the selector hubs (9-12) receive only their own digits from columns to the left of the one being sorted. This is the principle used in performing zero elimination during numerical sorting.
2. The zone-punching hubs do not emit unless a selector hub (9-12) is impulsed by a digit other than its own.
3. If a selector hub receives any impulse other than its own, the card sorts into pocket 12 if the column being sorted is blank.
4. The sc hub receives any impulse to cause the card to sort into the corresponding pocket if the sort-selection switches are out.

When both the multiple-column selection switch and the zero-elimination switch are on:

1. Cards sort into the 12-pocket or reject pocket only.
2. Cards sort into the 12-pocket if the sc hub is impulsed by a digit (9-1) and the corresponding sort-selection switch is out; or if any one of the selector hubs (9-12) is impulsed by a digit other than its own, and the sc hub is impulsed by a zone (0, 11, or 12).
3. Cards reject if neither the sc hub nor the selector hubs are impulsed by digits.

**Common-Digit Selection:** Figure 37 shows the control panel wired so cards with an X-punch in any of brush positions 10, 9, 4, 2, and 1 are selected into pocket 11. All other cards are rejected.

1. The zone-punching hubs of each position are wired together and to the sc hub (Figure 37).

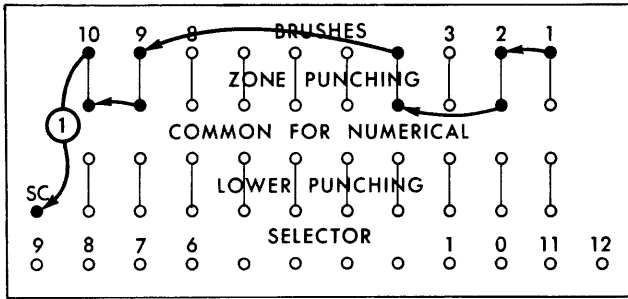

Figure 37. Common-Digit Selection (82)

2. Sort-selection switch 11 is out (normal); all other sort-selection switches are in.
3. Multiple-column selection switch is off. Zero-elimination switch is off. The ten brush-selection-for-sorting switches are set on SELECT.

*Zero Elimination During Numerical Sorting:* Wire the panel as shown in Figure 38 to reject cards requiring no further sorting after the column being sorted.

1. Set the brush assembly so brush 1 reads the units column of the field.
2. Wire the lower-punching hubs together and to the zero selector hub (Figure 38).
3. Turn off the multiple-column selection switch. Turn on the zero-elimination switch. Set the sort-selection switches OUT.
4. On the first sort, set switch 1 to SORT; set switches to the left to SELECT. As sorting proceeds from column to column, set switches 2, 3, 4, and so on, to SORT.
5. On each sorting run, a card rejects if the column being sorted and all columns to the left are blank or punched with 0's, 1's, or 12's.
6. If the column being sorted is blank and any of the columns to the left are punched with a digit (9-1), the card sorts into pocket 12.

*Accelerated Alphabetic Sorting:* Zero elimination (Figure 38) can accelerate alphabetic sorting by rejecting cards with short names that do not have to be sorted on every column of the alphabetic field. In the example in Figure 39 all cards punched in 5

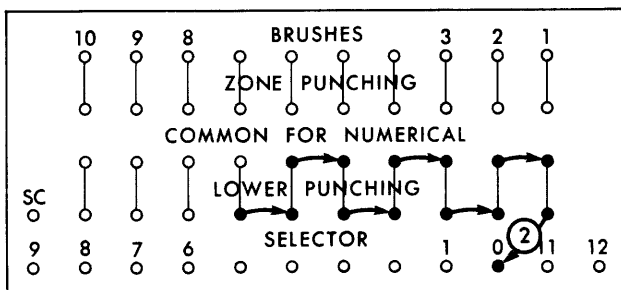

Figure 38. Zero Elimination (82)

Column	1	2	3	4	5	6	7	8	9	10	11	12
Brush		10	9	8	7	6	5	4	3	2	1	
Card 1	C	H	R	I	S	T	I	A	N	S	O	N
Card 2	B	R	O	T	H	E	R	S				
Card 3	J	O	N	E	S							

Figure 39. Accelerated Alphabetic Punching (82)

columns or fewer reject on the first run, because they do not require sorting on columns 6-11.

On the numerical sort for column 12, card 1 and all other cards punched in column 12 sort numerically; card 2 and all other cards punched in columns 6-11 sort into pocket 12; card 3 and all other cards punched in 5 columns or fewer reject, because columns 6-12 are wired for zero elimination. Zero elimination switch is ON; brush-selector-for-sorting switch 1 is set on SORT; switches 2-10 are on SELECT. Lay aside rejected cards until the numerical sort for column 5, and then place them in front of the entire file. Lay aside the cards from pocket 12 until the numerical sort for column 11, and then place them in front of the cards previously sorted on column 12. As sorting progresses from column 12 to column 3, the switches are successively set on SORT. Because sorting is necessary on columns 2 and 1, re-position the brush assembly after sorting column 3. Turn off the zero-elimination switch for each column on the zone sort.

The number of positions to wire for zero elimination on the first run may vary, depending on the application. You may wire smaller portions of the field for zero elimination on successive sorts. For example, while sorting numerically on column 11 in the previous illustration, remove the wires from the brush positions 7 and 6 and turn on the zero-elimination switch to reject cards not punched in columns 8, 9, 10, and 11. Thus, these cards need no sorting on columns 8-10.

*Multiple-Column Selection of Numerical Information:*

Figure 40 shows the control panel wired so cards punched 552105 reject; and all other cards sort into pocket 12.

1. Jackplug the zone-punching and lower-punching hubs.
2. Wire each position to the selector hub corresponding to the digit to be selected.
3. Wire three brush positions (1, 5, and 6), which are wired together, to hub 5.

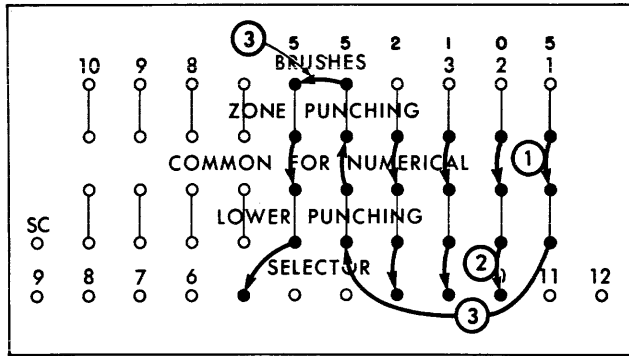

Figure 40. Multiple-Column Selection of Numerical Information (82)

4. Turn on the multiple-column selection switch. Turn off the zero-elimination switch. Set all the brush-selection-for-sorting switches on SELECT.

NOTE: This feature does not differentiate between a blank column and a specific digit in that column wired for selection. For example, cards punched 5-2105 or 55-105 reject with cards punched 552105. Therefore, sight-check all cards.

*Multiple-Column Selection of Alphabetic Information:*

Figure 41 shows the control panel wired to reject all cards punched GPNEZ and to sort all other cards into pocket 12.

1. Wire each lower-punching hub to the selector hub corresponding to the digit to be selected. When a digit is repeated in several letters (as 7 in G and P, 5 in N and E) wire the positions together.

2. Wire each zone-punching hub to the selector hub corresponding to the zone to be selected. When a zone is repeated in several letters (as 11 in P and N, 12 in G and E) wire the positions together.

3. The dotted wires in Figure 41 insure the selection of cards punched GPNEZ and not, for example, GPNEZABLE.

4. Turn on the multiple-column selection switch.

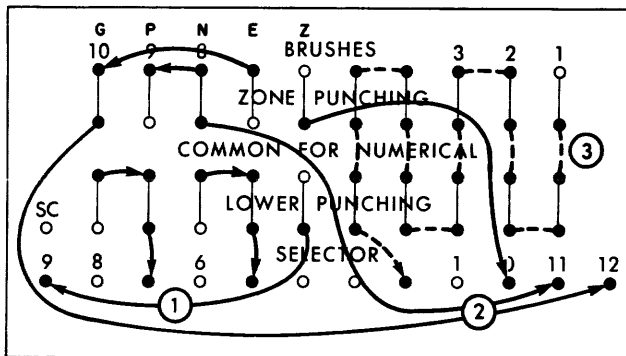

Figure 41. Multiple-Column Selection of Alphabetic Information (82)

Turn off the zero-elimination switch. Set all brush-selection-for-sorting switches on SELECT.

NOTE: Because this feature does not differentiate between a blank and a specific punch in that column wired for selection, sight-check all cards.

*Multiple-Column Selection in Combination with Normal Sorting:*

Although zero elimination is primarily for rejecting cards with a zero in the column being sorted and in columns to the left, it also can reject cards with a zero, 11, 12, or blank in the column being sorted and any specific numbers in the columns to the left. For example (Figure 42) cards punched 516860 can be rejected while sorting on the column in which the zero is punched. The operation is similar to multiple-column selection, except that it is combined with normal sorting and the column being sorted must be blank or punched zero, 11, or 12.

*MULTIPLE-COLUMN SELECTOR FEATURE FOR THE IBM 83*

When the 83 also has a card-counting unit, the multiple-column selector feature supersedes the card counter and prevents a pocket count.

*Control Panel:*

Each brush of the ten-position brush assembly has a double set of entry hubs on the control panel, labeled BRUSH POSITIONS 1-10. Two sets of entry hubs for each brush position allow setting up combinations of codes without creating back circuits. A back circuit can occur when an emitted zone or digit is common to several positions. The brush entries are normally wired from the emitter with the alphabetic, numerical, or code combinations in the cards.

The emitter generates an impulse for each punching position on the card (9-12). For instance, emitter-hub 4 emits an impulse at the same time the 4-position of the card is being read.

CD SW (common-digit switch) must be wired ON during a common-digit selection-operation.

ZE (zero-elimination emitter) is a source for a test impulse to recognize zeros or zone punches only to the left of significant digits.

Keys: Each brush has a column-control key that is raised for a select operation and pressed in for a

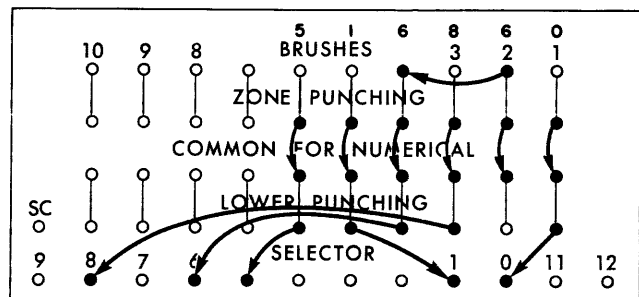

Figure 42. Multiple-Column Selection with Normal Sorting (82)



sort operation. For normal sorting, press the key for the column being sorted, and set the other keys to SELECT (out). Do not wire the control panel. When pressed, the keys automatically latch down like the digit-suppression keys.

Before performing a particular operation, press the corresponding control key labeled MCS (multiple-column selection), ZE (zero elimination) or LF (length of field). Because of an interlocking feature, the key farthest to the left takes precedence when more than one key has been pressed.

The normal sort and edit circuits are not operative during any of these operations.

**Selection of Alpha-Numerical Punching:** Figure 43 shows control-panel wiring and switch settings for multiple-column selection of cards punched A 7 J in columns 3, 7, 9. Columns 1, 2, 4, 5, 6, 8, and 10 are not to be tested. Cards that do not have the desired pattern reject.

1. Press the MCS control key.
2. Set column-control keys 3, 7, and 9 to SELECT (out) to compare the card punching with the predetermined emitted pattern A 7 J.
3. Press column-control keys 1, 2, 4, 5, 6, 8, and 10 to prevent testing on these columns.
4. Wire combination punches 12-1 (A) to any of the entries of brush-position 3.
5. Wire emitter-position 7 to brush-entry 7.
6. Wire combination punches 11-1 (J) to brush-entry 9. Emitter 1 is used in two brush settings so

Brush Pos.	1	2	3	4	5	6	7	8	9	10
Select			A				7		J	
Punched			12 1				7		11 1	
Col UP (Select)			3				7		9	
Sw DOWN (Off)	1	2		4	5	6		8		10

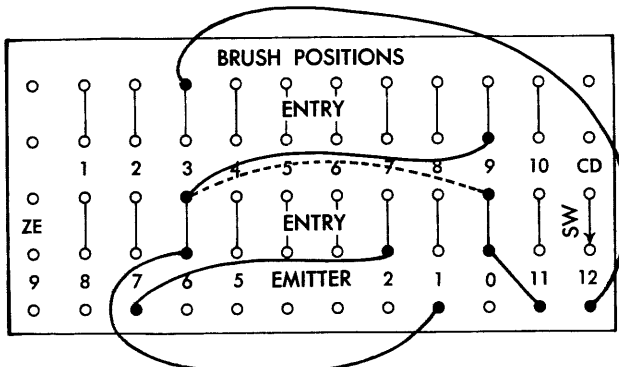

Figure 43. Selection of Alpha-Numerical Punching (83)

take care to isolate position 1 to prevent a connection between the 12-zone of letter A with the 11-zone of letter J. The dotted wire (Figure 43) would cause a back circuit if it were wired into lower brush-entry 9 instead of upper brush-entry 9. This would connect the 11-zone with brush-entry 3, which should receive the 12-zone impulse only.

**Selection with Blanks and Special Codes:** Figure 44 shows control-panel wiring and column-control switch settings for multiple-column selection of alphabetic, numerical, multiple-punch code combinations, and blanks.

1. Press the MCS control key.
2. Set column-control keys 1, 2, 3, 4, 5, 6, 7, 9, and 10 to SELECT (out) to compare the card punching with the predetermined pattern. Column-control 5 is out to verify the presence of a blank column. If a card is to be selected, a brush position with no wiring and with the column-control key out senses a blank column.
3. Press column-control key 8 to prevent testing column 22 read by brush 8.
4. Wire the emitter positions for the predetermined sort pattern to the proper brush entries.

**Common-Digit Selection:** The ten-position brush holder in combination with a pluggable switch on the control panel allows selection of a common digit or several common digits from any of the ten columns.

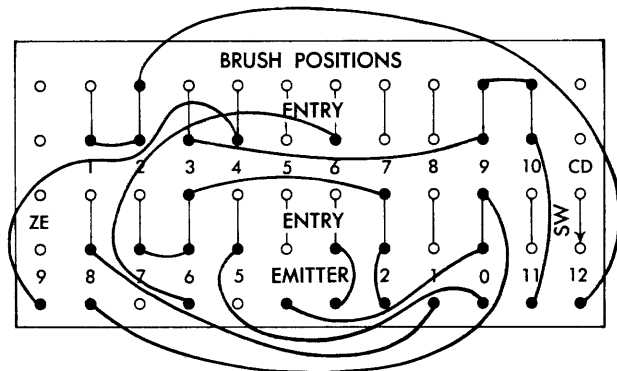

Brush Pos.	1	2	3	4	5	6	7	8	9	10
Select (Card cols. 15-24)	A	B	K	Z		6-3	2		*	11
Punched	12 1	12 2	11 2	0 9	B L A N K	6 3	2	0 M I T	11 4 8	11
Col UP (Select)	1	2	3	4	5	6	7		9	10
Sw DOWN								8		

Figure 44. Selection with Blanks and Special Codes (83)



When this switch is wired ON, the columns to be analyzed are connected through the sort side of the column-control keys. Therefore, press the column-control keys corresponding to the brush positions being searched. The cards sort into the common digit or digits pockets. Whenever two common digits are recognized within the same card, the first digit read controls the sort pocket. For example, cards with one or more X's in columns 3-9 can be selected with the common-digit feature. These cards sort into the zero pocket. All others reject. Figure 45 summarizes the operation.

1. Wire CD sw. Turn off (raise) control-keys MC, ZE, and LF.
2. Press column-control keys 1-7, which correspond to the brush positions being searched.
3. Set to SELECT (out) column-control keys 8-10, which sense card columns outside the required field.
4. Press all digit-suppression keys, except 11, to disregard any card punches other than those with X's.

**Zero Elimination:** The ten-column brush assembly combined with control key ZE and a pluggable ZE (zero-elimination) emitter hub on the control panel rejects cards that require no further sorting. The cards sort into the pockets according to four classifications.

1. Cards reject when the column being sorted and the columns to the left are blank or punched with zeros, 11's, or 12's only. These rejected cards require no further sorting and are available for immediate use in other operations.
2. If the column being sorted is blank, any punch 1-9 in any sensed column to the left sorts the card into pocket 12.
3. If the column being sorted has a zero, 11, or 12, and any punch 1-9 occurs in a column to the left, the card sorts into the corresponding pocket (zero, 11, or 12).
4. If the column being sorted is punched with any digit 1-9, the card sorts into the corresponding pocket regardless of punching in any position to the left.

Figure 46 shows sorting in numerical sequence columns 5-14, omitting column 9. Columns 14, 13,

12, and 11 have been sorted and the cards are still in the pockets.

1. Press control key ZE; MCS and LF are out (off).
2. Wire the ZE (zero-elimination) emitter to either of the two brush-position entries corresponding to each card column to be tested.
3. Press the column-control key corresponding to the units position of the field.
4. Press each successive column-control key to the left (tens, hundreds, and so on) as sorting continues. Note that all column-control keys for positions to the right of the column being sorted, as well as for the column being sorted, must be set to sort (in) whether inside or outside the required field. All switches to the left of the column being sorted must be set to select (out) whether it is inside or outside the field.

**Length of Field:** The ten-position brush assembly, combined with control key LF (length-of-field) and column-control keys, distributes variable-length fields into the pockets as determined by the last significant-punched column, regardless of intervening spaces to the left. In this way the feature separates cards by length of names punched in a field. This reduces the number of times a card must be fed through the sorter to put the cards in alphabetic order.

Figure 47 shows the pocket distribution of cards with a 17-column field for city and state. Set the brush assembly to read the ten right-hand columns (8-17) to determine the last position that must be sorted.

1. Press the LF key.
2. Set column-control keys 1-10 to select (out).
3. At the end of the length-of-field sort, the cards are in the pockets according to the pattern in Figure 46.
4. Remove the cards from the sorter and stack them separately according to pocket. Sort alphabetically the cards from pocket 11. Place the original zero-pocket cards in front of these sorted cards, and sort alphabetically on the next column. Place the original 1-pocket cards in front of these sorted cards, and continue sorting this way for the remaining columns.

Brush Pos.	1	2	3	4	5	6	7	8	9	10			
Card Col.	3	4	5	6	7	8	9	10	11	12			
Column Control	UP							8	9	10			
	DOWN	1	2	3	4	5	6	7					
Digit Suppress	UP											11	
	DOWN		9	8	7	6	5	4	3	2	1	0	12

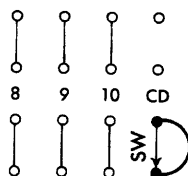

Figure 45. Common-Digit Selection (83)

Brush Position	1	2	3	4	5	6	7	8	9	10	Sort Pocket	Sorting Complete
Card Column	5	6	7	8	9	10	11	12	13	14		
Card No 1	3	0	0	0	O M I T T E D			0	7	0	12	
2	3	0	0	0		0	0	1	0	3	0	
3	0	0	0	4		0	0	2	5	2	0	
4	0	0	0	0		0	0	2	9	7	Reject	X
5	0	0	0	7		0	11	3	6	9	11	
6	0	0	0	0		0	11	3	6	9	11	
7	12	0	0	0		0	0	4	6	8	Reject	X
8	0	0	0	0		8	2	6	9	3	2	
9							2	8	7	5	2	
Column	UP (Select)	1	2	3	4	5	6					
Control	DOWN (Sort)						7	8	9	10		

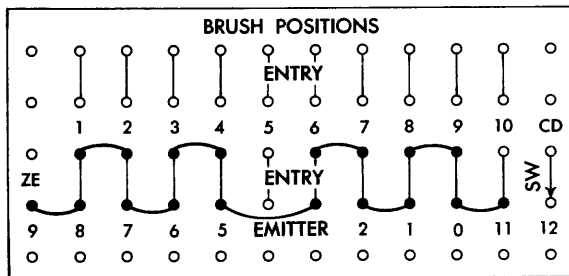

Figure 46. Zero Elimination (83)

Card Col.	1	2	3	4	5	6	7	8	9	10	11	12	13	14	15	16	17	Pocket
Brush Position								1	2	3	4	5	6	7	8	9	10	
Card No.																		
1			(BLANK)															9
2	R	Y	E	O	N	Y												9
3	M	A	C	R	N			A										8
4	M	O	O	R	O		A										7	
5	L	E	B	A	N	E			O									6
6	S	T	A	L	O	O		S		O								5
7	C	A	R	L	S	B		S										4
8	F	A	I	R	M	O		D										3
9	W	I	N	R	E	M		T										2
10	T	H	E	R	M	O		C										1
11	W	A	L	L	A			O										0
12	A	R	K	A	N	S		A										11
Col	UP (Select)							1	2	3	4	5	6	7	8	9	10	
Sw	DOWN (Sort)																	

Figure 47. Length of Field (83)

### **Sort-Suppression Feature (IBM 82, 83, 84)**

With this feature, the sorter separates cards into the reject pocket and pocket 12, without disturbing the sequence within the two groups of cards. Unpunched cards reject and all other cards sort into pocket 12 in their original sequence.

The main advantage of sort suppression is in selecting cards with specific punches without disturbing the sequence of the selected or the unselected cards. For example, if sorting is suppressed for all digits except 1 and 3 (sort-selection switch on the 83 set on N), all cards punched 1 and 3 sort into pocket 12 and other cards sort into the reject pocket.

### **SORT SUPPRESSION WITH THE IBM 83 OR 84**

To edit cards without disturbing their sequence, turn on the edit-stop switch while using the sort-suppression feature as previously described. Cards are separated and errors fall into the reject pocket in sequence with the other cards that are rejected. The edit-stop switch locates the point at which error cards fall into the reject pocket.

It is also possible by using this same principle to do a blank-column and double-punch detection test on a single column without disturbing the sequence of the cards. Turn the sort-selection switch to N when the edit and sort-suppression switches are ON. If only a few columns need be analyzed, this is a rapid process.

## Index

Accelerated Alphabetic Sorting .....	29	Interlock Switch .....	18, 21
Access Cover .....	21	Jam .....	7, 12, 18, 21
Alignment Levers .....	22	Joggle Plate .....	25
Alphabetic Sorting .....	10, 16, 19, 23, 29, 30	Joggling .....	5, 13, 20, 25
Alphabetic-Sort Switch .....	7	Length of Field .....	26, 32
Alpha-Numerical .....	16, 19, 23, 31	Letters .....	10, 19, 23
Auxiliary Card Counter .....	23	Locking Key .....	18
Blanks .....	8, 19, 23	Locking Lever .....	6, 12, 17
Block Sorting .....	10, 12, 18	Locking Screw .....	7
Brush .....	5, 6, 8, 13, 17, 27	Main-Line Switch .....	5, 6, 12
Brush Cover .....	7, 13, 17, 18, 21	Major Sort .....	9
Brush Gage .....	17, 18	Manual Sorting .....	14
Brush Holder .....	6, 12, 13	Matching .....	25
Brushless Card-Sensing .....	20	Minor Sort .....	9
Card Counter .....	23, 24	Missorting .....	13, 14
Card-Counting Unit .....	24	Multiple-Column Selection .....	27
Card Deck .....	21	Multiple-Field Sort .....	9
Card-Deck Support .....	22	Multiple Punch .....	16, 19
Card Feed .....	5, 8, 12, 16, 20, 21, 25	Needle, Sorting .....	14
Card Gage .....	13	Numerical Sorting .....	7, 9, 16, 18, 29
Card Matching .....	25	Off Punching .....	13
Card Pusher .....	22	Operation .....	5, 6, 12, 18, 20, 22
Card-Retaining Levers .....	22	Patches .....	22
Cards, Damaged .....	13, 18, 21	Pivot Assembly .....	22
Card Weight .....	5, 12, 25, 26	Pockets .....	7, 8, 17, 20, 25
Chute Blades .....	8, 13, 17, 18, 21	Pocket-Stop Lever .....	7, 17, 20
Cleaning .....	12, 20	Power On .....	17
Column .....	5, 7	Protection Against Jams .....	12, 18, 21
Column Indicator .....	5, 6, 20	Punch .....	5, 7, 8, 13, 19, 24
Column Selector .....	6, 12, 17, 21	Pusher, Card .....	22
Common-Digit Selection .....	27, 28, 31	Radial Stackers .....	20, 21, 22
Controls .....	6, 15, 20	Rail Brush .....	26
Corner Cut .....	25	Ready Light .....	6
Counter, Card .....	23, 24	Reject .....	7, 8, 16, 19, 23
Cover, Brush .....	7	Reports .....	10
Damaged Cards .....	13, 18, 21, 22	Roller .....	8
Digits .....	10, 11, 16, 19	Selection .....	5, 7, 9, 11, 16, 18, 19, 27, 29
Digit Suppression .....	5, 15, 19	Selector Cover .....	21
Diode .....	20	Sensing Mechanism .....	5, 20, 21, 22
Double Punch .....	8, 16	Sequence .....	10
Duplicating .....	13	Short Cut .....	12
Edit .....	16	Sight Checking .....	13
Edit-Stop .....	16, 19	Significant Punch .....	25
Error .....	16, 17	Single-Column Selection .....	12, 19
Features, Special .....	5, 23	Solid-State Circuitry .....	20
Feed .....	5, 8, 12, 16, 20, 21	Sort Brush .....	5, 6, 8, 13, 17, 18
Feed Cover .....	21	Sort-Brush Gage .....	17
Field .....	9	Sorting Needle .....	14
File Feed .....	5, 20, 25	Sort Magnet .....	8
Finger Lever .....	6	Sort-Selection Switch .....	16, 19, 25
Full-Pocket Light .....	20, 22	Sort Suppression .....	34
Gage, Card .....	13	Sort-Test .....	16
Gage, Sort-Brush .....	17, 18	Special Codes .....	10, 31
Group Sorting .....	26	Special Features .....	5, 23
Guide Assembly .....	22	Speed .....	5, 6, 15, 20
Hand Feed Wheel .....	7, 13	Stackers, Radial .....	20, 21, 22
Hand Filing .....	14	Stackers .....	5, 20, 21, 22
Handling Cards .....	12, 25	Stacker-Stop Switch .....	22
Hopper .....	5, 6	Stacking Cards .....	13, 19

Start Key .....	5, 6, 8	Vacuum .....	20
Stop Key .....	6, 12	Warm Up .....	6
Stop-Reset .....	17	Weight, Card .....	5, 12, 25, 26
Tens Column .....	9	Wheel, Hand Feed .....	7, 13
Test .....	16	X-Punch .....	7, 19
Throat .....	12	Zero Elimination .....	27, 28, 29, 32
Timing .....	13, 16	Zone Punch .....	7, 10, 16
Trailer Card .....	26	Zone Sorting .....	19
Trays .....	14, 25		
Units Column .....	9		

**IBM**

**International Business Machines Corporation**

**Data Processing Division**

**112 East Post Road, White Plains, New York**