

# The AME2003 atomic mass evaluation <sup>\*</sup>

## (II). Tables, graphs and references

G. Audi<sup>a,§</sup>, A.H. Wapstra<sup>b</sup> and C. Thibault<sup>a</sup>

<sup>a</sup> *Centre de Spectrométrie Nucléaire et de Spectrométrie de Masse, CSNSM, IN2P3-CNRS&UPS, Bâtiment 108,  
F-91405 Orsay Campus, France*

<sup>b</sup> *National Institute of Nuclear Physics and High-Energy Physics, NIKHEF, PO Box 41882, 1009DB Amsterdam,  
The Netherlands*

---

### Abstract

This paper is the second part of the new evaluation of atomic masses AME2003. From the results of a least-squares calculation described in Part I for all accepted experimental data, we derive here tables and graphs to replace those of 1993. The first table lists atomic masses. It is followed by a table of the influences of data on primary nuclides, a table of separation energies and reaction energies, and finally, a series of graphs of separation and decay energies. The last section in this paper lists all references to the input data used in Part I of this AME2003 and also to the data entering the NUBASE2003 evaluation (first paper in this volume).

AMDC: <http://csnwww.in2p3.fr/AMDC/>

---

### 1. Introduction

The description of the general procedures and policies are given in Part I of this series of two papers, where the input data used in the evaluation are presented. In this paper we give tables and graphs derived from the evaluation of the input data in Part I.

Firstly, we present the table of atomic masses (Table I) expressed as mass excesses in energy units, together with the binding energy per nucleon, the beta-decay energy and the full atomic mass in mass units.

---

<sup>\*</sup> This work has been undertaken with the encouragement of the IUPAP Commission on Symbols, Units, Nomenclature, Atomic Masses and Fundamental Constants (SUN-AMCO).

<sup>§</sup> Corresponding author. *E-mail address:* [audi@csnsm.in2p3.fr](mailto:audi@csnsm.in2p3.fr) (G. Audi).

The second table is the table of *influences* on primary nuclides (Table II). For each of the *primary* nuclides entering this evaluation, we give the three main data and their influences on the mass of this nuclide (see the definitions in Part I, Section 3).

Thirdly, we give a table for values and their estimated precision for the separation energies and reaction energies for twelve carefully selected combinations of nuclides. This selection, together with the  $\beta$ -decay energies above, yields all differences in masses between any pair of nuclei differing at most by 2 units in  $Z$  and  $N$ . A method is indicated in which many more reaction energy values can be derived from the present table.

The following series of graphs are then presented: two-neutron separation energies and  $\alpha$ -decay energies as a function of neutron number, two-proton separation energies as a function of proton number and double  $\beta$ -decay energies as a function of mass number which are considered as the most illustrative ones for the systematic trends.

Finally, references to the input data used in Part I of this AME2003 and in NUBASE2003 in the first paper of this volume are given in the last section of this paper.

## 2. The atomic mass table

As in our previous work AME'93 [1]–[4] and AME'95 [5], the tables presented in this work give atomic masses and derived quantities. With very few exceptions, experimental data on masses of nuclei refer to “*atomic*” masses or to masses of singly ionized atoms. In this last case the ionization energy is generally (much) smaller than the error on the mass, and, for the small number of very precise mass measurements, corrections for the first -and second- ionization potentials could be applied without much loss of accuracy. The same is true for the electron mass  $M_e$  involved, see Table A in Part I. This is the reason for the decision to present, in our evaluations, atomic rather than nuclear masses.

Nuclear masses can be calculated from atomic ones by using the formula:

$$M_N(A, Z) = M_A(A, Z) - Z \times M_e + B_e(Z) \quad (1)$$

Nowadays, several mass measurements are made on fully or almost fully ionized particles. Then, a correction must be made for the total binding energy of all removed electrons  $B_e(Z)$ . They can be found in the table for calculated total atomic binding energy of all electrons of Huang et al. [6]. Unfortunately, the precision of the calculated values  $B_e(Z)$  is not clear; this quantity (up to 760 keV for  ${}_{92}\text{U}$ ) cannot be measured easily. Very probably, its precision for  ${}_{92}\text{U}$  is rather better than the 2 keV accuracy with which the mass of, e.g.,  ${}^{238}\text{U}$  is known. A simple formula, approximating the results of [6], is given in the review of Lunney, Pearson and Thibault [7]:

$$B_{el}(Z) = 14.4381 Z^{2.39} + 1.55468 \times 10^{-6} Z^{5.35} \text{ eV} \quad (2)$$

**Table A.** The most precisely known masses.

	Mass excess (keV <sub>90</sub> )		Atomic mass (μu)	
<sup>1</sup> n	8 071.317 10	0.000 53	1 008 664.915 74	0.000 56
<sup>1</sup> H	7 288.970 50	0.000 11	1 007 825.032 07	0.000 10
<sup>2</sup> H	13 135.721 58	0.000 35	2 014 101.777 85	0.000 36
<sup>3</sup> H	14 949.806 00	0.002 31	3 016 049.277 67	0.002 47
<sup>3</sup> He	14 931.214 75	0.002 42	3 016 029.319 14	0.002 60
<sup>4</sup> He	2 424.915 65	0.000 06	4 002 603.254 15	0.000 06
<sup>13</sup> C	3 125.011 29	0.000 91	13 003 354.837 78	0.000 98
<sup>14</sup> C	3 019.893 05	0.003 80	14 003 241.988 70	0.004 08
<sup>14</sup> N	2 863.417 04	0.000 58	14 003 074.004 78	0.000 62
<sup>15</sup> N	101.438 05	0.000 70	15 000 108.898 23	0.000 75
<sup>16</sup> O	−4 737.001 41	0.000 16	15 994 914.619 56	0.000 16
<sup>20</sup> Ne	−7 041.931 31	0.001 79	19 992 440.175 42	0.001 92
<sup>23</sup> Na	−9 529.853 58	0.002 73	22 989 769.280 87	0.002 93
<sup>28</sup> Si	−21 492.796 78	0.001 81	27 976 926.532 46	0.001 94
<sup>40</sup> Ar	−35 039.896 02	0.002 68	39 962 383.122 51	0.002 86

The atomic masses are given in mass units and the derived quantities in energy units. For the atomic mass unit we use the “unified atomic mass unit,” symbol “u”, defined as 1/12 of the atomic mass of one <sup>12</sup>C atom in its electronic and nuclear ground states and in its rest coordinate system. In our work energy values are expressed as electron-volt, using the *maintained* volt V<sub>90</sub>. For a discussion see Part I, Section 2.

As mentioned in Part I, we no longer give values for the binding energies,  $ZM_H + NM_n - M$ , as we used to in earlier tables. Otherwise than before, its error equals that in the value of the mass excess, which makes its use unnecessary. We now give instead the binding energy per nucleon, which is of educational interest, connected to the Aston curve and the maximum stability around the ‘iron-peak’ of importance in astrophysics.

Due to the drastic increase in the precision of the mass values of the very light nuclei, the printing format of the mass table is not adequate. Table A gives, for the most precise among them, values of mass excesses and atomic masses. Conversion of the errors from μu to keV were obtained by:

$$\sigma_{M_{keV}}^2 = (\sigma_{M_u} \times u)^2 + (M_u \times \sigma_u)^2 \quad (3)$$

where  $M_u$  is the mass excess in μu, and  $\sigma_u$  the error of  $u$  expressed in eV<sub>90</sub>. The part

**Table B.** Correlation matrices for the most precisely known very light nuclei (in squared nano atomic mass units).

	n	H	D	<sup>4</sup> He	<sup>13</sup> C	<sup>14</sup> N	<sup>15</sup> N	<sup>16</sup> O	<sup>28</sup> Si
n	0.316817								
H	-0.007978	0.010689							
D	0.124508	0.002709	0.127243						
<sup>4</sup> He	0.000000	0.000000	0.000000	0.004011					
<sup>13</sup> C	0.125909	-0.007584	0.118352	0.000000	0.954145				
<sup>14</sup> N	-0.008911	0.012558	0.003645	0.000000	-0.008470	0.384729			
<sup>15</sup> N	0.094981	0.016262	0.111262	0.000000	0.090285	0.019496	0.558755		
<sup>16</sup> O	-0.001022	0.001377	0.000355	0.000000	-0.000972	0.005718	0.002100	0.027039	
<sup>28</sup> Si	0.227453	0.008282	0.235786	0.000000	0.216210	0.010584	0.653732	0.001078	3.761099

	n	H	D	<sup>3</sup> H	<sup>3</sup> He	<sup>16</sup> O	<sup>20</sup> Ne	<sup>23</sup> Na	<sup>28</sup> Si
n	0.316817								
H	-0.007978	0.010689							
D	0.124508	0.002709	0.127243						
<sup>3</sup> H	0.008197	0.000942	0.009139	6.116907					
<sup>3</sup> He	0.009704	0.001116	0.010822	5.694194	6.743975				
<sup>16</sup> O	-0.001022	0.001377	0.000355	0.000122	0.000144	0.027039			
<sup>20</sup> Ne	0.326227	0.014358	0.340650	0.024965	0.029563	0.001866	3.687126		
<sup>23</sup> Na	-0.000000	0.000000	0.000000	0.000000	0.000000	0.000000	0.000000	8.587458	
<sup>28</sup> Si	0.227453	0.008282	0.235786	0.017163	0.020325	0.001078	0.633419	0.000000	3.761099

dependent on  $M_i$  is only important for very few nuclides.

### 3. Influences on primary nuclides

Table II presents a list of all primary nuclides, and for each of these the main data contributing to its mass determination (up to the three most important ones) and the *influences* of these data on this nuclide.

This Table II complements the information given in the main table (Part I, Table I) where we display the *significance* (total flux) and the main *flux* of each datum. In other words, the flow-of-information matrix  $\mathbf{F}$ , defined in Part I, Section 5.1, is (partly) displayed once along lines and once along columns.

### 4. Nuclear-reaction and separation energies

The result of the least-squares adjustment of experimental data (reaction and decay energies and mass-spectrometric data) determining atomic masses of nuclides, as described in Part I, is not represented completely by the adjusted values of the input data given there and the resulting values of the atomic masses given in the Table I. A com-

plete representation would require reproduction of a matrix of correlation coefficients. Since this matrix contains  $\frac{1}{2}N(N+1)$  elements in which  $N = 847$ , this is not very attractive.

The main use of the correlation matrix is in obtaining errors in linear combinations of atomic masses. In practice, the correlations are important only for combinations involving two neighbouring nuclides with small differences in mass number and particles such as n, p, d, t,  $^3\text{He}$  and  $\alpha$ . Such combinations, consisting of various kinds of decay and binding energies of particles or groups of particles, are important for systematic studies of the nuclear energy surface and for Q-values of frequently studied reactions. As before [2], we present in Table III values for 12 such combinations and their standard errors. The  $\beta$ -decay energies are given in Table I.

With the help of the instructions given in the ‘Explanation of Table’, values for 28 additional reactions and their standard errors can be derived. The derived values will be correct, but in a few cases (of reactions on very light nuclei measured with extreme precision) the errors will be slightly larger than would follow from a calculation including correlations.

The precision (standard error) in the value of any combination of the most precise mass values, for very light nuclei, can be obtained with the help of the correlation coefficients given in Table B. When doing this, one should calculate the values to which these errors belong from the mass values (in  $\mu\text{u}$ ), and not from the mass-excesses (in keV), in the mass table (Table I).

We have also prepared a table of neutron, proton and deuteron pairing energies, available from the AMDC [8], defined as:

$$P_n(A, Z) = \frac{1}{4}(-1)^{A-Z+1}[S_n(A+1, Z) - 2S_n(A, Z) + S_n(A-1, Z)]$$

$$P_p(A, Z) = \frac{1}{4}(-1)^{Z+1}[S_p(A+1, Z+1) - 2S_p(A, Z) + S_p(A-1, Z-1)]$$

$$P_d(A, Z) = \frac{1}{4}(-1)^{Z+1}[S_d(A+2, Z+1) - 2S_d(A, Z) + S_d(A-2, Z-1)]$$

$S_n$ ,  $S_p$ , and  $S_d$  are the neutron, proton and deuteron separation energies, the latter being defined as

$$S_d(A, Z) = -M(A, Z) + M(A-2, Z-1) + M(d) = -Q(\gamma, d),$$

and  $S_n$ , and  $S_p$ , are defined below in the Explanation of Table.

Remark:  $P_n$  is also sometimes written as:

$$P_n(A, Z) = \frac{1}{4}(-1)^{A-Z+1}[-M(A+1, Z) + 3M(A, Z) - 3M(A-1, Z) + M(A-2, Z)]$$

displaying thus more clearly the combination of the involved masses. And similarly for  $P_p$  and  $P_d$ .

## 5. Graphs of systematic trends

All the information contained in the mass table (Table I) and in the nuclear reaction and separation energy table (Table III) can in principle be displayed in a plot of the binding energy or the mass versus  $Z$ ,  $N$ , or  $A$ . Such a plot, in which the binding energies vary rapidly, is complicated by the fact that there are four sheets, corresponding to the four possible combinations of parity for  $Z$  and  $N$ . These sheets are nearly parallel almost everywhere in this three dimensional space and have remarkably regular trends, as one may convince oneself by making various cuts (e.g.  $Z$  or  $N$  or  $A$  constant). Any derivative of the binding energies also defines four sheets. In the present context, *derivative* means a specified difference between the masses of two nearby nuclei. They are also smooth and have the advantage of displaying much smaller variations (see also Part I, Section 4). For a derivative specified in such a way that differences are between nuclides in the same mass sheet, the nearly parallelism of these leads to an (almost) unique surface for the derivative, allowing thus a single display. Therefore, in order to illustrate the systematic trends of the masses, four derivatives of this last type were chosen:

1. the two-neutron separation energies versus  $N$ , with lines connecting the isotopes of a given element (Figs. 1–9);
2. the two-proton separation energies versus  $Z$ , with lines connecting the isotones (the same number of neutrons) (Figs. 10–17);
3. the  $\alpha$ -decay energies versus  $N$ , with lines connecting the isotopes of a given element (Figs. 18–26);
4. the double  $\beta$ -decay energies versus  $A$ , with lines connecting the isotopes and the isotones (Figs. 27–36).

These graphs of systematic trends supersede earlier graphs [3].

Other various representations are possible (e.g. separately for odd and even nuclei: one-neutron separation energies versus  $N$ , one-proton separation energy versus  $Z$ ,  $\beta$ -decay energy versus  $A$ , . . .); they can all be built starting from the values in Table III. They cannot all be given in the present printed version, but they are retrievable from the *Web* distribution [8].

Clearly showing the systematic trends, these graphs can be quite useful for checking the quality of any interpolation or extrapolation (if not too far) and generally is an excellent testground for theoretical mass models. When some masses in a defined region deviate from the systematic trends, almost always there is a serious physical cause, like a shell or subshell closure or an onset of deformation. But, if only one mass exhibits an irregular pattern, violating the systematic trends, then one may seriously question the correctness of the related data. See the discussion in Part I, Section 4.

## 6. List of references for the NUBASE2003 and AME2003 evaluations

Full references related to all the input data used in the present AME2003 evaluation, as well as in the NUBASE2003 evaluation (first article in this volume), are listed in a special table, at the end of this paper.

A list of identifiers for journals, books, conferences . . . is given first, as much as possible in the CODEN-style (see [9]). With one exception though, for the *Eur. Phys. Journal* for which we preferred the ‘EPJAA’ identifier, that we think more practical to use, than the ‘ZAANE’ identifier as adopted by the NSR.

The references were quoted, in both evaluations in the NSR [9] key number style, where available, and only for the regular journals. They are listed here by year of publication and first author name.

## References

- [1] G. Audi and A.H. Wapstra, Nucl. Phys. A 565 (1993) 1;  
<http://csnwww.in2p3.fr/AMDC/masstables/Ame1993/>
- [2] G. Audi and A.H. Wapstra, Nucl. Phys. A 565 (1993) 66.
- [3] C. Borcea, G. Audi, A.H. Wapstra and P. Favaron, Nucl. Phys. A 565 (1993) 158.
- [4] G. Audi, A.H. Wapstra and M. Dedieu, Nucl. Phys. A 565 (1993) 193.
- [5] G. Audi and A.H. Wapstra, Nucl. Phys. A 595 (1995) 409;  
<http://csnwww.in2p3.fr/AMDC/masstables/Ame1995/>
- [6] K.-N. Huang, M. Aoyagi, M.H. Chen, B. Crasemann and H. Mark, At. Nucl. Data Tables 18 (1976) 243.
- [7] D. Lunney, J.M. Pearson and C. Thibault, Rev. Mod. Phys. 75 (2003) 1021.
- [8] The AME2003 files in the electronic distribution and complementary documents can be retrieved from the Atomic Mass Data Center (AMDC) through the *Web*:  
<http://csnwww.in2p3.fr/amdc/>
- [9] Nuclear Structure Reference (NSR): a computer file of indexed references maintained by NNDC, Brookhaven National Laboratory; <http://www2.nndc.bnl.gov/nsr/>

**Table I. Atomic mass table****EXPLANATION OF TABLE**

$N$	Number of neutrons.
$Z$	Number of protons.
$A$	Mass number $A = N + Z$ .
Elt.	Element symbol (for $Z > 109$ see Section 2).
Orig.	Origin of values for secondary nuclides. $z p m$ mass of ${}^A Z$ derived from mass of ${}^{A+z+n}(Z+z)$ .
	Special notations:
	IT when $z = 0, n = 0$ ;
	+ when $z = +1, n = -1$ ;
	– when $z = -1, n = +1$ ;
	++ when $z = +2, n = -2$ ;
	-- when $z = -2, n = +2$ ;
	$\epsilon p$ when $z = -2, n = +1$ ;
	$+\alpha$ when $z = +2, n = +2$ ;
	$-\alpha$ when $z = -2, n = -2$ ;
	x for distant connection.
Mass excess	Mass excess $[M(\text{in u}) - A]$ , in keV, and its one standard deviation error. In cases where the furthest-left significant digit in the error was larger than 3, values and errors were rounded off, but not to more than tens of keV. (Examples: $2345.67 \pm 2.78 \rightarrow 2345.7 \pm 2.8$ , $2345.67 \pm 4.68 \rightarrow 2346 \pm 5$ , but $2346.7 \pm 468.2 \rightarrow 2350 \pm 470$ ). # in place of decimal point: value and error derived not from purely experimental data, but at least partly from systematic trends.
Binding energy per nucleon	Tabulated binding energy per nucleon (in keV): $B/A = 1/A[ZM({}^1\text{H}) + NM({}^1\text{n}) - M(A, Z)]$ . and its one standard deviation error. # in place of decimal point: see above.
Beta-decay energy	Direction of decay, value and standard error in keV: for $\beta^-$ : $Q^- = M(A, Z) - M(A, Z + 1)$ ; for $\beta^+$ : $Q^+ = M(A, Z) - M(A, Z - 1)$ . For a few odd-odd nuclides near maximum $\beta$ -stability decaying both $\beta^-$ and $\beta^+$ , the $Q^+$ values are given as negative $Q^-$ values for the preceding even-even isobar. * in place of value: not calculable. # in place of decimal point: see above.
Atomic mass	Atomic mass $M$ and its one standard deviation error in $\mu\text{u}$ . # in place of decimal point: see above.



N	Z	A	Elt.	Orig.	Mass excess (keV)	Binding energy per nucleon (keV)	Beta-decay energy (keV)	Atomic mass $\mu u$
1	0	1	n		8071.3171	0.0005	0.0	0.0006
0	1	1	H		7288.97050	0.00011	0.0	0.00010
1	1	2	H		13135.7216	0.0003	1112.283	0.0004
2	1	3	H		14949.8060	0.0023	2827.266	0.0025
1	2	3	He		14931.2148	0.0024	2572.681	0.0026
0	3	3	Li	-pp	28670#	2000#	-2270#	2150#
3	1	4	H	-n	25900	100	1400	110
2	2	4	He		2424.91565	0.00006	7073.915	0.00006
1	3	4	Li	-p	25320	210	1150	230
4	1	5	H	-nn	32890	100	1336	110
3	2	5	He	-n	11390	50	5481	50
2	3	5	Li	-p	11680	50	5266	50
1	4	5	Be	x	38000#	4000#	-150#	4290#
5	1	6	H	-3n	41860	260	960	280
4	2	6	He		17595.1	0.8	4878.02	0.8
3	3	6	Li		14086.793	0.015	5332.345	0.016
2	4	6	Be	-	18375	5	4487.3	6
1	5	6	B	x	43600#	700#	150#	750#
6	1	7	H	-nn	49140#	1010#	940#	1080#
5	2	7	He	-n	26101	17	4119.1	18
4	3	7	Li		14908.14	0.08	5606.291	0.08
3	4	7	Be		15770.03	0.11	5371.400	0.11
2	5	7	B	+3n	27870	70	3531	80
6	2	8	He		31598	7	3926.0	7
5	3	8	Li		20946.84	0.09	5159.582	0.10
4	4	8	Be		4941.67	0.04	7062.435	0.04
3	5	8	B		22921.5	1.0	4717.16	1.1
2	6	8	C	4n	35094	23	3097.8	25
7	2	9	He		40939	29	3349	30
6	3	9	Li		24954.3	1.9	5037.84	2.1
5	4	9	Be		11347.6	0.4	6462.76	0.4
4	5	9	B	-	12415.7	1.0	6257.16	1.1
3	6	9	C	-pp	28910.5	2.1	4337.48	2.3
8	2	10	He	++	48810	70	3034	80
7	3	10	Li	-n	33051	15	4531.6	16
6	4	10	Be		12606.7	0.4	6497.71	0.4
5	5	10	B		12050.7	0.4	6475.07	0.4
4	6	10	C	-	15698.7	0.4	6032.04	0.4
3	7	10	N	--	38800	400	3640	430
8	3	11	Li		40797	19	4149.1	21
7	4	11	Be	-n	20174	6	5952.8	7
6	5	11	B		8667.9	0.4	6927.71	0.4
5	6	11	C		10650.3	1.0	6676.37	1.0
4	7	11	N	-p	24300	50	5364	50
9	3	12	Li	x	50100#	1000#	3700#	1070#
8	4	12	Be	-nn	25077	15	5720.8	16
7	5	12	B	+pn	13368.9	1.4	6631.26	1.5
6	6	12	C		0.0	0.0	7680.144	0.0
5	7	12	N		17338.1	1.0	6170.11	1.1
4	8	12	O	-pp	32048	18	4879.1	20

N	Z	A	Elt.	Orig.	Mass excess (keV)		Binding energy per nucleon (keV)		Beta-decay energy (keV)		Atomic mass $\mu$		
9	4	13	Be	-n	33250	70	5273	6	$\beta^-$	16690	70	13 035690	80
8	5		B	-nn	16562.2	1.1	6496.40	0.08	$\beta^-$	13437.2	1.1	13 017780.2	1.2
7	6		C		3125.0113	0.0009	7469.849	0.000	*			13 003354.8378	0.0010
6	7		N		5345.48	0.27	7238.863	0.021	$\beta^+$	2220.47	0.27	13 005738.61	0.29
5	8		O	+3n	23112	10	5812.0	0.7	$\beta^+$	17767	10	13 024812	10
10	4	14	Be	x	39950	130	4994	9	$\beta^-$	16290	130	14 042890	140
9	5		B		23664	21	6101.6	1.5	$\beta^-$	20644	21	14 025404	23
8	6		C		3019.893	0.004	7520.319	0.000	$\beta^-$	156.476	0.004	14 003241.989	0.004
7	7		N		2863.4170	0.0006	7475.614	0.000	*			14 003074.0048	0.0006
6	8		O		8007.36	0.11	7052.308	0.008	$\beta^+$	5143.94	0.11	14 008596.25	0.12
5	9		F	x	32660#	400#	5236#	29#	$\beta^+$	24650#	400#	14 035060#	430#
11	4	15	Be	-n2p	49800#	500#	4540#	30#	$\beta^-$	20830#	500#	15 053460#	540#
10	5		B	+3p	28972	22	5879.0	1.5	$\beta^-$	19099	22	15 031103	24
9	6		C	-n	9873.1	0.8	7100.17	0.05	$\beta^-$	9771.7	0.8	15 010599.3	0.9
8	7		N		101.4380	0.0007	7699.459	0.000	*			15 000108.8982	0.0007
7	8		O		2855.6	0.5	7463.69	0.03	$\beta^+$	2754.2	0.5	15 003065.6	0.5
6	9		F	p4n	16780	130	6484	9	$\beta^+$	13920	130	15 018010	140
12	4	16	Be	x	57680#	500#	4270#	30#	$\beta^-$	20600#	510#	16 061920#	540#
11	5		B	x	37080	60	5509	4	$\beta^-$	23390	60	16 039810	60
10	6		C	-nn	13694	4	6922.05	0.22	$\beta^-$	8010	4	16 014701	4
9	7		N	-n	5683.7	2.6	7373.81	0.16	$\beta^-$	10420.7	2.6	16 006101.7	2.8
8	8		O		-4737.00141	0.00016	7976.206	0.000	*			15 994914.61956	0.00016
7	9		F	-	10680	8	6963.7	0.5	$\beta^+$	15417	8	16 011466	9
6	10		Ne	--	23996	20	6082.6	1.3	$\beta^+$	13316	22	16 025761	22
12	5	17	B	x	43770	170	5266	10	$\beta^-$	22730	170	17 046990	180
11	6		C	2p-n	21039	17	6557.6	1.0	$\beta^-$	13167	23	17 022586	19
10	7		N	+p	7871	15	7286.2	0.9	$\beta^-$	8680	15	17 008450	16
9	8		O		-808.81	0.11	7750.731	0.006	*			16 999131.70	0.12
8	9		F		1951.70	0.25	7542.328	0.015	$\beta^+$	2760.51	0.27	17 002095.24	0.27
7	10		Ne	+3n	16461	27	6642.8	1.6	$\beta^+$	14509	27	17 017672	29
13	5	18	B	x	52320#	800#	4950#	50#	$\beta^-$	27400#	800#	18 056170#	860#
12	6		C	++	24930	30	6425.7	1.7	$\beta^-$	11810	40	18 026760	30
11	7		N	+	13114	19	7038.5	1.0	$\beta^-$	13896	19	18 014079	20
10	8		O		-781.5	0.6	7767.03	0.03	*			17 999161.0	0.7
9	9		F		873.7	0.5	7631.605	0.030	$\beta^+$	1655.2	0.6	18 000938.0	0.6
8	10		Ne	4n	5317.17	0.28	7341.282	0.016	$\beta^+$	4443.5	0.6	18 005708.2	0.3
7	11		Na	x	24190	50	6249.3	2.8	$\beta^+$	18870	50	18 025970	50
14	5	19	B	x	59360#	400#	4741#	21#	$\beta^-$	26940#	410#	19 063730#	430#
13	6		C	-n	32420	100	6118	5	$\beta^-$	16560	100	19 034810	110
12	7		N	p-2n	15862	16	6948.2	0.9	$\beta^-$	12527	17	19 017029	18
11	8		O	-n	3334.9	2.8	7566.39	0.15	$\beta^-$	4822.3	2.8	19 003580	3
10	9		F		-1487.39	0.07	7779.015	0.004	*			18 998403.22	0.07
9	10		Ne		1751.44	0.29	7567.375	0.015	$\beta^+$	3238.83	0.29	19 001880.2	0.3
8	11		Na	p4n	12927	12	6938.0	0.6	$\beta^+$	11175	12	19 013877	13
7	12		Mg	x	33040	250	5838	13	$\beta^+$	20110	250	19 035470	270
14	6	20	C	x	37560	240	5959	12	$\beta^-$	15790	250	20 040320	260
13	7		N	x	21770	60	6709.2	2.8	$\beta^-$	17970	60	20 023370	60
12	8		O	-nn	3797.5	1.1	7568.51	0.05	$\beta^-$	3814.9	1.1	20 004076.7	1.2
11	9		F		-17.40	0.08	7720.131	0.004	$\beta^-$	7024.53	0.08	19 999981.32	0.08
10	10		Ne		-7041.9313	0.0018	8032.240	0.000	*			19 992440.1754	0.0019
9	11		Na	-	6848	7	7298.6	0.3	$\beta^+$	13890	7	20 007351	7
8	12		Mg	4n	17570	27	6723.4	1.4	$\beta^+$	10723	28	20 018863	29

N	Z	A	Elt.	Orig.	Mass excess (keV)	Binding energy per nucleon (keV)	Beta-decay energy (keV)	Atomic mass $\mu$		
15	6	21	C	x	45960#	500#	5659# 24#	$\beta^-$ 20710# 510#	21 049340#	540#
14	7		N	x	25250	100	6608 5	$\beta^-$ 17190 100	21 027110	100
13	8		O	-3n	8063	12	7389.3 0.6	$\beta^-$ 8110 12	21 008656	13
12	9		F	-nn	-47.6	1.8	7738.29 0.09	$\beta^-$ 5684.2 1.8	20 999949.0	1.9
11	10		Ne	-n	-5731.78	0.04	7971.713 0.002	*	20 993846.68	0.04
10	11		Na	-p	-2184.2	0.7	7765.52 0.03	$\beta^+$ 3547.6 0.7	20 997655.2	0.8
9	12		Mg	+3n	10911	16	7104.7 0.8	$\beta^+$ 13095 16	21 011713	18
8	13		Al	x	26120#	300#	6343# 14#	$\beta^+$ 15210# 300#	21 028040#	320#
16	6	22	C	x	53280#	900#	5440# 40#	$\beta^-$ 21240# 920#	22 057200#	970#
15	7		N	x	32040	190	6366 9	$\beta^-$ 22750 200	22 034390	210
14	8		O	-4n	9280	60	7364.8 2.6	$\beta^-$ 6490 60	22 009970	60
13	9		F	+	2793	12	7624.3 0.6	$\beta^-$ 10818 12	22 002999	13
12	10		Ne	-	-8024.715	0.018	8080.465 0.001	*	21 991385.114	0.019
11	11		Na	-	-5182.4	0.4	7915.709 0.019	$\beta^+$ 2842.3 0.4	21 994436.4	0.4
10	12		Mg	+nn	-397.0	1.3	7662.63 0.06	$\beta^+$ 4785.5 1.4	21 999573.8	1.4
9	13		Al	x	18180#	90#	6783# 4#	$\beta^+$ 18580# 90#	22 019520#	100#
8	14		Si	x	32160#	200#	6111# 9#	$\beta^+$ 13980# 220#	22 034530#	220#
16	7	23	N	x	38400#	300#	6164# 13#	$\beta^-$ 23780# 320#	23 041220#	320#
15	8		O	x	14610	120	7164 5	$\beta^-$ 11280 150	23 015690	130
14	9		F	p-2n	3330	80	7620 3	$\beta^-$ 8480 80	23 003570	90
13	10		Ne	-n	-5154.05	0.10	7955.255 0.005	$\beta^-$ 4375.81 0.10	22 994466.90	0.11
12	11		Na	-	-9529.8536	0.0027	8111.493 0.000	*	22 989769.2809	0.0029
11	12		Mg	-	-5473.8	1.3	7901.13 0.06	$\beta^+$ 4056.1 1.3	22 994123.7	1.4
10	13		Al	p4n	6770	19	7334.8 0.8	$\beta^+$ 12243 19	23 007267	20
9	14		Si	x	23770#	200#	6562# 9#	$\beta^+$ 17000# 200#	23 025520#	210#
17	7	24	N	x	47540#	400#	5862# 17#	$\beta^-$ 28470# 470#	24 051040#	430#
16	8		O	x	19070	240	7016 10	$\beta^-$ 11510 250	24 020470	250
15	9		F	x	7560	70	7463 3	$\beta^-$ 13510 70	24 008120	80
14	10		Ne	-nn	-5951.5	0.4	7993.319 0.016	$\beta^-$ 2466.6 0.4	23 993610.8	0.4
13	11		Na	-n	-8418.11	0.08	8063.496 0.003	$\beta^-$ 5515.45 0.08	23 990962.78	0.08
12	12		Mg	-	-13933.567	0.013	8260.709 0.001	*	23 985041.700	0.014
11	13		Al	-	-56.9	2.8	7649.92 0.12	$\beta^+$ 13876.6 2.8	23 999938.9	3.0
10	14		Si	--	10755	19	7166.8 0.8	$\beta^+$ 10812 20	24 011546	21
9	15		P	x	32000#	500#	6249# 21#	$\beta^+$ 21240# 500#	24 034350#	540#
18	7	25	N	x	56500#	500#	5592# 20#	$\beta^-$ 29060# 570#	25 060660#	540#
17	8		O	-n	27440#	260#	6723# 10#	$\beta^-$ 16170# 280#	25 029460#	280#
16	9		F	x	11270	100	7339 4	$\beta^-$ 13380 100	25 012100	110
15	10		Ne	x	-2108	26	7842.7 1.0	$\beta^-$ 7250 26	24 997737	28
14	11		Na	-nn	-9357.8	1.2	8101.40 0.05	$\beta^-$ 3835.0 1.2	24 989954.0	1.3
13	12		Mg	-	-13192.83	0.03	8223.504 0.001	*	24 985836.92	0.03
12	13		Al	-p	-8916.2	0.5	8021.144 0.019	$\beta^+$ 4276.7 0.5	24 990428.1	0.5
11	14		Si	+3n	3824	10	7480.2 0.4	$\beta^+$ 12740 10	25 004106	11
10	15		P	x	18870#	200#	6847# 8#	$\beta^+$ 15050# 200#	25 020260#	210#
18	8	26	O	-nn	35710#	260#	6457# 10#	$\beta^-$ 17440# 310#	26 038340#	280#
17	9		F	x	18270	170	7098 6	$\beta^-$ 17840 170	26 019620	180
16	10		Ne	x	430	27	7753.9 1.0	$\beta^-$ 7292 27	26 000461	29
15	11		Na	x	-6862	6	8004.26 0.22	$\beta^-$ 9352 6	25 992633	6
14	12		Mg	-	-16214.582	0.027	8333.872 0.001	*	25 982592.929	0.030
13	13		Al	-	-12210.31	0.06	8149.771 0.002	$\beta^+$ 4004.27 0.06	25 986891.69	0.06
12	14		Si	+nn	-7145	3	7924.85 0.12	$\beta^+$ 5066 3	25 992330	3
11	15		P	x	10970#	200#	7198# 8#	$\beta^+$ 18120# 200#	26 011780#	210#
10	16		S	x	25970#	300#	6591# 11#	$\beta^+$ 15000# 360#	26 027880#	320#

N	Z	A	El.	Orig.	Mass excess (keV)		Binding energy per nucleon (keV)		Beta-decay energy (keV)		Atomic mass $\mu$		
19	8	27	O	x	44950#	500#	6175#	19#	$\beta^-$	20030#	630#	27 048260#	540#
18	9		F	x	24930	380	6887	14	$\beta^-$	17860	390	27 026760	400
17	10		Ne	x	7070	110	7520	4	$\beta^-$	12590	110	27 007590	120
16	11		Na		-5517	4	7956.93	0.13	$\beta^-$	9069	4	26 994077	4
15	12		Mg	-n	-14586.65	0.05	8263.854	0.002	$\beta^-$	2610.01	0.13	26 984340.59	0.05
14	13		Al		-17196.66	0.12	8331.545	0.004	*			26 981538.63	0.12
13	14		Si	-	-12384.30	0.15	8124.334	0.006	$\beta^+$	4812.36	0.10	26 986704.91	0.16
12	15		P	p4n	-717	26	7663.2	1.0	$\beta^+$	11667	26	26 999230	28
11	16		S	-	17540#	200#	6958#	7#	$\beta^+$	18260#	200#	27 018830#	220#
20	8	28	O	x	53850#	600#	5925#	21#	$\beta^-$	20620#	790#	28 057810#	640#
19	9		F	x	33230#	510#	6633#	18#	$\beta^-$	21980#	530#	28 035670#	550#
18	10		Ne	x	11240	150	7390	5	$\beta^-$	12230	150	28 012070	160
17	11		Na		-989	13	7799.3	0.5	$\beta^-$	14029	13	27 998938	14
16	12		Mg	+	-15018.6	2.0	8272.41	0.07	$\beta^-$	1831.8	2.0	27 983876.8	2.2
15	13		Al	-n	-16850.44	0.13	8309.886	0.005	$\beta^-$	4642.36	0.13	27 981910.31	0.14
14	14		Si		-21492.7968	0.0018	8447.744	0.000	*			27 976926.5325	0.0019
13	15		P	--	-7159	3	7907.87	0.12	$\beta^+$	14334	3	27 992315	4
12	16		S	--	4070	160	7479	6	$\beta^+$	11230	160	28 004370	170
11	17		Cl	x	26560#	500#	6648#	18#	$\beta^+$	22480#	530#	28 028510#	540#
20	9	29	F	x	40300#	580#	6439#	20#	$\beta^-$	22240#	640#	29 043260#	620#
19	10		Ne	x	18060	270	7179	9	$\beta^-$	15390	270	29 019390	290
18	11		Na		2665	13	7682.7	0.4	$\beta^-$	13284	19	29 002861	14
17	12		Mg	x	-10619	14	8113.8	0.5	$\beta^-$	7596	14	28 988600	15
16	13		Al	-nn	-18215.3	1.2	8348.72	0.04	$\beta^-$	3679.7	1.2	28 980445.0	1.3
15	14		Si	-n	-21895.046	0.021	8448.634	0.001	*			28 976494.700	0.022
14	15		P	-p	-16952.6	0.6	8251.228	0.021	$\beta^+$	4942.4	0.6	28 981800.6	0.6
13	16		S	+3n	-3160	50	7748.6	1.7	$\beta^+$	13790	50	28 996610	50
12	17		Cl	x	13140#	200#	7159#	7#	$\beta^+$	16300#	200#	29 014110#	210#
21	9	30	F	x	48900#	600#	6206#	20#	$\beta^-$	25800#	830#	30 052500#	640#
20	10		Ne	x	23100	570	7040	19	$\beta^-$	14740	570	30 024800	610
19	11		Na	x	8361	25	7505.8	0.8	$\beta^-$	17272	27	30 008976	27
18	12		Mg	x	-8911	8	8055.40	0.28	$\beta^-$	6962	16	29 990434	9
17	13		Al	+	-15872	14	8261.4	0.5	$\beta^-$	8561	14	29 982960	15
16	14		Si	-n	-24432.928	0.030	8520.653	0.001	*			29 973770.17	0.03
15	15		P	-p	-20200.6	0.3	8353.496	0.010	$\beta^+$	4232.4	0.3	29 978313.8	0.3
14	16		S	+nn	-14063	3	8122.82	0.10	$\beta^+$	6138	3	29 984903	3
13	17		Cl	x	4440#	200#	7480#	7#	$\beta^+$	18510#	200#	30 004770#	210#
12	18		Ar	x	20080#	300#	6932#	10#	$\beta^+$	15640#	360#	30 021560#	320#
22	9	31	F	-nn	56290#	600#	6028#	19#	$\beta^-$	25450#	1080#	31 060430#	640#
21	10		Ne	x	30840#	900#	6824#	29#	$\beta^-$	18190#	930#	31 033110#	970#
20	11		Na	x	12650	210	7385	7	$\beta^-$	15870	210	31 013590	230
19	12		Mg	x	-3217	12	7872.3	0.4	$\beta^-$	11736	24	30 996546	13
18	13		Al	p-2n	-14954	20	8225.6	0.7	$\beta^-$	7995	20	30 983947	22
17	14		Si	-n	-22949.01	0.04	8458.290	0.001	$\beta^-$	1491.88	0.19	30 975363.23	0.04
16	15		P		-24440.88	0.18	8481.178	0.006	*			30 973761.63	0.20
15	16		S	+n	-19044.6	1.5	8281.87	0.05	$\beta^+$	5396.2	1.5	30 979554.7	1.6
14	17		Cl	p4n	-7070	50	7870.3	1.6	$\beta^+$	11980	50	30 992410	50
13	18		Ar	-	11290#	210#	7253#	7#	$\beta^+$	18360#	200#	31 012120#	220#
22	10	32	Ne	x	37280#	800#	6662#	25#	$\beta^-$	18210#	880#	32 040020#	860#
21	11		Na	x	19060	360	7207	11	$\beta^-$	20020	360	32 020470	380
20	12		Mg	x	-955	18	7807.8	0.6	$\beta^-$	10110	90	31 998975	19
19	13		Al	x	-11060	90	8099.2	2.7	$\beta^-$	13020	90	31 988120	90
18	14		Si	-n	-24080.91	0.05	8481.569	0.002	$\beta^-$	224.31	0.19	31 974148.08	0.05
17	15		P	-n	-24305.22	0.19	8464.130	0.006	$\beta^-$	1710.48	0.22	31 973907.27	0.20
16	16		S		-26015.70	0.14	8493.134	0.004	*			31 972071.00	0.15
15	17		Cl	-	-13330	7	8072.25	0.21	$\beta^+$	12686	7	31 985690	7
14	18		Ar	x	-2200.2	1.8	7700.00	0.06	$\beta^+$	11130	7	31 997638.0	1.9
13	19		K	x	20420#	500#	6969#	16#	$\beta^+$	22620#	500#	32 021920#	540#

N	Z	A	Elt.	Orig.	Mass excess (keV)		Binding energy per nucleon (keV)		Beta-decay energy (keV)		Atomic mass $\mu$		
23	10	33	Ne	x	46000#	800#	6440#	24#	$\beta^-$	21110#	1190#	33 049380#	860#
22	11		Na	x	24890	870	7056	27	$\beta^-$	20000	880	33 026720	940
21	12		Mg	x	4894	20	7638.5	0.6	$\beta^-$	13420	80	33 005254	21
20	13		Al	x	-8530	70	8021.6	2.2	$\beta^-$	11960	70	32 990840	80
19	14		Si	+n2p	-20493	16	8360.4	0.5	$\beta^-$	5845	16	32 978000	17
18	15		P	+	-26337.5	1.1	8513.81	0.03	$\beta^-$	248.5	1.1	32 971725.5	1.2
17	16		S		-26585.99	0.14	8497.634	0.004	*			32 971458.76	0.15
16	17		Cl	-p	-21003.4	0.5	8304.758	0.014	$\beta^+$	5582.6	0.4	32 977451.9	0.5
15	18		Ar	x	-9384.1	0.4	7928.950	0.013	$\beta^+$	11619.3	0.6	32 989925.7	0.5
14	19		K	x	6760#	200#	7416#	6#	$\beta^+$	16150#	200#	33 007260#	210#
24	10	34	Ne	-nn	53120#	810#	6279#	24#	$\beta^-$	20360#	1210#	34 057030#	870#
23	11		Na	-n	32760#	900#	6855#	26#	$\beta^-$	23950#	930#	34 035170#	960#
22	12		Mg	x	8810	230	7536	7	$\beta^-$	11740	260	34 009460	250
21	13		Al	x	-2930	110	7858	3	$\beta^-$	17020	110	33 996850	120
20	14		Si	+pp	-19957	14	8336.1	0.4	$\beta^-$	4601	15	33 978576	15
19	15		P	+pn	-24558	5	8448.45	0.15	$\beta^-$	5374	5	33 973636	5
18	16		S		-29931.79	0.11	8583.501	0.003	*			33 967866.90	0.12
17	17		Cl		-24439.78	0.18	8398.961	0.005	$\beta^+$	5492.01	0.15	33 973762.82	0.19
16	18		Ar	p4n	-18377.2	0.4	8197.640	0.011	$\beta^+$	6062.6	0.4	33 980271.2	0.4
15	19		K	x	-1480#	300#	7678#	9#	$\beta^+$	16900#	300#	33 998410#	320#
14	20		Ca	x	13150#	300#	7224#	9#	$\beta^+$	14630#	420#	34 014120#	320#
24	11	35	Na	-n	39580#	950#	6695#	27#	$\beta^-$	23430#	1030#	35 042490#	1020#
23	12		Mg	x	16150#	400#	7342#	11#	$\beta^-$	16280#	440#	35 017340#	430#
22	13		Al	x	-130	180	7784	5	$\beta^-$	14230	180	34 999860	190
21	14		Si	2p-n	-14360	40	8168.7	1.1	$\beta^-$	10500	40	34 984580	40
20	15		P	+p	-24857.7	1.9	8446.25	0.05	$\beta^-$	3988.6	1.9	34 973314.1	2.0
19	16		S		-28846.36	0.10	8537.854	0.003	$\beta^-$	167.18	0.09	34 969032.16	0.11
18	17		Cl		-29013.54	0.04	8520.278	0.001	*			34 968852.68	0.04
17	18		Ar	-	-23047.4	0.7	8327.465	0.021	$\beta^+$	5966.1	0.7	34 975257.6	0.8
16	19		K	p4n	-11169	20	7965.7	0.6	$\beta^+$	11879	20	34 988010	21
15	20		Ca	x	4600#	200#	7493#	6#	$\beta^+$	15770#	200#	35 004940#	210#
25	11	36	Na	-n	47950#	950#	6500#	26#	$\beta^-$	26530#	1080#	36 051480#	1020#
24	12		Mg	x	21420#	500#	7215#	14#	$\beta^-$	15640#	550#	36 023000#	540#
23	13		Al	x	5780	210	7628	6	$\beta^-$	18260	250	36 006210	230
22	14		Si	x	-12480	120	8114	3	$\beta^-$	7770	120	35 986600	130
21	15		P	+	-20251	13	8307.9	0.4	$\beta^-$	10413	13	35 978260	14
20	16		S		-30664.07	0.19	8575.387	0.005	$\beta^-$	-1142.22	0.19	35 967080.76	0.20
19	17		Cl		-29521.86	0.07	8521.927	0.002	$\beta^-$	709.68	0.08	35 968306.98	0.08
18	18		Ar		-30231.540	0.027	8519.909	0.001	*			35 967545.106	0.029
17	19		K	-	-17426	8	8142.47	0.22	$\beta^+$	12805	8	35 981292	8
16	20		Ca	4n	-6440	40	7815.6	1.1	$\beta^+$	10990	40	35 993090	40
15	21		Sc	x	13900#	500#	7229#	14#	$\beta^+$	20340#	510#	36 014920#	540#
26	11	37	Na	-nn	55280#	960#	6345#	26#	$\beta^-$	26030#	1320#	37 059340#	1030#
25	12		Mg	x	29250#	900#	7027#	24#	$\beta^-$	19300#	960#	37 031400#	970#
24	13		Al	x	9950	330	7528	9	$\beta^-$	16530	370	37 010680	360
23	14		Si	x	-6580	170	7953	5	$\beta^-$	12410	170	36 992940	180
22	15		P	p-2n	-18990	40	8267.5	1.0	$\beta^-$	7900	40	36 979610	40
21	16		S	-n	-26896.36	0.20	8459.934	0.005	$\beta^-$	4865.17	0.20	36 971125.57	0.21
20	17		Cl		-31761.53	0.05	8570.280	0.001	*			36 965902.59	0.05
19	18		Ar	-	-30947.66	0.21	8527.139	0.006	$\beta^+$	813.87	0.20	36 966776.32	0.22
18	19		K	-p	-24800.20	0.09	8339.847	0.003	$\beta^+$	6147.46	0.23	36 973375.89	0.10
17	20		Ca	+3n	-13162	22	8004.2	0.6	$\beta^+$	11638	22	36 985870	24
16	21		Sc	x	2840#	300#	7550#	8#	$\beta^+$	16000#	300#	37 003050#	320#

N	Z	A	Elt.	Orig.	Mass excess (keV)		Binding energy per nucleon (keV)		Beta-decay energy (keV)		Atomic mass $\mu$		
26	12	38	Mg	x	35000#	500#	6903#	13#	$\beta^-$	18950#	890#	38 037570#	540#
25	13		Al	x	16050	730	7381	19	$\beta^-$	20120	740	38 017230	780
24	14		Si	x	-4070	140	7890	4	$\beta^-$	10690	170	37 995630	150
23	15		P	x	-14760	100	8150.9	2.7	$\beta^-$	12100	100	37 984160	110
22	16		S	+	-26861	7	8448.78	0.19	$\beta^-$	2937	7	37 971163	8
21	17		Cl	-n	-29798.10	0.10	8505.480	0.003	$\beta^-$	4916.5	0.3	37 968010.43	0.10
20	18		Ar		-34714.6	0.3	8614.273	0.009	*			37 962732.4	0.4
19	19		K		-28800.7	0.4	8438.057	0.012	$\beta^+$	5913.86	0.29	37 969081.2	0.5
18	20		Ca	+nn	-22059	5	8240.06	0.12	$\beta^+$	6741	5	37 976318	5
17	21		Sc	x	-4940#	300#	7769#	8#	$\beta^+$	17120#	300#	37 994700#	320#
16	22		Ti	x	9100#	250#	7379#	7#	$\beta^+$	14040#	390#	38 009770#	270#
27	12	39	Mg	-n	43570#	510#	6713#	13#	$\beta^-$	22170#	1560#	39 046770#	550#
26	13		Al	x	21400	1470	7260	40	$\beta^-$	19470	1510	39 022970	1580
25	14		Si	x	1930	340	7741	9	$\beta^-$	14800	350	39 002070	360
24	15		P	x	-12870	100	8100.5	2.7	$\beta^-$	10290	110	38 986180	110
23	16		S	2p-n	-23160	50	8344.3	1.3	$\beta^-$	6640	50	38 975130	50
22	17		Cl	-nn	-29800.2	1.7	8494.40	0.04	$\beta^-$	3442	5	38 968008.2	1.9
21	18		Ar	+	-33242	5	8562.59	0.13	$\beta^-$	565	5	38 964313	5
20	19		K		-33807.01	0.19	8557.020	0.005	*			38 963706.68	0.20
19	20		Ca	-	-27274.4	1.9	8369.46	0.05	$\beta^+$	6532.6	1.9	38 970719.7	2.0
18	21		Sc	2n-p	-14168	24	8013.3	0.6	$\beta^+$	13106	24	38 984790	26
17	22		Ti	x	1500#	210#	7592#	5#	$\beta^+$	15670#	210#	39 001610#	220#
28	12	40	Mg	x	50240#	900#	6581#	23#	$\beta^-$	20940#	1140#	40 053930#	970#
27	13		Al	x	29300#	700#	7085#	17#	$\beta^-$	23830#	890#	40 031450#	750#
26	14		Si	x	5470	560	7661	14	$\beta^-$	13570	570	40 005870	600
25	15		P	x	-8110	140	7981	3	$\beta^-$	14760	200	39 991300	150
24	16		S	x	-22870	140	8330	4	$\beta^-$	4690	140	39 975450	150
23	17		Cl	+	-27560	30	8427.8	0.8	$\beta^-$	7480	30	39 970420	30
22	18		Ar		-35039.8960	0.0027	8595.259	0.000	$\beta^-$	-1504.69	0.19	39 962383.1225	0.0029
21	19		K		-33535.20	0.19	8538.083	0.005	$\beta^-$	1311.07	0.11	39 963998.48	0.21
20	20		Ca		-34846.27	0.21	8551.301	0.005	*			39 962590.98	0.22
19	21		Sc	-	-20523.2	2.8	8173.67	0.07	$\beta^+$	14323.0	2.8	39 977967	3
18	22		Ti	--	-8850	160	7862	4	$\beta^+$	11670	160	39 990500	170
17	23		V	x	10330#	500#	7363#	13#	$\beta^+$	19180#	530#	40 011090#	540#
28	13	41	Al	x	35700#	800#	6952#	20#	$\beta^-$	22140#	2010#	41 038330#	860#
27	14		Si	x	13560	1840	7470	40	$\beta^-$	18840	1860	41 014560	1980
26	15		P	x	-5280	220	7914	5	$\beta^-$	13740	250	40 994340	230
25	16		S	x	-19020	120	8229.9	2.9	$\beta^-$	8290	140	40 979580	130
24	17		Cl	x	-27310	70	8413.0	1.7	$\beta^-$	5760	70	40 970680	70
23	18		Ar		-33067.5	0.3	8534.371	0.008	$\beta^-$	2491.6	0.4	40 964500.6	0.4
22	19		K		-35559.07	0.19	8576.061	0.005	*			40 961825.76	0.21
21	20		Ca		-35137.76	0.24	8546.703	0.006	$\beta^+$	421.31	0.18	40 962278.06	0.26
20	21		Sc		-28642.39	0.23	8369.198	0.006	$\beta^+$	6495.37	0.16	40 969251.13	0.24
19	22		Ti	x	-15700#	100#	8034#	2#	$\beta^+$	12940#	100#	40 983150#	110#
18	23		V	x	-210#	210#	7637#	5#	$\beta^+$	15500#	230#	40 999780#	220#
29	13	42	Al	x	43680#	900#	6789#	22#	$\beta^-$	25240#	1030#	42 046890#	970#
28	14		Si	x	18430#	500#	7372#	12#	$\beta^-$	17500#	670#	42 019790#	540#
27	15		P	x	940	450	7770	11	$\beta^-$	18620	460	42 001010	480
26	16		S	x	-17680	120	8194.2	3.0	$\beta^-$	7240	190	41 981020	130
25	17		Cl	x	-24910	140	8348	3	$\beta^-$	9510	140	41 973250	150
24	18		Ar	x	-34423	6	8555.61	0.14	$\beta^-$	599	6	41 963046	6
23	19		K	-n	-35021.56	0.22	8551.245	0.005	$\beta^-$	3525.52	0.22	41 962402.81	0.24
22	20		Ca		-38547.07	0.25	8616.559	0.006	*			41 958618.01	0.27
21	21		Sc		-32121.24	0.27	8444.935	0.006	$\beta^+$	6425.83	0.12	41 965516.43	0.29
20	22		Ti	-pp	-25122	5	8259.65	0.13	$\beta^+$	7000	5	41 973031	6
19	23		V	x	-8170#	200#	7837#	5#	$\beta^+$	16950#	200#	41 991230#	210#
18	24		Cr	x	5990#	300#	7482#	7#	$\beta^+$	14160#	360#	42 006430#	320#

N	Z	A	Elt.	Orig.	Mass excess (keV)		Binding energy per nucleon (keV)		Beta-decay energy (keV)		Atomic mass $\mu$		
29	14	43	Si	x	26700#	700#	7196#	16#	$\beta^-$	20930#	1190#	43 028660#	750#
28	15		P	x	5770	970	7664	23	$\beta^-$	17730	990	43 006190	1040
27	16		S	x	-11970	200	8058	5	$\beta^-$	12200	260	42 987150	220
26	17		Cl	x	-24170	160	8324	4	$\beta^-$	7840	160	42 974050	170
25	18		Ar	x	-32010	5	8488.24	0.12	$\beta^-$	4583	10	42 965636	6
24	19		K	+	-36593	9	8576.63	0.21	$\beta^-$	1815	9	42 960716	10
23	20		Ca		-38408.6	0.3	8600.659	0.007	*			42 958766.6	0.3
22	21		Sc	-p	-36187.9	1.9	8530.82	0.04	$\beta^+$	2220.7	1.9	42 961150.7	2.0
21	22		Ti	-n2p	-29321	7	8352.93	0.16	$\beta^+$	6867	7	42 968522	7
20	23		V	x	-18020#	230#	8072#	5#	$\beta^+$	11300#	230#	42 980650#	250#
19	24		Cr	x	-2130#	220#	7684#	5#	$\beta^+$	15890#	320#	42 997710#	240#
30	14	44	Si	x	32840#	800#	7076#	18#	$\beta^-$	20740#	1060#	44 035260#	860#
29	15		P	x	12100#	700#	7530#	16#	$\beta^-$	21220#	800#	44 012990#	750#
28	16		S	x	-9120	390	7994	9	$\beta^-$	11110	410	43 990210	420
27	17		Cl	x	-20230	110	8228.8	2.5	$\beta^-$	12440	110	43 978280	120
26	18		Ar	x	-32673.1	1.6	8493.84	0.04	$\beta^-$	3140	40	43 964924.0	1.7
25	19		K	+	-35810	40	8547.3	0.8	$\beta^-$	5660	40	43 961560	40
24	20		Ca		-41468.5	0.4	8658.170	0.009	*			43 955481.8	0.4
23	21		Sc	-p	-37816.1	1.8	8557.38	0.04	$\beta^+$	3652.4	1.8	43 959402.8	1.9
22	22		Ti	$-\alpha$	-37548.5	0.7	8533.518	0.017	$\beta^+$	267.6	1.9	43 959690.1	0.8
21	23		V	x	-24120	120	8210.5	2.8	$\beta^+$	13430	120	43 974110	130
20	24		Cr	x	-13460#	50#	7951#	1#	$\beta^+$	10660#	130#	43 985550#	50#
19	25		Mn	x	6400#	500#	7481#	11#	$\beta^+$	19860#	510#	44 006870#	540#
30	15	45	P	x	17900#	800#	7413#	18#	$\beta^-$	21160#	1920#	45 019220#	860#
29	16		S	x	-3250	1740	7870	40	$\beta^-$	15110	1750	44 996510	1870
28	17		Cl	x	-18360	120	8183.8	2.8	$\beta^-$	11410	120	44 980290	130
27	18		Ar	x	-29770.6	0.5	8419.947	0.012	$\beta^-$	6838	10	44 968040.0	0.6
26	19		K	+p	-36608	10	8554.51	0.23	$\beta^-$	4204	10	44 960699	11
25	20		Ca		-40812.0	0.4	8630.540	0.009	$\beta^-$	255.8	0.8	44 956186.6	0.4
24	21		Sc		-41067.8	0.8	8618.840	0.019	*			44 955911.9	0.9
23	22		Ti	-	-39005.7	1.0	8555.631	0.022	$\beta^+$	2062.1	0.5	44 958125.6	1.1
22	23		V	p4n	-31880	17	8379.9	0.4	$\beta^+$	7126	17	44 965776	18
21	24		Cr	x	-18970	500	8076	11	$\beta^+$	12910	500	44 979640	540
20	25		Mn	x	-5110#	300#	7750#	7#	$\beta^+$	13850#	590#	44 994510#	320#
19	26		Fe	-pp	13580#	220#	7318#	5#	$\beta^+$	18690#	370#	45 014580#	240#
31	15	46	P	x	25500#	900#	7262#	20#	$\beta^-$	24810#	1140#	46 027380#	970#
30	16		S	x	700#	700#	7784#	15#	$\beta^-$	15410#	1000#	46 000750#	750#
29	17		Cl	x	-14710	720	8102	16	$\beta^-$	15010	720	45 984210	770
28	18		Ar	+pp	-29720	40	8411.3	0.9	$\beta^-$	5700	40	45 968090	40
27	19		K	+pn	-35418	16	8518.1	0.3	$\beta^-$	7717	16	45 961977	17
26	20		Ca		-43135.1	2.3	8668.89	0.05	$\beta^-$	-1378.0	2.2	45 953692.6	2.4
25	21		Sc	-n	-41757.1	0.8	8621.922	0.018	$\beta^-$	2366.3	0.6	45 955171.9	0.9
24	22		Ti		-44123.4	0.8	8656.356	0.018	*			45 952631.6	0.9
23	23		V	-	-37073.0	1.0	8486.079	0.022	$\beta^+$	7050.4	0.6	45 960200.5	1.1
22	24		Cr	x	-29474	20	8303.9	0.4	$\beta^+$	7599	20	45 968359	21
21	25		Mn	x	-12370#	110#	7915#	2#	$\beta^+$	17100#	110#	45 986720#	120#
20	26		Fe	x	760#	350#	7613#	8#	$\beta^+$	13130#	370#	46 000810#	380#
31	16	47	S	x	8000#	800#	7635#	17#	$\beta^-$	18520#	1000#	47 008590#	860#
30	17		Cl	x	-10520#	600#	8012#	13#	$\beta^-$	15390#	600#	46 988710#	640#
29	18		Ar	2p-n	-25910	100	8322.9	2.1	$\beta^-$	9790	100	46 972190	110
28	19		K	+	-35696	8	8514.54	0.17	$\beta^-$	6644	8	46 961678	9
27	20		Ca		-42340.1	2.3	8639.26	0.05	$\beta^-$	1992.0	1.2	46 954546.0	2.4
26	21		Sc		-44332.1	2.0	8664.99	0.04	$\beta^-$	600.3	1.9	46 952407.5	2.2
25	22		Ti		-44932.4	0.8	8661.121	0.017	*			46 951763.1	0.9
24	23		V	-p	-42002.1	0.8	8582.127	0.018	$\beta^+$	2930.34	0.30	46 954908.9	0.9
23	24		Cr	+3n	-34558	14	8407.11	0.30	$\beta^+$	7444	14	46 962900	15
22	25		Mn	x	-22260#	160#	8129#	3#	$\beta^+$	12300#	160#	46 976100#	170#
21	26		Fe	x	-6620#	260#	7779#	6#	$\beta^+$	15640#	310#	46 992890#	280#
20	27		Co	x	10700#	500#	7394#	11#	$\beta^+$	17330#	570#	47 011490#	540#

N	Z	A	Elt.	Orig.	Mass excess (keV)		Binding energy per nucleon (keV)		Beta-decay energy (keV)		Atomic mass $\mu$ u		
32	16	48	S	x	13200#	900#	7536#	19#	$\beta^-$	17900#	1140#	48 014170#	970#
31	17		Cl	x	-4700#	700#	7892#	15#	$\beta^-$	19010#	760#	47 994950#	750#
30	18		Ar	x	-23720#	300#	8272#	6#	$\beta^-$	8410#	300#	47 974540#	320#
29	19		K	+	-32124	24	8430.9	0.5	$\beta^-$	12090	24	47 965514	26
28	20		Ca		-44214	4	8666.47	0.09	$\beta^-$	282	5	47 952534	4
27	21		Sc		-44496	5	8656.04	0.11	$\beta^-$	3992	5	47 952231	6
26	22		Ti		-48487.7	0.8	8722.903	0.017	*			47 947946.3	0.9
25	23		V	-	-44475.4	2.6	8623.01	0.05	$\beta^+$	4012.3	2.4	47 952253.7	2.7
24	24		Cr	+nn	-42819	7	8572.21	0.15	$\beta^+$	1656	8	47 954032	8
23	25		Mn	x	-29320	110	8274.7	2.3	$\beta^+$	13500	110	47 968520	120
22	26		Fe	x	-18160#	70#	8026#	1#	$\beta^+$	11160#	130#	47 980500#	80#
21	27		Co	x	1640#	400#	7597#	8#	$\beta^+$	19800#	410#	48 001760#	430#
20	28		Ni	x	18400#	500#	7232#	10#	$\beta^+$	16760#	640#	48 019750#	540#
33	16	49	S	-n	22000#	950#	7367#	19#	$\beta^-$	21700#	1240#	49 023620#	1020#
32	17		Cl	x	300#	800#	7794#	16#	$\beta^-$	18440#	950#	49 000320#	860#
31	18		Ar	x	-18150#	500#	8154#	10#	$\beta^-$	12170#	510#	48 980520#	540#
30	19		K	+	-30320	70	8386.7	1.4	$\beta^-$	10970	70	48 967450	80
29	20		Ca	-n	-41289	4	8594.63	0.08	$\beta^-$	5263.1	2.9	48 955674	4
28	21		Sc		-46552	4	8686.07	0.08	$\beta^-$	2006	4	48 950024	4
27	22		Ti		-48558.8	0.8	8711.055	0.017	*			48 947870.0	0.9
26	23		V	-	-47956.9	1.2	8682.806	0.024	$\beta^+$	601.9	0.8	48 948516.1	1.2
25	24		Cr	+n	-45330.5	2.4	8613.24	0.05	$\beta^+$	2626.5	2.6	48 951335.7	2.6
24	25		Mn	p4n	-37616	24	8439.8	0.5	$\beta^+$	7715	24	48 959618	26
23	26		Fe	x	-24580#	150#	8158#	3#	$\beta^+$	13030#	150#	48 973610#	160#
22	27		Co	x	-9580#	260#	7836#	5#	$\beta^+$	15010#	300#	48 989720#	280#
21	28		Ni	x	9000#	400#	7441#	8#	$\beta^+$	18570#	480#	49 009660#	430#
33	17	50	Cl	x	7300#	900#	7659#	18#	$\beta^-$	21810#	1140#	50 007840#	970#
32	18		Ar	x	-14500#	700#	8080#	14#	$\beta^-$	10850#	750#	49 984430#	750#
31	19		K	+	-25350	280	8281	6	$\beta^-$	14220	280	49 972780	300
30	20		Ca	-nn	-39571	9	8549.80	0.19	$\beta^-$	4966	17	49 957519	10
29	21		Sc	-pn	-44537	16	8633.5	0.3	$\beta^-$	6890	16	49 952188	17
28	22		Ti		-51426.7	0.8	8755.618	0.016	$\beta^-$	-2205.1	1.0	49 944791.2	0.9
27	23		V	+n	-49221.6	1.0	8695.869	0.020	$\beta^-$	1037.9	0.3	49 947158.5	1.1
26	24		Cr		-50259.5	1.0	8700.981	0.020	*			49 946044.2	1.1
25	25		Mn		-42626.8	1.0	8532.680	0.021	$\beta^+$	7632.69	0.23	49 954238.2	1.1
24	26		Fe	4n	-34480	60	8354.0	1.2	$\beta^+$	8150	60	49 962990	60
23	27		Co	x	-17200#	170#	7993#	3#	$\beta^+$	17280#	180#	49 981540#	180#
22	28		Ni	x	-3790#	260#	7709#	5#	$\beta^+$	13400#	310#	49 995930#	280#
34	17	51	Cl	x	13500#	1000#	7546#	20#	$\beta^-$	21290#	1220#	51 014490#	1070#
33	18		Ar	x	-7800#	700#	7948#	14#	$\beta^-$	14210#	860#	50 991630#	750#
32	19		K	x	-22000#	500#	8211#	10#	$\beta^-$	13860#	510#	50 976380#	540#
31	20		Ca	-3n	-35860	90	8467.7	1.8	$\beta^-$	7350	100	50 961500	100
30	21		Sc	-p2n	-43218	20	8596.6	0.4	$\beta^-$	6510	20	50 953603	22
29	22		Ti	-n	-49727.8	1.0	8708.890	0.019	$\beta^-$	2473.5	1.1	50 946615.0	1.0
28	23		V		-52201.4	1.0	8742.051	0.020	*			50 943959.5	1.1
27	24		Cr		-51448.8	1.0	8711.954	0.020	$\beta^+$	752.58	0.24	50 944767.4	1.1
26	25		Mn		-48241.3	1.0	8633.723	0.020	$\beta^+$	3207.5	0.4	50 948210.8	1.1
25	26		Fe	+3n	-40222	15	8461.15	0.29	$\beta^+$	8019	15	50 956820	16
24	27		Co	x	-27270#	150#	8192#	3#	$\beta^+$	12950#	150#	50 970720#	160#
23	28		Ni	x	-11440#	260#	7866#	5#	$\beta^+$	15840#	300#	50 987720#	280#



N	Z	A	Elt.	Orig.	Mass excess (keV)		Binding energy per nucleon (keV)		Beta-decay energy (keV)		Atomic mass $\mu$ u		
34	18	52	Ar	x	-3000#	900#	7858#	17#	$\beta^-$	13200#	1140#	51 996780#	970#
33	19		K	x	-16200#	700#	8097#	13#	$\beta^-$	16310#	990#	51 982610#	750#
32	20		Ca	x	-32510	700	8396	13	$\beta^-$	7850	720	51 965100	750
31	21		Sc	x	-40360	190	8531	4	$\beta^-$	9110	190	51 956680	210
30	22		Ti	-nn	-49465	7	8691.57	0.14	$\beta^-$	1976	7	51 946897	8
29	23		V	-n	-51441.3	1.0	8714.535	0.019	$\beta^-$	3975.6	1.0	51 944775.5	1.1
28	24		Cr		-55416.9	0.8	8775.944	0.015	*			51 940507.5	0.8
27	25		Mn	+pn	-50705.4	2.0	8670.29	0.04	$\beta^+$	4711.5	1.9	51 945565.5	2.1
26	26		Fe	-	-48332	7	8609.60	0.13	$\beta^+$	2374	6	51 948114	7
25	27		Co	x	-33920#	70#	8317#	1#	$\beta^+$	14420#	70#	51 963590#	70#
24	28		Ni	x	-22650#	80#	8086#	2#	$\beta^+$	11260#	110#	51 975680#	90#
23	29		Cu	x	-2630#	260#	7686#	5#	$\beta^+$	20030#	270#	51 997180#	280#
35	18	53	Ar	x	4600#	1000#	7719#	19#	$\beta^-$	16600#	1220#	53 004940#	1070#
34	19		K	x	-12000#	700#	8017#	13#	$\beta^-$	15900#	860#	52 987120#	750#
33	20		Ca	x	-27900#	500#	8302#	9#	$\beta^-$	9730#	590#	52 970050#	540#
32	21		Sc	x	-37620#	300#	8471#	6#	$\beta^-$	9210#	310#	52 959610#	320#
31	22		Ti	+	-46830	100	8630.1	1.9	$\beta^-$	5020	100	52 949730	110
30	23		V	+p	-51849	3	8710.09	0.06	$\beta^-$	3436	3	52 944338	3
29	24		Cr		-55284.7	0.8	8760.155	0.015	*			52 940649.4	0.8
28	25		Mn		-54687.9	0.8	8734.133	0.015	$\beta^+$	596.8	0.4	52 941290.1	0.9
27	26		Fe	+n	-50945.3	1.8	8648.76	0.03	$\beta^+$	3742.6	1.7	52 945307.9	1.9
26	27		Co	p4n	-42645	18	8477.4	0.3	$\beta^+$	8300	18	52 954219	19
25	28		Ni	x	-29370#	160#	8212#	3#	$\beta^+$	13280#	160#	52 968470#	170#
24	29		Cu	x	-13460#	260#	7897#	5#	$\beta^+$	15910#	310#	52 985550#	280#
35	19	54	K	x	-5400#	900#	7896#	17#	$\beta^-$	18490#	1140#	53 994200#	970#
34	20		Ca	x	-23890#	700#	8224#	13#	$\beta^-$	10330#	790#	53 974350#	750#
33	21		Sc	x	-34220	370	8401	7	$\beta^-$	11380	390	53 963260	400
32	22		Ti	x	-45590	120	8596.9	2.3	$\beta^-$	4300	130	53 951050	130
31	23		V	+	-49891	15	8662.00	0.28	$\beta^-$	7042	15	53 946440	16
30	24		Cr		-56932.5	0.8	8777.914	0.014	$\beta^-$	-1377.2	1.0	53 938880.4	0.8
29	25		Mn	-p	-55555.4	1.3	8737.923	0.023	$\beta^-$	697.1	1.1	53 940358.9	1.4
28	26		Fe		-56252.5	0.7	8736.344	0.013	*			53 939610.5	0.7
27	27		Co		-48009.5	0.7	8569.209	0.013	$\beta^+$	8242.92	0.20	53 948459.6	0.8
26	28		Ni	4n	-39210	50	8391.8	0.9	$\beta^+$	8800	50	53 957910	50
25	29		Cu	x	-21690#	210#	8053#	4#	$\beta^+$	17520#	220#	53 976710#	230#
24	30		Zn	x	-6570#	400#	7758#	7#	$\beta^+$	15130#	450#	53 992950#	430#
36	19	55	K	x	-270#	1000#	7806#	18#	$\beta^-$	17850#	1220#	54 999710#	1070#
35	20		Ca	x	-18120#	700#	8116#	13#	$\beta^-$	11460#	1020#	54 980550#	750#
34	21		Sc	x	-29580	740	8310	13	$\beta^-$	12090	750	54 968240	790
33	22		Ti	x	-41670	150	8516.0	2.8	$\beta^-$	7480	180	54 955270	160
32	23		V	+	-49150	100	8637.8	1.8	$\beta^-$	5960	100	54 947230	110
31	24		Cr	-n	-55107.5	0.8	8731.884	0.014	$\beta^-$	2603.1	0.4	54 940839.7	0.8
30	25		Mn		-57710.6	0.7	8764.988	0.012	*			54 938045.1	0.7
29	26		Fe		-57479.4	0.7	8746.560	0.012	$\beta^+$	231.21	0.18	54 938293.4	0.7
28	27		Co		-54027.6	0.7	8669.575	0.013	$\beta^+$	3451.8	0.4	54 941999.0	0.8
27	28		Ni	+3n	-45336	11	8497.31	0.20	$\beta^+$	8692	11	54 951330	12
26	29		Cu	x	-31620#	300#	8234#	5#	$\beta^+$	13710#	300#	54 966050#	320#
25	30		Zn	x	-14920#	250#	7916#	5#	$\beta^+$	16700#	390#	54 983980#	270#
36	20	56	Ca	x	-13440#	900#	8032#	16#	$\beta^-$	11830#	1140#	55 985570#	970#
35	21		Sc	x	-25270#	700#	8229#	12#	$\beta^-$	13670#	730#	55 972870#	750#
34	22		Ti	x	-38940	200	8459	3	$\beta^-$	7140	280	55 958200	210
33	23		V	x	-46080	200	8573	4	$\beta^-$	9200	200	55 950530	220
32	24		Cr	x	-55281.2	1.9	8723.19	0.03	$\beta^-$	1628.5	2.0	55 940653.1	2.0
31	25		Mn		-56909.7	0.7	8738.300	0.012	$\beta^-$	3695.64	0.21	55 938904.9	0.7
30	26		Fe		-60605.4	0.7	8790.323	0.012	*			55 934937.5	0.7
29	27		Co	-	-56039.4	2.1	8694.82	0.04	$\beta^+$	4566.0	2.0	55 939839.3	2.3
28	28		Ni	-pp	-53904	11	8642.71	0.20	$\beta^+$	2136	11	55 942132	12
27	29		Cu	x	-38600#	140#	8355#	2#	$\beta^+$	15300#	140#	55 958560#	150#
26	30		Zn	x	-25730#	260#	8112#	5#	$\beta^+$	12870#	300#	55 972380#	280#
25	31		Ga	x	-4740#	260#	7723#	5#	$\beta^+$	20990#	370#	55 994910#	280#

N	Z	A	Elt.	Orig.	Mass excess (keV)	Binding energy per nucleon (keV)	Beta-decay energy (keV)	Atomic mass $\mu$ u					
37	20	57	Ca	x	-7120#	1000#	7922#	18#	$\beta^-$	13570#	1220#	56 992360#	1070#
36	21		Sc	x	-20690#	700#	8146#	12#	$\beta^-$	12860#	830#	56 977790#	750#
35	22		Ti	x	-33540	460	8358	8	$\beta^-$	10640	510	56 963990	490
34	23		V	x	-44190	230	8531	4	$\beta^-$	8340	230	56 952560	250
33	24		Cr	x	-52524.1	1.9	8663.38	0.03	$\beta^-$	4962.7	2.6	56 943613.0	2.0
32	25		Mn		-57486.8	1.8	8736.72	0.03	$\beta^-$	2693.3	1.9	56 938285.4	2.0
31	26		Fe		-60180.1	0.7	8770.249	0.012	*			56 935394.0	0.7
30	27		Co		-59344.2	0.7	8741.858	0.013	$\beta^+$	835.9	0.5	56 936291.4	0.8
29	28		Ni		-56082.0	1.8	8670.90	0.03	$\beta^+$	3262.2	1.9	56 939793.5	1.9
28	29		Cu	2n-p	-47310	16	8503.27	0.27	$\beta^+$	8772	16	56 949211	17
27	30		Zn	x	-32800#	100#	8235#	2#	$\beta^+$	14510#	100#	56 964790#	110#
26	31		Ga	x	-15900#	260#	7925#	5#	$\beta^+$	16900#	280#	56 982930#	280#
37	21	58	Sc	x	-15170#	800#	8050#	14#	$\beta^-$	15590#	1060#	57 983710#	860#
36	22		Ti	x	-30770#	700#	8305#	12#	$\beta^-$	9440#	740#	57 966970#	750#
35	23		V	x	-40210	250	8454	4	$\beta^-$	11630	320	57 956830	270
34	24		Cr	x	-51830	200	8641	3	$\beta^-$	4070	210	57 944350	220
33	25		Mn	+	-55910	30	8698.0	0.5	$\beta^-$	6250	30	57 939980	30
32	26		Fe		-62153.4	0.7	8792.221	0.012	$\beta^-$	-2307.5	1.2	57 933275.6	0.8
31	27		Co		-59845.9	1.2	8738.947	0.022	$\beta^-$	381.8	1.1	57 935752.8	1.3
30	28		Ni		-60227.7	0.6	8732.041	0.011	*			57 935342.9	0.7
29	29		Cu	-	-51662.1	1.6	8570.869	0.027	$\beta^+$	8565.6	1.4	57 944538.5	1.7
28	30		Zn	--	-42300	50	8395.9	0.9	$\beta^+$	9360	50	57 954590	50
27	31		Ga	x	-23990#	210#	8067#	4#	$\beta^+$	18310#	220#	57 974250#	230#
26	32		Ge	x	-8370#	320#	7784#	5#	$\beta^+$	15610#	380#	57 991010#	340#
38	21	59	Sc	x	-10040#	900#	7963#	15#	$\beta^-$	15170#	1140#	58 989220#	970#
37	22		Ti	x	-25220#	700#	8207#	12#	$\beta^-$	11850#	760#	58 972930#	750#
36	23		V	x	-37070	310	8395	5	$\beta^-$	10820	390	58 960210	330
35	24		Cr	x	-47890	240	8565	4	$\beta^-$	7590	250	58 948590	260
34	25		Mn	3p2n	-55480	30	8680.1	0.5	$\beta^-$	5180	30	58 940440	30
33	26		Fe	-n	-60663.1	0.7	8754.743	0.012	$\beta^-$	1565.3	0.6	58 934875.5	0.8
32	27		Co		-62228.4	0.6	8768.013	0.011	*			58 933195.0	0.7
31	28		Ni		-61155.7	0.6	8736.570	0.010	$\beta^+$	1072.76	0.19	58 934346.7	0.7
30	29		Cu	-p	-56357.2	0.8	8641.981	0.013	$\beta^+$	4798.4	0.5	58 939498.0	0.8
29	30		Zn	-	-47260	40	8474.5	0.6	$\beta^+$	9100	40	58 949260	40
28	31		Ga	x	-34120#	170#	8239#	3#	$\beta^+$	13140#	170#	58 963370#	180#
27	32		Ge	x	-17000#	280#	7935#	5#	$\beta^+$	17120#	330#	58 981750#	300#
39	21	60	Sc	x	-4000#	900#	7864#	15#	$\beta^-$	17650#	1210#	59 995710#	970#
38	22		Ti	x	-21650#	800#	8145#	13#	$\beta^-$	10930#	930#	59 976760#	860#
37	23		V	x	-32580	470	8314	8	$\beta^-$	13930	520	59 965030	510
36	24		Cr	x	-46500	210	8533	4	$\beta^-$	6670	230	59 950080	230
35	25		Mn	+	-53180	90	8631.6	1.4	$\beta^-$	8230	90	59 942910	90
34	26		Fe	-nn	-61412	3	8755.83	0.06	$\beta^-$	237	3	59 934072	4
33	27		Co	-n	-61649.0	0.6	8746.745	0.010	$\beta^-$	2823.07	0.21	59 933817.1	0.7
32	28		Ni		-64472.1	0.6	8780.757	0.010	*			59 930786.4	0.7
31	29		Cu	-	-58344.1	1.7	8665.585	0.028	$\beta^+$	6128.0	1.6	59 937365.0	1.8
30	30		Zn	-pp	-54188	11	8583.27	0.18	$\beta^+$	4156	11	59 941827	11
29	31		Ga	x	-40000#	110#	8334#	2#	$\beta^+$	14190#	110#	59 957060#	120#
28	32		Ge	x	-27770#	230#	8117#	4#	$\beta^+$	12230#	260#	59 970190#	250#
27	33		As	x	-6400#	600#	7748#	10#	$\beta^+$	21370#	640#	59 993130#	640#

N	Z	A	Elt.	Orig.	Mass excess (keV)		Binding energy per nucleon (keV)		Beta-decay energy (keV)		Atomic mass $\mu$		
39	22	61	Ti	x	-15650#	900#	8046#	15#	$\beta^-$	13710#	990#	60 983200#	970#
38	23		V	x	-29360#	400#	8258#	7#	$\beta^-$	12820#	480#	60 968480#	430#
37	24		Cr	x	-42180	250	8455	4	$\beta^-$	9380	340	60 954720	270
36	25		Mn	x	-51560	230	8596	4	$\beta^-$	7370	230	60 944650	240
35	26		Fe	+n2p	-58921	20	8703.8	0.3	$\beta^-$	3977	20	60 936745	21
34	27		Co	p2n	-62898.4	0.9	8756.154	0.015	$\beta^-$	1322.5	0.8	60 932475.8	1.0
33	28		Ni		-64220.9	0.6	8765.009	0.010	*			60 931056.0	0.7
32	29		Cu	p2n	-61983.6	1.0	8715.507	0.016	$\beta^+$	2237.3	1.0	60 933457.8	1.1
31	30		Zn	+3n	-56345	16	8610.25	0.27	$\beta^+$	5638	16	60 939511	17
30	31		Ga	-	-47090	50	8445.7	0.9	$\beta^+$	9260	50	60 949450	60
29	32		Ge	x	-33730#	300#	8214#	5#	$\beta^+$	13360#	300#	60 963790#	320#
28	33		As	x	-18050#	600#	7944#	10#	$\beta^+$	15680#	670#	60 980620#	640#
40	22	62	Ti	x	-11650#	900#	7982#	15#	$\beta^-$	12770#	1030#	61 987490#	970#
39	23		V	x	-24420#	500#	8175#	8#	$\beta^-$	15990#	610#	61 973780#	540#
38	24		Cr	x	-40410	340	8420	5	$\beta^-$	7620	400	61 956610	360
37	25		Mn	x	-48040	220	8531	4	$\beta^-$	10860	220	61 948430	240
36	26		Fe	+pp	-58901	14	8693.25	0.23	$\beta^-$	2531	25	61 936767	16
35	27		Co	+	-61432	20	8721.4	0.3	$\beta^-$	5315	20	61 934051	21
34	28		Ni		-66746.1	0.6	8794.549	0.010	*			61 928345.1	0.6
33	29		Cu	-	-62798	4	8718.25	0.07	$\beta^+$	3948	4	61 932584	4
32	30		Zn	+nn	-61171	10	8679.40	0.16	$\beta^+$	1626	11	61 934330	11
31	31		Ga	-	-52000	28	8518.9	0.4	$\beta^+$	9171	26	61 944175	30
30	32		Ge	x	-42240#	140#	8349#	2#	$\beta^+$	9760#	140#	61 954650#	150#
29	33		As	x	-24960#	300#	8058#	5#	$\beta^+$	17280#	330#	61 973200#	320#
41	22	63	Ti	x	-5200#	1000#	7881#	16#	$\beta^-$	15710#	1160#	62 994420#	1070#
40	23		V	x	-20910#	600#	8118#	9#	$\beta^-$	14620#	670#	62 977550#	640#
39	24		Cr	x	-35530#	300#	8337#	5#	$\beta^-$	10820#	390#	62 961860#	320#
38	25		Mn	x	-46350	260	8497	4	$\beta^-$	9190	310	62 950240	280
37	26		Fe	x	-55550	170	8630.1	2.7	$\beta^-$	6290	170	62 940370	180
36	27		Co	+p	-61840	20	8717.6	0.3	$\beta^-$	3672	20	62 933612	21
35	28		Ni		-6512.6	0.6	8763.489	0.009	$\beta^-$	66.975	0.015	62 929669.4	0.6
34	29		Cu		-65579.5	0.6	8752.134	0.009	*			62 929597.5	0.6
33	30		Zn		-62213.0	1.6	8686.279	0.025	$\beta^+$	3366.5	1.6	62 933211.6	1.7
32	31		Ga	x	-56547.1	1.3	8583.926	0.021	$\beta^+$	5665.9	2.1	62 939294.2	1.4
31	32		Ge	x	-46910#	200#	8419#	3#	$\beta^+$	9640#	200#	62 949640#	210#
30	33		As	x	-33820#	500#	8198#	8#	$\beta^+$	13090#	540#	62 963690#	540#
41	23	64	V	x	-15400#	700#	8031#	11#	$\beta^-$	17750#	810#	63 983470#	750#
40	24		Cr	x	-33150#	400#	8296#	6#	$\beta^-$	9470#	480#	63 964410#	430#
39	25		Mn	x	-42620	270	8432	4	$\beta^-$	12150	380	63 954250	290
38	26		Fe	x	-54770	280	8609	4	$\beta^-$	5020	280	63 941200	300
37	27		Co	+	-59793	20	8675.5	0.3	$\beta^-$	7307	20	63 935810	21
36	28		Ni		-67099.3	0.6	8777.467	0.010	$\beta^-$	-1675.03	0.20	63 927966.0	0.7
35	29		Cu		-65424.2	0.6	8739.070	0.009	$\beta^-$	579.4	0.7	63 929764.2	0.6
34	30		Zn		-66003.6	0.7	8735.898	0.011	*			63 929142.2	0.7
33	31		Ga		-58834.3	2.0	8611.65	0.03	$\beta^+$	7169.3	2.1	63 936838.7	2.2
32	32		Ge	x	-54350	30	8529.4	0.5	$\beta^+$	4480	30	63 941650	30
31	33		As	-p	-39520#	360#	8285#	6#	$\beta^+$	14830#	360#	63 957570#	380#
42	23	65	V	x	-11250#	800#	7968#	12#	$\beta^-$	16540#	950#	64 987920#	860#
41	24		Cr	x	-27800#	500#	8210#	8#	$\beta^-$	12880#	740#	64 970160#	540#
40	25		Mn	x	-40670	540	8396	8	$\beta^-$	10210	590	64 956340	580
39	26		Fe	x	-50880	240	8541	4	$\beta^-$	8290	240	64 945380	260
38	27		Co	3p2n	-59170	13	8656.65	0.20	$\beta^-$	5956	13	64 936478	14
37	28		Ni		-65126.1	0.6	8736.246	0.010	$\beta^-$	2137.6	0.7	64 930084.3	0.7
36	29		Cu		-67263.7	0.7	8757.096	0.010	*			64 927789.5	0.7
35	30		Zn		-65911.6	0.7	8724.259	0.011	$\beta^+$	1352.1	0.3	64 929241.0	0.7
34	31		Ga		-62657.2	0.8	8662.154	0.013	$\beta^+$	3254.4	0.7	64 932734.8	0.9
33	32		Ge	ep	-56410	100	8554.1	1.5	$\beta^+$	6240	100	64 939440	110
32	33		As	-p	-46980#	300#	8397#	5#	$\beta^+$	9430#	320#	64 949560#	320#
31	34		Se	x	-32920#	600#	8169#	9#	$\beta^+$	14060#	670#	64 964660#	640#

N	Z	A	Elt.	Orig.	Mass excess (keV)		Binding energy per nucleon (keV)		Beta-decay energy (keV)		Atomic mass $\mu$		
42	24	66	Cr	x	-24800#	600#	8163#	9#	$\beta^-$	11460#	720#	65 973380#	640#
41	25		Mn	x	-36250#	400#	8324#	6#	$\beta^-$	13320#	500#	65 961080#	430#
40	26		Fe	x	-49570	300	8514	5	$\beta^-$	6540	390	65 946780	320
39	27		Co	x	-56110	250	8601	4	$\beta^-$	9890	250	65 939760	270
38	28		Ni	x	-66006.3	1.4	8739.508	0.021	$\beta^-$	252.0	1.6	65 929139.3	1.5
37	29		Cu		-66258.3	0.7	8731.472	0.010	$\beta^-$	2641.2	1.0	65 928868.8	0.7
36	30		Zn		-68899.4	0.9	8759.636	0.014	*	*	*	65 926033.4	1.0
35	31		Ga	—	-63724	3	8669.37	0.05	$\beta^+$	5175	3	65 931589	3
34	32		Ge	—	-61620	30	8625.7	0.5	$\beta^+$	2100	30	65 933840	30
33	33		As	x	-51500	680	8460	10	$\beta^+$	10120	680	65 944710	730
32	34		Se	x	-41720#	300#	8300#	5#	$\beta^+$	9780#	740#	65 955210#	320#
43	24	67	Cr	x	-19050#	700#	8075#	10#	$\beta^-$	14350#	860#	66 979550#	750#
42	25		Mn	x	-33400#	500#	8278#	8#	$\beta^-$	12290#	650#	66 964140#	540#
41	26		Fe	x	-45690	420	8450	6	$\beta^-$	9370	520	66 950950	450
40	27		Co	x	-55060	320	8578	5	$\beta^-$	8680	320	66 940890	340
39	28		Ni	x	-63742.7	2.9	8695.75	0.04	$\beta^-$	3576	3	66 931569	3
38	29		Cu	x	-67318.8	1.2	8737.447	0.018	$\beta^-$	561.7	1.5	66 927730.3	1.3
37	30		Zn		-67880.4	0.9	8734.154	0.014	*	*	*	66 927127.3	1.0
36	31		Ga		-66879.7	1.3	8707.540	0.019	$\beta^+$	1000.8	1.2	66 928201.7	1.4
35	32		Ge	-n2p	-62658	5	8632.85	0.07	$\beta^+$	4222	5	66 932734	5
34	33		As	—	-56650	100	8531.5	1.5	$\beta^+$	6010	100	66 939190	110
33	34		Se	x	-46490#	200#	8368#	3#	$\beta^+$	10160#	220#	66 950090#	210#
32	35		Br	x	-32800#	500#	8152#	8#	$\beta^+$	13690#	540#	66 964790#	540#
43	25	68	Mn	x	-28600#	600#	8204#	9#	$\beta^-$	14530#	920#	67 969300#	640#
42	26		Fe	x	-43130	700	8406	10	$\beta^-$	8220	770	67 953700	750
41	27		Co	x	-51350	320	8516	5	$\beta^-$	12110	320	67 944870	340
40	28		Ni	x	-63463.8	3.0	8682.47	0.04	$\beta^-$	2103	3	67 931869	3
39	29		Cu	x	-65567.0	1.6	8701.890	0.023	$\beta^-$	4440.2	1.8	67 929610.9	1.7
38	30		Zn		-70007.2	1.0	8755.682	0.014	*	*	*	67 924844.2	1.0
37	31		Ga	—	-67086.1	1.5	8701.220	0.023	$\beta^+$	2921.1	1.2	67 927980.1	1.6
36	32		Ge		-66980	6	8688.15	0.09	$\beta^+$	106	6	67 928094	7
35	33		As	—	-58900	40	8557.8	0.6	$\beta^+$	8080	40	67 936770	50
34	34		Se	x	-54210	30	8477.4	0.5	$\beta^+$	4680	50	67 941800	40
33	35		Br	-p	-38640#	360#	8237#	5#	$\beta^+$	15570#	360#	67 958520#	380#
44	25	69	Mn	x	-25300#	800#	8155#	12#	$\beta^-$	13100#	950#	68 972840#	860#
43	26		Fe	x	-38400#	500#	8333#	7#	$\beta^-$	11610#	610#	68 958780#	540#
42	27		Co	x	-50000	340	8490	5	$\beta^-$	9980	340	68 946320	360
41	28		Ni	x	-59979	4	8623.10	0.05	$\beta^-$	5758	4	68 935610	4
40	29		Cu	x	-65736.2	1.4	8695.203	0.020	$\beta^-$	2681.8	1.7	68 929429.3	1.5
39	30		Zn	-n	-68418.0	1.0	8722.731	0.014	$\beta^-$	909.8	1.5	68 926550.3	1.0
38	31		Ga		-69327.8	1.2	8724.578	0.017	*	*	*	68 925573.6	1.3
37	32		Ge		-67100.6	1.3	8680.962	0.019	$\beta^+$	2227.2	0.5	68 927964.5	1.4
36	33		As		-63090	30	8611.5	0.5	$\beta^+$	4010	30	68 932270	30
35	34		Se		-56300	30	8501.8	0.5	$\beta^+$	6790	40	68 939560	40
34	35		Br	-p	-46480#	110#	8348#	2#	$\beta^+$	9830#	110#	68 950110#	110#
33	36		Kr	x	-32440#	400#	8133#	6#	$\beta^+$	14040#	410#	68 965180#	430#
44	26	70	Fe	x	-35900#	600#	8294#	9#	$\beta^-$	9740#	1030#	69 961460#	640#
43	27		Co	x	-45640	840	8422	12	$\beta^-$	13510	910	69 951000	900
42	28		Ni	x	-59150	350	8603	5	$\beta^-$	3830	350	69 936500	370
41	29		Cu	x	-62976.1	1.6	8646.861	0.023	$\beta^-$	6588.5	2.5	69 932392.3	1.7
40	30		Zn		-69564.6	2.0	8729.806	0.028	$\beta^-$	-654.6	1.6	69 925319.3	2.1
39	31		Ga		-68910.1	1.2	8709.279	0.017	$\beta^-$	1653.0	1.6	69 926022.0	1.3
38	32		Ge		-70563.1	1.0	8721.717	0.015	*	*	*	69 924247.4	1.1
37	33		As	—	-64340	50	8621.7	0.7	$\beta^+$	6220	50	69 930920	50
36	34		Se	x	-62050	60	8577.7	0.9	$\beta^+$	2300	80	69 933390	70
35	35		Br	—	-51430#	310#	8415#	4#	$\beta^+$	10620#	300#	69 944790#	330#
34	36		Kr	—	-41680#	390#	8264#	5#	$\beta^+$	9750#	480#	69 955260#	410#

N	Z	A	Elt.	Orig.	Mass excess (keV)		Binding energy per nucleon (keV)		Beta-decay energy (keV)		Atomic mass $\mu$		
45	26	71	Fe	x	-31000#	800#	8221#	11#	$\beta^-$	12870#	1160#	70 966720#	860#
44	27		Co	x	-43870	840	8392	12	$\beta^-$	11330	920	70 952900	900
43	28		Ni	x	-55200	370	8540	5	$\beta^-$	7510	370	70 940740	400
42	29		Cu	x	-62711.1	1.5	8635.022	0.021	$\beta^-$	4616	10	70 932676.8	1.6
41	30		Zn	-n	-67327	10	8689.01	0.14	$\beta^-$	2813	10	70 927722	11
40	31		Ga		-70140.2	1.0	8717.620	0.014	*			70 924701.3	1.1
39	32		Ge		-69907.7	1.0	8703.326	0.014	$\beta^+$	232.51	0.22	70 924951.0	1.1
38	33		As	—	-67894	4	8663.95	0.06	$\beta^+$	2013	4	70 927112	5
37	34		Se	—	-63120	30	8585.6	0.4	$\beta^+$	4780	30	70 932240	30
36	35		Br	x	-57060	570	8489	8	$\beta^+$	6050	570	70 938740	610
35	36		Kr	—	-46920	650	8336	9	$\beta^+$	10140	320	70 949630	700
34	37		Rb	x	-32300#	500#	8119#	7#	$\beta^+$	14620#	820#	70 965320#	540#
46	26	72	Fe	x	-28300#	800#	8182#	11#	$\beta^-$	11000#	1000#	71 969620#	860#
45	27		Co	x	-39300#	600#	8324#	8#	$\beta^-$	14640#	740#	71 957810#	640#
44	28		Ni	x	-53940	440	8516	6	$\beta^-$	5840	440	71 942090	470
43	29		Cu	x	-59783.0	1.4	8586.525	0.019	$\beta^-$	8348	6	71 935820.3	1.5
42	30		Zn	+	-68131	6	8691.61	0.08	$\beta^-$	458	6	71 926858	7
41	31		Ga		-68589.4	1.0	8687.104	0.014	$\beta^-$	3996.5	1.8	71 926366.3	1.1
40	32		Ge		-72585.9	1.6	8731.745	0.023	*			71 922075.8	1.8
39	33		As	—	-68230	4	8660.38	0.06	$\beta^+$	4356	4	71 926752	5
38	34		Se		-67894	12	8644.85	0.17	$\beta^+$	335	13	71 927112	13
37	35		Br		-59020	60	8510.7	0.8	$\beta^+$	8880	60	71 936640	60
36	36		Kr		-53941	8	8429.32	0.11	$\beta^+$	5070	60	71 942092	9
35	37		Rb	x	-38120#	500#	8199#	7#	$\beta^+$	15820#	500#	71 959080#	540#
46	27	73	Co	x	-37040#	700#	8289#	10#	$\beta^-$	12830#	760#	72 960240#	750#
45	28		Ni	x	-49860#	300#	8454#	4#	$\beta^-$	9120#	300#	72 946470#	320#
44	29		Cu	x	-58987	4	8568.56	0.05	$\beta^-$	6420	40	72 936675	4
43	30		Zn	+n2p	-65410	40	8645.8	0.5	$\beta^-$	4290	40	72 929780	40
42	31		Ga	x	-69699.3	1.7	8693.873	0.023	$\beta^-$	1598.2	2.3	72 925174.7	1.8
41	32		Ge		-71297.5	1.6	8705.049	0.022	*			72 923458.9	1.8
40	33		As		-70957	4	8689.66	0.05	$\beta^+$	341	4	72 923825	4
39	34		Se		-68218	11	8641.42	0.15	$\beta^+$	2739	10	72 926765	11
38	35		Br		-63630	50	8567.8	0.7	$\beta^+$	4590	50	72 931690	50
37	36		Kr	x	-56552	7	8460.18	0.09	$\beta^+$	7080	50	72 939289	7
36	37		Rb	-p	-46050#	150#	8306#	2#	$\beta^+$	10500#	150#	72 950560#	160#
35	38		Sr	x	-31700#	600#	8098#	8#	$\beta^+$	14350#	620#	72 965970#	640#
47	27	74	Co	x	-32250#	800#	8222#	11#	$\beta^-$	16120#	900#	73 965380#	860#
46	28		Ni	x	-48370#	400#	8429#	5#	$\beta^-$	7630#	400#	73 948070#	430#
45	29		Cu	x	-56006	6	8521.56	0.08	$\beta^-$	9700	50	73 939875	7
44	30		Zn	+pp	-65710	50	8642.1	0.6	$\beta^-$	2340	50	73 929460	50
43	31		Ga	x	-68050	4	8663.17	0.05	$\beta^-$	5373	4	73 926946	4
42	32		Ge		-73422.4	1.6	8725.200	0.022	$\beta^-$	-2562.5	1.7	73 921177.8	1.8
41	33		As		-70860.0	2.3	8680.00	0.03	$\beta^-$	1352.8	1.8	73 923928.7	2.5
40	34		Se		-72212.7	1.7	8687.708	0.023	*			73 922476.4	1.8
39	35		Br	—	-65306	15	8583.80	0.20	$\beta^+$	6907	15	73 929891	16
38	36		Kr		-62331.5	2.0	8533.034	0.028	$\beta^+$	2975	15	73 933084.4	2.2
37	37		Rb		-51917	4	8381.73	0.05	$\beta^+$	10414	4	73 944265	4
36	38		Sr	x	-40700#	500#	8220#	7#	$\beta^+$	11220#	500#	73 956310#	540#
48	27	75	Co	x	-29500#	800#	8183#	11#	$\beta^-$	14400#	900#	74 968330#	860#
47	28		Ni	x	-43900#	400#	8365#	5#	$\beta^-$	10220#	1060#	74 952870#	430#
46	29		Cu	x	-54120	980	8490	13	$\beta^-$	8350	980	74 941900	1050
45	30		Zn	+	-62470	70	8591.3	0.9	$\beta^-$	6000	70	74 932940	80
44	31		Ga	x	-68464.6	2.4	8660.81	0.03	$\beta^-$	3391.8	2.9	74 926500.2	2.6
43	32		Ge	-n	-71856.4	1.6	8695.602	0.022	$\beta^-$	1176.0	1.0	74 922858.9	1.8
42	33		As		-73032.4	1.8	8700.850	0.024	*			74 921596.5	2.0
41	34		Se		-72169.0	1.7	8678.907	0.022	$\beta^+$	863.4	0.8	74 922523.4	1.8
40	35		Br	—	-69139	14	8628.08	0.19	$\beta^+$	3030	14	74 925776	15
39	36		Kr	x	-64324	8	8553.44	0.11	$\beta^+$	4815	16	74 930946	9
38	37		Rb	x	-57222	7	8448.32	0.10	$\beta^+$	7102	11	74 938570	8
37	38		Sr	—	-46620	220	8296.6	2.9	$\beta^+$	10600	220	74 949950	240

N	Z	A	Elt.	Orig.	Mass excess (keV)	Binding energy per nucleon (keV)	Beta-decay energy (keV)	Atomic mass $\mu$					
48	28	76	Ni	x	-41610#	900#	8331#	12#	$\beta^-$	9370#	900#	75 955330#	970#
47	29		Cu	x	-50976	7	8443.53	0.09	$\beta^-$	11160	80	75 945275	7
46	30		Zn	+	-62140	80	8580.1	1.1	$\beta^-$	4160	80	75 933290	90
45	31		Ga	x	-66296.6	2.0	8624.526	0.026	$\beta^-$	6916.4	2.6	75 928827.6	2.1
44	32		Ge		-73213.0	1.7	8705.238	0.022	$\beta^-$	-923.5	0.8	75 921402.6	1.8
43	33		As		-72289.5	1.8	8682.792	0.024	$\beta^-$	2962.5	0.8	75 922394.0	2.0
42	34		Se		-75252.1	1.7	8711.478	0.022	*	*	*	75 919213.6	1.8
41	35		Br	-	-70289	9	8635.88	0.12	$\beta^+$	4963	9	75 924541	10
40	36		Kr		-69014	4	8608.81	0.05	$\beta^+$	1275	10	75 925910	4
39	37		Rb	x	-60479.8	1.9	8486.225	0.025	$\beta^+$	8534	4	75 935072.2	2.0
38	38		Sr	x	-54240	40	8393.9	0.5	$\beta^+$	6240	40	75 941770	40
37	39		Y	x	-38700#	500#	8179#	7#	$\beta^+$	15540#	500#	75 958450#	540#
49	28	77	Ni	x	-36750#	500#	8264#	7#	$\beta^-$	11830#	640#	76 960550#	540#
48	29		Cu	x	-48580#	400#	8408#	5#	$\beta^-$	10150#	420#	76 947850#	430#
47	30		Zn	+	-58720	120	8529.1	1.6	$\beta^-$	7270	120	76 936960	130
46	31		Ga	x	-65992.3	2.4	8613.39	0.03	$\beta^-$	5221.7	3.0	76 929154.3	2.6
45	32		Ge	-n	-71214.0	1.7	8671.044	0.022	$\beta^-$	2702.5	1.8	76 923548.6	1.8
44	33		As		-73916.6	2.3	8695.981	0.030	$\beta^-$	683.0	1.8	76 920647.3	2.5
43	34		Se		-74599.6	1.7	8694.691	0.021	*	*	*	76 919914.0	1.8
42	35		Br	-	-73235	3	8666.81	0.04	$\beta^+$	1364.7	2.8	76 921379	3
41	36		Kr	x	-70169.4	2.0	8616.836	0.025	$\beta^+$	3065	4	76 924670.0	2.1
40	37		Rb	x	-64825	7	8537.26	0.10	$\beta^+$	5345	8	76 930408	8
39	38		Sr	x	-57804	9	8435.93	0.12	$\beta^+$	7020	12	76 937945	10
38	39		Y	-p	-46910#	60#	8284#	1#	$\beta^+$	10900#	60#	76 949650#	70#
50	28	78	Ni	x	-34300#	1100#	8230#	14#	$\beta^-$	10450#	1170#	77 963180#	1180#
49	29		Cu	x	-44750#	400#	8354#	5#	$\beta^-$	12590#	410#	77 951960#	430#
48	30		Zn	+	-57340	90	8505.6	1.2	$\beta^-$	6360	90	77 938440	100
47	31		Ga	x	-63706.6	2.4	8577.14	0.03	$\beta^-$	8156	5	77 931608.2	2.6
46	32		Ge	-nn	-71862	4	8671.66	0.05	$\beta^-$	955	10	77 922853	4
45	33		As	+pn	-72817	10	8673.88	0.13	$\beta^-$	4209	10	77 921827	11
44	34		Se		-77026.1	1.7	8717.808	0.021	$\beta^-$	-3574	4	77 917309.1	1.8
43	35		Br	-	-73452	4	8661.96	0.05	$\beta^-$	727	4	77 921146	4
42	36		Kr		-74179.7	1.1	8661.256	0.014	*	*	*	77 920364.8	1.2
41	37		Rb	x	-66936	7	8558.36	0.10	$\beta^+$	7243	8	77 928141	8
40	38		Sr	x	-63174	7	8500.10	0.10	$\beta^+$	3762	11	77 932180	8
39	39		Y	x	-52530#	400#	8354#	5#	$\beta^+$	10650#	400#	77 943610#	430#
38	40		Zr	x	-41700#	500#	8205#	6#	$\beta^+$	10820#	640#	77 955230#	540#
50	29	79	Cu	x	-42330#	500#	8320#	6#	$\beta^-$	11090#	570#	78 954560#	540#
49	30		Zn	+	-53420#	260#	8450#	3#	$\beta^-$	9090#	240#	78 942650#	280#
48	31		Ga	+	-62510	100	8555.6	1.2	$\beta^-$	6980	40	78 932890	110
47	32		Ge	+	-69490	90	8634.0	1.1	$\beta^-$	4150	90	78 925400	100
46	33		As	+p	-73637	6	8676.62	0.07	$\beta^-$	2281	5	78 920948	6
45	34		Se	-n	-75917.6	1.7	8695.593	0.021	$\beta^-$	150.9	1.7	78 918499.1	1.8
44	35		Br	+n	-76068.5	2.0	8687.600	0.026	*	*	*	78 918337.1	2.2
43	36		Kr	-	-74443	4	8657.12	0.05	$\beta^+$	1626	3	78 920082	4
42	37		Rb		-70803	6	8601.15	0.08	$\beta^+$	3639	7	78 923989	6
41	38		Sr	x	-65477	8	8523.82	0.11	$\beta^+$	5327	10	78 929708	9
40	39		Y	-	-58360	450	8424	6	$\beta^+$	7120	450	78 937350	480
39	40		Zr	x	-47360#	400#	8275#	5#	$\beta^+$	11000#	600#	78 949160#	430#

N	Z	A	Elt.	Orig.	Mass excess (keV)		Binding energy per nucleon (keV)		Beta-decay energy (keV)		Atomic mass $\mu$		
51	29	80	Cu	x	-36450#	600#	8243#	7#	$\beta^-$	15400#	620#	79 960870#	640#
50	30		Zn	+	-51840	170	8426.0	2.2	$\beta^-$	7290	120	79 944340	180
49	31		Ga	+	-59140	120	8507.3	1.5	$\beta^-$	10380	120	79 936520	130
48	32		Ge		-69515	28	8627.3	0.4	$\beta^-$	2644	19	79 925370	30
47	33		As		-72159	23	8650.59	0.29	$\beta^-$	5601	23	79 922534	25
46	34		Se		-77759.9	2.0	8710.819	0.025	$\beta^-$	-1870.5	0.3	79 916521.3	2.1
45	35		Br	-	-75889.5	2.0	8677.659	0.025	$\beta^-$	2003.0	2.4	79 918529.3	2.2
44	36		Kr		-77892.5	1.5	8692.917	0.018	*			79 916379.0	1.6
43	37		Rb		-72173	7	8611.64	0.09	$\beta^+$	5720	7	79 922519	7
42	38		Sr	x	-70308	7	8578.56	0.08	$\beta^+$	1865	10	79 924521	7
41	39		Y	x	-61220	180	8455.1	2.2	$\beta^+$	9090	180	79 934280	190
40	40		Zr	x	-55520	1490	8374	19	$\beta^+$	5700	1500	79 940400	1600
51	30	81	Zn	x	-46130#	300#	8351#	4#	$\beta^-$	11860#	360#	80 950480#	320#
50	31		Ga	+	-57980	190	8487.7	2.4	$\beta^-$	8320	150	80 937750	210
49	32		Ge	+	-66300	120	8580.8	1.5	$\beta^-$	6230	120	80 928820	130
48	33		As	+p	-72533	6	8648.06	0.07	$\beta^-$	3856	5	80 922132	6
47	34		Se	-n	-76389.5	2.0	8686.005	0.025	$\beta^-$	1585.3	2.2	80 917992.5	2.2
46	35		Br		-77974.8	2.0	8695.918	0.024	*			80 916290.6	2.1
45	36		Kr		-77694.0	2.0	8682.793	0.025	$\beta^+$	280.8	0.5	80 916592.0	2.1
44	37		Rb		-75455	6	8645.49	0.07	$\beta^+$	2239	6	80 918996	6
43	38		Sr	x	-71528	6	8587.35	0.08	$\beta^+$	3927	9	80 923212	7
42	39		Y	-	-66020	60	8509.7	0.8	$\beta^+$	5510	60	80 929130	70
41	40		Zr	$\epsilon p$	-58490	170	8407.1	2.1	$\beta^+$	7530	180	80 937210	180
40	41		Nb	-p	-47480#	1500#	8261#	18#	$\beta^+$	11010#	1510#	80 949030#	1610#
52	30	82	Zn	x	-42460#	500#	8303#	6#	$\beta^-$	10650#	590#	81 954420#	540#
51	31		Ga	x	-53100#	300#	8423#	4#	$\beta^-$	12520#	390#	81 942990#	320#
50	32		Ge	+	-65620	240	8566.3	3.0	$\beta^-$	4700	140	81 929550	260
49	33		As	+	-70320	200	8614.1	2.4	$\beta^-$	7270	200	81 924500	210
48	34		Se		-77594.0	2.0	8693.198	0.025	$\beta^-$	-97.5	2.1	81 916699.4	2.2
47	35		Br		-77496.5	1.9	8682.468	0.024	$\beta^-$	3093.0	1.0	81 916804.1	2.1
46	36		Kr		-80589.5	1.8	8710.647	0.022	*			81 913483.6	1.9
45	37		Rb		-76188.2	2.8	8647.43	0.03	$\beta^+$	4401	3	81 918208.6	3.0
44	38		Sr		-76008	6	8635.70	0.07	$\beta^+$	180	6	81 918402	6
43	39		Y	-	-68190	100	8530.8	1.3	$\beta^+$	7820	100	81 926790	110
42	40		Zr	-	-64190#	230#	8473#	3#	$\beta^+$	4000#	200#	81 931090#	240#
41	41		Nb	x	-52970#	300#	8326#	4#	$\beta^+$	11220#	370#	81 943130#	320#
53	30	83	Zn	x	-36300#	500#	8226#	6#	$\beta^-$	13090#	590#	82 961030#	540#
52	31		Ga	x	-49390#	300#	8374#	4#	$\beta^-$	11510#	360#	82 946980#	320#
51	32		Ge	x	-60900#	200#	8503#	2#	$\beta^-$	8980#	290#	82 934620#	210#
50	33		As	+	-69880	220	8602.2	2.7	$\beta^-$	5460	220	82 924980	240
49	34		Se	-n	-75341	4	8658.56	0.04	$\beta^-$	3668	5	82 919118	4
48	35		Br		-79009	4	8693.33	0.05	$\beta^-$	973	4	82 915180	5
47	36		Kr		-79981.7	2.8	8695.62	0.03	*			82 914136	3
46	37		Rb		-79075	6	8675.27	0.07	$\beta^+$	907	7	82 915110	6
45	38		Sr	-	-76795	10	8638.38	0.12	$\beta^+$	2279	8	82 917557	11
44	39		Y	-	-72330	40	8575.1	0.5	$\beta^+$	4470	40	82 922350	50
43	40		Zr	-	-66460	100	8495.0	1.2	$\beta^+$	5870	90	82 928650	100
42	41		Nb	-	-58960	310	8395	4	$\beta^+$	7500	300	82 936710	340
41	42		Mo	x	-47750#	500#	8251#	6#	$\beta^+$	11210#	590#	82 948740#	540#

N	Z	A	Elt.	Orig.	Mass excess (keV)		Binding energy per nucleon (keV)		Beta-decay energy (keV)		Atomic mass $\mu$		
53	31	84	Ga	x	-44110#	400#	8308#	5#	$\beta^-$	14140#	500#	83 952650#	430#
52	32		Ge	x	-58250#	300#	8467#	4#	$\beta^-$	7840#	420#	83 937470#	320#
51	33		As	+	-66080#	300#	8551#	4#	$\beta^-$	9870#	300#	83 929060#	320#
50	34		Se	+	-75952	15	8658.84	0.17	$\beta^-$	1848	20	83 918462	16
49	35		Br		-77799	15	8671.52	0.17	$\beta^-$	4632	14	83 916479	16
48	36		Kr		-82431.0	2.8	8717.35	0.03	$\beta^-$	-2681.0	2.3	83 911507	3
47	37		Rb		-79750.0	2.8	8676.12	0.03	$\beta^-$	894	3	83 914385	3
46	38		Sr		-80644	3	8677.44	0.04	*			83 913425	3
45	39		Y	-	-74160	90	8590.9	1.1	$\beta^+$	6490	90	83 920390	100
44	40		Zr	x	-71490#	200#	8550#	2#	$\beta^+$	2670#	220#	83 923250#	210#
43	41		Nb	x	-61880#	300#	8426#	4#	$\beta^+$	9610#	360#	83 93570#	320#
42	42		Mo	x	-55810#	400#	8344#	5#	$\beta^+$	6070#	500#	83 940090#	430#
54	31	85	Ga	x	-40050#	500#	8257#	6#	$\beta^-$	13010#	640#	84 957000#	540#
53	32		Ge	x	-53070#	400#	8401#	5#	$\beta^-$	10260#	450#	84 943030#	430#
52	33		As	x	-63320#	200#	8513#	2#	$\beta^-$	9110#	200#	84 932020#	210#
51	34		Se	+	-72428	30	8610.5	0.4	$\beta^-$	6182	23	84 922250	30
50	35		Br	+	-78610	19	8674.00	0.22	$\beta^-$	2870	19	84 915608	21
49	36		Kr		-81480.3	1.9	8698.562	0.023	$\beta^-$	687.1	1.9	84 912527.3	2.1
48	37		Rb		-82167.331	0.011	8697.441	0.000	*			84 911789.738	0.012
47	38		Sr		-81102.6	2.8	8675.71	0.03	$\beta^+$	1064.8	2.8	84 912933	3
46	39		Y	x	-77842	19	8628.15	0.22	$\beta^+$	3260	19	84 916433	20
45	40		Zr	-	-73150	100	8563.7	1.2	$\beta^+$	4690	100	84 921470	110
44	41		Nb	-	-67150	220	8483.9	2.6	$\beta^+$	6000	200	84 927910	240
43	42		Mo	ep	-59100#	280#	8380#	3#	$\beta^+$	8050#	360#	84 93650#	300#
42	43		Tc	x	-47670#	400#	8236#	5#	$\beta^+$	11440#	490#	84 948830#	430#
55	31	86	Ga	x	-34350#	800#	8189#	9#	$\beta^-$	15490#	950#	85 963120#	860#
54	32		Ge	x	-49840#	500#	8360#	6#	$\beta^-$	9310#	590#	85 946490#	540#
53	33		As	x	-59150#	300#	8459#	3#	$\beta^-$	11390#	300#	85 936500#	320#
52	34		Se	+	-70541	16	8582.26	0.18	$\beta^-$	5099	11	85 924272	17
51	35		Br	+	-75640	11	8632.45	0.13	$\beta^-$	7626	11	85 918798	12
50	36		Kr	x	-83265.57	0.10	8712.027	0.001	$\beta^-$	-518.55	0.22	85 910610.73	0.11
49	37		Rb		-82747.02	0.20	8696.901	0.002	$\beta^-$	1776.6	1.1	85 911167.42	0.21
48	38		Sr		-84523.6	1.1	8708.461	0.012	*			85 909260.2	1.2
47	39		Y	-	-79284	14	8638.43	0.16	$\beta^+$	5240	14	85 914886	15
46	40		Zr	4n	-77800	30	8612.1	0.3	$\beta^+$	1480	30	85 916470	30
45	41		Nb	-	-69830	90	8510.3	1.0	$\beta^+$	7980	80	85 925040	90
44	42		Mo	-	-64560	440	8440	5	$\beta^+$	5270	430	85 930700	470
43	43		Tc	x	-53210#	300#	8299#	3#	$\beta^+$	11350#	530#	85 942880#	320#
55	32	87	Ge	x	-44240#	500#	8292#	6#	$\beta^-$	11750#	590#	86 952510#	540#
54	33		As	x	-55980#	300#	8418#	3#	$\beta^-$	10600#	300#	86 939900#	320#
53	34		Se	+	-66580	40	8530.9	0.5	$\beta^-$	7280	40	86 928520	40
52	35		Br	+	-73857	18	8605.51	0.20	$\beta^-$	6852	18	86 920711	19
51	36		Kr	-n	-80709.43	0.27	8675.282	0.003	$\beta^-$	3888.37	0.27	86 913354.86	0.29
50	37		Rb		-84597.795	0.012	8710.983	0.000	$\beta^-$	282.6	1.1	86 909180.527	0.013
49	38		Sr		-84880.4	1.1	8705.239	0.012	*			86 908877.1	1.2
48	39		Y	-	-83018.7	1.6	8674.848	0.018	$\beta^+$	1861.7	1.1	86 910875.7	1.7
47	40		Zr	+3n	-79348	8	8623.67	0.10	$\beta^+$	3671	8	86 914816	9
46	41		Nb	-	-74180	60	8555.3	0.7	$\beta^+$	5170	60	86 920360	70
45	42		Mo	-	-67690	220	8471.7	2.6	$\beta^+$	6490	210	86 927330	240
44	43		Tc	x	-59120#	300#	8364#	3#	$\beta^+$	8570#	370#	86 936530#	320#
43	44		Ru	x	-47340#	600#	8220#	7#	$\beta^+$	11780#	670#	86 949180#	640#



N	Z	A	Elt.	Orig.	Mass excess (keV)		Binding energy per nucleon (keV)		Beta-decay energy (keV)		Atomic mass $\mu$		
56	32	88	Ge	x	-40140#	700#	8243#	8#	$\beta^-$	11150#	860#	87 956910#	750#
55	33		As	x	-51290#	500#	8361#	6#	$\beta^-$	12590#	510#	87 944940#	540#
54	34		Se	+	-63880	50	8494.9	0.6	$\beta^-$	6850	30	87 931420	50
53	35		Br	+	-70730	40	8563.9	0.4	$\beta^-$	8960	40	87 924070	40
52	36		Kr	-nn	-79692	13	8656.86	0.15	$\beta^-$	2917	13	87 914447	14
51	37		Rb	-n	-82609.00	0.16	8681.114	0.002	$\beta^-$	5312.7	1.1	87 911315.59	0.17
50	38		Sr		-87921.7	1.1	8732.596	0.012	*			87 905612.1	1.2
49	39		Y	-	-84299.1	1.9	8682.540	0.021	$\beta^+$	3622.6	1.5	87 909501.1	2.0
48	40		Zr	+nn	-83623	10	8665.97	0.12	$\beta^+$	676	10	87 910227	11
47	41		Nb	-	-76070	100	8571.3	1.1	$\beta^+$	7550	100	87 918330	110
46	42		Mo	4n	-72700	20	8524.06	0.23	$\beta^+$	3370	100	87 921953	22
45	43		Tc	-	-62710#	200#	8402#	2#	$\beta^+$	9990#	200#	87 932680#	220#
44	44		Ru	x	-55650#	400#	8313#	5#	$\beta^+$	7060#	450#	87 940260#	430#
57	32	89	Ge	x	-33690#	900#	8169#	10#	$\beta^-$	13450#	1030#	88 963830#	970#
56	33		As	x	-47140#	500#	8311#	6#	$\beta^-$	12050#	590#	88 949390#	540#
55	34		Se	x	-59200#	300#	8438#	3#	$\beta^-$	9380#	300#	88 936450#	320#
54	35		Br	+	-68570	60	8534.1	0.7	$\beta^-$	8150	30	88 926390	60
53	36		Kr	+	-76730	50	8617.0	0.6	$\beta^-$	4990	50	88 917630	60
52	37		Rb		-81713	5	8664.19	0.06	$\beta^-$	4497	5	88 912278	6
51	38		Sr		-86209.1	1.1	8705.924	0.012	$\beta^-$	1492.6	2.6	88 907450.7	1.2
50	39		Y		-87701.7	2.6	8713.904	0.029	*			88 905848.3	2.7
49	40		Zr		-84869	4	8673.28	0.04	$\beta^+$	2832.9	2.8	88 908890	4
48	41		Nb	x	-80650	27	8617.1	0.3	$\beta^+$	4218	27	88 913418	29
47	42		Mo	+3n	-75004	15	8544.86	0.17	$\beta^+$	5650	30	88 919480	17
46	43		Tc	-	-67840#	200#	8456#	2#	$\beta^+$	7160#	200#	88 927170#	220#
45	44		Ru	x	-59510#	500#	8353#	6#	$\beta^+$	8330#	540#	88 936110#	540#
44	45		Rh	-p	-47660#	450#	8211#	5#	$\beta^+$	11860#	670#	88 948840#	480#
57	33	90	As	x	-41450#	800#	8245#	9#	$\beta^-$	14480#	900#	89 955500#	860#
56	34		Se	x	-55930#	400#	8397#	4#	$\beta^-$	8690#	410#	89 939960#	430#
55	35		Br	+	-64620	80	8485.1	0.9	$\beta^-$	10350	80	89 930630	80
54	36		Kr	+	-74970	19	8591.38	0.21	$\beta^-$	4392	17	89 919517	20
53	37		Rb		-79362	7	8631.48	0.07	$\beta^-$	6580	7	89 914802	7
52	38		Sr		-85941.6	2.9	8695.90	0.03	$\beta^-$	545.9	1.4	89 907738	3
51	39		Y		-86487.5	2.6	8693.272	0.028	$\beta^-$	2279.8	1.7	89 907151.9	2.7
50	40		Zr		-88767.3	2.4	8709.910	0.026	*			89 904704.4	2.5
49	41		Nb	-	-82656	5	8633.32	0.05	$\beta^+$	6111	4	89 911265	5
48	42		Mo	-	-80167	6	8596.97	0.07	$\beta^+$	2489	4	89 913937	7
47	43		Tc	-	-71210	240	8488.7	2.7	$\beta^+$	8960	240	89 923560	260
46	44		Ru	x	-65310#	300#	8414#	3#	$\beta^+$	5900#	380#	89 929890#	320#
45	45		Rh	x	-53220#	500#	8271#	6#	$\beta^+$	12090#	590#	89 942870#	540#
58	33	91	As	x	-36860#	900#	8193#	10#	$\beta^-$	13480#	1030#	90 960430#	970#
57	34		Se	x	-50340#	500#	8332#	6#	$\beta^-$	11170#	510#	90 945960#	540#
56	35		Br	+	-61510	70	8446.3	0.8	$\beta^-$	9800	40	90 933970	80
55	36		Kr	+	-71310	60	8545.4	0.6	$\beta^-$	6440	60	90 923450	60
54	37		Rb		-77745	8	8607.56	0.09	$\beta^-$	5900	9	90 916537	9
53	38		Sr		-83645	5	8663.80	0.05	$\beta^-$	2700	4	90 910203	5
52	39		Y		-86345.0	2.9	8684.87	0.03	$\beta^-$	1545.4	1.8	90 907305	3
51	40		Zr		-87890.4	2.3	8693.257	0.026	*			90 905645.8	2.5
50	41		Nb	-	-86632	4	8670.84	0.04	$\beta^+$	1258.0	3.0	90 906996	4
49	42		Mo	+n	-82204	11	8613.58	0.12	$\beta^+$	4428	12	90 911750	12
48	43		Tc	-	-75980	200	8536.6	2.2	$\beta^+$	6220	200	90 918430	220
47	44		Ru	IT	-68660#	580#	8448#	6#	$\beta^+$	7330#	620#	90 926290#	630#
46	45		Rh	x	-59100#	400#	8334#	4#	$\beta^+$	9560#	710#	90 936550#	430#
45	46		Pd	-	-47400#	570#	8197#	6#	$\beta^+$	11700#	400#	90 949110#	610#

<i>N</i>	<i>Z</i>	<i>A</i>	Elt.	Orig.	Mass excess (keV)		Binding energy per nucleon (keV)		Beta-decay energy (keV)		Atomic mass $\mu$		
59	33	92	As	x	-30930#	900#	8127#	10#	$\beta^-$	15720#	1080#	91 966800#	970#
58	34		Se	x	-46650#	600#	8289#	6#	$\beta^-$	9930#	600#	91 949920#	640#
57	35		Br	+	-56580	50	8388.7	0.5	$\beta^-$	12200	50	91 939260	50
56	36		Kr	+	-68785	12	8512.85	0.13	$\beta^-$	5987	10	91 926156	13
55	37		Rb		-74772	6	8569.42	0.07	$\beta^-$	8096	6	91 919729	7
54	38		Sr		-82868	3	8648.91	0.04	$\beta^-$	1946	9	91 911038	4
53	39		Y		-84813	9	8661.55	0.10	$\beta^-$	3641	9	91 908949	10
52	40		Zr		-88453.9	2.3	8692.622	0.025	$\beta^-$	-2005.5	1.8	91 905040.8	2.5
51	41		Nb		-86448.3	2.8	8662.32	0.03	$\beta^-$	357	4	91 907194	3
50	42		Mo		-86805	4	8657.69	0.04	*			91 906811	4
49	43		Tc	-	-78935	26	8563.64	0.28	$\beta^+$	7870	26	91 915260	28
48	44		Ru	x	-74410#	300#	8506#	3#	$\beta^+$	4530#	300#	91 920120#	320#
47	45		Rh	x	-63360#	400#	8377#	4#	$\beta^+$	11050#	500#	91 931980#	430#
46	46		Pd	x	-55500#	500#	8283#	5#	$\beta^+$	7860#	640#	91 940420#	540#
59	34	93	Se	x	-40720#	800#	8223#	9#	$\beta^-$	12330#	860#	92 956290#	860#
58	35		Br	x	-53050#	300#	8347#	3#	$\beta^-$	10970#	310#	92 943050#	320#
57	36		Kr	+	-64020	100	8456.8	1.1	$\beta^-$	8600	100	92 931270	110
56	37		Rb		-72618	8	8540.89	0.08	$\beta^-$	7467	9	92 922042	8
55	38		Sr		-80085	8	8612.77	0.08	$\beta^-$	4139	12	92 914026	8
54	39		Y		-84223	11	8648.86	0.11	$\beta^-$	2894	10	92 909583	11
53	40		Zr		-87117.0	2.3	8671.566	0.025	$\beta^-$	91.2	1.6	92 906476.0	2.5
52	41		Nb		-87208.3	2.4	8664.135	0.026	*			92 906378.1	2.6
51	42		Mo		-86803	4	8651.37	0.04	$\beta^+$	405	4	92 906813	4
50	43		Tc	-p	-83603	4	8608.54	0.04	$\beta^+$	3201.0	1.0	92 910249	4
49	44		Ru	-	-77270	90	8532.0	0.9	$\beta^+$	6340	90	92 917050	90
48	45		Rh	x	-69170#	400#	8437#	4#	$\beta^+$	8090#	410#	92 925740#	430#
47	46		Pd	x	-59700#	400#	8326#	4#	$\beta^+$	9470#	570#	92 935910#	430#
46	47		Ag	x	-46780#	600#	8179#	6#	$\beta^+$	12920#	720#	92 949780#	640#
60	34	94	Se	x	-36800#	800#	8180#	9#	$\beta^-$	11000#	900#	93 960490#	860#
59	35		Br	x	-47800#	400#	8289#	4#	$\beta^-$	13340#	500#	93 948680#	430#
58	36		Kr	+	-61140#	300#	8422#	3#	$\beta^-$	7410#	300#	93 934360#	320#
57	37		Rb		-68553	8	8492.66	0.09	$\beta^-$	10287	10	93 926405	9
56	38		Sr		-78840	7	8593.78	0.08	$\beta^-$	3508	8	93 915361	8
55	39		Y		-82348	7	8622.77	0.08	$\beta^-$	4918	7	93 911595	8
54	40		Zr		-87266.8	2.4	8666.774	0.026	$\beta^-$	-902.3	2.2	93 906315.2	2.6
53	41		Nb		-86364.5	2.4	8648.852	0.026	$\beta^-$	2045.2	2.0	93 907283.9	2.6
52	42		Mo		-88409.7	1.9	8662.287	0.020	*			93 905088.3	2.1
51	43		Tc	-	-84154	4	8608.69	0.05	$\beta^+$	4256	4	93 909657	5
50	44		Ru	+nn	-82568	13	8583.49	0.14	$\beta^+$	1586	13	93 911360	14
49	45		Rh	IT	-72940#	450#	8473#	5#	$\beta^+$	9630#	450#	93 921700#	480#
48	46		Pd	x	-66350#	400#	8394#	4#	$\beta^+$	6590#	600#	93 928770#	430#
47	47		Ag	x	-53300#	500#	8247#	5#	$\beta^+$	13050#	640#	93 942780#	540#
60	35	95	Br	x	-43900#	500#	8245#	5#	$\beta^-$	12140#	640#	94 952870#	540#
59	36		Kr	x	-56040#	400#	8365#	4#	$\beta^-$	9820#	400#	94 939840#	430#
58	37		Rb		-65854	21	8459.81	0.22	$\beta^-$	9263	21	94 929303	23
57	38		Sr		-75117	7	8549.08	0.08	$\beta^-$	6090	8	94 919359	8
56	39		Y		-81207	7	8604.95	0.08	$\beta^-$	4451	7	94 912821	8
55	40		Zr		-85657.8	2.4	8643.569	0.025	$\beta^-$	1124.1	1.8	94 908042.6	2.6
54	41		Nb		-86781.9	2.0	8647.166	0.021	$\beta^-$	925.6	0.5	94 906835.8	2.1
53	42		Mo		-87707.5	1.9	8648.674	0.020	*			94 905842.1	2.1
52	43		Tc		-86017	5	8622.64	0.06	$\beta^+$	1691	5	94 907657	6
51	44		Ru		-83450	12	8587.39	0.12	$\beta^+$	2567	13	94 910413	13
50	45		Rh	-	-78340	150	8525.4	1.6	$\beta^+$	5110	150	94 915900	160
49	46		Pd	x	-70150#	400#	8431#	4#	$\beta^+$	8190#	430#	94 924690#	430#
48	47		Ag	x	-60100#	400#	8317#	4#	$\beta^+$	10050#	570#	94 935480#	430#
47	48		Cd	x	-46700#	600#	8168#	6#	$\beta^+$	13400#	720#	94 949870#	640#

<i>N</i>	<i>Z</i>	<i>A</i>	El.	Orig.	Mass excess (keV)		Binding energy per nucleon (keV)		Beta-decay energy (keV)		Atomic mass $\mu$		
61	35	96	Br	x	-38630#	700#	8188#	7#	$\beta^-$	14400#	860#	95 958530#	750#
60	36		Kr	x	-53030#	500#	8330#	5#	$\beta^-$	8200#	500#	95 943070#	540#
59	37		Rb		-61225	29	8407.5	0.3	$\beta^-$	11714	29	95 934270	30
58	38		Sr		-72939	27	8521.42	0.29	$\beta^-$	5408	18	95 921697	29
57	39		Y		-78347	23	8569.60	0.24	$\beta^-$	7096	23	95 915891	25
56	40		Zr		-85442.8	2.8	8635.368	0.029	$\beta^-$	161	4	95 908273.4	3.0
55	41		Nb	+	-85604	4	8628.90	0.04	$\beta^-$	3187	3	95 908101	4
54	42		Mo		-88790.5	1.9	8653.941	0.020	$\beta^-$	-2973	5	95 904679.5	2.1
53	43		Tc	-	-85817	5	8614.82	0.06	$\beta^-$	255	10	95 907871	6
52	44		Ru		-86072	8	8609.33	0.08	*	*	*	95 907598	8
51	45		Rh	-	-79679	13	8534.59	0.13	$\beta^+$	6393	10	95 914461	14
50	46		Pd	-	-76230	150	8490.5	1.6	$\beta^+$	3450	150	95 918160	160
49	47		Ag	x	-64570#	400#	8361#	4#	$\beta^+$	11660#	430#	95 930680#	430#
48	48		Cd	x	-56100#	500#	8265#	5#	$\beta^+$	8470#	640#	95 939770#	540#
62	35	97	Br	x	-34650#	800#	8146#	8#	$\beta^-$	13260#	950#	96 962800#	860#
61	36		Kr	x	-47920#	500#	8275#	5#	$\beta^-$	10440#	500#	96 948560#	540#
60	37		Rb		-58360	30	8374.5	0.3	$\beta^-$	10432	28	96 937350	30
59	38		Sr		-68788	19	8473.99	0.20	$\beta^-$	7470	16	96 926153	21
58	39		Y		-76258	12	8542.93	0.12	$\beta^-$	6689	11	96 918134	13
57	40		Zr		-82946.6	2.8	8603.820	0.029	$\beta^-$	2659.0	1.8	96 910953.1	3.0
56	41		Nb		-85605.6	2.6	8623.167	0.026	$\beta^-$	1934.8	1.8	96 908098.6	2.7
55	42		Mo		-87540.4	1.9	8635.048	0.020	*	*	*	96 906021.5	2.1
54	43		Tc		-87220	5	8623.68	0.05	$\beta^+$	320	4	96 906365	5
53	44		Ru	-n	-86112	8	8604.19	0.09	$\beta^+$	1108	9	96 907555	9
52	45		Rh	-	-82590	40	8559.8	0.4	$\beta^+$	3520	40	96 911340	40
51	46		Pd	-	-77800	300	8502	3	$\beta^+$	4790	300	96 916480	320
50	47		Ag	-	-70820	320	8422	3	$\beta^+$	6980	110	96 923970	350
49	48		Cd	x	-60600#	400#	8309#	4#	$\beta^+$	10220#	510#	96 934940#	430#
48	49		In	x	-47000#	600#	8161#	6#	$\beta^+$	13600#	720#	96 949540#	640#
62	36	98	Kr	x	-44800#	600#	8241#	6#	$\beta^-$	9430#	600#	97 951910#	640#
61	37		Rb		-54220	50	8329.2	0.5	$\beta^-$	12420	50	97 941790	50
60	38		Sr		-66646	26	8448.02	0.27	$\beta^-$	5822	10	97 928453	28
59	39		Y		-72467	25	8499.44	0.25	$\beta^-$	8820	15	97 922203	26
58	40		Zr		-81287	20	8581.45	0.20	$\beta^-$	2242	20	97 912735	21
57	41		Nb	-pn	-83529	6	8596.34	0.06	$\beta^-$	4583	5	97 910328	6
56	42		Mo		-88111.7	1.9	8635.125	0.020	$\beta^-$	-1684	3	97 905408.2	2.1
55	43		Tc		-86428	4	8609.96	0.04	$\beta^-$	1797	7	97 907216	4
54	44		Ru		-88224	6	8620.31	0.06	*	*	*	97 905287	7
53	45		Rh	-	-83175	12	8560.80	0.12	$\beta^+$	5050	10	97 910708	13
52	46		Pd	-pp	-81300	21	8533.68	0.22	$\beta^+$	1875	25	97 912721	23
51	47		Ag	-	-73060	70	8441.6	0.7	$\beta^+$	8240	60	97 921570	70
50	48		Cd	-	-67630	80	8378.2	0.8	$\beta^+$	5430	40	97 927400	80
49	49		In	x	-53900#	200#	8230#	2#	$\beta^+$	13730#	210#	97 942140#	210#
63	36	99	Kr	x	-39500#	600#	8186#	6#	$\beta^-$	11380#	610#	98 957600#	640#
62	37		Rb		-50880	130	8292.9	1.3	$\beta^-$	11310	110	98 945380	130
61	38		Sr		-62190	80	8399.2	0.8	$\beta^-$	8020	80	98 933240	90
60	39		Y		-70201	24	8472.22	0.25	$\beta^-$	7568	14	98 924636	26
59	40		Zr		-77768	20	8540.76	0.20	$\beta^-$	4558	15	98 916512	22
58	41		Nb		-82327	13	8578.90	0.13	$\beta^-$	3639	13	98 911618	14
57	42		Mo		-85965.8	1.9	8607.754	0.019	$\beta^-$	1357.3	1.0	98 907711.9	2.1
56	43		Tc		-87323.1	2.0	8613.562	0.020	$\beta^-$	293.8	1.4	98 906254.7	2.1
55	44		Ru		-87617.0	2.0	8608.627	0.020	*	*	*	98 905939.3	2.2
54	45		Rh		-85574	7	8580.09	0.07	$\beta^+$	2043	7	98 908132	8
53	46		Pd		-82188	15	8537.98	0.15	$\beta^+$	3387	15	98 911768	16
52	47		Ag	-	-76760	150	8475.2	1.5	$\beta^+$	5430	150	98 917600	160
51	48		Cd	x	-69850#	210#	8398#	2#	$\beta^+$	6910#	250#	98 925010#	220#
50	49		In	x	-61270#	400#	8303#	4#	$\beta^+$	8580#	450#	98 934220#	430#
49	50		Sn	x	-47200#	600#	8153#	6#	$\beta^+$	14080#	720#	98 949330#	640#

N	Z	A	Elt.	Orig.	Mass excess (keV)		Binding energy per nucleon (keV)		Beta-decay energy (keV)		Atomic mass $\mu$	
64	36	100	Kr	x	-36200#	500#	8152#	5#	$\beta^-$	10500#	590#	99 961140# 540#
63	37		Rb	x	-46700#	300#	8249#	3#	$\beta^-$	13520#	320#	99 949870# 320#
62	38		Sr	+	-60220	130	8376.2	1.3	$\beta^-$	7080	100	99 935350 140
61	39		Y	+	-67290	80	8439.1	0.8	$\beta^-$	9310	70	99 927760 80
60	40		Zr	+	-76600	40	8524.4	0.4	$\beta^-$	3335	25	99 917760 40
59	41		Nb	+	-79939	26	8549.95	0.26	$\beta^-$	6245	25	99 914182 28
58	42		Mo		-86184	6	8604.57	0.06	$\beta^-$	-168	6	99 907477 6
57	43		Tc	-n	-86016.2	2.2	8595.070	0.022	$\beta^-$	3202.8	1.7	99 907657.8 2.4
56	44		Ru		-89219.0	2.0	8619.274	0.020	*			99 904219.5 2.2
55	45		Rh		-85584	18	8575.10	0.18	$\beta^+$	3635	18	99 908122 20
54	46		Pd		-85226	11	8563.70	0.11	$\beta^+$	358	21	99 908506 12
53	47		Ag		-78150	80	8485.1	0.8	$\beta^+$	7080	80	99 916100 80
52	48		Cd		-74250	100	8438.3	1.0	$\beta^+$	3900	70	99 920290 100
51	49		In	-	-64170	250	8329.7	2.5	$\beta^+$	10080	230	99 931110 270
50	50		Sn	-	-56780	710	8248	7	$\beta^+$	7390	660	99 939040 760
64	37	101	Rb	+	-43600	170	8216.4	1.6	$\beta^-$	11810	110	100 953200 180
63	38		Sr	+	-55410	120	8325.6	1.2	$\beta^-$	9510	80	100 940520 130
62	39		Y	+	-64910	100	8411.9	0.9	$\beta^-$	8540	90	100 930310 100
61	40		Zr	+	-73460	30	8488.8	0.3	$\beta^-$	5485	25	100 921140 30
60	41		Nb	+	-78942	19	8535.34	0.19	$\beta^-$	4569	18	100 915252 20
59	42		Mo	-n	-83511	6	8572.83	0.06	$\beta^-$	2825	25	100 910347 6
58	43		Tc	+	-86336	24	8593.05	0.24	$\beta^-$	1614	24	100 907315 26
57	44		Ru		-87949.7	2.0	8601.282	0.020	*			100 905582.1 2.2
56	45		Rh	+nn	-87408	17	8588.17	0.17	$\beta^+$	542	17	100 906164 18
55	46		Pd	-	-85428	18	8560.82	0.18	$\beta^+$	1980	4	100 908289 19
54	47		Ag	-	-81220	100	8511.5	1.0	$\beta^+$	4200	100	100 912800 110
53	48		Cd	-	-75750	150	8449.5	1.5	$\beta^+$	5480	110	100 918680 160
52	49		In	x	-68610#	300#	8371#	3#	$\beta^+$	7130#	330#	100 926340# 320#
51	50		Sn	x	-59560#	300#	8274#	3#	$\beta^+$	9050#	420#	100 936060# 320#
65	37	102	Rb	x	-38310#	500#	8163#	5#	$\beta^-$	14770#	520#	101 958870# 540#
64	38		Sr	+	-53080	110	8300.2	1.1	$\beta^-$	8810	70	101 943020 120
63	39		Y	+	-61890	90	8379.0	0.8	$\beta^-$	9850	70	101 933560 90
62	40		Zr	+	-71740	50	8467.9	0.5	$\beta^-$	4610	30	101 922980 50
61	41		Nb	+	-76350	40	8505.3	0.4	$\beta^-$	7210	40	101 918040 40
60	42		Mo	-nn	-83557	21	8568.37	0.20	$\beta^-$	1008	22	101 910297 22
59	43		Tc		-84566	9	8570.58	0.09	$\beta^-$	4532	9	101 909215 10
58	44		Ru		-89098.0	2.0	8607.344	0.020	$\beta^-$	-2323	5	101 904349.3 2.2
57	45		Rh		-86775	5	8576.90	0.05	$\beta^-$	1150	5	101 906843 5
56	46		Pd		-87925.1	3.0	8580.505	0.029	*			101 905609 3
55	47		Ag	x	-82265	28	8517.34	0.27	$\beta^+$	5660	28	101 911690 30
54	48		Cd	-	-79678	29	8484.31	0.28	$\beta^+$	2587	8	101 914460 30
53	49		In	-	-70710	110	8388.7	1.1	$\beta^+$	8970	110	101 924090 120
52	50		Sn	-	-64930	130	8324.4	1.3	$\beta^+$	5780	70	101 930300 140
65	38	103	Sr	x	-47550#	500#	8244#	5#	$\beta^-$	11380#	590#	102 948950# 540#
64	39		Y	x	-58940#	300#	8347#	3#	$\beta^-$	9440#	320#	102 936730# 320#
63	40		Zr	+	-68370	110	8431.3	1.1	$\beta^-$	6950	90	102 926600 120
62	41		Nb	+	-75320	70	8491.1	0.7	$\beta^-$	5530	30	102 919140 70
61	42		Mo	+	-80850	60	8537.2	0.6	$\beta^-$	3750	60	102 913210 70
60	43		Tc	+p	-84597	10	8566.04	0.10	$\beta^-$	2662	10	102 909181 11
59	44		Ru		-87258.8	2.0	8584.283	0.020	$\beta^-$	763.4	2.1	102 906323.8 2.2
58	45		Rh		-88022.2	2.8	8584.100	0.027	*			102 905504 3
57	46		Pd		-87479.1	2.9	8571.231	0.028	$\beta^+$	543.1	0.8	102 906087 3
56	47		Ag		-84791	17	8537.54	0.16	$\beta^+$	2688	17	102 908973 18
55	48		Cd		-80649	15	8489.73	0.15	$\beta^+$	4142	10	102 913419 17
54	49		In	-	-74599	25	8423.40	0.24	$\beta^+$	6050	20	102 919914 27
53	50		Sn	x	-66970#	300#	8342#	3#	$\beta^+$	7630#	300#	102 928100# 320#
52	51		Sb	x	-56180#	300#	8229#	3#	$\beta^+$	10800#	420#	102 939690# 320#

N	Z	A	Elt.	Orig.	Mass excess (keV)	Binding energy per nucleon (keV)	Beta-decay energy (keV)	Atomic mass $\mu$					
66	38	104	Sr	x	-44400#	700#	8212#	7#	$\beta^-$	10510#	810#	103 952330#	750#
65	39		Y	x	-54910#	400#	8306#	4#	$\beta^-$	11430#	570#	103 941050#	430#
64	40		Zr	x	-66340#	400#	8408#	4#	$\beta^-$	5880#	410#	103 928780#	430#
63	41		Nb	+	-72220	100	8457.4	1.0	$\beta^-$	8100	90	103 922460	110
62	42		Mo	+	-80330	50	8527.8	0.5	$\beta^-$	2157	28	103 913760	60
61	43		Tc	+	-82490	50	8541.0	0.4	$\beta^-$	5600	50	103 911450	50
60	44		Ru		-88089	3	8587.33	0.03	$\beta^-$	-1139	4	103 905433	3
59	45		Rh	-n	-86949.8	2.8	8568.858	0.027	$\beta^-$	2440	5	103 906656	3
58	46		Pd	+n	-89390	4	8584.80	0.04	*			103 904036	4
57	47		Ag	-	-85111	6	8536.14	0.06	$\beta^+$	4279	4	103 908629	6
56	48		Cd		-83975	9	8517.68	0.09	$\beta^+$	1137	11	103 909849	10
55	49		In		-76110	80	8434.5	0.8	$\beta^+$	7870	80	103 918300	90
54	50		Sn	-	-71590	100	8383.6	1.0	$\beta^+$	4510	60	103 923140	110
53	51		Sb	$+\alpha$	-59180#	360#	8257#	3#	$\beta^+$	12420#	380#	103 936470#	390#
67	38	105	Sr	x	-38580#	700#	8156#	7#	$\beta^-$	12770#	860#	104 958580#	750#
66	39		Y	x	-51350#	500#	8270#	5#	$\beta^-$	11010#	640#	104 944870#	540#
65	40		Zr	x	-62360#	400#	8367#	4#	$\beta^-$	8490#	410#	104 933050#	430#
64	41		Nb	+	-70850	100	8440.6	1.0	$\beta^-$	6490	70	104 923940	110
63	42		Mo	+	-77340	70	8494.9	0.7	$\beta^-$	4950	50	104 916970	80
62	43		Tc	+	-82290	60	8534.6	0.5	$\beta^-$	3640	60	104 911660	60
61	44		Ru		-85928	3	8561.835	0.030	$\beta^-$	1918	3	104 907753	3
60	45		Rh		-87846	4	8572.65	0.04	$\beta^-$	567.2	2.5	104 905694	4
59	46		Pd		-88413	4	8570.60	0.04	*			104 905085	4
58	47		Ag		-87068	11	8550.34	0.10	$\beta^+$	1345	11	104 906529	12
57	48		Cd		-84330	12	8516.82	0.11	$\beta^+$	2738	4	104 909468	12
56	49		In		-79481	17	8463.18	0.17	$\beta^+$	4849	13	104 914674	19
55	50		Sn	$+\alpha$	-73260	80	8396.5	0.8	$\beta^+$	6220	80	104 921350	90
54	51		Sb	-p	-63820	100	8299.1	1.0	$\beta^+$	9440	130	104 931490	110
53	52		Te	x	-52500#	500#	8184#	5#	$\beta^+$	11320#	510#	104 943640#	540#
67	39	106	Y	x	-46770#	700#	8225#	7#	$\beta^-$	12930#	860#	105 949790#	750#
66	40		Zr	x	-59700#	500#	8339#	5#	$\beta^-$	7400#	540#	105 935910#	540#
65	41		Nb	x	-67100#	200#	8402#	2#	$\beta^-$	9160#	200#	105 927970#	210#
64	42		Mo	+	-76255	18	8480.72	0.17	$\beta^-$	3520	12	105 918137	19
63	43		Tc	+	-79775	13	8506.55	0.13	$\beta^-$	6547	11	105 914358	14
62	44		Ru	+	-86322	8	8560.93	0.07	$\beta^-$	39.40	0.21	105 907329	8
61	45		Rh	+	-86361	8	8553.92	0.07	$\beta^-$	3541	6	105 907287	8
60	46		Pd		-89902	4	8579.94	0.04	$\beta^-$	-2965.1	2.8	105 903486	4
59	47		Ag		-86937	5	8544.59	0.05	$\beta^-$	195	8	105 906669	5
58	48		Cd		-87132	6	8539.05	0.06	*			105 906459	6
57	49		In		-80606	12	8470.10	0.12	$\beta^+$	6526	11	105 913465	13
56	50		Sn		-77430	50	8432.7	0.5	$\beta^+$	3180	50	105 916880	50
55	51		Sb	$+\alpha$	-66330#	310#	8321#	3#	$\beta^+$	11100#	320#	105 928790#	340#
54	52		Te	$-\alpha$	-58210	130	8236.7	1.2	$\beta^+$	8120#	340#	105 937500	140
68	39	107	Y	x	-42720#	500#	8185#	5#	$\beta^-$	12470#	590#	106 954140#	540#
67	40		Zr	x	-55190#	300#	8295#	3#	$\beta^-$	9730#	500#	106 940750#	320#
66	41		Nb	x	-64920#	400#	8378#	4#	$\beta^-$	8030#	430#	106 930310#	430#
65	42		Mo	+	-72940	160	8445.9	1.5	$\beta^-$	6160	60	106 921690	170
64	43		Tc	+	-79100	150	8496.2	1.4	$\beta^-$	4820	90	106 915080	160
63	44		Ru	+	-83920	120	8533.9	1.2	$\beta^-$	2940	120	106 909910	130
62	45		Rh		-86863	12	8554.10	0.11	$\beta^-$	1504	12	106 906748	13
61	46		Pd		-88368	4	8560.85	0.04	$\beta^-$	34.1	2.7	106 905133	4
60	47		Ag		-88402	4	8553.85	0.04	*			106 905097	5
59	48		Cd		-86985	6	8533.30	0.05	$\beta^+$	1417	4	106 906618	6
58	49		In		-83560	11	8493.98	0.11	$\beta^+$	3425	10	106 910295	12
57	50		Sn		-78580	80	8440.1	0.8	$\beta^+$	4980	80	106 915640	90
56	51		Sb	x	-70650#	300#	8359#	3#	$\beta^+$	7920#	310#	106 924150#	320#
55	52		Te	$-\alpha$	-60540#	300#	8257#	3#	$\beta^+$	10110#	420#	106 935010#	320#

<i>N</i>	<i>Z</i>	<i>A</i>	Elt.	Orig.	Mass excess (keV)		Binding energy per nucleon (keV)		Beta-decay energy (keV)		Atomic mass $\mu$		
69	39	108	Y	x	-37740#	800#	8138#	7#	$\beta^-$	14460#	1000#	107 959480#	860#
68	40		Zr	x	-52200#	600#	8265#	6#	$\beta^-$	8500#	670#	107 943960#	640#
67	41		Nb	x	-60700#	300#	8336#	3#	$\beta^-$	10610#	360#	107 934840#	320#
66	42		Mo	+	-71300#	200#	8427#	2#	$\beta^-$	4650#	150#	107 923450#	210#
65	43		Tc	+	-75950	130	8463.1	1.2	$\beta^-$	7720	50	107 918460	140
64	44		Ru	+	-83670	120	8527.3	1.1	$\beta^-$	1350	50	107 910170	120
63	45		Rh	+	-85020	110	8532.6	1.0	$\beta^-$	4500	110	107 908730	110
62	46		Pd		-89524	3	8567.02	0.03	$\beta^-$	-1922	5	107 903892	4
61	47		Ag	-n	-87602	4	8541.98	0.04	$\beta^-$	1650	7	107 905956	5
60	48		Cd		-89252	6	8550.02	0.05		*		107 904184	6
59	49		In		-84116	10	8495.21	0.09	$\beta^+$	5137	9	107 909698	10
58	50		Sn		-82041	20	8468.76	0.18	$\beta^+$	2075	19	107 911925	21
57	51		Sb	x	-72510#	210#	8373#	2#	$\beta^+$	9530#	210#	107 922160#	220#
56	52		Te	$-\alpha$	-65720	100	8303.2	1.0	$\beta^+$	6790#	230#	107 929440	110
55	53		I	-p	-52650#	360#	8175#	3#	$\beta^+$	13070#	370#	107 943480#	390#
69	40	109	Zr	x	-47280#	500#	8218#	5#	$\beta^-$	10820#	710#	108 949240#	540#
68	41		Nb	x	-58100#	500#	8310#	5#	$\beta^-$	9150#	590#	108 937630#	540#
67	42		Mo	x	-67250#	300#	8387#	3#	$\beta^-$	7290#	310#	108 927810#	320#
66	43		Tc	+	-74540	100	8446.5	0.9	$\beta^-$	6310	70	108 919980	100
65	44		Ru	+	-80850	70	8497.3	0.6	$\beta^-$	4160	70	108 913200	70
64	45		Rh	+p	-85011	12	8528.24	0.11	$\beta^-$	2596	12	108 908737	13
63	46		Pd		-87607	3	8544.88	0.03	$\beta^-$	1116.1	2.0	108 905950	4
62	47		Ag		-88722.7	2.9	8547.944	0.027		*		108 904752	3
61	48		Cd		-88508	4	8538.80	0.04	$\beta^+$	214.2	2.9	108 904982	4
60	49		In		-86489	6	8513.09	0.05	$\beta^+$	2020	6	108 907151	6
59	50		Sn	+3n	-82639	10	8470.60	0.09	$\beta^+$	3850	11	108 911283	11
58	51		Sb	-	-76259	19	8404.89	0.17	$\beta^+$	6380	16	108 918132	20
57	52		Te	ep	-67610	60	8318.4	0.6	$\beta^+$	8650	70	108 927420	70
56	53		I	-p	-57610	100	8219.5	1.0	$\beta^+$	10000	120	108 938150	110
70	40	110	Zr	x	-43900#	800#	8186#	7#	$\beta^-$	9720#	950#	109 952870#	860#
69	41		Nb	x	-53620#	500#	8267#	5#	$\beta^-$	11840#	640#	109 942440#	540#
68	42		Mo	x	-65460#	400#	8368#	4#	$\beta^-$	5510#	410#	109 929730#	430#
67	43		Tc	+	-70960	80	8410.6	0.7	$\beta^-$	9020	60	109 923820	80
66	44		Ru		-79980	50	8485.5	0.5	$\beta^-$	2790	40	109 914140	60
65	45		Rh		-82780	50	8503.8	0.5	$\beta^-$	5570	50	109 911140	50
64	46		Pd		-88349	11	8547.33	0.10	$\beta^-$	-889	11	109 905153	12
63	47		Ag		-87460.6	2.9	8532.138	0.026	$\beta^-$	2892.4	1.6	109 906107	3
62	48		Cd		-90353.0	2.7	8551.320	0.024		*		109 903002.1	2.9
61	49		In	-	-86475	12	8508.95	0.11	$\beta^+$	3878	12	109 907165	13
60	50		Sn	x	-85844	14	8496.10	0.13	$\beta^+$	631	18	109 907843	15
59	51		Sb	-	-77540#	200#	8414#	2#	$\beta^+$	8300#	200#	109 916750#	220#
58	52		Te	$-\alpha$	-72280	50	8358.5	0.5	$\beta^+$	5270#	210#	109 922410	60
57	53		I	+ $\alpha$	-60320#	310#	8243#	3#	$\beta^+$	11960#	310#	109 935240#	330#
56	54		Xe	$-\alpha$	-51900	130	8159.1	1.2	$\beta^+$	8420#	340#	109 944280	140
70	41	111	Nb	x	-50630#	500#	8238#	5#	$\beta^-$	10470#	640#	110 945650#	540#
69	42		Mo	x	-61100#	400#	8326#	4#	$\beta^-$	8120#	420#	110 934410#	430#
68	43		Tc	+	-69220	110	8391.8	1.0	$\beta^-$	7450	80	110 925690	120
67	44		Ru	x	-76670	70	8451.9	0.7	$\beta^-$	5690	80	110 917700	80
66	45		Rh	+	-82357	30	8496.11	0.27	$\beta^-$	3647	28	110 911590	30
65	46		Pd	-n	-86004	11	8521.91	0.10	$\beta^-$	2217	11	110 907671	12
64	47		Ag	+	-88221	3	8534.834	0.027	$\beta^-$	1036.8	1.4	110 905291	3
63	48		Cd		-89257.5	2.7	8537.127	0.024		*		110 904178.1	2.9
62	49		In		-88396	5	8522.31	0.04	$\beta^+$	862	5	110 905103	5
61	50		Sn	+n	-85945	7	8493.19	0.06	$\beta^+$	2451	7	110 907734	7
60	51		Sb	x	-80888	28	8440.58	0.25	$\beta^+$	5057	29	110 913160	30
59	52		Te	ep	-73480	70	8366.8	0.6	$\beta^+$	7400	80	110 921110	80
58	53		I	$-\alpha$	-64950#	300#	8283#	3#	$\beta^+$	8540#	310#	110 930280#	320#
57	54		Xe	$-\alpha$	-54400#	300#	8181#	3#	$\beta^+$	10550#	430#	110 941600#	330#

N	Z	A	Elt.	Orig.	Mass excess (keV)		Binding energy per nucleon (keV)		Beta-decay energy (keV)		Atomic mass $\mu$ u		
71	41	112	Nb	x	-45800#	700#	8194#	6#	$\beta^-$	13030#	920#	111 950830#	750#
70	42		Mo	x	-58830#	600#	8303#	5#	$\beta^-$	7170#	610#	111 936840#	640#
69	43		Tc	+	-66000	120	8360.2	1.1	$\beta^-$	9480	100	111 929150	130
68	44		Ru	x	-75480	70	8437.9	0.7	$\beta^-$	4260	90	111 918970	80
67	45		Rh	+	-79740	50	8469.0	0.5	$\beta^-$	6600	50	111 914390	60
66	46		Pd		-86336	18	8520.86	0.16	$\beta^-$	288	17	111 907314	19
65	47		Ag		-86624	17	8516.44	0.15	$\beta^-$	3956	17	111 907005	18
64	48		Cd		-90580.5	2.7	8544.780	0.024	$\beta^-$	-2584	5	111 902757.8	2.9
63	49		In		-87996	5	8514.72	0.05	$\beta^-$	665	5	111 905532	6
62	50		Sn		-88661	4	8513.67	0.04	*			111 904818	5
61	51		Sb	x	-81601	18	8443.65	0.16	$\beta^+$	7061	18	111 912398	19
60	52		Te	2p-n	-77300	170	8398.3	1.5	$\beta^+$	4300	170	111 917010	180
59	53		I	$-\alpha$	-67100#	210#	8300#	2#	$\beta^+$	10210#	270#	111 927970#	230#
58	54		Xe	$-\alpha$	-59970	100	8229.5	0.9	$\beta^+$	7130#	240#	111 935620	110
57	55		Cs	-p	-46290#	300#	8100#	3#	$\beta^+$	13670#	320#	111 950300#	330#
72	41	113	Nb	x	-42200#	800#	8161#	7#	$\beta^-$	11940#	1000#	112 954700#	860#
71	42		Mo	x	-54140#	600#	8260#	5#	$\beta^-$	9590#	670#	112 941880#	640#
70	43		Tc	x	-63720#	300#	8338#	3#	$\beta^-$	8480#	310#	112 931590#	320#
69	44		Ru	+	-72200	70	8405.6	0.6	$\beta^-$	6480	50	112 922490	80
68	45		Rh		-78680	50	8456.1	0.4	$\beta^-$	5010	40	112 915530	50
67	46		Pd		-83690	40	8493.5	0.3	$\beta^-$	3340	30	112 910150	40
66	47		Ag		-87033	17	8516.12	0.15	$\beta^-$	2017	16	112 906567	18
65	48		Cd		-89049.3	2.7	8527.040	0.024	$\beta^-$	320	3	112 904401.7	2.9
64	49		In		-89370	3	8522.951	0.028	*			112 904058	3
63	50		Sn		-88333	4	8506.85	0.04	$\beta^+$	1036.6	2.7	112 905171	4
62	51		Sb	-	-84420	18	8465.30	0.16	$\beta^+$	3913	17	112 909372	19
61	52		Te	x	-78347	28	8404.64	0.25	$\beta^+$	6070	30	112 915890	30
60	53		I	$-\alpha$	-71130	50	8333.8	0.5	$\beta^+$	7220	60	112 923640	60
59	54		Xe	$-\alpha$	-62090	80	8246.9	0.7	$\beta^+$	9040	100	112 933340	90
58	55		Cs	-p	-51700	100	8148.1	0.9	$\beta^+$	10390	130	112 944490	110
72	42	114	Mo	x	-51310#	700#	8233#	6#	$\beta^-$	8420#	920#	113 944920#	750#
71	43		Tc	x	-59730#	600#	8300#	5#	$\beta^-$	10800#	640#	113 935880#	640#
70	44		Ru	+	-70530#	230#	8388#	2#	$\beta^-$	5100#	200#	113 924280#	250#
69	45		Rh	x	-75630	110	8425.9	1.0	$\beta^-$	7860	120	113 918810	120
68	46		Pd		-83497	24	8488.06	0.21	$\beta^-$	1452	18	113 910363	25
67	47		Ag		-84949	25	8493.94	0.22	$\beta^-$	5072	25	113 908804	27
66	48		Cd		-90020.9	2.7	8531.565	0.023	$\beta^-$	-1449	3	113 903358.5	2.9
65	49		In		-88572	3	8511.994	0.028	$\beta^-$	1988.7	0.7	113 904914	3
64	50		Sn		-90561	3	8522.576	0.028	*			113 902779	3
63	51		Sb	x	-84515	28	8462.68	0.25	$\beta^+$	6046	28	113 909270	30
62	52		Te	x	-81889	28	8432.78	0.25	$\beta^+$	2630	40	113 912090	30
61	53		I	x	-72800#	300#	8346#	3#	$\beta^+$	9090#	300#	113 921850#	320#
60	54		Xe	x	-67086	11	8289.20	0.10	$\beta^+$	5710#	300#	113 927980	12
59	55		Cs	$\epsilon$ p	-54540#	310#	8172#	3#	$\beta^+$	12550#	310#	113 941450#	330#
58	56		Ba	$-\alpha$	-45950	140	8090.0	1.2	$\beta^+$	8590#	340#	113 950680	150
73	42	115	Mo	x	-46310#	800#	8188#	7#	$\beta^-$	10810#	1060#	114 950290#	860#
72	43		Tc	x	-57110#	700#	8275#	6#	$\beta^-$	9320#	710#	114 938690#	750#
71	44		Ru	+	-66430	130	8349.6	1.1	$\beta^-$	7780	100	114 928690	140
70	45		Rh	x	-74210	80	8410.5	0.7	$\beta^-$	6190	100	114 920330	90
69	46		Pd	+	-80400	60	8457.5	0.5	$\beta^-$	4580	50	114 913680	70
68	47		Ag	+	-84990	30	8490.6	0.3	$\beta^-$	3100	30	114 908760	40
67	48		Cd		-88090.5	2.7	8510.777	0.024	$\beta^-$	1446	4	114 905431.0	2.9
66	49		In		-89537	4	8516.55	0.04	$\beta^-$	499	4	114 903878	5
65	50		Sn		-90036.0	2.9	8514.088	0.026	*			114 903342	3
64	51		Sb	x	-87003	16	8480.91	0.14	$\beta^+$	3033	16	114 906598	17
63	52		Te	x	-82063	28	8431.15	0.24	$\beta^+$	4940	30	114 911900	30
62	53		I	x	-76338	29	8374.56	0.25	$\beta^+$	5720	40	114 918050	30
61	54		Xe	x	-68657	12	8300.97	0.11	$\beta^+$	7680	30	114 926294	13
60	55		Cs	x	-59700#	300#	8216#	3#	$\beta^+$	8960#	300#	114 935910#	320#
59	56		Ba	x	-49030#	600#	8117#	5#	$\beta^+$	10680#	670#	114 947370#	640#

N	Z	A	Elt.	Orig.	Mass excess (keV)		Binding energy per nucleon (keV)		Beta-decay energy (keV)		Atomic mass $\mu$		
73	43	116	Tc	x	-52750#	700#	8236#	6#	$\beta^-$	11700#	990#	115 943370#	750#
72	44		Ru	x	-64450#	700#	8330#	6#	$\beta^-$	6290#	710#	115 930810#	750#
71	45		Rh	x	-70740	140	8377.6	1.2	$\beta^-$	9220	150	115 924060	150
70	46		Pd	+	-79960	60	8450.4	0.5	$\beta^-$	2610	30	115 914160	60
69	47		Ag	+	-82570	50	8466.1	0.4	$\beta^-$	6150	50	115 911360	50
68	48		Cd		-88719	3	8512.410	0.027	$\beta^-$	-469	5	115 904756	3
67	49		In	-n	-88250	4	8501.62	0.04	$\beta^-$	3278	4	115 905260	5
66	50		Sn		-91528.1	2.9	8523.134	0.025	*			115 901741	3
65	51		Sb		-86821	6	8475.81	0.05	$\beta^+$	4707	5	115 906794	6
64	52		Te	x	-85269	28	8455.69	0.24	$\beta^+$	1552	29	115 908460	30
63	53		I	+	-77490	100	8381.9	0.8	$\beta^+$	7780	100	115 916810	100
62	54		Xe	x	-73047	13	8336.83	0.11	$\beta^+$	4450	100	115 921581	14
61	55		Cs	-p	-62070#	100#	8235#	1#	$\beta^+$	10980#	100#	115 933370#	110#
60	56		Ba	x	-54600#	400#	8164#	3#	$\beta^+$	7460#	410#	115 941380#	430#
74	43	117	Tc	x	-49850#	700#	8210#	6#	$\beta^-$	10150#	990#	116 946480#	750#
73	44		Ru	x	-60010#	700#	8290#	6#	$\beta^-$	8940#	860#	116 935580#	750#
72	45		Rh	x	-68950#	500#	8360#	4#	$\beta^-$	7580#	510#	116 925980#	540#
71	46		Pd	+	-76530	60	8417.8	0.5	$\beta^-$	5730	30	116 917840	60
70	47		Ag	+	-82270	50	8460.2	0.4	$\beta^-$	4160	50	116 911680	50
69	48		Cd	-n	-86425	3	8489.032	0.028	$\beta^-$	2520	6	116 907219	4
68	49		In		-88945	6	8503.88	0.05	$\beta^-$	1455	5	116 904514	6
67	50		Sn		-90400.0	2.9	8509.630	0.025	*			116 902952	3
66	51		Sb		-88645	9	8487.94	0.08	$\beta^+$	1755	9	116 904836	10
65	52		Te	x	-85097	13	8450.93	0.11	$\beta^+$	3548	16	116 908645	14
64	53		I	x	-80435	28	8404.40	0.24	$\beta^+$	4660	30	116 913650	30
63	54		Xe	x	-74185	10	8344.30	0.09	$\beta^+$	6249	30	116 920359	11
62	55		Cs		-66440	60	8271.4	0.5	$\beta^+$	7740	60	116 928670	70
61	56		Ba	ep	-57290#	300#	8186#	3#	$\beta^+$	9160#	310#	116 938500#	320#
60	57		La	-p	-46510#	400#	8088#	3#	$\beta^+$	10780#	500#	116 950070#	430#
75	43	118	Tc	x	-45200#	900#	8169#	8#	$\beta^-$	12720#	1210#	117 951480#	970#
74	44		Ru	x	-57920#	800#	8270#	7#	$\beta^-$	7220#	950#	117 937820#	860#
73	45		Rh	x	-65140#	500#	8325#	4#	$\beta^-$	10330#	550#	117 930070#	540#
72	46		Pd	+	-75470	210	8405.9	1.8	$\beta^-$	4100	200	117 918980	230
71	47		Ag	+	-79570	60	8434.0	0.5	$\beta^-$	7140	60	117 914580	70
70	48		Cd	-nn	-86709	20	8487.89	0.17	$\beta^-$	522	22	117 906915	22
69	49		In		-87230	8	8485.68	0.07	$\beta^-$	4426	8	117 906354	9
68	50		Sn		-91656.1	2.9	8516.561	0.024	*			117 901603	3
67	51		Sb	-	-87999	4	8478.94	0.04	$\beta^+$	3656.6	3.0	117 905529	4
66	52		Te	+nn	-87721	15	8469.95	0.13	$\beta^+$	278	15	117 905828	16
65	53		I	x	-80971	20	8406.12	0.17	$\beta^+$	6750	25	117 913074	21
64	54		Xe	x	-78079	10	8374.98	0.09	$\beta^+$	2892	22	117 916179	11
63	55		Cs		-68409	13	8286.40	0.11	$\beta^+$	9670	16	117 926559	14
62	56		Ba	x	-62370#	200#	8229#	2#	$\beta^+$	6040#	200#	117 933040#	210#
61	57		La	x	-49620#	300#	8114#	3#	$\beta^+$	12750#	360#	117 946730#	320#
75	44	119	Ru	x	-53240#	700#	8229#	6#	$\beta^-$	10000#	920#	118 942840#	750#
74	45		Rh	x	-63240#	600#	8307#	5#	$\beta^-$	8380#	670#	118 932110#	640#
73	46		Pd	x	-71620#	300#	8371#	3#	$\beta^-$	6940#	310#	118 923110#	320#
72	47		Ag	+	-78560	90	8422.5	0.8	$\beta^-$	5350	40	118 915670	100
71	48		Cd	+	-83910	80	8460.9	0.7	$\beta^-$	3800	80	118 909920	90
70	49		In		-87704	8	8486.19	0.06	$\beta^-$	2364	8	118 905845	8
69	50		Sn		-90068.4	2.9	8499.477	0.024	*			118 903308	3
68	51		Sb		-89477	8	8487.94	0.07	$\beta^+$	591	8	118 903942	9
67	52		Te	-	-87184	8	8462.09	0.07	$\beta^+$	2293.0	2.0	118 906404	9
66	53		I	x	-83766	28	8426.79	0.23	$\beta^+$	3419	29	118 910070	30
65	54		Xe	x	-78794	10	8378.44	0.09	$\beta^+$	4971	30	118 915411	11
64	55		Cs	IT	-72305	14	8317.33	0.12	$\beta^+$	6489	17	118 922377	15
63	56		Ba	ep	-64590	200	8245.9	1.7	$\beta^+$	7710	200	118 930660	210
62	57		La	x	-54970#	400#	8158#	3#	$\beta^+$	9620#	450#	118 940990#	430#
61	58		Ce	x	-44000#	600#	8060#	5#	$\beta^+$	10960#	720#	118 952760#	640#



N	Z	A	Elt.	Orig.	Mass excess (keV)		Binding energy per nucleon (keV)		Beta-decay energy (keV)		Atomic mass $\mu$		
76	44	120	Ru	x	-50940#	800#	8209#	7#	$\beta^-$	8290#	1000#	119 945310#	860#
75	45		Rh	x	-59230#	600#	8272#	5#	$\beta^-$	10920#	610#	119 936410#	640#
74	46		Pd	+	-70150	120	8356.0	1.0	$\beta^-$	5500	100	119 924690	130
73	47		Ag	+	-75650	70	8395.3	0.6	$\beta^-$	8320	70	119 918790	80
72	48		Cd	+ $\alpha$	-83974	19	8458.16	0.16	$\beta^-$	1760	40	119 909850	20
71	49		In	+	-85740	40	8466.3	0.3	$\beta^-$	5370	40	119 907960	40
70	50		Sn		-91105.1	2.5	8504.548	0.021	$\beta^-$	-2681	7	119 902194.7	2.7
69	51		Sb	-	-88424	8	8475.69	0.06	$\beta^-$	980	12	119 905072	8
68	52		Te		-89405	10	8477.34	0.08	*			119 904020	10
67	53		I	-	-83790	18	8424.03	0.15	$\beta^+$	5615	15	119 910048	19
66	54		Xe	x	-82172	12	8404.03	0.10	$\beta^+$	1617	21	119 911784	13
65	55		Cs	IT	-73889	10	8328.48	0.08	$\beta^+$	8284	15	119 920677	11
64	56		Ba	-	-68890	300	8280.3	2.5	$\beta^+$	5000	300	119 926040	320
63	57		La	x	-57690#	500#	8180#	4#	$\beta^+$	11200#	590#	119 938070#	540#
62	58		Ce	x	-49710#	700#	8107#	6#	$\beta^+$	7980#	860#	119 946640#	750#
76	45	121	Rh	x	-57080#	900#	8252#	7#	$\beta^-$	9180#	1030#	120 938720#	970#
75	46		Pd	x	-66260#	500#	8321#	4#	$\beta^-$	8400#	520#	120 928870#	540#
74	47		Ag	+	-74660	150	8384.5	1.2	$\beta^-$	6400	120	120 919850	160
73	48		Cd	+	-81060	80	8430.9	0.7	$\beta^-$	4780	80	120 912980	90
72	49		In	+p	-85841	27	8463.93	0.23	$\beta^-$	3363	27	120 907846	29
71	50		Sn		-89204.1	2.5	8485.257	0.021	$\beta^-$	391.0	2.1	120 904235.5	2.7
70	51		Sb		-89595.1	2.2	8482.023	0.018	*			120 903815.7	2.4
69	52		Te		-88551	26	8466.93	0.21	$\beta^+$	1044	26	120 904936	28
68	53		I		-86287	10	8441.75	0.09	$\beta^+$	2264	27	120 907367	11
67	54		Xe	x	-82473	11	8403.76	0.09	$\beta^+$	3814	15	120 911462	12
66	55		Cs	x	-77100	14	8352.90	0.11	$\beta^+$	5372	18	120 917229	15
65	56		Ba	-	-70740	140	8293.9	1.2	$\beta^+$	6360	140	120 924050	150
64	57		La	x	-62400#	500#	8218#	4#	$\beta^+$	8340#	520#	120 933010#	540#
63	58		Ce	x	-52700#	500#	8132#	4#	$\beta^+$	9700#	710#	120 943420#	540#
62	59		Pr	-p	-41580#	700#	8033#	6#	$\beta^+$	11130#	860#	120 955360#	750#
77	45	122	Rh	x	-52900#	700#	8216#	6#	$\beta^-$	11790#	810#	121 943210#	750#
76	46		Pd	x	-64690#	400#	8307#	3#	$\beta^-$	6540#	450#	121 930550#	430#
75	47		Ag	x	-71230#	210#	8354#	2#	$\beta^-$	9500#	210#	121 923530#	220#
74	48		Cd	+pp	-80730	40	8425.2	0.4	$\beta^-$	2850	70	121 913330	50
73	49		In	+	-83580	50	8442.2	0.4	$\beta^-$	6370	50	121 910280	50
72	50		Sn		-89945.9	2.7	8487.945	0.022	$\beta^-$	-1615.8	2.8	121 903439.0	2.9
71	51		Sb		-88330.2	2.2	8468.288	0.018	$\beta^-$	1983.9	1.9	121 905173.7	2.4
70	52		Te		-90314.0	1.5	8478.137	0.012	*			121 903043.9	1.6
69	53		I	-	-86080	5	8437.02	0.04	$\beta^+$	4234	5	121 907589	6
68	54		Xe	x	-85355	11	8424.66	0.09	$\beta^+$	725	12	121 908368	12
67	55		Cs		-78140	30	8359.11	0.26	$\beta^+$	7220	30	121 916110	30
66	56		Ba	x	-74609	28	8323.76	0.23	$\beta^+$	3530	40	121 919900	30
65	57		La	x	-64540#	300#	8235#	2#	$\beta^+$	10070#	300#	121 930710#	320#
64	58		Ce	x	-57840#	400#	8173#	3#	$\beta^+$	6710#	500#	121 937910#	430#
63	59		Pr	x	-44890#	500#	8061#	4#	$\beta^+$	12950#	640#	121 951810#	540#
77	46	123	Pd	x	-60610#	600#	8272#	5#	$\beta^-$	9340#	630#	122 934930#	640#
76	47		Ag	x	-69960#	210#	8341#	2#	$\beta^-$	7360#	210#	122 924900#	220#
75	48		Cd	+	-77310	40	8394.6	0.3	$\beta^-$	6120	30	122 917000	40
74	49		In	+	-83426	24	8437.91	0.20	$\beta^-$	4394	24	122 910438	26
73	50		Sn		-87820.5	2.7	8467.278	0.022	$\beta^-$	1403.6	2.9	122 905720.8	2.9
72	51		Sb		-89224.1	2.1	8472.329	0.017	*			122 904214.0	2.2
71	52		Te		-89171.9	1.5	8465.544	0.012	$\beta^+$	52.2	1.5	122 904270.0	1.6
70	53		I		-87943	4	8449.19	0.03	$\beta^+$	1229	3	122 905589	4
69	54		Xe		-85249	10	8420.93	0.08	$\beta^+$	2695	10	122 908482	10
68	55		Cs	x	-81044	12	8380.38	0.10	$\beta^+$	4205	15	122 912996	13
67	56		Ba	x	-75655	12	8330.21	0.10	$\beta^+$	5389	17	122 918781	13
66	57		La	x	-68710#	200#	8267#	2#	$\beta^+$	6950#	200#	122 926240#	210#
65	58		Ce	x	-60180#	300#	8192#	2#	$\beta^+$	8530#	360#	122 935400#	320#
64	59		Pr	x	-50340#	600#	8105#	5#	$\beta^+$	9840#	670#	122 945960#	640#

N	Z	A	Elt.	Orig.	Mass excess (keV)		Binding energy per nucleon (keV)		Beta-decay energy (keV)		Atomic mass $\mu$		
78	46	124	Pd	x	-58800#	500#	8255#	4#	$\beta^-$	7680#	540#	123 936880#	540#
77	47		Ag	x	-66470#	200#	8311#	2#	$\beta^-$	10240#	210#	123 928640#	210#
76	48		Cd	+	-76710	60	8387.1	0.5	$\beta^-$	4170	40	123 917650	70
75	49		In	+	-80880	50	8414.4	0.4	$\beta^-$	7360	50	123 913180	50
74	50		Sn		-88236.8	1.4	8467.441	0.011	$\beta^-$	-616.5	2.1	123 905273.9	1.5
73	51		Sb		-87620.3	2.1	8456.161	0.017	$\beta^-$	2904.3	1.5	123 905935.7	2.2
72	52		Te		-90524.5	1.5	8473.273	0.012	$\beta^-$	-3159.6	1.9	123 902817.9	1.6
71	53		I	-	-87365.0	2.4	8441.483	0.019	$\beta^-$	295.1	2.8	123 906209.9	2.5
70	54		Xe		-87660.1	1.8	8437.554	0.015	*			123 905893.0	2.0
69	55		Cs	x	-81731	8	8383.43	0.07	$\beta^+$	5929	9	123 912258	9
68	56		Ba	x	-79090	12	8355.82	0.10	$\beta^+$	2642	15	123 915094	13
67	57		La	x	-70260	60	8278.3	0.5	$\beta^+$	8830	60	123 924570	60
66	58		Ce	x	-64820#	300#	8228#	2#	$\beta^+$	5440#	300#	123 930410#	320#
65	59		Pr	x	-53130#	600#	8128#	5#	$\beta^+$	11690#	670#	123 942960#	640#
64	60		Nd	x	-44500#	600#	8052#	5#	$\beta^+$	8640#	840#	123 952230#	640#
78	47	125	Ag	x	-64800#	300#	8296#	2#	$\beta^-$	8550#	310#	124 930430#	320#
77	48		Cd	+	-73360	70	8357.8	0.6	$\beta^-$	7120	60	124 921250	70
76	49		In	+	-80480	30	8408.48	0.24	$\beta^-$	5420	30	124 913600	30
75	50		Sn	-n	-85898.5	1.5	8445.567	0.012	$\beta^-$	2357.0	2.7	124 907784.1	1.6
74	51		Sb	+	-88255.5	2.6	8458.164	0.021	$\beta^-$	766.7	2.1	124 905253.8	2.8
73	52		Te		-89022.2	1.5	8458.039	0.012	*			124 904430.7	1.6
72	53		I	-	-88836.4	1.5	8450.294	0.012	$\beta^+$	185.77	0.06	124 904630.2	1.6
71	54		Xe		-87192.1	1.9	8430.880	0.015	$\beta^+$	1644.4	2.2	124 906395.5	2.0
70	55		Cs		-84088	8	8399.79	0.06	$\beta^+$	3104	8	124 909728	8
69	56		Ba	x	-79668	11	8358.17	0.09	$\beta^+$	4420	14	124 914473	12
68	57		La	x	-73759	26	8304.64	0.21	$\beta^+$	5909	28	124 920816	28
67	58		Ce	x	-66660#	200#	8242#	2#	$\beta^+$	7100#	200#	124 928440#	210#
66	59		Pr	x	-57910#	400#	8165#	3#	$\beta^+$	8750#	450#	124 937830#	430#
65	60		Nd	x	-47620#	400#	8077#	3#	$\beta^+$	10290#	570#	124 948880#	430#
79	47	126	Ag	x	-61010#	300#	8264#	2#	$\beta^-$	11320#	300#	125 934500#	320#
78	48		Cd	+	-72330	50	8347.3	0.4	$\beta^-$	5490	40	125 922350	60
77	49		In	+	-77810	40	8384.6	0.3	$\beta^-$	8210	40	125 916460	40
76	50		Sn	-nn	-86020	11	8443.56	0.08	$\beta^-$	380	30	125 907653	11
75	51		Sb	-	-86400	30	8440.35	0.25	$\beta^-$	3670	30	125 907250	30
74	52		Te		-90064.6	1.5	8463.242	0.012	$\beta^-$	-2154	4	125 903311.7	1.6
73	53		I		-87911	4	8439.937	0.030	$\beta^-$	1258	5	125 905624	4
72	54		Xe	-	-89169	6	8443.71	0.05	*			125 904274	7
71	55		Cs	x	-84345	12	8399.22	0.10	$\beta^+$	4824	14	125 909452	13
70	56		Ba	x	-82670	12	8379.72	0.10	$\beta^+$	1675	17	125 911250	13
69	57		La	x	-74970	90	8312.4	0.7	$\beta^+$	7700	90	125 919510	100
68	58		Ce	x	-70821	28	8273.26	0.22	$\beta^+$	4150	90	125 923970	30
67	59		Pr	x	-60260#	200#	8183#	2#	$\beta^+$	10560#	200#	125 935310#	210#
66	60		Nd	x	-52890#	400#	8119#	3#	$\beta^+$	7370#	450#	125 943220#	430#
65	61		Pm	x	-39570#	500#	8007#	4#	$\beta^+$	13320#	640#	125 957520#	540#
80	47	127	Ag	x	-58900#	300#	8246#	2#	$\beta^-$	9620#	310#	126 936770#	320#
79	48		Cd	+	-68520	70	8315.1	0.6	$\beta^-$	8470	60	126 926440	80
78	49		In	+	-76990	40	8375.6	0.3	$\beta^-$	6510	30	126 917350	40
77	50		Sn	+	-83499	25	8420.78	0.19	$\beta^-$	3201	24	126 910360	26
76	51		Sb	+	-86700	5	8439.82	0.04	$\beta^-$	1581	5	126 906924	6
75	52		Te		-88281.1	1.5	8446.113	0.012	$\beta^-$	702	3	126 905226.3	1.6
74	53		I		-88983	4	8445.481	0.028	*			126 904473	4
73	54		Xe		-88321	4	8434.11	0.03	$\beta^+$	662.3	2.0	126 905184	4
72	55		Cs		-86240	6	8411.56	0.04	$\beta^+$	2081	6	126 907418	6
71	56		Ba	x	-82816	11	8378.44	0.09	$\beta^+$	3424	13	126 911094	12
70	57		La	x	-77896	26	8333.54	0.20	$\beta^+$	4920	28	126 916375	28
69	58		Ce	x	-71980	60	8280.8	0.5	$\beta^+$	5920	60	126 922730	60
68	59		Pr	x	-64430#	200#	8215#	2#	$\beta^+$	7540#	200#	126 930830#	210#
67	60		Nd	x	-55420#	400#	8138#	3#	$\beta^+$	9010#	450#	126 940500#	430#
66	61		Pm	x	-45060#	600#	8050#	5#	$\beta^+$	10370#	720#	126 951630#	640#

N	Z	A	Elt.	Orig.	Mass excess (keV)	Binding energy per nucleon (keV)	Beta-decay energy (keV)	Atomic mass $\mu$					
81	47	128	Ag	x	-54800#	300#	8212#	2#	$\beta^-$	12490#	420#	127 941170#	320#
80	48		Cd	+	-67290	290	8303.6	2.3	$\beta^-$	7070	290	127 927760	320
79	49		In	+	-74360	50	8352.8	0.4	$\beta^-$	8980	40	127 920170	50
78	50		Sn	+	-83335	27	8416.76	0.21	$\beta^-$	1274	15	127 910537	29
77	51		Sb	IT	-84609	25	8420.61	0.20	$\beta^-$	4384	25	127 909169	27
76	52		Te		-88992.1	1.7	8448.740	0.014	$\beta^-$	-1254	4	127 904463.1	1.9
75	53		I		-87738	4	8432.829	0.028	$\beta^-$	2122	4	127 905809	4
74	54		Xe		-89860.0	1.4	8443.296	0.011	*			127 903531.3	1.5
73	55		Cs		-85931	5	8406.49	0.04	$\beta^+$	3929	5	127 907749	6
72	56		Ba		-85402	10	8396.24	0.08	$\beta^+$	530	11	127 908318	11
71	57		La	x	-78630	50	8337.2	0.4	$\beta^+$	6770	60	127 915590	60
70	58		Ce	x	-75534	28	8306.93	0.22	$\beta^+$	3100	60	127 918910	30
69	59		Pr	x	-66331	30	8228.91	0.23	$\beta^+$	9200	40	127 928790	30
68	60		Nd	x	-60180#	200#	8175#	2#	$\beta^+$	6150#	200#	127 935390#	210#
67	61		Pm	x	-48050#	400#	8074#	3#	$\beta^+$	12140#	450#	127 948420#	430#
66	62		Sm	x	-39050#	500#	7997#	4#	$\beta^+$	9000#	640#	127 958080#	540#
82	47	129	Ag	x	-52450#	400#	8193#	3#	$\beta^-$	10750#	500#	128 943690#	430#
81	48		Cd	x	-63200#	300#	8270#	2#	$\beta^-$	9740#	300#	128 932150#	320#
80	49		In	+	-72940	40	8339.6	0.3	$\beta^-$	7660	30	128 921700	50
79	50		Sn	x	-80594	29	8392.84	0.22	$\beta^-$	4030	40	128 913480	30
78	51		Sb	+	-84628	21	8418.05	0.17	$\beta^-$	2375	21	128 909148	23
77	52		Te		-87003.2	1.8	8430.396	0.014	$\beta^-$	1500	3	128 906598.2	1.9
76	53		I		-88503	3	8435.960	0.025	$\beta^-$	194	3	128 904988	3
75	54		Xe		-88697.4	0.7	8431.400	0.006	*			128 904779.4	0.8
74	55		Cs		-87500	5	8416.06	0.04	$\beta^+$	1197	5	128 906064	5
73	56		Ba		-85065	11	8391.11	0.08	$\beta^+$	2436	11	128 908679	12
72	57		La	x	-81326	21	8356.06	0.16	$\beta^+$	3738	24	128 912693	22
71	58		Ce	x	-76287	28	8310.94	0.22	$\beta^+$	5040	30	128 918100	30
70	59		Pr	x	-69774	30	8254.38	0.23	$\beta^+$	6510	40	128 925100	30
69	60		Nd	$\epsilon$ p	-62240#	200#	8190#	2#	$\beta^+$	7540#	200#	128 933190#	220#
68	61		Pm	x	-52950#	400#	8112#	3#	$\beta^+$	9290#	450#	128 943160#	430#
67	62		Sm	x	-42250#	500#	8023#	4#	$\beta^+$	10690#	640#	128 954640#	540#
83	47	130	Ag	-nn	-46160#	330#	8144#	3#	$\beta^-$	15410#	440#	129 950450#	360#
82	48		Cd	+	-61570	280	8256.1	2.2	$\beta^-$	8320	280	129 933900	300
81	49		In	+	-69890	40	8314.0	0.3	$\beta^-$	10250	40	129 924970	40
80	50		Sn		-80139	11	8386.87	0.08	$\beta^-$	2153	14	129 913967	11
79	51		Sb		-82292	17	8397.41	0.13	$\beta^-$	5060	17	129 911656	18
78	52		Te		-87351.4	1.9	8430.312	0.015	$\beta^-$	-419	3	129 906224.4	2.1
77	53		I		-86932	3	8421.071	0.024	$\beta^-$	2949	3	129 906674	3
76	54		Xe		-89881.7	0.7	8437.740	0.006	$\beta^-$	-2981	8	129 903508.0	0.8
75	55		Cs		-86900	8	8408.79	0.06	$\beta^-$	361	9	129 906709	9
74	56		Ba		-87261.6	2.8	8405.549	0.021	*			129 906320.8	3.0
73	57		La	x	-81628	26	8356.20	0.20	$\beta^+$	5634	26	129 912369	28
72	58		Ce	x	-79423	28	8333.22	0.21	$\beta^+$	2210	40	129 914740	30
71	59		Pr	x	-71180	60	8263.8	0.5	$\beta^+$	8250	70	129 923590	70
70	60		Nd	x	-66596	28	8222.51	0.21	$\beta^+$	4580	70	129 928510	30
69	61		Pm	x	-55470#	300#	8131#	2#	$\beta^+$	11130#	300#	129 940450#	320#
68	62		Sm	x	-47580#	400#	8064#	3#	$\beta^+$	7890#	500#	129 948920#	430#
67	63		Eu	-p	-33940#	500#	7953#	4#	$\beta^+$	13650#	640#	129 963570#	540#

N	Z	A	Elt.	Orig.	Mass excess (keV)		Binding energy per nucleon (keV)		Beta-decay energy (keV)		Atomic mass $\mu$		
83	48	131	Cd	x	-55270#	300#	8207#	2#	$\beta^-$	12870#	300#	130 940670#	320#
82	49		In	+	-68137	28	8298.81	0.21	$\beta^-$	9177	18	130 926850	30
81	50		Sn		-77314	21	8362.90	0.16	$\beta^-$	4674	11	130 917000	23
80	51		Sb		-81988	21	8392.60	0.16	$\beta^-$	3221	21	130 911982	22
79	52		Te		-85209.5	1.9	8411.221	0.015	$\beta^-$	2234.9	2.2	130 908523.9	2.1
78	53		I	+	-87444.4	1.1	8422.309	0.009	$\beta^-$	970.8	0.6	130 906124.6	1.2
77	54		Xe		-88415.2	1.0	8423.748	0.007	*			130 905082.4	1.0
76	55		Cs		-88060	5	8415.06	0.04	$\beta^+$	355	5	130 905464	5
75	56		Ba		-86683.8	2.8	8398.587	0.021	$\beta^+$	1376	5	130 906941	3
74	57		La	x	-83769	28	8370.37	0.21	$\beta^+$	2915	28	130 910070	30
73	58		Ce	x	-79720	30	8333.45	0.26	$\beta^+$	4050	40	130 914420	40
72	59		Pr	x	-74280	50	8286.0	0.4	$\beta^+$	5440	60	130 920260	60
71	60		Nd	x	-67769	28	8230.31	0.21	$\beta^+$	6510	60	130 927250	30
70	61		Pm	x	-59740#	200#	8163#	1#	$\beta^+$	8030#	200#	130 935870#	210#
69	62		Sm	x	-50200#	300#	8084#	2#	$\beta^+$	9540#	360#	130 946110#	320#
68	63		Eu	-p	-39350#	400#	7995#	3#	$\beta^+$	10850#	500#	130 957750#	430#
84	48	132	Cd	x	-50720#	500#	8171#	4#	$\beta^-$	11700#	510#	131 945550#	540#
83	49		In	+	-62420	60	8253.8	0.5	$\beta^-$	14140	60	131 932990	70
82	50		Sn		-76554	14	8354.93	0.10	$\beta^-$	3119	9	131 917816	15
81	51		Sb		-79674	14	8372.63	0.11	$\beta^-$	5509	14	131 914467	15
80	52		Te		-85182	7	8408.44	0.05	$\beta^-$	518	4	131 908553	7
79	53		I		-85700	6	8406.43	0.04	$\beta^-$	3581	6	131 907997	6
78	54		Xe		-89280.5	1.0	8427.633	0.007	$\beta^-$	-2124.6	2.1	131 904153.5	1.0
77	55		Cs		-87155.9	1.9	8405.612	0.014	$\beta^-$	1278.9	2.2	131 906434.3	2.0
76	56		Ba		-88434.8	1.1	8409.373	0.008	*			131 905061.3	1.1
75	57		La	x	-83740	40	8367.88	0.30	$\beta^+$	4690	40	131 910100	40
74	58		Ce		-82474	21	8352.36	0.16	$\beta^+$	1270	40	131 911460	22
73	59		Pr	x	-75210	60	8291.4	0.4	$\beta^+$	7260	60	131 919260	60
72	60		Nd	x	-71426	24	8256.81	0.18	$\beta^+$	3790	60	131 923321	26
71	61		Pm	x	-61710#	200#	8177#	1#	$\beta^+$	9710#	200#	131 933750#	210#
70	62		Sm	x	-55250#	300#	8122#	2#	$\beta^+$	6470#	360#	131 940690#	320#
69	63		Eu	x	-42500#	400#	8020#	3#	$\beta^+$	12740#	500#	131 954370#	430#
84	49	133	In	x	-57930#	300#	8219#	2#	$\beta^-$	13020#	300#	132 937810#	320#
83	50		Sn	+	-70950	40	8310.68	0.27	$\beta^-$	7990	25	132 923830	40
82	51		Sb	+	-78943	25	8364.87	0.19	$\beta^-$	4002	7	132 915252	27
81	52		Te	+	-82945	24	8389.08	0.18	$\beta^-$	2942	24	132 910955	26
80	53		I	+	-85887	5	8405.32	0.04	$\beta^-$	1757	4	132 907797	5
79	54		Xe	+	-87643.6	2.4	8412.647	0.018	$\beta^-$	427.4	2.4	132 905910.7	2.6
78	55		Cs		-88070.958	0.022	8409.978	0.000	*			132 905451.933	0.024
77	56		Ba		-87553.5	1.0	8400.205	0.007	$\beta^+$	517.5	1.0	132 906007.5	1.1
76	57		La	x	-85494	28	8378.84	0.21	$\beta^+$	2059	28	132 908220	30
75	58		Ce	x	-82423	16	8349.87	0.12	$\beta^+$	3070	30	132 911515	18
74	59		Pr	x	-77938	12	8310.26	0.09	$\beta^+$	4486	21	132 916331	13
73	60		Nd	x	-72330	50	8262.2	0.4	$\beta^+$	5610	50	132 922350	50
72	61		Pm	x	-65410	50	8204.3	0.4	$\beta^+$	6920	70	132 929780	50
71	62		Sm	x	-57130#	200#	8136#	1#	$\beta^+$	8280#	200#	132 938670#	210#
70	63		Eu	x	-47280#	300#	8056#	2#	$\beta^+$	9850#	360#	132 949240#	320#

N	Z	A	Elt.	Orig.	Mass excess (keV)		Binding energy per nucleon (keV)		Beta-decay energy (keV)		Atomic mass $\mu$		
85	49	134	In	x	-52020#	400#	8173#	3#	$\beta^-$	14770#	410#	133 944150#	430#
84	50		Sn	+	-66800	100	8277.9	0.7	$\beta^-$	7370	90	133 928290	110
83	51		Sb	+	-74170	40	8327.0	0.3	$\beta^-$	8390	40	133 920380	50
82	52		Te	+	-82559	11	8383.84	0.08	$\beta^-$	1513	7	133 911369	11
81	53		I	+	-84072	8	8389.29	0.06	$\beta^-$	4052	8	133 909744	9
80	54		Xe	x	-88124.5	0.8	8413.689	0.006	$\beta^-$	-1233.3	0.8	133 905394.5	0.9
79	55		Cs		-86891.181	0.026	8398.646	0.000	$\beta^-$	2058.7	0.4	133 906718.475	0.028
78	56		Ba		-88949.9	0.4	8408.171	0.003	*			133 904508.4	0.4
77	57		La	x	-85219	20	8374.49	0.15	$\beta^+$	3731	20	133 908514	21
76	58		Ce	x	-84836	20	8365.79	0.15	$\beta^+$	383	29	133 908925	22
75	59		Pr	x	-78510	40	8312.78	0.26	$\beta^+$	6320	40	133 915710	40
74	60		Nd	x	-75646	12	8285.54	0.09	$\beta^+$	2870	40	133 918790	13
73	61		Pm	x	-66740	60	8213.2	0.4	$\beta^+$	8910	60	133 928350	60
72	62		Sm	x	-61510#	200#	8168#	1#	$\beta^+$	5230#	200#	133 933970#	210#
71	63		Eu	x	-49830#	200#	8075#	1#	$\beta^+$	11680#	280#	133 946510#	210#
70	64		Gd	x	-41570#	400#	8008#	3#	$\beta^+$	8250#	450#	133 955370#	430#
86	49	135	In	x	-47200#	500#	8137#	4#	$\beta^-$	13600#	640#	134 949330#	540#
85	50		Sn	x	-60800#	400#	8232#	3#	$\beta^-$	8910#	410#	134 934730#	430#
84	51		Sb	+	-69710	100	8292.1	0.8	$\beta^-$	8120	50	134 925170	110
83	52		Te	+	-77830	90	8346.5	0.7	$\beta^-$	5960	90	134 916450	100
82	53		I		-83790	7	8384.84	0.05	$\beta^-$	2627	6	134 910048	8
81	54		Xe		-86417	5	8398.50	0.03	$\beta^-$	1165	4	134 907227	5
80	55		Cs		-87581.9	1.0	8401.338	0.007	$\beta^-$	268.7	1.1	134 905977.0	1.1
79	56		Ba		-87850.5	0.4	8397.533	0.003	*			134 905688.6	0.4
78	57		La	-	-86651	10	8382.85	0.07	$\beta^+$	1200	10	134 906977	11
77	58		Ce	-	-84625	11	8362.05	0.08	$\beta^+$	2026	5	134 909151	12
76	59		Pr	x	-80936	12	8328.93	0.09	$\beta^+$	3689	16	134 913112	13
75	60		Nd	x	-76214	19	8288.15	0.14	$\beta^+$	4722	23	134 918181	21
74	61		Pm	x	-69980	60	8236.2	0.4	$\beta^+$	6240	60	134 924880	60
73	62		Sm	x	-62860	150	8177.6	1.1	$\beta^+$	7120	170	134 932520	170
72	63		Eu	x	-54190#	300#	8108#	2#	$\beta^+$	8660#	340#	134 941820#	320#
71	64		Gd	x	-44180#	500#	8028#	4#	$\beta^+$	10010#	590#	134 952570#	540#
86	50	136	Sn	x	-56500#	500#	8199#	4#	$\beta^-$	8370#	590#	135 939340#	540#
85	51		Sb	x	-64880#	300#	8255#	2#	$\beta^-$	9550#	300#	135 930350#	320#
84	52		Te		-74430	50	8319.4	0.3	$\beta^-$	5070	60	135 920100	50
83	53		I		-79500	50	8351.0	0.4	$\beta^-$	6930	50	135 914650	50
82	54		Xe		-86425	7	8396.16	0.05	$\beta^-$	-86	7	135 907219	8
81	55		Cs	+	-86338.7	1.9	8389.770	0.014	$\beta^-$	2548.2	1.9	135 907311.6	2.0
80	56		Ba		-88886.9	0.4	8402.755	0.003	$\beta^-$	-2850	50	135 904575.9	0.4
79	57		La	x	-86040	50	8376.0	0.4	$\beta^-$	430	50	135 907640	60
78	58		Ce		-86468	13	8373.47	0.10	*			135 907172	14
77	59		Pr		-81327	12	8329.91	0.09	$\beta^+$	5141	15	135 912692	13
76	60		Nd	x	-79199	12	8308.51	0.09	$\beta^+$	2128	17	135 914976	13
75	61		Pm	x	-71200	80	8243.9	0.6	$\beta^+$	8000	80	135 923570	80
74	62		Sm	x	-66811	12	8205.92	0.09	$\beta^+$	4390	80	135 928276	13
73	63		Eu	x	-56260#	200#	8123#	1#	$\beta^+$	10550#	200#	135 939600#	210#
72	64		Gd	x	-49050#	400#	8064#	3#	$\beta^+$	7210#	450#	135 947340#	430#
71	65		Tb	x	-35970#	600#	7962#	4#	$\beta^+$	13080#	720#	135 961380#	640#

N	Z	A	Elt.	Orig.	Mass excess (keV)		Binding energy per nucleon (keV)		Beta-decay energy (keV)		Atomic mass $\mu$ u		
87	50	137	Sn	x	-50310#	600#	8153#	4#	$\beta^-$	9950#	720#	136 945990#	640#
86	51		Sb	x	-60260#	400#	8220#	3#	$\beta^-$	9300#	420#	136 935310#	430#
85	52		Te	+	-69560	120	8282.1	0.9	$\beta^-$	6940	120	136 925320	130
84	53		I	p-2n	-76503	28	8327.07	0.20	$\beta^-$	5877	27	136 917871	30
83	54		Xe	-n	-82379	7	8364.26	0.05	$\beta^-$	4166	7	136 911562	8
82	55		Cs		-86545.6	0.5	8388.956	0.003	$\beta^-$	1175.63	0.17	136 907089.5	0.5
81	56		Ba		-87721.2	0.4	8391.827	0.003	*			136 905827.4	0.5
80	57		La	+	-87101	13	8381.59	0.10	$\beta^+$	621	13	136 906494	14
79	58		Ce		-85879	13	8366.96	0.10	$\beta^+$	1222.1	1.6	136 907806	14
78	59		Pr		-83177	12	8341.53	0.09	$\beta^+$	2701	9	136 910705	13
77	60		Nd		-79580	11	8309.56	0.08	$\beta^+$	3597	16	136 914567	12
76	61		Pm	x	-74073	13	8263.65	0.10	$\beta^+$	5507	17	136 920479	14
75	62		Sm		-68030	40	8213.8	0.3	$\beta^+$	6050	40	136 926970	50
74	63		Eu	x	-60020#	200#	8150#	1#	$\beta^+$	8010#	200#	136 935570#	210#
73	64		Gd	x	-51210#	400#	8080#	3#	$\beta^+$	8800#	450#	136 945020#	430#
72	65		Tb	x	-41000#	600#	7999#	4#	$\beta^+$	10210#	720#	136 955980#	640#
87	51	138	Sb	x	-55150#	300#	8182#	2#	$\beta^-$	10780#	360#	137 940790#	320#
86	52		Te	x	-65930#	210#	8254#	1#	$\beta^-$	6400#	220#	137 929220#	220#
85	53		I	+	-72330	80	8295.0	0.6	$\beta^-$	7820	70	137 922350	90
84	54		Xe	+	-80150	40	8346.0	0.3	$\beta^-$	2740	40	137 913950	50
83	55		Cs		-82887	9	8360.15	0.07	$\beta^-$	5374	9	137 911017	10
82	56		Ba		-88261.6	0.4	8393.420	0.003	$\beta^-$	-1737	4	137 905247.2	0.5
81	57		La	+n	-86525	4	8375.164	0.026	$\beta^-$	1044	10	137 907112	4
80	58		Ce		-87569	10	8377.06	0.07	*			137 905991	11
79	59		Pr	-	-83132	14	8339.24	0.10	$\beta^+$	4437	10	137 910755	15
78	60		Nd	x	-82018	12	8325.50	0.09	$\beta^+$	1113	19	137 911950	13
77	61		Pm	x	-74940	27	8268.54	0.20	$\beta^+$	7078	30	137 919548	30
76	62		Sm	x	-71498	12	8237.93	0.09	$\beta^+$	3443	30	137 923244	13
75	63		Eu	x	-61750	28	8161.62	0.20	$\beta^+$	9750	30	137 933710	30
74	64		Gd	x	-55780#	200#	8113#	1#	$\beta^+$	5970#	200#	137 940120#	210#
73	65		Tb	x	-43630#	400#	8019#	3#	$\beta^+$	12150#	450#	137 953160#	430#
72	66		Dy	x	-34940#	600#	7950#	4#	$\beta^+$	8690#	720#	137 962490#	640#
88	51	139	Sb	x	-50320#	500#	8146#	4#	$\beta^-$	10480#	640#	138 945980#	540#
87	52		Te	x	-60800#	400#	8216#	3#	$\beta^-$	8040#	400#	138 934730#	430#
86	53		I	+	-68840	30	8268.25	0.22	$\beta^-$	6806	23	138 926100	30
85	54		Xe	+	-75644	21	8311.58	0.15	$\beta^-$	5057	21	138 918793	22
84	55		Cs	+	-80701	3	8342.338	0.023	$\beta^-$	4213	3	138 913364	3
83	56		Ba		-84913.7	0.4	8367.017	0.003	$\beta^-$	2317.6	2.4	138 908841.3	0.5
82	57		La		-87231.4	2.4	8378.063	0.017	*			138 906353.3	2.6
81	58		Ce		-86952	7	8370.43	0.05	$\beta^+$	279	7	138 906653	8
80	59		Pr		-84823	8	8349.48	0.06	$\beta^+$	2129.2	3.0	138 908938	8
79	60		Nd		-81992	26	8323.48	0.19	$\beta^+$	2832	26	138 911978	28
78	61		Pm		-77496	13	8285.51	0.10	$\beta^+$	4495	25	138 916804	14
77	62		Sm	x	-72380	11	8243.08	0.08	$\beta^+$	5116	17	138 922297	12
76	63		Eu	x	-65398	13	8187.22	0.09	$\beta^+$	6982	17	138 929792	14
75	64		Gd	x	-57530#	200#	8125#	1#	$\beta^+$	7870#	200#	138 938240#	210#
74	65		Tb	x	-48170#	300#	8052#	2#	$\beta^+$	9360#	360#	138 948290#	320#
73	66		Dy	x	-37690#	500#	7971#	4#	$\beta^+$	10480#	590#	138 959540#	540#

N	Z	A	Elt.	Orig.	Mass excess (keV)		Binding energy per nucleon (keV)		Beta-decay energy (keV)		Atomic mass $\mu$ u		
88	52	140	Te	x	-56960#	300#	8188#	2#	$\beta^-$	7310#	360#	139 938850#	320#
87	53		I	x	-64270#	200#	8234#	1#	$\beta^-$	8720#	210#	139 931000#	210#
86	54		Xe	+	-72990	60	8290.9	0.4	$\beta^-$	4060	60	139 921640	70
85	55		Cs		-77051	8	8314.33	0.06	$\beta^-$	6220	10	139 917282	9
84	56		Ba		-83271	8	8353.17	0.06	$\beta^-$	1050	8	139 910605	9
83	57		La		-84321.0	2.4	8355.083	0.017	$\beta^-$	3762.2	1.8	139 909477.6	2.6
82	58		Ce		-88083.3	2.5	8376.368	0.018	*			139 905438.7	2.6
81	59		Pr	-	-84695	6	8346.58	0.05	$\beta^+$	3388	6	139 909076	7
80	60		Nd	x	-84252	28	8337.82	0.20	$\beta^+$	444	29	139 909550	30
79	61		Pm	-	-78210	40	8289.06	0.26	$\beta^+$	6045	24	139 916040	40
78	62		Sm	x	-75456	12	8263.82	0.09	$\beta^+$	2750	40	139 918995	13
77	63		Eu	-	-66990	50	8197.7	0.4	$\beta^+$	8470	50	139 928090	60
76	64		Gd	x	-61782	28	8154.97	0.20	$\beta^+$	5200	60	139 933670	30
75	65		Tb	-	-50480	800	8069	6	$\beta^+$	11300	800	139 945810	860
74	66		Dy	x	-42840#	500#	8008#	4#	$\beta^+$	7640#	950#	139 954010#	540#
73	67		Ho	-p	-29310#	500#	7906#	4#	$\beta^+$	13530#	710#	139 968540#	540#
89	52	141	Te	x	-51560#	400#	8148#	3#	$\beta^-$	8960#	450#	140 944650#	430#
88	53		I	x	-60520#	200#	8206#	1#	$\beta^-$	7810#	220#	140 935030#	210#
87	54		Xe	+	-68330	90	8256.3	0.6	$\beta^-$	6150	90	140 926650	100
86	55		Cs		-74477	11	8294.35	0.07	$\beta^-$	5249	11	140 920046	11
85	56		Ba		-79726	8	8326.03	0.06	$\beta^-$	3213	9	140 914411	9
84	57		La		-82938	5	8343.26	0.03	$\beta^-$	2502	4	140 910962	5
83	58		Ce		-85440.1	2.5	8355.459	0.017	$\beta^-$	580.8	1.1	140 908276.3	2.6
82	59		Pr		-86020.9	2.5	8354.029	0.018	*			140 907652.8	2.6
81	60		Nd	-	-84198	4	8335.552	0.027	$\beta^+$	1823.0	2.8	140 909610	4
80	61		Pm	x	-80523	14	8303.94	0.10	$\beta^+$	3675	14	140 913555	15
79	62		Sm		-75939	9	8265.88	0.06	$\beta^+$	4584	16	140 918476	9
78	63		Eu		-69927	13	8217.69	0.09	$\beta^+$	6012	14	140 924931	14
77	64		Gd	x	-63224	20	8164.61	0.14	$\beta^+$	6702	23	140 932126	21
76	65		Tb	x	-54540	110	8097.5	0.7	$\beta^+$	8680	110	140 941450	110
75	66		Dy	x	-45320#	300#	8027#	2#	$\beta^+$	9220#	320#	140 951350#	320#
74	67		Ho	-p	-34370#	500#	7943#	4#	$\beta^+$	10940#	590#	140 963100#	540#
90	52	142	Te	x	-47430#	600#	8119#	4#	$\beta^-$	8290#	720#	141 949080#	640#
89	53		I	x	-55720#	400#	8172#	3#	$\beta^-$	9750#	410#	141 940180#	430#
88	54		Xe	+	-65480	100	8234.9	0.7	$\beta^-$	5040	100	141 929710	110
87	55		Cs		-70515	11	8264.88	0.07	$\beta^-$	7308	11	141 924299	11
86	56		Ba		-77823	6	8310.84	0.04	$\beta^-$	2212	5	141 916453	7
85	57		La		-80035	6	8320.90	0.04	$\beta^-$	4504	5	141 914079	6
84	58		Ce		-84538.5	3.0	8347.108	0.021	$\beta^-$	-745.8	2.4	141 909244	3
83	59		Pr		-83792.7	2.5	8336.347	0.017	$\beta^-$	2162.5	1.5	141 910044.8	2.6
82	60		Nd		-85955.2	2.3	8346.066	0.016	*			141 907723.3	2.5
81	61		Pm	x	-81157	25	8306.77	0.18	$\beta^+$	4798	25	141 912874	27
80	62		Sm		-78993	6	8286.02	0.04	$\beta^+$	2164	26	141 915198	6
79	63		Eu	-	-71320	30	8226.47	0.22	$\beta^+$	7670	30	141 923430	30
78	64		Gd	x	-66960	28	8190.26	0.20	$\beta^+$	4360	40	141 928120	30
77	65		Tb	-	-57060#	300#	8115#	2#	$\beta^+$	9900#	300#	141 938740#	320#
76	66		Dy	-	-49960#	360#	8060#	3#	$\beta^+$	7100	200	141 946370#	390#
75	67		Ho	x	-37470#	500#	7966#	4#	$\beta^+$	12490#	620#	141 959770#	540#

N	Z	A	Elt.	Orig.	Mass excess (keV)		Binding energy per nucleon (keV)		Beta-decay energy (keV)		Atomic mass $\mu$		
90	53	143	I	x	-51640#	400#	8142#	3#	$\beta^-$	8800#	450#	142 944560#	430#
89	54		Xe	x	-60450#	200#	8199#	1#	$\beta^-$	7230#	200#	142 935110#	210#
88	55		Cs		-67671	24	8243.64	0.17	$\beta^-$	6264	22	142 927352	25
87	56		Ba		-73936	13	8281.98	0.09	$\beta^-$	4251	18	142 920627	14
86	57		La		-78187	15	8306.24	0.11	$\beta^-$	3425	15	142 916063	17
85	58		Ce		-81612.0	3.0	8324.715	0.021	$\beta^-$	1461.5	1.8	142 912386	3
84	59		Pr		-83073.5	2.6	8329.464	0.018	$\beta^-$	933.9	1.4	142 910816.9	2.8
83	60		Nd		-84007.4	2.3	8330.524	0.016	*			142 909814.3	2.5
82	61		Pm		-82966	3	8317.769	0.023	$\beta^+$	1041.7	2.4	142 910933	4
81	62		Sm		-79523	4	8288.224	0.025	$\beta^+$	3443	4	142 914628	4
80	63		Eu	x	-74242	11	8245.82	0.08	$\beta^+$	5281	12	142 920298	12
79	64		Gd	-	-68230	200	8198.3	1.4	$\beta^+$	6010	200	142 926750	220
78	65		Tb	x	-60430	60	8138.3	0.4	$\beta^+$	7800	210	142 935120	60
77	66		Dy	x	-52320#	200#	8076#	1#	$\beta^+$	8110#	200#	142 943830#	210#
76	67		Ho	x	-42280#	400#	8000#	3#	$\beta^+$	10040#	450#	142 954610#	430#
75	68		Er	x	-31350#	600#	7919#	4#	$\beta^+$	10930#	720#	142 966340#	640#
91	53	144	I	x	-46580#	500#	8107#	3#	$\beta^-$	10690#	590#	143 949990#	540#
90	54		Xe	x	-57280#	300#	8176#	2#	$\beta^-$	5990#	300#	143 938510#	320#
89	55		Cs		-63270	26	8211.88	0.18	$\beta^-$	8499	26	143 932077	28
88	56		Ba		-71769	13	8265.47	0.09	$\beta^-$	3120	50	143 922953	14
87	57		La		-74890	50	8281.7	0.3	$\beta^-$	5540	50	143 919600	50
86	58		Ce		-80437	3	8314.795	0.024	$\beta^-$	318.7	0.8	143 913647	4
85	59		Pr		-80756	3	8311.575	0.023	$\beta^-$	2997.5	2.4	143 913305	4
84	60		Nd		-83753.2	2.3	8326.959	0.016	$\beta^-$	-2332.1	2.2	143 910087.3	2.5
83	61		Pm		-81421	3	8305.331	0.022	$\beta^-$	550.9	2.6	143 912591	3
82	62		Sm		-81972.0	2.8	8303.723	0.019	*			143 911999	3
81	63		Eu		-75622	11	8254.19	0.08	$\beta^+$	6350	11	143 918817	12
80	64		Gd	x	-71760	28	8221.94	0.19	$\beta^+$	3862	30	143 922960	30
79	65		Tb	x	-62368	28	8151.29	0.19	$\beta^+$	9390	40	143 933050	30
78	66		Dy	x	-56580	30	8105.69	0.21	$\beta^+$	5780	40	143 939250	30
77	67		Ho	x	-45200#	300#	8021#	2#	$\beta^+$	11390#	300#	143 951480#	320#
76	68		Er	x	-36910#	400#	7958#	3#	$\beta^+$	8290#	500#	143 960380#	430#
91	54	145	Xe	x	-52100#	300#	8139#	2#	$\beta^-$	7960#	300#	144 944070#	320#
90	55		Cs		-60057	11	8188.75	0.07	$\beta^-$	7360	70	144 935526	12
89	56		Ba	-	-67410	70	8234.1	0.5	$\beta^-$	5570	110	144 927630	80
88	57		La	+	-72990	90	8267.1	0.6	$\beta^-$	4110	80	144 921650	100
87	58		Ce	+	-77100	40	8290.08	0.29	$\beta^-$	2530	40	144 917230	40
86	59		Pr		-79632	7	8302.17	0.05	$\beta^-$	1805	7	144 914512	8
85	60		Nd		-81437.1	2.3	8309.223	0.016	*			144 912573.6	2.5
84	61		Pm		-81274	3	8302.701	0.022	$\beta^+$	163.4	2.2	144 912749	3
83	62		Sm		-80657.7	2.8	8293.057	0.019	$\beta^+$	616.0	2.4	144 913410	3
82	63		Eu		-77998	4	8269.321	0.027	$\beta^+$	2659.3	2.7	144 916265	4
81	64		Gd	x	-72927	19	8228.95	0.13	$\beta^+$	5071	19	144 921709	20
80	65		Tb	x	-65880	60	8175.0	0.4	$\beta^+$	7050	60	144 929270	60
79	66		Dy	x	-58290	50	8117.2	0.3	$\beta^+$	7590	70	144 937430	50
78	67		Ho	x	-49180#	300#	8049#	2#	$\beta^+$	9110#	300#	144 947200#	320#
77	68		Er	x	-39690#	400#	7978#	3#	$\beta^+$	9490#	500#	144 957390#	430#
76	69		Tm	-p	-27880#	400#	7891#	3#	$\beta^+$	11810#	570#	144 970070#	430#



N	Z	A	Elt.	Orig.	Mass excess (keV)		Binding energy per nucleon (keV)		Beta-decay energy (keV)		Atomic mass $\mu$		
92	54	146	Xe	x	-48670#	400#	8115#	3#	$\beta^-$	6950#	410#	145 947750#	430#
91	55		Cs		-55620	70	8157.6	0.5	$\beta^-$	9380	40	145 940290	80
90	56		Ba		-65000	70	8216.4	0.5	$\beta^-$	4120	40	145 930220	80
89	57		La		-69120	70	8239.3	0.5	$\beta^-$	6550	50	145 925790	80
88	58		Ce		-75680	70	8278.8	0.5	$\beta^-$	1040	40	145 918760	70
87	59		Pr		-76710	60	8280.6	0.4	$\beta^-$	4220	60	145 917640	70
86	60		Nd		-80931.1	2.3	8304.127	0.016	$\beta^-$	-1471	4	145 913116.9	2.5
85	61		Pm	+	-79460	5	8288.69	0.03	$\beta^-$	1542	3	145 914696	5
84	62		Sm		-81002	4	8293.895	0.025	*			145 913041	4
83	63		Eu		-77122	6	8261.96	0.04	$\beta^+$	3880	6	145 917206	7
82	64		Gd		-76093	5	8249.56	0.03	$\beta^+$	1029	7	145 918311	5
81	65		Tb		-67770	50	8187.2	0.3	$\beta^+$	8320	50	145 927250	50
80	66		Dy		-62554	27	8146.11	0.19	$\beta^+$	5220	50	145 932845	29
79	67		Ho	x	-51570#	200#	8065#	1#	$\beta^+$	10990#	200#	145 944640#	210#
78	68		Er	x	-44710#	300#	8013#	2#	$\beta^+$	6860#	360#	145 952000#	320#
77	69		Tm	-p	-31280#	400#	7916#	3#	$\beta^+$	13440#	500#	145 966430#	430#
93	54	147	Xe	x	-43260#	400#	8078#	3#	$\beta^-$	8760#	400#	146 953560#	430#
92	55		Cs		-52020	50	8132.5	0.4	$\beta^-$	8580#	210#	146 944160	60
91	56		Ba	+	-60600#	210#	8186#	1#	$\beta^-$	6250#	200#	146 934950#	220#
90	57		La	+	-66850	50	8222.7	0.3	$\beta^-$	5180	40	146 928240	50
89	58		Ce	+	-72030	30	8252.63	0.21	$\beta^-$	3426	20	146 922670	30
88	59		Pr	+	-75455	23	8270.61	0.16	$\beta^-$	2697	23	146 918996	25
87	60		Nd		-78151.9	2.3	8283.638	0.016	$\beta^-$	896.0	0.9	146 916100.4	2.5
86	61		Pm		-79047.9	2.4	8284.411	0.016	$\beta^-$	224.1	0.3	146 915138.5	2.6
85	62		Sm		-79272.1	2.4	8280.614	0.016	*			146 914897.9	2.6
84	63		Eu		-77550	3	8263.580	0.022	$\beta^+$	1721.6	2.3	146 916746	3
83	64		Gd		-75363	3	8243.378	0.021	$\beta^+$	2187.4	2.8	146 919094	3
82	65		Tb	-	-70752	12	8206.69	0.08	$\beta^+$	4611	12	146 924045	13
81	66		Dy	x	-64188	20	8156.71	0.13	$\beta^+$	6564	23	146 931092	21
80	67		Ho	x	-55837	28	8094.58	0.19	$\beta^+$	8350	30	146 940060	30
79	68		Er	x	-47050#	300#	8029#	2#	$\beta^+$	8790#	300#	146 949490#	320#
78	69		Tm	-p	-36370#	300#	7951#	2#	$\beta^+$	10690#	420#	146 960960#	320#
93	55	148	Cs		-47300	580	8100	4	$\beta^-$	10710	580	147 949220	620
92	56		Ba	+	-58010	80	8167.3	0.6	$\beta^-$	5110	60	147 937720	90
91	57		La	+	-63130	60	8196.6	0.4	$\beta^-$	7260	50	147 932230	60
90	58		Ce	+	-70391	29	8240.34	0.20	$\beta^-$	2140	14	147 924430	30
89	59		Pr	+	-72531	26	8249.51	0.17	$\beta^-$	4883	26	147 922135	28
88	60		Nd		-77413.4	2.8	8277.213	0.019	$\beta^-$	-542	6	147 916893	3
87	61		Pm	+p	-76872	6	8268.27	0.04	$\beta^-$	2470	6	147 917475	7
86	62		Sm		-79342.2	2.4	8279.673	0.016	*			147 914822.7	2.6
85	63		Eu		-76302	10	8253.85	0.07	$\beta^+$	3040	10	147 918086	11
84	64		Gd		-76275.8	2.8	8248.382	0.019	$\beta^+$	27	10	147 918115	3
83	65		Tb		-70540	14	8204.34	0.09	$\beta^+$	5735	14	147 924272	15
82	66		Dy		-67859	11	8180.94	0.07	$\beta^+$	2681	10	147 927150	11
81	67		Ho	x	-58020	130	8109.1	0.9	$\beta^+$	9840	130	147 937720	140
80	68		Er	x	-51650#	200#	8061#	1#	$\beta^+$	6360#	240#	147 944550#	210#
79	69		Tm	x	-39270#	400#	7972#	3#	$\beta^+$	12380#	450#	147 957840#	430#
78	70		Yb	x	-30350#	600#	7906#	4#	$\beta^+$	8920#	720#	147 967420#	640#

N	Z	A	Elt.	Orig.	Mass excess (keV)		Binding energy per nucleon (keV)		Beta-decay energy (keV)		Atomic mass $\mu$ u		
94	55	149	Cs	x	-43850#	200#	8077#	1#	$\beta^-$	9640#	280#	148 952930#	210#
93	56		Ba	x	-53490#	200#	8136#	1#	$\beta^-$	7310#	370#	148 942580#	210#
92	57		La	+	-60800#	320#	8180#	2#	$\beta^-$	5900#	300#	148 934730#	340#
91	58		Ce	+	-66700	100	8214.4	0.7	$\beta^-$	4360	50	148 928400	100
90	59		Pr	+	-71060	80	8238.4	0.6	$\beta^-$	3320	80	148 923720	90
89	60		Nd		-74380.9	2.8	8255.479	0.019	$\beta^-$	1690	3	148 920149	3
88	61		Pm		-76071	4	8261.573	0.028	$\beta^-$	1071	4	148 918334	4
87	62		Sm		-77141.9	2.4	8263.508	0.016	*			148 917184.7	2.6
86	63		Eu		-76447	4	8253.590	0.029	$\beta^+$	695	4	148 917931	5
85	64		Gd		-75133	4	8239.527	0.027	$\beta^+$	1313	4	148 919341	4
84	65		Tb		-71496	4	8209.864	0.029	$\beta^+$	3637	4	148 923246	5
83	66		Dy		-67715	9	8179.24	0.06	$\beta^+$	3781	9	148 927305	9
82	67		Ho	-	-61688	18	8133.54	0.12	$\beta^+$	6027	16	148 933775	20
81	68		Er	x	-53742	28	8074.95	0.19	$\beta^+$	7950	30	148 942310	30
80	69		Tm	x	-44040#	300#	8005#	2#	$\beta^+$	9700#	300#	148 952720#	320#
79	70		Yb	x	-33500#	500#	7929#	3#	$\beta^+$	10550#	590#	148 964040#	540#
95	55	150	Cs	x	-38960#	300#	8044#	2#	$\beta^-$	11630#	500#	149 958170#	320#
94	56		Ba	x	-50600#	400#	8117#	3#	$\beta^-$	6440#	570#	149 945680#	430#
93	57		La	x	-57040#	400#	8154#	3#	$\beta^-$	7790#	400#	149 938770#	430#
92	58		Ce	+	-64820	50	8201.0	0.3	$\beta^-$	3480	40	149 930410	50
91	59		Pr	+	-68304	26	8218.95	0.17	$\beta^-$	5386	26	149 926673	28
90	60		Nd		-73690	3	8249.643	0.021	$\beta^-$	-86	20	149 920891	3
89	61		Pm	+	-73603	20	8243.85	0.13	$\beta^-$	3454	20	149 920984	22
88	62		Sm		-77057.3	2.4	8261.663	0.016	$\beta^-$	-2260	6	149 917275.5	2.6
87	63		Eu		-74797	6	8241.38	0.04	$\beta^-$	971	4	149 919702	7
86	64		Gd		-75769	6	8242.64	0.04	*			149 918659	7
85	65		Tb		-71111	8	8206.37	0.05	$\beta^+$	4658	8	149 923660	8
84	66		Dy		-69317	5	8189.20	0.03	$\beta^+$	1794	8	149 925585	5
83	67		Ho		-61948	14	8134.86	0.09	$\beta^+$	7369	15	149 933496	15
82	68		Er		-57833	17	8102.21	0.11	$\beta^+$	4115	14	149 937914	18
81	69		Tm	x	-46610#	200#	8022#	1#	$\beta^+$	11220#	200#	149 949960#	210#
80	70		Yb	x	-38730#	400#	7964#	3#	$\beta^+$	7880#	450#	149 958420#	430#
79	71		Lu	-p	-24940#	500#	7867#	3#	$\beta^+$	13790#	640#	149 973230#	540#
96	55	151	Cs	x	-35220#	500#	8020#	3#	$\beta^-$	10600#	640#	150 962190#	540#
95	56		Ba	x	-45820#	400#	8085#	3#	$\beta^-$	8470#	570#	150 950810#	430#
94	57		La	x	-54290#	400#	8136#	3#	$\beta^-$	7210#	410#	150 941720#	430#
93	58		Ce	+	-61500	100	8178.1	0.7	$\beta^-$	5270	100	150 933980	110
92	59		Pr	+	-66771	23	8207.82	0.15	$\beta^-$	4182	23	150 928319	25
91	60		Nd	-n	-70953	3	8230.338	0.021	$\beta^-$	2442	4	150 923829	3
90	61		Pm		-73395	5	8241.33	0.04	$\beta^-$	1187	5	150 921207	6
89	62		Sm		-74582.5	2.4	8244.012	0.016	$\beta^-$	76.6	0.5	150 919932.4	2.6
88	63		Eu		-74659.1	2.5	8239.339	0.016	*			150 919850.2	2.6
87	64		Gd		-74195	4	8231.084	0.024	$\beta^+$	464.2	2.8	150 920348	4
86	65		Tb		-71630	5	8208.91	0.03	$\beta^+$	2565	4	150 923103	5
85	66		Dy	$-\alpha$	-68759	4	8184.719	0.027	$\beta^+$	2871	5	150 926185	4
84	67		Ho	$-\alpha$	-63632	12	8145.59	0.08	$\beta^+$	5127	12	150 931688	13
83	68		Er	x	-58266	16	8104.87	0.11	$\beta^+$	5366	20	150 937449	18
82	69		Tm	$+\alpha$	-50782	20	8050.12	0.13	$\beta^+$	7484	26	150 945483	22
81	70		Yb	$\epsilon p$	-41540	300	7983.8	2.0	$\beta^+$	9240	300	150 955400	320
80	71		Lu	-p	-30200#	400#	7903#	3#	$\beta^+$	11340#	500#	150 967580#	430#

N	Z	A	Elt.	Orig.	Mass excess (keV)		Binding energy per nucleon (keV)		Beta-decay energy (keV)		Atomic mass $\mu$		
96	56	152	Ba	x	-42600#	500#	8063#	3#	$\beta^-$	7470#	640#	151 954270#	540#
95	57		La	x	-50070#	400#	8107#	3#	$\beta^-$	9050#	450#	151 946250#	430#
94	58		Ce	x	-59110#	200#	8162#	1#	$\beta^-$	4700#	230#	151 936540#	210#
93	59		Pr	+	-63810	120	8187.4	0.8	$\beta^-$	6350	120	151 931500	130
92	60		Nd		-70158	25	8224.06	0.16	$\beta^-$	1104	19	151 924682	26
91	61		Pm		-71262	26	8226.18	0.17	$\beta^-$	3506	26	151 923497	28
90	62		Sm		-74768.8	2.5	8244.102	0.016	$\beta^-$	-1874.3	0.7	151 919732.4	2.7
89	63		Eu		-72894.5	2.5	8226.624	0.016	$\beta^-$	1819.7	1.2	151 921744.5	2.6
88	64		Gd	+n	-74714.2	2.5	8233.449	0.017	*	*	*	151 919791.0	2.7
87	65		Tb	-	-70720	40	8202.05	0.26	$\beta^+$	3990	40	151 924070	40
86	66		Dy	$-\alpha$	-70124	5	8192.96	0.03	$\beta^+$	600	40	151 924718	6
85	67		Ho	$-\alpha$	-63608	14	8144.94	0.09	$\beta^+$	6516	15	151 931714	15
84	68		Er	$-\alpha$	-60500	11	8119.35	0.07	$\beta^+$	3108	10	151 935050	11
83	69		Tm	x	-51770	70	8056.8	0.5	$\beta^+$	8730	70	151 944420	80
82	70		Yb	-	-46310	210	8015.7	1.4	$\beta^+$	5470	200	151 950290	220
81	71		Lu	x	-33420#	200#	7926#	1#	$\beta^+$	12880#	290#	151 964120#	210#
97	56	153	Ba	x	-37620#	800#	8031#	5#	$\beta^-$	9310#	1000#	152 959610#	860#
96	57		La	x	-46930#	600#	8087#	4#	$\beta^-$	8420#	720#	152 949620#	640#
95	58		Ce	x	-55350#	400#	8137#	3#	$\beta^-$	6280#	410#	152 940580#	430#
94	59		Pr	+	-61630	100	8172.4	0.7	$\beta^-$	5720	100	152 933840	110
93	60		Nd	+	-67349	27	8204.70	0.18	$\beta^-$	3336	25	152 927698	29
92	61		Pm		-70685	11	8221.39	0.07	$\beta^-$	1881	11	152 924117	12
91	62		Sm		-72565.8	2.5	8228.574	0.016	$\beta^-$	807.6	0.7	152 922097.4	2.7
90	63		Eu		-73373.5	2.5	8228.740	0.016	*	*	*	152 921230.3	2.6
89	64		Gd		-72889.8	2.5	8220.465	0.016	$\beta^+$	483.6	1.2	152 921749.5	2.7
88	65		Tb		-71320	4	8205.093	0.029	$\beta^+$	1570	4	152 923435	5
87	66		Dy		-69150	5	8185.793	0.030	$\beta^+$	2170.5	1.9	152 925765	5
86	67		Ho	$-\alpha$	-65019	6	8153.68	0.04	$\beta^+$	4130	6	152 930199	6
85	68		Er		-60488	9	8118.95	0.06	$\beta^+$	4531	10	152 935063	9
84	69		Tm	$-\alpha$	-54015	18	8071.54	0.12	$\beta^+$	6473	16	152 942012	20
83	70		Yb	x	-47060#	200#	8021#	1#	$\beta^+$	6960#	200#	152 949480#	210#
82	71		Lu	$+\alpha$	-38410	210	7959.3	1.4	$\beta^+$	8650#	290#	152 958770	220
81	72		Hf	x	-27300#	500#	7882#	3#	$\beta^+$	11110#	550#	152 970690#	540#
97	57	154	La	x	-42380#	600#	8057#	4#	$\beta^-$	10320#	780#	153 954500#	640#
96	58		Ce	x	-52700#	500#	8119#	3#	$\beta^-$	5500#	530#	153 943420#	540#
95	59		Pr	+	-58200	150	8149.5	1.0	$\beta^-$	7490	100	153 937520	160
94	60		Nd	+	-65690	110	8193.1	0.7	$\beta^-$	2810	120	153 929480	120
93	61		Pm	+	-68500	40	8206.22	0.29	$\beta^-$	3960	40	153 926460	50
92	62		Sm		-72461.6	2.5	8226.876	0.017	$\beta^-$	-717.2	1.1	153 922209.3	2.7
91	63		Eu		-71744.4	2.5	8217.139	0.016	$\beta^-$	1968.8	1.1	153 922979.2	2.6
90	64		Gd		-73713.2	2.5	8224.843	0.016	$\beta^-$	-3550	50	153 920865.6	2.7
89	65		Tb	-	-70160	50	8196.70	0.29	$\beta^-$	240	50	153 924680	50
88	66		Dy		-70398	8	8193.16	0.05	*	*	*	153 924424	8
87	67		Ho	$-\alpha$	-64644	8	8150.71	0.05	$\beta^+$	5754	10	153 930602	9
86	68		Er		-62612	5	8132.44	0.04	$\beta^+$	2032	10	153 932783	6
85	69		Tm	$-\alpha$	-54429	14	8074.22	0.09	$\beta^+$	8183	15	153 941568	15
84	70		Yb	$-\alpha$	-49934	17	8039.95	0.11	$\beta^+$	4496	14	153 946394	19
83	71		Lu	$+\alpha$	-39570#	200#	7968#	1#	$\beta^+$	10370#	200#	153 957520#	220#
82	72		Hf	x	-32730#	500#	7918#	3#	$\beta^+$	6840#	540#	153 964860#	540#

N	Z	A	Elt.	Orig.	Mass excess (keV)	Binding energy per nucleon (keV)	Beta-decay energy (keV)	Atomic mass $\mu$ u					
98	57	155	La	x	-38800#	800#	8034#	5#	$\beta^-$	9600#	1000#	154 958350#	860#
97	58		Ce	x	-48400#	600#	8091#	4#	$\beta^-$	7380#	670#	154 948040#	640#
96	59		Pr	x	-55780#	300#	8133#	2#	$\beta^-$	6700#	340#	154 940120#	320#
95	60		Nd	+	-62470#	150#	8172#	1#	$\beta^-$	4500#	150#	154 932930#	160#
94	61		Pm	+	-66970	30	8195.51	0.19	$\beta^-$	3220	30	154 928100	30
93	62		Sm	-n	-70197.2	2.6	8211.264	0.017	$\beta^-$	1627.2	1.2	154 924640.2	2.8
92	63		Eu		-71824.5	2.5	8216.715	0.016	$\beta^-$	252.7	1.2	154 922893.3	2.7
91	64		Gd		-72077.1	2.5	8213.297	0.016	*			154 922622.0	2.7
90	65		Tb	+	-71254	12	8202.94	0.08	$\beta^+$	823	12	154 923505	13
89	66		Dy	+n	-69160	12	8184.38	0.08	$\beta^+$	2094.5	1.9	154 925754	13
88	67		Ho	x	-66040	18	8159.20	0.12	$\beta^+$	3120	22	154 929103	19
87	68		Er	$-\alpha$	-62215	7	8129.48	0.04	$\beta^+$	3824	19	154 933209	7
86	69		Tm	$-\alpha$	-56635	13	8088.44	0.09	$\beta^+$	5580	14	154 939199	14
85	70		Yb	$-\alpha$	-50503	17	8043.83	0.11	$\beta^+$	6132	21	154 945782	18
84	71		Lu	$+\alpha$	-42554	20	7987.49	0.13	$\beta^+$	7949	26	154 954316	22
83	72		Hf	x	-34100#	400#	7928#	3#	$\beta^+$	8450#	400#	154 963390#	430#
82	73		Ta	-p	-23670#	500#	7856#	3#	$\beta^+$	10430#	640#	154 974590#	540#
98	58	156	Ce	x	-45400#	600#	8071#	4#	$\beta^-$	6510#	720#	155 951260#	640#
97	59		Pr	x	-51910#	400#	8108#	3#	$\beta^-$	8620#	450#	155 944270#	430#
96	60		Nd	+	-60530	200	8158.4	1.3	$\beta^-$	3690	200	155 935020	220
95	61		Pm	+	-64220	30	8177.07	0.22	$\beta^-$	5150	30	155 931060	40
94	62		Sm		-69370	10	8205.07	0.06	$\beta^-$	723	8	155 925528	10
93	63		Eu		-70093	6	8204.68	0.04	$\beta^-$	2449	5	155 924752	6
92	64		Gd		-72542.2	2.5	8215.368	0.016	$\beta^-$	-2445	4	155 922122.7	2.7
91	65		Tb		-70098	4	8194.682	0.028	$\beta^-$	432	7	155 924747	5
90	66		Dy		-70530	7	8192.44	0.04	*			155 924283	7
89	67		Ho	x	-65350	40	8154.25	0.29	$\beta^+$	5180	50	155 929840	50
88	68		Er	x	-64213	24	8141.91	0.16	$\beta^+$	1140	50	155 931065	26
87	69		Tm	$-\alpha$	-56840	16	8089.64	0.10	$\beta^+$	7373	29	155 938980	17
86	70		Yb	$-\alpha$	-53264	11	8061.70	0.07	$\beta^+$	3575	13	155 942818	12
85	71		Lu	$-\alpha$	-43750	70	7995.7	0.5	$\beta^+$	9510	70	155 953030	80
84	72		Hf	$-\alpha$	-37850	210	7952.9	1.3	$\beta^+$	5900	200	155 959360	220
83	73		Ta	-p	-25800#	400#	7871#	3#	$\beta^+$	12050#	450#	155 972300#	430#
99	58	157	Ce	x	-40670#	700#	8041#	4#	$\beta^-$	8300#	810#	156 956340#	750#
98	59		Pr	x	-48970#	400#	8089#	3#	$\beta^-$	7830#	450#	156 947430#	430#
97	60		Nd	x	-56790#	200#	8134#	1#	$\beta^-$	5580#	230#	156 939030#	210#
96	61		Pm	+	-62370	110	8164.6	0.7	$\beta^-$	4360	100	156 933040	120
95	62		Sm	+	-66730	50	8187.4	0.3	$\beta^-$	2730	50	156 928360	50
94	63		Eu		-69467	5	8199.85	0.03	$\beta^-$	1363	5	156 925424	6
93	64		Gd		-70830.7	2.5	8203.550	0.016	*			156 923960.1	2.7
92	65		Tb		-70770.6	2.5	8198.184	0.016	$\beta^+$	60.05	0.30	156 924024.6	2.7
91	66		Dy		-69428	7	8184.65	0.04	$\beta^+$	1343	6	156 925466	7
90	67		Ho	x	-66829	24	8163.11	0.16	$\beta^+$	2599	25	156 928256	26
89	68		Er	x	-63420	28	8136.41	0.18	$\beta^+$	3410	40	156 931920	30
88	69		Tm	x	-58709	28	8101.43	0.18	$\beta^+$	4710	40	156 936970	30
87	70		Yb		-53442	10	8062.89	0.06	$\beta^+$	5267	30	156 942628	11
86	71		Lu	IT	-46483	19	8013.59	0.12	$\beta^+$	6959	18	156 950098	20
85	72		Hf	$-\alpha$	-38750#	200#	7959#	1#	$\beta^+$	7730#	200#	156 958400#	210#
84	73		Ta	IT	-29630	210	7896.3	1.3	$\beta^+$	9130#	290#	156 968190	220

N	Z	A	Elt.	Orig.	Mass excess (keV)		Binding energy per nucleon (keV)		Beta-decay energy (keV)		Atomic mass $\mu$		
99	59	158	Pr	x	-44730#	600#	8062#	4#	$\beta^-$	9670#	720#	157 951980#	640#
98	60		Nd	x	-54400#	400#	8119#	3#	$\beta^-$	4690#	420#	157 941600#	430#
97	61		Pm	+	-59090	130	8143.3	0.8	$\beta^-$	6120	100	157 936560	140
96	62		Sm	+	-65210	80	8177.1	0.5	$\beta^-$	1999	15	157 929990	80
95	63		Eu	+	-67210	80	8184.8	0.5	$\beta^-$	3490	80	157 927850	80
94	64		Gd		-70696.8	2.5	8201.865	0.016	$\beta^-$	-1219.5	0.9	157 924103.9	2.7
93	65		Tb		-69477.2	2.6	8189.195	0.017	$\beta^-$	934.9	2.6	157 925413.1	2.8
92	66		Dy		-70412	3	8190.160	0.022	*			157 924409	4
91	67		Ho	-	-66191	27	8158.49	0.17	$\beta^+$	4221	27	157 928941	29
90	68		Er		-65304	25	8147.93	0.16	$\beta^+$	890	40	157 929893	27
89	69		Tm		-58703	25	8101.20	0.16	$\beta^+$	6600	30	157 936980	27
88	70		Yb		-56015	8	8079.23	0.05	$\beta^+$	2688	27	157 939866	9
87	71		Lu	$-\alpha$	-47214	15	8018.58	0.10	$\beta^+$	8800	17	157 949313	16
86	72		Hf	$-\alpha$	-42104	18	7981.29	0.11	$\beta^+$	5110	15	157 954799	19
85	73		Ta	$+\alpha$	-31020#	200#	7906#	1#	$\beta^+$	11090#	200#	157 966700#	220#
84	74		W	$-\alpha$	-23700#	500#	7855#	3#	$\beta^+$	7320#	540#	157 974560#	540#
100	59	159	Pr	x	-41450#	700#	8042#	4#	$\beta^-$	8770#	860#	158 955500#	750#
99	60		Nd	x	-50220#	500#	8092#	3#	$\beta^-$	6630#	540#	158 946090#	540#
98	61		Pm	x	-56850#	200#	8129#	1#	$\beta^-$	5360#	220#	158 938970#	210#
97	62		Sm	+	-62210	100	8157.5	0.6	$\beta^-$	3840	100	158 933210	110
96	63		Eu		-66053	7	8176.76	0.05	$\beta^-$	2515	7	158 929089	8
95	64		Gd		-68568.5	2.5	8187.659	0.016	$\beta^-$	970.5	0.7	158 926388.7	2.7
94	65		Tb		-69539.0	2.6	8188.842	0.016	*			158 925346.8	2.7
93	66		Dy		-69173.5	2.7	8181.623	0.017	$\beta^+$	365.6	1.2	158 925739.2	2.9
92	67		Ho	-	-67336	4	8165.145	0.024	$\beta^+$	1837.6	2.7	158 927712	4
91	68		Er	-	-64567	4	8142.813	0.027	$\beta^+$	2768.5	2.0	158 930684	5
90	69		Tm	x	-60570	28	8112.75	0.18	$\beta^+$	3997	28	158 934980	30
89	70		Yb	x	-55843	18	8078.10	0.12	$\beta^+$	4730	30	158 940050	20
88	71		Lu	x	-49710	40	8034.64	0.24	$\beta^+$	6130	40	158 946630	40
87	72		Hf	$-\alpha$	-42854	17	7986.57	0.11	$\beta^+$	6860	40	158 953995	18
86	73		Ta	IT	-34448	21	7928.78	0.13	$\beta^+$	8405	27	158 963018	22
85	74		W	$-\alpha$	-25230#	400#	7866#	3#	$\beta^+$	9220#	400#	158 972920#	430#
100	60	160	Nd	x	-47420#	600#	8074#	4#	$\beta^-$	5680#	670#	159 949090#	640#
99	61		Pm	x	-53100#	300#	8105#	2#	$\beta^-$	7310#	360#	159 942990#	320#
98	62		Sm	x	-60420#	200#	8146#	1#	$\beta^-$	2950#	280#	159 935140#	210#
97	63		Eu	+	-63370#	200#	8159#	1#	$\beta^-$	4580#	200#	159 931970#	220#
96	64		Gd		-67948.6	2.6	8183.057	0.016	$\beta^-$	-105.7	1.0	159 927054.1	2.7
95	65		Tb		-67842.9	2.6	8177.507	0.016	$\beta^-$	1835.1	1.3	159 927167.6	2.7
94	66		Dy		-69678.1	2.5	8184.087	0.016	*			159 925197.5	2.7
93	67		Ho	-	-66388	15	8158.63	0.10	$\beta^+$	3290	15	159 928729	16
92	68		Er	x	-66058	24	8151.69	0.15	$\beta^+$	330	29	159 929083	26
91	69		Tm	x	-60300	30	8110.82	0.21	$\beta^+$	5760	40	159 935260	40
90	70		Yb	x	-58170	17	8092.60	0.10	$\beta^+$	2130	40	159 937552	18
89	71		Lu	x	-50270	60	8038.3	0.4	$\beta^+$	7900	60	159 946030	60
88	72		Hf	$-\alpha$	-45937	12	8006.37	0.07	$\beta^+$	4330	60	159 950684	12
87	73		Ta	$-\alpha$	-35880	90	7938.6	0.6	$\beta^+$	10060	90	159 961490	100
86	74		W	$-\alpha$	-29360	210	7893.0	1.3	$\beta^+$	6510	200	159 968480	220
85	75		Re	-p	-16660#	400#	7809#	3#	$\beta^+$	12700#	450#	159 982120#	430#

N	Z	A	Elt.	Orig.	Mass excess (keV)		Binding energy per nucleon (keV)		Beta-decay energy (keV)		Atomic mass $\mu$	
101	60	161	Nd	x	-42960#	700#	8047#	4#	$\beta^-$	7470#	860#	160 953880# 750#
100	61		Pm	x	-50430#	500#	8088#	3#	$\beta^-$	6550#	590#	160 945860# 540#
99	62		Sm	x	-56980#	300#	8124#	2#	$\beta^-$	4800#	420#	160 938830# 320#
98	63		Eu	x	-61780#	300#	8149#	2#	$\beta^-$	3740#	300#	160 933680# 320#
97	64		Gd	-n	-65512.7	2.7	8167.233	0.017	$\beta^-$	1955.5	1.4	160 929669.2 2.9
96	65		Tb		-67468.2	2.6	8174.520	0.016	$\beta^-$	592.9	1.3	160 927569.9 2.8
95	66		Dy		-68061.1	2.5	8173.344	0.016	*			160 926933.4 2.7
94	67		Ho		-67203	3	8163.153	0.020	$\beta^+$	858.3	2.2	160 927855 3
93	68		Er	+n	-65209	9	8145.91	0.06	$\beta^+$	1994	9	160 929995 10
92	69		Tm	x	-61899	28	8120.49	0.17	$\beta^+$	3310	29	160 933550 30
91	70		Yb	x	-57844	16	8090.45	0.10	$\beta^+$	4050	30	160 937902 17
90	71		Lu	x	-52562	28	8052.78	0.17	$\beta^+$	5280	30	160 943570 30
89	72		Hf		-46319	23	8009.14	0.14	$\beta^+$	6240	40	160 950275 24
88	73		Ta	IT	-38730#	60#	7957#	0#	$\beta^+$	7590#	60#	160 958420# 60#
87	74		W	$-\alpha$	-30410#	200#	7901#	1#	$\beta^+$	8330#	200#	160 967360# 210#
86	75		Re	-p	-20880	210	7836.5	1.3	$\beta^+$	9530#	290#	160 977590 220
101	61	162	Pm	x	-46310#	700#	8063#	4#	$\beta^-$	8450#	860#	161 950290# 750#
100	62		Sm	x	-54750#	500#	8110#	3#	$\beta^-$	3890#	590#	161 941220# 540#
99	63		Eu	x	-58650#	300#	8129#	2#	$\beta^-$	5640#	300#	161 937040# 320#
98	64		Gd	-nn	-64287	5	8159.077	0.028	$\beta^-$	1390	40	161 930985 5
97	65		Tb	+	-65680	40	8162.85	0.23	$\beta^-$	2510	40	161 929490 40
96	66		Dy		-68186.8	2.5	8173.490	0.016	$\beta^-$	-2140	3	161 926798.4 2.7
95	67		Ho		-66047	4	8155.452	0.024	$\beta^-$	296	4	161 929096 4
94	68		Er		-66343	3	8152.447	0.021	*			161 928778 4
93	69		Tm	-	-61484	26	8117.62	0.16	$\beta^+$	4859	26	161 933995 28
92	70		Yb	x	-59832	16	8102.60	0.10	$\beta^+$	1650	30	161 935768 17
91	71		Lu	x	-52840	80	8054.6	0.5	$\beta^+$	6990	80	161 943280 80
90	72		Hf	$-\alpha$	-49173	10	8027.15	0.06	$\beta^+$	3660	80	161 947210 10
89	73		Ta	$-\alpha$	-39780	50	7964.3	0.3	$\beta^+$	9390	50	161 957290 60
88	74		W	$-\alpha$	-34002	18	7923.84	0.11	$\beta^+$	5780	50	161 963497 19
87	75		Re	$+\alpha$	-22350#	200#	7847#	1#	$\beta^+$	11650#	200#	161 976000# 220#
86	76		Os	$-\alpha$	-14500#	500#	7794#	3#	$\beta^+$	7850#	540#	161 984430# 540#
102	61	163	Pm	x	-43150#	800#	8043#	5#	$\beta^-$	7750#	1060#	162 953680# 860#
101	62		Sm	x	-50900#	700#	8086#	4#	$\beta^-$	5730#	860#	162 945360# 750#
100	63		Eu	x	-56630#	500#	8116#	3#	$\beta^-$	4860#	590#	162 939210# 540#
99	64		Gd	x	-61490#	300#	8141#	2#	$\beta^-$	3110#	300#	162 933990# 320#
98	65		Tb	+p	-64601	5	8155.666	0.029	$\beta^-$	1785	4	162 930648 5
97	66		Dy		-66386.5	2.5	8161.818	0.016	*			162 928731.2 2.7
96	67		Ho		-66383.9	2.5	8157.002	0.016	$\beta^+$	2.555	0.016	162 928733.9 2.7
95	68		Er		-65174	5	8144.78	0.03	$\beta^+$	1210	5	162 930033 6
94	69		Tm	-	-62735	6	8125.02	0.04	$\beta^+$	2439	3	162 932651 6
93	70		Yb	x	-59304	16	8099.17	0.10	$\beta^+$	3431	17	162 936334 17
92	71		Lu	x	-54791	28	8066.68	0.17	$\beta^+$	4510	30	162 941180 30
91	72		Hf	x	-49286	28	8028.11	0.17	$\beta^+$	5510	40	162 947090 30
90	73		Ta	$-\alpha$	-42540	40	7981.93	0.23	$\beta^+$	6750	50	162 954330 40
89	74		W	$-\alpha$	-34910	50	7930.3	0.3	$\beta^+$	7630	70	162 962520 60
88	75		Re	IT	-26007	20	7870.89	0.12	$\beta^+$	8900	60	162 972081 21
87	76		Os	$-\alpha$	-16120#	400#	7805#	2#	$\beta^+$	9880#	400#	162 982690# 430#

N	Z	A	Elt.	Orig.	Mass excess (keV)		Binding energy per nucleon (keV)		Beta-decay energy (keV)		Atomic mass $\mu$ u		
102	62	164	Sm	x	-48180#	800#	8069#	5#	$\beta^-$	4930#	1000#	163 948280#	860#
101	63		Eu	x	-53100#	600#	8095#	4#	$\beta^-$	6640#	720#	163 942990#	640#
100	64		Gd	x	-59750#	400#	8130#	2#	$\beta^-$	2340#	410#	163 935860#	430#
99	65		Tb	+	-62080	100	8139.8	0.6	$\beta^-$	3890	100	163 933350	110
98	66		Dy		-65973.3	2.5	8158.746	0.015	$\beta^-$	-986.2	1.4	163 929174.8	2.7
97	67		Ho		-64987.1	2.8	8147.963	0.017	$\beta^-$	962.5	2.3	163 930233.5	3.0
96	68		Er		-65950	3	8149.061	0.019	*			163 929200	3
95	69		Tm	x	-61888	28	8119.53	0.17	$\beta^+$	4061	28	163 933560	30
94	70		Yb	x	-61023	16	8109.48	0.10	$\beta^+$	870	30	163 934489	17
93	71		Lu	x	-54642	28	8065.80	0.17	$\beta^+$	6380	30	163 941340	30
92	72		Hf	$+\alpha$	-51822	20	8043.83	0.12	$\beta^+$	2820	30	163 944367	22
91	73		Ta	x	-43283	28	7987.00	0.17	$\beta^+$	8540	30	163 953530	30
90	74		W	$-\alpha$	-38234	12	7951.44	0.07	$\beta^+$	5050	30	163 958954	13
89	75		Re	$+\alpha$	-27640#	160#	7882#	1#	$\beta^+$	10590#	160#	163 970320#	170#
88	76		Os	$-\alpha$	-20460	210	7833.5	1.3	$\beta^+$	7180#	240#	163 978040	220
87	77		Ir	$-\alpha$	-7270#	410#	7748#	3#	$\beta^+$	13200#	460#	163 992200#	440#
103	62	165	Sm	x	-43800#	900#	8043#	5#	$\beta^-$	6760#	1140#	164 952980#	970#
102	63		Eu	x	-50560#	700#	8079#	4#	$\beta^-$	5910#	860#	164 945720#	750#
101	64		Gd	x	-56470#	500#	8110#	3#	$\beta^-$	4190#	540#	164 939380#	540#
100	65		Tb	x	-60660#	200#	8131#	1#	$\beta^-$	2960#	200#	164 934880#	210#
99	66		Dy	-n	-63617.9	2.5	8143.942	0.015	$\beta^-$	1286.6	0.9	164 931703.3	2.7
98	67		Ho		-64904.6	2.5	8146.998	0.015	*			164 930322.1	2.7
97	68		Er		-64528	3	8139.976	0.019	$\beta^+$	376.3	2.0	164 930726	3
96	69		Tm		-62936	3	8125.584	0.020	$\beta^+$	1592.4	1.5	164 932435	4
95	70		Yb	x	-60287	28	8104.79	0.17	$\beta^+$	2649	28	164 935280	30
94	71		Lu	x	-56442	27	8076.75	0.16	$\beta^+$	3840	40	164 939407	28
93	72		Hf	x	-51636	28	8042.87	0.17	$\beta^+$	4810	40	164 944570	30
92	73		Ta	$+\alpha$	-45855	17	8003.10	0.11	$\beta^+$	5780	30	164 950773	19
91	74		W		-38862	25	7955.97	0.15	$\beta^+$	6990	30	164 958280	27
90	75		Re	$+\alpha$	-30657	28	7901.50	0.17	$\beta^+$	8210	40	164 967089	30
89	76		Os	$-\alpha$	-21650#	200#	7842#	1#	$\beta^+$	9010#	200#	164 976760#	220#
88	77		Ir	IT	-11630#	220#	7777#	1#	$\beta^+$	10020#	300#	164 987520#	230#
103	63	166	Eu	x	-46600#	800#	8055#	5#	$\beta^-$	7800#	1000#	165 949970#	860#
102	64		Gd	x	-54400#	600#	8097#	4#	$\beta^-$	3360#	600#	165 941600#	640#
101	65		Tb	+	-57760	100	8112.9	0.6	$\beta^-$	4830	100	165 937990	110
100	66		Dy	-n	-62590.1	2.6	8137.313	0.015	$\beta^-$	486.8	1.0	165 932806.7	2.8
99	67		Ho		-63076.9	2.5	8135.532	0.015	$\beta^-$	1854.7	0.9	165 932284.2	2.7
98	68		Er		-64931.6	2.5	8141.992	0.015	*			165 930293.1	2.7
97	69		Tm	-	-61894	12	8118.98	0.07	$\beta^+$	3038	12	165 933554	13
96	70		Yb	$+\text{nn}$	-61588	8	8112.43	0.05	$\beta^+$	305	14	165 933882	9
95	71		Lu	x	-56021	30	8074.17	0.18	$\beta^+$	5570	30	165 939860	30
94	72		Hf	x	-53859	28	8056.44	0.17	$\beta^+$	2160	40	165 942180	30
93	73		Ta	x	-46098	28	8004.97	0.17	$\beta^+$	7760	40	165 950510	30
92	74		W	$-\alpha$	-41892	10	7974.92	0.06	$\beta^+$	4206	30	165 955027	11
91	75		Re	IT	-31850#	90#	7910#	1#	$\beta^+$	10040#	90#	165 965810#	90#
90	76		Os	$-\alpha$	-25438	18	7866.38	0.11	$\beta^+$	6410#	90#	165 972691	20
89	77		Ir	-p	-13210#	200#	7788#	1#	$\beta^+$	12230#	200#	165 985820#	220#
88	78		Pt	$-\alpha$	-4790#	500#	7733#	3#	$\beta^+$	8410#	540#	165 994860#	540#

N	Z	A	Elt.	Orig.	Mass excess (keV)		Binding energy per nucleon (keV)		Beta-decay energy (keV)		Atomic mass $\mu$		
104	63	167	Eu	x	-43590#	800#	8037#	5#	$\beta^-$	7120#	1000#	166 953210#	860#
103	64		Gd	x	-50700#	600#	8075#	4#	$\beta^-$	5140#	720#	166 945570#	640#
102	65		Tb	x	-55840#	400#	8101#	2#	$\beta^-$	4090#	410#	166 940050#	430#
101	66		Dy	+	-59940	60	8121.0	0.4	$\beta^-$	2350	60	166 935660	60
100	67		Ho	p2n	-62287	6	8130.41	0.03	$\beta^-$	1010	5	166 933133	6
99	68		Er		-63296.7	2.5	8131.779	0.015	*			166 932048.2	2.7
98	69		Tm		-62548.3	2.7	8122.613	0.016	$\beta^+$	748.4	1.5	166 932851.6	2.9
97	70		Yb		-60594	5	8106.226	0.028	$\beta^+$	1954	4	166 934950	5
96	71		Lu	x	-57500	30	8083.02	0.19	$\beta^+$	3090	30	166 938270	30
95	72		Hf	x	-53468	28	8054.18	0.17	$\beta^+$	4030	40	166 942600	30
94	73		Ta	x	-48351	28	8018.86	0.17	$\beta^+$	5120	40	166 948090	30
93	74		W	$+\alpha$	-42089	19	7976.68	0.12	$\beta^+$	6260	30	166 954816	21
92	75		Re	$+\alpha$	-34840#	50#	7929#	0#	$\beta^+$	7250#	60#	166 962600#	60#
91	76		Os	$-\alpha$	-26500	70	7874.0	0.4	$\beta^+$	8330#	90#	166 971550	80
90	77		Ir	-p	-17079	19	7812.86	0.11	$\beta^+$	9420	80	166 981665	20
89	78		Pt	$-\alpha$	-6540#	410#	7745#	2#	$\beta^+$	10540#	410#	166 992980#	440#
104	64	168	Gd	x	-48100#	700#	8060#	4#	$\beta^-$	4400#	860#	167 948360#	750#
103	65		Tb	x	-52500#	500#	8081#	3#	$\beta^-$	6070#	520#	167 943640#	540#
102	66		Dy	+pp	-58560	140	8112.6	0.8	$\beta^-$	1500	140	167 937130	150
101	67		Ho	+	-60070	30	8116.85	0.18	$\beta^-$	2930	30	167 935520	30
100	68		Er		-62996.7	2.5	8129.634	0.015	$\beta^-$	-1679.1	1.9	167 932370.2	2.7
99	69		Tm		-61317.7	2.9	8114.982	0.017	$\beta^-$	257	4	167 934173	3
98	70		Yb		-61575	4	8111.855	0.026	*			167 933897	5
97	71		Lu	-	-57060	50	8080.35	0.28	$\beta^+$	4510	50	167 938740	50
96	72		Hf	x	-55361	28	8065.55	0.17	$\beta^+$	1700	50	167 940570	30
95	73		Ta	x	-48394	28	8019.43	0.17	$\beta^+$	6970	40	167 948050	30
94	74		W	$+\alpha$	-44890	16	7993.92	0.10	$\beta^+$	3500	30	167 951808	17
93	75		Re	$-\alpha$	-35790	30	7935.12	0.18	$\beta^+$	9100	30	167 961570	30
92	76		Os	$-\alpha$	-29991	12	7895.91	0.07	$\beta^+$	5800	30	167 967804	13
91	77		Ir	IT	-18740#	150#	7824#	1#	$\beta^+$	11250#	150#	167 979880#	160#
90	78		Pt	$-\alpha$	-11040	210	7773.8	1.2	$\beta^+$	7700#	240#	167 988150	220
105	64	169	Gd	x	-43900#	800#	8035#	5#	$\beta^-$	6190#	1000#	168 952870#	860#
104	65		Tb	x	-50100#	600#	8067#	4#	$\beta^-$	5510#	670#	168 946220#	640#
103	66		Dy	+	-55600	300	8094.8	1.8	$\beta^-$	3200	300	168 940310	320
102	67		Ho	+p	-58803	20	8109.10	0.12	$\beta^-$	2126	20	168 936872	22
101	68		Er		-60928.7	2.5	8117.052	0.015	$\beta^-$	351.3	1.1	168 934590.4	2.7
100	69		Tm		-61280.0	2.5	8114.501	0.015	*			168 934213.3	2.7
99	70		Yb		-60370	4	8104.489	0.026	$\beta^+$	910	4	168 935190	5
98	71		Lu	-	-58077	5	8086.29	0.03	$\beta^+$	2293	3	168 937651	6
97	72		Hf	x	-54717	28	8061.78	0.17	$\beta^+$	3360	28	168 941260	30
96	73		Ta	x	-50290	28	8030.96	0.17	$\beta^+$	4430	40	168 946010	30
95	74		W		-44918	15	7994.54	0.09	$\beta^+$	5370	30	168 951779	17
94	75		Re		-38386	28	7951.26	0.17	$\beta^+$	6530	30	168 958790	30
93	76		Os	$-\alpha$	-30721	25	7901.28	0.15	$\beta^+$	7660	40	168 967019	27
92	77		Ir	$+\alpha$	-22081	26	7845.52	0.16	$\beta^+$	8640	40	168 976295	28
91	78		Pt	$-\alpha$	-12380#	200#	7783#	1#	$\beta^+$	9710#	200#	168 986720#	220#
90	79		Au	x	-1790#	300#	7716#	2#	$\beta^+$	10590#	360#	168 998080#	320#



N	Z	A	Elt.	Orig.	Mass excess (keV)		Binding energy per nucleon (keV)		Beta-decay energy (keV)		Atomic mass $\mu$		
105	65	170	Tb	x	-46340#	700#	8045#	4#	$\beta^-$	7320#	730#	169 950250#	750#
104	66		Dy	x	-53660#	200#	8083#	1#	$\beta^-$	2580#	200#	169 942390#	210#
103	67		Ho	+	-56240	50	8093.83	0.29	$\beta^-$	3870	50	169 939620	50
102	68		Er		-60114.6	2.8	8111.994	0.016	$\beta^-$	-314.0	1.8	169 935464.3	3.0
101	69		Tm		-59800.6	2.5	8105.545	0.015	$\beta^-$	968.3	0.8	169 935801.4	2.7
100	70		Yb		-60769.0	2.4	8106.639	0.014	*			169 934761.8	2.6
99	71		Lu	-	-57310	17	8081.69	0.10	$\beta^+$	3459	17	169 938475	18
98	72		Hf	x	-56254	28	8070.88	0.16	$\beta^+$	1060	30	169 939610	30
97	73		Ta	x	-50138	28	8030.30	0.16	$\beta^+$	6120	40	169 946180	30
96	74		W	$+\alpha$	-47293	15	8008.96	0.09	$\beta^+$	2840	30	169 949228	16
95	75		Re	x	-38918	26	7955.09	0.15	$\beta^+$	8376	30	169 958220	28
94	76		Os	$-\alpha$	-33928	11	7921.14	0.06	$\beta^+$	4990	28	169 963577	12
93	77		Ir	$-\alpha$	-23320#	100#	7854#	1#	$\beta^+$	10610#	100#	169 974970#	110#
92	78		Pt	$-\alpha$	-16306	19	7808.27	0.11	$\beta^+$	7010#	100#	169 982495	20
91	79		Au	-p	-3610#	200#	7729#	1#	$\beta^+$	12690#	200#	169 996120#	220#
106	65	171	Tb	x	-43500#	800#	8028#	5#	$\beta^-$	6610#	860#	170 953300#	860#
105	66		Dy	x	-50110#	300#	8062#	2#	$\beta^-$	4410#	670#	170 946200#	320#
104	67		Ho	+	-54520	600	8084	4	$\beta^-$	3200	600	170 941470	640
103	68		Er		-57724.9	2.8	8097.781	0.016	$\beta^-$	1490.7	1.2	170 938029.8	3.0
102	69		Tm		-59215.6	2.6	8101.923	0.015	$\beta^-$	96.5	1.0	170 936429.4	2.8
101	70		Yb		-59312.1	2.4	8097.913	0.014	*			170 936325.8	2.6
100	71		Lu		-57833.5	2.8	8084.691	0.016	$\beta^+$	1478.6	1.9	170 937913.1	3.0
99	72		Hf	x	-55431	29	8066.07	0.17	$\beta^+$	2402	29	170 940490	30
98	73		Ta	x	-51720	28	8039.79	0.16	$\beta^+$	3710	40	170 944480	30
97	74		W	x	-47086	28	8008.12	0.16	$\beta^+$	4630	40	170 949450	30
96	75		Re	x	-41250	28	7969.41	0.16	$\beta^+$	5840	40	170 955720	30
95	76		Os		-34293	19	7924.15	0.11	$\beta^+$	6960	30	170 963185	20
94	77		Ir	$-\alpha$	-26430	40	7873.59	0.23	$\beta^+$	7860	40	170 971630	40
93	78		Pt	$-\alpha$	-17470	90	7816.6	0.5	$\beta^+$	8960	100	170 981240	90
92	79		Au	IT	-7565	26	7754.12	0.15	$\beta^+$	9910	90	170 991879	28
91	80		Hg	x	3500#	300#	7685#	2#	$\beta^+$	11070#	300#	171 003760#	320#
106	66	172	Dy	x	-47730#	400#	8049#	2#	$\beta^-$	3670#	570#	171 948760#	430#
105	67		Ho	x	-51400#	400#	8065#	2#	$\beta^-$	5090#	400#	171 944820#	430#
104	68		Er		-56489	5	8090.444	0.027	$\beta^-$	891	5	171 939356	5
103	69		Tm		-57380	6	8091.07	0.03	$\beta^-$	1880	6	171 938400	6
102	70		Yb		-59260.3	2.4	8097.457	0.014	*			171 936381.5	2.6
101	71		Lu		-56741.3	3.0	8078.263	0.017	$\beta^+$	2518.9	2.4	171 939086	3
100	72		Hf	x	-56404	24	8071.75	0.14	$\beta^+$	338	25	171 939448	26
99	73		Ta	x	-51330	28	8037.70	0.16	$\beta^+$	5070	40	171 944900	30
98	74		W	x	-49097	28	8020.17	0.16	$\beta^+$	2230	40	171 947290	30
97	75		Re	$+\alpha$	-41520	50	7971.6	0.3	$\beta^+$	7570	60	171 955420	60
96	76		Os	$+\alpha$	-37238	15	7942.13	0.08	$\beta^+$	4290	60	171 960023	16
95	77		Ir	$-\alpha$	-27520#	110#	7881#	1#	$\beta^+$	9720#	110#	171 970460#	110#
94	78		Pt	$-\alpha$	-21101	13	7839.21	0.07	$\beta^+$	6420#	110#	171 977347	14
93	79		Au	$-\alpha$	-9280#	160#	7766#	1#	$\beta^+$	11820#	160#	171 990040#	170#
92	80		Hg	$-\alpha$	-1090	210	7713.8	1.2	$\beta^+$	8200#	240#	171 998830	220
107	66	173	Dy	x	-43780#	500#	8026#	3#	$\beta^-$	5320#	640#	172 953000#	540#
106	67		Ho	x	-49100#	400#	8052#	2#	$\beta^-$	4560#	450#	172 947290#	430#
105	68		Er	x	-53650#	200#	8074#	1#	$\beta^-$	2610#	200#	172 942400#	210#
104	69		Tm	p2n	-56259	5	8084.479	0.029	$\beta^-$	1297	5	172 939604	5
103	70		Yb		-57556.3	2.4	8087.456	0.014	*			172 938210.8	2.6
102	71		Lu		-56885.8	2.4	8079.058	0.014	$\beta^+$	670.5	1.7	172 938930.6	2.6
101	72		Hf	x	-55412	28	8066.02	0.16	$\beta^+$	1474	28	172 940510	30
100	73		Ta	x	-52397	28	8044.06	0.16	$\beta^+$	3020	40	172 943750	30
99	74		W	x	-48727	28	8018.33	0.16	$\beta^+$	3670	40	172 947690	30
98	75		Re	x	-43554	28	7983.91	0.16	$\beta^+$	5170	40	172 953240	30
97	76		Os		-37438	15	7944.03	0.09	$\beta^+$	6120	30	172 959808	16
96	77		Ir	$+\alpha$	-30272	14	7898.09	0.08	$\beta^+$	7166	20	172 967502	15
95	78		Pt	$-\alpha$	-21940	60	7845.4	0.3	$\beta^+$	8330	60	172 976440	60
94	79		Au	$+\alpha$	-12820	26	7788.16	0.15	$\beta^+$	9120	60	172 986237	28
93	80		Hg	$-\alpha$	-2570#	210#	7724#	1#	$\beta^+$	10250#	210#	172 997240#	220#

N	Z	A	Elt.	Orig.	Mass excess (keV)		Binding energy per nucleon (keV)		Beta-decay energy (keV)		Atomic mass $\mu$		
107	67	174	Ho	x	-45500#	500#	8032#	3#	$\beta^-$	6450#	590#	173 951150#	540#
106	68		Er	x	-51950#	300#	8064#	2#	$\beta^-$	1920#	300#	173 944230#	320#
105	69		Tm	+	-53870	40	8070.67	0.26	$\beta^-$	3080	40	173 942170	50
104	70		Yb		-56949.6	2.4	8083.876	0.014	$\beta^-$	-1374.3	1.6	173 938862.1	2.6
103	71		Lu		-55575.3	2.4	8071.482	0.014	$\beta^-$	271.3	2.1	173 940337.5	2.6
102	72		Hf		-55846.6	2.8	8068.545	0.016	*			173 940046	3
101	73		Ta	x	-51741	28	8040.45	0.16	$\beta^+$	4106	28	173 944450	30
100	74		W	x	-50227	28	8027.26	0.16	$\beta^+$	1510	40	173 946080	30
99	75		Re	x	-43673	28	7985.09	0.16	$\beta^+$	6550	40	173 953120	30
98	76		Os	$+\alpha$	-39996	11	7959.47	0.06	$\beta^+$	3680	30	173 957062	12
97	77		Ir	$-\alpha$	-30869	28	7902.51	0.16	$\beta^+$	9128	30	173 966861	30
96	78		Pt	$-\alpha$	-25319	12	7866.12	0.07	$\beta^+$	5550	30	173 972819	13
95	79		Au	$-\alpha$	-14200#	100#	7798#	1#	$\beta^+$	11120#	100#	173 984760#	110#
94	80		Hg	$-\alpha$	-6647	20	7749.82	0.11	$\beta^+$	7550#	100#	173 992864	21
108	67	175	Ho	x	-42800#	600#	8016#	3#	$\beta^-$	5850#	720#	174 954050#	640#
107	68		Er	x	-48650#	400#	8045#	2#	$\beta^-$	3660#	400#	174 947770#	430#
106	69		Tm	+	-52320	50	8061.80	0.29	$\beta^-$	2390	50	174 943840	50
105	70		Yb		-54700.6	2.4	8070.954	0.014	$\beta^-$	470.1	1.3	174 941276.5	2.6
104	71		Lu		-55170.7	2.2	8069.169	0.012	*			174 940771.8	2.3
103	72		Hf		-54483.8	2.8	8060.774	0.016	$\beta^+$	686.8	1.9	174 941509	3
102	73		Ta	x	-52409	28	8044.44	0.16	$\beta^+$	2075	28	174 943740	30
101	74		W	x	-49633	28	8024.11	0.16	$\beta^+$	2780	40	174 946720	30
100	75		Re	x	-45288	28	7994.82	0.16	$\beta^+$	4340	40	174 951380	30
99	76		Os	$+\alpha$	-40105	14	7960.72	0.08	$\beta^+$	5180	30	174 956946	15
98	77		Ir		-33429	20	7918.11	0.11	$\beta^+$	6676	24	174 964113	21
97	78		Pt		-25690	19	7869.41	0.11	$\beta^+$	7739	27	174 972421	20
96	79		Au	$-\alpha$	-17440	40	7817.82	0.24	$\beta^+$	8250	50	174 981270	50
95	80		Hg	$-\alpha$	-7990	100	7759.3	0.6	$\beta^+$	9450	110	174 991420	110
108	68	176	Er	x	-46500#	400#	8033#	2#	$\beta^-$	2870#	410#	175 950080#	430#
107	69		Tm	+	-49370	100	8045.1	0.6	$\beta^-$	4120	100	175 946990	110
106	70		Yb		-53494.1	2.6	8064.100	0.015	$\beta^-$	-106.8	1.6	175 942571.7	2.8
105	71		Lu		-53387.4	2.2	8059.049	0.012	$\beta^-$	1190.2	0.8	175 942686.3	2.3
104	72		Hf		-54577.5	2.2	8061.366	0.013	*			175 941408.6	2.4
103	73		Ta	x	-51370	30	8038.67	0.17	$\beta^+$	3210	30	175 944860	30
102	74		W	x	-50642	28	8030.11	0.16	$\beta^+$	720	40	175 945630	30
101	75		Re	x	-45063	28	7993.97	0.16	$\beta^+$	5580	40	175 951620	30
100	76		Os	x	-42098	28	7972.68	0.16	$\beta^+$	2960	40	175 954810	30
99	77		Ir		-33861	20	7921.43	0.12	$\beta^+$	8240	30	175 963649	22
98	78		Pt	$+\alpha$	-28928	14	7888.96	0.08	$\beta^+$	4933	25	175 968945	15
97	79		Au	$-\alpha$	-18540#	110#	7825#	1#	$\beta^+$	10390#	110#	175 980100#	110#
96	80		Hg	$-\alpha$	-11779	14	7782.63	0.08	$\beta^+$	6760#	110#	175 987355	15
95	81		Tl	x	550#	200#	7708#	1#	$\beta^+$	12330#	200#	176 000590#	210#
109	68	177	Er	x	-42800#	500#	8013#	3#	$\beta^-$	4670#	590#	176 954050#	540#
108	69		Tm	x	-47470#	300#	8035#	2#	$\beta^-$	3520#	300#	176 949040#	320#
107	70		Yb	-n	-50989.2	2.6	8049.989	0.015	$\beta^-$	1399.8	1.6	176 945260.8	2.8
106	71		Lu		-52389.0	2.2	8053.478	0.012	$\beta^-$	500.6	0.7	176 943758.1	2.3
105	72		Hf		-52889.6	2.1	8051.886	0.012	*			176 943220.7	2.3
104	73		Ta	-	-51724	4	8040.878	0.021	$\beta^+$	1166	3	176 944472	4
103	74		W	x	-49702	28	8025.04	0.16	$\beta^+$	2022	28	176 946640	30
102	75		Re	x	-46269	28	8001.22	0.16	$\beta^+$	3430	40	176 950330	30
101	76		Os	$+\alpha$	-41950	16	7972.40	0.09	$\beta^+$	4320	30	176 954965	17
100	77		Ir	x	-36047	20	7934.63	0.11	$\beta^+$	5902	25	176 961302	21
99	78		Pt		-29370	15	7892.49	0.08	$\beta^+$	6677	25	176 968469	16
98	79		Au		-21550	13	7843.89	0.07	$\beta^+$	7820	20	176 976865	14
97	80		Hg	$-\alpha$	-12780	80	7789.9	0.4	$\beta^+$	8770	80	176 986280	80
96	81		Tl	IT	-3328	25	7732.10	0.14	$\beta^+$	9450	80	176 996427	27

N	Z	A	Elt.	Orig.	Mass excess (keV)		Binding energy per nucleon (keV)		Beta-decay energy (keV)		Atomic mass $\mu$ u		
109	69	178	Tm	x	-44120#	400#	8016#	2#	$\beta^-$	5580#	400#	177 952640#	430#
108	70		Yb	-nn	-49698	10	8042.86	0.06	$\beta^-$	645	10	177 946647	11
107	71		Lu		-50343.0	2.9	8042.083	0.016	$\beta^-$	2101.3	2.0	177 945955	3
106	72		Hf		-52444.3	2.1	8049.493	0.012	*			177 943698.8	2.3
105	73		Ta	-	-50507	15	8034.22	0.09	$\beta^+$	1937	15	177 945778	16
104	74		W	-	-50416	15	8029.31	0.09	$\beta^+$	91.3	2.0	177 945876	16
103	75		Re	x	-45653	28	7998.16	0.16	$\beta^+$	4760	30	177 950990	30
102	76		Os	$+\alpha$	-43546	16	7981.92	0.09	$\beta^+$	2110	30	177 953251	18
101	77		Ir	x	-36252	20	7936.55	0.11	$\beta^+$	7294	26	177 961082	21
100	78		Pt	$+\alpha$	-31998	11	7908.26	0.06	$\beta^+$	4254	23	177 965649	12
99	79		Au	$-\alpha$	-22330	60	7849.5	0.3	$\beta^+$	9670	60	177 976030	60
98	80		Hg	$-\alpha$	-16317	13	7811.37	0.07	$\beta^+$	6010	60	177 982483	14
97	81		Tl	$-\alpha$	-4750#	110#	7742#	1#	$\beta^+$	11560#	110#	177 994900#	120#
96	82		Pb	$-\alpha$	3568	24	7690.87	0.14	$\beta^+$	8320#	120#	178 003830	26
110	69	179	Tm	x	-41600#	500#	8002#	3#	$\beta^-$	4820#	590#	178 955340#	540#
109	70		Yb	x	-46420#	300#	8025#	2#	$\beta^-$	2650#	300#	178 950170#	320#
108	71		Lu		-49064	5	8035.10	0.03	$\beta^-$	1408	5	178 947327	6
107	72		Hf		-50471.9	2.1	8038.596	0.012	*			178 945816.1	2.3
106	73		Ta		-50366.3	2.2	8033.636	0.012	$\beta^+$	105.6	0.4	178 945929.5	2.3
105	74		W	+n	-49304	16	8023.33	0.09	$\beta^+$	1063	16	178 947070	17
104	75		Re	x	-46586	24	8003.78	0.14	$\beta^+$	2717	29	178 949988	26
103	76		Os	$+\alpha$	-43020	18	7979.48	0.10	$\beta^+$	3570	30	178 953816	19
102	77		Ir	$+\alpha$	-38077	11	7947.50	0.06	$\beta^+$	4943	21	178 959122	12
101	78		Pt	$+\alpha$	-32264	9	7910.65	0.05	$\beta^+$	5814	14	178 965363	10
100	79		Au		-24952	17	7865.43	0.09	$\beta^+$	7312	19	178 973213	18
99	80		Hg		-16922	27	7816.20	0.15	$\beta^+$	8030	30	178 981834	29
98	81		Tl	$-\alpha$	-8300	40	7763.67	0.24	$\beta^+$	8620	50	178 991090	50
97	82		Pb	x	2000#	200#	7702#	1#	$\beta^+$	10300#	200#	179 002150#	210#
110	70	180	Yb	x	-44400#	400#	8014#	2#	$\beta^-$	2280#	410#	179 952330#	430#
109	71		Lu	+	-46690	70	8022.1	0.4	$\beta^-$	3100	70	179 949880	80
108	72		Hf		-49788.4	2.1	8034.981	0.012	$\beta^-$	-852.2	2.5	179 946550.0	2.3
107	73		Ta		-48936.2	2.2	8025.900	0.012	$\beta^-$	708	4	179 947464.8	2.4
106	74		W		-49644	4	8025.488	0.022	*			179 946704	4
105	75		Re	x	-45840	21	8000.00	0.12	$\beta^+$	3805	22	179 950789	23
104	76		Os	$+\alpha$	-44359	20	7987.43	0.11	$\beta^+$	1481	29	179 952379	22
103	77		Ir	x	-37978	22	7947.63	0.12	$\beta^+$	6381	30	179 959229	23
102	78		Pt	$+\alpha$	-34436	11	7923.61	0.06	$\beta^+$	3542	24	179 963031	12
101	79		Au		-25596	21	7870.16	0.12	$\beta^+$	8840	24	179 972521	23
100	80		Hg		-20245	14	7836.08	0.08	$\beta^+$	5352	25	179 978266	15
99	81		Tl	$-\alpha$	-9400#	120#	7771#	1#	$\beta^+$	10840#	120#	179 989910#	130#
98	82		Pb	$-\alpha$	-1939	21	7725.69	0.12	$\beta^+$	7460#	120#	179 997918	22
111	70	181	Yb	x	-40850#	400#	7994#	2#	$\beta^-$	3890#	500#	180 956150#	430#
110	71		Lu	x	-44740#	300#	8012#	2#	$\beta^-$	2670#	300#	180 951970#	320#
109	72		Hf		-47411.9	2.1	8022.052	0.012	$\beta^-$	1029.8	2.1	180 949101.2	2.3
108	73		Ta		-48441.6	1.8	8023.418	0.010	*			180 947995.8	1.9
107	74		W		-48254	5	8018.059	0.026	$\beta^+$	188	5	180 948197	5
106	75		Re	4n	-46511	13	8004.11	0.07	$\beta^+$	1743	13	180 950068	14
105	76		Os	x	-43550	30	7983.44	0.17	$\beta^+$	2960	30	180 953240	30
104	77		Ir	x	-39472	26	7956.57	0.14	$\beta^+$	4080	40	180 957625	28
103	78		Pt	x	-34375	15	7924.09	0.08	$\beta^+$	5097	30	180 963097	16
102	79		Au	$-\alpha$	-27871	20	7883.84	0.11	$\beta^+$	6503	25	180 970079	21
101	80		Hg		-20661	15	7839.68	0.08	$\beta^+$	7210	25	180 977819	17
100	81		Tl		-12801	9	7791.93	0.05	$\beta^+$	7860	18	180 986257	10
99	82		Pb	$-\alpha$	-3140	90	7734.3	0.5	$\beta^+$	9660	90	180 996620	100

N	Z	A	Elt.	Orig.	Mass excess (keV)		Binding energy per nucleon (keV)		Beta-decay energy (keV)		Atomic mass $\mu$		
111	71	182	Lu	x	-41880#	200#	7996#	1#	$\beta^-$	4180#	200#	181 955040#	210#
110	72		Hf	-nn	-46059	6	8014.89	0.04	$\beta^-$	375	6	181 950554	7
109	73		Ta		-46433.3	1.8	8012.647	0.010	$\beta^-$	1814.3	1.7	181 950151.8	1.9
108	74		W		-48247.5	0.8	8018.316	0.005	*			181 948204.2	0.9
107	75		Re	IT	-45450	100	7998.6	0.6	$\beta^+$	2800	100	181 951210	110
106	76		Os		-44609	22	7989.73	0.12	$\beta^+$	840	100	181 952110	23
105	77		Ir		-39052	21	7954.89	0.12	$\beta^+$	5560	30	181 958076	23
104	78		Pt	$+\alpha$	-36169	16	7934.76	0.09	$\beta^+$	2882	26	181 961171	17
103	79		Au	$-\alpha$	-28301	20	7887.23	0.11	$\beta^+$	7869	26	181 969618	22
102	80		Hg	x	-23576	10	7856.97	0.05	$\beta^+$	4725	22	181 974690	10
101	81		Tl	$-\alpha$	-13350	80	7796.5	0.4	$\beta^+$	10230	80	181 985670	80
100	82		Pb	$-\alpha$	-6826	14	7756.34	0.08	$\beta^+$	6520	80	181 992672	15
112	71	183	Lu	x	-39520#	300#	7984#	2#	$\beta^-$	3760#	300#	182 957570#	320#
111	72		Hf	+	-43290	30	8000.04	0.16	$\beta^-$	2010	30	182 953530	30
110	73		Ta	-n	-45296.1	1.8	8006.753	0.010	$\beta^-$	1070.9	1.7	182 951372.6	1.9
109	74		W		-46367.0	0.8	8008.330	0.005	*			182 950223.0	0.9
108	75		Re	-	-45811	8	8001.02	0.04	$\beta^+$	556	8	182 950820	9
107	76		Os	x	-43660	50	7985.00	0.27	$\beta^+$	2150	50	182 953130	50
106	77		Ir		-40197	25	7961.79	0.14	$\beta^+$	3470	60	182 956846	27
105	78		Pt		-35772	16	7933.34	0.09	$\beta^+$	4425	30	182 961597	17
104	79		Au	$+\alpha$	-30187	10	7898.54	0.06	$\beta^+$	5586	19	182 967593	11
103	80		Hg		-23800	8	7859.36	0.04	$\beta^+$	6387	13	182 974450	9
102	81		Tl		-16587	10	7815.67	0.05	$\beta^+$	7213	13	182 982193	10
101	82		Pb	$-\alpha$	-7569	28	7762.12	0.15	$\beta^+$	9019	30	182 991870	30
113	71	184	Lu	x	-36410#	400#	7967#	2#	$\beta^-$	5090#	400#	183 960910#	430#
112	72		Hf	+	-41500	40	7990.73	0.22	$\beta^-$	1340	30	183 955450	40
111	73		Ta	+	-42841	26	7993.76	0.14	$\beta^-$	2866	26	183 954008	28
110	74		W		-45707.3	0.9	8005.087	0.005	$\beta^-$	-1481	4	183 950931.2	0.9
109	75		Re		-44227	4	7992.788	0.024	$\beta^-$	30	4	183 952521	5
108	76		Os		-44256.1	1.3	7988.696	0.007	*			183 952489.1	1.4
107	77		Ir	x	-39611	28	7959.20	0.15	$\beta^+$	4645	28	183 957480	30
106	78		Pt		-37332	18	7942.56	0.10	$\beta^+$	2280	30	183 959922	19
105	79		Au	$-\alpha$	-30319	22	7900.19	0.12	$\beta^+$	7013	29	183 967452	24
104	80		Hg		-26349	10	7874.37	0.05	$\beta^+$	3970	24	183 971713	11
103	81		Tl		-16890	50	7818.68	0.27	$\beta^+$	9460	50	183 981870	50
102	82		Pb		-11045	14	7782.69	0.08	$\beta^+$	5840	50	183 988142	15
101	83		Bi	$-\alpha$	1050#	130#	7713#	1#	$\beta^+$	12090#	130#	184 001120#	140#
113	72	185	Hf	x	-38360#	200#	7974#	1#	$\beta^-$	3040#	200#	184 958820#	210#
112	73		Ta	+	-41396	14	7986.37	0.08	$\beta^-$	1994	14	184 955559	15
111	74		W		-43389.7	0.9	7992.917	0.005	$\beta^-$	432.5	0.9	184 953419.3	1.0
110	75		Re		-43822.2	1.2	7991.026	0.006	*			184 952955.0	1.3
109	76		Os		-42809.4	1.3	7981.323	0.007	$\beta^+$	1012.8	0.4	184 954042.3	1.4
108	77		Ir	x	-40336	28	7963.72	0.15	$\beta^+$	2474	28	184 956700	30
107	78		Pt	x	-36680	40	7939.75	0.22	$\beta^+$	3650	50	184 960620	40
106	79		Au	$-\alpha$	-31867	26	7909.49	0.14	$\beta^+$	4820	50	184 965789	28
105	80		Hg	$-\alpha$	-26176	16	7874.50	0.08	$\beta^+$	5690	30	184 971899	17
104	81		Tl	IT	-19760	50	7835.56	0.29	$\beta^+$	6420	60	184 978790	60
103	82		Pb	$-\alpha$	-11541	16	7786.93	0.09	$\beta^+$	8210	60	184 987610	17
102	83		Bi	IT	-2210#	50#	7732#	0#	$\beta^+$	9330#	60#	184 997630#	60#

N	Z	A	Elt.	Orig.	Mass excess (keV)		Binding energy per nucleon (keV)		Beta-decay energy (keV)		Atomic mass $\mu$	
114	72	186	Hf	x	-36430#	300#	7964#	2#	$\beta^-$	2180#	300#	185 960890# 320#
113	73		Ta	+	-38610	60	7971.8	0.3	$\beta^-$	3900	60	185 958550 60
112	74		W		-42509.5	1.7	7988.607	0.009	$\beta^-$	-579.3	1.5	185 954364.1 1.9
111	75		Re		-41930.2	1.2	7981.286	0.006	$\beta^-$	1069.3	0.9	185 954986.1 1.3
110	76		Os		-42999.5	1.4	7982.829	0.007	*			185 953838.2 1.5
109	77		Ir	x	-39173	17	7958.05	0.09	$\beta^+$	3827	17	185 957946 18
108	78		Pt		-37864	22	7946.81	0.12	$\beta^+$	1308	27	185 959351 23
107	79		Au		-31715	21	7909.54	0.11	$\beta^+$	6150	30	185 965953 23
106	80		Hg	x	-28539	11	7888.26	0.06	$\beta^+$	3176	24	185 969362 12
105	81		Tl	x	-20190	180	7839.2	1.0	$\beta^+$	8350	180	185 978330 200
104	82		Pb	$-\alpha$	-14681	11	7805.34	0.06	$\beta^+$	5510	180	185 984239 12
103	83		Bi	$-\alpha$	-3170	80	7739.2	0.4	$\beta^+$	11510	80	185 996600 80
115	72	187	Hf	x	-32980#	400#	7946#	2#	$\beta^-$	3780#	450#	186 964590# 430#
114	73		Ta	x	-36770#	200#	7963#	1#	$\beta^-$	3140#	200#	186 960530# 210#
113	74		W		-39904.8	1.7	7975.120	0.009	$\beta^-$	1310.9	1.3	186 957160.5 1.9
112	75		Re		-41215.7	1.4	7977.947	0.008	$\beta^-$	2.469	0.004	186 955753.1 1.5
111	76		Os		-41218.2	1.4	7973.776	0.008	*			186 955750.5 1.5
110	77		Ir	-	-39716	6	7961.56	0.03	$\beta^+$	1502	6	186 957363 7
109	78		Pt	x	-36713	28	7941.32	0.15	$\beta^+$	3003	29	186 960590 30
108	79		Au		-33005	25	7917.31	0.13	$\beta^+$	3710	40	186 964568 27
107	80		Hg		-28118	14	7886.99	0.07	$\beta^+$	4887	29	186 969814 15
106	81		Tl		-22444	8	7852.46	0.04	$\beta^+$	5674	16	186 975906 9
105	82		Pb		-14980	8	7808.36	0.04	$\beta^+$	7464	12	186 983918 9
104	83		Bi		-6373	15	7758.15	0.08	$\beta^+$	8607	17	186 993158 16
116	72	188	Hf	x	-30880#	500#	7936#	3#	$\beta^-$	2930#	540#	187 966850# 540#
115	73		Ta	x	-33810#	200#	7947#	1#	$\beta^-$	4850#	200#	187 963700# 210#
114	74		W	+	-38667	3	7969.048	0.018	$\beta^-$	349	3	187 958489 4
113	75		Re	-n	-39016.1	1.4	7966.743	0.008	$\beta^-$	2120.28	0.19	187 958114.4 1.5
112	76		Os		-41136.4	1.4	7973.860	0.008	*			187 955838.2 1.5
111	77		Ir		-38328	7	7954.76	0.04	$\beta^+$	2808	7	187 958853 8
110	78		Pt		-37823	5	7947.912	0.029	$\beta^+$	505	7	187 959395 6
109	79		Au	x	-32301	20	7914.38	0.11	$\beta^+$	5522	21	187 965324 22
108	80		Hg		-30202	12	7899.05	0.06	$\beta^+$	2099	23	187 967577 12
107	81		Tl	x	-22350	30	7853.11	0.17	$\beta^+$	7860	30	187 976010 40
106	82		Pb	$-\alpha$	-17815	11	7824.84	0.06	$\beta^+$	4530	30	187 980874 11
105	83		Bi	$-\alpha$	-7200	50	7764.24	0.26	$\beta^+$	10610	50	187 992270 50
104	84		Po	$-\alpha$	-538	19	7724.62	0.10	$\beta^+$	6670	50	187 999422 21
116	73	189	Ta	x	-31830#	300#	7938#	2#	$\beta^-$	3650#	360#	188 965830# 320#
115	74		W	+	-35480	200	7952.7	1.1	$\beta^-$	2500	200	188 961910 210
114	75		Re	+p	-37978	8	7961.80	0.04	$\beta^-$	1007	8	188 959229 9
113	76		Os		-38985.4	1.5	7962.995	0.008	*			188 958147.5 1.6
112	77		Ir		-38453	13	7956.04	0.07	$\beta^+$	532	13	188 958719 14
111	78		Pt		-36483	11	7941.48	0.06	$\beta^+$	1970	14	188 960834 12
110	79		Au	x	-33582	20	7921.99	0.11	$\beta^+$	2901	23	188 963948 22
109	80		Hg		-29630	30	7896.94	0.18	$\beta^+$	3950	40	188 968190 40
108	81		Tl	$+\alpha$	-24602	11	7866.20	0.06	$\beta^+$	5030	40	188 973588 12
107	82		Pb	x	-17880	30	7826.48	0.18	$\beta^+$	6720	40	188 980810 40
106	83		Bi	$-\alpha$	-10060	50	7780.98	0.29	$\beta^+$	7820	60	188 989200 60
105	84		Po	$-\alpha$	-1415	22	7731.10	0.12	$\beta^+$	8650	60	188 998481 24

N	Z	A	Elt.	Orig.	Mass excess (keV)		Binding energy per nucleon (keV)		Beta-decay energy (keV)		Atomic mass $\mu$ u		
117	73	190	Ta	x	-28660#	400#	7922#	2#	$\beta^-$	5630#	430#	189 969230#	430#
116	74		W	+	-34300	160	7947.1	0.9	$\beta^-$	1270	70	189 963180	180
115	75		Re	+	-35570	150	7949.7	0.8	$\beta^-$	3140	150	189 961820	160
114	76		Os		-38706.3	1.5	7962.096	0.008	$\beta^-$	-1955.1	1.2	189 958447.0	1.6
113	77		Ir	+n	-36751.2	1.7	7947.688	0.009	$\beta^-$	572	6	189 960546.0	1.8
112	78		Pt		-37323	6	7946.58	0.03	*			189 959932	6
111	79		Au	-	-32881	16	7919.09	0.08	$\beta^+$	4442	15	189 964700	17
110	80		Hg		-31370	16	7907.02	0.08	$\beta^+$	1511	23	189 966322	17
109	81		Tl	$+\alpha$	-24330	50	7865.86	0.26	$\beta^+$	7040	50	189 973880	50
108	82		Pb	$-\alpha$	-20417	12	7841.13	0.06	$\beta^+$	3920	50	189 978082	13
107	83		Bi	$-\alpha$	-10900	180	7786.9	1.0	$\beta^+$	9510	180	189 988300	200
106	84		Po	$-\alpha$	-4563	13	7749.45	0.07	$\beta^+$	6340	180	189 995101	14
117	74	191	W	x	-31110#	200#	7931#	1#	$\beta^-$	3240#	200#	190 966600#	210#
116	75		Re	+p	-34349	10	7943.95	0.05	$\beta^-$	2045	10	190 963125	11
115	76		Os		-36393.7	1.5	7950.560	0.008	$\beta^-$	312.7	1.1	190 960929.7	1.6
114	77		Ir		-36706.4	1.7	7948.101	0.009	*			190 960594.0	1.8
113	78		Pt		-35698	4	7938.725	0.023	$\beta^+$	1008	4	190 961677	5
112	79		Au		-33810	40	7924.74	0.19	$\beta^+$	1890	40	190 963700	40
111	80		Hg		-30593	23	7903.81	0.12	$\beta^+$	3220	40	190 967157	24
110	81		Tl	$+\alpha$	-26281	8	7877.13	0.04	$\beta^+$	4312	24	190 971786	8
109	82		Pb	x	-20250	40	7841.44	0.20	$\beta^+$	6040	40	190 978270	40
108	83		Bi		-13240	7	7800.66	0.04	$\beta^+$	7010	40	190 985786	8
107	84		Po		-5054	11	7753.71	0.06	$\beta^+$	8186	13	190 994574	12
118	74	192	W	x	-29650#	600#	7924#	3#	$\beta^-$	2060#	630#	191 968170#	640#
117	75		Re	x	-31710#	200#	7931#	1#	$\beta^-$	4170#	200#	191 965960#	210#
116	76		Os		-35880.5	2.6	7948.516	0.013	$\beta^-$	-1047.3	2.3	191 961480.7	2.7
115	77		Ir		-34833.2	1.7	7938.986	0.009	$\beta^-$	1459.7	1.9	191 962605.0	1.8
114	78		Pt		-36292.9	2.5	7942.514	0.013	*			191 961038.0	2.7
113	79		Au	-	-32777	16	7920.13	0.08	$\beta^+$	3516	16	191 964813	17
112	80		Hg	x	-32011	16	7912.07	0.08	$\beta^+$	765	22	191 965634	17
111	81		Tl	x	-25870	30	7876.02	0.16	$\beta^+$	6140	40	191 972230	30
110	82		Pb	$-\alpha$	-22556	13	7854.67	0.07	$\beta^+$	3320	30	191 975785	14
109	83		Bi	$-\alpha$	-13550	30	7803.67	0.17	$\beta^+$	9010	40	191 985460	40
108	84		Po	$-\alpha$	-8071	12	7771.08	0.06	$\beta^+$	5470	40	191 991335	13
118	75	193	Re	x	-30300#	200#	7924#	1#	$\beta^-$	3090#	200#	192 967470#	210#
117	76		Os		-33392.6	2.6	7936.261	0.013	$\beta^-$	1141.2	2.3	192 964151.6	2.7
116	77		Ir		-34533.8	1.7	7938.121	0.009	*			192 962926.4	1.8
115	78		Pt		-34477.0	1.7	7933.773	0.009	$\beta^+$	56.79	0.30	192 962987.4	1.8
114	79		Au		-33394	11	7924.11	0.06	$\beta^+$	1083	11	192 964150	11
113	80		Hg		-31051	15	7907.91	0.08	$\beta^+$	2343	14	192 966665	17
112	81		Tl	x	-27320	110	7884.5	0.6	$\beta^+$	3730	110	192 970670	120
111	82		Pb	x	-22190	50	7853.92	0.26	$\beta^+$	5120	120	192 976170	50
110	83		Bi	x	-15873	10	7817.11	0.05	$\beta^+$	6320	50	192 982960	10
109	84		Po	$-\alpha$	-8360	30	7774.13	0.18	$\beta^+$	7510	40	192 991030	40
108	85		At	$-\alpha$	-150	50	7727.52	0.28	$\beta^+$	8210	60	192 999840	60
119	75	194	Re	x	-27550#	300#	7911#	2#	$\beta^-$	4880#	300#	193 970420#	320#
118	76		Os	+	-32432.7	2.6	7932.010	0.013	$\beta^-$	96.6	2.0	193 965182.1	2.8
117	77		Ir	-n	-32529.3	1.7	7928.475	0.009	$\beta^-$	2233.8	1.7	193 965078.4	1.8
116	78		Pt		-34763.1	0.9	7935.957	0.005	*			193 962680.3	0.9
115	79		Au		-32262	10	7919.03	0.05	$\beta^+$	2501	10	193 965365	11
114	80		Hg		-32193	13	7914.64	0.06	$\beta^+$	69	14	193 965439	13
113	81		Tl	x	-26830	140	7883.0	0.7	$\beta^+$	5370	140	193 971200	150
112	82		Pb		-24208	17	7865.42	0.09	$\beta^+$	2620	140	193 974012	19
111	83		Bi	x	-15990	50	7819.02	0.25	$\beta^+$	8220	50	193 982830	50
110	84		Po	$-\alpha$	-11005	13	7789.30	0.06	$\beta^+$	4990	50	193 988186	13
109	85		At	$-\alpha$	-1190	190	7734.7	1.0	$\beta^+$	9820	190	193 998730	200

N	Z	A	Elt.	Orig.	Mass excess (keV)		Binding energy per nucleon (keV)		Beta-decay energy (keV)		Atomic mass $\mu$		
119	76	195	Os	+	-29690	500	7918.7	2.6	$\beta^-$	2000	500	194 968130	540
118	77		Ir	-n	-31689.8	1.7	7924.902	0.009	$\beta^-$	1107.0	1.7	194 965979.6	1.8
117	78		Pt		-32796.8	0.9	7926.567	0.005	*			194 964791.1	0.9
116	79		Au		-32570.0	1.3	7921.392	0.007	$\beta^+$	226.8	1.0	194 965034.6	1.4
115	80		Hg		-31000	23	7909.33	0.12	$\beta^+$	1570	23	194 966720	25
114	81		Tl	$+\alpha$	-28155	14	7890.73	0.07	$\beta^+$	2845	27	194 969774	15
113	82		Pb	x	-23714	23	7863.94	0.12	$\beta^+$	4441	27	194 974542	25
112	83		Bi	x	-18024	6	7830.748	0.029	$\beta^+$	5690	24	194 980651	6
111	84		Po	$-\alpha$	-11070	40	7791.10	0.20	$\beta^+$	6950	40	194 988110	40
110	85		At	$-\alpha$	-3476	9	7748.12	0.05	$\beta^+$	7600	40	194 996268	10
109	86		Rn	$-\alpha$	5070	50	7700.31	0.26	$\beta^+$	8540	50	195 005440	50
120	76	196	Os	+pp	-28280	40	7912.25	0.20	$\beta^-$	1160	60	195 969640	40
119	77		Ir	+	-29440	40	7914.16	0.20	$\beta^-$	3210	40	195 968400	40
118	78		Pt		-32647.4	0.9	7926.544	0.004	$\beta^-$	-1507.4	3.0	195 964951.5	0.9
117	79		Au		-31140.0	3.0	7914.861	0.015	$\beta^-$	687	3	195 966570	3
116	80		Hg		-31826.7	2.9	7914.373	0.015	*			195 965833	3
115	81		Tl	x	-27497	12	7888.29	0.06	$\beta^+$	4330	12	195 970481	13
114	82		Pb	x	-25361	14	7873.40	0.07	$\beta^+$	2136	19	195 972774	15
113	83		Bi	x	-18009	24	7831.90	0.12	$\beta^+$	7352	28	195 980667	26
112	84		Po	$-\alpha$	-13474	13	7804.77	0.07	$\beta^+$	4535	28	195 985535	14
111	85		At	$-\alpha$	-3920	60	7752.1	0.3	$\beta^+$	9550	60	195 995790	60
110	86		Rn	$-\alpha$	1970	15	7717.99	0.08	$\beta^+$	5890	60	196 002115	16
120	77	197	Ir	+p	-28268	20	7909.02	0.10	$\beta^-$	2155	20	196 969653	22
119	78		Pt		-30422.4	0.8	7915.984	0.004	$\beta^-$	718.7	0.6	196 967340.2	0.9
118	79		Au		-31141.1	0.6	7915.661	0.003	*			196 966568.7	0.6
117	80		Hg		-30541	3	7908.643	0.016	$\beta^+$	600	3	196 967213	3
116	81		Tl	$+\alpha$	-28341	16	7893.51	0.08	$\beta^+$	2200	17	196 969575	18
115	82		Pb	IT	-24749	6	7871.298	0.028	$\beta^+$	3592	17	196 973431	6
114	83		Bi	$+\alpha$	-19688	8	7841.64	0.04	$\beta^+$	5061	10	196 978864	9
113	84		Po	$-\alpha$	-13360	50	7805.53	0.25	$\beta^+$	6330	50	196 985660	50
112	85		At	$-\alpha$	-6340	50	7765.96	0.26	$\beta^+$	7010	70	196 993190	50
111	86		Rn	$-\alpha$	1480	60	7722.3	0.3	$\beta^+$	7820	80	197 001580	70
121	77	198	Ir	x	-25820#	200#	7897#	1#	$\beta^-$	4090#	200#	197 972280#	210#
120	78		Pt	-n	-29908	3	7914.169	0.016	$\beta^-$	-326	3	197 967893	3
119	79		Au		-29582.1	0.6	7908.573	0.003	$\beta^-$	1372.3	0.5	197 968242.3	0.6
118	80		Hg		-30954.4	0.3	7911.553	0.002	*			197 966769.0	0.4
117	81		Tl	-	-27490	80	7890.1	0.4	$\beta^+$	3460	80	197 970480	90
116	82		Pb	x	-26050	15	7878.88	0.07	$\beta^+$	1440	80	197 972034	16
115	83		Bi	x	-19369	28	7841.19	0.14	$\beta^+$	6680	30	197 979210	30
114	84		Po		-15473	17	7817.56	0.09	$\beta^+$	3900	30	197 983389	19
113	85		At	$-\alpha$	-6670	50	7769.16	0.25	$\beta^+$	8800	50	197 992840	50
112	86		Rn	$-\alpha$	-1231	13	7737.73	0.07	$\beta^+$	5440	50	197 998679	14
122	77	199	Ir	p-2n	-24400	40	7891.22	0.21	$\beta^-$	2990	40	198 973800	40
121	78		Pt	-n	-27392	3	7902.319	0.016	$\beta^-$	1703	3	198 970593	3
120	79		Au		-29095.0	0.6	7906.943	0.003	$\beta^-$	452.0	0.6	198 968765.2	0.6
119	80		Hg		-29547.1	0.4	7905.284	0.002	*			198 968279.9	0.4
118	81		Tl	x	-28059	28	7893.88	0.14	$\beta^+$	1488	28	198 969880	30
117	82		Pb	$+\alpha$	-25228	26	7875.72	0.13	$\beta^+$	2830	40	198 972917	28
116	83		Bi	$+\alpha$	-20798	12	7849.53	0.06	$\beta^+$	4430	29	198 977672	13
115	84		Po	$-\alpha$	-15215	23	7817.54	0.12	$\beta^+$	5583	26	198 983666	25
114	85		At	$-\alpha$	-8820	50	7781.47	0.25	$\beta^+$	6400	60	198 990530	50
113	86		Rn	$-\alpha$	-1520	60	7740.8	0.3	$\beta^+$	7300	80	198 998370	70
112	87		Fr	$-\alpha$	6760	40	7695.31	0.21	$\beta^+$	8280	80	199 007260	40

N	Z	A	Elt.	Orig.	Mass excess (keV)		Binding energy per nucleon (keV)		Beta-decay energy (keV)		Atomic mass $\mu$ u		
122	78	200	Pt	-nn	-26603	20	7899.22	0.10	$\beta^-$	670	50	199 971441	22
121	79		Au	+	-27270	50	7898.63	0.25	$\beta^-$	2240	50	199 970730	50
120	80		Hg		-29504.1	0.4	7905.899	0.002	*			199 968326.0	0.4
119	81		Tl	-	-27048	6	7889.707	0.029	$\beta^+$	2456	6	199 970963	6
118	82		Pb	4n	-26243	11	7881.77	0.05	$\beta^+$	805	12	199 971827	12
117	83		Bi	$+\alpha$	-20370	24	7848.49	0.12	$\beta^+$	5873	26	199 978132	26
116	84		Po	$-\alpha$	-16954	14	7827.50	0.07	$\beta^+$	3416	28	199 981799	15
115	85		At	$-\alpha$	-8988	24	7783.76	0.12	$\beta^+$	7967	28	199 990351	26
114	86		Rn	$-\alpha$	-4006	13	7754.94	0.07	$\beta^+$	4982	28	199 995699	14
113	87		Fr	$-\alpha$	6120	80	7700.4	0.4	$\beta^+$	10130	80	200 006570	80
123	78	201	Pt	+	-23740	50	7885.83	0.25	$\beta^-$	2660	50	200 974510	50
122	79		Au		-26401	3	7895.176	0.016	$\beta^-$	1262	3	200 971657	3
121	80		Hg		-27663.3	0.6	7897.564	0.003	*			200 970302.3	0.6
120	81		Tl	+nn	-27182	15	7891.28	0.07	$\beta^+$	481	15	200 970819	16
119	82		Pb	$+\alpha$	-25258	22	7877.81	0.11	$\beta^+$	1924	27	200 972885	24
118	83		Bi	$+\alpha$	-21416	15	7854.81	0.08	$\beta^+$	3842	27	200 977009	16
117	84		Po	$-\alpha$	-16525	6	7826.580	0.029	$\beta^+$	4891	16	200 982260	6
116	85		At	$+\alpha$	-10789	8	7794.15	0.04	$\beta^+$	5735	10	200 988417	9
115	86		Rn	$-\alpha$	-4070	70	7756.8	0.4	$\beta^+$	6720	70	200 995630	80
114	87		Fr	$-\alpha$	3600	70	7714.8	0.4	$\beta^+$	7670	100	201 003860	80
124	78	202	Pt	x	-22600#	300#	7881#	1#	$\beta^-$	1800#	340#	201 975740#	320#
123	79		Au	+	-24400	170	7886.1	0.8	$\beta^-$	2950	170	201 973810	180
122	80		Hg		-27345.9	0.6	7896.852	0.003	*			201 970643.0	0.6
121	81		Tl		-25983	15	7886.23	0.07	$\beta^+$	1363	15	201 972106	16
120	82		Pb		-25934	8	7882.12	0.04	$\beta^+$	50	15	201 972159	9
119	83		Bi	x	-20733	20	7852.50	0.10	$\beta^+$	5201	22	201 977742	22
118	84		Po	$-\alpha$	-17924	15	7834.72	0.07	$\beta^+$	2809	25	201 980758	16
117	85		At	$-\alpha$	-10591	28	7794.54	0.14	$\beta^+$	7330	30	201 988630	30
116	86		Rn	$-\alpha$	-6275	18	7769.30	0.09	$\beta^+$	4320	30	201 993263	19
115	87		Fr	$-\alpha$	3140	50	7718.81	0.25	$\beta^+$	9420	50	202 003370	50
114	88		Ra	$-\alpha$	9210	60	7684.9	0.3	$\beta^+$	6070	80	202 009890	70
124	79	203	Au		-23143	3	7880.864	0.015	$\beta^-$	2126	3	202 975155	3
123	80		Hg		-25269.1	1.7	7887.482	0.008	$\beta^-$	492.1	1.2	202 972872.5	1.8
122	81		Tl		-25761.2	1.3	7886.052	0.006	*			202 972344.2	1.4
121	82		Pb		-24787	7	7877.40	0.03	$\beta^+$	975	6	202 973391	7
120	83		Bi		-21540	22	7857.55	0.11	$\beta^+$	3247	22	202 976876	23
119	84		Po	x	-17307	26	7832.84	0.13	$\beta^+$	4230	30	202 981420	28
118	85		At		-12163	12	7803.65	0.06	$\beta^+$	5144	29	202 986942	13
117	86		Rn	$-\alpha$	-6160	24	7770.23	0.12	$\beta^+$	6003	26	202 993387	25
116	87		Fr	x	861	16	7731.78	0.08	$\beta^+$	7022	28	203 000925	17
115	88		Ra	$-\alpha$	8640	80	7689.6	0.4	$\beta^+$	7780	80	203 009270	90
125	79	204	Au	+	-20750#	200#	7870#	1#	$\beta^-$	3940#	200#	203 977720#	220#
124	80		Hg		-24690.2	0.3	7885.545	0.002	$\beta^-$	-344.3	1.3	203 973493.9	0.4
123	81		Tl		-24346.0	1.3	7880.022	0.006	$\beta^-$	763.76	0.18	203 973863.5	1.3
122	82		Pb		-25109.7	1.2	7879.931	0.006	*			203 973043.6	1.3
121	83		Bi	$+\alpha$	-20667	26	7854.32	0.13	$\beta^+$	4442	26	203 977813	28
120	84		Po	$-\alpha$	-18334	11	7839.04	0.05	$\beta^+$	2334	28	203 980318	12
119	85		At		-11875	24	7803.55	0.12	$\beta^+$	6458	26	203 987251	26
118	86		Rn	$-\alpha$	-7984	15	7780.64	0.07	$\beta^+$	3891	28	203 991429	16
117	87		Fr	$-\alpha$	608	25	7734.69	0.12	$\beta^+$	8593	29	204 000653	26
116	88		Ra	$-\alpha$	6054	15	7704.16	0.08	$\beta^+$	5446	29	204 006500	17



N	Z	A	Elt.	Orig.	Mass excess (keV)		Binding energy per nucleon (keV)		Beta-decay energy (keV)		Atomic mass $\mu$		
126	79	205	Au	x	-18750#	300#	7861#	1#	$\beta^-$	3540#	300#	204 979870#	320#
125	80		Hg		-22287	4	7874.731	0.018	$\beta^-$	1533	4	204 976073	4
124	81		Tl		-23820.6	1.3	7878.393	0.006	*			204 974427.5	1.4
123	82		Pb		-23770.1	1.2	7874.330	0.006	$\beta^+$	50.5	0.5	204 974481.8	1.3
122	83		Bi		-21062	7	7857.30	0.04	$\beta^+$	2708	7	204 977389	8
121	84		Po	x	-17509	20	7836.16	0.10	$\beta^+$	3553	21	204 981203	21
120	85		At	$+\alpha$	-12972	15	7810.21	0.07	$\beta^+$	4537	25	204 986074	16
119	86		Rn	$-\alpha$	-7710	50	7780.74	0.25	$\beta^+$	5260	50	204 991720	50
118	87		Fr	x	-1310	8	7745.69	0.04	$\beta^+$	6400	50	204 998594	8
117	88		Ra	$-\alpha$	5840	90	7707.0	0.4	$\beta^+$	7150	90	205 006270	90
126	80	206	Hg	$+\alpha$	-20946	20	7869.17	0.10	$\beta^-$	1308	20	205 977514	22
125	81		Tl		-22253.1	1.4	7871.720	0.007	$\beta^-$	1532.3	0.6	205 976110.3	1.5
124	82		Pb		-23785.4	1.2	7875.361	0.006	*			205 974465.3	1.3
123	83		Bi	-	-20028	8	7853.32	0.04	$\beta^+$	3758	8	205 978499	8
122	84		Po	$-\alpha$	-18182	8	7840.56	0.04	$\beta^+$	1846	11	205 980481	9
121	85		At	$-\alpha$	-12420	20	7808.79	0.10	$\beta^+$	5762	22	205 986667	22
120	86		Rn	$-\alpha$	-9116	15	7788.96	0.07	$\beta^+$	3304	25	205 990214	16
119	87		Fr	$-\alpha$	-1243	28	7746.94	0.14	$\beta^+$	7870	30	205 998570	30
118	88		Ra	$-\alpha$	3565	18	7719.80	0.09	$\beta^+$	4810	30	206 003827	19
117	89		Ac	$-\alpha$	13510	70	7667.7	0.3	$\beta^+$	9950	70	206 014500	80
127	80	207	Hg	+	-16220	150	7847.3	0.7	$\beta^-$	4820	150	206 982590	160
126	81		Tl		-21034	5	7866.793	0.027	$\beta^-$	1418	5	206 977419	6
125	82		Pb		-22451.9	1.2	7869.865	0.006	*			206 975896.9	1.3
124	83		Bi		-20054.4	2.4	7854.504	0.012	$\beta^+$	2397.5	2.1	206 978470.7	2.6
123	84		Po		-17146	7	7836.67	0.03	$\beta^+$	2909	7	206 981593	7
122	85		At		-13243	21	7814.04	0.10	$\beta^+$	3903	22	206 985784	23
121	86		Rn	$-\alpha$	-8631	26	7787.98	0.13	$\beta^+$	4610	30	206 990734	28
120	87		Fr		-2840	50	7756.23	0.24	$\beta^+$	5790	60	206 996950	50
119	88		Ra	$-\alpha$	3540	60	7721.63	0.27	$\beta^+$	6380	80	207 003800	60
118	89		Ac	$-\alpha$	11130	50	7681.17	0.25	$\beta^+$	7590	80	207 011950	60
128	80	208	Hg	x	-13100#	300#	7833#	1#	$\beta^-$	3650#	300#	207 985940#	320#
127	81		Tl	$+\alpha$	-16749.5	2.0	7847.180	0.010	$\beta^-$	4999.0	1.7	207 982018.7	2.1
126	82		Pb		-21748.5	1.2	7867.452	0.006	*			207 976652.1	1.3
125	83		Bi	$+\alpha$	-18870.0	2.4	7849.852	0.011	$\beta^+$	2878.4	2.0	207 979742.2	2.5
124	84		Po	$-\alpha$	-17469.5	1.8	7839.357	0.009	$\beta^+$	1400.5	2.4	207 981245.7	1.9
123	85		At	$+\alpha$	-12491	26	7811.66	0.12	$\beta^+$	4978	26	207 986590	28
122	86		Rn	$-\alpha$	-9648	11	7794.23	0.05	$\beta^+$	2843	28	207 989642	12
121	87		Fr		-2670	50	7756.90	0.22	$\beta^+$	6980	50	207 997140	50
120	88		Ra	$-\alpha$	1714	15	7732.08	0.07	$\beta^+$	4380	50	208 001840	17
119	89		Ac	$-\alpha$	10760	60	7684.83	0.27	$\beta^+$	9050	60	208 011550	60
129	80	209	Hg	x	-8350#	200#	7812#	1#	$\beta^-$	5290#	200#	208 991040#	210#
128	81		Tl	$+\alpha$	-13638	8	7833.36	0.04	$\beta^-$	3976	8	208 985359	8
127	82		Pb		-17614.4	1.8	7848.647	0.009	$\beta^-$	644.0	1.1	208 981090.1	1.9
126	83		Bi		-18258.5	1.4	7847.985	0.007	*			208 980398.7	1.6
125	84		Po	$-\alpha$	-16365.9	1.8	7835.187	0.009	$\beta^+$	1892.5	1.6	208 982430.4	2.0
124	85		At		-12880	7	7814.76	0.04	$\beta^+$	3486	7	208 986173	8
123	86		Rn	$-\alpha$	-8929	20	7792.12	0.10	$\beta^+$	3951	21	208 990415	21
122	87		Fr		-3769	15	7763.69	0.07	$\beta^+$	5159	25	208 995954	16
121	88		Ra	$-\alpha$	1850	50	7733.03	0.24	$\beta^+$	5620	50	209 001990	50
120	89		Ac	$-\alpha$	8840	50	7695.85	0.24	$\beta^+$	6990	70	209 009490	50
119	90		Th	$-\alpha$	16500	100	7655.5	0.5	$\beta^+$	7660	110	209 017720	110

N	Z	A	Elt.	Orig.	Mass excess (keV)		Binding energy per nucleon (keV)		Beta-decay energy (keV)		Atomic mass $\mu$		
130	80	210	Hg	x	-5110#	300#	7798#	1#	$\beta^-$	4130#	300#	209 994510#	320#
129	81		Tl	$+\alpha$	-9246	12	7813.58	0.06	$\beta^-$	5482	12	209 990074	12
128	82		Pb		-14728.3	1.5	7835.964	0.007	$\beta^-$	63.5	0.5	209 984188.5	1.6
127	83		Bi		-14791.8	1.4	7832.541	0.007	$\beta^-$	1161.3	0.8	209 984120.4	1.6
126	84		Po		-15953.1	1.2	7834.345	0.006	*			209 982873.7	1.3
125	85		At	$-\alpha$	-11972	8	7811.66	0.04	$\beta^+$	3981	8	209 987148	8
124	86		Rn	$-\alpha$	-9598	9	7796.63	0.04	$\beta^+$	2374	12	209 989696	9
123	87		Fr		-3346	22	7763.14	0.11	$\beta^+$	6252	24	209 996408	24
122	88		Ra	$-\alpha$	461	15	7741.28	0.07	$\beta^+$	3807	27	210 000495	16
121	89		Ac	$-\alpha$	8790	60	7697.90	0.27	$\beta^+$	8330	60	210 009440	60
120	90		Th	$-\alpha$	14043	25	7669.16	0.12	$\beta^+$	5250	60	210 015075	27
130	81	211	Tl	$+\alpha$	-6080#	200#	7800#	1#	$\beta^-$	4420#	200#	210 993480#	220#
129	82		Pb		-10491.4	2.7	7817.000	0.013	$\beta^-$	1367	6	210 988737.0	2.9
128	83		Bi		-11858	6	7819.770	0.026	$\beta^-$	574	5	210 987269	6
127	84		Po	$-\alpha$	-12432.5	1.3	7818.783	0.006	*			210 986653.2	1.4
126	85		At	$-\alpha$	-11647.1	2.8	7811.354	0.013	$\beta^+$	785.4	2.5	210 987496.3	3.0
125	86		Rn	$-\alpha$	-8756	7	7793.94	0.03	$\beta^+$	2892	7	210 990601	7
124	87		Fr		-4158	21	7768.44	0.10	$\beta^+$	4598	22	210 995537	23
123	88		Ra	$-\alpha$	836	26	7741.07	0.12	$\beta^+$	4990	30	211 000898	28
122	89		Ac	$-\alpha$	7200	70	7707.2	0.3	$\beta^+$	6370	80	211 007730	80
121	90		Th	$-\alpha$	13910	70	7671.7	0.4	$\beta^+$	6700	100	211 014930	80
131	81	212	Tl	$+\alpha$	-1650#	300#	7780#	1#	$\beta^-$	5900#	300#	211 998230#	320#
130	82		Pb		-7547.4	2.2	7804.312	0.010	$\beta^-$	569.9	1.9	211 991897.5	2.4
129	83		Bi		-8117.3	2.0	7803.310	0.009	$\beta^-$	2252.1	1.7	211 991285.7	2.1
128	84		Po		-10369.4	1.2	7810.243	0.006	$\beta^-$	-1748	7	211 988868.0	1.3
127	85		At	$-\alpha$	-8621	7	7798.31	0.03	$\beta^-$	38	8	211 990745	8
126	86		Rn	$-\alpha$	-8660	3	7794.797	0.015	*			211 990704	3
125	87		Fr		-3538	26	7766.95	0.12	$\beta^+$	5122	26	211 996202	28
124	88		Ra	$-\alpha$	-191	11	7747.47	0.05	$\beta^+$	3346	28	211 999794	12
123	89		Ac	$-\alpha$	7280	70	7708.5	0.3	$\beta^+$	7470	70	212 007810	70
122	90		Th	$-\alpha$	12091	18	7682.16	0.09	$\beta^+$	4810	70	212 012980	20
121	91		Pa	$-\alpha$	21610	70	7633.5	0.4	$\beta^+$	9520	80	212 023200	80
131	82	213	Pb	$+\alpha$	-3184	8	7785.08	0.04	$\beta^-$	2046	9	212 996581	8
130	83		Bi		-5231	5	7791.016	0.023	$\beta^-$	1423	5	212 994385	5
129	84		Po		-6653	3	7794.023	0.015	*			212 992857	3
128	85		At	$-\alpha$	-6579	5	7790.003	0.023	$\beta^+$	74	5	212 992937	5
127	86		Rn	$-\alpha$	-5698	6	7782.192	0.027	$\beta^+$	881	7	212 993883	6
126	87		Fr		-3550	8	7768.43	0.04	$\beta^+$	2148	9	212 996189	8
125	88		Ra	$-\alpha$	358	20	7746.41	0.10	$\beta^+$	3908	22	213 000384	22
124	89		Ac	$-\alpha$	6150	50	7715.52	0.24	$\beta^+$	5800	60	213 006610	60
123	90		Th	$-\alpha$	12120	70	7683.9	0.3	$\beta^+$	5960	90	213 013010	80
122	91		Pa	$-\alpha$	19660	70	7644.8	0.3	$\beta^+$	7540	100	213 021110	80
132	82	214	Pb		-181.3	2.4	7772.386	0.011	$\beta^-$	1019	11	213 999805.4	2.6
131	83		Bi		-1200	11	7773.49	0.05	$\beta^-$	3270	11	213 998712	12
130	84		Po		-4469.9	1.5	7785.115	0.007	$\beta^-$	-1090	4	213 995201.4	1.6
129	85		At	$-\alpha$	-3380	4	7776.365	0.020	$\beta^-$	940	10	213 996372	5
128	86		Rn	$-\alpha$	-4320	9	7777.10	0.04	*			213 995363	10
127	87		Fr	$-\alpha$	-958	9	7757.74	0.04	$\beta^+$	3361	13	213 998971	9
126	88		Ra	$-\alpha$	101	9	7749.13	0.04	$\beta^+$	1059	13	214 000108	10
125	89		Ac	$-\alpha$	6429	22	7715.91	0.11	$\beta^+$	6328	24	214 006902	24
124	90		Th	$-\alpha$	10712	17	7692.24	0.08	$\beta^+$	4283	28	214 011500	18
123	91		Pa	$-\alpha$	19490	80	7647.6	0.4	$\beta^+$	8770	80	214 020920	80

N	Z	A	Elt.	Orig.	Mass excess (keV)		Binding energy per nucleon (keV)		Beta-decay energy (keV)		Atomic mass $\mu$ u		
133	82	215	Pb	$+\alpha$	4480#	410#	7752#	2#	$\beta^-$	2830#	410#	215 004810#	440#
132	83		Bi	x	1649	15	7761.63	0.07	$\beta^-$	2189	15	215 001770	16
131	84		Po		-540.3	2.5	7768.169	0.012	$\beta^-$	715	7	214 999420.0	2.7
130	85		At	$-\alpha$	-1255	7	7767.86	0.03	*			214 998653	7
129	86		Rn	$-\alpha$	-1169	8	7763.81	0.04	$\beta^+$	87	10	214 998745	8
128	87		Fr	$-\alpha$	318	7	7753.26	0.03	$\beta^+$	1487	10	215 000341	8
127	88		Ra	$-\alpha$	2534	8	7739.32	0.04	$\beta^+$	2215	10	215 002720	8
126	89		Ac	$-\alpha$	6012	21	7719.50	0.10	$\beta^+$	3478	22	215 006454	23
125	90		Th	$-\alpha$	10927	27	7693.00	0.13	$\beta^+$	4920	30	215 011730	29
124	91		Pa	$-\alpha$	17870	90	7657.1	0.4	$\beta^+$	6940	90	215 019190	90
133	83	216	Bi	x	5874	11	7743.50	0.05	$\beta^-$	4090	11	216 006306	12
132	84		Po		1783.8	2.2	7758.813	0.010	$\beta^-$	-473	4	216 001915.0	2.4
131	85		At		2257	4	7752.999	0.017	$\beta^-$	2002	8	216 002423	4
130	86		Rn	$-\alpha$	256	7	7758.64	0.03	*			216 000274	8
129	87		Fr	$-\alpha$	2979	14	7742.41	0.07	$\beta^+$	2723	16	216 003198	15
128	88		Ra	$-\alpha$	3291	9	7737.35	0.04	$\beta^+$	312	17	216 003533	9
127	89		Ac	$-\alpha$	8123	27	7711.36	0.12	$\beta^+$	4832	28	216 008720	29
126	90		Th	$-\alpha$	10304	13	7697.63	0.06	$\beta^+$	2182	30	216 011062	14
125	91		Pa	$-\alpha$	17800	70	7659.3	0.3	$\beta^+$	7500	70	216 019110	80
134	83	217	Bi	x	8820#	200#	7731#	1#	$\beta^-$	2920#	200#	217 009470#	210#
133	84		Po	$+\alpha$	5901	7	7741.28	0.03	$\beta^-$	1505	8	217 006335	7
132	85		At		4396	5	7744.612	0.023	$\beta^-$	737	6	217 004719	5
131	86		Rn	$-\alpha$	3659	4	7744.403	0.019	*			217 003928	5
130	87		Fr	$-\alpha$	4315	7	7737.77	0.03	$\beta^+$	656	8	217 004632	7
129	88		Ra	$-\alpha$	5887	9	7726.92	0.04	$\beta^+$	1573	11	217 006320	9
128	89		Ac	$-\alpha$	8707	13	7710.32	0.06	$\beta^+$	2819	15	217 009347	14
127	90		Th	$-\alpha$	12216	21	7690.55	0.10	$\beta^+$	3509	24	217 013114	22
126	91		Pa	$-\alpha$	17070	50	7664.58	0.24	$\beta^+$	4850	60	217 018320	60
125	92		U	$-\alpha$	22700	90	7635.0	0.4	$\beta^+$	5630	100	217 024370	90
135	83	218	Bi	$+\alpha$	13340#	360#	7712#	2#	$\beta^-$	4980#	360#	218 014320#	390#
134	84		Po		8358.3	2.4	7731.521	0.011	$\beta^-$	260	12	218 008973.0	2.6
133	85		At	$-\alpha$	8099	12	7729.12	0.05	$\beta^-$	2881	12	218 008694	12
132	86		Rn		5217.5	2.4	7738.751	0.011	$\beta^-$	-1842	5	218 005601.3	2.5
131	87		Fr	$-\alpha$	7059	5	7726.715	0.022	$\beta^-$	408	12	218 007578	5
130	88		Ra	$-\alpha$	6651	11	7725.00	0.05	*			218 007140	12
129	89		Ac	$-\alpha$	10840	50	7702.18	0.23	$\beta^+$	4190	50	218 011640	50
128	90		Th	$-\alpha$	12374	13	7691.57	0.06	$\beta^+$	1530	50	218 013284	14
127	91		Pa	$-\alpha$	18669	25	7659.10	0.11	$\beta^+$	6294	28	218 020042	26
126	92		U	$-\alpha$	21920	30	7640.59	0.14	$\beta^+$	3250	40	218 023540	30
135	84	219	Po	$+\alpha$	12800#	360#	7713#	2#	$\beta^-$	2410#	360#	219 013740#	390#
134	85		At	$+\alpha$	10397	4	7720.191	0.018	$\beta^-$	1566	3	219 011162	4
133	86		Rn		8830.8	2.5	7723.771	0.012	$\beta^-$	212	7	219 009480.2	2.7
132	87		Fr	$-\alpha$	8618	7	7721.17	0.03	*			219 009252	8
131	88		Ra	$-\alpha$	9394	8	7714.05	0.04	$\beta^+$	776	11	219 010085	9
130	89		Ac	$-\alpha$	11570	50	7700.55	0.23	$\beta^+$	2180	50	219 012420	50
129	90		Th	$-\alpha$	14470	50	7683.72	0.23	$\beta^+$	2900	70	219 015540	50
128	91		Pa	$-\alpha$	18520	50	7661.66	0.25	$\beta^+$	4050	70	219 019880	60
127	92		U	$-\alpha$	23210	60	7636.67	0.26	$\beta^+$	4690	80	219 024920	60
136	84	220	Po	$+\alpha$	15470#	360#	7702#	2#	$\beta^-$	1110#	360#	220 016600#	390#
135	85		At	$-\alpha$	14350	50	7703.81	0.23	$\beta^-$	3740	50	220 015410	60
134	86		Rn		10613.4	2.2	7717.248	0.010	$\beta^-$	-869	4	220 011394.0	2.4
133	87		Fr		11483	4	7709.740	0.019	$\beta^-$	1210	10	220 012327	4
132	88		Ra	$-\alpha$	10273	9	7711.68	0.04	*			220 011028	10
131	89		Ac	$-\alpha$	13752	15	7692.31	0.07	$\beta^+$	3479	17	220 014763	16
130	90		Th	$-\alpha$	14669	22	7684.59	0.10	$\beta^+$	917	27	220 015748	24
129	91		Pa	$-\alpha$	20380	60	7655.09	0.26	$\beta^+$	5710	60	220 021880	60
128	92		U	$-\alpha$	23030#	200#	7639#	1#	$\beta^+$	2650#	210#	220 024720#	220#

N	Z	A	Elt.	Orig.	Mass excess (keV)		Binding energy per nucleon (keV)		Beta-decay energy (keV)		Atomic mass $\mu$ u		
136	85	221	At	x	16810#	200#	7694#	1#	$\beta^-$	2340#	200#	221 018050#	210#
135	86		Rn	$+\alpha$	14472	6	7701.388	0.027	$\beta^-$	1194	7	221 015537	6
134	87		Fr		13278	5	7703.252	0.022	$\beta^-$	314	6	221 014255	5
133	88		Ra	$-\alpha$	12964	5	7701.134	0.021	*			221 013917	5
132	89		Ac	$-\alpha$	14520	50	7690.54	0.23	$\beta^+$	1560	50	221 015590	50
131	90		Th	$-\alpha$	16938	9	7676.07	0.04	$\beta^+$	2410	50	221 018184	10
130	91		Pa	$-\alpha$	20380	50	7656.96	0.23	$\beta^+$	3440	50	221 021880	60
129	92		U	$-\alpha$	24590#	100#	7634#	0#	$\beta^+$	4210#	110#	221 026400#	110#
137	85	222	At	x	20800#	300#	7678#	1#	$\beta^-$	4430#	300#	222 022330#	320#
136	86		Rn		16373.6	2.4	7694.491	0.011	$\beta^-$	24	21	222 017577.7	2.5
135	87		Fr		16349	21	7691.08	0.10	$\beta^-$	2028	22	222 017552	23
134	88		Ra		14321	5	7696.687	0.021	*			222 015375	5
133	89		Ac	$-\alpha$	16621	5	7682.802	0.023	$\beta^+$	2300	7	222 017844	6
132	90		Th	$-\alpha$	17203	12	7676.66	0.06	$\beta^+$	582	13	222 018468	13
131	91		Pa	$-\alpha$	22120#	70#	7651#	0#	$\beta^+$	4910#	70#	222 023740#	80#
130	92		U	$-\alpha$	24300#	100#	7638#	0#	$\beta^+$	2180#	120#	222 026090#	110#
138	85	223	At	x	23460#	400#	7668#	2#	$\beta^-$	3170#	500#	223 025190#	430#
137	86		Rn	x	20300#	300#	7679#	1#	$\beta^-$	1910#	300#	223 021790#	320#
136	87		Fr	$+\alpha$	18383.8	2.4	7683.658	0.011	$\beta^-$	1149.2	0.8	223 019735.9	2.6
135	88		Ra		17234.7	2.5	7685.303	0.011	*			223 018502.2	2.7
134	89		Ac	$-\alpha$	17826	7	7679.14	0.03	$\beta^+$	592	7	223 019137	8
133	90		Th	$-\alpha$	19386	9	7668.64	0.04	$\beta^+$	1559	12	223 020811	10
132	91		Pa	$-\alpha$	22320	70	7652.0	0.3	$\beta^+$	2930	70	223 023960	80
131	92		U	$-\alpha$	25840	70	7632.7	0.3	$\beta^+$	3520	100	223 027740	80
138	86	224	Rn	x	22440#	300#	7671#	1#	$\beta^-$	780#	300#	224 024090#	320#
137	87		Fr	+	21660	50	7670.78	0.22	$\beta^-$	2830	50	224 023250	50
136	88		Ra		18827.2	2.2	7679.917	0.010	$\beta^-$	-1408	4	224 020211.8	2.4
135	89		Ac	$-\alpha$	20235	4	7670.140	0.019	$\beta^-$	238	12	224 021723	4
134	90		Th	$-\alpha$	19996	11	7667.71	0.05	*			224 021467	12
133	91		Pa	$-\alpha$	23870	16	7646.93	0.07	$\beta^+$	3874	19	224 025626	17
132	92		U	$-\alpha$	25714	25	7635.20	0.11	$\beta^+$	1843	30	224 027605	27
139	86	225	Rn	x	26490#	300#	7655#	1#	$\beta^-$	2680#	300#	225 028440#	320#
138	87		Fr	+	23810	30	7662.97	0.13	$\beta^-$	1820	30	225 025570	30
137	88		Ra		21994.0	3.0	7667.581	0.013	$\beta^-$	356	5	225 023612	3
136	89		Ac		21638	5	7665.686	0.021	*			225 023230	5
135	90		Th	$-\alpha$	22310	5	7659.222	0.023	$\beta^+$	672	7	225 023951	5
134	91		Pa	$-\alpha$	24340	70	7646.7	0.3	$\beta^+$	2030	70	225 026130	80
133	92		U	$-\alpha$	27377	12	7629.75	0.05	$\beta^+$	3040	70	225 029391	12
132	93		Np	$-\alpha$	31590	70	7607.5	0.3	$\beta^+$	4210	70	225 033910	80
140	86	226	Rn	x	28770#	400#	7646#	2#	$\beta^-$	1400#	410#	226 030890#	430#
139	87		Fr	+	27370	100	7649.0	0.4	$\beta^-$	3700	100	226 029390	110
138	88		Ra		23669.1	2.3	7661.956	0.010	$\beta^-$	-641	3	226 025409.8	2.5
137	89		Ac		24310	3	7655.658	0.015	$\beta^-$	1113	5	226 026098	4
136	90		Th		23197	5	7657.121	0.021	*			226 024903	5
135	91		Pa	$-\alpha$	26033	11	7641.11	0.05	$\beta^+$	2836	12	226 027948	12
134	92		U	$-\alpha$	27329	13	7631.92	0.06	$\beta^+$	1296	17	226 029339	14
133	93		Np	$-\alpha$	32740#	90#	7605#	0#	$\beta^+$	5410#	90#	226 035150#	100#
141	86	227	Rn	$+\alpha$	32980#	420#	7630#	2#	$\beta^-$	3330#	440#	227 035410#	450#
140	87		Fr	+	29650	100	7640.8	0.4	$\beta^-$	2480	100	227 031840	110
139	88		Ra	-n	27179.0	2.4	7648.297	0.010	$\beta^-$	1328.0	2.3	227 029177.8	2.5
138	89		Ac		25850.9	2.4	7650.701	0.011	$\beta^-$	44.8	0.8	227 027752.1	2.6
137	90		Th		25806.2	2.5	7647.452	0.011	*			227 027704.1	2.7
136	91		Pa	$-\alpha$	26832	7	7639.49	0.03	$\beta^+$	1026	7	227 028805	8
135	92		U	$-\alpha$	29022	17	7626.39	0.07	$\beta^+$	2190	18	227 031156	18
134	93		Np	$-\alpha$	32560	70	7607.4	0.3	$\beta^+$	3540	70	227 034960	80

N	Z	A	Elt.	Orig.	Mass excess (keV)		Binding energy per nucleon (keV)		Beta-decay energy (keV)		Atomic mass $\mu$ u		
142	86	228	Rn	$+\alpha$	35380#	410#	7621#	2#	$\beta^-$	2100#	460#	228 037990#	440#
141	87		Fr	+	33280#	200#	7627#	1#	$\beta^-$	4340#	200#	228 035730#	220#
140	88		Ra	$+\alpha$	28941.8	2.4	7642.421	0.011	$\beta^-$	45.8	0.7	228 031070.3	2.6
139	89		Ac	-	28896.0	2.5	7639.191	0.011	$\beta^-$	2123.8	2.7	228 031021.1	2.7
138	90		Th		26772.2	2.2	7645.074	0.010	*			228 028741.1	2.4
137	91		Pa	$-\alpha$	28924	4	7632.204	0.019	$\beta^+$	2152	4	228 031051	5
136	92		U	$-\alpha$	29225	15	7627.45	0.07	$\beta^+$	301	16	228 031374	16
135	93		Np	x	33700#	200#	7604#	1#	$\beta^+$	4480#	200#	228 036180#	210#
134	94		Pu	$-\alpha$	36090	30	7590.49	0.14	$\beta^+$	2390#	200#	228 038740	30
142	87	229	Fr	x	35820	40	7617.69	0.16	$\beta^-$	3250	40	229 038450	40
141	88		Ra		32563	19	7628.48	0.08	$\beta^-$	1810	30	229 034958	20
140	89		Ac		30750	30	7632.97	0.15	$\beta^-$	1170	30	229 033020	40
139	90		Th		29586.5	2.8	7634.646	0.012	*			229 031762	3
138	91		Pa		29898.0	2.7	7629.869	0.012	$\beta^+$	311	3	229 032096.8	3.0
137	92		U	$-\alpha$	31211	6	7620.721	0.026	$\beta^+$	1313	6	229 033506	6
136	93		Np	$-\alpha$	33780	90	7606.1	0.4	$\beta^+$	2570	90	229 036260	90
135	94		Pu	$-\alpha$	37400	50	7586.86	0.22	$\beta^+$	3620	100	229 040150	60
143	87	230	Fr	$+\alpha$	39600#	450#	7603#	2#	$\beta^-$	5080#	450#	230 042510#	480#
142	88		Ra	x	34518	12	7621.91	0.05	$\beta^-$	710	300	230 037056	13
141	89		Ac	-	33810	300	7621.6	1.3	$\beta^-$	2940	300	230 036290	320
140	90		Th		30864.0	1.8	7630.990	0.008	$\beta^-$	-1310.5	2.8	230 033133.8	1.9
139	91		Pa		32175	3	7621.891	0.014	$\beta^-$	560	5	230 034541	4
138	92		U	$-\alpha$	31615	5	7620.923	0.021	*			230 033940	5
137	93		Np	$-\alpha$	35240	50	7601.78	0.22	$\beta^+$	3620	50	230 037830	60
136	94		Pu	$-\alpha$	36934	15	7590.99	0.07	$\beta^+$	1700	50	230 039650	16
144	87	231	Fr	$+\alpha$	42330#	470#	7593#	2#	$\beta^-$	3930#	550#	231 045440#	500#
143	88		Ra	x	38400#	300#	7607#	1#	$\beta^-$	2480#	310#	231 041220#	320#
142	89		Ac	+	35920	100	7614.4	0.4	$\beta^-$	2100	100	231 038560	110
141	90		Th		33817.3	1.8	7620.112	0.008	$\beta^-$	391.6	1.5	231 036304.3	1.9
140	91		Pa		33425.7	2.3	7618.420	0.010	*			231 035884.0	2.4
139	92		U	$-\alpha$	33807	3	7613.381	0.013	$\beta^+$	381.6	2.0	231 036294	3
138	93		Np	$-\alpha$	35630	50	7602.13	0.22	$\beta^+$	1820	50	231 038250	50
137	94		Pu	$-\alpha$	38285	26	7587.22	0.11	$\beta^+$	2660	60	231 041101	28
136	95		Am	x	42440#	300#	7566#	1#	$\beta^+$	4150#	300#	231 045560#	320#
145	87	232	Fr	$+\alpha$	46360#	640#	7578#	3#	$\beta^-$	5710#	700#	232 049770#	690#
144	88		Ra	$+\alpha$	40650#	280#	7599#	1#	$\beta^-$	1500#	300#	232 043640#	300#
143	89		Ac	+	39150	100	7602.5	0.4	$\beta^-$	3700	100	232 042030	110
142	90		Th		35448.3	2.0	7615.026	0.009	$\beta^-$	-500	8	232 038055.3	2.1
141	91		Pa	+	35948	8	7609.50	0.03	$\beta^-$	1337	7	232 038592	8
140	92		U	$-\alpha$	34610.7	2.2	7611.892	0.010	*			232 037156.2	2.4
139	93		Np	-	37360#	100#	7597#	0#	$\beta^+$	2750#	100#	232 040110#	110#
138	94		Pu	$-\alpha$	38366	18	7588.96	0.08	$\beta^+$	1010#	100#	232 041187	19
137	95		Am	x	43400#	300#	7564#	1#	$\beta^+$	5030#	300#	232 046590#	320#
145	88	233	Ra	$+\alpha$	44770#	470#	7584#	2#	$\beta^-$	3270#	560#	233 048060#	500#
144	89		Ac	x	41500#	300#	7594#	1#	$\beta^-$	2770#	300#	233 044550#	320#
143	90		Th		38733.2	2.0	7602.886	0.009	$\beta^-$	1243.1	1.4	233 041581.8	2.1
142	91		Pa		37490.1	2.2	7604.864	0.009	$\beta^-$	570.1	2.0	233 040247.3	2.3
141	92		U		36920.0	2.7	7603.953	0.012	*			233 039635.2	2.9
140	93		Np	$-\alpha$	37950	50	7596.18	0.22	$\beta^+$	1030	50	233 040740	50
139	94		Pu	$-\alpha$	40050	50	7583.80	0.22	$\beta^+$	2100	70	233 043000	50
138	95		Am	$-\alpha$	43170#	100#	7567#	0#	$\beta^+$	3120#	110#	233 046350#	110#
137	96		Cm	$-\alpha$	47290	70	7546.0	0.3	$\beta^+$	4120#	120#	233 050770	80

N	Z	A	El.	Orig.	Mass excess (keV)		Binding energy per nucleon (keV)		Beta-decay energy (keV)		Atomic mass $\mu$ u		
146	88	234	Ra	$+\alpha$	47230#	490#	7575#	2#	$\beta^-$	2130#	630#	234 050700#	530#
145	89		Ac	x	45100#	400#	7581#	2#	$\beta^-$	4490#	400#	234 048420#	430#
144	90		Th	$+\alpha$	40614	3	7596.849	0.015	$\beta^-$	273	3	234 043601	4
143	91		Pa	IT	40341	5	7594.673	0.020	$\beta^-$	2195	4	234 043308	5
142	92		U		38146.6	1.8	7600.708	0.008	*			234 040952.1	2.0
141	93		Np	-	39956	9	7589.63	0.04	$\beta^+$	1810	8	234 042895	9
140	94		Pu	$-\alpha$	40350	7	7584.607	0.030	$\beta^+$	393	11	234 043317	7
139	95		Am	$-\alpha$	44530#	210#	7563#	1#	$\beta^+$	4180#	210#	234 047810#	220#
138	96		Cm	$-\alpha$	46724	18	7550.68	0.08	$\beta^+$	2190#	210#	234 050160	20
146	89	235	Ac	$+\alpha$	47720#	360#	7572#	2#	$\beta^-$	3470#	360#	235 051230#	380#
145	90		Th	+n2p	44260	50	7583.37	0.21	$\beta^-$	1920	70	235 047510	50
144	91		Pa	+	42330	50	7588.24	0.21	$\beta^-$	1410	50	235 045440	50
143	92		U		40920.5	1.8	7590.907	0.008	*			235 043929.9	2.0
142	93		Np		41044.7	2.0	7587.049	0.008	$\beta^+$	124.2	0.9	235 044063.3	2.1
141	94		Pu	$-\alpha$	42184	21	7578.87	0.09	$\beta^+$	1139	21	235 045286	22
140	95		Am	$-\alpha$	44660#	120#	7565#	1#	$\beta^+$	2480#	120#	235 047950#	130#
139	96		Cm	$-\alpha$	47910#	200#	7548#	1#	$\beta^+$	3250#	240#	235 051430#	220#
138	97		Bk	x	52700#	400#	7524#	2#	$\beta^+$	4790#	450#	235 056580#	430#
147	89	236	Ac	$+\alpha$	51510#	500#	7558#	2#	$\beta^-$	5050#	540#	236 055300#	540#
146	90		Th	x	46450#	200#	7576#	1#	$\beta^-$	1110#	280#	236 049870#	210#
145	91		Pa	+	45350	200	7577.5	0.8	$\beta^-$	2900	200	236 048680	210
144	92		U		42446.3	1.8	7586.477	0.008	$\beta^-$	-930	50	236 045568.0	2.0
143	93		Np	IT	43380	50	7579.21	0.21	$\beta^-$	480	50	236 046570	50
142	94		Pu	$-\alpha$	42902.7	2.2	7577.913	0.009	*			236 046058.0	2.4
141	95		Am	-	46180#	100#	7561#	0#	$\beta^+$	3280#	100#	236 049580#	110#
140	96		Cm	$-\alpha$	47890#	200#	7550#	1#	$\beta^+$	1710#	220#	236 051410#	220#
139	97		Bk	x	53400#	400#	7523#	2#	$\beta^+$	5510#	450#	236 057330#	430#
147	90	237	Th	$+\alpha$	50200#	360#	7562#	2#	$\beta^-$	2560#	370#	237 053890#	390#
146	91		Pa	+	47640	100	7569.9	0.4	$\beta^-$	2250	100	237 051150	110
145	92		U		45391.9	1.9	7576.094	0.008	$\beta^-$	518.6	0.5	237 048730.2	2.0
144	93		Np		44873.3	1.8	7574.982	0.008	*			237 048173.4	2.0
143	94		Pu		45093.3	2.2	7570.752	0.009	$\beta^+$	220.0	1.3	237 048409.7	2.4
142	95		Am	$-\alpha$	46570#	60#	7561#	0#	$\beta^+$	1480#	60#	237 050000#	60#
141	96		Cm	$-\alpha$	49280#	210#	7546#	1#	$\beta^+$	2710#	220#	237 052900#	220#
140	97		Bk	$-\alpha$	53100#	220#	7527#	1#	$\beta^+$	3820#	310#	237 057000#	240#
139	98		Cf	x	57820#	500#	7504#	2#	$\beta^+$	4720#	550#	237 062070#	540#
148	90	238	Th	$+\alpha$	52630#	280#	7554#	1#	$\beta^-$	1860#	290#	238 056500#	300#
147	91		Pa	+	50770	60	7558.87	0.25	$\beta^-$	3460	60	238 054500	60
146	92		U		47308.9	1.9	7570.120	0.008	$\beta^-$	-147.3	1.2	238 050788.2	2.0
145	93		Np	-n	47456.3	1.8	7566.214	0.008	$\beta^-$	1291.5	0.4	238 050946.4	2.0
144	94		Pu		46164.7	1.8	7568.354	0.008	*			238 049559.9	2.0
143	95		Am	$-\alpha$	48420	50	7555.58	0.21	$\beta^+$	2260	50	238 051980	50
142	96		Cm	$-\alpha$	49400	40	7548.20	0.15	$\beta^+$	970	60	238 053030	40
141	97		Bk	$-\alpha$	54290#	290#	7524#	1#	$\beta^+$	4890#	290#	238 058280#	310#
140	98		Cf	x	57200#	400#	7509#	2#	$\beta^+$	2920#	490#	238 061410#	430#
148	91	239	Pa	x	53340#	200#	7550#	1#	$\beta^-$	2760#	200#	239 057260#	210#
147	92		U	-n	50573.9	1.9	7558.557	0.008	$\beta^-$	1261.5	1.6	239 054293.3	2.1
146	93		Np		49312.4	2.1	7560.561	0.009	$\beta^-$	722.5	1.0	239 052939.0	2.2
145	94		Pu		48589.9	1.8	7560.311	0.008	*			239 052163.4	2.0
144	95		Am	$-\alpha$	49392.0	2.4	7553.681	0.010	$\beta^+$	802.1	1.7	239 053024.5	2.6
143	96		Cm	-	51190#	100#	7543#	0#	$\beta^+$	1800#	100#	239 054960#	110#
142	97		Bk	$-\alpha$	54290#	230#	7527#	1#	$\beta^+$	3100#	250#	239 058280#	250#
141	98		Cf	$-\alpha$	58150#	210#	7507#	1#	$\beta^+$	3860#	310#	239 062420#	230#

N	Z	A	Elt.	Orig.	Mass excess (keV)		Binding energy per nucleon (keV)		Beta-decay energy (keV)		Atomic mass $\mu$		
149	91	240	Pa	x	56800#	300#	7538#	1#	$\beta^-$	4090#	300#	240 060980#	320#
148	92		U	+ $\alpha$	52715	5	7551.771	0.021	$\beta^-$	400	16	240 056592	6
147	93		Np	+	52315	15	7550.18	0.06	$\beta^-$	2188	15	240 056162	16
146	94		Pu		50127.0	1.8	7556.036	0.008	*			240 053813.5	2.0
145	95		Am	+n	51512	14	7547.01	0.06	$\beta^+$	1385	14	240 0555300	15
144	96		Cm	- $\alpha$	51725.4	2.3	7542.856	0.010	$\beta^+$	214	14	240 055529.5	2.5
143	97		Bk	-	55670#	150#	7523#	1#	$\beta^+$	3940#	150#	240 059760#	160#
142	98		Cf	- $\alpha$	58030#	200#	7510#	1#	$\beta^+$	2370#	250#	240 062300#	220#
141	99		Es	x	64200#	400#	7481#	2#	$\beta^+$	6160#	450#	240 068920#	430#
149	92	241	U	x	56200#	300#	7539#	1#	$\beta^-$	1940#	310#	241 060330#	320#
148	93		Np	+	54260	70	7544.26	0.29	$\beta^-$	1300	70	241 058250	80
147	94		Pu		52956.8	1.8	7546.432	0.008	$\beta^-$	20.78	0.13	241 056851.5	2.0
146	95		Am		52936.0	1.8	7543.272	0.008	*			241 056829.1	2.0
145	96		Cm		53703.4	2.2	7536.841	0.009	$\beta^+$	767.4	1.2	241 057653.0	2.3
144	97		Bk	-	56100#	200#	7524#	1#	$\beta^+$	2400#	200#	241 060230#	220#
143	98		Cf	- $\alpha$	59360#	260#	7507#	1#	$\beta^+$	3260#	320#	241 063730#	270#
142	99		Es	- $\alpha$	63840#	230#	7485#	1#	$\beta^+$	4480#	340#	241 068540#	240#
150	92	242	U	+ $\alpha$	58620#	200#	7532#	1#	$\beta^-$	1200#	280#	242 062930#	220#
149	93		Np	+	57420	200	7533.4	0.8	$\beta^-$	2700	200	242 061640	210
148	94		Pu		54718.4	1.9	7541.321	0.008	$\beta^-$	-751.3	0.7	242 058742.6	2.0
147	95		Am	-n	55469.7	1.8	7534.984	0.008	$\beta^-$	664.5	0.4	242 059549.2	2.0
146	96		Cm	- $\alpha$	54805.2	1.8	7534.497	0.008	*			242 058835.8	2.0
145	97		Bk	-	57740#	200#	7519#	1#	$\beta^+$	2930#	200#	242 061980#	220#
144	98		Cf	- $\alpha$	59340	40	7509.30	0.15	$\beta^+$	1600#	200#	242 063700	40
143	99		Es	- $\alpha$	64970#	330#	7483#	1#	$\beta^+$	5630#	330#	242 069750#	350#
142	100		Fm	x	68400#	400#	7465#	2#	$\beta^+$	3430#	520#	242 073430#	430#
150	93	243	Np	IT	59880#	30#	7525#	0#	$\beta^-$	2120#	30#	243 064280#	30#
149	94		Pu		57756	3	7531.004	0.013	$\beta^-$	579.4	2.9	243 062003	3
148	95		Am		57176.1	2.3	7530.169	0.009	*			243 061381.1	2.5
147	96		Cm	- $\alpha$	57183.6	2.1	7526.918	0.009	$\beta^+$	7.5	1.7	243 061389.1	2.2
146	97		Bk	- $\alpha$	58691	5	7517.495	0.020	$\beta^+$	1508	5	243 063008	5
145	98		Cf	- $\alpha$	60950#	140#	7505#	1#	$\beta^+$	2250#	140#	243 065430#	150#
144	99		Es	- $\alpha$	64780#	230#	7486#	1#	$\beta^+$	3840#	270#	243 069550#	250#
143	100		Fm	- $\alpha$	69260#	220#	7464#	1#	$\beta^+$	4480#	320#	243 074350#	230#
151	93	244	Np	x	63200#	300#	7514#	1#	$\beta^-$	3400#	300#	244 067850#	320#
150	94		Pu		59806	5	7524.817	0.021	$\beta^-$	-75	5	244 064204	5
149	95		Am	+	59881.0	2.1	7521.301	0.009	$\beta^-$	1427.3	1.0	244 064284.8	2.2
148	96		Cm	- $\alpha$	58453.7	1.8	7523.944	0.007	*			244 062752.6	2.0
147	97		Bk	- $\alpha$	60716	14	7511.47	0.06	$\beta^+$	2262	14	244 065181	16
146	98		Cf	- $\alpha$	61479.2	2.9	7505.132	0.012	$\beta^+$	764	15	244 066001	3
145	99		Es	- $\alpha$	66030#	180#	7483#	1#	$\beta^+$	4550#	180#	244 070880#	200#
144	100		Fm	- $\alpha$	69010#	280#	7468#	1#	$\beta^+$	2980#	340#	244 074080#	300#
151	94	245	Pu	-n	63106	14	7513.58	0.06	$\beta^-$	1206	15	245 067747	15
150	95		Am	+ $\alpha$	61900	3	7515.306	0.014	$\beta^-$	895.0	2.8	245 066452	4
149	96		Cm	- $\alpha$	61004.7	2.1	7515.766	0.008	*			245 065491.2	2.2
148	97		Bk	- $\alpha$	61815.4	2.3	7509.264	0.009	$\beta^+$	810.7	1.7	245 066361.6	2.5
147	98		Cf	- $\alpha$	63386.9	2.9	7499.657	0.012	$\beta^+$	1571.4	2.6	245 068049	3
146	99		Es	- $\alpha$	66440#	200#	7484#	1#	$\beta^+$	3050#	200#	245 071320#	220#
145	100		Fm	- $\alpha$	70220#	280#	7465#	1#	$\beta^+$	3780#	340#	245 075390#	300#
144	101		Md	IT	75290#	320#	7441#	1#	$\beta^+$	5070#	420#	245 080830#	350#
152	94	246	Pu		65395	15	7506.54	0.06	$\beta^-$	401	14	246 070205	16
151	95		Am	IT	64995	18	7504.99	0.07	$\beta^-$	2376	18	246 069775	20
150	96		Cm		62618.4	2.1	7511.465	0.008	*			246 067223.7	2.2
149	97		Bk	-	63970	60	7502.80	0.24	$\beta^+$	1350	60	246 068670	60
148	98		Cf	- $\alpha$	64091.7	2.1	7499.115	0.009	$\beta^+$	120	60	246 068805.3	2.2
147	99		Es	- $\alpha$	67900#	220#	7480#	1#	$\beta^+$	3810#	220#	246 072900#	240#
146	100		Fm	- $\alpha$	70140	40	7468.17	0.16	$\beta^+$	2240#	230#	246 075300	40
145	101		Md	- $\alpha$	76280#	330#	7440#	1#	$\beta^+$	6140#	330#	246 081890#	350#

N	Z	A	Elt.	Orig.	Mass excess (keV)		Binding energy per nucleon (keV)		Beta-decay energy (keV)		Atomic mass $\mu$		
153	94	247	Pu	x	69000#	300#	7494#	1#	$\beta^-$	1840#	310#	247 074070#	320#
152	95		Am	+	67150#	100#	7499#	0#	$\beta^-$	1620#	100#	247 072090#	110#
151	96		Cm		65534	4	7501.928	0.018	$\beta^-$	43	7	247 070354	5
150	97		Bk	$-\alpha$	65491	6	7498.936	0.022	*	*	*	247 070307	6
149	98		Cf	-	66137	8	7493.15	0.03	$\beta^+$	646	6	247 071001	9
148	99		Es	$-\alpha$	68610#	30#	7480#	0#	$\beta^+$	2470#	30#	247 073660#	30#
147	100		Fm	$-\alpha$	71580#	140#	7465#	1#	$\beta^+$	2970#	150#	247 076850#	150#
146	101		Md	IT	76040#	320#	7444#	1#	$\beta^+$	4460#	350#	247 081640#	350#
153	95	248	Am	+	70560#	200#	7487#	1#	$\beta^-$	3170#	200#	248 075750#	220#
152	96		Cm		67392	5	7496.731	0.020	$\beta^-$	-690#	70#	248 072349	5
151	97		Bk	IT	68080#	70#	7491#	0#	$\beta^-$	840#	70#	248 073090#	80#
150	98		Cf	$-\alpha$	67240	5	7491.036	0.021	*	*	*	248 072185	6
149	99		Es	$-\alpha$	70300#	50#	7476#	0#	$\beta^+$	3060#	50#	248 075470#	60#
148	100		Fm	$-\alpha$	71906	12	7465.91	0.05	$\beta^+$	1610#	50#	248 077195	13
147	101		Md	$-\alpha$	77150#	240#	7442#	1#	$\beta^+$	5240#	240#	248 082820#	260#
146	102		No	$-\alpha$	80660#	300#	7424#	1#	$\beta^+$	3520#	380#	248 086600#	320#
154	95	249	Am	x	73100#	300#	7479#	1#	$\beta^-$	2350#	300#	249 078480#	320#
153	96		Cm	-n	70750	5	7485.552	0.020	$\beta^-$	901	5	249 075953	5
152	97		Bk	+	69849.6	2.6	7486.027	0.010	$\beta^-$	124.0	1.4	249 074986.7	2.8
151	98		Cf	$-\alpha$	69725.6	2.2	7483.383	0.009	*	*	*	249 074853.5	2.4
150	99		Es	$-\alpha$	71180#	30#	7474#	0#	$\beta^+$	1450#	30#	249 076410#	30#
149	100		Fm	$-\alpha$	73620#	100#	7461#	0#	$\beta^+$	2440#	110#	249 079030#	110#
148	101		Md	$-\alpha$	77330#	220#	7443#	1#	$\beta^+$	3710#	250#	249 083010#	240#
147	102		No	$-\alpha$	81820#	340#	7422#	1#	$\beta^+$	4490#	410#	249 087830#	370#
154	96	250	Cm	-nn	72989	11	7478.94	0.04	$\beta^-$	38	12	250 078357	12
153	97		Bk	$+\alpha$	72951	4	7475.961	0.016	$\beta^-$	1780	3	250 078317	4
152	98		Cf	$-\alpha$	71171.8	2.1	7479.950	0.008	*	*	*	250 076406.1	2.2
151	99		Es	-	73230#	100#	7469#	0#	$\beta^+$	2060#	100#	250 078610#	110#
150	100		Fm	$-\alpha$	74074	12	7462.08	0.05	$\beta^+$	850#	100#	250 079521	13
149	101		Md	$-\alpha$	78640#	300#	7441#	1#	$\beta^+$	4560#	300#	250 084420#	320#
148	102		No	$-\alpha$	81520#	200#	7426#	1#	$\beta^+$	2880#	360#	250 087510#	220#
155	96	251	Cm	+	76648	23	7466.72	0.09	$\beta^-$	1420	20	251 082285	24
154	97		Bk	+	75228	11	7469.26	0.04	$\beta^-$	1093	10	251 080760	12
153	98		Cf	$-\alpha$	74135	4	7470.502	0.018	*	*	*	251 079587	5
152	99		Es	$-\alpha$	74512	6	7465.881	0.024	$\beta^+$	378	7	251 079992	7
151	100		Fm	$-\alpha$	75987	8	7456.89	0.03	$\beta^+$	1474	7	251 081575	9
150	101		Md	$-\alpha$	79030#	200#	7442#	1#	$\beta^+$	3040#	200#	251 084840#	220#
149	102		No	$-\alpha$	82910#	180#	7423#	1#	$\beta^+$	3890#	270#	251 089010#	190#
148	103		Lr	x	87900#	300#	7400#	1#	$\beta^+$	4980#	350#	251 094360#	320#
156	96	252	Cm	x	79060#	300#	7460#	1#	$\beta^-$	520#	360#	252 084870#	320#
155	97		Bk	+	78530#	200#	7459#	1#	$\beta^-$	2500#	200#	252 084310#	220#
154	98		Cf	$-\alpha$	76034	5	7465.349	0.020	$\beta^-$	-1260	50	252 081626	5
153	99		Es	-	77290	50	7457.24	0.20	$\beta^-$	480	50	252 082980	50
152	100		Fm	$-\alpha$	76817	6	7456.031	0.023	*	*	*	252 082467	6
151	101		Md	x	80630#	200#	7438#	1#	$\beta^+$	3810#	200#	252 086560#	210#
150	102		No	$-\alpha$	82881	13	7425.76	0.05	$\beta^+$	2250#	200#	252 088977	14
149	103		Lr	$-\alpha$	88840#	250#	7399#	1#	$\beta^+$	5960#	250#	252 095370#	270#
156	97	253	Bk	$-\alpha$	80930#	360#	7451#	1#	$\beta^-$	1630#	360#	253 086880#	390#
155	98		Cf	$-\alpha$	79301	6	7454.831	0.024	$\beta^-$	287	6	253 085133	7
154	99		Es	$-\alpha$	79013.7	2.6	7452.874	0.010	*	*	*	253 084824.7	2.8
153	100		Fm	$-\alpha$	79350	4	7448.455	0.015	$\beta^+$	336	3	253 085185	4
152	101		Md	x	81300#	210#	7438#	1#	$\beta^+$	1950#	210#	253 087280#	220#
151	102		No	$-\alpha$	84470#	100#	7422#	0#	$\beta^+$	3170#	230#	253 090680#	110#
150	103		Lr	$-\alpha$	88690#	220#	7402#	1#	$\beta^+$	4220#	250#	253 095210#	240#
149	104		Rf	$-\alpha$	93790#	450#	7379#	2#	$\beta^+$	5100#	510#	253 100690#	490#



N	Z	A	Elt.	Orig.	Mass excess (keV)		Binding energy per nucleon (keV)		Beta-decay energy (keV)		Atomic mass $\mu$ u		
157	97	254	Bk	x	84390#	300#	7440#	1#	$\beta^-$	3050#	300#	254 090600#	320#
156	98		Cf	$-\alpha$	81341	12	7449.23	0.05	$\beta^-$	-651	13	254 087323	13
155	99		Es	$-\alpha$	81992	4	7443.584	0.017	$\beta^-$	1088	3	254 088022	5
154	100		Fm	$-\alpha$	80904.2	2.8	7444.786	0.011	*			254 086854.2	3.0
153	101		Md	-	83510#	100#	7431#	0#	$\beta^+$	2610#	100#	254 089660#	110#
152	102		No	$-\alpha$	84724	18	7423.59	0.07	$\beta^+$	1210#	100#	254 090955	19
151	103		Lr	$-\alpha$	89850#	340#	7400#	1#	$\beta^+$	5120#	340#	254 096450#	360#
150	104		Rf	$-\alpha$	93320#	290#	7384#	1#	$\beta^+$	3470#	440#	254 100180#	310#
157	98	255	Cf	+	84810#	200#	7438#	1#	$\beta^-$	720#	200#	255 091050#	220#
156	99		Es	$-\alpha$	84089	11	7437.82	0.04	$\beta^-$	290	10	255 090273	12
155	100		Fm	$-\alpha$	83799	5	7435.890	0.019	*			255 089962	5
154	101		Md	$-\alpha$	84843	7	7428.729	0.026	$\beta^+$	1044	8	255 091083	7
153	102		No	$-\alpha$	86854	10	7417.78	0.04	$\beta^+$	2011	9	255 093241	11
152	103		Lr	$-\alpha$	90060#	210#	7402#	1#	$\beta^+$	3200#	210#	255 096680#	220#
151	104		Rf	$-\alpha$	94400#	180#	7382#	1#	$\beta^+$	4340#	270#	255 101340#	190#
150	105		Db	$-\alpha$	100040#	420#	7357#	2#	$\beta^+$	5640#	460#	255 107400#	450#
158	98	256	Cf	x	87040#	300#	7432#	1#	$\beta^-$	-150#	310#	256 093440#	320#
157	99		Es	+	87190#	100#	7428#	0#	$\beta^-$	1700#	100#	256 093600#	110#
156	100		Fm	$-\alpha$	85486	7	7431.783	0.028	*			256 091773	8
155	101		Md	$-\alpha$	87620	50	7420.41	0.21	$\beta^+$	2130	50	256 094060	60
154	102		No	$-\alpha$	87824	8	7416.54	0.03	$\beta^+$	210	50	256 094283	8
153	103		Lr	$-\alpha$	91870#	220#	7398#	1#	$\beta^+$	4050#	220#	256 098630#	240#
152	104		Rf	$-\alpha$	94236	24	7385.38	0.09	$\beta^+$	2360#	220#	256 101166	26
151	105		Db	$-\alpha$	100720#	290#	7357#	1#	$\beta^+$	6480#	290#	256 108130#	310#
158	99	257	Es	$-\alpha$	89400#	410#	7422#	2#	$\beta^-$	810#	410#	257 095980#	440#
157	100		Fm	$-\alpha$	88589	6	7422.196	0.025	*			257 095105	7
156	101		Md	$-\alpha$	88996.2	2.8	7417.569	0.011	$\beta^+$	407	6	257 095541	3
155	102		No	$-\alpha$	90241	22	7409.68	0.08	$\beta^+$	1244	22	257 096877	23
154	103		Lr	$-\alpha$	92740#	210#	7397#	1#	$\beta^+$	2490#	210#	257 099560#	220#
153	104		Rf	$-\alpha$	95930#	100#	7381#	0#	$\beta^+$	3200#	230#	257 102990#	110#
152	105		Db	$-\alpha$	100340#	230#	7361#	1#	$\beta^+$	4410#	250#	257 107720#	240#
159	99	258	Es	x	92700#	300#	7412#	1#	$\beta^-$	2280#	360#	258 099520#	320#
158	100		Fm	$-\alpha$	90430#	200#	7418#	1#	$\beta^-$	-1260#	200#	258 097080#	220#
157	101		Md	$-\alpha$	91688	5	7409.669	0.018	$\beta^-$	210#	200#	258 098431	5
156	102		No	$-\alpha$	91480#	200#	7407#	1#	*			258 098210#	220#
155	103		Lr	$-\alpha$	94840#	100#	7391#	0#	$\beta^+$	3360#	220#	258 101810#	110#
154	104		Rf	$-\alpha$	96400#	200#	7382#	1#	$\beta^+$	1560#	230#	258 103490#	220#
153	105		Db	$-\alpha$	101750#	340#	7359#	1#	$\beta^+$	5350#	400#	258 109230#	370#
152	106		Sg	$-\alpha$	105420#	410#	7341#	2#	$\beta^+$	3670#	540#	258 113170#	450#
159	100	259	Fm	$-\alpha$	93700#	280#	7407#	1#	$\beta^-$	80#	350#	259 100600#	300#
158	101		Md	$-\alpha$	93620#	200#	7405#	1#	*			259 100510#	220#
157	102		No	$-\alpha$	94110#	100#	7400#	0#	$\beta^+$	490#	220#	259 101030#	110#
156	103		Lr	$-\alpha$	95850#	70#	7390#	0#	$\beta^+$	1740#	120#	259 102900#	80#
155	104		Rf	$-\alpha$	98400#	70#	7377#	0#	$\beta^+$	2550#	100#	259 105640#	80#
154	105		Db	$-\alpha$	102100#	210#	7360#	1#	$\beta^+$	3700#	220#	259 109610#	230#
153	106		Sg	$-\alpha$	106660#	180#	7339#	1#	$\beta^+$	4560#	280#	259 114500#	190#
160	100	260	Fm	$-\alpha$	95640#	500#	7403#	2#	$\beta^-$	-910#	590#	260 102680#	540#
159	101		Md	$-\alpha$	96550#	320#	7396#	1#	$\beta^-$	940#	370#	260 103650#	340#
158	102		No	$-\alpha$	95610#	200#	7397#	1#	*			260 102640#	220#
157	103		Lr	$-\alpha$	98280#	120#	7383#	0#	$\beta^+$	2670#	230#	260 105500#	120#
156	104		Rf	$-\alpha$	99150#	200#	7377#	1#	$\beta^+$	870#	230#	260 106440#	220#
155	105		Db	$-\alpha$	103680#	230#	7357#	1#	$\beta^+$	4530#	310#	260 111300#	250#
154	106		Sg	$-\alpha$	106580	40	7342.42	0.15	$\beta^+$	2910#	230#	260 114420	40
153	107		Bh	$-\alpha$	113610#	580#	7312#	2#	$\beta^+$	7030#	580#	260 121970#	620#

N	Z	A	Elt.	Orig.	Mass excess (keV)		Binding energy per nucleon (keV)		Beta-decay energy (keV)		Atomic mass $\mu$	
160	101	261	Md	$-\alpha$	98480#	650#	7391#	2#	*		261 105720#	700#
159	102		No	$-\alpha$	98500#	300#	7388#	1#	$\beta^+$	30# 710#	261 105750#	320#
158	103		Lr	$-\alpha$	99560#	200#	7381#	1#	$\beta^+$	1060# 360#	261 106880#	220#
157	104		Rf	$-\alpha$	101315	29	7371.40	0.11	$\beta^+$	1750# 200#	261 108770	30
156	105		Db	$-\alpha$	104380#	230#	7357#	1#	$\beta^+$	3060# 230#	261 112060#	250#
155	106		Sg	$-\alpha$	108160#	130#	7339#	0#	$\beta^+$	3780# 260#	261 116120#	140#
154	107		Bh	$-\alpha$	113330#	230#	7316#	1#	$\beta^+$	5170# 260#	261 121660#	250#
161	101	262	Md	$-\alpha$	101410#	580#	7383#	2#	$\beta^-$	1460# 730#	262 108870#	630#
160	102		No	$-\alpha$	99950#	450#	7385#	2#	*		262 107300#	480#
159	103		Lr	$-\alpha$	102120#	200#	7374#	1#	$\beta^+$	2170# 490#	262 109630#	220#
158	104		Rf	$-\alpha$	102390#	280#	7370#	1#	$\beta^+$	270# 350#	262 109930#	300#
157	105		Db	$-\alpha$	106270#	180#	7352#	1#	$\beta^+$	3880# 340#	262 114080#	200#
156	106		Sg	$-\alpha$	108420#	280#	7341#	1#	$\beta^+$	2160# 340#	262 116400#	300#
155	107		Bh	$-\alpha$	114470#	350#	7315#	1#	$\beta^+$	6050# 450#	262 122890#	370#
161	102	263	No	$-\alpha$	102980#	490#	7376#	2#	*		263 110550#	530#
160	103		Lr	$-\alpha$	103670#	360#	7371#	1#	$\beta^+$	690# 610#	263 111290#	390#
159	104		Rf	$-\alpha$	104840#	180#	7363#	1#	$\beta^+$	1170# 400#	263 112550#	200#
158	105		Db	$-\alpha$	107110#	170#	7352#	1#	$\beta^+$	2270# 250#	263 114990#	180#
157	106		Sg	IT	110220#	120#	7337#	0#	$\beta^+$	3110# 210#	263 118320#	130#
156	107		Bh	$-\alpha$	114610#	370#	7317#	1#	$\beta^+$	4390# 390#	263 123040#	390#
155	108		Hs	$-\alpha$	119750#	350#	7295#	1#	$\beta^+$	5150# 510#	263 128560#	370#
162	102	264	No	$-\alpha$	104650#	640#	7373#	2#	$\beta^-$	-1580# 770#	264 112350#	690#
161	103		Lr	$-\alpha$	106230#	440#	7364#	2#	$\beta^-$	50# 620#	264 114040#	470#
160	104		Rf	$-\alpha$	106180#	450#	7361#	2#	*		264 113990#	480#
159	105		Db	$-\alpha$	109360#	230#	7346#	1#	$\beta^+$	3190# 500#	264 117400#	250#
158	106		Sg	$-\alpha$	110780#	280#	7338#	1#	$\beta^+$	1420# 370#	264 118930#	300#
157	107		Bh	$-\alpha$	116070#	280#	7315#	1#	$\beta^+$	5280# 400#	264 124600#	300#
156	108		Hs	$-\alpha$	119600	40	7298.24	0.17	$\beta^+$	3530# 280#	264 128390	50
162	103	265	Lr	$-\alpha$	107900#	710#	7360#	3#	*		265 115840#	770#
161	104		Rf	$-\alpha$	108710#	420#	7354#	2#	$\beta^+$	810# 830#	265 116700#	460#
160	105		Db	$-\alpha$	110480#	280#	7344#	1#	$\beta^+$	1770# 510#	265 118600#	300#
159	106		Sg	$-\alpha$	112820	60	7332.65	0.22	$\beta^+$	2340# 290#	265 121110	60
158	107		Bh	$-\alpha$	116570#	380#	7316#	1#	$\beta^+$	3760# 380#	265 125150#	410#
157	108		Hs	$-\alpha$	121170#	140#	7295#	1#	$\beta^+$	4600# 400#	265 130090#	150#
156	109		Mt	$-\alpha$	126820#	460#	7271#	2#	$\beta^+$	5650# 480#	265 136150#	500#
163	103	266	Lr	$-\alpha$	111130#	660#	7351#	2#	$\beta^-$	1260# 850#	266 119310#	700#
162	104		Rf	$-\alpha$	109880#	540#	7352#	2#	*		266 117960#	580#
161	105		Db	$-\alpha$	112740#	360#	7339#	1#	$\beta^+$	2860# 650#	266 121030#	390#
160	106		Sg	$-\alpha$	113700#	290#	7332#	1#	$\beta^+$	970# 460#	266 122070#	310#
159	107		Bh	$-\alpha$	118250#	200#	7312#	1#	$\beta^+$	4540# 350#	266 126940#	220#
158	108		Hs	$-\alpha$	121190#	280#	7298#	1#	$\beta^+$	2940# 350#	266 130100#	310#
157	109		Mt	$-\alpha$	127890#	350#	7270#	1#	$\beta^+$	6710# 450#	266 137300#	370#
163	104	267	Rf	$-\alpha$	113200#	580#	7343#	2#	*		267 121530#	620#
162	105		Db	$-\alpha$	113990#	470#	7337#	2#	$\beta^+$	790# 740#	267 122380#	500#
161	106		Sg	$-\alpha$	115900#	270#	7327#	1#	$\beta^+$	1910# 540#	267 124430#	290#
160	107		Bh	$-\alpha$	118910#	260#	7312#	1#	$\beta^+$	3000# 380#	267 127650#	280#
159	108		Hs	$-\alpha$	122760#	100#	7295#	0#	$\beta^+$	3860# 280#	267 131790#	110#
158	109		Mt	$-\alpha$	127900#	540#	7273#	2#	$\beta^+$	5140# 550#	267 137310#	580#
157	110		Ea	$-\alpha$	134450#	370#	7245#	1#	$\beta^+$	6550# 660#	267 144340#	390#
164	104	268	Rf	$-\alpha$	115170#	710#	7338#	3#	*		268 123640#	760#
163	105		Db	$-\alpha$	116850#	530#	7329#	2#	$\beta^+$	1680# 880#	268 125450#	570#
162	106		Sg	$-\alpha$	117000#	540#	7325#	2#	$\beta^+$	150# 760#	268 125610#	580#
161	107		Bh	$-\alpha$	120870#	380#	7308#	1#	$\beta^+$	3870# 660#	268 129760#	410#
160	108		Hs	$-\alpha$	123110#	410#	7297#	2#	$\beta^+$	2240# 560#	268 132160#	440#
159	109		Mt	$-\alpha$	129220#	320#	7271#	1#	$\beta^+$	6120# 520#	268 138730#	340#
158	110		Ea	$-\alpha$	133940#	500#	7250#	2#	$\beta^+$	4720# 590#	268 143800#	540#

N	Z	A	Elt.	Orig.	Mass excess (keV)		Binding energy per nucleon (keV)		Beta-decay energy (keV)		Atomic mass $\mu$ u			
164	105	269	Db	$-\alpha$	118730#	770#	7325#	3#	*		269	127460#	830#	
163	106		Sg	$-\alpha$	119930#	660#	7317#	2#	$\beta^+$	1210#	1010#	269	128760#	700#
162	107		Bh	$-\alpha$	121740#	410#	7308#	2#	$\beta^+$	1810#	780#	269	130690#	440#
161	108		Hs	$-\alpha$	124870#	120#	7293#	0#	$\beta^+$	3130#	430#	269	134060#	130#
160	109		Mt	$-\alpha$	129530#	550#	7273#	2#	$\beta^+$	4660#	560#	269	139060#	590#
159	110		Ea	$-\alpha$	135180#	140#	7249#	1#	$\beta^+$	5650#	570#	269	145120#	150#
165	105	270	Db	$-\alpha$	121760#	720#	7316#	3#	$\beta^-$	360#	950#	270	130710#	770#
164	106		Sg	$-\alpha$	121400#	620#	7315#	2#	*			270	130330#	660#
163	107		Bh	$-\alpha$	124460#	470#	7300#	2#	$\beta^+$	3060#	780#	270	133620#	500#
162	108		Hs	$-\alpha$	125430#	290#	7294#	1#	$\beta^+$	960#	550#	270	134650#	310#
161	109		Mt	$-\alpha$	131020#	540#	7270#	2#	$\beta^+$	5600#	610#	270	140660#	580#
160	110		Ea	$-\alpha$	134810#	290#	7253#	1#	$\beta^+$	3790#	610#	270	144720#	310#
165	106	271	Sg	$-\alpha$	124330#	650#	7307#	2#	*			271	133470#	700#
164	107		Bh	$-\alpha$	125920#	560#	7298#	2#	$\beta^+$	1590#	850#	271	135180#	600#
163	108		Hs	$-\alpha$	128230#	340#	7286#	1#	$\beta^+$	2310#	650#	271	137660#	360#
162	109		Mt	$-\alpha$	131470#	570#	7272#	2#	$\beta^+$	3240#	660#	271	141140#	610#
161	110		Ea	$-\alpha$	136060#	110#	7252#	0#	$\beta^+$	4590#	570#	271	146060#	110#
166	106	272	Sg	$-\alpha$	125900#	770#	7304#	3#	*			272	135160#	820#
165	107		Bh	$-\alpha$	128580#	610#	7291#	2#	$\beta^+$	2680#	980#	272	138030#	650#
164	108		Hs	$-\alpha$	129530#	580#	7284#	2#	$\beta^+$	950#	840#	272	139050#	620#
163	109		Mt	$-\alpha$	133890#	480#	7266#	2#	$\beta^+$	4370#	750#	272	143740#	520#
162	110		Ea	$-\alpha$	136290#	650#	7254#	2#	$\beta^+$	2400#	810#	272	146320#	700#
161	111		Eb	$-\alpha$	143090#	330#	7226#	1#	$\beta^+$	6800#	730#	272	153620#	360#
167	106	273	Sg	x	128750#	660#	7296#	2#	*			273	138220#	710#
166	107		Bh	$-\alpha$	130050#	830#	7288#	3#	$\beta^+$	1300#	1060#	273	139620#	890#
165	108		Hs	$-\alpha$	132260#	830#	7277#	3#	$\beta^+$	2210#	1170#	273	141990#	890#
164	109		Mt	$-\alpha$	134990#	510#	7264#	2#	$\beta^+$	2730#	970#	273	144910#	550#
163	110		Ea	$-\alpha$	138670#	130#	7248#	0#	$\beta^+$	3680#	530#	273	148860#	140#
162	111		Eb	$-\alpha$	143150#	610#	7229#	2#	$\beta^+$	4490#	620#	273	153680#	650#
167	107	274	Bh	$-\alpha$	132680#	780#	7282#	3#	*			274	142440#	840#
166	108		Hs	$-\alpha$	133330#	650#	7276#	2#	$\beta^+$	640#	1010#	274	143130#	700#
165	109		Mt	$-\alpha$	137390#	560#	7259#	2#	$\beta^+$	4060#	850#	274	147490#	600#
164	110		Ea	$-\alpha$	139250#	490#	7249#	2#	$\beta^+$	1860#	740#	274	149490#	530#
163	111		Eb	$-\alpha$	145050#	620#	7225#	2#	$\beta^+$	5800#	790#	274	155710#	660#
168	107	275	Bh	x	134370#	650#	7278#	2#	*			275	144250#	700#
167	108		Hs	$-\alpha$	135950#	710#	7270#	3#	$\beta^+$	1590#	970#	275	145950#	770#
166	109		Mt	$-\alpha$	138460#	590#	7258#	2#	$\beta^+$	2510#	930#	275	148650#	640#
165	110		Ea	$-\alpha$	141750#	450#	7243#	2#	$\beta^+$	3290#	740#	275	152180#	480#
164	111		Eb	$-\alpha$	145450#	690#	7227#	3#	$\beta^+$	3690#	830#	275	156140#	740#
168	108	276	Hs	$-\alpha$	137120#	820#	7268#	3#	*			276	147210#	890#
167	109		Mt	$-\alpha$	140800#	680#	7252#	2#	$\beta^+$	3680#	1070#	276	151160#	730#
166	110		Ea	$-\alpha$	142550#	610#	7243#	2#	$\beta^+$	1750#	910#	276	153030#	650#
165	111		Eb	$-\alpha$	147640#	630#	7222#	2#	$\beta^+$	5090#	870#	276	158490#	670#
169	108	277	Hs	$-\alpha$	139580#	730#	7262#	3#	*			277	149840#	780#
168	109		Mt	$-\alpha$	141980#	880#	7251#	3#	$\beta^+$	2400#	1140#	277	152420#	950#
167	110		Ea	$-\alpha$	144980#	960#	7237#	3#	$\beta^+$	3010#	1310#	277	155650#	1040#
166	111		Eb	$-\alpha$	148590#	620#	7221#	2#	$\beta^+$	3610#	1150#	277	159520#	660#
165	112		Ec	$-\alpha$	152710#	130#	7204#	0#	$\beta^+$	4120#	630#	277	163940#	140#
169	109	278	Mt	$-\alpha$	144210#	840#	7246#	3#	*			278	154810#	900#
168	110		Ea	$-\alpha$	145750#	680#	7237#	2#	$\beta^+$	1540#	1080#	278	156470#	730#
167	111		Eb	$-\alpha$	150530#	630#	7217#	2#	$\beta^+$	4780#	930#	278	161600#	680#
166	112		Ec	$-\alpha$	153060#	530#	7206#	2#	$\beta^+$	2520#	830#	278	164310#	570#

N	Z	A	Elt.	Orig.	Mass excess (keV)		Binding energy per nucleon (keV)		Beta-decay energy (keV)		Atomic mass $\mu$	
170	109	279	Mt	$-\alpha$	145490#	720#	7244#	3#	*		279 156190#	770#
169	110		Ea	$-\alpha$	147980#	740#	7232#	3#	$\beta^+$	2490# 1030#	279 158860#	800#
168	111		Eb	$-\alpha$	151340#	660#	7218#	2#	$\beta^+$	3360# 1000#	279 162470#	710#
167	112		Ec	$-\alpha$	155140#	490#	7201#	2#	$\beta^+$	3800# 830#	279 166550#	530#
170	110	280	Ea	$-\alpha$	148850#	850#	7232#	3#	*		280 159800#	910#
169	111		Eb	$-\alpha$	153210#	740#	7214#	3#	$\beta^+$	4360# 1130#	280 164470#	800#
168	112		Ec	$-\alpha$	155600#	640#	7203#	2#	$\beta^+$	2390# 980#	280 167040#	690#
171	110	281	Ea	$-\alpha$	150960#	730#	7228#	3#	*		281 162060#	780#
170	111		Eb	$-\alpha$	154040#	930#	7214#	3#	$\beta^+$	3080# 1180#	281 165370#	1000#
169	112		Ec	$-\alpha$	157690#	990#	7198#	4#	$\beta^+$	3650# 1360#	281 169290#	1060#
171	111	282	Eb	$-\alpha$	156010#	890#	7210#	3#	*		282 167490#	950#
170	112		Ec	$-\alpha$	158140#	710#	7200#	3#	$\beta^+$	2120# 1140#	282 169770#	760#
172	111	283	Eb	$-\alpha$	156880#	780#	7210#	3#	*		283 168420#	840#
171	112		Ec	$-\alpha$	160020#	770#	7196#	3#	$\beta^+$	3150# 1090#	283 171790#	830#
170	113		Ed	$-\alpha$	164360#	730#	7178#	3#	$\beta^+$	4340# 1060#	283 176450#	780#
172	112	284	Ec	$-\alpha$	160570#	850#	7197#	3#	*		284 172380#	910#
171	113		Ed	$-\alpha$	165880#	800#	7176#	3#	$\beta^+$	5310# 1170#	284 178080#	860#
173	112	285	Ec	$-\alpha$	162180#	730#	7195#	3#	*		285 174110#	780#
172	113		Ed	$-\alpha$	166490#	980#	7177#	3#	$\beta^+$	4310# 1220#	285 178730#	1050#
171	114		Ee	$-\alpha$	171110#	1030#	7158#	4#	$\beta^+$	4630# 1420#	285 183700#	1110#
173	113	286	Ed	$-\alpha$	168120#	940#	7174#	3#	*		286 180480#	1010#
172	114		Ee	$-\alpha$	171260#	770#	7161#	3#	$\beta^+$	3140# 1210#	286 183860#	830#
174	113	287	Ed	$-\alpha$	168640#	830#	7176#	3#	*		287 181050#	900#
173	114		Ee	$-\alpha$	172880#	770#	7158#	3#	$\beta^+$	4240# 1140#	287 185600#	830#
172	115		Ef	$-\alpha$	178090#	790#	7137#	3#	$\beta^+$	5200# 1100#	287 191190#	850#
174	114	288	Ee	$-\alpha$	172970#	850#	7161#	3#	*		288 185690#	910#
173	115		Ef	$-\alpha$	179310#	850#	7136#	3#	$\beta^+$	6340# 1210#	288 192490#	920#
175	114	289	Ee	$-\alpha$	174450#	730#	7159#	3#	*		289 187280#	790#
174	115		Ef	$-\alpha$	179510#	1020#	7139#	4#	$\beta^+$	5060# 1260#	289 192720#	1100#
173	116		Eg	$-\alpha$	185240#	1090#	7116#	4#	$\beta^+$	5730# 1490#	289 198860#	1170#
175	115	290	Ef	$-\alpha$	180840#	980#	7137#	3#	*		290 194140#	1060#
174	116		Eg	$-\alpha$	184990#	840#	7120#	3#	$\beta^+$	4140# 1300#	290 198590#	910#
176	115	291	Ef	$-\alpha$	181070#	890#	7140#	3#	*		291 194380#	950#
175	116		Eg	$-\alpha$	186310#	850#	7119#	3#	$\beta^+$	5240# 1230#	291 200010#	910#
174	117		Eh	$-\alpha$	192410#	880#	7096#	3#	$\beta^+$	6100# 1220#	291 206560#	950#
176	116	292	Eg	$-\alpha$	186100#	850#	7123#	3#	*		292 199790#	920#
175	117		Eh	$-\alpha$	193330#	940#	7096#	3#	$\beta^+$	7230# 1270#	292 207550#	1010#
175	118	293	Ei	$-\alpha$	199960#	1200#	7074#	4#	*		293 214670#	1290#

**Table II. Influences on primary nuclei**

## EXPLANATION OF TABLE

This table gives for each of the 847 primary nuclei the up to three most important contributing data and their *influences* ( $\times 100$ ) on its mass, as given by the flow-of-information matrix.

Nucleus	Nucleus (primaries only)		
Influence	<i>Influence</i> ( $\times 100$ ) brought to the determination of the mass of the nucleus, by the piece of data represented by the equation in following column		
Equation	In mass-doublet equation: H = $^1\text{H}$ , N = $^{14}\text{N}$ , D = $^2\text{H}$ , O = $^{16}\text{O}$ , C = $^{12}\text{C}$ .	In mass-triplet equation: Rb <sup>x</sup> , Rb <sup>y</sup> : different mixtures of isomers or contaminants.	In nuclear reaction: K <sup>m</sup> , Cs <sup>m</sup> , Cs <sup>n</sup> : upper isomers, see NUBASE.

Nucleus	Infl.	Equation	Infl.	Equation	Infl.	Equation
$0\pi^+$	100.0	$\pi^+$				
$0\pi^-$	99.6	$\pi^+(2\beta^+)\pi^-$				
$1n$	100.0	$^1\text{H}(n,\gamma)^2\text{H}$				
$^1\text{H}$	77.9	$\text{H}_{12}-\text{C}$	17.8	$\text{C H}_4-\text{O}$	2.8	$\text{C H}_2-\text{N}$
$^2\text{H}$	61.3	$\text{D}_6-\text{C}$	24.2	$\text{C}_2\text{D}_8-^{40}\text{Ar}$	10.0	$\text{C D}_4-^{20}\text{Ne}$
$^3\text{H}$	72.7	$^3\text{H}_4-\text{C}$	27.3	$^3\text{H}(\beta^-)^3\text{He}$		
$^3\text{He}$	67.7	$^3\text{H}(\beta^-)^3\text{He}$	24.0	$^3\text{He}_4-\text{C}$	8.3	$\text{H D}-^3\text{He}$
$^4\text{He}$	100.0	$^4\text{He}_3-\text{C}$				
$^6\text{He}$	99.8	$^7\text{Li}(d,^3\text{He})^6\text{He}-^{19}\text{F}^{18}\text{O}$	0.2	$^{144}\text{Sm}(^3\text{He},^6\text{He})^{141}\text{Sm}$		
$^6\text{Li}$	100.0	$^6\text{Li}_2-\text{C}$				
$^7\text{Li}$	100.0	$^6\text{Li}(n,\gamma)^7\text{Li}$				
$^7\text{Be}$	100.0	$^7\text{Li}(p,n)^7\text{Be}$				
$^8\text{He}$	94.4	$^4\text{He}(^{64}\text{Ni},^{60}\text{Ni})^8\text{He}$	5.1	$^{197}\text{Au}(\alpha,^8\text{He})^{193}\text{Au}$	0.4	$^9\text{He}(\gamma,n)^8\text{He}$
$^8\text{Li}$	100.0	$^7\text{Li}(n,\gamma)^8\text{Li}$				
$^8\text{Be}$	99.9	$^8\text{Be}(\alpha)^4\text{He}$	0.1	$^9\text{Be}(\gamma,n)^8\text{Be}$		
$^8\text{B}$	100.0	$^6\text{Li}(^3\text{He},n)^8\text{B}$				
$^9\text{He}$	91.3	$^9\text{He}(\gamma,n)^8\text{He}$	8.7	$^9\text{Be}(^{14}\text{C},^{14}\text{O})^9\text{He}$		
$^9\text{Li}$	58.4	$^{10}\text{Be}(d,^3\text{He})^9\text{Li}$	41.6	$^7\text{Li}(t,p)^9\text{Li}$		
$^9\text{Be}$	88.0	$^9\text{Be}(\gamma,n)^8\text{Be}$	11.0	$^6\text{Li}(\alpha,p)^9\text{Be}$	1.0	$^9\text{Be}(n,\gamma)^{10}\text{Be}$
$^{10}\text{Be}$	98.9	$^9\text{Be}(n,\gamma)^{10}\text{Be}$	1.1	$^{10}\text{Be}(d,^3\text{He})^9\text{Li}$		
$^{10}\text{B}$	100.0	$^{10}\text{B}(\alpha,d)^{12}\text{C}$				
$^{11}\text{Li}$	54.7	$^{11}\text{Li}-\text{C}_{917}$	45.3	$^{11}\text{B}(\pi^-, \pi^+)^{11}\text{Li}$		
$^{11}\text{B}$	100.0	$^{10}\text{B}(n,\gamma)^{11}\text{B}$				
$^{11}\text{C}$	100.0	$^{11}\text{C}(\beta^+)^{11}\text{B}$				
$^{12}\text{N}$	100.0	$^{14}\text{N}(p,t)^{12}\text{N}$				
$^{13}\text{C}$	57.5	$\text{C D}-^{13}\text{C H}$	36.8	$\text{C D}-^{13}\text{C H}$	5.7	$^{13}\text{C}-\text{C}_{1.083}$
$^{13}\text{N}$	100.0	$^{12}\text{C}(p,\gamma)^{13}\text{N}$				
$^{14}\text{B}$	100.0	$^{14}\text{C}(^7\text{Li},^7\text{Be})^{14}\text{B}$				
$^{14}\text{C}$	79.9	$^{14}\text{C H}_2-\text{N D}$	20.1	$\text{C D}_2-^{14}\text{C H}_2$		
$^{14}\text{N}$	56.2	$\text{C H}_2-\text{N}$	31.6	$\text{N}_2-\text{C O}$	11.9	$^{14}\text{N}-\text{C}_{1.167}$
$^{14}\text{O}$	57.9	$^{26}\text{Mg}(^3\text{He},t)^{26}\text{Al}-^{14}\text{N}^{14}\text{O}$	42.1	$^{14}\text{N}(p,n)^{14}\text{O}$		
$^{15}\text{N}$	67.4	$\text{C D H}-^{15}\text{N}$	17.6	$\text{C H}_3-^{15}\text{N}$	15.0	$^{15}\text{N}_2-^{28}\text{Si H}_2$
$^{15}\text{O}$	100.0	$^{15}\text{N}(p,n)^{15}\text{O}$				
$^{16}\text{O}$	97.3	$\text{C}_4-\text{O}_3$	2.3	$\text{C H}_4-\text{O}$	0.3	$\text{N}_2-\text{C O}$
$^{17}\text{O}$	99.5	$^{16}\text{O}(n,\gamma)^{17}\text{O}$	0.2	$^{17}\text{O}(p,\gamma)^{18}\text{F}$	0.2	$^{17}\text{O}(n,\gamma)^{18}\text{O}$
$^{17}\text{F}$	100.0	$^{16}\text{O}(p,\gamma)^{17}\text{F}$				
$^{18}\text{O}$	45.2	$^{18}\text{F}(\beta^+)^{18}\text{O}$	37.5	$^{17}\text{O}(n,\gamma)^{18}\text{O}$	17.1	$^{18}\text{O}(^3\text{He},p)^{20}\text{F}$
$^{18}\text{F}$	76.1	$^{17}\text{O}(p,\gamma)^{18}\text{F}$	23.9	$^{18}\text{F}(\beta^+)^{18}\text{O}$		
$^{19}\text{F}$	98.6	$\text{C D}_4-\text{H }^{19}\text{F}$	1.2	$^{19}\text{F}(p,n)^{19}\text{Ne}$	0.2	$^{19}\text{F}(n,\gamma)^{20}\text{F}$
$^{19}\text{Ne}$	72.8	$^{19}\text{Ne}-^{22}\text{Ne}_{864}$	27.2	$^{19}\text{F}(p,n)^{19}\text{Ne}$		
$^{20}\text{F}$	99.8	$^{19}\text{F}(n,\gamma)^{20}\text{F}$	0.2	$^{18}\text{O}(^3\text{He},p)^{20}\text{F}$		
$^{20}\text{Ne}$	44.0	$^{20}\text{Ne}_2-^{40}\text{Ar}$	34.4	$\text{C D}_4-^{20}\text{Ne}$	21.6	$^{20}\text{Ne}_2-^{40}\text{Ar}$
$^{22}\text{Ne}$	99.9	$^{22}\text{Ne}-\text{C}_{1.833}$	0.1	$^{19}\text{Ne}-^{22}\text{Ne}_{864}$		
$^{23}\text{Na}$	100.0	$^{23}\text{Na}-\text{C}_{1.917}$				
$^{23}\text{Mg}$	73.5	$^{24}\text{Mg}(p,d)^{23}\text{Mg}$	26.5	$^{23}\text{Na}(p,n)^{23}\text{Mg}$		
$^{24}\text{Mg}$	95.9	$^{24}\text{Mg}-\text{C}_2$	4.1	$^{24}\text{Mg}(n,\gamma)^{25}\text{Mg}$		
$^{25}\text{Mg}$	55.9	$^{24}\text{Mg}(n,\gamma)^{25}\text{Mg}$	39.8	$^{25}\text{Mg}(n,\gamma)^{26}\text{Mg}$	4.3	$^{25}\text{Mg}(p,\gamma)^{26}\text{Al}$
$^{26}\text{Mg}$	75.4	$^{26}\text{Mg}-\text{C}_{2.167}$	21.5	$^{25}\text{Mg}(n,\gamma)^{26}\text{Mg}$	1.5	$^{26}\text{Mg}(p,n)^{26}\text{Al}$
$^{26}\text{Al}$	67.2	$^{25}\text{Mg}(p,\gamma)^{26}\text{Al}$	21.7	$^{26}\text{Mg}(p,n)^{26}\text{Al}$	6.9	$^{26}\text{Mg}(^3\text{He},t)^{26}\text{Al}-^{14}\text{N}^{14}\text{O}$
$^{27}\text{Na}$	88.3	$^{27}\text{Na}-^{27}\text{Al}$	11.7	$^{27}\text{Na}-\text{C}_{2.25}$		
$^{27}\text{Al}$	83.9	$^{27}\text{Al}(p,\gamma)^{28}\text{Si}$	16.1	$^{26}\text{Mg}(p,\gamma)^{27}\text{Al}$		
$^{28}\text{Na}$	100.0	$^{28}\text{Na}-\text{C}_{3.333}$				
$^{28}\text{Si}$	57.1	$\text{C}_2\text{D}_2-^{28}\text{Si}$	42.9	$^{15}\text{N}_2-^{28}\text{Si H}_2$		
$^{29}\text{Na}$	100.0	$^{29}\text{Na}-\text{C}_{2.417}$				
$^{31}\text{P}$	83.5	$^{31}\text{P}(p,\alpha)^{28}\text{Si}$	16.5	$^{31}\text{P}(p,\gamma)^{32}\text{S}$		
$^{32}\text{S}$	90.8	$^{32}\text{S}(n,\gamma)^{33}\text{S}$	8.7	$^{31}\text{P}(p,\gamma)^{32}\text{S}$	0.5	$\text{C }^{32}\text{S}_2-^{74}\text{Ge H}_2$
$^{33}\text{S}$	87.0	$^{33}\text{S}(n,\gamma)^{34}\text{S}$	8.8	$^{32}\text{S}(n,\gamma)^{33}\text{S}$	4.2	$^{33}\text{S}(p,\gamma)^{34}\text{Cl}$
$^{34}\text{S}$	94.7	$^{34}\text{S}(n,\gamma)^{35}\text{S}$	5.1	$^{33}\text{S}(n,\gamma)^{34}\text{S}$	0.2	$^{34}\text{S}(^3\text{He},t)^{34}\text{Cl}$
$^{34}\text{Cl}$	87.0	$^{33}\text{S}(p,\gamma)^{34}\text{Cl}$	13.0	$^{34}\text{S}(^3\text{He},t)^{34}\text{Cl}$		
$^{35}\text{S}$	95.5	$^{35}\text{S}(\beta^-)^{35}\text{Cl}$	4.5	$^{34}\text{S}(n,\gamma)^{35}\text{S}$		
$^{35}\text{Cl}$	62.3	$\text{C}_3-^{35}\text{Cl H}$	17.1	$\text{C}_5\text{H}_{10}-^{35}\text{Cl}_2$	5.9	$^{199}\text{Hg}-\text{C}_2\text{ }^{35}\text{Cl}_3$

Nucleus	Infl.	Equation	Infl.	Equation	Infl.	Equation
<sup>36</sup> S	64.8	<sup>36</sup> S(p,γ) <sup>37</sup> Cl	35.2	<sup>36</sup> S(p,n) <sup>36</sup> Cl		
<sup>36</sup> Cl	96.6	<sup>35</sup> Cl(n,γ) <sup>36</sup> Cl	3.4	<sup>36</sup> S(p,n) <sup>36</sup> Cl		
<sup>36</sup> Ar	99.4	<sup>36</sup> Ar–C <sub>3</sub>	0.6	<sup>39</sup> K– <sup>36</sup> Ar <sub>1,083</sub>		
<sup>37</sup> Cl	70.9	C <sub>3</sub> H <sub>6</sub> O <sub>2</sub> – <sup>37</sup> Cl <sub>2</sub>	8.1	C <sub>5</sub> H <sub>12</sub> – <sup>35</sup> Cl <sup>37</sup> Cl	7.9	C <sub>3</sub> D <sub>8</sub> – <sup>37</sup> Cl H <sub>3</sub>
<sup>38</sup> Ar	69.2	<sup>38</sup> Ar– <sup>39</sup> K <sub>974</sub>	19.4	<sup>38</sup> Ar(p,γ) <sup>39</sup> K	11.4	<sup>37</sup> Cl(p,γ) <sup>38</sup> Ar
<sup>38</sup> K	82.5	<sup>38</sup> K <sup>m</sup> (IT) <sup>38</sup> K	17.5	<sup>38</sup> Ar(p,n) <sup>38</sup> K		
<sup>38</sup> K <sup>m</sup>	97.7	<sup>38</sup> Ar(p,n) <sup>38</sup> K <sup>m</sup>	2.3	<sup>38</sup> K <sup>m</sup> (IT) <sup>38</sup> K		
<sup>39</sup> K	47.1	<sup>39</sup> K– <sup>36</sup> Ar <sub>1,083</sub>	39.6	<sup>39</sup> K(n,γ) <sup>40</sup> K	7.4	<sup>41</sup> K– <sup>39</sup> K <sub>1,051</sub>
<sup>40</sup> Ar	65.6	C <sub>3</sub> H <sub>4</sub> – <sup>40</sup> Ar	24.3	C <sub>3</sub> D <sub>8</sub> – <sup>40</sup> Ar	6.7	<sup>20</sup> Ne <sub>2</sub> – <sup>40</sup> Ar
<sup>40</sup> K	51.3	<sup>39</sup> K(n,γ) <sup>40</sup> K	37.7	<sup>40</sup> K(n,γ) <sup>41</sup> K	11.0	<sup>40</sup> K(n,p) <sup>40</sup> Ar
<sup>40</sup> Ca	94.2	<sup>39</sup> K(p,γ) <sup>40</sup> Ca	5.8	<sup>40</sup> Ca(n,γ) <sup>41</sup> Ca	0.1	<sup>40</sup> Ca(p,γ) <sup>41</sup> Sc
<sup>41</sup> Ar	91.2	<sup>40</sup> Ar(n,γ) <sup>41</sup> Ar	8.8	<sup>41</sup> Ar(β <sup>-</sup> ) <sup>41</sup> K		
<sup>41</sup> K	48.4	<sup>40</sup> K(n,γ) <sup>41</sup> K	41.9	<sup>40</sup> Ar(p,γ) <sup>41</sup> K	4.7	<sup>41</sup> K– <sup>39</sup> K <sub>1,051</sub>
<sup>41</sup> Ca	87.2	<sup>40</sup> Ca(n,γ) <sup>41</sup> Ca	10.7	<sup>41</sup> K(p,n) <sup>41</sup> Ca	2.0	<sup>41</sup> Ca(n,γ) <sup>42</sup> Ca
<sup>41</sup> Sc	88.0	<sup>40</sup> Ca(p,γ) <sup>41</sup> Sc	12.0	<sup>41</sup> Sc <sup>r</sup> (IT) <sup>41</sup> Sc		
<sup>41</sup> Sc <sup>r</sup>	84.2	<sup>41</sup> Sc <sup>r</sup> (IT) <sup>41</sup> Sc	15.8	<sup>41</sup> Ca(p,γ) <sup>42</sup> Sc <sup>r</sup> – <sup>40</sup> Ca() <sup>41</sup> Sc <sup>r</sup>		
<sup>42</sup> Ca	92.6	<sup>41</sup> Ca(n,γ) <sup>42</sup> Ca	4.1	<sup>42</sup> Ca( <sup>3</sup> He,t) <sup>42</sup> Sc– <sup>26</sup> Mg() <sup>26</sup> Al	2.2	<sup>42</sup> Ca(n,γ) <sup>43</sup> Ca
<sup>42</sup> Sc	71.1	<sup>42</sup> Sc <sup>r</sup> (IT) <sup>42</sup> Sc	23.0	<sup>42</sup> Ca( <sup>3</sup> He,t) <sup>42</sup> Sc– <sup>26</sup> Mg() <sup>26</sup> Al	5.9	<sup>54</sup> Fe( <sup>3</sup> He,t) <sup>54</sup> Co– <sup>42</sup> Ca() <sup>42</sup> Sc
<sup>42</sup> Sc <sup>r</sup>	80.5	<sup>41</sup> Ca(p,γ) <sup>42</sup> Sc <sup>r</sup> – <sup>40</sup> Ca() <sup>41</sup> Sc <sup>r</sup>	19.5	<sup>42</sup> Sc <sup>r</sup> (IT) <sup>42</sup> Sc		
<sup>43</sup> Ca	96.7	<sup>42</sup> Ca(n,γ) <sup>43</sup> Ca	3.3	<sup>43</sup> Ca(n,γ) <sup>44</sup> Ca		
<sup>44</sup> Ca	94.7	<sup>43</sup> Ca(n,γ) <sup>44</sup> Ca	3.8	<sup>44</sup> Ca(p,γ) <sup>45</sup> Sc	1.5	<sup>44</sup> Ca(n,γ) <sup>45</sup> Ca
<sup>45</sup> Ca	97.9	<sup>44</sup> Ca(n,γ) <sup>45</sup> Ca	1.9	<sup>45</sup> Ca(β <sup>-</sup> ) <sup>45</sup> Sc	0.2	<sup>46</sup> Ca(d,t) <sup>45</sup> Ca
<sup>45</sup> Sc	42.6	<sup>44</sup> Ca(p,γ) <sup>45</sup> Sc	42.2	<sup>45</sup> Sc(p,γ) <sup>46</sup> Ti	15.2	<sup>45</sup> Ca(β <sup>-</sup> ) <sup>45</sup> Sc
<sup>46</sup> Ca	89.8	<sup>46</sup> Ca(n,γ) <sup>47</sup> Ca	10.2	<sup>46</sup> Ca(d,t) <sup>45</sup> Ca		
<sup>46</sup> Ti	57.0	<sup>46</sup> Ti(n,γ) <sup>47</sup> Ti	40.7	<sup>45</sup> Sc(p,γ) <sup>46</sup> Ti	1.3	<sup>46</sup> Ti– <sup>37</sup> Cl– <sup>48</sup> Ti– <sup>35</sup> Cl
<sup>47</sup> Ca	82.8	<sup>47</sup> Ca(β <sup>-</sup> ) <sup>47</sup> Sc	10.1	<sup>46</sup> Ca(n,γ) <sup>47</sup> Ca	7.1	<sup>48</sup> Ca(d,t) <sup>47</sup> Ca
<sup>47</sup> Sc	87.1	<sup>47</sup> Sc(β <sup>-</sup> ) <sup>47</sup> Ti	12.9	<sup>47</sup> Ca(β <sup>-</sup> ) <sup>47</sup> Sc		
<sup>47</sup> Ti	43.6	<sup>47</sup> Ti(n,γ) <sup>48</sup> Ti	36.2	<sup>46</sup> Ti(n,γ) <sup>47</sup> Ti	18.5	C– <sup>35</sup> Cl– <sup>47</sup> Ti
<sup>48</sup> Ca	45.4	<sup>48</sup> Ca(p,γ) <sup>49</sup> Sc	38.2	<sup>48</sup> Ca(d,t) <sup>47</sup> Ca	16.3	<sup>48</sup> Ca(p,n) <sup>48</sup> Sc
<sup>48</sup> Sc	58.2	<sup>48</sup> Sc(β <sup>-</sup> ) <sup>48</sup> Ti	41.8	<sup>48</sup> Ca(p,n) <sup>48</sup> Sc		
<sup>48</sup> Ti	56.3	<sup>47</sup> Ti(n,γ) <sup>48</sup> Ti	22.1	<sup>13</sup> C– <sup>35</sup> Cl– <sup>48</sup> Ti	20.7	<sup>48</sup> Ti(n,γ) <sup>49</sup> Ti
<sup>49</sup> Sc	61.3	<sup>49</sup> Sc(β <sup>-</sup> ) <sup>49</sup> Ti	38.7	<sup>48</sup> Ca(p,γ) <sup>49</sup> Sc		
<sup>49</sup> Ti	79.3	<sup>48</sup> Ti(n,γ) <sup>49</sup> Ti	16.0	<sup>49</sup> Ti(n,γ) <sup>50</sup> Ti	4.7	<sup>49</sup> Ti– <sup>37</sup> Cl– <sup>51</sup> V– <sup>35</sup> Cl
<sup>50</sup> Ti	84.0	<sup>49</sup> Ti(n,γ) <sup>50</sup> Ti	16.0	<sup>50</sup> Ti(p,γ) <sup>51</sup> V		
<sup>50</sup> Cr	52.0	<sup>50</sup> Cr(p,γ) <sup>51</sup> Mn	48.0	<sup>50</sup> Cr(n,γ) <sup>51</sup> Cr	0.2	<sup>50</sup> Cr( <sup>3</sup> He,t) <sup>50</sup> Mn
<sup>50</sup> Mn	67.5	<sup>50</sup> Cr( <sup>3</sup> He,t) <sup>50</sup> Mn– <sup>54</sup> Fe() <sup>54</sup> Co	32.5	<sup>50</sup> Cr( <sup>3</sup> He,t) <sup>50</sup> Mn	9.5	<sup>49</sup> Ti– <sup>37</sup> Cl– <sup>51</sup> V– <sup>35</sup> Cl
<sup>51</sup> V	49.3	<sup>51</sup> V(p,n) <sup>51</sup> Cr	32.3	<sup>50</sup> Ti(p,γ) <sup>51</sup> V		
<sup>51</sup> Cr	50.9	<sup>50</sup> Cr(n,γ) <sup>51</sup> Cr	49.1	<sup>51</sup> V(p,n) <sup>51</sup> Cr		
<sup>51</sup> Mn	54.5	<sup>54</sup> Fe(p,α) <sup>51</sup> Mn	45.5	<sup>50</sup> Cr(p,γ) <sup>51</sup> Mn		
<sup>52</sup> Cr	76.2	<sup>52</sup> Cr(n,γ) <sup>53</sup> Cr	20.0	<sup>52</sup> Cr(p,γ) <sup>53</sup> Mn	3.8	<sup>51</sup> V(p,γ) <sup>52</sup> Cr
<sup>53</sup> Cr	78.4	<sup>53</sup> Cr(n,γ) <sup>54</sup> Cr	21.6	<sup>52</sup> Cr(n,γ) <sup>53</sup> Cr		
<sup>53</sup> Mn	66.9	<sup>52</sup> Cr(p,γ) <sup>53</sup> Mn	33.1	<sup>56</sup> Fe(p,α) <sup>53</sup> Mn		
<sup>54</sup> Cr	80.1	<sup>54</sup> Cr(p,γ) <sup>55</sup> Mn	19.9	<sup>53</sup> Cr(n,γ) <sup>54</sup> Cr		
<sup>54</sup> Fe	55.8	<sup>54</sup> Fe(n,γ) <sup>55</sup> Fe	22.4	<sup>54</sup> Fe(p,γ) <sup>55</sup> Co	11.6	<sup>54</sup> Fe(p,α) <sup>51</sup> Mn
<sup>54</sup> Co	79.5	<sup>54</sup> Fe( <sup>3</sup> He,t) <sup>54</sup> Co– <sup>42</sup> Ca() <sup>42</sup> Sc	20.5	<sup>50</sup> Cr( <sup>3</sup> He,t) <sup>50</sup> Mn– <sup>54</sup> Fe() <sup>54</sup> Co		
<sup>55</sup> Mn	37.2	<sup>55</sup> Fe(ε) <sup>55</sup> Mn	34.0	<sup>55</sup> Mn(p,γ) <sup>56</sup> Fe	23.4	<sup>55</sup> Mn(n,γ) <sup>56</sup> Mn
<sup>55</sup> Fe	59.6	<sup>55</sup> Fe(ε) <sup>55</sup> Mn	40.4	<sup>54</sup> Fe(n,γ) <sup>55</sup> Fe		
<sup>55</sup> Co	69.0	<sup>54</sup> Fe(p,γ) <sup>55</sup> Co	31.0	<sup>58</sup> Ni(p,α) <sup>55</sup> Co		
<sup>56</sup> Mn	75.9	<sup>55</sup> Mn(n,γ) <sup>56</sup> Mn	24.1	<sup>56</sup> Mn– <sup>85</sup> Rb <sub>659</sub>		
<sup>56</sup> Fe	60.7	<sup>55</sup> Mn(p,γ) <sup>56</sup> Fe	20.1	<sup>56</sup> Fe(n,γ) <sup>57</sup> Fe	18.8	<sup>56</sup> Fe(p,γ) <sup>57</sup> Co
<sup>57</sup> Mn	74.5	<sup>57</sup> Mn– <sup>85</sup> Rb <sub>671</sub>	25.5	<sup>55</sup> Mn(t,p) <sup>57</sup> Mn		
<sup>57</sup> Fe	79.8	<sup>56</sup> Fe(n,γ) <sup>57</sup> Fe	11.7	<sup>57</sup> Fe(n,γ) <sup>58</sup> Fe	6.7	<sup>57</sup> Fe(p,n) <sup>57</sup> Co
<sup>57</sup> Co	35.6	<sup>60</sup> Ni(p,α) <sup>57</sup> Co	31.5	<sup>58</sup> Fe(p,γ) <sup>59</sup> Co– <sup>56</sup> Fe() <sup>57</sup> Co	24.3	<sup>56</sup> Fe(p,γ) <sup>57</sup> Co
<sup>57</sup> Ni	52.0	<sup>57</sup> Ni– <sup>85</sup> Rb <sub>671</sub>	28.5	<sup>59</sup> Ni(p,t) <sup>57</sup> Ni	19.4	<sup>58</sup> Ni( <sup>3</sup> He,α) <sup>57</sup> Ni
<sup>58</sup> Fe	84.3	<sup>57</sup> Fe(n,γ) <sup>58</sup> Fe	15.7	<sup>58</sup> Fe(p,γ) <sup>59</sup> Co– <sup>56</sup> Fe() <sup>57</sup> Co		
<sup>58</sup> Co	61.0	<sup>59</sup> Co(d,t) <sup>58</sup> Co	25.0	<sup>60</sup> Ni(d,α) <sup>58</sup> Co	14.0	<sup>57</sup> Fe(p,γ) <sup>58</sup> Co
<sup>58</sup> Ni	87.7	<sup>58</sup> Ni(n,γ) <sup>59</sup> Ni	11.1	<sup>62</sup> Ni(p,α) <sup>55</sup> Co	1.2	<sup>58</sup> Ni( <sup>3</sup> He,α) <sup>57</sup> Ni
<sup>59</sup> Co	69.9	<sup>59</sup> Co(p,n) <sup>59</sup> Ni	14.4	<sup>62</sup> Ni(p,α) <sup>59</sup> Co	8.9	<sup>58</sup> Fe(p,γ) <sup>59</sup> Co– <sup>56</sup> Fe() <sup>57</sup> Co
<sup>59</sup> Ni	67.4	<sup>59</sup> Ni(n,γ) <sup>60</sup> Ni	18.8	<sup>59</sup> Co(p,n) <sup>59</sup> Ni	12.1	<sup>58</sup> Ni(n,γ) <sup>59</sup> Ni
<sup>60</sup> Ni	44.1	<sup>60</sup> Ni(n,γ) <sup>61</sup> Ni	31.9	<sup>59</sup> Ni(n,γ) <sup>60</sup> Ni	16.6	<sup>60</sup> Ni– <sup>85</sup> Rb <sub>706</sub>
<sup>61</sup> Ni	55.4	<sup>60</sup> Ni(n,γ) <sup>61</sup> Ni	44.6	<sup>61</sup> Ni(n,γ) <sup>62</sup> Ni		











Nucleus	Infl.	Equation	Infl.	Equation	Infl.	Equation
$^{122}\text{Te}$	91.8	$^{122}\text{Te}(n,\gamma)^{123}\text{Te}$	7.1	$^{122}\text{Sb}(\beta^-)^{122}\text{Te}$	0.6	$^{122}\text{Te}(\beta^-\text{He,d})^{123}\text{I}$
$^{122}\text{Cs}$	58.1	$^{122}\text{Cs}-^{133}\text{Cs}_{917}$	41.9	$^{122}\text{Cs}-\text{C}_{10,167}$		
$^{123}\text{Sn}$	45.2	$^{122}\text{Sn}(n,\gamma)^{123}\text{Sn}$	43.5	$^{124}\text{Sn}(d,t)^{123}\text{Sn}$	11.3	$^{123}\text{Sn}(\beta^-)^{123}\text{Sb}$
$^{123}\text{Sb}$	78.7	$^{123}\text{Sb}(n,\gamma)^{124}\text{Sb}$	12.5	$^{123}\text{Sb}(\gamma,n)^{122}\text{Sb}$	5.3	$^{123}\text{Sn}(\beta^-)^{123}\text{Sb}$
$^{123}\text{Te}$	92.0	$^{123}\text{Te}(n,\gamma)^{124}\text{Te}$	8.0	$^{122}\text{Te}(n,\gamma)^{123}\text{Te}$		
$^{123}\text{I}$	96.2	$^{122}\text{Te}(\beta^-\text{He,d})^{123}\text{I}$	3.8	$^{123}\text{Xe}(\beta^+)^{123}\text{I}$		
$^{123}\text{Xe}$	62.0	$^{123}\text{Xe}-^{133}\text{Cs}_{925}$	38.0	$^{123}\text{Xe}(\beta^+)^{123}\text{I}$		
$^{124}\text{Sn}$	70.5	$^{124}\text{Sn}-^{13}\text{C }^{37}\text{Cl}_3$	24.2	$^{124}\text{Sn}-^{124}\text{Te}$	4.2	$^{124}\text{Sn}(d,t)^{123}\text{Sn}$
$^{124}\text{Sb}$	78.7	$^{124}\text{Sb}(\beta^-)^{124}\text{Te}$	21.3	$^{123}\text{Sb}(n,\gamma)^{124}\text{Sb}$		
$^{124}\text{Te}$	29.7	$^{124}\text{Sn}-^{124}\text{Te}$	25.1	$^{124}\text{Te}-^{13}\text{C }^{37}\text{Cl}_3$	17.0	$^{124}\text{Te}(n,\gamma)^{125}\text{Te}$
$^{124}\text{Xe}$	57.3	$^{124}\text{Xe}-^{54}\text{Fe }^{35}\text{Cl}_2$	24.6	$^{124}\text{Xe}-^{13}\text{C }^{37}\text{Cl}_3$	16.9	$^{124}\text{Xe}-^{124}\text{Te}$
$^{125}\text{Te}$	83.0	$^{124}\text{Te}(n,\gamma)^{125}\text{Te}$	17.0	$^{125}\text{Te}(n,\gamma)^{126}\text{Te}$		
$^{125}\text{Xe}$	98.8	$^{124}\text{Xe}(n,\gamma)^{125}\text{Xe}$	1.2	$^{125}\text{Cs}(\beta^+)^{125}\text{Xe}$		
$^{125}\text{Cs}$	70.5	$^{125}\text{Cs}-^{133}\text{Cs}_{940}$	29.5	$^{125}\text{Cs}(\beta^+)^{125}\text{Xe}$		
$^{126}\text{Te}$	83.0	$^{125}\text{Te}(n,\gamma)^{126}\text{Te}$	9.6	$^{128}\text{Te }^{35}\text{Cl}-^{126}\text{Te }^{37}\text{Cl}$	3.0	$^{128}\text{Te }^{35}\text{Cl}-^{126}\text{Te }^{37}\text{Cl}$
$^{126}\text{I}$	50.0	$^{127}\text{I}(\gamma,n)^{126}\text{I}$	50.0	$^{126}\text{I}(\beta^+)^{126}\text{Te}$		
$^{127}\text{Te}$	98.0	$^{126}\text{Te}(n,\gamma)^{127}\text{Te}$	2.0	$^{127}\text{Te}(\beta^-)^{127}\text{I}$		
$^{127}\text{I}$	32.9	$^{127}\text{I}(\gamma,n)^{126}\text{I}$	22.3	$^{127}\text{Te}(\beta^-)^{127}\text{I}$	19.9	$\text{C}_{10} \text{H}_7-^{127}\text{I}$
$^{127}\text{Xe}$	91.5	$^{127}\text{Xe}(e)^{127}\text{I}$	8.5	$^{127}\text{Cs}(\beta^+)^{127}\text{Xe}$		
$^{127}\text{Cs}$	81.6	$^{127}\text{Cs}-^{133}\text{Cs}_{955}$	18.4	$^{127}\text{Cs}(\beta^+)^{127}\text{Xe}$		
$^{128}\text{Te}$	56.9	$^{128}\text{Te}-^{128}\text{Xe}$	15.8	$^{130}\text{Te }^{35}\text{Cl}-^{128}\text{Te }^{37}\text{Cl}$	14.6	$^{128}\text{Te }^{35}\text{Cl}-^{126}\text{Te }^{37}\text{Cl}$
$^{128}\text{I}$	87.9	$^{127}\text{I}(n,\gamma)^{128}\text{I}$	12.1	$^{128}\text{I}(\beta^-)^{128}\text{Xe}$		
$^{128}\text{Xe}$	76.7	$\text{C}_{10} \text{H}_8-^{128}\text{Xe}$	20.5	$^{128}\text{Te}-^{128}\text{Xe}$	1.7	$^{128}\text{I}(\beta^-)^{128}\text{Xe}$
$^{128}\text{Cs}$	79.4	$^{128}\text{Cs}(\beta^+)^{128}\text{Xe}$	20.6	$^{128}\text{Cs}-^{133}\text{Cs}_{962}$		
$^{128}\text{Ba}$	82.5	$^{128}\text{Ba}-^{133}\text{Cs}_{962}$	17.5	$^{130}\text{Ba}(p,t)^{128}\text{Ba}$		
$^{129}\text{Te}$	91.8	$^{128}\text{Te}(n,\gamma)^{129}\text{Te}$	8.2	$^{129}\text{Te}(\beta^-)^{129}\text{I}$		
$^{129}\text{I}$	51.5	$^{129}\text{Te}(\beta^-)^{129}\text{I}$	38.8	$^{129}\text{I}(\beta^-)^{129}\text{Xe}$	9.7	$^{129}\text{I}(n,\gamma)^{130}\text{I}$
$^{129}\text{Xe}$	59.5	$^{129}\text{Xe}-\text{C}_2^{35}\text{Cl}_3$	39.2	$^{129}\text{Xe}(n,\gamma)^{130}\text{Xe}$	0.9	$^{129}\text{I}(\beta^-)^{129}\text{Xe}$
$^{129}\text{Cs}$	82.9	$^{129}\text{Cs}(\beta^+)^{129}\text{Xe}$	12.5	$^{129}\text{Cs}-^{133}\text{Cs}_{970}$	4.6	$^{129}\text{Ba}(\beta^+)^{129}\text{Cs}$
$^{129}\text{Ba}$	51.5	$^{130}\text{Ba}(d,t)^{129}\text{Ba}$	48.5	$^{129}\text{Ba}(\beta^+)^{129}\text{Cs}$		
$^{130}\text{Sn}$	94.9	$^{130}\text{Sn}-\text{C}_{10,833}$	5.1	$^{130}\text{Sn}(\beta^-)^{130}\text{Sb}$		
$^{130}\text{Sb}$	85.6	$^{130}\text{Sn}(\beta^-)^{130}\text{Sb}$	14.4	$^{130}\text{Sb}(\beta^-)^{130}\text{Te}$		
$^{130}\text{Te}$	79.7	$^{130}\text{Te }^{35}\text{Cl}-^{128}\text{Te }^{37}\text{Cl}$	20.0	$^{130}\text{Te}-^{130}\text{Xe}$	0.2	$^{130}\text{Te}(n,\gamma)^{131}\text{Te}$
$^{130}\text{I}$	90.2	$^{129}\text{I}(n,\gamma)^{130}\text{I}$	9.7	$^{130}\text{I}(\beta^-)^{130}\text{Xe}$		
$^{130}\text{Xe}$	56.8	$^{129}\text{Xe}(n,\gamma)^{130}\text{Xe}$	21.2	$^{13}\text{C }^8 \text{N H}_7-^{130}\text{Xe}$	19.3	$^{130}\text{Xe}-\text{C }^{13}\text{C }^{35}\text{Cl}_3$
$^{130}\text{Cs}$	47.7	$^{130}\text{Cs}-^{133}\text{Cs}_{977}$	34.8	$^{130}\text{Cs}(\beta^+)^{130}\text{Xe}$	17.4	$^{129}\text{Xe}(\beta^-\text{He,d})^{130}\text{Cs}$
$^{130}\text{Ba}$	77.6	$^{130}\text{Ba}-^{85}\text{Rb}_{,529}$	10.8	$^{130}\text{Ba}(n,\gamma)^{131}\text{Ba}$	8.9	$^{132}\text{Ba}-^{130}\text{Ba}$
$^{131}\text{Sn}$	55.3	$^{131}\text{Sn}(\beta^-)^{131}\text{Sb}$	44.7	$^{131}\text{Sn}-\text{C}_{10,917}$		
$^{131}\text{Sb}$	62.5	$^{131}\text{Sb}(\beta^-)^{131}\text{Te}$	37.5	$^{131}\text{Sn}(\beta^-)^{131}\text{Sb}$		
$^{131}\text{Te}$	99.8	$^{130}\text{Te}(n,\gamma)^{131}\text{Te}$	0.2	$^{131}\text{Sb}(\beta^-)^{131}\text{Te}$		
$^{131}\text{Xe}$	73.2	$^{131}\text{Xe}-\text{C}_2^{35}\text{Cl}_2^{37}\text{Cl}$	25.9	$^{131}\text{Xe}(n,\gamma)^{132}\text{Xe}$	0.9	$^{131}\text{Cs}(e)^{131}\text{Xe}$
$^{131}\text{Cs}$	60.2	$^{131}\text{Cs}(e)^{131}\text{Xe}$	25.0	$^{131}\text{Ba}(\beta^+)^{131}\text{Cs}$	14.8	$^{131}\text{Cs}-^{133}\text{Cs}_{985}$
$^{131}\text{Ba}$	89.1	$^{130}\text{Ba}(n,\gamma)^{131}\text{Ba}$	6.2	$^{131}\text{Ba}(\beta^+)^{131}\text{Cs}$	4.6	$^{131}\text{Ba}-^{133}\text{Cs}_{985}$
$^{132}\text{Sn}$	66.2	$^{132}\text{Sn}-\text{C}_{11}$	33.8	$^{132}\text{Sn}(\beta^-)^{132}\text{Sb}$		
$^{132}\text{Sb}$	54.2	$^{132}\text{Sn}(\beta^-)^{132}\text{Sb}$	45.8	$^{132}\text{Sb}(\beta^-)^{132}\text{Te}$		
$^{132}\text{Te}$	93.9	$^{132}\text{Te}(\beta^-)^{132}\text{I}$	6.1	$^{132}\text{Sb}(\beta^-)^{132}\text{Te}$		
$^{132}\text{I}$	95.8	$^{132}\text{I}(\beta^-)^{132}\text{Xe}$	4.2	$^{132}\text{Te}(\beta^-)^{132}\text{I}$		
$^{132}\text{Xe}$	73.0	$^{131}\text{Xe}(n,\gamma)^{132}\text{Xe}$	24.5	$^{132}\text{Xe}-\text{C }^{13}\text{C }^{35}\text{Cl}_2^{37}\text{Cl}$	2.4	$^{132}\text{Cs}(\beta^+)^{132}\text{Xe}$
$^{132}\text{Cs}$	90.2	$^{133}\text{Cs}(\gamma,n)^{132}\text{Cs}$	9.8	$^{132}\text{Cs}(\beta^+)^{132}\text{Xe}$		
$^{132}\text{Ba}$	98.8	$^{132}\text{Ba}(n,\gamma)^{133}\text{Ba}$	1.2	$^{132}\text{Ba}-^{130}\text{Ba}$		
$^{132}\text{Ce}$	54.2	$^{132}\text{Ce}-\text{C}_{11}$	45.8	$^{132}\text{Ce O}-^{142}\text{Sm}_{1,042}$		
$^{133}\text{Cs}$	82.8	$^{133}\text{Cs}-\text{C}_2 \text{O}_6$	17.2	$^{133}\text{Cs}-\text{C}_{10} \text{H}_{12}$		
$^{133}\text{Ba}$	99.0	$^{133}\text{Ba}(e)^{133}\text{Cs}$	1.0	$^{132}\text{Ba}(n,\gamma)^{133}\text{Ba}$		
$^{134}\text{Cs}$	100.0	$^{133}\text{Cs}(n,\gamma)^{134}\text{Cs}$				
$^{134}\text{Ba}$	99.2	$^{134}\text{Cs}(\beta^-)^{134}\text{Ba}$	0.8	$^{134}\text{Ba}(n,\gamma)^{135}\text{Ba}$		
$^{135}\text{I}$	94.0	$^{135}\text{I}(\beta^-)^{135}\text{Xe}$	5.6	$^{136}\text{Xe}(d,\beta^-\text{He})^{135}\text{I}$	0.4	$^{136}\text{Te}(\beta^-n)^{135}\text{I}$
$^{135}\text{Xe}$	97.8	$^{135}\text{Xe}(\beta^-)^{135}\text{Cs}$	2.2	$^{135}\text{I}(\beta^-)^{135}\text{Xe}$		
$^{135}\text{Cs}$	99.9	$^{134}\text{Cs}(n,\gamma)^{135}\text{Cs}$	0.1	$^{135}\text{Xe}(\beta^-)^{135}\text{Cs}$		
$^{135}\text{Ba}$	99.2	$^{134}\text{Ba}(n,\gamma)^{135}\text{Ba}$	0.8	$^{135}\text{Ba}(n,\gamma)^{136}\text{Ba}$		
$^{136}\text{Te}$	80.1	$^{136}\text{Te}(\beta^-n)^{135}\text{I}$	19.9	$^{136}\text{Te}(\beta^-)^{136}\text{I}$		
$^{136}\text{I}$	74.0	$^{136}\text{I}(\beta^-)^{136}\text{Xe}$	26.0	$^{136}\text{Te}(\beta^-)^{136}\text{I}$		











Nucleus	Infl.	Equation	Infl.	Equation	Infl.	Equation
<sup>184</sup> Pb	84.1	<sup>184</sup> Pb(α) <sup>180</sup> Hg	15.9	<sup>185</sup> Bi <sup>m</sup> (p) <sup>184</sup> Pb		
<sup>185</sup> W	92.8	<sup>184</sup> W(n,γ) <sup>185</sup> W	7.2	<sup>185</sup> W(β <sup>-</sup> ) <sup>185</sup> Re		
<sup>185</sup> Re	67.9	<sup>185</sup> W(β <sup>-</sup> ) <sup>185</sup> Re	14.7	<sup>185</sup> Re(n,γ) <sup>186</sup> Re	14.6	<sup>185</sup> Re <sup>35</sup> Cl– <sup>183</sup> W <sup>37</sup> Cl
<sup>185</sup> Os	99.6	<sup>185</sup> Os(ε) <sup>185</sup> Re	0.4	<sup>184</sup> Os(n,γ) <sup>185</sup> Os		
<sup>185</sup> Bi <sup>m</sup>	67.4	<sup>185</sup> Bi <sup>m</sup> (p) <sup>184</sup> Pb	32.6	<sup>185</sup> Bi <sup>m</sup> (α) <sup>181</sup> Tl		
<sup>186</sup> W	67.7	<sup>186</sup> W(n,γ) <sup>187</sup> W	22.7	<sup>186</sup> W <sup>35</sup> Cl– <sup>184</sup> W <sup>37</sup> Cl	9.6	<sup>186</sup> W(p,t) <sup>184</sup> W
<sup>186</sup> Re	84.6	<sup>185</sup> Re(n,γ) <sup>186</sup> Re	15.4	<sup>186</sup> Re(β <sup>-</sup> ) <sup>186</sup> Os		
<sup>186</sup> Os	64.4	<sup>186</sup> Re(β <sup>-</sup> ) <sup>186</sup> Os	35.4	<sup>186</sup> Os(n,γ) <sup>187</sup> Os	0.2	<sup>190</sup> Pt(α) <sup>186</sup> Os
<sup>186</sup> Pt	60.6	<sup>186</sup> Pt–C <sub>15.5</sub>	39.4	<sup>186</sup> Pt(α) <sup>182</sup> Os		
<sup>186</sup> Au	56.3	<sup>186</sup> Au–C <sub>15.5</sub>	43.7	<sup>186</sup> Au(α) <sup>182</sup> Ir		
<sup>187</sup> W	67.8	<sup>187</sup> W(β <sup>-</sup> ) <sup>187</sup> Re	32.2	<sup>186</sup> W(n,γ) <sup>187</sup> W		
<sup>187</sup> Re	76.1	<sup>187</sup> Re(β <sup>-</sup> ) <sup>187</sup> Os	14.4	<sup>187</sup> W(β <sup>-</sup> ) <sup>187</sup> Re	9.8	<sup>187</sup> Re <sup>35</sup> Cl– <sup>185</sup> Re <sup>37</sup> Cl
<sup>187</sup> Os	56.1	<sup>186</sup> Os(n,γ) <sup>187</sup> Os	23.4	<sup>187</sup> Re(β <sup>-</sup> ) <sup>187</sup> Os	19.7	<sup>187</sup> Os(n,γ) <sup>188</sup> Os
<sup>187</sup> Au	80.8	<sup>187</sup> Au–C <sub>15.5,583</sub>	19.2	<sup>187</sup> Au(α) <sup>183</sup> Ir		
<sup>187</sup> Hg	55.7	<sup>187</sup> Hg– <sup>208</sup> Pb <sub>899</sub>	18.4	<sup>187</sup> Hg(α) <sup>183</sup> Pt	17.2	<sup>187</sup> Hg–C <sub>15.5,583</sub>
<sup>187</sup> Hg <sup>m</sup>	51.1	<sup>187</sup> Hg <sup>m</sup> (IT) <sup>187</sup> Hg	48.9	<sup>187</sup> Hg <sup>m</sup> (α) <sup>183</sup> Pt		
<sup>187</sup> Tl	62.0	<sup>191</sup> Bi(α) <sup>187</sup> Tl	38.0	<sup>187</sup> Tl <sup>m</sup> (IT) <sup>187</sup> Tl		
<sup>187</sup> Tl <sup>m</sup>	75.3	<sup>191</sup> Bi(α) <sup>187</sup> Tl <sup>m</sup>	15.0	<sup>187</sup> Tl <sup>m</sup> –C <sub>15.5,583</sub>	9.7	<sup>187</sup> Tl <sup>m</sup> (IT) <sup>187</sup> Tl
<sup>187</sup> Pb	43.7	<sup>187</sup> Pb(α) <sup>183</sup> Hg	40.4	<sup>187</sup> Pb– <sup>133</sup> Cs <sub>1,406</sub>	15.9	<sup>191</sup> Po(α) <sup>187</sup> Pb
<sup>187</sup> Pb <sup>m</sup>	66.8	<sup>187</sup> Pb <sup>m</sup> – <sup>133</sup> Cs <sub>1,406</sub>	33.2	<sup>191</sup> Po(α) <sup>187</sup> Pb <sup>m</sup>		
<sup>187</sup> Bi	69.3	<sup>187</sup> Bi(α) <sup>183</sup> Tl	30.7	<sup>187</sup> Bi(α) <sup>183</sup> Tl <sup>m</sup>		
<sup>188</sup> Os	80.1	<sup>187</sup> Os(n,γ) <sup>188</sup> Os	19.6	<sup>188</sup> Os(n,γ) <sup>189</sup> Os	0.3	<sup>188</sup> Ir(β <sup>+</sup> ) <sup>188</sup> Os
<sup>188</sup> Ir	64.2	<sup>188</sup> Ir(β <sup>+</sup> ) <sup>188</sup> Os	35.8	<sup>188</sup> Pt(ε) <sup>188</sup> Ir		
<sup>188</sup> Pt	64.4	<sup>188</sup> Pt(α) <sup>184</sup> Os	19.7	<sup>190</sup> Pt(p,t) <sup>188</sup> Pt	15.9	<sup>188</sup> Pt(ε) <sup>188</sup> Ir
<sup>188</sup> Hg	71.9	<sup>188</sup> Hg– <sup>208</sup> Pb <sub>904</sub>	17.0	<sup>188</sup> Hg–C <sub>15.667</sub>	11.1	<sup>188</sup> Hg(α) <sup>184</sup> Pt
<sup>189</sup> Os	78.3	<sup>188</sup> Os(n,γ) <sup>189</sup> Os	21.7	<sup>189</sup> Os(n,γ) <sup>190</sup> Os		
<sup>189</sup> Ir	71.0	<sup>191</sup> Ir(p,t) <sup>189</sup> Ir	29.0	<sup>189</sup> Pt(β <sup>+</sup> ) <sup>189</sup> Ir		
<sup>189</sup> Pt	80.4	<sup>190</sup> Pt(p,d) <sup>189</sup> Pt	19.6	<sup>189</sup> Pt(β <sup>+</sup> ) <sup>189</sup> Ir		
<sup>189</sup> Hg	60.8	<sup>189</sup> Hg–C <sub>15.75</sub>	39.2	<sup>189</sup> Hg <sup>m</sup> (IT) <sup>189</sup> Hg		
<sup>189</sup> Hg <sup>m</sup>	92.6	<sup>189</sup> Hg <sup>m</sup> – <sup>208</sup> Pb <sub>909</sub>	7.4	<sup>189</sup> Hg <sup>m</sup> (IT) <sup>189</sup> Hg		
<sup>190</sup> Os	78.0	<sup>189</sup> Os(n,γ) <sup>190</sup> Os	21.0	<sup>190</sup> Os(n,γ) <sup>191</sup> Os	0.6	<sup>192</sup> Os(p,t) <sup>190</sup> Os
<sup>190</sup> Pt	57.8	<sup>192</sup> Pt(p,t) <sup>190</sup> Pt	23.3	<sup>190</sup> Pt(p,t) <sup>188</sup> Pt	14.9	<sup>190</sup> Pt(α) <sup>186</sup> Os
<sup>190</sup> Hg	72.6	<sup>190</sup> Hg– <sup>208</sup> Pb <sub>913</sub>	27.4	<sup>194</sup> Pb(α) <sup>190</sup> Hg		
<sup>191</sup> Os	78.9	<sup>190</sup> Os(n,γ) <sup>191</sup> Os	21.1	<sup>191</sup> Os(β <sup>-</sup> ) <sup>191</sup> Ir		
<sup>191</sup> Ir	63.3	<sup>191</sup> Os(β <sup>-</sup> ) <sup>191</sup> Ir	35.6	<sup>191</sup> Ir(n,γ) <sup>192</sup> Ir	1.1	<sup>193</sup> Ir(t,α) <sup>192</sup> Os– <sup>191</sup> Ir(α) <sup>190</sup> Os
<sup>191</sup> Pt	69.0	<sup>192</sup> Pt(p,d) <sup>191</sup> Pt– <sup>194</sup> Pt(α) <sup>193</sup> Pt	30.6	<sup>192</sup> Pt(p,d) <sup>191</sup> Pt	0.3	<sup>191</sup> Au(β <sup>+</sup> ) <sup>191</sup> Pt
<sup>191</sup> Au	54.4	<sup>191</sup> Au(β <sup>+</sup> ) <sup>191</sup> Pt	25.2	<sup>191</sup> Hg(β <sup>+</sup> ) <sup>191</sup> Au	20.4	<sup>191</sup> Au–C <sub>15.917</sub>
<sup>191</sup> Hg	69.8	<sup>191</sup> Hg– <sup>208</sup> Pb <sub>918</sub>	22.6	<sup>191</sup> Hg–C <sub>15.917</sub>	7.6	<sup>191</sup> Hg(β <sup>+</sup> ) <sup>191</sup> Au
<sup>191</sup> Bi	86.0	<sup>191</sup> Bi– <sup>133</sup> Cs <sub>1,436</sub>	12.4	<sup>191</sup> Bi(α) <sup>187</sup> Tl <sup>m</sup>	1.6	<sup>191</sup> Bi(α) <sup>187</sup> Tl
<sup>191</sup> Po	61.7	<sup>191</sup> Po(α) <sup>187</sup> Pb <sup>m</sup>	38.3	<sup>191</sup> Po(α) <sup>187</sup> Pb		
<sup>192</sup> Os	45.4	<sup>192</sup> Os(p,t) <sup>190</sup> Os	27.6	<sup>193</sup> Ir(t,α) <sup>192</sup> Os– <sup>191</sup> Ir(α) <sup>190</sup> Os	18.0	<sup>192</sup> Os(n,γ) <sup>193</sup> Os
<sup>192</sup> Ir	64.3	<sup>191</sup> Ir(n,γ) <sup>192</sup> Ir	34.8	<sup>192</sup> Ir(n,γ) <sup>193</sup> Ir	1.0	<sup>192</sup> Ir(β <sup>-</sup> ) <sup>192</sup> Pt
<sup>192</sup> Pt	58.6	<sup>192</sup> Ir(β <sup>-</sup> ) <sup>192</sup> Pt	37.4	<sup>192</sup> Pt(n,γ) <sup>193</sup> Pt	5.5	<sup>192</sup> Pt(p,d) <sup>191</sup> Pt– <sup>194</sup> Pt(α) <sup>193</sup> Pt
<sup>193</sup> Os	81.9	<sup>192</sup> Os(n,γ) <sup>193</sup> Os	18.1	<sup>193</sup> Os(β <sup>-</sup> ) <sup>193</sup> Ir		
<sup>193</sup> Ir	64.5	<sup>192</sup> Ir(n,γ) <sup>193</sup> Ir	33.4	<sup>193</sup> Pt(ε) <sup>193</sup> Ir	3.1	<sup>193</sup> Os(β <sup>-</sup> ) <sup>193</sup> Ir
<sup>193</sup> Pt	65.3	<sup>193</sup> Pt(ε) <sup>193</sup> Ir	28.0	<sup>194</sup> Pt(p,d) <sup>193</sup> Pt	5.7	<sup>192</sup> Pt(p,d) <sup>191</sup> Pt– <sup>194</sup> Pt(α) <sup>193</sup> Pt
<sup>193</sup> Au	86.5	<sup>197</sup> Au(α, <sup>8</sup> He) <sup>193</sup> Au	13.5	<sup>193</sup> Hg(β <sup>+</sup> ) <sup>193</sup> Au		
<sup>193</sup> Hg	58.0	<sup>193</sup> Hg(β <sup>+</sup> ) <sup>193</sup> Au	32.3	<sup>193</sup> Hg– <sup>208</sup> Pb <sub>928</sub>	9.7	<sup>193</sup> Hg–C <sub>16.083</sub>
<sup>194</sup> Pt	93.6	<sup>194</sup> Pt(n,γ) <sup>195</sup> Pt	5.3	<sup>194</sup> Pt(p,d) <sup>193</sup> Pt	1.1	<sup>192</sup> Pt(p,d) <sup>191</sup> Pt– <sup>194</sup> Pt(α) <sup>193</sup> Pt
<sup>194</sup> Au	83.3	<sup>194</sup> Au(β <sup>+</sup> ) <sup>194</sup> Pt	16.7	<sup>194</sup> Hg(ε) <sup>194</sup> Au		
<sup>194</sup> Hg	49.9	<sup>194</sup> Hg– <sup>208</sup> Pb <sub>933</sub>	29.9	<sup>194</sup> Hg(ε) <sup>194</sup> Au	20.1	<sup>194</sup> Hg–C <sub>16.167</sub>
<sup>194</sup> Pb	60.3	<sup>198</sup> Po(α) <sup>194</sup> Pb	39.7	<sup>194</sup> Pb(α) <sup>190</sup> Hg		
<sup>195</sup> Pt	93.7	<sup>195</sup> Pt(n,γ) <sup>196</sup> Pt	6.3	<sup>194</sup> Pt(n,γ) <sup>195</sup> Pt		
<sup>195</sup> Au	99.9	<sup>195</sup> Au(ε) <sup>195</sup> Pt	0.1	<sup>195</sup> Hg(β <sup>+</sup> ) <sup>195</sup> Au		
<sup>195</sup> Hg	78.6	<sup>195</sup> Hg– <sup>208</sup> Pb <sub>938</sub>	21.4	<sup>195</sup> Hg(β <sup>+</sup> ) <sup>195</sup> Au		
<sup>196</sup> Pt	93.0	<sup>196</sup> Pt(n,γ) <sup>197</sup> Pt	6.2	<sup>195</sup> Pt(n,γ) <sup>196</sup> Pt	0.8	<sup>196</sup> Au(β <sup>+</sup> ) <sup>196</sup> Pt
<sup>196</sup> Au	51.7	<sup>197</sup> Au(γ,n) <sup>196</sup> Au	31.0	<sup>196</sup> Au(β <sup>-</sup> ) <sup>196</sup> Hg	17.3	<sup>196</sup> Au(β <sup>+</sup> ) <sup>196</sup> Pt
<sup>196</sup> Hg	57.2	<sup>198</sup> Hg <sup>35</sup> Cl– <sup>196</sup> Hg <sup>37</sup> Cl	29.9	<sup>196</sup> Au(β <sup>-</sup> ) <sup>196</sup> Hg	12.9	<sup>196</sup> Hg(n,γ) <sup>197</sup> Hg
<sup>197</sup> Pt	93.7	<sup>197</sup> Pt(β <sup>-</sup> ) <sup>197</sup> Au	6.3	<sup>196</sup> Pt(n,γ) <sup>197</sup> Pt		
<sup>197</sup> Au	96.6	<sup>197</sup> Au(n,γ) <sup>198</sup> Au	2.8	<sup>197</sup> Pt(β <sup>-</sup> ) <sup>197</sup> Au	0.5	<sup>197</sup> Au(γ,n) <sup>196</sup> Au
<sup>197</sup> Hg	84.1	<sup>196</sup> Hg(n,γ) <sup>197</sup> Hg	15.9	<sup>199</sup> Hg(p,t) <sup>197</sup> Hg		

Nucleus	Infl.	Equation	Infl.	Equation	Infl.	Equation
$^{198}\text{Au}$	70.0	$^{198}\text{Au}(\beta^-)^{198}\text{Hg}$	26.7	$^{198}\text{Au}(\text{n},\gamma)^{199}\text{Au}$	3.3	$^{197}\text{Au}(\text{n},\gamma)^{198}\text{Au}$
$^{198}\text{Hg}$	70.9	$^{198}\text{Hg}-\text{C}_{16.5}$	20.2	$^{198}\text{Hg}(\text{n},\gamma)^{199}\text{Hg}$	4.0	$^{198}\text{Au}(\beta^-)^{198}\text{Hg}$
$^{198}\text{Po}$	60.6	$^{198}\text{Po}-^{208}\text{Pb}_{952}$	39.4	$^{198}\text{Po}(\alpha)^{194}\text{Pb}$		
$^{199}\text{Au}$	71.8	$^{198}\text{Au}(\text{n},\gamma)^{199}\text{Au}$	28.2	$^{199}\text{Au}(\beta^-)^{199}\text{Hg}$		
$^{199}\text{Hg}$	42.7	$^{199}\text{Hg}-\text{C}_2^{35}\text{Cl}_3$	28.0	$^{198}\text{Hg}(\text{n},\gamma)^{199}\text{Hg}$	15.0	$^{199}\text{Hg}(\text{n},\gamma)^{200}\text{Hg}$
$^{200}\text{Hg}$	82.3	$^{199}\text{Hg}(\text{n},\gamma)^{200}\text{Hg}$	7.2	$^{204}\text{Hg}^{35}\text{Cl}_2-^{200}\text{Hg}^{37}\text{Cl}_2$	6.8	$^{200}\text{Hg}^{35}\text{Cl}-^{198}\text{Hg}^{37}\text{Cl}$
$^{201}\text{Au}$	100.0	$^{202}\text{Hg}(\text{d},^3\text{He})^{201}\text{Au}-^{206}\text{Pb}^{205}\text{Tl}$				
$^{201}\text{Hg}$	52.4	$^{201}\text{Hg}(\text{n},\gamma)^{202}\text{Hg}$	34.1	$^{201}\text{Hg}^{35}\text{Cl}-^{199}\text{Hg}^{37}\text{Cl}$	12.9	$^{201}\text{Hg}^{35}\text{Cl}-^{199}\text{Hg}^{37}\text{Cl}$
$^{202}\text{Hg}$	43.0	$^{201}\text{Hg}(\text{n},\gamma)^{202}\text{Hg}$	24.7	$^{202}\text{Hg}^{35}\text{Cl}-^{200}\text{Hg}^{37}\text{Cl}$	20.7	$^{204}\text{Hg}^{35}\text{Cl}-^{202}\text{Hg}^{37}\text{Cl}$
$^{202}\text{Tl}$	54.1	$^{203}\text{Tl}(\text{p},\text{d})^{202}\text{Tl}$	45.9	$^{202}\text{Pb}(\epsilon)^{202}\text{Tl}$		
$^{202}\text{Pb}$	65.7	$^{204}\text{Pb}(\text{p},\text{t})^{202}\text{Pb}$	26.0	$^{202}\text{Pb}-\text{C}_{16.833}$	8.2	$^{202}\text{Pb}(\epsilon)^{202}\text{Tl}$
$^{203}\text{Au}$	100.0	$^{204}\text{Hg}(\text{d},^3\text{He})^{203}\text{Au}-^{206}\text{Pb}^{205}\text{Tl}$				
$^{203}\text{Hg}$	83.6	$^{203}\text{Hg}(\beta^-)^{203}\text{Tl}$	11.3	$^{204}\text{Hg}(\text{d},\text{t})^{203}\text{Hg}$	5.1	$^{202}\text{Hg}(\text{d},\text{p})^{203}\text{Hg}-^{204}\text{Hg}^{205}\text{Hg}$
$^{203}\text{Tl}$	75.8	$^{203}\text{Tl}(\text{n},\gamma)^{204}\text{Tl}$	11.1	$^{203}\text{Tl}^{35}\text{Cl}-^{201}\text{Hg}^{37}\text{Cl}$	8.2	$^{203}\text{Hg}(\beta^-)^{203}\text{Tl}$
$^{203}\text{Pb}$	51.4	$^{204}\text{Pb}(\text{p},\text{d})^{203}\text{Pb}$	37.0	$^{207}\text{Po}(\alpha)^{203}\text{Pb}$	10.3	$^{203}\text{Pb}(\epsilon)^{203}\text{Tl}$
$^{203}\text{Bi}$	81.6	$^{207}\text{At}(\alpha)^{203}\text{Bi}$	18.4	$^{203}\text{Bi}(\beta^+)^{203}\text{Pb}$		
$^{203}\text{At}$	99.9	$^{203}\text{At}-^{208}\text{Pb}_{976}$	0.1	$^{207}\text{Fr}(\alpha)^{203}\text{At}$		
$^{204}\text{Hg}$	87.1	$^{204}\text{Hg}-\text{C}_{17}$	5.9	$^{204}\text{Hg}^{35}\text{Cl}_2-^{200}\text{Hg}^{37}\text{Cl}_2$	5.3	$^{204}\text{Hg}^{35}\text{Cl}-^{202}\text{Hg}^{37}\text{Cl}$
$^{204}\text{Tl}$	77.6	$^{204}\text{Tl}(\beta^-)^{204}\text{Pb}$	18.5	$^{203}\text{Tl}(\text{n},\gamma)^{204}\text{Tl}$	3.9	$^{205}\text{Tl}(\text{d},\text{t})^{204}\text{Tl}$
$^{204}\text{Pb}$	78.9	$^{204}\text{Pb}(\text{n},\gamma)^{205}\text{Pb}$	19.3	$^{204}\text{Tl}(\beta^-)^{204}\text{Pb}$	1.3	$^{206}\text{Pb}^{35}\text{Cl}-^{204}\text{Pb}^{37}\text{Cl}$
$^{204}\text{At}$	94.0	$^{204}\text{At}-\text{C}_{17}$	6.0	$^{208}\text{Fr}(\alpha)^{204}\text{At}$		
$^{205}\text{Hg}$	52.7	$^{204}\text{Hg}(\text{d},\text{p})^{205}\text{Hg}$	47.3	$^{202}\text{Hg}(\text{d},\text{p})^{203}\text{Hg}-^{204}\text{Hg}^{205}\text{Hg}$		
$^{205}\text{Tl}$	56.7	$^{205}\text{Tl}(\text{d},\text{t})^{204}\text{Tl}$	13.5	$^{205}\text{Tl}^{35}\text{Cl}-^{203}\text{Tl}^{37}\text{Cl}$	11.7	$^{205}\text{Tl}(^3\text{He},\text{d})^{206}\text{Pb}$
$^{205}\text{Pb}$	80.9	$^{205}\text{Pb}(\text{n},\gamma)^{206}\text{Pb}$	19.1	$^{204}\text{Pb}(\text{n},\gamma)^{205}\text{Pb}$		
$^{205}\text{Bi}$	100.0	$^{205}\text{Bi}(\beta^+)^{205}\text{Pb}$				
$^{206}\text{Tl}$	84.1	$^{205}\text{Tl}(\text{n},\gamma)^{206}\text{Tl}$	15.9	$^{210}\text{Bi}(\alpha)^{206}\text{Tl}$		
$^{206}\text{Pb}$	70.0	$^{206}\text{Pb}^{35}\text{Cl}_2-^{202}\text{Hg}^{37}\text{Cl}_2$	18.5	$^{205}\text{Pb}(\text{n},\gamma)^{206}\text{Pb}$	8.1	$^{206}\text{Pb}(\text{n},\gamma)^{207}\text{Pb}$
$^{207}\text{Tl}$	45.4	$^{207}\text{Tl}(\beta^-)^{207}\text{Pb}$	41.7	$^{211}\text{Bi}(\alpha)^{207}\text{Tl}$	12.9	$^{205}\text{Tl}(\text{t},\text{p})^{207}\text{Tl}$
$^{207}\text{Pb}$	88.9	$^{206}\text{Pb}(\text{n},\gamma)^{207}\text{Pb}$	10.1	$^{207}\text{Pb}(\text{n},\gamma)^{208}\text{Pb}$	0.6	$^{207}\text{Tl}(\beta^-)^{207}\text{Pb}$
$^{207}\text{Bi}$	97.4	$^{209}\text{Bi}(\text{p},\text{t})^{207}\text{Bi}$	2.6	$^{207}\text{Po}(\beta^+)^{207}\text{Bi}$		
$^{207}\text{Po}$	59.3	$^{207}\text{Po}(\alpha)^{203}\text{Pb}$	40.7	$^{207}\text{Po}(\beta^+)^{207}\text{Bi}$		
$^{207}\text{At}$	81.9	$^{211}\text{Fr}(\alpha)^{207}\text{At}$	18.1	$^{207}\text{At}(\alpha)^{203}\text{Bi}$		
$^{207}\text{Fr}$	97.4	$^{207}\text{Fr}(\alpha)^{203}\text{At}$	2.6	$^{208}\text{Fr}-^{209}\text{Fr}_{498}$		
$^{208}\text{Pb}$	89.1	$^{207}\text{Pb}(\text{n},\gamma)^{208}\text{Pb}$	7.5	$^{212}\text{Po}(\alpha)^{208}\text{Pb}$	1.7	$^{208}\text{Pb}^{35}\text{Cl}-^{206}\text{Pb}^{37}\text{Cl}$
$^{208}\text{Fr}$	69.6	$^{208}\text{Fr}(\alpha)^{204}\text{At}$	9.3	$^{208}\text{Fr}-^{209}\text{Fr}_{498}$	6.7	$^{210}\text{Fr}-^{220}\text{Fr}_{159}$
$^{209}\text{Pb}$	87.0	$^{209}\text{Pb}(\beta^-)^{209}\text{Bi}$	11.1	$^{208}\text{Pb}(\text{d},\text{p})^{209}\text{Pb}$	1.9	$^{213}\text{Po}(\alpha)^{209}\text{Pb}$
$^{209}\text{Bi}$	85.8	$^{209}\text{Bi}(\text{n},\gamma)^{210}\text{Bi}$	9.6	$^{209}\text{Bi}(\alpha)^{205}\text{Tl}$	4.2	$^{209}\text{Pb}(\beta^-)^{209}\text{Bi}$
$^{209}\text{At}$	100.0	$^{209}\text{At}(\alpha)^{205}\text{Bi}$				
$^{209}\text{Fr}$	99.0	$^{209}\text{Fr}-^{226}\text{Ra}_{925}$	0.9	$^{209}\text{Fr}-^{213}\text{Fr}_{196}$	0.2	$^{208}\text{Fr}-^{209}\text{Fr}_{498}$
$^{210}\text{Pb}$	97.8	$^{210}\text{Pb}(\beta^-)^{210}\text{Bi}$	2.2	$^{214}\text{Po}(\alpha)^{210}\text{Pb}$		
$^{210}\text{Bi}$	50.3	$^{210}\text{Bi}(\beta^-)^{210}\text{Po}$	33.7	$^{210}\text{Bi}(\alpha)^{206}\text{Tl}$	14.1	$^{209}\text{Bi}(\text{n},\gamma)^{210}\text{Bi}$
$^{210}\text{Po}$	98.5	$^{210}\text{Po}(\alpha)^{206}\text{Pb}$	1.5	$^{210}\text{Bi}(\beta^-)^{210}\text{Po}$		
$^{210}\text{Fr}$	98.0	$^{210}\text{Fr}-^{226}\text{Ra}_{929}$	2.0	$^{210}\text{Fr}-^{220}\text{Fr}_{159}$		
$^{211}\text{Pb}$	94.4	$^{215}\text{Po}(\alpha)^{211}\text{Pb}$	5.6	$^{211}\text{Pb}(\beta^-)^{211}\text{Bi}$		
$^{211}\text{Bi}$	58.2	$^{211}\text{Bi}(\alpha)^{207}\text{Tl}$	41.8	$^{211}\text{Pb}(\beta^-)^{211}\text{Bi}$		
$^{211}\text{Fr}$	81.4	$^{211}\text{Fr}-^{226}\text{Ra}_{934}$	17.2	$^{211}\text{Fr}(\alpha)^{207}\text{At}$	1.4	$^{211}\text{Fr}-^{220}\text{Fr}_{240}$
$^{212}\text{Pb}$	54.2	$^{216}\text{Po}(\alpha)^{212}\text{Pb}$	45.8	$^{212}\text{Pb}(\beta^-)^{212}\text{Bi}$		
$^{212}\text{Bi}$	72.6	$^{212}\text{Bi}(\beta^-)^{212}\text{Po}$	27.4	$^{212}\text{Pb}(\beta^-)^{212}\text{Bi}$		
$^{212}\text{Po}$	92.5	$^{212}\text{Po}(\alpha)^{208}\text{Pb}$	7.5	$^{212}\text{Bi}(\beta^-)^{212}\text{Po}$		
$^{212}\text{Fr}$	97.2	$^{212}\text{Fr}-^{226}\text{Ra}_{938}$	2.8	$^{212}\text{Fr}-^{220}\text{Fr}_{321}$		
$^{213}\text{Bi}$	77.7	$^{217}\text{At}(\alpha)^{213}\text{Bi}$	22.3	$^{213}\text{Bi}(\beta^-)^{213}\text{Po}$		
$^{213}\text{Po}$	93.2	$^{213}\text{Po}(\alpha)^{209}\text{Pb}$	6.8	$^{213}\text{Bi}(\beta^-)^{213}\text{Po}$		
$^{213}\text{Fr}$	100.0	$^{213}\text{Fr}(\alpha)^{209}\text{At}$				
$^{214}\text{Pb}$	99.1	$^{218}\text{Po}(\alpha)^{214}\text{Pb}$	0.9	$^{214}\text{Pb}(\beta^-)^{214}\text{Bi}$		
$^{214}\text{Bi}$	69.0	$^{214}\text{Bi}(\beta^-)^{214}\text{Po}$	31.0	$^{214}\text{Pb}(\beta^-)^{214}\text{Bi}$		
$^{214}\text{Po}$	97.8	$^{214}\text{Po}(\alpha)^{210}\text{Pb}$	2.0	$^{218}\text{Rn}(\alpha)^{214}\text{Po}$	0.3	$^{214}\text{Bi}(\beta^-)^{214}\text{Po}$
$^{215}\text{Po}$	94.9	$^{219}\text{Rn}(\alpha)^{215}\text{Po}$	5.1	$^{215}\text{Po}(\alpha)^{211}\text{Pb}$		
$^{216}\text{Po}$	55.6	$^{220}\text{Rn}(\alpha)^{216}\text{Po}$	44.4	$^{216}\text{Po}(\alpha)^{212}\text{Pb}$		
$^{216}\text{At}$	100.0	$^{216}\text{At}(\alpha)^{212}\text{Bi}$				
$^{217}\text{At}$	78.8	$^{221}\text{Fr}(\alpha)^{217}\text{At}$	21.2	$^{217}\text{At}(\alpha)^{213}\text{Bi}$		
$^{218}\text{Po}$	99.1	$^{222}\text{Rn}(\alpha)^{218}\text{Po}$	0.9	$^{218}\text{Po}(\alpha)^{214}\text{Pb}$		

Nucleus	Infl.	Equation	Infl.	Equation	Infl.	Equation
<sup>218</sup> Rn	94.0	<sup>218</sup> Rn(α) <sup>214</sup> Po	6.0	<sup>222</sup> Ra(α) <sup>218</sup> Rn		
<sup>219</sup> Rn	95.0	<sup>223</sup> Ra(α) <sup>219</sup> Rn	5.0	<sup>219</sup> Rn(α) <sup>215</sup> Po		
<sup>220</sup> Rn	55.7	<sup>224</sup> Ra(α) <sup>220</sup> Rn	44.3	<sup>220</sup> Rn(α) <sup>216</sup> Po		
<sup>220</sup> Fr	100.0	<sup>220</sup> Fr(α) <sup>216</sup> At				
<sup>221</sup> Fr	80.2	<sup>225</sup> Ac(α) <sup>221</sup> Fr	19.8	<sup>221</sup> Fr(α) <sup>217</sup> At		
<sup>222</sup> Rn	99.2	<sup>226</sup> Ra(α) <sup>222</sup> Rn	0.8	<sup>222</sup> Rn(α) <sup>218</sup> Po		
<sup>222</sup> Fr	82.2	<sup>222</sup> Fr– <sup>226</sup> Ra <sub>982</sub>	17.8	<sup>226</sup> Ac(α) <sup>222</sup> Fr		
<sup>222</sup> Ra	64.9	<sup>222</sup> Ra(α) <sup>218</sup> Rn	35.1	<sup>226</sup> Th(α) <sup>222</sup> Ra		
<sup>223</sup> Ra	95.0	<sup>227</sup> Th(α) <sup>223</sup> Ra	5.0	<sup>223</sup> Ra(α) <sup>219</sup> Rn		
<sup>224</sup> Ra	55.8	<sup>228</sup> Th(α) <sup>224</sup> Ra	44.2	<sup>224</sup> Ra(α) <sup>220</sup> Rn		
<sup>225</sup> Ra	94.9	<sup>229</sup> Th(α) <sup>225</sup> Ra	5.1	<sup>225</sup> Ra(β <sup>-</sup> ) <sup>225</sup> Ac		
<sup>225</sup> Ac	63.7	<sup>229</sup> Pa(α) <sup>225</sup> Ac	18.3	<sup>225</sup> Ac(α) <sup>221</sup> Fr	17.9	<sup>225</sup> Ra(β <sup>-</sup> ) <sup>225</sup> Ac
<sup>226</sup> Ra	98.9	<sup>230</sup> Th(α) <sup>226</sup> Ra	0.8	<sup>226</sup> Ra(α) <sup>222</sup> Rn	0.1	<sup>211</sup> Fr– <sup>226</sup> Ra <sub>934</sub>
<sup>226</sup> Ac	86.1	<sup>230</sup> Pa(α) <sup>226</sup> Ac	13.7	<sup>226</sup> Ac(β <sup>-</sup> ) <sup>226</sup> Th	0.3	<sup>226</sup> Ac(α) <sup>222</sup> Fr
<sup>226</sup> Th	58.9	<sup>226</sup> Th(α) <sup>222</sup> Ra	41.1	<sup>226</sup> Ac(β <sup>-</sup> ) <sup>226</sup> Th		
<sup>227</sup> Ac	95.6	<sup>231</sup> Pa(α) <sup>227</sup> Ac	4.4	<sup>227</sup> Ac(β <sup>-</sup> ) <sup>227</sup> Th		
<sup>227</sup> Th	95.0	<sup>227</sup> Ac(β <sup>-</sup> ) <sup>227</sup> Th	5.0	<sup>227</sup> Th(α) <sup>223</sup> Ra		
<sup>228</sup> Th	56.1	<sup>230</sup> Th(p,t) <sup>228</sup> Th– <sup>232</sup> Th() <sup>230</sup> Th	43.9	<sup>228</sup> Th(α) <sup>224</sup> Ra		
<sup>229</sup> Ra	91.5	<sup>229</sup> Ra– <sup>133</sup> Cs <sub>1,722</sub>	8.5	<sup>229</sup> Ra(β <sup>-</sup> ) <sup>229</sup> Ac		
<sup>229</sup> Ac	55.8	<sup>229</sup> Ra(β <sup>-</sup> ) <sup>229</sup> Ac	44.2	<sup>229</sup> Ac(β <sup>-</sup> ) <sup>229</sup> Th		
<sup>229</sup> Th	68.2	<sup>233</sup> U(α) <sup>229</sup> Th	27.3	<sup>230</sup> Th(d,t) <sup>229</sup> Th	4.3	<sup>229</sup> Th(α) <sup>225</sup> Ra
<sup>229</sup> Pa	92.9	<sup>231</sup> Pa(p,t) <sup>229</sup> Pa	7.1	<sup>229</sup> Pa(α) <sup>225</sup> Ac		
<sup>230</sup> Th	59.9	<sup>230</sup> Th(p,t) <sup>228</sup> Th– <sup>232</sup> Th() <sup>230</sup> Th	21.2	<sup>234</sup> U(α) <sup>230</sup> Th	14.4	<sup>230</sup> Th(n,γ) <sup>231</sup> Th
<sup>230</sup> Pa	86.7	<sup>230</sup> Pa(ε) <sup>230</sup> Th	13.3	<sup>230</sup> Pa(α) <sup>226</sup> Ac		
<sup>231</sup> Th	83.7	<sup>230</sup> Th(n,γ) <sup>231</sup> Th	12.0	<sup>235</sup> U(α) <sup>231</sup> Th	4.3	<sup>231</sup> Th(β <sup>-</sup> ) <sup>231</sup> Pa
<sup>231</sup> Pa	50.5	<sup>231</sup> Th(β <sup>-</sup> ) <sup>231</sup> Pa	41.7	<sup>235</sup> Np(α) <sup>231</sup> Pa	3.9	<sup>231</sup> Pa(p,t) <sup>229</sup> Pa
<sup>232</sup> Th	69.5	<sup>236</sup> U(α) <sup>232</sup> Th	22.6	<sup>C</sup> <sub>4</sub> <sup>37</sup> H <sub>16</sub> – <sup>232</sup> Th <sup>37</sup> Cl <sup>35</sup> Cl	18.3	<sup>C</sup> <sub>18</sub> <sup>37</sup> H <sub>16</sub> – <sup>232</sup> Th
<sup>233</sup> Th	92.9	<sup>232</sup> Th(n,γ) <sup>233</sup> Th	7.1	<sup>233</sup> Th(β <sup>-</sup> ) <sup>233</sup> Pa		
<sup>233</sup> Pa	74.9	<sup>237</sup> Np(α) <sup>233</sup> Pa	14.8	<sup>233</sup> Th(β <sup>-</sup> ) <sup>233</sup> Pa	10.2	<sup>233</sup> Pa(β <sup>-</sup> ) <sup>233</sup> U
<sup>233</sup> U	48.0	<sup>233</sup> Pa(β <sup>-</sup> ) <sup>233</sup> U	25.4	<sup>233</sup> U(α) <sup>229</sup> Th	15.3	<sup>237</sup> Pu(α) <sup>233</sup> U
<sup>234</sup> U	49.7	<sup>234</sup> U(n,γ) <sup>235</sup> U	36.2	<sup>234</sup> U(α) <sup>230</sup> Th	13.7	<sup>238</sup> Pu(α) <sup>234</sup> U
<sup>235</sup> U	31.7	<sup>234</sup> U(n,γ) <sup>235</sup> U	24.1	<sup>239</sup> Pu(α) <sup>235</sup> U	22.3	<sup>235</sup> U(n,γ) <sup>236</sup> U
<sup>235</sup> Np	86.2	<sup>235</sup> Np(ε) <sup>235</sup> U	13.8	<sup>235</sup> Np(α) <sup>231</sup> Pa		
<sup>236</sup> U	58.7	<sup>240</sup> Pu(α) <sup>236</sup> U	31.5	<sup>235</sup> U(n,γ) <sup>236</sup> U	8.9	<sup>236</sup> U(α) <sup>232</sup> Th
<sup>237</sup> U	82.5	<sup>236</sup> U(n,γ) <sup>237</sup> U	17.5	<sup>241</sup> Pu(α) <sup>237</sup> U		
<sup>237</sup> Np	97.8	<sup>241</sup> Am(α) <sup>237</sup> Np	2.2	<sup>237</sup> Np(α) <sup>233</sup> Pa		
<sup>237</sup> Pu	94.0	<sup>241</sup> Cm(α) <sup>237</sup> Pu	6.0	<sup>237</sup> Pu(α) <sup>233</sup> U		
<sup>238</sup> U	54.3	<sup>242</sup> Pu(α) <sup>238</sup> U	34.1	<sup>C</sup> <sub>4</sub> <sup>35</sup> H <sub>20</sub> – <sup>238</sup> U <sup>35</sup> Cl <sub>2</sub>	11.6	<sup>C</sup> <sub>18</sub> <sup>35</sup> H <sub>22</sub> – <sup>238</sup> U
<sup>238</sup> Pu	76.0	<sup>238</sup> Pu(α) <sup>234</sup> U	24.0	<sup>238</sup> Pu(n,γ) <sup>239</sup> Pu		
<sup>239</sup> Np	98.0	<sup>239</sup> Np(β <sup>-</sup> ) <sup>239</sup> Pu	2.0	<sup>243</sup> Am(α) <sup>239</sup> Np		
<sup>239</sup> Pu	44.3	<sup>239</sup> Pu(α) <sup>235</sup> U	41.3	<sup>239</sup> Pu(n,γ) <sup>240</sup> Pu	14.0	<sup>238</sup> Pu(n,γ) <sup>239</sup> Pu
<sup>240</sup> Pu	37.5	<sup>240</sup> Pu(n,γ) <sup>241</sup> Pu	31.3	<sup>240</sup> Pu(α) <sup>236</sup> U	31.2	<sup>239</sup> Pu(n,γ) <sup>240</sup> Pu
<sup>241</sup> Pu	62.4	<sup>240</sup> Pu(n,γ) <sup>241</sup> Pu	34.9	<sup>241</sup> Pu(n,γ) <sup>242</sup> Pu	2.2	<sup>241</sup> Pu(β <sup>-</sup> ) <sup>241</sup> Am
<sup>241</sup> Am	97.6	<sup>241</sup> Pu(β <sup>-</sup> ) <sup>241</sup> Am	2.0	<sup>241</sup> Am(α) <sup>237</sup> Np	0.4	<sup>241</sup> Cm(ε) <sup>241</sup> Am
<sup>241</sup> Cm	95.0	<sup>241</sup> Cm(ε) <sup>241</sup> Am	5.0	<sup>241</sup> Cm(α) <sup>237</sup> Pu		
<sup>242</sup> Pu	61.0	<sup>241</sup> Pu(n,γ) <sup>242</sup> Pu	38.4	<sup>242</sup> Pu(α) <sup>238</sup> U	0.5	<sup>242</sup> Pu(n,γ) <sup>243</sup> Pu
<sup>243</sup> Pu	74.9	<sup>242</sup> Pu(n,γ) <sup>243</sup> Pu	13.5	<sup>243</sup> Pu(β <sup>-</sup> ) <sup>243</sup> Am	7.9	<sup>247</sup> Cm(α) <sup>243</sup> Pu
<sup>243</sup> Am	96.3	<sup>243</sup> Am(α) <sup>239</sup> Np	3.7	<sup>243</sup> Pu(β <sup>-</sup> ) <sup>243</sup> Am		
<sup>244</sup> Pu	65.2	<sup>244</sup> Pu(d,t) <sup>243</sup> Pu	32.4	<sup>248</sup> Cm(α) <sup>244</sup> Pu	2.4	<sup>244</sup> Pu(t,p) <sup>246</sup> Pu
<sup>246</sup> Pu	54.2	<sup>244</sup> Pu(t,p) <sup>246</sup> Pu	45.8	<sup>246</sup> Pu(β <sup>-</sup> ) <sup>246</sup> Am <sup>m</sup>		
<sup>246</sup> Am <sup>m</sup>	56.6	<sup>246</sup> Am <sup>m</sup> (β <sup>-</sup> ) <sup>246</sup> Cm	43.4	<sup>246</sup> Pu(β <sup>-</sup> ) <sup>246</sup> Am <sup>m</sup>		
<sup>246</sup> Cm	98.7	<sup>246</sup> Cm(α) <sup>242</sup> Pu	0.9	<sup>246</sup> Cm(d,p) <sup>247</sup> Cm	0.3	<sup>248</sup> Cm(p,t) <sup>246</sup> Cm
<sup>247</sup> Cm	63.4	<sup>247</sup> Cm(α) <sup>243</sup> Pu	24.1	<sup>246</sup> Cm(d,p) <sup>247</sup> Cm	12.5	<sup>248</sup> Cm(d,t) <sup>247</sup> Cm
<sup>248</sup> Cm	67.5	<sup>248</sup> Cm(α) <sup>244</sup> Pu	22.7	<sup>248</sup> Cm(d,t) <sup>247</sup> Cm	9.8	<sup>248</sup> Cm(p,t) <sup>246</sup> Cm

**Table III. Nuclear-reaction and separation energies**

## EXPLANATION OF TABLE

We present, for all nuclei for which such data can be derived, separation energies (in keV) of particles or groups of particles and nuclear-reaction energies obtained as the following combinations of atomic masses (see accompanying diagram):

$Q(\beta^-)$	=	$M(A, Z) - M(A, Z + 1)$ (in part I)	(a)
$Q(2\beta^-)$	=	$M(A, Z) - M(A, Z + 2)$	(b)
$Q(4\beta^-)$	=	$M(A, Z) - M(A, Z + 4)$	(c)
$Q(\beta^-n)$	=	$M(A, Z) - M(A - 1, Z + 1) - n$	(d)
$S(n)$	=	$-M(A, Z) + M(A - 1, Z) + n$	(e)
$S(p)$	=	$-M(A, Z) + M(A - 1, Z - 1) + {}^1\text{H}$	(f)
$Q(\varepsilon p)$	=	$M(A, Z) - M(A - 1, Z - 2) - {}^1\text{H}$	(g)
$S(2n)$	=	$-M(A, Z) + M(A - 2, Z) + 2n$	(h)
$Q(d, \alpha)$	=	$M(A, Z) - M(A - 2, Z - 1) - {}^2\text{H} - {}^4\text{He}$	(i)
$S(2p)$	=	$-M(A, Z) + M(A - 2, Z - 2) + 2{}^1\text{H}$	(j)
$Q(p, \alpha)$	=	$M(A, Z) - M(A - 3, Z - 1) - {}^4\text{He} + p$	(k)
$Q(n, \alpha)$	=	$M(A, Z) - M(A - 3, Z - 2) - {}^4\text{He} + n$	(l)
$Q(\alpha)$	=	$M(A, Z) - M(A - 4, Z - 2) - {}^4\text{He}$	(m)

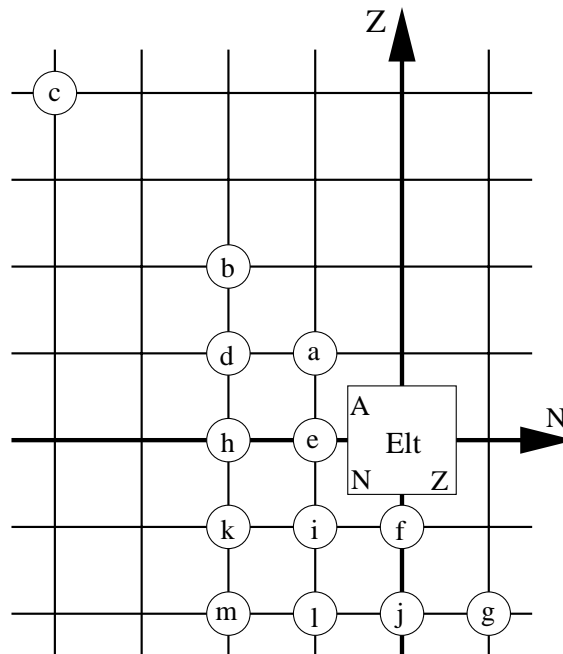

A	Mass number.
Elt.	Element symbol (for $Z > 103$ see part I, sect. 2).
Z	Atomic number.
2224.57 0.04	2224.57 ± 0.04 keV. The errors are derived from the adjusted masses and the correlation matrix. For the most precise very light nuclides the precisions are often better than 5 eV and could not be given conveniently in this table. In Table B, the correlation matrix for these nuclides allows easy derivation.
	* in place of value: not calculable from the present input data.
	# in place of decimal point: values and errors estimated from systematic trends.

Other reaction energies can be derived from the given data with the help of the following relations:

$$\begin{aligned}
 Q(\gamma, p) &= - S(p) \\
 Q(\gamma, n) &= - S(n) \\
 Q(\gamma, 2p) &= - S(2p) \\
 Q(\gamma, pn) &= Q(d, \alpha) - 26071.0935 \pm 0.0008 \\
 Q(\gamma, d) &= Q(d, \alpha) - 23846.5275 \pm 0.0007 \\
 Q(\gamma, 2n) &= - S(2n) \\
 Q(\gamma, t) &= Q(p, \alpha) - 19813.8608 \pm 0.0023 \\
 Q(\gamma, {}^3\text{He}) &= Q(n, \alpha) - 20577.6162 \pm 0.0025 \\
 Q(\gamma, \alpha) &= Q(\alpha) \\
 \\
 Q(p, n) &= Q(\beta) - 782.3466 \pm 0.0005 \\
 Q(p, 2p) &= - S(p) \\
 Q(p, pn) &= - S(n) \\
 Q(p, d) &= - S(n) + 2224.5660 \pm 0.0004 \\
 Q(p, 2n) &= Q(\beta^- n) - 782.3466 \pm 0.0005 \\
 Q(p, t) &= - S(2n) + 8481.7987 \pm 0.0025 \\
 Q(p, {}^3\text{He}) &= Q(d, \alpha) - 18353.0502 \pm 0.0025 \\
 \\
 Q(n, 2p) &= Q(\epsilon p) + 782.3466 \pm 0.0005 \\
 Q(n, np) &= - S(p) \\
 Q(n, d) &= - S(p) + 2224.5660 \pm 0.0004 \\
 Q(n, 2n) &= - S(n) \\
 Q(n, t) &= Q(d, \alpha) - 17589.2948 \pm 0.0023 \\
 Q(n, {}^3\text{He}) &= - S(2p) + 7718.0433 \pm 0.0025 \\
 \\
 Q(d, pn) &= 0 - 2224.5660 \pm 0.0004 \\
 Q(d, t) &= - S(n) + 6257.2327 \pm 0.0024 \\
 Q(d, {}^3\text{He}) &= - S(p) + 5493.4773 \pm 0.0024 \\
 \\
 Q({}^3\text{He}, t) &= Q(\beta^-) - 18.5912 \pm 0.0011 \\
 Q({}^3\text{He}, \alpha) &= - S(n) + 20577.6162 \pm 0.0025 \\
 \\
 Q(t, \alpha) &= - S(p) + 19813.8608 \pm 0.0023
 \end{aligned}$$

A	Elt.	Z	S(n)		S(p)		Q( $4\beta^-$ )		Q(d, $\alpha$ )		Q(p, $\alpha$ )		Q(n, $\alpha$ )	
1	n	0	0.0	0.0	*		*	*	*	*	*	*		
	H	1	*		0.0	0.0	*	*	*	*	*	*		
2	H	1	2224.57	0.00	2224.57	0.00	*	23846.53	0.00	*	*	*		
3	H	1	6257.23	0.00	*		*	17589.29	0.00	19813.86	0.00	*	*	
	He	2	*		5493.48	0.00	*	18353.05	0.00	*	*	20577.62	0.00	
	Li	3	*		*		*	*	*	*	*	*		
4	H	1	-2880	100	*		*	*		22690	100	*	*	
	He	2	20577.62	0.00	19813.86	0.00	*	0.0	0.0	0.0	0.0	0.0	0.0	0.0
	Li	3	11420#	2010#	-3100	210	*	*	*	*	*	23680	210	
5	H	1	1080	140	*		*	*	*	*	*	*	*	
	He	2	-890	50	21800	110	*	7150	50	3110	50	*	*	
	Li	3	21720	220	-1970	50	*	7460	50	*	*	4190	50	
	Be	4	*		-5380#	4000#	*	20040#	4470#	*	*	*	*	
6	H	1	-900	280	*		-1740#	750#	*	*	*	*	*	
	He	2	1860	50	22590	100	*	2400	100	7509.4	0.8	*	*	
	Li	3	5660	50	4590	50	*	22372.68	0.02	4019.63	0.02	4783.39	0.02	
	Be	4	27690#	4000#	590	50	*	3760	210	-5430#	2000#	9090	5	
	B	5	*		1680#	4060#	*	*	*	*	*	20580#	2120#	
7	H	1	800#	1040#	*		21270#	1010#	*	*	*	*	*	
	He	2	-435	17	23050	270	*	3920	100	5060	100	*	*	
	Li	3	7249.97	0.08	9975.9	0.8	*	14230	50	17347.28	0.08	-5350	100	
	Be	4	10676	5	5605.73	0.10	*	14800	50	-4690	210	18991.52	0.11	
	B	5	23810#	700#	-2200	70	*	580#	4000#	*	*	8190	220	
8	He	2	2574	18	24830#	1010#	-3496	24	450	260	3570	100	*	
	Li	3	2032.61	0.05	12443	17	*	14062.5	0.8	14420	50	-6300	100	
	Be	4	18899.68	0.11	17255.44	0.09	*	1565.69	0.04	-1870	50	-800	50	
	B	5	13020	70	137.5	1.0	*	15257	6	-10210#	4000#	16890	50	
	C	6	*		60	70	*	2200#	700#	*	*	2750#	4000#	
9	He	2	-1270	29	*		12029	29	2520#	1010#	3940	270	*	
	Li	3	4063.9	1.9	13933	7	*	9564	17	12223.2	2.1	-11260	260	
	Be	4	1665.3	0.4	16888.2	0.4	*	7150.3	0.4	2124.9	0.4	-601.1	0.9	
	B	5	18577.1	1.4	-185.0	1.0	*	7356.5	1.0	-1095	6	3975.3	1.0	
	C	6	14255	23	1300.0	2.4	*	11750	70	-9830#	700#	16182	6	
10	He	2	200	80	*		33110	70	*	4540#	1010#	*	*	
	Li	3	-25	15	15180	30	-5750	400	12163	17	11814	22	-10440#	1010#
	Be	4	6812.29	0.06	19636.6	1.9	*	2370.6	0.4	2562.6	0.4	-7848	17	
	B	5	8436.3	1.1	6585.9	0.6	*	17819.9	0.4	1144.8	0.4	2789.0	0.4	
	C	6	21283.1	2.2	4006.0	1.1	*	3488.0	1.1	-7310	70	5575.0	0.4	
	N	7	*		-2600	400	*	14420	400	*	*	16580	410	
11	Li	3	325	25	15300	70	16490	50	10570	40	14063	20	*	
	Be	4	504	6	20165	16	*	5931	7	4091	6	-5778	9	
	B	5	11454.12	0.16	11227.7	0.6	*	8031.1	0.6	8590.3	0.4	-6632.5	0.4	
	C	6	13119.7	0.9	8689.4	0.9	*	8945.5	1.4	-7407.1	1.4	11355.1	1.0	
	N	7	22570	400	-1320	50	*	6100	50	-5930	50	7030	50	
12	Li	3	-1230#	1000#	*		32760#	1000#	12000#	1000#	14020#	1000#	*	
	Be	4	3169	16	23010	24	-6971	24	2737	21	4986	15	-10220	30
	B	5	3370.3	1.5	14094	7	*	11473.0	1.5	6885.3	1.5	-5939.0	2.4	
	C	6	18721.7	1.0	15956.9	0.4	*	-1339.9	0.4	-7551.6	1.0	-5701.2	0.4	
	N	7	15040	50	601.2	1.4	*	12350.2	1.1	-6708.4	2.4	10568.8	1.4	
	O	8	*		-460	50	*	3960	400	*	*	8784	19	

A	El.	Z	S(2n)		S(2p)		Q( $\alpha$ )		Q( $2\beta^-$ )		Q( $\epsilon p$ )		Q( $\beta^- n$ )	
1	n	0	*		*		*		*		*		*	
	H	1	*		*		*		*		*		*	
2	H	1	*		*		*		*		*		*	
3	H	1	8481.80	0.00	*		*		-13720#	2000#	*		*	
	He	2	*		7718.04	0.00	*		*		*		*	
	Li	3	*		-6800#	2000#	*		*		8240#	2000#	*	
4	H	1	3380	100	*		*		580	240	*		2900	100
	He	2	*		*		0.0	0.0	*		*		-34310#	2000#
	Li	3	*		2390	210	*		*		3080	210	*	
5	H	1	-1800	100	*		*		21210	110	*		22400	100
	He	2	19690	50	*		890	50	-26610#	4000#	*		-22010	220
	Li	3	33130#	2000#	17850	50	1970	50	*		-21510	110	*	
	Be	4	*		-8490#	4000#	*		*		28280#	4000#	*	
6	H	1	180	280	*		*		27780	260	*		22410	270
	He	2	972.4	0.8	*		*		-780	5	*		-2160	50
	Li	3	27380	210	26390	100	-1473.84	0.02	-29520#	700#	-26090	100	-31980#	4000#
	Be	4	*		-1372	5	*		*		-300	50	*	
	B	5	*		-3700#	730#	*		*		24640#	700#	*	
7	H	1	-100#	1000#	*		*		34230#	1010#	*		23470#	1010#
	He	2	1430	50	*		*		10331	17	*		3943	17
	Li	3	12910	50	32560	100	-2466.58	0.08	-12960	70	-34240	260	-11538	5
	Be	4	38370#	4000#	10190	50	-1586.10	0.11	*		-9114.0	0.8	-35910#	700#
	B	5	*		-1610	90	-3220#	2000#	*		6490	70	*	
8	He	2	2140	7	*		*		26656	7	*		8619	7
	Li	3	9282.58	0.09	35490	260	-7380	100	-1974.6	1.0	-35480#	1010#	-2894.51	0.09
	Be	4	29576	5	27231.4	0.8	91.84	0.04	-30152	23	-28448	17	-31000	70
	B	5	36820#	700#	5743.2	1.0	-4830	210	*		724.4	1.0	*	
	C	6	*		-2141	24	*		*		12035	23	*	
9	He	2	1300	30	*		*		29592	29	*		11921	29
	Li	3	6096.5	1.9	38760#	1010#	-10360	100	12538.6	2.1	*		11941.3	1.9
	Be	4	20565.0	0.4	29331	17	-2460	50	-17562.8	2.2	-27539	7	-19645.2	1.1
	B	5	31600	70	17070.4	1.0	-1690	50	*		-15820.1	1.0	-30750	23
	C	6	*		1437.5	2.1	-11510#	4000#	*		16679.8	2.1	*	
10	He	2	-1070	70	*		*		36200	70	*		15780	70
	Li	3	4039	15	*		-11240	270	21000	15	*		13632	15
	Be	4	8477.6	0.4	33569	7	-7413.4	0.9	-3092.0	0.6	-35622	29	-7880.3	0.9
	B	5	27013.4	1.1	23474.1	0.4	-4461.0	0.4	-26750	400	-20192.5	2.0	-24931.1	2.2
	C	6	35538	23	3820.9	0.4	-5101	5	*		-2937.9	0.6	*	
	N	7	*		-1300	400	-7230#	810#	*		19100	400	*	
11	Li	3	300	19	*		-10760#	1010#	32129	19	*		20119	19
	Be	4	7316	6	35340	30	-8352	18	9524	6	-35920	70	52	6
	B	5	19890.4	1.1	30864.3	2.0	-8665.1	0.4	-15640	50	-31672	15	-15102.07	0.20
	C	6	34402.8	2.3	15275.2	1.0	-7544.6	1.0	*		-9245.3	1.0	-36220	400
	N	7	*		2690	50	-5990	80	*		4960	50	*	
12	Li	3	-900#	1000#	*		*		36730#	1000#	*		21850#	1000#
	Be	4	3673	15	38310	70	-8946	17	25077	15	*		8337	15
	B	5	14824.5	1.5	34260	15	-10002.9	1.4	-3969.2	1.7	-34717	19	-5352.8	1.7
	C	6	31841.3	0.4	27184.6	0.4	-7366.59	0.04	-32048	18	-27463	6	-32370	50
	N	7	37600	400	9290.6	1.1	-8008.3	1.4	*		1381.2	1.1	*	
	O	8	*		-1771	18	-5471	30	*		14109	18	*	

A	Elt.	Z	S(n)		S(p)		Q( $4\beta^-$ )		Q(d, $\alpha$ )		Q(p, $\alpha$ )		Q(n, $\alpha$ )	
13	Be	4	-100	70	24140#	1000#	10140	70	3160	70	5060	70	-9910	100
	B	5	4878.1	1.8	15803	15	*	*	7099	6	8819.6	1.2	-10842	15
	C	6	4946.31	0.00	17532.9	1.4	*	*	5167.9	0.4	-4061.7	0.4	-3835.3	0.4
	N	7	20063.9	1.0	1943.49	0.27	*	*	5405.9	1.0	-5489.1	0.5	-1058.8	0.5
	O	8	17007	21	1515	10	*	*	9520	50	-10820	400	13060	10
14	Be	4	1360	150	*	*	31950	130	570#	1010#	4020	130	*	*
	B	5	970	21	16870	70	-8990#	400#	9298	26	8354	22	-11487	29
	C	6	8176.43	0.00	20831.2	1.1	*	*	361.8	1.4	-784.0	0.4	-11508	6
	N	7	10553.38	0.27	7550.56	0.00	*	*	13574.22	0.00	-2922.9	1.0	-158.1	0.4
	O	8	23176	10	4627.10	0.29	*	*	1380.1	1.0	-11430	50	3003.4	1.0
	F	9	*	*	-2260#	400#	*	*	11320#	400#	*	*	14000#	400#
15	Be	4	-1770#	520#	*	*	46940#	500#	*	*	4570#	1120#	*	*
	B	5	2760	30	18270	130	12200	140	6440	80	8760	27	-15480#	1000#
	C	6	1218.1	0.8	21080	21	*	*	4021.8	1.3	1368.3	1.6	-9557	15
	N	7	10833.30	0.00	10207.42	0.00	*	*	7687.23	0.00	4965.49	0.00	-7621.1	1.4
	O	8	13223.1	0.5	7296.8	0.5	*	*	8220.9	0.6	-9618.4	1.1	8502.0	0.5
	F	9	23950#	420#	-1480	130	*	*	4370	130	-10410	140	5080	130
16	Be	4	190#	710#	*	*	62420#	500#	*	*	*	*	*	*
	B	5	-40	60	20010#	510#	26400	60	7840	150	8700	90	*	*
	C	6	4250	4	22567	23	-10302	21	741	22	1996	4	-13910	70
	N	7	2489.1	2.6	11478.5	2.7	*	*	13374.6	2.6	7422.7	2.6	-5232.1	2.8
	O	8	15663.9	0.5	12127.41	0.00	*	*	3110.39	0.00	-5218.43	0.27	-2215.61	0.00
	F	9	14170	130	-536	8	*	*	13384	8	-7568	13	10981	8
	Ne	10	*	*	70	140	*	*	2050#	400#	*	*	6530	23
17	B	5	1380	180	21200#	530#	41820	170	4680#	530#	8680	220	*	*
	C	6	727	18	23330	60	4580	30	2777	28	2239	27	-13270	130
	N	7	5884	15	13112	15	*	*	8709	15	9716	15	-10146	26
	O	8	4143.13	0.11	13781.4	2.6	*	*	9800.56	0.11	1191.82	0.11	1817.70	0.11
	F	9	16800	8	600.27	0.25	*	*	9806.9	0.5	-1191.60	0.27	4734.69	0.25
	Ne	10	15610	30	1508	28	*	*	10400	140	-11330#	400#	14100	27
18	B	5	-480#	820#	*	*	51450#	800#	5360#	950#	7390#	950#	*	*
	C	6	4180	30	26130	170	19610	30	-1440	70	820	40	-19230#	500#
	N	7	2828	24	15213	25	-11080	50	10131	19	8105	19	-10211	29
	O	8	8044.0	0.6	15942	15	*	*	4245.6	2.7	3981.1	0.6	-5008.3	1.0
	F	9	9149.3	0.6	5606.5	0.5	*	*	16321.5	0.5	2882.2	0.7	6418.7	0.5
	Ne	10	19215	27	3923.5	0.4	*	*	5348	8	-6590	130	8108.0	0.6
	Na	11	*	*	-440	60	*	*	10900	50	*	*	13060	140
19	B	5	1030#	900#	*	*	60850#	400#	*	*	6550#	640#	*	*
	C	6	580	90	27190#	810#	30670	100	-640	200	200	120	-19610#	510#
	N	7	5324	25	16350	30	2935	20	5534	24	7032	17	-15570	60
	O	8	3954.9	2.8	17069	19	-29710	250	6174	15	2515	4	-4713	5
	F	9	10432.4	0.5	7994.8	0.6	*	*	10032.23	0.13	8113.67	0.07	-1524.6	2.6
	Ne	10	11637.0	0.4	6411.2	0.6	*	*	10510.5	0.4	-4065	8	12134.84	0.29
	Na	11	19330	50	-321	12	*	*	7177	30	-6206	24	7893	15
	Mg	12	*	*	-1560	260	*	*	*	*	*	*	14690	250
20	C	6	2930	260	29100#	470#	44600	240	-4050#	840#	-1350	290	*	*
	N	7	2170	60	17940	110	14920	60	7550	60	5590	60	-16360	180
	O	8	7608.7	2.9	19354	16	-13773	27	1394	19	790	15	-11595	17
	F	9	6601.33	0.03	10641.2	2.8	*	*	11474.9	0.6	5655.46	0.13	-2242	15
	Ne	10	16864.69	0.29	12843.52	0.07	*	*	2795.2	0.5	-4129.58	0.25	-586.72	0.11
	Na	11	14150	14	2193	7	*	*	12241	7	-4749	28	10542	7
	Mg	12	23540	250	2645	30	*	*	4090	60	*	*	6760	40



A	Elt.	Z	S(2n)		S(2p)		Q( $\alpha$ )		Q( $2\beta^-$ )		Q( $\epsilon p$ )		Q( $\beta^- n$ )	
13	Be	4	3070	70	*	*	-10120	80	30120	70	*	*	11810	70
	B	5	8248.4	1.0	38813	19	-10817.0	2.2	11216.7	1.1	-40820#	1000#	8490.8	1.1
	C	6	23668.0	1.0	31627	6	-10647.6	0.4	-19987	10	-29240	15	-22284.4	1.0
	N	7	35100	50	17900.4	0.5	-9495.1	1.0	*	*	-15312.4	1.4	-34774	18
	O	8	*	*	2116	10	-8223	10	*	*	15823	10	*	*
14	Be	4	1260	130	*	*	-11280	150	36930	130	*	*	15320	130
	B	5	5848	21	41010#	1000#	-11812	26	20800	21	*	*	12467	21
	C	6	13122.74	0.00	36635	15	-12011.7	0.4	-4987.46	0.11	-37520	70	-10396.90	0.27
	N	7	30617.3	1.0	25083.4	1.4	-11612.2	0.4	-29800#	400#	-20987.7	1.1	-28320	10
	O	8	40183	18	6570.59	0.11	-10116.2	0.4	*	*	-2406.63	0.11	*	*
	F	9	*	*	-740#	400#	-8570#	570#	*	*	20020#	400#	*	*
15	Be	4	-410#	510#	*	*	*	*	39930#	500#	*	*	18060#	500#
	B	5	3733	22	*	*	-14250	30	28871	22	*	*	17881	22
	C	6	9394.5	0.8	37950	70	-12726	6	7017.5	0.9	-37370	130	-1061.6	0.8
	N	7	21386.68	0.27	31038.7	1.1	-10991.4	0.4	-16670	130	-30851	21	-15977.23	0.11
	O	8	36399	10	14847.3	0.5	-10219.7	1.1	*	*	-7453.3	0.5	-37870#	400#
	F	9	*	*	3150	130	-9950	140	*	*	6620	130	*	*
16	Be	4	-1580#	520#	*	*	*	*	43980#	500#	*	*	20640#	500#
	B	5	2720	60	*	*	-15440#	1000#	31400	60	*	*	19140	60
	C	6	5468	4	40840	130	-13807	15	18431	4	-43390#	500#	5521	4
	N	7	13322.4	2.6	32558	21	-10110.2	3.0	-4997	9	-30578	23	-5243.3	2.7
	O	8	28886.99	0.11	22334.83	0.00	-7161.92	0.00	-28733	20	-21899.1	0.8	-29580	130
	F	9	38120#	400#	6761	8	-9083	8	*	*	3290	8	*	*
	Ne	10	*	*	-1411	20	-10476	28	*	*	13852	20	*	*
17	B	5	1340	170	*	*	*	*	35900	170	*	*	22010	170
	C	6	4977	17	43340#	500#	-14630	70	21848	17	-43930#	500#	7284	18
	N	7	8373	15	35679	27	-11116	15	5920	15	-36500	60	4537	15
	O	8	19807.1	0.5	25259.9	0.8	-6358.74	0.11	-17270	27	-21792	4	-19560	8
	F	9	30970	130	12727.68	0.25	-5818.7	0.4	*	*	-11020.9	2.6	-30116	20
	Ne	10	*	*	973	27	-9076	29	*	*	13909	27	*	*
18	B	5	900#	800#	*	*	*	*	39210#	800#	*	*	23210#	800#
	C	6	4910	30	47330#	500#	-17450	140	25710	30	*	*	8980	30
	N	7	8712	19	38550	60	-12974	28	12241	19	-37950	170	5852	19
	O	8	12187.2	0.6	29054	4	-6226.3	0.6	-6098.7	0.7	-29109	17	-10804.5	0.7
	F	9	25949	8	19387.9	2.7	-4414.6	0.5	-23320	50	-14287	15	-23659	27
	Ne	10	34822	20	4523.77	0.28	-5115.1	0.3	*	*	-1163.0	0.3	*	*
	Na	11	*	*	1070	50	-10890#	400#	*	*	14950	50	*	*
19	B	5	550#	440#	*	*	*	*	43500#	400#	*	*	26370#	400#
	C	6	4760	100	*	*	-19800#	510#	29090	100	*	*	11230	100
	N	7	8152	22	42490	170	-15535	28	17350	16	-43750#	800#	8572	16
	O	8	11999.0	2.8	32282	18	-8963.2	2.9	1583.4	2.8	-28880	30	-5610.1	2.8
	F	9	19581.72	0.26	23937	15	-4013.74	0.07	-14414	12	-21891	19	-14875.87	0.29
	Ne	10	30852	27	12017.7	0.3	-3529.1	0.6	-31290	250	-4756.0	0.7	-30510	50
	Na	11	*	*	3603	12	-6270	130	*	*	4764	12	*	*
	Mg	12	*	*	-2000	250	*	*	*	*	20430	250	*	*
20	C	6	3510	240	*	*	-22550#	560#	33760	240	*	*	13620	240
	N	7	7490	60	45140#	800#	-17740	80	21780	60	-44890#	400#	10360	60
	O	8	11563.7	0.9	35710	30	-12322	4	10839.4	1.1	-35910	100	-2786.5	1.1
	F	9	17033.7	0.5	27710	19	-8126.0	2.6	-6865	7	-23169	16	-9840.16	0.29
	Ne	10	28501.73	0.28	20838.4	0.6	-4729.85	0.00	-24612	27	-17665.8	2.8	-28040	12
	Na	11	33480	50	8604	7	-6257	11	*	*	1046	7	-34260	250
	Mg	12	*	*	2325	27	-8850	30	*	*	8530	27	*	*

A	El.	Z	S(n)		S(p)		Q(4β <sup>-</sup> )		Q(d,α)		Q(p,α)		Q(n,α)	
21	C	6	-330#	560#	*		51690#	500#	-2690#	640#	-1500#	950#	*	
	N	7	4590	110	19600	260	27440	100	3540	140	5190	100	-21420#	810#
	O	8	3806	12	20990	60	-2848	20	2912	20	-188	22	-11220	30
	F	9	8101.5	1.8	11134.0	2.1	-26170#	300#	7328	3	5598.0	1.9	-7516	19
	Ne	10	6761.16	0.04	13003.34	0.08	*		6466.42	0.08	-1741.4	0.5	696.1	0.6
	Na	11	17103	7	2431.2	0.7	*		6775.2	0.8	-2637.3	0.8	2588.5	0.9
	Mg	12	14730	30	3226	18	*		8695	20	-8420	50	11240	16
	Al	13	*		-1260#	300#	*		3790#	390#	*		7580#	300#
22	C	6	750#	1030#	*		61310#	900#	*		-1220#	990#	*	
	N	7	1280	210	21210#	540#	37220	190	5190	310	4480	220	-21680#	440#
	O	8	6850	60	23260	110	9680	60	-1770	80	-1710	60	-17490	110
	F	9	5230	13	12558	17	-15390#	90#	9707	12	4323	13	-7422	21
	Ne	10	10364.26	0.04	15266.1	1.8	-40190#	200#	2703.50	0.08	-1673.27	0.07	-5713.2	2.8
	Na	11	11069.6	0.8	6739.6	0.4	*		12570.3	0.4	-2069.8	0.5	1951.4	0.4
	Mg	12	19379	16	5501.8	1.5	*		3466	7	-8460	12	3498.0	1.4
	Al	13	16010#	310#	20#	100#	*		11320#	100#	-9990#	270#	10900#	90#
	Si	14	*		1240#	360#	*		*		*		4770#	320#
23	N	7	1710#	360#	22170#	950#	47930#	300#	3150#	590#	5700#	380#	*	
	O	8	2740	130	24710	230	20090	120	70	150	-2290	130	-17300	270
	F	9	7530	80	13240	100	-3440	80	5980	80	4400	80	-12790	100
	Ne	10	5200.65	0.10	15236	12	-28930#	200#	5604.3	1.8	-272.59	0.13	-3305.1	1.1
	Na	11	12418.7	0.4	8794.11	0.02	*		6912.73	0.04	2376.13	0.00	-3866.05	0.08
	Mg	12	13148.1	1.9	7580.3	1.4	*		7421.2	1.5	-7457	7	7214.6	1.3
	Al	13	19490#	100#	122	19	*		6570	25	-5940	30	5568	20
	Si	14	16460#	280#	1700#	220#	*		8360#	360#	*		11850#	200#
24	N	7	-1080#	500#	*		55960#	400#	4970#	990#	6450#	640#	*	
	O	8	3610	270	26620#	380#	33000	240	-2260	300	-1320	250	-21240#	560#
	F	9	3840	110	14340	140	7620	70	8990	90	4360	70	-12050	120
	Ne	10	8868.8	0.4	16570	80	-16706	19	1966	12	-1039.9	1.8	-8368	12
	Na	11	6959.58	0.08	10553.04	0.13	-40420#	500#	10317.41	0.08	2177.72	0.09	-2724.2	1.8
	Mg	12	16531.1	1.3	11692.68	0.01	*		1959.7	0.4	-6885.4	0.7	-2555.39	0.04
	Al	13	14898	19	1872	3	*		11051	3	-6103	17	7773.6	2.9
	Si	14	21090#	200#	3304	27	*		3280#	100#	-10500#	300#	5491	25
	P	15	*		-940#	540#	*		10540#	540#	*		11520#	590#
25	N	7	-890#	640#	*		65860#	500#	*		8090#	1030#	*	
	O	8	-300#	100#	27390#	480#	40640#	260#	-240#	390#	270#	320#	-20190#	940#
	F	9	4360	120	15090	260	20190	100	7370	160	6850	110	-15120	220
	Ne	10	4228	26	16960	80	-5932	28	5270	80	-37	28	-5750	60
	Na	11	9011.0	1.2	10695.3	1.3	-28230#	200#	6507.0	1.2	3531.0	1.2	-6505	12
	Mg	12	7330.58	0.03	12063.68	0.08	*		7047.83	0.03	-3146.3	0.4	478.29	0.04
	Al	13	16930.5	2.8	2271.6	0.5	*		7268.4	1.4	-3655.2	1.4	1912.7	0.6
	Si	14	15002	22	3408	10	*		7766	21	-9490#	90#	9868	10
	P	15	21200#	540#	-830#	200#	*		5810#	280#	-8430#	280#	6340#	220#
26	O	8	-200#	140#	28080#	570#	51930#	260#	-1120#	480#	2180#	390#	*	
	F	9	1070	190	16460#	310#	30480	170	9910	290	8520	210	-14480#	340#
	Ne	10	5530	40	18130	100	7574	27	3580	80	1960	80	-8540	120
	Na	11	5576	6	12043	26	-17840#	200#	9800	6	3156	6	-4550	80
	Mg	12	11093.07	0.03	14145.7	1.2	-42190#	300#	2914.34	0.08	-1820.67	0.03	-5414.14	0.11
	Al	13	11365.5	0.5	6306.45	0.05	*		12434.06	0.06	-1872.5	1.3	2965.95	0.06
	Si	14	19040	10	5517	3	*		3623	4	-9050	19	3976	3
	P	15	15970#	280#	140#	200#	*		10930#	200#	-7940#	280#	9850#	200#
	S	16	*		190#	360#	*		4680#	590#	*		7850#	360#

A	El.	Z	S(2n)		S(2p)		Q( $\alpha$ )		Q( $2\beta^-$ )		Q( $\epsilon p$ )		Q( $\beta^- n$ )	
21	C	6	2600#	510#	*	*	*	*	37900#	500#	*	*	16120#	510#
	N	7	6750	100	48690#	410#	-20940	200	25300	100	*	*	13380	100
	O	8	11415	12	38940	100	-15401	21	13795	12	-36780	240	9	12
	F	9	14702.8	1.8	30488	17	-10344	15	2136.6	1.9	-29100	60	-1076.9	1.8
	Ne	10	23625.85	0.29	23644.6	2.8	-7347.88	0.12	-16642	16	-16818.2	1.1	-20651	7
	Na	11	31254	12	15274.7	0.7	-6560.8	0.7	-28300#	300#	-9455.7	0.7	-27826	27
	Mg	12	38270	250	5419	16	-7980	30	*	*	10663	16	*	*
	Al	13	*	*	1390#	300#	*	*	*	*	11980#	300#	*	*
22	C	6	420#	940#	*	*	*	*	44000#	910#	*	*	19960#	910#
	N	7	5870	200	*	*	-22710#	820#	29250	190	*	*	15900	190
	O	8	10660	60	42850	250	-18070	60	17310	60	-43970#	510#	1260	60
	F	9	13332	12	33550	60	-12746	22	7976	12	-29750	100	454	12
	Ne	10	17125.42	0.02	26400.1	1.1	-9668.1	0.6	-7627.8	1.3	-23377	12	-13911.9	0.7
	Na	11	28173	7	19743.0	0.4	-8481.1	0.7	-23370#	90#	-12423.9	1.8	-24164	16
	Mg	12	34110	27	7933.0	1.3	-8139.0	1.4	-32560#	200#	-1954.2	1.3	-34590#	300#
	Al	13	*	*	3240#	90#	-8430#	110#	*	*	13080#	90#	*	*
	Si	14	*	*	-20#	200#	*	*	*	*	13970#	200#	*	*
23	N	7	3000#	310#	*	*	-23390#	500#	35070#	310#	*	*	21040#	300#
	O	8	9590	120	45930#	520#	-20230	160	19770	120	-45960#	910#	3750	120
	F	9	12770	80	36500	120	-14960	80	12860	80	-36000	210	3280	80
	Ne	10	15564.90	0.11	27795	12	-10913.8	2.8	319.7	1.3	-21730	60	-8042.9	0.4
	Na	11	23488.3	0.7	24060.2	1.8	-10467.38	0.07	-16299	19	-19612	12	-17204.2	1.3
	Mg	12	32527	16	14319.9	1.3	-9650.1	1.3	-29250#	200#	-4738.0	1.3	-31730#	90#
	Al	13	35490#	300#	5624	19	-8582	22	*	*	4663	19	-33470#	200#
	Si	14	*	*	1720#	200#	-11690#	320#	*	*	16880#	200#	*	*
24	N	7	640#	440#	*	*	*	*	39980#	410#	*	*	24860#	420#
	O	8	6360	240	48790#	930#	-20910	340	25020	240	*	*	7670	250
	F	9	11380	70	39060	210	-16630	90	15980	70	-38130#	310#	4640	70
	Ne	10	14069.4	0.4	29810	60	-12173.9	1.1	7982.0	0.4	-27850	120	-4493.0	0.4
	Na	11	19378.3	0.4	25789	12	-10825.63	0.11	-8361.2	2.8	-19040	80	-11015.7	1.3
	Mg	12	29679.2	1.3	20486.79	0.02	-9316.55	0.01	-24688	19	-16068.49	0.11	-28774	19
	Al	13	34380#	90#	9452.5	2.8	-9330	7	-32050#	500#	2183.9	2.8	-31900#	200#
	Si	14	37550#	200#	3426	20	-9240	30	*	*	8939	20	*	*
	P	15	*	*	760#	510#	*	*	*	*	17940#	500#	*	*
25	N	7	-1970#	590#	*	*	*	*	45230#	510#	*	*	29360#	560#
	O	8	3310#	280#	*	*	-20940#	570#	29550#	260#	*	*	11810#	270#
	F	9	8200	130	41700#	310#	-16400	140	20630	100	-43560#	410#	9150	100
	Ne	10	13097	26	31300	120	-12596	28	11085	26	-28470	240	-1761	26
	Na	11	15970.6	1.2	27270	80	-11735.2	2.2	-441.6	1.3	-24210	70	-3495.6	1.2
	Mg	12	23861.7	1.3	22616.72	0.11	-9885.97	0.05	-17017	10	-14530.3	0.4	-21207.2	2.8
	Al	13	31828	19	13964.3	0.5	-9156.9	0.8	-27790#	200#	-7787.0	0.5	-27742	19
	Si	14	36090#	200#	5280	10	-9511	19	*	*	10469	10	-36240#	500#
	P	15	*	*	2480#	200#	-9670#	360#	*	*	11640#	200#	*	*
26	O	8	-500#	100#	*	*	-19990#	940#	35280#	260#	*	*	16370#	280#
	F	9	5430	180	43850#	430#	-16190	250	25130	170	-45520#	530#	12310	170
	Ne	10	9762	27	33220	240	-11280	60	16644	27	-34300#	260#	1716	27
	Na	11	14587	6	29000	70	-12081	14	5348	6	-25420	100	-1741	6
	Mg	12	18423.65	0.03	24841.0	0.4	-10614.78	0.03	-9070	3	-21395	26	-15369.7	0.5
	Al	13	28296.0	2.8	18370.14	0.10	-9452.8	0.4	-23180#	200#	-10141.5	1.2	-24106	10
	Si	14	34042	20	7789	3	-9173	3	-33120#	300#	-1241	3	-34090#	200#
	P	15	37170#	540#	3550#	200#	-9640#	220#	*	*	12600#	200#	*	*
	S	16	*	*	-640#	300#	-8620#	360#	*	*	14860#	300#	*	*

A	El.	Z	S(n)	S(p)	$Q(4\beta^-)$	$Q(d,\alpha)$	$Q(p,\alpha)$	$Q(n,\alpha)$						
27	O	8	-1170#	570#	*	59540#	500#	-840#	710#	2280#	640#	*		
	F	9	1420	410	18080#	460#	42120	380	8200#	460#	10720	440	-16970#	550#
	Ne	10	1430	110	18490	200	19450	110	6510	150	4370	130	-6350	260
	Na	11	6726	7	13236	27	-4800	27	7301	26	5298	4	-7430	70
	Mg	12	6443.39	0.04	15013	6	-32130#	200#	5482.0	1.2	-1304.48	0.09	-2988.7	0.4
	Al	13	13057.67	0.13	8271.05	0.12	*	*	6706.97	0.12	1600.96	0.12	-3132.14	0.14
	Si	14	13311	3	7462.96	0.16	*	*	7242.7	0.5	-7463.3	2.8	7195.67	0.15
	P	15	19760#	200#	861	27	*	*	6169	28	-6610	30	4986	26
	S	16	16500#	360#	720#	280#	*	*	9380#	280#	-9590#	540#	12440#	200#
28	O	8	-820#	780#	*	68870#	600#	*	*	2210#	780#	*		
	F	9	-230#	640#	19020#	720#	50080#	510#	8220#	570#	10650#	570#	-17630#	720#
	Ne	10	3900	180	20970	400	32740	150	3680	220	4840	180	-10550#	300#
	Na	11	3543	14	15350	110	6170	13	9292	30	5983	29	-6620	100
	Mg	12	8503.3	2.0	16790	4	-19090	160	2554	6	-796.8	2.3	-7264	26
	Al	13	7725.10	0.06	9552.76	0.14	-43410#	500#	10074.95	0.13	1206.44	0.13	-1846.2	1.2
	Si	14	17179.81	0.15	11585.11	0.12	*	*	1428.32	0.06	-7712.6	0.5	-2653.57	0.03
	P	15	14513	27	2063	3	*	*	10697	4	-6119	11	7404	3
	S	16	21540#	260#	2500	160	*	*	3810#	250#	-9940#	250#	5900	160
	Cl	17	*	-1730#	540#	*	*	*	11300#	590#	*	*	13330#	540#
29	F	9	1000#	770#	20840#	830#	58510#	580#	6050#	770#	9450#	630#	*	
	Ne	10	1260	310	22460#	580#	39950	270	3840	460	4650	320	-12010#	370#
	Na	11	4417	18	15870	150	19618	13	6310	110	7099	30	-9960	170
	Mg	12	3672	14	16919	19	-7460	50	5609	14	1107	15	-5400	30
	Al	13	9436.2	1.2	10485.7	2.3	-31360#	200#	7082.1	1.2	2863.3	1.2	-5707	6
	Si	14	8473.57	0.02	12333.58	0.13	*	*	6012.42	0.12	-4820.68	0.06	-34.06	0.03
	P	15	17865	3	2748.8	0.6	*	*	6142.5	0.6	-4944	3	904.1	0.6
	S	16	15300	170	3290	50	*	*	8270	60	-9270#	200#	9630	50
	Cl	17	21490#	540#	-1780#	250#	*	*	6310#	280#	-7960#	360#	7820#	280#
30	F	9	-540#	830#	*	64780#	600#	5770#	840#	8810#	780#	*		
	Ne	10	3030	630	24480#	810#	47530	570	590#	770#	3040	680	-16210#	760#
	Na	11	2375	28	16990	270	28562	25	7830	150	6160	110	-10920	380
	Mg	12	6363	16	18865	16	5152	9	2789	16	1471	9	-10330	110
	Al	13	5728	14	12542	20	-20320#	200#	9857	14	3578	14	-4709	14
	Si	14	10609.20	0.02	13506.6	1.2	-44520#	300#	3128.32	0.13	-2372.22	0.12	-4199.88	0.06
	P	15	11319.3	0.7	5594.5	0.3	*	*	12003.0	0.3	-2952.2	0.3	2642.5	0.3
	S	16	18970	50	4399	3	*	*	3807	4	-8481	27	3968	3
	Cl	17	16770#	280#	-310#	200#	*	*	11080#	250#	-8240#	280#	10810#	200#
	Ar	18	*	350#	360#	*	*	*	4240#	590#	*	*	8190#	360#
31	F	9	690#	840#	*	71240#	600#	*	*	7300#	840#	*		
	Ne	10	330#	1070#	25350#	1080#	53790#	900#	1260#	1070#	2480#	1040#	-17360#	1080#
	Na	11	3780	210	17740	610	37100	210	5310	340	6270	260	-14930#	550#
	Mg	12	2378	15	18867	28	15827	12	4828	18	2636	18	-8820	150
	Al	13	7153	25	13332	22	-7890	50	6376	25	4929	20	-8318	24
	Si	14	6587.40	0.03	14366	14	-34240#	210#	5977.1	1.2	-1234.51	0.14	-2284.0	2.0
	P	15	12311.6	0.4	7296.93	0.19	*	*	8164.97	0.18	1915.97	0.18	-1944.04	0.23
	S	16	13053	3	6133.0	1.5	*	*	8618.8	1.6	-7022	4	8094.6	1.5
	Cl	17	19580#	200#	290	50	*	*	6800	70	-6280	170	5740	50
	Ar	18	16860#	360#	440#	280#	*	*	8860#	280#	-10400#	540#	12870#	260#
32	Ne	10	1640#	1210#	26300#	1000#	61360#	800#	-910#	1000#	1850#	990#	*	
	Na	11	1660	410	19070#	970#	43370	360	6670	670	5870	450	-15590#	680#
	Mg	12	5809	21	20900	210	25061	18	1390	30	1244	22	-13370	270
	Al	13	4180	90	15130	90	2270	90	8560	90	4420	90	-8080	90
	Si	14	9203.22	0.03	16416	20	-21880.7	1.8	2502	14	-1001.5	1.2	-7815	14
	P	15	7935.65	0.04	8645.18	0.19	-44720#	500#	10838.52	0.19	2453.88	0.19	-443.5	1.2
	S	16	15042.4	1.5	8863.78	0.21	*	*	4895.7	0.3	-4199.0	0.6	1525.75	0.14
	Cl	17	14330	50	1574	7	*	*	11444	7	-5310	50	9269	7
	Ar	18	21560#	210#	2420	50	*	*	4070#	200#	-10480#	200#	6610	50
	K	19	*	-1840#	540#	*	*	*	11050#	590#	*	*	12920#	540#

A	El.	Z	S(2n)	S(2p)	Q( $\alpha$ )	Q( $2\beta^-$ )	Q( $\epsilon p$ )	Q( $\beta^- n$ )					
27	O	8	-1370#	570#	*	*	37880#	520#	*	18610#	530#		
F	9	2490	390	46160#	630#	-15890#	480#	30440	380	*	16430	380	
Ne	10	6960	110	34950#	280#	-9970	160	21660	110	-35930#	280#	5860	110
Na	11	12302	4	31370	100	-11270	80	11679	4	-31080	170	2626	4
Mg	12	17536.46	0.05	27057	26	-11857.52	0.12	-2202.35	0.16	-22305	27	-10447.66	0.07
Al	13	24423.1	0.5	22416.8	1.2	-10091.72	0.12	-16480	26	-17623	6	-18123	3
Si	14	32351	10	13769.42	0.15	-9335.4	1.3	-29930#	200#	-3458.69	0.15	-31430#	200#
P	15	35730#	200#	6379	26	-9910	30	*	*	4204	26	-34760#	300#
S	16	*	*	860#	200#	-8650#	280#	*	*	17400#	200#	*	*
28	O	8	-1990#	650#	*	*	42610#	610#	*	*	20850#	710#	
F	9	1190#	540#	*	*	-16740#	650#	34220#	510#	*	*	18090#	520#
Ne	10	5330	150	39050#	300#	-10250	280	26260	150	-41000#	520#	8690	150
Na	11	10270	14	33840	170	-10970	70	15861	13	-33210	380	5526	13
Mg	12	14946.7	2.0	30026	27	-11492.0	2.0	6474.2	2.0	-29380	110	-5893.3	2.0
Al	13	20782.77	0.14	24566	6	-10857.24	0.15	-9692	3	-18622	4	-12537.46	0.11
Si	14	30491	3	19856.16	0.03	-9984.14	0.01	-25570	160	-14195.12	0.05	-28847	26
P	15	34270#	200#	9526	3	-9527	4	-33720#	500#	2749	3	-32770#	200#
S	16	38040#	340#	3360	160	-9110	160	*	*	9170	160	*	*
Cl	17	*	*	-1010#	540#	-7870#	710#	*	*	19990#	500#	*	*
29	F	9	770#	690#	*	-18630#	770#	37630#	580#	*	*	20980#	600#
Ne	10	5150	290	41470#	570#	-11810#	370#	28680	270	-43080#	650#	10980	270
Na	11	7960	14	36840	380	-11030	100	20880	13	-37850#	510#	9612	13
Mg	12	12175	14	32270	110	-10936	29	11276	14	-29150	150	-1840	14
Al	13	17161.3	1.2	27276	4	-11282.4	1.7	-1262.7	1.3	-24515	13	-4793.8	1.2
Si	14	25653.38	0.15	21886.34	0.05	-11127.14	0.04	-18740	50	-14165.4	2.0	-22808	3
P	15	32378	26	14333.9	0.6	-10461.4	0.8	-30100#	200#	-7391.2	0.6	-29100	160
S	16	36850#	210#	5350	50	-9410	50	*	*	11040	50	-37790#	510#
Cl	17	*	*	720#	200#	-8150#	280#	*	*	13010#	200#	*	*
30	F	9	470#	790#	*	*	40540#	600#	*	*	22770#	650#	
Ne	10	4290	590	45330#	830#	-15040#	630#	32010	570	*	*	12370	570
Na	11	6792	28	39440#	510#	-12340	170	24234	29	-39220#	580#	10909	29
Mg	12	10035	9	34730	150	-11765	28	15522	8	-34260	270	1233	8
Al	13	15165	14	29461	19	-11435	15	4328	14	-25826	19	-2049	14
Si	14	19082.76	0.03	23992.2	2.0	-10643.26	0.04	-10370	3	-21103	14	-15551.6	0.6
P	15	29184	3	17928.1	0.3	-10415.2	0.3	-24640#	200#	-9274.2	1.2	-25110	50
S	16	34280	160	7148	3	-9343	4	-34150#	300#	544	3	-35280#	200#
Cl	17	38260#	540#	2980#	200#	-8960#	280#	*	*	14110#	200#	*	*
Ar	18	*	*	-1430#	340#	-8310#	420#	*	*	15950#	300#	*	*
31	F	9	150#	150#	*	*	43630#	630#	*	*	25120#	830#	
Ne	10	3360#	940#	*	*	-16540#	1030#	34060#	900#	*	*	14410#	900#
Na	11	6150	210	42220#	620#	-14700	430	27610	210	-43540#	630#	13490	210
Mg	12	8741	18	35850	270	-12710	110	19732	12	-33610	570	4584	19
Al	13	12881	20	32197	24	-11861	21	9487	20	-30600	30	1408	20
Si	14	17196.59	0.03	26908	14	-10787.27	0.06	-3904.4	1.5	-21327	8	-10819.7	0.3
P	15	23630.9	0.6	20803.5	1.2	-9669.14	0.22	-17370	50	-15857	14	-18450	3
S	16	32030	50	11727.5	1.5	-9085.3	1.5	-30340#	210#	-1900.7	1.5	-31560#	200#
Cl	17	36350#	200#	4690	50	-8780	60	*	*	5840	50	-35220#	300#
Ar	18	*	*	130#	210#	-8680#	290#	*	*	18070#	210#	*	*
32	Ne	10	1970#	980#	*	-19000#	1000#	38230#	800#	*	*	16550#	830#
Na	11	5440	360	44420#	690#	-16590#	620#	30130	370	-44510#	700#	14210	360
Mg	12	8187	20	38630	570	-14620	150	23126	18	-39090#	900#	5928	27
Al	13	11330	90	34000	90	-12500	90	13240	90	-31010	230	3820	90
Si	14	15790.61	0.04	29748	8	-11487.2	2.0	1934.79	0.15	-28152	12	-7711.34	0.19
P	15	20247.3	0.4	23011	14	-9879.69	0.23	-10975	7	-16641	20	-13331.9	1.5
S	16	28096	3	16160.71	0.14	-6947.82	0.14	-23815.5	1.8	-10355.66	0.14	-27020	50
Cl	17	33920#	200#	7707	7	-8596	7	-33750#	500#	3822	7	-32690#	210#
Ar	18	38430#	300#	2716	3	-8700	160	*	*	9555.5	2.3	*	*
K	19	*	*	-1400#	540#	-8560#	710#	*	*	20200#	510#	*	*

A	El.	Z	S(n)	S(p)	$Q(4\beta^-)$	$Q(d,\alpha)$	$Q(p,\alpha)$	$Q(n,\alpha)$						
33	Ne	10	-650#	1130#	*	66490#	800#	420#	1000#	1960#	1000#	*		
	Na	11	2250	940	19680#	1190#	51230	870	4760#	1260#	6650	1040	-18370#	1060#
	Mg	12	2222	26	21460	360	31480	20	2950	210	1400	30	-12560	570
	Al	13	5540	110	14860	70	12470	70	5400	70	5250	70	-11240	80
	Si	14	4483	16	16720	90	-11109	16	5172	26	244	21	-5936	18
	P	15	10103.6	1.1	9545.6	1.1	-33100#	200#	7322.3	1.1	2959.5	1.1	-4819	14
	S	16	8641.61	0.03	9569.75	0.22	*		8565.70	0.21	-1521.4	0.3	3493.33	0.14
	Cl	17	15745	7	2276.7	0.4	*		8752.0	1.6	-2077	3	4843.5	0.6
	Ar	18	15255.3	1.8	3343	7	*		8390	50	-8960#	200#	10325	3
	K	19	21730#	540#	-1670#	200#	*		6180#	280#	-8460#	360#	7970#	280#
34	Ne	10	950#	1140#	*	73080#	810#	*		1700#	1000#	*		
	Na	11	200#	200#	20530#	1200#	57320#	900#	6190#	1200#	6780#	1270#	-17880#	1080#
	Mg	12	4160	230	23370	910	38740	230	450	420	1020	310	-16390#	930#
	Al	13	2470	130	15120	110	21510	110	8730	110	5150	110	-9940	240
	Si	14	7535	21	18720	70	-1580	14	1820	90	-139	25	-11093	19
	P	15	6291	5	11354	17	-23080#	300#	10234	5	3255	5	-3958	21
	S	16	11417.11	0.09	10883.3	1.1	-43080#	300#	5084.24	0.21	-626.85	0.20	-1336.38	0.11
	Cl	17	11507.7	0.5	5142.75	0.12	*		12286.73	0.13	-531.1	1.5	5647.51	0.24
	Ar	18	17064.4	0.5	4662.8	0.6	*		5663	7	-6450	50	6313.8	1.6
	K	19	16320#	360#	-610#	300#	*		11430#	300#	-7910#	360#	11230#	300#
	Ca	20	*		900#	360#	*		3450#	590#	*		7510#	360#
35	Na	11	1250#	300#	20830#	1240#	64440#	950#	4300#	1240#	7170#	1240#	*	
	Mg	12	730#	460#	23900#	980#	45000#	400#	1970#	960#	1950#	540#	-15480#	900#
	Al	13	5270	210	16230	290	28880	180	5690	180	5690	180	-13550	400
	Si	14	2470	40	18720	120	8690	40	4880	80	1570	90	-7760	40
	P	15	8371	5	12190	14	-13689	20	6346	16	4087.2	1.9	-8150	90
	S	16	6985.88	0.04	11578	5	-33450#	200#	8201.9	1.1	322.92	0.20	880.95	0.11
	Cl	17	12645.08	0.18	6370.72	0.10	*		8283.26	0.13	1866.21	0.13	938.08	0.19
	Ar	18	12741.5	0.8	5896.6	0.8	*		8666.8	0.9	-4854	7	8614.7	0.8
	K	19	17760#	300#	81	20	*		8926	20	-4105	20	7807	21
	Ca	20	16620#	360#	1210#	360#	*		8550#	280#	-10950#	540#	12450#	200#
36	Na	11	-300#	100#	*	68200#	950#	5540#	1250#	6820#	1240#	*		
	Mg	12	2800#	640#	25450#	1070#	52090#	500#	-630#	1030#	1400#	1010#	-18930#	950#
	Al	13	2160	280	17660#	450#	35300	210	7680	320	5750	220	-13460	900
	Si	14	6190	130	19640	210	17750	120	1160	170	910	140	-11730	120
	P	15	3465	13	13180	40	-2825	15	10417	19	5106	21	-6080	70
	S	16	9889.04	0.21	13095.3	1.9	-24220	40	4604	5	537.5	1.1	-4525	16
	Cl	17	8579.63	0.06	7964.47	0.11	-43420#	500#	11120.74	0.12	1928.19	0.15	2462.0	1.1
	Ar	18	15255.4	0.7	8506.97	0.05	*		4919.04	0.18	-4364.1	0.5	2000.86	0.14
	K	19	14329	21	1668	8	*		11662	8	-3178	8	9224	8
	Ca	20	19110#	200#	2560	40	*		5750#	300#	-8340#	200#	8590	40
	Sc	21	*		-2010#	540#	*		11460#	590#	*		12780#	540#
37	Na	11	750#	180#	*	74270#	960#	*		7020#	1250#	*		
	Mg	12	250#	1030#	25990#	1310#	56150#	900#	380#	1310#	1350#	1270#	-18230#	1210#
	Al	13	3910	390	18770#	600#	41710	330	4510#	520#	6000	400	-17170#	960#
	Si	14	2170	210	19650	270	24370	170	4260	240	1220	200	-9740	290
	P	15	6810	40	13800	130	5810	40	6080	50	5830	40	-10420	120
	S	16	4303.60	0.06	13934	13	-13735	22	8672.2	1.9	2525	5	-1293	14
	Cl	17	10310.99	0.08	8386.43	0.19	-34600#	300#	7795.63	0.11	3034.31	0.12	-1557	5
	Ar	18	8787.44	0.21	8714.77	0.22	*		8776.69	0.21	-1643.83	0.27	4630.53	0.23
	K	19	15445	8	1857.63	0.09	*		8958.0	0.8	-1558.9	0.4	5285.98	0.20
	Ca	20	14790	50	3025	24	*		8720	30	-6820#	300#	10862	22
	Sc	21	19130#	590#	-1990#	300#	*		8950#	360#	-5450#	420#	9970#	420#

A	Elt.	Z	S(2n)	S(2p)	Q( $\alpha$ )	Q(2 $\beta^-$ )	Q( $\epsilon p$ )	Q( $\beta^- n$ )						
33	Ne	10	990#	1210#	*	*	41100#	800#	*	18860#	880#			
	Na	11	3910	900	45980#	1060#	-17830#	1050#	33420	880	17770	880		
	Mg	12	8031	23	40530#	900#	-15590	270	25387	25	-39670#	800#	7880	90
	Al	13	9720	80	35760	220	-13620	70	17810	70	-34880	360	7480	70
	Si	14	13686	16	31853	20	-12299	21	6093	16	-26827	24	-4259	16
	P	15	18039.2	1.1	25962	20	-10547.1	1.6	-5334.1	1.2	-22560	90	-8393.1	1.1
	S	16	23684.0	1.5	18214.93	0.14	-7115.86	0.14	-17201.9	0.5	-9794.06	0.14	-21328	7
	Cl	17	30080	50	11140.5	0.5	-6475.7	0.8	-27770#	200#	-3987.2	0.5	-26874.5	1.8
	Ar	18	36820#	210#	4917.4	1.6	-8650	50	*	*	9342.6	0.5	-37870#	500#
	K	19	*	750#	200#	-8810#	280#	*	*	12800#	200#	*	*	*
34	Ne	10	300#	100#	*	*	44310#	840#	*	*	20160#	1190#		
	Na	11	2450#	970#	*	-18570#	1080#	35690#	910#	*	*	19800#	900#	
	Mg	12	6380	230	43050#	830#	-16720	620	28770	230	-44480#	830#	9270	240
	Al	13	8010	140	36570	370	-13720	120	21630	110	-35110	880	9490	110
	Si	14	12018	14	33580	23	-13471	16	9975	14	-32140	24	-1691	14
	P	15	16395	5	28070	90	-11110	15	-118	5	-23320	70	-6043	5
	S	16	20058.73	0.09	20428.82	0.12	-7923.78	0.11	-11554.6	0.4	-16728	16	-16999.7	0.4
	Cl	17	27253	7	14712.50	0.25	-6664.1	0.4	-22960#	300#	-5391.3	1.1	-23127.0	0.5
	Ar	18	32319.6	1.8	6939.5	0.4	-6740	3	-31530#	300#	919.8	0.4	-33210#	200#
	K	19	38040#	590#	2730#	300#	-8350#	360#	*	*	12230#	300#	*	*
	Ca	20	*	-780#	300#	-9360#	420#	*	*	15250#	300#	*	*	*
35	Na	11	1450#	360#	*	-19130#	1120#	39710#	960#	*	*	22700#	970#	
	Mg	12	4890#	400#	44420#	900#	-17120#	990#	30510#	400#	-44260#	900#	11010#	420#
	Al	13	7740	190	39600	890	-15210	270	24730	180	-40180#	910#	11760	180
	Si	14	10010	40	33830	40	-13570	40	14490	40	-30460	230	2130	40
	P	15	14662.9	2.2	30910	70	-12329	20	4155.8	1.9	-29210	110	-2997.3	1.9
	S	16	18403.00	0.10	22932	16	-8322.27	0.11	-5798.9	0.8	-16179	14	-12477.90	0.15
	Cl	17	24152.7	0.5	17254.0	1.1	-6997.57	0.19	-17845	20	-11745	5	-18707.6	0.4
	Ar	18	29805.9	0.9	11039.4	0.8	-6427.7	1.7	-27650#	200#	-404.6	0.8	-29640#	300#
	K	19	34070#	200#	4743	20	-6530	50	*	*	5982	20	-32390#	300#
	Ca	20	*	590#	200#	-9120#	280#	*	*	15690#	200#	*	*	*
36	Na	11	950#	320#	*	*	42170#	980#	*	*	23730#	1030#		
	Mg	12	3530#	550#	46280#	950#	-18280#	950#	33910#	520#	*	*	13480#	530#
	Al	13	7430	240	41560#	920#	-15710	420	26030	220	-41090#	970#	12070	220
	Si	14	8670	120	35870	260	-13950	120	18180	120	-35920#	420#	4300	120
	P	15	11836	14	31900	110	-11610	90	9271	13	-27410	180	524	13
	S	16	16874.92	0.22	25285	14	-9008.08	0.20	-432.53	0.19	-23590	40	-9721.85	0.19
	Cl	17	21224.72	0.19	19542	5	-7641.55	0.20	-12096	8	-11953.1	1.9	-14545.8	0.7
	Ar	18	27997.0	0.4	14877.69	0.11	-6640.76	0.14	-23790	40	-8674.15	0.10	-27134	20
	K	19	32090#	300#	7564	8	-6521	10	-31320#	500#	4298	8	-30100#	200#
	Ca	20	35740#	300#	2640	40	-6660	40	*	*	9320	40	*	*
	Sc	21	*	-800#	590#	-8950#	710#	*	*	17780#	500#	*	*	*
37	Na	11	450#	150#	*	*	45330#	1010#	*	*	25780#	1080#		
	Mg	12	3050#	990#	*	-19170#	1210#	35830#	920#	*	*	15400#	930#	
	Al	13	6070	370	44210#	1000#	-17370	940	28940	330	-45300#	1010#	14360	350
	Si	14	8360	170	37310#	440#	-13900	170	20320	170	-35290#	530#	5600	170
	P	15	10280	40	33440	180	-12890	80	12770	40	-32070	220	3600	40
	S	16	14192.64	0.22	27110	40	-8829	16	4051.30	0.28	-21700	120	-5445.82	0.20
	Cl	17	18890.63	0.06	21481.7	1.9	-7849.0	1.1	-6961.33	0.11	-18800	13	-9601.31	0.05
	Ar	18	24042.9	0.8	16679.24	0.23	-6786.58	0.25	-17786	22	-7572.55	0.27	-21593	8
	K	19	29774	20	10364.60	0.10	-6221.7	0.5	-27640#	300#	-2567.31	0.12	-26430	40
	Ca	20	33910#	200#	4692	22	-6203	22	*	*	9781	22	-35130#	500#
	Sc	21	*	570#	300#	-6350#	360#	*	*	12980#	300#	*	*	*

A	El.	Z	S(n)	S(p)	$Q(4\beta^-)$	$Q(d,\alpha)$	$Q(p,\alpha)$	$Q(n,\alpha)$						
38	Mg	12	2320#	1030#	27570#	1080#	61860#	500#	-2250#	1080#	280#	1070#	*	
	Al	13	1970	800	20490#	1160#	45850	730	5340#	890#	4760#	830#	-17890#	1200#
	Si	14	5560	220	21300	360	30650	140	860	250	930	220	-14570#	420#
	P	15	3830	110	15470	200	14040	100	8440	160	4470	110	-8980	200
	S	16	8036	7	15160	40	-4802	8	4101	15	2861	7	-6850	40
	Cl	17	6107.88	0.08	10190.71	0.21	-24860#	300#	11576.78	0.20	3912.31	0.14	706.0	1.9
	Ar	18	11838.2	0.4	10242.0	0.3	-43820#	250#	5518.1	0.3	-837.0	0.3	-221.8	0.4
	K	19	12071.8	0.5	5142.0	0.5	*		12141.7	0.4	-889.2	0.9	5859.3	0.4
	Ca	20	16969	23	4548	5	*		6078	9	-6026	21	6635	5
	Sc	21	15850#	420#	-940#	300#	*		12210#	300#	-4670#	360#	11880#	300#
	Ti	22	*		1030#	390#	*		5910#	560#	*		10150#	320#
39	Mg	12	-500#	100#	*		66730#	520#	-1000#	1090#	480#	1080#	*	
	Al	13	2730	1640	20890#	1560#	51200	1470	2860#	1730#	4840#	1560#	-20910#	1750#
	Si	14	2080	360	21410	800	35170	340	2690	470	1010	400	-13850#	610#
	P	15	6190	150	16100	170	20930	100	4420	200	4470	160	-13010	240
	S	16	4370	50	15690	110	4110	50	6540	60	1950	50	-5030	130
	Cl	17	8073.4	1.7	10228	7	-15632	24	7807.0	1.7	5727.9	1.7	-3903	13
	Ar	18	6599	5	10733	5	-34740#	210#	9230	5	1144	5	3068	5
	K	19	13077.6	0.4	6381.43	0.29	*		7851.45	0.28	1288.58	0.19	1361.25	0.20
	Ca	20	13286	5	5762.7	1.9	*		8236.6	1.9	-4984	8	8603.5	1.9
	Sc	21	17300#	300#	-602	24	*		9700	30	-2860	50	8905	25
	Ti	22	15670#	320#	850#	360#	*		9370#	360#	-7530#	540#	13590#	210#
40	Mg	12	1400#	1040#	*		73100#	920#	*		-180#	1320#	*	
	Al	13	170#	1630#	21560#	870#	56850#	700#	5010#	860#	4910#	1140#	-20330#	1190#
	Si	14	4530	650	23220	1570	40510	560	130	920	380	650	-18140#	1060#
	P	15	3300	170	17320	370	25430	140	6670	200	3340	220	-12410	360
	S	16	7780	150	17280	180	11980	140	2600	180	990	150	-10640	220
	Cl	17	5830	30	11680	60	-7030	30	10010	30	4200	30	-2920	50
	Ar	18	9869	5	12528.7	1.7	-26190	160	5469.01	0.10	1585.69	0.05	-2497.13	0.20
	K	19	7799.51	0.07	7582	5	-43870#	500#	11890.15	0.30	2276.51	0.28	3872.73	0.20
	Ca	20	15643.2	1.9	8328.23	0.09	*		4665.2	0.4	-5182.02	0.23	1747.79	0.29
	Sc	21	14427	24	538	3	*		12247	5	-2497	23	9923.4	2.8
	Ti	22	18420#	260#	1970	160	*		6800#	340#	-6830#	340#	9960	160
	V	23	*		-1540#	540#	*		11940#	560#	*		13140#	590#
41	Al	13	1660#	1060#	21820#	1210#	63010#	800#	2850#	950#	5570#	950#	*	
	Si	14	-20	1930	23020#	1970#	46630	1840	2880	2360	2380	1980	-15790#	1910#
	P	15	5240	260	18030	600	30280	220	3510	400	3650	260	-15680	760
	S	16	4220	180	18200	180	16120	120	4570	160	600	160	-9310	180
	Cl	17	7820	80	11730	160	1340	70	6570	80	4420	70	-6900	120
	Ar	18	6098.9	0.3	12800	30	-17370#	100#	7443.5	1.8	1594.7	0.3	-560	7
	K	19	10095.19	0.08	7808.15	0.19	-35350#	210#	8394	5	4019.5	0.3	-114.57	0.22
	Ca	20	8362.80	0.13	8891.52	0.17	*		9380.06	0.16	-1473.0	0.4	5223.2	0.3
	Sc	21	16190.5	2.8	1085.09	0.08	*		9342.8	1.9	-1719	5	5804.7	0.4
	Ti	22	14920#	190#	2470#	100#	*		9180#	100#	-5900#	310#	12010#	100#
	V	23	18610#	540#	-1360#	260#	*		9010#	290#	-4440#	320#	10380#	360#
42	Al	13	100#	1210#	*		68590#	920#	4150#	1280#	4970#	1040#	*	
	Si	14	3200#	1910#	24560#	950#	52860#	500#	-150#	860#	1900#	1560#	-19490#	720#
	P	15	1860	500	19910	1900	35960	450	6180	710	3870	560	-14810	1540
	S	16	6730	170	19690	250	20870	120	1140	190	60	160	-13960	360
	Cl	17	5680	160	13180	190	7210	140	8660	200	3110	150	-6390	180
	Ar	18	9427	6	14400	70	-9301	8	3850	30	242	6	-5610	50
	K	19	7533.80	0.11	9243.1	0.4	-26850#	200#	10729.15	0.22	3085	5	425.0	1.7
	Ca	20	11480.63	0.06	10276.97	0.19	-44540#	300#	5698.94	0.18	123.99	0.17	341	5
	Sc	21	11550.16	0.16	4272.45	0.12	*		13435.84	0.18	17.2	1.9	7332.17	0.19
	Ti	22	17490#	100#	3768	5	*		6112	6	-6089	25	7799	6
	V	23	16040#	280#	-240#	220#	*		11390#	250#	-4810#	280#	11650#	200#
	Cr	24	*		1100#	360#	*		6370#	590#	*		10140#	360#



A	Elt.	Z	S(2n)	S(2p)	Q( $\alpha$ )	Q( $2\beta^-$ )	Q( $\epsilon p$ )	Q( $\beta^- n$ )						
38	Mg	12	2570#	710#	*	-20550#	950#	39060#	520#	*	16980#	600#		
	Al	13	5870	760	46480#	1200#	-19140#	1160#	30810	740	-46510#	1210#	14560	750
	Si	14	7730	180	40070#	520#	-15300	270	22790	140	-40610#	910#	6860	140
	P	15	10650	100	35120	240	-14250	150	15040	100	-31990	350	4070	100
	S	16	12340	7	28960	120	-9329	16	7853	7	-27570	170	-3171	7
	Cl	17	16418.87	0.12	24125	13	-7665	5	-997.4	0.5	-18090	40	-6921.76	0.22
	Ar	18	20625.6	0.3	18628.4	0.4	-7207.7	0.4	-12655	5	-15107.2	0.4	-17985.7	0.3
	K	19	27517	8	13856.8	0.5	-6785.8	0.5	-23860#	300#	-4328.1	0.4	-23710	22
	Ca	20	31760	40	6406	5	-6107	5	-31160#	250#	1599	5	-32970#	300#
	Sc	21	34980#	590#	2090#	300#	-5880#	420#	*		12570#	300#	*	
	Ti	22	*	-960#	260#	-6480#	390#	*			14970#	250#	*	
39	Mg	12	1820#	1040#	*	*	*	41640#	610#	*	*	19450#	890#	
	Al	13	4690	1510	48460#	1760#	-20610#	1750#	34270	1480	*	*	17390	1480
	Si	14	7630	380	41900#	970#	-16650#	520#	25090	340	-40360#	610#	8610	350
	P	15	10020	110	37400	350	-15170	200	16930	100	-36210	740	5920	100
	S	16	12410	50	31160	180	-11230	60	10080	50	-26380	150	-1440	50
	Cl	17	14181.3	1.7	25380	40	-7367.4	2.5	4006.8	1.7	-22330	100	-3157.0	1.8
	Ar	18	18437	5	20924	5	-6821	5	-5968	5	-13670	9	-12513	5
	K	19	25149.45	0.21	16623.42	0.20	-7218.39	0.19	-19639	24	-11297.88	0.21	-19819	5
	Ca	20	30255	22	10904.7	1.9	-6651.9	2.0	-28770#	210#	151.2	1.9	-30410#	300#
	Sc	21	33150#	300#	3946	24	-5420	30	*		7344	24	-31340#	250#
	Ti	22	*	-80#	210#	-5530#	280#	*			16270#	210#	*	
40	Mg	12	900#	1030#	*	*	*	44770#	1060#	*	*	20770#	1730#	
	Al	13	2900#	1010#	*	-21080#	1180#	37400#	710#	*	*	19300#	780#	
	Si	14	6610	570	44110#	750#	-18380#	750#	28330	570	-45390#	760#	10270	570
	P	15	9490	170	38740	740	-16310	260	19450	140	-36790	1480	6980	150
	S	16	12150	140	33380	200	-12810	190	12170	140	-32080	370	-1140	140
	Cl	17	13900	30	27380	110	-9730	30	5980	30	-21970	110	-2390	30
	Ar	18	16468.0	0.3	22757	7	-6800.74	0.19	-193.62	0.21	-19170	50	-9304.20	0.19
	K	19	20877.1	0.4	18315.05	0.21	-6438.26	0.20	-13012.0	2.8	-11024.0	1.7	-14332.1	1.9
	Ca	20	28930	5	14709.7	0.3	-7039.65	0.21	-26000	160	-8893	5	-28750	24
	Sc	21	31730#	300#	6300.5	2.9	-5522	8	-30850#	500#	5994.8	2.8	-30090#	210#
	Ti	22	34090#	300#	1370	160	-4840	160	*		11140	160	*	
	V	23	*	-690#	590#	-5990#	710#	*			17210#	500#	*	
41	Al	13	1840#	1680#	*	-22000#	1250#	40980#	830#	*	*	22170#	980#	
	Si	14	4510	1880	44580#	1910#	-18110#	2050#	32580	1850	-43960#	2050#	13600	1850
	P	15	8550	240	41250	1490	-17650	400	22030	230	-41860#	730#	9520	260
	S	16	12000	130	35530	360	-14860	210	14050	120	-31780	570	470	120
	Cl	17	13650	70	29010	120	-10740	80	8250	70	-26490	160	-340	70
	Ar	18	15968	5	24480	50	-8596.0	0.4	2070.3	0.4	-17490	140	-7603.6	0.4
	K	19	17894.70	0.10	20336.8	1.7	-6222.46	0.20	-6916.68	0.16	-15290	30	-8784.12	0.13
	Ca	20	24006.0	1.9	16474	5	-6615.0	0.3	-19440#	100#	-7386.83	0.24	-22685.8	2.8
	Sc	21	30617	24	9413.32	0.12	-6267.11	0.24	-28440#	210#	-2396.16	0.14	-27860	160
	Ti	22	33340#	230#	3000#	100#	-4960#	100#	*		11860#	100#	-34100#	510#
	V	23	*	620#	210#	-5470#	360#	*			13030#	210#	*	
42	Al	13	1760#	1140#	*	*	*	42740#	1010#	*	*	22040#	2050#	
	Si	14	3180#	750#	46380#	1030#	-18990#	710#	36110#	520#	*	*	15640#	550#
	P	15	7100	470	42940#	830#	-17540	860	25850	470	-42050#	920#	11890	460
	S	16	10950	190	37720	570	-16040	190	16750	120	-38530	1850	1560	140
	Cl	17	13500	150	31380	200	-12580	180	10110	140	-26930	260	80	140
	Ar	18	15525	6	26130	140	-9986	9	4124	6	-22690	120	-6935	6
	K	19	17628.99	0.13	22040	30	-7648.37	0.24	-2900.32	0.24	-15000	70	-7955.11	0.21
	Ca	20	19843.43	0.14	18085.12	0.25	-6257.4	0.3	-13426	5	-12768.6	0.4	-17976.00	0.16
	Sc	21	27740.6	2.8	13163.98	0.20	-5745.5	0.5	-23950#	200#	-3851.14	0.21	-24490#	100#
	Ti	22	32410	160	4853	5	-5487	7	-31110#	300#	2727	5	-32990#	210#
	V	23	34640#	540#	2220#	200#	-5660#	360#	*		13180#	200#	*	
	Cr	24	*	-260#	340#	-5540#	390#	*			14400#	310#	*	

A	El.	Z	S(n)	S(p)	Q(4β <sup>-</sup> )	Q(d,α)	Q(p,α)	Q(n,α)						
43	Si	14	-190#	860#	24270#	1140#	58710#	700#	1700#	1060#	2270#	990#	-17890#	1140#
	P	15	3240	1070	19960#	1090#	42360	970	2910	2080	5160	1120	-17880#	1190#
	S	16	2360	240	20190	490	26440	200	4020	300	1010	250	-11790	590
	Cl	17	7330	210	13780	200	12020	160	5560	200	3560	210	-10410	210
	Ar	18	5658	8	14390	140	-2689	9	6010	70	410	30	-3500	140
	K	19	9643	9	9460	11	-18570#	230#	7185	9	3311	9	-3390	30
	Ca	20	7932.88	0.17	10676.05	0.28	-36280#	220#	7861.24	0.25	-9.38	0.25	2277.7	0.3
	Sc	21	12138.0	1.9	4929.8	1.9	*		9660.6	1.9	3522.4	1.9	2993.7	1.9
	Ti	22	12271	9	4489	7	*		10032	7	-3934	7	11172	7
	V	23	17930#	300#	190#	230#	*		8390#	250#	-4310#	280#	8150#	230#
	Cr	24	16190#	370#	1250#	290#	*		8780#	300#	-7600#	550#	12360#	270#
44	Si	14	1920#	1060#	*		65520#	800#	-120#	1210#	2000#	1130#	*	
	P	15	1740#	1190#	21890#	990#	47910#	700#	4380#	860#	3400#	1970#	-17960#	1060#
	S	16	5220	440	22170	1050	32350	390	660	600	1020	450	-17030	1890
	Cl	17	4130	190	15550	230	17590	110	8160	160	3650	160	-9310	240
	Ar	18	8735	6	15790	160	4875.4	1.7	2950	140	-500	70	-8010	120
	K	19	7290	40	11090	40	-11690	130	9320	40	2120	40	-2860	80
	Ca	20	11131.16	0.23	12164	9	-28010#	50#	4263.9	0.4	-1045.4	0.3	-2754.6	0.5
	Sc	21	9699.5	2.6	6696.4	1.7	-44220#	500#	11441.8	1.7	2185.7	1.8	3389.4	1.8
	Ti	22	16299	7	8649.5	2.0	*		5283.6	0.7	-4042.0	0.7	3235.7	0.7
	V	23	14160#	260#	2080	120	*		11720	120	-3550#	160#	10170	120
	Cr	24	19400#	230#	2730#	240#	*		5420#	200#	-8390#	210#	7890#	110#
	Mn	25	*		-1240#	550#	*		11120#	590#	*		12250#	540#
45	P	15	2270#	1060#	22230#	1130#	54510#	800#	1920#	1060#	4330#	950#	-20130#	1210#
	S	16	2210	1790	22640#	1880#	37560	1740	1690	1990	670	1800	-16040#	1810#
	Cl	17	6200	160	16540	410	22710	120	4310	240	4180	180	-13660	460
	Ar	18	5168.9	1.7	16830	110	9235.1	1.1	5110	160	10	140	-6450	120
	K	19	8870	40	11224	10	-4729	20	6112	12	2679	12	-6050	140
	Ca	20	7414.79	0.17	12290	40	-21850	500	6492	9	-926.3	0.4	-743	6
	Sc	21	11323.0	1.9	6888.3	0.8	-35950#	300#	8051.7	0.8	2343.3	0.8	-399.8	0.8
	Ti	22	9528.6	1.2	8478.6	2.0	-52590#	220#	7893.0	2.1	-2020.4	1.0	5187.7	1.0
	V	23	15830	120	1620	17	*		8152	18	-1894	18	5888	17
	Cr	24	13580#	510#	2140	520	*		9770#	550#	-5930#	540#	11800	500
	Mn	25	19590#	590#	-1060#	300#	*		7730#	370#	-6240#	420#	8700#	360#
	Fe	26	*		110#	550#	*		*	*	*		13240#	370#
46	P	15	470#	1210#	*		60920#	900#	3370#	1210#	3670#	1140#	*	
	S	16	4120#	1880#	24490#	1060#	43830#	700#	-690#	990#	-200#	1190#	-20350#	990#
	Cl	17	4420	730	18740	1880	27050	720	5120	820	2120	750	-14830	1210
	Ar	18	8020	40	18650	130	14400	40	1220	120	-690	160	-12110	210
	K	19	6881	18	12937	16	1655	16	7966	16	1456	16	-5600	160
	Ca	20	10394.4	2.3	13816	10	-13661	20	3390	40	-1678	9	-5479	6
	Sc	21	8760.64	0.10	8234.1	0.8	-29390#	110#	10422.2	0.8	1515.6	0.8	483	9
	Ti	22	13189.0	0.8	10344.6	0.6	-44880#	350#	4403.5	1.9	-3071.4	2.0	-68.4	0.8
	V	23	13265	17	5356.2	1.0	*		11186.3	1.2	-2888	7	4761.3	2.1
	Cr	24	18580	500	4883	26	*		5350	120	-6590#	230#	5494	21
	Mn	25	15330#	320#	690#	520#	*		11800#	120#	-5370#	250#	11300#	260#
	Fe	26	20900#	420#	1420#	460#	*		5070#	620#	*		8530#	420#
47	S	16	770#	1060#	24790#	1210#	50340#	800#	810#	1130#	770#	1060#	-19200#	1130#
	Cl	17	3880#	930#	18500#	920#	33820#	600#	3450#	1840#	3460#	720#	-16970#	920#
	Ar	18	4260	110	18490	720	19020	100	3170	160	-810	150	-11150	410
	K	19	8349	16	13270	40	6306	8	4785	8	1841	8	-9820	110
	Ca	20	7276.36	0.27	14211	16	-7782	14	4979	10	-1670	40	-4020.7	2.8
	Sc	21	10646.3	2.0	8486.0	1.2	-22070#	160#	7190.6	2.0	2000.4	2.0	-2880	40
	Ti	22	8880.29	0.29	10464.2	0.7	-38310#	260#	6846.2	0.7	-2252.2	1.9	2182.5	0.8
	V	23	13000.4	0.6	5167.60	0.07	-52710#	500#	7714.5	0.8	410.5	1.1	1460.4	1.9
	Cr	24	13156	24	4774	14	*		8032	22	-5580	120	8636	14
	Mn	25	17960#	190#	80#	160#	*		7410#	530#	-3940#	170#	7500#	200#
	Fe	26	15450#	440#	1540#	280#	*		9200#	400#	-8160#	570#	12480#	270#
	Co	27	*		-2660#	620#	*		7830#	550#	*		9950#	710#

A	El.	Z	S(2n)	S(2p)	Q( $\alpha$ )	Q( $2\beta^-$ )	Q( $\epsilon\text{p}$ )	Q( $\beta^-n$ )						
43	Si	14	3010#	1970#	*	-19300#	870#	38660#	730#	*	17690#	830#		
	P	15	5100	990	44520#	1260#	-18060	1760	29930	980	-45200#	1330#	15370	980
	S	16	9090	230	40110	1860	-16320	390	20040	200	-37690#	540#	4880	250
	Cl	17	13000	170	33470	270	-13720	190	12430	160	-32400	470	2180	160
	Ar	18	15085	5	27570	120	-11270	50	6399	5	-21620	120	-5060	5
	K	19	17177	9	23860	70	-9218	9	-405	9	-18970	140	-6117	9
	Ca	20	19413.51	0.18	19919.1	0.4	-7592	5	-9088	7	-11275	6	-14358.72	0.21
	Sc	21	23688.2	1.9	15206.8	1.9	-4805.8	1.9	-18160#	230#	-8455.3	1.9	-19138	6
	Ti	22	29760#	100#	8761	7	-4472	7	-27190#	220#	1937	7	-29220#	200#
	V	23	33960#	310#	3960#	230#	-6280#	230#	*	6810#	230#	-32090#	380#	
	Cr	24	*		1010#	240#	-6060#	300#	*	15700#	220#	*		
44	Si	14	1730#	950#	*	-19820#	1210#	41960#	890#	*	19010#	1260#		
	P	15	4980#	830#	46160#	1140#	-19620#	990#	32330#	710#	*	15990#	730#	
	S	16	7580	410	42130#	640#	-17010	680	23560	390	-43100#	800#	6980	420
	Cl	17	11460	180	35750	460	-14550	180	15580	110	-33290	970	3710	110
	Ar	18	14393	6	29570	120	-12230	140	8795.4	1.6	-28000	200	-4151	9
	K	19	16930	40	25470	150	-10680	50	2010	40	-18930	160	-5470	40
	Ca	20	19064.04	0.29	21624	6	-8853.5	0.4	-3920.0	0.8	-16748	5	-13351.9	1.9
	Sc	21	21837.5	1.8	17372.5	1.8	-6705.8	1.8	-13700	120	-8512	9	-16566	7
	Ti	22	28570	5	13579.3	0.7	-5127.1	0.7	-24090#	50#	-6428.8	0.7	-27600#	230#
	V	23	32090#	230#	6570	120	-6020	120	-30520#	520#	4780	120	-30060#	250#
	Cr	24	35590#	300#	2920#	50#	-7040#	170#	*	8570#	50#	*		
	Mn	25	*		10#	540#	-6360#	710#	*	17140#	550#	*		
45	P	15	4010#	1260#	*	-20230#	1130#	36270#	810#	*	18950#	890#		
	S	16	7430	1750	44530#	1880#	-19240	2540	26520	1740	-43390#	1920#	8910	1750
	Cl	17	10340	200	38710	980	-15510	250	18250	120	-37750#	710#	6240	120
	Ar	18	13903	5	32380	200	-13180	120	11041.4	0.6	-27940	390	-2030	40
	K	19	16158	14	27020	160	-11730	70	4460	10	-23670	110	-3211	10
	Ca	20	18545.95	0.29	23380	5	-10169.4	0.5	-1806.2	1.0	-15427.9	1.6	-11067.2	1.8
	Sc	21	21022.5	2.0	19052	9	-7933.6	0.8	-9188	17	-12550	40	-11590.7	1.1
	Ti	22	25827	7	15175.0	1.0	-6292.9	1.0	-20040	500	-4826.2	1.0	-22960	120
	V	23	30000#	230#	10270	17	-5662	17	-26770#	300#	-1353	17	-26490#	50#
	Cr	24	32980#	550#	4220	500	-5690#	510#	-32550#	550#	11290	500	-33440#	710#
	Mn	25	*		1670#	380#	-7330#	360#	*	11710#	320#	*		
	Fe	26	*		-1130	40	*	*	*	19750#	230#	*		
46	P	15	2740#	1140#	*	-20600#	1280#	40210#	1150#	*	20690#	1960#		
	S	16	6330#	800#	46720#	1060#	-20160#	860#	30420#	700#	*	10990#	710#	
	Cl	17	10620	730	41390#	1000#	-18070	850	20710	720	-39900#	1080#	6990	720
	Ar	18	13190	40	35180	400	-14470	130	13410	40	-33760	1740	-1180	40
	K	19	15750	40	29770	110	-12930	140	6339	16	-24340	120	-2678	16
	Ca	20	17809.2	2.3	25040.0	2.8	-11137	6	988.3	2.2	-20653.5	2.3	-10138.6	2.2
	Sc	21	20083.7	1.9	20530	40	-9160.5	0.8	-4684.1	0.9	-12438	10	-10822.7	0.5
	Ti	22	22717.6	1.1	17232.9	0.8	-8001.3	0.8	-14650	20	-10600.4	0.9	-20315	17
	V	23	29100	120	13834.9	2.0	-7376.7	1.0	-24700#	110#	-3294.2	0.9	-26180	500
	Cr	24	32160#	50#	6503	20	-6777	21	-30230#	360#	2243	20	-32430#	300#
	Mn	25	34910#	520#	2830#	170#	-6630#	230#	*	12220#	110#	-34020#	250#	
	Fe	26	*		360#	360#	-7660#	460#	*	12430#	620#	*		
47	S	16	4890#	1920#	*	-21120#	1060#	33910#	810#	*	14640#	1080#		
	Cl	17	8300#	610#	43000#	1000#	-18710#	1140#	25180#	600#	-43310#	1080#	11130#	600#
	Ar	18	12280	100	37230	1750	-16370	230	16430	100	-33900#	710#	1440	100
	K	19	15231	13	31910	120	-13950	160	8636	8	-28280	720	-633	8
	Ca	20	17670.8	2.3	27147.5	2.3	-12755	6	2592.3	2.1	-19910	40	-8654.3	2.2
	Sc	21	19407.0	2.0	22302	10	-10164	9	-2330.1	1.9	-16203	16	-8280.0	1.9
	Ti	22	22069.3	0.8	18698.4	0.9	-8948.7	0.8	-10374	14	-9086.3	2.1	-15930.7	0.7
	V	23	26265	17	15512.2	0.6	-8239.0	2.0	-19740#	160#	-7533.9	0.6	-20600	20
	Cr	24	31740	500	10131	14	-7662	16	-27940#	260#	2276	14	-30260#	110#
	Mn	25	33290#	340#	4960#	160#	-6660#	280#	-32970#	530#	7520#	160#	-31090#	390#
	Fe	26	36350#	340#	2240#	570#	-6920#	340#	*	15560#	260#	*		
	Co	27	*		-1240#	590#	*	*	*	15780#	520#	*		

A	Elt.	Z	S(n)	S(p)	$Q(4\beta^-)$	$Q(d,\alpha)$	$Q(p,\alpha)$	$Q(n,\alpha)$						
48	S	16	2870#	1210#	*	57410#	900#	-1590#	1280#	160#	1210#	*		
	Cl	17	2260#	920#	20000#	1060#	39790#	700#	5310#	990#	3410#	1880#	-16960#	1060#
	Ar	18	5880#	310#	20490#	670#	24770#	300#	1700#	780#	-490#	320#	-14820#	1770#
	K	19	4499	25	13510	100	12351	24	8310	50	2511	24	-8110	130
	Ca	20	9945	4	15807	7	-1395	8	1915	15	-2742	11	-8797	4
	Sc	21	8235	6	9445	6	-15170	110	9350	6	1180	5	-2242	11
	Ti	22	11626.65	0.04	11444.6	1.9	-30330#	70#	3980.2	0.7	-2555.9	0.7	-2029.4	0.9
	V	23	10544.7	2.4	6832.0	2.4	-46120#	400#	10358.8	2.4	-605.6	2.6	2238.8	2.5
	Cr	24	16332	16	8106	7	-61220#	500#	4965	7	-6075	19	1833	7
	Mn	25	15130#	190#	2050	110	*	10860	110	-5490	520	8200	110	
	Fe	26	19610#	270#	3190#	170#	*	4920#	130#	-8180#	310#	6450#	510#	
	Co	27	17140#	640#	-970#	480#	*	11600#	540#	-7080#	460#	12400#	500#	
	Ni	28	*		-410#	710#	*		*		*	10460#	550#	
49	S	16	-730#	300#	*	63290#	950#	*		1360#	1310#	*		
	Cl	17	3070#	1060#	20190#	1210#	46850#	800#	3010#	1130#	4460#	1060#	-19560#	1210#
	Ar	18	2500#	590#	20730#	860#	30410#	500#	3080#	780#	1430#	880#	-13200#	860#
	K	19	6270	70	13890#	310#	17640	70	6300	120	4260	80	-9960	720
	Ca	20	5146.45	0.18	16454	24	4041	5	5118	7	-1007	15	-5920	40
	Sc	21	10128	6	9627.2	2.9	-8937	24	6499	4	1447	4	-5488	15
	Ti	22	8142.39	0.03	11352	5	-23980#	150#	6484.1	1.9	-1937.6	0.7	222.7	2.1
	V	23	11552.9	2.6	6758.2	0.8	-38380#	260#	7686.3	0.8	1030.5	0.9	-553.4	1.1
	Cr	24	10128	8	8144	3	-54330#	400#	7382.4	2.4	-3393.4	2.5	4439.3	2.4
	Mn	25	16360	110	2085	25	*	7654	28	-3280	30	5104	24	
	Fe	26	14490#	170#	2550#	190#	*	8390#	220#	-7350#	190#	10540#	150#	
	Co	27	19290#	480#	-1300#	270#	*	7760#	370#	-5470#	440#	8440#	280#	
	Ni	28	17470#	640#	-70#	570#	*	9010#	640#	*		13890#	540#	
50	Cl	17	1070#	1210#	21990#	1310#	51840#	900#	4810#	1280#	4170#	1210#	*	
	Ar	18	4430#	860#	22090#	1060#	36920#	700#	910#	990#	880#	920#	-16860#	1060#
	K	19	3100	290	14500#	580#	23870	280	9080#	410#	5420	300	-9190#	660#
	Ca	20	6353	8	16540	70	10689	9	3264	25	989	11	-8020	100
	Sc	21	6056	15	10537	15	-1910	16	10388	15	2667	16	-3194	16
	Ti	22	10939.19	0.04	12163	4	-16950	60	3780	5	-2230.5	1.9	-3440.1	2.1
	V	23	9335.9	1.3	7951.7	1.0	-32030#	170#	9977.0	1.0	574.9	1.0	757.0	2.1
	Cr	24	13000.3	2.2	9591.5	1.3	-46470#	260#	4926.7	2.6	-3393.4	1.0	319.3	1.0
	Mn	25	13083	24	4585.3	2.2	*	10903	7	-3204	14	5021.6	1.1	
	Fe	26	17970#	160#	4150	60	*	5560	130	-7350#	170#	5730	60	
	Co	27	15690#	310#	-100#	220#	*	11680#	180#	-5710#	310#	10710#	230#	
	Ni	28	20860#	480#	1500#	370#	*	5280#	480#	-9630#	570#	8480#	370#	
51	Cl	17	1880#	1350#	*	56720#	1000#	2210#	1380#	5160#	1350#	*		
	Ar	18	1370#	990#	22390#	1140#	41930#	700#	2620#	1060#	1770#	990#	-15350#	1140#
	K	19	4720#	580#	14790#	860#	30200#	500#	6850#	710#	6580#	590#	-11650#	860#
	Ca	20	4360	90	17800	290	15590	90	5170	120	1120	100	-6500#	310#
	Sc	21	6753	25	10936	22	5023	20	8782	20	5860	20	-5450	30
	Ti	22	6372.5	0.5	12480	16	-9506	15	7535	4	-368	5	133	4
	V	23	11051.15	0.08	8063.7	1.0	-24930#	150#	7068.2	1.0	1150.4	1.0	-2059	5
	Cr	24	9260.62	0.20	9516.22	0.25	-40010#	260#	7218.9	1.3	-2109.4	2.6	2685.3	1.0
	Mn	25	13685.8	0.4	5270.81	0.30	*	7799.9	2.2	-558	7	1880.4	2.6	
	Fe	26	13820	60	4884	15	*	8104	28	-6030	110	8243	17	
	Co	27	18150#	220#	90#	160#	*	8020#	210#	-4250#	170#	7700#	190#	
	Ni	28	15720#	370#	1530#	310#	*	8850#	370#	-8210#	480#	12370#	270#	

A	El.	Z	S(2n)	S(2p)	Q( $\alpha$ )	Q( $2\beta^-$ )	Q( $\epsilon\text{p}$ )	Q( $\beta^-n$ )						
48	S	16	3640#	1140#	*	-22070#	1210#	36920#	950#	*	15650#	1080#		
	Cl	17	6140#	1000#	44790#	1140#	-19230#	990#	27420#	700#	*	13130#	710#	
	Ar	18	10140#	300#	38990#	760#	-17030#	490#	20500#	300#	-39010#	860#	3910#	300#
	K	19	12848	28	31990	720	-14320	110	12372	24	-28900#	600#	2145	24
	Ca	20	17222	4	29070	40	-13966	4	4274	4	-25600	100	-7953	4
	Sc	21	18882	5	23656	16	-11110	40	-21	6	-16089	9	-7635	5
	Ti	22	20506.94	0.29	19930.6	2.1	-9444.2	0.8	-5669	7	-13436.6	2.1	-14557.0	0.3
	V	23	23545.0	2.5	17296.2	2.5	-9084	3	-15150	110	-7432	3	-17988	14
	Cr	24	29488	21	13274	7	-7696	7	-24660#	70#	-5176	7	-28630#	160#
	Mn	25	33100#	160#	6830	110	-7630	160	-30960#	420#	5390	110	-30770#	280#
	Fe	26	35060#	360#	3270#	70#	-7120#	90#	-36560#	510#	9110#	70#	-36940#	510#
	Co	27	*		570#	420#	-7190#	640#	*		16610#	430#	*	
	Ni	28	*		-3070#	620#	*	*	*		17730#	570#	*	
49	S	16	2140#	1240#	*	*	*	40150#	1080#	*	*	18630#	1180#	
	Cl	17	5330#	1000#	*		-20030#	1130#	30620#	800#	*	15940#	860#	
	Ar	18	8380#	510#	40730#	950#	-17320#	1810#	23140#	500#	-38630#	1030#	5910#	500#
	K	19	10770	70	34380#	600#	-14380	140	16230	70	-32900#	700#	5820	70
	Ca	20	15092	4	29960	100	-13944	4	7270	4	-24860#	300#	-4864	5
	Sc	21	18363	4	25434	7	-12369	11	1405	4	-21717	24	-6136	4
	Ti	22	19769.04	0.05	20796.6	2.1	-10171.8	0.9	-3228.3	2.4	-11634	4	-12154.7	2.4
	V	23	22097.5	0.9	18202.8	2.0	-9314.1	1.1	-10341	24	-10750	5	-13209	7
	Cr	24	26915	14	14976.0	2.4	-8749.7	2.5	-20750#	150#	-4131.7	2.4	-24080	110
	Mn	25	31500#	160#	10191	24	-8161	29	-28040#	260#	-429	24	-27530#	70#
	Fe	26	34100#	300#	4600#	150#	-8040#	530#	-33580#	430#	10950#	150#	-34290#	430#
	Co	27	36420#	570#	1890#	310#	-6890#	400#	*		12460#	280#	-36040#	570#
	Ni	28	*		-1040#	480#	-7010#	460#	*		19870#	410#	*	
50	Cl	17	4140#	1140#	*		-20630#	1280#	32660#	950#	*	*	17380#	1030#
	Ar	18	6930#	760#	42280#	1140#	-17630#	990#	25070#	700#	-43790#	1180#	7750#	700#
	K	19	9370	280	35230#	750#	-13070	770	19180	280	-32940#	850#	7870	280
	Ca	20	11499	8	30430#	300#	-12280	40	11856	9	-28710#	500#	-1090	9
	Sc	21	16183	16	26991	28	-11543	21	4685	16	-21510	70	-4049	16
	Ti	22	19081.58	0.05	21790	4	-10716.5	2.1	-1167.2	1.0	-17426	4	-11541.0	0.8
	V	23	20888.8	2.6	19303	5	-9889.4	1.1	-6594.7	0.4	-9958	4	-11962.4	2.2
	Cr	24	23583	7	16349.7	1.0	-8561.0	1.0	-15780	60	-8989.7	1.0	-20715	24
	Mn	25	29450	110	12729.4	2.6	-7978.7	1.2	-25430#	170#	-1958.8	1.3	-26120#	150#
	Fe	26	32460#	90#	6230	60	-7430	60	-30680#	270#	3570	60	-32970#	270#
	Co	27	34980#	430#	2450#	200#	-7250#	200#	*		13130#	170#	-34270#	430#
	Ni	28	38330#	570#	210#	270#	-6970#	440#	*		13500#	300#	*	
51	Cl	17	2940#	1280#	*		*	35500#	1120#	*	*	19930#	1220#	
	Ar	18	5790#	860#	44380#	1180#	-18220#	1060#	28070#	710#	*	*	9480#	750#
	K	19	7830#	510#	36880#	950#	-13910#	780#	21220#	500#	-36590#	1030#	9500#	500#
	Ca	20	10720	90	32300#	510#	-12380	140	13860	90	-28650#	710#	600	90
	Sc	21	12808	20	27480	70	-9947	21	8983	20	-25160	280	137	20
	Ti	22	17311.7	0.5	23017	4	-9812.6	2.2	1721.0	1.1	-17446	9	-8577.6	1.1
	V	23	20387.1	1.3	20227	4	-10294.2	2.1	-3960.0	0.4	-14953	16	-10013.2	0.3
	Cr	24	22261.0	2.2	17467.9	1.0	-8941.3	1.0	-11226	15	-7311.1	1.0	-16893.3	0.3
	Mn	25	26768	24	14862.3	1.3	-8664.2	1.0	-20970#	150#	-6308.8	0.4	-21840	60
	Fe	26	31780#	150#	9470	15	-8089	21	-28780#	260#	2748	15	-31100#	170#
	Co	27	33840#	300#	4240#	150#	-7440#	220#	*		8060#	150#	-31550#	300#
	Ni	28	36580#	480#	1440#	300#	-7240#	370#	*		15750#	270#	*	

A	El.	Z	S(n)	S(p)	Q(4β <sup>-</sup> )	Q(d,α)	Q(p,α)	Q(n,α)						
52	Ar	18	3270#	1140#	23790#	1350#	46470#	900#	410#	1280#	1570#	1210#	-19350#	1310#
	K	19	2270#	860#	15690#	990#	35240#	700#	9020#	990#	6810#	860#	-10850#	1060#
	Ca	20	4720	700	17800#	860#	22910	700	3550	750	2670	700	-8720#	860#
	Sc	21	5210	190	11780	210	10350	190	9930	190	5800	190	-4390	210
	Ti	22	7808	7	13536	22	-1133	10	5783	17	1952	8	-2529	8
	V	23	7311.24	0.13	9002.4	1.1	-17530#	70#	10696.2	1.0	1981.5	1.0	757	4
	Cr	24	12039.4	1.0	10504.5	1.0	-32760#	80#	4515.4	1.0	-2595.9	1.3	-1211.7	1.0
	Mn	25	10535.4	2.0	6545.6	2.1	-48080#	260#	10264.9	2.0	-511	3	2897.9	2.2
	Fe	26	16181	16	7379	7	*	*	5006	7	-5852	25	2645	7
	Co	27	14710#	160#	980#	70#	*	*	11270#	90#	-4470#	160#	9350#	70#
	Ni	28	19290#	270#	2670#	170#	*	*	5250#	190#	-8210#	270#	7580#	170#
	Cu	29	*	*	-1520#	370#	*	*	11880#	370#	-6760#	480#	12600#	370#
53	Ar	18	470#	1350#	*	*	51430#	1000#	1820#	1410#	2160#	1350#	*	*
	K	19	3870#	990#	16290#	1140#	39850#	700#	6510#	990#	7370#	990#	-13650#	1140#
	Ca	20	3460#	860#	18990#	860#	27390#	500#	4810#	710#	2320#	580#	-7750#	860#
	Sc	21	5340#	360#	12400#	760#	17070#	300#	8950#	310#	6810#	300#	-6630#	410#
	Ti	22	5440	100	13760	220	4120	100	7100	100	2570	100	-1610	100
	V	23	8479	3	9673	8	-9204	18	8590	3	4442	3	-1666	16
	Cr	24	7939.12	0.14	11132.4	1.0	-25920#	160#	7627.4	1.0	-1199.1	1.0	1788.3	1.0
	Mn	25	12053.8	1.9	6559.9	0.3	-41230#	260#	7471.7	1.0	435.7	1.0	180.1	1.0
	Fe	26	10685	7	7528.9	2.5	*	*	8006.8	1.9	-3454.5	1.9	4960.6	1.9
	Co	27	16800#	70#	1602	19	*	*	8288	23	-3310	60	5628	18
	Ni	28	14790#	180#	2740#	170#	*	*	8620#	220#	-7310#	230#	10750#	170#
	Cu	29	18910#	370#	-1910#	270#	*	*	8690#	370#	-4810#	370#	9380#	310#
54	K	19	1480#	1140#	17290#	1350#	44490#	900#	8310#	1280#	7260#	1140#	-13250#	1350#
	Ca	20	4070#	860#	19180#	990#	33040#	700#	3020#	990#	2970#	860#	-10450#	990#
	Sc	21	4670#	480#	13610#	630#	21340	370	9000	790	6510	380	-6570#	630#
	Ti	22	6840	160	15260#	320#	10660	120	5470	230	2490	130	-4080	160
	V	23	6113	15	10350	100	-1881	15	10285	17	4701	15	-1026	25
	Cr	24	9719.12	0.12	12373	3	-17720	50	5219.6	1.0	132.9	1.0	-1558.3	1.1
	Mn	25	8938.8	1.1	7559.6	1.0	-33860#	210#	10572.4	1.0	757.5	1.4	2292.4	1.4
	Fe	26	13378.4	1.6	8853.5	0.5	-49690#	400#	5163.8	1.8	-3147.1	0.9	842.8	0.9
	Co	27	13436	18	4353.2	1.6	*	*	11033	7	-2923	15	5878.2	0.9
	Ni	28	17910#	170#	3850	50	*	*	5420#	80#	-7070#	160#	6660	50
	Cu	29	16310#	340#	-390#	270#	*	*	11670#	230#	-5390#	340#	11230#	260#
	Zn	30	*	*	400#	480#	*	*	6770#	480#	*	*	10520#	480#
55	K	19	2940#	1350#	*	*	48880#	1000#	5840#	1410#	7590#	1350#	*	*
	Ca	20	2300#	990#	20000#	1140#	36990#	700#	4590#	990#	2950#	990#	-9470#	1140#
	Sc	21	3430	820	12980#	1020#	28130	740	9030#	890#	7790	1010	-7740#	1020#
	Ti	22	4150	200	14740	400	15810	150	6660#	340#	3550	250	-3510	710
	V	23	7330	100	10850	160	4880	100	8390	140	5180	100	-3150	220
	Cr	24	6246.26	0.19	12506	15	-9772	11	7452	3	1197.9	1.0	4	7
	Mn	25	10226.5	1.1	8067.0	0.4	-26090#	300#	8285.0	0.4	2570.4	0.4	-622.9	0.9
	Fe	26	9298.23	0.20	9213.0	1.1	-42560#	250#	7919.3	0.5	-1909.9	1.8	3584.0	0.4
	Co	27	14089.3	0.4	5064.1	0.3	*	*	7628.6	1.7	-832	7	2324.3	1.9
	Ni	28	14200	50	4615	11	*	*	8020	21	-6560#	70#	8642	13
	Cu	29	18000#	370#	-300#	300#	*	*	8460#	340#	-4110#	310#	7940#	310#
	Zn	30	16430#	470#	520#	330#	*	*	9250#	360#	-7430#	360#	13380#	270#
56	Ca	20	3400#	1140#	20460#	1350#	41840#	900#	2670#	1280#	3420#	1140#	-12400#	1350#
	Sc	21	3760#	1020#	14440#	990#	31640#	700#	9330#	990#	7490#	860#	-7630#	990#
	Ti	22	5340	250	16650	760	21670	200	5990	420	3550#	360#	-5390#	540#
	V	23	5000	230	11700	250	9960	200	10230	240	5610	230	-2810#	360#
	Cr	24	8245.1	2.0	13420	100	-1378	11	5321	15	1432	4	-2810	100
	Mn	25	7270.45	0.13	9091.2	0.4	-18310#	140#	10733.6	0.4	3239.1	0.4	586	3
	Fe	26	11197.30	0.25	10183.74	0.17	-34880#	260#	5660.8	1.1	-1053.4	0.5	325.8	0.4
	Co	27	10083.1	2.0	5849.0	2.0	-51300#	260#	10923.9	2.0	-230.0	2.6	4295.0	2.1
	Ni	28	16639	16	7165	11	*	*	4817	11	-6395	21	2688	11
	Cu	29	15050#	330#	560#	140#	*	*	11320#	150#	-4370#	210#	9690#	140#
	Zn	30	18880#	360#	1390#	400#	*	*	6680#	340#	-7400#	370#	9290#	310#
	Ga	31	*	*	-2890#	360#	*	*	12540#	480#	*	*	14370#	370#

A	El.	Z	S(2n)	S(2p)	Q( $\alpha$ )	Q( $2\beta^-$ )	Q( $\epsilon p$ )	Q( $\beta^- n$ )						
52	Ar	18	4640#	1140#	*	-18620#	1280#	29510#	1140#	*	10930#	1030#		
	K	19	6990#	750#	38080#	1140#	-13920#	990#	24160#	730#	-36990#	1220#	11590#	710#
	Ca	20	9080	700	32580#	990#	-11220#	760#	16960	700	-32000#	990#	2640	700
	Sc	21	11960	190	29580	340	-10660	190	11080	190	-25640#	540#	1300	190
	Ti	22	14181	7	24472	12	-7676	8	5952	7	-20890	90	-5335	7
	V	23	18362.39	0.15	21482	16	-9370	5	-735.9	2.1	-15512	20	-8063.82	0.27
	Cr	24	21300.1	1.0	18568.2	1.0	-9354.1	1.0	-7085	7	-12978.1	1.1	-15246.9	1.0
	Mn	25	24221.3	2.1	16061.8	2.1	-8655	3	-16790#	70#	-5793.0	2.1	-18554	15
	Fe	26	30000	60	12650	7	-7937	10	-25680#	80#	-4172	7	-29130#	150#
	Co	27	32860#	180#	5870#	70#	-7020#	130#	-31290#	270#	7040#	70#	-30550#	270#
	Ni	28	35010#	270#	2760#	100#	-6920#	110#	*		10280#	90#	*	
	Cu	29	*		10#	310#	-6690#	480#	*		17360#	300#	*	
53	Ar	18	3740#	1220#	*	-19820#	1380#	32500#	1120#	*		12730#	1220#	
	K	19	6140#	860#	40070#	1220#	-14720#	1060#	25630#	760#	*		12440#	990#
	Ca	20	8180#	510#	34680#	860#	-12180#	710#	18930#	510#	-32190#	1030#	4390#	540#
	Sc	21	10550#	300#	30200#	590#	-9730#	310#	14230#	300#	-28710#	760#	3770#	300#
	Ti	22	13240	100	25540	140	-7960	100	8460	100	-21610	710	-3460	100
	V	23	15790	3	23209	21	-7721	5	2839	3	-18780	190	-4503	3
	Cr	24	19978.6	1.0	20134.8	1.1	-9150.9	1.0	-4339.4	1.7	-13109	7	-12650.6	1.9
	Mn	25	22589.2	1.0	17064.5	1.0	-9155.9	1.3	-12043	18	-10535.6	1.0	-14428	7
	Fe	26	26866	15	14074.5	1.9	-8039.8	2.9	-21580#	160#	-2817.4	1.7	-25100#	70#
	Co	27	31510#	150#	8981	18	-7450	30	-29190#	260#	772	18	-28060#	90#
	Ni	28	34070#	310#	3730#	160#	-7210#	220#	*		11670#	160#	-34820#	310#
	Cu	29	*		760#	300#	-6310#	370#	*		13170#	270#	*	
54	K	19	5350#	1140#	*	-15130#	1280#	28820#	980#	*		14420#	1030#	
	Ca	20	7530#	990#	35470#	1140#	-11810#	990#	21700#	710#	-35780#	1220#	5660#	760#
	Sc	21	10000	420	32600#	790#	-11290	460	15670	370	-29510#	790#	4540	380
	Ti	22	12270	120	27660	710	-8450	130	11340	120	-24990#	520#	-1820	120
	V	23	14592	15	24110	190	-7779	22	5664	15	-19560#	300#	-2678	15
	Cr	24	17658.25	0.19	22046	7	-7930.8	1.0	-680.1	0.4	-17390	100	-10316.0	0.4
	Mn	25	20992.6	2.1	18692.0	1.4	-8758.7	1.4	-7545.8	1.1	-10996	3	-12681.4	2.0
	Fe	26	24063	7	15413.5	0.5	-8417.9	0.9	-17040	50	-8256.7	0.5	-21679	18
	Co	27	30240#	70#	11882.0	1.8	-7807.6	0.9	-26320#	210#	-610.6	0.6	-26710#	160#
	Ni	28	32700#	100#	5460	50	-7160	80	-32640#	400#	4450	50	-33820#	270#
	Cu	29	35210#	340#	2360#	220#	-6920#	270#	*		13660#	220#	*	
	Zn	30	*		-1510#	410#	-5200#	480#	*		15510#	430#	*	
55	K	19	4420#	1220#	*	-16190#	1410#	29310#	1240#	*		15550#	1220#	
	Ca	20	6360#	860#	37300#	1220#	-12750#	990#	23550#	720#	*		8030#	790#
	Sc	21	8100#	790#	32160#	1020#	-10000#	890#	19570	740	-31470#	1170#	7940	750
	Ti	22	10980	180	28350#	530#	-8230	180	13440	150	-25070#	720#	150	150
	V	23	13450	100	26110#	310#	-8360	100	8560	100	-22220	380	-290	100
	Cr	24	15965.38	0.22	22860	100	-7804.6	1.1	2371.9	0.4	-16800	120	-7623.4	1.0
	Mn	25	19165.3	0.5	20440	3	-7934.1	0.9	-3683.0	0.4	-15109	15	-9529.44	0.26
	Fe	26	22676.7	1.6	16772.6	0.4	-8455.5	0.9	-12144	11	-7835.8	0.4	-17541.14	0.28
	Co	27	27525	18	13917.6	0.6	-8211.1	0.9	-22400#	300#	-5761.2	1.1	-22890	50
	Ni	28	32110#	160#	8968	11	-7538	19	-30410#	250#	3628	11	-31710#	220#
	Cu	29	34310#	400#	3560#	300#	-6780#	330#	*		9100#	300#	-33130#	500#
	Zn	30	*		130#	300#	-5910#	360#	*		17000#	260#	*	
56	Ca	20	5690#	1140#	*	-12870#	1280#	25500#	930#	*		8070#	1170#	
	Sc	21	7200#	790#	34450#	1140#	-11500#	990#	20810#	730#	-32290#	1220#	8330#	720#
	Ti	22	9490	230	29620#	730#	-8850	730	16340	200	-28110#	730#	2140	220
	V	23	12330	200	26440	420	-8150	280	10830	200	-23790	760	960	200
	Cr	24	14491.3	2.0	24260	120	-8241	7	5324.1	2.0	-20900	150	-5642.0	2.0
	Mn	25	17497.0	1.1	21597	15	-7893.3	1.0	-870.4	2.0	-15050	100	-7501.66	0.23
	Fe	26	20495.5	0.3	18250.7	0.4	-7613.3	0.4	-6702	11	-12786.8	0.4	-14649.1	0.4
	Co	27	24172.4	2.0	15061.9	2.3	-7758.8	2.7	-17440#	140#	-5617.7	2.0	-18775	11
	Ni	28	30840	50	12229	11	-7997	13	-28180#	260#	-3713	11	-30350#	300#
	Cu	29	33050#	260#	5170#	140#	-7110#	150#	-33860#	300#	8140#	140#	-31750#	290#
	Zn	30	35300#	480#	1100#	270#	-5500#	270#	*		12320#	260#	*	
	Ga	31	*		-2380#	340#	-4540#	370#	*		19590#	400#	*	

A	El.	Z	S(n)	S(p)	Q(4β <sup>-</sup> )	Q(d,α)	Q(p,α)	Q(n,α)						
57	Ca	20	1750#	1350#	*	45400#	1000#	3860#	1410#	3150#	1350#	*		
	Sc	21	3490#	990#	14540#	1140#	36800#	700#	8140#	990#	8070#	990#	-9640#	1140#
	Ti	22	2680	500	15560#	830#	26640	460	6750	870	5540	590	-4010#	830#
	V	23	6180	310	12540	300	15160	230	8190	280	6270	260	-4320	440
	Cr	24	5314.2	2.6	13730	200	3557.8	2.6	7340	100	2231	15	-1280	120
	Mn	25	8648.4	1.9	9494.5	2.6	-10177	16	8331.5	1.9	4309.8	1.9	-1949	15
	Fe	26	7646.10	0.03	10559.39	0.21	-27380#	100#	8241.26	0.17	239.3	1.1	2398.8	0.4
	Co	27	11376.2	2.1	6027.8	0.5	-43440#	260#	8846.0	0.6	1772.3	0.6	1857.6	1.2
	Ni	28	10250	11	7331.6	2.7	*	*	8656.4	1.9	-3208.4	1.9	5816.9	1.9
	Cu	29	16780#	140#	695	19	*	*	8737	19	-3230	50	6346	16
	Zn	30	15140#	280#	1490#	170#	*	*	9540#	320#	-6240#	240#	12060#	110#
	Ga	31	19230#	370#	-2540#	370#	*	*	9730#	360#	-4470#	480#	11440#	340#
58	Sc	21	2560#	1060#	15340#	1280#	40730#	800#	8980#	1210#	7810#	1060#	-9260#	1280#
	Ti	22	5300#	830#	17370#	990#	31390#	700#	5220#	990#	3680#	1020#	-7000#	990#
	V	23	4090	340	13950	520	19640	250	9440	320	6330	290	-4980	780
	Cr	24	7380	200	14930	310	8390	200	4960	290	2180	230	-4520	250
	Mn	25	6490	30	10670	30	-4240	30	10090	30	4060	30	-1110	100
	Fe	26	10044.60	0.18	11955.6	1.9	-19860	50	5467.10	0.28	421.22	0.25	-1399.5	0.5
	Co	27	8573.0	1.2	6954.7	1.2	-35860#	210#	11470.3	1.2	2497.6	1.2	3511.1	1.2
	Ni	28	12217.0	1.8	8172.5	0.5	-51850#	320#	6522.5	2.1	-1336.1	0.6	2898.1	0.6
	Cu	29	12424	16	2869.1	2.3	*	*	12952	11	-1462	11	8011.9	1.6
	Zn	30	17570#	110#	2280	50	*	*	7010#	150#	-5810#	300#	8680	50
	Ga	31	16160#	340#	-1530#	240#	*	*	12450#	340#	-4200#	330#	13290#	370#
	Ge	32	*	*	-240#	410#	*	*	7080#	410#	*	*	12200#	400#
59	Sc	21	2940#	1210#	*	45440#	900#	7790#	1350#	8260#	1280#	*	*	
	Ti	22	2520#	990#	17330#	1060#	35450#	700#	6180#	990#	4920#	990#	-6130#	1140#
	V	23	4930	390	13590#	760#	25160	310	7190	550	6730	360	-6150#	760#
	Cr	24	4130	320	14970	350	13260	240	7010	340	3050	320	-3310	310
	Mn	25	7640	40	10930	210	880	30	7760	30	4670	30	-3750	210
	Fe	26	6581.01	0.11	12050	30	-13400	40	7534.5	1.9	1110.6	0.3	264.5	2.0
	Co	27	10453.9	1.1	7364.0	0.6	-28110#	170#	8662.5	0.5	3241.0	0.5	327.7	0.6
	Ni	28	8999.27	0.05	8598.8	1.1	-44160#	280#	8899.4	0.5	-252.2	2.1	5096.1	0.5
	Cu	29	12766.5	1.5	3418.5	0.5	*	*	10435.6	1.9	2411	11	5328.5	2.1
	Zn	30	13030	60	2890	40	*	*	10760	40	-3800#	150#	12290	40
	Ga	31	18210#	270#	-890#	180#	*	*	9390#	200#	-3530#	310#	10130#	220#
	Ge	32	16700#	420#	300#	350#	*	*	9610#	380#	-7390#	380#	14380#	380#
60	Sc	21	2030#	1280#	*	49180#	910#	*	7990#	1350#	1350#	*	*	
	Ti	22	4500#	1060#	18900#	1210#	39760#	800#	4240#	1130#	3910#	1060#	-8880#	1280#
	V	23	3580	570	14650#	850#	29070	470	8900#	850#	5830	660	-6240#	850#
	Cr	24	6680	320	16730	370	17970	210	4420	330	2550	320	-7310	500
	Mn	25	5770	90	12580	260	5170	90	9370	220	4210	90	-3340	250
	Fe	26	8820	3	13220	30	-7224	11	5210	30	939	4	-3241	4
	Co	27	7491.92	0.07	8274.9	0.6	-21650#	110#	11215.2	0.6	3395.2	0.6	1484.2	1.9
	Ni	28	11387.75	0.05	9532.64	0.19	-36700#	230#	6084.6	1.1	-263.8	0.5	1354.5	0.5
	Cu	29	10058.2	1.7	4477.4	1.6	-51950#	600#	12594.4	1.6	2601.9	2.4	6646.5	1.6
	Zn	30	15000	40	5120	11	*	*	8185	11	-2014	19	7541	11
	Ga	31	13950#	200#	30#	120#	*	*	13010#	120#	-2340#	150#	12960#	110#
	Ge	32	18840#	360#	940#	290#	*	*	6930#	320#	-7000#	350#	10680#	250#
	As	33	*	*	-3310#	660#	*	*	12690#	680#	*	*	15150#	650#



A	El.	Z	S(2n)	S(2p)	Q( $\alpha$ )	Q( $2\beta^-$ )	Q( $\epsilon p$ )	Q( $\beta^- n$ )						
57	Ca	20	5150#	1220#	*	-14150#	1410#	26420#	1100#	*	10080#	1220#		
	Sc	21	7250#	1020#	35000#	1220#	-11120#	990#	23500#	740#	*	10180#	730#	
	Ti	22	8020	480	30000#	830#	-8070#	680#	18980	460	-27390#	1010#	4460	500
	V	23	11180	250	29190	770	-8990#	380#	13300	230	-26210#	740#	3020	230
	Cr	24	13559.3	2.0	25430	150	-8120	100	7656.0	2.0	-20880	200	-3685.7	2.0
	Mn	25	15918.9	1.9	22910	100	-8063	4	1857.4	1.9	-18700	200	-4952.8	1.9
	Fe	26	18843.40	0.25	19650.6	0.4	-7320.3	0.4	-4098.2	1.9	-12187.9	2.0	-12212.1	2.0
	Co	27	21459.3	0.6	16211.6	0.6	-7081.2	0.7	-12035	16	-9723.5	0.6	-13512	11
	Ni	28	26889	11	13180.5	1.9	-7561.6	2.5	-23280#	100#	-2765.6	1.9	-25550#	140#
	Cu	29	31830#	300#	7860	16	-7090	24	-31410#	260#	1441	16	-29650#	260#
	Zn	30	34020#	270#	2040#	100#	-5860#	190#	*	13820#	100#	-36130#	280#	
	Ga	31	*		-1150#	400#	-4870#	370#	*	15410#	300#	*		
58	Sc	21	6050#	1060#	*	-12200#	1210#	25040#	840#	*		10300#	920#	
	Ti	22	7970#	730#	31900#	1140#	-9300#	990#	21070#	730#	-30940#	1220#	5350#	740#
	V	23	10270	320	29520#	740#	-8410	450	15700	250	-26810#	740#	4240	250
	Cr	24	12700	200	27480	280	-8670	240	10320	200	-25580	500	-2420	200
	Mn	25	15140	30	24400	210	-8440	30	3940	30	-19010	230	-3800	30
	Fe	26	17690.70	0.19	21450.1	2.0	-7645.8	0.4	-1925.7	0.6	-16918.2	2.0	-10880.5	0.6
	Co	27	19949.2	2.3	17514.1	1.2	-6715.4	1.6	-8183.8	1.8	-9648.0	2.2	-11835.2	2.1
	Ni	28	22467	11	14200.3	0.5	-6400.2	0.6	-17930	50	-7336.5	0.5	-20989	16
	Cu	29	29200#	140#	10200.6	2.5	-6077.4	1.6	-27680#	210#	393.2	1.5	-26930#	100#
	Zn	30	32710#	270#	2970	50	-5510	70	-33920#	320#	6500	50	-34470#	270#
	Ga	31	35390#	340#	-40#	260#	-4720#	300#	*	16040#	220#	*		
	Ge	32	*		-2780#	410#	-4230#	510#	*	17140#	330#	*		
59	Sc	21	5500#	1140#	*	-12200#	1350#	27030#	950#	*		12650#	1140#	
	Ti	22	7810#	830#	32670#	1220#	-9520#	990#	22680#	740#	*		6920#	740#
	V	23	9020	390	30960#	760#	-9910	800	18410	310	-29180#	860#	6700	370
	Cr	24	11510	240	28930	520	-8650	290	12770	240	-24410#	740#	-60	250
	Mn	25	14140	30	25870	230	-8750	100	6750	30	-22560	250	-1400	30
	Fe	26	16625.62	0.21	22716.9	2.0	-7980.5	0.5	492.5	0.6	-16120	200	-8888.6	1.2
	Co	27	19026.8	0.5	19319.6	1.9	-6942.7	0.6	-5871.2	0.5	-13610	30	-10072.03	0.19
	Ni	28	21216.3	1.8	15553.5	0.5	-6101.2	0.6	-13900	40	-6291.2	0.6	-17564.9	1.4
	Cu	29	25190	16	11591.0	0.7	-4754.6	0.8	-22240#	170#	-3800.3	1.2	-22130	50
	Zn	30	30600#	110#	5760	40	-4350	40	-30260#	280#	5680	40	-31350#	220#
	Ga	31	34360#	310#	1390#	170#	-4920#	340#	*	10250#	170#	-33820#	360#	
	Ge	32	*		-1220#	300#	-4500#	380#	*	18010#	280#	*		
60	Sc	21	4970#	1210#	*	*	*	28580#	1020#	*		13150#	1140#	
	Ti	22	7020#	1060#	*	-10630#	1210#	24860#	830#	*		7350#	860#	
	V	23	8510	540	31980#	930#	-9730#	850#	20600	480	-29830#	1020#	7240	530
	Cr	24	10810	290	30320#	730#	-9990	290	14910	210	-28580#	730#	900	220
	Mn	25	13410	90	27550	260	-9520	220	8470	90	-23400	320	-590	90
	Fe	26	15401	3	24160	200	-8556	4	3060	3	-20810	240	-7255	3
	Co	27	17945.8	1.1	20320	30	-7164.2	0.6	-3304.9	1.6	-13460	30	-8564.68	0.20
	Ni	28	20387.02	0.07	16896.6	0.6	-6291.6	0.5	-10284	11	-11097.9	0.6	-16186.2	0.5
	Cu	29	22824.7	2.1	13076.2	1.9	-4729.7	2.6	-18350#	110#	-3404.7	1.6	-19150	40
	Zn	30	28030	50	8538	11	-2709	15	-26420#	230#	-321	11	-28140#	170#
	Ga	31	32160#	240#	2910#	110#	-3820#	180#	-33600#	610#	9070#	110#	-31070#	300#
	Ge	32	35540#	390#	50#	240#	-4470#	350#	*	12200#	240#	*		
	As	33	*		-3010#	630#	-4080#	650#	*	20430#	620#	*		

A	Elt.	Z	$S(n)$	$S(p)$	$Q(4\beta^-)$	$Q(d,\alpha)$	$Q(p,\alpha)$	$Q(n,\alpha)$						
61	Ti	22	2070#	1210#	18940#	1280#	43270#	900#	5100#	1280#	4390#	1210#	*	
	V	23	4860#	620#	15000#	900#	33540#	400#	6570#	810#	6270#	810#	-8540#	900#
	Cr	24	3750	330	16890	540	22040	250	5600	400	2890	360	-5770#	740#
	Mn	25	6450	240	12340	310	10430	230	7050	330	5140	310	-5700	340
	Fe	26	5581	20	13030	90	-2576	26	7270	40	1850	40	-1440	200
	Co	27	9320.7	0.8	8776	4	-15810	50	8475.5	1.0	4119.1	0.9	-1350	30
	Ni	28	7820.13	0.05	9860.85	0.21	-30490#	300#	8718.33	0.20	489.0	1.1	3578.9	0.6
	Cu	29	11710.9	1.9	4800.5	1.0	-43930#	600#	9882.8	1.0	3108.1	1.0	3508.6	1.5
	Zn	30	10229	19	5290	16	*	*	10723	16	181	16	9529	16
	Ga	31	15160#	120#	190	50	*	*	10880	60	70	70	10220	50
	Ge	32	14030#	380#	1020#	320#	*	*	11100#	340#	-4880#	370#	14220#	300#
	As	33	19720#	840#	-2430#	640#	*	*	9660#	660#	-4810#	680#	11580#	630#
62	Ti	22	4080#	1280#	*	*	47250#	900#	3050#	1280#	3250#	1280#	*	*
	V	23	3130#	640#	16060#	1030#	37010#	500#	7940#	950#	5660#	860#	-8740#	1030#
	Cr	24	6310	420	18340#	520#	26330	340	2870	580	1520	460	-9550#	780#
	Mn	25	4550	320	13150	340	14760	220	9180	310	4720	330	-5330	380
	Fe	26	8051	25	14630	230	2271	18	4990	90	1440	30	-5360	240
	Co	27	6604	20	9799	28	-9430	30	10691	20	4096	20	-310	40
	Ni	28	10596.52	0.29	11136.6	0.7	-24500#	140#	5613.7	0.3	346.4	0.3	-436.6	0.6
	Cu	29	8886	4	5866	4	-37830#	300#	12385	4	3222	4	5077	4
	Zn	30	12897	19	6477	10	*	*	7883	10	50	10	5631	10
	Ga	31	12980	60	2940	30	*	*	12898	30	120	50	10003	28
	Ge	32	16590#	330#	2440#	150#	*	*	8470#	180#	-3260#	220#	10660#	150#
	As	33	14980#	670#	-1480#	420#	*	*	13520#	380#	-3100#	410#	14800#	340#
63	Ti	22	1620#	1350#	*	*	50350#	1010#	*	*	3660#	1350#	*	*
	V	23	4560#	780#	16550#	1080#	40930#	600#	5450#	1080#	5600#	1000#	-11270#	1080#
	Cr	24	3180#	450#	18390#	590#	29990#	300#	4540#	500#	1910#	560#	-8230#	860#
	Mn	25	6380	340	13230	420	19230	260	6540	360	5020	340	-8130	540
	Fe	26	4720	170	14800	280	6670	170	6720	280	2500	190	-3400	270
	Co	27	8480	28	10229	25	-5293	20	7792	28	4435	20	-3020	90
	Ni	28	6837.78	0.06	11370	20	-18600#	200#	8096.7	0.7	1000.5	0.3	1546	3
	Cu	29	10853	4	6122.41	0.06	-31760#	500#	9352.17	0.30	3756.60	0.30	1715.9	0.3
	Zn	30	9113	10	6704	4	*	*	10481.4	1.6	995.1	2.2	7905.5	1.6
	Ga	31	12618	28	2665	10	*	*	10509	16	2505	11	7443.4	2.1
	Ge	32	12740#	240#	2200#	200#	*	*	10890#	200#	-2050#	230#	12920#	200#
	As	33	16930#	590#	-1130#	520#	*	*	10620#	590#	-1190#	550#	11820#	520#
64	V	23	2560#	920#	17490#	1220#	44400#	700#	6970#	1140#	5120#	1140#	*	*
	Cr	24	5700#	500#	19530#	720#	33950#	400#	1980#	640#	1070#	570#	-11860#	990#
	Mn	25	4340	370	14380#	400#	22810	270	8510	430	4430	370	-7610#	480#
	Fe	26	7300	320	15710	380	11230	280	3980	360	1650	360	-6940	380
	Co	27	6024	28	11540	170	-958	20	9819	25	3993	28	-2590	230
	Ni	28	9658.04	0.19	12548	20	-12750	30	5043	20	663.2	0.7	-2531	20
	Cu	29	7916.03	0.09	7200.66	0.09	-25900#	360#	12032.66	0.11	3660.7	0.3	3120.6	0.7
	Zn	30	11861.9	1.5	7713.0	0.7	*	*	7505	4	844.1	0.7	3863.7	0.7
	Ga	31	10358.6	2.4	3910.3	2.5	*	*	13048	10	2375	16	8795.7	2.2
	Ge	32	15510#	200#	5090	30	*	*	8360	40	-2400	60	7640	40
	As	33	13770#	620#	-100#	300#	*	*	13430#	380#	-930#	470#	13220#	360#
65	V	23	3930#	1060#	*	*	47920#	800#	4660#	1280#	5270#	1210#	*	*
	Cr	24	2720#	640#	19690#	860#	37330#	500#	3830#	780#	1490#	710#	-10500#	1030#
	Mn	25	6130	600	14810#	670#	26590	540	5570#	610#	4610	630	-10600#	740#
	Fe	26	4180	370	15550	360	15030	240	6180	350	2020	330	-4820	420
	Co	27	7449	24	11690	280	3487	13	7090	170	4595	20	-5480	220
	Ni	28	6098.09	0.14	12622	20	-8710	100	7425	20	1170	20	-579	14
	Cu	29	9910.7	0.7	7453.4	0.7	-20280#	300#	8959.7	0.7	4346.5	0.7	-186	20
	Zn	30	7979.32	0.17	7776.3	0.7	-32990#	600#	10378.7	0.7	1750	4	6480.9	0.7
	Ga	31	11894.2	2.1	3942.5	0.6	*	*	10266.7	1.6	3378	10	5787	4
	Ge	32	10140	100	4870	100	*	*	10840	100	450	100	10400	100
	As	33	15530#	470#	-80#	300#	*	*	10640#	360#	130#	330#	10670#	300#
	Se	34	*	*	690#	700#	*	*	11610#	780#	-3090#	670#	14970#	610#

A	El.	Z	S(2n)	S(2p)	Q( $\alpha$ )	Q( $2\beta^-$ )	Q( $\epsilon p$ )	Q( $\beta^- n$ )						
61	Ti	22	6580#	1140#	*	-10950#	1350#	26530#	940#	*	8860#	1020#		
	V	23	8440#	510#	33900#	990#	-11100#	810#	22200#	460#	-32650#	990#	9070#	450#
	Cr	24	10430	350	31540#	740#	-11060	520	16740	260	-27820#	840#	2930	270
	Mn	25	12220	230	29070	380	-9790	330	11340	230	-26270	530	1780	230
	Fe	26	14401	20	25610	250	-8822	20	5300	20	-19710	210	-5344	20
	Co	27	16812.6	0.8	22000	30	-7836.5	2.0	-914.8	1.2	-17010	90	-6497.7	0.8
	Ni	28	19207.88	0.07	18135.7	0.6	-6465.7	0.5	-7875	16	-10098	3	-13948.1	1.6
	Cu	29	21769.1	1.1	14333.2	1.0	-5064.4	1.1	-14890	50	-7623.6	1.0	-15867	11
	Zn	30	25230	40	9768	16	-2688	16	-22620#	300#	838	16	-24420#	110#
	Ga	31	29110#	180#	5310	50	-2210	50	-29040#	600#	3960	50	-27390#	240#
	Ge	32	32870#	410#	1050#	300#	-3360#	320#	*		13170#	300#	-35400#	670#
	As	33	*		-1490#	620#	-4580#	650#	*		14660#	610#	*	
62	Ti	22	6150#	1210#	*	*	*	28760#	960#	*	*	9640#	990#	
	V	23	7990#	690#	35010#	1030#	-11680#	950#	23620#	550#	*	9690#	560#	
	Cr	24	10050	400	33350#	870#	-12070#	780#	18490	340	-32050#	960#	3070	410
	Mn	25	11000	240	30040	520	-10250	330	13390	220	-25970#	460#	2810	220
	Fe	26	13632	15	26970	210	-9490	200	7845	14	-24010	260	-4074	14
	Co	27	15925	20	22830	90	-7950	40	1366	20	-17160	230	-5282	20
	Ni	28	18416.65	0.29	19912	3	-7017.6	0.6	-5575	10	-15114	20	-12833.8	1.0
	Cu	29	20596	4	15727	4	-5377	4	-10797	28	-7188	4	-14524	17
	Zn	30	23126	15	11277	10	-3369	10	-18930#	140#	-4240	10	-22150	50
	Ga	31	28150#	120#	8234	28	-2763	28	-27040#	300#	2694	28	-26340#	300#
	Ge	32	30620#	270#	2630#	140#	-2370#	150#	*		6810#	140#	-32260#	610#
	As	33	34710#	670#	-460#	320#	-3400#	370#	*		14840#	300#	*	
63	Ti	22	5690#	1350#	*	*	*	30330#	1040#	*	*	11160#	1120#	
	V	23	7690#	720#	*	-13300#	1080#	25440#	650#	*	*	11430#	690#	
	Cr	24	9490#	390#	34460#	950#	-12740#	760#	20020#	340#	-31160#	950#	4440#	370#
	Mn	25	10940	340	31570#	480#	-11710	400	15490	260	-29220#	570#	4480	260
	Fe	26	12770	170	27940	310	-10080	300	9970	170	-22420	380	-2190	170
	Co	27	15085	20	24860	230	-8790	40	3739	20	-21090	220	-3166	20
	Ni	28	17434.30	0.30	21169	20	-7274.4	0.6	-3299.5	1.6	-13901	14	-10786	4
	Cu	29	19738.5	1.0	17259.0	0.7	-5776.0	0.3	-9032.4	1.4	-11437	20	-12479	10
	Zn	30	22010	16	12570.1	1.6	-3482.3	1.6	-15300#	200#	-2755.9	1.6	-18284	28
	Ga	31	25600	50	9141.4	1.6	-2614.8	1.5	-22730#	500#	-1038	4	-22380#	140#
	Ge	32	29320#	360#	5140#	200#	-2070#	200#	*		6970#	200#	-30020#	360#
	As	33	31910#	780#	1310#	510#	-2130#	530#	*		10890#	500#	*	
64	V	23	7120#	860#	*	-13830#	1140#	27220#	750#	*	*	12060#	760#	
	Cr	24	8880#	520#	36080#	990#	-13930#	900#	21620#	490#	-35240#	1070#	5130#	480#
	Mn	25	10720	350	32770#	570#	-12460	540	17180	270	-28990#	650#	4860	320
	Fe	26	12010	280	28930	440	-10690	350	12330	280	-26530#	410#	-1000	280
	Co	27	14504	28	26330	220	-9040	90	5632	20	-20730	260	-2351	20
	Ni	28	16495.82	0.20	22776	14	-8112	3	-1095.7	0.7	-18840	170	-9591.06	0.19
	Cu	29	18769	4	18571	20	-6200.1	0.4	-6589.9	2.1	-10873	20	-11282.5	1.6
	Zn	30	20975	10	13835.4	0.7	-3956.4	0.7	-11650	30	-7780.0	0.7	-17527.8	1.5
	Ga	31	22977	28	10614	5	-2915.1	2.6	-19310#	360#	-543.8	2.1	-20000#	200#
	Ge	32	28250#	140#	7760	30	-2590	30	*		570	30	-28600#	500#
	As	33	30700#	470#	2100#	360#	-1950#	380#	*		9740#	360#	*	
65	V	23	6480#	1000#	*	*	*	29420#	960#	*	*	13830#	900#	
	Cr	24	8410#	590#	37180#	1120#	-14570#	1030#	23080#	560#	*	*	6750#	570#
	Mn	25	10460	600	34340#	800#	-13740#	670#	18500	540	-32560#	880#	6030	600
	Fe	26	11470	300	29930#	390#	-11120	350	14250	240	-25020#	470#	840	240
	Co	27	13472	24	27400	260	-10040	230	8094	13	-23840	270	-142	13
	Ni	28	15756.13	0.24	24160	170	-8630	20	785.5	0.7	-17640	280	-7773.13	0.24
	Cu	29	17826.8	0.7	20001	20	-6790.2	1.0	-4606.5	0.7	-14760	20	-9331.4	0.4
	Zn	30	19841.2	1.5	14977.0	0.7	-4115.6	0.7	-9500	100	-6101.3	0.7	-15148.6	2.1
	Ga	31	22252.7	1.5	11655.6	0.9	-3098.4	1.0	-15680#	300#	-4521.9	0.9	-16380	30
	Ge	32	25650#	220#	8780	100	-2490	100	-23500#	600#	2300	100	-24970#	370#
	As	33	29300#	590#	5010#	300#	-2320#	310#	*		4560#	300#	*	
	Se	34	*		590#	630#	-1620#	670#	*		14140#	600#	*	

A	Elt.	Z	S(n)	S(p)	Q(4β <sup>-</sup> )	Q(d,α)	Q(p,α)	Q(n,α)						
66	Cr	24	5070#	780#	20830#	1000#	41210#	600#	1310#	920#	980#	840#	-13950#	1160#
	Mn	25	3650#	670#	15750#	640#	30010#	400#	7610#	570#	4140#	500#	-9700#	720#
	Fe	26	6770	390	16190	620	19330	300	3750	400	1640	400	-8400#	430#
	Co	27	5010	250	12520	350	7610	250	9370	370	4300	300	-4110	360
	Ni	28	8951.6	1.5	14125	13	-4380	30	4497	20	698	20	-4810	170
	Cu	29	7065.93	0.09	8421.2	0.7	-14760	680	11551.8	0.7	4118.3	0.7	1229	20
	Zn	30	11059.1	1.0	8924.7	1.0	-27180#	300#	7235.6	0.8	1544.2	0.8	2259.5	0.8
	Ga	31	9139	3	5102	3	*	*	12990	3	3353	3	7502	3
	Ge	32	13280	100	6260	30	*	*	7920	30	-210	30	6240	30
	As	33	12590#	740#	2380	690	*	*	13560	680	270#	710#	10690	680
	Se	34	16870#	670#	2030#	420#	*	*	8510#	470#	-3040#	590#	10840#	360#
67	Cr	24	2320#	920#	*	*	44690#	700#	2910#	1060#	1210#	990#	*	*
	Mn	25	5220#	640#	15900#	780#	33920#	500#	5100#	710#	4610#	640#	-12360#	860#
	Fe	26	4190	510	16730#	580#	22190	420	5690	680	1790	490	-6890#	580#
	Co	27	7020	410	12780	440	11820	320	6530	400	4570	420	-6800	420
	Ni	28	5808	3	14920	250	-1085	5	6138	13	914	20	-3330	280
	Cu	29	9131.8	1.4	8601.5	1.8	-10670	100	8518.1	1.4	4644.6	1.4	-1880	20
	Zn	30	7052.33	0.22	8911.1	1.0	-21390#	200#	10094.0	1.0	2407.9	0.8	4865.2	0.8
	Ga	31	11227	3	5269.2	1.2	-34080#	500#	9742.7	1.4	3988.0	1.4	4191.0	1.3
	Ge	32	9100	30	6222	6	*	*	10710	5	1041	5	8992	5
	As	33	13220	690	2310	100	*	*	10480	140	2570	100	7830	100
	Se	34	12840#	360#	2280#	710#	*	*	11200#	360#	-2110#	410#	13510#	200#
	Br	35	*	*	-1640#	590#	*	*	10830#	780#	*	*	12370#	620#
68	Mn	25	3270#	780#	16840#	920#	36970#	600#	6910#	840#	4060#	780#	-11700#	1000#
	Fe	26	5510	810	17010#	860#	26880	700	3840#	810#	2410	880	-9690#	860#
	Co	27	4360	450	12950	520	15740	320	8930	440	4390	400	-5030	620
	Ni	28	7792	4	15690	320	3516	7	3360	250	570	13	-6940	240
	Cu	29	6319.6	2.0	9113	3	-6670	40	11150.1	2.1	4423.1	1.7	-751	13
	Zn	30	10198.10	0.19	9977.4	1.5	-15790	30	6961.9	1.0	2120.5	1.0	765.2	0.8
	Ga	31	8277.8	1.7	6494.6	1.2	-28440#	360#	12524.1	1.2	3689.5	1.6	5823.9	1.6
	Ge	32	12393	8	7389	6	*	*	7455	7	541	6	4578	6
	As	33	10320	110	3530	40	*	*	13440	50	2380	110	9400	40
	Se	34	15800#	200#	4860	110	*	*	8000	680	-2370#	300#	7850	110
	Br	35	13920#	620#	-560#	300#	*	*	13790#	470#	-860#	700#	13990#	470#
69	Mn	25	4770#	1000#	*	*	40440#	800#	4460#	1060#	4360#	1000#	*	*
	Fe	26	3340#	860#	17090#	780#	30020#	500#	5720#	710#	2720#	640#	-7950#	780#
	Co	27	6720	460	14160	770	19330	340	6400	530	4430	450	-8100#	520#
	Ni	28	4586	5	15920	320	7122	4	5790	320	1000	250	-4760	300
	Cu	29	8240.5	2.1	9561	3	-2650	30	8717	3	5134.1	2.0	-3980	250
	Zn	30	6482.07	0.16	10139.9	1.9	-12120	30	9611.6	1.6	2704.4	1.1	3234.7	1.7
	Ga	31	10313.0	1.9	6609.5	1.5	-22850#	110#	9263.5	1.5	4435.7	1.5	2576.9	1.4
	Ge	32	8192	6	7303.5	2.0	-34670#	400#	10489.9	1.8	1488	3	7445.2	1.6
	As	33	12260	50	3400	30	*	*	10280	30	3400	40	6280	30
	Se	34	10160	50	4690	50	*	*	11060	110	60	680	10970	50
	Br	35	15910#	370#	-450#	100#	*	*	10730#	220#	110#	320#	10670#	690#
	Kr	36	*	*	1080#	540#	*	*	11070#	640#	*	*	14930#	500#
70	Fe	26	5580#	780#	17890#	1000#	33670#	600#	3410#	840#	2370#	780#	-11200#	920#
	Co	27	3710	900	14540#	980#	23270	840	8200	1090	4910	940	-6590#	980#
	Ni	28	7240	350	16440	480	11410	350	2910	470	780	470	-7810	540
	Cu	29	5311.2	2.1	10286	4	1370	50	11198	3	5631	3	-2270	320
	Zn	30	9218.0	2.1	11117.4	2.4	-7520	60	6713.2	2.5	2618.2	2.3	-176	3
	Ga	31	7653.65	0.17	7781.1	1.5	-17480#	310#	11807.9	1.5	3834.4	1.5	4055.1	1.7
	Ge	32	11533.8	1.7	8524.3	1.6	-28890#	390#	7233.8	1.7	1180.6	1.2	2963.7	1.2
	As	33	9330	60	4530	50	*	*	13350	50	3180	50	8180	50
	Se	34	13820	70	6250	70	*	*	7560	80	-530	120	6260	60
	Br	35	13020#	320#	2410#	310#	*	*	13500#	310#	-70#	360#	10870#	320#
	Kr	36	17310#	560#	2490#	400#	*	*	7680#	530#	-4010#	630#	10460#	430#

A	Elt.	Z	S(2n)	S(2p)	Q( $\alpha$ )	Q( $2\beta^-$ )	Q( $\epsilon p$ )	Q( $\beta^- n$ )						
66	Cr	24	7790#	720#	*	-15570#	1080#	24780#	670#	*	7810#	800#		
	Mn	25	9780#	480#	35430#	810#	-14260#	640#	19860#	470#	-32290#	900#	6550#	470#
	Fe	26	10950	410	31000#	500#	-11580	450	16430	300	-29070#	590#	1530	300
	Co	27	12460	250	28070	370	-10500	340	10150	250	-22730	590	940	250
	Ni	28	15049.6	1.5	25810	280	-9530	15	2893.1	1.7	-22420	240	-6813.9	1.6
	Cu	29	16976.7	0.7	21044	20	-7252	20	-2534	3	-14377	13	-8418.0	0.3
	Zn	30	19038.5	1.0	16378.1	0.8	-4578.2	0.8	-7280	30	-11062.3	0.8	-14313.6	1.1
	Ga	31	21033	4	12878	3	-3352	5	-12220	680	-3750	3	-15380	100
	Ge	32	23420	40	10200	30	-2880	30	-19900#	300#	-3000	30	-22720#	300#
	As	33	28120#	770#	7250	680	-1930	680	*		3870	680	-26660#	900#
	Se	34	*		1950#	300#	-1900#	330#	*		7400#	310#	*	
67	Cr	24	7400#	860#	*	-16280#	1220#	26640#	810#	*		9130#	810#	
	Mn	25	8870#	740#	36730#	950#	-14920#	780#	21660#	600#	*		8100#	590#
	Fe	26	10960	480	32480#	650#	-12590#	510#	18050	420	-28190#	730#	2350	490
	Co	27	12030	320	28970	620	-11130	410	12260	320	-26100#	510#	2870	320
	Ni	28	14759.3	3.0	27440	240	-10620	170	4138	3	-21460	300	-5555.7	3.0
	Cu	29	16197.8	1.4	22727	13	-7903	20	-439.1	1.8	-18500	250	-6490.7	1.5
	Zn	30	18111.5	1.0	17332.3	0.8	-4792.8	0.8	-5223	5	-9163.1	1.7	-12227	3
	Ga	31	20365.1	1.5	14194.0	1.4	-3725.1	1.3	-10230	100	-7910.4	1.4	-13330	30
	Ge	32	22390	100	11324	5	-2870	5	-16170#	200#	-1047	5	-19230	680
	As	33	25810#	320#	8570	100	-2530	100	-23850#	510#	-210	100	-23000#	310#
	Se	34	29720#	630#	4650#	220#	-2010#	280#	*		7850#	200#	*	
	Br	35	*		400#	590#	-1400#	710#	*		11420#	850#	*	
68	Mn	25	8490#	720#	*	-15620#	920#	22750#	680#	*		9020#	730#	
	Fe	26	9700	760	32910#	920#	-12400#	810#	20340	700	-31370#	990#	3860	770
	Co	27	11380	410	29680#	510#	-11160	420	14220	320	-25240#	600#	4320	320
	Ni	28	13600	3	28470	300	-11120	280	6543	3	-25060	420	-4216	3
	Cu	29	15451.4	1.7	24030	250	-8199	20	1519.1	2.2	-17790	320	-5757.9	1.8
	Zn	30	17250.43	0.29	18578.9	1.7	-5332.9	0.8	-3027	6	-13554	3	-11198.9	1.2
	Ga	31	19504	3	15405.8	1.6	-4086.8	1.4	-8190	40	-7056.3	2.0	-12500	5
	Ge	32	21500	30	12658	6	-3401	6	-12760	30	-6388	6	-18400	100
	As	33	23540	680	9750	40	-2490	40	-20260#	360#	690	40	-20480#	200#
	Se	34	28640#	300#	7170	40	-2290	50	*		1150	30	-29490#	500#
	Br	35	*		1720#	770#	-1550#	510#	*		10720#	370#	*	
69	Mn	25	8040#	950#	*	-16470#	1130#	24700#	870#	*		9760#	1060#	
	Fe	26	8850#	650#	33930#	860#	-13030#	710#	21580#	500#	*		4880#	600#
	Co	27	11080	460	31180#	610#	-11750	630	15730	340	-28700#	680#	5390	340
	Ni	28	12379	5	28860	420	-11530	240	8439	4	-24140	700	-2483	4
	Cu	29	14560.1	1.8	25250	320	-8991	13	3591.5	1.8	-21670	320	-3800.3	1.7
	Zn	30	16680.17	0.25	19253	3	-5716.8	0.8	-1317.4	1.6	-12243	3	-9403.2	1.2
	Ga	31	18590.7	1.7	16586.9	1.7	-4489.0	1.4	-6240	30	-11049.7	2.0	-10419	6
	Ge	32	20585	5	13798.1	1.6	-3613.9	1.5	-10800	30	-4382.4	1.6	-16270	40
	As	33	22580	100	10780	30	-2850	30	-16610#	110#	-3290	30	-16940	50
	Se	34	25950#	200#	8220	30	-2310	110	-23870#	400#	3390	30	-25730#	360#
	Br	35	29820#	510#	4410#	150#	-1920#	320#	*		5130#	110#	*	
	Kr	36	*		520#	450#	-1940#	720#	*		14490#	400#	*	
70	Fe	26	8910#	920#	*	-13530#	840#	23250#	690#	*		6030#	680#	
	Co	27	10440	900	31620#	1030#	-11810#	930#	17330	840	-27630#	1160#	6260	840
	Ni	28	11830	350	30600	780	-12000	460	10410	350	-28040#	610#	-1480	350
	Cu	29	13551.7	2.2	26200	320	-9290	250	5934.0	2.0	-20260	340	-2629.5	1.9
	Zn	30	15700.1	2.1	20679	4	-5983.3	2.4	998.5	2.2	-16875	4	-8308.2	1.6
	Ga	31	17966.6	1.9	17921.0	2.0	-5076.7	1.4	-4570	50	-10462.8	1.8	-9880.8	0.6
	Ge	32	19726	6	15133.8	1.2	-4088.6	1.2	-8520	60	-9434.1	1.3	-15550	30
	As	33	21590	70	11830	50	-3040	50	-12920#	310#	-2300	50	-16110	60
	Se	34	23970	70	9640	60	-2850	70	-20370#	380#	-2230	60	-23640#	120#
	Br	35	28930#	470#	7110#	310#	-2350#	750#	*		4370#	310#	-27060#	500#
	Kr	36	*		2040#	390#	-2380#	490#	*		7340#	390#	*	

A	Elt.	Z	S(n)	S(p)	Q( $4\beta^-$ )	Q(d, $\alpha$ )	Q(p, $\alpha$ )	Q(n, $\alpha$ )						
71	Fe	26	3170#	1000#	*	36330#	800#	5010#	1130#	2460#	1000#	*		
	Co	27	6300	1190	15260#	1030#	26270	840	5230#	980#	4120	1090	-9630#	1030#
	Ni	28	4130	510	16850	920	14700	370	5510	500	1010	490	-6430	790
	Cu	29	7806.3	2.2	10850	350	5183	4	7978	4	5617	3	-5710	320
	Zn	30	5834	10	11640	10	-4210	30	9120	10	3104	10	1783	11
	Ga	31	9301.5	1.6	7864.6	2.2	-13080	570	8988.5	1.3	4731.0	1.2	1073.2	1.9
	Ge	32	7415.94	0.11	8286.6	1.6	-22980	650	10130.8	1.6	2042.4	1.7	5745.9	1.2
	As	33	11620	50	4620	4	-35590#	500#	9917	4	3950	7	4838	4
	Se	34	9140	70	6060	60	*	*	10680	40	650	50	9510	30
	Br	35	13710#	650#	2310	570	*	*	9950	570	2020	570	7480	570
	Kr	36	13320#	760#	2790#	720#	*	*	10260#	660#	-3420#	740#	12940	650
	Rb	37	*	*	-2080#	630#	*	*	10840#	640#	*	*	11980#	620#
72	Fe	26	5370#	1130#	*	39830#	800#	*	*	1870#	1130#	*		
	Co	27	3500#	1030#	15590#	1000#	29290#	600#	7310#	840#	3960#	780#	-8350#	1000#
	Ni	28	6810	570	17360	950	18650	440	2410	950	930	550	-9900#	670#
	Cu	29	5143.2	2.0	11870	370	8447	5	10080	350	5060	4	-4130	340
	Zn	30	8876	12	12709	6	-237	13	5556	6	2469	6	-2506	7
	Ga	31	6520.45	0.19	8551	10	-9570	60	11686.1	2.2	4692.6	1.3	2793.2	1.7
	Ge	32	10749.5	1.8	9734.6	1.8	-18645	8	7035.0	2.0	1605.9	2.0	1478.5	1.9
	As	33	8407	6	5611	4	-30110#	500#	13044	4	3735	5	6744	5
	Se	34	12850	30	7289	13	*	*	7160	50	60	30	4853	12
	Br	35	10020	570	3190	70	*	*	13740	90	2150	70	9720	70
	Kr	36	15090	650	4170	570	*	*	8200#	310#	-2600#	110#	8010	40
	Rb	37	13880#	710#	-1520#	820#	*	*	14270#	630#	-820#	640#	14010#	510#
73	Co	27	5810#	920#	16030#	1060#	32660#	700#	4680#	1060#	3730#	920#	*	
	Ni	28	3990#	530#	17850#	670#	21440#	300#	4720#	890#	640#	890#	-8320#	670#
	Cu	29	7275	4	12340	440	11970	6	6930	370	5030	350	-7700	840
	Zn	30	5350	40	12920	40	2810	40	8010	40	2430	40	-610	350
	Ga	31	9181.3	2.0	8857	6	-6070	50	8338	10	4729.4	2.6	-1076.8	2.3
	Ge	32	6782.94	0.05	9997.1	1.8	-14746	7	9553.5	1.8	2476.6	2.0	3913.5	2.5
	As	33	10798	5	5660	4	-24910#	150#	9662	4	4470	4	3600	4
	Se	34	8395	16	7277	11	-36520#	600#	10388	11	990	50	7992	11
	Br	35	12690	80	3020	50	*	*	10200	60	3280	80	6360	70
	Kr	36	10682	10	4830	60	*	*	11220	570	-260#	310#	11140	60
	Rb	37	16010#	530#	-600#	150#	*	*	11580#	670#	490#	410#	11020#	340#
	Sr	38	*	*	870#	780#	*	*	11320#	780#	*	*	15620#	710#
74	Co	27	3280#	1060#	*	35800#	800#	6760#	1130#	3620#	1130#	*		
	Ni	28	6580#	500#	18630#	810#	25050#	400#	1640#	720#	370#	930#	-11730#	900#
	Cu	29	5091	7	13430#	300#	14854	7	8640	440	4060	370	-6490	840
	Zn	30	8370	60	14010	50	6500	50	4780	50	1870	50	-4860	370
	Ga	31	6422	4	9930	40	-2744	16	10793	7	4141	11	308	4
	Ge	32	10196.22	0.06	11012.1	2.3	-11090.9	2.6	5877.7	1.8	1581.9	1.8	-449	10
	As	33	7975	4	6851.4	1.7	-18943	4	12436.8	1.7	3911.8	2.5	4926.7	2.5
	Se	34	12066	11	8545	4	-31520#	500#	6728	4	546	4	3341.4	1.9
	Br	35	9750	50	4377	18	*	*	13299	19	2670	40	8235	16
	Kr	36	13851	7	5990	50	*	*	7390	60	-400	570	6430	30
	Rb	37	13940#	150#	2654	8	*	*	12735	9	-130	650	10790	570
	Sr	38	17070#	780#	1930#	530#	*	*	8130#	710#	-3530#	710#	11870#	820#
75	Co	27	5320#	1130#	*	38960#	800#	*	*	3660#	1130#	*		
	Ni	28	3600#	570#	18940#	900#	27960#	400#	3850#	810#	260#	720#	-9960#	900#
	Cu	29	6180	980	13040#	1060#	18910	980	6450#	1020#	4680	1070	-9170#	1150#
	Zn	30	4830	80	13750	70	9700	70	7230	70	2180	70	-2880	440
	Ga	31	8486	4	10040	50	674	14	7660	40	4531	7	-3035.2	2.8
	Ge	32	6505.31	0.07	11096	4	-7533	8	8553.7	2.3	1597.0	1.8	1921	6
	As	33	10243.8	1.9	6898.9	1.0	-15811	8	8975.9	1.0	4417.6	1.0	1203.4	2.0
	Se	34	8027.60	0.07	8598.0	1.8	-25550	220	9498	4	925	4	6063.3	0.6
	Br	35	11904	21	4215	14	*	*	9789	18	3619	19	4737	15
	Kr	36	10063	8	6307	17	*	*	10020	50	-440	60	9217	15
	Rb	37	13376	8	2179	8	*	*	10041	10	1583	11	7440	60
	Sr	38	14000#	550#	1990	220	*	*	10140#	270#	-3640#	550#	12970	220

A	Elt.	Z	S(2n)	S(2p)	Q( $\alpha$ )	Q( $2\beta^-$ )	Q( $\epsilon p$ )	Q( $\beta^- n$ )						
71	Fe	26	8750#	950#	*	-14380#	1060#	24200#	880#	*	6570#	1160#		
	Co	27	10010	900	33150#	1160#	-12900#	980#	18840	840	*	7210	910	
	Ni	28	11370	370	31390#	620#	-11940	560	12120	370	-26590#	700#	-300	370
	Cu	29	13117.5	2.0	27290	340	-10070	320	7429.1	1.8	-24360	840	-1217.8	2.5
	Zn	30	15052	10	21926	11	-6009	11	2581	10	-15470	350	-6488	10
	Ga	31	16955.1	1.6	18982.0	1.7	-5246.4	1.6	-2246	4	-14453.1	1.9	-7648.45	0.24
	Ge	32	18949.8	1.7	16067.7	1.3	-4452.2	1.2	-6790	30	-7632.1	2.2	-13640	50
	As	33	20950	30	13145	4	-3440	4	-10830	570	-6273	4	-13920	60
	Se	34	22960	50	10590	30	-2880	30	-16190	650	160	30	-19760#	310#
	Br	35	26730#	580#	8550	570	-2840	580	-24760#	760#	-10	570	-23460#	690#
	Kr	36	30630#	770#	5200	650	-2860#	680#	*	*	7830	660	*	*
	Rb	37	*	*	410#	510#	-1930#	710#	*	*	11830#	590#	*	*
72	Fe	26	8540#	1000#	*	*	*	25640#	910#	*	*	7500#	1160#	
	Co	27	9800#	1030#	*	*	-13130#	840#	20480#	600#	*	7830#	700#	
	Ni	28	10930	560	32620#	740#	-13240	820	14190	440	-30230#	910#	700	440
	Cu	29	12949.5	2.1	28720	840	-10860	320	8806.4	1.7	-23200	840	-527	10
	Zn	30	14709	6	23560	350	-7092	7	4455	6	-20220	370	-6062	6
	Ga	31	15821.9	1.6	20191.2	1.9	-5447.3	1.9	-360	4	-13167.2	1.8	-6752.96	0.29
	Ge	32	18165.4	1.8	17599.2	2.5	-5003.6	1.9	-4692	12	-12548	10	-12763	4
	As	33	20030	50	13898	5	-3569	5	-9210	60	-5379	4	-13180	30
	Se	34	21990	60	11909	12	-3340	14	-13953	14	-5276	12	-18900	570
	Br	35	23730#	310#	9250	80	-2540	70	-20900#	510#	1590	60	-20160	650
	Kr	36	28410#	390#	6470	60	-2150	30	*	*	1890	30	-29710#	500#
	Rb	37	*	*	1270#	590#	-1900#	620#	*	*	11660#	760#	*	*
73	Co	27	9310#	1090#	*	*	-14160#	1060#	21950#	700#	*	*	8830#	820#
	Ni	28	10800#	470#	33440#	860#	-13890#	590#	15550#	300#	-28850#	860#	1850#	300#
	Cu	29	12418	4	29690	840	-11410	340	10713	4	-26980#	600#	1073	7
	Zn	30	14230	40	24780	370	-7860	40	5890	40	-18760	440	-4890	40
	Ga	31	15701.7	2.0	21566.1	2.2	-6388.0	2.2	1257	4	-17205.3	2.2	-5184.7	2.3
	Ge	32	17532.4	1.8	18549	10	-5304.5	1.9	-3080	11	-10455	6	-11139	4
	As	33	19205	6	15394	4	-4054	4	-7330	50	-9656	4	-11134	12
	Se	34	21240	30	12888	11	-3542	11	-11666	13	-2921	11	-17270	60
	Br	35	22710	570	10310	50	-2970	60	-17580#	160#	-2690	50	-17760	50
	Kr	36	25770	650	8010	30	-2680	40	-24850#	600#	4054	14	-26510#	500#
	Rb	37	29890#	530#	3570#	590#	-2000#	180#	*	*	5670#	160#	*	*
	Sr	38	*	*	-650#	880#	-1690#	720#	*	*	14950#	600#	*	*
74	Co	27	9090#	1000#	*	*	*	23760#	800#	*	*	9540#	860#	
	Ni	28	10580#	590#	34650#	900#	-14900#	720#	17340#	400#	*	*	2540#	400#
	Cu	29	12366	6	31280#	600#	-12790	840	12043	7	-26260#	700#	1330	40
	Zn	30	13720	50	26350	440	-8980	350	7710	50	-23140#	300#	-4080	50
	Ga	31	15603	4	22845	4	-7498	4	2810	4	-16352	5	-4823	4
	Ge	32	16979.16	0.08	19869	6	-6282.7	2.5	-1209.7	0.6	-15300	40	-10537	4
	As	33	18773	4	16848.5	2.5	-4374.8	2.6	-5554	15	-8449.6	2.9	-10714	11
	Se	34	20461	12	14204.8	0.6	-4074.5	1.9	-9881.2	2.6	-8204.2	0.6	-16660	50
	Br	35	22430	60	11654	16	-3390	50	-13389	16	-1638	15	-16826	16
	Kr	36	24533	8	9015	12	-2710	60	-21640#	500#	-1403	11	-24350#	150#
	Rb	37	29940#	500#	7480	60	-2920#	310#	*	*	4420	50	-28290#	600#
	Sr	38	*	*	1330#	500#	-1450#	630#	*	*	8570#	500#	*	*
75	Co	27	8610#	1060#	*	*	*	24620#	1260#	*	*	10800#	900#	
	Ni	28	10180#	500#	*	*	-15330#	900#	18570#	410#	*	*	4030#	400#
	Cu	29	11280	980	31660#	1200#	-12670	1290	14340	980	-29160#	1260#	3520	980
	Zn	30	13200	80	27180#	310#	-9690	370	9390	70	-21390#	410#	-2490	70
	Ga	31	14907.9	2.9	24056	5	-8178.4	2.8	4568	3	-19747	7	-3113.5	2.9
	Ge	32	16701.53	0.09	21020	40	-6954	10	312.6	0.6	-13440	50	-9067.8	1.7
	As	33	18218	4	17911.0	2.5	-5317.1	2.0	-3893	14	-12272	4	-8891.0	0.8
	Se	34	20094	11	15449.4	0.6	-4686.2	1.9	-7845	8	-6035.6	0.6	-14934	15
	Br	35	21650	50	12760	15	-3670	15	-11917	16	-5568	14	-14879	14
	Kr	36	23915	10	10684	13	-3630	30	-17700	220	600	8	-20478	9
	Rb	37	27310#	150#	8170	50	-2580	570	*	*	795	17	-24600#	500#
	Sr	38	31070#	640#	4650	220	-2120	690	*	*	8420	220	*	*

A	Elt.	Z	S(n)	S(p)	Q(4β <sup>-</sup> )	Q(d,α)	Q(p,α)	Q(n,α)						
76	Ni	28	5780#	990#	19400#	1210#	31600#	900#	1350#	1210#	290#	1140#	*	
	Cu	29	4930	980	14360#	400#	21314	7	8110#	400#	3750#	300#	-8290#	700#
	Zn	30	7740	110	15310	980	13120	80	4580	80	1710	80	-6630#	310#
	Ga	31	5903	3	11120	70	3993	10	10120	50	3980	40	-1664	4
	Ge	32	9427.9	0.5	12037.4	2.9	-4199	4	5547	4	1350.3	2.4	-2160	40
	As	33	7328.41	0.07	7722.0	1.0	-11809.7	2.6	11843.7	1.0	3872.1	1.0	3056.2	2.5
	Se	34	11154.35	0.29	9508.6	0.8	-21010	40	6318.7	1.7	569	4	1691.9	0.5
	Br	35	9221	17	5409	9	-31590#	500#	12634	9	2793	14	6314	10
	Kr	36	12762	9	7164	15	*	*	7003	16	-520	50	4850	11
	Rb	37	11329	8	3445	8	*	*	12562.5	2.8	936	7	8800	50
	Sr	38	15690	220	4310	40	*	*	8380	40	-3330#	160#	7950	40
	Y	39	*	*	-630#	550#	*	*	12700#	710#	-2140#	780#	13000#	530#
77	Ni	28	3210#	1030#	*	*	34470#	500#	3460#	950#	370#	950#	*	*
	Cu	29	5670#	400#	14260#	990#	25340#	400#	6040#	570#	4660#	570#	-10680#	900#
	Zn	30	4660	140	15040	120	15880	120	6110	990	2150	120	-4700#	420#
	Ga	31	7767	3	11140	80	7243	4	7190	70	4580	50	-4340	7
	Ge	32	6072.3	0.4	12206.4	2.6	-1044.6	2.6	7961.4	3.0	1700	4	140	50
	As	33	9698.4	1.9	7992.5	1.8	-9092	8	8650.7	1.8	4369.9	1.8	-221	4
	Se	34	7418.86	0.06	9599.1	0.8	-16796	9	9143.6	0.8	1124.4	1.7	4469.2	0.5
	Br	35	11017	10	5271.8	2.8	-26330#	60#	9644.9	2.8	3841.9	2.8	3271	3
	Kr	36	9226	4	7169	10	*	*	9680	14	1	15	7689.7	2.6
	Rb	37	12416	8	3099	8	*	*	10210	11	2371	8	6128	17
	Sr	38	11630	40	4613	9	*	*	10128	12	-1023	10	10174	10
	Y	39	16270#	510#	-50#	50#	*	*	10430#	230#	-1340#	510#	10660#	60#
78	Ni	28	5620#	1210#	*	*	37570#	1100#	*	*	70#	1360#	*	*
	Cu	29	4240#	570#	15290#	640#	28070#	400#	7570#	990#	4020#	570#	-9600#	900#
	Zn	30	6690	150	16050#	410#	19680	90	4340	90	1640	980	-7800#	410#
	Ga	31	5786	3	12270	120	9746	5	9140	80	3630	70	-3940	980
	Ge	32	8719	4	13159	5	2318	4	5145	4	1466	5	-3750	70
	As	33	6972	10	8892	10	-5881	12	11106	10	3903	10	1294	10
	Se	34	10497.81	0.16	10398.5	1.8	-13852	8	5974.2	0.8	870.4	0.8	476.7	0.5
	Br	35	8289	5	6142	4	-20930#	400#	12511	4	3581	4	5227	4
	Kr	36	12081.6	2.2	8234	3	-32480#	500#	6820	10	-177	14	3635.7	2.0
	Rb	37	10183	11	4056	8	*	*	12789	8	2251	11	7849	16
	Sr	38	13441	12	5638	11	*	*	8017	8	-1088	11	6796	11
	Y	39	13690#	410#	2010#	400#	*	*	12430#	400#	-1040#	460#	10340#	400#
	Zr	40	*	*	2090#	510#	*	*	7710#	710#	*	*	10570#	550#
79	Cu	29	5650#	640#	15320#	1210#	31310#	500#	5130#	710#	4150#	1030#	*	*
	Zn	30	4150#	270#	15960#	480#	22500#	260#	5870#	480#	2420#	260#	-6160#	940#
	Ga	31	6870	100	12460	130	13560	100	6920	160	4490	130	-5890	100
	Ge	32	5700	90	13070	90	4950	90	7210	90	1670	90	-1710	120
	As	33	8890	11	9063	7	-2833	8	8288	6	4441	5	-1693	6
	Se	34	6962.83	0.13	10389	10	-10441	9	8709.8	1.8	1236.0	0.9	2941.85	0.22
	Br	35	10688	4	6331.4	1.7	-17710	450	9241.9	1.7	4047.6	1.7	1867.4	1.8
	Kr	36	8334	4	8279	5	-27090#	400#	9503	5	710	10	6456	4
	Rb	37	11938	10	3913	6	*	*	10077	6	3075	7	5132	11
	Sr	38	10374	11	5829	11	*	*	10059	11	-133	9	9184	9
	Y	39	13900#	600#	2470	450	*	*	10160	450	750	450	7770	450
	Zr	40	13730#	640#	2120#	570#	*	*	10260#	410#	-3790#	640#	12530#	400#



A	Elt.	Z	S(2n)	S(2p)	Q( $\alpha$ )	Q( $2\beta^-$ )	Q( $\epsilon\text{p}$ )	Q( $\beta^-n$ )						
76	Ni	28	9380#	990#	*	-15740#	1210#	20530#	910#	*	4440#	1330#		
	Cu	29	11112	9	33310#	800#	-14100#	600#	15321	7	-28770#	800#	3420	70
	Zn	30	12570	90	28340#	410#	-10620	440	11080	80	-25520#	410#	-1740	80
	Ga	31	14390	4	24868	6	-8938.6	2.4	5992.9	2.7	-19470	980	-2511.5	2.6
	Ge	32	15933.2	0.5	22080	50	-7507	6	2039.00	0.05	-18030	70	-8252.0	0.8
	As	33	17572.2	1.9	18818	4	-6125.0	2.0	-2000	9	-11114	3	-8191.8	0.8
	Se	34	19181.9	0.3	16407.6	0.5	-5091.1	0.5	-6238	4	-10684.6	0.5	-14184	14
	Br	35	21126	18	14007	9	-4484	10	-9809	10	-4546	9	-14037	12
	Kr	36	22825	5	11380	4	-3545	13	-14770	40	-4134	4	-19864	8
	Rb	37	24705	4	9752	15	-3890	60	-21780#	500#	1370	14	-21930	220
	Sr	38	29690#	500#	6490	40	-2730	40	*	2790	40	*	*	*
	Y	39	*	1360#	500#	-3010#	710#	*	*	11230#	500#	*	*	*
77	Ni	28	8990#	640#	*	*	*	21980#	520#	*	*	6160#	500#	
	Cu	29	10600#	1060#	33660#	900#	-13970#	810#	17420#	400#	*	5490#	410#	
	Zn	30	12400	140	29400#	420#	-11280#	320#	12490	120	-24400#	910#	-500	120
	Ga	31	13670	3	26450	980	-9431	5	7924	3	-22305	7	-850.6	2.9
	Ge	32	15500.2	0.6	23320	70	-8230	40	3385.6	0.4	-16370	80	-6995.8	0.9
	As	33	17026.8	1.9	20030	3	-6642.2	2.8	-682	3	-14909	3	-6735.8	1.8
	Se	34	18573.2	0.3	17321.1	0.5	-5727.0	0.5	-4430.2	2.6	-8675.52	0.08	-12382	9
	Br	35	20239	14	14780.4	2.9	-4703	5	-8410	8	-8234.4	2.9	-12292	5
	Kr	36	21988	8	12578.4	2.6	-4377	11	-12365	10	-2206.4	2.6	-17760.9	2.7
	Rb	37	23745	11	10263	16	-3620	50	-17920#	60#	-1824	12	-18650	40
	Sr	38	27330	220	8058	12	-3677	11	*	3921	10	-27170#	500#	
	Y	39	*	4260#	60#	-3280#	160#	*	*	6290#	60#	*	*	*
78	Ni	28	8830#	1420#	*	*	*	23050#	1100#	*	*	6210#	1170#	
	Cu	29	9920#	400#	*	-14930#	900#	18960#	400#	*	*	5900#	420#	
	Zn	30	11350	120	30310#	910#	-11400#	410#	14520	90	-27880#	510#	580	90
	Ga	31	13553	3	27309	7	-10125	7	9111	10	-22420#	400#	-563.9	3.0
	Ge	32	14792	4	24300	80	-8580	50	5164	4	-20430	120	-6017	4
	As	33	16671	10	21099	10	-7193	11	635	10	-14114	10	-6289	10
	Se	34	17916.67	0.17	18390.98	0.18	-6028.6	0.5	-2846.4	2.0	-13101.0	0.4	-11862.5	2.8
	Br	35	19306	10	15741	4	-5017	4	-6516	8	-6825	4	-11354	4
	Kr	36	21308	4	13505.6	2.0	-4391.9	2.0	-11006	8	-6869.1	2.0	-17427	8
	Rb	37	22599	8	11225	12	-4055	17	-14410#	400#	-990	8	-17203	12
	Sr	38	25070	40	8738	8	-3267	8	-21470#	500#	-293	8	-24340#	60#
	Y	39	29970#	640#	6630#	400#	-3040#	400#	*	5010#	400#	*	*	*
	Zr	40	*	2040#	500#	-3430#	710#	*	*	8810#	500#	*	*	*
79	Cu	29	9890#	640#	*	-15250#	950#	20180#	510#	*	*	6940#	510#	
	Zn	30	10840#	290#	31250#	570#	-11940#	480#	16070#	240#	-26410#	1130#	2220#	260#
	Ga	31	12660	100	28510#	410#	-10810	980	11130	100	-25050#	410#	1280	100
	Ge	32	14420	90	25340	150	-9440	110	6430	90	-19430	130	-4740	90
	As	33	15863	6	22222	6	-7597	6	2432	5	-17219	6	-4682	5
	Se	34	17460.64	0.21	19281.5	0.5	-6486.1	0.5	-1475	4	-11344	4	-10537	4
	Br	35	18976	3	16729.9	2.0	-5461.0	1.8	-5265	6	-10540	10	-9960.1	2.3
	Kr	36	20416	4	14421	4	-4699	4	-8966	9	-4706	4	-15578	8
	Rb	37	22121	10	12146	7	-4089	15	-12450	450	-4640	7	-15701	10
	Sr	38	23815	13	9885	9	-3578	12	-18120#	400#	1414	8	-21020#	400#
	Y	39	27590#	450#	8110	450	-3560	450	*	1290	450	-24730#	680#	
	Zr	40	*	4130#	400#	-3160#	460#	*	*	8530#	400#	*	*	*

A	Elt.	Z	S(n)	S(p)	$Q(4\beta^-)$	$Q(d,\alpha)$	$Q(p,\alpha)$	$Q(n,\alpha)$						
80	Cu	29	2190#	780#	*	35710#	600#	8560#	1250#	5160#	780#	*		
	Zn	30	6500#	310#	16810#	530#	25920	170	3620#	440#	1600#	440#	-9450#	530#
	Ga	31	4700	160	13010#	290#	16750	120	8920	150	4450	170	-4910#	420#
	Ge	32	8100	90	14290	100	8377	28	4902	28	1341	28	-5150	120
	As	33	6594	24	9960	90	14	24	10414	24	3919	23	-521	23
	Se	34	9913.7	1.6	11412	5	-7452	7	5768	10	1020.7	2.0	-899.5	1.7
	Br	35	7892.28	0.13	7260.8	1.7	-14670	180	11847.4	1.6	3574.2	1.7	3673.5	2.0
	Kr	36	11521	4	9112.9	2.4	-22380	1490	6271	4	206	4	2353.5	2.2
	Rb	37	9441	9	5019	8	*	*	12718	7	2861	7	6708	8
	Sr	38	12903	11	6794	9	*	*	7339	10	-620	10	5508	7
	Y	39	10930	480	3030	180	*	*	12670	180	1450	180	9250	180
	Zr	40	16230#	1540#	4450	1560	*	*	7720#	1540#	-3750#	1490#	7930	1490
81	Zn	30	2350#	340#	16970#	670#	30260#	300#	6910#	590#	3490#	500#	-6180#	1140#
	Ga	31	6920	230	13430	260	19990	190	6150#	320#	4220	210	-7590#	440#
	Ge	32	4860	120	14460	170	11390	120	6920	160	2270	120	-3310	150
	As	33	8445	24	10307	29	2922	8	7670	90	4193	7	-3180	6
	Se	34	6700.9	0.4	11519	23	-4862	7	7958	5	1292	10	1119	4
	Br	35	10156.7	2.2	7503.9	2.2	-11960	60	8653.6	2.2	3915.3	2.2	489	10
	Kr	36	7872.9	2.3	9093.5	2.3	-19210	170	9085.3	2.3	622	4	4978.4	2.3
	Rb	37	11353	9	4851	6	-27980#	1500#	9699	7	3589	6	3644	7
	Sr	38	9291	9	6644	9	*	*	9986	9	273	10	8298	6
	Y	39	12870	190	3000	60	*	*	10170	60	2020	60	6570	60
	Zr	40	11040	1500	4560	240	*	*	10580	480	-1100#	430#	10330	170
	Nb	41	*		-750#	150#	*	*	10590#	1550#	-910#	1580#	10700#	1550#
82	Zn	30	4400#	590#	*		35140#	500#	4700#	780#	4730#	710#	*	
	Ga	31	3190#	360#	14270#	420#	24390#	300#	9450#	340#	5180#	400#	-5130#	590#
	Ge	32	7390	270	14930	310	14970	240	4220	270	1750	260	-6560#	360#
	As	33	5860	200	11310	230	5860	200	9900	200	4030	220	-2170	220
	Se	34	9275.8	1.2	12350	5	-1586	6	5276	23	907	5	-2460	90
	Br	35	7592.94	0.12	8395.9	2.2	-9300	100	10974.3	2.2	3285.2	2.2	1786	6
	Kr	36	10966.8	1.1	9903.6	1.0	-16400#	230#	6010.8	2.0	343.1	2.0	974.5	2.1
	Rb	37	8805	7	5783	3	-23210#	300#	12415	3	3119	5	5527	3
	Sr	38	12552	8	7843	8	*	*	6875	9	-341	8	4081	7
	Y	39	10250	120	3950	100	*	*	12830	100	2150	100	8260	100
	Zr	40	13780#	280#	5460#	230#	*	*	7740#	290#	-970#	500#	6930#	230#
	Nb	41	13570#	1530#	1780#	340#	*	*	13250#	1520#	-750#	500#	11030#	540#
83	Zn	30	1910#	710#	*		39040#	500#	*		5010#	780#	*	
	Ga	31	4360#	420#	14220#	590#	29620#	300#	7450#	420#	7320#	340#	-7290#	670#
	Ge	32	3350#	310#	15090#	360#	19080#	200#	7790#	270#	3100#	230#	-3410#	260#
	As	33	7630	300	11550	330	9190	220	7130	250	4500	220	-5100	250
	Se	34	5818	3	12310	200	1455	11	7903	6	1683	23	-179	28
	Br	35	9584	4	8704	4	-6680	40	8091	4	3615	4	-1203	24
	Kr	36	7464	3	9774	3	-13520	100	8704	3	772	3	3425	3
	Rb	37	10958	7	5774	6	-20120	310	9330	6	3682	6	2461	6
	Sr	38	8858	12	7896	11	-29050#	500#	9370	12	241	12	6743	10
	Y	39	12210	110	3610	40	*	*	9910	40	2850	40	5490	40
	Zr	40	10340#	240#	5560	140	*	*	10270	110	-380	200	9500	100
	Nb	41	14060#	430#	2060#	390#	*	*	10240	360	1420	1520	7910	360
	Mo	42	*		2060#	590#	*	*	10440#	1580#	*		13420#	1570#

A	El.	Z	S(2n)		S(2p)		Q( $\alpha$ )		Q(2 $\beta^-$ )		Q( $\epsilon p$ )		Q( $\beta^- n$ )	
80	Cu	29	7840#	720#	*	*	*	22690#	610#	*	*	8900#	650#	
	Zn	30	10640	190	32130#	1110#	-12660#	920#	17670	170	*	2590	200	
	Ga	31	11570	120	28960#	420#	-10580	120	13020	120	-24100#	520#	2280	150
	Ge	32	13796	29	26750	90	-9800	80	8245	28	-23390#	260#	-3950	29
	As	33	15485	25	23031	23	-8288	23	3730	23	-16940	100	-4313	23
	Se	34	16876.5	1.6	20476	4	-6971.8	1.6	132.6	2.4	-15560	90	-9762.7	0.3
	Br	35	18580	4	17650	10	-6024.9	1.8	-3717	7	-9542	5	-9518	3
	Kr	36	19855.4	1.8	15444.3	2.2	-5065.4	2.2	-7584	7	-9263.9	2.2	-15160	6
	Rb	37	21379	10	13298	8	-4309	12	-10960	180	-3393	7	-14768	11
	Sr	38	23277	10	10706	7	-3719	8	-14790	1490	-3154	8	-20020	450
	Y	39	24830#	440#	8860	180	-3160	180	*	*	2300	180	-21930#	440#
	Zr	40	29960#	1570#	6920	1490	-3700	1490	*	*	2670	1490	*	*
81	Zn	30	8850#	400#	*	*	-11810#	590#	20180#	320#	*	*	4940#	320#
	Ga	31	11620	220	30230#	540#	-11830#	440#	14550	190	-28820#	630#	3460	190
	Ge	32	12960	150	27460#	290#	-10010	170	10090	120	-21750	210	-2220	120
	As	33	15039	7	24600	100	-8966	6	5442	6	-20690	120	-2845	5
	Se	34	16614.6	1.7	21480	90	-7600.4	1.7	1304.5	2.3	-14163	28	-8571.4	0.5
	Br	35	18049.0	2.2	18916	6	-6483.2	2.7	-2520	6	-13105	23	-1853.7	2.2
	Kr	36	19394	4	16354.4	2.3	-5519.4	2.3	-6166	7	-7223.1	2.2	-13593	7
	Rb	37	20794	8	13964	6	-4645	7	-9440	60	-6854	6	-13218	9
	Sr	38	22194	10	11663	7	-3783	7	-13040	170	-924	6	-18380	180
	Y	39	23800	450	9790	60	-3620	60	-18540#	1500#	-1130	60	-18570	1490
	Zr	40	27270#	430#	7590	170	-3110	170	*	*	4530	170	*	*
	Nb	41	*	*	3700#	1560#	-3000#	1500#	*	*	6450#	1510#	*	*
82	Zn	30	6760#	530#	*	*	-10590#	1210#	23170#	560#	*	*	7450#	540#
	Ga	31	10110#	320#	31230#	670#	-10780#	500#	17220#	360#	*	*	5130#	320#
	Ge	32	12250	250	28360	300	-10710	260	11970	240	-26790#	390#	-1160	240
	As	33	14310	200	25770	230	-9040	200	7170	200	-19630	280	-2010	200
	Se	34	15976.7	1.1	22657	28	-8157	4	2995.5	1.9	-18580	120	-7690.5	2.1
	Br	35	17749.6	2.2	19915	23	-7104	10	-1308	3	-12252	6	-7873.7	0.5
	Kr	36	18839.7	2.1	17407.5	2.0	-5988.3	2.1	-4581	6	-11489.0	2.0	-13206	6
	Rb	37	20158	7	14877	3	-5161	5	-8000	100	-5502	3	-12732	7
	Sr	38	21843	9	12694	6	-4254	6	-11820#	230#	-5603	6	-18060	60
	Y	39	23120	200	10600	100	-3680	100	-15220#	320#	-30	100	-17780	200
	Zr	40	24820#	1510#	8460#	230#	-3440#	230#	*	*	50#	230#	-24790#	1520#
	Nb	41	*	*	6330#	350#	-2870#	500#	*	*	5750#	300#	*	*
83	Zn	30	6320#	590#	*	*	*	24600#	540#	*	*	*	8730#	590#
	Ga	31	7550#	360#	*	*	-9490#	590#	20490#	370#	*	*	8170#	390#
	Ge	32	10740#	230#	29350#	360#	-9910#	330#	14440#	200#	-25730#	540#	1350#	280#
	As	33	13490	220	26480	290	-9800	240	9130	220	-24070#	370#	-360	220
	Se	34	15094	3	23620	120	-8280	90	4641	4	-17010	240	-5916	4
	Br	35	17177	4	21054	7	-7797	7	66	7	-15970	200	-6491	4
	Kr	36	18430	3	18170	3	-6489	3	-3186	11	-9677	3	-11865	4
	Rb	37	19763	8	15678	6	-5431	6	-6750	40	-8867	6	-11138	8
	Sr	38	21410	12	13679	10	-4778	11	-10340	100	-3495	10	-16670	100
	Y	39	22450	80	11450	40	-3950	40	-13370	310	-3430	40	-16210#	230#
	Zr	40	24110	190	9510	100	-3410	100	-18710#	510#	2260	100	-21560#	310#
	Nb	41	27620#	1530#	7520	320	-3030	550	*	*	1940	330	*	*
	Mo	42	*	*	3840#	530#	-2820#	640#	*	*	9160#	550#	*	*

A	Elt.	Z	S(n)	S(p)	$Q(4\beta^-)$	$Q(d,\alpha)$	$Q(p,\alpha)$	$Q(n,\alpha)$						
84	Ga	31	2790#	500#	15100#	640#	33690#	400#	9060#	640#	6890#	500#	*	
	Ge	32	5420#	360#	16150#	420#	24190#	300#	5570#	420#	4600#	360#	-6470#	420#
	As	33	4270#	370#	12470#	360#	13670#	300#	10250#	390#	5090#	320#	-2450#	360#
	Se	34	8682	15	13360	220	4692	15	5080	200	1446	15	-4000	120
	Br	35	6862	15	9748	15	-3640	90	10505	15	3454	15	3800	16
	Kr	36	10520.60	0.30	10711	4	-10940#	200#	5776	3	408	3	-395	3
	Rb	37	8747	7	7057.3	2.3	-17870#	300#	11550	3	2808	3	3871	3
	Sr	38	11920	11	8858	7	-24840#	400#	6255	4	-325	7	2697	4
	Y	39	9900	100	4650	90	*		12560	90	2230	90	6940	90
	Zr	40	13110#	220#	6460#	200#	*		7410#	220#	-610#	210#	5680#	200#
	Nb	41	10990#	430#	2710#	310#	*		13020#	370#	1470#	340#	9790#	300#
	Mo	42	16130#	640#	4140#	510#	*		7880#	500#	-3460#	1550#	8330#	430#
85	Ga	31	4020#	640#	*		38560#	500#	6960#	710#	7270#	710#	*	
	Ge	32	2890#	500#	16250#	570#	28410#	400#	7030#	500#	4900#	500#	-4960#	640#
	As	33	5310#	360#	12370#	360#	18840#	200#	8290#	280#	7170#	310#	-4570#	360#
	Se	34	4550	30	13640#	300#	8670	30	8160	220	2760	200	-1160	250
	Br	35	8882	24	9947	24	-768	27	7441	19	3848	19	-2640	200
	Kr	36	7121	3	10970	15	-8330	100	8239	5	880.3	2.8	1760.1	2.8
	Rb	37	10488.6	2.8	7025.3	2.8	-15020	220	8525.2	2.8	3286.2	1.8	975.5	1.9
	Sr	38	8530	4	8642	4	-22000#	280#	8683	7	-50	4	5133	3
	Y	39	11760	90	4487	19	-30180#	400#	9664	22	3030	20	3992	19
	Zr	40	9730#	220#	6280	140	*		9890	110	-90	140	8510	100
	Nb	41	13340#	370#	2950#	300#	*		10020	240	1910#	320#	6690	250
	Mo	42	11370#	490#	4510#	410#	*		10570#	420#	-1270#	410#	10740#	360#
	Tc	43	*		-850#	570#	*		10800#	640#	*		10960#	500#
86	Ga	31	2370#	950#	*		41290#	800#	*		6810#	950#	*	
	Ge	32	4850#	640#	17080#	710#	33420#	500#	4970#	640#	4410#	590#	-7900#	710#
	As	33	3900#	360#	13370#	500#	23600#	300#	9810#	420#	6620#	360#	-4120#	420#
	Se	34	6180	30	14510#	200#	13983	16	6250#	300#	4200	220	-3990#	200#
	Br	35	5101	22	10500	30	3644	18	11023	18	4565	12	-110	220
	Kr	36	9856.6	2.0	11944	19	-5460	30	5245	15	607	4	-2279	4
	Rb	37	8651.00	0.20	8555.7	2.0	-12920	90	10394.8	2.8	2098.7	2.8	1908	4
	Sr	38	11492	3	9645.2	1.1	-19970	440	5937.3	3.0	-585	6	1105	3
	Y	39	9513	24	5470	14	-26080#	300#	12071	15	2376	18	5438	15
	Zr	40	12730	110	7250	40	*		7060	100	-610	50	4640	30
	Nb	41	10750	240	3970	130	*		12380#	210#	1500	130	8150	100
	Mo	42	13520#	520#	4700	490	*		8030#	530#	-730	540	7550	450
	Tc	43	13610#	500#	1390#	410#	*		13310#	500#	-600#	590#	11400#	430#
87	Ge	32	2460#	710#	17170#	950#	36470#	500#	6530#	710#	4730#	640#	*	
	As	33	4900#	420#	13430#	590#	28620#	300#	7800#	500#	7130#	420#	-6230#	500#
	Se	34	4110	40	14720#	300#	18300	40	7450#	200#	4360#	300#	-2690#	300#
	Br	35	6289	21	10605	24	9162	18	9280	30	6959	23	-2130#	300#
	Kr	36	5515.17	0.25	12359	11	-1361	8	8612	19	1954	15	889	15
	Rb	37	9922.10	0.20	8621.20	0.10	-10410	60	7593.3	1.9	2697.3	2.8	-1152	15
	Sr	38	8428.15	0.12	9422.4	1.1	-17190	220	7997.7	1.1	-266.3	3.0	3197.0	3.0
	Y	39	11806	14	5784.1	1.1	-23900#	300#	8795	3	2489	4	2378	3
	Zr	40	9620	30	7354	16	-32010#	600#	9205	21	-330	90	6942	9
	Nb	41	12430	100	3670	70	*		9680	120	2170#	210#	5620	110
	Mo	42	11210	490	5160	240	*		10170	320	-950#	370#	9440#	300#
	Tc	43	13990#	420#	1860#	530#	*		10690#	410#	1550#	500#	8400#	420#
	Ru	44	*		1420#	670#	*		11040#	720#	*		14110#	720#

A	Elt.	Z	S(2n)	S(2p)	Q( $\alpha$ )	Q( $2\beta^-$ )	Q( $\epsilon p$ )	Q( $\beta^- n$ )						
84	Ga	31	7140#	500#	*	-10080#	720#	21980#	500#	*	8720#	450#		
	Ge	32	8770#	390#	30370#	590#	-8830#	340#	17710#	300#	-29240#	590#	3560#	370#
	As	33	11900#	360#	27560#	420#	-9370#	330#	11720#	300#	-23980#	420#	1190#	300#
	Se	34	14500	14	24910	240	-8860	30	6479	15	-22340#	200#	-5014	15
	Br	35	16446	15	22050	200	-8065	28	1951	15	-15210	220	-5889	14
	Kr	36	17984	3	19415	3	-7096	3	-1787	4	-14379	4	-11428	7
	Rb	37	19704	4	16832	3	-6285	3	-5590	90	-8030	4	-11026	11
	Sr	38	20778	6	14632	4	-5176	4	-9150#	200#	-7951	4	-16390	40
	Y	39	22110	140	12550	90	-4410	90	-12280#	310#	-2370	90	-15770	130
	Zr	40	23440#	300#	10060#	200#	-3610#	200#	-15690#	450#	-1990#	200#	-20610#	370#
	Nb	41	25050#	420#	8270#	320#	-3090#	350#	*	*	3160#	300#	-22200#	590#
	Mo	42	*	6190#	460#	-2710#	1540#	*	*	3360#	410#	*	*	*
85	Ga	31	6810#	590#	*	*	*	23270#	540#	*	*	10120#	590#	
	Ge	32	8310#	450#	31350#	640#	-9370#	500#	19360#	400#	*	4940#	500#	
	As	33	9590#	290#	28510#	360#	-7770#	270#	15290#	200#	-26510#	450#	4560#	200#
	Se	34	13230	30	26110#	200#	-8550	120	9052	30	-21470#	300#	-2700	30
	Br	35	15744	20	23310	220	-8502	20	3557	19	-19820#	300#	-4251	19
	Kr	36	17641	3	20718	4	-7515.7	2.8	-378	3	-12817	15	-9802	3
	Rb	37	19235	6	17736	4	-6617.4	2.0	-4325	19	-11657	15	-9595	3
	Sr	38	20450	11	15699	4	-5833	3	-7950	100	-5961	4	-15020	90
	Y	39	21660	50	13345	20	-4812	20	-10690	220	-5381	19	-14420#	200#
	Zr	40	22830	140	10930	100	-4050	100	-14050#	300#	210	100	-19340#	320#
	Nb	41	24330	390	9400	230	-3560	230	-19490#	460#	-280	240	-19420#	460#
	Mo	42	27500#	580#	7220#	300#	-3040#	330#	*	*	5100	200	*	*
	Tc	43	*	3280#	510#	-2610#	1550#	*	*	6930#	500#	*	*	*
86	Ga	31	6390#	900#	*	*	*	24800#	860#	*	*	10640#	900#	
	Ge	32	7740#	590#	31350#	640#	-9370#	710#	20700#	500#	*	5410#	540#	
	As	33	9210#	420#	29620#	500#	-8470#	420#	16490#	300#	-26390#	590#	5210#	300#
	Se	34	10731	21	26870#	300#	-7340	240	12725	16	-24760#	400#	-2	25
	Br	35	13983	18	24140#	300#	-7740	200	7107	11	-19610#	200#	-2231	11
	Kr	36	16977.2	2.8	21892	15	-8096.5	2.0	1258.0	1.1	-18126	30	-9169.56	0.10
	Rb	37	19139.6	2.8	19526	15	-7675.5	2.0	-3463	14	-11426	19	-9715.8	2.8
	Sr	38	20022	3	16670.5	3.0	-6359.0	2.1	-6720	30	-10332.3	2.2	-14753	19
	Y	39	21270	90	14111	14	-5520	14	-9460	90	-4405	14	-14210	100
	Zr	40	22460#	200#	11740	30	-4220	30	-13250	440	-3990	30	-18730	230
	Nb	41	24090#	310#	10250	130	-4060	130	-16620#	310#	730	90	-18790#	290#
	Mo	42	24890#	590#	7640#	480#	-2790#	490#	*	*	1300	450	-24960#	590#
	Tc	43	*	5910#	420#	-2660#	420#	*	*	6650#	370#	*	*	*
87	Ge	32	7310#	640#	*	-10360#	710#	22350#	510#	*	*	6840#	590#	
	As	33	8800#	360#	30510#	590#	-9020#	420#	17870#	300#	-28920#	860#	6490#	300#
	Se	34	10300	50	28090#	400#	-8110#	200#	14130	40	-24030#	510#	990	40
	Br	35	11389	26	25110#	200#	-6400	220	10741	18	-22000#	300#	1337	18
	Kr	36	15371.8	2.0	22859	30	-7794	4	4171.0	1.1	-17458	16	-6033.7	0.3
	Rb	37	18573.10	0.02	20565	19	-8014	4	-1579.1	1.6	-16247	11	-8145.5	1.1
	Sr	38	19920	3	17978.1	2.2	-7324	3	-5532	8	-8903.8	1.1	-13668	14
	Y	39	21319	19	15429.3	1.6	-6369	6	-8840	60	-7560.7	1.6	-13290	30
	Zr	40	22340	100	12824	9	-4978	13	-11650	220	-2114	8	-17590	90
	Nb	41	23180	230	10920	60	-4280	80	-15060#	300#	-2190	60	-17700	440
	Mo	42	24730#	360#	9120	240	-3660	240	-20360#	640#	2820	230	-22560#	370#
	Tc	43	27600#	500#	6550#	370#	-2590#	430#	*	*	3420#	310#	*	*
	Ru	44	*	2810#	660#	-2020#	780#	*	*	9930#	740#	*	*	*

A	Elt.	Z	S(n)	S(p)	Q(4β <sup>-</sup> )	Q(d,α)	Q(p,α)	Q(n,α)						
88	Ge	32	3970#	860#	*	39550#	700#	4930#	1060#	4780#	860#	*		
	As	33	3380#	590#	14340#	710#	31320#	500#	9270#	710#	6640#	640#	-5590#	710#
	Se	34	5370	60	15180#	300#	24040	50	5980#	300#	4310#	200#	-5170#	400#
	Br	35	4950	40	11440	50	13570	40	10520	40	6560	50	-1760#	200#
	Kr	36	7054	13	13124	22	3931	17	6658	17	3782	23	-1620	30
	Rb	37	6082.52	0.16	9188.5	0.3	-6540	100	11367.38	0.19	3735.3	2.0	1648	19
	Sr	38	11112.64	0.16	10612.9	1.1	-15222	20	5536.1	1.1	-890.4	1.1	-795.1	2.2
	Y	39	9351.7	1.9	6707.7	1.5	-21590#	200#	10935.2	1.5	1667	3	3514.6	1.9
	Zr	40	12346	13	7893	10	-27980#	400#	6371	17	-917	22	3126	11
	Nb	41	9960	120	4010	100	*		12440	100	1940	140	7420	100
	Mo	42	13080	220	5810	60	*		7840	90	-690	220	6100	100
	Tc	43	11660#	360#	2300#	300#	*		12560#	480#	1260#	340#	10090#	300#
	Ru	44	16380#	720#	3810#	500#	*		8270#	500#	-3120#	570#	9100#	490#
89	Ge	32	1630#	1140#	*	43030#	910#	*		5530#	1210#	*		
	As	33	3930#	710#	14290#	860#	34570#	500#	7810#	710#	7570#	710#	-7140#	950#
	Se	34	3390#	300#	15200#	590#	27010#	300#	7500#	420#	4820#	420#	-3710#	590#
	Br	35	5910	70	11980	80	19130	60	8720	70	6830	60	-3780#	300#
	Kr	36	5110	50	13280	60	8140	50	7840	50	3780	50	-540	50
	Rb	37	7175	5	9309	14	-1062	27	9708	5	6417	5	-427	12
	Sr	38	6358.72	0.09	10889.1	1.1	-11205	16	9099.5	1.1	1401.9	1.1	2702.8	1.1
	Y	39	11474	3	7069.0	2.6	-19860#	200#	7889.5	2.6	1685.9	2.6	691.7	2.6
	Zr	40	9317	10	7859	4	-25360#	500#	8861	4	-721	15	5301	4
	Nb	41	12650	100	4316	29	-32990#	450#	9409	28	2020	40	4280	30
	Mo	42	10375	25	6220	100	*		9890	60	-310	90	8450	30
	Tc	43	13210#	280#	2430#	200#	*		10560#	300#	1580#	480#	7630#	220#
	Ru	44	11940#	640#	4090#	540#	*		10320#	590#	-1440#	590#	10690#	670#
	Rh	45	*		-700#	200#	*		10390#	750#	*		11200#	540#
90	As	33	2380#	950#	15050#	1210#	37910#	800#	9400#	1060#	7650#	950#	*	
	Se	34	4800#	500#	16070#	640#	30020#	400#	6070#	640#	4920#	500#	-6040#	640#
	Br	35	4120	100	12710#	310#	21870	80	9970	90	6830	90	-2990#	310#
	Kr	36	6310	50	13690	60	13797	19	6470	40	3751	26	-2740	40
	Rb	37	5721	9	9920	50	3295	8	11041	15	6212	7	142	19
	Sr	38	7803.8	2.9	11518	6	-5774	6	7378.2	2.9	3520.2	2.9	414.2	2.9
	Y	39	6857.03	0.10	7567.3	2.6	-15280	240	12145.1	2.6	3257.0	2.6	3756.7	2.6
	Zr	40	11970	3	8354.5	1.7	-23460#	300#	6242.7	2.9	-884.5	2.7	1759.5	2.5
	Nb	41	10077	27	5076	5	-29440#	500#	11678	11	1556	9	6009	5
	Mo	42	13235	16	6806	27	*		6620	100	-1120	60	4827	10
	Tc	43	11430#	310#	3490	240	*		12200	240	1350	330	8620	250
	Ru	44	13870#	590#	4750#	360#	*		8110#	360#	-1320#	420#	8030#	370#
	Rh	45	13630#	670#	990#	710#	*		13140#	640#	-1010#	780#	11550#	590#
91	As	33	3480#	1210#	*	40890#	900#	7540#	1280#	8140#	1140#	*		
	Se	34	2480#	640#	16180#	950#	33310#	500#	7520#	710#	5810#	710#	-4550#	860#
	Br	35	4960	110	12870#	410#	24840	70	8400#	310#	7230	90	-4570#	510#
	Kr	36	4410	60	13980	100	16580	60	7970	80	4290	70	-1790	80
	Rb	37	6455	10	10064	20	8887	9	9690	50	6811	16	-1370	40
	Sr	38	5775	5	11573	8	-1441	12	8778	7	3828	5	1693	14
	Y	39	7928.9	2.5	7692.4	2.8	-10360	200	10574.9	3.0	6440.8	3.0	1910.4	2.9
	Zr	40	7194.5	0.5	8691.9	1.7	-19230#	580#	10522.2	1.7	1272.8	2.9	5677.7	2.5
	Nb	41	12047	5	5154.1	3.0	-27530#	400#	8947	4	1855	10	3313	4
	Mo	42	10108	13	6837	12	-34800#	570#	9157	29	-1270	100	7065	15
	Tc	43	12850	310	3110	200	*		9730	200	1580	200	5740	220
	Ru	44	11420#	660#	4740#	630#	*		9900#	620#	-1080#	620#	9690#	580#
	Rh	45	13960#	640#	1090#	500#	*		11120#	640#	1410#	570#	9250#	450#
	Pd	46	*		1480#	760#	*		10970#	720#	*		13890#	690#

A	Elt.	Z	S(2n)	S(2p)	Q( $\alpha$ )	Q(2 $\beta^-$ )	Q( $\epsilon p$ )	Q( $\beta^- n$ )						
88	Ge	32	6440#	860#	*	*	23740#	700#	*	7770#	760#			
	As	33	8280#	590#	31510#	950#	-9610#	640#	19440#	500#	7220#	510#		
	Se	34	9480	50	28610#	510#	-8060#	300#	15810	50	-26930#	510#	1910	50
	Br	35	11240	40	26160#	300#	-7080#	300#	11880	40	-22040#	300#	1910	40
	Kr	36	12569	13	23730	21	-6165	20	8230	13	-20400	40	-3166	13
	Rb	37	16004.62	0.26	21547	11	-7235	15	1690.1	1.9	-16041	18	-5799.9	1.1
	Sr	38	19540.80	0.20	19234.1	1.1	-7915.7	3.0	-4299	10	-14501.3	1.1	-12974.3	1.1
	Y	39	21158	14	16130.1	1.9	-6974	3	-8230	100	-6990.3	1.9	-13022	9
	Zr	40	21960	30	13677	10	-5404	11	-10923	23	-6032	10	-17510	60
	Nb	41	22390	130	11370	100	-4340	140	-13360#	230#	-340	100	-16450	240
	Mo	42	24290	440	9470	40	-3630#	200#	-17050#	400#	-641	22	-21650#	300#
	Tc	43	25650#	360#	7460#	220#	-3260#	360#	*	*	4180#	210#	-23440#	630#
	Ru	44	*	5670#	590#	-2270#	570#	*	*	4760#	460#	*	*	*
89	Ge	32	5600#	1030#	*	*	*	25500#	950#	*	*	9530#	1030#	
	As	33	7300#	590#	*	-9510#	710#	21430#	510#	*	*	8660#	510#	
	Se	34	8760#	300#	29540#	590#	-8550#	500#	17530#	300#	-26350#	760#	3460#	300#
	Br	35	10860	60	27170#	300#	-7670#	210#	13140	60	-24570#	510#	3050	60
	Kr	36	12160	50	24720	60	-6720	60	9480	50	-20140	70	-2190	50
	Rb	37	13257	5	22434	19	-5527	20	5989	6	-18270	40	-1862	5
	Sr	38	17471.36	0.18	20077.7	1.1	-7153.8	2.2	-1340	4	-13806	13	-9981.3	1.5
	Y	39	20825.7	2.8	17681.9	2.6	-7959.3	2.6	-7051	27	-12381.7	2.6	-12150	10
	Zr	40	21663	9	14566	4	-6191	5	-9865	16	-4236	4	-16870	100
	Nb	41	22610	70	12210	27	-5230	30	-12810#	200#	-3640	27	-16020	30
	Mo	42	23450	220	10234	17	-4280	100	-15490#	500#	1330	18	-20370#	200#
	Tc	43	24870#	360#	8240#	210#	-3120#	300#	-20190#	490#	940#	220#	-20270#	450#
	Ru	44	28320#	780#	6400#	550#	-2840#	580#	*	*	5900#	500#	*	*
	Rh	45	*	3110#	540#	-2420#	600#	*	*	7760#	490#	*	*	*
90	As	33	6310#	950#	*	-9520#	1130#	23170#	810#	*	*	9670#	860#	
	Se	34	8190#	400#	30370#	810#	-8510#	640#	19040#	400#	-29520#	990#	4570#	410#
	Br	35	10030	90	27910#	510#	-7900#	310#	14740	80	-24770#	510#	4040	90
	Kr	36	11420	23	25670	50	-6854	24	10972	19	-23060#	300#	-1329	19
	Rb	37	12895	7	23210	40	-6147	13	7126	7	-18080	60	-1224	7
	Sr	38	14162.5	2.9	20827	14	-5100.9	2.9	2825.7	2.2	-16500	50	-6311.2	1.4
	Y	39	18331	3	18456.4	2.6	-6165.4	2.6	-3831	4	-12064	6	-9689.9	2.8
	Zr	40	21287	10	15423.5	2.5	-6668.6	2.5	-8600	6	-9847.1	2.5	-16188	27
	Nb	41	22730	100	12935	5	-5798	15	-11450	240	-2243	4	-15724	16
	Mo	42	23610	21	11122	11	-4790	30	-14860#	300#	-2587	6	-20400#	200#
	Tc	43	24640#	320#	9710	260	-3810	260	-17990#	560#	2150	240	-19770#	560#
	Ru	44	25800#	500#	7190#	300#	-3180#	530#	*	*	2410#	300#	-25720#	540#
	Rh	45	*	5080#	540#	-2430#	590#	*	*	7340#	540#	*	*	*
91	As	33	5860#	1030#	*	*	*	24650#	910#	*	*	11000#	990#	
	Se	34	7280#	590#	31220#	1030#	-8530#	710#	20970#	510#	*	*	6210#	510#
	Br	35	9080	90	28940#	510#	-7950#	310#	16240	70	-27350#	800#	5390	70
	Kr	36	10730	80	26690#	300#	-7150	70	12330	60	-22670#	410#	-20	60
	Rb	37	12175	10	23750	60	-6313	19	8600	8	-20410	80	125	9
	Sr	38	13579	5	21500	50	-5361	5	4245	4	-15964	19	-5229	5
	Y	39	14785.9	2.5	19210	6	-4172.2	2.9	287	3	-14272	7	-5649.1	1.9
	Zr	40	19164	3	16259.2	2.5	-5434.9	2.5	-5686	11	-9237.8	2.2	-13305	4
	Nb	41	22125	27	13509	3	-6039	4	-10650	200	-7434	3	-14536	6
	Mo	42	23343	18	11913	12	-5281	14	-13550#	580#	-726	11	-19070	240
	Tc	43	24280#	280#	9910	200	-4230	210	-16880#	450#	-620	200	-18750#	360#
	Ru	44	25290#	770#	8230#	580#	-3390#	620#	-21260#	810#	4220#	580#	-23510#	770#
	Rh	45	27590#	600#	5840#	450#	-2410#	500#	*	*	4810#	470#	*	*
	Pd	46	*	2470#	760#	-2490#	820#	*	*	10620#	640#	*	*	*

A	Elt.	Z	S(n)		S(p)		Q( $4\beta^-$ )		Q(d, $\alpha$ )		Q(p, $\alpha$ )		Q(n, $\alpha$ )	
92	As	33	2140#	1280#	*		43850#	900#	*		7630#	1280#	*	
	Se	34	4380#	780#	17080#	1080#	36220#	600#	5510#	1000#	5360#	780#	-7310#	1080#
	Br	35	3140	90	13530#	510#	28230	50	10060#	400#	7480#	300#	-3790#	510#
	Kr	36	5550	60	14570	70	19669	12	6550	80	4650	60	-3940#	300#
	Rb	37	5098	10	10750	60	11676	7	10909	19	6820	50	-550	60
	Sr	38	7294	6	12411	9	3937	5	7205	7	3709	6	-490	50
	Y	39	6540	9	8457	10	-5879	28	11839	9	6260	9	2546	11
	Zr	40	8634.80	0.11	9397.8	1.8	-14050#	300#	8744.4	1.7	4111.9	1.7	3401.7	2.5
	Nb	41	7887	3	5846.9	1.8	-23090#	400#	13029.7	1.9	3285	4	6899.8	2.5
	Mo	42	12672	11	7462	5	-31310#	500#	6562	5	-1291	27	3710	5
	Tc	43	11020	200	4019	28	*		11943	27	933	30	7360	40
	Ru	44	13820#	660#	5710#	360#	*		7510#	380#	-1700#	360#	6240#	300#
	Rh	45	12330#	570#	1990#	710#	*		12660#	500#	1020#	640#	10130#	450#
Pd	46	16170#	760#	3680#	640#	*		8430#	710#	-2980#	670#	9660#	710#	
93	Se	34	2140#	1000#	17080#	1210#	39370#	800#	6850#	1210#	5600#	1130#	*	
	Br	35	4540#	300#	13690#	670#	31180#	300#	8000#	590#	7740#	500#	-5950#	860#
	Kr	36	3300	100	14730	110	23100	100	8200	120	5470	130	-2440#	410#
	Rb	37	5917	10	11121	14	14591	8	9400	60	7216	20	-2350	80
	Sr	38	5288	8	12602	10	6719	8	8372	11	4141	10	532	20
	Y	39	7481	14	8644	11	-621	11	10133	11	6582	11	785	12
	Zr	40	6734.5	0.4	9593	9	-9850	90	9938.8	1.9	4234.5	1.8	4471.0	2.2
	Nb	41	8831.3	2.0	6043.4	1.6	-18040#	400#	11392.9	1.6	6423.0	1.7	4925.6	2.3
	Mo	42	8069.81	0.09	7644	4	-27100#	400#	10540	5	717	5	7610	4
	Tc	43	12739	26	4086.5	1.0	-36820#	600#	9312	11	1429	7	4700	6
	Ru	44	10930#	310#	5620	90	*		9430	220	-1190	260	8550	90
	Rh	45	13880#	570#	2050#	500#	*		10200#	710#	1000#	500#	7680#	470#
	Pd	46	12270#	640#	3630#	570#	*		10120#	570#	-1620#	640#	11250#	500#
Ag	47	*		-1430#	780#	*		11330#	820#	*		12080#	780#	
94	Se	34	4160#	1130#	*		42040#	800#	4830#	1210#	4920#	1210#	*	
	Br	35	2830#	500#	14380#	900#	34540#	400#	9560#	720#	7400#	640#	-5300#	990#
	Kr	36	5200#	320#	15380#	420#	26120#	300#	6150#	300#	5230#	310#	-5160#	590#
	Rb	37	4007	11	11820	100	17811	9	10943	14	7620	60	-1400	70
	Sr	38	6827	10	13512	10	9569	7	6642	9	3769	11	-1880	60
	Y	39	6197	13	9553	10	1805	8	11230	8	6161	8	1043	11
	Zr	40	8221.1	1.9	10333	11	-4699	13	8257	9	3942.2	2.7	2025	5
	Nb	41	7227.54	0.08	6536.4	1.6	-13430#	450#	12800.2	1.6	6390.0	1.6	5626.9	2.4
	Mo	42	9678	4	8490.4	2.0	-22060#	400#	8749.4	2.5	3087	4	5127.1	2.0
	Tc	43	8623	6	4639	5	-30850#	500#	13362	5	2914	12	8125	5
	Ru	44	13370	90	6254	13	*		7078	29	-1720	200	5283	17
	Rh	45	11840#	600#	2960#	460#	*		12180#	540#	580#	740#	8690#	490#
	Pd	46	14720#	570#	4470#	570#	*		7720#	570#	-2380#	570#	7950#	710#
Ag	47	14590#	780#	890#	640#	*		12910#	710#	-1030#	760#	11450#	640#	
95	Br	35	4170#	640#	14390#	950#	37310#	500#	7530#	950#	7610#	780#	-7330#	1030#
	Kr	36	2970#	500#	15520#	570#	29620#	400#	7720#	500#	5410#	400#	-3740#	720#
	Rb	37	5372	22	12000#	300#	20928	21	8870	100	7795	24	-3630	50
	Sr	38	4348	10	13852	11	12591	8	8212	11	4519	10	-685	14
	Y	39	6930	10	9656	10	4810	9	9588	10	6525	8	-789	9
	Zr	40	6462.2	0.9	10598	7	-2208	12	9276	11	4020	9	2856	4
	Nb	41	8488.7	2.0	6804.0	1.9	-8440	150	11045.9	2.1	6536.0	2.1	3678	9
	Mo	42	7369.10	0.10	8632.0	2.0	-17560#	400#	10211.6	2.0	3604.9	2.5	6392.8	2.0
	Tc	43	9934	7	4896	5	-25920#	400#	11497	6	5652	6	6078	6
	Ru	44	8953	14	6585	13	-36750#	600#	10864	12	349	29	9002	12
	Rh	45	13470#	470#	3060	150	*		9640	170	930#	330#	6240	150
	Pd	46	11870#	570#	4500#	600#	*		9730#	570#	-1930#	570#	9900#	500#
	Ag	47	14870#	640#	1040#	570#	*		10310#	570#	260#	640#	8910#	570#
Cd	48	*		690#	780#	*		10800#	840#	*		14450#	780#	



A	Elt.	Z	S(2n)	S(2p)	Q( $\alpha$ )	Q( $2\beta^-$ )	Q( $\epsilon p$ )	Q( $\beta^- n$ )						
92	As	33	5620#	1210#	*	*	25660#	910#	*	11340#	1030#			
	Se	34	6870#	720#	*	-8940#	920#	22140#	600#	*	6790#	600#		
	Br	35	8100	90	29710#	800#	-7720#	510#	18190	50	-27010#	910#	6660	80
	Kr	36	9958	22	27440#	400#	-7330	50	14083	12	-25740#	500#	889	14
	Rb	37	11553	9	24730	80	-6460	40	10041	11	-20550	70	802	7
	Sr	38	13069	4	22476	19	-5600	14	5586	4	-18850	60	-4594	4
	Y	39	14468	9	20030	11	-4629	9	1635	9	-14357	12	-4994	9
	Zr	40	15829.3	0.5	17090.2	2.2	-2957.1	2.5	-1649	4	-12098	4	-9892.8	3.0
	Nb	41	19935	4	14538.8	2.5	-4574	3	-7514	26	-7392.3	2.6	-12315	11
	Mo	42	22780	7	12616	4	-5607	11	-12400#	300#	-6204	4	-18890	200
	Tc	43	23870	240	10856	26	-5290	100	-15570#	400#	409	26	-18350#	580#
	Ru	44	25240#	420#	8820#	300#	-4130#	300#	-18910#	590#	510#	300#	-23380#	500#
	Rh	45	26290#	640#	6730#	470#	-3080#	450#	*	5340#	450#	450#	-24030#	690#
	Pd	46	*		4770#	590#	-2280#	640#	*	5870#	770#		*	
93	Se	34	6520#	950#	*	-9450#	1210#	23300#	810#	*			7790#	800#
	Br	35	7680#	310#	30770#	950#	-8330#	590#	19570#	300#	-29410#	950#	7670#	300#
	Kr	36	8850	120	28260#	510#	-7250#	310#	16070	100	-24660#	610#	2680	100
	Rb	37	11015	11	25690	70	-6470	60	11606	13	-23330	50	2179	8
	Sr	38	12582	9	23350	60	-5780	50	7032	8	-18589	14	-3343	12
	Y	39	14021	11	21056	13	-4936	12	2985	11	-16740	12	-3841	11
	Zr	40	15369.3	0.5	18050	4	-3332.8	2.5	-314	4	-11538	4	-8740.0	1.8
	Nb	41	16718	3	15441.2	2.4	-1931.4	2.3	-3606	4	-9684	9	-8475	4
	Mo	42	20742	11	13491	4	-4360	5	-9540	90	-5639	4	-15940	26
	Tc	43	23760	200	11548	5	-5377	27	-14430#	400#	-4443	4	-17270#	300#
	Ru	44	24750#	590#	9640	90	-4690	90	-17570#	410#	2250	90	-21980#	410#
	Rh	45	26210#	570#	7770#	450#	-3750#	450#	-22390#	720#	2470#	400#	-21750#	640#
	Pd	46	28440#	690#	5620#	710#	-2610#	640#	*	7420#	500#		*	
	Ag	47	*		2250#	720#	-1550#	750#	*	9290#	720#		*	
94	Se	34	6300#	1000#	*	*		24340#	860#	*			8170#	860#
	Br	35	7370#	400#	31460#	990#	-8780#	900#	20750#	400#	*		8140#	410#
	Kr	36	8500#	300#	29070#	670#	-7640#	500#	17700#	300#	-27720#	860#	3400#	300#
	Rb	37	9924	10	26550	50	-6360	80	13795	11	-22790#	300#	3460	11
	Sr	38	12115	8	24633	14	-6295	20	8426	7	-22110	100	-2689	13
	Y	39	13678	12	22154	9	-5412	10	4016	7	-17020	10	-3303	7
	Zr	40	14955.6	2.0	18977	4	-3750.1	2.9	1142.9	1.9	-14471	8	-8129.9	2.2
	Nb	41	16058.8	2.0	16129	9	-2302.0	2.3	-2211	5	-9430	11	-7632	4
	Mo	42	17747	4	14533.8	2.0	-2067.4	2.1	-5842	13	-8581.6	2.0	-12878	4
	Tc	43	21362	26	12284	5	-3923	6	-11220#	450#	-4235	5	-14960	90
	Ru	44	24300#	300#	10341	13	-4826	14	-16220#	400#	-3053	13	-21470#	400#
	Rh	45	25720#	600#	8580#	450#	-4160#	510#	-19640#	670#	3380#	450#	-21310#	600#
	Pd	46	27000#	640#	6520#	500#	-3470#	500#	*	3630#	410#	410#	-27640#	720#
	Ag	47	*		4520#	640#	-2510#	710#	*	8580#	640#		*	
95	Br	35	7000#	590#	*	-9470#	1030#	21950#	500#	*			9170#	590#
	Kr	36	8160#	410#	29900#	900#	-8130#	640#	19080#	400#	-26520#	900#	4440#	400#
	Rb	37	9379	22	27380#	300#	-6770	80	15353	22	-25340#	400#	4915	22
	Sr	38	11175	11	25680	100	-6230	60	10541	8	-21260#	300#	-840	10
	Y	39	13127	13	23167	10	-5887	11	5575	7	-19943	11	-2012	7
	Zr	40	14683.4	2.0	20151	8	-4437	5	2049.7	1.8	-14106	7	-7364.6	2.2
	Nb	41	15716.3	2.0	17137	11	-2861.8	2.7	-765	5	-11722	7	-6443.5	0.5
	Mo	42	17047	4	15168.4	2.0	-2242.0	2.0	-4258	12	-7729.6	1.9	-11625	4
	Tc	43	18557	6	13387	5	-1809	6	-7680	150	-6941	5	-11520	14
	Ru	44	22330	90	11224	12	-3671	16	-13300#	400#	-2329	12	-18580#	450#
	Rh	45	25310#	430#	9320	150	-4780	250	-18240#	430#	-1470	150	-20060#	430#
	Pd	46	26590#	570#	7460#	410#	-3920#	710#	-23460#	720#	5130#	400#	-24920#	640#
	Ag	47	29460#	720#	5510#	570#	-3420#	570#	*	5550#	600#		*	
	Cd	48	*		1570#	720#	-1720#	820#	*	12370#	720#		*	

A	Elt.	Z	S(n)	S(p)	$Q(4\beta^-)$	$Q(d,\alpha)$	$Q(p,\alpha)$	$Q(n,\alpha)$						
96	Br	35	2800#	860#	*	39720#	700#	8890#	1060#	6950#	1060#	*		
	Kr	36	5060#	640#	16420#	710#	32410#	500#	5490#	640#	4880#	590#	-6670#	950#
	Rb	37	3442	29	12480#	400#	24379	30	10630#	300#	7660	100	-2530#	300#
	Sr	38	5893	28	14370	30	15852	27	6325	29	4543	28	-3280	100
	Y	39	5211	24	10519	24	7471	24	11205	24	6602	25	-83	25
	Zr	40	7856.3	2.2	11525	7	629	8	7617	7	3644	11	288	8
	Nb	41	6893	3	7235	4	-5924	13	12374	4	6377	4	4266	11
	Mo	42	9154.32	0.05	9297.6	0.5	-12560	150	8284.8	2.0	3281.8	2.0	3972.9	2.0
	Tc	43	7872	7	5399	5	-21250#	400#	13303	5	5850	6	7037	6
	Ru	44	10694	10	7344	9	-29970#	500#	8793	9	2395	9	6378	9
	Rh	45	9410	150	3519	14	*		13599	14	2450	90	9570	13
	Pd	46	14150#	430#	5180	210	*		7420#	470#	-2190#	430#	6680	170
	Ag	47	12540#	570#	1710#	570#	*		12490#	570#	-10#	570#	10250#	570#
Cd	48	17480#	780#	3290#	640#	*		7910#	710#	-4460#	780#	9240#	640#	
97	Br	35	4090#	1060#	*	41610#	800#	*		7020#	1130#	*		
	Kr	36	2960#	710#	16580#	860#	35030#	500#	6700#	710#	4750#	640#	-5470#	950#
	Rb	37	5200	30	12620#	500#	27250	30	8390#	400#	7650#	300#	-4910#	400#
	Sr	38	3920	30	14850	30	18752	19	7777	27	4629	21	-2000#	300#
	Y	39	5982	26	10608	29	10962	12	9570	14	7447	14	-2058	14
	Zr	40	5575.2	0.4	11889	23	3166	9	8971	7	4266	7	1540	8
	Nb	41	8073	4	7451.8	1.8	-3020	40	10762.9	2.2	6525.2	2.3	2389	7
	Mo	42	6821.26	0.21	9226	3	-9740	300	9952.3	0.5	3688.1	2.0	5372.8	1.9
	Tc	43	9474	7	5719	4	-16400	320	11198	4	6054	4	4791	5
	Ru	44	8111.5	2.8	7584	10	-25510#	400#	10615	10	2906	9	7944	9
	Rh	45	10980	40	3810	40	-35590#	600#	11570	40	4840	40	7210	40
	Pd	46	9640	340	5410	300	*		11250	340	0#	540#	10420	300
	Ag	47	14320#	510#	1880	350	*		10040#	510#	400#	510#	7770#	550#
Cd	48	12570#	640#	3320#	570#	*		10210#	570#	-2440#	640#	11390#	570#	
In	49	*		-1810#	780#	*		10400#	840#	*		11940#	780#	
98	Kr	36	4950#	780#	17430#	1000#	36490#	600#	4540#	920#	3970#	780#	*	
	Rb	37	3940	50	13600#	510#	29310	50	9520#	510#	6680#	400#	-4670#	510#
	Sr	38	5930	30	15580	40	21466	26	5290	40	4070	30	-4960#	400#
	Y	39	4281	27	10970	30	13960	25	11180	40	7513	26	-970	30
	Zr	40	6412	20	12318	23	6938	21	7770	30	4784	21	-524	21
	Nb	41	5994	5	7871	5	-354	13	12625	5	6993	5	3325	9
	Mo	42	8642.60	0.07	9795.1	1.8	-6812	22	8203	3	3534.2	0.5	3192.4	1.8
	Tc	43	7279	5	6176	3	-13370	70	13074	3	6144	3	6001	3
	Ru	44	10184	10	8293	8	-20590	80	8304	8	2656	8	5129	6
	Rh	45	8660	40	4352	14	-29280#	200#	13608	14	5139	17	8488	13
	Pd	46	11570	300	6000	40	*		9090	22	1900	150	7796	22
	Ag	47	10310	330	2550	310	*		13880	160	1950#	410#	10930	160
	Cd	48	15100#	410#	4100	330	*		7650#	410#	-2670#	410#	8170#	410#
In	49	14960#	630#	580#	450#	*		12920#	540#	-2340#	630#	11850#	450#	
99	Kr	36	2770#	840#	*	38270#	600#	5870#	1000#	4000#	920#	*		
	Rb	37	4730	130	13370#	610#	31450	130	7750#	520#	7020#	520#	-6600#	710#
	Sr	38	3610	80	15250	90	23780	80	6880	80	3900	80	-3510#	510#
	Y	39	5800	30	10840	40	17122	24	9300	30	7600	40	-3330	40
	Zr	40	4553	28	12590	30	9849	20	9200	23	5440	30	820	30
	Nb	41	6870	14	8329	24	3247	15	11330	13	7980	13	1666	27
	Mo	42	5925.43	0.15	9726	5	-3778	15	10350.6	1.8	4502	3	5123.4	2.2
	Tc	43	8967	3	6500.4	1.0	-10570	150	10928.1	1.0	6331.4	1.0	3927	3
	Ru	44	7464	7	8478	4	-17760#	210#	10314	4	3064	5	6819.9	1.6
	Rh	45	10471	14	4639	9	-24300#	400#	11249	11	5362	10	5889	9
	Pd	46	8959	25	6302	19	-34990#	600#	11110	40	2356	18	9531	15
	Ag	47	11770	160	2750	150	*		11750	340	4340	210	8570	150
	Cd	48	10290#	220#	4080#	220#	*		11680#	380#	-420#	450#	12020#	250#
In	49	15450#	450#	930#	410#	*		10040#	570#	-310#	640#	8940#	570#	
Sn	50	*		590#	630#	*		10520#	840#	*		14550#	780#	

A	Elt.	Z	S(2n)	S(2p)	Q( $\alpha$ )	Q( $2\beta^-$ )	Q( $\epsilon p$ )	Q( $\beta^- n$ )						
96	Br	35	6970#	810#	*	-10130#	1140#	22600#	700#	*	9340#	810#		
	Kr	36	8030#	590#	30810#	950#	-8810#	780#	19910#	500#	*	4750#	500#	
	Rb	37	8810	30	28000#	400#	-7070	60	17120	30	-24610#	500#	5821	30
	Sr	38	10241	28	26370#	300#	-6579	30	12504	27	-24190#	400#	197	28
	Y	39	12141	24	24371	25	-6000	24	7257	24	-19782	29	-760	23
	Zr	40	14318.6	2.3	21180	8	-5000	4	3347.7	2.2	-17615	8	-6732.2	2.2
	Nb	41	15382	4	17833	8	-3215	10	214	6	-11686	8	-5968	3
	Mo	42	16523.42	0.11	16101.6	1.9	-2761.5	2.0	-2718	8	-10421.7	1.8	-10845	5
	Tc	43	17806	7	14031	6	-1794	6	-6138	14	-6324	5	-10439	13
	Ru	44	19647	10	12240	8	-1692	9	-9840	150	-5654	8	-15800	150
	Rh	45	22880#	450#	10103	13	-3170	29	-15110#	400#	-952	14	-17600#	400#
	Pd	46	26020#	430#	8240	150	-4250#	330#	-20130#	530#	-70	150	-24200#	430#
	Ag	47	27410#	640#	6210#	600#	-3640#	570#	*		6480#	430#	-25950#	720#
	Cd	48	*		4330#	640#	-3030#	710#	*		6760#	640#	*	
97	Br	35	6890#	950#	*	*	*	23710#	800#	*		10310#	950#	
	Kr	36	8020#	640#	*	-9630#	950#	20870#	500#	*		5240#	500#	
	Rb	37	8650	30	29030#	500#	-7730#	300#	17901	30	-27020#	700#	6510	40
	Sr	38	9814	20	27330#	400#	-7200	100	14159	19	-23050#	500#	1487	29
	Y	39	11193	13	24982	23	-6065	14	9348	11	-22320	30	1114	11
	Zr	40	13431.5	2.2	22408	8	-5287	8	4593.8	2.2	-17297	27	-5414	4
	Nb	41	14966.4	1.8	18977	7	-3807	11	1614	4	-14548	23	-4886.5	1.8
	Mo	42	15975.58	0.22	16460.6	1.8	-2848.3	2.0	-1428	8	-9386.6	2.2	-9795	5
	Tc	43	17346	7	15016	4	-2437	5	-4630	40	-8905	5	-9219	9
	Ru	44	18805	10	12983	8	-1734	9	-8310	300	-4611	8	-14504	10
	Rh	45	20390	150	11150	40	-1410	40	-11770	320	-4060	40	-14430	150
	Pd	46	23790#	500#	8930	300	-2960	310	-17200#	500#	980	300	-21300#	500#
	Ag	47	26860#	510#	7060	350	-4070#	510#	-23820#	680#	1570	320	-22790#	600#
	Cd	48	30050#	720#	5030#	570#	-3330#	570#	*		8340#	430#	*	
	In	49	*		1480#	720#	-2650#	840#	*		10280#	720#	*	
98	Kr	36	7910#	780#	*	-10420#	1000#	21850#	600#	*		5490#	600#	
	Rb	37	9140	60	30170#	700#	-8840#	400#	18250	50	-26860#	800#	6500	50
	Sr	38	9850	40	28190#	500#	-7930#	300#	14641	18	-26020#	500#	1541	28
	Y	39	10260	30	25820	40	-6339	26	11061	25	-21400	40	2408	24
	Zr	40	11987	20	22930	30	-4871	21	6825	20	-19788	27	-3753	20
	Nb	41	14067	6	19760	24	-3605	9	2899	6	-14560	12	-4059	5
	Mo	42	15463.86	0.22	17246.9	2.2	-3269.8	1.9	113	6	-12454.0	2.2	-8963	4
	Tc	43	16753	6	15402	5	-2488	4	-3253	12	-8111	4	-8387	9
	Ru	44	18295	10	14012	6	-2240	6	-6925	22	-7973	6	-13710	40
	Rh	45	19638	17	11936	13	-1446	13	-10110	70	-3244	13	-13450	300
	Pd	46	21210	150	9806	20	-1157	22	-13670	70	-2477	20	-18550	320
	Ag	47	24630#	410#	7960	70	-2550#	450#	-19160#	210#	2240	80	-20530#	410#
	Cd	48	27670#	510#	5980	170	-3710#	410#	*		2880	310	-28700#	600#
	In	49	*		3900#	450#	-3020#	540#	*		9630#	380#	*	
99	Kr	36	7720#	780#	*	*	*	22690#	600#	*		6660#	600#	
	Rb	37	8670	130	30810#	810#	-9400#	520#	19320	120	*		7700	130
	Sr	38	9540	80	28850#	510#	-8570#	410#	15580	80	-24680#	600#	2210	80
	Y	39	10086	27	26420	40	-6770	30	12126	20	-23270	60	3010	30
	Zr	40	10964	20	23558	28	-5077	21	8197	20	-18410	30	-2311	21
	Nb	41	12864	13	20647	18	-3545	15	4996	13	-17149	28	-2287	13
	Mo	42	14568.03	0.16	17597.1	2.2	-2733.0	1.8	1651.1	1.6	-11968	20	-7609	3
	Tc	43	16246	4	16295.4	2.0	-2966.2	1.1	-1749	7	-11084	6	-7170	7
	Ru	44	17647	9	14654.5	1.6	-2334.4	1.6	-5429	15	-6794.2	1.6	-12513	12
	Rh	45	19130	40	12932	8	-1982	9	-8820	150	-6436	8	-12346	22
	Pd	46	20530	300	10653	15	-1163	18	-12340#	210#	-1252	16	-17200	70
	Ag	47	22080	360	8750	150	-840	210	-15480#	430#	-870	150	-17200	170
	Cd	48	25390#	450#	6630#	370#	-2130#	450#	-22650#	630#	4160#	210#	-24030#	280#
	In	49	30410#	720#	5030#	510#	-3600#	570#	*		4500#	410#	*	
	Sn	50	*		1170#	720#	-2930#	840#	*		13140#	600#	*	

A	Elt.	Z	S(n)		S(p)		Q( $4\beta^-$ )		Q(d, $\alpha$ )		Q(p, $\alpha$ )		Q(n, $\alpha$ )		
100	Kr	36	4770#	780#	*		40410#	500#	*		3320#	950#	*		
	Rb	37	3890#	320#	14490#	670#	33240#	300#	8810#	670#	6080#	590#	-6400#	860#	
	Sr	38	6100	150	16630	180	25970	130	4710	140	3000	130	-6660#	520#	
	Y	39	5160	80	12400	110	18720	80	10060	80	6360	80	-3290	80	
	Zr	40	6910	40	13690	40	12610	40	6570	40	4520	40	-2170	40	
	Nb	41	5684	28	9460	30	5640	30	12060	30	7871	26	1965	28	
	Mo	42	8290	6	11146	12	-958	13	8055	8	4285	6	2409	6	
	Tc	43	6764.4	1.0	7339.4	1.4	-7870	80	12806.3	1.4	6388.3	1.4	5235.8	2.3	
	Ru	44	9673.32	0.03	9184.8	1.4	-14970	100	7920	4	2865	4	3967.9	1.6	
	Rh	45	8081	19	5256	18	-21410	250	13351	19	5392	20	7282	19	
	Pd	46	11110	18	6941	13	-28450	710	8659	16	2230	40	6532	13	
	Ag	47	9460	170	3250	80	*		13860	80	4510	310	10090	90	
	Cd	48	12470#	230#	4780	180	*		9520	120	1430	340	9200	320	
	In	49	10970#	470#	1610#	320#	*		14170	260	1300#	470#	12300	410	
	Sn	50	17650#	920#	2800#	810#	*		7830#	730#	-4910#	920#	9470#	810#	
	101	Rb	37	4970#	340#	14690#	530#	35350	170	6610#	620#	6060#	620#	*	
Sr		38	3260	180	16000#	320#	28100	120	6180	180	3680	130	-4970#	610#	
Y		39	5690	120	11980	160	21420	100	7980	120	6600	100	-5040	110	
Zr		40	4920	50	13450	80	14490	30	7450	40	3870	40	-1170	40	
Nb		41	7070	30	9630	40	8466	26	9537	26	7209	27	-830	30	
Mo		42	5398.24	0.07	10861	25	1917	19	9527	12	4881	8	3422	21	
Tc		43	8391	24	7441	25	-5110	110	10341	24	6640	24	2839	25	
Ru		44	6802.05	0.24	9222.5	1.7	-12200	150	10084.2	1.4	3342	4	5808.4	1.6	
Rh		45	9895	25	5478	17	-18790#	300#	10920	17	5681	18	4666	18	
Pd		46	8273	21	7133	25	-25870#	300#	10857	19	2611	21	8443	19	
Ag		47	11150	130	3290	100	*		11670	110	4940	110	7600	110	
Cd		48	9570	180	4890	170	*		11720	210	2180	170	11200	150	
In		49	12520#	390#	1650#	310#	*		11950#	360#	3880#	310#	10090#	310#	
Sn		50	10850#	770#	2680#	390#	*		12430#	500#	-800#	360#	13720#	310#	
102		Rb	37	2790#	530#	*		38040#	510#	8600#	710#	6050#	780#	*	
		Sr	38	5740	170	16770	200	30480	110	4330#	320#	2670	170	-7940#	610#
	Y	39	5050	130	13770	150	22670	90	9040	150	5160	120	-5370	150	
	Zr	40	6360	60	14120	110	17360	50	6260	90	3320	60	-3910	90	
	Nb	41	5480	40	10180	50	10430	40	10970	50	6290	40	-500	50	
	Mo	42	8118	20	11904	27	4368	21	7090	30	3634	23	-143	28	
	Tc	43	6301	26	8343	10	-2301	29	12329	10	6264	9	3408	16	
	Ru	44	9219.64	0.05	10051	24	-9420	29	7629.0	1.7	3089.2	1.4	2514.2	1.6	
	Rh	45	7438	18	6114	5	-16070	110	13155	5	5706	5	6195	5	
	Pd	46	10568	17	7806	17	-23000	130	8370	18	2513	7	5338.3	2.4	
	Ag	47	9110	110	4130	30	*		13670	30	4790	30	8956	29	
	Cd	48	12000	150	5740	110	*		9180	80	1940	150	8160	30	
	In	49	10170#	320#	2250	190	*		14250	150	4010#	230#	11690	190	
	Sn	50	13440#	330#	3610#	330#	*		9950	280	1210#	420#	10570#	240#	
	103	Sr	38	2550#	520#	16530#	710#	33290#	510#	6760#	530#	4010#	590#	-5710#	710#
		Y	39	5110#	310#	13150#	320#	25660#	300#	7180#	320#	6150#	320#	-6590#	420#
Zr		40	4700	120	13770	140	18890	110	7250	140	3790	130	-2510	170	
Nb		41	7040	80	10860	80	12710	70	8850	70	6150	80	-2380	100	
Mo		42	5360	60	11790	70	6630	60	8810	60	3960	70	1400	70	
Tc		43	8103	13	8329	23	194	19	9625	11	6451	11	989	27	
Ru		44	6232.05	0.15	9982	9	-6609	15	9788	24	3621.5	1.8	4572	6	
Rh		45	9318	5	6213.1	2.1	-13423	25	10638.3	2.1	6060.9	2.1	3640.4	2.7	
Pd		46	7625.4	0.8	7993	5	-20510#	300#	10640	17	2969	18	7386.3	2.3	
Ag		47	10600	30	4155	17	-28610#	300#	11347	24	5299	20	6439	25	
Cd		48	9040	30	5670	30	*		11290	110	2360	80	10223	19	
In		49	11960	110	2210	40	*		11860	150	4510	100	9200	80	
Sn		50	10120#	330#	3550#	320#	*		12350#	420#	2060#	390#	12920#	310#	
Sb		51	*		-1460#	330#	*		14090#	420#	5470#	770#	13640#	390#	

A	Elt.	Z	S(2n)		S(2p)		Q( $\alpha$ )		Q(2 $\beta^-$ )		Q( $\epsilon p$ )		Q( $\beta^- n$ )	
100	Kr	36	7550#	780#	*	*	*	24020#	520#	*	*	6610#	520#	
	Rb	37	8620#	300#	*	*	-10490#	760#	20600#	310#	*	7420#	310#	
	Sr	38	9720	130	30000#	610#	-9610#	520#	16390	120	-28010#	610#	1910	130
	Y	39	10970	80	27650	90	-8490	80	12650	70	-23700	150	2400	80
	Zr	40	11460	40	24540	40	-6090	50	9580	40	-21710	90	-2350	40
	Nb	41	12553	26	22050	40	-4020	30	6077	26	-17030	30	-2045	26
	Mo	42	14215	6	19475	21	-3166	6	3035	6	-15705	19	-6932	6
	Tc	43	15731	4	17066	6	-2837	3	-432	18	-10978	13	-6470.6	1.7
	Ru	44	17137	7	15685.2	1.6	-2853.4	1.6	-3993	11	-10542.1	1.6	-11716	7
	Rh	45	18552	22	13734	18	-2192	19	-7440	80	-5550	18	-11468	24
	Pd	46	20069	24	11580	13	-1579	13	-10980	90	-4898	11	-16540	150
	Ag	47	21230	100	9550	80	-890	80	-13980	240	140	80	-16370#	220#
	Cd	48	22760	120	7530	100	-450	180	-17470	700	650	100	-21050#	410#
	In	49	26420#	320#	5690	260	-2020#	470#	*	*	5300	290	-25040#	650#
	Sn	50	*	*	3730	710	-3100#	870#	*	*	5780#	740#	*	*
101	Rb	37	8860	210	*	*	-11370#	820#	21320	140	*	*	8550	210
	Sr	38	9360	150	30490#	610#	-9920#	520#	18050	120	-26500#	520#	3820	150
	Y	39	10850	100	28610	160	-8980	100	14030	90	-25510#	310#	3620	100
	Zr	40	11830	40	25850	90	-7090	40	10050	30	-20530	130	-1590	40
	Nb	41	12758	22	23319	30	-5109	22	7390	30	-18940	80	-829	18
	Mo	42	13688	6	20321	19	-2990	6	4438	6	-14200	40	-5566	6
	Tc	43	15155	24	18587	27	-3155	24	1072	29	-13690	40	-5188	24
	Ru	44	16475.38	0.24	16561.8	1.6	-2834.2	1.6	-2522	18	-9054	6	-10437	18
	Rh	45	17976	18	14663	17	-2613	18	-6180	100	-8681	17	-10253	20
	Pd	46	19383	23	12389	18	-1741	20	-9680	150	-3498	18	-15350	80
	Ag	47	20610	180	10230	100	-1060	110	-12610#	320#	-2930	110	-15050	140
	Cd	48	22040#	260#	8140	150	-370	340	-16190#	330#	2190	150	-19650	290
	In	49	23480#	500#	6430#	330#	-220#	440#	*	*	2250#	310#	-19910#	770#
	Sn	50	28500#	670#	4290#	360#	-1380#	500#	*	*	7400#	310#	*	*
102	Rb	37	7760#	590#	*	*	*	*	23580#	510#	*	*	9020#	520#
	Sr	38	9000	170	31460#	520#	-10710#	610#	18670	100	*	*	3760	150
	Y	39	10740	120	29780#	310#	-10100	100	14460	80	-25580	190	3490	90
	Zr	40	11280	60	26100	140	-7520	60	11820	50	-23620	130	-870	50
	Nb	41	12550	50	23630	90	-6300	50	8220	40	-18720	100	-910	40
	Mo	42	13516	20	21530	40	-4695	29	5541	21	-17390	40	-5290	30
	Tc	43	14692	9	19204	27	-3462	11	2209	10	-12912	21	-4687	9
	Ru	44	16021.69	0.24	17492	6	-3411.2	1.6	-1173.0	2.4	-12876	6	-9761	17
	Rh	45	17333	19	15337	5	-2772	6	-4510	28	-7728	24	-9418	18
	Pd	46	18841	11	13284.0	2.4	-2126	7	-8247	29	-7264.3	2.4	-14770	100
	Ag	47	20260	80	11260	30	-1510	30	-11560	110	-2150	30	-14590	150
	Cd	48	21570	100	9030	30	-800	40	-14750	130	-1540	30	-19140#	300#
	In	49	22680	270	7140	140	-70	130	*	*	3230	150	-19220#	320#
	Sn	50	24290	720	5260	160	280	150	*	*	3530	200	*	*
103	Sr	38	8290#	520#	*	*	-10480#	780#	20820#	520#	*	*	6270#	510#
	Y	39	10170#	310#	29920#	340#	-10480#	320#	16380#	310#	-27910#	590#	4740#	300#
	Zr	40	11060	110	27540	170	-8610	130	12480	90	-22580	160	-100	120
	Nb	41	12520	70	24980	120	-7540	70	9280	70	-20710	110	170	70
	Mo	42	13480	60	21970	70	-5500	60	6410	60	-16390	80	-4350	60
	Tc	43	14404	26	20233	21	-4695	17	3425	10	-15540	40	-3570	10
	Ru	44	15451.69	0.16	18325	6	-3717.9	1.6	220.3	2.2	-10990	21	-8555	5
	Rh	45	16757	17	16264	24	-3124.0	2.5	-3231	17	-10745	10	-8168.4	1.1
	Pd	46	18194	17	14107.3	2.2	-2287.0	2.3	-6830	15	-5670.0	2.2	-13286	28
	Ag	47	19710	110	11961	24	-1642	18	-10192	23	-5305	17	-13180	30
	Cd	48	21040	150	9799	23	-887	22	-13680#	300#	-13	16	-18010	110
	In	49	22130#	300#	7950	110	-270	150	-18420#	300#	380	40	-17740	130
	Sn	50	23560#	420#	5810#	330#	450#	360#	*	*	5420#	300#	*	*
	Sb	51	*	*	2140#	420#	2670#	500#	*	*	7240#	320#	*	*

A	Elt.	Z	S(n)	S(p)	$Q(4\beta^-)$	$Q(d,\alpha)$	$Q(p,\alpha)$	$Q(n,\alpha)$						
104	Sr	38	4920#	860#	*	35920#	700#	4620#	860#	4060#	720#	*		
	Y	39	4050#	500#	14650#	640#	27580#	400#	8880#	420#	5360#	420#	-5670#	430#
	Zr	40	6040#	420#	14690#	500#	21750#	400#	6260#	410#	3440#	410#	-5290#	420#
	Nb	41	4980	120	11140	150	14730	100	10230	120	6100	110	-1670	140
	Mo	42	7550	80	12300	90	9060	50	6730	70	3480	60	-1230	60
	Tc	43	5960	50	8930	80	2630	50	11780	50	5890	50	2100	50
	Ru	44	8901.4	2.8	10781	9	-4114	10	7188	9	3111	24	1069	6
	Rh	45	6998.96	0.08	6980.0	2.1	-10840	80	12859.0	2.1	5863.9	2.1	5032	24
	Pd	46	9982	5	8657	5	-17800	100	8096	6	2882	18	4206	4
	Ag	47	8391	18	4921	6	-25940#	360#	13524	6	5181	19	7943	18
	Cd	48	11397	17	6472	18	*	*	9001	30	2110	100	7100	20
	In	49	9580	90	2750	90	*	*	14280	90	4510	170	10760	130
	Sn	50	12690#	320#	4280	110	*	*	9830	150	1890#	320#	9800	180
	Sb	51	11070#	470#	-510#	210#	*	*	16460#	390#	5250#	470#	15080#	470#
105	Sr	38	2250#	990#	*	38760#	700#	*	4590#	860#	*	*		
	Y	39	4510#	640#	14240#	860#	30930#	510#	6910#	710#	6590#	520#	-7400#	710#
	Zr	40	4090#	570#	14740#	570#	23560#	400#	7280#	500#	4390#	410#	-3640#	420#
	Nb	41	6700	140	11800#	410#	16990	100	8230	150	5750	110	-3310	130
	Mo	42	5080	90	12400	130	11080	70	8690	100	3870	80	50	90
	Tc	43	7870	70	9250	80	4780	60	9270	80	6130	60	-290	70
	Ru	44	5910.10	0.11	10730	50	-1598	12	9380	9	3502	9	3276	21
	Rh	45	8967	5	7046	3	-8365	17	10124	4	6116	4	2366	10
	Pd	46	7094.1	0.7	8752	5	-15150	80	10320	5	3226	6	6332	4
	Ag	47	10028	11	4967	11	-23250	110	11122	11	5721	11	5353	12
	Cd	48	8427	14	6508	12	-31830#	500#	11172	20	2800	30	9241	12
	In	49	11450	90	2795	19	*	*	11879	23	5060	30	8430	30
	Sn	50	9740	130	4440	120	*	*	12050	80	2310	140	12060	90
	Sb	51	12720#	380#	-483	15	*	*	13870#	320#	5970	170	12540	150
Te	52	*	*	610#	620#	*	*	14390#	590#	*	*	18080#	520#	
106	Y	39	3490#	860#	15480#	990#	33010#	700#	8350#	990#	5650#	860#	*	
	Zr	40	5410#	640#	15640#	710#	26620#	500#	5920#	640#	4100#	590#	-6500#	710#
	Nb	41	4310#	220#	12020#	450#	19270#	200#	9960#	450#	6140#	220#	-2510#	360#
	Mo	42	6990	70	12690	100	13647	17	6680	110	3930	70	-2240	110
	Tc	43	5560	60	9730	70	7162	13	11260	60	5940	60	1190	70
	Ru	44	8466	7	11320	60	810	10	6870	50	3139	12	170	60
	Rh	45	6587	7	7723	7	-5755	14	12438	7	5761	8	3882	12
	Pd	46	9560.97	0.28	9345.8	2.5	-12480	50	7758	5	2984	5	3003	4
	Ag	47	7941	11	5813.5	2.8	-20610#	310#	13163.5	2.9	5406	5	6731	5
	Cd	48	10874	12	7353	12	-28920	130	8690	8	2523	16	5993	7
	In	49	9197	21	3565	17	*	*	14079	13	4907	19	9831	20
	Sn	50	12230	90	5230	50	*	*	9390	100	2040	60	8870	50
	Sb	51	10580#	330#	360#	320#	*	*	15970#	330#	5510#	430#	13920#	310#
	Te	52	13790#	520#	1680	170	*	*	11670#	390#	2830#	330#	14410#	330#
107	Y	39	4020#	860#	*	36390#	530#	6580#	860#	6550#	860#	*		
	Zr	40	3560#	590#	15710#	760#	28730#	320#	6870#	590#	4590#	500#	-5140#	760#
	Nb	41	5890#	450#	12510#	640#	21950#	400#	8160#	570#	6290#	570#	-4360#	570#
	Mo	42	4760	160	13140#	250#	15420	160	8620	190	4140	190	-960#	430#
	Tc	43	7400	150	10140	150	9300	150	8950	170	6090	160	-1230	180
	Ru	44	5670	120	11440	120	3060	120	9080	140	3430	130	2050	130
	Rh	45	8573	14	7830	14	-3304	16	9775	12	6090	12	1270	50
	Pd	46	6536.4	0.5	9295	6	-9790	80	10188.9	2.6	3446	5	5368	4
	Ag	47	9536	4	5788.2	2.7	-17750#	300#	10721.9	2.8	5852.4	2.8	4194	5
	Cd	48	7924	8	7336	5	-26440#	300#	10794	11	2991	6	8052	5
	In	49	11024	17	3716	13	*	*	11481	16	5279	15	7198	12
	Sn	50	9220	90	5260	80	*	*	11620	90	2390	120	11040	80
	Sb	51	12400#	430#	520#	300#	*	*	13320#	310#	5800#	320#	11100#	310#
	Te	52	10400#	330#	1500#	430#	*	*	13990#	320#	3500#	210#	16700#	320#

A	Elt.	Z	S(2n)		S(2p)		Q( $\alpha$ )		Q( $2\beta^-$ )		Q( $\epsilon p$ )		Q( $\beta^- n$ )	
104	Sr	38	7470#	710#	*		-10630#	860#	21940#	810#	*		6460#	760#
	Y	39	9160#	410#	31180#	640#	-10640#	500#	17310#	410#	*		5390#	420#
	Zr	40	10740#	400#	27840#	420#	-8550#	420#	13990#	400#	-26080#	640#	910#	410#
	Nb	41	12020	110	24910	140	-7350	130	10260	90	-20580#	320#	550	120
	Mo	42	12910	60	23160	70	-6150	60	7760	50	-19250	120	-3800	50
	Tc	43	14060	50	20720	60	-4970	50	4460	50	-14460	80	-3300	50
	Ru	44	15133.5	2.8	19109	21	-4329	6	1301	4	-14530	60	-8138	4
	Rh	45	16317	5	16962	10	-3358.5	2.7	-1838	6	-9642	10	-7542.0	0.8
	Pd	46	17608	5	14870	4	-2596	4	-5415	10	-9420	4	-12670	17
	Ag	47	18989	29	12914	7	-1952	19	-9000	80	-4378	6	-12533	16
	Cd	48	20440	30	10628	10	-1173	15	-12380	100	-3785	10	-17447	26
	In	49	21540	140	8420	90	-380	110	-16930#	370#	1400	90	-17200#	310#
	Sn	50	22800	170	6490	110	230	140	*		1770	100	-23490#	320#
	Sb	51	*		3050#	380#	2570#	440#	*		8130#	360#	*	
105	Sr	38	7170#	860#	*		*		23780#	810#	*		8260#	810#
	Y	39	8560#	590#	*		-10180#	530#	19500#	510#	*		6920#	640#
	Zr	40	10130#	420#	29390#	640#	-9380#	420#	14970#	410#	-25250#	810#	1790#	410#
	Nb	41	11680	120	26500#	310#	-8370	140	11430	80	-23230#	410#	1400	110
	Mo	42	12630	90	23540	130	-6310	80	8590	70	-18290#	410#	-2920	80
	Tc	43	13830	60	21550	90	-5770	60	5560	60	-17350	120	-2270	60
	Ru	44	14811.5	2.8	19660	60	-4841	6	2485	4	-12890	50	-7049	4
	Rh	45	15966	5	17827	10	-3935	24	-778	11	-12650	50	-6526.9	2.6
	Pd	46	17076	5	15732	4	-2888	4	-4083	11	-7613	4	-11373	4
	Ag	47	18419	20	13624	11	-2085	20	-7587	14	-7407	11	-11165	14
	Cd	48	19823	19	11429	12	-1327	21	-11070	80	-2229	11	-16290	90
	In	49	21020	30	9268	24	-680	110	-15660	110	-1659	18	-15960	100
	Sn	50	22430#	310#	7190	80	60	170	-20760#	510#	3420	80	-22160#	370#
	Sb	51	23780#	320#	3800	110	2370#	320#	*		5000	60	*	
Te	52	*		100#	590#	4640#	590#	*		11800#	510#	*		
106	Y	39	8000#	810#	*		-10880#	860#	20330#	730#	*		7520#	810#
	Zr	40	9500#	640#	29870#	860#	-9050#	520#	16560#	500#	-28410#	860#	3080#	510#
	Nb	41	11010#	220#	26760#	450#	-7630#	210#	12680#	200#	-23030#	540#	2170#	210#
	Mo	42	12070	60	24490#	400#	-6940	50	10067	16	-21180#	400#	-2040	60
	Tc	43	13430	50	22130	110	-5850	40	6586	11	-16210	100	-1919	13
	Ru	44	14376	7	20570	50	-5190	22	3580	6	-16270	70	-6548	7
	Rh	45	15554	8	18450	50	-4221	12	576	7	-11360	60	-6020	6
	Pd	46	16655.1	0.8	16392	4	-3229	4	-2770	7	-11264	4	-10906	11
	Ag	47	17969	5	14565	5	-2587	7	-6331	13	-6381	4	-10679	12
	Cd	48	19300	7	12320	7	-1632	7	-9710	50	-6009	7	-15723	18
	In	49	20640	90	10073	14	-770	30	-14280#	310#	-827	16	-15420	80
	Sn	50	21980	120	8030	50	-170	60	-19210	140	-380	50	-21680	120
	Sb	51	23300#	480#	4800#	320#	1950#	330#	*		5860#	310#	-21900#	590#
	Te	52	*		1200	170	4290	9	*		7760	150	*	
107	Y	39	7510#	710#	*		*		22200#	640#	*		8910#	710#
	Zr	40	8970#	500#	31190#	760#	-10060#	590#	17750#	340#	*		3830#	360#
	Nb	41	10210#	410#	28140#	640#	-8410#	500#	14190#	430#	-25430#	810#	3270#	400#
	Mo	42	11750	180	25160#	430#	-7000	190	10980	100	-20530#	530#	-1240	160
	Tc	43	12960	160	22830	180	-6210	160	7760	150	-19300#	250#	-850	150
	Ru	44	14140	120	21160	140	-5500	140	4440	120	-14960	120	-5630	120
	Rh	45	15160	12	19150	60	-4691	16	1538	13	-14377	18	-5032	12
	Pd	46	16097.4	0.6	17018	4	-3534	4	-1383	5	-9334	6	-9501.6	2.9
	Ag	47	17476	11	15134	4	-2804	5	-4842	11	-9329	7	-9341	7
	Cd	48	18797	12	13150	5	-1931	6	-8410	80	-4371	5	-14450	14
	In	49	20221	20	11070	15	-1193	20	-12910#	300#	-3911	11	-14210	50
	Sn	50	21460	110	8820	80	-350	80	-18040#	310#	1270	80	-20320#	320#
	Sb	51	22980#	320#	5750#	300#	1520#	300#	*		2660#	300#	-20510#	330#
	Te	52	24190#	590#	1860#	310#	4008	5	*		9600#	300#	*	

A	Elt.	Z	S(n)		S(p)		Q(4β <sup>-</sup> )		Q(d,α)		Q(p,α)		Q(n,α)	
108	Y	39	3100#	950#	*		38210#	810#	*		5700#	1060#	*	
	Zr	40	5080#	670#	16770#	780#	31470#	610#	5280#	920#	4020#	780#	-7970#	920#
	Nb	41	3850#	500#	12790#	420#	24320#	320#	9710#	590#	6530#	500#	-3700#	590#
	Mo	42	6430#	250#	13680#	450#	18220#	200#	6500#	280#	4410#	220#	-3290#	450#
	Tc	43	4920	200	10300	210	11650	130	11010	130	6250	150	550	160
	Ru	44	7820	170	11860	190	5580	120	6810	120	3480	130	-690	140
	Rh	45	6230	110	8390	160	-900	110	12010	110	5770	110	2910	120
	Pd	46	9228	5	9950	12	-7483	20	7548	8	3185	5	2050	5
	Ag	47	7271.41	0.17	6523.2	2.7	-15090#	210#	13011.4	2.7	5675.0	2.8	5890	4
	Cd	48	10339	8	8140	7	-23530	100	8396	7	2680	12	4807	7
	In	49	8627	15	4420	11	-31460#	360#	13728	11	5079	15	8599	15
	Sn	50	11540	80	5770	23	*		9276	23	2304	26	7936	23
	Sb	51	9930#	360#	1220#	220#	*		15630#	210#	5620#	220#	12620#	210#
	Te	52	13250#	320#	2360#	320#	*		11320#	330#	2962	16	13190	130
	I	53	*		-600#	200#	*		16270#	380#	4710#	620#	16810#	370#
109	Zr	40	3150#	780#	16830#	950#	33570#	510#	6150#	710#	4350#	860#	*	
	Nb	41	5470#	590#	13190#	780#	26910#	500#	7810#	590#	6470#	710#	-5680#	860#
	Mo	42	4010#	360#	13840#	420#	20360#	300#	8380#	500#	4720#	360#	-1900#	590#
	Tc	43	6650	160	10520#	220#	14190	100	9120	190	6580	100	-1790#	220#
	Ru	44	5250	130	12190	140	7660	70	8960	160	3790	70	1050	70
	Rh	45	8060	110	8630	120	1478	13	9620	120	6175	14	411	18
	Pd	46	6153.60	0.15	9880	110	-4967	10	9968	12	3619	8	4362	8
	Ag	47	9192	5	6487.3	2.0	-12464	19	10356	5	6044	5	3285	8
	Cd	48	7327	6	8196	6	-20900	60	10604	6	3293	6	7040	6
	In	49	10444	10	4525	5	-28880	100	11207	8	5508	8	6095	8
	Sn	50	8669	22	5813	14	*		11631	15	2831	16	10140	12
	Sb	51	11820#	210#	1507	27	*		13030	90	6030	50	9994	23
	Te	52	9960	120	2390#	210#	*		13750#	310#	3580#	320#	15460	80
	I	53	13030#	370#	-819.5	1.9	*		13640#	320#	5470	170	14360#	330#
110	Zr	40	4690#	950#	*		36080#	800#	4550#	1130#	3680#	950#	*	
	Nb	41	3590#	710#	13620#	710#	29160#	510#	9300#	780#	6440#	590#	-5250#	710#
	Mo	42	6280#	500#	14650#	640#	22890#	400#	5950#	500#	4320#	570#	-4620#	500#
	Tc	43	4500	120	11010#	310#	16500	80	11050#	210#	6850	180	-400#	410#
	Ru	44	7200	80	12740	110	10370	50	6680	140	3990	160	-1390	170
	Rh	45	5840	50	9210	80	3700	50	11610	130	6010	130	1970	160
	Pd	46	8814	11	10627	5	-2505	18	7380	110	3378	16	1220	120
	Ag	47	6809.20	0.10	7142.9	2.0	-9920#	200#	12774.6	2.0	5771	5	5049	12
	Cd	48	9916	3	8919.3	1.6	-18080	50	7960	5	2913	5	3661	5
	In	49	8058	13	5256	12	-26150#	310#	13488	13	5374	13	7573	13
	Sn	50	11276	17	6644	15	-33940	130	8983	17	2580	18	6787	15
	Sb	51	9360#	200#	2190#	200#	*		15210#	200#	5900#	220#	11660#	200#
	Te	52	12740	80	3310	60	*		10940#	210#	3240#	300#	11950	90
	I	53	10780#	330#	-0#	320#	*		16110#	330#	5080#	430#	15980#	430#
	Xe	54	*		1580	170	*		11460#	380#	*		14280#	330#
111	Nb	41	5080#	710#	14010#	950#	31730#	500#	7370#	710#	6440#	780#	-7240#	950#
	Mo	42	3710#	570#	14770#	640#	24910#	400#	7710#	640#	4460#	500#	-3250#	720#
	Tc	43	6330	130	11050#	420#	19000	110	8740#	320#	6950#	220#	-2870#	320#
	Ru	44	4760	90	12990	110	12590	70	8580	120	4150	150	280#	210#
	Rh	45	7650	60	9660	60	6039	30	9200	70	6180	120	-760	130
	Pd	46	5726.3	0.4	10520	50	-59	13	9717	5	3880	110	3320	120
	Ag	47	8831.5	2.2	7161	11	-7333	28	10096.7	2.9	6167.6	2.9	2440	110
	Cd	48	6975.85	0.19	9085.9	1.6	-15770	70	10176.0	1.6	3208	5	5913.2	2.5
	In	49	9992	12	5332	5	-23450#	300#	10824	5	5721	8	4853	6
	Sn	50	8172	15	6759	13	-31550#	300#	11255	8	3035	12	8954	9
	Sb	51	11420#	200#	2330	30	*		12462	30	6020	30	8874	30
	Te	52	9280	90	3230#	210#	*		13490	70	3890#	220#	14200	70
	I	53	12700#	430#	-40#	310#	*		13380#	310#	5640#	320#	13210#	370#
	Xe	54	10560#	330#	1370#	430#	*		13930#	320#	3120#	210#	16970#	320#







A	Elt.	Z	S(2n)	S(2p)	Q( $\alpha$ )	Q( $2\beta^-$ )	Q( $\epsilon p$ )	Q( $\beta^- n$ )						
112	Nb	41	8330#	860#	*	-10480#	1060#	20200#	710#	*	7220#	810#		
	Mo	42	9520#	720#	29510#	1000#	-9060#	840#	16650#	600#	*	2310#	610#	
	Tc	43	11180	150	26960#	520#	-7730#	320#	13740	130	-22660#	520#	2590	140
	Ru	44	11640	90	24610#	410#	-6610#	210#	10850	80	-21680#	410#	-1200	80
	Rh	45	13110	70	23360	90	-6210	140	6880	50	-17810	120	-1810	50
	Pd	46	14130	17	20930	60	-5090	120	4244	18	-16960	80	-6187	18
	Ag	47	15307	17	18430	50	-4030	110	1372	17	-11560	30	-5438	17
	Cd	48	16370.2	0.4	16809	11	-3481.1	2.5	-1919	4	-11865	11	-10256	5
	In	49	17664	12	15113	5	-2819	7	-6395	19	-7064	5	-10123	7
	Sn	50	18960	14	12886	4	-1834	7	-11360	170	-6693	4	-15844	28
	Sb	51	20200#	200#	9704	21	90	20	-14510#	210#	-494	18	-16190	70
	Te	52	21170	180	6040	170	2310	170	-17330	200	1350	170	-20430#	350#
	I	53	22920#	370#	4130#	290#	2990	50	-20800#	370#	6500#	210#	-20770#	370#
	Xe	54	24200	170	2270	120	3330	6	*	*	6230	130	*	*
	Cs	55	*	*	550#	430#	3930#	210#	*	*	11360#	430#	*	*
113	Nb	41	7710#	950#	*	*	*	21530#	860#	*	*	8570#	1000#	
	Mo	42	9180#	720#	*	-9280#	780#	18060#	600#	*	*	3790#	610#	
	Tc	43	10650#	320#	27680#	590#	-8050#	590#	14960#	300#	-25210#	760#	3690#	310#
	Ru	44	11680	100	25680#	410#	-7380#	310#	11490	70	-20660#	600#	-530	90
	Rh	45	12470	60	24040	120	-6570	110	8350	50	-19970	130	-420	50
	Pd	46	13830	40	21600	80	-5270	80	5360	40	-15500	80	-5140	40
	Ag	47	14955	16	19250	30	-4447	20	2337	17	-14580	50	-4523	16
	Cd	48	15934.4	0.7	17623	11	-3867.6	2.6	-716	4	-10002	18	-9125	5
	In	49	17117	4	15727	4	-3072	3	-4950	17	-10034	17	-8780	3
	Sn	50	18531	6	13653	4	-2250	5	-9986	28	-5041	4	-14804	18
	Sb	51	19670	30	10602	18	-356	18	-13290	60	-3713	18	-15190	170
	Te	52	21000	80	6980	29	1867	30	-16250	90	3025	28	-19320#	210#
	I	53	22320#	310#	4820	60	2710	50	-19420	120	3180	60	-19230	120
	Xe	54	23840#	310#	3190	110	3090	50	*	*	7920	150	-23870#	310#
	Cs	55	*	*	1340#	320#	3484	7	*	*	8100#	240#	*	*
114	Mo	42	8620#	920#	*	-9830#	1060#	19230#	740#	*	*	4350#	760#	
	Tc	43	9870#	610#	28500#	920#	-8540#	780#	15900#	610#	-24820#	1000#	4400#	600#
	Ru	44	11190#	240#	26280#	640#	-7500#	460#	12970#	230#	-23680#	640#	80#	240#
	Rh	45	12030	120	24210	170	-7100	140	9320	120	-19200#	320#	-10	120
	Pd	46	13303	30	22590	80	-5940	60	6524	23	-18580	70	-4535	29
	Ag	47	14467	30	19790	60	-4600	60	3623	25	-13560	50	-3971	25
	Cd	48	15583.1	0.6	18262	18	-4097	11	540	3	-13620	40	-8723	3
	In	49	16719	5	16526	17	-3537	3	-4057	28	-8828	17	-8310.4	2.7
	Sn	50	18042	3	14558	3	-2633	3	-8672	28	-8801	3	-14212	17
	Sb	51	19060	30	11097	28	-470	30	-11720#	300#	-2435	28	-14240	40
	Te	52	20730	170	7805	28	1530	30	-14800	30	-845	28	-18830	60
	I	53	21840#	370#	5770#	300#	2320#	360#	-18260#	430#	4340#	300#	-18780#	310#
	Xe	54	23260	100	4360	170	2770	50	-21140	140	3970	30	-23450	100
	Cs	55	24390#	430#	2020#	370#	3360	50	*	*	9300#	300#	*	*
	Ba	56	*	*	560	170	3530	40	*	*	8860	160	*	*
115	Mo	42	8310#	1000#	*	*	*	20120#	810#	*	*	5350#	1000#	
	Tc	43	9530#	760#	29490#	1060#	-8910#	860#	17100#	700#	*	*	5350#	740#
	Ru	44	10370	150	26870#	610#	-7760#	420#	13970	140	-22410#	710#	1130	170
	Rh	45	11670	90	25060#	310#	-7420	140	10780	90	-21770#	600#	1220	80
	Pd	46	12850	70	22780	90	-6160	100	7690	60	-17160#	240#	-3530	70
	Ag	47	14100	40	20880	60	-5050	50	4550	40	-16640	120	-3040	30
	Cd	48	15183.8	0.6	18980	40	-4511	11	1945	3	-11883	24	-7590	3
	In	49	16310	4	17082	17	-3741	4	-2533	17	-11877	25	-7047	4
	Sn	50	17846	3	15565	3	-3203	3	-7973	28	-7304	3	-13592	28
	Sb	51	18726	24	12212	16	-1033	17	-10670	30	-5720	16	-13190	30
	Te	52	19860	40	8308	28	1457	29	-13410	30	1209	28	-17340#	300#
	I	53	21350	60	6500	30	2130	40	-16640#	300#	890	40	-17320	30
	Xe	54	22710	80	4890	30	2400	70	-19630#	600#	5940	30	-22190#	310#
	Cs	55	24140#	320#	3150#	300#	2820#	430#	*	*	5810#	420#	-21830#	330#
	Ba	56	*	*	1510#	600#	2950#	670#	*	*	10770#	600#	*	*







A	Elt.	Z	S(2n)	S(2p)	Q( $\alpha$ )	Q( $2\beta^-$ )	Q( $\epsilon p$ )	Q( $\beta^- n$ )
120	Ru	44	9170#	1130#	*			
	Rh	45	10240#	780#	28620#	1080#	*	4220# 1000#
	Pd	46	10830	240	26810#	810#	-8910#	920# 16420# 600#
	Ag	47	12230	100	25090#	510#	-8120#	710# 13830 120
	Cd	48	13408	28	23090	210	-7340	160 10090 80
	In	49	14650	40	20750	80	-6440	60 7131 19
	Sn	50	15591.6	2.3	18974	20	-5590	60 2690 40
	Sb	51	16568	8	15772	11	-4811	4 -1700 10
	Te	52	17826	11	12326	10	-2599	8 -4635 19
	I	53	18961	27	10368	18	-301	10 -6625 10
	Xe	54	20236	16	9029	19	607	19 -9901 20
	Cs	55	21622	16	7496	22	1180	100 -13280 300
	Ba	56	22660#	360#	5390	300	1730	300 -16200# 500#
	La	57	24210#	590#	3860#	500#	1960#	510# 7330# 500#
	Ce	58	*	*	1910#	730#	2480#	810# * 7600# 730#
121	Rh	45	9990#	1080#	*	-9650#	1140#	17580# 920#
	Pd	46	10780#	590#	27590#	860#	-8680#	860# 14800# 510#
	Ag	47	12250	170	26000#	610#	-8140#	520# 11180 140
	Cd	48	13300	120	24020#	310#	-6960	100 8140 80
	In	49	14279	28	21860	90	-6000	60 3754 27
	Sn	50	15278.3	2.2	19870	80	-5204	4 -653 26
	Sb	51	16260	8	16469	8	-3075	6 -3308 10
	Te	52	17509	27	13061	26	-576	26 -6078 28
	I	53	18664	30	11388	13	-67	14 -9187 17
	Xe	54	19821	15	9866	14	199	17 -11730 140
	Cs	55	20938	20	7910	30	910	30 -14700# 500#
	Ba	56	22300	250	6530	140	1020	140 -18040# 520#
	La	57	23580#	640#	4670#	500#	1620#	510# -20820# 860#
	Ce	58	24840#	780#	2690#	540#	2160#	590# * 8900# 590#
	Pr	59	*	*	1190#	810#	2510#	810# * 8820# 860#
122	Rh	45	9810#	920#	*	-10130#	1140#	18330# 730#
	Pd	46	10690#	420#	28330#	900#	-9200#	900# 16040# 400#
	Ag	47	11730#	220#	26580#	630#	-8520#	540# 12350# 210#
	Cd	48	12900	50	25160	130	-7690	210 9220 40
	In	49	13980	60	22510	90	-6440	80 4750 50
	Sn	50	14983.5	2.5	20550	19	-5662	20 368.1 2.7
	Sb	51	16048	7	17170	40	-3525	8 -2250 5
	Te	52	17052	10	13786.9	2.4	-1082.9	2.9 -4959 11
	I	53	18433	19	12234	9	-506	6 -7940 30
	Xe	54	19325	16	10528	15	-59	18 -10750 30
	Cs	55	20390	30	8930	40	410	40 -13600# 300#
	Ba	56	21860	300	7010	30	1045	30 -16770# 400#
	La	57	23000#	590#	5230#	300#	1440#	300# -19660# 590#
	Ce	58	24280#	810#	3530#	500#	2110#	450# * 5620# 430#
	Pr	59	*	*	1780#	710#	2310#	590# * 10220# 710#
123	Pd	46	10500#	780#	*	-9790#	920#	16700# 600#
	Ag	47	11440#	250#	27450#	930#	-9140#	630# 13470# 210#
	Cd	48	12390	90	25630#	510#	-8110#	300# 10510 40
	In	49	13730	40	23340	150	-7290	90 5798 24
	Sn	50	14759.0	2.6	21340	80	-6340	80 1351.4 2.7
	Sb	51	15771.6	2.1	17961	27	-3945	8 -1281 4
	Te	52	16763	26	14545.8	2.4	-1528.4	2.9 -3923 10
	I	53	17799	11	12926	4	-891	9 -6900 13
	Xe	54	18918	15	11275	28	-489	13 -9594 15
	Cs	55	20086	18	9334	16	300	30 -12340# 200#
	Ba	56	21050	140	7760	16	715	16 -15480# 300#
	La	57	22450#	540#	6180#	200#	1170#	200# -18370# 630#
	Ce	58	23610#	590#	4010#	330#	1990#	360# * 7150# 300#
	Pr	59	24900#	920#	2520#	780#	2210#	720# * 6920# 670#





A	El.	Z	S(2n)	S(2p)	Q( $\alpha$ )	Q( $2\beta^-$ )	Q( $\epsilon p$ )	Q( $\beta^- n$ )						
124	Pd	46	10250#	640#	*	-10280#	950#	17920#	510#	*	3090#	540#		
	Ag	47	11380#	280#	28150#	730#	-9660#	630#	14410#	200#	*	2770#	200#	
	Cd	48	12120	80	26600#	410#	-8990	140	11530	60	-23390#	600#	-1360	70
	In	49	13440	70	24220#	210#	-7650	90	6740	50	-18210#	210#	-1130	50
	Sn	50	14433.4	2.6	22080	40	-6688	19	2287.8	1.5	-18210	40	-7084.0	2.1
	Sb	51	15432.8	2.1	18620	50	-4310	40	-255.3	2.4	-11483	24	-6519.7	1.5
	Te	52	16353.15	0.23	15156.5	2.7	-1844.4	2.4	-2864.4	2.2	-9993.0	2.7	-10653	3
	I	53	17428	5	13612.7	2.6	-1365	8	-5634	9	-5429.8	2.4	-10188	10
	Xe	54	18448	11	11924.0	2.2	-680	10	-8570	13	-5777.2	2.2	-14688	12
	Cs	55	19730	30	10229	10	-367	20	-11470	60	-1077	9	-14148	15
	Ba	56	20620	30	8313	17	658	17	-14270#	300#	-1130	16	-18450#	200#
	La	57	21860#	300#	6700	70	1210	60	-17130#	600#	3500	60	-18160#	300#
	Ce	58	23130#	500#	4790#	300#	1640#	420#	-20330#	670#	3540#	300#	-22560#	670#
	Pr	59	24390#	780#	3170#	670#	2130#	780#	*	*	8290#	630#	*	*
	Nd	60	*	*	1240#	720#	2780#	920#	*	*	8390#	670#	*	*
125	Ag	47	10990#	360#	*	-10150#	950#	15680#	300#	*	*	3840#	310#	
	Cd	48	12190	80	27320#	600#	-9530#	510#	12540	70	-21850#	510#	-550	80
	In	49	13200	40	25100#	210#	-8240	150	7770	30	-21300#	200#	-320	30
	Sn	50	14220.7	2.6	23170	40	-7260	80	3123.7	1.6	-16480	60	-6349.6	2.2
	Sb	51	15174.0	2.6	19407	24	-4839	28	580.9	2.1	-14670	50	-5802.3	2.1
	Te	52	15992.94	0.17	15779.7	2.7	-2243.0	2.4	-1830.1	2.2	-8074.4	1.5	-9728.6	1.9
	I	53	17036	3	14190.3	1.5	-1666.2	1.9	-4749	8	-8505.1	1.5	-9247.6	2.2
	Xe	54	18086	10	12598.1	2.2	-1066	26	-7524	11	-3956.5	2.2	-13532	9
	Cs	55	19187	14	10722	9	-225	13	-10328	27	-4012	8	-13069	15
	Ba	56	20156	16	8997	15	380	16	-13010#	200#	703	11	-17480	60
	La	57	21200#	200#	7294	29	916	29	-15850#	400#	683	27	-17010#	300#
	Ce	58	22630#	360#	5580#	200#	1660#	240#	-19040#	450#	5140#	200#	-21600#	630#
	Pr	59	23720#	720#	3780#	450#	2070#	640#	*	*	5060#	410#	-21490#	720#
	Nd	60	*	*	2020#	500#	2660#	640#	*	*	9920#	500#	*	*
126	Ag	47	10680#	360#	*	-10540#	760#	16800#	300#	*	*	4270#	310#	
	Cd	48	11760	80	28110#	510#	-10060#	400#	13690	50	*	*	80	60
	In	49	13080	60	25920#	200#	-9010#	210#	8580	50	-20300#	300#	10	40
	Sn	50	13926	11	23890	60	-7720	40	4044	11	-19950	70	-5836	11
	Sb	51	14920	30	20100	60	-5250	60	1510	30	-13210	40	-5450	30
	Te	52	15682.66	0.09	16405.8	1.5	-2543.5	2.7	-896	6	-11455.0	1.6	-9299.46	0.10
	I	53	16688	4	14868	4	-2005	4	-3566	13	-6944	4	-8790	4
	Xe	54	17651	6	13222	6	-1279	6	-6499	14	-7435	6	-13152	10
	Cs	55	18756	15	11558	12	-690	13	-9370	90	-2797	12	-12748	16
	Ba	56	19723	18	9588	13	260	17	-11850	30	-2767	13	-16982	29
	La	57	20860	110	7820	90	740	100	-14720#	220#	1830	90	-16390#	220#
	Ce	58	22140#	300#	6310	30	1360	40	-17930#	400#	1560	30	-20980#	400#
	Pr	59	23270#	630#	4580#	200#	1860#	360#	-20690#	540#	6210#	200#	-20710#	450#
	Nd	60	24540#	720#	2650#	500#	2520#	570#	*	*	6480#	450#	*	*
	Pm	61	*	*	1020#	780#	2890#	710#	*	*	11050#	640#	*	*
127	Ag	47	10240#	420#	*	*	*	18090#	300#	*	*	5360#	300#	
	Cd	48	11300	100	*	-10330#	600#	14980	70	*	*	1220	80	
	In	49	12650	50	26760#	300#	-9460#	210#	9720	40	-23260#	300#	960	40
	Sn	50	13743	25	24720	70	-8610	50	4782	25	-18460	60	-5170	40
	Sb	51	14587	5	20800	30	-5699	25	2283	6	-16180	40	-4707	5
	Te	52	15401.5	0.4	16960.5	1.7	-2885.5	2.7	40	4	-9550	11	-8442	4
	I	53	16289	3	15306	4	-2184	4	-2743	6	-9870	30	-7886	6
	Xe	54	17271	4	13877	4	-1574	4	-5505	12	-5545	4	-12047	13
	Cs	55	18295	10	11982	6	-722	7	-8344	27	-5618	6	-11641	14
	Ba	56	19290	16	10201	12	8	15	-10840	60	-936	13	-15910	90
	La	57	20280	40	8386	27	723	29	-13460#	200#	-840	29	-15150	40
	Ce	58	21460#	200#	6890	60	1250	60	-16550#	410#	3410	60	-19790#	200#
	Pr	59	22660#	450#	5250#	200#	1850#	280#	-19380#	630#	3250#	220#	-19610#	450#
	Nd	60	23950#	570#	3340#	450#	2330#	500#	*	*	8110#	400#	-23930#	640#
	Pm	61	*	*	1720#	720#	2860#	840#	*	*	7910#	630#	*	*

A	Elt.	Z	S(n)	S(p)	Q(4β <sup>-</sup> )	Q(d,α)	Q(p,α)	Q(n,α)						
128	Ag	47	3970#	420#	*	29810#	300#	*	*					
	Cd	48	6840	300	15680#	420#	21700	290	4440#	420#	2380#	420#	*	
	In	49	5450	60	13130	90	13380	50	8680	70	3860	80	-3910#	300#
	Sn	50	7910	40	13640	50	6525	27	5190	50	2010	40	-4330	70
	Sb	51	5980	26	8400	40	1323	26	12123	27	6154	25	1520	40
	Te	52	8782.3	2.1	9581	5	-3591	10	8120	30	4127.5	3.0	2552.8	2.2
	I	53	6826.13	0.05	6746	3	-9110	50	13037	3	6148	3	6164	4
	Xe	54	9611	4	8166	4	-14326	28	8761	4	3840.4	1.9	4808.6	1.9
	Cs	55	7763	8	4900	7	-19600	30	13948	8	6125	6	8551	6
	Ba	56	10657	15	6450	12	-25220#	200#	9654	16	3550	13	7437	10
	La	57	8810	60	3110	60	-30590#	400#	14750	60	5900	60	11100	50
	Ce	58	11630	60	4930	40	-36490#	500#	10150	90	3090	40	9780	30
	Pr	59	9970#	200#	1640	60	*	*	15200	40	5190#	200#	13080	40
	Nd	60	12830#	450#	3040#	280#	*	*	10790#	280#	2590#	450#	12120#	280#
	Pm	61	11060#	720#	-90#	570#	*	*	15560#	570#	4440#	570#	15510#	570#
	Sm	62	*	*	1280#	780#	*	*	11230#	710#	*	*	14220#	640#
	129	Ag	47	5720#	500#	*	32180#	400#	*	*	*	*	*	
Cd		48	3980#	420#	15690#	420#	23800#	300#	6410#	420#	2680#	420#	*	
In		49	6650	60	12940	300	15560	40	6290	90	4250	70	-6280#	300#
Sn		50	5330	40	13520	60	8104	29	7100	50	2080	50	-2620	60
Sb		51	8090	30	8580	30	2873	22	9580	30	6257	24	-1170	50
Te		52	6082.41	0.08	9684	25	-1939	11	10408	5	4260	30	4664	11
I		53	8837	5	6800	3	-7177	21	10489	3	6425	3	3540	30
Xe		54	6908.7	1.6	8248	4	-12410	28	10997	4	4077	4	7013.6	1.6
Cs		55	9640	7	4929	5	-17730	30	11531	6	6532	8	6057	6
Ba		56	7734	15	6422	12	-22830#	200#	11886	12	4144	16	9750	13
La		57	10770	60	3214	23	-28380#	400#	12200	24	6208	24	8665	24
Ce		58	8820	40	4940	60	-34040#	500#	12320	40	3550	90	12030	30
Pr		59	11510	40	1530	40	*	*	12910	60	5910	40	10850	100
Nd		60	10120#	280#	3190#	200#	*	*	12910#	280#	2890#	280#	14230#	200#
Pm		61	12970#	570#	50#	450#	*	*	13190#	570#	4810#	570#	12960#	450#
Sm		62	11280#	710#	1500#	640#	*	*	13520#	780#	2180#	710#	16280#	640#
130		Ag	47	1780#	520#	*	36130#	330#	*	*	*	*	*	
	Cd	48	6440#	410#	16410#	490#	25780	280	3940#	410#	2190#	410#	*	
	In	49	5020	60	13980#	300#	17040	40	8110	300	3490	80	-5350#	300#
	Sn	50	7620	30	14490	40	9743	11	4930	50	1710	40	-5980	80
	Sb	51	5735	27	8990	30	4609	19	11750	30	6072	30	340	40
	Te	52	8419.5	1.0	10013	21	-90	3	7968	25	4213	5	1794	25
	I	53	6500.33	0.04	7218	3	-5304	26	12771	3	6213	3	5414	6
	Xe	54	9255.64	0.29	8667	3	-10459	28	8567	4	3965	4	4045.8	1.7
	Cs	55	7471	10	5492	8	-15720	60	13670	8	6284	9	7729	9
	Ba	56	10268	11	7050	5	-20665	28	9381	6	3842	6	6706	5
	La	57	8370	30	3852	28	-26160#	300#	14484	28	6052	28	10258	27
	Ce	58	11210	40	5390	30	-31840#	400#	9920	60	3340	40	9040	30
	Pr	59	9470	70	2180	70	-37240#	510#	15070	70	5660	90	12370	70
	Nd	60	12430#	200#	4110	40	*	*	10450	40	2700#	200#	11030	60
	Pm	61	10600#	500#	520#	360#	*	*	15420#	360#	4820#	500#	14610#	360#
	Sm	62	13400#	640#	1920#	570#	*	*	11180#	570#	2340#	720#	13490#	570#
	Eu	63	*	*	-1028	15	*	*	15820#	710#	*	*	16770#	780#

A	El.	Z	S(2n)	S(2p)	Q( $\alpha$ )	Q( $2\beta^-$ )	Q( $\epsilon p$ )	Q( $\beta^- n$ )						
128	Ag	47	9930#	420#	*	*	19560#	300#	*	5650#	310#			
	Cd	48	11100	300	*	−10920#	580#	16050	290	*	1620	300		
	In	49	12690	60	27920#	300#	−10310#	200#	10250	40	−22750#	300#	1070	50
	Sn	50	13457	29	25590	60	−9050	70	5657	27	−22110	80	−4706	28
	Sb	51	14350	40	21370	50	−6160	60	3129	25	−14910	50	−4399	25
	Te	52	15070.1	2.1	17550	11	−3180.3	2.1	867.9	1.5	−12782	25	−8080	4
	I	53	15970.0	2.7	15920	30	−2543	4	−1807	6	−8327	6	−7488.5	2.0
	Xe	54	16834	6	14373.4	1.9	−1760.4	1.9	−4459	10	−8867.9	2.0	−11691	6
	Cs	55	17729	13	12599	7	−991	6	−7300	50	−4237	6	−11187	13
	Ba	56	18874	16	10811	12	−166	10	−9868	30	−4370	11	−15577	28
	La	57	19800	110	8860	60	670	60	−12300	60	320	50	−14730	80
	Ce	58	20860	40	7440	30	1130	30	−15350#	200#	−10	30	−19170#	200#
	Pr	59	22220#	200#	5940	100	1500	60	−18280#	400#	4280	40	−18980#	400#
	Nd	60	23440#	450#	3940#	200#	2210#	360#	−21140#	540#	4500#	200#	−23200#	630#
	Pm	61	24620#	640#	2370#	450#	2660#	720#	*	*	9100#	450#	*	*
	Sm	62	*	740#	640#	3020#	780#	*	*	9090#	640#	*	*	*
	129	Ag	47	9700#	500#	*	*	20490#	400#	*	*	6770#	500#	
Cd		48	10830#	310#	*	*	17390#	300#	*	*	3090#	300#		
In		49	12100	60	28620#	300#	−10560#	300#	11690	50	−25430#	300#	2320	50
Sn		50	13240	40	26650	80	−9660	70	6409	29	−20590	300	−4060	40
Sb		51	14070	22	22220	40	−6570	40	3876	21	−17560	50	−3707	21
Te		52	14864.7	2.1	18082	25	−3529.6	2.2	1694.2	1.8	−10958	27	−7337	4
I		53	15663	5	16381	6	−2673	4	−1003	6	−11184	25	−6715	3
Xe		54	16519	4	14994.2	1.7	−2100.1	1.6	−3633	11	−6994.3	1.8	−10837	6
Cs		55	17403	7	13095	6	−1089	5	−6174	21	−7051	6	−10170	11
Ba		56	18392	16	11322	12	−297	11	−8780	30	−2493	11	−14500	60
La		57	19570	30	9664	22	337	22	−11550	40	−2684	22	−13860	30
Ce		58	20450	60	8050	30	960	30	−14050#	200#	1825	30	−18030	40
Pr		59	21490#	200#	6460	40	1560	40	−16830#	400#	1570	60	−17660#	200#
Nd		60	22950#	450#	4840#	210#	2000#	280#	−19980#	540#	6010#	200#	−22260#	450#
Pm		61	24030#	720#	3090#	450#	2540#	570#	*	*	6100#	400#	−21970#	640#
Sm		62	*	1410#	640#	2940#	640#	*	*	10640#	540#	*	*	
130		Ag	47	7500#	150#	*	*	23730#	340#	*	*	8970#	450#	
	Cd	48	10420	410	*	*	18570	280	*	*	3300	290		
	In	49	11670	60	29670#	300#	−11300#	300#	12400	40	−24730#	400#	2630	50
	Sn	50	12947	29	27430	290	−10240	60	7212	11	−24230#	300#	−3583	24
	Sb	51	13830	30	22510	50	−6900	40	4641	17	−16640	50	−3360	17
	Te	52	14502.0	1.0	18595	27	−3756	11	2530.3	2.0	−14047	29	−6919	3
	I	53	15337	5	16902	25	−2960	30	−32	9	−9594	21	−6306	3
	Xe	54	16164.3	1.6	15467.6	1.8	−2242.1	1.6	−2620.1	2.9	−10167.5	1.8	−10453	5
	Cs	55	17112	10	13740	9	−1415	9	−5272	27	−5686	9	−9907	14
	Ba	56	18003	10	11980	3	−518	7	−7839	28	−5853.2	2.9	−14007	21
	La	57	19140	60	10275	27	292	29	−10450	70	−1417	26	−13410	40
	Ce	58	20030	40	8599	30	820	30	−12830	40	−1650	30	−17720	40
	Pr	59	20990	70	7120	80	1370	110	−15710#	310#	2860	70	−17010#	210#
	Nd	60	22560#	200#	5640	40	1800	40	−19020#	400#	2400	40	−21720#	400#
	Pm	61	23570#	500#	3720#	300#	2360#	360#	−21540#	590#	7010#	300#	−21290#	590#
	Sm	62	24680#	640#	1980#	450#	2890#	570#	*	*	7370#	450#	*	*
	Eu	63	*	470#	640#	3210#	710#	*	*	11720#	640#	*	*	

A	Elt.	Z	S(n)	S(p)	Q(4β <sup>-</sup> )	Q(d,α)	Q(p,α)	Q(n,α)						
131	Cd	48	1770#	410#	16400#	450#	29940#	300#	7900#	500#	4400#	420#	*	
	In	49	6320	50	13860	280	19307	28	5780#	300#	4020	300	-7690#	300#
	Sn	50	5247	24	14710	40	11101	21	6340	50	1910	50	-4380	290
	Sb	51	7768	27	9138	23	6072	21	9320	40	6210	30	-1980	50
	Te	52	5929.38	0.06	10207	17	1474	3	10129	21	4263	25	3772	27
	I	53	8583	3	7381.9	2.2	-3675	28	10269.6	2.1	6411.8	2.1	2811	25
	Xe	54	6604.8	1.2	8772	3	-8700	30	10799	3	4187	4	6223.3	2.0
	Cs	55	9231	10	5467	5	-13780	50	11348	5	6664	5	5325	6
	Ba	56	7493.50	0.30	7072	9	-18915	28	11527	5	4112	6	8823	3
	La	57	10210	40	3797	28	-24030#	200#	12010	30	6496	30	7809	28
	Ce	58	8360	40	5380	40	-29520#	300#	12320	40	3780	60	11330	40
	Pr	59	11170	80	2140	60	-34930#	400#	12720	60	6120	60	10000	80
	Nd	60	9240	40	3880	70	*		12720	40	3430	40	13410	40
	Pm	61	12340#	360#	430#	200#	*		13210#	280#	5310#	280#	12240#	200#
	Sm	62	10690#	500#	2020#	420#	*		13460#	500#	2710#	500#	15630#	360#
	Eu	63	13490#	640#	-939	7	*		13610#	640#	4560#	640#	14340#	570#
	132	Cd	48	3530#	590#	*		34460#	500#	6150#	600#	6600#	640#	*
In		49	2350	70	14440#	300#	23280	60	9860	290	5650#	300#	-4320#	410#
Sn		50	7311	25	15710	30	12726	14	4050	40	1250	50	-7710#	300#
Sb		51	5757	25	9648	26	7482	14	11176	18	5780	30	-1090	50
Te		52	8044	7	10483	22	3253	7	7820	18	4310	22	1058	30
I		53	6327	6	7779	6	-1960	40	12362	6	6167	6	4574	22
Xe		54	8936.59	0.22	9125.1	0.6	-6806	21	8363	3	4087	3	3369.1	2.0
Cs		55	7167	5	6029.7	2.1	-11940	60	13436.6	2.0	6405.5	2.0	6994	4
Ba		56	9822.4	3.0	7664	5	-17009	24	9176	8	3930	5	5908.9	1.3
La		57	8040	50	4350	40	-22030#	200#	14230	40	6190	40	9410	40
Ce		58	10830	40	5990	30	-27230#	300#	9860	30	3716	29	8237	23
Pr		59	9010	80	2790	70	-32710#	410#	14920	60	5940	60	11760	60
Nd		60	11730	40	4440	60	*		10460	70	3210	40	10510	40
Pm		61	10050#	280#	1230#	200#	*		15600#	200#	5390#	280#	13710#	200#
Sm		62	13120#	420#	2800#	360#	*		10930#	420#	2560#	500#	12630#	360#
Eu		63	11220#	570#	-410#	500#	*		15790#	570#	4610#	640#	16090#	570#
133		In	49	3580#	300#	14500#	590#	27960#	300#	8050#	420#	8500#	410#	-6130#
	Sn	50	2470	40	15820	70	16690	40	7900	50	3800	50	-3740	290
	Sb	51	7340	29	9677	29	9128	25	9080	30	6060	28	-3410	50
	Te	52	5834	25	10560	28	4609	24	9750	30	4211	30	2841	27
	I	53	8258	7	7993	8	-392	28	10034	5	6329	5	2051	18
	Xe	54	6434.4	2.6	9233	6	-5220	17	10511.6	2.7	4153	4	5354	3
	Cs	55	8986.3	1.9	6079.4	1.0	-10133	12	11055.1	1.0	6674.8	0.8	4508	3
	Ba	56	7189.9	0.4	7686.5	2.1	-15220	50	11217	5	4211	8	7974.7	1.2
	La	57	9830	50	4349	28	-20090	60	11900	28	6631	28	7052	29
	Ce	58	8021	26	5970	40	-25300#	200#	12060	30	4070	30	10485	17
	Pr	59	10800	60	2753	24	-30660#	300#	12490	40	6350	30	9337	29
	Nd	60	8980	50	4410	70	*		12660	70	3710	80	12740	50
	Pm	61	11770#	200#	1270	60	*		13070	60	6050	60	11410	80
	Sm	62	9950#	360#	2710#	280#	*		13320#	280#	3210#	360#	15110#	200#
	Eu	63	12850#	500#	-680#	420#	*		13630#	420#	5160#	500#	13830#	420#

A	Elt.	Z	S(2n)	S(2p)	Q( $\alpha$ )	Q( $2\beta^-$ )	Q( $\epsilon p$ )	Q( $\beta^- n$ )						
131	Cd	48	8210#	420#	*	*	22050#	300#	*	6550#	300#			
	In	49	11340	50	30260#	400#	-11660#	300#	13851	21	-29270#	340#	3930	30
	Sn	50	12860	40	28690#	300#	-11220	80	7895	21	-23030	280	-3094	27
	Sb	51	13503	30	23630	50	-7430	40	5456	21	-19390	40	-2708	21
	Te	52	14348.9	1.0	19194	29	-4135	25	3205.7	2.2	-12359	11	-6348	3
	I	53	15084	3	17395	21	-3169	5	615	5	-12442	17	-5634.0	1.4
	Xe	54	15860.5	1.2	15990.0	2.0	-2559.0	1.8	-1731.4	2.9	-8352.8	2.2	-9586	8
	Cs	55	16702	7	14134	6	-1502	6	-4291	28	-8416	6	-8870	5
	Ba	56	17762	11	12564.3	2.9	-788	5	-6970	30	-4091.0	2.9	-13127	26
	La	57	18590	30	10847	28	46	28	-9490	60	-4158	29	-12420	40
	Ce	58	19570	40	9230	40	680	40	-11950	40	260	30	-16610	70
	Pr	59	20650	60	7530	60	1190	60	-14540#	200#	60	60	-15750	60
	Nd	60	21680#	200#	6060	40	1780	60	-17570#	300#	4360	40	-20370#	300#
	Pm	61	22930#	450#	4540#	200#	2270#	280#	-20380#	450#	4150#	210#	-20230#	450#
	Sm	62	24090#	590#	2540#	360#	2800#	500#	*	*	9110#	300#	-24330#	590#
	Eu	63	*	*	980#	570#	3280#	720#	*	*	8830#	500#	*	*
132	Cd	48	5290#	580#	*	*	25830#	500#	*	*	9350#	500#		
	In	49	8670	70	30840#	340#	-10040#	300#	17250	60	*	*	6820	70
	Sn	50	12558	17	29560	280	-11690	290	8628	14	-28580#	300#	-2638	25
	Sb	51	13525	22	24360	40	-7740	50	6026	14	-18830	30	-2535	15
	Te	52	13973	7	19621	13	-4273	28	4098	7	-15157	22	-5809	7
	I	53	14910	7	17986	18	-3516	26	1456	6	-11001	21	-5356	6
	Xe	54	15541.4	1.2	16507.0	2.2	-2713.3	2.0	-845.6	1.4	-11360.0	2.2	-9292	5
	Cs	55	16398	9	14801	4	-1843	4	-3420	40	-7000.5	2.2	-8543	3
	Ba	56	17315.9	3.0	13131.1	1.3	-999.7	1.8	-5961	21	-7308.6	1.4	-12737	28
	La	57	18250	50	11420	40	-230	40	-8530	70	-2970	40	-12100	50
	Ce	58	19190	30	9790	21	503	23	-11050	30	-3079	21	-16270	60
	Pr	59	20180	90	8160	60	990	80	-13500#	200#	1270	60	-15520	60
	Nd	60	20970	40	6580	40	1680	40	-16180#	300#	1000	40	-19760#	200#
	Pm	61	22380#	360#	5110#	210#	2190#	200#	-19210#	450#	5280#	200#	-19590#	360#
	Sm	62	23810#	500#	3230#	300#	2510#	360#	*	*	5230#	300#	-23970#	500#
	Eu	63	24710#	640#	1610#	500#	3120#	570#	*	*	9940#	450#	*	*
133	In	49	5940#	300#	*	*	-7900#	500#	21010#	300#	*	*	10550#	300#
	Sn	50	9780	40	30270#	300#	-10180#	300#	11992	26	-27520#	500#	650	40
	Sb	51	13100	30	25380	40	-8430	50	6944	25	-23810	70	-1832	26
	Te	52	13878	25	20210	30	-4780	40	4699	24	-13679	28	-5316	25
	I	53	14585	5	18477	21	-3684	22	2184	5	-13502	15	-4677	5
	Xe	54	15371.0	2.6	17012	3	-3065.3	3.0	-90.1	2.6	-9750	7	-8559	3
	Cs	55	16154	5	15204.5	1.1	-1993	3	-2577	28	-9660	6	-7707.4	1.1
	Ba	56	17012.3	2.9	13716.2	1.4	-1281.0	1.2	-5130	16	-5561.9	1.4	-11880	40
	La	57	17870	40	12013	28	-419	28	-7560	30	-5627	28	-11090	30
	Ce	58	18850	40	10317	17	216	20	-10090	50	-1277	16	-15280	60
	Pr	59	19800	50	8750	30	964	24	-12530	50	-1490	40	-14583	27
	Nd	60	20710	50	7190	60	1530	50	-15200#	200#	2850	50	-18690#	200#
	Pm	61	21810#	200#	5710	70	1940	60	-18130#	300#	2520	80	-18230#	300#
	Sm	62	23070#	360#	3940#	200#	2680#	280#	*	*	7010#	200#	-22700#	450#
	Eu	63	24070#	500#	2120#	360#	3240#	500#	*	*	7140#	360#	*	*

A	Elt.	Z	S(n)		S(p)		Q(4β <sup>-</sup> )		Q(d,α)		Q(p,α)		Q(n,α)	
134	In	49	2170#	500#	*		32050#	400#	9410#	640#	8110#	500#	*	
	Sn	50	3910	110	16160#	310#	21330	100	6330	120	6210	100	-5880#	310#
	Sb	51	3290	50	10500	60	12730	40	13100	50	8010	50	-380	50
	Te	52	7686	27	10906	28	6390	11	7825	18	4293	23	401	24
	I	53	6257	9	8417	26	1146	21	11820	11	6001	8	3562	22
	Xe	54	8552.2	2.5	9527	5	-3289	20	8286	6	4183.9	1.4	2731.4	2.1
	Cs	55	6891.54	0.01	6536.6	2.4	-8380	40	13100.1	1.0	6388.1	1.0	6199.6	1.1
	Ba	56	9467.7	1.1	8167.9	0.4	-13303	12	8916.9	1.9	3974	5	5111.7	1.0
	La	57	7800	30	4954	20	-18480	60	13927	20	6329	20	8488	21
	Ce	58	10484	26	6630	30	-23330#	200#	9620	40	3800	30	7494	21
	Pr	59	8650	40	3380	40	-28690#	200#	14670	40	6070	50	10900	50
	Nd	60	11390	50	4998	17	-34070#	400#	10280	60	3500	50	9720	40
	Pm	61	9400	80	1700	70	*		15400	60	5890	60	13190	80
	Sm	62	12450#	280#	3390#	200#	*		10920#	280#	3090#	280#	11910#	200#
	Eu	63	10610#	360#	-10#	280#	*		16130#	360#	5240#	360#	15560#	280#
Gd	64	*		1580#	500#	*		11640#	570#	2640#	570#	14270#	500#	
135	In	49	3250#	640#	*		36590#	500#	*		8390#	710#	*	
	Sn	50	2070#	410#	16060#	570#	25620#	400#	7840#	500#	6490#	410#	-4430#	640#
	Sb	51	3610	110	10200	140	17870	100	11960	110	11710	100	-1640	120
	Te	52	3340	90	10950	100	10020	90	11830	90	6710	90	4370	90
	I	53	7788	11	8519	13	2861	12	9866	26	6257	10	1530	16
	Xe	54	6364	5	9634	9	-1792	12	10180	7	4147	7	4412	8
	Cs	55	8762.0	1.0	6746.3	1.3	-6646	12	10772.6	2.6	6562.7	1.4	3764	6
	Ba	56	6971.96	0.10	8248.3	0.4	-11637	19	10931.3	0.4	4169.5	1.9	7076.4	1.1
	La	57	9503	22	4990	10	-16670	60	11614	10	6648	10	6152	10
	Ce	58	7860	23	6695	23	-21770	160	11580	30	3980	40	9456	11
	Pr	59	10490	40	3389	24	-26740#	300#	12198	20	6402	24	8450	40
	Nd	60	8639	23	4990	40	-32030#	500#	12435	23	3860	60	11907	28
	Pm	61	11310	80	1620	60	*		13070	70	6310	60	10880	80
	Sm	62	9420#	250#	3410	170	*		13260	160	3720#	250#	14210	160
	Eu	63	12440#	360#	-20#	360#	*		13650#	360#	5920#	420#	13160#	360#
Gd	64	10680#	640#	1640#	540#	*		13810#	590#	3190#	640#	16710#	590#	
136	Sn	50	3780#	640#	16600#	710#	29920#	500#	6230#	640#	6290#	590#	*	
	Sb	51	3240#	320#	11370#	500#	21460#	300#	12630#	310#	10940#	300#	-1300#	420#
	Te	52	4670	100	12010	110	14460	50	10450	60	9380	50	2170	60
	I	53	3780	50	8960	100	6540	70	13770	50	8310	60	5090	60
	Xe	54	8079	8	9924	10	43	15	8358	11	4326	8	2166	25
	Cs	55	6828.2	2.1	7211	5	-5011	12	12496.6	2.1	6169	3	5194	5
	Ba	56	9107.74	0.04	8594.1	1.1	-9688	12	8715.1	0.4	4048.1	0.4	4403.1	2.4
	La	57	7460	50	5480	50	-14840	90	13620	50	6380	50	7680	50
	Ce	58	9915	17	7107	17	-19657	18	9461	24	3890	30	6732	13
	Pr	59	8463	17	3991	16	-25070#	200#	14220	24	5960	20	9810	30
	Nd	60	11057	23	5552	17	-30150#	400#	10030	40	3602	17	8870	20
	Pm	61	9290	100	2270	80	-35220#	600#	15160	80	6000	90	12390	80
	Sm	62	12030	160	4120	60	*		10640	60	3460	50	11170	50
	Eu	63	10140#	360#	690#	250#	*		15960#	280#	5730#	280#	14790#	200#
	Gd	64	12940#	640#	2150#	500#	*		11480#	450#	3090#	500#	13720#	450#
Tb	65	*		-920#	780#	*		16310#	720#	*		16960#	670#	

A	Elt.	Z	S(2n)	S(2p)	Q( $\alpha$ )	Q(2 $\beta^-$ )	Q( $\epsilon\text{p}$ )	Q( $\beta^-$ n)						
134	In	49	5750#	410#	*	-8290#	520#	22140#	400#	*	10860#	400#		
	Sn	50	6380	100	30650#	510#	-7650	300	15760	100	*	4080	100	
	Sb	51	10630	50	26320	80	-6700	60	9910	40	-23530#	300#	710	50
	Te	52	13520	13	20583	17	-4845	15	5565	11	-18900	40	-4744	12
	I	53	14515	10	18977	16	-4206	19	2819	8	-12419	27	-4500	8
	Xe	54	14986.6	1.3	17520	7	-3198.0	2.1	825.4	0.9	-12469	24	-8124.8	0.8
	Cs	55	15877.9	1.9	15769	6	-2384	3	-1673	20	-8294	5	-7409.0	1.0
	Ba	56	16657.7	1.1	14247.3	1.1	-1493.1	0.8	-4114	20	-8595.2	2.4	-11527	28
	La	57	17620	40	12641	20	-743	22	-6700	40	-4437	20	-10867	26
	Ce	58	18505	29	10979	20	1	21	-9190	24	-4571	20	-14970	24
	Pr	59	19440	70	9350	50	690	40	-11780	70	-310	50	-14250	60
	Nd	60	20363	27	7750	24	1350	30	-14140#	200#	-512	20	-18310	50
	Pm	61	21170#	200#	6100	80	2010	90	-16910#	200#	3910	60	-17680#	200#
	Sm	62	22400#	360#	4660#	200#	2670#	200#	-19930#	450#	3540#	200#	-22300#	360#
	Eu	63	23460#	450#	2690#	280#	3220#	360#	*	*	8290#	200#	*	*
	Gd	64	*	*	900#	500#	3580#	570#	*	*	8270#	450#	*	*
	135	In	49	5410#	590#	*	*	*	22510#	510#	*	*	11530#	510#
Sn		50	5990#	400#	*	*	-7960#	500#	17030#	410#	*	5300#	400#	
Sb		51	6910	110	26360#	320#	-4000	110	14080	100	-24970#	410#	4780	100
Te		52	11030	90	21450	100	-2940	90	8590	90	-18320	130	-1830	90
I		53	14046	9	19425	26	-4227	22	3792	7	-16910	40	-3736	7
Xe		54	14916	5	18050	25	-3632	5	1433	5	-11147	12	-7597	5
Cs		55	15653.5	1.0	16273	5	-2562.4	1.5	-931	10	-10798	8	-6703.3	1.1
Ba		56	16439.7	1.1	14784.9	2.4	-1860.2	1.0	-3226	11	-7015.0	0.9	-10703	20
La		57	17299	30	13157	10	-1016	11	-5715	15	-7048	10	-9886	23
Ce		58	18344	20	11649	11	-366	11	-8411	22	-2964	11	-14180	40
Pr		59	19141	17	10020	30	410	30	-10960	60	-3006	23	-13361	17
Nd		60	20020	50	8368	25	1080	40	-13360	160	1333	28	-17550	60
Pm		61	20710	80	6620	60	1880	80	-15780#	300#	1250	70	-16540#	200#
Sm		62	21870#	250#	5100	160	2490	160	-18680#	530#	5500	160	-21100#	250#
Eu		63	23050#	420#	3370#	300#	3120#	360#	*	*	5260#	300#	-20690#	500#
Gd		64	*	*	1630#	540#	3590#	590#	*	*	10040#	540#	*	*
136		Sn	50	5850#	510#	*	-8210#	710#	17920#	510#	*	*	5130#	510#
	Sb	51	6860#	300#	27430#	500#	-4880#	300#	14620#	300#	-24970#	590#	4880#	310#
	Te	52	8010	50	22210	110	-300	50	12000	50	-20920#	400#	1290	40
	I	53	11570	50	19910	70	-2250	50	6840	50	-17080	110	-1150	50
	Xe	54	14443	7	18444	13	-3668	10	2462	7	-15890	90	-6915	7
	Cs	55	15590.2	1.9	16844	8	-3064	6	-300	50	-9838	8	-6559.5	1.9
	Ba	56	16079.70	0.11	15340.4	0.9	-2031.4	1.1	-2419	13	-9759	5	-10308	10
	La	57	16960	60	13720	50	-1310	50	-4710	50	-5740	50	-9480	50
	Ce	58	17775	24	12096	13	-458	13	-7269	18	-5907	13	-13604	18
	Pr	59	18960	40	10687	23	-10	40	-10130	80	-1966	16	-13185	23
	Nd	60	19695	17	8941	24	850	24	-12388	17	-1863	16	-17290	60
	Pm	61	20600	100	7260	90	1590	100	-14940#	210#	2450	80	-16410	170
	Sm	62	21450#	200#	5742	17	2190	27	-17760#	400#	2114	23	-20690#	300#
	Eu	63	22580#	280#	4100#	200#	3020#	280#	-20290#	630#	6430#	200#	-20150#	540#
	Gd	64	23620#	570#	2120#	450#	3770#	500#	*	*	6520#	430#	*	*
	Tb	65	*	*	730#	630#	4110#	720#	*	*	10930#	670#	*	*

A	Elt.	Z	S(n)		S(p)		Q(4β <sup>-</sup> )		Q(d,α)		Q(p,α)		Q(n,α)	
137	Sn	50	1880#	780#	*		32070#	600#	7600#	780#	6580#	720#	*	
	Sb	51	3450#	500#	11040#	640#	26290#	400#	11250#	570#	11400#	410#	-2590#	570#
	Te	52	3210	130	11970#	320#	18160	120	10860	160	9470	130	2880	160
	I	53	5070	60	9370	50	10600	30	12040	90	10921	30	3310	50
	Xe	54	4025.53	0.11	10170	50	3499	15	12121	10	6557	11	5827	13
	Cs	55	8278.2	1.9	7409	7	-3368	12	10582	5	6442.9	1.0	3173	8
	Ba	56	6905.61	0.08	8671.5	1.9	-8141	11	10571.4	1.1	4034.0	0.4	6049.7	0.9
	La	57	9140	50	5503	13	-13028	19	11461	13	6713	13	5437	13
	Ce	58	7481.54	0.16	7130	50	-17850	40	11483	17	4204	24	8718	13
	Pr	59	9921	15	3998	9	-23160#	200#	12158	16	6523	24	7688	23
	Nd	60	8452	16	5542	17	-28370#	400#	12066	16	3800	40	10902	23
	Pm	61	10950	80	2163	18	-33070#	600#	12852	23	6438	18	10090	40
	Sm	62	9290	40	4120	90	*		12660	70	3580	70	13270	40
	Eu	63	11830#	280#	490#	200#	*		13550#	250#	6350#	280#	12370#	200#
Gd	64	10230#	570#	2240#	450#	*		13690#	500#	3480#	450#	15940#	450#	
Tb	65	13100#	840#	-760#	720#	*		13890#	780#	5430#	720#	14470#	630#	
138	Sb	51	2970#	500#	12130#	670#	27730#	300#	12060#	590#	10510#	500#	-2310#	590#
	Te	52	4440#	240#	12960#	450#	22330#	210#	9660#	360#	8640#	230#	510#	450#
	I	53	3900	90	10060	150	14190	80	12810	90	10360	120	3020	130
	Xe	54	5840	40	10940	50	7420	40	10060	70	8500	40	3320	100
	Cs	55	4413	9	7797	12	244	17	14249	12	8394	10	6549	12
	Ba	56	8611.72	0.04	9005.00	0.18	-6244	12	8787.9	1.9	4184.3	1.1	3802	5
	La	57	7495	14	6092	4	-11584	28	13073	4	6190	4	6704	4
	Ce	58	9761	16	7757	16	-16071	16	9180	50	3946	14	5928	10
	Pr	59	8026	18	4542	19	-21380	30	14048	19	6357	18	9165	17
	Nd	60	10509	16	6130	17	-26240#	200#	10020	17	3782	17	8253	16
	Pm	61	8940	30	2649	30	-31310#	400#	14970	30	6140	30	11642	30
	Sm	62	11540	40	4714	18	-36560#	600#	10410	80	3340	60	10362	23
	Eu	63	9810#	200#	1010	50	*		15770	30	5970	160	13870	60
	Gd	64	12640#	450#	3050#	280#	*		11200#	280#	3280#	360#	12730#	250#
Tb	65	10700#	720#	-290#	570#	*		16130#	570#	5410#	640#	16210#	500#	
Dy	66	*		1230#	840#	*		11750#	840#	*		14890#	780#	
139	Sb	51	3240#	590#	*		30380#	500#	10700#	780#	11050#	710#	*	
	Te	52	2940#	450#	12930#	500#	24120#	400#	10170#	570#	8940#	500#	1350#	640#
	I	53	4580	90	10200#	210#	18390	30	11430	130	10450	50	1690#	300#
	Xe	54	3560	50	10600	80	11309	22	11570	30	8720	50	4430	50
	Cs	55	5885	10	7840	40	4122	9	12389	8	10588	8	4440	50
	Ba	56	4723.43	0.04	9315	9	-2922	26	12342.66	0.18	6289.0	1.9	7158	7
	La	57	8778.0	2.6	6258.7	2.4	-9735	14	11200.7	2.4	6519.6	2.4	4754	3
	Ce	58	7455	12	7717	7	-14572	13	10859	15	3950	50	7581	7
	Pr	59	9763	16	4544	13	-19425	15	11766	15	6509	15	6860	50
	Nd	60	8045	28	6149	29	-24460#	200#	11896	28	4200	29	10123	29
	Pm	61	10630	30	2767	18	-29330#	300#	12795	18	6567	18	9477	18
	Sm	62	8954	16	4729	30	-34690#	500#	12403	17	3680	80	12465	16
	Eu	63	11720	30	1189	18	*		13340	40	6277	18	11450	80
	Gd	64	9820#	280#	3070#	200#	*		13200#	280#	3600#	280#	14930#	200#
Tb	65	12610#	500#	-320#	360#	*		13760#	500#	5750#	500#	13740#	360#	
Dy	66	10820#	780#	1350#	640#	*		14030#	780#	3150#	780#	17010#	640#	



A	El.	Z	S(2n)		S(2p)		Q( $\alpha$ )		Q(2 $\beta^-$ )		Q( $\epsilon p$ )		Q( $\beta^- n$ )	
137	Sn	50	5650#	720#	*	*	*	19250#	610#	*	*	6500#	670#	
	Sb	51	6690#	410#	27640#	640#	-4750#	500#	16240#	400#	*	*	6100#	400#
	Te	52	7880	150	23340#	420#	-1030	130	12820	120	-20350#	520#	1870	130
	I	53	8856	29	21370	110	10	40	10043	28	-18910#	300#	1851	27
	Xe	54	12105	8	19130	90	-1860	25	5342	7	-15240	50	-4112	7
	Cs	55	15106.4	1.1	17334	7	-3084	5	555	13	-14340	50	-5729.98	0.19
	Ba	56	16013.35	0.09	15882	5	-2502.5	2.4	-1843	13	-8585	7	-9760	50
	La	57	16593	17	14097	13	-1455	13	-3923	9	-8051	14	-8703.6	1.6
	Ce	58	17396	17	12606	13	-750	13	-6298	17	-4281	13	-12623	15
	Pr	59	18384	17	11105	15	-110	30	-9104	18	-4430	50	-12049	17
	Nd	60	19509	22	9533	16	418	20	-11550	40	-401	17	-16450	80
	Pm	61	20240	60	7715	18	1440	18	-14060#	200#	-35	18	-15333	18
	Sm	62	21310	160	6390	50	1880	60	-16810#	400#	3880	40	-19830#	200#
	Eu	63	21960#	360#	4620#	200#	2970#	200#	-19010#	630#	3890#	210#	-19040#	450#
	Gd	64	23180#	640#	2930#	430#	3490#	450#	*	*	8310#	400#	-23310#	720#
	Tb	65	*	*	1390#	670#	3850#	670#	*	*	7970#	630#	*	*
	138	Sb	51	6420#	420#	*	*	-5560#	500#	17180#	310#	*	*	6340#
Te		52	7650#	210#	24010#	540#	-1560#	230#	14220#	210#	-22910#	630#	2500#	210#
I		53	8970	100	22030#	310#	-590	90	10560	80	-19360#	410#	1980	80
Xe		54	9870	40	20300	60	-20	40	8110	40	-17880	130	-1680	40
Cs		55	12691	9	17970	50	-1240	12	3637	10	-13674	29	-3237	9
Ba		56	15517.33	0.09	16414	7	-2562.1	0.9	-693	10	-13171	7	-9232	13
La		57	16630	50	14764	4	-2058	4	-3393	14	-7268	4	-8717	14
Ce		58	17243	16	13260	10	-1044	10	-5550	16	-7136	10	-12463	15
Pr		59	17947	19	11670	50	-338	25	-8190	30	-3320	19	-11623	18
Nd		60	18961	17	10128	18	393	24	-10520	17	-3429	18	-16017	18
Pm		61	19880	80	8190	30	1150	40	-13190	40	948	30	-14990	50
Sm		62	20830	17	6876	17	1724	17	-15720#	200#	793	16	-19550#	200#
Eu		63	21630#	200#	5130	80	2560	60	-18120#	400#	5030	30	-18610#	400#
Gd		64	22870#	450#	3550#	200#	3300#	280#	-20840#	630#	4960#	200#	-22850#	630#
Tb		65	23800#	720#	1950#	450#	3770#	450#	*	*	9100#	450#	*	*
Dy		66	*	*	470#	720#	4210#	720#	*	*	8980#	720#	*	*
139		Sb	51	6200#	640#	*	*	-5550#	710#	18520#	500#	*	*	7540#
	Te	52	7380#	420#	25070#	720#	-2430#	570#	14850#	400#	*	*	3460#	410#
	I	53	8480	40	23160#	400#	-1560	110	11860	30	-20970#	300#	3240	50
	Xe	54	9407	22	20660	120	-240	90	9270	21	-17000#	210#	-828	23
	Cs	55	10298	3	18776	28	664	8	6530	4	-15660	80	-511	3
	Ba	56	13335.15	0.06	17112	7	-922	5	2039	7	-12050	40	-6460	4
	La	57	16273	14	15263.7	2.4	-2074.4	2.6	-2408	8	-11633	9	-7734	10
	Ce	58	17217	15	13809	7	-1527	7	-4961	26	-5980	7	-11892	16
	Pr	59	17789	14	12301	16	-598	13	-7327	15	-5588	8	-10877	14
	Nd	60	18554	28	10691	29	208	28	-9611	28	-1712	28	-15120	40
	Pm	61	19566	19	8897	18	1014	18	-12098	19	-1654	20	-14070	18
	Sm	62	20500	40	7378	16	1409	22	-14850#	200#	2349	16	-18702	30
	Eu	63	21530#	200#	5903	19	2150	60	-17230#	300#	2250	30	-17690#	200#
	Gd	64	22460#	450#	4080#	200#	2900#	250#	-19840#	540#	6680#	200#	-21970#	450#
	Tb	65	23310#	670#	2730#	360#	3600#	420#	*	*	6290#	300#	-21300#	670#
	Dy	66	*	*	1050#	640#	4070#	710#	*	*	10800#	540#	*	*

A	Elt.	Z	S(n)	S(p)	Q(4 $\beta^-$ )	Q(d, $\alpha$ )	Q(p, $\alpha$ )	Q(n, $\alpha$ )						
140	Te	52	4230#	500#	13930#	590#	26310#	300#	8900#	420#	8160#	500#	-1000#	670#
	I	53	3510#	200#	10760#	450#	20050#	200#	12370#	280#	10150#	230#	1630#	450#
	Xe	54	5420	60	11440	70	15090	60	10050	100	8380	70	2220	140
	Cs	55	4421	9	8696	22	7644	10	13810	40	10192	11	5098	29
	Ba	56	6429	8	9859	9	980	29	10327	12	8138	8	4754	11
	La	57	5160.98	0.04	6696.3	2.4	-6110	40	14651.4	2.4	8264.3	2.4	7871.0	2.4
	Ce	58	9202	7	8140.9	1.8	-12627	13	9152	3	3881	14	5284.4	2.5
	Pr	59	7943	10	5032	9	-17710	50	13584	12	6047	15	8052	15
	Nd	60	10330	40	6717	29	-22470	40	9590	30	3790	30	7270	30
	Pm	61	8780	40	3500	40	-27720	800	14520	40	6240	40	10620	40
	Sm	62	11147	17	5248	18	-32620#	500#	10200	30	3481	18	9771	17
	Eu	63	9660	50	1890	50	-37680#	510#	15220	50	5900	70	12730	50
	Gd	64	12330#	200#	3670	30	*		10680	40	3100#	200#	11890	50
	Tb	65	10390#	850#	240#	820#	*		16010#	820#	5600#	900#	15180#	820#
	Dy	66	13220#	710#	1960#	590#	*		11500#	640#	3030#	780#	14020#	640#
	Ho	67	*		-1094	10	*		16350#	780#	*		17350#	780#
141	Te	52	2670#	500#	*		28170#	400#	9470#	640#	8460#	500#	*	
	I	53	4320#	280#	10850#	360#	22420#	200#	10990#	450#	10280#	280#	280#	360#
	Xe	54	3410	110	11340#	220#	17110	90	11220	100	8870	120	3250#	220#
	Cs	55	5497	13	8770	60	11544	11	11878	23	10540	40	3500	80
	Ba	56	4526	11	9964	11	4472	9	11686	9	8026	12	6070	40
	La	57	6689	4	6956	9	-2415	15	12686	5	10187	5	5596	10
	Ce	58	5428.14	0.10	8408.0	1.8	-9501	9	12502.1	1.8	5949	3	8467.9	2.5
	Pr	59	9397	6	5226.6	1.1	-16094	13	11642	7	6412	10	6150	3
	Nd	60	8017	28	6792	7	-20974	20	11336	8	3798	14	9017	10
	Pm	61	10390	40	3560	30	-25980	110	12180	29	6359	18	8255	20
	Sm	62	8554	15	5020	40	-30620#	300#	12269	16	3866	29	11726	15
	Eu	63	11010	50	1760	18	-35550#	500#	13164	17	6435	17	10660	30
	Gd	64	9510	30	3530	60	*		12885	24	3390	30	13920	23
	Tb	65	12130	810	50	110	*		13700#	220#	6100#	220#	12860	110
	Dy	66	10550#	590#	2120#	850#	*		13560#	420#	3180#	500#	16110#	360#
	Ho	67	13140#	710#	-1177	7	*		14030#	710#	5430#	780#	14900#	640#
142	Te	52	3950#	720#	*		30390#	600#	*		7750#	780#	*	
	I	53	3270#	450#	11450#	570#	24310#	400#	11950#	500#	9940#	570#	240#	640#
	Xe	54	5220	140	12250#	220#	19060	100	9510#	220#	8230	110	970#	410#
	Cs	55	4110	15	9480	90	13278	11	13190	60	9993	23	3970	30
	Ba	56	6169	10	10635	12	8132	6	9939	10	7742	7	3467	22
	La	57	5168	7	7598	10	1122	26	13947	10	9743	6	6313	6
	Ce	58	7169.7	2.4	8889	5	-5546	6	10493.4	2.9	7556.9	2.9	6022	3
	Pr	59	5843.15	0.08	5641.6	1.1	-12470	30	15001.4	1.1	8024	7	9085.0	2.0
	Nd	60	9829	3	7223.3	1.5	-18996	28	9451	6	3732	8	6644	7
	Pm	61	8705	29	4248	25	-24100#	300#	13810	40	5700	40	9313	26
	Sm	62	11126	10	5759	15	-29030#	360#	9920	40	3368	15	8645	26
	Eu	63	9460	30	2670	30	-33850#	500#	14850	30	5920	30	11820	30
	Gd	64	11810	30	4320	30	*		10740	60	3300	30	11067	30
	Tb	65	10590#	320#	1120#	300#	*		15430#	300#	5330#	360#	13990#	300#
	Dy	66	12710#	470#	2710#	380#	*		11230#	880#	3070#	470#	13220#	410#
	Ho	67	11170#	710#	-550#	590#	*		16080#	710#	5080#	710#	16340#	590#

A	Elt.	Z	S(2n)	S(2p)	Q( $\alpha$ )	Q( $2\beta^-$ )	Q( $\epsilon p$ )	Q( $\beta^- n$ )						
140	Te	52	7170#	360#	*	-2880#	590#	16030#	300#	*	3810#	300#		
	I	53	8090#	210#	23700#	360#	-1820#	360#	12780#	200#	-21240#	540#	3300#	200#
	Xe	54	8980	70	21640#	210#	-990	80	10280	60	-19480#	410#	-360	60
	Cs	55	10306	12	19300	80	20	50	7270	8	-15500	30	-209	8
	Ba	56	11152	8	17700	40	729	11	4812	8	-14916	22	-4111	8
	La	57	13939.0	2.6	16012	9	-407	3	374	6	-10909	4	-5440	7
	Ce	58	16657	10	14399.6	2.5	-1621.3	2.5	-3832	28	-10458.5	2.5	-11331	8
	Pr	59	17706	15	12749	7	-1080	50	-6490	40	-4753	6	-10775	27
	Nd	60	18380	30	11261	30	-210	30	-8800	30	-4588	29	-14830	30
	Pm	61	19410	50	9650	40	700	40	-11220	60	-670	40	-13900	40
	Sm	62	20101	17	8016	17	1318	17	-13670	30	-753	29	-18129	18
	Eu	63	21380	60	6620	60	1790	90	-16500	800	3220	50	-17530#	200#
	Gd	64	22150#	200#	4860	30	2600	30	-18940#	500#	3309	30	-21690#	300#
	Tb	65	22990#	900#	3310	800	3360#	820#	-21180#	950#	7630	800	-20870#	950#
	Dy	66	24040#	780#	1640#	540#	3790#	640#	*	*	7400#	540#	*	*
	Ho	67	*	250#	640#	4240#	780#	*	*	11570#	590#	*	*	*
141	Te	52	6900#	570#	*	-3670#	720#	16770#	410#	*	4640#	450#		
	I	53	7820#	200#	24780#	540#	-2690#	450#	13960#	200#	*	4400#	210#	
	Xe	54	8830	90	22110#	410#	-1190	150	11400	90	-18660#	310#	650	90
	Cs	55	9919	11	20220	30	-399	30	8461	11	-17490#	200#	723	13
	Ba	56	10955	8	18660	22	229	11	5714	8	-14020	60	-3476	8
	La	57	11849	4	16815	6	1182	5	3083	4	-13176	9	-2926	4
	Ce	58	14630	7	15104.3	2.5	-143.8	2.5	-1242	3	-9458	8	-8816	6
	Pr	59	17340	8	13367.5	2.0	-1345	14	-5498	14	-8988.8	2.0	-9840	28
	Nd	60	18349	26	11823	8	-744	14	-8259	9	-3404	3	-14060	40
	Pm	61	19169	19	10278	16	229	18	-10596	19	-3117	15	-13138	19
	Sm	62	19701	14	8525	27	1217	14	-12714	22	1024	29	-17020	50
	Eu	63	20671	18	7008	18	1721	18	-15390	110	990	40	-16220	30
	Gd	64	21840#	200#	5422	23	2380	50	-17910#	300#	4943	23	-20810	800
	Tb	65	22520#	320#	3720	110	3050#	220#	-20170#	510#	5160	120	-19770#	510#
	Dy	66	23770#	590#	2370#	360#	3470#	500#	*	*	9180#	300#	-24080#	590#
	Ho	67	*	780#	590#	4210#	780#	*	*	8820#	950#	*	*	*
142	Te	52	6610#	670#	*	*	18040#	610#	*	*	5020#	630#		
	I	53	7590#	450#	*	-2990#	500#	14790#	400#	*	4530#	410#		
	Xe	54	8630	120	23090#	320#	-1970#	230#	12350	100	-21210#	410#	930	100
	Cs	55	9607	13	20820#	200#	-610	80	9520	11	-17290#	200#	1139	13
	Ba	56	10694	10	19410	60	-100	40	6715	6	-16790	90	-2956	7
	La	57	11856	6	17562	10	428	11	3758	6	-12847	12	-2666	6
	Ce	58	12597.8	2.4	15845	8	1298	3	1416.7	2.1	-12102	9	-6588.9	2.4
	Pr	59	15240	6	14049.6	2.0	307	3	-2636	25	-8143	4	-7666.2	2.8
	Nd	60	17846	28	12449.9	1.7	-812	10	-6962	6	-7804.1	1.7	-13504	14
	Pm	61	19090	40	11040	26	-450	29	-9840	40	-2425	25	-13290	27
	Sm	62	19680	14	9319	29	600	13	-12033	29	-2084	6	-17138	14
	Eu	63	20480	60	7690	50	1200	40	-14260#	300#	1910	30	-16170	40
	Gd	64	21320	40	6080	30	2110	30	-17000#	360#	1690	29	-20490	110
	Tb	65	22720#	860#	4650#	310#	2270#	300#	-19590#	590#	5580#	300#	-19810#	420#
	Dy	66	23260#	620#	2760#	360#	3390#	410#	*	*	5980#	360#	-23660#	620#
	Ho	67	24310#	710#	1570#	950#	3730#	640#	*	*	9780#	510#	*	*

A	El.	Z	S(n)		S(p)		Q(4β <sup>-</sup> )		Q(d,α)		Q(p,α)		Q(n,α)	
143	I	53	3990#	570#	11500#	720#	26550#	400#	10630#	570#	10180#	500#	*	
	Xe	54	3040#	220#	12010#	450#	21170#	200#	10790#	280#	8690#	280#	2160#	360#
	Cs	55	5228	25	9490	100	15402	24	11370	90	10180	70	2250#	200#
	Ba	56	4184	15	10710	17	10072	13	11252	17	7979	16	4700	60
	La	57	6224	16	7653	16	4779	16	12249	17	9948	17	4510	17
	Ce	58	5144.84	0.09	8866	5	-2089	4	12037	5	7573.1	2.9	7306	8
	Pr	59	7352.1	1.9	5824.0	1.8	-8831	11	13077.4	2.1	9873.8	2.1	6893.9	2.6
	Nd	60	6123.57	0.07	7503.7	1.5	-15780	200	12724.3	1.5	5552	6	9722.2	1.7
	Pm	61	9880	25	4299.5	2.4	-22530	60	11943	4	6150	28	7376	7
	Sm	62	8602	6	5655	25	-27200#	200#	11711	14	3550	40	10375	28
	Eu	63	10990	30	2538	12	-31960#	400#	12407	14	6078	17	9610	40
	Gd	64	9340	200	4200	200	-36880#	630#	12400	200	3620	210	12870	200
	Tb	65	11450#	310#	760	70	*	*	13500	60	6210	70	12200	80
	Dy	66	10430#	410#	2550#	360#	*	*	12930#	220#	3020#	820#	15110#	200#
Ho	67	12880#	640#	-390#	540#	*	*	13750#	500#	5420#	640#	13850#	900#	
Er	68	*	*	1170#	780#	*	*	13730#	780#	2820#	780#	17130#	780#	
144	I	53	3010#	640#	*	*	28310#	510#	11560#	780#	9840#	640#	*	
	Xe	54	4900#	360#	12930#	500#	23160#	300#	9160#	500#	8110#	360#	-70#	500#
	Cs	55	3670	30	10110#	200#	17486	26	12920	100	9920	90	2900#	200#
	Ba	56	5905	19	11387	27	11984	14	9457	17	7572	17	2200	90
	La	57	4780	50	8250	50	6530	50	13640	50	9700	50	5230	50
	Ce	58	6896	3	9539	16	1535	3	10309	6	7365	5	4935	9
	Pr	59	5753.5	2.8	6433	3	-5134	11	14494	3	9548.5	2.9	7829	5
	Nd	60	7817.03	0.05	7968.6	1.4	-11994	28	10750.4	1.5	7131.8	1.5	7333.3	1.7
	Pm	61	6526.7	1.5	4702.6	2.2	-19053	28	15244.9	2.3	7641	4	10246.2	2.7
	Sm	62	10520.1	2.4	6295.2	2.7	-25390	30	9896	25	3415	14	7872	4
	Eu	63	9451	15	3387	11	-30430#	300#	14082	12	5181	14	10548	18
	Gd	64	11600	200	4810	30	-34850#	400#	10270	40	3030	30	9826	29
	Tb	65	10010	70	1420	200	*	*	15300	40	5720	30	13200	30
	Dy	66	12330#	200#	3440	70	*	*	11190#	300#	2820	110	12290	40
Ho	67	10990#	500#	160#	360#	*	*	15470#	470#	4990#	420#	14990#	320#	
Er	68	13620#	720#	1910#	570#	*	*	11280#	640#	2330#	640#	14060#	500#	
145	Xe	54	2890#	420#	12800#	590#	25000#	300#	10250#	500#	8490#	500#	980#	670#
	Cs	55	4858	27	10070#	300#	19575	13	11100#	200#	10280	100	1310#	400#
	Ba	56	3720	70	11430	80	14020	70	10970	70	7960	70	3710	120
	La	57	6170	100	8510	90	8290	90	11660	90	9700	90	3170	90
	Ce	58	4730	40	9490	60	3560	40	11800	40	7800	40	6370	40
	Pr	59	6948	7	6484	8	-1633	8	12691	7	9771	7	6049	9
	Nd	60	5755.29	0.25	7970.5	2.4	-8510	19	12347.2	1.4	7219.6	1.5	8747.7	2.1
	Pm	61	7924.0	1.5	4809.6	2.2	-15390	60	13444.5	2.2	9545.5	2.2	8165.4	2.6
	Sm	62	6757.10	0.30	6525.6	2.6	-22370	50	13018.8	2.7	5363	25	10943.9	1.8
	Eu	63	10448	11	3315.4	2.7	-28820#	300#	12236	4	5859	6	8805	25
	Gd	64	9240	30	4595	22	-33240#	400#	12026	22	3260	40	11712	20
	Tb	65	11580	60	1410	60	-38000#	410#	13060	210	5940	60	11090	60
	Dy	66	9780	60	3210	50	*	*	12860	80	3640#	310#	14320	50
	Ho	67	12060#	420#	-110#	300#	*	*	13850#	360#	5640#	470#	13520#	420#
Er	68	10860#	570#	1780#	500#	*	*	13300#	570#	2650#	640#	15920#	540#	
Tm	69	*	*	-1740	10	*	*	14190#	720#	*	*	15240#	640#	

A	Elt.	Z	S(2n)	S(2p)	Q( $\alpha$ )	Q(2 $\beta^-$ )	Q( $\epsilon\text{p}$ )	Q( $\beta^-$ n)						
143	I	53	7270#	450#	*	-3750#	640#	16030#	400#	*	5760#	410#		
	Xe	54	8260#	220#	23460#	450#	-2070#	450#	13490#	200#	-20300#	630#	2000#	200#
	Cs	55	9337	26	21730#	200#	-1260	40	10516	27	-19240#	400#	2080	24
	Ba	56	10353	16	20190	90	-717	25	7676	13	-15750	100	-1972	14
	La	57	11391	16	18288	19	89	16	4886	15	-14961	19	-1720	15
	Ce	58	12314.5	2.4	16464	9	877	3	2395.4	2.1	-11078	6	-5890.6	2.4
	Pr	59	13195.2	1.9	14713	4	1733.0	2.6	-107.8	2.8	-10328	5	-5189.6	1.4
	Nd	60	15952	3	13145.3	1.7	520	7	-4484.3	2.9	-6757.9	2.1	-10922	25
	Pm	61	18585	14	11522.8	2.8	-567	8	-8723	11	-6462.0	2.8	-12044	6
	Sm	62	19727	9	9903	4	44	26	-11290	200	-857.0	2.9	-16270	30
	Eu	63	20458	17	8297	18	829	17	-13810	60	-374	27	-15350	30
	Gd	64	21150	200	6870	200	1720	200	-15910#	280#	3470	200	-19240#	360#
	Tb	65	22040	120	5090	60	2540	60	-18150#	410#	3600	70	-18550#	370#
	Dy	66	23150#	360#	3680#	200#	2780#	280#	-20970#	630#	7350#	200	-22920#	540#
	Ho	67	24050#	640#	2320#	410#	3460#	500#	*	*	7490#	500#	*	*
	Er	68	*	620#	670#	3910#	780#	*	*	11320#	700#	*	*	*
144	I	53	7010#	640#	*	*	*	16690#	500#	*	*	5790#	540#	
	Xe	54	7950#	320#	24420#	670#	-2740#	420#	14490#	300#	*	*	2320#	300#
	Cs	55	8897	28	22130#	400#	-1420#	200#	11620	50	-18920#	400#	2594	29
	Ba	56	10088	15	20870	100	-1200	60	8668	14	-18610#	200#	-1653	20
	La	57	11000	50	18960	50	-270	50	5860	50	-14510	50	-1350	50
	Ce	58	12041	3	17192	7	409	9	3316.2	2.5	-13790	14	-5434.8	2.9
	Pr	59	13105.6	2.8	15299	6	1140	3	665	3	-9858	16	-4819.5	2.4
	Nd	60	13940.60	0.09	13792.6	2.1	1905.2	1.7	-1781.2	1.8	-9430.1	2.1	-8858.7	2.4
	Pm	61	16407	25	12206.3	2.7	849	7	-5799	11	-5636.6	2.6	-9969	3
	Sm	62	19122	6	10594.7	1.8	-145	28	-10212	28	-5253.5	1.8	-15801	11
	Eu	63	20440	30	9043	27	160	40	-13253	30	55	11	-15460	200
	Gd	64	20940	40	7345	29	1270	30	-15170	40	475	28	-19400	70
	Tb	65	21450#	300#	5630	40	2190	60	-17170#	300#	4590	30	-18120#	200#
	Dy	66	22770#	360#	4200	40	2770	40	-19680#	400#	4360	200	-22380#	400#
	Ho	67	23870#	590#	2720#	420#	2860#	850#	*	*	7950#	300#	-21910#	670#
	Er	68	*	1520#	540#	3510#	640#	*	*	8130#	450#	*	*	*
145	Xe	54	7800#	360#	*	-2970#	500#	15320#	310#	*	*	3100#	300#	
	Cs	55	8528	26	22990#	400#	-1960#	200#	12930	90	-20760#	500#	3641	17
	Ba	56	9620	70	21550#	210#	-1510	120	9680	80	-17430#	310#	-590	90
	La	57	10940	90	19890	90	-930	90	6640	90	-17010	90	-620	90
	Ce	58	11630	40	17740	40	200	40	4340	40	-12620	40	-4410	40
	Pr	59	12701	7	16023	17	881	8	1642	7	-12030	50	-3950	7
	Nd	60	13572.32	0.25	14403.1	2.1	1578.1	1.7	-779.4	1.8	-8289.1	2.6	-8087.3	2.3
	Pm	61	14450.7	2.0	12778.2	2.6	2322.2	2.6	-3275	4	-7807	3	-7373.1	2.4
	Sm	62	17277.2	2.4	11228.2	1.8	1115	4	-7730	19	-4193.5	1.8	-13107	11
	Eu	63	19899	12	9611	4	100	14	-12120	60	-3866	4	-14310	28
	Gd	64	20840	200	7982	19	586	21	-14640	50	1756	19	-18630	30
	Tb	65	21590	80	6220	60	1620	60	-16700#	300#	2450	60	-17370	60
	Dy	66	22110#	200#	4630	210	2510	50	-18600#	400#	6180	50	-21160#	300#
	Ho	67	23050#	500#	3330#	300#	2930#	320#	-21310#	500#	5900#	300#	-20350#	500#
	Er	68	24480#	720#	1950#	450#	3200#	500#	*	*	9610#	400#	*	*
	Tm	69	*	170#	570#	4070#	640#	*	*	10030#	500#	*	*	*

A	Elt.	Z	S(n)	S(p)	Q(4 $\beta^-$ )	Q(d, $\alpha$ )	Q(p, $\alpha$ )	Q(n, $\alpha$ )						
146	Xe	54	4640#	500#	*	27010#	410#	8620#	640#	7840#	570#	*		
	Cs	55	3630	70	10810#	310#	21090	70	12370#	310#	9690#	210#	1670#	410#
	Ba	56	5660	100	12230	70	15930	70	8980	80	7540	80	1090#	210#
	La	57	4210	110	9000	100	10340	70	13360	70	9680	70	4190	80
	Ce	58	6650	80	9980	110	5330	70	9930	80	7380	70	3910	70
	Pr	59	5150	60	6910	70	410	60	14430	60	9760	60	7120	60
	Nd	60	7565.23	0.09	8588	7	-4838	4	10535.4	2.4	7006.5	1.4	6327.4	2.1
	Pm	61	6257	5	5312	4	-11690	50	15004	4	9412	4	9260	4
	Sm	62	8415	3	7017	3	-18448	27	11130	4	6828	4	8652.0	2.9
	Eu	63	7195	7	3754	6	-25560#	200#	15560	6	7265	6	11490	6
	Gd	64	11237	19	5384	5	-31380#	300#	10239	12	3013	12	9076	5
	Tb	65	9960	70	2130	50	-36490#	400#	14700	50	5330	210	12120	50
	Dy	66	12340	50	3960	60	*		10520	40	2740	70	11320	200
	Ho	67	10460#	360#	570#	200#	*		15730#	200#	5620#	280#	14510#	200#
	Er	68	13090#	500#	2820#	420#	*		11200#	420#	2430#	500#	13260#	360#
	Tm	69	11470#	570#	-1127	4	*		16340#	570#	4940#	720#	16650#	570#
	147	Xe	54	2660#	570#	*	28770#	400#	*		8190#	640#	*	
Cs		55	4470	90	10640#	400#	23440	60	10790#	300#	10120#	300#	210#	510#
Ba		56	3670#	220#	12270#	220#	17550#	210#	10170#	210#	7540#	210#	2330#	360#
La		57	5800	90	9140	90	12200	50	11280	90	9780	50	2070	50
Ce		58	4420	70	10190	80	7240	30	11670	100	7730	60	5390	30
Pr		59	6810	70	7070	70	2096	23	12350	50	9846	23	5080	50
Nd		60	5292.20	0.09	8730	60	-2788.9	2.1	12191	7	7467.8	2.4	7931.5	2.6
Pm		61	7659	4	5405.9	0.9	-8296	12	13100.0	0.9	9569.3	0.9	7354.1	2.6
Sm		62	6341.5	3.0	7101	4	-15084	20	12712.5	2.3	7013.1	2.4	10127.5	1.0
Eu		63	8500	6	3838	4	-21713	28	13818.0	2.7	9285.5	2.6	9517.0	2.9
Gd		64	7341	4	5530	6	-28310#	300#	13346.2	3.0	5123	11	12255.3	1.3
Tb		65	11050	50	1948	12	-34390#	300#	12886	22	5870	30	10516	16
Dy		66	9710	30	3710	50	*		12400	60	3040	30	13220	30
Ho		67	12340#	200#	570	40	*		13160	50	5610	40	12180	40
Er		68	10410#	420#	2770#	360#	*		12840#	420#	3010#	420#	15180#	300#
Tm		69	13160#	500#	-1058	3	*		14040#	500#	5410#	500#	14480#	420#
148		Cs	55	3360	580	11330#	700#	25230	580	12080#	700#	9660#	650#	*
	Ba	56	5490#	220#	13280	100	19400	80	8320	110	6910	80	-270#	310#
	La	57	4350	80	9820#	210#	13740	60	12580	90	9150	90	2570	60
	Ce	58	6430	40	10830	60	8951	29	9440	80	7460	90	2670	80
	Pr	59	5150	30	7790	40	3772	28	13860	70	9430	50	6100	90
	Nd	60	7332.8	1.6	9248	23	-1137.6	2.4	10010	60	7082	7	5330	40
	Pm	61	5895	6	6009	6	-6331	15	14770	6	9429	6	8406	9
	Sm	62	8141.41	0.28	7583.2	0.4	-11483	11	10829	4	6795.6	2.3	7741.4	1.0
	Eu	63	6823	10	4319	10	-18290	130	15410	11	9219	10	10618	10
	Gd	64	8984.1	1.3	6014.3	2.6	-24620#	200#	11557	6	6586.7	2.7	10028.3	0.3
	Tb	65	7860	18	2466	14	-31270#	400#	16264	15	7251	23	13104	14
	Dy	66	11743	22	4396	16	-37510#	600#	10620	50	2890	60	10714	22
	Ho	67	10250	130	1120	130	*		15250	130	5140	140	13510	140
	Er	68	12670#	360#	3100#	200#	*		10630#	280#	2400#	360#	12280#	200#
	Tm	69	10980#	500#	-490#	500#	*		16150#	500#	5280#	570#	15560#	500#
	Yb	70	*		1270#	670#	*		11640#	720#	2390#	720#	14990#	720#

A	Elt.	Z	S(2n)	S(2p)	Q( $\alpha$ )	Q( $2\beta^-$ )	Q( $\epsilon p$ )	Q( $\beta^- n$ )						
146	Xe	54	7540#	500#	*	-3660#	720#	16330#	410#	*	3320#	400#		
	Cs	55	8490	80	23610#	510#	-2320#	410#	13500	50	*	3720	100	
	Ba	56	9370	70	22300#	310#	-1950	120	10680	60	-20190#	310#	-80	120
	La	57	10370	90	20430	80	-1030	70	7590	60	-16350	70	-100	80
	Ce	58	11380	70	18480	70	-280	70	5260	70	-15550	100	-4110	70
	Pr	59	12100	60	16400	80	900	60	2750	60	-11020	110	-3350	60
	Nd	60	13320.52	0.26	15072.0	2.6	1182.5	2.1	70.8	2.9	-11120	40	-7728.6	2.2
	Pm	61	14181	5	13282	5	1908	4	-2338	7	-7117	8	-6873	4
	Sm	62	15173	3	11826.7	2.9	2528.4	2.9	-4909	5	-6853.7	2.9	-11075	4
	Eu	63	17643	12	10279	6	1610	26	-9350	50	-3137	6	-12266	20
	Gd	64	20476	28	8699	4	475	6	-13539	27	-2724	4	-18280	60
	Tb	65	21540	50	6730	50	1130	50	-16200#	200#	2940	50	-17550	60
	Dy	66	22110	40	5370	40	1980	40	-17840#	300#	3080	30	-21440#	300#
	Ho	67	22510#	360#	3780#	200#	3070#	360#	-20290#	450#	7020#	200#	-19950#	450#
	Er	68	23950#	500#	2710#	300#	2820#	470#	*		6290#	300#	-24910#	500#
	Tm	69	*		660#	500#	3770#	640#	*		10620#	500#	*	
147	Xe	54	7300#	500#	*	*	*	17340#	450#	*	*	4290#	410#	
	Cs	55	8100	50	*	-2800#	400#	14830	70	*	*	4910	90	
	Ba	56	9330#	220#	23080#	360#	-2580#	280#	11430#	200#	-19220#	450#	450#	220#
	La	57	10000	100	21370	50	-1600	50	8610	40	-18520	90	760	80
	Ce	58	11070	50	19190	80	-520	30	6120	30	-14320	80	-3390	70
	Pr	59	11966	24	17050	90	307	28	3593	23	-13620	70	-2595	23
	Nd	60	12857.44	0.12	15630	40	1035.1	2.1	1120.1	0.9	-9770	70	-6763	4
	Pm	61	13916.8	2.3	13994	7	1600.6	1.6	-1497.4	2.3	-9620	60	-6117.4	2.9
	Sm	62	14757.0	1.9	12412.9	0.9	2310.5	1.0	-3909.0	2.2	-5630.0	0.9	-10221	6
	Eu	63	15695	4	10854.7	2.9	2990.3	3.0	-6798	12	-5380	5	-9529	5
	Gd	64	18578	19	9283.3	1.3	1735.2	2.0	-11175	20	-1650	3	-15670	50
	Tb	65	21010	60	7332	12	1065	16	-14910	30	-919	13	-16269	30
	Dy	66	22040	50	5838	27	1620	200	-17140#	300#	4616	20	-20690#	200#
	Ho	67	22800#	300#	4530	60	2170	70	-19470#	300#	4640	50	-19200#	300#
	Er	68	23500#	500#	3340#	300#	2850#	360#	*		8220#	300#	-23850#	500#
	Tm	69	24630#	500#	1760#	420#	3490#	500#	*		7910#	360#	*	
148	Cs	55	7830	580	*	-3140#	770#	15830	580	*	*	5220#	610#	
	Ba	56	9160	110	23920#	410#	-3160#	310#	12380	80	-22040#	410#	760	100
	La	57	10150	90	22090	90	-2280	60	9400	50	-18400	80	830	70
	Ce	58	10860	70	19970	80	-1050	30	7023	29	-17080#	210#	-3010	40
	Pr	59	11960	70	17990	80	-60	60	4341	26	-12970	50	-2450	26
	Nd	60	12625.0	1.6	16320	70	599	3	1928.8	1.9	-12670	30	-6436.8	1.8
	Pm	61	13555	7	14740	60	1459	6	-569	12	-8706	24	-5671	6
	Sm	62	14482.9	3.0	12989.1	1.0	1986.1	1.0	-3066.3	1.9	-8479.2	1.0	-9863.0	2.3
	Eu	63	15323	12	11421	11	2694	10	-5762	17	-4544	10	-9011	10
	Gd	64	16325	4	9852	3	3271.21	0.03	-8416	11	-4292.7	1.9	-13595	12
	Tb	65	18910	50	7996	15	2656	18	-12530	130	-279	14	-14424	24
	Dy	66	21448	29	6344	12	1475	30	-16210#	200#	215	11	-20093	30
	Ho	67	22590#	240#	4820	140	1930	130	-18740#	420#	5450	130	-19040#	330#
	Er	68	23080#	360#	3680#	200#	2510#	200#	-21300#	630#	5250#	200#	-23360#	360#
	Tm	69	24140#	570#	2280#	450#	3500#	500#	*		9280#	400#	*	
	Yb	70	*		210#	670#	4130#	720#	*		9410#	670#	*	

A	Elt.	Z	S(n)	S(p)	Q( $4\beta^-$ )	Q(d, $\alpha$ )	Q(p, $\alpha$ )	Q(n, $\alpha$ )						
149	Cs	55	4610#	610#	*	27210#	210#	10120#	450#	9690#	450#	*		
	Ba	56	3540#	210#	13470#	610#	20890#	200#	9240#	200#	7000#	210#	830#	450#
	La	57	5740#	320#	10070#	330#	15280#	320#	10510#	380#	9070#	320#	470#	320#
	Ce	58	4380	100	10860	110	10450	100	10860	110	7290	120	3950	120
	Pr	59	6600	90	7950	90	5390	80	11680	90	9480	110	3710	110
	Nd	60	5038.79	0.07	9139	26	753	4	11785	23	7200	60	6940	70
	Pm	61	7271	7	5947	3	-4575	5	12791	4	9724	4	6290	60
	Sm	62	5871.1	0.9	7559	6	-9427	9	12616.8	0.9	7182	4	9435.5	1.2
	Eu	63	8215	11	4393	4	-14758	19	13536	4	9419	5	8660	6
	Gd	64	6929	3	6120	11	-21392	28	13128	4	6853	7	11515	4
	Tb	65	9027	14	2509	3	-27460#	300#	14578	4	9461	5	11273	7
	Dy	66	7927	14	4464	16	-34220#	500#	13748	14	4920	50	14024	9
	Ho	67	11740	130	1118	21	*	*	13210	27	5730	30	11730	50
	Er	68	10160#	200#	3020	130	*	*	12810	40	2690#	200#	14460	40
	Tm	69	12840#	500#	-320#	360#	*	*	13720#	420#	5540#	420#	13170#	360#
	Yb	70	11220#	780#	1510#	640#	*	*	13580#	590#	2640#	640#	16860#	590#
150	Cs	55	3190#	360#	*	29340#	300#	*		9160#	500#	*		
	Ba	56	5180#	450#	14040#	450#	23090#	400#	7420#	700#	6290#	400#	-1690#	570#
	La	57	4310#	510#	10840#	450#	16570#	400#	11690#	410#	8430#	450#	630#	400#
	Ce	58	6200	110	11320#	320#	12230	50	9020	80	6890	70	1420#	210#
	Pr	59	5320	90	8900	100	6494	27	12800	40	8590	40	4190	50
	Nd	60	7380.1	2.7	9920	80	2079	6	9552	26	6629	23	3990	30
	Pm	61	5603	20	6511	20	-2493	21	14521	20	9413	20	7500	30
	Sm	62	7986.7	0.4	8275	4	-7740	5	10525	6	6854.7	0.9	6741.0	1.2
	Eu	63	6422	7	4944	6	-12849	16	15256	6	9339	6	9897	6
	Gd	64	8707	7	6611	7	-17936	18	11245	12	6646	6	9150	6
	Tb	65	7686	8	3266	8	-24500#	200#	15876	7	9117	7	12086	8
	Dy	66	9673	10	5110	5	-30590#	400#	11934	15	6299	12	11693	4
	Ho	67	8331	23	1522	17	-37010#	500#	16622	18	7104	24	14451	18
	Er	68	12160	30	3433	25	*	*	10890	130	2870	30	12001	26
	Tm	69	10640#	360#	160#	200#	*	*	15750#	280#	5300#	360#	14870#	200#
	Yb	70	13310#	640#	1980#	500#	*	*	11250#	570#	2500#	500#	13970#	500#
	Lu	71	*		-1269.6	2.8	*	*	16120#	780#	*		17070#	590#
151	Cs	55	4330#	590#	*	31550#	500#	*		*	*	*	*	
	Ba	56	3290#	570#	14150#	500#	25130#	400#	8740#	450#	6350#	700#	*	
	La	57	5320#	570#	10980#	570#	19110#	400#	9910#	450#	8590#	410#	-1340#	700#
	Ce	58	4750	110	11750#	410#	13080	100	10010#	330#	6490	120	2160	130
	Pr	59	6540	30	9240	50	7888	23	10640	100	8480	40	2000	60
	Nd	60	5334.55	0.10	9938	26	3242	4	10810	80	6442	26	5084	29
	Pm	61	7863	21	6995	4	-1766	6	11696	5	8882	5	4782	26
	Sm	62	5596.46	0.11	8268	20	-5824	4	12200	4	7153	6	8477.3	2.0
	Eu	63	7933	6	4890.7	0.5	-11027	12	13193.6	0.7	9547.1	1.0	7859	6
	Gd	64	6497	7	6687	7	-15929	17	12962	5	6972	11	10793.7	2.9
	Tb	65	8590	8	3150	7	-20848	21	14215	5	9510	4	10319	11
	Dy	66	7513	5	4937	8	-27210	300	13448	4	6646	14	13163.6	2.9
	Ho	67	9755	19	1604	12	-33430#	400#	14794	15	9091	16	12555	18
	Er	68	8504	24	3607	22	*	*	14133	25	4610	130	15240	20
	Tm	69	12240#	200#	238	11	*	*	13670	30	5730#	200#	12880	130
	Yb	70	10880#	500#	2220#	360#	*	*	13210#	420#	2590#	500#	15750#	360#
	Lu	71	13340#	640#	-1241.0	2.8	*	*	14010#	640#	5010#	720#	14720#	570#



A	Elt.	Z	S(2n)	S(2p)	Q( $\alpha$ )	Q( $2\beta^-$ )	Q( $\epsilon p$ )	Q( $\beta^- n$ )						
149	Cs	55	7970#	200#	*	*	16950#	370#	*	6100#	210#			
	Ba	56	9030#	280#	24810#	450#	-3810#	360#	13210#	220#	*	1570#	200#	
	La	57	10090#	320#	23350#	320#	-3160#	320#	10260#	300#	-20780#	660#	1520#	320#
	Ce	58	10810	100	20680#	230#	-1710	120	7690	100	-15970	130	-2240	100
	Pr	59	11740	90	18790	100	-490	120	5010	80	-15220	100	-1710	80
	Nd	60	12371.6	1.6	16930	30	290	40	2761.0	2.0	-11279	29	-5580	6
	Pm	61	13166	4	15194	23	1136	8	375	5	-10829	26	-4800	4
	Sm	62	14012.5	0.9	13567.9	1.2	1870.3	1.2	-2008	3	-7017.5	2.0	-8911	10
	Eu	63	15039	4	11977	4	2402	4	-4951	5	-6864	7	-8242	4
	Gd	64	15913	3	10439	3	3099	3	-7418	9	-3080	3	-12664	14
	Tb	65	16887	12	8523	4	4077.5	2.2	-9808	18	-2482	11	-11708	11
	Dy	66	19670	22	6930	9	2787	21	-13974	29	1272	9	-1770	130
	Ho	67	21990	30	5514	22	1770	60	-17650#	300#	1563	23	-18110#	200#
	Er	68	22830#	300#	4130	30	2120	50	-20250#	500#	6829	30	-22540#	400#
	Tm	69	23820#	420#	2780#	300#	2720#	420#	*	*	6690#	330#	-21760#	670#
	Yb	70	*	1030#	590#	3770#	640#	*	*	10870#	540#	*	*	*
150	Cs	55	7800#	650#	*	*	18070#	500#	*	*	6450#	360#		
	Ba	56	8730#	410#	*	-4350#	570#	14230#	400#	*	*	2130#	510#	
	La	57	10050#	410#	24310#	700#	-3840#	410#	11270#	400#	-20480#	450#	1590#	410#
	Ce	58	10580	60	21390	100	-2250	90	8870	50	-18630#	200#	-1840	90
	Pr	59	11920	40	19750	60	-1610	80	5300	30	-14800#	320#	-1994	26
	Nd	60	12418.9	2.7	17877	29	-440	70	3367.7	2.2	-14280	100	-5690	4
	Pm	61	12874	21	15650	30	690	60	1194	21	-9840	80	-4533	20
	Sm	62	13857.8	0.9	14221.9	1.9	1448.8	1.2	-1289	6	-9965.4	1.9	-8682	4
	Eu	63	14637	12	12503	8	2238	7	-3687	9	-6015	7	-7735	7
	Gd	64	15636	6	11005	6	2808	6	-6452	7	-5916	6	-12344	7
	Tb	65	16713	16	9386	13	3587	5	-9163	16	-1953	8	-11467	11
	Dy	66	17600	12	7619	4	4351.3	1.5	-11484	18	-1472	5	-15700	19
	Ho	67	20080	130	5985	20	3400	50	-15340#	200#	2259	15	-16280	30
	Er	68	22320#	200#	4551	20	2300	30	-19100#	400#	2593	19	-21860#	300#
	Tm	69	23480#	450#	3180#	240#	2530#	280#	-21670#	540#	7790#	200#	-21190#	540#
	Yb	70	24530#	720#	1660#	450#	3560#	500#	*	*	7720#	400#	*	*
	Lu	71	*	240#	640#	3910#	640#	*	*	11810#	590#	*	*	*
151	Cs	55	7520#	540#	*	*	19070#	640#	*	*	7310#	640#		
	Ba	56	8480#	450#	*	-4990#	570#	15680#	410#	*	*	3140#	570#	
	La	57	9640#	510#	25020#	450#	-4690#	400#	12480#	400#	-22610#	500#	2470#	400#
	Ce	58	10950	140	22590#	220#	-3330#	230#	9450	100	-18190#	410#	-1270	110
	Pr	59	11860	90	20550#	320#	-2350	50	6624	23	-17020#	400#	-1152	23
	Nd	60	12714.7	2.7	18840	100	-1350	30	3629.6	2.2	-13420	50	-5421	20
	Pm	61	13467	6	16920	80	-365	23	1264	5	-12381	26	-4409	5
	Sm	62	13583.2	0.4	14779.5	2.0	1144.5	1.2	-387.6	2.8	-8181.8	2.2	-7857	6
	Eu	63	14355	4	13166	4	1963.9	1.0	-3030	4	-8345	20	-6962	6
	Gd	64	15204	4	11630.9	2.8	2652.2	2.9	-5436	4	-4426.5	2.8	-11156	8
	Tb	65	16276	5	9761	5	3496	4	-7997	12	-4121	7	-10384	6
	Dy	66	17186	9	8203	4	4179.5	2.6	-10493	17	-279	7	-14882	15
	Ho	67	18086	22	6714	12	4695.0	1.8	-12850	24	189	14	-13871	21
	Er	68	20670	30	5129	19	3497	26	-16720	300	3762	17	-19730#	200#
	Tm	69	22880#	300#	3671	27	2630	30	-20580#	400#	3877	17	-20120#	400#
	Yb	70	24190#	590#	2380	300	3080#	420#	*	*	9000	300	-24680#	590#
	Lu	71	*	740#	500#	3740#	500#	*	*	9120#	450#	*	*	*

A	Elt.	Z	S(n)		S(p)		Q(4β <sup>-</sup> )		Q(d,α)		Q(p,α)		Q(n,α)	
152	Ba	56	4850#	640#	14670#	710#	27560#	500#	7080#	590#	6110#	540#	*	
	La	57	3850#	570#	11540#	570#	21190#	400#	11240#	570#	8280#	450#	-580#	450#
	Ce	58	5680#	220#	12110#	450#	15660#	200#	8630#	450#	6550#	370#	20#	280#
	Pr	59	5110	120	9600	160	9090	120	11730	130	7750	160	2630#	340#
	Nd	60	7276	24	10680	30	4556	25	8860	40	5760	90	2180	100
	Pm	61	5938	26	7598	26	-540	50	13138	26	7983	26	5440	90
	Sm	62	8257.6	0.6	8663	5	-4644	5	9545	20	6167	4	5258.5	2.0
	Eu	63	6306.72	0.10	5601.0	0.5	-9286	14	14873.6	0.6	9111.5	0.7	8823	4
	Gd	64	8591	3	7344.1	1.2	-14214	11	10794	6	6596	4	8074.1	1.3
	Tb	65	7170	40	3820	40	-18950	80	15760	40	9270	40	11370	40
	Dy	66	9437	5	5784	6	-23820	210	11697	9	6236	5	10655	5
	Ho	67	8047	18	2139	14	-30190#	200#	16419	15	8971	16	13534	15
	Er	68	10306	20	4157	16	*		12159	18	6052	21	12861	14
	Tm	69	9060	80	790	80	*		16770	80	6840	80	15560	80
	Yb	70	12830	370	2810	210	*		11020#	290#	2600#	360#	13080	210
	Lu	71	11290#	450#	-830#	360#	*		16020#	450#	4940#	540#	16270#	360#
153	Ba	56	3100#	950#	*		29730#	800#	8310#	950#	6210#	860#	*	
	La	57	4930#	720#	11620#	780#	23760#	600#	9600#	720#	8530#	720#	-2320#	670#
	Ce	58	4310#	450#	12570#	570#	17220#	400#	9650#	570#	6550#	570#	900#	570#
	Pr	59	5890	160	9810#	220#	11740	100	10580	150	8060	110	1050#	410#
	Nd	60	5260	40	10830	130	5541	27	10130	40	5820	40	3120	50
	Pm	61	7494	28	7816	27	636	12	10979	11	7869	11	3265	28
	Sm	62	5868.40	0.13	8593	26	-3416	4	11540	5	5902	20	6770.2	2.3
	Eu	63	8550.29	0.12	5893.7	0.7	-8354	5	11919.8	0.6	8547.9	0.6	5876	20
	Gd	64	6246.94	0.13	7284.3	1.2	-12402	9	12480.1	1.2	6771	6	9813.9	1.2
	Tb	65	8670	40	3895	4	-17305	19	13585	5	9313	7	9123	7
	Dy	66	7097	6	5710	40	-22090#	200#	13191	6	6825	8	12265	7
	Ho	67	9482	15	2184	7	-26610	210	14450	6	9162	6	11738	9
	Er	68	8059	14	4169	16	-33190#	500#	13855	15	6324	17	14475	10
	Tm	69	10320	80	804	21	*		14961	25	8682	25	13579	23
	Yb	70	8830#	290#	2580#	210#	*		14430#	200#	4420#	280#	16420#	200#
	Lu	71	13060#	290#	-609	10	*		13850	370	5190#	450#	13850#	290#
	Hf	72	*		1170#	540#	*		13610#	640#	2500#	710#	17080#	640#
154	La	57	3530#	840#	12050#	1000#	26120#	600#	10930#	780#	8300#	720#	-1520#	780#
	Ce	58	5430#	640#	13060#	780#	19760#	500#	8080#	640#	6450#	640#	-1240#	640#
	Pr	59	4640	180	10140#	430#	13540	150	11620#	250#	8160	180	1730#	430#
	Nd	60	6410	120	11350	150	8020	110	8830	170	5940	120	1460	150
	Pm	61	5890	50	8440	50	1660	60	12370	50	7320	40	3920	50
	Sm	62	7967.1	0.9	9066	11	-2063	8	9511	26	5798	5	4137.7	2.4
	Eu	63	6442.23	0.24	6467.5	0.8	-7100	8	13735.2	0.7	7702.2	0.6	7297	5
	Gd	64	8894.71	0.17	7628.7	1.1	-11101	5	9892.1	1.2	5809.9	1.2	6515.7	1.2
	Tb	65	6910	50	4560	50	-15730	50	15260	50	8900	50	10140	50
	Dy	66	9320	8	6367	8	-20464	19	11040	40	6095	8	9443	8
	Ho	67	7696	10	2783	9	-25080#	200#	16191	9	8978	9	12632	9
	Er	68	10196	10	4882	7	-29880#	500#	11707	15	5884	13	11793	6
	Tm	69	8485	23	1230	17	*		16782	18	8701	22	14849	19
	Yb	70	10950#	200#	3207	25	*		12550	80	5712	11	13979	24
	Lu	71	9230#	290#	-200	50	*		17450#	290#	6840#	360#	16860#	200#
	Hf	72	13500#	710#	1610#	550#	*		11400#	540#	2330#	640#	14460#	590#

A	Elt.	Z	S(2n)	S(2p)	Q( $\alpha$ )	Q(2 $\beta^-$ )	Q( $\epsilon\text{p}$ )	Q( $\beta^-n$ )						
152	Ba	56	8140#	640#	*	*	16520#	540#	*	3620#	640#			
	La	57	9180#	570#	25680#	500#	-5190#	700#	13740#	420#	-22140#	640#	3360#	410#
	Ce	58	10430#	200#	23090#	450#	-3520#	210#	11050#	200#	-20580#	450#	-410#	200#
	Pr	59	11650	130	21350#	420#	-3100	140	7450	120	-16810#	420#	-930	120
	Nd	60	12611	24	19910	50	-2190	40	4611	25	-15950	110	-4834	25
	Pm	61	13800	30	17540	40	-1160	40	1632	26	-11780	30	-4751	26
	Sm	62	13854.1	0.6	15657.0	2.3	219.7	2.0	-54.6	1.2	-11104.8	2.3	-8181.0	0.7
	Eu	63	14240	6	13869	20	1552	6	-2170	40	-6788	5	-6770.9	2.8
	Gd	64	15088	6	12234.8	1.2	2203.0	1.4	-4590	5	-7420.7	1.2	-11156	4
	Tb	65	15760	40	10500	40	3150	40	-7120	40	-3350	40	-10040	40
	Dy	66	16950	6	8934	8	3726	4	-9624	12	-3219	6	-14564	13
	Ho	67	17803	20	7076	16	4507.3	1.3	-11840	70	732	15	-13414	22
	Er	68	18810	20	5761	12	4934.4	1.6	-14190	210	969	11	-17790	23
	Tm	69	21300#	210#	4400	70	3820	150	-18350#	210#	4570	70	-18300	310
	Yb	70	23720#	450#	3050	210	2920#	290#	*	4670	210	-24180#	450#	
	Lu	71	24630#	540#	1390#	280#	3430#	450#	*	10070#	200#	*		
153	Ba	56	7950#	900#	*	*	17730#	900#	*	*	4370#	900#		
	La	57	8780#	720#	26290#	780#	-5510#	630#	14700#	610#	*	4110#	630#	
	Ce	58	9990#	410#	24110#	570#	-4290#	450#	12000#	400#	-20040#	640#	390#	420#
	Pr	59	11000	110	21920#	410#	-3260#	330#	9060	100	-18850#	410#	460	110
	Nd	60	12538	27	20430	110	-3080	100	5217	27	-15530#	200#	-4160	40
	Pm	61	13432	12	18492	25	-2050	80	2689	11	-14170	120	-3987	11
	Sm	62	14126.0	0.6	16190.9	2.3	-609.9	2.0	324.0	1.2	-9697	25	-7742.7	0.7
	Eu	63	14857.01	0.16	14556	5	273	4	-2053	4	-9400	26	-6730.6	1.2
	Gd	64	14838	3	12885.3	1.2	1827.2	1.3	-3740	4	-5410.0	1.2	-10240	40
	Tb	65	15833	6	11239	4	2701	5	-6301	6	-5715	4	-9267	6
	Dy	66	16534	5	9533	5	3559	4	-8662	10	-1725	4	-13613	15
	Ho	67	17530	13	7968	6	4052	4	-11004	19	-1580	40	-12591	12
	Er	68	18365	19	6307	9	4802.3	1.4	-13430#	200#	2348	10	-16790	70
	Tm	69	19376	27	4961	22	5248.1	1.5	-15610	210	2304	23	-15780	210
	Yb	70	21660#	360#	3370#	200#	4260#	200#	-19760#	540#	6150#	200#	-21710#	280#
	Lu	71	24350#	450#	2200	210	3210#	360#	*	6070	200	*		
	Hf	72	*	340#	590#	3770#	710#	*	*	11720#	540#	*		
154	La	57	8460#	720#	*	-5840#	670#	15820#	620#	*	*	4900#	720#	
	Ce	58	9730#	540#	24690#	710#	-4530#	640#	12990#	520#	-22370#	950#	850#	510#
	Pr	59	10540	190	22710#	430#	-3590#	430#	10300	160	-18560#	620#	1080	150
	Nd	60	11680	120	21160#	230#	-3290	120	6770	110	-17630#	420#	-3080	110
	Pm	61	13380	50	19270	130	-2620	50	3250	40	-14160	110	-4000	40
	Sm	62	13835.5	0.9	16881	25	-1196.8	2.4	1251.6	1.3	-12402	27	-7159.4	1.1
	Eu	63	14992.52	0.27	15060	26	-566	20	-1580	50	-8349	11	-6925.9	1.2
	Gd	64	15141.65	0.21	13522.4	1.2	919.2	1.2	-3315	8	-8436.3	1.2	-10464	4
	Tb	65	15580	60	11850	50	2210	50	-5520	50	-4080	50	-9080	50
	Dy	66	16416	9	10262	8	2946	5	-7786	9	-4797	8	-13450	9
	Ho	67	17179	16	8500	40	4041	4	-10215	17	-613	9	-12228	12
	Er	68	18255	12	7066	6	4279.9	2.6	-12678	18	-751	6	-16668	19
	Tm	69	18800	70	5399	20	5093.8	2.6	-14860#	200#	3301	15	-15440#	200#
	Yb	70	19770	210	4012	20	5474.2	1.7	-17200#	500#	3265	19	-19600	210
	Lu	71	22290#	280#	2380#	220#	4620#	280#	*	7160#	200#	-20340#	540#	
	Hf	72	*	1010#	540#	3570#	640#	*	*	7040#	540#	*		

A	Elt.	Z	S(n)		S(p)		Q(4β <sup>-</sup> )		Q(d,α)		Q(p,α)		Q(n,α)	
155	La	57	4490#	1000#	*		28180#	800#	9540#	1130#	8670#	950#	*	
	Ce	58	3770#	780#	13310#	840#	21800#	600#	9240#	840#	6530#	720#	-160#	780#
	Pr	59	5650#	330#	10360#	590#	16050#	300#	10280#	500#	8200#	360#	-60#	500#
	Nd	60	4850#	190#	11560#	220#	9600#	150#	9870#	190#	6200#	200#	2290#	250#
	Pm	61	6550	50	8570	120	4280	30	11090	40	8050	40	2480	130
	Sm	62	5806.96	0.27	8990	40	-1037	12	11198	11	5929	26	5607	25
	Eu	63	8151.4	0.4	6651.8	1.1	-5785	18	11452.2	0.9	7808.4	0.8	5084	26
	Gd	64	6435.22	0.18	7621.7	1.1	-9862	6	12007.2	1.2	5681.4	1.2	8338.0	1.2
	Tb	65	9160	50	4830	12	-14619	18	12346	12	8324	12	7286	12
	Dy	66	6833	14	6290	50	-18656	20	12871	12	6430	40	11201	12
	Ho	67	9467	20	2930	19	-23486	27	13821	18	8949	19	10330	40
	Er	68	7675	8	4860	10	-28110#	400#	13515	8	6257	15	13555	7
	Tm	69	10277	19	1312	14	-32970#	500#	14563	16	8729	17	12619	19
	Yb	70	8641	24	3363	22	*		14223	25	6130	80	15643	20
	Lu	71	11060#	200#	-91	10	*		15220#	200#	8620	210	14860	80
Hf	72	9440#	640#	1820#	450#	*		15020#	450#	4180#	450#	17850#	450#	
Ta	73	*		-1776	10	*		14350#	710#	*		15400#	540#	
156	Ce	58	5070#	840#	13890#	1000#	23970#	600#	7690#	840#	6390#	840#	-2130#	1000#
	Pr	59	4210#	500#	10800#	720#	18180#	400#	11500#	640#	8300#	570#	660#	720#
	Nd	60	6130#	250#	12040#	360#	12010	200	8380	250	5960	230	470#	450#
	Pm	61	5320	50	9040#	160#	5880	30	12180	120	7990	40	3050	110
	Sm	62	7244	9	9690	30	1160	11	9840	50	6178	14	3625	29
	Eu	63	6340	5	7185	5	-4740	50	13080	5	7337	5	6238	12
	Gd	64	8536.39	0.07	8006.7	1.2	-8329	25	9913.0	1.2	5695.3	1.2	5670.1	1.2
	Tb	65	6914	12	5309	4	-13258	16	14327	4	7656	4	8922	4
	Dy	66	9441	10	6564	10	-17265	13	10340	50	5654	7	8006	6
	Ho	67	7390	50	3480	50	-21600	90	15750	50	8660	40	11610	40
	Er	68	10069	25	5460	30	-26360	210	11142	26	5671	25	10583	25
	Tm	69	8276	21	1913	17	-31040#	400#	16483	17	8512	18	13826	17
	Yb	70	10832	20	3918	17	*		11876	18	5615	22	12870	14
	Lu	71	9270	80	540	80	*		16890	80	8170#	210#	15910	80
	Hf	72	11820#	450#	2590	210	*		12430#	290#	5420	9	14850#	290#
Ta	73	10200#	640#	-1014	5	*		17640#	640#	6370#	640#	18260#	450#	
157	Ce	58	3340#	920#	*		26060#	700#	8840#	1060#	6580#	920#	*	
	Pr	59	5130#	570#	10860#	720#	20500#	400#	10140#	720#	8600#	640#	-940#	720#
	Nd	60	4330#	280#	12170#	450#	14040#	200#	9700#	360#	6270#	250#	1560#	540#
	Pm	61	6220	120	9130	230	8400	110	10810#	190#	8180	160	1470	190
	Sm	62	5430	50	9800	60	2690	50	10950	60	6630	70	4600	120
	Eu	63	7446	7	7386	10	-2638	25	11441	5	7858	5	4680	40
	Gd	64	6359.80	0.15	8027	5	-7411	28	11704.6	1.2	5777.8	1.2	7277.3	1.3
	Tb	65	8744	4	5517.4	0.3	-12061	28	12017.3	0.3	7806.6	0.4	6620.2	1.2
	Dy	66	6969	6	6619	7	-15986	12	12537	12	5600	50	9932	6
	Ho	67	9550	50	3588	25	-20350	30	13042	27	8433	26	8980	50
	Er	68	7280	40	5350	50	-24670#	200#	13330	30	6088	29	12625	29
	Tm	69	9940	30	1790	40	-29080	210	14217	29	8767	28	11581	29
	Yb	70	8249	15	3891	19	*		13904	16	5851	18	14817	11
	Lu	71	10800	80	508	22	*		14731	25	8315	25	13593	24
	Hf	72	8970#	290#	2290#	210#	*		14510#	200#	5680	50	16830#	200#
Ta	73	11900#	450#	-935	10	*		15180#	450#	7970#	550#	15590#	290#	

A	Elt.	Z	S(2n)	S(2p)	Q( $\alpha$ )	Q( $2\beta^-$ )	Q( $\epsilon p$ )	Q( $\beta^- n$ )						
155	La	57	8010#	1000#	*	-6000#	950#	16980#	860#	*	5840#	950#		
	Ce	58	9190#	720#	25360#	1000#	-5010#	720#	14070#	620#	*	1730#	620#	
	Pr	59	10290#	320#	23430#	670#	-3920#	500#	11200#	300#	-20680#	670#	1840#	320#
	Nd	60	11270#	160#	21700#	430#	-3400#	180#	7720#	150#	-17060#	530#	-2050#	160#
	Pm	61	12430	30	19920	110	-2630	40	4850	30	-16060	150	-2580	30
	Sm	62	13774.0	0.9	17427	27	-1669.3	2.4	1879.9	1.3	-11790	110	-6524.2	1.1
	Eu	63	14593.6	0.5	15718	11	-854	5	-570	12	-10620	40	-6182.6	1.2
	Gd	64	15329.93	0.25	14089.2	1.2	80.4	1.2	-2917	12	-6904.5	1.3	-9990	50
	Tb	65	16077	13	12459	12	980	12	-5215	22	-6799	12	-8928	14
	Dy	66	16153	12	10848	12	2610	12	-6944	13	-2736	12	-12587	14
	Ho	67	17163	19	9297	18	3165	18	-9404	22	-3170	50	-11499	19
	Er	68	17870	11	7644	7	4118	5	-11712	18	894	10	-15858	16
	Tm	69	18763	23	6194	14	4572	5	-14081	24	720	15	-14773	22
	Yb	70	19590#	200#	4593	19	5337.6	2.3	-16400#	400#	4820	18	-19010#	200#
	Lu	71	20290	210	3117	27	5802.7	2.6	-18890#	500#	4586	17	-17890#	500#
	Hf	72	22940#	640#	1620#	450#	5020#	500#	*	8540#	400#	*	*	
	Ta	73	*	-160#	550#	4110#	640#	*	8610#	540#	*	*	*	
156	Ce	58	8840#	780#	*	-5230#	780#	15130#	630#	*	2310#	670#		
	Pr	59	9850#	430#	24110#	720#	-4270#	570#	12310#	400#	-20400#	900#	2490#	430#
	Nd	60	10980	230	22400#	540#	-3840#	280#	8840	200	-19420#	630#	-1630	210
	Pm	61	11860	60	20600	160	-2840	130	5870	30	-15730#	300#	-2090	30
	Sm	62	13051	9	18260	110	-1637	26	3172	9	-14190#	150#	-5617	9
	Eu	63	14491	5	16170	50	-1255	26	5	6	-10410	30	-6087	5
	Gd	64	14971.61	0.19	14658.5	1.3	-198.3	1.2	-2012	6	-9633.9	1.3	-9359	12
	Tb	65	16080	50	12931	4	372	4	-4740	40	-5562	4	-9009	12
	Dy	66	16274	10	11395	6	1759	6	-6317	25	-5742	6	-12561	19
	Ho	67	16850	50	9770	60	2940	60	-8510	50	-1390	50	-11210	50
	Er	68	17743	25	8393	26	3487	25	-10948	27	-2342	27	-15649	28
	Tm	69	18553	21	6774	18	4344	7	-13090	80	1911	24	-14408	23
	Yb	70	19473	21	5230	13	4811	4	-15410	210	1662	13	-18782	23
	Lu	71	20330#	220#	3900	80	5596	3	-17950#	410#	5600	70	-17720#	410#
	Hf	72	21260#	540#	2500	210	6028	4	*	5360	210	-22260#	550#	
	Ta	73	*	810#	450#	5200#	450#	*	9470#	400#	*	*		
157	Ce	58	8410#	920#	*	-5470#	1060#	16120#	730#	*	3170#	810#		
	Pr	59	9330#	500#	24750#	900#	-4470#	720#	13410#	420#	*	3490#	450#	
	Nd	60	10460#	250#	22970#	630#	-3870#	450#	9940#	200#	-18680#	630#	-640#	200#
	Pm	61	11540	120	21170#	320#	-3170	150	7090	110	-17750#	420#	-1070	110
	Sm	62	12680	50	18840#	160#	-1810	60	4100	50	-13490	210	-4710	50
	Eu	63	13786	5	17070	30	-1208	12	1303	5	-12540	30	-4997	5
	Gd	64	14896.19	0.16	15211.4	1.3	-689.7	1.2	-1403	6	-8749	9	-8804	4
	Tb	65	15659	12	13524.1	1.2	177.9	1.2	-3942	25	-7967	5	-8312	6
	Dy	66	16411	12	11929	6	1037	6	-6008	29	-4175	6	-12140	50
	Ho	67	16930	30	10152	27	2066	25	-8120	40	-4020	25	-10690	30
	Er	68	17347	29	8840	30	3305	28	-9978	30	-179	29	-14650	30
	Tm	69	18220	30	7250	30	3885	28	-12230	30	-640	50	-13520	30
	Yb	70	19081	19	5804	12	4621	6	-14690#	200#	3482	26	-17760	70
	Lu	71	20072	27	4426	23	5107.3	2.9	-16850	210	3068	24	-16700	210
	Hf	72	20800#	450#	2830#	200#	5880	3	*	7220#	200#	-21030#	450#	
	Ta	73	22100#	550#	1650	210	6355	6	*	6830	200	*	*	

A	Elt.	Z	S(n)		S(p)		Q(4 $\beta^-$ )		Q(d, $\alpha$ )		Q(p, $\alpha$ )		Q(n, $\alpha$ )	
158	Pr	59	3830#	720#	11350#	920#	22480#	600#	11380#	840#	8530#	840#	-290#	1000#
	Nd	60	5680#	450#	12720#	570#	16300#	400#	8220#	570#	6240#	500#	-350#	720#
	Pm	61	4790	170	9590#	230#	10380	130	12150	240	8250#	200#	2330#	320#
	Sm	62	6550	90	10130	140	5200	80	9720	90	6620	80	2910#	170#
	Eu	63	5820	80	7770	90	-1020	80	12870	80	7850	80	5410	80
	Gd	64	7937.39	0.06	8518	5	-5393	25	10107	5	5991.8	1.2	5146.9	1.3
	Tb	65	6777.9	1.0	5935.5	0.9	-10774	25	13775.8	1.0	7464.0	1.0	7993.7	1.5
	Dy	66	9056	6	6930.5	2.6	-14397	8	10396	4	5706	12	7311.4	2.6
	Ho	67	7430	40	4052	28	-18980	30	15050	28	7833	29	10710	29
	Er	68	9960	40	5760	40	-23200	30	10760	50	5600	30	9503	28
	Tm	69	8070	40	2570	40	-27680#	200#	16220	40	8376	26	12980	30
	Yb	70	10644	12	4595	29	-32320#	500#	11536	18	5485	15	11847	10
	Lu	71	8803	24	1062	18	*	*	16761	19	8153	22	15067	20
	Hf	72	11420#	200#	2910	26	*	*	12360	80	5314	10	14046	24
	Ta	73	9460#	290#	-450	50	*	*	17540#	290#	7950#	450#	17180#	200#
W	74	*	*	1360#	550#	*	*	12820#	640#	4837	10	16050#	640#	
159	Pr	59	4790#	920#	*	*	24600#	700#	9930#	990#	8810#	920#	*	*
	Nd	60	3890#	640#	12780#	780#	18350#	500#	9460#	640#	6560#	640#	830#	780#
	Pm	61	5830#	230#	9740#	450#	12690#	200#	10660#	280#	8550#	280#	710#	450#
	Sm	62	5070	130	10410	160	6960	100	10870	150	6870	110	3960	230
	Eu	63	6910	80	8130	80	1283	8	11390	50	8181	12	3810	30
	Gd	64	5943.09	0.12	8650	80	-4001	4	11610	5	6388	5	6448	9
	Tb	65	8133.1	0.6	6131.3	0.7	-8969	28	12002.4	0.7	7867.2	0.8	6200	5
	Dy	66	6832.7	2.7	6985.2	1.3	-13331	18	12308.0	1.4	5788	4	9015.1	1.3
	Ho	67	9216	27	4213	4	-17620	40	12803	7	8058	7	8408	5
	Er	68	7335	26	5665	27	-21714	17	12972	25	5650	40	11609	7
	Tm	69	9940	40	2560	40	-26120	30	13560	40	8510	40	10430	50
	Yb	70	7899	19	4430	30	-30620#	400#	13580	30	5861	24	14020	30
	Lu	71	10570	40	990	40	*	*	14440	40	8410	40	12770	40
	Hf	72	8821	24	2928	23	*	*	14340	25	5760	80	16057	20
	Ta	73	11500#	200#	-367	11	*	*	15020#	200#	8270	210	14950	80
W	74	9600#	640#	1500#	450#	*	*	15110#	450#	5437	6	18270#	450#	
160	Nd	60	5280#	780#	13260#	920#	20530#	600#	8020#	840#	6410#	720#	-1110#	920#
	Pm	61	4330#	360#	10180#	590#	14740#	300#	12010#	500#	8550#	360#	1510#	500#
	Sm	62	6280#	220#	10860#	280#	9260#	200#	9390#	230#	6820#	230#	2020#	280#
	Eu	63	5390#	200#	8440#	220#	3020#	200#	12560#	220#	8230#	210#	4650#	230#
	Gd	64	7451.4	0.7	9184	7	-1890	25	9970	80	6383	5	4430	50
	Tb	65	6375.21	0.13	6563.4	0.8	-7540	30	13564.6	0.8	7851.8	0.8	7271	5
	Dy	66	8575.9	1.5	7428.0	1.2	-11508	17	10510.0	1.4	5956.6	1.3	6799.0	1.2
	Ho	67	7124	15	4504	15	-16120	60	14735	15	7904	16	10029	15
	Er	68	9562	25	6012	25	-20121	27	10840	40	5630	30	9016	25
	Tm	69	7800	40	3020	30	-24430	100	15710	40	7980	40	12170	40
	Yb	70	10398	23	4890	30	-28810	210	11240	30	5400	30	10900	30
	Lu	71	8630	70	1720	60	-33610#	410#	16460	60	8040	60	14090	60
	Hf	72	11155	20	3510	40	*	*	11988	19	5410	22	13151	15
	Ta	73	9500	90	310	90	*	*	16940	90	7740#	220#	16250	90
	W	74	12210#	450#	2200	210	*	*	12370#	290#	5131	9	15040#	290#
Re	75	*	*	-1278	8	*	*	17750#	640#	*	*	18620#	450#	

A	Elt.	Z	S(2n)	S(2p)	Q( $\alpha$ )	Q( $2\beta^-$ )	Q( $\epsilon p$ )	Q( $\beta^- n$ )						
158	Pr	59	8960#	720#	*	-4770#	840#	14360#	610#	*	3990#	630#		
	Nd	60	10010#	450#	23580#	720#	-4120#	640#	10810#	410#	-21020#	810#	-100#	420#
	Pm	61	11020	130	21760#	420#	-3320	200	8120	100	-17410#	420#	-430	140
	Sm	62	11980	80	19260	220	-1950	140	5480	80	-15710#	210#	-3820	80
	Eu	63	13260	80	17570	80	-1140	90	2270	80	-12130	140	-4450	80
	Gd	64	14297.19	0.16	15904	9	-660.1	1.3	-284.6	2.5	-11250	50	-7997.4	0.3
	Tb	65	15522	4	13962	5	-157.8	1.5	-3286	27	-7299	5	-8121	6
	Dy	66	16025	6	12447.9	2.6	876.2	2.6	-5108	25	-6870.4	2.5	-11654	25
	Ho	67	16980	50	10671	27	1550	50	-7490	40	-2709	27	-10840	40
	Er	68	17230	40	9352	26	2669	26	-9289	27	-3165	26	-14670	40
	Tm	69	18006	30	7930	50	3516	27	-11489	29	840	40	-13333	27
	Yb	70	18893	14	6380	26	4172	7	-13911	19	116	29	-17603	20
	Lu	71	19610	80	4952	22	4790	5	-16200#	200#	4210	30	-16530#	200#
	Hf	72	20390	210	3418	21	5404.7	2.7	-18410#	500#	4049	20	-20550	210
	Ta	73	21360#	450#	1850#	220#	6124	4	*	*	8180#	200#	*	*
	W	74	*	420#	540#	6613	3	*	*	7770#	540#	*	*	*
159	Pr	59	8630#	810#	*	-5080#	1060#	15400#	730#	*	4880#	810#		
	Nd	60	9570#	540#	24130#	860#	-4240#	780#	12000#	510#	*	810#	520#	
	Pm	61	10620#	230#	22460#	450#	-3500#	360#	9200#	200#	-19410#	630#	290#	210#
	Sm	62	11620	110	20000#	220#	-2170#	180#	6360	100	-15100#	410#	-3070	130
	Eu	63	12729	5	18260	110	-1500	30	3486	7	-14250	130	-3428	7
	Gd	64	13880.48	0.14	16410	50	-796.2	1.3	605.0	1.3	-10640	80	-7162.6	0.9
	Tb	65	14911.1	0.8	14650	5	-139.5	1.4	-2203.2	2.9	-9620	80	-7198.3	2.5
	Dy	66	15888	6	12920.7	1.3	478.7	1.3	-4606	3	-5765.7	1.3	-11054	27
	Ho	67	16650	25	11143	3	1494	12	-6765	28	-5147.6	3.0	-10103	26
	Er	68	17290	28	9717	7	2168	12	-8724	19	-1444	4	-13935	26
	Tm	69	18000	40	8320	40	3040	30	-10860	50	-1670	40	-12627	29
	Yb	70	18544	20	7000	30	3948	19	-12989	25	2170	30	-16700	24
	Lu	71	19370	40	5580	50	4500	40	-15270	40	1700	50	-15680	40
	Hf	72	20240#	200#	3990	20	5225.0	2.7	-17630#	400#	5872	19	-19910#	200#
	Ta	73	20960	210	2543	28	5681	6	*	*	5477	18	-18830#	500#
	W	74	*	1050#	450#	6450	4	*	*	9590#	400#	*	*	*
160	Nd	60	9170#	720#	*	-4450#	840#	12990#	630#	*	1360#	630#		
	Pm	61	10150#	320#	22950#	670#	-3620#	500#	10260#	360#	-18940#	760#	1040#	310#
	Sm	62	11350#	210#	20600#	450#	-2310#	280#	7530#	200#	-17490#	540#	-2440#	200#
	Eu	63	12300#	210#	18850#	240#	-1570#	200#	4470#	200#	-13810#	280#	-2870#	200#
	Gd	64	13394.5	0.7	17310	80	-1003	9	1729.4	1.3	-13020	100	-6480.9	1.0
	Tb	65	14508.4	0.6	15210	80	-175	5	-1455	15	-9079	7	-6740.8	1.2
	Dy	66	15408.6	2.3	13559.3	1.2	439.2	1.2	-3620	25	-8398.5	1.2	-10414	3
	Ho	67	16340	30	11489	15	1285	15	-6090	40	-4138	15	-9892	15
	Er	68	16900	40	10224	25	2046	25	-7889	29	-4174	25	-13560	40
	Tm	69	17740	40	8690	40	2630	60	-10030	70	-260	30	-12530	40
	Yb	70	18297	18	7440	30	3618	29	-12232	20	-891	17	-16530	40
	Lu	71	19200	60	6140	60	4140	60	-14390	110	3010	60	-15490	60
	Hf	72	19976	21	4500	14	4902.4	2.6	-16580	210	2617	22	-19560	24
	Ta	73	21000#	220#	3240	90	5450	50	-19220#	410#	6550	100	-18720#	410#
	W	74	21810#	550#	1840	210	6065	5	*	*	6200	210	*	*
	Re	75	*	220#	450#	6715	10	*	*	10500#	400#	*	*	*

A	Elt.	Z	S(n)	S(p)	$Q(4\beta^-)$	$Q(d,\alpha)$	$Q(p,\alpha)$	$Q(n,\alpha)$						
161	Nd	60	3610#	920#	*	22550#	700#	9200#	990#	6630#	920#	*		
	Pm	61	5400#	590#	10300#	780#	17040#	500#	10500#	710#	8830#	640#	-50#	780#
	Sm	62	4630#	360#	11160#	420#	11080#	300#	10580#	360#	6980#	320#	3070#	500#
	Eu	63	6480#	360#	8650#	360#	5430#	300#	11150#	310#	8300#	310#	2960#	320#
	Gd	64	5635.4	1.0	9430#	200#	-304	9	11251	7	6560	80	5350	80
	Tb	65	7696.6	0.5	6808.5	1.0	-5569	28	11811.1	0.9	8092.6	0.9	5390	80
	Dy	66	6454.39	0.08	7507.2	1.3	-10217	16	12188.7	1.2	6280.1	1.4	8282.0	1.2
	Ho	67	8886	15	4813.7	2.2	-14640	28	12681.4	2.6	8073	3	7920.8	2.5
	Er	68	7222	26	6110	18	-18890	24	12838	10	5846	29	10850	9
	Tm	69	9670	40	3130	40	-23170#	60#	13379	28	8270	40	9940	40
	Yb	70	7746	22	4830	40	-27440#	200#	13440	30	5723	30	13106	30
	Lu	71	10360	60	1680	30	-31690	210	13990	30	8317	29	11790	40
	Hf	72	8453	25	3340	60	*		14110	40	5760	27	15343	24
	Ta	73	10930#	110#	90#	50#	*		14830#	60#	8230#	60#	14130#	60#
	W	74	9120#	290#	1820#	220#	*		14750#	200#	5480	50	17340#	200#
	Re	75	12290#	450#	-1197	5	*		15060#	450#	7680#	550#	15790#	290#
	162	Pm	61	3950#	860#	10630#	990#	19380#	700#	11830#	920#	8780#	860#	790#
Sm		62	5850#	590#	11610#	710#	13430#	500#	9060#	590#	6960#	540#	1110#	710#
Eu		63	4940#	420#	8960#	420#	7400#	300#	12480#	360#	8430#	310#	3850#	360#
Gd		64	6846	4	9800#	300#	2055	5	9790#	200#	6630	8	3570	100
Tb		65	6280	40	7460	40	-4200	40	12980	40	7750	40	6020	40
Dy		66	8196.99	0.06	8007.6	1.3	-8355	16	10366.9	1.3	6216.3	1.2	6028.1	1.2
Ho		67	6916	4	5275	3	-13210	80	14342	3	7990	3	9138	3
Er		68	9205	9	6429	3	-17170	10	10756	15	5857	4	8477.3	2.9
Tm		69	7660	40	3564	27	-21700	60	15290	40	7948	26	11499	26
Yb		70	10059	21	5220	30	-25830	24	11180	40	5600	30	10382	16
Lu		71	8350	80	2280	80	-30480#	220#	16040	80	7870	80	13380	80
Hf		72	10926	24	3900	30	-34670#	500#	11810	60	5410	40	12316	20
Ta		73	9120#	80#	750	60	*		16870	50	7940	50	15580	60
W		74	11670#	200#	2560#	60#	*		12580	90	5310	10	14498	24
Re		75	9550#	290#	-760	50	*		17720#	290#	7740#	450#	17740#	200#
Os		76	*		920#	550#	*		12870#	640#	*		16370#	640#
163		Pm	61	4910#	1060#	*	21460#	800#	10530#	1060#	9140#	1000#	*	
	Sm	62	4220#	860#	11880#	990#	15490#	700#	10250#	860#	7070#	760#	2170#	920#
	Eu	63	6050#	590#	9160#	710#	9760#	500#	11070#	590#	8660#	540#	2130#	590#
	Gd	64	5270#	300#	10130#	420#	3690#	300#	11000#	420#	6750#	360#	4580#	360#
	Tb	65	6990	40	7603	6	-1866	7	11622	4	8211	4	4410#	200#
	Dy	66	6271.01	0.05	7990	40	-7082	16	11792.5	1.3	6320.5	1.3	7208.5	1.3
	Ho	67	8408	3	5486.11	0.05	-11593	28	12388.00	0.08	8158.18	0.11	7105.4	1.3
	Er	68	6903	5	6416	6	-15888	28	12740	5	6078	16	10150	5
	Tm	69	9323	27	3681	6	-20190	40	13185	10	8187	25	9299	16
	Yb	70	7544	21	5110	30	-24400	60	13310	30	5860	40	12401	29
	Lu	71	10030	80	2250	30	-28780	30	13760	30	8240	30	11160	40
	Hf	72	8184	30	3740	80	-33160#	410#	13990	40	5850	60	14530	30
	Ta	73	10830	60	660	40	*		14490	40	8260	40	13380	70
	W	74	8980	60	2420	70	*		14540#	80#	5830	100	16670	50
	Re	75	11720#	200#	-706	9	*		15110#	200#	8220	210	15520	90
	Os	76	9690#	650#	1060#	450#	*		15460#	450#	5400	50	18880#	450#



A	Elt.	Z	S(2n)		S(2p)		Q( $\alpha$ )		Q(2 $\beta^-$ )		Q( $\epsilon p$ )		Q( $\beta^- n$ )	
161	Nd	60	8890#	860#	*		-4720#	990#	14020#	760#	*		2070#	760#
	Pm	61	9730#	540#	23560#	860#	-3890#	640#	11350#	590#	*		1910#	540#
	Sm	62	10910#	310#	21340#	590#	-2610#	360#	8530#	300#	-16850#	670#	-1680#	360#
	Eu	63	11870#	300#	19510#	360#	-1830#	320#	5690#	300#	-15960#	420#	-1900#	300#
	Gd	64	13086.8	1.2	17880	100	-1200	50	2548.4	1.6	-12390#	200#	-5741.1	1.4
	Tb	65	14071.8	0.6	15993	7	-426	5	-265.3	2.5	-11390#	200#	-5861.4	1.3
	Dy	66	15030.3	1.5	14070.6	1.2	344.6	1.2	-2852	9	-7401.5	1.3	-9744	15
	Ho	67	16010	4	12241.7	2.5	1142.9	2.5	-5304	28	-6648.9	2.5	-9216	25
	Er	68	16784	10	10613	9	1794	11	-7365	18	-2820	9	-12980	40
	Tm	69	17470	40	9141	28	2510	40	-9340	40	-2800	30	-11800	30
	Yb	70	18144	23	7855	16	3150	30	-11526	28	925	29	-15650	60
	Lu	71	18990	50	6570	40	3720	40	-13830#	60#	450	40	-14700	30
	Hf	72	19608	28	5054	29	4698	24	-15910#	200#	4562	28	-18510	90
	Ta	73	20430#	60#	3600#	70#	5320#	60#	-17860#	220#	4250#	80#	-17440#	220#
	W	74	21320#	450#	2130#	200#	5923	4	*	*	8240#	200#	-21820#	450#
	Re	75	*		1010	210	6328	7	*	*	7710	200	*	*
162	Pm	61	9340#	760#	*		-4000#	920#	12340#	760#	*		2600#	760#
	Sm	62	10480#	540#	21910#	780#	-2780#	640#	9530#	500#	-19080#	860#	-1050#	590#
	Eu	63	11420#	360#	20120#	420#	-1980#	320#	7030#	300#	-15510#	590#	-1210#	300#
	Gd	64	12481	4	18450#	200#	-1500	80	3900	4	-14600#	300#	-4890	4
	Tb	65	13980	40	16890#	200#	-890	90	370	40	-11190#	300#	-5690	40
	Dy	66	14651.38	0.10	14816.1	1.3	85.0	1.2	-1844.2	2.7	-9963.1	1.6	-9055.3	2.2
	Ho	67	15802	15	12782	3	1005	3	-4564	26	-5868	3	-8909	10
	Er	68	16427	25	11242.5	2.7	1645	3	-6511	16	-5570.5	2.7	-12515	28
	Tm	69	17320	40	9670	30	2280	40	-8650	80	-1570	26	-11710	30
	Yb	70	17805	22	8351	29	3047	30	-10658	18	-1912	18	-15340	30
	Lu	71	18710	90	7110	80	3440	80	-13050	90	1770	80	-14590	80
	Hf	72	19379	15	5581	18	4417	5	-15171	20	1382	18	-18510#	60#
	Ta	73	20050	100	4090	80	5010	50	-17430#	210#	5490	60	-17450#	200#
	W	74	20780	210	2643	21	5677.3	2.7	-19500#	500#	5028	29	-21200	210
	Re	75	21840#	450#	1060#	220#	6240	5	*	*	9090#	210#	*	*
	Os	76	*		-280#	550#	6767	3	*	*	8620#	540#	*	*
163	Pm	61	8860#	950#	*		-4120#	1060#	13480#	950#	*		3540#	950#
	Sm	62	10060#	760#	22510#	990#	-3110#	860#	10590#	760#	*		-320#	760#
	Eu	63	10990#	590#	20770#	710#	-2200#	540#	7980#	500#	-17610#	860#	-410#	500#
	Gd	64	12120#	300#	19090#	420#	-1700#	310#	4900#	300#	-14020#	590#	-3880#	300#
	Tb	65	13276	4	17400#	300#	-973	8	1783	4	-13240#	300#	-4486	4
	Dy	66	14468.00	0.08	15451.7	1.6	-242.9	1.2	-1212	5	-9388	4	-8411	3
	Ho	67	15323.7	2.2	13493.7	1.3	730.2	1.3	-3649	6	-7990	40	-8112.6	2.7
	Er	68	16108	10	11691	5	1574	5	-5870	17	-4276	5	-11762	27
	Tm	69	16979	29	10110	6	2176	6	-7944	29	-3977	6	-10975	17
	Yb	70	17603	21	8673	18	2838	16	-10020	30	-251	16	-14540	80
	Lu	71	18370	40	7470	40	3350	40	-12250	50	-600	40	-13690	30
	Hf	72	19110	40	6020	30	4130	30	-14380	60	3260	30	-17580	60
	Ta	73	19950#	70#	4560	50	4749	5	-16530	40	3010	80	-16610	40
	W	74	20650#	200#	3170	60	5520	50	-18790#	410#	6980	50	-20630#	210#
	Re	75	21270	210	1850#	60#	6017	7	*	*	6490	50	-19580#	500#
	Os	76	*		300#	450#	6680	50	*	*	10590#	400#	*	*

A	Elt.	Z	S(n)		S(p)		Q(4 $\beta^-$ )		Q(d, $\alpha$ )		Q(p, $\alpha$ )		Q(n, $\alpha$ )	
164	Sm	62	5350#	1060#	12320#	1130#	17800#	800#	8840#	1060#	7120#	950#	430#	1060#
	Eu	63	4550#	780#	9500#	920#	11880#	600#	12360#	780#	8740#	670#	2970#	780#
	Gd	64	6330#	500#	10410#	640#	6200#	400#	9610#	500#	6900#	500#	2880#	500#
	Tb	65	5550	100	7880#	310#	-190	100	12910	100	8290	100	5340#	310#
	Dy	66	7658.11	0.07	8661	4	-4951	16	10420	40	6358.9	1.3	5185.8	1.6
	Ho	67	6674.4	1.4	5889.5	1.4	-10345	28	13910.5	1.4	7938.1	1.4	8127.5	1.9
	Er	68	8847	5	6854.6	2.1	-14128	21	10808	4	6117.3	2.8	7758.0	2.1
	Tm	69	7225	29	4003	28	-18610	40	15165	28	8185	29	10961	28
	Yb	70	9790	21	5577	17	-22789	20	11170	30	5740	30	9833	18
	Lu	71	7920	40	2630	30	-27000#	160#	15900	30	8070	30	12900	40
	Hf	72	10610	30	4320	30	-31360	210	11730	80	5600	30	11669	26
	Ta	73	8810	50	1290	40	-36020#	410#	16601	30	7900	40	14930	40
	W	74	11400	50	2980	40	*	*	12260	50	5360#	50#	13731	25
	Re	75	9710#	160#	20#	170#	*	*	17070#	160#	7630#	250#	16740#	170#
	Os	76	12410#	450#	1740	210	*	*	12610#	290#	5280	8	15590#	290#
	Ir	77	*	*	-1570#	110#	*	*	17950#	650#	*	*	19260#	460#
165	Sm	62	3690#	1210#	*	*	19820#	900#	10060#	1210#	7370#	1140#	*	*
	Eu	63	5530#	920#	9670#	1060#	14340#	700#	11050#	990#	9060#	860#	1390#	990#
	Gd	64	4790#	640#	10650#	780#	8060#	500#	10870#	710#	7040#	590#	3930#	710#
	Tb	65	6650#	220#	8200#	450#	2280#	200#	11540#	360#	8490#	200#	3630#	360#
	Dy	66	5715.96	0.05	8820	100	-3331	28	11694	4	6930	40	6316	4
	Ho	67	7988.8	1.1	6220.2	0.9	-8462	27	12192.7	0.9	8146.3	0.9	6420	40
	Er	68	6650.1	0.6	6830.2	2.3	-12893	28	12566.4	2.1	6383	4	9304.9	2.1
	Tm	69	9119	28	4275.3	1.5	-17081	18	12949	5	8270.7	2.9	8758	4
	Yb	70	7340	30	5690	40	-21430	40	13159	29	6060	40	11702	28
	Lu	71	9870	40	2710	30	-25790	40	13570	30	8250	30	10690	40
	Hf	72	7890	30	4280	40	-29990#	200#	13870	40	6070	80	13840	30
	Ta	73	10640	30	1323	26	-34230#	220#	14140	30	8182	20	12630	80
	W	74	8700	28	2870	40	*	*	14390	50	5780	60	15958	27
	Re	75	11090#	160#	-288	25	*	*	14960	60	8210	30	14770	60
	Os	76	9260#	290#	1290#	260#	*	*	15070#	200#	5572	10	18000#	200#
	Ir	77	12430#	470#	-1550#	50#	*	*	15210#	460#	7740#	550#	16380#	300#
166	Eu	63	4110#	1060#	10090#	1210#	16470#	800#	12290#	1130#	9160#	1060#	2190#	1130#
	Gd	64	6000#	780#	11130#	920#	10530#	600#	9420#	840#	7090#	780#	2140#	920#
	Tb	65	5170#	220#	8580#	510#	4130	100	12700#	410#	8590#	310#	4510#	510#
	Dy	66	7043.5	0.4	9220#	200#	-1002	8	10200	100	6875	4	4540#	300#
	Ho	67	6243.64	0.02	6747.9	0.9	-7056	30	13607.2	0.9	8173.7	0.9	7171	4
	Er	68	8474.6	1.9	7316.0	0.9	-11073	28	10766.3	1.5	6316.4	1.2	7101.3	1.2
	Tm	69	7029	12	4655	12	-15800	30	14766	12	8144	12	10136	12
	Yb	70	9373	29	5942	8	-19697	13	11011	29	6011	10	9232	9
	Lu	71	7650	40	3020	40	-24170#	90#	15710	30	8150	30	12360	30
	Hf	72	10290	40	4710	40	-28420	30	11490	40	5800	40	11090	30
	Ta	73	8310	30	1750	40	-32890#	200#	16430	30	8050	40	14340	40
	W	74	11101	27	3326	20	-37100#	500#	12102	30	5510	40	13041	30
	Re	75	9260#	90#	280#	90#	*	*	17100#	90#	7920#	100#	16340#	100#
	Os	76	11860#	200#	2070	30	*	*	12920#	160#	5432	8	15120	60
	Ir	77	9650#	300#	-1152	8	*	*	17970#	290#	7780#	450#	18450#	200#
	Pt	78	*	*	460#	550#	*	*	13180#	650#	*	*	16980#	650#

A	Elt.	Z	S(2n)	S(2p)	Q( $\alpha$ )	Q( $2\beta^-$ )	Q( $\epsilon p$ )	Q( $\beta^- n$ )						
164	Sm	62	9570#	950#	*	-3180#	1000#	11570#	900#	*	380#	950#		
	Eu	63	10600#	670#	21380#	920#	-2430#	670#	8980#	600#	-17250#	1000#	310#	670#
	Gd	64	11600#	400#	19570#	640#	-1750#	450#	6230#	400#	-16140#	810#	-3220#	400#
	Tb	65	12540	110	18010#	310#	-1140#	220#	2900	100	-12750#	510#	-3770	100
	Dy	66	13929.12	0.08	16264	4	-449.6	1.3	-23.7	2.1	-11770#	300#	-7660.67	0.07
	Ho	67	15083	3	13880	40	431.0	1.8	-3099	28	-7675	4	-7884	5
	Er	68	15749.6	2.5	12340.7	2.1	1303.6	2.1	-4927	16	-6852.0	2.1	-11286	6
	Tm	69	16550	40	10419	28	2070	30	-7250	40	-2793	28	-10660	30
	Yb	70	17334	21	9258	16	2611	29	-9201	26	-3138	17	-14300	30
	Lu	71	17950	80	7740	40	3240	40	-11360	40	804	29	-13430	40
	Hf	72	18791	23	6568	26	3923	26	-13588	24	194	26	-17350	40
	Ta	73	19640	60	5020	80	4560	60	-15640#	160#	4220	40	-16450	60
	W	74	20374	21	3639	15	5278.5	2.0	-17770	210	3760	30	-20298	23
	Re	75	21430#	260#	2440#	170#	5810#	130#	-20380#	440#	7610#	160#	-19590#	430#
	Os	76	22100#	550#	1040	210	6477	6	*	*	7160	220	*	*
	Ir	77	*	*	-510#	460#	6970#	100#	*	*	11450#	410#	*	*
165	Sm	62	9050#	1140#	*	-3260#	1140#	12670#	1030#	*	1230#	1080#		
	Eu	63	10080#	860#	21990#	1060#	-2560#	860#	10100#	730#	*	1110#	810#	
	Gd	64	11120#	590#	20150#	860#	-1910#	590#	7150#	500#	-15580#	950#	-2460#	510#
	Tb	65	12200#	200#	18610#	540#	-1310#	360#	4250#	200#	-14840#	630#	-2760#	200#
	Dy	66	13374.07	0.09	16710#	300#	-530.1	1.6	910.4	2.1	-11160#	400#	-6702.2	1.4
	Ho	67	14663.3	0.9	14881	4	138.7	1.5	-1968.6	2.5	-10110	100	-7026.3	2.0
	Er	68	15497	5	12719.8	2.1	1107.9	2.1	-4241	28	-5844.0	2.1	-10711	28
	Tm	69	16343	6	11129.9	2.6	1842	3	-6494	27	-5237.8	2.7	-9985	16
	Yb	70	17130	30	9691	28	2497	29	-8650	40	-1627	28	-13720	40
	Lu	71	17790	40	8285	27	3030	40	-10590	30	-1840	40	-12690	30
	Hf	72	18490	40	6910	30	3780	30	-12770	40	2100	30	-16420	40
	Ta	73	19460	40	5640	30	4280	30	-15200	30	1500	30	-15693	21
	W	74	20100	60	4150	40	5032	30	-17220#	200#	5670	30	-19290#	160#
	Re	75	20790	30	2690	50	5650#	60#	-19030#	220#	5340	40	-18270	210
	Os	76	21660#	450#	1320#	210#	6340	50	*	*	9300#	200#	-22450#	460#
	Ir	77	*	*	200#	220#	6830#	50#	*	*	8730#	250#	*	*
166	Eu	63	9640#	1000#	*	-2720#	1060#	11160#	810#	*	1790#	950#		
	Gd	64	10800#	720#	20800#	1000#	-2070#	780#	8190#	600#	-17890#	1080#	-1810#	630#
	Tb	65	11820	140	19230#	600#	-1540#	310#	5320	100	-14490#	710#	-2210	100
	Dy	66	12759.5	0.4	17420#	400#	-728	4	2341.5	1.3	-13410#	500#	-5756.9	1.0
	Ho	67	14232.5	1.1	15570	100	180	40	-1183	12	-9710#	200#	-6619.9	2.0
	Er	68	15124.7	1.9	13536.2	1.2	830.3	1.2	-3343	8	-8602.6	1.2	-10067.0	2.4
	Tm	69	16150	30	11485	12	1728	12	-5870	30	-4278	12	-9680	30
	Yb	70	16708	18	10217	8	2329	8	-7729	29	-4349	8	-13218	28
	Lu	71	17520	40	8710	40	3040	40	-9920	40	-374	30	-12460	40
	Hf	72	18180	30	7410	30	3550	30	-11967	30	-860	40	-16080	30
	Ta	73	18960	40	6030	40	4310	80	-14250#	90#	3060	40	-15310	40
	W	74	19801	16	4648	23	4856	4	-16453	21	2455	30	-19306	30
	Re	75	20350#	180#	3150#	90#	5510#	70#	-18650#	220#	6720#	90#	-18280#	220#
	Os	76	21120	210	1783	22	6139	4	-20650#	500#	6130	30	-21890#	220#
	Ir	77	22080#	460#	140#	260#	6724	6	*	*	10160#	200#	*	*
	Pt	78	*	*	-1090#	550#	7286	15	*	*	9570#	540#	*	*

A	Elt.	Z	S(n)		S(p)		Q(4β <sup>-</sup> )		Q(d,α)		Q(p,α)		Q(n,α)	
167	Eu	63	5050#	1130#	*		18700#	800#	10930#	1210#	9460#	1130#	*	
	Gd	64	4370#	840#	11390#	1000#	12600#	600#	10570#	920#	7270#	840#	3120#	1000#
	Tb	65	6150#	410#	8730#	720#	6710#	400#	11340#	640#	8770#	570#	2910#	720#
	Dy	66	5420	60	9470	120	660	60	11430#	210#	7010	120	5460#	410#
	Ho	67	7281	5	6985	5	-4790	30	12042	5	8551	5	5440	100
	Er	68	6436.45	0.18	7508.8	0.9	-9829	28	12318.6	0.9	6554.4	1.5	8323.0	1.2
	Tm	69	8726	12	4905.7	1.5	-14197	28	12690.8	2.4	8265.3	2.4	8085.2	2.0
	Yb	70	7077	9	5989	12	-18505	20	13053	5	6158	28	11002	4
	Lu	71	9550	40	3200	30	-22660#	60#	13500	40	8390	40	10030	40
	Hf	72	7680	40	4740	40	-26960	80	13690	40	6040	40	13200	30
	Ta	73	10320	40	1780	40	-31270	30	14000	40	8330	30	11940	40
	W	74	8268	22	3280	30	-35550#	410#	14477	26	6060	30	15379	28
	Re	75	11060#	100#	230#	50#	*		14740#	60#	8260#	50#	14090#	60#
	Os	76	9140	70	1940#	110#	*		14860	80	6010#	180#	17380	70
	Ir	77	11950#	200#	-1071	5	*		15280#	200#	8240	210	16210#	160#
	Pt	78	9820#	650#	620#	450#	*		15800#	460#	5590#	120#	19570#	460#
168	Gd	64	5470#	920#	11810#	1060#	14890#	700#	9210#	1060#	7320#	990#	1340#	1140#
	Tb	65	4730#	640#	9090#	780#	8820#	500#	12610#	780#	8830#	710#	3710#	860#
	Dy	66	6700	150	10010#	420#	3010	140	9910	170	6960#	240#	3550#	520#
	Ho	67	5850	30	7420	70	-3000	60	13230	30	8420	30	6240#	200#
	Er	68	7771.32	0.12	7999	5	-7636	28	10791.0	0.9	6771.9	0.9	6267.6	1.2
	Tm	69	6840.7	1.8	5309.9	1.8	-12924	28	14324.7	1.8	8074.7	2.6	9233.3	2.0
	Yb	70	9052	5	6315	4	-16684	17	11030	12	6225	4	8600	4
	Lu	71	7630	60	3760	50	-21270	60	15240	50	8090	50	11520	50
	Hf	72	9960	40	5150	40	-25370	30	11370	40	5950	40	10570	40
	Ta	73	8110	40	2220	40	-29650#	150#	16180	40	8110	40	13690	40
	W	74	10873	25	3830	30	-33850	210	11920	30	5829	23	12390	30
	Re	75	9030#	60#	1000	40	*		16810	30	7930	40	15710	40
	Os	76	11560	70	2440#	50#	*		12570#	90#	5530	25	14518	28
	Ir	77	9730#	150#	-470#	170#	*		17410#	150#	7770#	250#	17560#	150#
	Pt	78	12570#	460#	1250	210	*		12880#	290#	5450#	50#	16260#	290#
	169	Gd	64	3870#	1060#	*		17030#	800#	10390#	1130#	7570#	1130#	*
Tb		65	5670#	780#	9280#	920#	11180#	600#	11320#	840#	9170#	840#	2150#	1000#
Dy		66	5110	330	10390#	590#	4770	300	10950#	500#	7020	320	4440#	670#
Ho		67	6810	40	7530	140	-726	21	11840	60	8651	20	4600	100
Er		68	6003.27	0.15	8150	30	-6212	28	12069	5	7012.3	0.9	7307.8	1.3
Tm		69	8033.6	1.5	5572.2	1.1	-10990	28	12727.6	1.1	8515.7	1.1	7443.3	1.3
Yb		70	6866.98	0.15	6342	4	-15453	16	12889	4	6388	12	10208	4
Lu		71	9080	50	3792	3	-19691	29	13228	6	8375	8	9463	13
Hf		72	7430	40	4940	50	-24000	40	13500	40	6170	40	12518	29
Ta		73	9970	40	2220	40	-28210	40	13890	40	8430	40	11380	40
W		74	8099	22	3810	30	-32540#	200#	14140	30	6040	30	14590	30
Re		75	10660	40	780	30	-36600#	300#	14410	30	8370	30	13360	40
Os		76	8802	28	2220	40	*		14830#	60#	5990#	90#	16817	27
Ir		77	11410#	150#	-621	24	*		15130	80	8220	30	15420#	90#
Pt		78	9410#	290#	920#	250#	*		15420#	200#	5694	15	18710#	200#
Au		79	*		-1960#	360#	*		15460#	500#	7870#	590#	17060#	360#

A	Elt.	Z	S(2n)	S(2p)	Q( $\alpha$ )	Q( $2\beta^-$ )	Q( $\epsilon\text{p}$ )	Q( $\beta^-n$ )						
167	Eu	63	9170#	1060#	*	-2860#	1130#	12260#	900#	*	2740#	1000#		
	Gd	64	10380#	780#	21480#	1080#	-2230#	920#	9240#	600#	*	-1010#	600#	
	Tb	65	11330#	450#	19860#	810#	-1640#	640#	6440#	400#	-16530#	900#	-1320#	400#
	Dy	66	12460	60	18050#	510#	-870#	300#	3360	60	-12830#	600#	-4930	60
	Ho	67	13525	5	16210#	200#	-110	7	262	5	-11820	100	-5426	5
	Er	68	14911.1	1.9	14256.7	1.2	664.8	1.2	-2703	4	-7995.6	1.3	-9474	12
	Tm	69	15755.0	2.6	12221.7	1.6	1410.7	1.8	-5050	30	-6760.4	1.6	-9031	8
	Yb	70	16449	28	10644	4	2155	6	-7126	28	-2951	4	-12640	30
	Lu	71	17200	40	9140	30	2810	30	-9150	40	-2900	30	-11710	40
	Hf	72	17970	40	7760	40	3410	30	-11380	30	832	29	-15440	40
	Ta	73	18640	30	6490	40	4020	40	-13510#	60#	380	40	-14531	30
	W	74	19370	30	5030	30	4770	30	-15590	80	4480	30	-18310#	90#
	Re	75	20320#	60#	3560#	60#	5280#	40#	-17760#	60#	3970#	60#	-17470#	60#
	Os	76	21000#	220#	2220	80	5980	50	-19960#	410#	8100	70	-21370#	220#
	Ir	77	21600#	220#	1000	30	6503	6	*	*	7480#	90#	-20360#	500#
	Pt	78	*	-530#	450#	7160	50	*	*	11610#	410#	*	*	*
168	Gd	64	9850#	920#	*	-2350#	1060#	10460#	710#	*	-330#	810#		
	Tb	65	10880#	510#	20470#	950#	-1820#	780#	7570#	500#	-16200#	950#	-630#	510#
	Dy	66	12120	140	18740#	610#	-1240#	420#	4430	140	-15150#	610#	-4350	140
	Ho	67	13130	30	16880	100	-410	100	1250	30	-11510#	400#	-4840	30
	Er	68	14207.77	0.21	14984.6	1.3	551.6	1.2	-1422	4	-10350	60	-8519.7	1.5
	Tm	69	15566	12	12818.7	2.0	1244.5	2.3	-4250	50	-6320	6	-8795	4
	Yb	70	16129	7	11221	4	1950	4	-6214	28	-5567	4	-12140	30
	Lu	71	17190	60	9750	50	2400	50	-8670	50	-1800	50	-11670	50
	Hf	72	17640	40	8350	29	3240	30	-10470	30	-2055	28	-15080	40
	Ta	73	18440	40	6950	40	3820	40	-12600	40	1820	40	-14380	30
	W	74	19141	19	5610	30	4506	12	-14900	20	1290	30	-18120#	60#
	Re	75	20090#	90#	4280	40	5063	13	-17050#	160#	5270	40	-17360	80
	Os	76	20695	22	2677	16	5818.2	2.9	-18950	210	4809	23	-20983	22
	Ir	77	21680#	250#	1470#	180#	6480	50	*	*	8810#	160#	-20270#	430#
	Pt	78	22390#	550#	180	210	6997	9	*	*	8180	220	*	*
169	Gd	64	9340#	1000#	*	-2530#	1210#	11700#	860#	*	530#	950#		
	Tb	65	10400#	720#	21090#	1000#	-1960#	920#	8710#	600#	*	400#	610#	
	Dy	66	11810	310	19480#	670#	-1560#	590#	5330	300	-14790#	760#	-3610	300
	Ho	67	12659	21	17540#	400#	-570#	200#	2477	20	-13590#	500#	-3878	20
	Er	68	13774.59	0.19	15570	60	264.3	1.2	-558	4	-9650	140	-7682.3	1.9
	Tm	69	14874.3	1.0	13571	5	1199.7	1.3	-3203	5	-8500	30	-7777	4
	Yb	70	15919	5	11652	4	1733	4	-5653	28	-4663	4	-11380	50
	Lu	71	16720	30	10107	5	2434	5	-7787	28	-4049	5	-10788	28
	Hf	72	17390	40	8701	28	3150	40	-9800	30	-431	28	-14390	40
	Ta	73	18080	40	7370	40	3730	40	-11900	40	-520	50	-13470	30
	W	74	18972	25	6030	30	4290	30	-14196	30	3150	30	-17190	30
	Re	75	19690#	60#	4610	40	5044	29	-16300	40	2720	40	-16470	30
	Os	76	20360	80	3210	30	5716	3	-18350#	200#	6880	30	-20050#	150#
	Ir	77	21140	30	1820#	60#	6151	8	-20290#	300#	6420	40	-19110	210
	Pt	78	21980#	450#	450#	220#	6846	13	*	*	10330#	200#	*	*
	Au	79	*	-710#	300#	7410#	370#	*	*	9660#	330#	*	*	*

A	Elt.	Z	S(n)	S(p)	Q(4β <sup>-</sup> )	Q(d,α)	Q(p,α)	Q(n,α)						
170	Tb	65	4320#	920#	9730#	1060#	13460#	700#	12470#	990#	9220#	920#	2890#	1060#
	Dy	66	6130#	360#	10860#	630#	7110#	200#	9550#	540#	7040#	450#	2680#	630#
	Ho	67	5510	50	7930	300	1070	50	13030	150	8560	80	5250#	400#
	Er	68	7257.2	1.5	8600	20	-3861	28	10660	30	7036	5	5470	60
	Tm	69	6591.97	0.17	6160.9	1.1	-9663	28	13906.9	1.1	8360.2	1.1	8132	5
	Yb	70	8470	4	6778.0	0.8	-13476	15	11259.5	1.7	6643.4	1.3	8174.2	1.2
	Lu	71	7304	18	4229	17	-18390	30	14975	17	8148	17	10885	17
	Hf	72	9610	40	5466	28	-22326	30	11520	50	6110	40	9987	28
	Ta	73	7920	40	2710	40	-26820#	110#	15930	40	8190	40	13010	40
	W	74	10447	22	4290	30	-30988	24	11810	30	5920	30	11820	30
	Re	75	8600	40	1290	30	-35310#	210#	16680	30	8030	30	15080	40
	Os	76	11278	27	2830	30	*	*	12580	30	5770#	50#	13807	22
	Ir	77	9310#	110#	-110#	110#	*	*	17380#	100#	8050#	130#	17160#	110#
	Pt	78	12000#	200#	1510	30	*	*	13150#	150#	5637	6	15840	80
	Au	79	9900#	360#	-1474	15	*	*	18140#	290#	7790#	460#	19110#	200#
171	Tb	65	5230#	1060#	*	*	15720#	800#	11110#	1130#	9470#	1060#	*	*
	Dy	66	4520#	360#	11060#	760#	9200#	300#	10690#	670#	7250#	590#	3630#	760#
	Ho	67	6350	600	8150#	630#	3310	600	11790	670	8900	620	3620#	780#
	Er	68	5681.6	0.4	8770	50	-2294	29	11789	20	7210	30	6490	140
	Tm	69	7486.3	1.3	6390.0	1.2	-7495	28	12423.9	1.6	8645.2	1.6	6500	30
	Yb	70	6614.5	0.6	6800.5	0.9	-12226	28	12678.6	0.9	6869.6	1.7	9331.0	1.3
	Lu	71	8595	17	4353.6	1.9	-16583	28	13248	4	8605	4	9130.5	2.5
	Hf	72	7250	40	5410	30	-21140	30	13357	29	6500	60	11790	29
	Ta	73	9650	40	2760	40	-25290	50	13710	40	8500	40	10990	50
	W	74	7860	30	4240	40	-29620	90	13920	40	6170	40	13920	40
	Re	75	10400	40	1250	30	-33690	40	14380	30	8500	30	12790	40
	Os	76	8437	22	2660	30	-37800#	300#	14800	30	6370	40	16243	25
	Ir	77	11180#	110#	-210	40	*	*	15000	50	8420	40	15010	50
	Pt	78	9240	90	1440#	140#	*	*	15320	90	6140#	180#	18170	90
	Au	79	12020#	210#	-1452	18	*	*	15520#	200#	8340	210	16820#	150#
	Hg	80	*	*	170#	360#	*	*	16000#	420#	*	*	20190#	360#
172	Dy	66	5690#	500#	11520#	900#	11530#	400#	9320#	810#	7230#	720#	1820#	900#
	Ho	67	4950#	720#	8570#	500#	5340#	400#	12970#	450#	9070#	500#	4340#	720#
	Er	68	6836	4	9250	600	-86	25	10470	50	7178	20	4760	300
	Tm	69	6236	5	6944	5	-6050	29	13445	5	8413	6	7070	21
	Yb	70	8019.46	0.14	7333.7	1.0	-10163	28	11251.1	0.9	6883.7	0.9	7314.8	1.3
	Lu	71	6979.1	2.7	4718.2	2.4	-15220	50	14738.4	2.4	8493	4	10185.0	2.5
	Hf	72	9040	40	5859	25	-19165	28	11617	30	6538	25	9613	25
	Ta	73	7680	40	3190	40	-23810#	110#	15630	40	8250	40	12394	28
	W	74	10080	40	4670	40	-28000	30	11750	40	6060	40	11270	40
	Re	75	8340	60	1730	60	-32240#	170#	16480	60	8260	60	14410	60
	Os	76	11016	24	3280	30	-36150	210	12391	30	6010	30	13326	21
	Ir	77	9160#	110#	520#	110#	*	*	17120#	110#	8070#	110#	16510#	110#
	Pt	78	11700	90	1960	40	*	*	12930#	100#	5844	23	15267	28
	Au	79	9790#	160#	-900#	180#	*	*	17730#	160#	7960#	260#	18450#	160#
	Hg	80	12660#	360#	810	210	*	*	13240#	290#	5570#	360#	16930#	290#
173	Dy	66	4120#	640#	*	*	13780#	500#	10430#	950#	7430#	860#	*	*
	Ho	67	5770#	570#	8660#	570#	7790#	400#	11730#	500#	9430#	450#	2890#	810#
	Er	68	5240#	200#	9540#	450#	1760#	200#	11580#	630#	7460#	200#	5660#	280#
	Tm	69	6950	7	7058	6	-3862	28	12177	5	8720	5	5630	50
	Yb	70	6367.3	0.3	7465	6	-8829	28	12370.1	1.0	7108.4	0.9	8204.7	1.6
	Lu	71	8215.8	2.2	4914.5	1.6	-13332	28	13137.2	1.6	8747.2	1.7	8561.2	1.8
	Hf	72	7080	40	5959	28	-17970	30	13133	28	6760	30	11004	28
	Ta	73	9140	40	3280	40	-22120	30	13750	40	8720	40	10560	30
	W	74	7700	40	4690	40	-26790	60	13700	40	6270	40	13170	40
	Re	75	10100	60	1750	40	-30730	40	14240	40	8600	30	12230	40
	Os	76	8271	21	3200	60	-34870#	210#	14520	30	6344	30	15502	21
	Ir	77	10820#	110#	323	19	*	*	14732	23	8520	18	14292	29
	Pt	78	8910	60	1710#	120#	*	*	15200	70	6240#	120#	17630	60
	Au	79	11610#	160#	-992	23	*	*	15360	90	8350	30	16150#	110#
	Hg	80	9550#	300#	580#	260#	*	*	15710#	210#	5910	50	19380#	210#

A	Elt.	Z	S(2n)	S(2p)	Q( $\alpha$ )	Q( $2\beta^-$ )	Q(ep)	Q( $\beta^-n$ )						
170	Tb	65	9990#	860#	*	-2160#	1060#	9900#	700#	*	1190#	760#		
	Dy	66	11240#	240#	20140#	730#	-1690#	630#	6450#	200#	-17050#	830#	-2930#	200#
	Ho	67	12320	60	18320#	510#	-910	110	3560	50	-13440#	600#	-3390	50
	Er	68	13260.5	1.5	16130	140	50.6	1.9	654.4	1.6	-11800	300	-6906.0	1.8
	Tm	69	14625.6	1.5	14310	30	851.4	1.3	-2490	17	-8286	20	-7502	4
	Yb	70	15337	4	12350.2	1.2	1737.7	1.2	-4515	28	-7129.2	1.2	-10763	5
	Lu	71	16390	50	10570	17	2159	20	-7170	30	-3319	17	-10660	30
	Hf	72	17040	40	9257	28	2910	29	-8960	30	-3173	28	-14030	40
	Ta	73	17890	40	7650	50	3460	40	-11220	40	651	28	-13290	30
	W	74	18546	22	6510	30	4140	30	-13366	19	130	30	-16980	30
	Re	75	19270	40	5100	40	4760	40	-15600#	110#	4080	40	-16270	40
	Os	76	20080	16	3616	20	5539	3	-17622	21	3701	19	-19918	29
	Ir	77	20720#	180#	2100#	110#	6110#	50#	-19710#	230#	7780#	110#	-19020#	230#
	Pt	78	21410	210	893	22	6708	4	*	*	7130	30	-22590#	300#
	Au	79	*	*	-550#	250#	7168	21	*	*	11180#	210#	*	*
171	Tb	65	9550#	1000#	*	-2340#	1130#	11020#	1000#	*	*	2090#	830#	
	Dy	66	10650#	420#	20790#	860#	-1840#	670#	7610#	300#	*	*	-1940#	300#
	Ho	67	11860	600	19010#	850#	-1110#	720#	4690	600	-15470#	920#	-2480	600
	Er	68	12938.8	1.5	16700	300	-210	60	1587.3	1.5	-11350#	200#	-5995.6	1.8
	Tm	69	14078.3	1.3	14990	20	646	5	-1382.1	2.1	-10260	50	-6518.0	1.1
	Yb	70	15084	4	12961.4	1.3	1559.7	1.3	-3881	29	-6486.5	1.5	-10073	17
	Lu	71	15899	5	11131.5	2.0	2289.9	2.3	-6113	28	-5321.9	2.0	-9651	28
	Hf	72	16860	40	9639	29	2738	29	-8350	40	-1951	29	-13360	40
	Ta	73	17570	40	8221	28	3360	40	-10470	40	-1700	30	-12500	30
	W	74	18310	30	6950	40	3960	40	-12790	30	1880	40	-16240	40
	Re	75	19010	40	5540	40	4680	40	-14820	50	1600	40	-15394	30
	Os	76	19710	30	3953	24	5371	4	-16820	90	5711	24	-19050#	100#
	Ir	77	20490	50	2620	50	5980#	30#	-18870	50	5200	50	-18200	40
	Pt	78	21240#	220#	1330	90	6610	50	-20970#	310#	9170	90	-21930#	220#
	Au	79	21920#	300#	60	40	7089	17	*	*	8470#	100#	*	*
	Hg	80	*	*	-1300#	360#	7620#	500#	*	*	12520#	300#	*	*
172	Dy	66	10210#	450#	*	-2050#	810#	8760#	400#	*	*	-1280#	720#	
	Ho	67	11300#	400#	19640#	810#	-1330#	640#	5980#	400#	-15190#	900#	-1750#	400#
	Er	68	12517	4	17400#	200#	-350	140	2771	4	-13660#	300#	-5345	4
	Tm	69	13722	6	15710	50	260	30	-639	6	-10140	600	-6139	6
	Yb	70	14634.0	0.6	13723.6	1.5	1311.5	1.3	-2857	25	-8824.4	1.6	-9498.1	1.9
	Lu	71	15574	17	11518.7	2.5	2151.4	2.9	-5411	28	-4814.7	2.6	-9381	29
	Hf	72	16290	40	10213	25	2746	25	-7310	40	-4380	25	-12750	40
	Ta	73	17330	40	8600	30	3310	50	-9810	60	-785	28	-12320	40
	W	74	17950	30	7420	40	3840	40	-11860	30	-950	40	-15920	40
	Re	75	18750	60	5960	60	4450	60	-14000#	120#	2910	60	-15300	60
	Os	76	19453	18	4523	21	5227	7	-16137	19	2560	30	-18880	40
	Ir	77	20340#	150#	3180#	110#	5850#	100#	-18240#	190#	6440#	110#	-18120#	140#
	Pt	78	20938	23	1751	17	6465	4	-20010	210	5903	23	-21608	29
	Au	79	21810#	260#	540#	190#	7030	50	*	*	9860#	160#	-20860#	340#
	Hg	80	*	*	-640	210	7525	12	*	*	9090	230	*	*
173	Dy	66	9810#	590#	*	-2300#	950#	9870#	540#	*	*	-450#	640#	
	Ho	67	10720#	720#	20180#	900#	-1430#	720#	7160#	400#	*	*	-680#	400#
	Er	68	12070#	200#	18120#	360#	-480#	360#	3900#	200#	-13210#	450#	-4350#	200#
	Tm	69	13186	5	16310	600	119	21	627	5	-12150#	400#	-5070	5
	Yb	70	14386.8	0.4	14409.4	1.6	947.5	1.3	-2144	28	-8356	4	-8886.3	2.4
	Lu	71	15194.9	2.0	12248.1	1.9	1969.3	1.8	-4489	28	-6795	6	-8554	25
	Hf	72	16120	40	10678	28	2534	28	-6680	40	-3440	28	-12150	40
	Ta	73	16820	40	9141	28	3256	28	-8840	40	-2944	28	-11370	40
	W	74	17780	40	7870	40	3560	40	-11290	30	390	40	-15280	60
	Re	75	18450	40	6410	40	4310	40	-13280	30	490	40	-14390	30
	Os	76	19288	24	4930	30	5055	6	-15500	60	4370	30	-17990#	110#
	Ir	77	19980	40	3600	30	5689	27	-17452	29	3960	60	-17242	19
	Pt	78	20610	100	2230	60	6350	50	-19370#	220#	8010	60	-20730#	170#
	Au	79	21400	40	970	50	6836	5	*	*	7410#	110#	-19800	210
	Hg	80	22210#	360#	-320#	230#	7380	50	*	*	11240#	210#	*	*

A	Elt.	Z	S(n)	S(p)	$Q(4\beta^-)$	$Q(d,\alpha)$	$Q(p,\alpha)$	$Q(n,\alpha)$						
174	Ho	67	4480#	640#	9010#	710#	10070#	500#	12940#	640#	9480#	590#	3640#	950#
	Er	68	6370#	360#	10140#	500#	3900#	300#	10160#	500#	7440#	670#	3810#	420#
	Tm	69	5680	40	7510#	200#	-2130	50	13330	40	8720	40	6300	600
	Yb	70	7464.63	0.06	7980	5	-6723	28	11141	6	7130.1	1.0	6421.7	1.6
	Lu	71	6760.8	1.5	5308.0	1.6	-11902	28	14395.8	1.6	8600.9	1.6	9286.7	1.9
	Hf	72	8506	28	6249.8	2.2	-15850	11	11605.5	2.8	6851.0	2.6	9111.9	2.3
	Ta	73	7420	40	3620	40	-20870	40	15370	40	8550	40	11739	28
	W	74	9570	40	5120	40	-24910	30	11810	40	6360	40	10850	40
	Re	75	8190	40	2230	40	-29480#	110#	16130	40	8280	40	13690	40
	Os	76	10629	19	3730	30	-33349	23	12240	60	6120	30	12740	30
	Ir	77	8670	30	720	30	*	*	17080	30	8290	30	16030	40
	Pt	78	11450	60	2336	18	*	*	12910#	110#	5980	40	14620	22
	Au	79	9450#	110#	-460#	120#	*	*	17620#	100#	8140#	140#	17880#	110#
	Hg	80	12150#	210#	1120	30	*	*	13350#	160#	5781	19	16470	90
175	Ho	67	5370#	780#	*	*	12370#	600#	11690#	780#	9790#	720#	*	*
	Er	68	4770#	500#	10440#	640#	5830#	400#	11160#	570#	7610#	570#	4720#	570#
	Tm	69	6520	70	7660#	300#	90	60	12050#	200#	9040	50	4730#	400#
	Yb	70	5822.35	0.07	8120	40	-5068	28	12269	5	7543	6	7435	4
	Lu	71	7666.7	1.0	5510.1	1.3	-9882	28	13096.4	1.3	8953.6	1.3	7856	6
	Hf	72	6708.5	0.4	6197.5	2.2	-14379	14	13112.7	2.2	7121.5	2.8	10422.8	2.3
	Ta	73	8740	40	3851	28	-18980	30	13710	40	8860	40	9979	28
	W	74	7480	40	5180	40	-23940	30	13470	40	6560	40	12420	40
	Re	75	9690	40	2350	40	-27850	50	14150	40	8670	40	11690	40
	Os	76	8180	17	3720	30	-32120	100	14160	30	6280	60	14640	30
	Ir	77	10630	30	721	23	*	*	14720	25	8673	25	13740	60
	Pt	78	8442	22	2110	30	*	*	15293	23	6690#	110#	17194	24
	Au	79	11320#	110#	-590	40	*	*	15210	70	8520	40	15720#	110#
	Hg	80	9410	100	1080#	140#	*	*	15540	100	6160#	190#	18760	100
176	Er	68	5920#	570#	10990#	720#	8080#	400#	9710#	640#	7460#	570#	2930#	640#
	Tm	69	5130	110	8010#	410#	1990	100	13290#	310#	9140#	220#	5370#	410#
	Yb	70	6864.8	1.0	8470	50	-2853	28	11090	40	7629	4	5810#	200#
	Lu	71	6287.98	0.15	5975.7	1.3	-8324	28	14273.0	1.3	9033.0	1.3	8518	5
	Hf	72	8165.0	1.8	6695.8	0.8	-12480	28	11708.6	1.3	7172.3	1.3	8625.2	1.5
	Ta	73	7030	40	4170	30	-17500	40	15190	30	8910	40	11170	30
	W	74	9080	40	5520	40	-21710	30	11810	40	6620	40	10420	40
	Re	75	7850	40	2720	40	-26530#	110#	15880	40	8530	40	12980	40
	Os	76	10060	30	4100	40	-30320	30	12290	40	6320	40	12280	40
	Ir	77	8504	28	1045	24	-34410#	200#	16846	23	8441	25	15340	30
	Pt	78	11309	24	2788	24	*	*	12650	30	6208	19	14157	21
	Au	79	9170#	110#	140#	110#	*	*	17490#	110#	8270#	120#	17380#	110#
	Hg	80	11860	100	1630	40	*	*	13130#	100#	5905	22	15810	60
	Tl	81	*	*	-1250#	220#	*	*	17910#	200#	7980#	290#	19020#	200#
177	Er	68	4370#	640#	*	*	10090#	500#	10710#	780#	7570#	710#	*	*
	Tm	69	6170#	310#	8260#	500#	4260#	300#	11890#	500#	9350#	420#	3680#	590#
	Yb	70	5566.40	0.22	8900	100	-1287	28	12040	50	7740	40	6610#	300#
	Lu	71	7072.99	0.16	6183.9	1.6	-6120	28	13022.4	1.3	9424.6	1.3	7130	40
	Hf	72	6383.4	0.7	6791.2	0.7	-10940	16	12991.9	0.7	7549.7	1.2	9706.4	1.4
	Ta	73	8430	30	4435	3	-15676	20	13471	4	8987	4	9498	3
	W	74	7130	40	5630	40	-20330	30	13420	40	6900	40	11791	28
	Re	75	9280	40	2920	40	-24720	30	14070	40	8820	40	11120	40
	Os	76	7920	30	4180	30	-29170	80	14050	30	6590	30	13920	30
	Ir	77	10258	28	1240	30	-32720	30	14768	24	8813	23	13270	30
	Pt	78	8514	21	2798	25	*	*	14769	25	6360	30	16272	19
	Au	79	11080#	110#	-89	19	*	*	14851	23	8633	17	14960	30
	Hg	80	9070	80	1530#	130#	*	*	15370	90	6280#	130#	18180	80
	Tl	81	11950#	200#	-1162	21	*	*	15370	100	8180	30	16510#	110#



A	Elt.	Z	S(2n)	S(2p)	Q( $\alpha$ )	Q( $2\beta^-$ )	Q( $\epsilon p$ )	Q( $\beta^- n$ )						
174	Ho	67	10250#	640#	*	-1590#	860#	8370#	510#	*	80#	540#		
	Er	68	11600#	300#	18800#	500#	-710#	360#	5000#	300#	-15460#	590#	-3760#	300#
	Tm	69	12630	50	17050#	400#	-50	70	1710	40	-12060#	400#	-4380	40
	Yb	70	13832.0	0.3	15038	4	740.1	1.6	-1103.0	2.3	-10590#	200#	-8135.1	1.7
	Lu	71	14976.6	2.3	12773	6	1800.4	1.8	-3835	28	-6605	5	-8235	28
	Hf	72	15586	25	11164.3	2.3	2497.4	2.4	-5620	28	-5579.3	2.3	-11521	28
	Ta	73	16550	40	9577	28	3140	30	-8070	40	-2144	28	-11080	40
	W	74	17270	40	8400	40	3600	40	-10230	30	-2100	40	-14740	40
	Re	75	18290	60	6920	40	4040	40	-12800	40	1430	40	-14310	30
	Os	76	18901	18	5480	30	4872	10	-14677	16	1440	30	-17796	18
	Ir	77	19490#	110#	3920	60	5624	10	-16670#	110#	5400	40	-17000	60
	Pt	78	20361	17	2659	19	6184	5	-18672	23	4830	19	-20571	29
	Au	79	21060#	190#	1250#	150#	6699	7	*		8790#	100#	-19700#	230#
	Hg	80	21700	210	124	23	7233	6	*		8010	60	*	
175	Ho	67	9850#	720#	*	-1730#	1000#	9510#	600#	*		1080#	670#	
	Er	68	11140#	450#	19450#	640#	-960#	500#	6050#	400#	*		-2850#	400#
	Tm	69	12200	50	17800#	400#	-220	600	2860	50	-14100#	510#	-3440	50
	Yb	70	13286.99	0.09	15630#	200#	599.3	1.6	-216.8	2.3	-10040#	300#	-7196.7	1.6
	Lu	71	14427.6	1.1	13490	5	1620.0	1.6	-2762	28	-8590	40	-7395.4	1.9
	Hf	72	15215	28	11505.5	2.3	2403.4	2.3	-4851	28	-4823.2	2.3	-10814	28
	Ta	73	16150	40	10101	28	3000	28	-7120	40	-4122	28	-10250	40
	W	74	17050	40	8800	40	3370	40	-9530	30	-1075	28	-14030	40
	Re	75	17880	40	7470	40	4010	40	-11860	30	-840	40	-13360	30
	Os	76	18809	20	5960	30	4560	30	-14415	23	2830	30	-17310	30
	Ir	77	19299	24	4450	30	5400	30	-15990	50	2960	30	-16181	23
	Pt	78	19890	60	2830	24	6178.1	2.6	-17700	100	7017	22	-19570#	100#
	Au	79	20770	50	1750	40	6562	15	*		6140	50	-18870	50
	Hg	80	21560#	230#	630	120	7060	50	*		10040	100	*	
176	Er	68	10690#	500#	*	-1200#	570#	6990#	400#	*		-2260#	400#	
	Tm	69	11650	110	18450#	510#	-400#	410#	4010	100	-13860#	600#	-2740	100
	Yb	70	12687.2	1.0	16120#	300#	570	4	1083.4	1.8	-12130#	400#	-6394.8	1.6
	Lu	71	13954.7	1.0	14100	40	1568	6	-2020	30	-8360	50	-6974.8	1.9
	Hf	72	14873.5	1.7	12205.9	1.5	2257.9	1.5	-3936	28	-7165.8	1.5	-10240	28
	Ta	73	15770	40	10370	30	2950	30	-6300	40	-3480	30	-9800	40
	W	74	16560	40	9373	28	3340	40	-8540	40	-3447	28	-13420	40
	Re	75	17530	40	7900	40	3840	40	-11200	30	60	40	-13030	30
	Os	76	18240	30	6450	40	4570	40	-13170	30	250	40	-16740	30
	Ir	77	19130	30	4770	30	5240	50	-15320#	110#	4140	30	-16242	28
	Pt	78	19751	19	3510	18	5885.2	2.1	-17149	20	3888	20	-19560	40
	Au	79	20480#	150#	2250#	110#	6558	7	-19090#	220#	7600#	110#	-18620#	150#
	Hg	80	21274	24	1038	18	6897	6	*		6622	24	*	
	Tl	81	*		-170#	220#	7410#	250#	*		10700#	200#	*	
177	Er	68	10290#	640#	*	-1450#	710#	8190#	500#	*		-1500#	510#	
	Tm	69	11300#	300#	19250#	670#	-800#	500#	4920#	300#	*		-2050#	300#
	Yb	70	12431.2	1.0	16920#	400#	240#	200#	1900.4	1.7	-11780#	400#	-5673.2	1.6
	Lu	71	13360.97	0.22	14650	50	1445	5	-665	3	-10300	100	-5882.8	0.8
	Hf	72	14548.4	1.9	12766.9	1.4	2241.7	1.5	-3188	28	-6684.5	1.7	-9600	30
	Ta	73	15458	28	11131	3	2737	3	-5454	28	-5625	3	-9153	28
	W	74	16210	40	9796	28	3290	40	-7750	30	-2413	28	-12710	40
	Re	75	17120	40	8440	40	3700	40	-10220	30	-2190	40	-12240	40
	Os	76	17987	21	6890	30	4350	30	-12579	22	1400	30	-16160	26
	Ir	77	18761	28	5340	30	5080	30	-14497	24	1730	30	-15191	24
	Pt	78	19823	24	3844	20	5642.8	2.7	-16590	80	5440	30	-18910#	110#
	Au	79	20250	40	2700	24	6297	5	-18222	28	5022	24	-17842	19
	Hg	80	20930	130	1670	80	6740	50	*		8860	80	-21400#	210#
	Tl	81	*		460	50	7067	7	*		7920#	110#	*	

A	Elt.	Z	S(n)	S(p)	$Q(4\beta^-)$	$Q(d,\alpha)$	$Q(p,\alpha)$	$Q(n,\alpha)$						
178	Tm	69	4720#	500#	8600#	640#	6390#	400#	13100#	570#	9400#	570#	4330#	720#
	Yb	70	6780	10	9520#	300#	718	18	10390	100	7480	50	4600#	400#
	Lu	71	6025.3	1.9	6642.8	2.5	-4690	28	13861.9	2.5	9221.7	2.3	7620	50
	Hf	72	7625.96	0.18	7344.2	0.7	-8898	17	11653.9	0.7	7590.5	0.8	7902.8	1.5
	Ta	73	6855	15	4907	15	-14255	25	14781	15	8841	15	10310	15
	W	74	8790	30	5981	15	-18418	19	11660	30	6860	30	9714	15
	Re	75	7460	40	3240	40	-23330	60	15700	40	8840	40	12400	40
	Os	76	9668	23	4570	30	-27229	21	12230	30	6610	30	11730	30
	Ir	77	8276	28	1591	25	-31500#	120#	16560	30	8717	24	14680	30
	Pt	78	10699	18	3240	23	-35566	27	12574	23	6295	23	13753	17
	Au	79	8850	60	240	60	*	*	17310	60	8230	60	16750	60
	Hg	80	11610	80	2056	18	*	*	12930#	110#	5990	40	15020	23
	Tl	81	9500#	120#	-740#	140#	*	*	17740#	110#	8100#	150#	18340#	120#
	Pb	82	*	*	390	30	*	*	13730#	200#	*	*	17200	100
179	Tm	69	5560#	640#	*	*	8770#	500#	11910#	710#	9760#	640#	*	*
	Yb	70	4790#	300#	9590#	500#	2890#	300#	11760#	420#	7820#	310#	5730#	500#
	Lu	71	6792	5	6655	11	-2478	25	12636	5	9294	5	5960	100
	Hf	72	6098.99	0.08	7417.9	2.0	-7452	18	12627.9	0.7	7779.5	0.7	8668.6	1.7
	Ta	73	7930	15	5211.0	0.4	-12289	11	13234.1	0.5	9075.2	0.8	8667.4	0.9
	W	74	6959	22	6085	22	-17040	18	13131	16	6930	30	10920	16
	Re	75	9000	40	3459	29	-21634	30	13830	40	8920	40	10430	40
	Os	76	7545	24	4660	30	-26100	30	13960	30	6910	30	13270	30
	Ir	77	9897	23	1820	20	-29780	40	14583	19	8885	30	12632	30
	Pt	78	8337	14	3301	22	-34270#	200#	14494	22	6461	22	15481	29
	Au	79	10700	60	243	20	*	*	15129	22	8840	22	14555	26
	Hg	80	8680	30	1880	60	*	*	15340	30	6480#	110#	17650	30
	Tl	81	11620#	120#	-730	50	*	*	15190	90	8340	50	15880#	110#
	Pb	82	9640#	200#	530#	230#	*	*	16040#	200#	6320#	280#	19430#	200#
180	Yb	70	6060#	500#	10090#	640#	5240#	400#	10420#	570#	7930#	500#	4040#	640#
	Lu	71	5690	70	7560#	310#	-850	70	13720	70	9170	70	6430#	310#
	Hf	72	7387.78	0.15	8013	5	-5430	20	11265.4	2.0	7464.7	0.8	6847.2	1.8
	Ta	73	6641.2	2.5	5753.2	2.5	-10959	22	14218.9	2.5	8817.5	2.5	9099.2	2.6
	W	74	8412	15	6567	4	-15209	12	11574	16	6943	5	8892	4
	Re	75	7320	30	3825	26	-20243	30	15287	26	8730	40	11530	22
	Os	76	9410	27	5060	30	-24114	25	12010	30	6770	30	10990	30
	Ir	77	7971	24	2246	28	-28580#	120#	16279	27	8836	27	13940	40
	Pt	78	10243	14	3648	15	-32497	24	12527	23	6476	23	13160	19
	Au	79	8716	27	622	23	*	*	17112	24	8638	26	16097	29
	Hg	80	11390	30	2582	22	*	*	12790	60	6170	18	14772	20
	Tl	81	9170#	120#	-230#	120#	*	*	17630#	120#	8240#	140#	17790#	120#
	Pb	82	12010#	200#	930	50	*	*	13530#	120#	6253	26	16490	80
181	Yb	70	4510#	570#	*	*	7410#	400#	11470#	640#	8130#	570#	*	*
	Lu	71	6130#	310#	7620#	500#	1770#	300#	12390#	420#	9820#	300#	5020#	500#
	Hf	72	5694.80	0.07	8020	70	-3860	30	12363	5	7795.2	2.0	7933	10
	Ta	73	7576.8	1.3	5942.2	2.1	-8970	26	12741.1	2.1	8866.7	2.1	7547.8	2.9
	W	74	6681	6	6607	5	-13879	16	12823	5	7117	16	9837	5
	Re	75	8743	25	4156	13	-18640	24	13503	20	8769	20	9642	20
	Os	76	7270	40	5000	40	-22890	40	13740	40	6960	40	12510	40
	Ir	77	9570	30	2400	30	-26671	27	14260	30	8940	30	11830	40
	Pt	78	8010	18	3686	26	-31230	90	14414	18	6741	25	14818	22
	Au	79	10346	29	724	23	*	*	15103	22	8991	23	14027	28
	Hg	80	8488	21	2354	26	*	*	15002	23	6530	60	16983	19
	Tl	81	11470#	120#	-155	16	*	*	14831	29	8380	16	15170	60
	Pb	82	9280	90	1030#	150#	*	*	15870	100	6470#	150#	18820	90

A	El.	Z	S(2n)	S(2p)	Q( $\alpha$ )	Q( $2\beta^-$ )	Q( $\epsilon p$ )	Q( $\beta^- n$ )						
178	Tm	69	10880#	410#	*	-1040#	640#	6230#	400#	*	-1200#	400#		
	Yb	70	12347	10	17780#	400#	-170#	300#	2746	10	-14190#	500#	-5381	10
	Lu	71	13098.3	1.9	15550	100	1100	40	164	15	-10160#	300#	-5524.7	2.0
	Hf	72	14009.4	0.7	13528.1	1.7	2080.4	1.5	-2028	15	-8744.0	1.8	-8792	3
	Ta	73	15280	30	11698	15	2643	15	-4850	30	-5407	15	-8880	30
	W	74	15920	30	10416	15	3006	15	-6870	22	-4815	15	-12220	30
	Re	75	16730	40	8870	40	3660	40	-9400	30	-1219	28	-11780	30
	Os	76	17590	30	7480	30	4260	30	-11548	20	-1130	30	-15570	26
	Ir	77	18533	28	5770	30	5000	30	-13930	60	2730	30	-14953	25
	Pt	78	19213	18	4478	30	5573.4	2.6	-15681	17	2663	19	-18519	17
	Au	79	19930#	120#	3040	60	6120	50	-17570#	130#	6430	60	-17620	90
	Hg	80	20680	19	1967	19	6577	5	-19885	27	5765	20	-21060	28
	Tl	81	21450#	230#	790#	160#	7020	50	*	*	9510#	110#	*	*
	Pb	82	*		-769	28	7790	14	*	*	9060	80	*	*
179	Tm	69	10270#	590#	*	-1220#	780#	7460#	500#	*	*	30#	500#	
	Yb	70	11570#	300#	18190#	590#	-190#	500#	4060#	300#	*	*	-4150#	300#
	Lu	71	12818	5	16170#	300#	830	50	1302	5	-12240#	400#	-4691	5
	Hf	72	13724.95	0.19	14060.7	1.8	1803.8	1.5	-1168	16	-8063	10	-8036	15
	Ta	73	14785	3	12555.2	0.8	2379.5	0.9	-3780	25	-7312.3	2.1	-8022	15
	W	74	15740	30	10992	16	2755	16	-6283	24	-4148	16	-11720	30
	Re	75	16460	40	9441	25	3400	40	-8509	27	-3368	29	-11111	29
	Os	76	17213	24	7900	30	4190	30	-10756	20	107	24	-14840	27
	Ir	77	18173	23	6386	30	4786	30	-13125	20	287	30	-14151	15
	Pt	78	19036	18	4892	18	5416	10	-15342	29	3993	19	-18010	60
	Au	79	19545	21	3483	26	6052	18	-16650	50	4011	26	-16707	21
	Hg	80	20280	80	2130	30	6344	30	-18920#	200#	7787	29	-20240#	120#
	Tl	81	21120	50	1330	50	6718	8	*	*	6740	70	-19940	50
	Pb	82	*		-210#	210#	7570#	220#	*	*	11030#	200#	*	*
180	Yb	70	10850#	400#	*	-330#	570#	5380#	400#	*	*	-3410#	400#	
	Lu	71	12490	70	17150#	410#	260	120	2250	70	-12370#	510#	-4280	70
	Hf	72	13486.77	0.17	14668	10	1280.8	1.7	-144	4	-10660#	300#	-7493.4	0.4
	Ta	73	14572	15	13171	3	2026.2	2.6	-3097	22	-7161	6	-7704	16
	W	74	15371	16	11778	4	2508	4	-5286	21	-6462	4	-11130	25
	Re	75	16330	40	9910	26	3100	40	-7860	30	-2762	22	-10891	28
	Os	76	16955	26	8521	25	3860	30	-9923	23	-2344	26	-14353	23
	Ir	77	17868	29	6900	40	4660	40	-12380	30	1320	30	-13785	24
	Pt	78	18581	15	5468	20	5240	30	-14191	18	1295	21	-17555	20
	Au	79	19410	60	3922	29	5840	18	-16190#	120#	5192	24	-16750	30
	Hg	80	20071	19	2825	18	6258	4	-18306	25	4730	17	-20020	50
	Tl	81	20790#	160#	1660#	130#	6710	50	*	*	8260#	120#	-19480#	230#
	Pb	82	21650	30	200	25	7415	15	*	*	7690	30	*	*
181	Yb	70	10570#	500#	*	-470#	640#	6570#	400#	*	*	-2230#	410#	
	Lu	71	11820#	300#	17720#	590#	300#	420#	3700#	300#	*	*	-3020#	300#
	Hf	72	13082.58	0.17	15570#	300#	1152.4	1.8	842	5	-10300#	400#	-6547.0	2.5
	Ta	73	14218.0	2.1	13955	5	1522.5	2.2	-1930	13	-9050	70	-6868	4
	W	74	15093	16	12360	5	2211	5	-4700	30	-5755	5	-10486	22
	Re	75	16068	27	10723	13	2787	13	-7040	29	-4864	13	-10224	24
	Os	76	16680	40	8830	40	3720	40	-9180	30	-1200	30	-13650	40
	Ir	77	17537	28	7460	40	4370	40	-11600	30	-920	30	-13107	28
	Pt	78	18254	17	5932	23	5150	5	-13713	21	2695	25	-16850	26
	Au	79	19062	26	4372	23	5751.3	2.9	-15070	22	2817	29	-15698	24
	Hg	80	19880	30	2975	18	6284	4	-17520	90	6486	19	-19330#	120#
	Tl	81	20640	40	2427	19	6324	9	*	*	5506	23	-18933	23
	Pb	82	21290#	220#	800	90	7210	50	*	*	9810	90	*	*

A	El.	Z	S(n)	S(p)	Q( $4\beta^-$ )	Q(d, $\alpha$ )	Q(p, $\alpha$ )	Q(n, $\alpha$ )						
182	Lu	71	5210#	360#	8320#	450#	3570#	220#	13240#	450#	9400#	360#	5370#	540#
	Hf	72	6718	6	8610#	300#	-1449	23	11340	70	7870	8	6000#	300#
	Ta	73	6062.94	0.11	6310.3	2.1	-7382	21	14066.0	2.1	8902.7	2.1	8277	5
	W	74	8065	5	7094.9	1.7	-12078	16	11399.5	2.1	6982.9	2.2	7870.8	2.2
	Re	75	7010	100	4480	100	-17150	100	14910	100	8720	100	10570	100
	Os	76	9130	40	5387	25	-21033	24	11940	30	6840	30	10341	27
	Ir	77	7650	30	2790	40	-25700	80	16018	29	8832	28	13180	30
	Pt	78	9866	22	3990	30	-29343	21	12519	27	6772	19	12497	24
	Au	79	8501	28	1215	25	*	*	16846	23	8827	22	15423	23
	Hg	80	10986	18	2994	22	*	*	12731	23	6240	19	14334	13
	Tl	81	8620	80	-20	80	*	*	17600	80	8430	80	17250	80
	Pb	82	11750	90	1314	17	*	*	13290#	120#	6340	50	15740	30
	183	Lu	71	5720#	360#	*	6290#	300#	12030#	500#	9750#	500#	*	*
		Hf	72	5300	30	8700#	200#	380	60	12160#	300#	8260	80	6770#
Ta		73	6934.18	0.20	6527	6	-5099	25	12826.6	2.1	9356.3	2.1	7040	70
W		74	6190.82	0.09	7222.7	1.7	-10595	16	12785.4	1.7	7433.2	2.1	9067.8	2.2
Re		75	8430	100	4852	8	-15624	13	13154	9	8698	9	8772	8
Os		76	7120	50	5500	110	-19860	50	13560	50	7040	50	11630	50
Ir		77	9220	30	2880	30	-23610	27	14070	40	9030	30	11290	30
Pt		78	7674	22	4010	26	-28200	30	14410	30	7069	27	14233	26
Au		79	9957	23	1307	19	*	*	14899	18	9113	15	13437	24
Hg		80	8295	13	2788	22	*	*	14782	22	6661	23	16283	14
Tl		81	11310	80	300	14	*	*	14785	18	8521	17	14656	23
Pb		82	8810	30	1510	80	*	*	15943	30	6700#	120#	18320	30
184		Lu	71	4960#	500#	*	7820#	400#	*	9300#	570#	*	*	*
		Hf	72	6290	50	9270#	300#	2750	40	11090#	200#	8100#	300#	4990#
	Ta	73	5617	26	6840	40	-3230	40	13928	27	9435	26	7550#	300#
	W	74	7411.60	0.26	7700.2	1.7	-8375	18	11436.8	1.7	7598.4	1.7	7351.0	2.2
	Re	75	6487	9	5149	4	-13908	23	14732	4	8891	6	9861	5
	Os	76	8660	50	5734	8	-17907	10	11900	100	7119	13	9644	5
	Ir	77	7480	40	3240	60	-22730	60	15710	40	8810	40	12550	30
	Pt	78	9631	24	4420	30	-26287	23	12430	28	7000	30	11870	40
	Au	79	8203	25	1835	27	-31370#	130#	16561	27	8920	27	14800	30
	Hg	80	10621	13	3451	15	*	*	12662	23	6386	22	13672	18
	Tl	81	8370	50	370	50	*	*	17400	50	8640	50	16630	50
	Pb	82	11550	30	1747	17	*	*	13020	80	6620	16	15262	21
	Bi	83	*	*	-1330#	130#	*	*	18580#	130#	9060#	160#	19490#	130#
	185	Hf	72	4930#	200#	9240#	450#	4450#	200#	11880#	360#	8390#	280#	*
Ta		73	6626	30	7180	40	-1060	30	12600	30	9526	16	6130#	200#
W		74	5753.69	0.30	7837	26	-6710	40	12617.2	1.7	7907.6	1.7	8315	6
Re		75	7667	4	5403.8	0.9	-11955	26	13255.7	0.9	9289.4	0.9	8257.5	1.9
Os		76	6624.53	0.28	5872	4	-16634	16	13712	8	7500	100	11084.6	1.0
Ir		77	8800	40	3368	28	-20580	60	14040	60	9140	40	10760	110
Pt		78	7420	40	4360	50	-25140	40	14220	50	7230	50	13570	50
Au		79	9620	30	1820	30	-29650#	60#	14620	30	9170	30	12830	30
Hg		80	7898	19	3146	27	*	*	14722	19	6989	26	15640	22
Tl		81	10940	70	700	50	*	*	14750	50	8680	50	14190	60
Pb		82	8567	22	1950	50	*	*	15757	19	6670	80	17681	19
Bi		83	11330#	140#	-1540#	50#	*	*	16070#	60#	9480#	60#	16790#	90#

A	Elt.	Z	S(2n)	S(2p)	Q( $\alpha$ )	Q( $2\beta^-$ )	Q( $\epsilon p$ )	Q( $\beta^- n$ )						
182	Lu	71	11340#	210#	*	-190#	450#	4550#	200#	*	-2540#	200#		
	Hf	72	12413	6	16230#	400#	1215	12	2189	6	-12500#	400#	-5688	6
	Ta	73	13639.7	1.3	14330	70	1484.8	2.9	-990	100	-8980#	300#	-6251	5
	W	74	14746	4	13037.1	2.2	1771.8	2.2	-3638	22	-8124.6	2.2	-9807	13
	Re	75	15750	100	11090	100	2630	100	-6400	100	-4290	100	-9970	110
	Os	76	16393	30	9543	22	3382	27	-8440	27	-3644	22	-13210	30
	Ir	77	17220	30	7790	30	4180	30	-10751	29	171	24	-12748	26
	Pt	78	17876	19	6388	26	4952	5	-12593	18	90	40	-16369	25
	Au	79	18847	29	4901	30	5526	4	-14950	80	3880	30	-15711	25
	Hg	80	19474	17	3718	15	5997	5	-16750	17	3510	18	-18846	13
	Tl	81	20090#	140#	2330	80	6550	50	*	*	7230	80	-18280	120
	Pb	82	21030	25	1159	20	7066	6	*	*	6546	21	*	*
183	Lu	71	10930#	420#	*	-350#	590#	5770#	300#	*	-1540#	300#		
	Hf	72	12020	30	17020#	400#	710#	300#	3080	30	*	-4920	30	
	Ta	73	12997.12	0.23	15130#	300#	1343	5	515	8	-10710#	200#	-5119.9	1.7
	W	74	14256	5	13533.1	2.2	1680.0	2.2	-2700	50	-7597	6	-8990	100
	Re	75	15442	15	11947	8	2130	8	-5614	26	-6667	8	-9273	23
	Os	76	16250	60	9990	50	3220	50	-7890	50	-2700	50	-12680	50
	Ir	77	16870	40	8264	28	3960	40	-10010	27	-2040	110	-12099	30
	Pt	78	17540	22	6800	40	4823	9	-11973	18	1548	27	-15543	26
	Au	79	18458	23	5293	28	5465.6	3.0	-13600	14	1576	23	-14682	14
	Hg	80	19281	17	4003	17	6039	4	-16231	29	5081	18	-18520	80
	Tl	81	19929	14	3294	22	5940	17	*	*	4425	22	-17832	17
	Pb	82	20570	90	1490	30	6928	7	*	*	8718	30	*	*
184	Lu	71	10680#	450#	*	*	*	6430#	400#	*	-1200#	400#		
	Hf	72	11590	40	*	*	480#	400#	4210	40	*	-4280	40	
	Ta	73	12551	26	15540#	200#	1420	80	1385	26	-10610#	300#	-4546	26
	W	74	13602.42	0.27	14227	6	1656.2	2.2	-1451.2	1.0	-9710	30	-7968	8
	Re	75	14920	100	12371	5	2285	5	-4616	28	-6219	5	-8640	50
	Os	76	15790	22	10586.6	1.1	2963	4	-6924	18	-5178.1	1.1	-12130	25
	Ir	77	16700	30	8740	110	3800	40	-9290	40	-1089	29	-11910	30
	Pt	78	17306	24	7301	28	4602	9	-10983	21	-960	50	-15217	21
	Au	79	18160	30	5840	30	5234	5	-13430	50	2590	30	-14590	24
	Hg	80	18916	14	4758	19	5662	4	-15304	17	2134	19	-17833	14
	Tl	81	19680	90	3160	50	6290	50	-17930#	140#	6010	50	-17390	60
	Pb	82	20362	20	2047	17	6774	4	*	*	5466	16	*	*
	Bi	83	*	*	180#	150#	8020	50	*	*	10350#	130#	*	*
185	Hf	72	11220#	200#	*	60#	450#	5030#	200#	*	-3590#	200#		
	Ta	73	12243	14	16450#	300#	920#	300#	2426	14	-12270#	400#	-3760	14
	W	74	13165.3	0.4	14680	30	1597.3	2.2	-580.3	1.0	-9180	40	-7234	4
	Re	75	14154	8	13104.0	1.9	2194.6	1.9	-3487	28	-8270	26	-7637.3	0.5
	Os	76	15290	50	11020.3	1.0	3020	5	-6130	40	-4391.0	1.0	-11270	28
	Ir	77	16280	40	9102	29	3750	30	-8470	40	-3398	28	-11070	30
	Pt	78	17050	40	7600	60	4440	50	-10510	40	280	40	-14440	50
	Au	79	17823	28	6250	40	5180	5	-12110	60	450	40	-13589	28
	Hg	80	18519	18	4981	22	5774	5	-14635	22	3867	24	-17360	50
	Tl	81	19310	50	4150	50	5690	50	-17540#	80#	3270	60	-16780	60
	Pb	82	20120	30	2319	18	6695	5	*	*	7519	19	-20660#	130#
	Bi	83	*	*	200#	50#	8160#	50#	*	*	7380#	70#	*	*

A	Elt.	Z	S(n)	S(p)	$Q(4\beta^-)$	$Q(d,\alpha)$	$Q(p,\alpha)$	$Q(n,\alpha)$						
186	Hf	72	6140#	360#	*	6570#	300#	10690#	500#	7960#	420#	*		
	Ta	73	5280	60	7540#	210#	560	60	13600	70	9540	70	6560#	300#
	W	74	7191.2	1.6	8402	14	-4645	22	11043	26	7650.6	2.3	6420	30
	Re	75	6179.36	0.18	5829.5	0.9	-10215	21	14487.9	0.9	9300.9	0.9	9012.3	1.9
	Os	76	8261.4	1.0	6466.3	0.9	-14460	11	11938	4	7676	8	9013.9	1.2
	Ir	77	6910	30	3653	17	-18980	190	15794	17	9350	50	12284	18
	Pt	78	9250	50	4820	40	-23183	25	12460	40	7200	30	11440	50
	Au	79	7920	30	2320	50	-28550	80	16328	28	8922	26	14130	30
	Hg	80	10435	19	3961	28	*	*	12490	25	6512	15	12880	19
	Tl	81	8510	190	1300	190	*	*	16870	180	8470	180	15640	180
	Pb	82	11211	20	2210	60	*	*	12910	50	6770	15	14765	14
	Bi	83	9030#	90#	-1080	80	*	*	18590	80	9260	80	19060	80
	187	Hf	72	4630#	500#	*	8230#	400#	*	*	8290#	570#	*	
Ta		73	6230#	210#	7620#	360#	2950#	200#	12300#	280#	9600#	200#	5290#	450#
W		74	5466.54	0.11	8590	60	-3192	28	12202	14	7801	26	7240	40
Re		75	7356.8	1.0	5995.1	1.3	-8211	25	12884.8	1.2	9355.6	1.2	7272	26
Os		76	6290.0	0.6	6577.0	1.0	-13100	14	13314.8	1.0	7873	4	10135.5	1.2
Ir		77	8614	18	4005	6	-17272	10	13804	6	9404	6	10157	7
Pt		78	6920	40	4830	30	-21733	29	14330	40	7760	40	13190	28
Au		79	9360	30	2430	30	-26632	29	14390	50	9190	30	12250	40
Hg		80	7650	18	3692	25	*	*	14460	30	7065	26	14861	23
Tl		81	10320	180	1193	14	*	*	14443	18	8770	13	13522	24
Pb		82	8370	14	2080	180	*	*	15490	50	6770	50	17016	13
Bi		83	11280	80	-1019	19	*	*	15879	22	9536	21	16160	50
188		Hf	72	5970#	640#	*	10260#	500#	*	*	*	*	*	
	Ta	73	5120#	280#	8120#	450#	4520#	200#	13330#	360#	9410#	280#	*	
	W	74	6834	3	9190#	200#	-844	6	10650	60	7593	15	5340#	200#
	Re	75	5871.75	0.12	6400.4	1.3	-6715	20	14204.2	1.3	9237.6	1.2	8026	14
	Os	76	7989.56	0.15	7209.68	0.15	-10935	12	11504.6	1.0	7549.8	1.0	7899.7	1.2
	Ir	77	6684	9	4399	7	-15980	30	15382	7	9345	7	11140	7
	Pt	78	9181	28	5396	8	-20008	12	12061	17	7377	28	10633	5
	Au	79	7370	30	2880	30	-25100	50	16274	30	9250	50	13680	30
	Hg	80	10155	18	4486	28	-29663	23	12224	24	6529	28	12130	40
	Tl	81	7970	30	1520	40	*	*	16900	30	8690	40	15170	40
	Pb	82	10907	13	2661	13	*	*	13090	180	6800	50	14007	19
	Bi	83	8900	50	-490	50	*	*	18190	50	9200	50	18200	70
	Po	84	*	*	1454	25	*	*	13340	80	6540#	50#	16649	25
189	Ta	73	6090#	360#	8240#	590#	6620#	300#	11870#	500#	9470#	420#	*	
	W	74	4880	200	8950#	280#	1010	200	12000#	280#	7990	210	6600#	360#
	Re	75	7033	8	6600	9	-4396	22	12638	8	9396	8	6280	60
	Os	76	5920.3	0.5	7258.2	0.5	-9350	30	12941.1	0.5	7808.9	1.1	9170.6	1.4
	Ir	77	8196	14	4606	13	-13851	17	13476	13	9410	13	9124	13
	Pt	78	6732	12	5444	13	-18610	40	13943	13	7554	20	12163	11
	Au	79	9352	29	3048	21	-23520	60	13840	30	9147	30	11237	26
	Hg	80	7500	40	4620	40	-28220	40	14090	40	6950	40	13880	40
	Tl	81	10330	30	1689	16	*	*	14226	18	8801	16	12759	24
	Pb	82	8130	40	2820	50	*	*	15280	40	7180	190	16310	40
	Bi	83	10930	70	-470	50	*	*	15630	50	9480	60	15780	190
	Po	84	8948	29	1500	50	*	*	15669	27	6620	80	18912	25

A	Elt.	Z	S(2n)	S(2p)	Q( $\alpha$ )	Q(2 $\beta^-$ )	Q( $\epsilon p$ )	Q( $\beta^- n$ )						
186	Hf	72	11070#	300#	*	*	6080#	300#	*	-3110#	300#			
	Ta	73	11910	70	16770#	410#	850#	210#	3320	60	*	-3290	60	
	W	74	12944.9	1.6	15590	40	1124	7	489.9	1.4	-11440#	200#	-6758.7	1.5
	Re	75	13846	4	13667	26	2078.1	1.9	-2757	17	-7823	14	-7192.2	0.5
	Os	76	14886.0	1.0	11870.1	1.2	2823.1	1.2	-5135	22	-6898.8	1.2	-10735	28
	Ir	77	15700	30	9524	17	3850	100	-7458	27	-2640	17	-10560	40
	Pt	78	16675	28	8186	22	4320	18	-9325	24	-2344	22	-14070	30
	Au	79	17540	30	6680	30	4912	14	-11520	190	1330	30	-13610	26
	Hg	80	18333	15	5785	21	5205	11	-13858	16	850	40	-16850	60
	Tl	81	19450	190	4450	190	5690	190	-17020	200	4390	190	-16720	190
	Pb	82	19779	18	2910	15	6470	6	*	*	4206	19	-20540#	50#
	Bi	83	20360#	150#	860	90	7757	12	*	*	9300	90	*	*
	187	Hf	72	10770#	450#	*	*	6920#	400#	*	*	-2450#	410#	
Ta		73	11510#	200#	*	330#	360#	4450#	200#	*	-2330#	200#		
W		74	12657.7	1.6	16120#	200#	960	30	1313.4	1.3	-10760#	300#	-6045.9	1.5
Re		75	13536.2	1.0	14397	14	1655.5	2.1	-1500	6	-9900	60	-6287.6	0.6
Os		76	14551.5	1.1	12406.4	1.2	2723.9	1.2	-4505	28	-5997.6	1.3	-10117	17
Ir		77	15523	29	10472	6	3670	10	-6711	26	-5075	6	-9923	23
Pt		78	16170	50	8482	28	4520	60	-8600	30	-1002	28	-13070	30
Au		79	17280	40	7250	40	4770	30	-10562	26	-1120	30	-12537	28
Hg		80	18085	21	6010	40	5230	14	-13138	16	2458	26	-16000	180
Tl		81	18830	50	5154	27	5318	8	-16070	17	1982	22	-15834	14
Pb		82	19581	18	3382	18	6395	6	*	*	6270	14	-19880	80
Bi		83	20300#	60#	1200	60	7789	14	*	*	6530	190	*	*
188		Hf	72	10590#	590#	*	*	7790#	500#	*	*	-2180#	540#	
	Ta	73	11350#	210#	*	170#	450#	5200#	200#	*	-1980#	200#		
	W	74	12300	3	16810#	300#	410	40	2469	3	-12970#	400#	-5523	3
	Re	75	13228.6	1.0	14990	60	1400	26	-688	7	-9540#	200#	-5869.28	0.12
	Os	76	14279.6	0.6	13204.8	1.3	2146.0	1.2	-3313	5	-8520.6	1.3	-9492	6
	Ir	77	15298	18	10976	7	3474	8	-6027	22	-4401	7	-9686	29
	Pt	78	16101	22	9401	5	4008	5	-7621	13	-3894	5	-12889	26
	Au	79	16729	29	7706	26	4890	30	-9950	40	126	21	-12254	25
	Hg	80	17805	16	6915	25	4705	17	-12386	16	-780	30	-15830	14
	Tl	81	18300	190	5210	40	5550	40	-15140	60	3370	40	-15440	30
	Pb	82	19277	15	3854	15	6109	3	-17277	22	3013	17	-19513	19
	Bi	83	20180	90	1590	190	7255	7	*	*	7950	50	*	*
	Po	84	*	*	435	22	8082	13	*	*	7153	21	*	*
189	Ta	73	11210#	360#	*	*	6150#	300#	*	*	-1230#	300#		
	W	74	11720	200	17070#	450#	460#	280#	3510	200	-11890#	540#	-4530	200
	Re	75	12905	8	15790#	200#	993	16	475	15	-11450#	200#	-4913	8
	Os	76	13909.8	0.5	13658.6	1.4	1979.4	1.3	-2502	11	-7607	3	-8729	7
	Ir	77	14880	14	11815	13	2944	13	-4871	24	-6726	13	-8701	14
	Pt	78	15910	30	9843	11	3901	11	-6850	40	-2636	11	-12254	23
	Au	79	16720	30	8444	21	4330	30	-8980	23	-2543	21	-11451	23
	Hg	80	17660	40	7500	40	4630	50	-11750	50	900	30	-15360	50
	Tl	81	18301	14	6175	27	4840	28	-14540	60	410	23	-14858	15
	Pb	82	19040	40	4340	40	5870	40	-16460	40	5030	40	-18740	60
	Bi	83	19830	60	2200	50	7269.8	2.8	*	*	5000	60	-17590	60
	Po	84	*	*	1013	24	7701	15	*	*	9111	24	*	*

A	Elt.	Z	S(n)	S(p)	$Q(4\beta^-)$	$Q(d,\alpha)$	$Q(p,\alpha)$	$Q(n,\alpha)$							
190	Ta	73	4900#	500#	*	8090#	400#	12930#	640#	9190#	570#	*			
	W	74	6890	260	9760#	340#	3030	160	10230#	260#	7330#	260#	4330#	430#	
	Re	75	5660	150	7380	250	-2680	150	13810	150	9200	150	6850#	250#	
	Os	76	7792.26	0.19	8017	8	-7336	16	11020.6	0.6	7373.4	0.5	6844.8	1.4	
	Ir	77	6369	13	5054.8	1.2	-12420	50	15096.0	1.3	9331.0	1.3	10110.9	1.3	
	Pt	78	8912	10	6159	13	-16906	13	11715	8	7256	8	9541	6	
	Au	79	7371	26	3687	18	-21980	190	15652	16	8700	30	12481	17	
	Hg	80	9810	40	5077	26	-26807	21	11641	26	6499	30	10990	30	
	Tl	81	7800	50	1990	60	*	*	16580	50	8650	50	14320	60	
	Pb	82	10610	40	3104	16	*	*	12640	30	6891	15	13347	18	
	Bi	83	8910	190	310	190	*	*	17620	180	8940	180	17190	180	
	Po	84	11219	26	1790	60	*	*	13350	50	6674	20	16063	16	
	191	W	74	4890#	260#	9740#	450#	4590#	200#	11430#	360#	7570#	280#	5410#	540#
Re		75	6850	150	7340	170	-540	40	11840	200	9183	11	5110#	200#	
Os		76	5758.72	0.11	8120	150	-5801	23	12295	8	7486.5	0.6	7920	3	
Ir		77	8026.5	0.4	5289.1	1.1	-10425	8	12989.8	1.1	9294.1	1.2	7956.1	1.2	
Pt		78	6446	6	6236	4	-15450	40	13466	13	7494	8	11085	4	
Au		79	9000	40	3770	40	-20570	40	13380	40	8880	40	10170	40	
Hg		80	7294	28	5001	28	-25539	25	13700	30	6570	30	12876	23	
Tl		81	10020	50	2200	18	*	*	14060	30	8785	14	11666	22	
Pb		82	7900	40	3200	60	*	*	15070	40	6960	50	15600	40	
Bi		83	10410	180	112	14	*	*	15350	40	9439	13	14750	30	
Po		84	8562	17	1440	180	*	*	15720	60	7020	50	18408	15	
192		W	74	6610#	630#	*	6640#	600#	9720#	720#	7040#	670#	*		
		Re	75	5430#	200#	7890#	280#	1070#	200#	13300#	260#	8630#	280#	5770#	360#
	Os	76	7558.1	2.1	8821	10	-3869	16	10400	150	6961	8	5240	200	
	Ir	77	6198.11	0.11	5728.4	1.1	-8960	30	14583.9	1.1	9016.2	1.1	8791	8	
	Pt	78	8666	3	6875.4	1.9	-13737	13	11169.1	1.9	7024	13	8338.9	2.1	
	Au	79	7040	40	4368	16	-19230	40	15258	17	8571	19	11323	20	
	Hg	80	9490	27	5490	40	-23940	20	11581	22	6435	25	10118	19	
	Tl	81	7660	30	2570	40	*	*	16210	40	8620	50	13360	40	
	Pb	82	10380	40	3564	15	*	*	12490	50	6910	17	12720	40	
	Bi	83	8380	30	590	50	*	*	17580	40	9200	50	16700	30	
	Po	84	11089	16	2120	14	*	*	13540	180	6850	60	15450	40	
	193	Re	75	6670#	280#	7940#	630#	3090#	200#	11520#	280#	8860#	260#	4010#	450#
		Os	76	5583.41	0.20	8970#	200#	-2342	16	11667	10	7040	150	6550	160
Ir		77	7771.92	0.20	5942.3	2.3	-7210	110	12570.7	1.1	9036.6	1.1	6680	150	
Pt		78	6255.5	1.9	6932.8	0.4	-12280	50	12940.2	0.4	7138.2	0.5	9875.7	1.2	
Au		79	8689	19	4390	11	-17521	14	13014	12	8793	12	9003	11	
Hg		80	7111	22	5563	22	-22690	40	13470	40	6695	22	11919	16	
Tl		81	9520	120	2600	110	-27170	120	13980	110	8920	110	11210	110	
Pb		82	7710	50	3610	60	*	*	14800	50	7000	70	14820	50	
Bi		83	10400	30	606	16	*	*	15080	40	9408	15	14110	50	
Po		84	8360	40	2100	50	*	*	15590	40	7410	190	17700	40	
At		85	*		-640	60	*	*	15620	60	9280	60	16400	190	
194		Re	75	5320#	360#	*	4710#	300#	12810#	670#	8420#	360#	*		
		Os	76	7111	3	9420#	200#	-240	13	9990#	200#	6780	10	4330#	200#
	Ir	77	6066.79	0.11	6425.6	2.3	-5700	140	14062.0	2.3	8728.5	1.1	7466	10	
	Pt	78	8357.4	1.7	7518.3	1.7	-10556	17	10780.9	1.7	6807.3	1.7	7277.0	1.6	
	Au	79	6939	15	5074	10	-16270	50	14742	10	8300	11	10091	10	
	Hg	80	9213	20	6088	16	-21188	18	11294	20	6480	40	9151	13	
	Tl	81	7580	170	3070	140	-25640	230	15900	140	8630	140	12630	140	
	Pb	82	10080	50	4180	110	*	*	12380	40	6937	19	12032	29	
	Bi	83	8190	50	1080	70	*	*	17280	50	9120	60	15940	50	
	Po	84	10720	40	2421	16	*	*	13250	40	7099	15	14890	40	
	At	85	9110	190	120	190	*	*	17590	190	8730	190	17700	190	



A	Elt.	Z	S(2n)	S(2p)	Q( $\alpha$ )	Q(2 $\beta^-$ )	Q( $\epsilon p$ )	Q( $\beta^- n$ )						
190	Ta	73	10990#	450#	*	*	6900#	430#	*	-1260#	450#			
	W	74	11770	160	18000#	530#	-290#	340#	4410	160	*	-4390	170	
	Re	75	12690	150	16330#	250#	620	160	1180	150	-11030#	330#	-4650	150
	Os	76	13712.5	0.5	14617	3	1378.3	1.4	-1383	6	-10520	200	-8325	13
	Ir	77	14566	7	12313.0	1.3	2754.1	1.5	-3870	16	-6062	8	-8339	11
	Pt	78	15643	7	10765	6	3251	6	-5953	17	-5627	6	-11813	21
	Au	79	16723	26	9131	17	3867	23	-8550	50	-1717	20	-11320	40
	Hg	80	17311	20	8125	17	4069	27	-10954	20	-2176	19	-14840	19
	Tl	81	18130	60	6610	50	4960	50	-13430	190	1960	50	-14530	60
	Pb	82	18744	16	4793	17	5697	5	-15854	18	1920	40	-18430	60
	Bi	83	19840	190	3130	190	6862	5	*	*	6410	180	-17560	190
	Po	84	20167	24	1326	17	7693	7	*	*	6030	40	*	*
191	W	74	11780#	280#	*	-550#	450#	5280#	200#	*	*	-3620#	250#	
	Re	75	12513	13	17100#	300#	-10#	200#	2358	10	-12980#	400#	-3714	10
	Os	76	13550.99	0.22	15490	200	1086.1	1.4	-696	4	-9390	160	-7713.9	1.2
	Ir	77	14396	13	13306	8	2084.4	1.2	-2900	40	-8430	150	-7454	6
	Pt	78	15357	12	11291	4	3095	4	-5105	23	-4281	4	-10888	16
	Au	79	16370	40	9930	40	3480	40	-7530	40	-4350	40	-10510	40
	Hg	80	17100	40	8688	25	3700	40	-10350	50	-559	23	-14330	50
	Tl	81	17821	13	7277	21	4299	26	-13041	11	-689	18	-13935	14
	Pb	82	18510	50	5190	50	5450	40	-15190	40	3840	40	-17410	190
	Bi	83	19320	50	3216	13	6778	3	*	*	3800	50	-16748	15
	Po	84	19781	25	1750	40	7501	11	*	*	8074	16	*	*
192	W	74	11500#	620#	*	-1200#	780#	6230#	600#	*	*	-3370#	600#	
	Re	75	12280#	250#	17620#	450#	-320#	280#	3130#	200#	*	*	-3390#	200#
	Os	76	13316.8	2.1	16160	160	362	4	412.4	2.9	-12060#	200#	-7245.4	2.3
	Ir	77	14224.6	0.4	13840	150	1758.0	1.2	-2057	16	-7774	10	-7207	4
	Pt	78	15112	5	12164.5	2.1	2418.6	2.2	-4281	16	-7188.1	2.1	-10550	40
	Au	79	16038	22	10603	16	3127	17	-6900	40	-3359	16	-10255	28
	Hg	80	16784	22	9266	17	3387	16	-9455	20	-3602	16	-13802	17
	Tl	81	17680	60	7570	40	4000	40	-12330	50	650	50	-13700	50
	Pb	82	18282	17	5763	20	5221	5	-14485	17	748	26	-17387	15
	Bi	83	18790	190	3790	60	6376	5	*	*	5450	30	-16560	30
	Po	84	19651	18	2232	17	7319	5	*	*	4890	40	*	*
193	Re	75	12100#	200#	*	-900#	360#	4230#	200#	*	*	-2490#	200#	
	Os	76	13141.5	2.1	16860#	200#	-340	200	1084.4	2.3	-11030#	600#	-6630.7	2.3
	Ir	77	13970.03	0.23	14763	10	1019	8	-1139	11	-10120#	200#	-6312.3	1.9
	Pt	78	14922	4	12661.2	1.1	2083.5	1.2	-3426	15	-5885.5	2.3	-9772	16
	Au	79	15730	40	11266	11	2634	17	-6080	110	-5850	11	-9454	19
	Hg	80	16601	27	9931	16	3007	19	-8860	50	-2047	16	-13250	40
	Tl	81	17180	110	8090	120	3840	110	-11450	110	-1830	110	-12830	110
	Pb	82	18090	60	6180	50	5010	60	-13830	60	2530	50	-16720	60
	Bi	83	18775	12	4170	12	6304	5	-15730	60	2710	30	-15873	15
	Po	84	19450	40	2690	50	7093	4	*	*	6910	40	*	*
	At	85	*	*	1480	50	7490	6	*	*	6110	60	*	*
194	Re	75	11990#	360#	*	-1320#	500#	4980#	300#	*	*	-2230#	300#	
	Os	76	12695	3	17360#	600#	-560	160	2330.4	2.6	*	*	-5970.2	2.0
	Ir	77	13838.71	0.23	15400#	200#	610	150	-267	10	-9520#	200#	-6123.6	0.3
	Pt	78	14612.9	2.5	13460.6	2.6	1518.3	1.6	-2570	13	-8659.5	2.6	-9440	11
	Au	79	15628	19	12007	10	2064	10	-5440	140	-5017	10	-9282	18
	Hg	80	16324	20	10478	13	2706	14	-7985	21	-5005	13	-12950	110
	Tl	81	17100	140	8630	140	3630	140	-10840	140	-720	140	-12700	140
	Pb	82	17794	21	6774	23	4738	17	-13203	21	-446	23	-16406	20
	Bi	83	18590	60	4700	60	5918	5	-14800	190	4040	120	-15700	60
	Po	84	19076	17	3027	18	6987	3	*	*	3900	50	-18930	60
	At	85	*	*	2220	190	7291	20	*	*	7400	190	*	*

A	Elt.	Z	S(n)	S(p)	$Q(4\beta^-)$	$Q(d,\alpha)$	$Q(p,\alpha)$	$Q(n,\alpha)$						
195	Os	76	5330	500	9430#	580#	1310	500	11320#	540#	6880#	540#	5610#	780#
	Ir	77	7231.86	0.06	6546.1	2.0	-3535	14	12413.6	2.3	9054.7	2.3	5670#	200#
	Pt	78	6105.04	0.12	7556.5	1.7	-9083	23	12447.8	1.7	6900.4	1.7	8730.1	2.6
	Au	79	8379	10	5095.9	1.0	-14546	6	12617.8	2.0	8586.9	2.7	7909.6	2.0
	Hg	80	6878	26	6027	25	-19930	50	13105	25	6641	28	10939	23
	Tl	81	9400	140	3251	19	-24679	17	13607	21	8720	21	10268	21
	Pb	82	7578	29	4180	140	-28780	60	14320	110	7020	40	13944	28
	Bi	83	10100	50	1105	18	*	*	14880	50	9396	14	13490	30
	Po	84	8140	40	2370	60	*	*	15510	40	7340	50	17130	40
	At	85	10360	190	-240	15	*	*	15590	40	9459	15	15720	30
	Rn	86	*	*	1040	190	*	*	15920	70	*	*	18780	50
196	Os	76	6660	500	*	*	3550	40	9980#	300#	6890#	200#	*	*
	Ir	77	5820	40	7040	500	-1940	40	13710	40	8820	40	6510#	200#
	Pt	78	7921.92	0.13	8246.6	1.7	-7287	14	10592.6	1.7	6750.4	1.7	6391.6	2.6
	Au	79	6641	3	5632.1	3.0	-13131	25	14333.9	3.0	8201	3	9040	3
	Hg	80	8898	23	6546	3	-18352	13	11146	11	6432	11	8297	3
	Tl	81	7413	18	3786	26	-23570	60	15407	17	8418	20	11544	16
	Pb	82	9718	27	4495	20	-27331	21	12180	140	6820	110	11337	21
	Bi	83	8057	25	1580	30	*	*	16910	30	9050	60	14960	110
	Po	84	10470	40	2740	14	*	*	13230	50	7262	16	14370	50
	At	85	8520	60	140	70	*	*	17790	60	9300	70	17600	60
	Rn	86	11170	50	1842	18	*	*	13870	190	6980	60	15980	40
197	Ir	77	6900	40	7280	40	73	26	12130	500	9029	20	4930#	300#
	Pt	78	5846.29	0.27	8270	40	-5674	6	11978.2	1.7	6970.9	1.7	7656.7	2.6
	Au	79	8072.4	2.9	5782.6	0.6	-11453	8	12366.6	0.7	8486.1	0.7	7034.6	1.7
	Hg	80	6785.6	1.5	6690	3	-17180	50	12740	3	6585	11	9869	3
	Tl	81	8916	20	3803	17	-22000	50	13370	28	8716	21	9567	19
	Pb	82	7459	15	4541	13	-26220	60	14117	15	6940	140	13091	14
	Bi	83	9750	26	1616	17	*	*	14737	25	9384	19	12790	140
	Po	84	7950	50	2640	60	*	*	15380	50	7500	70	16500	50
	At	85	10490	80	160	50	*	*	15440	60	9520	50	15290	70
	Rn	86	8570	60	1890	90	*	*	15660	60	7530	200	18130	60
198	Ir	77	5630#	200#	*	*	1670#	210#	13170#	200#	8730#	540#	*	*
	Pt	78	7557	3	8929	20	-3857	15	10240	40	6646	3	5430	500
	Au	79	6512.33	0.09	6448.7	0.6	-10213	28	13776.1	0.7	8078.8	0.7	7754.1	1.7
	Hg	80	8485	3	7102.3	0.5	-15481	17	10896.4	3.0	6479.6	1.3	7488.8	0.8
	Tl	81	7220	80	4240	80	-20820	90	15040	80	8370	80	10720	80
	Pb	82	9373	16	4998	22	-24819	20	12157	19	6969	20	10596	27
	Bi	83	7753	29	1910	28	*	*	16700	30	9210	40	14430	30
	Po	84	10190	50	3075	19	*	*	13250	30	7414	18	13887	29
	At	85	8400	70	600	70	*	*	17510	50	9270	60	17000	50
	Rn	86	10780	60	2180	50	*	*	13400	60	7109	16	15490	40
199	Ir	77	6650#	200#	*	*	3660	50	*	*	8740	60	*	*
	Pt	78	5556.0	0.5	8860#	200#	-2164	27	11586	20	6910	40	6530	40
	Au	79	7584.25	0.15	6476	3	-8297	12	12038.2	0.6	8416.5	0.7	5990	40
	Hg	80	6663.9	0.3	7253.9	0.6	-14332	23	12304.8	0.6	6457.0	3.0	8746.8	0.9
	Tl	81	8640	80	4394	28	-19240	60	13192	28	8631	28	8727	28
	Pb	82	7250	30	5020	80	-23710	70	13820	30	7133	29	12245	27
	Bi	83	9500	30	2037	19	-27560	40	14661	13	9426	18	12345	17
	Po	84	7813	29	3130	40	*	*	15183	25	7660	30	15792	27
	At	85	10220	70	630	50	*	*	15250	70	9520	50	14840	60
	Rn	86	8360	60	2130	80	*	*	15540	80	7270	90	17600	60
	Fr	87	*	*	-700	40	*	*	16000	70	9650	40	16330	70

A	Elt.	Z	S(2n)	S(2p)	Q( $\alpha$ )	Q(2 $\beta^-$ )	Q( $\epsilon\text{p}$ )	Q( $\beta^-$ n)						
195	Os	76	12440	500	*	-1000#	540#	3110	500	*	-5230	500		
	Ir	77	13298.65	0.13	15970#	200#	234	10	880.2	2.0	-11430#	300#	-4998.0	1.7
	Pt	78	14462.5	1.7	13982.2	2.6	1172.0	1.6	-1797	23	-7653.1	2.6	-8606	10
	Au	79	15318	11	12614.2	2.0	1711.5	2.0	-4415	14	-7329.7	2.0	-8448	13
	Hg	80	16092	28	11101	23	2273	24	-7290	30	-3526	23	-12240	140
	Tl	81	16980	110	9339	17	3230	40	-10131	15	-3182	17	-12019	22
	Pb	82	17660	50	7241	28	4450	30	-12640	50	1190	27	-15800	50
	Bi	83	18293	11	5280	110	5832	5	-14547	11	1510	140	-15090	14
	Po	84	18860	50	3460	60	6746	3	-16140	60	5840	40	-17960	190
	At	85	19470	60	2181	13	7339	5	*	*	5220	50	*	*
	Rn	86	*	*	1150	60	7690	50	*	*	8780	50	*	*
196	Os	76	11990	40	*	-1060#	600#	4370	40	*	*	-4660	40	
	Ir	77	13050	40	16460#	300#	-160#	200#	1700	40	*	*	-4710	40
	Pt	78	14026.96	0.18	14792.7	2.6	808.1	2.6	-821	3	-10250	500	-8148.7	1.0
	Au	79	15021	11	13189	3	1268	3	-3643	12	-6739	3	-8211	23
	Hg	80	15776	13	11642	3	2041	4	-6466	15	-6319	3	-11743	14
	Tl	81	16810	140	9813	16	2855	20	-9488	27	-2216	12	-11854	26
	Pb	82	17296	22	7746	19	4226	21	-11886	19	-1650	27	-15408	15
	Bi	83	18160	50	5760	140	5440	40	-14090	60	2857	28	-15010	50
	Po	84	18612	18	3845	22	6657	3	-15445	20	2951	27	-18070	16
	At	85	18880	200	2510	80	7200	50	*	*	6810	60	-17060	80
	Rn	86	*	*	1603	20	7617	9	*	*	5760	40	*	*
197	Ir	77	12721	20	*	-390#	200#	2873	20	*	*	-3692	20	
	Pt	78	13768.21	0.30	15310	500	545.3	2.6	119	3	-9430	40	-7353.7	3.0
	Au	79	14713.7	1.2	14029.2	1.7	967.8	1.7	-2800	16	-8990	40	-7385.7	2.9
	Hg	80	15684	23	12322	3	1511	4	-5792	6	-5183	3	-11116	13
	Tl	81	16329	21	10349	16	2628	19	-8654	18	-4490	17	-11052	22
	Pb	82	17177	24	8327	24	3877	16	-11390	50	-211	6	-14811	25
	Bi	83	17807	10	6111	16	5210	110	-13340	50	520	15	-14284	15
	Po	84	18430	60	4220	50	6412	4	-14830	80	4710	50	-17510	80
	At	85	19010	50	2900	50	7100	50	*	*	4380	60	-16390	50
	Rn	86	19730	80	2030	70	7410	50	*	*	7660	60	*	*
198	Ir	77	12530#	200#	*	-690#	360#	3760#	200#	*	*	-3470#	200#	
	Pt	78	13403	3	16200	40	100	4	1047	3	*	*	-6838	3
	Au	79	14584.7	2.9	14720	40	522.3	1.7	-2090	80	-8603	20	-7112	3
	Hg	80	15270.4	2.9	12884.9	0.8	1383.8	0.8	-4904	15	-7821.0	0.8	-10685	16
	Tl	81	16140	80	10930	80	2340	80	-8120	80	-3640	80	-10820	80
	Pb	82	16832	20	8801	15	3718	19	-10577	23	-2798	15	-14434	17
	Bi	83	17500	40	6450	30	5030	140	-12700	60	1680	30	-14080	60
	Po	84	18142	22	4691	22	6309.3	2.1	-14243	22	1986	18	-17200	50
	At	85	18890	80	3240	50	6893.0	2.2	*	*	5730	50	-16220	80
	Rn	86	19344	20	2334	18	7349	4	*	*	4840	50	*	*
199	Ir	77	12280	50	*	*	*	4690	40	*	*	-2560	40	
	Pt	78	13113	3	*	-130	500	2155	3	*	*	-5882	3	
	Au	79	14096.58	0.17	15405	20	169.9	1.7	-1036	28	-10560#	200#	-6211.9	0.5
	Hg	80	15149	3	13702.6	0.8	824.9	0.9	-4319	26	-6928	3	-10120	80
	Tl	81	15860	30	11496	28	2086	28	-7260	30	-5766	28	-10080	30
	Pb	82	16622	27	9265	27	3350	40	-10010	40	-1563	26	-13930	40
	Bi	83	17253	15	7035	20	4932	7	-11980	50	-590	80	-13396	21
	Po	84	18000	50	5044	24	6074.0	2.0	-13700	70	3546	28	-16610	50
	At	85	18620	70	3710	50	6780	50	-15580	70	3260	60	-15660	50
	Rn	86	19140	90	2740	80	7130	50	*	*	6670	70	*	*
	Fr	87	*	*	1470	70	7810	40	*	*	6140	60	*	*

A	El.	Z	S(n)	S(p)	$Q(4\beta^-)$	$Q(d,\alpha)$	$Q(p,\alpha)$	$Q(n,\alpha)$						
200	Pt	78	7282	20	9490	50	-360	23	9930#	200#	6529	28	*	
	Au	79	6250	50	7170	50	-6900	60	13350	50	8020	50	6650	50
	Hg	80	8028.40	0.12	7698.1	0.6	-12550	14	10788.8	0.6	6501.0	0.6	6564.7	0.8
	Tl	81	7060	29	4790	6	-18060	25	14617	6	8357	7	9739	6
	Pb	82	9087	29	5470	30	-22237	17	11960	80	6962	20	9944	11
	Bi	83	7643	27	2430	40	-26490	80	16391	28	9243	25	13617	29
	Po	84	9811	28	3445	19	*		13130	30	7597	17	13441	15
	At	85	8240	60	1060	30	*		17200	30	9230	60	16346	26
	Rn	86	10560	60	2480	50	*		13380	50	7200	50	15000	50
	Fr	87	8710	90	-350	100	*		18060	80	9510	100	18110	90
201	Pt	78	5210	50	*		1520	50	11370	60	6940#	200#	*	
	Au	79	7200	50	7087	20	-4985	15	11702	4	8371	4	5070#	200#
	Hg	80	6230.4	0.5	7680	50	-11138	6	12142.6	0.8	6782.9	0.8	7891	3
	Tl	81	8205	16	4967	15	-16393	17	13076	15	8636	15	8046	15
	Pb	82	7086	25	5499	23	-21190	70	13510	40	7100	80	11343	22
	Bi	83	9117	28	2462	19	-25010	70	14520	30	9498	21	11720	80
	Po	84	7642	16	3444	25	*		14984	13	7709	29	15172	16
	At	85	9873	26	1124	17	*		15136	25	9548	19	14226	29
	Rn	86	8140	70	2370	70	*		15460	90	7460	90	17050	70
	Fr	87	10600	110	-310	70	*		15830	100	9690	70	15910	90
202	Pt	78	6930#	300#	*		3340#	300#	*		6670#	300#	*	
	Au	79	6070	170	7950	170	-3670	170	12910	170	7860	170	5650	170
	Hg	80	7753.92	0.21	8234	3	-9422	15	10630	50	6613.2	0.8	5693	3
	Tl	81	6873	21	5609	15	-15390	30	14232	15	8428	15	8758	15
	Pb	82	8747	24	6041	17	-19659	19	11825	10	6990	29	9260	8
	Bi	83	7388	25	2760	30	-23870	50	16221	23	9360	30	12970	30
	Po	84	9471	16	3797	21	-27140	60	13157	28	7738	19	12950	30
	At	85	7873	29	1355	29	*		17070	30	9490	40	15850	30
	Rn	86	10270	70	2774	19	*		13420	30	7410	50	14586	29
	Fr	87	8530	90	80	90	*		17860	50	9520	80	17610	70
	Ra	88	*		1670	90	*		13800	100	7320	80	16380	90
203	Au	79	6820	170	7830#	300#	-1604	22	11310	50	8323	20	*	
	Hg	80	5994.6	1.6	8160	170	-7962	26	11843	4	6860	50	6980	20
	Tl	81	7849	15	5704.3	1.2	-13598	12	12612.9	1.2	8607.0	1.3	7150	50
	Pb	82	6924	10	6092	16	-18626	24	13106	16	7126	9	10364	7
	Bi	83	8878	30	2895	23	-22401	27	14430	30	9567	24	11155	22
	Po	84	7454	30	3860	30	-25940	80	14820	30	7930	40	14583	28
	At	85	9640	30	1528	19	*		15072	13	9655	19	13853	27
	Rn	86	7957	29	2860	40	*		15340	25	7690	30	16441	28
	Fr	87	10350	50	153	24	*		15640	70	9731	21	15495	29
	Ra	88	8650	100	1790	90	*		15750	110	7380	110	18290	80
204	Au	79	5680#	200#	*		-80#	200#	12560#	360#	7860#	210#	*	
	Hg	80	7492.4	1.7	8836	3	-6357	11	10420	170	6575	3	4700	50
	Tl	81	6656.10	0.29	6365.8	1.3	-12471	24	13710.7	1.2	8181.3	1.2	7702	3
	Pb	82	8394	6	6637.5	0.3	-17126	14	11584	15	6936	15	8199.9	1.2
	Bi	83	7200	30	3170	27	-21280	40	15977	27	9450	30	12161	30
	Po	84	9098	28	4083	24	-24388	19	13110	23	7946	19	12571	25
	At	85	7783	27	1860	40	*		16760	28	9514	25	15187	28
	Rn	86	9895	28	3110	19	*		13320	30	7669	17	14187	16
	Fr	87	8324	29	520	30	*		17590	30	9540	70	17044	26
	Ra	88	10650	80	2096	22	*		13620	50	7320	70	15770	70

A	Elt.	Z	S(2n)	S(2p)	Q( $\alpha$ )	Q( $2\beta^-$ )	Q( $\epsilon p$ )	Q( $\beta^- n$ )						
200	Pt	78	12838	20	*	-750	40	2901	20	*	-5579	20		
	Au	79	13830	50	16030#	200#	-260	60	-220	50	-10160	60	-5790	50
	Hg	80	14692.3	0.4	14174	3	718.4	0.9	-3261	11	-9401	3	-9516	28
	Tl	81	15700	80	12044	6	1667	6	-6678	25	-5242	6	-9891	27
	Pb	82	16336	18	9867	11	3158	11	-9289	18	-3985	11	-13516	16
	Bi	83	17140	40	7450	80	4702	27	-11380	30	400	40	-13230	30
	Po	84	17624	23	5482	20	5981.3	2.0	-12948	20	980	30	-16210	50
	At	85	18460	50	4200	40	6596.4	1.4	-15110	80	4522	27	-15540	70
	Rn	86	18918	19	3111	22	7043.5	2.6	*	*	3920	27	-18840	40
	Fr	87	*		1780	90	7620	50	*		7650	90	*	
201	Pt	78	12490	50	*	*	*	3920	50	*	*		-4540	70
	Au	79	13449	3	16580	40	-558	20	781	15	*	*	-4968	3
	Hg	80	14258.8	0.5	14849	3	334.3	1.0	-2405	22	-8349	20	-8686	6
	Tl	81	15270	30	12665	15	1534	15	-5766	21	-7200	50	-9010	19
	Pb	82	16170	30	10289	22	2858	23	-8733	23	-3043	22	-12960	30
	Bi	83	16760	19	7930	30	4500	6	-10626	17	-1657	16	-12533	21
	Po	84	17453	24	5875	27	5798.9	1.7	-12450	70	2429	12	-15609	25
	At	85	18110	50	4569	14	6473.2	1.6	-14390	70	2292	25	-14855	16
	Rn	86	18700	90	3440	70	6860	50	*	*	5590	70	-18270	110
	Fr	87	19310	80	2160	90	7520	50	*	*	5300	80	*	
202	Pt	78	12140#	300#	*	*	*	4750#	300#	*	*		-4270#	300#
	Au	79	13270	170	*		-1000#	260#	1580	170	*	*	-4810	170
	Hg	80	13984.4	0.5	15321	20	137	3	-1412	8	-10890	50	-8235	15
	Tl	81	15078	16	13290	50	1174	15	-5250	25	-6871	15	-8797	27
	Pb	82	15833	14	11007	8	2596	8	-8009	17	-5559	8	-12589	17
	Bi	83	16510	30	8263	21	4340	80	-10140	30	-840	25	-12279	21
	Po	84	17112	20	6259	18	5701.0	1.7	-11649	23	45	27	-15206	17
	At	85	17750	40	4800	40	6353.7	1.4	-13730	60	3540	30	-14590	80
	Rn	86	18412	22	3898	23	6773.5	1.9	-15490	60	2961	18	-17940	70
	Fr	87	19120	90	2450	60	7389	5	*	*	6640	50	*	
	Ra	88	*		1360	60	8020	60	*	*	6000	90	*	
203	Au	79	12885	4	*		-1170	40	2618	3	*	*	-3869	3
	Hg	80	13748.5	1.6	16110	50	-302	4	-483	7	-9960#	300#	-7357	15
	Tl	81	14722	15	13938	3	908.9	1.4	-4221	22	-8650	170	-7899	8
	Pb	82	15671	23	11701	7	2336	7	-7480	27	-4730	7	-12125	21
	Bi	83	16267	26	8936	26	4090	40	-9376	25	-2846	26	-11687	26
	Po	84	16925	27	6630	30	5496	5	-11150	40	1338	27	-14790	40
	At	85	17517	14	5325	19	6210.1	0.8	-13025	20	1280	24	-13960	21
	Rn	86	18230	70	4213	24	6629.8	2.3	-14800	80	4475	28	-17370	50
	Fr	87	18880	70	2927	18	7260	50	*	*	4160	30	-16420	60
	Ra	88	*		1870	110	7730	50	*	*	7620	80	*	
204	Au	79	12490#	260#	*	*	*	3600#	200#	*	*		-3550#	200#
	Hg	80	13487.0	0.6	16670#	300#	-512	20	419.5	1.3	*	*	-7000.4	1.3
	Tl	81	14505	15	14520	170	500	50	-3679	26	-8492	3	-7631	6
	Pb	82	15319	8	12341.8	1.1	1969.5	1.2	-6776	11	-7129.6	1.3	-11641	22
	Bi	83	16080	30	9262	30	3956	27	-8790	40	-2195	26	-11430	40
	Po	84	16552	18	6978	14	5484.8	1.4	-10349	18	-836	13	-14241	16
	At	85	17430	40	5720	30	6069.8	1.5	-12480	30	2380	30	-13790	30
	Rn	86	17852	23	4638	21	6545.5	1.9	-14038	21	2034	30	-16917	21
	Fr	87	18680	60	3380	40	7171.3	2.5	*	*	5483	27	-16100	80
	Ra	88	19300	60	2249	23	7636	8	*	*	4926	28	*	

A	Elt.	Z	S(n)	S(p)	$Q(4\beta^-)$	$Q(d,\alpha)$	$Q(p,\alpha)$	$Q(n,\alpha)$						
205	Au	79	6070#	360#	*	2310#	300#	*	8710#	420#	*			
	Hg	80	5669	4	8830#	200#	–4779	20	11567	5	6980	170	5960#	300#
	Tl	81	7545.9	0.5	6419.3	1.3	–10849	15	12159.3	1.3	8389.3	1.2	6230	170
	Pb	82	6731.67	0.11	6713.09	0.21	–16060	50	12701.9	0.4	7077	15	9222.2	1.1
	Bi	83	8466	27	3241	7	–19752	11	14436	10	9736	11	10568	16
	Po	84	7247	23	4130	30	–23350	90	14742	29	8088	28	14071	22
	At	85	9168	28	1927	19	*		15050	30	9817	21	13408	25
	Rn	86	7800	50	3130	60	*		15160	50	7740	60	15860	50
	Fr	87	9989	26	615	17	*		15561	25	9829	19	14928	29
	Ra	88	8290	90	2060	90	*		15690	90	7560	100	17760	90
206	Hg	80	6729	21	9480#	300#	–2764	22	10520#	200#	7062	21	*	
	Tl	81	6503.8	0.4	7255	4	–9834	21	13148.0	1.4	7880.1	1.4	6537	3
	Pb	82	8086.67	0.06	7253.8	0.5	–14670	15	11271.34	0.21	6839.8	0.4	7130.1	1.3
	Bi	83	7038	10	3547	8	–18785	29	15793	8	9623	10	11380	8
	Po	84	8744	22	4409	11	–21747	20	13196	27	8222	23	12251	10
	At	85	7519	25	2200	29	–25930	70	16625	23	9750	30	14767	30
	Rn	86	9470	50	3433	21	*		13471	28	7912	19	13838	30
	Fr	87	8004	29	820	60	*		17450	30	9780	40	16570	30
	Ra	88	10350	90	2414	20	*		13670	30	7568	24	15372	30
	Ac	89	*		–380	110	*		18170	70	9740	110	18300	70
207	Hg	80	3340	150	*		930	150	13240#	330#	9400#	250#	*	
	Tl	81	6852	5	7377	21	–7791	22	11965	7	8521	6	5360#	200#
	Pb	82	6737.78	0.09	7487.8	0.6	–13821	26	12079.5	0.5	6758.12	0.23	7884.7	1.3
	Bi	83	8098	8	3558.0	2.1	–17210	50	14426.5	2.1	9919.4	2.1	9937.9	2.1
	Po	84	7035	11	4407	10	–20680	60	14627	10	8386	27	13610	7
	At	85	8894	30	2350	23	–24370	60	14977	29	9955	24	13070	30
	Rn	86	7587	30	3500	30	*		15050	30	8110	40	15349	28
	Fr	87	9670	60	1020	50	*		15580	70	10010	50	14680	60
	Ra	88	8100	60	2510	60	*		15560	60	7790	60	17170	60
	Ac	89	10450	90	–280	60	*		16000	100	9940	50	16170	60
208	Hg	80	4950#	330#	*	4370#	300#	*		10520#	420#	*		
	Tl	81	3787	6	7820	150	–4258	26	14907	20	10402	4	7650#	300#
	Pb	82	7367.87	0.05	8004	5	–12100	11	11215.4	0.6	6936.2	0.5	6185	4
	Bi	83	6886.9	2.7	3707.1	2.0	–16200	50	15626.2	2.0	9764.1	2.0	10597.0	2.0
	Po	84	8395	7	4704.1	2.5	–19183	15	13269	8	8456	7	11947.0	1.3
	At	85	7320	30	2634	27	–23250	60	16401	27	9880	30	14217	27
	Rn	86	9088	28	3694	24	*		13482	23	8188	19	13507	23
	Fr	87	7890	70	1320	50	*		17160	50	9910	70	15950	50
	Ra	88	9900	60	2730	50	*		13670	30	7888	17	15070	50
	Ac	89	8440	80	70	80	*		17910	60	9790	100	17720	60
209	Hg	80	3320#	360#	*	8020#	200#	*		*		*		
	Tl	81	4960	8	7830#	300#	–758	11	13290	150	12172	22	*	
	Pb	82	3937.3	1.3	8153.9	2.2	–8686	20	14130	6	9502.7	1.4	8977	20
	Bi	83	7459.8	1.9	3799.0	0.8	–14489	15	14904.2	0.8	10391.0	0.8	9641.0	0.8
	Po	84	6967.7	1.9	4784.9	2.4	–18220	50	14399.3	2.5	8526	8	13065.9	1.4
	At	85	8460	27	2699	7	–21720	50	14977	10	10166	11	12795	11
	Rn	86	7352	23	3730	30	–25430	100	15025	29	8355	29	14900	22
	Fr	87	9180	50	1410	18	*		15573	30	10210	21	14297	25
	Ra	88	7930	50	2770	70	*		15410	70	7960	60	16620	50
	Ac	89	9990	80	160	50	*		16020	70	10140	50	15730	60
Th	90	*		1550	110	*		16080	110	7850	120	18580	100	

A	Elt.	Z	S(2n)	S(2p)	Q( $\alpha$ )		Q(2 $\beta^-$ )		Q( $\epsilon p$ )		Q( $\beta^- n$ )	
205	Au	79	11750#	300#	*	*	5070#	300#	*		-2130#	300#
	Hg	80	13161	4	*	-970	50	1483	4	*	-6013	4
	Tl	81	14202.0	0.5	15255	3	156	3	-2759	7	-10360#	200#
	Pb	82	15126	6	13078.9	1.3	1468.3	1.2	-6261	20	-6368.8	1.3
	Pb	83	15664	23	9878	7	3695	17	-8090	17	-4005	7
	Po	84	16340	30	7300	21	5324	10	-9800	50	312	20
	At	85	16951	19	6010	26	6019.5	1.7	-11662	17	407	30
	Rn	86	17700	60	4980	60	6390	50	-13550	100	3330	50
	Fr	87	18314	18	3724	14	7054.9	2.7	*		3277	25
	Ra	88	18940	120	2580	90	7490	50	*		6530	90
206	Hg	80	12398	20	*	-770#	300#	2840	20	*	-5196	20
	Tl	81	14049.8	0.6	16080#	200#	-280	170	-2225	8	-10790#	300#
	Pb	82	14818.34	0.12	13673.1	1.3	1135.5	1.1	-5604	8	-8787	4
	Bi	83	15503	27	10260	8	3530	17	-7608	22	-3496	8
	Po	84	15991	14	7650	8	5326.9	1.3	-9066	17	-1701	8
	At	85	16690	30	6330	30	5888.4	1.9	-11180	30	1353	22
	Rn	86	17274	21	5360	18	6383.8	1.6	-12681	23	1105	25
	Fr	87	17990	40	3950	40	6923	4	-14750	80	4440	30
	Ra	88	18632	24	3029	23	7415	4	*		3990	50
	Ac	89	*	1680	70	7940	50	*		7530	70	
207	Hg	80	10070	150	*	*	6230	150	*		-2040	150
	Tl	81	13356	5	16860#	300#	-315	6	-979	6	*	-5320
	Pb	82	14824.45	0.11	14742	4	392.3	1.3	-5306	7	-8795	20
	Bi	83	15135	7	10811.8	2.1	3281.8	2.1	-6812	22	-5090.3	2.1
	Po	84	15779	21	7954	7	5215.8	2.5	-8515	27	-649	7
	At	85	16414	26	6759	23	5872	3	-10400	60	-504	23
	Rn	86	17060	60	5700	30	6251.1	1.6	-12170	60	2262	27
	Fr	87	17670	50	4450	50	6900	50	-13970	70	2290	50
	Ra	88	18440	100	3330	70	7270	50	*		5360	60
	Ac	89	*	2140	50	7840	50	*		5080	60	
208	Hg	80	8290#	300#	*	*	8650#	300#	*		-130#	300#
	Tl	81	10639.0	1.8	*	1580#	200#	2120.5	2.6	*	-2368.9	1.7
	Pb	82	14105.65	0.11	15381	20	516.9	1.3	-4278.9	1.3	-12820	150
	Bi	83	14985	8	11194.9	2.0	3051.0	2.0	-6379	26	-5125	6
	Po	84	15430	8	8262.0	1.3	5215.3	1.3	-7822	11	-2306.6	1.3
	At	85	16210	30	7041	27	5751.0	2.2	-9830	50	274	26
	Rn	86	16675	18	6044	14	6260.7	1.7	-11362	19	209	13
	Fr	87	17570	50	4820	50	6790	40	-13430	70	3290	50
	Ra	88	17994	24	3749	21	7273	5	*		3060	30
	Ac	89	18890	90	2580	60	7730	50	*		6310	80
209	Hg	80	8270#	250#	*	*	9270#	200#	*		330#	200#
	Tl	81	8747	9	*	2690#	300#	4620	8	*	39	8
	Pb	82	11305.2	1.3	15970	150	2248	4	-1248.5	1.9	-11810#	300#
	Bi	83	14346.7	2.0	11803	5	3137.2	0.8	-5379	7	-8798.0	1.9
	Po	84	15363	7	8492.0	1.4	4979.2	1.4	-7437	20	-1906.5	1.4
	At	85	15780	23	7403	8	5757.1	2.0	-9110	16	-1299	8
	Rn	86	16440	30	6361	21	6155.5	2.0	-10780	50	1252	20
	Fr	87	17070	50	5105	26	6777	4	-12610	50	1433	30
	Ra	88	17830	70	4090	60	7144	4	-14650	110	4210	50
	Ac	89	18430	70	2890	70	7730	50	*		4220	70
	Th	90	*	1610	110	8240	50	*		7500	100	

A	Elt.	Z	S(n)	S(p)	$Q(4\beta^-)$	$Q(d,\alpha)$	$Q(p,\alpha)$	$Q(n,\alpha)$						
210	Hg	80	4840#	360#	*	10840#	300#	*						
	Tl	81	3680	14	8190#	200#	2726	14	14560#	300#	11840	150	*	
	Pb	82	5185.2	1.3	8379	8	-5130	9	12732.0	1.9	11169	5	7140	150
	Bi	83	4604.63	0.08	4466.3	1.1	-11446	22	17667.5	0.8	12524.2	0.8	11888	5
	Po	84	7658.4	1.4	4983.6	0.8	-16414	15	13627.8	2.0	8965.4	2.1	12145.24	0.12
	At	85	7164	11	2895	8	-20760	60	16208	8	10038	10	13729	8
	Rn	86	8741	22	4007	11	-23641	26	13604	27	8509	23	13194	11
	Fr	87	7648	26	1707	30	*		17013	25	10150	30	15540	30
	Ra	88	9470	50	3059	21	*		13840	50	8170	50	14740	30
	Ac	89	8130	80	350	80	*		17790	60	10120	80	17280	80
	Th	90	10530	100	2090	60	*		13990	60	7780	60	16150	60
211	Tl	81	4900#	200#	8250#	360#	5570#	200#	12980#	280#	11880#	360#	*	
	Pb	82	3834.5	2.8	8534	12	-1736	7	13857	8	11122.1	2.8	8250#	300#
	Bi	83	5138	5	4419	6	-7701	22	16467	6	14754	5	10537	6
	Po	84	4550.8	0.5	4929.7	0.9	-13269	26	16536.8	0.9	11301.6	2.1	14962.4	0.5
	At	85	7747	8	2983.0	2.5	-18850	70	15429.6	2.8	10686.4	2.8	12869	3
	Rn	86	7229	11	4073	10	-22660	70	14835	10	8600	27	14360	7
	Fr	87	8880	30	1849	23	*		15482	29	10354	24	13980	30
	Ra	88	7700	30	3110	30	*		15320	30	8370	50	16131	29
	Ac	89	9660	90	550	70	*		16060	90	10360	70	15520	80
	Th	90	8210	80	2170	90	*		15770	90	8010	90	17840	80
	212	Tl	81	3650#	360#	*	6970#	300#	14170#	420#	11560#	360#	*	
Pb		82	5127.3	2.5	8760#	200#	1112	4	12410	12	10955	8	6450#	200#
Bi		83	4330	6	4914.8	2.8	-4580	26	17321.8	1.9	14361.2	2.2	11167	8
Po		84	6008.2	0.5	5800	5	-10178	11	15133.2	0.8	12753.1	0.8	12891.4	1.3
At		85	5045	7	3478	7	-15900	70	18043	7	12609	7	15284	7
Rn		86	7975	7	4301	4	-20751	19	14023	8	9084	8	13353	3
Fr		87	7450	30	2071	27	-25150	80	16771	27	10260	30	14988	27
Ra		88	9099	29	3323	24	*		13866	25	8442	18	14384	23
Ac		89	8000	100	850	70	*		17530	70	10290	80	16690	70
Th		90	9890	80	2400	70	*		14010	60	8110	50	15880	50
Pa		91	*		-420	110	*		18280	80	9980	120	18420	90
213	Pb	82	3708	8	8820#	300#	2514	10	13600#	200#	10926	14	7580#	300#
	Bi	83	5185	5	4972	5	-1681	9	15972	5	14362	5	9662	13
	Po	84	4355.3	2.9	5825	3	-7011	21	15916	6	13002.4	2.8	13721.3	2.8
	At	85	6030	8	3499	5	-12730	50	16564	5	14238	5	13859	5
	Rn	86	5110	6	4366	9	-17820	70	16660	6	11138	10	15901	6
	Fr	87	8084	27	2179	8	-23210	70	15917	10	10912	11	14068	11
	Ra	88	7522	23	3390	30	*		15226	29	8570	30	15602	22
	Ac	89	9190	90	940	50	*		16030	60	10560	50	15150	60
	Th	90	8040	70	2450	100	*		15620	100	8190	90	17300	70
	Pa	91	10020	100	-280	70	*		16470	100	10480	80	16520	90
	214	Pb	82	5068	8	*	4138	9	12180#	300#	10760#	200#	*	
Bi		83	4041	12	5305	14	-242	14	17058	11	14155	11	10520#	200#
Po		84	5887.8	2.8	6528	5	-4570	9	14358.2	1.9	12253	6	11667.9	2.8
At		85	4872	6	4015	5	-9809	23	17701	4	13917	4	14125	7
Rn		86	6693	11	5029	10	-15032	19	15012	12	12191	9	13759	9
Fr		87	5480	12	2549	10	-20440	80	18412	9	12661	11	16335	9
Ra		88	8328	22	3639	12	*		14349	27	9122	23	14502	11
Ac		89	7800	60	1220	30	*		17331	25	10460	30	16230	30
Th		90	9480	70	2730	50	*		14140	70	8370	70	15520	30
Pa		91	8250	100	-80	100	*		18110	80	10440	110	17930	100



A	Elt.	Z	S(2n)	S(2p)	Q( $\alpha$ )	Q( $2\beta^-$ )	Q( $\epsilon p$ )	Q( $\beta^- n$ )						
210	Hg	80	8160#	420#	*	*	9610#	300#	*	450#	300#			
	Tl	81	8639	12	*	*	5545	12	*	297	12			
	Pb	82	9122.5	0.9	16210#	300#	3792	20	1224.8	0.9	-13670#	200#	-4541.1	0.5
	Bi	83	12064.4	1.9	12620.2	1.9	5036.4	0.8	-2820	8	-8443	8	-6497.2	1.6
	Po	84	14626.2	1.3	8782.56	0.13	5407.45	0.07	-6355	9	-5627.6	1.3	-11145	7
	At	85	15623	27	7680	8	5631.2	1.0	-8626	24	-1002	8	-11115	21
	Rn	86	16093	14	6706	9	6158.9	2.2	-10059	17	-521	9	-13900	17
	Fr	87	16820	50	5430	30	6650	30	-12140	60	2244	23	-13270	60
	Ra	88	17395	22	4469	19	7152	4	-13582	29	2101	25	-16450	50
	Ac	89	18110	80	3120	70	7610	50	*	5270	60	-15780	120	
	Th	90	*	2249	29	8053	17	*	*	4900	60	*	*	
211	Tl	81	8580#	200#	*	*	5780#	200#	*	580#	200#			
	Pb	82	9019.6	3.0	16720#	200#	3300	150	1941.1	2.8	-12670#	300#	-3771.0	2.8
	Bi	83	9743	5	12798	9	6750.3	0.5	-211	6	-9901	13	-3977	5
	Po	84	12209.2	1.5	9396.0	1.4	7594.5	0.5	-3677	7	-4993.2	1.0	-8532	8
	At	85	14910	8	7966.6	2.4	5982.4	1.3	-7489	21	-4144.3	2.4	-10121	9
	Rn	86	15970	21	6968	7	5965.4	1.4	-9592	27	-91	7	-13481	23
	Fr	87	16531	26	5856	22	6660	5	-11360	70	525	22	-12690	26
	Ra	88	17160	60	4810	30	7043	4	-13070	80	3145	28	-16020	60
	Ac	89	17780	90	3600	70	7620	50	*	3260	70	-14910	80	
	Th	90	18740	120	2530	90	7940	50	*	6160	80	*	*	
212	Tl	81	8550#	300#	*	*	6470#	300#	*	770#	300#			
	Pb	82	8961.7	2.3	17010#	300#	3130#	300#	2822.0	2.2	*	*	-3760	6
	Bi	83	9468.2	1.9	13449	12	6207.26	0.03	504	7	-9330#	200#	-3756.1	1.8
	Po	84	10558.98	0.17	10219.1	0.9	8954.12	0.11	-1709.8	2.9	-7166.9	2.7	-6793.6	2.5
	At	85	12792	11	8407	7	7824	7	-5084	27	-4052	9	-7937	10
	Rn	86	15204	9	7284.5	2.9	6385.0	2.6	-8468	12	-3516.1	3.0	-12573	21
	Fr	87	16330	30	6144	27	6528.9	1.8	-10820	70	821	26	-12450	40
	Ra	88	16795	19	5171	14	7031.6	1.7	-12282	22	1275	13	-15470	70
	Ac	89	17650	90	3950	70	7520	50	-14340	100	4150	70	-14700	100
	Th	90	18090	30	2948	24	7952	10	*	3970	30	*	*	
	Pa	91	*	1750	90	8430	50	*	*	7120	100	*	*	
213	Pb	82	8835	8	*	2740#	200#	3469	8	*	*	-3138	8	
	Bi	83	9515	7	13730#	200#	5982	6	1349	7	-10870#	300#	-2933	5
	Po	84	10363.5	2.9	10740	4	8536.1	2.6	-955	6	-6395	4	-6104	8
	At	85	11075	5	9299	7	9254	5	-3030	9	-5751	5	-5991	6
	Rn	86	13085	9	7844	6	8243	5	-6056	21	-2618	6	-10232	26
	Fr	87	15535	22	6481	8	6904.9	1.8	-9700	50	-2218	10	-11430	14
	Ra	88	16620	30	5465	21	6861	4	-11760	70	1728	21	-14990	70
	Ac	89	17190	90	4270	60	7500	50	-13510	90	2400	60	-14010	60
	Th	90	17930	100	3300	80	7840	50	*	5020	70	-17570	100	
	Pa	91	*	2120	100	8390	50	*	*	5100	100	*	*	
214	Pb	82	8776.5	2.0	*	2510#	300#	4288.7	2.6	*	*	-3022	5	
	Bi	83	9226	11	14130#	300#	5621	3	2180	12	*	*	-2618	12
	Po	84	10243.1	0.9	11500.5	2.3	7833.46	0.06	-150	9	-8575	8	-5962	5
	At	85	10901	8	9840	4	8987	4	-2421	10	-5438	6	-5753	7
	Rn	86	11803	10	8528	9	9208	9	-4420	13	-4955	10	-8841	12
	Fr	87	13563	27	6915	11	8589	4	-7387	24	-1668	10	-9387	22
	Ra	88	15851	14	5818	10	7273	3	-10611	19	-1490	11	-14130	50
	Ac	89	16990	70	4610	30	7350	3	-13060	80	2690	24	-13760	70
	Th	90	17522	25	3675	20	7826	7	*	3065	26	-17020	70	
	Pa	91	18270	110	2370	100	8270	50	*	6040	90	*	*	

A	Elt.	Z	S(n)	S(p)	Q(4 $\beta^-$ )	Q(d, $\alpha$ )	Q(p, $\alpha$ )	Q(n, $\alpha$ )						
215	Pb	82	3410#	410#	*	5650#	410#	*	10990#	510#	*			
	Bi	83	5223	19	5459	15	1330	17	15544	17	14060	15	8950#	300#
	Po	84	4141.7	2.7	6629	11	-3074	8	15401	5	12441.1	2.7	12653.5	2.4
	At	85	5947	8	4074	7	-7267	22	16109	7	13978	7	12509	7
	Rn	86	4920	12	5078	9	-12095	28	16122	9	12317	10	14847	8
	Fr	87	6795	11	2651	11	-17550	90	16727	9	13842	8	14586	10
	Ra	88	5638	12	3797	11	*		16794	11	10935	27	16840	8
	Ac	89	8490	30	1378	23	*		16365	30	11067	24	15200	30
	Th	90	7860	30	2790	40	*		15480	60	8510	70	16765	29
	Pa	91	9690	120	130	90	*		16460	110	10640	90	16240	110
216	Bi	83	3846	19	5890#	410#	2895	18	16766	11	13922	14	*	
	Po	84	5747.2	2.3	7154	15	-1507	9	13695	11	11879	5	10615	8
	At	85	4559	8	4491	4	-5865	27	17438	4	13775	5	13134	6
	Rn	86	6647	10	5778	10	-10049	15	14346	8	11699	9	12555	8
	Fr	87	5411	16	3141	16	-14820	70	18009	17	13541	15	15205	15
	Ra	88	7314	11	4316	11	*		14960	12	11705	12	14636	10
	Ac	89	5960	30	1700	28	*		18733	28	12630	30	17319	28
	Th	90	8694	30	2996	25	*		14586	26	9010	50	15593	24
	Pa	91	8140	110	420	70	*		17800	70	10550	100	17290	90
217	Bi	83	5120#	200#	*	4510#	200#	15060#	460#	13870#	200#	*		
	Po	84	3954	7	7262	13	13	11	14963	16	11965	13	11728	7
	At	85	5933	6	4677	5	-4311	14	15647	5	13730	5	11242	12
	Rn	86	4668	8	5888	5	-8557	21	15625	8	11902	6	13775	4
	Fr	87	6736	15	3230	10	-12750	50	16194	10	13498	11	13341	8
	Ra	88	5475	12	4381	16	-16810	90	16280	11	11710	12	15854	12
	Ac	89	7487	29	1873	15	*		16884	15	13470	16	15311	15
	Th	90	6160	24	3200	30	*		16915	30	10650	30	17762	23
	Pa	91	8800	90	520	50	*		16850	60	11220	50	16290	60
	U	92	*		2390	110	*		15540	120	8080	120	17630	90
218	Bi	83	3560#	410#	*	6280#	360#	*		13720#	550#	*		
	Po	84	5614	7	7750#	200#	1707	11	13195	11	11574	15	9530#	410#
	At	85	4368	13	5091	13	-2750	50	17026	12	13503	12	12097	19
	Rn	86	6512	4	6467	5	-7157	13	13671	4	11337	7	11404	3
	Fr	87	5327	8	3888	6	-11610	25	17514	9	13092	9	13961	8
	Ra	88	7308	14	4953	13	-15270	30	14383	18	11197	13	13466	13
	Ac	89	5930	50	2330	50	*		18260	50	13170	50	16170	50
	Th	90	7913	24	3621	18	*		14963	30	11227	25	15487	15
	Pa	91	6470	60	840	30	*		19075	28	12610	40	18300	30
	U	92	8850	90	2430	60	*		14830	80	8920	90	16640	40
219	Po	84	3630#	360#	7820#	510#	3410#	360#	14690#	410#	11790#	360#	*	
	At	85	5773	12	5250	4	-1170	50	15207	7	13477	4	10170	12
	Rn	86	4458	3	6557	12	-5640	50	15146	5	11438	4	12693.3	2.3
	Fr	87	6512	8	3888	7	-9900	50	15671	8	13227	10	12007	8
	Ra	88	5328	14	4954	9	-13820	60	15790	10	11279	16	14785	11
	Ac	89	7350	70	2370	50	*		16390	50	13140	50	14240	50
	Th	90	5970	50	3660	70	*		16480	50	11210	60	16830	50
	Pa	91	8220	60	1140	60	*		17020	60	13080	60	16040	60
	U	92	6780	60	2750	60	*		16850	80	10280	90	18550	60
220	Po	84	5410#	510#	*	5190#	360#	12840#	510#	11510#	410#	*		
	At	85	4120	50	5740#	360#	600	50	16700	50	13320	50	11180#	200#
	Rn	86	6288.6	2.3	7073	4	-4056	22	13226	12	11082	5	10359	7
	Fr	87	5207	8	4637	4	-8890	60	16976	4	12688	6	12734	6
	Ra	88	7193	12	5634	12	-12760#	200#	13925	10	10822	11	12261	10
	Ac	89	5890	50	2932	17	*		17811	19	12728	17	15083	16
	Th	90	7870	60	4190	60	*		14540	60	10826	26	14428	24
	Pa	91	6220	80	1380	80	*		18710	60	13020	60	17320	60
	U	92	8250#	210#	2780#	210#	*		15070#	200#	10830#	210#	16460#	200#

A	Elt.	Z	S(2n)	S(2p)	Q( $\alpha$ )	Q(2 $\beta^-$ )	Q( $\epsilon p$ )	Q( $\beta^- n$ )							
215	Pb	82	8480#	410#	*	*	5020#	410#	*	-2390#	410#				
	Bi	83	9263	16	*	5300#	200#	2904	16	*	-1953	15			
	Po	84	10030	4	11934	8	7526.3	0.8	628	8	-7648.0	2.5	-5232	5	
	At	85	10818	8	10602	8	8178	4	-1573	10	-7344	13	-5007	11	
	Rn	86	11613	9	9093	8	8839	8	-3702	11	-3988	8	-8282	12	
	Fr	87	12275	10	7680	8	9540	7	-5693	22	-3591	8	-7854	12	
	Ra	88	13967	22	6346	9	8864	3	-8393	28	-436	12	-11967	24	
	Ac	89	16290	60	5017	23	7744	4	-11860	90	-319	23	-12772	27	
	Th	90	17330	80	4010	30	7665	6	*	*	3537	28	-16630	80	
	Pa	91	17930	110	2860	100	8240	50	*	*	4150	90	*	*	
216	Bi	83	9068	16	*	5100#	300#	3617	12	*	*	-1657	11		
	Po	84	9888.9	2.3	12612.8	2.0	6906.3	0.5	1528	8	-9980#	410#	-5032	7	
	At	85	10506	5	11120	12	7950	3	-722	15	-6680	15	-4645	8	
	Rn	86	11567	12	9852	7	8200	7	-3035	11	-6493	8	-8134	10	
	Fr	87	12205	17	8219	15	9175	12	-5140	30	-3055	16	-7626	16	
	Ra	88	12952	13	6967	13	9526	8	-7013	16	-2829	12	-10792	23	
	Ac	89	14450	30	5497	28	9235	6	-9680	70	516	27	-10880	40	
	Th	90	16550	21	4374	16	8071	6	*	*	482	15	-15640	90	
	Pa	91	17830	100	3210	70	8097	15	*	*	4500	70	*	*	
217	Bi	83	8970#	200#	*	*	4430#	200#	*	*	-1030#	200#			
	Po	84	9702	7	13160#	410#	6660	4	2242	8	*	*	-4428	7	
	At	85	10492	8	11831	16	7201.3	1.2	81	8	-8767	12	-3931	9	
	Rn	86	11315	9	10379	5	7887.1	2.9	-2229	9	-5414	5	-7392	15	
	Fr	87	12146	9	9008	9	8469	4	-4392	14	-5232	7	-7048	11	
	Ra	88	12789	11	7522	11	9161	6	-6329	22	-1657	11	-10307	28	
	Ac	89	13448	25	6189	14	9832	10	-8360	50	-1561	19	-9669	18	
	Th	90	14850	30	4896	22	9433	4	-10480	90	1636	23	-13660	70	
	Pa	91	16950	100	3520	60	8489	4	*	*	1660	60	*	*	
	U	92	*	*	2810	90	8160	50	*	*	5110	90	*	*	
218	Bi	83	8680#	360#	*	*	5240#	360#	*	*	-640#	360#			
	Po	84	9568.1	2.0	*	6114.68	0.09	3141	3	*	*	-4109	5		
	At	85	10301	12	12353	16	6874	3	1040	12	-8010#	200#	-3631	12	
	Rn	86	11181	7	11144.2	2.9	7262.5	1.9	-1434	11	-7972	7	-7168	7	
	Fr	87	12062	15	9776	6	8014.0	2.0	-3780	50	-4625	7	-6900	10	
	Ra	88	12783	14	8182	13	8546	6	-5723	17	-4296	12	-10127	17	
	Ac	89	13420	60	6710	50	9380	50	-7820	60	-760	50	-9440	50	
	Th	90	14072	18	5495	16	9849	9	-9550	30	-802	15	-12770	50	
	Pa	91	15270	70	4030	40	9815	10	*	*	2673	28	-12100	90	
	U	92	*	*	2960	30	8786	25	*	*	2420	40	*	*	
219	Po	84	9240#	360#	*	5900#	200#	3970#	360#	*	*	-3370#	360#		
	At	85	10141	6	13000#	200#	6324	15	1779	8	-10230#	360#	-2892	4	
	Rn	86	10970	5	11648	7	6946.1	0.3	-563	9	-6816.5	2.5	-6300	5	
	Fr	87	11839	10	10355	8	7448.5	1.8	-2950	50	-6769	14	-6104	13	
	Ra	88	12636	12	8842	9	8138	3	-5080	50	-3112	8	-9520	50	
	Ac	89	13280	50	7320	50	8830	50	-6950	70	-2780	50	-8880	50	
	Th	90	13890	50	5990	50	9510	50	-8740	80	530	50	-12270	60	
	Pa	91	14690	80	4760	60	10080	50	*	*	390	70	-11470	60	
	U	92	15630	100	3580	60	9860	50	*	*	3550	60	*	*	
220	Po	84	9040#	360#	*	*	4850#	360#	*	*	-3000#	360#			
	At	85	9890	50	13560#	360#	6050	50	2870	50	*	*	-2550	50	
	Rn	86	10746.7	2.9	12322.8	2.0	6404.67	0.10	341	9	-9480#	360#	-6076	7	
	Fr	87	11719	6	11194	12	6800.7	1.9	-2269	15	-6203	5	-5983	9	
	Ra	88	12521	14	9523	9	7592	6	-4396	24	-5847	10	-9370	50	
	Ac	89	13230	50	7885	16	8348	4	-6630	60	-2156	16	-8790	50	
	Th	90	13848	26	6560	25	8953	20	-8360#	200#	-2014	24	-11920	60	
	Pa	91	14430	60	5050	80	9830	50	*	*	1520	80	-10910	80	
	U	92	15040#	200#	3920#	200#	10300#	200#	*	*	1270#	210#	*	*	

A	Elt.	Z	S(n)	S(p)	$Q(4\beta^-)$	$Q(d,\alpha)$	$Q(p,\alpha)$	$Q(n,\alpha)$						
221	At	85	5610#	200#	5940#	410#	2290#	200#	14720#	410#	13320#	200#	9130#	410#
	Rn	86	4212	6	7170	50	-2466	11	14786	7	11238	13	11760	6
	Fr	87	6276	6	4624	5	-7100	50	15158	5	12925	5	10826	12
	Ra	88	5380	10	5808	6	-11630#	100#	15056	8	10769	6	13393	5
	Ac	89	7300	50	3040	50	*		15840	50	12740	50	13110	50
	Th	90	5802	24	4103	17	*		16080	50	10960	50	15933	14
	Pa	91	8070	80	1580	60	*		16620	70	12870	50	15180	70
	U	92	6510#	230#	3080#	120#	*		16780#	120#	10790#	110#	17860#	100#
222	At	85	4090#	360#	*		4180#	300#	16050#	470#	12860#	470#	*	
	Rn	86	6170	6	7730#	200#	-829	12	12730	50	10841	4	9220#	360#
	Fr	87	5000	22	5412	22	-5770#	80#	16447	21	12383	21	11599	21
	Ra	88	6714	6	6246	6	-9980#	100#	13549	6	10567	8	11137	5
	Ac	89	5970	50	3631	7	*		17059	10	12091	10	13650	9
	Th	90	7806	15	4610	50	*		14162	19	10500	50	13455	15
	Pa	91	6340#	90#	2110#	70#	*		18160#	80#	12510#	90#	16190#	90#
	U	92	8360#	140#	3370#	110#	*		14630#	120#	10640#	120#	15470#	110#
223	At	85	5410#	500#	*		5640#	400#	*		12860#	540#	*	
	Rn	86	4150#	300#	7790#	420#	910#	300#	14200#	360#	10810#	300#	10480#	470#
	Fr	87	6037	21	5278.7	2.3	-3940	70	14622	6	12634.5	2.2	9680	50
	Ra	88	5158	5	6404	21	-8600	70	14667	5	10616	4	12267.6	2.3
	Ac	89	6866	9	3784	8	*		15573	8	12418	12	11990	8
	Th	90	5889	15	4525	10	*		15570	50	10498	17	14759	13
	Pa	91	7870#	100#	2170	70	*		16090	70	12520	70	14220	70
	U	92	6530#	120#	3570#	100#	*		16170	90	10330	90	16820	70
224	Rn	86	5930#	420#	8310#	500#	2440#	300#	12350#	420#	10490#	360#	*	
	Fr	87	4800	50	5930#	300#	-2210	50	15990	50	12050	50	10490#	200#
	Ra	88	6478.8	2.3	6845.6	2.2	-6886	25	13189	21	10413	5	10001	6
	Ac	89	5663	8	4289	5	*		16624	6	12135	6	12603	6
	Th	90	7461	14	5119	13	*		14086	12	10340	50	12679	12
	Pa	91	6520	70	2804	18	*		17378	20	11796	18	14990	50
	U	92	8200	80	3900	80	*		14310#	80#	10200	60	14422	27
225	Rn	86	4020#	420#	*		4180#	300#	13740#	500#	10560#	420#	*	
	Fr	87	5910	60	5920#	300#	-530	80	14230#	300#	12300	30	8660#	300#
	Ra	88	4904.5	2.9	6950	50	-5383	12	14321.0	2.9	10509	21	11266.9	2.9
	Ac	89	6668	6	4478	5	-9950	70	15114	4	12181	6	10935	22
	Th	90	5757	12	5213	6	*		15195	9	10553	7	13635	7
	Pa	91	7600	70	2940	70	*		15670	70	12000	70	13370	70
	U	92	6408	28	3782	19	*		15770	70	10130#	70#	15821	17
	Np	93	*		1410	80	*		16460	100	12160#	120#	15120#	100#
226	Rn	86	5790#	500#	*		5580#	400#	*		10170#	570#	*	
	Fr	87	4510	100	6410#	310#	1340	100	15640#	310#	11940#	310#	9560#	410#
	Ra	88	6396.2	2.9	7430	30	-3660	13	12720	50	10149.3	2.3	9020#	300#
	Ac	89	5399	5	4973	4	-8430#	90#	16194	3	11940	3	11573	3
	Th	90	7184	7	5730	6	*		13673	6	10235	8	11609	5
	Pa	91	6380	70	3566	12	*		16748	16	11511	15	13853	13
	U	92	8120	17	4300	70	*		14169	20	9870	70	13589	16
	Np	93	6920#	110#	1930#	90#	*		17740#	90#	11760#	110#	16060#	110#
227	Rn	86	3860#	580#	*		7180#	420#	*		*		*	
	Fr	87	5790	140	6410#	410#	2820	100	13870#	310#	12080#	310#	*	
	Ra	88	4561.43	0.27	7480	100	-1843	17	14080	30	10390	50	10390#	300#
	Ac	89	6531	3	5107.1	2.3	-6710	70	14567.7	2.9	11887.8	2.1	9840	50
	Th	90	5462	5	5793	3	*		14879	4	10436	5	12625.4	2.3
	Pa	91	7273	14	3654	9	*		15232	9	11700	13	12243	8
	U	92	6378	21	4300	20	*		15390	70	10016	23	14672	20
	Np	93	8250#	110#	2060	70	*		15900	70	11710	80	14340	70

A	Elt.	Z	S(2n)	S(2p)	Q( $\alpha$ )	Q( $2\beta^-$ )	Q( $\epsilon p$ )	Q( $\beta^- n$ )						
221	At	85	9730#	200#	*	5570#	280#	3540#	200#	*	-1870#	200#		
	Rn	86	10501	6	12910#	360#	6147	3	1509	7	-8280#	360#	-5082	7
	Fr	87	11483	8	11697	5	6457.8	1.4	-1240	50	-8360	50	-5066	10
	Ra	88	12573	9	10445	5	6880.4	2.0	-3974	10	-4938	5	-8859	15
	Ac	89	13190	70	8670	50	7780	50	-5860	70	-4250	50	-8220	60
	Th	90	13680	50	7034	12	8626	4	-7650#	100#	-624	13	-11510	60
	Pa	91	14280	70	5770	70	9250	50	*		-660	50	-10720#	210#
	U	92	14760#	120#	4460#	110#	9950#	100#	*		2630#	110#	*	
222	At	85	9700#	300#	*	5040#	200#	4450#	300#	*		-1740#	300#	
	Rn	86	10382.5	1.9	13670#	360#	5590.3	0.3	2052	5	*		-4976	5
	Fr	87	11276	22	12580	60	5826	24	-272	22	-7750#	200#	-4686	22
	Ra	88	12094	10	10870	5	6679	4	-2882	13	-7440	7	-8270	50
	Ac	89	13273	16	9439	6	7137.4	2.0	-5490#	70#	-3946	7	-8388	11
	Th	90	13609	25	7648	15	8127	5	-7100#	100#	-3050	13	-11250	50
	Pa	91	14400#	90#	6210#	70#	8850#	50#	*		300#	90#	-10550#	130#
	U	92	14870#	220#	4950#	100#	9500#	100#	*		70#	100#	*	
223	At	85	9490#	450#	*	*	*	5080#	400#	*		-980#	400#	
	Rn	86	10320#	300#	*	5070#	200#	3060#	300#	*		-4120#	300#	
	Fr	87	11037	5	13010#	200#	5562	3	557	7	-9710#	300#	-4009	5
	Ra	88	11872	5	11816	6	5978.99	0.21	-2151	9	-6427.9	2.4	-7458	6
	Ac	89	12840	50	10030	8	6783.2	1.0	-4490	70	-5812	22	-7448	14
	Th	90	13695	13	8156	10	7567	4	-6450	70	-2225	10	-10800#	70#
	Pa	91	14200	90	6780	90	8330	50	*		-1590	70	-10050#	120#
	U	92	14900#	120#	5680	70	8940	50	*		1350	70	*	
224	Rn	86	10080#	300#	*	4550#	200#	3610#	300#	*		-4020#	300#	
	Fr	87	10830	50	13720#	300#	4880	70	1420	50	-9100#	400#	-3650	50
	Ra	88	11637	5	12124.3	1.9	5788.85	0.15	-1169	11	-8760#	300#	-7071	7
	Ac	89	12529	6	10693	22	6326.9	0.7	-3636	16	-5438	4	-7222	10
	Th	90	13349	16	8903	12	7298	6	-5717	28	-4527	11	-10400	70
	Pa	91	14390#	70#	7329	16	7694	4	*		-1245	17	-10040	70
	U	92	14730#	100#	6067	28	8620	12	*		-961	27	*	
225	Rn	86	9950#	420#	*	*	*	4500#	300#	*		-3240#	300#	
	Fr	87	10710	30	14230#	400#	4580#	200#	2180	30	*		-3080	30
	Ra	88	11383	3	12880#	300#	5097	5	-316	6	-7740#	300#	-6312	5
	Ac	89	12331	8	11324	4	5935.1	1.4	-2700	70	-7310	50	-6429	12
	Th	90	13218	10	9502	6	6921.4	2.1	-5067	13	-3806	5	-9631	16
	Pa	91	14120	100	8060	70	7390	50	-7250	100	-3180	70	-9440	80
	U	92	14600	70	6586	15	8014	7	*		92	16	*	
	Np	93	*	5310	100	8790	50	*	*		430	70	*	
226	Rn	86	9810#	500#	*	*	*	5110#	400#	*		-3110#	400#	
	Fr	87	10430	110	*	4150#	310#	3060	100	*		-2690	100	
	Ra	88	11300.7	1.9	13350#	300#	4870.62	0.25	472	5	-10110#	300#	-6040	5
	Ac	89	12067	5	11920	50	5536	21	-1723	12	-6790	30	-6071	6
	Th	90	12942	12	10208	5	6450.9	2.2	-4132	14	-6086	5	-9210	70
	Pa	91	13980	19	8779	12	6987	10	-6710#	90#	-2894	12	-9415	16
	U	92	14527	28	7245	17	7701	4	*		-2270	14	-12330	70
	Np	93	*	5710#	90#	8200	50	*	*		1110#	110#	*	
227	Rn	86	9650#	520#	*	*	*	5800#	420#	*		-2460#	440#	
	Fr	87	10300	100	*	3770#	410#	3800	100	*		-2090	100	
	Ra	88	10957.7	2.9	13890#	300#	4460#	300#	1372.8	2.4	-8880#	400#	-5203	3
	Ac	89	11930	4	12540	30	5042.19	0.14	-981	7	-8810	100	-5417	5
	Th	90	12647	6	10766	3	6146.60	0.10	-3216	17	-5151.9	2.4	-8298	12
	Pa	91	13650	70	9384	9	6580.4	2.1	-5730	70	-4767	8	-8568	15
	U	92	14498	20	7866	18	7211	14	*		-1464	17	-11790#	90#
	Np	93	15170	100	6360	100	7816	14	*		-760	70	*	

A	El.	Z	S(n)	S(p)	$Q(4\beta^-)$	$Q(d,\alpha)$	$Q(p,\alpha)$	$Q(n,\alpha)$						
228	Rn	86	5670#	590#	*	8610#	410#	*	*	*				
	Fr	87	4450#	220#	6990#	470#	4360#	200#	15220#	450#	11650#	360#	*	
	Ra	88	6308.5	2.4	8000	100	-283	15	12280	100	9990	30	8100#	300#
	Ac	89	5026.3	2.5	5572.0	2.4	-4810#	200#	15937.7	2.4	11766.0	3.0	10730	30
	Th	90	7105.3	2.3	6367.7	2.1	-9320	30	13173	3	9998	5	10424.6	2.8
	Pa	91	5979	8	4171	5	*	*	16438	6	11478	7	12932	6
	U	92	7869	22	4896	17	*	*	13902	19	9750	70	12561	16
	Np	93	6930#	210#	2610#	200#	*	*	17080#	200#	11190#	200#	15010#	210#
	Pu	94	*	*	3760	80	*	*	14060#	90#	9360	80	14360	30
229	Fr	87	5540#	200#	6860#	410#	5920	40	13550#	430#	11910#	400#	*	*
	Ra	88	4450	19	8010#	200#	1352	20	13620	100	10050	100	9440#	400#
	Ac	89	6210	30	5480	30	-3030	90	14290	30	11950	30	9030	110
	Th	90	5257.0	2.7	6598.4	2.8	-7810	50	14446.4	2.7	10140	4	11563.8	2.7
	Pa	91	7098	5	4163.2	2.5	*	*	14802.6	2.0	11565	5	11234	4
	U	92	6085	16	5003	7	*	*	15090	9	10041	13	13660	7
	Np	93	7990#	210#	2730	90	*	*	15470	90	11310	90	13390	90
	Pu	94	6760	60	3590#	200#	*	*	15550	90	9530#	100#	15720	50
230	Fr	87	4290#	450#	*		7420#	450#	14930#	610#	11480#	620#	*	*
	Ra	88	6116	22	8590	40	2903	13	11950#	200#	9730	100	7180#	420#
	Ac	89	5020	300	6040	300	-1430	300	15580	300	11490	300	9800	320
	Th	90	6793.9	2.3	7180	30	-6070	15	12678.8	1.9	9877.1	1.7	9331.4	1.5
	Pa	91	5795	4	4701	4	*	*	16113	3	11232	3	11970	3
	U	92	7667	7	5572	5	*	*	13401	6	9647	9	11455	5
	Np	93	6610	100	3260	50	*	*	16720	50	11080	50	14050	50
	Pu	94	8540	50	4130	90	*	*	13940#	200#	9240	70	13558	23
231	Fr	87	5340#	650#	*		8900#	470#	*		11810#	620#	*	*
	Ra	88	4190#	300#	8490#	540#	4590#	300#	13290#	300#	9980#	360#	8660#	510#
	Ac	89	5960	320	5890	100	290	110	14070	100	11840	100	8280#	220#
	Th	90	5118.02	0.20	7280	300	-4468	26	13770	30	9785.4	1.9	10521.9	1.8
	Pa	91	6820	3	4727.2	1.5	-9010#	300#	14550.0	2.6	11517.6	2.0	10176.1	2.3
	U	92	5879	5	5656	4	*	*	14620.2	2.6	9747	5	12681.6	2.8
	Np	93	7680	70	3280	50	*	*	15130	50	11260	50	12350	50
	Pu	94	6720	30	4240	60	*	*	15220	90	9450#	200#	14710	30
	Am	95	*	*	1780#	300#	*	*	15750#	300#	11220#	300#	14380#	360#
232	Fr	87	4040#	790#	*		10420#	640#	*		*	*	*	*
	Ra	88	5820#	410#	8970#	550#	6040#	280#	11760#	530#	9700#	280#	*	*
	Ac	89	4840	140	6540#	310#	1790#	140#	15340	100	11450	100	8980	110
	Th	90	6440.3	1.1	7760	100	-2917	18	12350	300	9560	30	8532	19
	Pa	91	5549	8	5158	8	-7450#	300#	15795	8	11225	8	10840	30
	U	92	7268.0	2.8	6104.0	2.0	*	*	13147	3	9576.8	2.5	10670.6	2.7
	Np	93	6340#	110#	3740#	100#	*	*	16460#	100#	11010#	100#	13110#	100#
	Pu	94	7990	30	4550	50	*	*	13840	50	9450	90	12801	19
	Am	95	7110#	420#	2180#	300#	*	*	17180#	300#	10860#	300#	15270#	310#
233	Ra	88	3950#	550#	8880#	790#	7850#	470#	13150#	660#	10030#	650#	*	*
	Ac	89	5720#	310#	6440#	410#	3550#	300#	13810#	420#	11840#	300#	7550#	540#
	Th	90	4786.39	0.09	7700	100	-1320	50	13530	100	9790	300	9862	12
	Pa	91	6529	8	5247.2	1.4	-5680#	100#	14383.6	1.4	11490.2	1.4	9330	300
	U	92	5762.1	2.6	6317	8	-10370	70	14205.0	2.5	9610	4	11702.4	2.1
	Np	93	7480#	110#	3950	50	*	*	14850	50	11200	50	11420	50
	Pu	94	6390	50	4600#	110#	*	*	15140	70	9680	70	14080	50
	Am	95	8300#	320#	2480#	100#	*	*	15600#	110#	11100#	100#	13580#	110#
	Cm	96	*	*	3390#	310#	*	*	15570#	310#	*	*	16010	70

A	Elt.	Z	S(2n)		S(2p)		Q( $\alpha$ )		Q(2 $\beta^-$ )		Q( $\epsilon p$ )		Q( $\beta^- n$ )		
228	Rn	86	9530#	570#	*	*	6440#	410#	*				-2340#	420#	
	Fr	87	10230#	220#	*	*	4390#	200#	*				-1970#	200#	
	Ra	88	10869.9	2.3	14410#	400#	4080#	300#	2169.6	2.6	-11330#	420#	-4980.5	2.4	
	Ac	89	11557	3	13060	100	4810	50	-28	5	-8050	100	-4981.5	2.6	
	Th	90	12568	5	11474.9	1.9	5520.08	0.22	-2453	15	-7695.8	1.9	-8131	8	
	Pa	91	13252	12	9964	5	6264.5	1.5	-4780#	200#	-4216	5	-8169	17	
	U	92	14247	20	8550	16	6803	10	-6860	40	-3870	15	-11410	70	
	Np	93	15180#	220#	6910#	200#	7410#	200#	*	*	-420#	200#	*	*	
	Pu	94	*	*	5820	30	7950	20	*	*	-220	40	*	*	
	229	Fr	87	9980	110	*	*	5060	50	*	*			-1200	40
Ra		88	10759	19	15000#	420#	3650#	300#	2976	19	-10110#	410#	-4405	19	
Ac		89	11240	30	13480	110	4510	40	860	30	-9820#	200#	-4090	30	
Th		90	12362.3	2.9	12170.4	2.7	5167.6	1.0	-1624	6	-6644.2	2.7	-7409	5	
Pa		91	13076	8	10530.9	1.8	5835	4	-3880	90	-6287.0	2.8	-7398	15	
U		92	13954	18	9174	6	6475	3	-6190	50	-2851	6	-10560#	200#	
Np		93	14930	110	7630	90	7010	50	*	*	-2430	90	-10380	90	
Pu		94	*	*	6200	50	7600	50	*	*	890	50	*	*	
230		Fr	87	9830#	490#	*	*	5790#	540#	*	*			-1040#	450#
		Ra	88	10567	12	15440#	410#	3320#	400#	3654	12	*	*	-4310	40
	Ac	89	11230	300	14050#	360#	4010	320	1630	300	-9300	300	-3850	300	
	Th	90	12050.8	1.2	12655.8	1.8	4770.0	1.5	-751	5	-8988	19	-7105.3	2.2	
	Pa	91	12892	5	11299	3	5439.4	0.7	-3060	50	-5870	30	-7107	7	
	U	92	13753	16	9735	5	5992.7	0.7	-5319	16	-5261	5	-10240	90	
	Np	93	14610#	200#	8270	50	6780	50	*	*	-1950	50	-10230	70	
	Pu	94	15300	40	6869	21	7180	8	*	*	-1566	16	*	*	
	231	Fr	87	9630#	470#	*	*	6410#	480#	*	*			-260#	470#
		Ra	88	10310#	300#	*	2990#	300#	4580#	300#	*	*		-3480#	420#
Ac		89	10980	110	14480	110	3840	140	2490	100	-10970#	460#	-3020	100	
Th		90	11911.9	2.3	13323	19	4213.4	1.6	9.9	2.5	-7990	12	-6428.5	2.8	
Pa		91	12614.9	1.6	11910	30	5149.9	0.8	-2200	50	-7670	300	-6260	5	
U		92	13546	7	10357	3	5576.3	1.7	-4478	27	-4345.6	2.5	-9500	50	
Np		93	14300	100	8850	50	6370	50	-6810#	300#	-3840	50	-9380	50	
Pu		94	15260	60	7503	27	6839	20	*	*	-618	27	*	*	
Am		95	*	*	5920#	310#	7450#	310#	*	*	-90#	300#	*	*	
232		Fr	87	9380#	780#	*	*	7210#	650#	*	*			-110#	710#
	Ra	88	10010#	280#	*	2840#	300#	5200#	280#	*	*		-3340#	300#	
	Ac	89	10800	320	15030#	460#	3440#	220#	3200	100	-10470#	480#	-2740	100	
	Th	90	11558.3	1.1	13647	12	4081.6	1.4	837.6	2.2	-10240#	300#	-6048.7	1.7	
	Pa	91	12369	8	12440	300	4627	8	-1410#	100#	-7260	100	-5931	8	
	U	92	13147	5	10831.2	1.2	5413.63	0.09	-3755	18	-6495.5	1.2	-9090	50	
	Np	93	14020#	110#	9390#	100#	6010#	100#	-6040#	310#	-3350#	100#	-9000#	100#	
	Pu	94	14711	23	7827	19	6716	10	*	*	-2731	18	-12150#	300#	
	Am	95	*	*	6420#	300#	7270#	360#	*	*	480#	300#	*	*	
	233	Ra	88	9770#	560#	*	*	6030#	470#	*	*			-2450#	480#
Ac		89	10560#	310#	15410#	550#	3260#	300#	4010#	300#	-12150#	710#	-2020#	300#	
Th		90	11226.7	1.1	14240#	300#	3746	19	1813.3	2.2	-9200#	280#	-5286	8	
Pa		91	12078.3	1.9	13010	100	4310	30	-460	50	-8950	100	-5192.0	2.1	
U		92	13030	3	11475.3	2.1	4908.5	1.2	-3130	50	-5817.3	2.2	-8510#	100#	
Np		93	13820	70	10050	50	5630	50	-5220#	110#	-5290	50	-8490	50	
Pu		94	14380	60	8330	50	6420	50	-7240	90	-1850	50	-11420#	300#	
Am		95	15410#	320#	7030#	110#	6970#	50#	*	*	-1480#	140#	*	*	
Cm		96	*	*	5570	80	7470	50	*	*	1640	70	*	*	

A	Elt.	Z	S(n)	S(p)	Q(4β <sup>-</sup> )	Q(d,α)	Q(p,α)	Q(n,α)						
234	Ra	88	5610#	680#	*	9080#	490#	11580#	810#	9770#	680#	*	8420#	620#
	Ac	89	4470#	500#	6950#	620#	5150#	400#	15170#	490#	11570#	500#	8420#	620#
	Th	90	6190	3	8170#	300#	265	8	12180	100	9560	100	7870#	300#
	Pa	91	5220	5	5681	5	-4190#	210#	15604	5	11388	5	10070	100
	U	92	6844.6	2.1	6632.4	1.2	-8577	18	12910	8	9585.0	1.5	9975.7	0.7
	Np	93	6060	50	4252	9	*	*	16057	8	11013	9	12177	8
	Pu	94	7770	50	4890	50	*	*	13700#	100#	9590	50	12189	7
	Am	95	6710#	230#	2810#	210#	*	*	16880#	210#	11110#	210#	14560#	210#
	Cm	96	8640	70	3740#	100#	*	*	14040#	300#	9150#	300#	14080	30
235	Ac	89	5450#	540#	6800#	610#	6680#	360#	13670#	590#	11940#	450#	7010#	730#
	Th	90	4430	50	8140#	400#	2070	50	13470#	300#	9970	110	9250#	280#
	Pa	91	6080	50	5570	50	-2330#	130#	14310	50	11750	50	8830	110
	U	92	5297.49	0.23	6710	4	-6990#	200#	14141.2	1.2	9837	8	11118.5	0.9
	Np	93	6983	8	4390.9	0.9	-11660#	400#	14835.5	2.2	11298.0	1.8	10743	8
	Pu	94	6237	22	5062	22	*	*	14940	50	9690#	100#	13219	21
	Am	95	7940#	240#	2980#	120#	*	*	15320#	130#	11160#	120#	12950#	160#
	Cm	96	6890#	200#	3910#	290#	*	*	15450#	230#	9380#	360#	15190#	200#
	Bk	97	*	*	1310#	400#	*	*	16120#	410#	*	*	14950#	500#
236	Ac	89	4290#	610#	*	*	8130#	500#	14990#	700#	11600#	680#	*	*
	Th	90	5870#	200#	8560#	410#	3550#	200#	12060#	450#	9820#	360#	7330#	510#
	Pa	91	5060	210	6200	210	-840#	220#	15440	200	11480	200	9500#	360#
	U	92	6545.45	0.26	7170	50	-5440#	200#	12816	4	9820.3	1.2	9359.5	0.9
	Np	93	5740	50	4830	50	-10020#	400#	15940	50	11320	50	11540	50
	Pu	94	7352	21	5430.9	1.8	*	*	13657	8	9820	50	11629.2	2.6
	Am	95	6550#	160#	3290#	100#	*	*	16540#	100#	11000#	110#	13880#	110#
	Cm	96	8090#	290#	4060#	230#	*	*	14070#	290#	9580#	230#	13490#	210#
	Bk	97	7370#	570#	1800#	450#	*	*	17390#	400#	10970#	410#	15880#	410#
237	Th	90	4320#	410#	8590#	620#	5110#	360#	13190#	510#	9960#	540#	8620#	610#
	Pa	91	5780	220	6100#	220#	1070#	120#	14100	110	11890	100	8190#	410#
	U	92	5125.8	0.5	7240	200	-3890#	210#	13770	50	9915	5	10424	3
	Np	93	6580	50	4862.02	0.23	-8230#	220#	14663.6	0.3	11590.7	0.4	10178	4
	Pu	94	5880.7	2.1	5570	50	-12730#	500#	14759.4	1.6	10001	8	12593.1	1.3
	Am	95	7680#	120#	3620#	60#	*	*	15100#	60#	11090#	60#	12260#	60#
	Cm	96	6690#	290#	4200#	230#	*	*	15330#	240#	9610#	290#	14570#	210#
	Bk	97	8380#	460#	2080#	300#	*	*	15900#	300#	11240#	230#	14210#	310#
	Cf	98	*	*	2870#	640#	*	*	15830#	640#	*	*	16740#	500#
238	Th	90	5650#	460#	*	*	6460#	280#	11830#	570#	9770#	460#	*	*
	Pa	91	4940	120	6720#	360#	2350	80	15030#	210#	11380	80	8690#	360#
	U	92	6154.2	1.3	7620	100	-2090	40	12670	200	9840	50	8700	50
	Np	93	5488.32	0.20	5224.6	0.5	-6830#	290#	15720.8	0.3	11399.9	0.4	10770	50
	Pu	94	6999.9	1.3	5997.5	0.4	-11040#	400#	13500	50	9984.1	0.9	10890.69	0.28
	Am	95	6220#	80#	3960	50	*	*	16230	50	11100	50	13020	50
	Cm	96	7950#	210#	4460#	70#	*	*	13920#	110#	9600#	130#	12860	40
	Bk	97	6880#	370#	2280#	350#	*	*	17110#	350#	11240#	350#	15270#	310#
	Cf	98	8690#	640#	3180#	460#	*	*	14510#	570#	9360#	570#	14940#	450#
239	Pa	91	5500#	210#	6580#	340#	3950#	200#	13850#	410#	11750#	280#	7480#	540#
	U	92	4806.38	0.17	7480	60	-620#	100#	13640	100	10090	200	9770#	200#
	Np	93	6215.2	1.1	5285.5	1.5	-4970#	230#	14631.3	1.1	11730.1	1.0	9610	200
	Pu	94	5646.2	0.3	6155.4	0.4	-9560#	210#	14427.41	0.29	10070	50	11789.95	0.25
	Am	95	7100	50	4061.7	1.7	*	*	15009.5	2.1	11353.3	2.3	11660	50
	Cm	96	6280#	110#	4520#	110#	*	*	15330#	120#	9870#	140#	13940#	100#
	Bk	97	8070#	370#	2400#	240#	*	*	15720#	310#	11260#	310#	13750#	250#
	Cf	98	7130#	450#	3430#	360#	*	*	15760#	310#	9610#	450#	15900#	290#



A	Elt.	Z	S(2n)		S(2p)		Q( $\alpha$ )		Q(2 $\beta^-$ )		Q( $\epsilon$ p)		Q( $\beta^-$ n)	
234														
Ra	88	9560#	560#	*	*	*	6620#	490#	*	*	-2340#	570#		
Ac	89	10190#	410#	15840#	760#	3080#	200#	4760#	400#	*	-1700#	400#		
Th	90	10977	3	14610#	280#	3672	13	2468	3	-11440#	470#	-4947	3	
Pa	91	11749	9	13390	100	4110	300	385	9	-8450#	300#	-4650	5	
U	92	12606.7	1.6	11879.6	0.9	4857.7	0.7	-2203	7	-7875.6	0.9	-7870	50	
Np	93	13550#	100#	10569	11	5357	9	-4580#	210#	-4823	8	-8170	50	
Pu	94	14159	19	8839	7	6310	5	-6374	19	-3859	7	-10900#	100#	
Am	95	15010#	360#	7410#	230#	6870#	200#	*	*	-710#	210#	-10830#	220#	
Cm	96	*	*	6220	26	7365	10	*	*	-620	50	*	*	
235														
Ac	89	9920#	470#	*	*	2970#	300#	5390#	360#	*	*	-960#	360#	
Th	90	10620	50	15090#	470#	3430#	300#	3330	50	-10260#	490#	-4160	50	
Pa	91	11300	50	13750#	300#	3990	110	1290	50	-10060#	400#	-3890	50	
U	92	12142.1	2.1	12390.7	0.9	4678.3	0.7	-1263	21	-6983	3	-7107	8	
Np	93	13050	50	11023.4	1.5	5194.0	1.5	-3620#	120#	-6585	5	-7376	7	
Pu	94	14010	50	9314	21	5951	20	-5730#	200#	-3252	21	-10420#	210#	
Am	95	14650#	160#	7870#	130#	6610#	110#	-8040#	420#	-2580#	120#	-10130#	120#	
Cm	96	15530#	210#	6720#	210#	7200#	200#	*	*	270#	200#	*	*	
Bk	97	*	*	5050#	410#	7840#	500#	*	*	880#	450#	*	*	
236														
Ac	89	9740#	640#	*	*	2720#	400#	6160#	540#	*	*	-820#	500#	
Th	90	10300#	200#	15360#	530#	3380#	200#	4010#	200#	*	*	-3950#	200#	
Pa	91	11140	200	14340#	450#	3770	220	1970	210	-9670#	410#	-3650	200	
U	92	11842.9	0.3	12746	3	4573.1	0.9	-456.4	1.7	-9100	50	-6669.7	0.9	
Np	93	12720	50	11540	50	5010	50	-2800#	110#	-6240	70	-6880	50	
Pu	94	13590	7	9821.8	1.6	5867.07	0.08	-4990#	200#	-5306.7	1.6	-9830#	120#	
Am	95	14490#	230#	8350#	100#	6400#	140#	-7220#	410#	-2150#	100#	-9800#	230#	
Cm	96	14980#	200#	7040#	200#	7100#	200#	*	*	-1580#	200#	-12890#	450#	
Bk	97	*	*	5710#	450#	7580#	500#	*	*	1450#	420#	*	*	
237														
Th	90	10200#	360#	*	*	3010#	300#	4810#	360#	*	*	-3220#	410#	
Pa	91	10830	110	14660#	370#	3720#	310#	2770	100	-11160#	510#	-2880	100	
U	92	11671.2	0.5	13440	50	4233.7	1.0	298.6	1.4	-8350#	200#	-6060	50	
Np	93	12314.0	0.9	12040	50	4958.3	1.2	-1700#	60#	-7760	200	-6100.8	1.7	
Pu	94	13233	21	10405.1	1.3	5748.4	2.3	-4180#	210#	-4642.0	1.3	-9160#	100#	
Am	95	14230#	130#	9050#	60#	6200#	30#	-6530#	230#	-4100#	80#	-9390#	210#	
Cm	96	14780#	290#	7490#	210#	6800#	200#	-8540#	540#	-920#	210#	-12200#	450#	
Bk	97	15750#	460#	6140#	260#	7500#	200#	*	*	-370#	250#	*	*	
Cf	98	*	*	4670#	540#	8100#	510#	*	*	2640#	540#	*	*	
238														
Th	90	9970#	340#	*	*	2970#	400#	5320#	280#	*	*	-3090#	300#	
Pa	91	10720	210	15320#	500#	3240#	410#	3310	60	*	*	-2690	60	
U	92	11280.0	1.2	13720#	200#	4269.7	2.9	1144.2	1.2	-10180#	360#	-5635.6	1.2	
Np	93	12070	50	12470	200	4690	4	-970	50	-7470	100	-5708.4	1.3	
Pu	94	12880.6	1.6	10859.5	0.4	5593.20	0.19	-3230	40	-6516.1	0.6	-8480#	60#	
Am	95	13900#	110#	9530	70	6040	50	-5870#	290#	-3740	50	-8930#	210#	
Cm	96	14640#	200#	8080	40	6620	40	-7810#	400#	-2990	40	-11770#	230#	
Bk	97	15260#	490#	6470#	310#	7330#	200#	*	*	430#	290#	-11600#	580#	
Cf	98	*	*	5270#	450#	8060#	400#	*	*	640#	450#	*	*	
239														
Pa	91	10450#	220#	*	*	3190#	300#	4030#	200#	*	*	-2040#	200#	
U	92	10960.6	1.3	14210#	360#	3890	50	1984.0	1.2	-9340#	280#	-4953.7	1.2	
Np	93	11703.5	1.0	12910	100	4560	50	-79.6	1.9	-8750	60	-4923.7	1.0	
Pu	94	12646.1	1.3	11379.9	0.5	5244.51	0.21	-2600#	100#	-6008.0	1.2	-7900	50	
Am	95	13320#	60#	10059.2	1.7	5922.4	1.4	-4900#	230#	-5353.3	1.7	-8080	40	
Cm	96	14230#	230#	8480#	100#	6580#	100#	-6950#	230#	-2260#	100#	-11170#	310#	
Bk	97	14950#	320#	6860#	240#	7200#	200#	*	*	-1430#	240#	-10990#	460#	
Cf	98	15820#	550#	5710#	290#	7810#	60#	*	*	1460#	210#	*	*	

A	Elt.	Z	S(n)	S(p)	$Q(4\beta^-)$	$Q(d,\alpha)$	$Q(p,\alpha)$	$Q(n,\alpha)$						
240	Pa	91	4610#	360#	*	5290#	300#	14890#	410#	11460#	470#	*		
	U	92	5930	5	7910#	200#	990	5	12660	60	9940	100	8160#	360#
	Np	93	5069	15	5548	15	-3350#	150#	15717	15	11787	15	10320	100
	Pu	94	6534.20	0.23	6474.4	1.0	-7910#	200#	13381.53	0.27	10117.78	0.18	10381.5	0.5
	Am	95	5952	14	4367	14	-12690#	400#	16058	14	11283	14	12285	14
	Cm	96	7540#	100#	4955.5	2.4	*		14010	50	10020#	60#	12278.5	2.2
	Bk	97	6690#	280#	2820#	180#	*		16980#	150#	11250#	260#	14740#	160#
	Cf	98	8180#	290#	3540#	310#	*		14460#	350#	9800#	300#	14400#	290#
	Es	99	*		1240#	450#	*		17710#	570#	11250#	640#	16750#	460#
241	U	92	4590#	300#	7890#	420#	2490#	300#	13570#	360#	10290#	300#	9220#	410#
	Np	93	6120	70	5740	70	-1840#	210#	14400	70	11820	70	9140	90
	Pu	94	5241.52	0.03	6647	15	-6400#	260#	14355.2	1.0	10364.57	0.27	11294.2	1.2
	Am	95	6647	14	4479.96	0.13	-10910#	230#	15056.94	0.27	11635.3	0.4	11126.14	0.23
	Cm	96	6093.3	2.1	5097	14	*		15022.2	2.0	10140	50	13185.1	1.2
	Bk	97	7630#	250#	2910#	200#	*		15620#	220#	11570#	200#	13330#	210#
	Cf	98	6750#	330#	3590#	300#	*		15790#	350#	9940#	390#	15610#	260#
	Es	99	8430#	460#	1480#	300#	*		16410#	310#	11500#	460#	15200#	370#
242	U	92	5650#	360#	*	3820#	200#	12530#	360#	10150#	280#	*		
	Np	93	4910	210	6070#	360#	-320#	280#	15410	200	11710	200	9730#	280#
	Pu	94	6309.7	0.7	6830	70	-4620	40	13114	15	10270.1	1.2	9790.9	1.0
	Am	95	5537.64	0.10	4776.08	0.16	-9500#	330#	16053.50	0.17	11743.86	0.28	11803.7	1.0
	Cm	96	6969.5	1.2	5419.8	0.4	-13590#	400#	14004	14	10277.3	1.7	11861.7	0.3
	Bk	97	6440#	280#	3260#	200#	*		16720#	200#	11410#	220#	13990#	200#
	Cf	98	8090#	260#	4060#	200#	*		14380#	150#	9920#	240#	13790#	110#
	Es	99	6950#	400#	1680#	410#	*		17640#	380#	11690#	390#	16330#	400#
	Fm	100	*		2730#	460#	*		14910#	570#	*		15900#	450#
243	Np	93	5610#	200#	6030#	200#	1180#	30#	14390#	300#	12020#	30#	8720#	300#
	Pu	94	5034.2	2.6	6950	200	-3190#	140#	14200	70	10305	15	10687	4
	Am	95	6364.9	1.4	4831.3	1.6	-7610#	230#	14930.1	1.4	11913.2	1.4	10508	15
	Cm	96	5692.9	1.0	5575.1	1.0	-12080#	220#	14958.4	1.0	10536	14	12703.0	1.0
	Bk	97	7120#	200#	3403	4	*		15699	5	11830	5	12826	14
	Cf	98	6460#	150#	4080#	250#	*		15550#	250#	10140#	210#	14870#	140#
	Es	99	8260#	400#	1840#	240#	*		16130#	350#	11610#	310#	14760#	280#
	Fm	100	7210#	460#	3000#	390#	*		16130#	310#	9930#	460#	16870#	300#
244	Np	93	4750#	300#	*	2490#	300#	15290#	360#	11870#	420#	*		
	Pu	94	6021	4	7360#	30#	-1674	5	13100	200	10410	70	9260#	300#
	Am	95	5366.5	1.7	5163.5	2.9	-6150#	180#	15873.4	1.2	11788.2	1.0	11270	70
	Cm	96	6801.3	1.0	6011.4	1.4	-10560#	280#	13694.77	0.17	10381.70	0.14	11143.26	0.06
	Bk	97	6047	15	3757	14	*		16621	14	11876	14	13426	14
	Cf	98	7540#	140#	4501	5	*		14460#	200#	10240#	200#	13422.2	2.8
	Es	99	6830#	300#	2210#	230#	*		17400#	190#	11530#	310#	15570#	270#
	Fm	100	8320#	360#	3060#	370#	*		14750#	430#	10030#	360#	15300#	380#
245	Pu	94	4771	14	7390#	300#	-281	14	13940#	30#	10550	200	10130#	200#
	Am	95	6053	3	5195	6	-4540#	200#	14855	4	12045	3	10130	200
	Cm	96	5520.3	1.0	6165.2	1.4	-9220#	280#	14539.4	1.7	10399.1	1.0	11932.7	1.2
	Bk	97	6971	14	3927.2	1.4	-13480#	320#	15342.7	1.7	11874.3	1.5	11992.2	1.4
	Cf	98	6164	3	4618	15	*		15407	5	10520#	200#	14228.1	2.2
	Es	99	7660#	270#	2330#	200#	*		16200#	250#	11960#	200#	14350#	280#
	Fm	100	6860#	400#	3100#	330#	*		16150#	360#	10120#	430#	16530#	280#
	Md	101	*		1010#	430#	*		16740#	390#	11760#	510#	15970#	460#
246	Pu	94	5782	20	*	1303	15	12900#	300#	10380#	40#	*		
	Am	95	4976	18	5400	23	-2910#	220#	15900	18	12103	18	10770#	40#
	Cm	96	6457.6	1.5	6570	3	-7520	40	13448.3	1.5	10306.4	1.8	10509.3	2.7
	Bk	97	5920	60	4330	60	-12310#	340#	16230	60	11650	60	12440	60
	Cf	98	7366.5	2.4	5012.7	1.8	*		14087	14	10265	5	12554.5	1.4
	Es	99	6610#	300#	2770#	220#	*		17130#	220#	11820#	270#	14860#	220#
	Fm	100	8150#	280#	3590#	200#	*		14830#	190#	10220#	240#	14840#	150#
	Md	101	7090#	460#	1230#	430#	*		17980#	440#	11880#	390#	17140#	400#

A	Elt.	Z	S(2n)	S(2p)	Q( $\alpha$ )	Q( $2\beta^-$ )	Q( $\epsilon p$ )	Q( $\beta^- n$ )						
240	Pa	91	10110#	300#	*	2870#	400#	4490#	300#	*	-1840#	300#		
	U	92	10736	5	14490#	280#	3840#	200#	2588	5	*	-4669	5	
	Np	93	11284	15	13030	60	4540	200	803	20	-8310#	200#	-4346	15
	Pu	94	12180.4	0.4	11759.9	1.2	5255.75	0.14	-1598.4	1.8	-7735.9	1.2	-7336.3	1.7
	Am	95	13050	50	10522	14	5710	50	-4150#	150#	-5090	14	-7750#	100#
	Cm	96	13810	40	9017.3	1.7	6397.8	0.6	-6310#	200#	-4153.4	1.7	-10630#	230#
	Bk	97	14770#	330#	7340#	160#	7060#	180#	-8530#	430#	-1020#	150#	-10550#	260#
	Cf	98	15310#	450#	5940#	200#	7719	10	*	*	-450#	230#	*	*
	Es	99	*	*	4670#	490#	8370#	570#	*	*	2620#	460#	*	*
241	U	92	10520#	300#	*	3570#	200#	3240#	300#	*	*	-4190#	300#	
	Np	93	11190	70	13650#	210#	4200	120	1330	70	-9830#	310#	-3940	70
	Pu	94	11775.72	0.23	12195.0	1.2	5140.0	0.5	-746.6	1.2	-7047	5	-6626	14
	Am	95	12598.6	1.7	10954.3	1.0	5637.82	0.12	-3170#	200#	-6668	15	-6860.7	1.8
	Cm	96	13630#	100#	9464.4	1.2	6185.2	0.6	-5660#	260#	-3712.5	1.2	-10030#	150#
	Bk	97	14330#	310#	7870#	200#	7110#	210#	-7740#	300#	-2700#	200#	-10000#	280#
	Cf	98	14930#	330#	6410#	270#	7660#	150#	*	*	350#	260#	-12910#	480#
	Es	99	*	*	5020#	330#	8320#	40#	*	*	890#	270#	*	*
242	U	92	10240#	200#	*	3570#	200#	3900#	200#	*	*	-3710#	210#	
	Np	93	11040	200	13960#	360#	4220	210	1950	200	*	*	-3610	200
	Pu	94	11551.2	0.7	12575	5	4984.5	1.0	-86.8	0.8	-8770#	300#	-6288.9	0.7
	Am	95	12185	14	11423	15	5588.50	0.25	-2270#	200#	-6080	70	-6305.1	1.2
	Cm	96	13062.9	1.7	9899.7	0.4	6215.56	0.08	-4530	40	-5440.5	0.4	-9370#	200#
	Bk	97	14070#	250#	8360#	200#	6890#	210#	-7230#	380#	-2490#	200#	-9700#	320#
	Cf	98	14840#	200#	6970	40	7517	4	-9060#	400#	-1650	40	-12580#	230#
	Es	99	15380#	520#	5280#	360#	8250#	150#	*	*	1570#	380#	*	*
	Fm	100	*	*	4210#	450#	8770#	570#	*	*	1750#	480#	*	*
243	Np	93	10530#	80#	*	4110#	200#	2700#	30#	*	*	-2910#	30#	
	Pu	94	11343.9	2.7	13020#	300#	4756.7	2.8	571.9	2.9	-8150#	200#	-5785.5	2.7
	Am	95	11902.5	1.4	11660	70	5438.8	1.0	-1515	5	-7530	200	-5700.4	1.4
	Cm	96	12662.5	1.6	10351.1	1.0	6168.8	1.0	-3760#	140#	-4823.8	1.2	-8620#	200#
	Bk	97	13560#	200#	8823	4	6874	4	-6090#	230#	-4067	4	-8720	40
	Cf	98	14560#	290#	7340#	140#	7330#	100#	-8310#	260#	-1150#	140#	-12090#	360#
	Es	99	15200#	330#	5900#	310#	8072	10	*	*	-240#	310#	-11690#	460#
	Fm	100	*	*	4680#	330#	8690	50	*	*	2630#	220#	*	*
244	Np	93	10360#	360#	*	3970#	420#	3320#	300#	*	*	-2630#	300#	
	Pu	94	11055	5	13390#	200#	4665.5	1.0	1352	5	*	*	-5442	5
	Am	95	11731.4	1.0	12120	200	5141	15	-835	14	-7280#	30#	-5374.0	1.4
	Cm	96	12494.2	0.4	10842.7	0.7	5901.74	0.05	-3025.6	2.5	-6590.8	2.7	-8309	4
	Bk	97	13160#	200#	9332	14	6779	4	-5310#	180#	-3750	14	-8300#	140#
	Cf	98	14000	40	7903.9	2.5	7328.9	1.8	-7530#	280#	-2993.3	2.7	-11380#	230#
	Es	99	15080#	370#	6290#	270#	7940#	100#	*	*	50#	180#	-11300#	280#
	Fm	100	15530#	490#	4910#	290#	8550#	200#	*	*	780#	320#	*	*
245	Pu	94	10792	14	*	4480#	300#	2101	14	*	*	-4846	14	
	Am	95	11419	3	12550#	30#	5210	70	84	3	-8590#	300#	-4625.2	2.9
	Cm	96	12321.5	1.4	11328.7	2.9	5623.0	1.0	-2382.2	2.4	-6090	5	-7782	14
	Bk	97	13018	5	9938.6	2.0	6454.5	1.4	-4620#	200#	-5354.5	1.7	-7735.1	2.9
	Cf	98	13700#	140#	8374.7	2.4	7258.5	1.9	-6830#	280#	-2355.7	2.2	-10710#	180#
	Es	99	14490#	310#	6830#	200#	7909	3	-8860#	380#	-1570#	200#	-10640#	350#
	Fm	100	15180#	350#	5300#	310#	8440#	100#	*	*	1450#	280#	*	*
	Md	101	*	*	4070#	400#	9020#	230#	*	*	1980#	370#	*	*
246	Pu	94	10553	15	*	4350#	200#	2777	15	*	*	-4576	15	
	Am	95	11029	18	12790#	300#	5150	200	1030	60	*	*	-4081	18
	Cm	96	11977.8	1.1	11765	5	5475.1	0.9	-1473.3	1.5	-7777	14	-7268.3	1.8
	Bk	97	12890	60	10490	60	6070	60	-3930#	230#	-5220	60	-7490	60
	Cf	98	13530.1	2.7	8939.9	1.1	6861.6	1.0	-6050	40	-4201.9	1.5	-10420#	200#
	Es	99	14270#	290#	7390#	220#	7740#	100#	-8370#	400#	-1200#	220#	-10390#	350#
	Fm	100	15010#	290#	5920	40	8378	12	*	*	-540	40	-13220#	330#
	Md	101	*	*	4330#	380#	8880	50	*	*	2550#	390#	*	*

A	Elt.	Z	S(n)	S(p)	$Q(4\beta^-)$	$Q(d,\alpha)$	$Q(p,\alpha)$	$Q(n,\alpha)$							
247	Pu	94	4470#	300#	*	2860#	300#	*	10660#	420#	*	9600#	310#		
	Am	95	5910#	100#	5530#	100#	-1460#	110#	14760#	100#	12210#	100#	11375	5	
	Cm	96	5156	4	6750	18	-6050#	140#	14345	5	10517	4	11256	5	
	Bk	97	6550	60	4417	5	-10550#	320#	15197	5	11901	5	11329	8	
	Cf	98	6026	8	5120	60	*	*	15032	8	10285	16	13540#	30#	
	Es	99	7360#	230#	2770#	30#	*	*	15930#	30#	12000#	30#	15750#	140#	
	Fm	100	6630#	150#	3610#	270#	*	*	15860#	250#	10420#	230#	15660#	370#	
	Md	101	8310#	460#	1390#	330#	*	*	16530#	430#	11900#	430#			
248	Am	95	4660#	220#	5720#	360#	260#	210#	15880#	200#	12320#	200#	*		
	Cm	96	6213	5	7050#	100#	-4514	13	13108	18	10357	6	9933	14	
	Bk	97	5480#	70#	4740#	70#	-9070#	250#	16170#	70#	11940#	70#	11830#	70#	
	Cf	98	6968	9	5540	7	-13420#	300#	13980	60	10288	5	11881	5	
	Es	99	6380#	60#	3130#	50#	*	*	16920#	50#	11780#	50#	14130#	50#	
	Fm	100	7750#	140#	3990#	30#	*	*	14720#	220#	10330#	200#	14166	12	
	Md	101	6970#	400#	1720#	280#	*	*	17720#	240#	11790#	360#	16360#	310#	
	No	102	*	2670#	440#	*	*	15100#	450#	10240#	440#	16090#	410#		
249	Am	95	5530#	360#	*	1930#	300#	14820#	420#	12570#	300#	*			
	Cm	96	4713.37	0.25	7100#	200#	-2870#	100#	14310#	100#	10620	18	11001	15	
	Bk	97	6300#	70#	4832	5	-7480#	220#	15027	4	12095.2	2.2	10501	18	
	Cf	98	5585	5	5640#	70#	-12090#	340#	14946	5	10620	60	12753.6	1.7	
	Es	99	7200#	60#	3350#	30#	*	*	15750#	30#	11950#	30#	12850#	70#	
	Fm	100	6360#	100#	3970#	110#	*	*	15720#	110#	10580#	250#	15170#	100#	
	Md	101	7890#	330#	1870#	220#	*	*	16450#	270#	12050#	230#	15070#	320#	
	No	102	6920#	450#	2620#	420#	*	*	16480#	470#	10400#	470#	17320#	340#	
250	Cm	96	5832	10	7400#	300#	-1085	16	13140#	200#	10700#	100#	9640#	300#	
	Bk	97	4970	4	5088	6	-5690#	300#	16270	6	12282	5	11440#	100#	
	Cf	98	6625.1	1.7	5966.8	2.2	-10340#	200#	13800#	70#	10545	5	11284	4	
	Es	99	6020#	100#	3790#	100#	*	*	16700#	100#	11950#	100#	13380#	100#	
	Fm	100	7620#	100#	4390#	30#	*	*	14480#	50#	10330#	30#	13583	14	
	Md	101	6760#	380#	2270#	320#	*	*	17440#	300#	11920#	330#	15670#	300#	
	No	102	8370#	400#	3100#	300#	*	*	15080#	310#	10340#	380#	15580#	250#	
251	Cm	96	4413	25	*	661	24	14260#	300#	10950#	200#	*			
	Bk	97	5795	11	5050	15	-3800#	200#	15188	11	12699	11	10310#	200#	
	Cf	98	5108	4	6106	5	-8780#	180#	14996	5	10920#	70#	12389	5	
	Es	99	6790#	100#	3949	6	-13380#	300#	15497	6	12136	8	12080#	70#	
	Fm	100	6158	14	4530#	100#	*	*	15520#	30#	10550#	50#	14393	10	
	Md	101	7680#	360#	2340#	200#	*	*	16120#	230#	11990#	200#	14370#	210#	
	No	102	6670#	270#	3010#	350#	*	*	16300#	280#	10630#	300#	16650#	180#	
	Lr	103	*	910#	360#	*	*	16790#	450#	12100#	420#	16390#	380#		
252	Cm	96	5660#	300#	*	2240#	300#	*	10820#	420#	*	*			
	Bk	97	4770#	200#	5400#	200#	-2100#	280#	16260#	200#	12650#	200#	11080#	360#	
	Cf	98	6172	5	6483	11	-6847	14	13793	6	11048	5	10930.24	0.25	
	Es	99	5290	50	4130	50	-11540#	250#	16830	50	12430	50	13090	50	
	Fm	100	7241	10	4984	8	*	*	14300#	100#	10510#	30#	12738	6	
	Md	101	6470#	280#	2650#	200#	*	*	17270#	200#	11880#	220#	15100#	200#	
	No	102	8100#	180#	3440#	200#	*	*	14960#	300#	10420#	220#	14910#	100#	
	Lr	103	7130#	390#	1370#	300#	*	*	18030#	320#	11890#	420#	17160#	330#	
253	Bk	97	5680#	410#	5420#	470#	-370#	410#	14990#	360#	12800#	360#	*		
	Cf	98	4804	4	6520#	200#	-5170#	100#	14784	12	11214	7	11958	11	
	Es	99	6350	50	4309	5	-9670#	220#	15590	5	12706.0	2.2	11709	4	
	Fm	100	5539	6	5230	50	-14440#	450#	15548	7	10990#	100#	13824	3	
	Md	101	7400#	280#	2810#	210#	*	*	16030#	210#	12090#	210#	13720#	230#	
	No	102	6490#	100#	3450#	220#	*	*	16150#	230#	10690#	320#	16040#	100#	
	Lr	103	8220#	340#	1480#	230#	*	*	16480#	280#	12040#	300#	15700#	380#	
	Rf	104	*	2340#	520#	*	*	16610#	540#	*	*	17920#	500#		

A	Elt.	Z	S(2n)	S(2p)	Q( $\alpha$ )	Q(2 $\beta^-$ )	Q( $\epsilon p$ )	Q( $\beta^- n$ )						
247	Pu	94	10250#	300#	*	*	3460#	300#	*	-4070#	300#			
	Am	95	10890#	100#	*	4850#	110#	1660#	100#	*	-3540#	100#		
	Cm	96	11613	4	12150	14	5353	3	-603	9	-7150	15	-6510	60
	Bk	97	12467	5	10987	6	5890	5	-3120#	30#	-6793	19	-6672	5
	Cf	98	13393	8	9446	8	6528	8	-5450#	140#	-3771	8	-9840#	220#
	Es	99	13970#	200#	7780#	30#	7490#	30#	-7430#	330#	-2650#	70#	-9600#	50#
	Fm	100	14780#	310#	6380#	140#	8213	18	*	200#	140#	-12770#	360#	
	Md	101	15390#	460#	4970#	380#	8830#	220#	*	850#	390#	*		
248	Am	95	10580#	200#	*	4940#	360#	2480#	210#	*	-3040#	200#		
	Cm	96	11369	5	12581	15	5161.73	0.25	152	7	-8890#	300#	-6170	7
	Bk	97	12030#	90#	11490#	70#	5770#	70#	-2220#	90#	-6360#	120#	-6130#	70#
	Cf	98	12995	5	9957	5	6361	5	-4667	13	-5583	6	-9440#	30#
	Es	99	13740#	230#	8250#	80#	7160#	50#	-6850#	240#	-2480#	50#	-9350#	150#
	Fm	100	14380	40	6763	12	8002	11	-8760#	300#	-1519	14	-12210#	320#
	Md	101	15270#	410#	5330#	330#	8700#	150#	*	1250#	240#	*		
	No	102	*	4060#	300#	9230#	100#	*	*	1790#	330#	*		
249	Am	95	10190#	310#	*	*	5169	18	1817	11	*	-4932	11	
	Cm	96	10926	5	12820#	300#	5219	14	1025	5	*	-5400#	70#	
	Bk	97	11784	6	11880#	100#	5525.0	2.3	-1330#	30#	-8000#	200#	-5461	5
	Cf	98	12554	8	10386	4	6296.0	0.7	-3890#	100#	-4956	5	-8650#	50#
	Es	99	13580#	40#	8890#	30#	6940#	30#	-6150#	230#	-4190#	80#	-8800#	30#
	Fm	100	14110#	180#	7100#	100#	7810#	100#	-8200#	360#	-910#	100#	-11600#	260#
	Md	101	14860#	390#	5860#	230#	8460#	100#	*	-260#	230#	-11410#	380#	
	No	102	*	4350#	370#	9170#	200#	*	*	2620#	340#	*		
250	Cm	96	10546	10	*	5169	18	1817	11	*	-4932	11		
	Bk	97	11270#	70#	12190#	200#	5532	18	-280#	100#	-7440#	300#	-4846	4
	Cf	98	12211	5	10798	5	6128.44	0.19	-2902	12	-6867	5	-8080#	30#
	Es	99	13220#	110#	9430#	120#	6830#	120#	-5410#	320#	-3910#	100#	-8460#	140#
	Fm	100	13975	17	7744	13	7557	12	-7440#	200#	-2941	12	-11320#	220#
	Md	101	14660#	380#	6240#	310#	8310#	200#	*	170#	300#	-11250#	450#	
	No	102	15290#	360#	4970#	200#	8950#	200#	*	610#	230#	*		
251	Cm	96	10245	23	*	5230#	300#	2513	22	*	-4375	23		
	Bk	97	10765	11	12450#	300#	5650#	100#	715	12	*	-4015	11	
	Cf	98	11734	4	11193	5	6175.8	1.0	-1852	9	-6143	11	-7160#	100#
	Es	99	12810#	30#	9915	6	6596.7	2.6	-4520#	200#	-5728	7	-7633	13
	Fm	100	13780#	100#	8317	8	7425.1	2.0	-6930#	180#	-2474	8	-10720#	300#
	Md	101	14440#	300#	6730#	210#	7990#	200#	-8870#	360#	-1490#	230#	-10560#	290#
	No	102	15040#	380#	5280#	200#	8910#	100#	*	1550#	180#	*		
	Lr	103	*	4010#	370#	9430#	440#	*	*	1970#	420#	*		
252	Cm	96	10080#	300#	*	*	5320#	300#	3020#	300#	*	-4240#	300#	
	Bk	97	10560#	200#	*	5550#	280#	1240#	210#	*	-3670#	200#		
	Cf	98	11280	5	11533	10	6216.87	0.04	-783	7	-7903	23	-6550	7
	Es	99	12080#	110#	10240	50	6790#	50#	-3340#	200#	-5220	50	-6760	50
	Fm	100	13399	13	8932	6	7152.7	2.0	-6064	14	-4606	7	-10280#	200#
	Md	101	14150#	360#	7180#	220#	7900#	200#	-8210#	320#	-1170#	200#	-10360#	260#
	No	102	14780#	200#	5770	17	8550	6	*	-395	15	-13090#	300#	
	Lr	103	*	4380#	390#	9260#	70#	*	*	2520#	320#	*		
253	Bk	97	10440#	360#	*	5400#	200#	1920#	360#	*	-3180#	360#		
	Cf	98	10976	6	11925	23	6126	4	-49	7	-7040#	300#	-6060	50
	Es	99	11641	6	10792	11	6739.16	0.05	-2290#	210#	-6810#	200#	-5875	6
	Fm	100	12780	9	9363	5	7199	3	-5120#	100#	-3973	6	-9350#	200#
	Md	101	13870#	290#	7790#	210#	7700#	210#	-7390#	300#	-3280#	210#	-9650#	210#
	No	102	14590#	200#	6100#	100#	8421	8	-9330#	470#	360#	100#	-12440#	270#
	Lr	103	15350#	370#	4920#	300#	8937	9	*	770#	300#	*		
	Rf	104	*	3700#	490#	9550#	300#	*	*	3620#	450#	*		

A	Elt.	Z	S(n)		S(p)		$Q(4\beta^-)$		$Q(d, \alpha)$		$Q(p, \alpha)$		$Q(n, \alpha)$	
254	Bk	97	4610#	470#	*		880#	310#	16050#	420#	12610#	300#	*	
	Cf	98	6032	12	6880#	360#	-3384	21	13520#	200#	10977	16	10340	25
	Es	99	5093	4	4598	7	-7860#	340#	16669	6	12721	6	12411	11
	Fm	100	6517	4	5398.5	2.9	-12420#	290#	14320	50	11256	6	12416	5
	Md	101	5860#	230#	3120#	100#	*		17410#	100#	12390#	100#	14650#	100#
	No	102	7810#	100#	3870#	210#	*		14810#	200#	10560#	200#	14384	19
	Lr	103	6910#	400#	1910#	350#	*		17680#	340#	11800#	380#	16470#	390#
	Rf	104	8540#	540#	2660#	360#	*		15190#	380#	10290#	410#	16050#	340#
255	Cf	98	4600#	200#	6870#	360#	-2050#	200#	14590#	410#	11140#	280#	11400#	360#
	Es	99	5974	12	4541	16	-5970#	210#	15499	12	12919	11	11200#	200#
	Fm	100	5176	5	5482	6	-10600#	180#	15496	5	11370	50	13412	5
	Md	101	6740#	100#	3350	7	-15200#	420#	16204	7	12890	8	13200	50
	No	102	5942	20	3950#	100#	*		16260#	210#	11090#	200#	15683	11
	Lr	103	7860#	390#	1960#	210#	*		16300#	230#	12040#	210#	15070#	280#
	Rf	104	7000#	340#	2740#	380#	*		16420#	280#	10420#	300#	17160#	180#
	Db	105	*		570#	510#	*		16960#	620#	*		16850#	490#
256	Cf	98	5840#	360#	*		-790#	300#	13360#	420#	10970#	470#	*	
	Es	99	4970#	100#	4910#	220#	-4690#	240#	16560#	100#	12750#	100#	11900#	370#
	Fm	100	6384	7	5892	12	-8750	25	14205	8	11336	7	11831	6
	Md	101	5300	50	3470	50	-13100#	300#	17420	50	13130	50	14250	50
	No	102	7101	13	4308	10	*		15020#	100#	11390#	210#	14121	8
	Lr	103	6260#	300#	2270#	220#	*		17860#	220#	12270#	240#	16220#	300#
	Rf	104	8230#	180#	3110#	210#	*		15100#	340#	10410#	230#	15420#	100#
	Db	105	7390#	510#	970#	340#	*		18110#	410#	11790#	540#	17680#	370#
257	Es	99	5850#	420#	4920#	510#	-3330#	460#	15310#	460#	12930#	410#	10660#	510#
	Fm	100	4968	6	5890#	100#	-7350#	100#	15211	12	11462	7	12895	12
	Md	101	6690	50	3779	7	-11350#	230#	15908	5	12956	3	12651	4
	No	102	5655	23	4660	60	*		16108	23	11590#	100#	14983	22
	Lr	103	7210#	300#	2380#	210#	*		16590#	210#	12880#	210#	14870#	230#
	Rf	104	6370#	110#	3230#	240#	*		16590#	230#	10950#	350#	16860#	100#
	Db	105	8450#	370#	1180#	230#	*		16660#	290#	11890#	360#	16140#	400#
	258	Es	99	4770#	510#	*		-2140#	320#	16370#	420#	12760#	360#	*
Fm		100	6240#	200#	6270#	460#	-5970#	280#	13950#	220#	11200#	200#	11260#	280#
Md		101	5379	5	4190	7	-10060#	340#	16913	8	12753	6	13246	12
No		102	6830#	200#	4810#	200#	-13940#	460#	14570#	210#	11500#	200#	13330#	200#
Lr		103	5970#	230#	2690#	100#	*		17730#	100#	12850#	100#	15640#	100#
Rf		104	7610#	230#	3630#	290#	*		15240#	300#	11210#	290#	15190#	200#
Db		105	6670#	410#	1480#	360#	*		18220#	340#	12210#	390#	17340#	400#
Sg		106	*		2220#	470#	*		15410#	510#	10240#	590#	16670#	450#
259	Fm	100	4790#	350#	6290#	410#	-4700#	290#	15010#	500#	11380#	300#	12310#	410#
	Md	101	6140#	200#	4090#	280#	-8480#	290#	15750#	200#	13000#	200#	12080#	220#
	No	102	5440#	220#	4870#	100#	-12550#	200#	15820#	100#	11360#	110#	14270#	100#
	Lr	103	7060#	120#	2920#	210#	*		16320#	70#	12890#	70#	13880#	90#
	Rf	104	6070#	210#	3730#	130#	*		16380#	220#	11390#	230#	16220#	70#
	Db	105	7720#	400#	1590#	290#	*		16880#	240#	12730#	210#	15880#	310#
	Sg	106	6830#	450#	2380#	390#	*		17030#	290#	10800#	340#	18070#	180#
260	Fm	100	6130#	570#	*		-3510#	540#	13650#	580#	11100#	650#	*	
	Md	101	5140#	370#	4440#	420#	-7130#	390#	16840#	370#	12830#	320#	12790#	520#
	No	102	6570#	220#	5300#	280#	-10970#	200#	14630#	200#	11480#	200#	12670#	200#
	Lr	103	5650#	140#	3120#	150#	-15340#	590#	17510#	230#	12900#	120#	14930#	120#
	Rf	104	7320#	210#	3990#	210#	*		15020#	230#	11280#	290#	14560#	200#
	Db	105	6500#	310#	2010#	240#	*		17990#	310#	12610#	250#	16590#	310#
	Sg	106	8140#	180#	2810#	220#	*		15550#	350#	11110#	230#	16300#	110#
	Bh	107	*		330#	610#	*		18910#	710#	*		18920#	620#

A	Elt.	Z	S(2n)	S(2p)	Q( $\alpha$ )	Q( $2\beta^-$ )	Q( $\epsilon\text{p}$ )	Q( $\beta^-$ n)						
254	Bk	97	10280#	360#	*	*	2400#	300#	*	-2980#	300#			
	Cf	98	10836	11	12290#	300#	5927	5	437	12	* -5744	12		
	Es	99	11440	50	11120#	200#	6615.7	1.5	-1520#	100#	-6230#	360# -5429	5	
	Fm	100	12056	6	9708	5	7307.5	1.9	-3820	18	-5686	6	-8470#	210#
	Md	101	13260#	220#	8360#	110#	7860#	140#	-6330#	350#	-2790#	100#	-9020#	140#
	No	102	14299	22	6671	18	8226	13	-8600#	290#	-1914	18	-12030#	230#
	Lr	103	15130#	420#	5360#	390#	8790#	150#	*		1260#	390#	-12020#	560#
	Rf	104	*		4140#	290#	9380#	200#	*		1570#	300#	*	
255	Cf	98	10640#	200#	*		5740#	200#	1010#	200#	*		-5250#	200#
	Es	99	11067	11	11420#	360#	6436.3	1.3	-754	13	-7590#	300#	-4887	11
	Fm	100	11693	6	10080	6	7239.7	1.8	-3054	11	-4830	12	-7790#	100#
	Md	101	12600#	210#	8749	7	7905.9	2.6	-5210#	210#	-4438	7	-7953	19
	No	102	13760#	100#	7074	11	8442	6	-7540#	180#	-1340	10	-11060#	340#
	Lr	103	14770#	310#	5820#	290#	8610#	30#	-9980#	470#	-750#	230#	-11330#	350#
	Rf	104	15540#	490#	4650#	200#	9058	9	*		2380#	180#	*	
	Db	105	*		3230#	480#	9720#	300#	*		2910#	540#	*	
256	Cf	98	10450#	300#	*		5560#	420#	1550#	300#	*		-5120#	300#
	Es	99	10950#	100#	11790#	310#	6230#	220#	-430#	110#	*		-4680#	100#
	Fm	100	11561	7	10433	12	7027	5	-2338	10	-6610#	200#	-7428	9
	Md	101	12040#	110#	8950	50	7897	16	-4260#	230#	-3760	50	-7310	50
	No	102	13043	19	7658	8	8581	5	-6412	25	-3264	9	-10310#	210#
	Lr	103	14120#	400#	6220#	240#	8820#	100#	-8850#	370#	-260#	220#	-10600#	280#
	Rf	104	15230#	290#	5067	30	8930	20	*		93	26	-13880#	420#
	Db	105	*		3710#	450#	9460#	150#	*		3370#	360#	*	
257	Es	99	10830#	410#	*		6050#	200#	410#	410#	*		-4150#	410#
	Fm	100	11352	6	10800#	200#	6863.5	1.4	-1651	22	-5740#	300#	-7100	50
	Md	101	11989	7	9671	11	7557.6	1.0	-3740#	210#	-5480#	100#	-6899	8
	No	102	12756	24	8137	22	8466	21	-5690#	110#	-2535	23	-9700#	220#
	Lr	103	13470#	290#	6690#	210#	9010#	30#	-7610#	310#	-2170#	210#	-9570#	210#
	Rf	104	14610#	200#	5500#	100#	9044	15	*		820#	100#	-12860#	310#
	Db	105	15840#	480#	4290#	310#	9230	15	*		1180#	320#	*	
258	Es	99	10630#	310#	*		5880#	420#	1010#	300#	*		-3960#	300#
	Fm	100	11200#	200#	11190#	360#	6660#	200#	-1050#	280#	*		-6640#	200#
	Md	101	12070	50	10080#	100#	7271.3	1.9	-3150#	100#	-5000#	410#	-6624	22
	No	102	12490#	200#	8590#	200#	8150#	200#	-4920#	280#	-4400#	200#	-9330#	290#
	Lr	103	13180#	240#	7350#	120#	8900	20	-6910#	360#	-1450#	100#	-9170#	150#
	Rf	104	13980#	200#	6000#	200#	9250#	200#	-9020#	460#	-1130#	200#	-12010#	300#
	Db	105	15120#	450#	4700#	410#	9480#	70#	*		1720#	400#	*	
	Sg	106	*		3400#	420#	9670#	300#	*		2190#	430#	*	
259	Fm	100	11030#	280#	*		6470#	200#	-410#	300#	*		-6060#	280#
	Md	101	11520#	200#	10360#	460#	7110#	200#	-2230#	210#	-6370#	360#	-5930#	280#
	No	102	12270#	100#	9060#	100#	7890#	100#	-4290#	120#	-3610#	220#	-8800#	140#
	Lr	103	13030#	220#	7720#	70#	8580#	70#	-6250#	220#	-3130#	70#	-8620#	210#
	Rf	104	13680#	130#	6420#	80#	9120#	70#	-8260#	190#	-370#	210#	-11420#	350#
	Db	105	14380#	310#	5210#	300#	9620	50	*		-30#	240#	-11390#	470#
	Sg	106	*		3860#	210#	9830	30	*		2970#	270#	*	
260	Fm	100	10930#	540#	*		6180#	400#	30#	540#	*		-6050#	540#
	Md	101	11280#	320#	10730#	440#	6940#	300#	-1730#	340#	*		-5630#	330#
	No	102	12010#	280#	9390#	280#	7700#	200#	-3540#	280#	-5380#	350#	-8310#	210#
	Lr	103	12710#	150#	7990#	120#	8240#	100#	-5400#	260#	-2640#	230#	-8200#	140#
	Rf	104	13390#	280#	6910#	280#	8900#	200#	-7440#	200#	-2250#	220#	-11020#	290#
	Db	105	14220#	410#	5740#	250#	9380	70	-9940#	620#	540#	240#	-11050#	290#
	Sg	106	14970#	420#	4390#	200#	9920	30	*		900#	80#	*	
	Bh	107	*		2710#	670#	10470#	500#	*		4220#	620#	*	

A	Elt.	Z	S(n)		S(p)		Q( $4\beta^-$ )		Q(d, $\alpha$ )		Q(p, $\alpha$ )		Q(n, $\alpha$ )	
261	Md	101	6140#	720#	4450#	820#	-5900#	690#	15490#	710#	12920#	680#	11420#	710#
	No	102	5180#	360#	5340#	440#	-9660#	330#	15590#	360#	11680#	300#	13730#	360#
	Lr	103	6790#	230#	3340#	280#	-13770#	310#	16160#	220#	12950#	280#	13520#	200#
	Rf	104	5910#	200#	4250#	120#	*		16180#	80#	11340#	110#	15480#	200#
	Db	105	7370#	330#	2060#	310#	*		16690#	240#	12840#	310#	15190#	250#
	Sg	106	6490#	130#	2800#	260#	*		16770#	250#	11280#	370#	17410#	240#
	Bh	107	8360#	620#	540#	230#	*		17380#	290#	12780#	470#	17230#	410#
262	Md	101	5140#	870#	*		-4860#	610#	16470#	770#	12570#	650#	*	
	No	102	6630#	540#	5820#	790#	-8470#	530#	14110#	550#	11190#	490#	11890#	530#
	Lr	103	5510#	280#	3670#	360#	-12350#	400#	17220#	280#	12880#	220#	14150#	280#
	Rf	104	6990#	280#	4460#	350#	*		14830#	310#	11410#	290#	13930#	300#
	Db	105	6180#	290#	2340#	180#	*		17830#	270#	12730#	200#	16060#	200#
	Sg	106	7810#	310#	3240#	370#	*		15460#	370#	11190#	350#	15670#	290#
	Bh	107	6930#	410#	980#	370#	*		18600#	350#	12680#	390#	18020#	410#
263	No	102	5040#	660#	5720#	760#	-7240#	510#	15210#	810#	11290#	580#	12980#	700#
	Lr	103	6530#	410#	3570#	580#	-10940#	520#	15880#	470#	12920#	410#	12760#	480#
	Rf	104	5630#	340#	4580#	270#	-14910#	390#	15990#	270#	11430#	220#	14870#	270#
	Db	105	7230#	250#	2570#	330#	*		16510#	170#	12830#	260#	14480#	200#
	Sg	106	6280#	310#	3340#	220#	*		16550#	260#	11410#	260#	16710#	240#
	Bh	107	7940#	500#	1110#	460#	*		17160#	390#	12890#	370#	16580#	430#
	Hs	108	*		2010#	490#	*		17130#	420#	11000#	680#	18810#	350#
264	No	102	6400#	810#	*		-6140#	700#	13950#	870#	11030#	910#	*	
	Lr	103	5510#	570#	4040#	660#	-9840#	520#	16990#	630#	12590#	530#	13390#	780#
	Rf	104	6730#	480#	4780#	580#	-13420#	450#	14760#	490#	11480#	490#	13320#	540#
	Db	105	5820#	290#	2770#	290#	*		17680#	370#	12910#	230#	15450#	310#
	Sg	106	7500#	310#	3620#	330#	*		15230#	340#	11270#	370#	15120#	280#
	Bh	107	6610#	460#	1440#	300#	*		18350#	400#	12770#	300#	17340#	360#
	Hs	108	8220#	350#	2300#	370#	*		15840#	350#	11130#	230#	17080#	130#
265	Lr	103	6390#	840#	4030#	960#	-8670#	810#	15640#	870#	12820#	840#	12140#	920#
	Rf	104	5540#	620#	4810#	610#	-12460#	450#	15750#	560#	11450#	470#	14410#	620#
	Db	105	6960#	370#	2990#	530#	-16350#	540#	16350#	340#	12950#	400#	14000#	350#
	Sg	106	6040#	290#	3830#	240#	*		16420#	180#	11410#	190#	16070#	290#
	Bh	107	7570#	470#	1500#	470#	*		17070#	400#	13010#	470#	15950#	420#
	Hs	108	6500#	140#	2180#	310#	*		17280#	390#	11560#	370#	18400#	310#
	Mt	109	*		60#	460#	*		17780#	580#	*		18000#	580#
266	Lr	103	4840#	970#	*		-7110#	690#	17190#	920#	13020#	820#	*	
	Rf	104	6910#	690#	5320#	890#	-11310#	610#	14360#	690#	11070#	650#	12540#	730#
	Db	105	5810#	460#	3260#	560#	-15160#	500#	17270#	580#	12770#	400#	14720#	510#
	Sg	106	7190#	290#	4060#	400#	*		15050#	370#	11460#	330#	14510#	340#
	Bh	107	6400#	430#	1860#	210#	*		18170#	350#	12890#	240#	16780#	260#
	Hs	108	8060#	320#	2680#	470#	*		15830#	400#	11440#	460#	16620#	310#
	Mt	109	7000#	580#	570#	370#	*		19010#	350#	13010#	490#	18930#	500#
267	Rf	104	4740#	790#	5220#	870#	-9560#	580#	16010#	920#	11840#	720#	14200#	860#
	Db	105	6820#	590#	3170#	710#	-13910#	720#	16000#	630#	12680#	650#	13410#	640#
	Sg	106	5870#	390#	4130#	450#	-18550#	460#	16140#	390#	11410#	360#	15370#	520#
	Bh	107	7410#	330#	2090#	390#	*		16800#	270#	12990#	390#	15190#	350#
	Hs	108	6500#	300#	2770#	230#	*		16900#	390#	11560#	300#	17620#	300#
	Mt	109	8060#	640#	570#	610#	*		17440#	560#	13170#	550#	17480#	610#
	Ea	110	*		730#	500#	*		18340#	590#	*		20500#	370#
268	Rf	104	6100#	910#	*		-7940#	820#	14750#	960#	12130#	1000#	*	
	Db	105	5210#	710#	3640#	780#	-12370#	620#	17690#	760#	13010#	680#	14590#	890#
	Sg	106	6970#	600#	4280#	710#	-16940#	740#	14970#	650#	11390#	610#	13940#	690#
	Bh	107	6110#	460#	2330#	470#	*		17870#	470#	12910#	380#	16040#	470#
	Hs	108	7720#	430#	3090#	490#	*		15570#	460#	11400#	560#	15940#	420#
	Mt	109	6750#	630#	830#	330#	*		18750#	420#	12920#	340#	18300#	490#
	Ea	110	8580#	620#	1250#	740#	*		16760#	610#	11980#	680#	18420#	520#



A	Elt.	Z	S(2n)		S(2p)		Q( $\alpha$ )		Q( $2\beta^-$ )		Q( $\epsilon\text{p}$ )		Q( $\beta^-$ n)	
261	Md	101	11290#	680#	*		6650#	500#	-1080#	680#	*		-5200#	680#
	No	102	11750#	320#	9780#	410#	7490#	300#	-2810#	300#	-4430#	580#	-7840#	320#
	Lr	103	12430#	210#	8640#	280#	8140#	200#	-4820#	310#	-4280#	370#	-7660#	280#
	Rf	104	13230#	80#	7370#	100#	8650	19	-6850#	130#	-1590#	200#	-10430#	230#
	Db	105	13870#	310#	6050#	240#	9220#	100#	-8950#	330#	-1190#	260#	-10280#	230#
	Sg	106	14640#	220#	4820#	140#	9800#	70#	*	*	1720#	240#	-13520#	590#
	Bh	107	*		3350#	310#	10560	50	*		2370#	330#	*	
262	Md	101	11290#	660#	*		6280#	500#	-720#	620#	*		-5170#	660#
	No	102	11800#	490#	10270#	670#	7100#	400#	-2440#	530#	*		-7680#	490#
	Lr	103	12300#	230#	9010#	370#	8010#	200#	-4150#	270#	-3640#	680#	-7260#	200#
	Rf	104	12900#	350#	7800#	350#	8490#	200#	-6030#	400#	-3400#	410#	-10060#	370#
	Db	105	13550#	290#	6590#	220#	9010#	150#	-8200#	390#	-580#	270#	-9960#	220#
	Sg	106	14300#	290#	5300#	350#	9600#	200#	*	*	-180#	290#	-12980#	370#
	Bh	107	15280#	670#	3780#	420#	10300	25	*		2810#	420#	*	
263	No	102	11670#	580#	*		6850#	400#	-1860#	520#	*		-7220#	530#
	Lr	103	12040#	410#	9390#	740#	7620#	300#	-3440#	400#	-5030#	690#	-6800#	460#
	Rf	104	12620#	190#	8250#	350#	8300#	150#	-5380#	220#	-2400#	480#	-9500#	260#
	Db	105	13410#	290#	7030#	260#	8830#	150#	-7500#	400#	-2300#	260#	-9390#	330#
	Sg	106	14090#	180#	5680#	130#	9390#	100#	-9540#	370#	530#	310#	-12330#	370#
	Bh	107	14870#	430#	4350#	430#	10080#	300#	*		1050#	410#	*	
	Hs	108	*		2990#	370#	10670#	300#	*		4040#	450#	*	
264	No	102	11450#	780#	*		6580#	400#	-1530#	780#	*		-7090#	730#
	Lr	103	12040#	480#	9760#	730#	7250#	300#	-3140#	490#	*		-6680#	470#
	Rf	104	12360#	530#	8350#	630#	8140#	400#	-4610#	530#	-4090#	660#	-9010#	480#
	Db	105	13050#	290#	7340#	310#	8660#	200#	-6710#	360#	-1600#	430#	-8930#	260#
	Sg	106	13780#	400#	6190#	400#	9210#	200#	-8820#	290#	-1340#	340#	-11890#	460#
	Bh	107	14550#	440#	4780#	330#	9970#	150#	*		1670#	320#	-11760#	450#
	Hs	108	*		3400#	290#	10591	20	*		2090#	130#	*	
265	Lr	103	11910#	800#	*		7000#	300#	-2570#	770#	*		-6340#	840#
	Rf	104	12270#	460#	8850#	650#	7780#	300#	-4110#	430#	-3230#	770#	-8720#	480#
	Db	105	12780#	330#	7770#	460#	8490#	200#	-6100#	470#	-3040#	520#	-8380#	400#
	Sg	106	13540#	140#	6600#	190#	9080	50	-8360#	150#	-650#	450#	-11320#	280#
	Bh	107	14180#	530#	5120#	410#	9770#	300#	-10250#	600#	-80#	440#	-11100#	380#
	Hs	108	14720#	370#	3620#	180#	10590	50	*		3100#	310#	*	
	Mt	109	*		2360#	590#	11070#	400#	*		3470#	540#	*	
266	Lr	103	11240#	790#	*		7300#	300#	-1610#	750#	*		-5650#	780#
	Rf	104	12440#	700#	9350#	840#	7500#	300#	-3830#	610#	*		-8670#	610#
	Db	105	12770#	430#	8070#	570#	8190#	300#	-5510#	410#	-2450#	800#	-8150#	370#
	Sg	106	13220#	400#	7050#	530#	8880	30	-7480#	400#	-2300#	510#	-10940#	470#
	Bh	107	13960#	340#	5690#	310#	9550#	90#	-9650#	400#	480#	350#	-11000#	240#
	Hs	108	14560#	290#	4180#	400#	10336	20	*		1080#	290#	-13710#	540#
	Mt	109	*		2750#	440#	10996	25	*		4030#	510#	*	
267	Rf	104	11650#	710#	*		7800#	300#	-2700#	640#	*		-7610#	680#
	Db	105	12630#	550#	8490#	850#	7900#	300#	-4910#	540#	-4430#	810#	-7780#	550#
	Sg	106	13060#	280#	7390#	500#	8640#	200#	-6860#	290#	-1260#	600#	-10420#	340#
	Bh	107	13810#	460#	6150#	390#	9370#	200#	-9000#	600#	-1120#	450#	-10350#	390#
	Hs	108	14560#	170#	4640#	120#	10120#	70#	-11690#	380#	1770#	300#	-13200#	360#
	Mt	109	15070#	710#	3250#	660#	10870#	400#	*		2370#	580#	*	
	Ea	110	*		1300#	390#	12280#	110#	*		5980#	460#	*	
268	Rf	104	10850#	890#	*		8100#	300#	-1830#	890#	*		-6890#	850#
	Db	105	12030#	640#	8860#	840#	8200#	300#	-4020#	650#	*		-7120#	590#
	Sg	106	12850#	610#	7450#	760#	8400#	300#	-6110#	680#	-3490#	790#	-9980#	600#
	Bh	107	13520#	430#	6450#	520#	9080#	300#	-8360#	490#	-420#	600#	-9970#	390#
	Hs	108	14220#	500#	5170#	500#	9900#	300#	-10840#	650#	-80#	490#	-12860#	680#
	Mt	109	14810#	470#	3600#	370#	10730#	150#	*		3030#	410#	-13300#	480#
	Ea	110	*		1820#	580#	11920#	500#	*		3890#	510#	*	

A	El.	Z	S(n)	S(p)	$Q(4\beta^-)$	$Q(d,\alpha)$	$Q(p,\alpha)$	$Q(n,\alpha)$						
269	Db	105	6190#	940#	3730#	1050#	-10800#	950#	16240#	960#	13720#	940#	13240#	1010#
	Sg	106	5140#	850#	4210#	840#	-15250#	670#	16650#	810#	12060#	750#	15710#	850#
	Bh	107	7200#	560#	2550#	680#	*		16550#	490#	12900#	500#	14650#	550#
	Hs	108	6310#	430#	3280#	400#	*		16680#	290#	11490#	230#	16820#	310#
	Mt	109	7770#	640#	870#	690#	*		17480#	560#	13210#	620#	16930#	590#
	Ea	110	6830#	520#	1330#	340#	*		17990#	560#	12150#	370#	19640#	320#
270	Db	105	5040#	1060#	*		-9260#	900#	17290#	1010#	13420#	920#	*	
	Sg	106	6610#	900#	4620#	990#	-13410#	680#	15260#	810#	12270#	780#	13840#	840#
	Bh	107	5350#	630#	2760#	810#	*		18170#	710#	13430#	540#	16120#	660#
	Hs	108	7520#	310#	3600#	500#	*		15270#	470#	11390#	390#	15170#	390#
	Mt	109	6580#	770#	1140#	550#	*		18620#	680#	13120#	550#	17760#	600#
	Ea	110	8450#	320#	2010#	620#	*		16290#	430#	11770#	620#	17690#	310#
271	Sg	106	5140#	900#	4720#	970#	-11730#	660#	16310#	1010#	12340#	840#	14800#	960#
	Bh	107	6620#	730#	2770#	830#	*		16700#	860#	13780#	780#	14710#	770#
	Hs	108	5270#	440#	3530#	580#	*		17200#	530#	12230#	510#	16870#	640#
	Mt	109	7620#	780#	1250#	630#	*		17310#	580#	13230#	700#	16250#	680#
	Ea	110	6820#	310#	2250#	550#	*		17240#	560#	11700#	330#	18590#	430#
272	Sg	106	6500#	1000#	*		-10400#	1000#	14850#	1050#	12030#	1090#	*	
	Bh	107	5410#	830#	3040#	890#	-14520#	690#	17890#	870#	13510#	890#	15490#	980#
	Hs	108	6770#	670#	3680#	800#	*		15770#	740#	12650#	710#	15240#	870#
	Mt	109	5650#	740#	1630#	590#	*		19180#	560#	13880#	500#	17800#	640#
	Ea	110	7830#	660#	2470#	860#	*		15980#	840#	11630#	850#	17070#	660#
	Eb	111	*	250#	350#		*		19000#	440#	12770#	360#	19210#	640#
273	Sg	106	5220#	1010#	*		-9910#	670#	*		11860#	980#	*	
	Bh	107	6590#	1030#	3130#	1130#	-13100#	1030#	16440#	1050#	13520#	1030#	13940#	1100#
	Hs	108	5340#	1010#	3610#	1030#	*		17050#	1000#	12660#	950#	16510#	1030#
	Mt	109	6980#	700#	1830#	770#	*		17470#	610#	14420#	590#	16170#	690#
	Ea	110	5700#	660#	2520#	500#	*		17910#	580#	12510#	550#	18890#	310#
	Eb	111	8010#	690#	430#	890#	*		17810#	610#	13210#	670#	17780#	810#
274	Bh	107	5440#	1140#	3360#	1020#	-12360#	1000#	17490#	1090#	13220#	1010#	*	
	Hs	108	7010#	1050#	4020#	1050#	*		15460#	890#	12270#	860#	14640#	920#
	Mt	109	5670#	760#	2160#	1000#	*		18570#	800#	14030#	650#	17120#	790#
	Ea	110	7490#	510#	3020#	710#	*		16070#	690#	12650#	750#	16670#	600#
	Eb	111	6180#	860#	910#	630#	*		19460#	900#	13850#	630#	19220#	840#
275	Bh	107	6390#	1020#	*		-11080#	950#	16330#	930#	13330#	1010#	*	
	Hs	108	5440#	960#	4020#	1060#	*		16610#	1100#	12240#	940#	15700#	1050#
	Mt	109	7000#	810#	2150#	880#	*		16920#	1020#	13800#	830#	15530#	850#
	Ea	110	5570#	670#	2930#	720#	*		17480#	680#	12730#	660#	17870#	730#
	Eb	111	7670#	930#	1100#	850#	*		17490#	700#	14020#	950#	17200#	840#
276	Hs	108	6900#	1090#	4530#	1050#	*		15150#	1140#	11930#	1170#	14020#	1060#
	Mt	109	5730#	900#	2440#	990#	*		18190#	940#	13410#	1070#	16390#	1070#
	Ea	110	7270#	760#	3200#	850#	*		15870#	830#	12430#	790#	15940#	1030#
	Eb	111	5880#	930#	1410#	770#	*		19100#	800#	13840#	640#	18300#	810#
277	Hs	108	5620#	1100#	*		-13140#	740#	15920#	980#	11760#	1070#	*	
	Mt	109	6890#	1110#	2430#	1210#	*		16740#	1140#	13520#	1100#	14940#	1180#
	Ea	110	5640#	1140#	3110#	1180#	*		17230#	1130#	12460#	1110#	17310#	1160#
	Eb	111	7120#	880#	1250#	870#	*		17550#	770#	14200#	790#	16850#	830#
	Ec	112	*	2210#	640#		*		17980#	700#	12530#	630#	19110#	510#
278	Mt	109	5840#	1220#	2660#	1110#	*		17790#	1170#	13120#	1100#	15490#	1060#
	Ea	110	7310#	1180#	3520#	1110#	*		15660#	960#	12150#	900#	15440#	990#
	Eb	111	6130#	890#	1740#	1150#	*		18690#	880#	13650#	780#	17720#	870#
	Ec	112	7730#	550#	2820#	820#	*		16130#	820#	12480#	870#	16950#	700#

A	Elt.	Z	S(2n)		S(2p)		Q( $\alpha$ )		Q( $2\beta^-$ )		Q( $\epsilon p$ )		Q( $\beta^- n$ )	
269	Db	105	11410#	910#	*		8400#	300#	–3010#	880#	*		–6340#	940#
	Sg	106	12110#	710#	7850#	870#	8800#	500#	–4940#	670#	–2530#	960#	–9000#	760#
	Bh	107	13310#	490#	6830#	630#	8840#	300#	–7790#	690#	–2400#	670#	–9440#	580#
	Hs	108	14030#	160#	5610#	300#	9630#	100#	–10310#	180#	580#	550#	–12420#	340#
	Mt	109	14520#	770#	3960#	610#	10530#	400#	*		1370#	670#	–12490#	750#
	Ea	110	15410#	390#	2160#	170#	11580	70	*		4790#	430#	*	
270	Db	105	11240#	890#	*		8200#	300#	–2710#	860#	*		–6250#	970#
	Sg	106	11740#	820#	8350#	940#	9100#	300#	–4030#	680#	*		–8410#	740#
	Bh	107	12550#	600#	6970#	710#	9300#	300#	–6560#	720#	–1550#	910#	–8480#	480#
	Hs	108	13830#	500#	6150#	610#	9300	30	–9380#	410#	–1800#	720#	–12170#	620#
	Mt	109	14350#	620#	4420#	660#	10350#	500#	*		1990#	680#	–12230#	560#
	Ea	110	15280#	580#	2880#	500#	11200	50	*		2640#	310#	*	
271	Sg	106	11750#	920#	*		8700#	300#	–3900#	730#	*		–8210#	800#
	Bh	107	11970#	690#	7390#	950#	9500#	300#	–5550#	790#	–3130#	910#	–7580#	630#
	Hs	108	12790#	360#	6290#	740#	9900#	200#	–7830#	350#	–460#	700#	–10870#	640#
	Mt	109	14200#	790#	4850#	700#	10140#	500#	*		–280#	730#	–11410#	630#
	Ea	110	15270#	170#	3400#	160#	10870	20	*		3340#	310#	*	
	Sg	106	11650#	980#	*		8300#	300#	–3630#	960#	*		–8090#	950#
272	Bh	107	12030#	770#	7760#	940#	9300#	300#	–5320#	780#	*		–7720#	700#
	Hs	108	12040#	640#	6450#	840#	10100#	200#	–6770#	870#	–2090#	870#	–10020#	810#
	Mt	109	13270#	720#	5150#	670#	10600#	300#	–9200#	590#	680#	740#	–10240#	490#
	Ea	110	14660#	710#	3710#	710#	10760#	500#	*		780#	730#	*	
	Eb	111	*		2510#	630#	11440#	100#	*		4330#	660#	*	
	Sg	106	11720#	930#	*		*		–3510#	1060#	*		–7900#	900#
273	Bh	107	12010#	1000#	*		8900#	300#	–4930#	970#	*		–7540#	1010#
	Hs	108	12110#	890#	6650#	1050#	9900#	500#	–6410#	830#	–930#	1130#	–9700#	960#
	Mt	109	12630#	760#	5510#	760#	10820#	300#	–8170#	790#	–880#	790#	–9380#	830#
	Ea	110	13530#	170#	4140#	360#	11370	50	*		1850#	590#	–12500#	360#
	Eb	111	*		2900#	830#	11200#	250#	*		1970#	770#	*	
	Bh	107	12040#	990#	*		8500#	300#	–4710#	960#	*		–7650#	1140#
274	Hs	108	12340#	870#	7150#	1000#	9500#	200#	–5930#	810#	–2720#	930#	–9730#	830#
	Mt	109	12650#	740#	5770#	830#	10500#	300#	–7660#	830#	50#	1000#	–9350#	570#
	Ea	110	13190#	810#	4850#	760#	11400#	400#	*		–300#	960#	–11970#	780#
	Eb	111	14190#	700#	3420#	780#	11600#	300#	*		2770#	800#	*	
	Bh	107	11830#	1060#	*		*		–4100#	880#	*		–7030#	920#
	275	Hs	108	12450#	1090#	7380#	970#	9200#	300#	–5800#	850#	*		–9510#
Mt		109	12670#	780#	6170#	1020#	10120#	200#	–6980#	910#	–1510#	980#	–8860#	770#
Ea		110	13060#	470#	5090#	940#	11100#	300#	*		1140#	790#	–11370#	760#
Eb		111	13850#	920#	4120#	860#	11550#	400#	*		770#	890#	*	
Hs		108	12350#	1050#	*		8800#	300#	–5430#	1020#	*		–9410#	1010#
276		Mt	109	12730#	880#	6460#	1030#	9800#	300#	–6840#	920#	–860#	940#	–9020#
	Ea	110	12840#	780#	5350#	890#	10600#	200#	*		–690#	940#	–10970#	920#
	Eb	111	13550#	880#	4330#	840#	11320#	400#	*		1880#	860#	*	
	Hs	108	12520#	1020#	*		8400#	300#	–5410#	1210#	*		–9300#	990#
277	Mt	109	12630#	1060#	6970#	1100#	9500#	300#	–6610#	1080#	*		–8640#	1070#
	Ea	110	12910#	1070#	5550#	1200#	10300#	500#	–7730#	970#	570#	1270#	–10720#	1150#
	Eb	111	13000#	930#	4450#	860#	11180#	350#	*		500#	920#	*	
	Ec	112	*		3620#	470#	11620	30	*		2870#	620#	*	
	Mt	109	12740#	1080#	*		9100#	300#	–6330#	1050#	*		–8850#	1280#
278	Ea	110	12940#	910#	5950#	1070#	10000#	200#	–7310#	860#	–1120#	990#	–10910#	920#
	Eb	111	13250#	890#	4850#	930#	10720#	300#	*		1270#	1090#	–10250#	650#
	Ec	112	*		4070#	810#	11380#	200#	*		780#	1100#	*	

A	Elt.	Z	S(n)		S(p)		$Q(4\beta^-)$	$Q(d,\alpha)$		$Q(p,\alpha)$		$Q(n,\alpha)$	
279	Mt	109	6790#	1100#	*	*		16630#	1020#	13230#	1090#	*	
	Ea	110	5840#	1010#	3520#	1120#	*	16710#	1150#	12040#	1010#	16500#	1110#
	Eb	111	7270#	920#	1700#	950#	*	17070#	1170#	13650#	900#	16180#	950#
	Ec	112	5990#	730#	2690#	800#	*	17260#	790#	12370#	800#	18230#	780#
280	Ea	110	7200#	1130#	3930#	1110#	*	15350#	1190#	11730#	1220#	14920#	1120#
	Eb	111	6200#	1000#	2060#	1050#	*	18170#	1010#	13090#	1220#	16870#	1150#
	Ec	112	7610#	810#	3030#	920#	*	15770#	900#	11870#	890#	16260#	1160#
281	Ea	110	5960#	1120#	*	*		16180#	1020#	11620#	1110#	*	
	Eb	111	7230#	1190#	2090#	1260#	*	16780#	1190#	13160#	1150#	15480#	1250#
	Ec	112	5980#	1180#	2810#	1230#	*	17060#	1190#	12020#	1170#	17590#	1200#
282	Eb	111	6100#	1290#	2240#	1150#	*	17870#	1230#	12900#	1160#	16170#	1140#
	Ec	112	7630#	1210#	3200#	1170#	*	15640#	1030#	11660#	970#	15800#	1030#
283	Eb	111	7210#	1180#	*	*		16630#	1070#	12890#	1150#	*	
	Ec	112	6180#	1040#	3280#	1170#	*	16690#	1210#	11680#	1070#	16820#	1140#
	Ed	113	*		1060#	1020#	*	17390#	1230#	13630#	970#	16800#	1040#
284	Ec	112	7520#	1150#	3590#	1150#	*	15270#	1230#	11400#	1260#	15260#	1120#
	Ed	113	6550#	1080#	1430#	1110#	*	18460#	1070#	13060#	1270#	17480#	1230#
285	Ec	112	6470#	1120#	*	*		16010#	1070#	11030#	1150#	*	
	Ed	113	7460#	1260#	1380#	1300#	*	17180#	1250#	13220#	1210#	16120#	1320#
	Ee	114	*		2060#	1300#	*	17460#	1260#	*		18630#	1250#
286	Ed	113	6440#	1360#	1350#	1190#	*	18250#	1270#	12960#	1210#	16890#	1220#
	Ee	114	7930#	1290#	2520#	1250#	*	16090#	1110#	11760#	1060#	16880#	1090#
287	Ed	113	7550#	1260#	*	*		17180#	1110#	12930#	1190#	*	
	Ee	114	6450#	1090#	2520#	1210#	*	17110#	1250#	11870#	1110#	17960#	1150#
	Ef	115	*		460#	1100#	*	17690#	1300#	*		17850#	1120#
288	Ee	114	7990#	1150#	2960#	1190#	*	15560#	1270#	11340#	1300#	16440#	1120#
	Ef	115	6850#	1160#	870#	1150#	*	18760#	1150#	13060#	1340#	18460#	1300#
289	Ee	114	6590#	1120#	*	*		16520#	1110#	11200#	1190#	*	
	Ef	115	7860#	1330#	740#	1330#	*	17340#	1280#	13120#	1280#	17040#	1390#
	Eg	116	*		1360#	1380#	*	17860#	1340#	*		19630#	1330#
290	Ef	115	6740#	1420#	900#	1230#	*	18590#	1300#	12820#	1250#	17850#	1290#
	Eg	116	8330#	1380#	1820#	1330#	*	16390#	1200#	11760#	1150#	17750#	1140#
291	Ef	115	7850#	1320#	*	*		17330#	1150#	12960#	1230#	*	
	Eg	116	6750#	1200#	1820#	1300#	*	17510#	1330#	11870#	1200#	18990#	1200#
	Eh	117	*		-140#	1220#	*	17890#	1400#	*		18750#	1230#
292	Eg	116	8280#	1200#	2260#	1230#	*	15970#	1300#	11450#	1330#	17300#	1120#
	Eh	117	7150#	1290#	270#	1270#	*	19060#	1270#	12960#	1440#	19460#	1390#
293	Ei	118	*		660#	1520#	*	18260#	1490#	*		20630#	1470#

A	Elt.	Z	S(2n)		S(2p)		Q( $\alpha$ )		Q( $2\beta^-$ )		Q( $\epsilon p$ )		Q( $\beta^- n$ )	
279	Mt	109	12630#	1140#	*		8700#	300#	-5850#	980#	*		-8330#	990#
	Ea	110	13150#	1220#	6180#	1040#	9600#	200#	-7160#	890#	*		-10630#	980#
	Eb	111	13400#	910#	5220#	1100#	10450#	300#	*		-160#	1070#	-9790#	850#
	Ec	112	13720#	510#	4430#	1080#	10960#	200#	*		2100#	840#	*	
280	Ea	110	13050#	1090#	*		9300#	200#	-6750#	1060#	*		-10560#	1080#
	Eb	111	13470#	980#	5580#	1120#	9980#	300#	*		420#	1030#	-10000#	890#
	Ec	112	13600#	830#	4730#	930#	10620#	200#	*		330#	980#	*	
281	Ea	110	13160#	1040#	*		8960	50	-6730#	1230#	*		-10320#	1040#
	Eb	111	13440#	1140#	6030#	1180#	9640#	300#	*		*		-9620#	1130#
	Ec	112	13590#	1100#	4870#	1230#	10280#	200#	*		1550#	1300#	*	
282	Eb	111	13340#	1160#	*		9380#	300#	*		*		-9750#	1330#
	Ec	112	13600#	950#	5290#	1100#	9960#	200#	*		-110#	1020#	*	
283	Eb	111	13310#	1210#	*		8960#	300#	-7490#	1070#	*		-9330#	1050#
	Ec	112	13810#	1250#	5510#	1060#	9620#	200#	*		*		*	
	Ed	113	*		4260#	1180#	10600#	300#	*		1060#	1150#	*	
284	Ec	112	13700#	1110#	*		9300	50	*		*		-11860#	1120#
	Ed	113	*		4710#	1200#	10250#	300#	*		1710#	1120#	*	
285	Ec	112	13990#	1060#	*		8790	50	-8940#	1260#	*		-11770#	1080#
	Ed	113	14020#	1220#	4970#	1250#	10020#	300#	*		*		*	
	Ee	114	*		3490#	1290#	11000#	300#	*		3250#	1340#	*	
286	Ed	113	13910#	1230#	*		9680#	300#	*		*		-11070#	1390#
	Ee	114	*		3890#	1150#	10700#	300#	*		1790#	1060#	*	
287	Ed	113	13990#	1290#	*		9340#	300#	-9450#	1150#	*		-10690#	1130#
	Ee	114	14370#	1290#	3870#	1060#	10440	50	*		*		*	
	Ef	115	*		2980#	1260#	11300#	300#	*		2680#	1220#	*	
288	Ee	114	14440#	1150#	*		9970	50	*		*		-13190#	1160#
	Ef	115	*		3390#	1270#	11000#	300#	*		3370#	1190#	*	
289	Ee	114	14580#	1060#	*		9850	50	-10790#	1310#	*		-12930#	1130#
	Ef	115	14720#	1290#	3710#	1320#	10600#	300#	*		*		*	
	Eg	116	*		2220#	1330#	11700#	350#	*		4980#	1380#	*	
290	Ef	115	14610#	1300#	*		10300#	300#	*		*		-12470#	1470#
	Eg	116	*		2560#	1200#	11300#	350#	*		3250#	1120#	*	
291	Ef	115	14590#	1350#	*		10000#	300#	-11350#	1250#	*		-11990#	1220#
	Eg	116	15070#	1380#	2720#	1120#	11000#	350#	*		*		*	
	Eh	117	*		1680#	1350#	11900#	400#	*		4280#	1320#	*	
292	Eg	116	15030#	1200#	*		10710	50	*		*		-14390#	1230#
	Eh	117	*		2090#	1360#	11600#	400#	*		4970#	1290#	*	
293	Ei	118	*		920#	1470#	12300#	500#	*		6580#	1470#	*	

## Graphs of separation and decay energies

Figs.	1–9.	$S_{2n}$	two-neutron separation energies.
Figs.	10–17.	$S_{2p}$	two-proton separation energies.
Figs.	18–26.	$Q_\alpha$	$\alpha$ -decay energies.
Figs.	27–36.	$Q_{\beta\beta}$	double $\beta$ -decay energies.

Mass numbers and element symbol are indicated only along the borders of the graphs; those for the intermediate points must be derived by enumeration.

Points represent experimental values.

Open circles represent values estimated from systematic trends.

Lines connect points for isotopes ( $S_{2n}$ ,  $Q_\alpha$ ,  $Q_{\beta\beta}$ ) or isotones ( $S_{2p}$ ,  $Q_{\beta\beta}$ ).

Other types of graphs are available from the AMDC web-site (see text).

Fig. 1. Two-neutron separation energies  $N = 0$  to 25

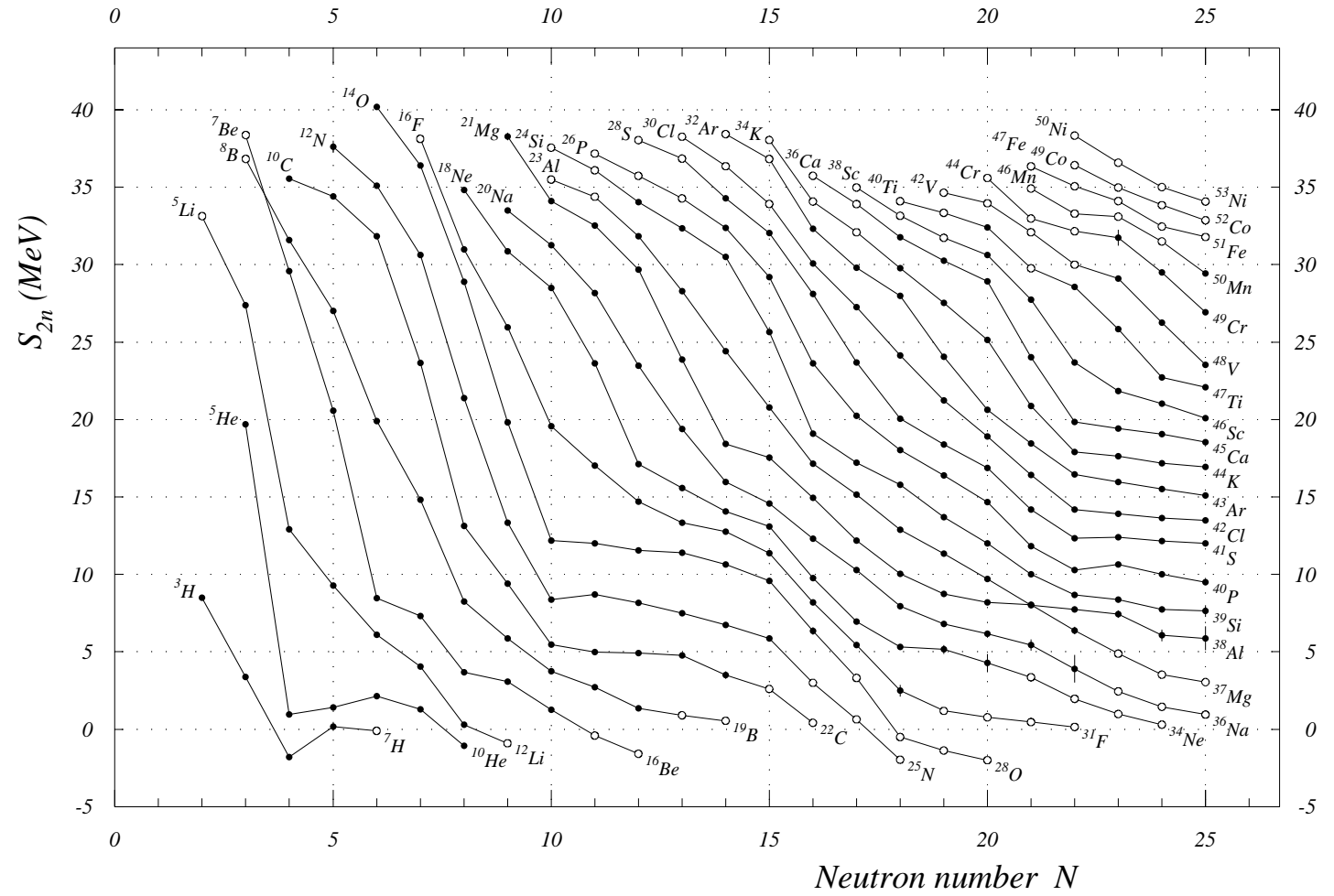

Fig. 2. Two-neutron separation energies  $N = 22$  to 45

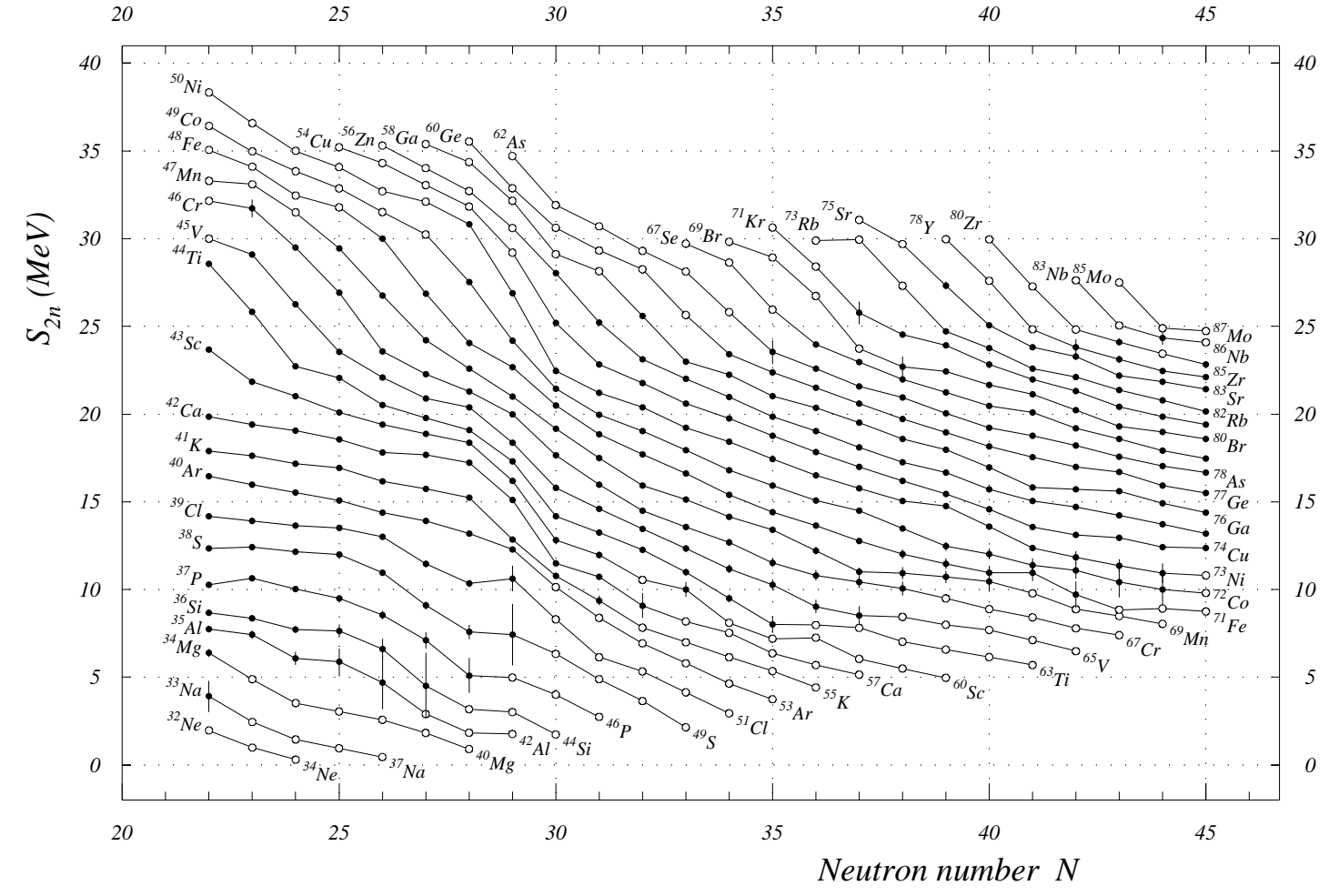



Fig. 3. Two-neutron separation energies  $N = 42$  to  $65$

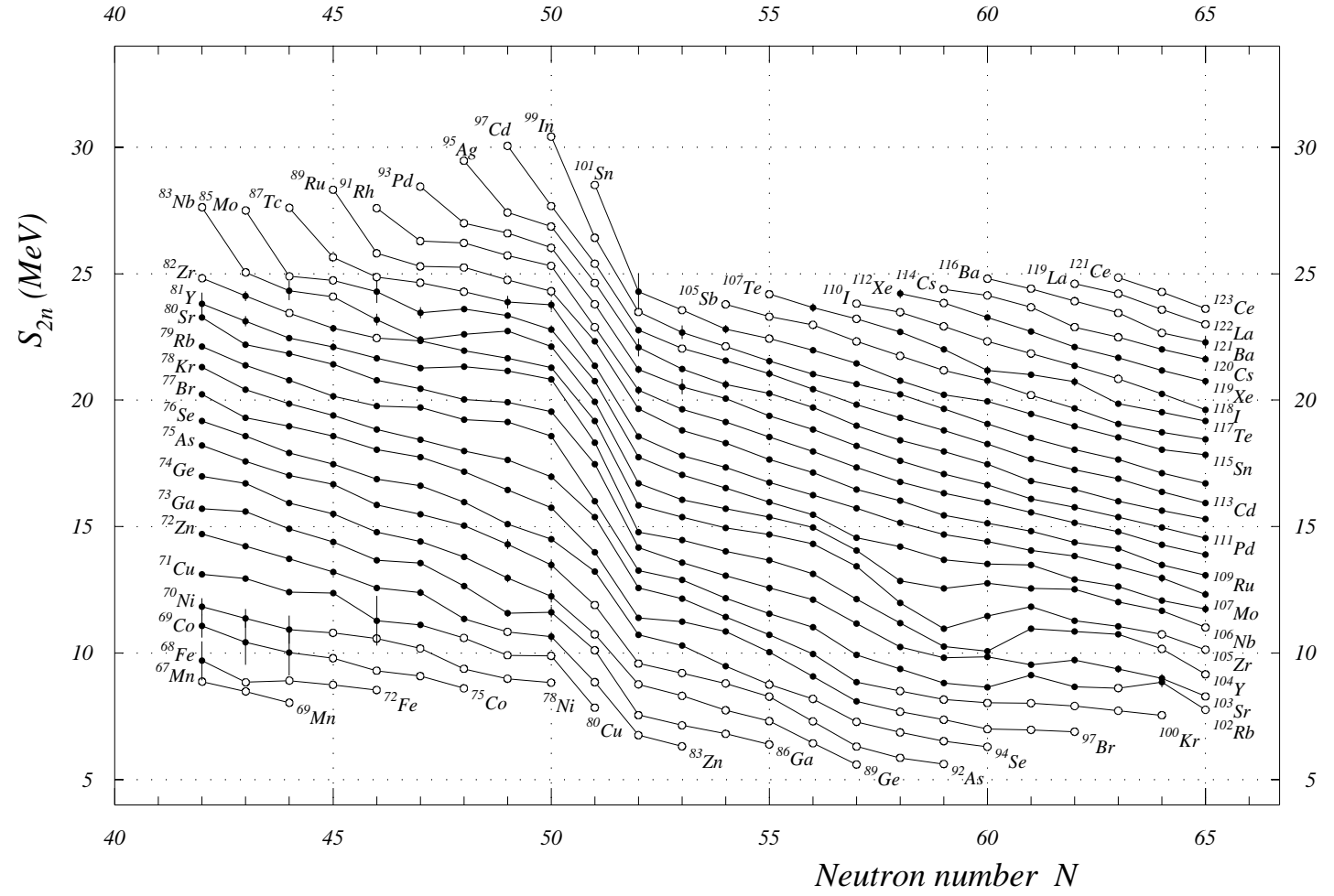

Fig. 4. Two-neutron separation energies  $N = 62$  to  $85$

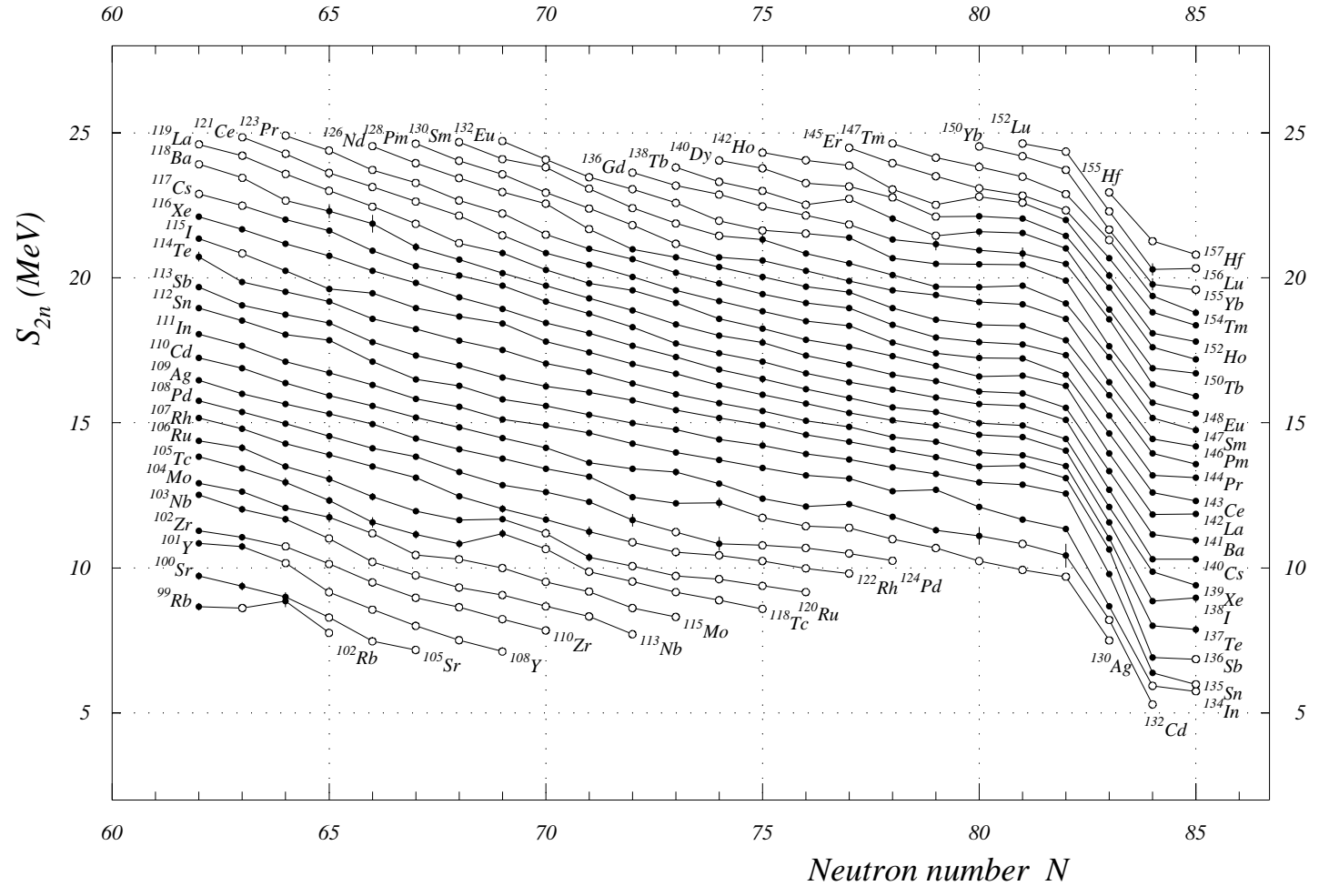

Fig. 5. Two-neutron separation energies  $N = 82$  to  $105$

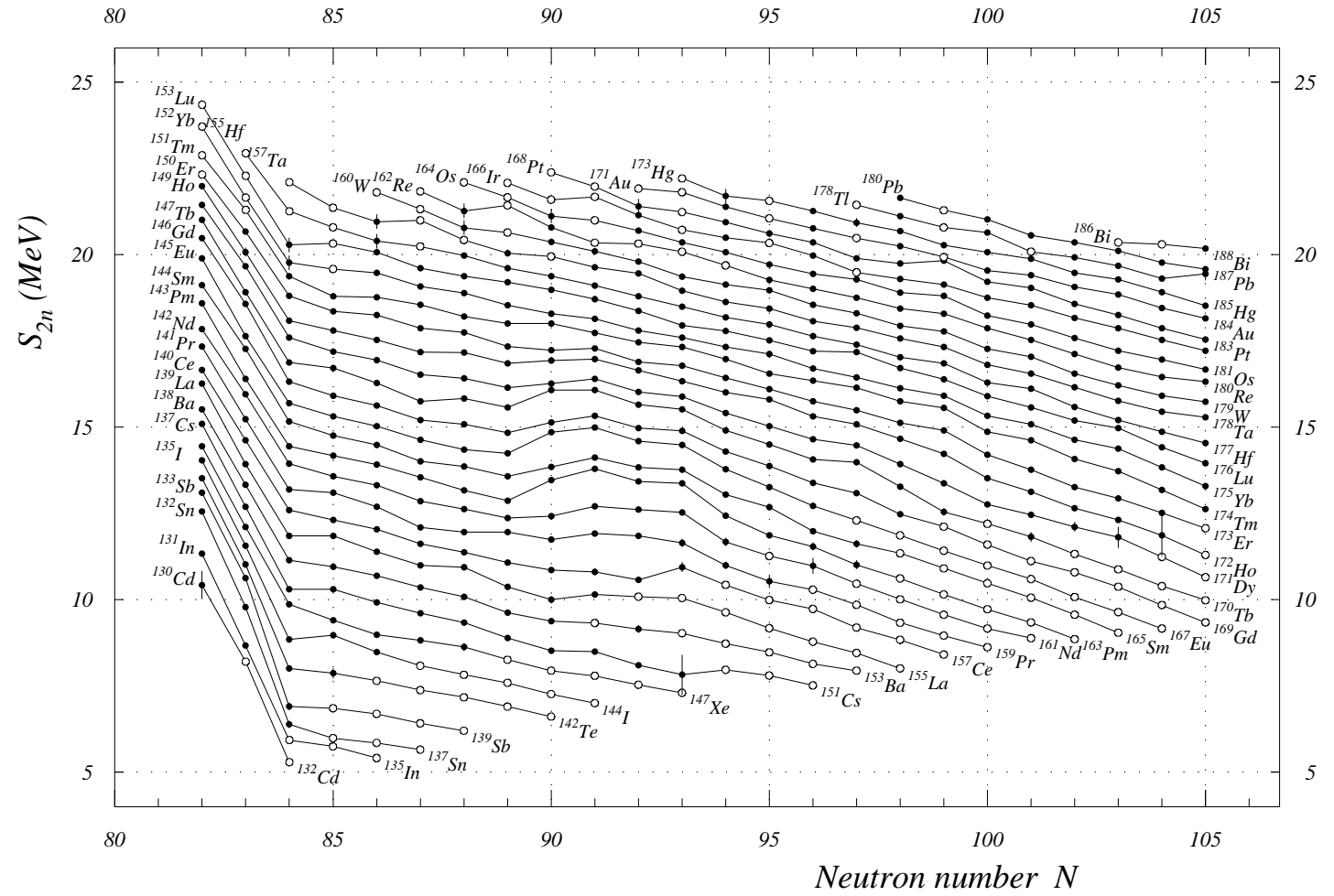

Fig. 6. Two-neutron separation energies  $N = 102$  to  $125$

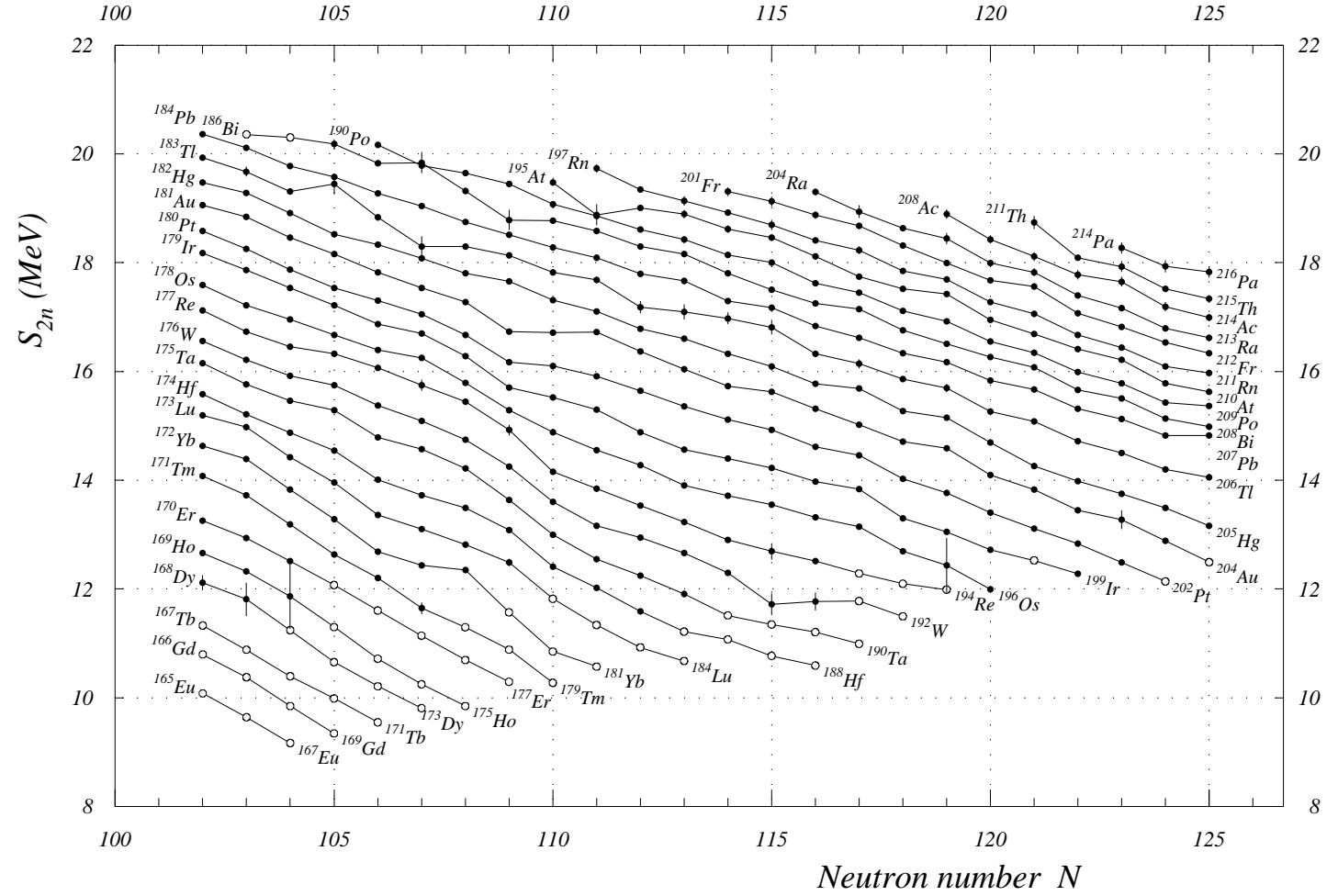

Fig. 7. Two-neutron separation energies  $N = 122$  to  $145$

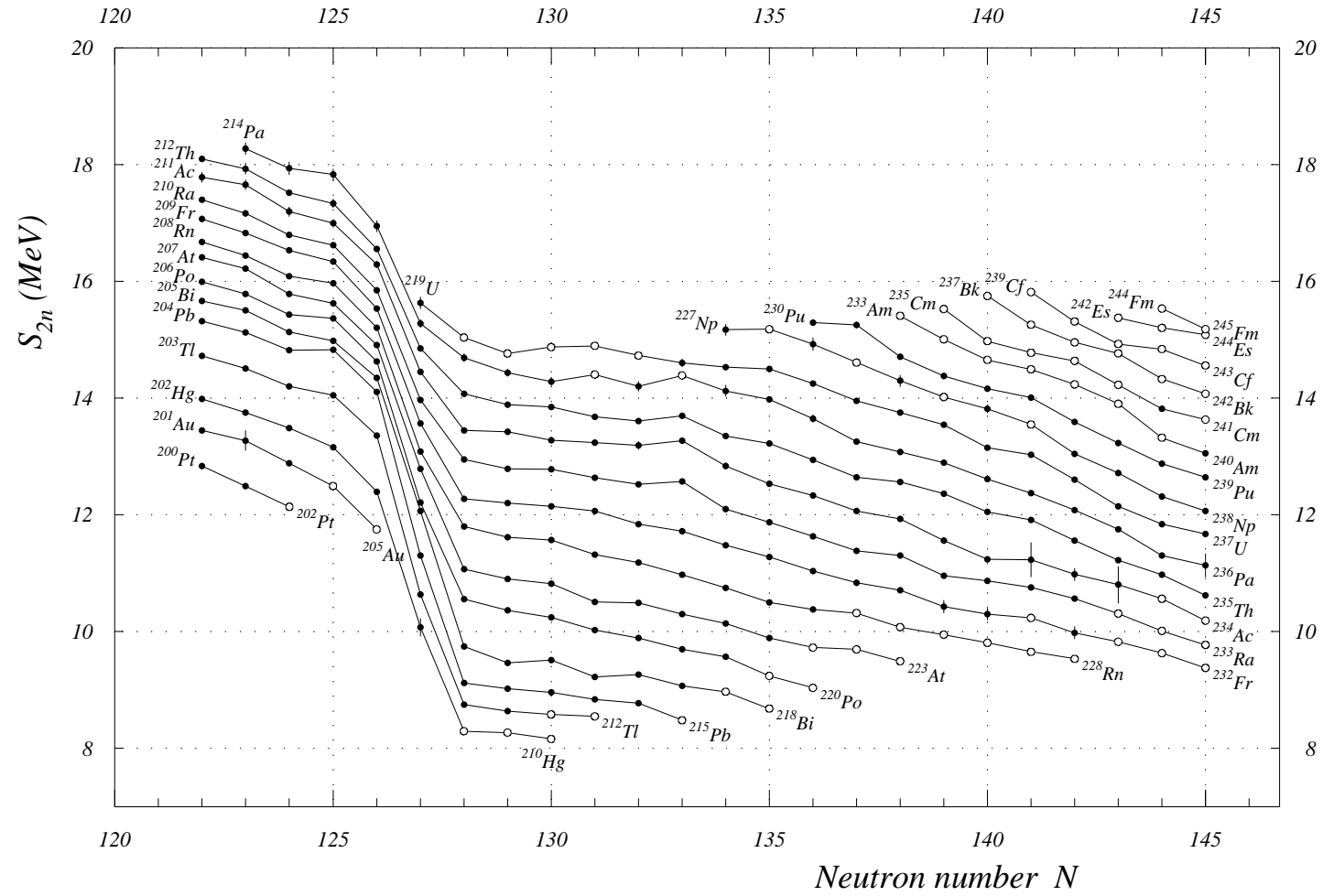

Fig. 8. Two-neutron separation energies  $N = 142$  to  $165$

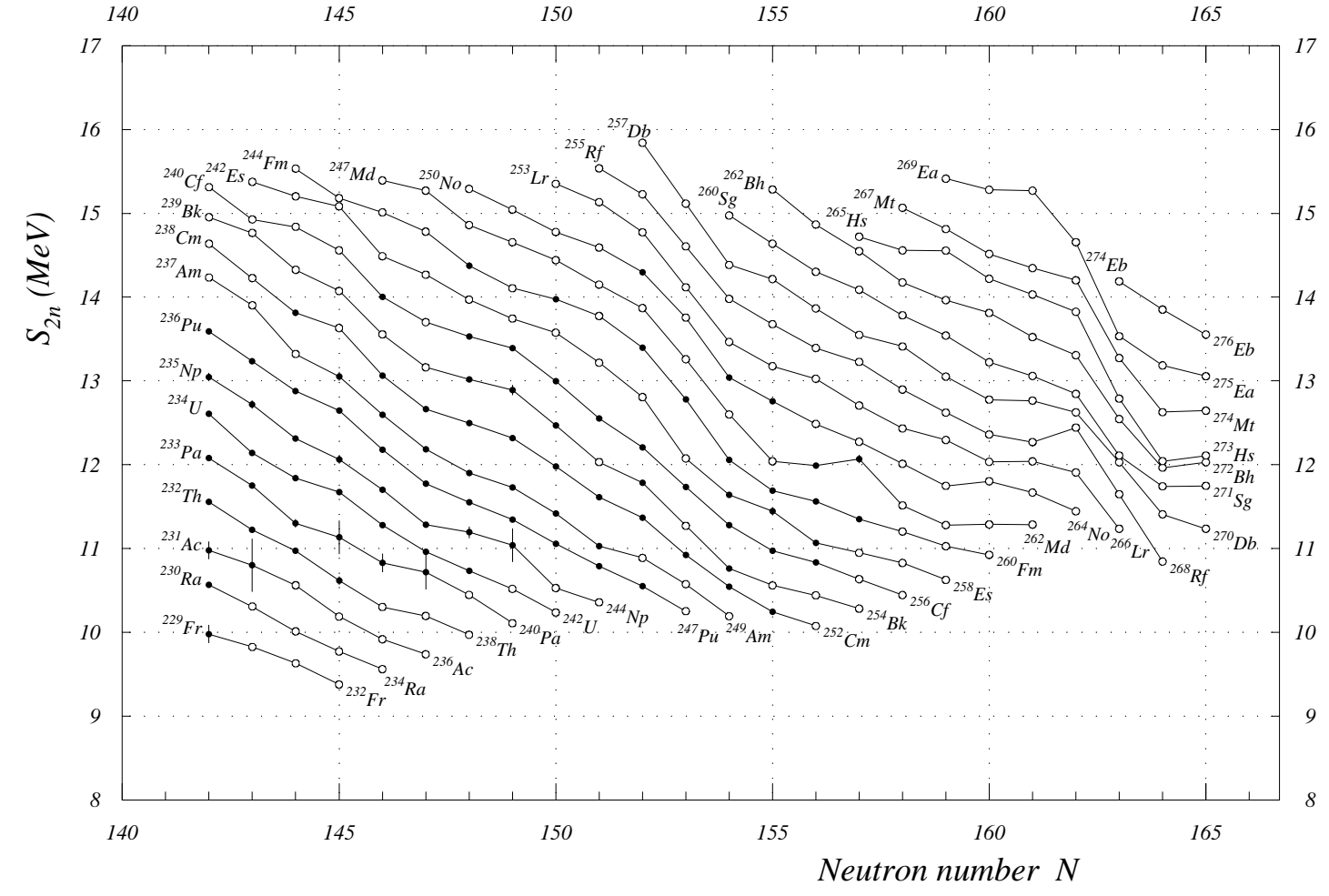

Fig. 9. Two-neutron separation energies  $N = 155$  to  $178$

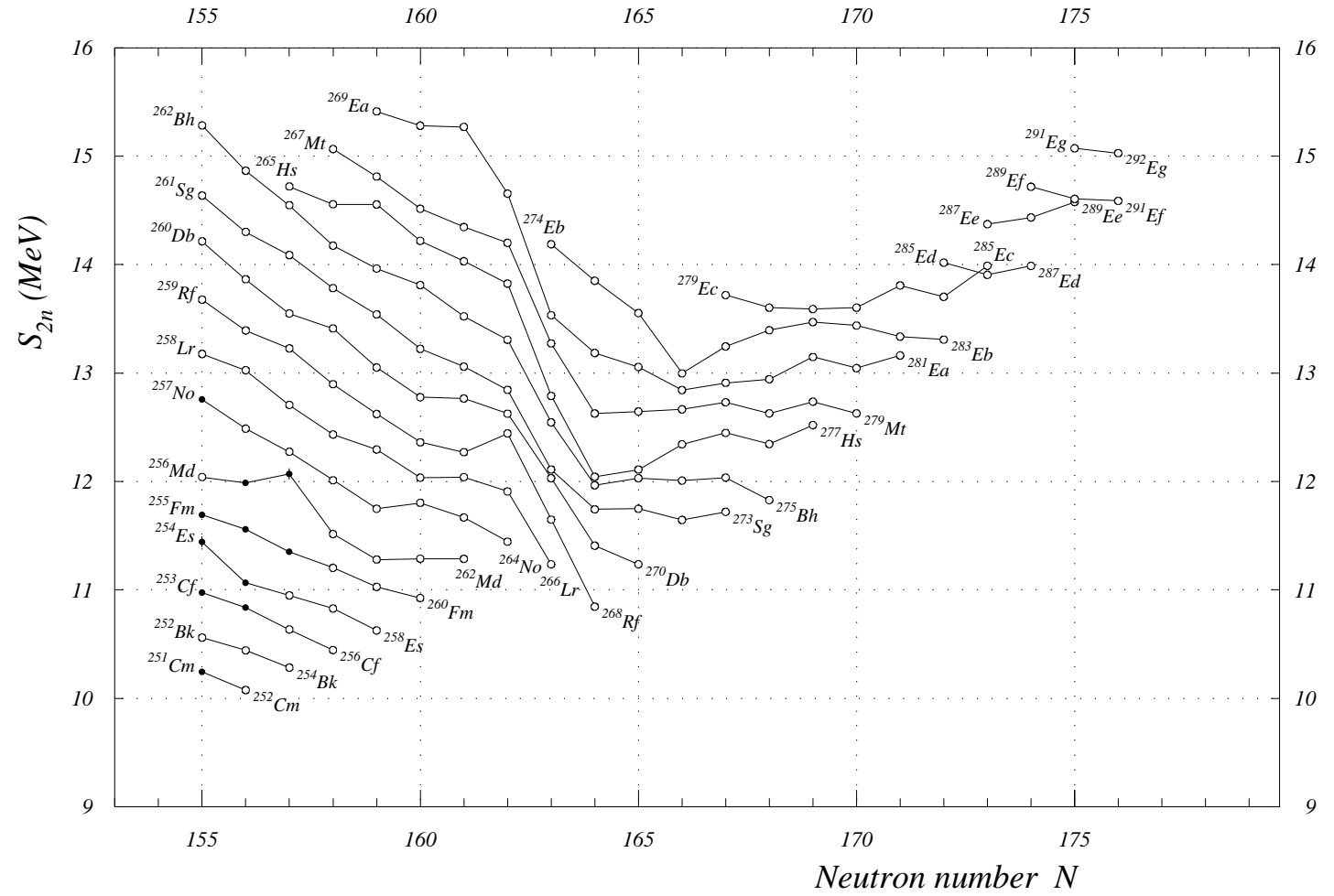

Fig. 10. Two-proton separation energies  $Z = 0$  to 20

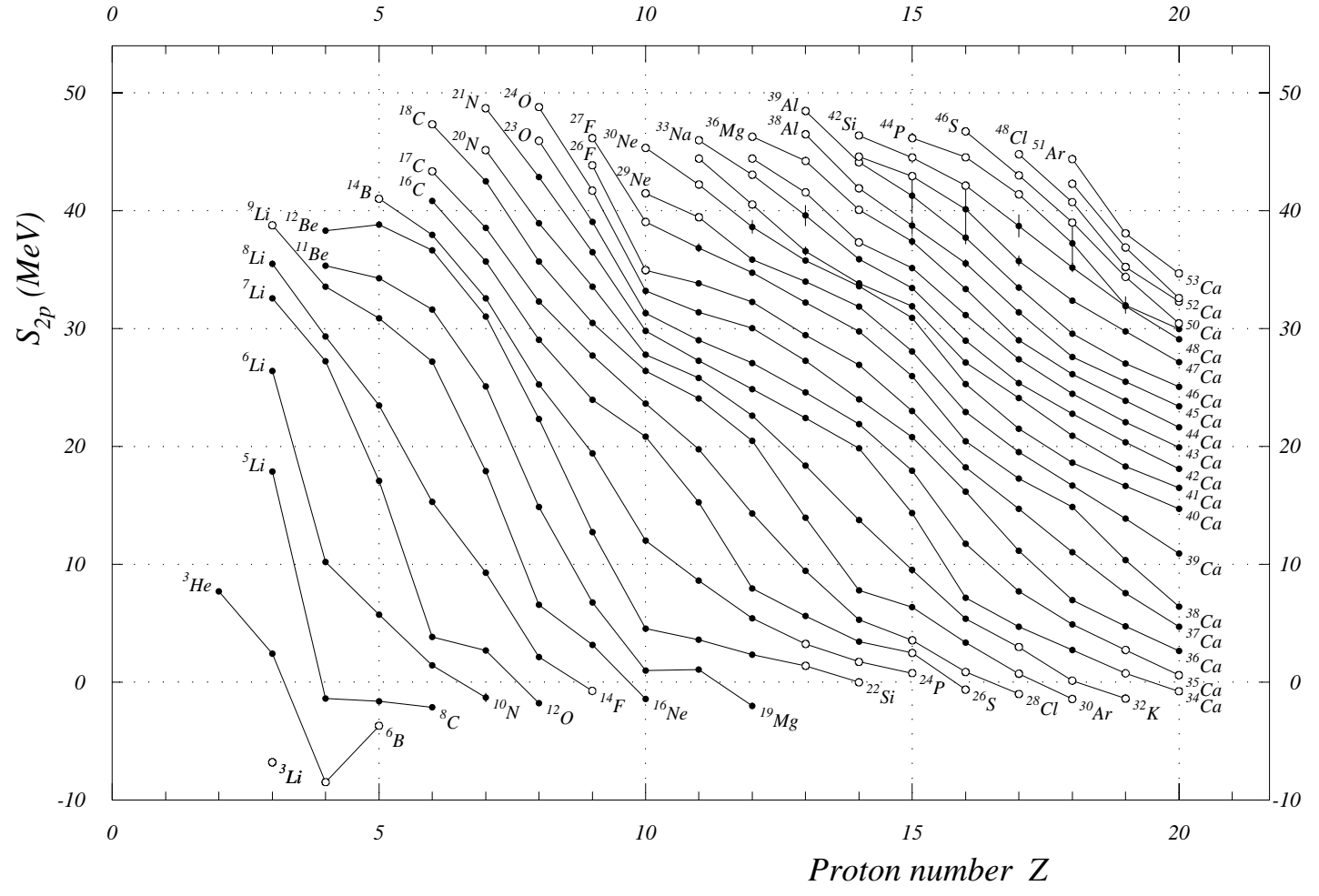



Fig. 11. Two-proton separation energies  $Z = 17$  to  $35$

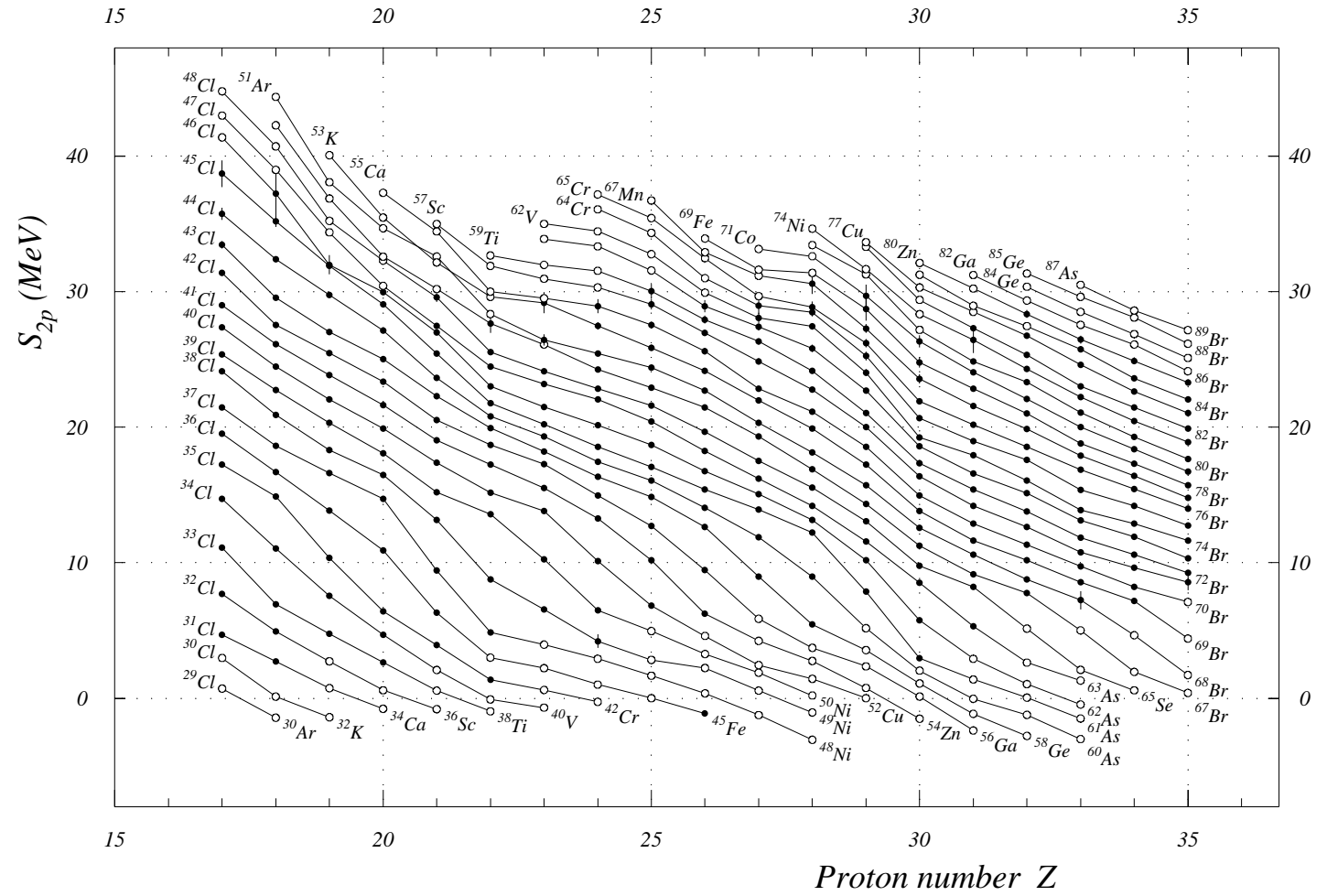

Fig. 12. Two-proton separation energies  $Z = 32$  to  $50$

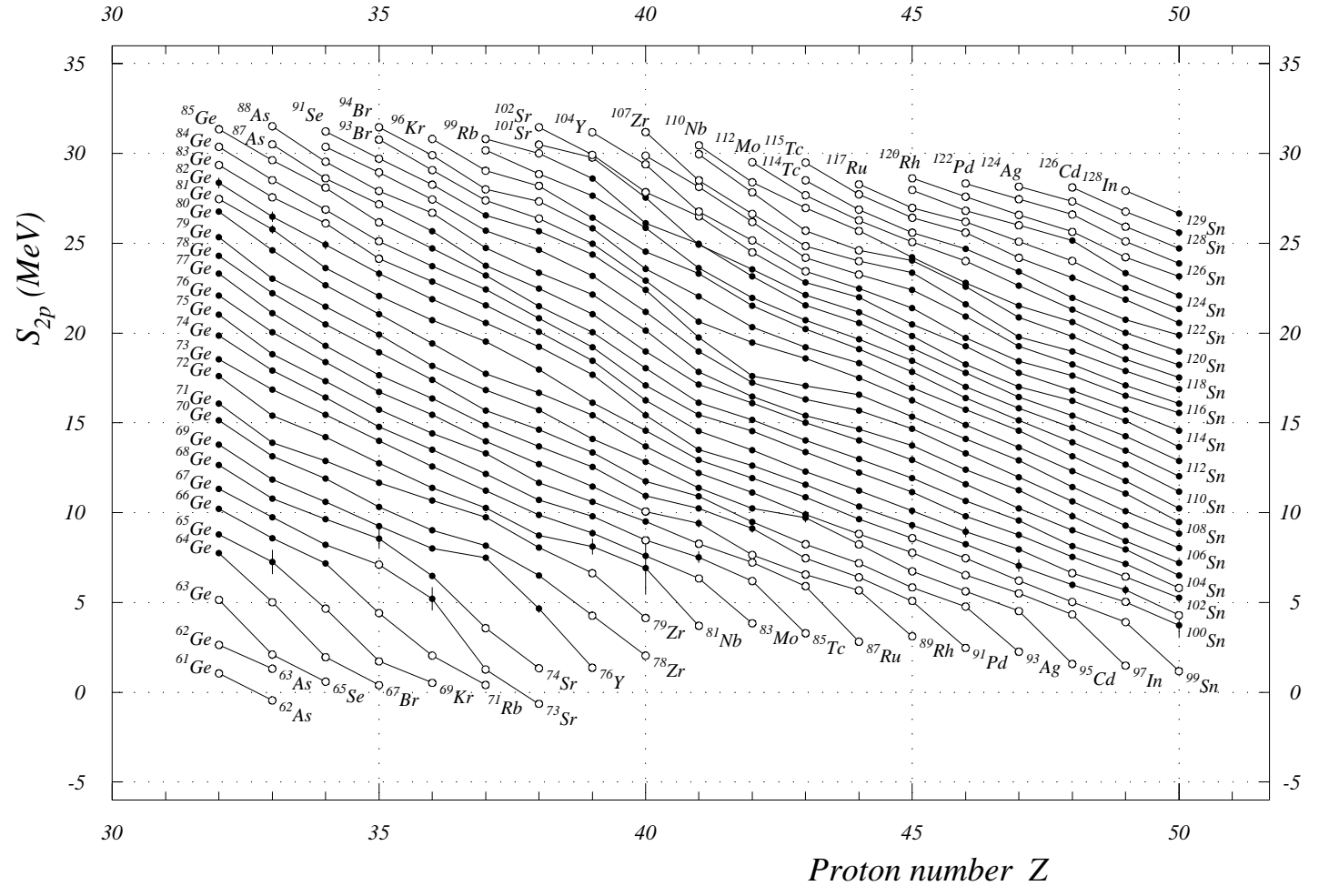

Fig. 13. Two-proton separation energies  $Z = 47$  to  $65$

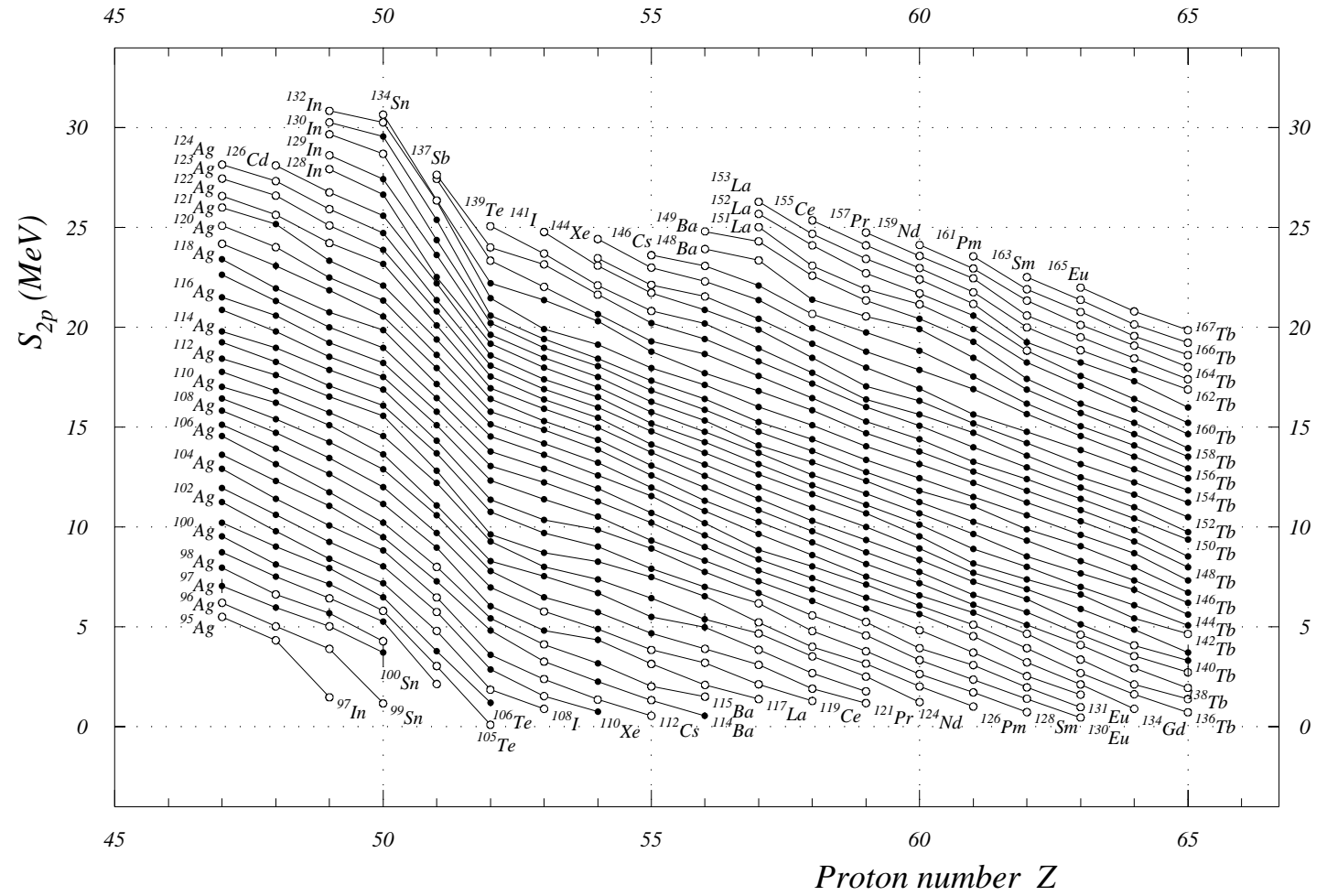

Fig. 14. Two-proton separation energies  $Z = 62$  to  $80$

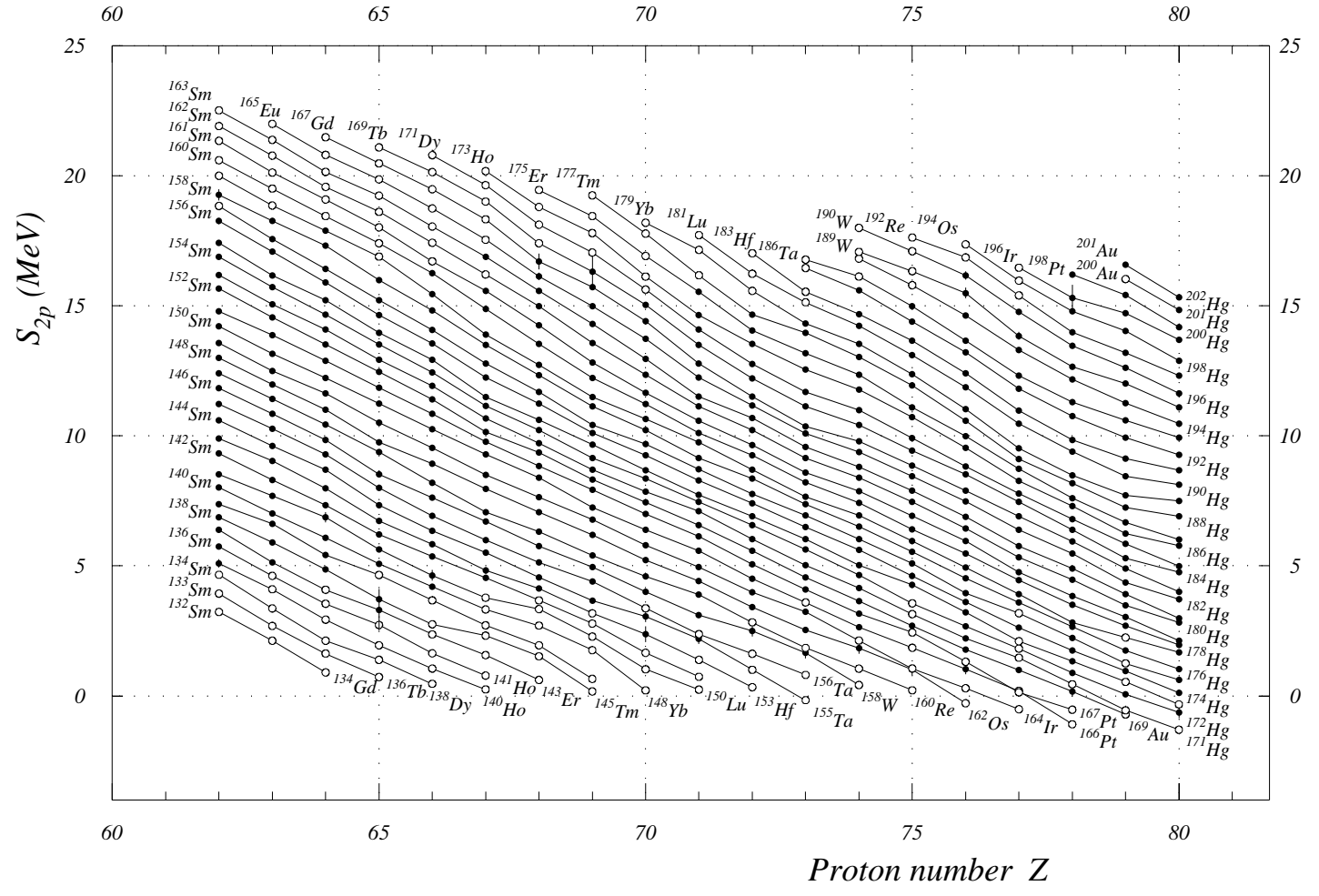

Fig. 15. Two-proton separation energies  $Z = 77$  to  $95$

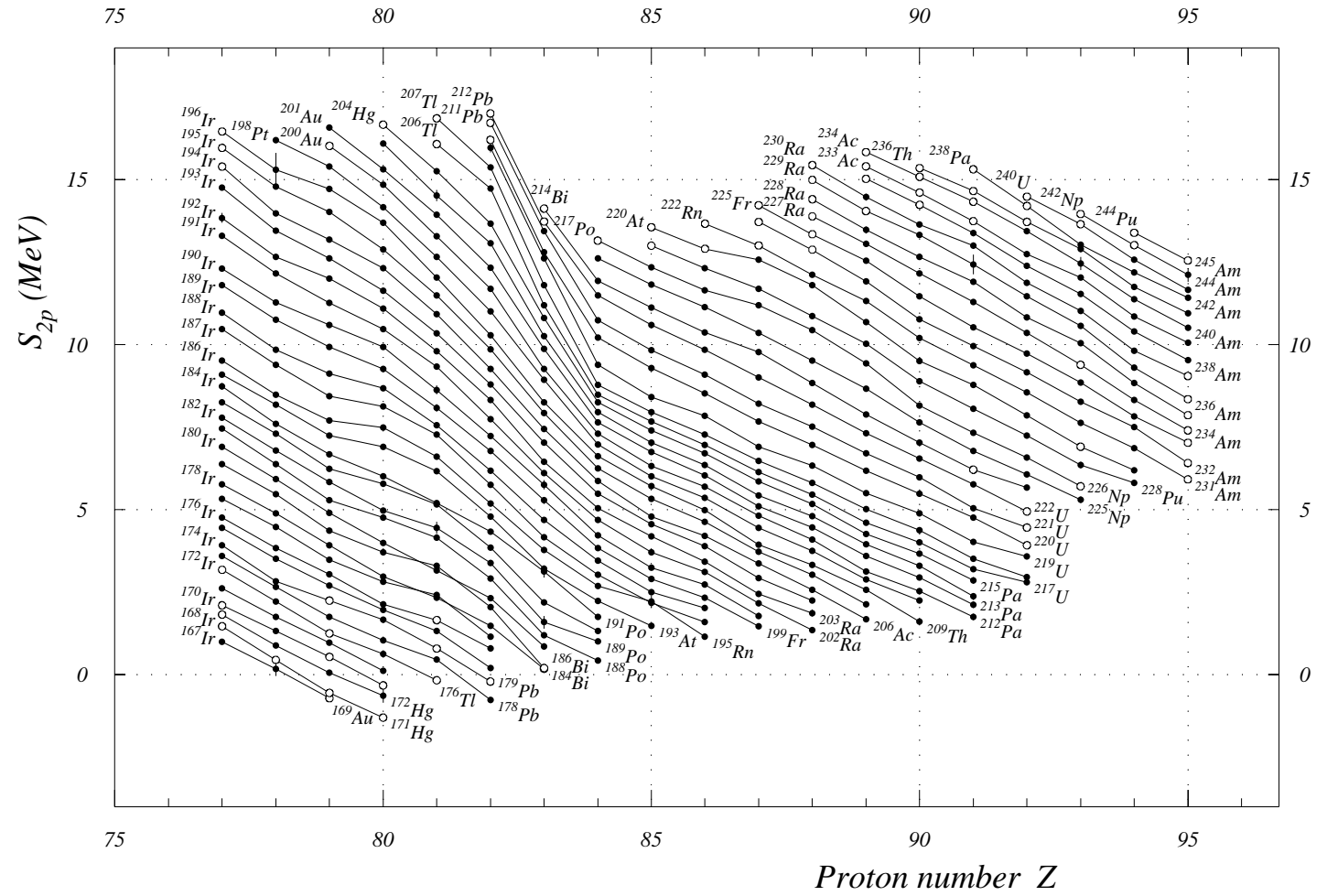

Fig. 16. Two-proton separation energies  $Z = 92$  to  $110$

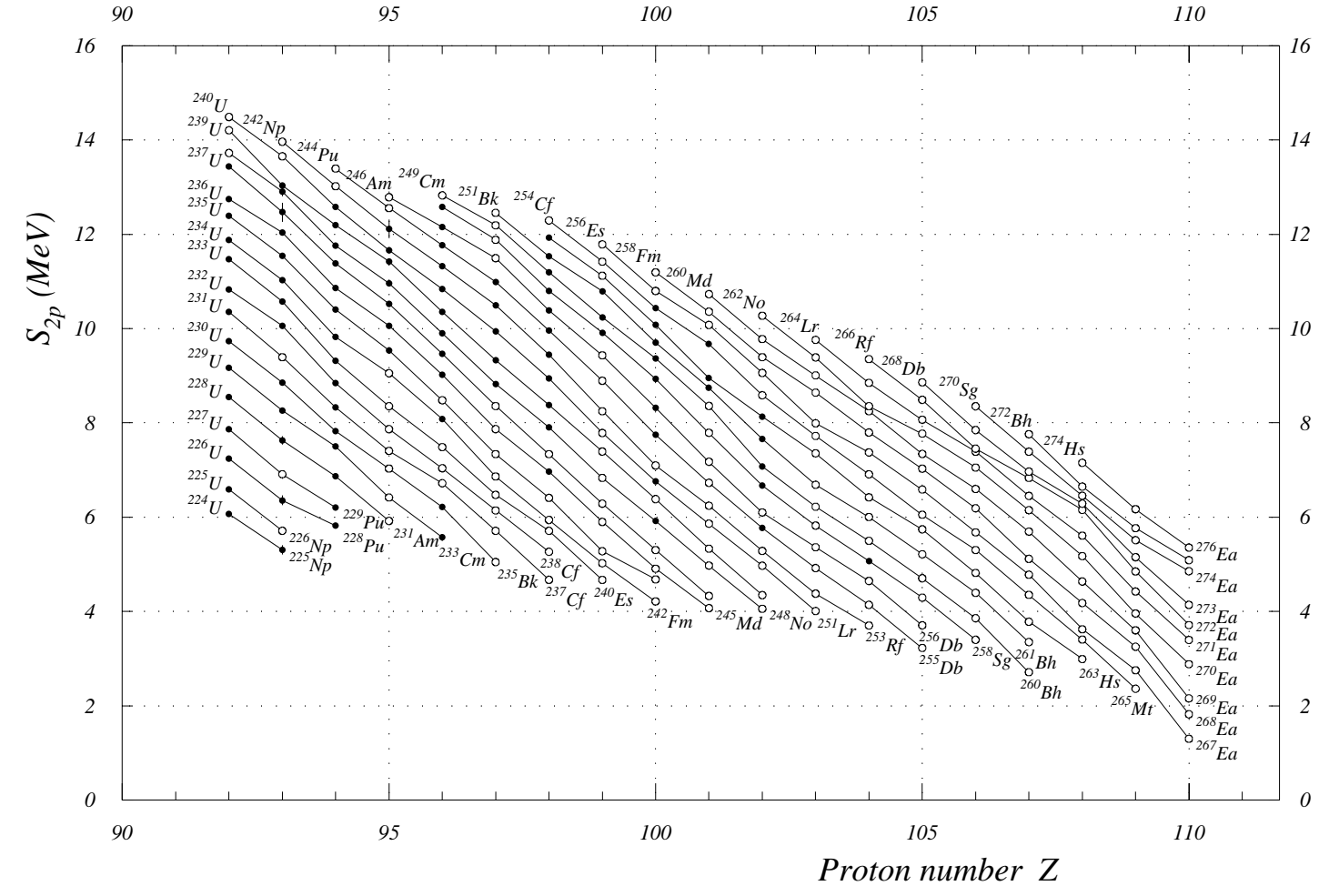

Fig. 17. Two-proton separation energies  $Z = 100$  to 118

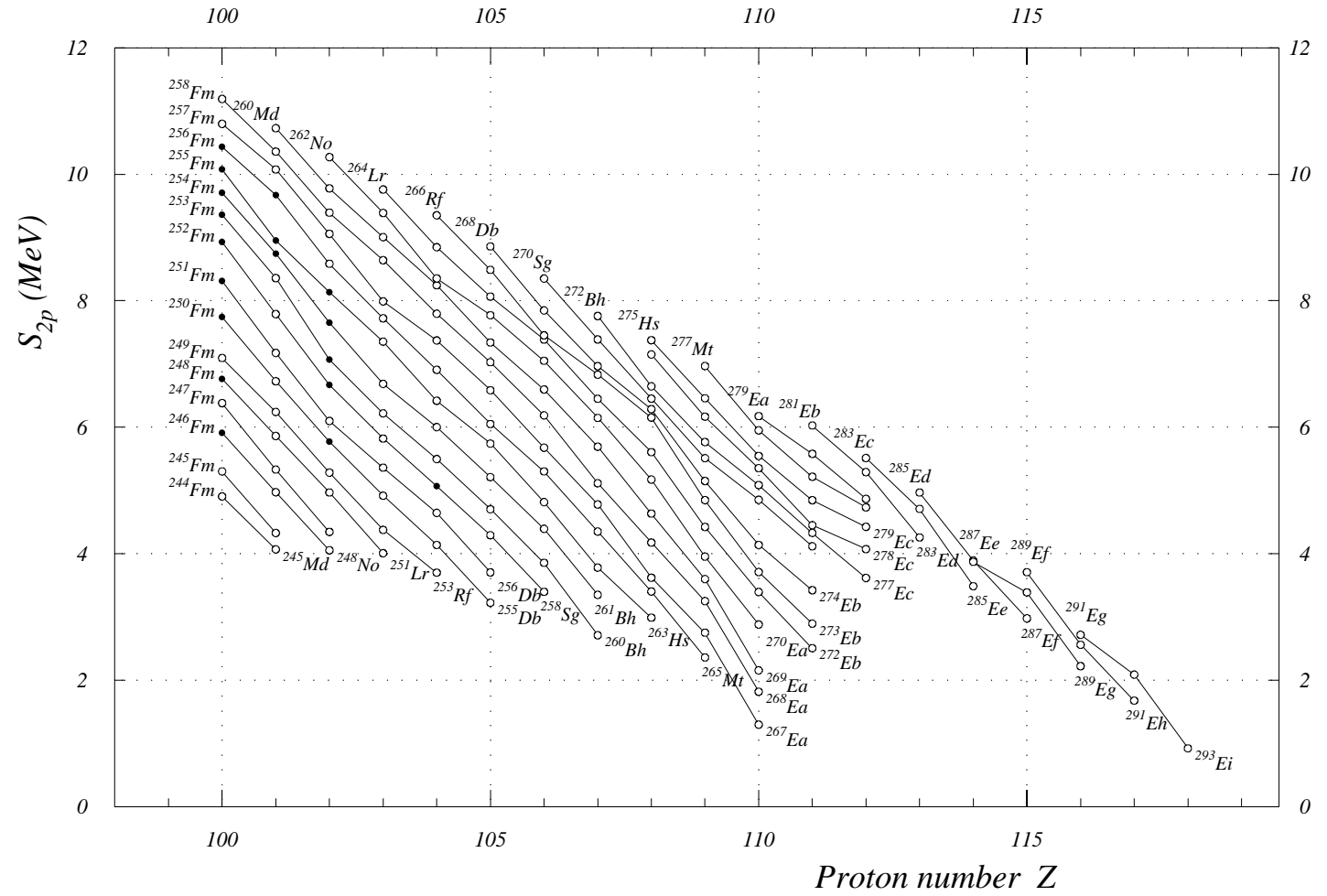

Fig. 18.  $\alpha$ -decay energies

$N = 0$  to 25

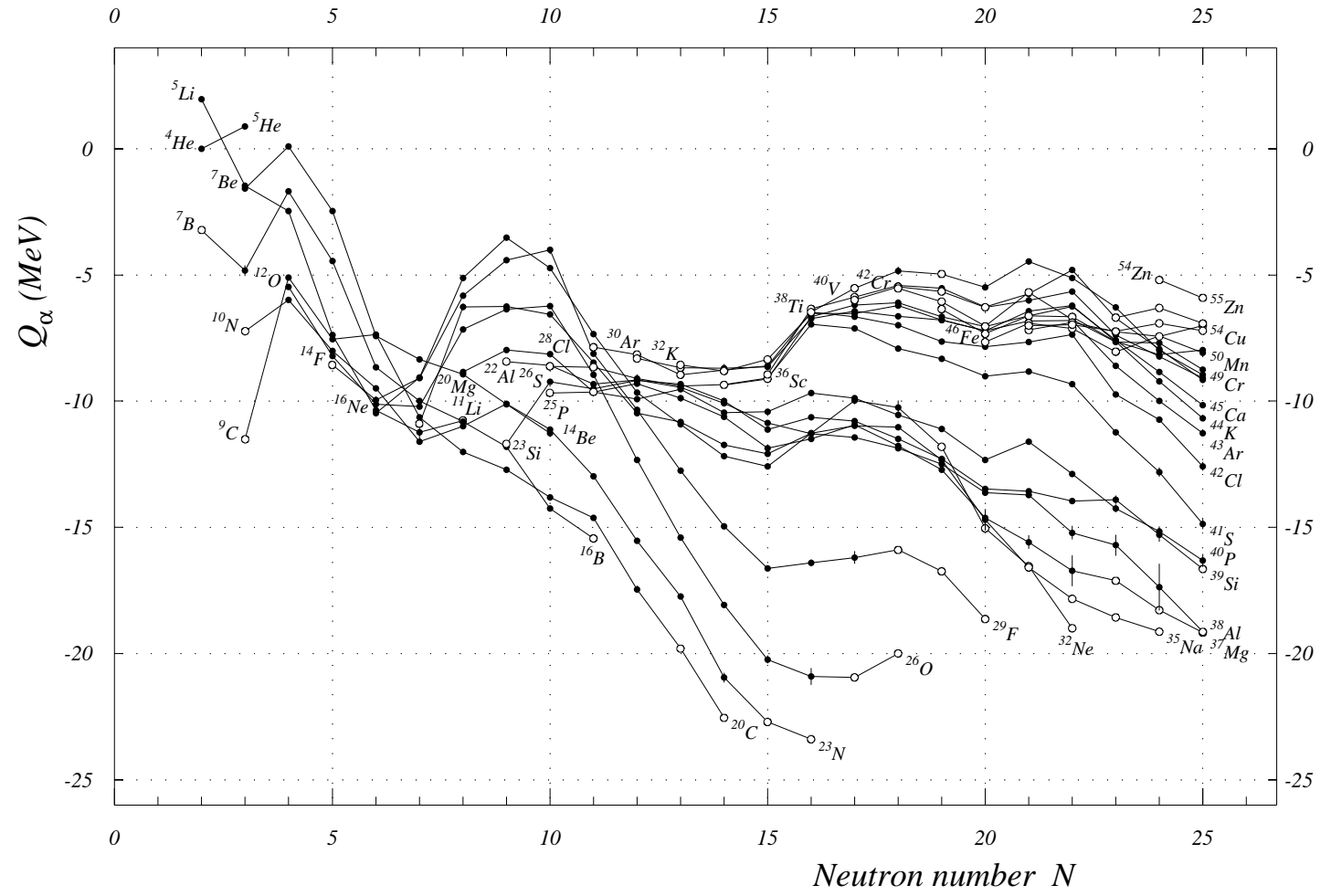



Fig. 19.  $\alpha$ -decay energies

$N = 22$  to  $45$

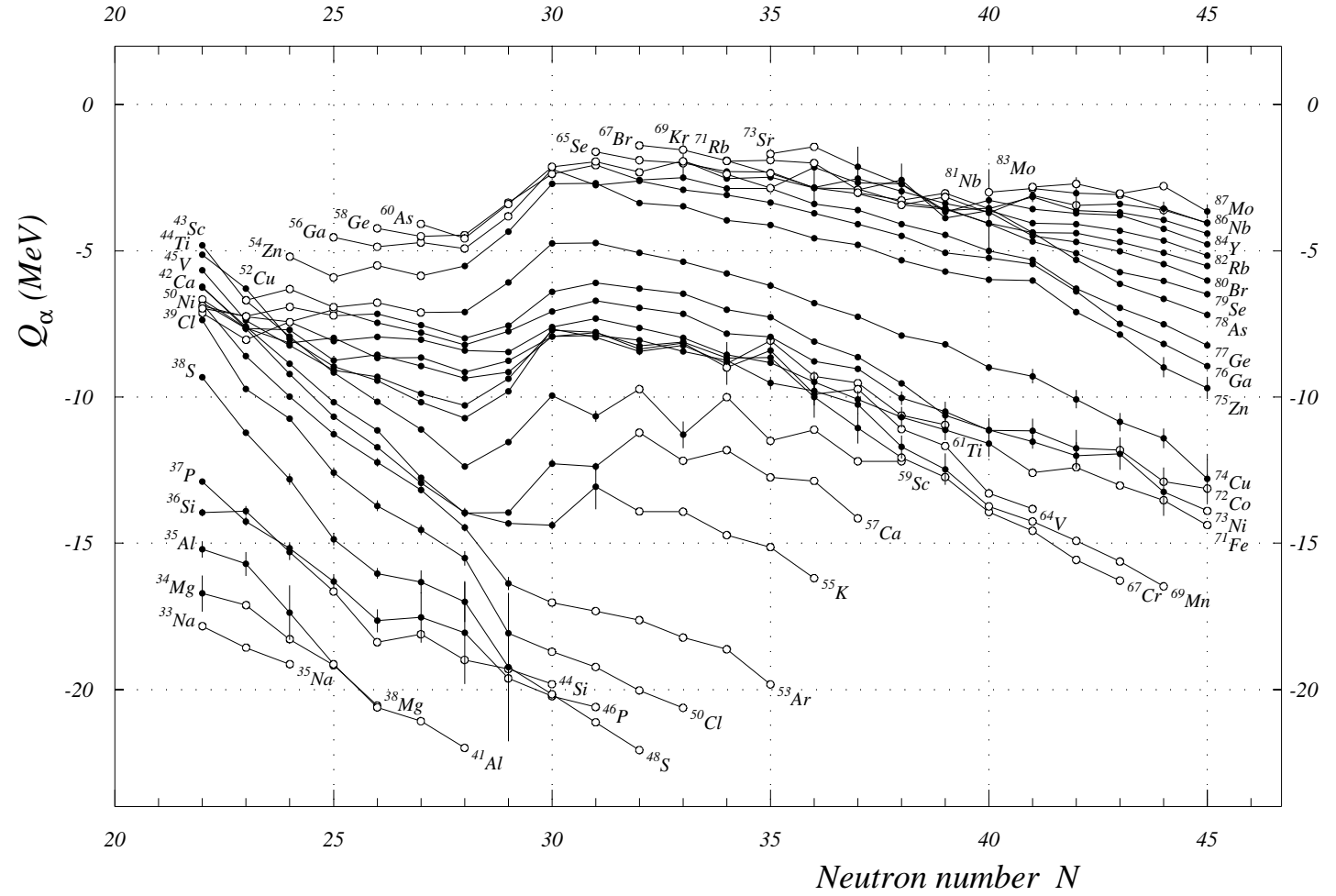

Fig. 20.  $\alpha$ -decay energies

$N = 42$  to  $65$

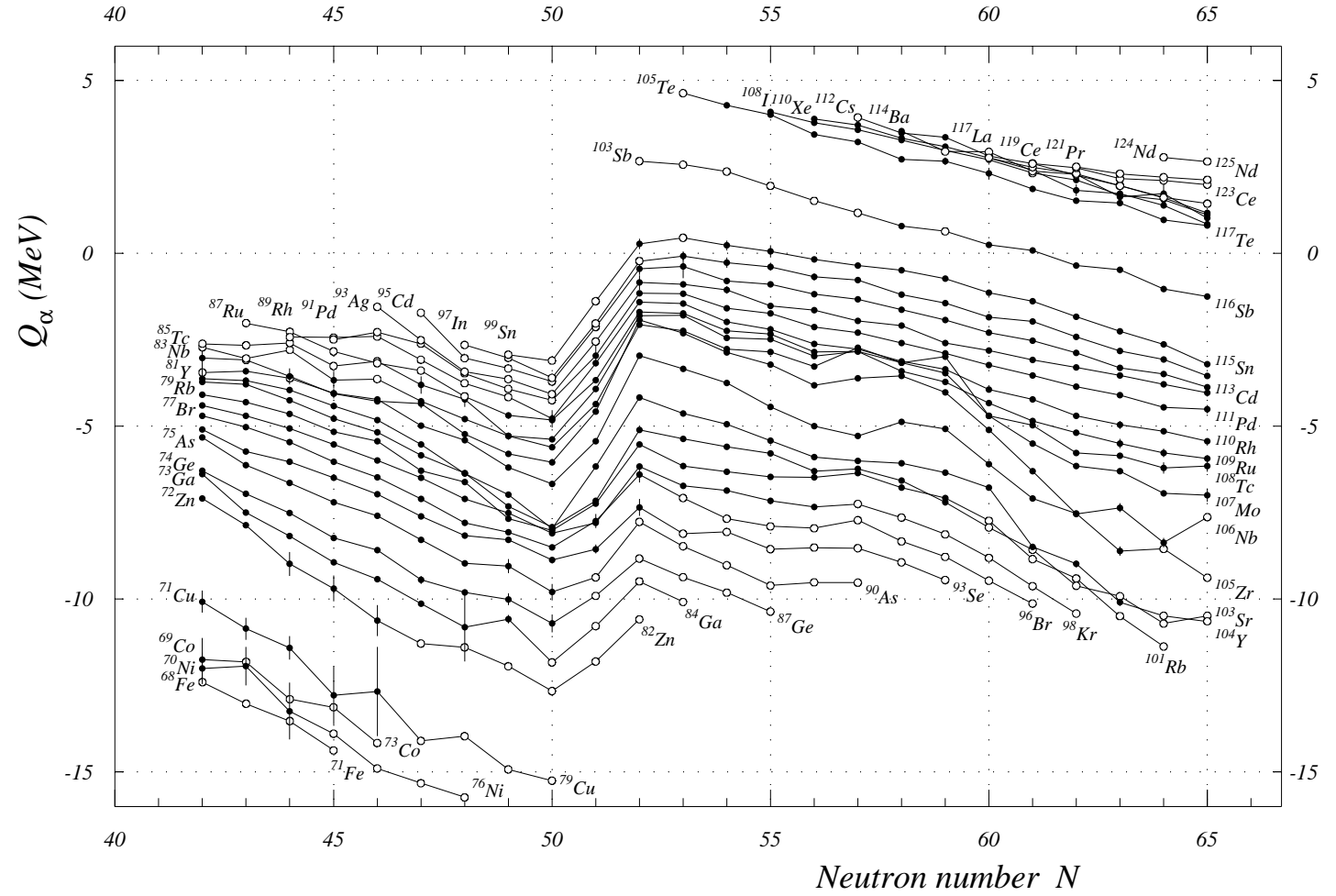

Fig. 21.  $\alpha$ -decay energies

$N = 62$  to  $85$

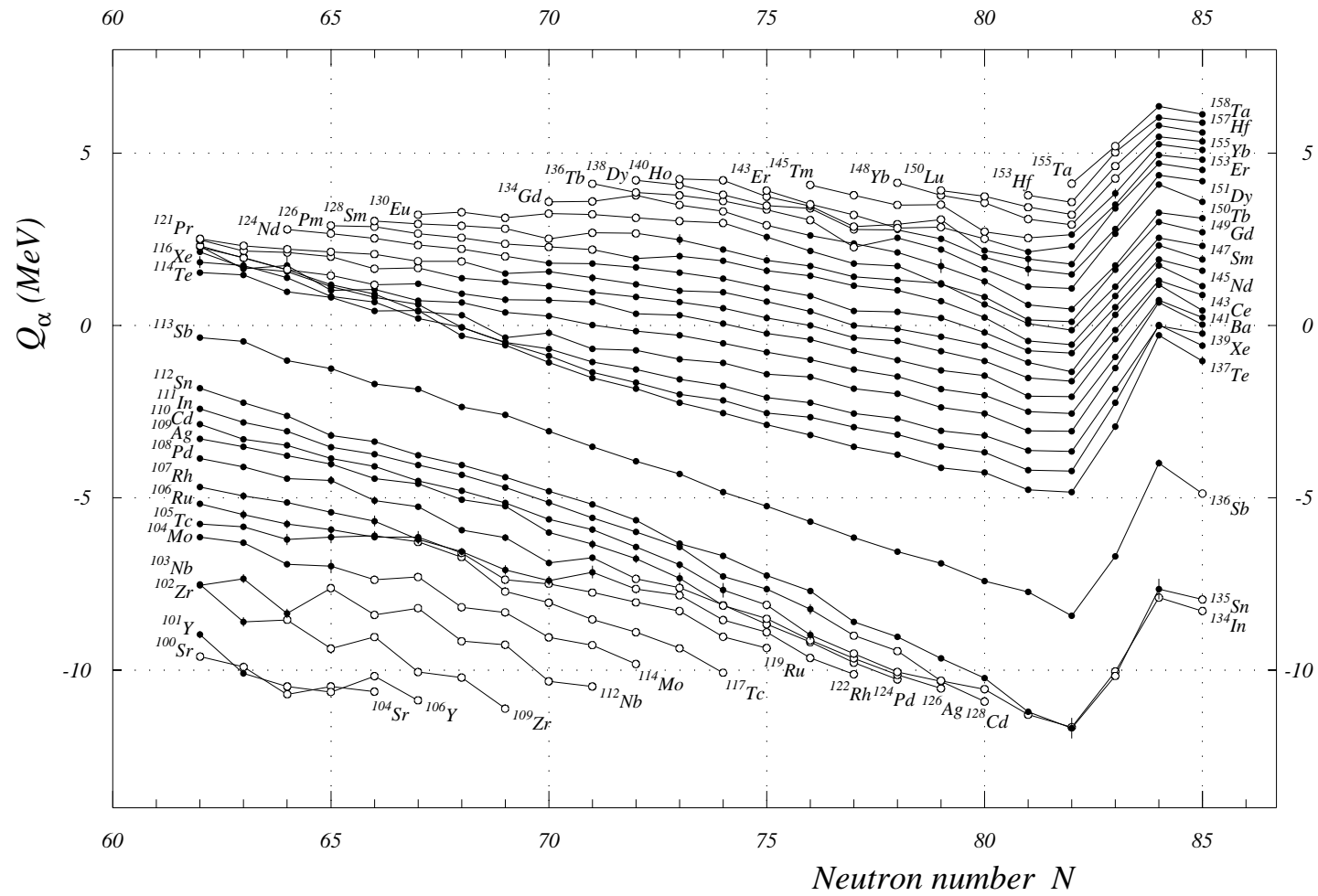

Fig. 22.  $\alpha$ -decay energies

$N = 82$  to  $105$

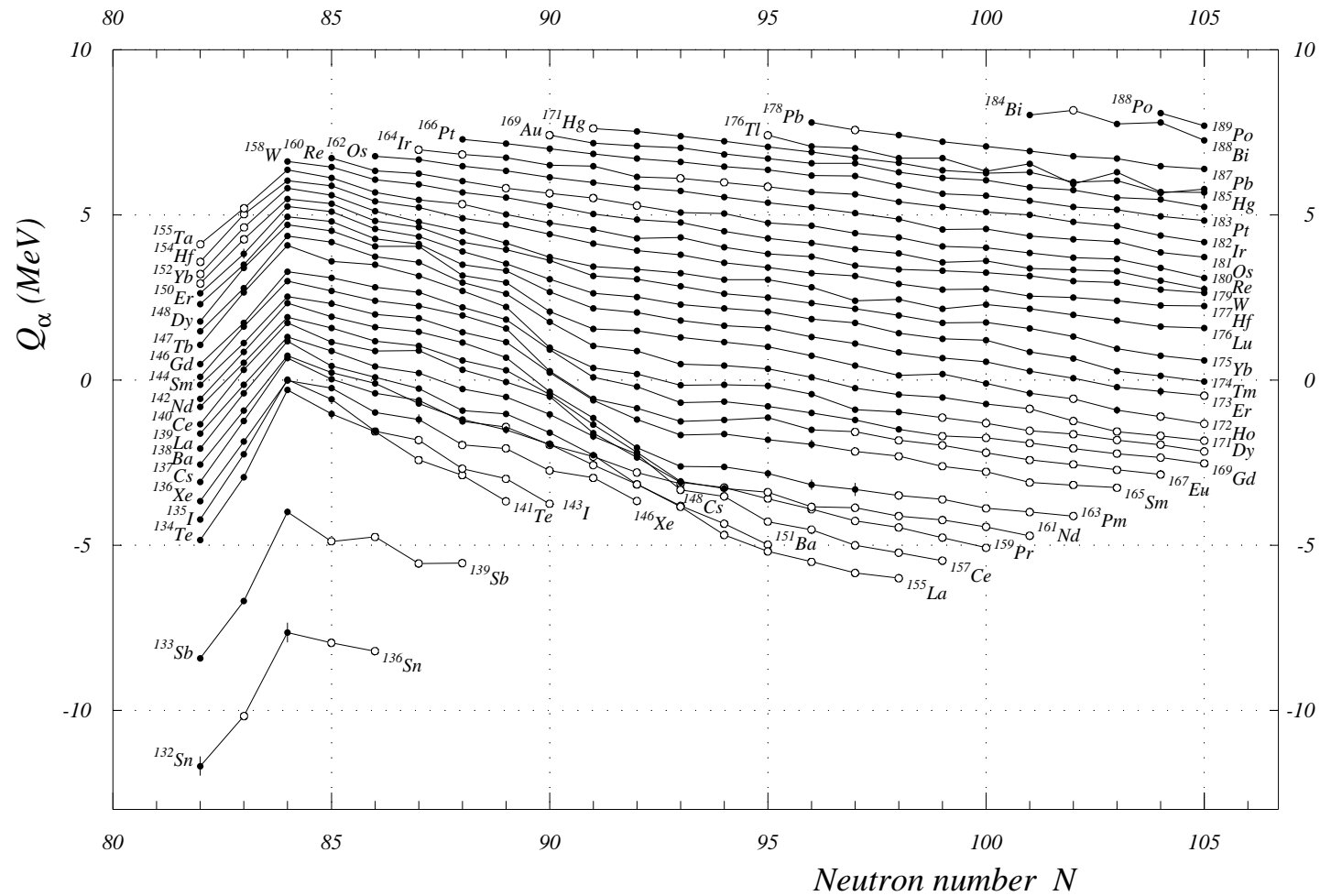

Fig. 23.  $\alpha$ -decay energies

$N = 102$  to  $125$

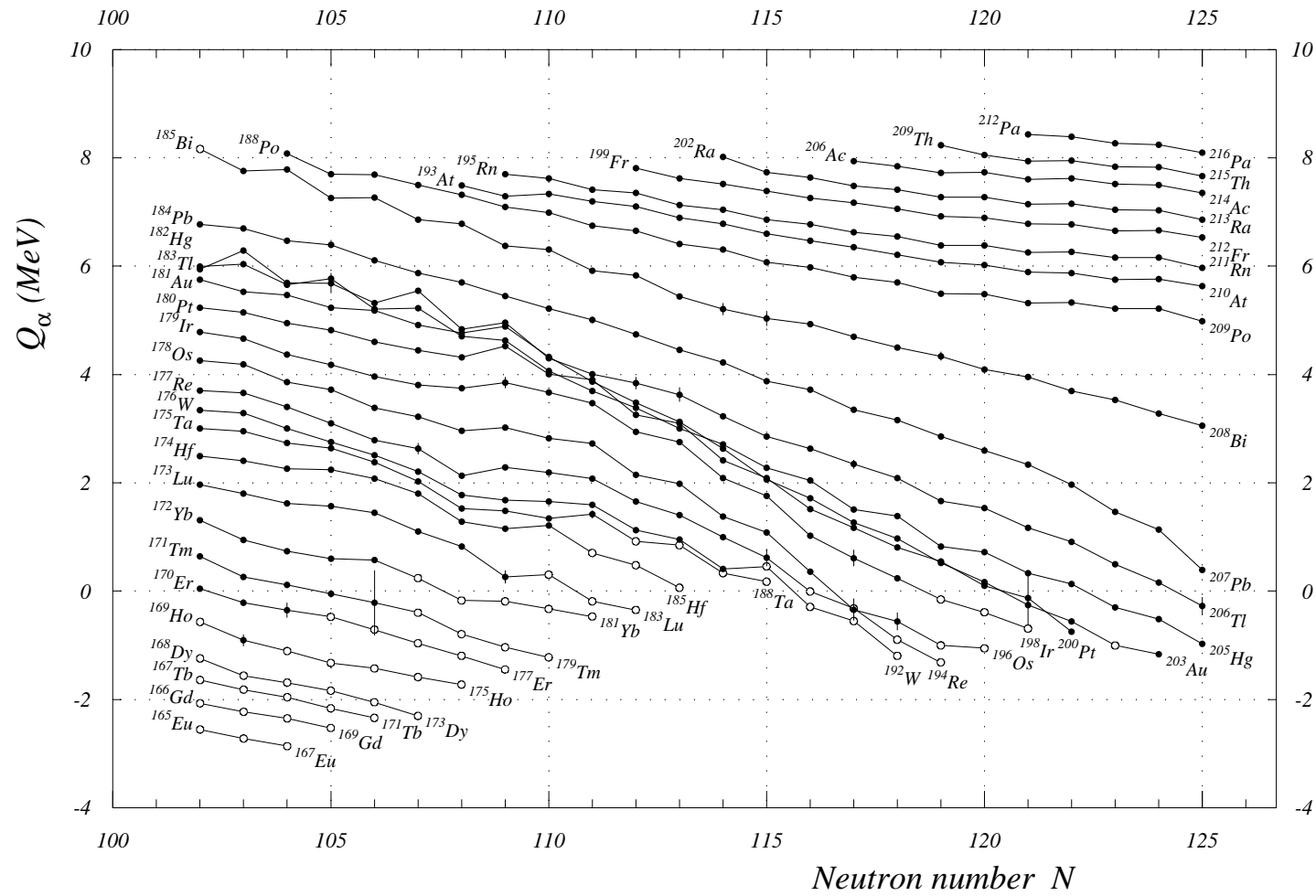

Fig. 24.  $\alpha$ -decay energies  $N = 122$  to  $145$

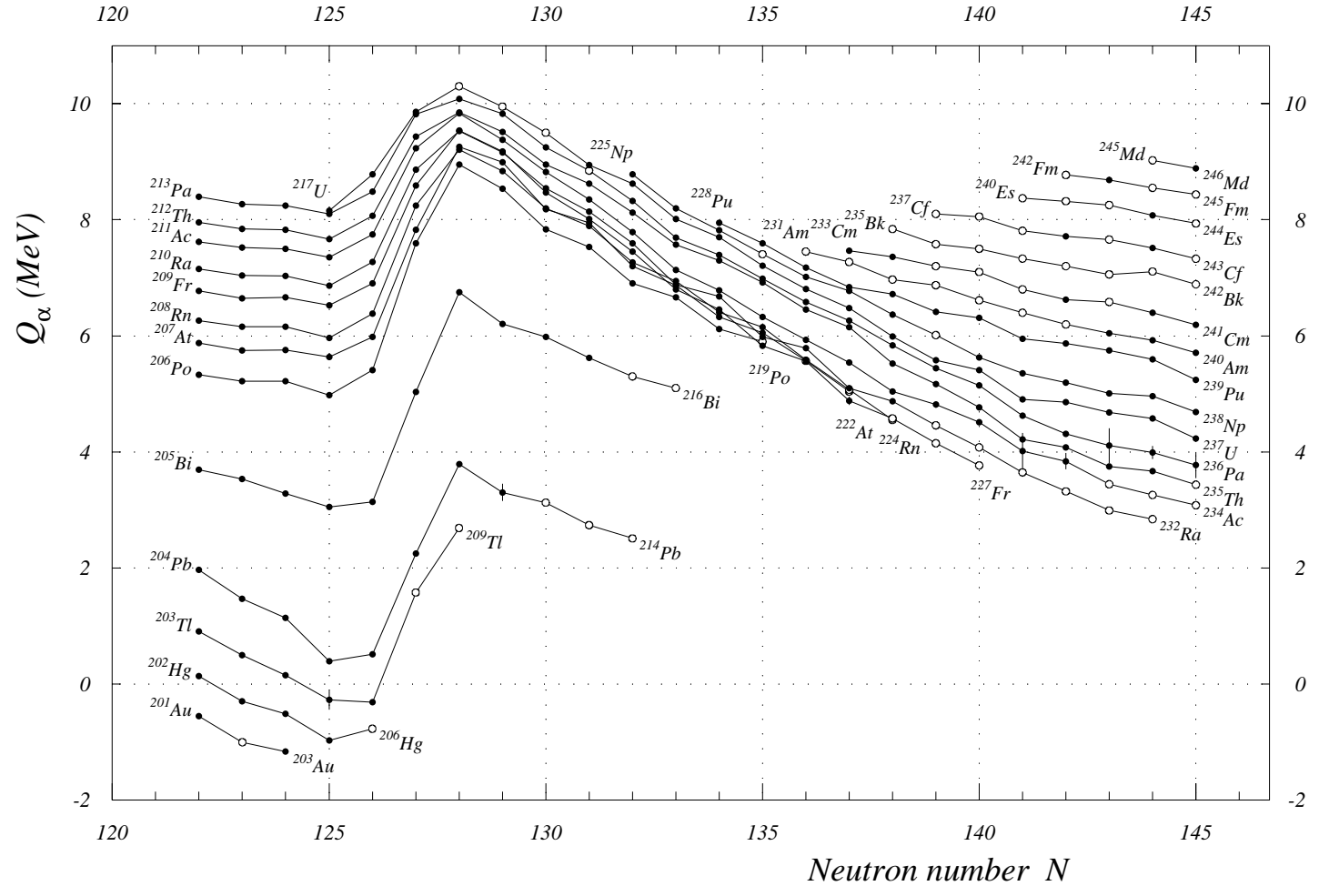

Fig. 25.  $\alpha$ -decay energies

$N = 142$  to  $165$

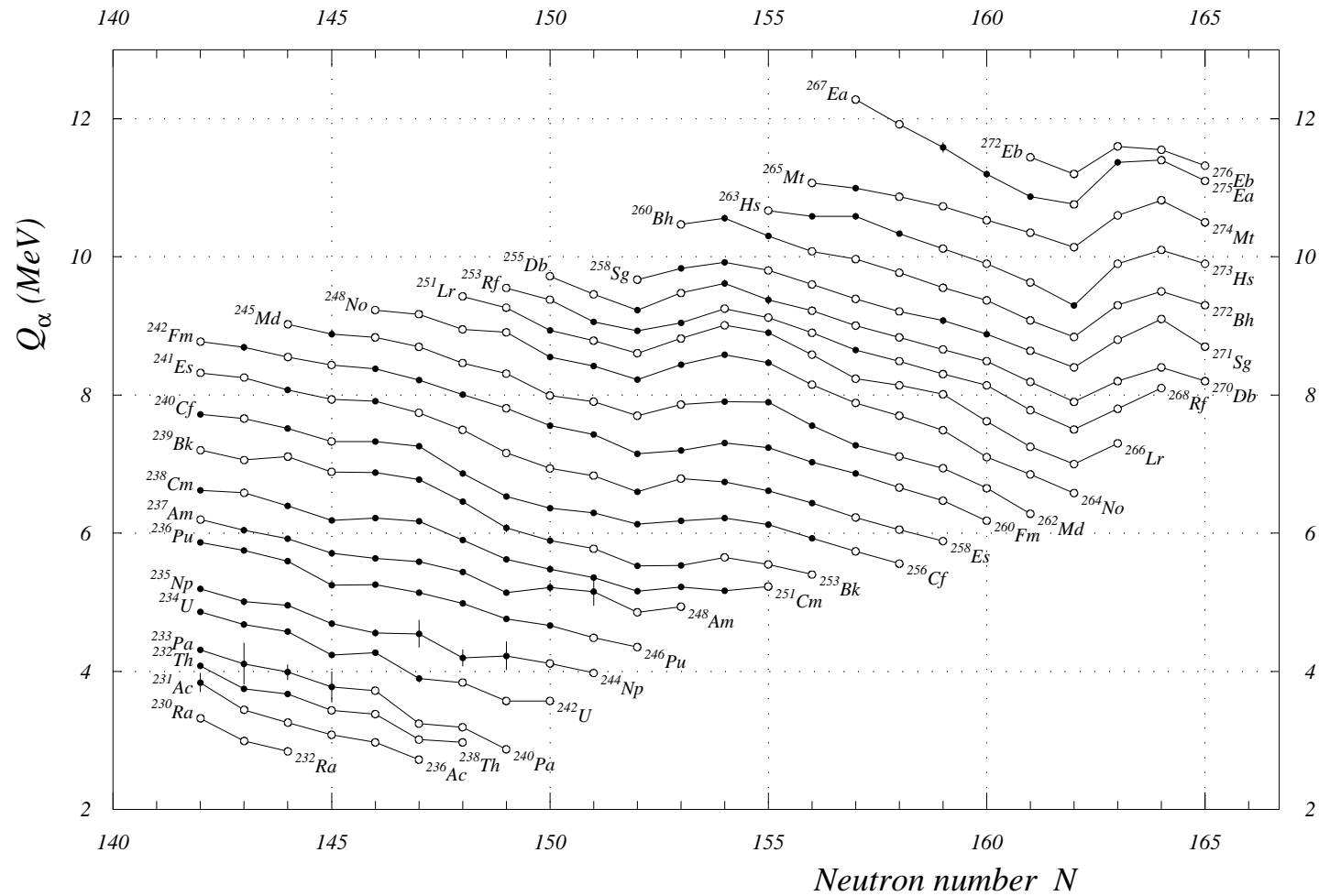

Fig. 26.  $\alpha$ -decay energies

$N = 157$  to  $178$

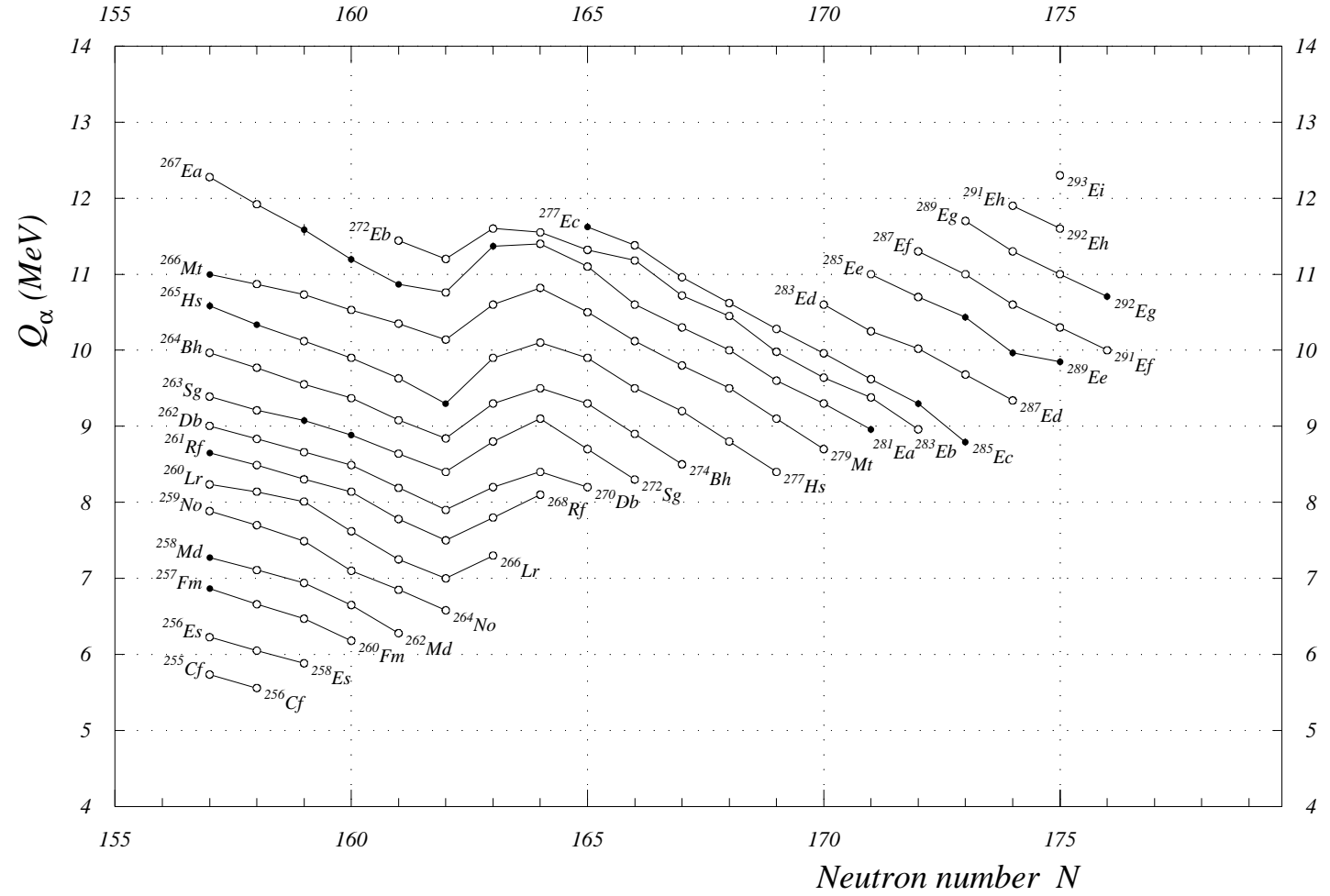



Fig. 27. Double  $\beta$ -decay energies  $A = 0$  to 35

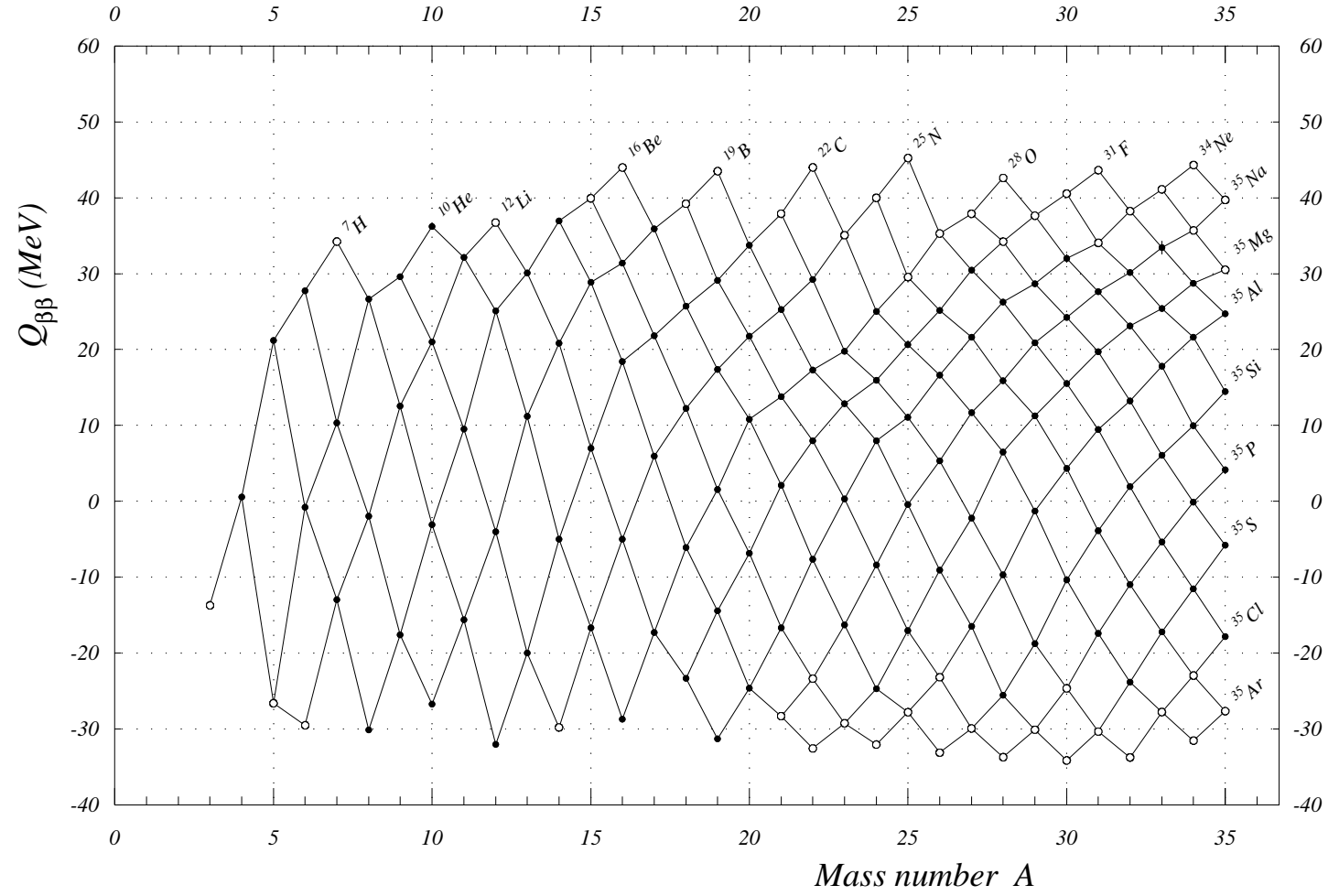

Fig. 28. Double  $\beta$ -decay energies

$A = 32$  to  $65$

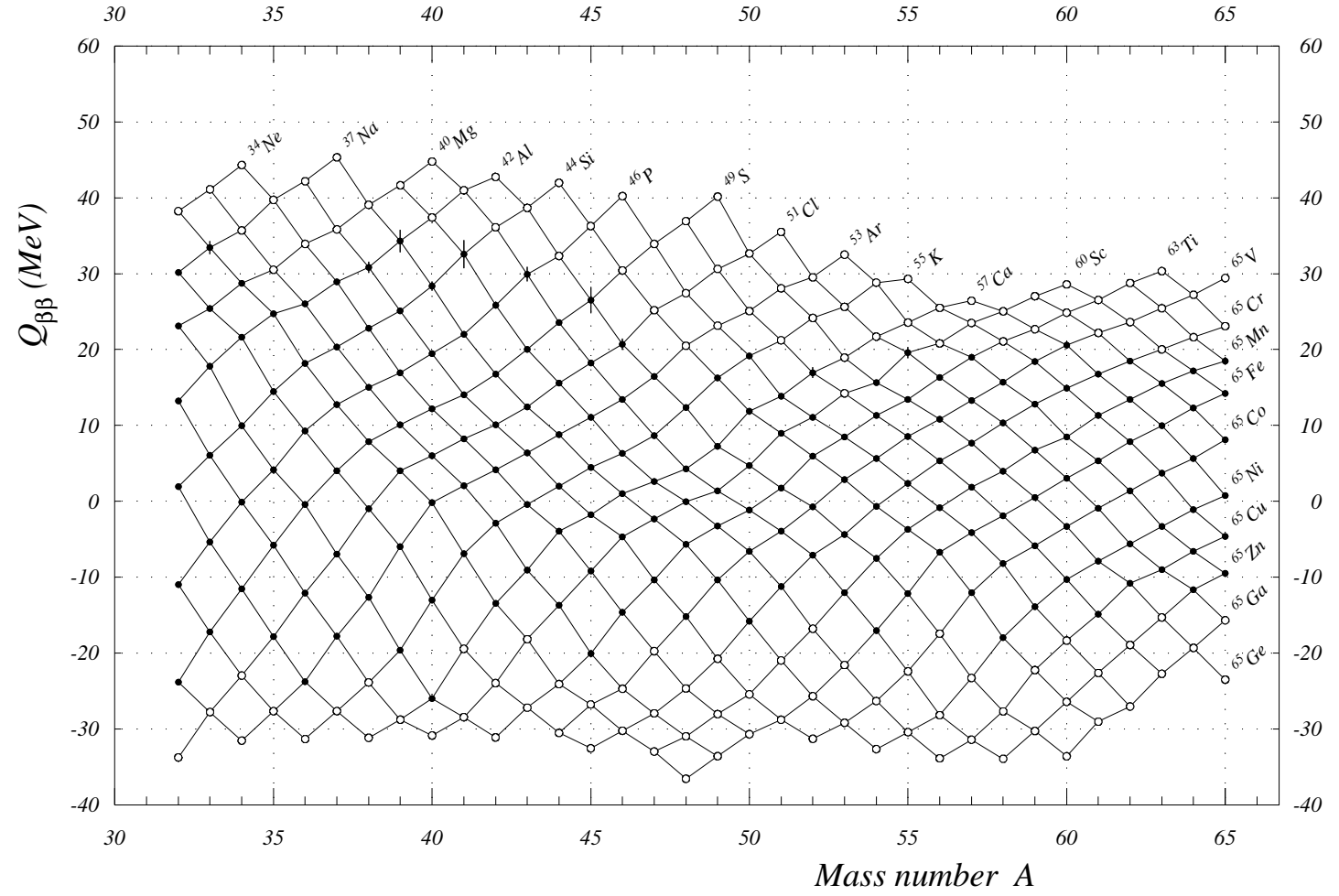

Fig. 29. Double  $\beta$ -decay energies  $A = 62$  to  $95$

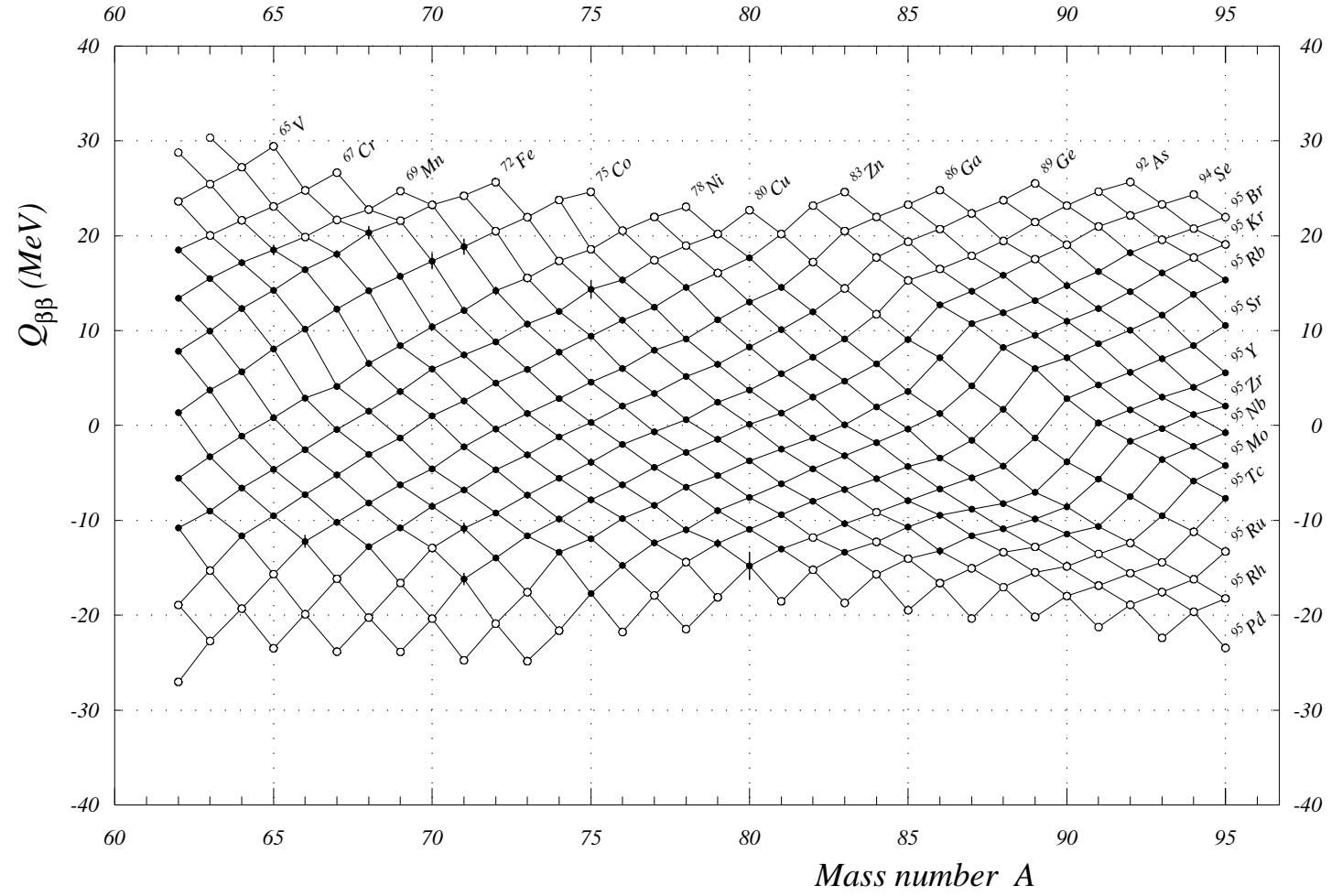

Fig. 30. Double  $\beta$ -decay energies  $A = 92$  to  $125$

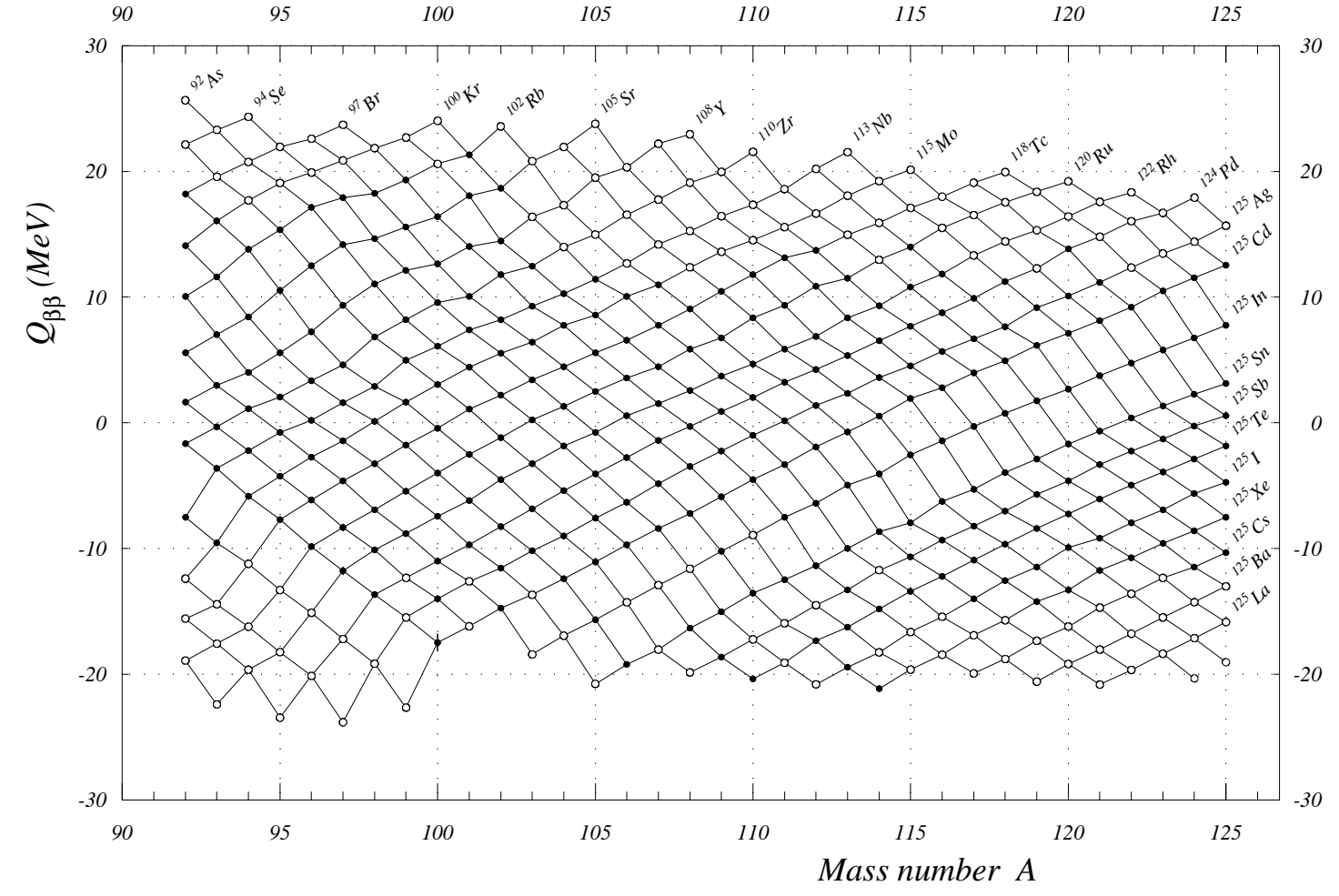

Fig. 31. Double  $\beta$ -decay energies

$A = 122$  to  $155$

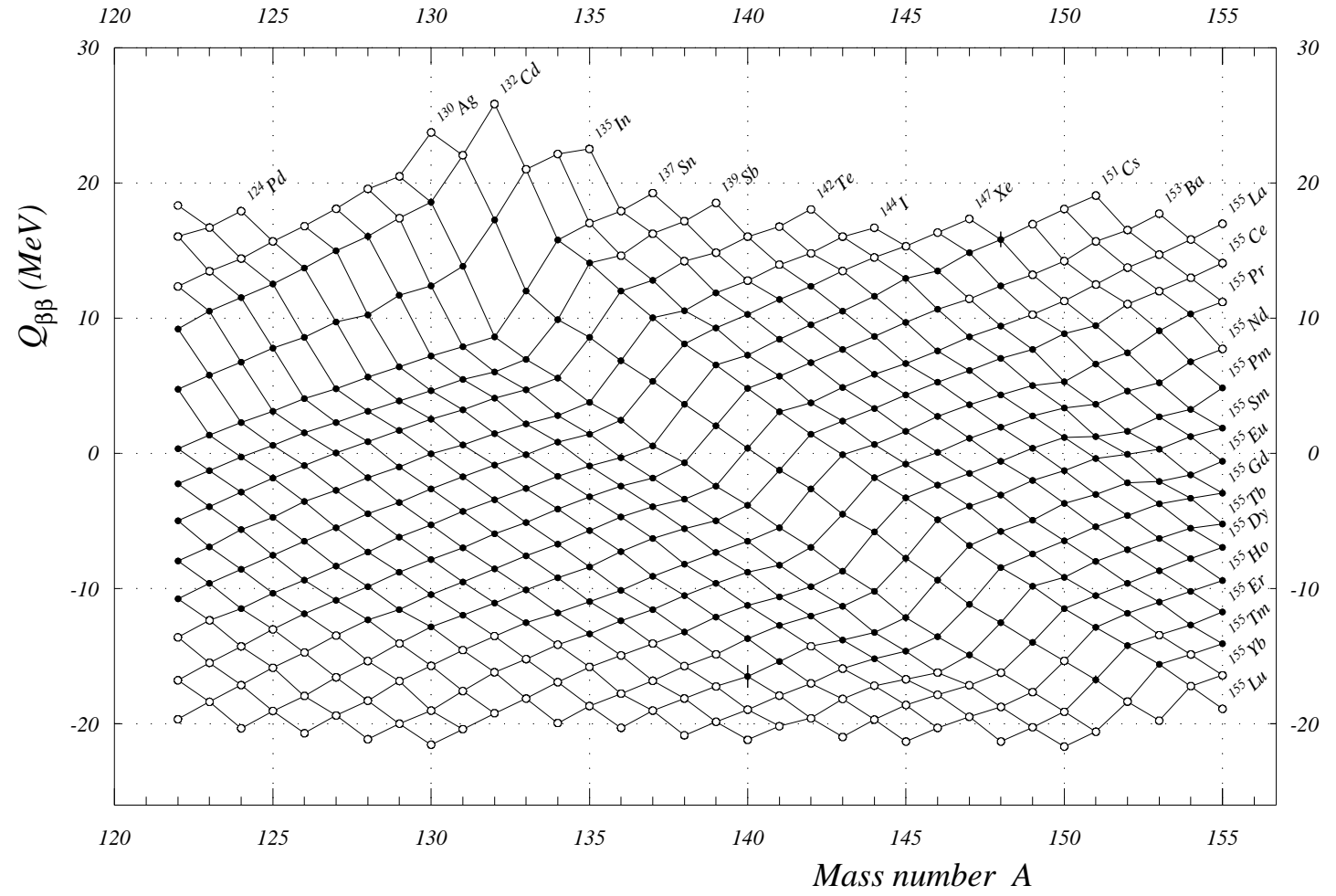

Fig. 32. Double  $\beta$ -decay energies  $A = 152$  to  $185$

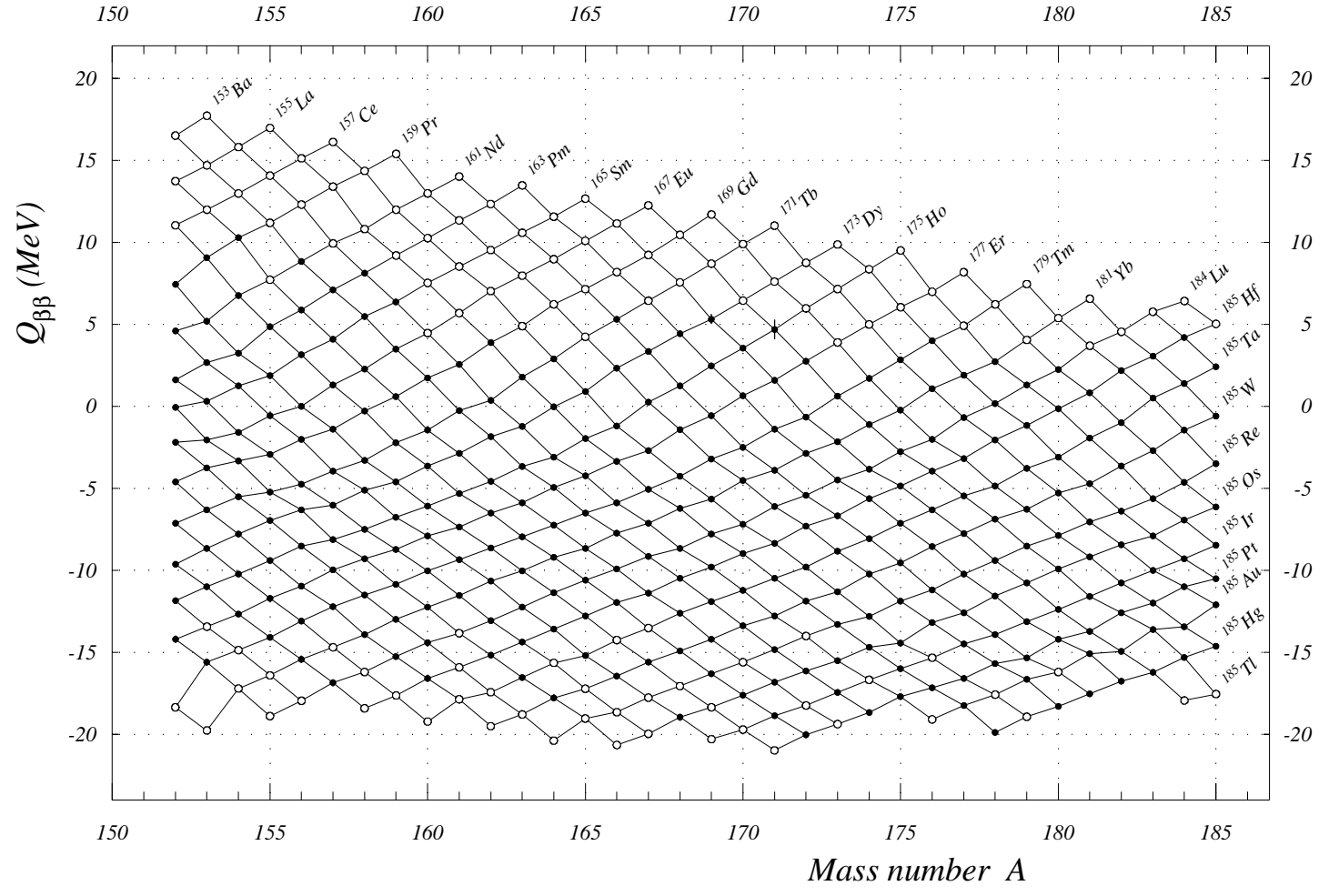

Fig. 33. Double  $\beta$ -decay energies

$A = 182$  to  $215$

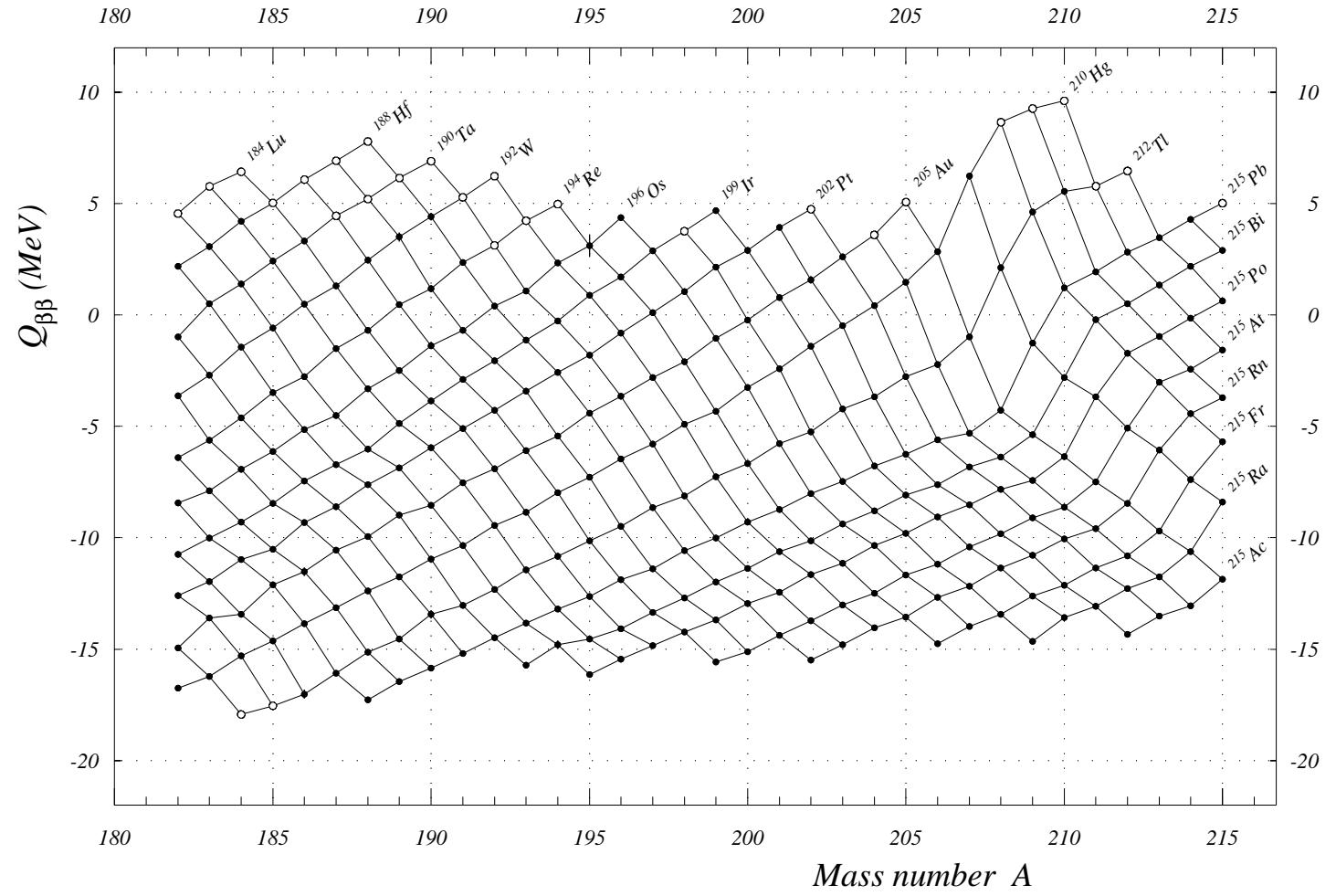

Fig. 34. Double  $\beta$ -decay energies

$A = 212$  to  $245$

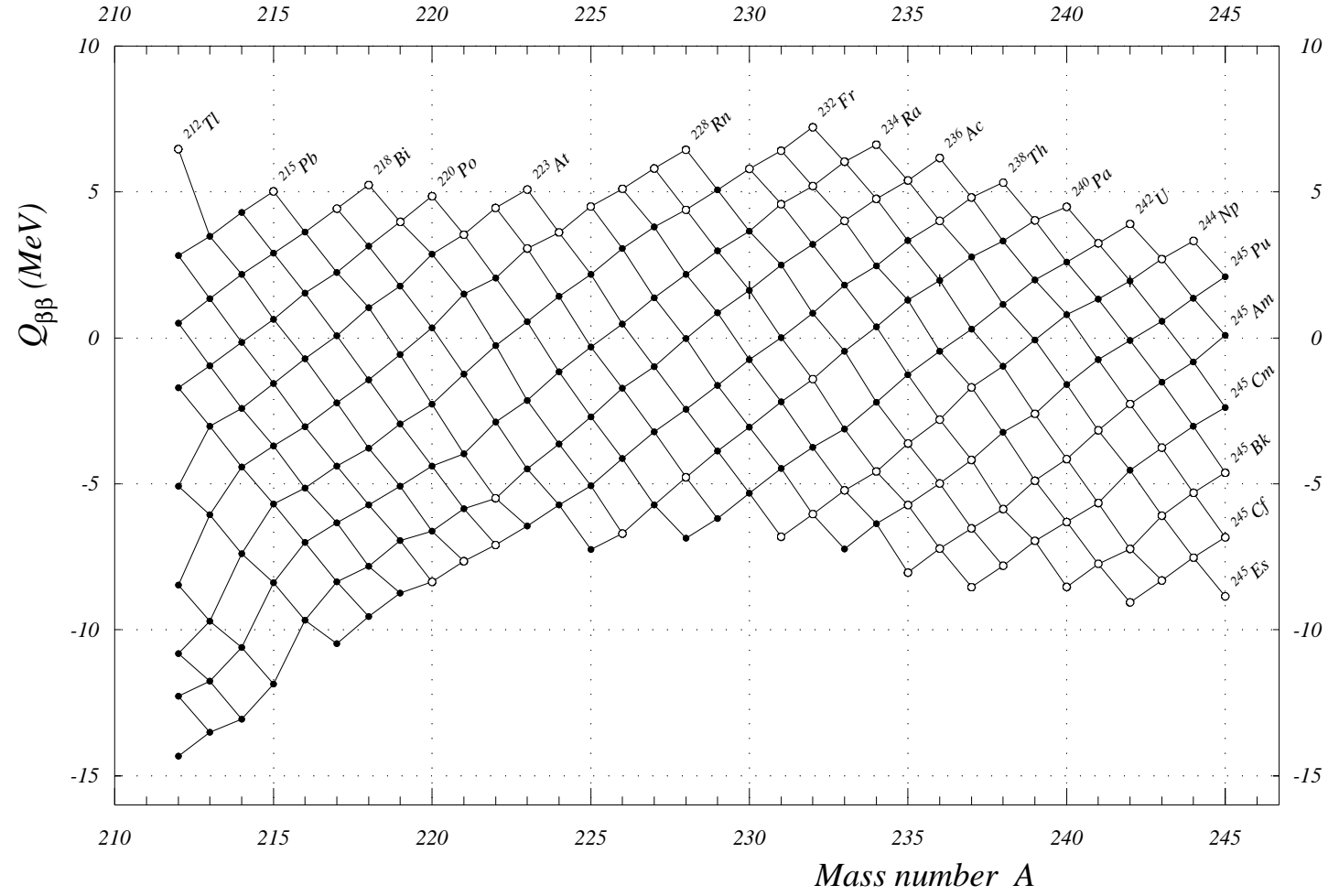



Fig. 35. Double  $\beta$ -decay energies

$A = 242$  to  $275$

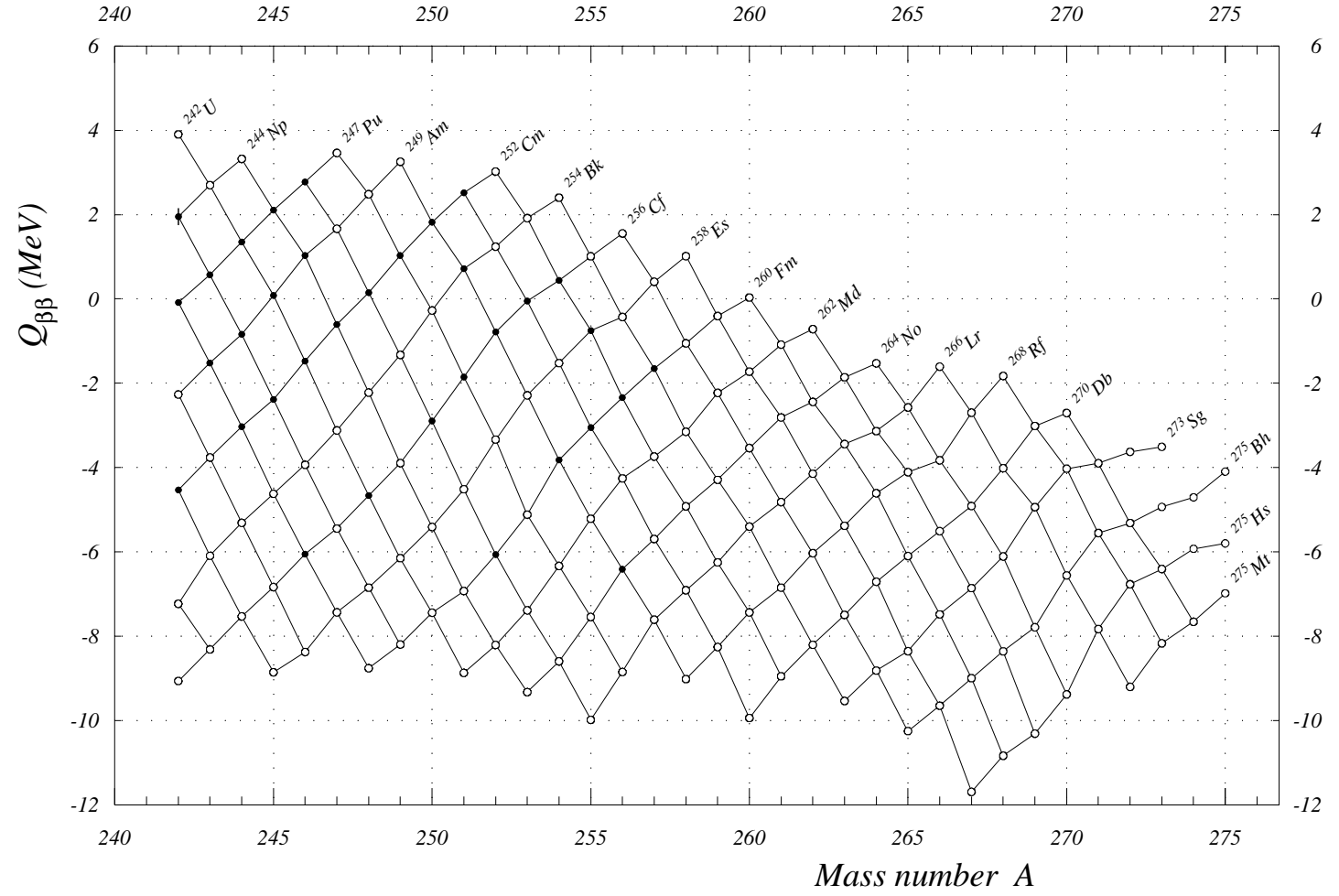
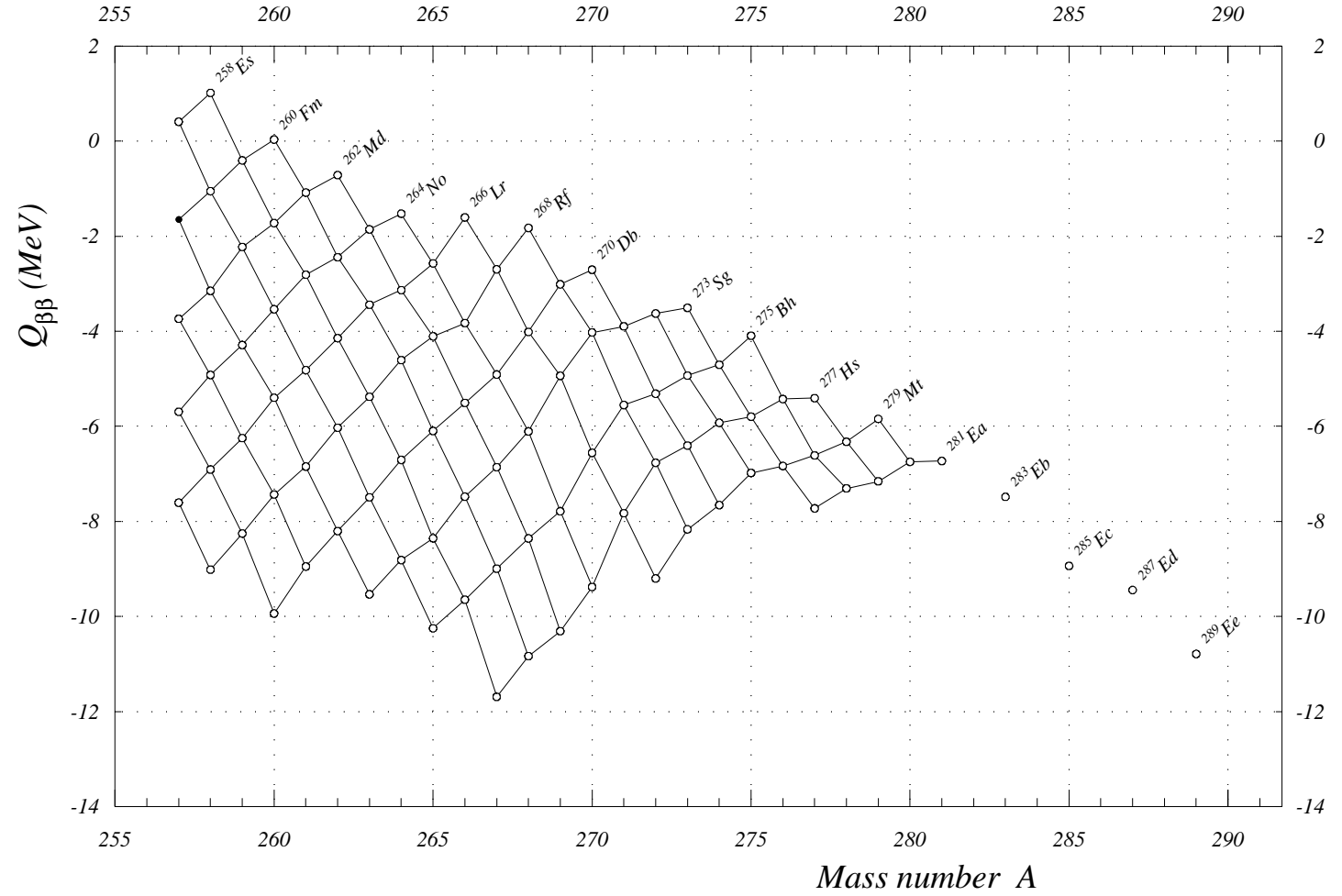

Fig. 36. Double  $\beta$ -decay energies

$A = 257$  to  $290$



**References used in the  
AME2003 and the NUBASE2003 evaluations**

**REGULAR JOURNALS (CODEN identifiers) AND BOOKS**

AAFP	Annales Academiae Scientiarum Fennicae, series A VI (Finland)
ADNDA	Atomic Data and Nuclear Data Tables (Elsevier, USA)
AENGA	Atomnaya Energiya (Russia)
AFYSA 1950-70	Arkiv för Fysik (Sweden)
ANPHA	Annales de Physique (France)
APAHA	Acta Physica Academiae Scientiarum Hungaricae
APASA	Acta Physica Austriaca
APOBB 1970-. . .	Acta Physica Polonica Section B
APPOA . . . -1969	Acta Physica Polonica
ARISE 1986-92	International Journal of Radiation Applications and Instrumentation - Part A - Applied Radiation and Isotopes (Great Britain)
ARISE 1993-. . .	Applied Radiation and Isotopes (Elsevier)
ATKEA	Atomkernenergie (Germany)
ATKOA	Atomki Kozlemenyekek (Hungary)
AUJPA	Australian Journal Physics
BAPMA	Bulletin de l'Académie Polonaise des Sciences, Série des Sciences Mathématiques, Astronomiques et Physiques
BAPSA	Bulletin of the American Physical Society
BRSPE	Bulletin of the Russian Academy of Sciences, Physics
CHDBA 1966-. . .	Comptes Rendus Hebdomadaires des Séances de l'Académie des Sciences, serie B (France)
CJCHA	Canadian Journal of Chemistry
CJPHA	Canadian Journal of Physics
CODBA	CODATA Bulletin (Committee on Data for Science and Technology - ICSU)
COREA . . . -1965	Comptes Rendus Hebdomadaires des Séances de l'Académie des Sciences (France)
CPHMA	Commentationes Physico-Mathematicae : Societas Scientiarum Fennicae (Finland)
CUSCA	Current Science (India)
CZYPA	Czechoslovak Journal of Physics (Kluwer, london)
DANKA	Doklady Akademii Nauk SSSR
EPJAA 1998-. . .	European Physical Journal A (replaces ZPAAD)
EPJDD 1998-. . .	European Physical Journal D
EULEE 1986-. . .	Europhysics Letters (replaces JPSLB and NCLTA)
FECLA	Particles and Nuclei, Letters (Russia)
FZKAA	Fizika (Croatia)
GCACA	Geochimica et Cosmochimica Acta (Elsevier, USA)
HPACA	Helvetica Physica Acta
HYIND	Hyperfine Interactions
IANFA	Izvestiya Akademii Nauk SSSR, seriya Fizicheskaya
IEIMA	IEEE Transactions on Instrumentation and Measurement (USA)
IJARA 1956-85	International Journal of Applied Radiation and Isotopes (Great Britain)

IJMPD	International Journal of Mass Spectrometry and Ion Processes (Elsevier)
IJOPA	Indian Journal of Pure and Applied Physics
IJPYA	Indian Journal of Physics and Proceedings of the Indian Association for the Cultivation of Science
IMPAE	International Journal of Modern Physics A (World Scientific Publishing, Singapore)
JCOMA ... -1991	Journal of the Less Common Metals (Switzerland)
JINCA ... -1981	Journal of Inorganic and Nuclear Chemistry (USA)
JMOPE	Journal of Modern Optics (Great Britain)
JNCEA	Journal of Nuclear Energy A and B (Great Britain)
JOPQA 1961-98	Journal de Physique (France)
JOPQS	Journal de Physique (France) Suppl. Colloques
JPAGB	Journal of Physics, A (Great Britain)
JPCRB	Journal of Physical and Chemical Reference Data (USA)
JPGPE 1989-...	Journal of Physics, G Nuclear Physics (Great Britain)
JPHGB ... -1988	Journal of Physics, G Nuclear Physics (Great Britain)
JPSLB ... -1985	Journal de Physique Lettres (France)
JUPSA	Journal of the Physical Society of Japan
KDVSA	Det Kongelige Danske Videnskabernes Selskab, Matematisk-Fysiske Meddelelser
KERNA	Kernenergie (Germany)
KURAA	Kyoto University, Research Reactor Institute : Annual Report
MPLAE	Modern Physics Letters section A (World Scientific Publishing, Singapore)
MTRGA	Metrologia
NATUA	Nature (Great Britain)
NCIAA 1970-...	Nuovo Cimento A (Italy)
NDSAA	Nuclear Data Tables, section A (USA)
NDSBA	Nuclear Data Sheets (USA)
NIMAE 1983-...	Nuclear Instruments and Methods in Physics Research A (Netherlands)
NIMBE 1983-...	Nuclear Instruments and Methods in Physics Research B (Netherlands)
NPBSE	Nuclear Physics, section B (Proceedings Supplements) (Netherlands)
NSENA	Nuclear Science and Engineering (American Nuclear Society, USA)
NUCIA ... -1969	Nuovo Cimento (Italy)
NUIMA ... -1983	Nuclear Instruments and Methods (Netherlands)
NUPAB 1967-...	Nuclear Physics, section A (Netherlands)
NUPBB 1967-...	Nuclear Physics, section B (Netherlands)
NUPHA 1957-66	Nuclear Physics (Netherlands)
PACHA	Pure and Applied Chemistry
PENUC	Particle Emission from Nuclei, ed. by D.N. Poenaru and M.S. Ivaşcu, CRC Press (USA), 1989
PHFEA	Physica Fennica (Finland)
PHLTA ... -1967	Physics Letters (Netherlands)
PHMAA ... -1955	Philosophical Magazine (Great Britain)
PHMAA 1956-...	Philosophical Magazine (Great Britain)
PHRVA 1930-69	Physical Review (USA) (not 1964 and 1965)
PHSTB 1970-...	Physica Scripta (Sweden)
PHYSA	Physica (Netherlands)

PISAA		Proceedings of the Indian Academy of Sciences, section A
PLRBA	1964-65	Physical Review, section B (USA)
PLSSA		Planetary and Space Science (Netherlands)
PPNPD		Progress in Particle and Nuclear Physics
PPSOA		Proceedings of the Physical Society (Great Britain)
PRAMC		Pramana, Journal of Physics (India)
PRLAA		Proceedings of the Royal Society of London, Series A
PRLTA		Physical Review Letters (USA)
PRVAA	1970-...	Physical Review, section A (USA)
PRVCA	1970-...	Physical Review, section C (USA)
PRVDA	1970-...	Physical Review, section D (USA)
PRYCA		Proceedings of the Royal Society of Canada
PYLAA	1968-...	Physics Letters, section A (Netherlands)
PYLBB	1968-...	Physics Letters, section B (Netherlands)
PZETA		Pis'ma v Zhurnal Eksperimental'noi i Teoreticheskoi Fiziki (Russia)
RAACA		Radiochimica Acta (Germany)
RAEFB		Radiation Effects and Defects in Solids (Great Britain)
RMPHA		Reviews of Modern Physics (USA)
RMXFA		Revista Mexicana de Física
RPPHA		Reports on Progress in Physics (Great Britain)
RRALA		Radiochemical and Radioanalytical Letters (Hungary)
SAPHD		South African Journal of Physics
SHIBA		Shitsuryo Bunseki (Mass Spectrometry, Japan)
THISc		Treatise on Heavy-Ion Science, ed. by D.A. Bromley, Plenum Press, 1989
UFZHA		Ukrains'kii Fizicheskii Zhurnal
YAFIA		Yadernaya Fizika (Russia)
YTHLD		Chinese Journal of Nuclear Physics
ZDACE	1974-...	Zeitschrift für Physik D (Germany)
ZENAA		Zeitschrift für Naturforschung, part A (Germany)
ZEPYA	...-1974	Zeitschrift für Physik (Germany)
ZETFA		Zhurnal Eksperimental'noi i Teoreticheskoi Fiziki (Russia)
ZPAAD	1974-97	Zeitschrift für Physik A (Germany)

## REPORTS, PREPRINTS, THESIS, ABSTRACTS, COMMUNICATIONS

AAAAA to be pd	To be published in journal AAAAA
PrvCom AHW Mon	Private communication to A.H. Wapstra in given Month
PrvCom GAu Mon	Private communication to G. Audi in given Month
PrvCom JBl Mon	Private communication to J. Blachot in given Month
PrvCom NDG Mon	Private communication to Nuclear Data Group in given Month
PrvCom Ref	Quoted by reference in question
Table of Isotopes	Table of Isotopes, LBL Brookhaven
Th.- City	Dissertation from corresponding University
Wallet Cards	Nuclear Wallet Cards, NNDC-BNL, Brookhaven, ed. J.K. Tuli
AnRpt Institute	Annual Report from Institute (or City)
ANL-	Argonne National Laboratory, report
CERN-	European Organization for Nuclear Research, report
COO-	Reports on work done with DOE support
DASA-	Defense Atomic Support Agency, Washington, DC, report
GSI-	Gesellschaft für Schwerionenforschung, report
IAEA-	International Atomic Energy Agency, report
IDO-	Idaho Operations Office of US Atomic Energy Commission, report
IPNO-DRE	Institut de Physique Nucléaire d'Orsay, report
ISOLDE-	Isotope Separator on Line (CERN), report
JINR-	Joint Institute for Nuclear Research Dubna, report
KFK-	Kernphysik Zentrum Karlsruhe, report
LBL-	Lawrence Berkeley National Laboratory, report
Leninst YF-	Leningradskii Institut Yadernoi Fiziki
ORNL-	Oak Ridge National Laboratory report
UCRL-	University of California Radiation Laboratory report

## CONFERENCE PROCEEDINGS AND ABSTRACTS

P-Alma Ata	1978	Program of 28th USSR Conference on Nuclear Spectroscopy
P-Alma Ata	1984	Program of 34th USSR Conference on Nuclear Spectroscopy
P-Amsterdam	1974	Proc. Intern. Conference Nuclear Structure
P-Amsterdam	1982	Proc. Intern. Conference Nuclear Structure
P-Amsterdam	1996	2nd. North-West Europe Nuclear Physics Conference NWE'96
P-Arles	1995	Proc. Int. Conf. on Exotic Nuclei and Atomic Masses ENAM-95
B-Arles	1995	Abstracts ENAM-95
P-Aulanko	2001	Proc. Int. Conf. on Exotic Nuclei and Atomic Masses ENAM-2001
B-Aulanko	2001	Abstracts ENAM-2001
P-BadHonnet	1988	Proc. Int. Workshop Nucl. Struct. of the Zr Region
P-Baku	1976	Program of 26th USSR Conference on Nuclear Spectroscopy
P-Bellaire	1998	Proc. Int. Conf. on Exotic Nuclei and Atomic Masses ENAM-98
P-Berkeley	1980	Proc. Intern. Conf. Nuclear Physics Berkeley
P-Bernkastel	1992	Proc. 9th Int. Conf. Atomic Masses and Fundamental Constants AMCO-9, and 6th Int. Conf. Nuclei far from Stability NUFAS-6
B-Bernkastel	1992	Abstracts AMCO-9 and NUFAS-6
P-Birmingham	1985	Proc. Specialists Meeting on Delayed Neutron Properties

- P-Bombay 1974 Proc. Nucl. Phys. and Solid State Phys. Symposium
- P-Bombay 1985 Symposium on Quantum Electronics
- P-Bormio 1999 XXXVII International Winter meeting on Nuclear Physics
- P-Brookhaven 1979 Proc. 3rd Int. Conf. Neutron Capture Gamma Ray Spectroscopy
- P-Budapest 1972 Proc. 1st Int. Conf. Neutron Capture Gamma Ray Spectroscopy
- P-Cargese 1976 Proc. 3rd Int. Conf. Nuclei far from Stability NUFAST-3 CERN 76-13
- P-Charkov 1986 Program of 38th USSR Conference on Nuclear Spectroscopy
- P-Chicago 1985 Proc. Meeting of the American Society for Nuclear Chemistry
- P-Darmstadt 1984 Proc. 7th Int. Conf. Atomic Masses and Fundamental Constants AMCO-7
- P-Debrecen 1968 Proc. Conf. Electron Capture and Higher Order Processes in Nuclear Decays
- P-Dubna 1961 Repts. Third Conf. Neutron-deficient Isotopes
- P-Dubna 1968 Proc. International Symposium on Nuclear Structure
- P-Dubna 1989 Int. School-Seminar on Heavy-Ion Physics
- P-Dubna 1999 Proc. 49th Ann. Conf. Nucl. Spectrosc. Struct. At. Nuclei
- P-Florence 1983 Proc. Intern. Conf. Nuclear Physics Florence
- P-Foros 1991 Proc. Intern. Conf. on Exotic Nuclei, South Crimea
- P-Fribourg 1993 Proc. 8th Int. Symp. Capture Gamma Ray Spectroscopy and Related Topics
- P-Gatlinburg 1967 Proc. Intern. Conf. Gatlinburg
- P-Grenoble 1981 Proc. 4th Int. Conf. Neutron Capture Gamma Ray Spectroscopy
- P-Helsingor 1981 Proc. 4th Int. Conf. Nuclei far from Stability NUFAST-4 CERN 81-09
- P-Kiev 1982 Program of 32th USSR Conference on Nuclear Spectroscopy
- P-Knoxville 1984 Proc. 5th Int. Symp. Capture Gamma-Ray Spectroscopy and Related Topics
- P-Kyoto 1970 Conference on Mass Spectroscopy
- P-Lansing 1979 Proc. 6th Int. Conf. Atomic Masses and Fundamental Constants AMCO-6
- P-Legnaro 1971 Proc. Conf. Structure of  $1f_{7/2}$  Nuclei, Legnaro
- P-Leningrad 1975 Program of 25th USSR Conference on Nuclear Spectroscopy
- P-Leningrad 1985 Program of 35th USSR Conference on Nuclear Spectroscopy
- P-Leningrad 1990 Program of 40th USSR Conference on Nuclear Spectroscopy
- P-Leuven 1987 Proc. 6th Int. Symp. Capture Gamma-Ray Spectroscopy and Related Topics
- P-Leysin 1970 Proc. 2nd Int. Conf. Nuclei far from Stability NUFAST-2 CERN 70-30
- P-Miami 1989 Symposium on Exotic Nuclear Spectroscopy
- P-Minsk 1991 Program of 41th USSR Conference on Nuclear Spectroscopy
- P-Monterey 1990 Proc. Xth Int. Conf. Neutron Capture Gamma Ray Spectroscopy
- P-Moscow 1955 Conf. Acad. Sci. USSR Peaceful Use of Atomic Energy
- P-Moscow 1971 Program of 21st USSR Conference on Nuclear Spectroscopy
- P-Moscow 1983 Program of 33rd USSR Conference on Nuclear Spectroscopy
- P-Niigata 1991 Proc. Int. Symp. on Structure and Reactions of Unstable Nuclei
- P-PacGrove 1991 Proc. 7th Int. Symp. Capture Gamma Ray Spectroscopy
- P-Paris 1958 Compt. Rend. Congr. Intern. Phys. Nucl., Paris, P. Gugenberger, Ed., Dunod, Paris(1959)

P-Paris	1975	Proc. 5th Int. Conf. Atomic Masses and Fundamental Constants AMCO-5
P-Petten	1975	Proc. 2nd Int. Conf. Neutron Capture Gamma Ray Spectroscopy
P-Rosseau	1987	Proc. 5th Int. Conf. Nuclei far from Stability NUFAS-5 AIP Conf.Proc.164
P-Samarkand	1981	Program of 31st USSR Conference on Nuclear Spectroscopy
B-Seeheim	1999	1st Int. Conf. Chemistry and Physics of the Transactinide Elements (TAN'99)
P-StMalo	1988	Proc. 3rd Int. Conf. Nucleus-Nucleus Collisions
P-StPetersbg	1995	Low Energy Nuclear Dynamics, EPS XV Nucl. Phys. Div.
P-Studsvik	1969	Proc. Conf, Neutron Capture Gamma Ray Spectroscopy
P-Swansea	1985	10th Int. Mass Spectrometry Conf. (in Adv. in Mass Spectr. 1985)
P-Tashkent	1977	Program of 27th USSR Conference on Nuclear Spectroscopy
P-Tbilis	1964	Program of 14th USSR Conference on Nuclear Spectroscopy
P-Teddington	1972	Proc. 4th Int. Conf. Atomic Masses and Fundamental Constants
P-Tokai	1994	Symposium on Nuclear Data, JAERI
P-Vienna	1964	Proc. 2nd Intern. Conf. Nuclidic Masses
P-Winnipeg	1967	Proc. 3rd Int. Conf. Atomic Masses and Fundamental Constants
P-Yerevan	1969	Program of 19th USSR Conference on Nuclear Spectroscopy
P-Yurmala	1987	Program of 37th USSR Conference on Nuclear Spectroscopy



## LIST OF REFERENCES

Before 1948

1934Le01 PRLAA 145, 235 W.B. Lewis, B.V. Bowden

1948

1948Fe09 PPSOA 61, 466 N. Feather, J. Kyles, R.W. Pringle  
 1948Ma29 PPSOA 60, 466 D.G.E. Martin, H.O.W. Richardson, Y.K. Hsu  
 1948Ma30 PRLAA 195, 287 D.G.E. Martin, H.O.W. Richardson  
 1948Sa18 PHRVA 74, 1264 D. Saxon  
 1948St.A PrvCom 58St50 K. Street, Jr., A. Ghiorso, D.A. Orth, G.T. Seaborg

1949

1949Be36 PHRVA 76, 1624 L.A. Beach, C.L. Peacock, R.G. Wilkinson  
 1949Be53 PHRVA 76, 574 P.R. Bell, B.H. Ketelle, J.M. Cassidy  
 1949Du15 PHRVA 76, 1272 R.B. Duffield, L.M. Langer  
 1949Fe18 PHRVA 76, 1888 L. Feldman, L. Lidofsky, P. Macklin, C.S. Wu  
 1949Pa.B ORNL-336 42 G.W. Parker, G.E. Creek, G.M. Hebert, P.M. Lantz

1950

1950Ag01 PHRVA 77, 655 H.M. Agnew  
 1950Br52 PHRVA 79, 606 J.A. Bruner, L.M. Langer  
 1950Br66 PHRVA 79, 902 A.R. Brosi, H. Zeldes, B.H. Ketelle  
 1950Fr58 PHRVA 79, 897 M.S. Freedman, D.W. Engelkemeir  
 1950Ha65 PHRVA 79, 541 R.W. Hayward  
 1950Ke11 PHRVA 79, 242 B.H. Ketelle, C.M. Nelson, G.E. Boyd  
 1950La04 PHRVA 77, 798 L.M. Langer, J.W. Motz, H.C. Price, Jr.  
 1950Ma14 PHRVA 78, 363 L.B. Magnusson, S.G. Thompson, G.T. Seaborg  
 1950Me55 PHRVA 79, 19 J.Y. Mei, A.C.G. Mitchell, C.M. Huddleston  
 1950Mo56 PHRVA 80, 309 R.C. Mobley, R.A. Laubenstein  
 1950Na09 PHRVA 77, 398 R.A. Naumann, F.L. Reynolds, I. Perlman  
 1950Ri59 PHRVA 80, 524 H.T. Richards, R.V. Smith, C.P. Browne

1951

1951Br87 PHRVA 84, 292 H.N. Brown, W.L. Bendel, F.J. Shore, R.A. Becker  
 1951Du03 PHRVA 81, 203 R.B. Duffield, L.M. Langer  
 1951Hy24 PHRVA 82, 944 E.K. Hyde, G.D. O'Kelley  
 1951Je01 PHRVA 81, 143 E.N. Jensen, R.T. Nichols, J. Clement  
 1951Ko17 AFYSA 3, 47 E. Kondaiah  
 1951Mc11 PHRVA 81, 734 C.L. McGinnis  
 1951Mc48 PHRVA 84, 384 J.J.G. McCue, W.M. Preston  
 1951Or.A UCRL-1951 D.A. Orth, K. Street, Jr.  
 1951Ta05 PHRVA 81, 461 S.I. Taimuty  
 1951Ve05 PHYSA 17, 637 N.F. Verster, G.J. Nijgh, R. van Lieshout, C.J. Bakker  
 1951Wi26 PHRVA 84, 731 R.M. Williamson, C.P. Browne, D.S. Craig, D.J. Donahue

1952

1952Al06 PHRVA 85, 734 D.E. Alburger  
 1952Be55 AFYSA 5, 191 I. Bergström  
 1952Be78 IANFA 16, 314 E.Y. Berlovich

1952Ch31	PHRVA	88,	887	L.S. Cheng, J.L. Dick, J.D. Kurbatov
1952Fa14	PHRVA	87,	252	C.Y. Fan
1952Fe16	PHRVA	87,	1091	L. Feldman, C.S. Wu
1952Fr23	PPSOA	65,	911	J.H. Fremlin, M.C. Walters, and 95Tr07 and 02Tr04
1952Fu04	PHRVA	86,	347	S.C. Fultz, M.L. Pool
1952Hi.A	Th.-Berkeley			G.H. Higgins
1952Ka41	PHRVA	85,	368	M.I. Kalkstein, W.F. Libby
1952Ko27	AFYSA	4,	81	E. Kondaiah
1952Mc34	PHRVA	87,	202	C.L. McGinnis (Also PrvCom NDG)
1952Ro16	PHRVA	86,	863	D. Rose, G. Hinman, L.G. Lang
1952Sc09	PHRVA	85,	873	W.A. Schoenfeld, R.W. Duborg, W.M. Preston, C. Goodman
1952Sc11	PHRVA	85,	1046	C.L. Scoville, S.C. Fultz, M.L. Pool
1952Sm41	PHRVA	87,	454	A.B. Smith, A.C.G. Mitchell, R.S. Caird
1952Wi26	PHRVA	85,	687	R.G. Winter
1953				
1953Am08	PHRVA	91,	68	D.P. Ames, M.E. Bunker, L.M. Langer, B.M. Sorenson
1953As.A	UCRL-2180			F. Asaro
1953Ba81	IANFA	17,	437	A.A. Bashilov, N.M. Antoneva, B.S. Dzelepov, A.I. Dolgintseva
1953Bl44	PHRVA	90,	464	E. Bleuler, J.W. Blue, S.A. Chowdary, A.C. Johnson, D.J. Tendam
1953Co02	PRLAA	216,	242	E.R. Collins, C.D. MacKenzie, C.A. Ramm
1953Du03	PHRVA	89,	854	R.B. Duffield, L.M. Langer
1953Ea11	PHRVA	91,	653	H.T. Easterday
1953Fi.A	Th.-Rochester			R.W. Fink
1953Gl.A	ANL-5000		55	L.E. Glendenin, E.P. Steinberg
1953Hy83	PHRVA	90,	267	E.K. Hyde, A. Ghiorso
1953Jo20	CJPHA	31,	1136	F.A. Johnson
1953Kn23	PHRVA	91,	889	J.D. Knight, M.E. Bunker, B. Warren, J.W. Starnes
1953Ma64	PHRVA	92,	1511	L. Marquez
1953Sh48	PHRVA	91,	1203	F.J. Shore, W.L. Bendel, H.N. Brown, R.A. Becker
1953St31	PHYSA	19,	279	P.H. Stoker, Ong Ping Hok
1954				
1954Be10	PHRVA	93,	1073	W. Bernstein, S.S. Markowitz, S. Katcoff
1954Br37	PPSOA	67,	397	W.D. Brodie
1954De17	PHRVA	95,	458	E. Der Mateosian, C.S. Wu
1954El10	PRLAA	224,	129	R.B. Elliott, D.J. Livesey
1954El24	PRYCA	48,	12	L.G. Elliott, R.L. Graham, J. Walker, J.L. Wolfson
1954Ha68	PHRVA	96,	1003	T.H. Handley, E.L. Olsen
1954Hu61	PHRVA	96,	548	J.R. Huizenga, C.M. Stevens
1954Le08	PHRVA	93,	155	M.R. Lee, R. Katz
1954Li19	PHRVA	94,	780	L. Lidofsky, R. Gold, C.S. Wu
1954Li24	PHRVA	95,	444	T. Lindqvist, A.C.G. Mitchell
1954Ma54	PHRVA	95,	708	H.B. Mathur, E.K. Hyde
1954Mi89	PHRVA	96,	996	C. Mileikowsky, K. Ahnlund
1954Ni06	PHRVA	94,	369	R.T. Nichols, E.N. Jensen
1954Nu27	PHYSA	20,	571	R.H. Nussbaum, A.H. Wapstra, R. van Lieshout, G.J. Nijgh, L. Th. M. Ornstein, (and PrvCom NDG)
1954O103	PHRVA	93,	1125	J.L. Olsen, G.D. O'Kelley
1954O105	PHRVA	95,	1539	J.L. Olsen, G.D. O'Kelley
1954Po26	PHRVA	95,	1523	A.V. Pohm, W.E. Lewis, J.H. Talbot, Jr., E.N. Jensen
1954Pr31	PHRVA	96,	1390	C.H. Pruett, R.G. Wilkinson
1954Sa22	PHRVA	94,	642	B. Saraf
1954Th17	AFYSA	7,	289	S. Thulin, K. Nybø
1954Th30	PHRVA	96,	850	J. Thirion, R. Cohen, W. Whaling
1954Th36	AFYSA	8,	219	S. Thulin, J. Moreau, H. Atterling
1954Th39	AFYSA	8,	229	S. Thulin, J. Moreau, H. Atterling

1954Za05	IANFA	18,	563	P.P. Zarubin
				1955
1955Ad10	COREA	240,	1421	J.P. Adloff
1955Ar21	PHYSA	21,	543	A.H.W. Aten, Jr., G.D. De Feyfer
1955Be20	ZEPYA	142,	585	W. Beekman
1955Bl23	PHRVA	100,	1324	J.W. Blue, E. Bleuler
1955Br16	PHRVA	100,	84	R.M. Brugger, T.W. Bonner, J.B. Marion
1955Da37	PHRVA	100,	796	M.C. Day, Jr., G.W. Eakins, A.F. Voigt
1955De18	PHMAA	46,	445	H. De Waard
1955De40	PHYSA	21,	803	E.F. De Haan, G.J.S. Sizoo, P. Kramer
1955Dr43	IANFA	19,	324	G.M. Drabkin, V.I. Orlov, L.I. Rusinov
1955Fa33	PHRVA	99,	1440	B. Farrelly, L. Koerts, N. Benczer, R. van Lieshout, C.S. Wu
1955Go.A	P-Moscow		226	L.L. Goldin, E.F. Tretyakov, G.I. Novikov
1955Gr08	PHRVA	97,	1033	W.E. Graves, A.C.G. Mitchell
1955Jo02	PHRVA	97,	1031	J.T. Jones, Jr., E.N. Jensen
1955Ki28	PHRVA	99,	1393	J.D. Kington, J.K. Bair, H.O. Cohn, H.B. Willard
1955Ko14	PHRVA	98,	1230	L. Koerts, P. Macklin, B. Farrelly, R. van Lieshout, C.S. Wu
1955Ma12	PHRVA	97,	103	P. Marmier, F. Boehm
1955Ma40	COREA	240,	291	N. Marty
1955Ma.A	ANL-5386			L.B. Magnusson, F. Wagner, Jr., D.W. Engelkemeir, M.S. Freedman
1955Mc17	PHRVA	97,	93	C.L. McGinnis
1955Mi90	PHRVA	100,	1390	J.P. Mize, M.E. Bunker, J.W. Starnier
1955Mo69	JINCA	1,	274	F.F. Momyer, Jr., F. Asaro, E.K. Hyde
1955Nu11	PHYSA	21,	77	R.H. Nussbaum, A.H. Wapstra, M.J. Sterk, R.E.W. Kropveld
1955On05	PHYSA	21,	676	Ong Ping Hok, P. Kramer
1955Pa50	AFYSA	9,	571	R.T. Pauli
1955Pe24	PHRVA	98,	262	I. Perlman, F. Stephens, F. Asaro
1955Th01	AFYSA	9,	137	S. Thulin
				1956
1956Ar33	AFYSA	10,	1	E. Arbman, N. Svartholm
1956As38	PHRVA	104,	91	F. Asaro, I. Perlman
1956Be18	PHRVA	101,	1027	N. Benczer, B. Farrelly, L. Koerts, C.S. Wu
1956Bi30	NUCIA	4,	758	A. Bisi, S. Terrani, L. Zappa
1956Ch.A	UCRL- 3322			A. Chetham-Strode (thesis Berkeley)
1956Co13	PHRVA	101,	1042	J.M. Cork, M.K. Brice, D.W. Martin, L.C. Schmid, R.G. Helmer
1956Da06	ZENAA	11,	212	H. Daniel, R. Nierhaus
1956Do41	PHRVA	104,	1059	R.A. Douglas, J.W. Broer, R. Chiba, D.F. Herring, E.A. Silverstein
1956Gr11	PHRVA	101,	1306	P.R. Gray
1956Gr12	PHRVA	101,	1368	W.E. Graves, S.K. Suri
1956Ha10	PHRVA	101,	93	R.W. Hayward, D.D. Hoppes
1956Ho23	JINCA	2,	209	D.C. Hoffman, C.P. Browne
1956Ho66	PHRVA	104,	368	D.D. Hoppes, R.W. Hayward
1956Jo05	CJPHA	34,	69	M.W. Johns, C.V. McMullen, I.R. Williams, S.V. Nablo
1956Jo20	PHRVA	102,	831	N.R. Johnson, R.K. Sheline, R. Wolfgang
1956Ke23	PHRVA	103,	190	B.H. Ketelle, H. Thomas, A.R. Brosi
1956Kn20	PHRVA	102,	1592	J.D. Knight, J.P. Mize, J.W. Starnier, J.W. Barnes
1956Ko67	ZETFA	31,	771	L.M. Kondratev, G.I. Novikova, Y.P. Sobolev, L.L. Goldin
1956La24	ANPHA	1,	152	J. Laberrigie-Frolow
1956Po16	ZENAA	11,	143	W. Porschen, W. Riezler
1956Po28	PHRVA	103,	921	F.T. Porter, M.S. Freedman, T.B. Novey, F. Wagner, Jr.
1956Sh31	ZETFA	30,	891	K.N. Shlyagin
1956Sm85	JINCA	3,	93	H.L. Smith, C.P. Browne, D.C. Hoffman, J.P. Mize, M.E. Bunker
1956Sm96	PHRVA	104,	706	F.B. Smith, N.B. Gove, R.W. Henry, R.A. Becker
1956Th11	PHRVA	102,	195	M.T. Thieme, E. Bleuler
1956Wa24	PHRVA	102,	816	R.G. Waddell, E.N. Jensen

## 1957

1957Ah19	AFYSA	11,	379	K. Ahnlund
1957Ba08	ZENAA	12,	520	G. Baro, P. Rey
1957Bu37	PHRVA	106,	1224	J.W. Butler, K.L. Dunning, R.O. Bondelid
1957Bu41	PHRVA	105,	227	M.E. Bunker, J.P. Mize, J.W. Starner
1957Co62	PPSOA	70,	769	R.D. Connor, I.L. Fairweather
1957Fr.A	PrvCom	58St50		M.S. Freedman, D.W. Engelkemeir, F.T. Porter, F. Wagner, Jr.
1957Ha08	CJPHA	35,	258	B.G. Harvey, H.G. Jackson, T.A. Eastwood, G.C. Hanna
1957He39	PHRVA	105,	1011	R.L. Heath
1957He43	NUPHA	3,	161	C.J. Herrlander, T.R. Gerholm
1957Je.A	PrvCom	NDG	Jun	E.N. Jensen
1957Kn.A	PrvCom	NDG	Apr	J.D. Knight
1957Mi63	ANPHA	2,	116	A. Michalowicz
1957Ok.A	BAPSA	2,	24	G.D. O'Kelley, Q.V. Larson, G.E. Boyd
1957Ol05	PHRVA	106,	985	J.L. Olsen, L.G. Mann, M. Lindner
1957Sm73	PHRVA	107,	1314	W.G. Smith, R.L. Robinson, J.H. Hamilton, L.M. Langer
1957Th10	PHRVA	106,	1228	T.D. Thomas, R. Vandenbosch, R.A. Glass, G.T. Seaborg
1957Va08	PHYSA	23,	753	B. Van Nooijen, J. Konijn, A. Heyligers, J.F. van den Brugge, A.H. Wapstra
1957Wa01	PHRVA	105,	639	E.K. Warburton, J.N. McGruer

## 1958

1958A199	PHRVA	112,	1998	D.E. Alburger, S. Ofer, M. Goldhaber
1958Ar56	AFYSA	13,	501	E. Arberman, J. Brude, T.R. Gerholm
1958Bi41	PHRVA	112,	1089	H. Bichsel
1958Br88	HPACA	31,	335	J. Brunner, J. Halter, P. Scherrer
1958Du78	PHRVA	110,	1076	K.L. Dunning, J.W. Butler, R.O. Bondelid
1958Gi05	PHRVA	109,	1263	J.E. Gindler, J.R. Huizenga, D.W. Engelkemeir
1958GI56	IANFA	22,	941	M.P. Glazunov, B.F. Fulev
1958Go77	PRLTA	1,	251	H.E. Gove, J.A. Kuehner, A.E. Litherland, E. Almqvist, D.A. Bromley, A.D. Ferguson, P.H. Rose, R.P. Bastide, N. Brooks, R.D. Connor
1958Gr07	IANFA	22,	194	E.P. Grigorev, A.V. Zolotavin, I.I. Kuzmin, E.D. Pavlitskaia
1958Ha32	PHRVA	112,	2010	J.H. Hamilton, L.M. Langer, W.G. Smith
1958Hi.A	UCRL- 8423			M.W. Hill
1958Jo01	PHRVA	109,	1243	C.H. Johnson, A. Galonsky, J.P. Ulrich
1958Ko57	PHYSA	24,	377	J. Konijn, B. van Nooijen, H.L. Hagedoorn
1958Na15	CJPHA	36,	1409	S.V. Nablo, M.W. Johns, A. Artna, R.H. Goodman
1958Ni28	NUPHA	9,	528	G.J. Nijgh, A.H. Wapstra, L.T.M. Ornstein, N. Salomons-Grobben
1958No30	AFYSA	14,	85	T. Novakov, R. Stockendal, M. Schmorak, B. Johansson
1958Ri23	ZENAA	13,	904	W. Riezler, G. Kauw
1958Ro09	PHRVA	109,	1255	R.L. Robinson, L.M. Langer
1958Se71	IANFA	22,	198	V.A. Sergienko
1958St50	RMPHA	30,	585	D. Strominger, J.M. Hollander, G.T. Seaborg
1958Wa.A	P-Paris		910	R.J. Walen, G. Bastin

## 1959

1959Ac28	PHRVA	114,	137	W.T. Achor, W.E. Phillips, J.I. Hopkins, S.K. Haynes
1959Al06	PHRVA	116,	939	D.E. Alburger, A. Gallmann, D.H. Wilkinson
1959Am16	PISAA	50,	342	K.S.Y. Ambiyee, M.C. Yoshi, B.V. Thosar
1959An33	NUPHA	13,	310	S.L. Anderson, T. Holtebekk, O. Lonsjo, R. Tangen
1959Be72	PHRVA	115,	108	N. Benczer-Koller, A. Schwarzschild, C.S. Wu
1959Bo61	NUPHA	14,	145	P. Boskma, H. De Waard
1959Br65	PHRVA	113,	239	A.R. Brosi, B.H. Kettle, H.C. Thomas, R.J. Kerr
1959Bu20	PHRVA	116,	143	M.E. Bunker, B.J. Dropesky, J.D. Knight, J.W. Stamer, B. Warren
1959Co63	PPSOA	74,	161	R.D. Connor, I.L. Fairweather
1959Dr.A	BAPSA	4,	57	B.J. Dropesky, D.C. Hoffman, W.R. Daniels

1959Fi40	PHRVA	116,	744	K.F. Flynn, L.E. Glendenin
1959Gi50	NUPHA	12,	204	R.K. Girgis, R. van Lieshout
1959Go68	PHRVA	113,	246	C.R. Gossett, J.W. Butler
1959Ha27	PHRVA	114,	1133	D.S. Harmer, M.L. Perlman
1959Ho97	AFYSA	15,	387	G. Holm, H. Ryde
1959Jo37	PHRVA	114,	279	N.R. Johnson, G.D. O'Kelley
1959Kn38	JINCA	10,	183	J.D. Knight, D.C. Hoffman, B.J. Dropesky, D.L. Frasco
1959Ku79	PHYSA	25,	600	J. Kuperus, P.J.M. Smulders, P.M. Endt
1959No41	ZETFA	37,	928	G.I. Novikova, E.A. Volkova, L.I. Goldin, D.M. Ziv, E.F. Tretyakov
1959Po77	PHRVA	114,	1286	F.T. Porter, P.P. Day
1959Ro53	CJPHA	37,	385	J.P. Roy, L.P. Roy
1959To.A	BAPSA	4,	366	C.W. Townley, J.D. Kurbatov, M.H. Kurbatov
1959Va02	PHRVA	115,	115	S.E. Vandenbosch, H. Diamond, R.K. Sjoblom, P.R. Fields
1959Va32	PHRVA	113,	259	S.E. Vandenbosch
1960				
1960Ar05	CJPHA	38,	1577	A. Artna, M.E. Law
1960Ba17	NUPHA	15,	566	G. Backstrom, O. Bergman, J. Burde, J. Lindskog
1960Ba44	IANFA	24,	1035	S.A. Baranov, A.G. Zelenkov, V.M. Kulakov
1960Bo21	PHRVA	120,	889	R.O. Bondelid, C.A. Kennedy, J.W. Butler
1960Cr01	NUPHA	14,	578	C.B. Creager, C.W. Kocher, A.C.G. Mitchell
1960Dz02	IANFA	24,	802	B.S. Dzelepov, I.F. Uchevatkin, S.A. Shestopalova
1960Fe03	ANPHA	5,	181	L. Feuvrais
1960Gi01	NUPHA	14,	589	R.K. Girgis, R.A. Ricci, R. van Lieshout
1960Ha26	PHRVA	119,	772	J.H. Hamilton, L.M. Langer, W.G. Smith
1960Ho.A	PrvCom	Hyde		R.W. Hoff, F. Asaro, I. Perlman, in E.K. Hyde, I. Perlman, G.T. Seaborg, Nuclear Properties Heavy Elements p. 799
1960Ja13	PHRVA	120,	914	N. Jarmie, M.G. Silbert
1960Je03	NUPHA	19,	654	B.S. Jensen, O.B. Nielsen, O. Skilbreit
1960Ka14	PHRVA	119,	1953	W.R. Kane, G.T. Emery, G. Scharff-Goldhaber, M. McKeown
1960Ka20	JUPSA	15,	2140	T. Katoh, M. Nozawa, Y. Yoshizawa, Y. Koh
1960Ko12	PHRVA	120,	1348	C.W. Kocher, A.C.G. Mitchell, C.B. Creager, T.D. Nainan
1960La04	PHRVA	119,	1308	L.M. Langer, D.R. Smith
1960Lu07	ZENAA	15,	939	G. Luhrs, C. Mayer-Boricke
1960Ma.A	UCRL- 8740			T.V. Marshall
1960Mo.A	BAPSA	5,	338	R.B. Moore
1960Po07	PHRVA	118,	113	W.W. Pratt, R.G. Cochran
1960Se05	NUPHA	16,	138	O.J. Segaert, J. Demuyne, A.M. Hoogenboom, H. van den Bold
1960Ta19	NUPHA	21,	133	K. Takahashi, H. Morinaga
1960Vo05	ZETFA	39,	70	A.A. Vorobiev, A.P. Komar, V.A. Korolev
1960Vo07	IANFA	24,	1092	A.A. Vorobiev, A.P. Komar, V.A. Korolev
1960Wa03	PHRVA	117,	191	W.R. Ware, E.O. Wiig
1960Wa14	NUPHA	16,	246	R.J. Walen, G. Bastin-Scoffier
1961				
1961Ar05	NUPHA	22,	341	E. Arberman, I.B. Haller
1961Ar15	CJPHA	39,	1817	A. Artna, M.W. Johns
1961Ba43	ZETFA	41,	1484	K.A. Baskova, S.S. Vasilev, N.S. Chang, L.Y. Shavtvalov
1961Be13	PHRVA	123,	2100	E.H. Beckner, R.L. Bramblett, G.C. Phillips, T.A. Eastwood
1961Be20	ZETFA	40,	91	A. Bedesku, O.M. Kalinkina, K.P. Mitrofanov, A.A. Sorokin, N.V. Forafontov, V.S. Shpinel
1961Be41	NUPHA	28,	570	G.B. Beard, W.H. Kelly
1961Bo13	PHRVA	124,	213	H.H. Bolotin, A.C. Li, A. Schwarzschild
1961Bo24	NUPHA	27,	581	N.A. Bonch-Osmolovskaya, B.S. Dzelepov, O.E. Kraft, Y.Y. Yang
1961Bo.B	P-Dubna			N.A. Bonch-Osmolovskaya, B.S. Dzelepov, O.E. Kraft
1961Da01	ZEPYA	164,	303	H. Daniel, P. Panussi
1961De17	NUPHA	28,	148	H.G. Devare

1961Di04	NUPHA	25,	248	R.M. Diamond, J.M. Hollander, D.J. Horen, R.A. Naumann
1961Du02	PHRVA	123,	1321	K.L. Dunning, J.W. Butler
1961Er04	AFYSA	20,	209	P. Erman, Z. Sujkowski
1961F05	AFYSA	19,	323	R.W. Fink, G. Andersson, J. Kantele
1961Ga05	PHRVA	122,	1590	C.J. Gallagher, Jr., H.L. Nielsen, O.B. Nielsen
1961Gr33	IANFA	25,	1217	E.P. Grigorev, K.Y. Gromov, B.S. Dzelepov, Z.T. Zhelev, V. Zvolzka, I. Zvolskii
1961Gu02	AFYSA	18,	443	R.K. Gupta, J. Svedberg, G. Andersson
1961Hi06	JUPSA	16,	1280	H. Hisatake
1961Ja07	PHRVA	123,	909	N. Jarmie, M.G. Silbert
1961Jo08	PHRVA	122,	1546	N.R. Johnson, E. Eichler, G.D. O'Kelley, J.W. Chase, J.T. Wasson
1961Jo15	PHRVA	124,	157	R.C. Jopson, H. Mark, C.S. Swift, J.H. Zenger
1961Ko11	IANFA	25,	237	G.E. Kocharov, G.A. Korolev
1961La05	DANKA	137,	551	A.K. Lavrukina, T.V. Malysheva, B.A. Khotin
1961Ni02	PHRVA	122,	172	R.T. Nichols, R.E. McAdams, E.N. Jensen
1961Pe23	ZETFA	41,	1780	K.A. Petrzhak, M.I. Yakunin
1961Re06	JINCA	18,	13	I. Rezanka, J. Frana, M. Vobecky, A. Mastalka
1961Ri02	NUPHA	24,	494	R. Rikmenspoel, C.M. Van Patter
1961Ru06	UCRL- 9511			C.P. Ruiz
1961Ry02	HPACA	34,	240	A. Rytz
1961Ry04	HPACA	34,	819	A. Rytz, H. Winkler, F. Zamboni, W. Zych
1961Sc11	PHRVA	123,	893	A.W. Schardt, A. Goodman
1961Se08	IANFA	25,	848	I.P. Selinov, V.L. Chikhladze, D.E. Khulelidze
1961Si03	PHRVA	123,	221	M.G. Silbert, N. Jarmie
1961To03	PPSOA	77,	399	J.H. Towle, B.E.F. Macefield
1961To10	JOPQA	22,	683	J. Tousset, A. Moussa
1961We11	PHRVA	124,	527	H.I. West, Jr., L.G. Mann, R.J. Nagle
1961Wr02	PHRVA	123,	205	P.M. Wright, E.P. Steinberg, L.E. Glendenin
1961Zy02	APPOA	20,	321	J. Żylicz, Z. Preibisz, S. Chojnacki, J. Wolowski, Y. Noursev
1962				
1962Ba23	PRLTA	9,	16	R.C. Barber, L.A. Cambey, J.H. Ormrod, R.L. Bishop, H.E. Duckworth
1962Ba24	CJPHA	40,	1496	R.C. Barber, R.L. Bishop, L.A. Cambey, W. McLatchie, H.E. Duckworth
1962Ba28	NUPHA	33,	347	B. Basu, A.P. Patro
1962Ba32	AFYSA	21,	65	E. Bashandy, M.S. El-Nesr
1962Bo25	AFYSA	22,	111	E.C.O. Bonacalza, P. Thieberger, I. Bergström
1962Br15	PHRVA	125,	1323	H.W. Brandhorst, Jr., J.W. Cobble
1962Bu16	PHRVA	127,	844	M.E. Bunker, B.J. Dropesky, J.D. Knight, J.W. Starnner
1962Ch21	ZETFA	43,	453	V.L. Chikhladze, D.E. Khulelidze, R.A. Ryukhin
1962Da03	NUPHA	31,	293	H. Daniel
1962Ei02	NUPHA	35,	625	E. Eichler, G.D. O'Kelley, R.L. Robinson, J.A. Marinsky, N.R. Johnson
1962Ei02	NUPHA	31,	128	M.S. El-Nesr, E. Bashandy
1962Ew01	NUPHA	29,	153	G.T. Ewan, R.L. Graham, J.S. Geiger
1962Fr09	NUPHA	38,	89	J.M. Freeman, D. West
1962Fu16	NUPHA	39,	147	E.G. Funk, Jr., J.W. Mihelich, C.F. Schwerdtfeger
1962Ga07	NUPHA	33,	285	C.J. Gallagher, Jr., M. Jorgensen, O. Skilbreid
1962Gu03	PHRVA	126,	642	R. Gunnink, A.W. Stoner
1962In01	NUPHA	38,	50	H. Inoue, J. Ruan, S. Yasukawa, Y. Yoshizawa
1962Ka08	NUPHA	32,	25	T. Katoh, M. Nozawa, Y. Yoshizawa
1962Ka23	NUPHA	36,	394	T. Katoh, M. Nozawa, Y. Yoshizawa, Y. Koh
1962Ka27	AAFPA	6,	96	P. Kauranen
1962Kh05	IANFA	26,	1036	D.E. Khulelidze, V.L. Chikhladze, N.A. Vartenov, Y.A. Kyukhin
1962La10	NUPHA	35,	582	N.L. Lark, P.F.A. Goudsmit, J.F.W. Jansen, J.E.J. Oberski, A.H. Wapstra
1962Li03	NUPHA	31,	584	E.W.A. Lingeman, K.E.G. Lobner, G.J. Nijgh, A.H. Wapstra
1962Lo10	ZETFA	43,	1579	V.M. Lobashov, V.A. Nazarenko, L.F. Saenko
1962No06	NUPHA	36,	411	M. Nozawa
1962Pe08	HPACA	35,	175	C.F. Perdrisat, J.H. Brunner, H.J. Leisi
1962Pe15	PHRVA	127,	917	I. Perlman, F. Asaro, A. Ghiorso, A. Larsh, R. Latimer

1962Pi02	PHRVA	127,	1708	W.R. Pierson, H.C. Griffin, C.D. Coryell
1962Pu01	NUPHA	36,	1	D.J. Pullen, A.E. Litherland, S. Hinds, R. Middleton
1962Sc04	PHRVA	125,	1641	C.F. Schwerdtfeger, E.G. Funk, Jr., J.W. Mihelich
1962Se03	PHRVA	125,	968	M.L. Seghal
1962Si14	AAFPA	6,	109	A. Siivola
1962Un01	NUPHA	36,	284	J. Unik, P. Day, S. Vandenbosch
1962Va08	NUPHA	30,	177	S.E. Vandenbosch, P. Day
1962Va10	NUPHA	31,	406	B. Van Nooijen, H. van Krugten, W.J. Wieseahn, A.H. Wapstra
1962Wa15	PHMAA	7,	105	D.E. Watt, R.N. Glover
1962Wa16	NUPHA	31,	575	A.H. Wapstra, J.F.W. Jansen, P.F.A. Goudsmit, J. Oberski
1962Wa18	NUPHA	35,	232	R.J. Walen, V. Nedovesov, G. Bastin-Scoffier
1962Wa20	NUPHA	36,	207	L.B. Warner, R.K. Sheline
1962Wa28	COREA	255,	1604	R.J. Walen
1962Ya01	NUPHA	30,	68	T. Yamazaki, H. Ikegami, M. Sakai
1963				
1963Ab02	PHLTA	5,	359	A. Abdumalikov, A. Abdurazakov, K. Gromov, Z. Zhelev, N. Lebedev, B. Dzelepov, A. Kudryavtseva
1963Ba32	NUPHA	43,	285	C.V.K. Baba, G.T. Ewan, J.F. Suarez
1963Ba37	ZETFA	44,	35	N.B. Badalov, S.S. Vasilenko, M.G. Kaganskii, D.L. Kaminskii, M.K. Nikitin
1963Ba47	CJPHA	41,	1482	R.C. Barber, W. McLatchie, R.L. Bishop, P. Van Rookhuyzen, H.E. Duckworth
1963Bi12	CJPHA	41,	1532	R.L. Bishop, R.C. Barber, W. McLatchie, J.D. Macdougall, P. Van Rookhuyzen, H.E. Duckworth
1963Bj01	NUPHA	42,	469	S. Bjornholm, F. Boehm, A.B. Knutsen, O.B. Nielsen
1963Bj02	NUPHA	42,	642	S. Bjornholm, O.B. Nielsen
1963Bl03	PHLTA	3,	257	H.R. Blieden
1963Bo07	PHRVA	130,	1078	R.O. Bondelid, J.W. Butler
1963Bo14	PHYSA	29,	277	P. Born, C. Bobeldijk, W.A. Oost, J. Blok
1963Bo17	PHYSA	29,	535	P. Born, A. Veeffkind, W.H. Elsenaar, J. Blok
1963Ca03	PHRVA	129,	1782	D.C. Camp, L.M. Langer
1963Cr06	PHRVA	132,	1681	B. Crasemann, G.T. Emery, W.R. Kane, M.L. Perlman
1963Da03	ZEPYA	172,	202	H. Daniel, O. Mehling, D. Schotte
1963Da10	PHRVA	132,	1673	R.A. Damerow, R.R. Ries, W.H. Johnson, Jr.
1963Do07	PHRVA	132,	2600	I. Dostrovsky, S. Katcoff, R.W. Stoenner
1963Em02	PHRVA	129,	2597	G.T. Emery, W.R. Kane, M. McKeown, M.L. Perlman, G. Scharff-Goldhaber
1963Fr10	PHRVA	132,	2169	G. Frick, A. Gallmann, D.E. Alburger, D.H. Wilkinson, J.P. Coffin
1963Fu17	KERNA	6,	152	L. Funke, K. Hohmuth, H. Jungclaussen, K.-H. Kaun, G. Muller, H. Sodan, L. Werner
1963Go06	NUCIA	30,	14	K.P. Gopinathan, M.C. Joshi, M. Radha Menon
1963Gr08	AAFPA	6,	128	G. Graeffe
1963Gu04	PHRVA	131,	301	R. Gunnink
1963Ho18	JINCA	25,	1303	R.W. Hoff, F. Asaro, I. Perlman
1963Ho.A	PrvCom	AHW		A.M. Hoogenboom
1963Ik01	NUPHA	41,	130	H. Ikegami, K. Sugiyama, T. Yamazaki, M. Sakai
1963Ja06	NUPHA	41,	303	A. Jasinski, J. Kownacki, H. Lancman, J. Ludziejewski, S. Chojnacki, I. Yutlandov
1963Ka21	PHLTA	6,	98	M. Karras, J. Kantele
1963La06	PHRVA	132,	324	L.M. Langer, D.E. Wortman
1963Ok01	JUPSA	18,	1563	K. Okano, K. Nishimira
1963Pa09	NUPHA	45,	336	M. Pasternak, T. Sonnino
1963Pe13	NUPHA	44,	653	L. Persson, H. Ryde, K. Oelsner-Ryde
1963Pe16	PHLTA	6,	347	L. Persson
1963Pi01	CZYPA	13,	23	Z. Plajner, L. Maly, N. Eissa, A. Benadek
1963Pr13	BAPMA	11,	691	Z. Preibisz, K. Pawlak, K. Stryczniewicz
1963Rh02	PHRVA	131,	1227	J.I. Rhode, O.E. Johnson

1963Ri07	PHRVA	132,	1662	R.R. Ries, R.A. Damerow, W.H. Johnson, Jr.
1963Ry01	AFYSA	23,	171	H. Ryde, L. Persson, K. Oelsner-Ryde
1963Sc15	PHRVA	132,	2650	F. Schima, E.G. Funk, Jr., J.W. Mihelich
1963Su.A	UCRL-11082			V.B. Subrahmanyam (thesis Berkeley)
1963Th02	NUPHA	41,	380	B.V. Thosar, R.P. Sharma, K.G. Prasad
1963Va24	PHYSA	29,	990	C. van der Leun, P.M. Endt
1963Wo04	RAACA	1,	225	G. Wolzak, H. Morinaga
1963Yo07	NUPHA	46,	78	Y. Yoshizawa, H. Okamura, S. Iwata, I. Fugiwara, T. Shigematsu, M. Tabushi, T. Tarumoto, K. Sakamoto
1963Zy01	NUPHA	42,	330	J. Żylicz, Z. Sujkowski, J. Jastrzebski, O. Wolczek, S. Chojnacki, I. Yutlandov
			1964	
1964Ag.A	P-Tbilis		63	V.K. Ageev, K.Y. Gromov, B.S. Dzelepov, Z. Zhelev, V. Kalinnikov, A. Kudryavtseva
1964As01	PLRBA	133,	291	F. Asaro, S. Bjornholm, I. Perlman
1964Ba03	CJPHA	42,	391	R.C. Barber, W. McLatchie, R.L. Bishop, J.D. Macdougall, P. van Rookhuyzen, H.E. Duckworth
1964Ba13	NUPHA	52,	125	H. Bakhru, S.K. Mukherjee
1964Ba36	PLRBA	136,	603	E.L. Bahn, Jr., B.D. Pate, R.D. Fink, C.D. Coryell
1964Be10	NUPHA	50,	657	U. Bertelsen, G.T. Ewan, H.L. Nielsen
1964Bo13	NUPHA	53,	618	R.O. Bondelid, J.W. Butler
1964Bo25	AFYSA	26,	141	E.C.O. Bonacalza
1964Bu10	PLRBA	136,	1	S.B. Burson, E.B. Shera, T. Gedayloo, R.G. Helmer, D. Zei
1964Da15	NUPHA	56,	147	H. Daniel, J. Huefner, T. Lorenz, O.W.B. Schult, U. Gruber
1964De10	PLRBA	134,	705	S.H. Devare, H.G. Devare
1964Do01	NUPHA	50,	489	D. Donhoffer
1964Er06	PLRBA	135,	110	J.R. Erskine
1964Fi02	RAACA	2,	210	J. Flegenheimer, G.B. Baro
1964Fu08	NUPHA	60,	294	M. Fujioka, K. Hisatake, K. Takahashi
1964Go08	PLRBA	134,	297	K.P. Gopinathan, M.G. Joshi
1964Gr11	AAFPA	6,	145	G. Graeffe, K. Valli, J. Aaltonen
1964Ha29	PHYSA	30,	1802	J.H. Hamilton, K.E.G. Lobner, A.R. Sattler, R. van Lieshout
1964Ho28	APASA	18,	309	I. Hofman
1964Jo11	PLRBA	136,	1719	C.H. Johnson, C.C. Trail, A. Galonsky
1964Ka10	PLRBA	135,	9	J. Kantele, M. Karras
1964Ka16	AAFPA	6,	162	J. Kantele, K.M. Broom, D.M. Chittenden
1964Ka23	AFYSA	27,	61	S.E. Karlsson, O. Bergman, W. Scheuer
1964La03	PLRBA	133,	1145	L.M. Langer, E.H. Spejewski, D.E. Wortman
1964La13	PLRBA	135,	581	L.M. Langer, E.H. Spejewski, D.E. Wortman
1964Ma30	CJPHA	42,	1700	K.C. Mann, F.A. Payne, R.P. Chaturvedi
1964Ma36	CZYPA	14,	240	L. Maly, Z. Plajner, J. Jursik, M. Finger
1964Ma.A	P-Vienna		279	J.B. Marion
1964Mc21	CPHMA	30,	#4	J.D. McCoy
1964Pa03	APASA	18,	315	H. Paul
1964Pe17	PLRBA	136,	330	N.F. Peek, J.A. Jungerman, C.G. Patten
1964Sa32	SHIBA	5,	54	K. Sato
1964Sc27	IDO-17042		11	R.P. Schuman
1964Sh21	JUPSA	19,	245	Y. Shida
1964Sp12	P-Vienna		289	A. Sperduto, W.W. Buechner
1964Ta11	JUPSA	19,	587	E. Takekoshi, Z.-I. Matumoto, M. Ishii, K. Sugiyama, S. Hayashibe, H. Sekiguchi, H. Natsume
1964Th05	NUPHA	60,	35	K.S. Thorne, E. Kashy
1964To04	PLRBA	136,	1233	K.S. Toth, T.H. Handley, E. Newman, I.R. Williams
1964Va20	AAFPA	6,	165	K. Valli
1964Wi07	PLRBA	135,	289	D.C. Williams, R.A. Naumann

1965



1965Bi04	PLRBA	138,	514	W.N. Bishop
1965Bi12	IANFA	29,	151	E.I. Biryukov, V.T. Novikov, N.S. Shimanskaya
1965Bi06	AFYSA	28,	415	P.H. Blichert-Toft
1965Br28	NUPHA	72,	194	C.P. Browne, W.E. Dorenbusch, F.H. O'Donnell
1965Br31	NUPHA	72,	529	L. Broman, J. Dubois
1965Bu03	JINCA	27,	907	F.D.S. Butement, S.M. Quaim
1965Bu07	NUPHA	65,	561	J. Burde, M. Rakavi, G. Adam
1965Ce02	PRLTA	15,	300	J. Cerny, C. Détraz, R.H. Pehl
1965Co06	CJPHA	43,	383	C.R. Cothorn, R.D. Connor
1965Cr04	NUPHA	70,	129	T. Cretzu, K. Hohmuth, J. Schintlmeister
1965Da01	NUPHA	63,	145	H. Daniel, M. Kuntze, B. Martin, P. Schmidlin, H. Schmitt
1965De20	NUPHA	73,	49	S.A. De Wit, A.H. Wapstra
1965De22	PLRBA	140,	536	S.H. Devare, R.M. Singru, H.G. Devare
1965Du02	COREA	261,	98	J.C. Duperrin, A. Guizon-Juillard
1965Eb01	NUPHA	61,	479	T.G. Ebrey, P.R. Gray
1965Fr04	NUPHA	64,	303	K. Fritze
1965Fr12	PLRBA	140,	563	M.S. Freedman, F.T. Porter, F. Wagner, Jr.
1965Go05	PLRBA	137,	1466	S. Gorodetsky, A. Gallmann, R. Rebmeister
1965Gu03	NUPHA	64,	401	M. Guttman, E.G. Funk, Jr., J.W. Mihelich
1965Ha30	PHLTA	19,	304	P.G. Hansen, H.L. Nielsen, K. Wilsky, J. Treherne
1965Ho07	NUPHA	71,	449	C.G. Hoot, M. Kondo, M.E. Rickey
1965Hs02	NUPHA	73,	379	S.T. Hsue, L.M. Langer, S.M. Tang, D.A. Zollman
1965Iv01	IANFA	29,	157	Y.F. Ivanov, I.A. Rumer, A.Y. Bukach
1965Jo04	NUPHA	61,	385	M.W. Johns, M. Kawamura
1965Jo13	NUPHA	72,	617	N.R. Johnson, K. Wilsky, P.G. Hansen, H.L. Nielsen
1965Ka07	JINCA	27,	1451	P. Kauranen, H. Ihochi
1965Ke04	NUPHA	61,	513	W.J. Keeler, R.D. Connor
1965Kv01	NUPHA	74,	27	E. Kvale, A.C. Pappas
1965Le06	NUPHA	63,	263	H. Leutz, K. Schneckenberger, H. Wennige
1965Le07	NUPHA	65,	337	W.H.G. Lewin, J. Lettinga, B. van Nooijen, A.H. Wapstra
1965Li11	JNCEA	19,	73	H. Liskien, A. Paulsen
1965Ma07	PHLTA	14,	46	A. Marinov, J.R. Erskine
1965Ma32	NUPHA	67,	73	J.H.E. Mattauch, W. Thiele, A.H. Wapstra
1965Ma51	IANFA	29,	1121	I. Mahunka, T. Fenyés
1965Me12	PHLTA	19,	133	R. Messlinger, H. Morinaga, C. Signorini
1965Mo16	NUPHA	74,	403	R. Moreh, T. Daniels
1965Mo19	NUPHA	70,	293	R. Moreh
1965Mu09	NUPHA	67,	466	A. Mukerji, D.N. McNelis, J.W. Kane, Jr.
1965Og01	NUPHA	66,	119	I. Ogawa, T. Doke, M. Miyajima, A. Nakamoto
1965Pa08	NUPHA	72,	326	H. Paul
1965Pe18	AFYSA	29,	423	H. Pettersson, O. Berhman, C. Bergman
1965Ra02	PLRBA	137,	13	A.V. Ramaya, Y. Yoshizawa
1965Re07	NUPHA	65,	609	R. Reising, B.D. Pate
1965Ry01	NUPHA	70,	369	A. Rytz
1965Sc19	PLRBA	140,	1496	F. Schima, T. Katoh
1965Va02	NUPHA	63,	241	B. Van Nooijen, W. Lourens, H. van Krugten, A.H. Wapstra
1965Va16	AAFPA	6,	177	K. Valli, J. Aaltonen, G. Graeffe, M. Nurmia, R. Poeyhoenen
1965Wi08	PHLTA	15,	143	E.T. Williams, P.G. Hansen, J. Lipperts, H.L. Nielsen, K. Wilsky
1966				
1966Ah.A	UCRL-16580	21	I. Ahmad, F. Asaro, I. Perlman	
1966Ah.B	UCRL-16888		I. Ahmad	
1966Ak01	AENGA	21,	243	G.N. Akapev, A.G. Demin, V.A. Druin, E.G. Imaev, I.V. Kolesov, Y.V. Lobanov, L.P. Pashchenko
1966An10	CHDBA	262,	214	S. Andre, P. Depommier
1966Au04	NUPHA	81,	441	R.L. Auble, W.H. Kelly
1966Av03	IANFA	30,	542	M.P. Avotina, E.P. Grigorev, B.S. Dzelepov, A.V. Zolotavin, V.O. Sergeev

1966Ba07	YAFIA	4,	1108	S.A. Baranov, Y.F. Rodionov, V.M. Kulakov, V.M. Shatinskii
1966Ba14	CHDBA	262,	89	G. Bastin, C.F. Leang, R.J. Walen
1966Be10	PHRVA	141,	1112	J.L. Benson, W.H. Johnson, Jr.
1966Be12	PHLTA	21,	205	H. Beekhuis
1966Bj01	NUPHA	86,	145	J.H. Bjerregaard, O. Hansen, O. Nathan, S. Hinds
1966Bl15	PHRVA	151,	930	A.G. Blair, D.D. Armstrong
1966Bo20	NUPHA	86,	187	B.E. Bonner, G. Rickards, D.L. Bernard, G.C. Phillips
1966Br14	NUPHA	81,	233	H.F. Brinckmann, C. Heiser, K.F. Alexander, W. Neubert, H. Rotter
1966Bu16	KDVSA	35,	#2	D.G. Burke, B. Zeidman, B. Elbek, B. Herskind, M. Olesen
1966Ca09	NUPHA	82,	471	R.C. Catura, J.R. Richardson
1966Ca10	NUPHA	85,	317	M.J. Canty, W.F. Davidson, R.D. Connor
1966Da04	NUPHA	76,	97	H. Daniel, G.T. Kaschl
1966Da06	PHRVA	147,	845	W.R. Daniels, D.C. Hoffman
1966De11	NUPHA	83,	289	E.Y. De Aisenberg, J.F. Suarez
1966Ei01	PHRVA	146,	899	E. Eichler, J.W. Chase, N.R. Johnson, G.D. O'Kelley
1966Ei09	ORNL-3889		49	J.S. Eldridge, W.S. Lyon
1966Er02	PHRVA	142,	633	J.R. Erskine, A. Marinov, J.P. Schiffer
1966Fu05	NUPHA	84,	461	L. Funke, H. Graber, K.-H. Kaun, R. Ross, H. Sodan, L. Werner, J. Frana
1966Fu08	NUPHA	84,	424	L. Funke, H. Graber, K.-H. Kaun, H. Sodan, G. Geske, J. Frana
1966Ga03	NUPHA	76,	353	R. Gaeta, M.A. Vigon
1966Ga08	PHRVA	147,	753	A. Gallmann, P. Fintz, J.B. Nelson, D.E. Alburger
1966Ha15	NUPHA	76,	257	P.G. Hansen, H.L. Nielsen, K. Wilsky, Y.K. Agarwal, C.V.K. Baba, S.K. Bhattacharjee
1966Ha29	NUPHA	84,	62	G.R. Hagee, R.C. Lange, J.T. McCarty
1966He10	NUPHA	88,	561	P.V. Hewka, C.H. Holbrow, R. Middleton
1966Hi01	PHLTA	21,	328	S. Hinds, J.H. Bjerregaard, O. Hansen, O. Nathan
1966Hs01	NUPHA	80,	657	S.T. Hsue, L.M. Langer, E.H. Spejewski, S.M. Tang
1966Ki06	CJPFA	44,	2661	J.E. Kitching, M.W. Johns
1966La04	NUPHA	78,	1	T. Lauritsen, F. Ajzenberg-Selove
1966Li04	PHRVA	141,	1089	A.C. Li, I.L. Preiss, P.M. Strudler, D.A. Bromley
1966Ma49	IANFA	30,	1185	E.P. Mazets, Y.V. Sergeenkov
1966Ma51	IANFA	30,	1375	I. Mahunka, L. Tron, T. Fenyess, V.A. Khalkin
1966Mc12	CJPFA	44,	3033	C.C. McMullen, K. Fritze, R.H. Tomlinson
1966Mo06	PHRVA	141,	1166	C.F. Moore, P. Richard, C.E. Watson, D. Robson, J.D. Fox
1966Ne01	PRLTA	16,	28	E. Newman, J.C. Hiebert, B. Zeidman
1966No05	NUPHA	86,	102	A.E. Norris, G. Friedlander, E.M. Franz
1966Ny01	NUPHA	88,	63	B. Nyman, A. Johansson, C. Bergman, G. Backstrom
1966Pa18	NUPHA	85,	504	P.B. Parks, P.M. Beard, E.G. Bilpuch, H.W. Newson
1966Pe10	NUPHA	83,	33	H. Pettersson, G. Backstrom, C. Bergman
1966Po04	PHRVA	146,	774	F.T. Porter, M.S. Freedman, F. Wagner, Jr., K.A. Orlandini
1966Qa02	NUPHA	88,	285	S.N. Qaim
1966Ra03	PHRVA	142,	768	P.V. Rao, B. Crasemann
1966Re02	PHLTA	20,	40	W. Reichart, H.H. Staub, H. Stussi, F. Zamboni
1966Rg01	PHRVA	148,	1192	Research-Group, Combined Radioactivity Group LRL-LASL-UCRL-ANL
1966Ri01	NUPHA	75,	381	P. Riehs
1966Ri09	NUPHA	86,	167	G. Rickards, B.E. Bonner, G.C. Phillips
1966Sc23	NUPHA	89,	401	D. Schwalm, B. Povh
1966Sc24	PHRVA	151,	950	F.J. Schima
1966Sh03	PHRVA	143,	857	R.K. Sheline, C.E. Watson, B.P. Maier, U. Gruber, R.H. Koch, O.W.B. Shult, H.T. Motz, E.T. Jurney, G.L. Struble, T. von Egidy, T. Elze, E. Bieber
1966Si08	NUPHA	84,	385	A. Siivola
1966Sn02	PHRVA	147,	967	R.E. Snyder, G.B. Beard
1966Va.A	UCRL-16580		85	K. Valli, E.K. Hyde
1966Vo05	ZEPYA	195,	343	H. Vonach, H. Munzer, P. Hille
1966Wh01	PHRVA	150,	836	W. Whaling
1966Wi04	ZEPYA	191,	137	K. Wien
1966Wi11	PHLTA	22,	162	D.C. Williams, J.D. Knight, W.T. Leland

1966Wi12	NUPHA	84,	609	I.R. Williams, K.S. Toth, T.H. Handley
				1967
1967Ah02	PHRVA	164,	1537	I. Ahmad, A.M. Friedman, R.F. Barnes, R.K. Sjoblom, J. Milsted, P.R. Fields
1967Ai08	NUPAB	98,	323	A.M. Aldridge, H.S. Plendl, J.P. Aldridge, III
1967An01	NUPAB	94,	289	S. Antman, H. Pettersson, A. Suarez
1967As02	PHRVA	158,	1073	F. Asaro, I. Perlman
1967Ba01	NUPAB	91,	465	V.A. Balalaev, B.S. Dzelepov, L.N. Moskvina, S.A. Shetopalova, N.A. Voinova
1967Ba15	PHRVA	155,	1319	P.D. Barnes, J.R. Comfort, C.D. Bockelman
1967Ba42	YAFIA	5,	241	S.A. Baranov, I.G. Aliev, L.V. Chistyakov
1967Ba43	YAFIA	5,	518	S.A. Baranov, M.K. Chadzhiev, V.M. Kulakov, V.M. Shatinskii
1967Ba51	CHDBA	265,	863	G. Bastin-Scoffier
1967Ba.A	P-Gatlinburg		261	C.A. Barnes, E.G. Adelsberger, D.C. Hensley, A.B. Macdonald
1967Be46	NUPAB	104,	241	G. Berzins, W.H. Kelly, G. Graeffe, W.B. Walters
1967Bj01	NUPAB	94,	457	J.H. Bjerregaard, O. Hansen, O. Nathan, S. Hinds
1967Bj05	PHRVA	160,	889	J.H. Bjerregaard, O. Hansen, G.R. Satchler
1967Ca18	NUPAB	104,	35	M.J. Canty, R.D. Connor
1967Ch05	NUPAB	94,	417	P. Charoenkwan, J.R. Richardson
1967Da10	CJPHA	45,	2295	W.F. Davidson, C.R. Cothorn, R.D. Connor
1967Dz02	IANFA	31,	568	B.S. Dzelepov, R.B. Ivanov, M.A. Mikhailov, L.N. Moskvina, O.M. Nazarenko, V.F. Radionov
1967Er02	P-Winnipeg		622	J.R. Erskine, A.M. Friedman, T.H. Braid, R.R. Chasman
1967Es06	AAFPA	6,	261	K. Eskola
1967Fi04	PYLBB	24,	340	P.R. Fields, R.F. Barnes, R.K. Sjoblom, J. Milsted
1967Fi15	AENGA	22,	342	G.N. Flerov, S.M. Polikanov, V.L. Mikheev, V.I. Ilyushchenko, M.B. Miller, V.A. Shchegolev
1967Fr02	NUPAB	94,	366	J. Frana, I. Rezanka, Z. Plajner, A. Spalek, J. Jursik, M. Vobecky, A. Mastalka, L. Funke, A. Graber, H. Sodan
1967Gh01	PRLTA	18,	401	A. Ghiorso, T. Sikkeland, M.J. Nurmi
1967Go22	NUPAB	104,	497	P.F.A. Goudsmit, J. Konijn, F.W.N. De Boer
1967Go25	PHYSA	35,	479	P.F.A. Goudsmit
1967Go32	IANFA	31,	1618	N.A. Golovkov, K.Y. Gromov, N.A. Lebedev, B. Makhmudov, A.S. Rudnev, V.G. Chumin
1967Gu11	IJPYA	41,	633	S.C. Gujrathi, S.K. Mukherjee
1967Gu12	IJPYA	41,	667	S.C. Gujrathi, S.K. Mukherjee
1967Ha03	NUPAB	90,	573	S.K. Haynes, M. Velinsky, L.J. Velinsky
1967Ha04	PYLBB	24,	95	P.G. Hansen, H.L. Nielsen, K. Wilsky, J.G. Cuninghame
1967Hi01	PYLBB	24,	89	S. Hinds, H. Marchant, R. Middleton
1967Ho01	NUPAB	90,	545	J.L. Honsaker
1967Ho12	PHRVA	159,	1000	K.J. Hofstetter, P.J. Daly
1967Ho19	AFYSA	36,	211	D.C. Hoffman, O.B. Michelsen, W.R. Daniels
1967Hs01	NUPAB	94,	146	S.T. Hsue, M.U. Kim, S.M. Tang
1967Hu05	ZEPYA	203,	435	E. Huster, H. Verbeek
1967Ii01	YAFIA	6,	1117	V.I. Ilyushchenko, M.B. Miller, V.L. Mikheev, V.A. Shchegolev
1967Ko01	NUPAB	90,	558	J. Konijn, E.W.A. Lingeman, S.A. De Wit
1967Ma07	NUPAB	95,	632	A. Marelus, P. Sparman, S.-E. Hagglund
1967Mc07	NUPAB	99,	6	W.R. McMurray, M. Peisach, R. Pretorius, P. Van der Merwe, I.J. Van Heerden
1967Mc14	PRLTA	19,	1442	R.L. McGrath, J. Cerny, E. Norbeck
1967Mi02	NUPAB	94,	261	R.G. Miller, R.W. Kavanagh
1967Mi03	AENGA	22,	90	V.L. Mikheev, V.I. Ilyushchenko, M.B. Miller, S.M. Polikanov, G.N. Flerov, Y.P. Kharitonov
1967Mo10	CHDBA	264,	330	E. Monnand, J.A. Pinston, R. Henck
1967Mo12	NUPAB	99,	652	J.A. Moragues, P. Reyes-Suter, T. Suter
1967Mo13	NUPAB	100,	45	Y. Motavalledi-Nobar, J. Berthier, J. Blachot, R. Henck
1967Mo17	NUPAB	102,	406	W.G. Mourad, K.E. Nielsen, M. Petrilak

1967Mu16	PHRVA	159,	1039	G. Muehlechner, A.S. Poltorak, W.C. Parkinson, R.H. Bassel
1967Ni02	NUPAB	93,	385	H.L. Nielsen, K. Wilsky, J. Zylicz, G. Sorensen
1967Nu01	PYLBB	26,	78	M. Nurmia, T. Sikkeland, R. Silva, A. Ghiorso
1967Oa01	PYLBB	24,	142	N.S. Oakey, R.D. McFarlane
1967Od01	PHRVA	158,	957	F.H. O'Donnell, C.P. Browne
1967Pa04	JOPQA	28,	388	P. Paris
1967Pa08	CJPHA	45,	2621	J.J.H. Park, P. Christmas
1967Pi03	PHRVA	159,	939	W.R. Pierson, K. Rengan
1967Ra13	NUPAB	99,	547	R.C. Ragaini, G.E. Gordon, W.B. Walters
1967Sc01	NUPAB	96,	337	S.O. Schriber, M.W. Johns
1967Sc10	ZEPYA	203,	289	G. Schulz
1967Sc15	NUPAB	101,	177	G. Schulte
1967Sc26	NUPAB	104,	692	G. Schulz, K. Ziegler
1967Sc30	PHRVA	164,	1548	O.W.B. Schult, W.R. Kane, M.A.J. Mariscotti, J.M. Simic
1967Si02	NUPAB	92,	475	A. Siivola
1967Si07	PYLBB	24,	331	T. Sikkeland, A. Ghiorso
1967Si08	PYLBB	24,	333	T. Sikkeland, A. Ghiorso, J. Maly, M.J. Nurmia
1967Si09	NUPAB	101,	129	A. Siivola
1967Sp03	PHRVA	155,	1368	R.R. Spencer, K.T. Faler
1967Sp06	NUPAB	99,	625	E.H. Spejewski, J.B. Willett
1967Sp08	ZEPYA	204,	129	A. Spalek, I. Rezanka, J. Frana, A. Mastalka
1967Sp09	P-Winnipeg		657	A. Sperduto
1967St30	P-Winnipeg		495	H.H. Staub
1967Ti04	NUPAB	100,	425	E. Tielsch-Cassel
1967Tr06	NUPAB	97,	405	W. Treytl, K. Valli
1967Va14	NUPAB	99,	473	J. Van Klinken, L.M. Taff
1967Va17	PHRVA	159,	1013	K. Valli, M.J. Nurmia, E.K. Hyde
1967Va20	JINCA	29,	2503	K. Valli, E.K. Hyde, W. Treytl
1967Va22	PHRVA	161,	1284	K. Valli, W. Treytl, E.K. Hyde
1967Va23	NUPAB	102,	369	L. Van Neste, R. Coussement, J.P. Deutsch
1967Vo05	PHRVA	164,	1374	D. Von Ehrenstein, J.P. Schiffer
1967Vr04	IANFA	31,	604	J. Vrzal, K.Y. Gromov, J. Liptak, F. Molnar, V.A. Morozov, J. Urbanets, V.G. Chumin
1967Wa09	NUPAB	97,	641	A.H. Wapstra
1967Wa23	PHRVA	164,	1545	T.E. Ward, H. Ihochi, M. Karras, J.L. Meason
1967Wi19	NUIMA	52,	77	J.B. Willet, E.H. Spejewski
1968				
1968Ab14	IANFA	32,	749	A.A. Abdurazakov, J. Vrzal, K. Ya. Gromov, Zh. T. Zhelev, V.G. Kalinnikov, J. Liptak, S.K. Li, F.N. Mukhtasimov, U.K. Nazarov, J. Urbanets
1968Ab17	IANFA	32,	793	L.N. Abesalashvili, K.Y. Gromov, Z.T. Zhelev, V.G. Kalinnikov, J. Liptak, U.K. Nazarov, J. Urbanets
1968Ad03	JPAGB	1,	549	J.M. Adams, A. Adams, J.M. Calvert
1968Ad08	APPOA	34,	529	B. Adamowicz, Z. Moroz, Z. Preibisz, A. Zglinski
1968Ah01	NUPAB	119,	27	I. Ahmad, A.M. Friedman, J.P. Unik
1968An03	NUPAB	110,	289	S. Antman, H. Petterson, Y. Grunditz
1968An11	NUPAB	121,	337	S. Andre, P. Liaud
1968Au04	NUPAB	116,	14	R.L. Auble, J.B. Ball, C.B. Fulmer
1968Ba25	YAFIA	7,	727	S.A. Baranov, V.M. Kulakov, V.M. Shatinskii
1968Ba53	YAFIA	7,	1153	I. Bacso, D.D. Bogdanov, S. Barocsy, V.A. Karnaukhov, L.A. Petrov
1968Ba73	JOPQS	1,C1	181	G. Bastin, C.F. Leang, R.J. Walen
1968Ba.A	PrvCom		Rytz	G. Bastin, C.F. Leang, R.J. Walen
1968Be02	NUPAB	106,	296	J.E. Benn, E.B. Dally, H.H. Muller, R.E. Pixley, H.H. Staub, H. Winkler
1968Be06	NUPAB	108,	382	H. Beekhuis, R.J. Van Duinen
1968Be21	NUPAB	121,	433	C.E. Bemis, Jr., J. Halperin
1968Be35	ZEPYA	216,	229	E. Beck, H. Daniel
1968Be.A	BAPSA	13,	1430	M.J. Bennet, R.K. Sheline
1968Bu02	PHRVA	166,	1096	G.W. Butler, J. Cerny, S.W. Cosper, R.L. McGrath

1968Ch20	NUPAB	119,	305	R. Chapman, S. Hinds, A.E. Macgregor
1968Ch.A	PrvCom	AHW	May	R.E. Chrien
1968Co22	NUPAB	117,	449	M. Conjeaud, S. Harar, Y. Cassagnou
1968Da02	NUPAB	107,	569	W.R. Daniels, D.C. Hoffman, F.O. Lawrence, C.J. Orth
1968Da09	PHRVA	172,	1176	J.M. D'Auria, H. Bakhru, J.C. Preiss
1968Da13	NUPAB	112,	241	W.R. Daniels, F.O. Lawrence, D.C. Hoffman
1968De27	ZEPYA	216,	103	I. Dermedde
1968En01	NUPAB	107,	305	G.A.P. Engelbertink, H. Lindeman, M.J.N. Jacobs
1968Et01	PHRVA	168,	1249	R.C. Etherton, L.M. Beyer, W.H. Kelly, D.J. Horen
1968Fi01	NUPAB	111,	338	E. Fincke, U. Jahnke
1968Fi04	PHRVA	173,	1078	H.J. Fischbeck
1968Fu07	NUPAB	118,	97	L. Funcke, W. Andrejtscheff, H. Graber, U. Hagemann, K.-H. Kaun, P. Kemnitz, W. Meiling, H. Sodan, F. Stary, G. Winter
1968Go34	APPOA	34,	511	M. Gonsior, G.I. Lizurei, G. Nevodnichanskii, A.V. Potempa
1968Go.A	BAPSA	13,	1452	K.P. Gopinathan, W. Rubinson
1968Go.B	P-Dubna		54	N.A. Golovkov, R.B. Ivanov, Y.V. Norseev, So Ki Kvan, V.A. Khalkin, V.G. Shumin
1968Go.C	P-Dubna		27	N.A. Golovkov, S.V. Khvan, V.G. Chumin
1968Gr09	NUPAB	113,	353	T.B. Grandy, W.J. McDonald, W.K. Dawson, G.C. Neilson
1968Ha14	NUPAB	113,	206	R.L. Hahn, M.F. Roche, K.S. Toth
1968Ho10	JOPQA	29,	138	J.C. Hocquenghem, S. Andre, P. Liaud
1968Ho13	NUPAB	115,	225	R.W. Hoff, J.E. Evans, E.K. Hulet, R.J. Dupzyk, B.J. Qualheim
1968Hs01	NUPAB	109,	423	S.T. Hsue, M.U. Kim, L.M. Langer, E.H. Spejewski
1968Hs02	NUPAB	117,	686	S.T. Hsue, M.U. Kim, L.M. Langer, W.F. Piel, E.H. Spejewski
1968Ja11	AFYSA	37,	585	A. Jasinski, C.J. Herrlander
1968La18	PHRVA	175,	1507	I.M. Ladenbauer-Bellis, H. Bakhru
1968Le07	CHDBA	266,	629	C.F. Leang, G. Bastin-Scoffier
1968Mc09	PHRVA	172,	1253	L.D. McIsaac
1968Mc10	PHRVA	171,	1254	W.J. McDonald, J.T. Sample, D.M. Sheppard, G.M. Stinson, K.W. Jon
1968Mi08	NUPAB	119,	609	W. Michaelis, F. Weller, H. Schmidt, G. Markus, U. Fanger
1968Mo21	PHRVA	175,	1516	P.A. Moore, P.J. Riley, C.M. Jones, M.D. Mancusi, J.L. Foster, Jr.
1968My.A	P-Debrecen		102	B. Mysek, Z. Sujkowski, B. Kotlinska
1968Pa03	NUPAB	110,	674	B. Parsa, G.E. Gordon, W.B. Walters
1968Pe01	NUPAB	108,	124	H. Petterson, S. Antman, Y. Grunditz
1968Pi03	JOPQA	29,	257	R.A. Pinston, E. Monnard, A. Moussa
1968Re12	JINCA	30,	2887	K. Rengan, H.C. Griffin
1968Sa09	NUPAB	118,	409	R. Santo, R. Stock, J.H. Bjerregaard, O. Hansen, O. Nathan, R. Chapman, S. Hinds
1968Sa13	NUPAB	121,	65	C. Samour, H.E. Jackson, J. Julien, A. Bloch, C. Lopata, J. Morgenstern
1968Sc04	PHRVA	166,	1212	D. Schroer, P.S. Jastram
1968Sc14	ZEPYA	217,	282	W.D. Schmidt-Ott, W. Weirauch, F. Smend, H. Langhoff, D.G. Foller
1968Sh12	PHRVA	170,	1108	E.B. Shera, M.E. Bunker, R.K. Sheline, S.H. Vegors
1968Si01	NUPAB	109,	231	A. Siivola
1968Sn01	NUPAB	113,	581	R.E. Snyder, G.B. Beard
1968Su02	PRLTA	21,	237	A.W. Sunyar, G. Scharff-Goldhaber, M. McKeown
1968Tr07	ZENAA	23,	2127	N. Trautmann, R. Denig, N. Karfeel, G. Herrmann
1968Va04	PHRVA	167,	1094	K. Valli, W.J. Treytl, E.K. Hyde
1968Va08	ATKOA	10,	27	E. Vatai, K. Hohmuth
1968Va17	PHYSA	40,	253	H. Van Krugten, E.W. Koopmans
1968Va18	PHRVA	176,	1377	K. Valli, E.K. Hyde
1968Vi01	PYLBB	26,	285	G.B. Vingiani, G. Chilosi, W. Bruynesteyn
1968Vi05	IANFA	32,	1625	V.D. Vitman, B.S. Dzelepov, A.I. Medvedev
1968We02	NUPAB	109,	561	H. Wenniger, J. Stiewe, H. Leutz
1968Wh03	NUIMA	66,	70	D.H. White, D.J. Groves, R.E. Birket
1968Wi25	ATKEA	13,	383	P. Wille
1968Wo02	NUPAB	112,	156	J.L. Wolfson, A.J. Collier
1968Ze04	APASA	27,	31	H. Zemmann, D. Zemrad
1968Zh04	IANFA	32,	1610	Zh. Zhelev, V.G. Kalinnikov, J. Liptak, L.K. Peker

1969

1969Aj03	PHRVA	188,	1813	F. Ajzenberg-Selove
1969An18	PYLBB	30,	160	S. Andre, P. Liaud, F. Perales, S.Y. van der Werf
1969Ar23	IANFA	33,	1218	R. Arlt, Z. Malek, G. Musiol, G. Pfrepper, H. Strusny
1969Ar.A	P-Studsvik			S.E. Arnell, R. Hardell, O. Skeppstedt, E. Wallander
1969Ba57	YAFIA	10,	1110	S.A. Baranov, V.M. Shatinskii, V.M. Kulakov
1969Be06	JINCA	31,	599	C.E. Bemis, Jr., J. Halperin, R. Eby
1969Be74	NUIMA	76,	77	E. Beck
1969Bj01	NUPAB	131,	481	J.H. Bjerregaard, O. Hansen, O. Nathan, R. Chapman, S. Hinds
1969Bi01	PRLTA	22,	470	A.G. Blair, J.G. Beery, E.R. Flynn
1969Bi03	NUPAB	123,	129	R. Bloch, T. Knellwolf, R.E. Pixley
1969Bo11	NUPAB	130,	195	M. Bormann, B. Lammers
1969Bo48	NUIMA	72,	40	H.M.W. Booij, E.A. Van Hoek, J. Blok
1969Bu05	PHRVA	179,	1113	D.L. Bushnell, R.P. Chaturvedi, R.K. Smither
1969Bu.A	P-Yerevan		71	V.R. Burmistrov, B.G. Kiselev
1969Ch18	PYLBB	29,	652	J. Chaumont, E. Roeckl, Y. Nir-El, C. Thibault-Philippe, R. Klapisch, R. Bernas
1969Co03	NUPAB	129,	10	M. Conjeaud, S. Harar, E. Thuriere
1969Da15	PHRVA	181,	1618	J.W. Dawson, R.K. Sheline, E.T. Jurney
1969Fr01	NUPAB	127,	33	A.M. Friedman, I. Ahmad, J. Milsted, D.W. Engelkemeir
1969Gh01	PRLTA	22,	1317	A. Ghiorso, M. Nurmia, J. Harris, K. Eskola, P. Eskola
1969Go23	IANFA	33,	1622	N.A. Golovkov, S. Guetch, B.S. Dzelepov, Yu. V. Norseev, V.A. Chalkin, V.G. Shumin
1969Gr08	NUPAB	131,	180	H. Gruppelaar, A.M.F. Op den Kamp, A.M.J. Spits
1969Gr24	NUPAB	136,	513	A. Graue, J.R. Lien, S. Royrvik, O.J. Aaroy, W.H. Moore
1969Gr28	CHDBA	269,	652	B. Grennberg, A. Rytz
1969Ha11	NUPAB	127,	71	O. Hansen, O. Nathan, R. Chapman, S. Hinds
1969Ha32	PHRVA	182,	1329	R.L. Hahn, M.F. Roche, K.S. Toth
1969Ha44	NUPAB	136,	414	P.E. Haustein, A.F. Voigt
1969Ho10	NUPAB	131,	551	D.C. Hoffman, F.O. Lawrence, W.R. Daniels
1969Jo07	PHYSA	42,	303	H.W. Jongsma, B. Bengtsson, G.H. Dulfer, H. Verheul
1969Ka06	JUPSA	26,	1071	T. Katoh, T. Morii, H. Inoue, Y. Yoshizawa, H. Gotoh, E. Sakai
1969Ki16	YAFIA	10,	1105	B.G. Kiselev, V.R. Burmistrov
1969Kl06	ZEPYA	225,	364	J. Kloppenburg
1969Ku03	ZEPYA	222,	144	E. Kuhlmann, K.E.G. Lobner
1969Ku07	NUPAB	133,	554	T. Kuroyanagi, T. Tamura
1969La11	PHRVA	178,	1919	R.G. Lanier, R.K. Sheline, H.F. Mahlein, T. von Egidy, W. Kaiser, H.R. Koch, U. Gruber, B.P.K. Maier, O.W.B. Schult, D.W. Hafemeister, E.B. Shera
1969La15	PHRVA	180,	1015	I.M. Ladenbauer-Bellis, H. Bakhru
1969La33	PHRVA	187,	1739	I.M. Ladenbauer-Bellis, H. Bakhru, A. Luzzati
1969Le05	NUPAB	135,	36	C.M. Lederer, J.M. Jaklevic, S.G. Prussin
1969Le.A	Th.-Paris			C.F. Leang
1969Mi10	PHRVA	177,	1455	R.C. Minehart, L. Coulson, W.F. Grubb, III, K. Ziocck
1969Mo16	NUPAB	134,	321	E. Monnard, J. Blachot, A. Moussa
1969Na03	PHRVA	178,	1968	T. Nagarajan, M. Ravindranath, K.V. Reddy, S. Janananda
1969Na05	NUPAB	134,	433	T. Nagarajan, M. Ravindranath, K.V. Reddy
1969Na11	NUPAB	137,	467	T. Nagarajan, M. Ravindranath, K.V. Reddy
1969Oh01	PHRVA	177,	1695	H. Ohnuma, J.R. Erskine, J.A. Nolen, Jr., J.P. Schiffer, P.G. Roos
1969Ov01	NUIMA	68,	61	J.C. Overley, P.D. Parker, D.A. Bromley
1969Ph01	NUPAB	135,	116	M.E. Phelps, D.G. Sarantes
1969Ph03	RRALA	1,	351	A. Phillippe, C. Ballaux, R. Dams, F. Adams
1969Pi08	NUPAB	133,	124	J.A. Pinston, F. Schussler, A. Moussa
1969Ra24	NUPAB	138,	49	S. Ray, J.N. Mo, S. Murzynski, S.K. Mark
1969Re04	PHYSA	40,	567	E.R. Reddingius, H. Postma
1969St02	PHRVA	178,	2024	R.H. Stokes, P.G. Young
1969St07	PHRVA	178,	1789	R.H. Stokes, P.G. Young
1969Te01	PHRVA	177,	1595	J. Tenenbaum, R. Moreh, Y. Wand, B. Arad, G. Ben-David

1969Tj01	KDVSA	37,	#7	P.O. Tjom, B. Elbek
1969Va06	NUPAB	130,	586	J.M. Vara, R. Gaeta
1969Va17	NUPAB	134,	215	S.Y. Van der Werf, H. De Waard, H. Beekhuis
1969Wa15	JINCA	31,	2679	T.E. Ward, P.H. Pile, P.K. Kuroda
1969Wa19	PHRVA	185,	1439	J. Walinga, J.C. Manthuruthil, C.P. Poirier
1969Wa.A	UCRL-18667		54	D. Ward, F.S. Stephens, R.M. Diamond
1969Ya02	NUPAB	130,	456	T. Yamazaki, J. Sato
1970				
1970Ab05	NUPAB	151,	187	C. Abulaffio, J. Felsteiner, R. Kalish, B. Rosner, G. Vourvopoulos
1970Af.A	JINR-P6-4972			V.P. Afanasiev, M. Bocharova, N.A. Golovkov, I. Gromova, R.B. Ivanov, V.I. Kuzmin, Y.V. Noursev, V.G. Chumin
1970Ag01	IANFA	34,	397	V.A. Ageev, N.F. Mitrokhovich, A.I. Feoktistov
1970Ag03	IANFA	34,	201	V.A. Ageev, N.F. Mitrokhovich, A.I. Feoktistov
1970Ah01	NUPAB	140,	141	I. Ahmad, R.K. Sjoblom, R.F. Barnes, E.P. Horwitz, P.R. Fields
1970Aj01	NUPAB	142,	641	F. Ajzenberg-Selove, G. Igo
1970Ak02	IANFA	34,	777	A.I. Akhmadzhanov, R. Broda, V. Valyus, I. Zvoliski, I. Molnar, Y. Stygen, V.I. Fominikh, A. Krynekevich, V.M. Tsupko-Sitnikov
1970An06	ZEPYA	234,	455	A. Antilla, M. Bister, E. Arminen
1970An14	NUPAB	153,	17	M.L. Andersen, S.A. Andersen, O. Nathan, K.M. Bisgard, K. Gregersen, O. Hansen, S. Hinds, R. Chapman
1970Ar04	IANFA	34,	409	R. Arlt, G. Beyer, G. Musiol, L.K. Peker, G. Pfrepper, H. Strusny
1970As08	NUPAB	158,	146	J. Ashkenazi, E. Friedman, D. Nir, J. Zioni
1970Ba61	NUPAB	158,	337	R.K. Bardin, P.J. Gollon, J.D. Ullman, C.S. Wu
1970Be24	PRVCA	2,	297	R.W. Bercaw, R.E. Warner
1970Be.A	P-Leysin		353	E. Beck, ISOLDE
1970Bo13	PRVCA	2,	1841	J. Borggreen, K. Valli, E.K. Hyde
1970Bo19	JINCA	32,	2805	G.G.J. Boswell, T. McGee
1970Bo29	PRVCA	2,	1951	L.M. Bollinger, G.E. Thomas
1970Bu19	PRVCA	2,	1513	D.J. Buss, R.K. Smither
1970Ca01	NUPAB	141,	97	P.E. Cavanagh, C.F. Coleman, A.G. Hardacre, G.A. Gard, J.F. Turner
1970Ce04	PYLBB	33,	284	J. Cerny, J.E. Esterl, R.A. Gough, R.G. Sextro
1970Ch02	NUPAB	142,	634	J.C. Chang, G. Schupp, R.R. Hurst
1970Ch28	NUPAB	156,	276	A. Charvet, R. Duffait, A. Emsallem, R. Chéry
1970Ch29	JOPQA	31,	737	A. Charvet, R. Duffait, A. Emsallem, R. Chéry
1970Ch.A	BAPSA	15,	87	R.E. Chrien, S. Bokharee, J.B. Garg
1970Cr04	NUPAB	153,	413	F.P. Cranston, R.E. Birkett, D.H. White, J.A. Hughes
1970De39	NUPAB	158,	166	F.W.N. De Boer, E.W.A. Lingeman, R. van Lieshout, R.A. Ricci
1970Do.A	COO-1779-49		47	R. Doeblér (Also Thesis Michigan State University)
1970Ei02	NUPAB	141,	289	J. Eidens, E. Roeckl, P. Armbruster
1970Er03	NUPAB	146,	43	B. Erlandson, A. Marcinkowski
1970Es02	PRVCA	2,	1058	P. Eskola, K. Eskola, M. Nurmi, A. Ghiorso
1970Es03	PYLBB	33,	287	J.E. Esterl, J.C. Hardy, R.G. Sextro, J. Cerny
1970Fa06	NUPAB	146,	549	U. Fanger, D. Heck, W. Michaelis, H. Ottmar, H. Schmidt, R. Gaeta
1970Fi03	NUPAB	144,	67	E. Fincke, U. Jahnke, B. Schreiber, A. Weidinger
1970Fi12	NUPAB	154,	407	P.R. Fields, I. Ahmad, R.F. Barnes, R.K. Sjoblom, E.P. Horwitz
1970Fi.A	CERN-70-29			M. Finger, R. Foucher, J.P. Husson, J. Jastrzebski, A. Johnson, C. Se-bille, R. Henck, J.M. Kuchly, R. Regal, P. Siffert, G. Astner, B.R. Erdal, E. Hagebo, A. Kjelberg, F. Munnich, P. Patzelt, E. Beck, H. Kugler
1970Fi05	NUPAB	154,	225	E.R. Flynn, J.G. Beery, A.G. Blair
1970Fi08	NUPAB	157,	1	D.G. Fleming, M. Blann, H.W. Fulbright, J.A. Robbins
1970Fo09	PYLBB	32,	689	I. Fodor, I. Szentpetery, J. Szucz
1970Ga32	IANFA	34,	2048	S. Gabrakov, Z. Zhelev, N.G. Zaitseva, I. Penev, S.S. Sabirov
1970Ge03	PRVCA	1,	1052	W. Gelletly, J.A. Moragues, M.A. Mariscotti, W.R. Kane
1970Gh01	PYLBB	32,	95	A. Ghiorso, M. Nurmi, K. Eskola, P. Eskola
1970Gh02	PRLTA	24,	1498	A. Ghiorso, M. Nurmi, K. Eskola, J. Harris, P. Eskola
1970Go11	PRVCA	1,	1939	D.R. Goosman, R.W. Kavanagh
1970Go20	NUPAB	151,	513	P.F.A. Goudsmit, J. Konijn, F.W.N. De Boer

1970Go39	NUIMA	88,	197	W. Goedbloed, S.C. Goverse, C.P. Gerner, A. Brinkman, J. Blok
1970Go42	PRVCA	2,	2406	D.J. Gorman, F. Asaro
1970Gr46	KDVSA	37,	#12	T. Grottdal, K. Nybø, B. Elbek
1970Gu14	JINCA	32,	3425	M.C. Gupta, R.D. MacFarlane
1970Ha18	NUPAB	148,	249	P.G. Hansen, H.L. Nielsen, K. Wilsky, M. Alpsten, M. Finger, A. Lindahl, R.A. Naumann, J.-V. Kratz, G. Herrmann, O.B. Nielsen
1970Ha21	NUPAB	158,	625	T. Hattula, S. Andre, F. Schussler, A. Moussa
1970Ha56	PHSTB	1,	85	R. Hardell, C. Boer
1970He14	CJPHA	48,	1040	A.W. Herman, E.A. Heighway, J.D. McArthur
1970Ka04	NUPAB	147,	120	M. Karras, T.E. Ward, H. Schoche
1970Ka22	PRLTA	25,	953	W.R. Kane
1970Ke05	P-Kyoto			D.P. Kerr, K.T. Bainbridge
1970Ke08	PRVCA	2,	213	K.W. Kemper, C.M. McKenna, J.W. Nelson
1970Ki01	NUPAB	142,	35	H.J. Kim, R.L. Robinson, C.H. Jonnson, S. Raman
1970Ki05	ZEPYA	238,	11	H.V. Klapdor, K. Buchholz, F. Kaestner
1970Kn03	PRLTA	25,	1210	D.W. Kneff, H.W. Lefevre, G.U. Din
1970Le05	YAFIA	11,	483	V.N. Levkovskii, I.V. Kazachevskii
1970Li04	AFYSA	40,	197	H. Linusson, R. Hardell, S. Arnell
1970Lo02	NUPAB	152,	463	W. Lourens, B.O. Ten Brink, A.H. Wapstra
1970Ma11	CJPHA	48,	2056	J.F. Mason, M.W. Johns
1970Ma19	NUPAB	147,	513	E.S. Macias, J.P. Op den Beeck, W.B. Walters
1970Ma25	NUPAB	149,	593	S. Maripuu
1970Ma31	NUPAB	151,	465	S. Maripuu
1970Ma36	NUPAB	153,	183	S. Maripuu
1970Mc03	NUPAB	145,	244	W. McLatchie, S. Whineray, J.D. Macdougall, H.E. Duckworth
1970Me11	PRLTA	25,	533	R. Mendelson, G.J. Wozniak, A.D. Bacher, J.M. Loiseaux, J. Cerny
1970Mi01	NUPAB	143,	225	W. Michaelis, F. Weller, U. Fanger, R. Gaeta, G. Markus, H. Ottmar, H. Schmidt
1970Mu15	PRVCA	2,	655	T.J. Mulligan, R.K. Sheline, M.E. Bunker, E.T. Jurney
1970Ob02	NUPAB	153,	593	B.J. O'Brien, G.E. Coote
1970Oh05	JUPSA	29,	1435	S. Ohya, T. Tamura, S. Kageyama
1970Or.A	DASA-2570			V.J. Orphan, N.C. Rasmussen, T.L. Harper
1970Pe04	ZEPYA	233,	260	H. Petterson, S. Antman, Y. Grunditz
1970Pi01	NUPAB	144,	42	J.A. Pinston, F. Schussler
1970Ra14	APAHA	28,	263	K. Raichev, L. Tron
1970Re02	PRVCA	1,	721	P.L. Reeder
1970Ro06	PRVCA	1,	1761	A.A. Rollefson, P.F. Jones, R.J. Shea
1970Ro07	NUPAB	147,	235	M.D. Roush, L.A. West, J.B. Marion
1970Sc06	ZEPYA	232,	398	W.D. Schmidt-Ott
1970Si19	PRVCA	2,	1948	R.J. Silva
1970Sm.A	BAPSA	15,	549	R.K. Smither, D.J. Bush, D.L. Bushnell
1970To07	NUPAB	149,	641	D.F. Torgerson, R.D. Macfarlane
1970To18	PRVCA	2,	2309	D.F. Torgerson, R.D. Macfarlane
1970Va13	PRVCA	1,	2115	K. Valli, E.K. Hyde, J. Borggreen
1970Va31	NUPAB	157,	385	J. Van Klinken, L.M. Taff, H.T. Dijkstra, A.H. De Haan, H. Hanson, B.K.S. Koene, J.W. Maring, J.J. Schuurman, F.B. Yano
1970Wo05	NUPAB	146,	33	F.K. Wahn, W.L. Talbert
1970Wo08	NUPAB	152,	561	F.K. Wahn, W.L. Talbert, Jr., J.K. Halbig
1971				
1971Af05	IANFA	35,	1618	V.P. Afanasiev, V.S. Buttsev, I.I. Gromova, V.G. Kalinnikov, N.A. Tikhonov
1971AI01	NUPAB	161,	209	G. Alenius, S.E. Arnell, C. Schale, E. Wallander
1971AI14	PHSTB	3,	55	G. Alenius, S.E. Arnell, C. Schale, E. Wallander
1971AI22	PHSTB	3,	105	G. Alenius, S.E. Arnell, C. Schale, E. Wallander
1971Ar12	NUPAB	166,	241	S.E. Arnell, H. Linusson, Z. Sawa
1971Ar23	NUPAB	169,	209	N.K. Aras, P. Fettweis, G. Chilosi, G.D. O'Kelley
1971Ar39	PHSTB	4,	89	S.E. Arnell, R. Hardell, A. Hasselgren, C.G. Mattson, O. Skeppstedt



1971Ba01	NUPAB	160,	225	J.B. Ball
1971Ba08	PRVCA	3,	937	H. Bakhru, I.M. Ladenbauer-Bellis, I. Rezanka
1971Ba18	NUPAB	164,	552	F. Bazan, R.A. Meyer
1971Ba43	PRVCA	4,	196	J.B. Ball, R.L. Auble, P.G. Roos
1971BaB2	YAFIA	14,	1101	S.A. Baranov, V.M. Shatinskii, V.M. Kulakov
1971Be10	PRVCA	3,	1294	F.M. Bernthal, J.O. Rasmussen, J.M. Hollander
1971Be41	NUPAB	171,	113	M.J. Bennet, R.K. Sheline, Y. Shida
1971Bi.A	UCRL-51060			R.E. Birkett
1971Bo01	NUPAB	160,	337	H.M.W. Booij, E.A. Van Hoek, H. Van der Molen, W.F. Slot, J. Blok
1971Bo06	NUPAB	162,	407	J. Borggreen, E.K. Hyde
1971Ca19	PRVCA	4,	130	R.F. Casten, E.R. Flynn, O. Hansen, T.J. Mulligan
1971Ch26	JOPQA	32,	359	A. Charvet, D.H. Phuoc, R. Duffait, A. Emsallem, R. Chery
1971Da16	NUPAB	170,	253	W. Darcey, R. Chapman, S. Hinds
1971Da19	PRVCA	4,	919	W.R. Daniels, D.C. Hoffman
1971Da28	NUPAB	178,	172	J.M. D'Auria, D. Ostrom, S.C. Gujrathi
1971De52	RMXFA	20,	17	H. Del Castillo, R. Roos, A. Tejera, F. Alba
1971Di03	PRLTA	26,	1037	P.F. Dittner, C.E. Bemis, Jr., D.C. Henley, R.J. Silva, C.D. Goodman
1971Do18	PYLBB	37,	173	W.E. Dorenbusch, J.B. Ball, R.L. Auble, J. Rapaport, T.A. Belote
1971Du02	PRVCA	3,	1391	J.L. Dubbard, R.K. Sheline, J.B. Ball
1971Dz08	IANFA	35,	2249	B.S. Dzelepov, A.G. Dmitriev, N.N. Zhukovskii
1971En01	PRVCA	3,	180	G.A.P. Engelbertink, J.W. Olness
1971Es01	PRVCA	4,	632	K. Eskola, P. Eskola, M. Nurmi, A. Ghiorso
1971Ev01	CJPHA	49,	402	F. Everling, G.L. Morgan, D.W. Miller, L.W. Seagondollar, P.W. Tillman, Jr.
1971Fi01	NUPAB	160,	460	P.R. Fields, I. Ahmad, A.M. Friedman, J. Lerner, D.N. Metta
1971Fo22	PYLBB	36,	334	B. Fogelberg, A. Backlin, T. Nagarajan
1971Fr03	NUPAB	165,	625	A. Frana, A. Spalek, M. Fiser, A. Kolec
1971Ge05	PRVCA	3,	1678	W. Gelletly, W.R. Kane, D.R. MacKenzie
1971Gh01	PRVCA	4,	1850	A. Ghiorso, M. Nurmi, K. Eskola, P. Eskola
1971Go01	PRVCA	3,	746	D.J. Gorman, F. Asaro
1971Go18	PRVCA	4,	1800	D.R. Goosman, K.W. Jones, E.K. Warburton, D.E. Alburger
1971Go35	IANFA	35,	2272	N.A. Golovkov, R.B. Ivanov, A. Kolaczkowski, Y.V. Noreseev, V.G. Chumin
1971Gr17	MTRGA	7,	65	B. Grennberg, A. Rytz
1971Gr22	YAFIA	13,	681	L.V. Groshev, A.M. Demidov, V.F. Leonov, L.L. Sokolovskii
1971Gr28	YAFIA	13,	1129	L.V. Groshev, L.I. Govor, A.M. Demidov, A.S. Rachimov
1971Gr37	YAFIA	14,	473	L.V. Groshev, A.M. Demidov, V.F. Leonov, L.L. Sokolovskii
1971Gr42	IANFA	35,	1644	L.V. Groshev, A.M. Demidov, V.F. Leonov, L.L. Sokolovskii
1971Gr.A	P-Moscow		70	L.V. Groshev, V.N. Dvoretzkii, A.M. Demidov
1971Gu02	NUPAB	161,	410	S.C. Gujrathi, J.M. D'Auria
1971Gu18	NUPAB	172,	353	S.C. Gujrathi, J.M. D'Auria
1971Gu.A	Th.-Strasbourg			G. Guillaume
1971Ha03	NUPAB	160,	445	P.G. Hansen, B. Jonson, J. Żylicz, M. Alpsten, A. Appelqvist, G. Nyman
1971He13	NUPAB	168,	449	R.G. Helmer, R.C. Greenwood, C.W. Reich
1971Ho01	NUPAB	163,	277	P. Hornshøj, K. Wilsky, P.G. Hansen, A. Lindahl, O.B. Nielsen
1971Ho07	PYLBB	34,	591	P. Hornshøj, K. Wilsky, P.G. Hansen, A. Lindahl, O.B. Nielsen
1971Ho16	NUPAB	169,	641	R.W. Hoff, E.K. Hulet, R.J. Dupzyk, R.W. Lougheed, J.E. Evans
1971Hu03	PRLTA	26,	523	E.K. Hulet, J.F. Wild, R.W. Lougheed, J.E. Evans, B.J. Qualheim, M. Nurmi, A. Ghiorso
1971Ib01	PHSTB	4,	161	N. Ibrahiem, H. Pettersson
1971Ka42	AOBB	2,	423	R. Kaczarowski, W. Kurcewicz, A. Plochocki, J. Żylicz
1971Ke07	PRVCA	4,	1431	B.H. Ketelle, A.R. Brosi, J.R. van Hise
1971Ke21	NUPAB	176,	449	R.L. Kernell, H.J. Kim, R.L. Robinson, C.H. Johnson
1971Ki01	NUPAB	170,	187	C.H. King, P.R. Maurenzig, N. Stein, T.P. Cleary
1971Ki15	YAFIA	14,	249	B.G. Kiselev, V.N. Levkovskii, O.I. Artem'ev
1971Le21	NUPAB	170,	115	J.R. Leslie, W. McLatchie, C.F. Monahan, J.K. Thrasher
1971Ma45	NUPAB	172,	298	P. Manfrass, H. Prade, M.R. Beitins, W.A. Bondarenko, N.D. Kramer, P.T. Prokofjew
1971Ma47	NUPAB	174,	343	S. Matsuki, Y. Yoshida, M. Hyakutake, M. Matoba, S. Nakamura
1971Mo01	PRVCA	3,	438	J.M. Mosher, R.W. Kavanagh, T.H. Tombrello

1971Mo02	NUPAB	161,	228	J.M. Morton, W.G. Davies, W. McLatchie, W. Darcey, J.E. Kitching
1971Mo03	PRLTA	26,	854	H.T. Motz, E.T. Jurney, E.B. Shera, R.K. Sheline
1971My01	AOBB	2,	441	B. Myslek, B. Pietrzek, Z. Sujkowski, J. Szczepankowski
1971Na01	PRVCA	3,	247	T. Nagarajan, M. Ravindranath, K.V. Reddy
1971Na02	PRVCA	3,	254	T. Nagarajan, M. Ravindranath, K.V. Reddy
1971Or04	PRVCA	3,	2402	C.J. Orth, B.J. Drolesky, N.J. Freeman
1971Ot01	NUPAB	164,	69	H. Ottmar, N.M. Ahmed, U. Fanger, D. Heck, W. Michaelis, H. Schmidt
1971Pl08	IANFA	35,	1569	Z. Plajner, M. Vejs, I. Prochazka, A. Mashtalka, O. Voitishok, M. Gonusek, A. Kokesh
1971Po.A	P-Legnaro		375	C.P. Poirier, J.C. Manthuruthil
1971Pr03	NUPAB	167,	667	R. Prieels, J.P. Deutsch
1971Ra08	ZEPYA	243,	105	F. Rauch
1971Ra35	NUPAB	177,	307	J. Rapaport, W.E. Dorenbusch, T.A. Belote
1971Sm01	PRVCA	4,	22	L.G. Smith
1971Sw01	PRVCA	3,	259	D.L. Swindle, T.E. Ward, P.K. Kuroda
1971Ta07	PRVCA	4,	517	K. Takehashi, D.L. Swindle, P.K. Kuroda
1971To01	PRVCA	3,	854	K.S. Toth, R.L. Hahn
1971To10	PRVCA	4,	2223	K.S. Toth, R.L. Hahn, M.A. Ijaz
1971Tr03	PRVCA	3,	2205	G.F. Trentelman, B.M. Freedom, E. Kashy
1971Um03	NUPAB	169,	109	C.J. Umbarger, J.A. Robinson, R.R. Reece, R.C. Bearce
1971We01	PRVCA	3,	1668	C.V. Weiffenbach, R. Tickle
1971Wi04	PRVCA	3,	1199	B.H. Wildenthal, E. Newman, R.L. Auble
1971Wi07	NUPAB	166,	661	D.H. Wilkinson, D.E. Alburger, D.R. Goosman, K.W. Jones, E.K. Warburton, G.T. Garvey, R.L. Williams
1971Ya10	PYLBB	37,	369	K. Yagi, K. Sato, Y. Aoki
1972				
1972Ah04	NUPAB	186,	620	I. Ahmad, R.K. Sjoblom, R.F. Barnes, F. Wagner, Jr., P.R. Fields
1972Ah07	JINCA	34,	3335	I. Ahmad, R.F. Barnes, R.K. Sjoblom, P.R. Fields
1972Al19	NUPAB	186,	209	G. Alenius, S.E. Arnell, C. Schale, E. Wallander
1972Am01	PRVCA	5,	270	S. Amiel, H. Feldstein, M. Oron, E. Yellin
1972Ba08	CJPHA	50,	34	R.C. Barber, R.L. Bishop, J.O. Meredith, F.C.G. Southon, P. Williams, H.E. Duckworth, P. van Rookhuyzen
1972Ba35	PRLTA	28,	1069	G.C. Ball, W.G. Davies, J.S. Forster, J.C. Hardy
1972Ba91	IANFA	36,	782	G.Y. Baier, V.S. Buttsev, K.Y. Gromov, V.G. Kalinnikov, K.O. Mortensen, G.L. Nilsson, N.A. Tikhonov
1972BaD2	ZETFA	63,	375	S.A. Baranov, V.M. Shatinskii, V.M. Kulakov, Y.F. Radionov
1972Be12	PRVCA	5,	1426	W. Benenson, J. Driesbach, I.D. Proctor, G.F. Trentelman, B.M. Freedom
1972Be44	ZEPYA	252,	349	H. Behrens, M. Kobelt, W.G. Thies, H. Appel
1972Bo46	PRVCA	6,	1322	L.M. Bollinger, G.E. Thomas
1972Bu05	JINCA	34,	1087	F.T. Bunus
1972Ca01	KDVSA	38,	#13	R.F. Casten, P. Kleinheinz, P.J. Daly, B. Elbek
1972Ca07	NUIMA	98,	432	J.L. Campbell, L.A. McNellen
1972Ca10	NUPAB	184,	357	R.F. Casten, E.R. Flynn, O. Hansen, T.J. Mulligan
1972Ch11	NUPAB	186,	603	R. Chapman, W. McLatchie, J.E. Kitching
1972Ch44	NUPAB	197,	490	A. Charvet, R. Chery, D.H. Phuoc, R. Duffait, A. Emsallem, G. Marguier
1972Co13	NUPAB	185,	644	W.F. Coetzee, M.A. Meyer, D. Reitmann
1972Cu07	NUPAB	196,	593	J.C. Cunnane, R. Hochel, C.W. Yates, P.J. Daly
1972Da.A	BAPSA	17,	71	C.N. Davids, D.L. Matthews, D. Whitmire
1972De47	NUPAB	195,	385	P. Debenham, N.H. Hintz
1972Er05	NUPAB	194,	449	B.R. Erdal, L. Westgaard, J. Żylicz, E. Roeckl, ISOLDE
1972Es03	PRVCA	5,	942	K. Eskola
1972Fa08	NUPAB	186,	545	L.C. Farwell, J.J. Kraushaar, H.W. Baer
1972Fi.A	AnRpt MSUCL		28	R.B. Firestone, K. Kosanke, W.C. McHarris, W.H. Kelly
1972Fi17	PYLBB	42,	49	E.R. Flynn, J.D. Garrett
1972Fo25	PHSTB	6,	309	I. Forsblom, T. Weckstrom, T. Sundius, G. Bergstrom, S. Forss, G. Wansen
1972Ga27	PRLTA	29,	958	H. Gauvin, Y. Le Beyec, M. Lefort, N.T. Porile
1972Gi17	NUIMA	105,	179	H.J. Gils, R. Lohken, W. Wiesner

1972Go33	CHDBA	275,	291	J. Gorman, A. Rytz, H.V. Michel
1972Go.A	PrvCom		91Ry01	J. Gorman, A. Rytz
1972Gr23	YAFIA	15,	625	L.V. Groshev, L.I. Govor, A.M. Demidov
1972Gr34	IANFA	36,	833	L.V. Groshev, L.I. Govor, A.M. Demidov
1972Gr39	PRVCA	6,	1756	M.B. Greenfield, C.R. Bingham, E. Newman, M.J. Saltmars
1972Ha74	NUPAB	198,	353	A. Hasselgren
1972He36	ZEPYA	255,	385	A. Helppi, A. Pakkanen
1972He.A	AnRpt Grenoble			M. Hermen, A. Gizon also Thesis Grenoble 1971
1972Ho18	NUPAB	187,	599	P. Hornshøj, K. Wilsky, P.G. Hansen, B. Jonson, O.B. Nielsen
1972Ho40	NUPAB	194,	481	G.A. Hokken, A.J.G. Hendricx, J. De Kogel
1972Hs01	NUPAB	179,	80	T.H. Hsu, R. Fournier, B. Hird, J. Kroon, G.C. Ball, F. Ingebretsen
1972Hu06	NUPAB	189,	264	F.R. Hudson, R.N. Glover
1972Ja.A	P-Teddington		236	A.A. Jaffe, G.A. Bissinger, S.M. Shafroth, T.A. White, T.G. Dzubay, F. Everling, D.W. Miller, D.A. Outlaw
1972Je02	NUPAB	185,	209	H.B. Jensen, H.B. Mak, C.A. Barnes
1972Jo08	ZEPYA	251,	425	H.W. Jongsma, R. Kamermand, H. Verheul
1972Ki06	ZEPYA	251,	93	A. Kiuru
1972Ko03	PRVCA	5,	568	J.J. Kolata, W.W. Daehnick
1972Ko50	NUPAB	198,	73	K. Komura, K. Sakamoto, S. Tanaka
1972La20	ZEPYA	253,	16	R. Lasijo, R.K. Sheline, R.D. Griffioen, J.L. Dubbard
1972Lo26	NUIMA	105,	453	G.D. Lopez, G.E. Thomas
1972Ma42	PHSTB	5,	58	C.G. Mattsson, S.E. Arnell, L. Jonsson
1972Ma.A	P-Budapest		90	P. Matusek, H. Ottmar, C. Weitkamp, H. Woods
1972Mc25	ZEPYA	255,	335	J.C. McGeorge, D.W. Nix, R.W. Fink, J.H. Landrum
1972Mi16	HPACA	45,	93	B. Michaud, J. Kern, L. Ribordy, L.A. Schaller
1972Mi26	JUPSA	33,	1505	K. Miyano, H. Nakharr, G. Gil
1972Mo12	PRVCA	5,	1678	R.A. Moyer
1972Mo33	NUPAB	195,	192	E. Monnard, R. Brissot, L.C. Carraz, J. Crançon, R. Ristori, F. Schussler, A. Moussa
1972Mu02	PRVCA	5,	95	T. Mukoyama, S. Shimizu
1972Mu09	PRVCA	6,	1802	T.J. Mulligan, E.R. Flynn, O. Hansen, R.F. Carsten, R.K. Sheline
1972Mu.A	BAPSA	17,	557	S.F. Mughabghab, G.W. Cole, R.E. Chrien, O.A. Wasson, M.R. Bhat
1972Na04	NCIAA	8,	305	T. Nagarajan, M. Ravindranath, K.V. Reddy
1972Ne05	NUPAB	185,	213	A.V. Nero
1972Pa02	PRVCA	5,	485	R.A. Paddock
1972Pi07	ZEPYA	252,	206	M. Piiparinen
1972Ra39	NUPAB	197,	129	D. Rabenstein, D. Harrach, H. Vonach, G.G. Dussel, R.P.I. Perazzo
1972Ri08	PRVCA	5,	2072	F.A. Rickey, E.T. Journey, H.C. Britt
1972Sc08	ZEPYA	249,	286	W.D. Schmidt-Ott, R.W. Fink
1972Sh08	NUPAB	189,	220	R.E. Shamu, E.M. Bernstein, D. Blondin, J.J. Ramirez
1972Sh13	PRVCA	6,	537	E.B. Shera, U. Gruber, B.P.K. Maier, H.R. Koch, O.W.B. Schult, R.G. Lanier, N. Onishi, R.K. Sheline
1972Sh.A	PrvCom	NDG	Jan	E.B. Shera
1972Si28	NUPAB	193,	449	M. Singh, J.W. Sunier, R.M. Devries, G.E. Johnson
1972SI03	NUPAB	186,	28	W.F. Slot, G.H. Dulfer, H. Van der Molen, H. Verheul
1972Sv02	PHSTB	5,	23	B. Svahn, C. Bergman, H. Petterson
1972Sw01	NUPAB	185,	561	D.L. Swindle, N.A. Morcos, T.E. Ward, J.L. Meason
1972Ta13	ZEPYA	251,	87	O. Tannila, J. Kantele
1972To05	NUPAB	185,	574	J.P. Torres, P. Paris
1972To06	PRVCA	5,	2060	K.S. Toth, R.L. Hahn, M.A. Ijaz, R.F. Walker, Jr.
1972To07	NUPAB	189,	609	J.P. Torres, P. Paris, D. Lecouturier, P. Kilcher
1972Vi11	RAACA	17,	213	J. Visser, L. Lindner
1972Wa04	JINCA	34,	13	T.E. Ward, N.A. Morcos, P.K. Kuroda
1972Wa10	NUPAB	188,	129	E. Wallander, E. Selin
1972We.A	P-Teddington		94	L. Westgaard, J. Żylicz, O.B. Nielsen, ISOLDE
1972Wh02	PRVCA	5,	513	D.H. White, R.E. Birkett
1972Wh05	NUPAB	187,	12	D.H. White, R.E. Howe
1972Zi02	NUPAB	181,	465	J. Zioni, A.A. Jaffe, E. Friedman, N. Haik, R. Schreckman, D. Nir

1973

1973Ah02	PRVCA	8,	737	I. Ahmad, J. Milsted, R.K. Sjoblom, J. Lerner, P.R. Fields
1973Ah04	NUPAB	208,	287	I. Ahmad, H. Diamond, J.M. Isted, J. Lerner, R.K. Sjoblom
1973AI20	IANFA	37,	1035	V.S. Aleksandrov, B.S. Dzelepov, A.I. Medvedev, V.E. Ter-Nersesyants, I.F. Uchevatkin, S.A. Shestopalova
1973Ba34	PRLTA	31,	395	G.C. Ball, J.G. Costa, W.G. Davies, J.S. Forster, J.C. Hardy, A.B. McDonald
1973Ba35	JPAGB	6,	1011	D.G. Barnes, J.M. Calvert, T. Toy
1973Ba56	PRVCA	8,	1438	J.B. Ball, J.J. Pinajian, J.S. Larsen, A.C. Rester
1973Ba72	NUPAB	217,	116	B.B. Back, E.R. Flynn, O. Hansen, R.F. Casten, J.D. Garrett
1973Be09	PYLBB	43,	117	W. Benenson, E. Kashy, I.D. Proctor, B.M. Freedom
1973Be23	PRVCA	8,	210	W. Benenson, E. Kashy, I.D. Proctor
1973Be33	PRLTA	31,	641	C.E. Bemis, Jr., R.J. Silva, D.C. Hensley, O.L. Keller, Jr., J.R. Tarrant, L.D. Hunt, P.F. Dittner, R.L. Hahn, C.D. Goodman
1973Bo13	PRVCA	7,	1686	W.W. Bowman, D.R. Haenni, T.T. Sugihara
1973Bo20	YAFIA	17,	457	D.D. Bogdanov, V.A. Karnaukhov, L.A. Petrov
1973Br06	PRVCA	7,	1545	R.A. Britten, W.H. Johnson
1973Br12	PRVCA	7,	2545	E. Browne, F. Asaro
1973Bu17	IANFA	37,	938	V.S. Buttsev, K.Y. Gromov, V.G. Kalinnikov, V.A. Morozov, T.M. Muminov, A.B. Khalikulov
1973Bu21	IANFA	37,	1024	V.S. Buttsev, K.Y. Gromov, V.G. Kalinnikov
1973Ca10	NUPAB	205,	121	M.H. Cardoso, P.F.A. Goudsmit, J. Konijn
1973Ch24	JINCA	35,	3061	K. Chayawattanangkur, G. Herrmann, N. Trautmann
1973CI12	NUPAB	215,	429	G.J. Clark, J.M. Freeman, D.C. Robinson, J.S. Ryder, W.E. Burcham, G.T.A. Squier
1973Da01	PRVCA	7,	122	C.N. Davids, D.R. Goosman
1973Da05	CJPHA	51,	686	J.M. D'Auria, R.D. Guy, S.C. Gujrathi
1973Da22	PRVCA	8,	1029	C.N. Davids, D.R. Goosman
1973De16	PRVCA	7,	2131	J.H. Degnan, G.R. Rao
1973De22	ZEPYA	260,	75	F.W.N. De Boer, P.F.A. Goudsmit, B.J. Meyer, and PrvCom AHW
1973Dr10	AENGA	35,	279	V.B. Druin, Y.V. Lobanov, D.M. Nadkarni, Y.P. Kharitonov, Y.S. Korotkin, S.P. Tretyakova, V.I. Krashonkin
1973Ea01	NUPAB	208,	119	D.A. Eastham, I.S. Grant
1973Es01	PRVCA	7,	280	P. Eskola
1973Es02	PHFEA	8,	357	P. Eskola, K. Eskola, M. Nurmi, A. Ghiorso
1973Fi06	NUPAB	208,	269	P.R. Fields, I. Ahmad, R.F. Barnes, R.K. Sjoblom, W.C. McHarris
1973Go05	NUPAB	201,	326	S.C. Goverse, J. Van Pelt, J. Vandenberg, J.C. Klein, J. Blok
1973Go29	CHDBA	276,	669	D.J. Gorman, H.V. Michel, F. Asaro, A. Rytz
1973Go33	PRVCA	8,	1324	D.R. Goosman, C.N. Davids, D.E. Alburger
1973Go39	CHDBA	277,	29	D.J. Gorman, A. Rytz
1973Go40	NUPAB	217,	159	J. Godart, A. Gizon
1973Ha02	NUPAB	199,	560	S.I. Hayakawa, S.K. Mark, J.K.P. Lee, J.E. Kitching, G.C. Ball, W.G. Davies
1973Ha11	NUPAB	203,	532	J.K. Halbig, F.K. Wahn, W.L. Talbert, Jr., J.J. Eitter
1973Ha32	PRLTA	31,	323	O. Hausser, W. Witthuhn, T.K. Alexander, A.B. McDonald, J.C.D. Milton, A. Olin
1973Ho09	NUPAB	211,	165	R. Hochele, P.J. Daly, K.J. Hofstetter
1973Ja06	ZEPYA	258,	337	U. Jäger, H. Münzel, G. Pfennig
1973Ja10	ZEPYA	261,	95	J.F.W. Jansen, A. Faas, W.J.B. Winter
1973Jo11	PHSTB	8,	99	A. Johansson, B. Nyman
1973Ka07	JUPSA	34,	857	K. Kawade, H. Yamamoto, K. Tsuchiya, T. Katoh
1973Ka23	PRVCA	8,	414	N. Kaffrell
1973Ki11	NUPAB	213,	61	K. Kimura
1973Ko03	PRVCA	7,	404	R.L. Kozub, D.H. Youngblood
1973Ko10	NUPAB	204,	185	S. Kochan, B. Rosner, I. Tserruya, R. Kalish
1973Ku09	JOPQA	34,	159	W. Kurcewicz, K. Stryczniewicz, J. Żylicz, R. Broda, S. Chojnacki, W. Walus, I. Yutlandov
1973Mc04	PRVCA	7,	2097	J.R. McPherson, F. Gabbard

1973Me09	NUPAB	204,	636	B.J. Meyer, F.W.N. De Boer, P.F.A. Goudsmit
1973Me28	IJMPD	10,	359	J.O. Meredith, F.C.G. Southon, R.C. Barber, P. Williams, H.E. Duckworth
1973Mo03	NUPAB	202,	473	M.A. Moinester, G. Finkel, J. Alster, P. Martin
1973Mo18	JINCA	35,	3659	N.A. Morcos, W.D. James, D.E. Adams, P.K. Kuroda
1973Mo23	PRVCA	8,	1961	A. Moalem, B.H. Wildenthal
1973No09	NUPAB	217,	253	T. Nomura, K. Hiruta, T. Inamura, M. Odera
1973Oe02	ZEPYA	259,	263	W. Oelert
1973Ok.A	PrvCom	NDG	Aug	G.D. O'Kelley, C.F. Goeking, L.L. Collins, Sr.
1973Oo01	NUPAB	213,	221	M.A. Oothoudt, N.M. Hintz
1973Pi05	JINCA	35,	1057	I.L. Preiss, J.J. Labrecque
1973Ra13	PYLBB	44,	255	S. Raman, H.J. Kim, T.A. Wakiewicz, M.J. Martin
1973Re03	PRVCA	7,	1663	I. Rezanka, I.M. Ladenbauer-Bellis, T. Tamura, W.B. Jones, F.M. Bernthal
1973Sc17	PYLBB	44,	449	H. Schmeing, J.C. Hardy, R.L. Graham, J.S. Geiger, K.P. Jackson
1973Sh.A	PrvCom	NDG	Jan	E.B. Shera in NDS974
1973Si40	NUPAB	216,	97	R.J. Silva, P.F. Dittner, M.L. Mallory, O.L. Keller, K. Eskola, P. Eskola, M. Nurmia, A. Ghiorso
1973Sp06	NUPAB	215,	260	A.M.J. Spits, J.A. Akkermans
1973To02	PRVCA	7,	2010	K.S. Toth, R.L. Hahn, C.R. Bingham, M.A. Ijaz, R.F. Walker, Jr.
1973Va11	ZEPYA	259,	45	S.Y. Van der Werf
1973Ve08	NUPAB	212,	493	J. Vernotte, S. Galès, M. Langevin, J.M. Maison
1973Vi10	NUPAB	217,	372	V.E. Viola, Jr., M.M. Minor, C.T. Roche
1973Wa18	PRVCA	8,	340	T.E. Ward, Y.Y. Chu, J.B. Cunnig
1973Wi06	PRLTA	30,	866	K.H. Willcox, N.A. Jelley, G.J. Wozniak, R.B. Weisenmiller, H.L. Harney, J. Cerny
1973Wo01	PRVCA	7,	160	F.K. Wohn, J.K. Halbig, W.L. Talbert, Jr., J.R. McConnel
1973Ya02	NUPAB	204,	33	S.W. Yates, P.J. Daly, N.R. Johnson, N.K. Arras
1974				
1974Aj01	NUPAB	227,	1	F. Ajzenberg-Selove, T. Lauritsen
1974An05	IANFA	38,	48	N.M. Antoneva, A.V. Barkov, A.V. Zolotavin, P.P. Dmitriev, S.V. Kamynov, G.S. Katykhin, E.T. Kondrat, N.I. Krasnov, Y.N. Podkopyayen, V.A. Sergienko, V.I. Fominikh
1974An22	IANFA	38,	1741	N.M. Antoneva, A.V. Barkov, V.M. Vinogradov, A.V. Zolotavin, G.S. Katykhin, V.M. Makarov, A.G. Shablinskii
1974An23	IANFA	38,	1748	N.M. Antoneva, A.V. Barkov, V.M. Vinogradov, A.V. Zolotavin, G.S. Katykhin, V.M. Makarov, A.G. Shablinskii
1974Ar27	IANFA	38,	1569	R. Arlt, K.Y. Gromov, A. Latuszynski, K.G. Ortlepp, A. Jasinski
1974Ba90	CJPHA	52,	2386	R.C. Barber, J.W. Barnard, D.A. Burrell, J.O. Meredith, F.C.G. Southon, P. Williams, H.E. Duckworth
1974Be20	PRVCA	9,	2130	W. Benenson, E. Kashy, D.H. Kong, A. Siou, A. Moalem, H. Nann
1974Bi08	PRVCA	10,	729	P.K. Bindal, D.H. Youngblood, L. Kozun
1974Bo05	PRVCA	9,	836	J.D. Bowman, A.M. Poskanzer, R.G. Korteling, G.W. Butler, J.D. Bowman, A.M. Poska, J.D. Bowman, A.M. Poskanzer, R.G. Korteling, G.W. Butler, R.G. Korteling, G.W. Butler
1974Bo26	NUIMA	117,	213	H.E. Bosch, J. Davidson, M.A. Fariolli, V. Silbergleit
1974Bu21	IANFA	38,	1566	V.P. Burminskii, B.G. Kiselev, O.D. Kovrigin
1974Bu22	PRVCA	10,	2483	D.L. Bushnell, D.J. Buss, R.K. Smither
1974By01	NUPAB	223,	125	T. Byrski, F.A. Beck, P. Engelstein
1974Ca.A	Th.-Amsterdam			M.H. Cardoso
1974Ch17	JPSLB	35,	41	A. Charvet, R. Chery, R. Duffait
1974Ch21	ZEPYA	267,	355	A. Charvet, R. Chery, D.P. Phuoc, R. Duffait
1974Co21	CJPHA	52,	1215	A.H. Colenbrander, T.J. Kennett
1974Co27	PRVCA	10,	1236	J.R. Comfort, R.W. Finlay, C.M. McKenna, P.T. Debevec
1974Co35	NUPAB	233,	185	F. Corvi, M. Stefanon
1974De09	NUPAB	225,	317	F.W.N. De Boer, P.F.A. Goudsmit, P. Koldewijn, B.J. Meyer
1974De31	CJPHA	52,	1416	P. Debenham, W.R. Falk, M. Cauty
1974De47	NUPAB	236,	349	F.W.N. De Boer, P.F.A. Goudsmit, B.J. Meijer, P. Koldewijn, J. Konijn, R. Beetz

1974Di03	PRVCA	10,	1172	M. Diksie, L. Yaffe, D.G. Sarantites
1974Di.A	P-Amsterdam		114	J.S. Dionisio, C. Vieu, V. Berg, C. Bourgeois
1974Do09	NUPAB	229,	47	G. Doukellis, C. McKenna, R. Finlay, J. Rappaport, H.J. Kim
1974FI01	PRVCA	9,	210	E.R. Flynn, J.D. Garrett
1974Fr01	PRVCA	9,	760	A.M. Friedman, K. Katori, D. Albroght, J.P. Schiffer
1974Ge05	PRVCA	9,	2363	W. Gelletly, W.R. Kane, D.R. MacKenzie
1974Gh04	PRLTA	33,	1490	A. Ghiorso, J.M. Nitschke, J.R. Alonso, C.T. Alonso, M. Nurmia, G.T. Seaborg, E.K. Hulet, R.W. Lougheed
1974Gi09	NUPAB	233,	81	S. Gilad, S. Cochavi, M.A. Moinester, J. Alster, M. Buenard, P. Nartin
1974GI10	AENGA	37,	78	V.M. Glazov, R.I. Borisova, A.I. Shaviev
1974Go17	PRVCA	10,	756	D.R. Goosman, D.E. Alburger
1974Go20	ZEPYA	269,	111	S.C. Goverse, J. Kuiper, J. Blok
1974Gr11	NUPAB	223,	66	R.C. Greenwood, C.W. Reich
1974Gr22	PRVCA	10,	624	R.D. Griffioen, R.K. Sheline
1974Gr29	JINCA	36,	2409	B. Grapengiesser, E. Lund, G. Rudstam
1974Gr37	NUIMA	121,	385	R.C. Greenwood, R.G. Helmer
1974Gr41	IANFA	38,	2499	E.P. Grigorev, A.V. Zolotavin, S.V. Kaminov
1974Gu10	YAFIA	19,	1167	K. Gurach, A.P. Kabachenko, I.V. Kuznetsov, N.I. Tarantin
1974Ha02	PRVCA	9,	252	J.C. Hardy, H. Schmeing, W. Benenson, G.M. Crawley, E. Kashy, H. Nann
1974Ho27	NUPAB	230,	380	P. Hornshøj, P.G. Hansen, B. Jonson
1974Hr01	NUPAB	219,	381	B. Hrastnik, H. Seyfarth, A.M. Hassan, W. Delang, P. Gottel
1974Hu15	NUIMA	121,	307	E. Huenges, H. Vonach, J. Labetzki
1974Ia01	CJPHA	52,	96	R. Iafigliola, S.C. Gujrathi, B.L. Tracy, J.K.P. Lee
1974Ie01	PRVCA	9,	2067	N.A. Jelley, K.H. Wilcox, R.B. Weisenmiller, G.J. Wozniak, J. Cerny
1974Jo14	PRVCA	10,	2449	P.L. Jolivet, J.D. Goss, G.L. Marolt, A.A. Rollefson, C.P. Browne
1974Ju.A	PrvCom		74AjLa	E.T. Jurney
1974Ju.B	PrvCom	AHW		E.T. Jurney
1974Ka05	ZEPYA	266,	21	N. Kaffrell, N. Trautmann, R. Denig
1974Ke01	NUPAB	221,	333	J. Kern, G. Mauron, B. Michaud, K. Schreckenbach, T. von Egidy, W. Mampe, H.R. Koch, H.A. Baader, D. Breitig, U. Gruber
1974Ke13	PRVCA	10,	1554	J. Kern, D. Duc
1974Kn02	PRVCA	9,	1467	J.D. Knight, C.J. Orth, W.T. Leland, A.B. Tucker
1974Ku01	NUPAB	218,	201	I. Kumabe, S. Matsuki, S. Nakamura, M. Hyakutake, M. Matoba, T. Sato
1974Le02	PRVCA	9,	1091	Y. Le Beyec, M. Lefort, J. Livet, N.T. Porile, A. Siivola
1974Ma09	PRVCA	9,	1633	R.G. Markham, H.W. Fulbright
1974Me15	YAFIA	19,	437	R.J. Metskvarishvili, Z.N. Miminoshvili, M.A. Elizbarashvili
1974Mu10	NUPAB	224,	437	F. Münnich, D. Lode, H. Schrader, A. Høglund, W. Pessara
1974Na07	PRVCA	9,	1848	H. Nann, W. Benenson, E. Kashy, P. Turek
1974Ne10	PRVCA	10,	320	K. Neubeck, H. Schober, H. Waffler
1974Ne14	ZEPYA	270,	121	W. Neumann, E. Huster
1974No02	PRVCA	9,	1168	T. Nomura, K. Hiruta, M. Yoshie, O. Hashimoto
1974No07	NUIMA	115,	189	J.A. Nolen, Jr., G. Hamilton, E. Kashy, D. Proctor
1974Oe03	NUPAB	230,	413	W. Oelert, G. Lindstrom, V. Riech
1974Po08	PRVCA	10,	803	F.T. Porter, I. Ahmad, M.S. Freedman, J. Milsted, A.M. Friedman
1974Pr15	IANFA	38,	2135	P.T. Prokofev, L.I. Simonov
1974Ra.A	P-Bombay		10	C.N. Rao, B.M. Rao, P.M. Rao, K.V. Reddy
1974Ro11	ZEPYA	266,	65	E. Roeckl, D. Lode, K. Bächmann, B. Neidhart, G.K. Wolf, W. Lauppe, N. Kaffrell, P. Patzelt
1974Ro16	PRVCA	9,	1801	R.G.H. Robertson, S.M. Austin
1974Ro31	PRVCA	10,	1181	E. Roeckl, P.F. Dittner, C. Détraz, R. Klapisch, C. Thibault, C. Rigaud
1974Ro44	PRAMC	3,	186	A. Roy, K.V.K. Iyengar, M.L. Jhingan, S.K. Bhattacharjee
1974Ru08	NUIMA	120,	333	G. Rudstam, S. Shalev, O.C. Jonsson
1974Sc02	CJPHA	52,	131	R.L. Schulte, J.D. King, W. Taylor
1974Sc06	ZEPYA	266,	129	H.M. Schupferling, K.-W. Hoffmann
1974Sc19	PRVCA	10,	296	W.D. Schmidt-Ott, K.S. Toth, E. Newman, C.R. Bingham
1974Sc26	PRLTA	33,	1343	D.K. Scott, B.G. Harvey, D.L. Hendrie, L. Krauss, C.F. Maguire, J. Mahoney, Y. Terrien, K. Yagi
1974Se05	PRLTA	33,	233	K.K. Seth, A. Saha, W. Benenson, W.A. Langford, H. Nann, B.H. Wildenthal

1974Se11	NUPAB	234,	130	R.G. Sextro, R.A. Gough, J. Cerny
1974To04	ZEPYA	268,	289	F. Tolea, K.R. Baker, W.D. Schmidt-Ott, R.W. Fink
1974To07	PRVCA	10,	2550	K.S. Toth, C.R. Bingham, W.D. Schmidt-Ott
1974Vi02	ZEPYA	269,	173	M. Viitasalo, I. Forsblom
1974Vo08	IANFA	38,	672	I. Votsilka, K.U. Zibert, B. Kracik, J. Liptak, A.F. Novgorodov, K.G. Ortlepp, M. Toshev, V. Habenicht
1974Vy01	IANFA	38,	701	Ts. Vylov, N.A. Golovkov, K.Y. Gromov, I.I. Gromova, A. Kolachkovsky, M.Y. Kuznetsova, Y.V. Narseev, V.G. Chumin
1974Wa08	PRVCA	9,	1396	C.W. Wang, Y.C. Liu, E.K. Lin, C.C. Hsu, G.C. Kiang
1974Wi17	PRVCA	10,	2184	B.H. Wildenthal, J.A. Rice, B.M. Freedom
1974Ya07	JUPSA	37,	10	H. Yamamoto, K. Kawade, H. Fukaya, T. Katoh
1975				
1975Ad08	IANFA	39,	1681	I. Adam, G. Baier, K.Y. Gromov, T.A. Islamov, K.G. Ortlepp, K. Tiroff, E. Herrmann, H. Strusnii
1975Ad09	NUPAB	254,	63	I. Adam, K.Y. Gromov
1975Ah01	NUPAB	239,	1	I. Ahmad, J. Milsted
1975Ah05	PRVCA	12,	541	I. Ahmad, F.T. Porter, M.S. Freedman, R.K. Sjoblom, J. Lerner, R.F. Barnes, J. Milsted, P.R. Fields
1975AlA	P-Leningrad			A.A. Aleksandrov, et al
1975An07	NUPAB	242,	93	R.E. Anderson, R.L. Bunting, J.D. Burch, S.R. Chinn, J.J. Kraushaar, R.J. Peterson, D.E. Prull, B.W. Ridley, R.A. Ristinen
1975As04	NUPAB	247,	359	M. Asghar, J.P. Gautheron, G. Bailleul, J.P. Bocquet, J. Greif, H. Schrader, G. Siegert, C. Ristori, J. Crancon, G.I. Crawford
1975Ba25	YAFIA	21,	230	S.A. Baranov, V.M. Shatinskii, L.V. Chistyakov, V.M. Shubko
1975Ba27	ZETFA	68,	8	S.A. Baranov, V.M. Shatinskii
1975Ba65	YAFIA	22,	670	S.A. Baranov, V.M. Shatinskii
1975Ba.B	AnRpt CSNSM			G. Bastin, C.F. Liang
1975Be09	ZENAA	30,	356	M.J. Bechara, O. Dietsch
1975Be21	NUPAB	245,	515	H. Behrens, M. Kobelt, L. Szybisz, W.G. Thies
1975Be28	NUPAB	246,	317	H. Behrens, M. Kobelt, L. Szybisz, W.G. Thies
1975Be38	PYLBB	58,	46	W. Benenson, A. Guilchard, E. Kashy, D. Mueller, H. Nann, L.W. Robinson
1975Be.B	P-Paris		54	U. Bertsche, F. Rauch, K. Stelzer
1975Bh01	PRVCA	12,	1457	M.R. Bhat, R.E. Chrien, G.W. Cole, O.A. Wasson
1975Bo29	ZPAAD	273,	373	H.E. Bosch, J. Davidson, V. Silbergleit, C.A. Heras, S.M. Abecassis
1975Br02	PRVCA	11,	546	D. Breitig, R.F. Casten, W.R. Kane, G.W. Cole, J.A. Cizewski
1975Br16	NUPAB	245,	243	A.R. Brosi, B.H. Ketelle
1975Br29	NCIAA	30,	483	A. Brondi, R. Moro, P. Pelter, F. Terassi
1975Bu01	PRVCA	11,	1401	D.L. Bushnell, J. Hawkins, R. Goebbert, R.K. Smither
1975Bu02	CJPHA	53,	948	D.G. Burke, J.M. Balogh, and erratum CJPHA 63(1985)649
1975Bu.A	BAPSA	20,	625	M.E. Bunker, B.S. Nielsen, J.W. Starner, B.J. Dropesky, W.R. Daniels
1975Ca06	NUPAB	241,	341	C. Cabot, C. Deprun, H. Gauvin, B. Lagarde, Y. Le Beyec, M. Lefort
1975Ch05	NUPAB	238,	333	A. Charvet, R. Chery, R. Duffait, M. Morgue
1975Ch21	JPHGB	1,	657	R. Chapman, G.D. Dracoulis
1975De.A	P-Petten		609	J. de Boer
1975Er.A	PrvCom	NDG	Jul	J.R. Erskine
1975Fl07	ZPAAD	272,	219	D. Flothman, H.J. Gils, W. Wiesner, R. Loehken
1975Fr.A	P-Paris		126	J.M. Freeman, R.J. Petty, S.H. Hoath, J.S. Ryder, W.E. Burcham, G.T.A. Squier
1975Fr.B	AnRpt AFI		146	K. Fransson, M. af Ugglas, P. Carle
1975Ga25	ANPHA	9,	241	H. Gauvin, Y. Le Beyec, J. Livet, J.L. Reyss
1975Gr32	NUPAB	252,	260	R.C. Greenwood, C.W. Reich, S.H. Vegors, Jr.
1975Ha43	ZPAAD	274,	335	H.H. Hansen, D. Mouchet
1975He.C	KFK-2223			D. Heck, J.A. Pinston, H. Börner, F. Braumandl, P. Jeuch, H.R. Koch, W. Mampe, R. Rousille, K. Schreckenbach
1975Ho09	PYLBB	57,	147	P. Hornshøj, P. Tidemand-Petersson, R. Bethoux, A.A. Caretto, J.W. Grütter, P.G. Hansen, B. Jonson, E. Hagberg, S. Mattsson
1975Ho14	NUPAB	248,	406	P. Hornshøj, P. Tidemand-Petersson, R. Kaczarowski, B. Kotlinska

1975Ka18	PRVCA	11,	1959	E. Kashy, W. Benenson, D. Mueller, R.G.H. Robertson, D.R. Goosman
1975Ka25	PRVCA	12,	1054	D. Kaiser, W.H. Johnson, Jr.
1975Ke08	PRVCA	12,	553	G.G. Kennedy, S.C. Gujrathi, S.K. Mark
1975Ke09	ZPAAD	274,	233	G.G. Kennedy, S.C. Gujrathi, S.K. Mark
1975Ke12	NUPAB	255,	296	J.J. Kent, S.L. Blatt
1975Ki06	NUPAB	245,	133	H.V. Klapdor, M. Schrader, G. Bergdolt, A.M. Bergdolt
1975Ko18	PRVCA	12,	1511	R. Kouzes, W.H. Moore, and erratum PRVCA 13,890
1975Ku14	NUPAB	247,	152	A.W. Kuhfeld, N.M. Hintz
1975Li14	JUPSA	39,	1	C.Y. Liu, T.H. Hsue, K. Lin, P.K. Tseng, C.C. Hsu, C.W. Wang
1975Li22	NUPAB	253,	165	J.R. Lien, J.S. Vaagen, A. Graue
1975Lo03	NUPAB	243,	413	M.A. Lone, E.D. Earle, G.A. Bartholemew
1975Lu02	PRVCA	11,	1470	D.H. Lueders, J.M. Daley, S.G. Buccino, F.E. Durham, C.E. Hollandsworth, W.P. Bucher, H.D. Jones
1975Ma04	NUPAB	237,	285	M.R. MacPhail, R.G. Summers-Gill, see also thesis Winnipeg, and Prv-Com AHW September 1980
1975Ma05	PRVCA	11,	587	G.J. Matthews, F.M. Bernthal, J.D. Immele
1975Ma.A	P-Petten		655	P. Matussek
1975Me13	PYLBB	58,	297	L.R. Medsker, H.T. Fortune
1975Me20	ZPAAD	275,	67	B.J. Meijer, J. Konijn
1975Me23	PRVCA	12,	2010	R.A. Meyer, R.G. Lanier, J.T. Larsen
1975Mu09	PRVCA	12,	51	D. Mueller, E. Kashy, W. Benenson, H. Nann
1975Na.A	P-Petten		566	M.R. Najam, A.F.M. Ishaq, M. Anwar, A.M. Khan, J.A. Mirza
1975No.A	P-Paris		140	J. Nolen
1975Pl06	IJARA	26,	579	J. Plich, J. Zderadicka, O. Dragoun
1975Ra07	NUPAB	242,	189	D. Rabenstein, D. Harrach
1975Ra08	JPHGB	1,	461	C.N. Rao, B.M. Rao, P.M. Rao, K.V. Reddy see 75Ra09
1975Ra09	PRVCA	11,	1735	C.N. Rao, B.M. Rao, K.V. Reddy
1975Re09	NUPAB	249,	166	W. Reiter, W.H. Breunlich, P. Hille
1975Ro05	NUPAB	240,	221	C. Rolfs, W.S. Rodney, S. Durrance, H. Winkler
1975Ro16	NUPAB	246,	380	R. Rousille, J.A. Pinston, H. Börner, H.R. Koch, D. Heck
1975Sc07	NUPAB	242,	232	H. Schmeing, J.C. Hardy, R.L. Graham, J.S. Geiger
1975Se.A	BAPSA	20,	73	F.J.D. Serduke, W. Henning
1975Sl.A	BAPSA	20,	560	G.G. Slaughter, S. Raman
1975Sm02	PRVCA	11,	1392	L.G. Smith, A.H. Wapstra
1975Sq01	NUPAB	242,	62	G.T.A. Squier, W.E. Burcham, J.M. Freedman, R.J. Petty, S.D. Hoath, J.S. Ryder
1975St08	CJPHA	53,	922	W.R. Stott, J.C. Waddington, D.G. Burke, G. Løvholden
1975St12	CZYPA	25,	626	H. Strusny, H. Tyrroff, E. Herrmann, G. Musiol
1975Ta12	PRVCA	12,	108	H. Taketani, H.L. Sharma, N.M. Hintz
1975Th04	NUPAB	242,	1	R.C. Thompson, J.S. Boyno, J.R. Huizenga, D.G. Burke, T.W. Elze
1975Th08	PRVCA	12,	644	C. Thibault, R. Klapisch, C. Rigaud, A.M. Poskanzer, R. Prieels, L. Lessard, W. Reisdorf
1975To05	PRVCA	12,	533	K.S. Toth, W.D. Schmidt-Ott, C.R. Bingham, M.A. Ijaz
1975Un.A	P-Paris		81	UNISOR consortium
1975Va.A	P-Leningrad		156	V.M. Vachte, N.A. Golovkov, B.S. Dzelepov, R.B. Ivanov, A. Lyushenski, M.A. Michailova, A.B. Mozhuchin, B.G. Shumin
1975Vy02	IANFA	39,	1671	Ts. Vylov, I.I. Gromova, V.G. Kalinnikov, V. Kuznetsov, T.M. Muminov, V.A. Morozov, V.I. Fominikh, R.R. Uzmanov, E.R. Shavgulidze
1975We03	CJPHA	53,	101	C. Weiffenbach, S.C. Gujrathi, J.K.P. Lee
1975We10	PHSTB	11,	10	T. Westrom, B. Fant, I. Forsblom, M. Viitasalo
1975We23	ZPAAD	275,	127	L. Westgaard, K. Aleklett, G. Nyman, E. Roeckl
1975We24	PHFEA	10,	167	T. Weckstrom, I. Forsblom, P. Holmberg
1975We.A	P-Petten		749	C. Weitkamp, P. Matussek, H. Ottmar
1975Wi06	PRVCA	11,	1477	W.M. Wilson, G.E. Thomas, H.E. Jackson
1975Wi08	ZPAAD	272,	291	G. Wirth, N. Kaffrell, K. Chayawattanangkur, G. Herrmann, K.E. Seyb
1975Wi26	PYLBB	59,	142	K.H. Wilcox, R.B. Weisenmiller, G.J. Wozniak, N.A. Jelley, D. Ashery, J. Cerny
1975Ze.A	JINR-P6-8929			A. Zelinsky, K. Zuber, Y. Zuber, V.V. Kuznetsov, A. Kolachkovsky, A. Lyatushinsky, Y.V. Norseev, H.G. Ortlev, I. Penev, A.V. Potempa



1976

1976Aj03	PRVCA	14,	767	F. Ajzenberg-Selove, E.R. Flynn, O. Hansen, J.D. Sherman, N. Stern, J.W. Sunier
1976Al01	NUPAB	257,	490	M.M. Aleonard, P. Hubert, L. Sarger, P. Mennrath
1976Al16	NUIMA	136,	323	D.E. Alburger
1976Ba99	AENGA	41,	342	S.A. Baranov, et al
1976Be02	NUPAB	256,	87	D. Berenyi, G. Hock, A. Menes, G. Szekely, Cs. Ujhelyi, B.A. Zon
1976Be08	PRVCA	13,	1479	W. Benenson, A. Guichard, E. Kashy, D. Mueller, H. Nann
1976Be11	NUPAB	260,	269	G. Beyer, A. Jasinski, O. Knotek, H.G. Ortlepp, H.U. Siebert, R. Aelt, E. Herrmann, G. Musiol, H. Tyrroff
1976Be.A	AnRpt OakRidge			C.E. Bemis, Jr., P.F. Dittner, R.J. Silva, D.C. Hensley, R.L. Hahn, J.R. Tarrant, L.D. Hunt, and PrvCom AHW July 1981
1976Be.B	AnRpt MSUCL		11	F.M. Bernthal
1976Bi09	PRVCA	14,	1586	C.R. Bingham, L.L. Riedinger, F.E. Turner, B.D. Kern, J.L. Weil, K.J. Hofstetter, J. Lin, E.F. Zganjar, A.V. Ramayya, J.H. Hamilton, J.L. Wood, G.M. Gowdy, R.W. Fink, E.H. Spejewski, W.D. Schmidt-Ott, R.L. Mlekodaj, H.K. Carter, K.S.R. Sastry
1976Ca10	NUPAB	261,	445	R.F. Casten, D. Burke, O. Hansen
1976Ca24	PRVCA	14,	1439	R.F. Carlton, S. Raman, J.A. Harvey, G.G. Slaughter
1976Ca25	PRVCA	14,	912	R.F. Casten, W.R. Kane, J.R. Erskine, A.M. Friedman, D.S. Gale
1976Cr.B	JINR-P6-9711			T. Cretzu, V.V. Kuznetsov, G. Luzurej, G. Macarie, M. Finger
1976Da20	PRVCA	14,	2011	W.W. Daehnick, M.M. Spisak, R.M. Del Vecchio
1976Da.C	P-Cargese		100	J.M. D'Auria, J.W. Grüter, L. Westgaard, G. Nyman, P. Peuser, E. Roeckl, H. Otto, ISOLDE
1976Di15	NUIMA	139,	181	J.S. Dionisio, C. Vieu, C.M. Truong, G. Leur
1976Di.A	AnRpt OakRidge			P.F. Dittner, R.J. Silva, D.C. Hensley, R.L. Hahn, J.R. Tarrant, L.D. Hunt, and PrvCom AHW July 1981
1976Ed.A	P-Cargese		258	M.D. Edmiston, R.A. Warner, W.C. McHarris, W.H. Kelly
1976E112	CJPHA	54,	1493	D. Elmore, W.P. Alford
1976F102	PRVCA	13,	568	E.R. Flynn, J.D. Sherman, N. Stein, D.K. Olsen, P.J. Riley
1976Ga.A	P-Baku			M. Gasior, B.G. Kalinnikov, T. Kretsus
1976Ge02	PRVCA	13,	1434	W. Gelletly, W.R. Kane, R.F. Casten
1976Ge14	PRVCA	14,	1896	R.J. Gehrke, R.G. Helmer, C.W. Reich, R.A. Anderl
1976Go02	PRVCA	13,	1601	G.M. Gowdy, A.C. Xenoulis, J.L. Wood, K.R. Baker, R.W. Fink, J.L. Weil, B.D. Kern, K.J. Hofstetter, E.H. Spejewski, R.L. Mlekodaj, H.K. Carter, W.D. Schmidt-Ott, J. Lin, C.B. Ringham, L.L. Riedinger, E.F. Zganjar, K.S. Sastry, A.V. Ramayya, J.H. Hamilton
1976Gr19	PHSTB	14,	263	T. Grottdal, L. Guldborg, K. Nybø, T.F. Thorsteinsen
1976Gr20	AOBB	7,	507	K.Y. Gromov, D.T. Dzelev, K. Zuber, Y. Zuber, T.A. Islamov, V.V. Kuznetsov, H.G. Ortlepp, A.V. Potempa
1976Gr.A	P-Cargese		428	J.W. Grüter, B. Jonson, O.B. Nielsen
1976Ha29	PYLBB	63,	27	J.C. Hardy, J.A. Macdonald, H. Schmeing, T. Faestermann, H.R. Andrews, J.S. Geiger, R.L. Graham, K.P. Jackson
1976Ha36	ZPAAD	278,	183	W. Hartl, J.W. Hammer
1976Ha39	PRVCA	14,	645	P.E. Hausteine, E.M. Franz, S. Katcoff, N.A. Morcos, H.A. Smith, Jr., T.E. Ward
1976He04	NUPAB	258,	83	R.G. Helmer, R.J. Gehrke, R.C. Greenwood, C.W. Reich, L.D. McIsaac
1976He.B	NDSBA	17,	287	E.A. Henry
1976Hi08	CJPHA	54,	1360	C.R. Hirning, D.G. Burke
1976Hi10	PRLTA	37,	130	G.T. Hickey, D.C. Weisser, J. Cerny, G.M. Crawley, A.F. Zeller, T.R. Ophel, D.F. Hebbard
1976Hi14	JPHGB	2,	L143	G.T. Hickey, G.M. Crawley, D.C. Weisser, N. Shikazono
1976Jo01	PRVCA	13,	439	P.L. Jolivet, J.D. Goss, J.A. Bieszk, R.D. Hichwa, C.P. Browne
1976Jo.A	P-Cargese		277	B. Jonson, E. Hagberg, P.G. Hansen, P. Hornshøj, P. Tidemand-Petersson, ISOLDE
1976Ka19	NUPAB	266,	346	R. Kamermans, H.W. Jongsma, T.J. Ketel, R. van der Wey, H. Verheul
1976Ka24	PRVCA	14,	1773	E. Kashy, W. Benenson, D. Mueller, H. Nann, L. Robinson

1976Ki12	NUPAB	272,	381	K. Kimura, N. Takagi, M. Tanaka
1976Lu02	PRVCA	13,	1544	E. Lund, G. Rudstam
1976Lu04	NUIMA	134,	173	E. Lund, G. Rudstam
1976Ma03	PRVCA	13,	118	J.F. Mateja, G.F. Neal, J.D. Goss, P.R. Chagnon, C.P. Browne
1976Ma16	PRVCA	13,	1117	D.J. Martin, M.R. MacPhail
1976Ma35	PRVCA	14,	1141	L.G. Mann, W.B. Walters, R.A. Meyer
1976Na23	PRVCA	14,	2338	H. Nann, D. Mueller, A. Saha, E. Kashy
1976Nu01	PRVCA	13,	2017	L.L. Nunnely, W. Loveland
1976Pi04	NUPAB	264,	1	J.A. Pinston, R. Rousille, H. Börner, H.R. Koch
1976Pi13	NUPAB	270,	61	J.A. Pinston, R. Rousille, H. Börner, W.F. Davidson, P. Jeuch, H.R. Koch, K. Schreckenbach
1976Ra33	CUSCA	45,	606	K.V. Ramania, G.K. Raju, K.V. Reddy
1976Ra37	ZPAAD	279,	301	D.G. Raich, H.R. Bowman, R.E. Eppley, J.O. Rasmussen, I. Rezanka
1976Ro04	PRVCA	13,	1018	R.G.H. Robertson, W. Benenson, E. Kashy, D. Mueller
1976Sc13	NUPAB	263,	193	M. Schrader, H. Reiss, G. Rosner, H.V. Klapdor
1976Sh24	NUIMA	135,	583	J.F. Sharpey-Schafer, A.M. Al Naser, A.H. Behbehani, L.L. Green, A.N. James, C. Lister, P.J. Nolan
1976SI06	NUPAB	274,	93	D.N. Slater, W. Booth
1976Sp08	NUPAB	265,	416	R.J. Sparks
1976St11	NUPAB	266,	424	W.F. Steele, P.A. Smith, J.E. Finck, G.M. Crawley
1976Su.A	BAPSA	21,	658	E. Sugarbaker, W.S. Gray
1976Su.B	BAPSA	21,	984	E. Sugarbaker, W.S. Gray
1976To06	PYLBB	63,	150	K.S. Toth, M.A. Ijaz, J. Lin, E.L. Robinson, B.O. Hannah, E.H. Spejewski, J.D. Cole, J.H. Hamilton, A.V. Ramayya
1976Tr01	PRVCA	13,	50	R.E. Tribble, R.A. Kenefick, R.L. Spross
1976Tr03	PYLBB	61,	353	R.E. Tribble, J.D. Cossairt, R.A. Kenefick
1976Tu.A	Th.-Berkeley			D.G. Tuggle
1976Vi02	PYLBB	60,	261	D.J. Vieira, D.F. Sherman, M.S. Zisman, R.A. Gough, J. Cerny
1976Vi.A	P-Cargese		462	C. Vieu, J.S. Dionisio, V. Berg, C. Bourgeois
1977				
1977A117	NUPAB	285,	1	K. Aleklett, E. Lund, G. Nyman, G. Rudstam
1977Ba10	CJPHA	55,	200	J.W. Barnard, P. Williams, R.C. Barber, S.S. Hague, K.S. Kozier, K.K. Sharma, H.E. Duckworth
1977Ba33	IANFA	41,	101	I.F. Barchuk, G.V. Belykh, V.I. Golyshkin, A.F. Ogorodnik, M.M. Tuschinski
1977Ba69	YAFIA	26,	461	S.A. Baranov, V.M. Shatinskii
1977Be09	PRVCA	15,	705	C.E. Bemis, Jr., R.L. Ferguson, F. Plasil, R.J. Silva, F. Pleasanton, R.L. Hahn
1977Be13	PRVCA	15,	1187	W. Benenson, D. Mueller, E. Kashy, H. Nann, L.W. Robinson
1977Be36	PRVCA	16,	1146	C.E. Bemis, Jr., P.F. Dittner, R.J. Silva, R.L. Hahn, J.R. Tarrant, L.D. Hunt, D.C. Hensley
1977Bh03	ZPAAD	281,	65	T.S. Bhatia, H. Hafner, R. Haupt, R. Maschuw, G.J. Wagner
1977Bo02	NUPAB	275,	229	D.D. Bogdanov, A.V. Demyanov, V.A. Karnaukhov, L.A. Petrov, A. Plochocki, V.G. Subbotin, J. Voboril
1977Bo28	PYLBB	71,	67	D.D. Bogdanov, J. Vobofil, A.V. Demyanov, L.A. Petrov
1977Bo31	IANFA	41,	1149	N.A. Bonch-Osmolovskaya, V.M. Gorodzankin, K.Y. Gromov, T. Kretsu, V.V. Kuznetsov, G. Makarie, A.S. Khamidov, M. Yatiski
1977Bo32	IANFA	41,	1189	B. Bogdan, M. Gasior, T. Kretsu, V.V. Kuznetsov, N.A. Lebedev, G.I. Lizurei, G. Makarie, D.G. Popescu, A.S. Khamidov
1977Bo.A	PrvCom	AHW	Oct	V.R. Bom, D. De Bruin
1977Ca09	PRVCA	15,	883	R.F. Carlton, S. Raman, G.G. Slaughter
1977Ca23	ZPAAD	283,	221	C. Cabot, S. Della Negra, C. Deprun, H. Gauvin, Y. Le Beyec
1977Co08	PRVCA	15,	1685	J.D. Cossairt, R.E. Tribble, R.A. Kenefick
1977Cr05	IANFA	41,	2032	T. Cretsu, G. Makarie, A.V. Potempa, E. Senyavski
1977Da22	GCACA	41,	1745	D.W. Davis, J. Gray, G.L. Cumming, H. Baadsgaard
1977De06	PRVCA	15,	800	J. Deslauriers, S.C. Gujrathi, S.K. Mark
1977De25	ZPAAD	283,	33	J. Deslauriers, S.C. Gujrathi, S.K. Mark

1977De32	JPSLB	38,	393	S. Della Negra, B. Lagarde, Y. Le Beyec
1977Dr07	AENGA	42,	314	A.A. Druzhinin, V.K. Grigorev, A.A. Lbov, S.P. Vesnovskii, N.G. Krylov, V.N. Polynov
1977Em02	NUPAB	293,	379	R.A. Emigh, R.E. Anderson
1977Er02	ZPAAD	280,	79	B. Erlandson, J. Lyttkens
1977Fl03	PRVCA	15,	879	E.R. Flynn, J.W. Sunier, F. Ajzenberg-Selove
1977Fo02	ZPAAD	281,	89	B. Fogelberg, W. Maup
1977Fo09	PYLBB	70,	408	H.T. Fortune, R. Middleton, M.E. Coburn, G.E. Moore, S. Mordechai, R.V. Kollarits, H. Nann, W. Chung, B.H. Wildenthal
1977Fr20	ZPAAD	281,	211	T. Freie, H. Lorenz-Wirba, B. Cleff, H.P. Trautvetter, C. Rolfs
1977Gu02	PRVCA	15,	894	P. Guilbault, D. Ardouin, R. Tamisier, P. Avignon, M. Vergnes, G. Rotbard, G. Berrier
1977Ha48	NUPAB	293,	1	E. Hagberg, P.G. Hansen, J.C. Hardy, P. Hornshøj, B. Jonson, S. Mattsson, P. Tidemand-Petersson
1977He26	NUIMA	147,	425	J.C.P. Heggie, Z.E. Zwitkowski
1977Ho02	NUPAB	276,	1	C.L. Hollas, K.A. Aniol, D.W. Gebbie, M. Borsaru, J. Nurzinski, L.O. Barbopoulos
1977Ho09	JUPSA	42,	1098	M. Hoshi, M. Fujiwara, Y. Yoshisama
1977Ho25	NUPAB	288,	429	P. Hornshøj, L. Hojsholt-Poulsen, N. Rud
1977Ij01	PRVCA	15,	2251	M.A. Ijaz, C.R. Bingham, H.K. Carter, E.L. Robinson, K.S. Toth
1977Is01	ZPAAD	281,	365	A.F.M. Ishaq, S. Robertson, W.V. Prestwich, T.J. Kennett
1977Je03	PRVCA	15,	1972	C.M. Jensen, W.R.G. Lanier, G.L. Struble, L.G. Mann, S.G. Prussin
1977Jo03	PRVCA	15,	915	C.H. Johnson, J.K. Bair, C.M. Jones
1977Ka08	NUPAB	279,	269	K. Kawade, H. Yamamoto, Y. Ikeda, V.N. Bhoraskar, T. Katoh
1977Ke03	PRVCA	15,	792	G. Kennedy, J. Deslauriers, S.C. Gujrathi, S.K. Mark
1977Ko04	PRVCA	15,	1947	J.J. Kolata, M. Oothoudt
1977Ko05	ZPAAD	281,	409	G. Korschinek, E. Nolte, H. Hick, K. Miyano, W. Kutschera, H. Morinaga
1977Ko15	PRVCA	16,	588	B.K.S. Koene, R.E. Chrien
1977Ko.A	PrvCom AHW		Feb	B.K. Koene, R.E. Chrien, M. Yachim
1977Ko.B	P-Tashkent		65	T. Kozłowski, T. Kormitski, Y. Lushtshnski, A. Yasinski
1977Kr.A	JINR-P6-10748			T. Kretsu, V.V. Kuznetsov, G. Luzurej, Chan Chen Mo, V.M. Gorodzankin, G. Makarie
1977Li16	PHSTB	15,	205	E. Lingeman
1977Lu06	NUPAB	286,	403	E. Lund, K. Aleklett, G. Rudstam
1977Ma12	PRVCA	15,	1708	J.F. Mateja, C.P. Browne
1977Ma24	NUPAB	288,	1	J.A. Macdonald, J.C. Hardy, H. Schmeing, T. Faestermann, H.R. Andrews, J.S. Geiger, R.L. Graham, K.P. Jackson
1977Mc05	NUPAB	281,	325	A.B. McDonald, E.D. Earle, M.A. Lone, F.C. Khanna, H.C. Lee
1977Mc09	PRVCA	16,	1278	D.A. McClure, S. Raman, G.C. Slaughter
1977Me04	PRVCA	15,	649	L.R. Medsker, L.H. Fry, Jr., J.L. Yntema
1977Mi.A	KFK-2438			M. Mirkiditsian
1977Mo13	NUPAB	289,	36	S. Mordechai, M.E. Coburn, G.E. Moore, H.T. Fortune
1977Mu03	PRVCA	15,	1282	D. Mueller, E. Kashy, W. Benenson
1977Na17	PRVCA	16,	1566	A.M. Nathan, D.E. Alburger, J.W. Olness, E.K. Warburton
1977Na24	NUIMA	144,	331	H. Naylor, R.E. White
1977No08	PYLBB	71,	314	J.A. Nolen, T.S. Bhatia, H. Hafner, P. Doll, C.A. Wiedner, G.J. Wagner
1977Nu01	PRVCA	15,	444	L.L. Nunnelle, W.D. Loveland
1977Pa01	PRVCA	15,	730	L.A. Parks, C.N. Davids, R.C. Pardo
1977Pa13	PRVCA	15,	1811	R.C. Pardo, C.N. Davids, M.J. Murphy, E.B. Norman, L.A. Parks
1977Pa18	PRVCA	16,	370	R.C. Pardo, C.N. Davids, M.J. Murphy, E.B. Norman, L.A. Parks
1977Pr07	PRVCA	16,	1001	S.G. Prussin, R.G. Lanier, G.L. Struble, L.G. Mann, S.M. Schoenung
1977Ra08	IJOPA	15,	41	K.V. Ramaniah, G.R. Raju, K.V. Reddy
1977Ra17	JPHGB	3,	637	Venkata Ramaniah, G. Kusa Raju, K. Venkata Reddy
1977Ra18	JPHGB	3,	633	Venkata Ramaniah, K. Venkata Reddy
1977Re05	PRVCA	15,	2108	P.L. Reeder, J.F. Wright, L.J. Alquist
1977Re12	CUSCA	46,	95	T.S. Reddy, R. Matthews, K.V. Reddy
1977Re.A	Th.-Montreal			D.M. Rehfield DABBB 38,4874(1978)
1977Sc03	PYLBB	66,	133	A.G. Schmidt, R.L. Mlekodaj, E.L. Robinson, F.T. Avignone, J. Lin, G.M. Gowdy, J.L. Wood, R.W. Fink

1977Sc21	ZPAAD	283,	43	F. Schussler, J. Blachot, E. Monnard, J.A. Pinston, B. Pfeiffer, K. Hawerkamp, R. Stippler
1977Sh04	CJPHA	55,	506	S.H. Sharma, K.S. Kozier, J.W. Barnard, R.C. Barber, S.S. Haque, H.E. Duckworth
1977Sh06	PRVCA	15,	903	J.D. Sherman, D.L. Hendrie, M.S. Zisman
1977Sh08	PYLBB	67,	275	J.D. Sherman, E.R. Flynn, O. Hansen, N. Stein, J.W. Sunier
1977Sh12	CJPHA	55,	1360	K.S. Sharma, J.O. Meredith, R.C. Barber, K.S. Kozier, S.S. Hague, J.W. Barnard, F.C.G. Southon, P. Williams, H.E. Duckworth
1977So02	CJPHA	55,	383	F.C.G. Southon, J.O. Meredith, R.C. Barber, H.E. Duckworth
1977St15	PRVCA	16,	574	M.L. Stelts, J.C. Browne
1977St22	CJPHA	55,	1687	O. Straume, D.G. Burke
1977Tr03	PRVCA	15,	2028	R.E. Tribble, J.D. Cossairt, R.A. Kenefick
1977Tr05	PRVCA	16,	917	R.E. Tribble, J.D. Cossairt, D.P. May, R.A. Kenefick
1977Tr07	PRVCA	16,	1835	R.E. Tribble, J.D. Cossairt, D.P. May, R.A. Kenefick
1977Tu01	ZPAAD	280,	309	T. Tuurnala, K. Katajanheimo, E. Hammaren
1977Vo02	NUPAB	278,	189	H. Vonach, P. Glass, E. Huenges, P. Maier-Komor, H. Reoser, H.J. Scheerer, H. Paul, D. Semrad
1977Vy02	IANFA	41,	1634	Ts. Vylov, N.A. Golovkov, B.S. Dzelepov, R.B. Ivanov, M.A. Mikhailova, Y.V. Norseev, V.G. Shumin
1977Wh03	AUJPA	30,	365	R.E. White, H. Naylor
1977Ya07	JUPSA	43,	8	H. Yamamoto, K. Kawade, K. Ikeda, T. Katoh
1978				
1978Aj01	PRVCA	17,	960	F. Ajzenberg-Selove, E.R. Flynn, J.W. Sunier, D.L. Hanson
1978Al18	PRVCA	18,	462	K. Aleklett, E. Lund, G. Rudstam
1978Al23	PRVCA	18,	1875	D.E. Alburger
1978Al29	PRVCA	18,	2727	D.E. Alburger, S. Mordechai, H.T. Fortune, R. Middleton
1978An10	NUPAB	303,	154	K.A. Aniol, D.W. Gebbie, C.L. Hollas, J. Nurzinski
1978An14	PHSTB	18,	165	G. Andersson, M. Ashgar, A. Emsallem, E. Hagberg, B. Jonson, P. Tidemand-Petersson
1978Ar12	PRVCA	18,	1201	D. Ardouin, C. Lebrun, F. Guibault, B. Remand, E.R. Flynn, D.L. Hanson, S.D. Orbesen, M.N. Vergnes, G. Rotbard, K. Kumar
1978Az01	PRVCA	17,	443	G. Azuelos, G.V. Rao, P. Taras
1978Ba44	PRLTA	41,	738	P.A. Baisden, R.E. Leber, M. Nurmia, J.M. Nitschke, M. Michel, A. Ghiorso
1978Ba.C	P-Alma Ata		123	S.A. Baranov, V.M. Shatinskii, L.V. Chistyakov, N.I. Aleshin
1978Be09	PRVCA	17,	529	G. Berrier-Ronsin, M. Vergnes, G. Rotbard, J. Vernotte, J. Kalifa, R. Seltz, H.L. Sharma
1978Be22	ZPAAD	285,	405	D. Benson, Jr., P. Kleinheinz, R.K. Sheline, E.B. Shera
1978Be26	PRVCA	17,	1939	W. Benenson, E. Kashy, A.G. Ledebuhr, R.C. Pardo, R.G.H. Robertson, L.W. Robinson
1978Bh02	PYLBB	76,	562	T.S. Bhatia, H. Hafner, J.A. Nolen, Jr., W. Saathoff, R. Schuhmacher, R.E. Tribble, G.J. Wagner, C.A. Wiedner
1978Bo20	NUPAB	303,	145	D.D. Bogdanov, A.V. Demyanov, V.A. Karnaukhov, L.A. Petrov, J. Voboril
1978Bo32	NUPAB	307,	421	D.D. Bogdanov, A.V. Demyanov, V.A. Karnaukhov, M. Nowicki, L.A. Petrov, J. Voboril, A. Plochocki
1978Bo.A	P-Alma Ata		54	D.D. Bogdanov, I. Bobordzil, A.V. Demianov, L.A. Petrov
1978Bu18	PRVCA	18,	693	D.G. Burke, G. Løvholden, E.R. Flynn, J.W. Sunier
1978Ca11	ZPAAD	287,	71	C. Cabot, S. Della Negra, C. Deprun, H. Gauvin, Y. Le Beyec
1978Ch22	MTRGA	14,	157	P. Christmas, P. Cross
1978Co.A	AnRpt Texas AM			J.D. Cossairt, D.P. May
1978Cr02	IANFA	42,	56	T. Cretzu, V.V. Kuznetsov, G. Luzurej, V.M. Gorodzankin, G. Macarie
1978Cr03	ZPAAD	287,	45	J. Crançon, C. Ristori, H. Ohm, W. Rudolph, K.-L. Kratz, M. Asghar
1978Da04	PRVCA	17,	1815	C.N. Davids, D.F. Geesaman, S.L. Tabor, M.J. Murphy, E.B. Norman, R.C. Pardo
1978Da07	NUPAB	301,	397	J.M. D'Auria, J.W. Grütter, E. Hagberg, P.G. Hansen, J.C. Hardy, P. Hornshøj, B. Jonson, S. Mattsson, H.L. Ravn, P. Tidemand-Petersson
1978Do06	ZPAAD	286,	107	P.H. Do, R. Chery, H.G. Börner, W.F. Davidson, J.A. Pinston, R. Rousille, K. Schreckenbach, H.R. Koch, H. Seyfarth, D. Heck

1978Ek05	HYIND	4,	165	C. Ekstrom, S. Ingelman, G. Wannberg, M. Skarestad, ISOLDE
1978El11	PRVCA	18,	2713	Y.A. Ellis, K.S. Toth, H.K. Carter
1978Fi02	PRVCA	17,	718	R.B. Firestone, R.A. Warner, W.C. McHarris, W.H. Kelly
1978Ga07	YAFIA	27,	894	Yu. P. Gangrskii, G.M. Marinescu, M.B. Miller, V.N. Samosyuk, I.F. Kharisov
1978Ge01	NUPAB	295,	221	C.P. Gerner, J. Van Pelt, O.W. De Ridder, J. Blok
1978Gr10	NUPAB	303,	265	H.C. Griffin, I. Ahmad, A.M. Friedman, L.E. Glendenin
1978Gr13	YAFIA	27,	1421	I.I. Gromova, T. Kretsu, V.V. Kuznetsov, G.I. Lizurei, N.A. Lebedev, V.M. Gorozhankin, G. Macarie
1978Gu14	ZPAAD	287,	271	H.H. Guven, B. Kardon, H. Seyfarth
1978Ha08	PYLBB	73,	139	E. Hagberg, P.G. Hansen, P. Hornshøj, B. Jonson, S. Mattsson, P. Tidemand-Petersson, ISOLDE
1978Ha11	NUPAB	296,	251	S.I. Hayakama, I.R. Hyman, J.K.P. Lee
1978Hu06	CJPHA	56,	936	H. Huang, B.P. Pathek, J.K.P. Lee
1978Ik03	JUPSA	45,	725	Y. Ikeda, H. Yamamoto, K. Kawade, T. Katoh, K. Nagahara
1978Ja06	JPHGB	4,	579	A.N. James, J.F. Sharpey-Schafer, A.M. Al Naser, A.H. Behbehani, C.J. Lister, P.J. Nolan, P.H. Barker, W.E. Burcham
1978Ka12	PRVCA	17,	1555	R. Kamermans, J. Van Driel, H.P. Blok, P.J. Blankhorst
1978Ke06	PRVCA	17,	1929	G.J. KeKelis, M.S. Zisman, D.K. Scott, R. Jahn, D.J. Vieira, J. Cerny, F. Ajzenberg-Selove
1978Ke10	PRVCA	18,	1938	B.D. Kern, F. Gabbard, R.G. Kruzek, M.R. McPherson, K.K. Sekharan, F.D. Snyder
1978Ko24	NUPAB	307,	71	R.T. Kouzes, D. Mueller
1978Ko27	NUPAB	309,	329	R.T. Kouzes, P. Kutt, D. Mueller, R. Sherr
1978Ko28	PRVCA	18,	1587	R.T. Kouzes, D. Mueller, C. Yu
1978Le.A	Table of Isotopes			C.M. Lederer, V.S. Shirley, E. Browne, J.M. Dairiki, R.E. Doebler, A.A. Shihab-Eldin, L.J. Jardine, J.K. Tuli, A.B. Buyrn
1978Lo07	NUPAB	302,	51	G. Løvholden, O. Straume, D.G. Burke
1978Lo13	JINCA	40,	1865	R.W. Lougheed, J.F. Wild, E.K. Hulet, R.W. Hoff, J.H. Landrum
1978Ma18	JUPSA	44,	1070	Z. Matumoto, T. Tamura
1978Ma23	NUPAB	301,	213	J.W. Maas, E. Somorjai, H.D. Graber, C.A. Vandenwijngaard, C. Van der Leun, P.M. Endt
1978Ma24	NUPAB	301,	237	J.W. Maas, A.J.C. Holvast, A. Baghus, H.J.M. Aarts, P.M. Endt
1978Mo12	NUPAB	305,	29	L.A. Montestraqe, M.C. Cobian Rozak, G. Szaloky, J.D. Zumbro, S.E. Darden
1978Mu05	PRVCA	17,	1574	M.J. Murphy, C.N. Davids, E.B. Norman, R.C. Pardo
1978No03	PRVCA	17,	2176	E.B. Norman, C.N. Davids, M.J. Murphy, R.C. Pardo
1978No05	PRVCA	18,	102	E.B. Norman, C.N. Davids
1978Pa11	PRVCA	18,	1249	R.C. Pardo, E. Kashy, W. Benenson, L.W. Robinson
1978Pa12	PRVCA	18,	1277	I. Paschopoulos, E. Müller, H.J. Körner, I.C. Oelrich, K.E. Rehm, H.J. Scheerer
1978Pe08	NUPAB	302,	1	J.G. Pengra, H. Genz, R.W. Fink
1978Pf01	PRLTA	41,	63	L.P. Pfeiffer, A.P. Mills, Jr., R.S. Raghavan, F. Achandros
1978Ra15	PRVCA	18,	1085	G.R. Rao, G. Azuelos, J.C. Kim, J.P. Martin, P. Taras
1978Ra16	PRVCA	18,	1158	S. Raman, R.F. Carlton, G.G. Slaughter, M.R. Meder
1978Re01	ZPAAD	284,	403	T.S. Reddy, R. Matthews, K.V. Reddy
1978Ro01	PRVCA	17,	4	R.G. HRobertson, E. Kashy, W. Benenson, A. Ledebuhr
1978Ro03	ZPAAD	284,	407	A. Robertson, T.J. Kennett, W.V. Prestwich
1978Ro14	PRVCA	18,	86	G. Rotbard, L. Larana, M. Vergnes, G. Berrier, J. Kalifa, F. Guilbault, R. Tamisier
1978Ro19	PYLBB	78B,	393	E. Roeckl, R. Kirchner, O. Klepper, G. Nyman, W. Reisdorf, D. Schardt, K. Wien, R. Fass, S. Mattsson
1978Sc26	ZPAAD	288,	189	U.J. Schrewe, W.D. Schmidt-Ott, R.-D. von Dincklage, E. Georg, P. Lemmertz, H. Jungclas, D. Hirdes
1978Se04	PRVCA	17,	1919	R.R. Sercely, R.J. Peterson, E.R. Flynn
1978Sh11	NUPAB	304,	40	S. Shastry, R.A. Emigh, R.J. Peterson, R.E. Anderson
1978St25	NUIMA	155,	253	H.L. Stelts, R.E. Chrien
1978Su03	ZPAAD	287,	287	K. Stümmerer, N. Kaffrell, H. Otto, P. Peuser, N. Trautmann
1978Sz04	PRVCA	17,	2253	A. Szanto De Toledo, H.V. Klapdor, H. Hafner, W. Saathoff, E.M. Szanto, M. Schrader

1978Sz09	JPHGB	4,	L187	A. Szanto De Toledo, H.V. Klapdor, H. Hafner, W. Saathoff, E.M. Szanto, M. Schrader, H. Dias
1978Ta10	PRVCA	18,	1064	R.W. Tarara, J.P. Zumbro, C.P. Browne
1978Tu04	PHSTB	18,	31	T. Tuurnala, R. Katajanheimo, O. Heinonen
1978Va04	NUPAB	295,	211	J. Van Pelt, C.P. Gerner, O.W. De Ridder, J. Blok
1978Ve10	JPSLB	39,	291	L. Vergnes, G. Rotbard, J. Kalifa, G. Berrier, J. Vernotte, Y. Deschamps, R. Selz
1978We12	PHSTB	18,	275	T. Weckstrom
1978We14	NUPAB	308,	222	D.C. Weissner, A.F. Zeller, T.R. Ophel, D.F. Hebbard
1978Wi04	PRVCA	18,	401	D.H. Wilkinson, A. Gallmann, D.E. Alburger
1978Wo01	PRVCA	17,	66	C. Woods
1978Wo15	PRVCA	18,	2328	F.K. Wohn, W.L. Talbert, Jr.
1978Ya07	PRVCA	17,	2061	Y. Yamazaki, R.K. Sheline, E.B. Shera corr PRVCA 18,2450
1978Ze04	PRVCA	18,	2122	B. Zeidman, J.A. Nolen, Jr.
1978Zg.A	PrvCom	AHW	Sep	E.F. Zganjar, W.R. Kane, G.J. Smith, J.A. Cizewski
1979				
1979Ad08	IANFA	43,	1089	I.A. Adam, A.V. Budzyak, M. Gonusek, V.M. Gorodzhankin, B.S. Dzelepov, V.G. Kalinnikov, A.V. Kudryavtseva, V.V. Kuznetsov, V.I. Stegaylov, A. Shshalek
1979Ah03	PRVCA	20,	200	I. Ahmad, S.W. Yates, R.K. Sjolblom, A.M. Friedman
1979Aj02	PRVCA	19,	1742	F. Ajzenberg-Selove, E.R. Flynn, D.L. Hansen, S. Orbesen
1979Aj03	PRVCA	19,	2068	F. Ajzenberg-Selove, E.R. Flynn, D.L. Hansen, S. Orbesen
1979Ai04	JPHGB	5,	423	A.M. Al Naser, A.H. Behbehani, P.A. Butler, L.L. Green, A.N. James, C.J. Lister, P.J. Nolan, N.R.F. Ramsmo, J.F. Sharpey-Schafer, H.M. Sheppard, L.H. Zyber, R. Zyber
1979Ai05	ZPAAD	290,	173	K. Aleklett, E. Lund, G. Rudstam
1979Ai16	ZPAAD	291,	397	G.D. Alkhazov, L.K. Batist, E.Y. Berlovich, Y.S. Blinnikov, Y.V. Yelkin, K.A. Mezilev, Y.N. Novikov, V.N. Pantelejev, A.G. Poljakov, N.D. Schigolev, V.N. Tatasov, V.P. Afanasjev, K.Y. Gromov, M. Jachim, M. Janicki, V.G. Kalinnikov, J. Kormicki, A. Potempa, E. Rurarz, F. Tarkanyi, Y.V. Yushkievich
1979An36	IANFA	43,	1076	N.M. Antoneva, V.M. Vinogradov, E.P. Grigorev, P.P. Dimitrev, A.V. Zolotavin, G.S. Katichin, N.N. Krasnov, V.M. Makarov
1979Ba06	ZPAAD	289,	325	J.N. Barkman, J.E. McFee, T.J. Kennett, W.V. Prestwich
1979Ba31	NUPAB	325,	305	G.C. Ball, W.G. Davies, J.S. Forster, H.R. Andrews, D. Horn, W. McLatchie
1979Ba67	AENGA	47,	404	S.A. Baranov, V.M. Shatinskii, L.V. Chistyakov
1979Be.A	P-Brookhaven		561	Z. Berant, Y. Birenbaum, R. Moreh, see NUIMA 166(1979)81, and PrvCom AHW February 1980
1979Bo37	ZENAA	34,	1536	T. Borello-Lewin, O. Dietsch
1979Br05	ZPAAD	289,	289	P. Brodeur, B.P. Pathek, S.K. Mark
1979Br19	PRVCA	20,	1301	R.E. Brown, J.A. Cizewski, E.R. Flynn, J.W. Sunier
1979Br25	NUIMA	166,	243	F. Braumandl, K. Schreckenbach, T. von Egidy
1979Br26	ZPAAD	292,	397	F. Braumandl, T. von Egidy, D.D. Warner
1979Br.A	Th.-McMaster			P.M. Brewste
1979Br.B	AnRpt NotrDame			C.P. Browne, et al
1979Bu05	NUPAB	318,	77	D.G. Burke, G. Løvhøiden, E.R. Flynn, J.W. Sunier
1979Ca02	NUPAB	316,	61	R.F. Casten, M.R. MacPhail, W.R. Kane, D. Breitig, K. Schreckenbach, J.A. Cizewski
1979Da04	PRVCA	19,	1463	C.N. Davids, C.A. Gagliardi, M.J. Murphy, E.B. Norman
1979Da.A	P-Lansing		419	C.N. Davids
1979De44	NUPAB	332,	382	K.R.S. Devan, C.E. Brient
1979Do09	PRVCA	20,	1112	R.E. Doebler, W.M. McHarris, W.H. Kelly
1979Du02	NUPAB	315,	317	F. Dubbers, L. Funke, P. Kemnitz, K.D. Schilling, H. Strusny, E. Will, G. Winter, M.K. Balodis
1979Fi07	PYLBB	89,	36	R.B. Firestone, R.C. Pardo, W.C. McHarris
1979Fi02	PRVCA	19,	355	E.R. Flynn, D.L. Hansen, R.A. Hardekopf

1979Fo10	NUPAB	323,	205	B. Fogelberg, P. Carlé
1979Ge02	PRVCA	19,	2224	D.F. Geesaman, R.L. McGrath, J.W. Noé, R.E. Malmin
1979Ha09	ZPAAD	290,	113	H.H. Hansen, E. Cellen, G. Grosse, D. Mouchel, A. Larsen, R. Vaninbrouck
1979Ha10	NUPAB	318,	29	E. Hagberg, P.G. Hansen, P. Hornshøj, B. Jonson, S. Mattsson, P. Tidemand-Petersson, ISOLDE
1979Ha26	PRVCA	19,	2332	P.E. Hausteim, H.-C. Hseuh, R.L. Klobuchar, E.M. Franz, S. Katcoff, L.K. Pekar
1979Ha32	PRVCA	20,	345	J.E. Halvarson, W.H. Johnson, Jr.
1979Ho10	ZPAAD	291,	53	S. Hofmann, W. Faust, G. Münzenberg, W. Reisdorf, P. Armbruster, K. Güttner, H. Ewald
1979Ho27	NUPAB	330,	429	J. Honkanen, M. Kortelahti, K. Valli, K. Eskola, A. Hautojärvi, K. Vierinen
1979Ik06	JUPSA	47,	1039	Y. Ikeda, H. Yamamoto, K. Kawade, T. Takeuchi, T. Katoh, T. Nagahara
1979Ik07	JUPSA	47,	1389	Y. Ikeda, H. Yamamoto, K. Kawade, T. Katoh, T. Nagahara
1979Io01	NUPAB	313,	283	V.A. Ionescu, J. Kern, R.F. Casten, W.R. Kane, I. Ahmad, J. Erskine, A.M. Friedman, K. Katori
1979Ja21	NUPAB	325,	337	J. Jänecke, F.D. Becchetti, C.E. Thorn
1979Ka.A	P-Lansing		39	E. Kashy, W. Benenson, J.A. Nolen, Jr., R.G.H. Robertson
1979Ke02	ZPAAD	289,	407	U. Keyser, H. Berg, F. Münnich, K. Hawerkamp, H. Schrader, B. Pfeiffer, E. Monnard
1979Ke.D	P-Brookhaven		646	M.J. Kenny, M.L. Stelts, R.E. Chrien
1979Ko10	CJPHA	57,	266	K.S. Kozier, K.S. Sharma, R.C. Barber, J.W. Barnard, R.J. Ellis, V.P. Derenchuk
1979Pe17	NUPAB	332,	95	P. Peuser, H. Otto, N. Kaffrell, G. Nyman, E. Roeckl
1979Pi08	NUPAB	321,	25	J.A. Pinston, W. Mampe, R. Rousille, K. Schreckenbach, D. Heck, H.G. Börner, H.R. Koch, S. Andre, D. Barnéoud
1979Pi06	NUPAB	332,	29	A. Plochocki, G.M. Gowdy, R. Kirchner, O. Klepper, W. Reisdorf, E. Roeckl, P. Tidemand-Petersson, J. Żylicz, U.J. Schrewe, R. Kantus, R.-D. von Dincklage, W.D. Schmidt-Ott
1979Ry.A	P-Lansing		249	A. Rytz
1979Sa.A	AnRpt KVI			A. Saha, R.H. Siemsen, J.W. Smits, J. Van Popta, and PrvCom AHW
1979Sc09	NUPAB	318,	253	K.-H. Schmidt, W. Faust, G. Münzenberg, H.-G. Clerc, W. Lang, K. Pielenz, D. Vermeulen, H. Wohlfarth, H. Ewald, K. Güttner
1979Sc11	ZPAAD	290,	359	F. Schussler, J. Blachot, E. Monnard, B. Fogelberg, S.H. Feenstra, J. van Klinken, G. Jung, K.D. Wütsch
1979Sc22	NUPAB	326,	65	D. Schardt, R. Kirchner, O. Klepper, W. Reisdorf, E. Roeckl, P. Tidemand-Petersson, G.T. Ewan, E. Hagberg, B. Jonson, S. Mattsson, G. Nyman
1979Sw01	NUIMA	159,	407	Z.E. Switkowski, R.J. Petty, J.C.P. Heggie, G.J. Clark
1979Ta.B	BAPSA	24,	836	R.W. Tarara, J.D. Zumbro, C.P. Browne
1979To06	PRVCA	19,	2399	K.S. Toth, M.A. Ijaz, C.R. Bingham, L.L. Riedinger, H.K. Carter, D.C. Sousa
1979To18	PRVCA	20,	1902	K.S. Toth, Y.A. Ellis, D.C. Sousa, H.K. Carter, D. Sen, E.F. Zganjar
1979Ve.A	P-Lansing		431	J. Verplancke, D. Vandeplassche, M. Huyse, K. Cornelis, G. Lhersonneau
1979Vi01	PRVCA	19,	177	D.J. Vieira, R.A. Gough, J. Cerny
1979Vo05	PRVCA	20,	944	T. von Egidy, J.A. Cizewski, C.M. McCullagh, S.S. Malik, M.L. Stelts, R.E. Chrien, D. Breitig, R.F. Casten, W.R. Kane, G.J. Smith
1979Wa04	NUPAB	316,	13	D.D. Warner, W.F. Davidson, H.G. Börner, R.F. Casten, A.I. Namenson
1979Wa22	JPHGB	5,	1723	D.D. Warner, W.F. Davidson, W. Gelletly
1979We02	NUPAB	313,	385	D. Weber, G.M. Crawley, W. Benenson, E. Kashy, H. Nann
1980				
1980Ad04	ZPAAD	295,	251	M. Adachi, A. Muroi, T. Matsuzaki, H. Taketani
1980AI02	PRVCA	21,	705	D.E. Alburger, P. Richards, T.H. Ku
1980AI14	ZPAAD	295,	305	G.D. Alkhazov, E.Y. Berlovich, K.A. Mezilev, Y.N. Novikov, V.N. Pan-telejev, A.G. Poljakov, K.Y. Gromov, V.G. Kalinnikov, J. Kormicki, A. Potempa, E. Rurarz, F. Tarkanyi
1980AI15	ZPAAD	295,	331	K. Aleklett, P. Hoff, E. Lund, G. Rudstam
1980An.A	P-Berkeley		134	M.S. Antony, A. Huck, G. Klotz, A. Knipper, C. Miehé, G. Walter
1980Ba.A	Th.-Utrecht			J.R. Balder

1980Br23	NUPAB	349,	61	R.A. Braga, W.R. Western, J.L. Wood, R.W. Fink, R. Stone, C.R. Bingham, L.L. Riedinger
1980Bu04	IANFA	44,	79	A.V. Budzyak, T. Kretsu, V.V. Kuznetsov, N.A. Lebedev, G.I. Lizurei, Y.V. Yushkvich, M. Yanitski
1980Bu15	PRVCA	22,	1180	G.R. Bureson, G.S. Blanpied, G.H. Daw, A.J. Viescas, C.L. Morris, H.A. Thiessen, S.J. Greene, W.J. Braithwaite, W.B. Cottingham, D.B. Holtkamp, I.B. Moore, C.F. Moore
1980Ca02	PRVCA	21,	65	R.F. Casten, G.J. Smith, M.R. MacPhail, D. Breitig, W.R. Kane, M.L. Stelts, S.F. Mughabghab, J.A. Cizewski, H.G. Börner, W.F. Davidson, K. Schreckenbach
1980De02	ZPAAD	294,	35	R. Decker, K.D. Wunsch, H. Wollnik, E. Koglin, G. Siegert, G. Jung
1980Di07	PRVCA	21,	2101	A.C. Di Rienzo, H.A. Enge, D.B. Gazes, M.K. Salomaa, A. Sperduto, W. Schier, H.E. Wegner
1980Du02	ZPAAD	294,	107	J.P. Dufour, A. Fleury, F. Hubert, Y. Llabador, M.B. Mahourat, R. Bimbert, D. Gardes
1980Ew03	ZPAAD	296,	223	G.T. Ewan, E. Hagberg, B. Jonson, S. Mattsson, P. Tidemand-Petersson
1980Ga07	YAFIA	31,	306	Yu. P. Gangrskii, M.B. Miller, L.V. Mikhailov, I.F. Kharisov
1980G04	PRVCA	21,	2041	J. Gilat, S. Katcoff, L.K. Peker
1980Go11	NUPAB	344,	1	H. Gokturk, N.K. Aras, P. Fettweis, P. Del Marmol, J. Vanhorenbeek, K. Cornelis
1980Ha20	PRVCA	22,	247	H.I. Hayakawa, I. Hyman, J.K.P. Lee
1980Ha36	PHSTB	22,	439	R. Hanninen, G.U. Din
1980Ho29	CZYPA	30,	763	J. Hinzatko, K. Konesny, F. Becvar, E.A. Eissa
1980Is02	CJPHA	58,	168	M.A. Islam, T.J. Kennett, S.A. Kerr, W.V. Prestwich
1980Ja.A	AnRpt KVI		31	J. Jänecke, E.H.L. Aarts, A.G. Drentje, C. Gaarde, M.H. Harakeh
1980Ka19	PRVCA	22,	997	J. Kalifa, G. Berrier-Ronsin, M. Vergnes, G. Rotbard, J. Vernotte, Y. Deschamps, R. Seltz
1980Ko01	NUPAB	334,	35	J. Kopecky, R.E. Chrien, H. Liou
1980Ko25	CJPHA	58,	1311	K.S. Kozier, K.S. Sharma, R.C. Barber, J.W. Barnard, R.J. Ellis, V.P. Derenchuk, H.E. Duckworth
1980Li07	NUPAB	337,	401	H.I. Liou, R.E. Chrien, J. Kopecky, J.A. Konter
1980Lo10	PHSTB	22,	203	G. Løvhøiden, D.G. Burke, E.R. Flynn, J.W. Sunier
1980Lu04	ZPAAD	294,	233	E. Lund, P. Hoff, K. Aleklett, O. Glomset, G. Rudstam
1980Ma40	PRVCA	22,	2449	W. Mayer, K.E. Rehm, H.J. Körner, W. Mayer, E. Müller, I. Oelrich, H.J. Scheerer, R.E. Segel, P. Sperr, W. Wagner
1980Mu12	PRVCA	22,	2204	M.J. Murphy, C.N. Davids, E.B. Norman
1980Na12	PYLBB	96,	261	H. Nann, K.K. Seth, S.G. Iversen, M.O. Kaletka, D.B. Barlow, D. Smith
1980Na14	JPSLB	41,	79	F. Naulin, C. Détraz, M. Bernas, D. Guillemaud, E. Kashy, M. Langevin, F. Pougheon, P. Roussel, M. Roy-Stephan
1980No01	PRVCA	21,	1109	E.B. Norman
1980Ox01	ZPAAD	294,	389	K. Oxorn, B. Singh, S.K. Mark
1980Pa02	PRVCA	21,	462	R.C. Pardo, L.W. Robinson, W. Benenson, E. Kashy, R.M. Ronnigen
1980Sa11	JPHGB	6,	525	J. Sala-Lizarraga, J. Byrne
1980Sc09	PYLBB	91,	46	U.J. Schrewe, P. Tidemand-Petersson, G.M. Gowdy, R. Kirchner, O. Klepper, A. Plochocki, W. Reisdorf, E. Roeckl, J.L. Wood, J. Zylicz, R. Fass, D. Schardt
1980Sh06	PYLBB	91,	211	K.S. Sharma, R.J. Ellis, V.P. Derenchuk, R.C. Barber, H.E. Duckworth
1980Sh14	CJPHA	58,	837	M.A.M. Shababuddin, D.G. Burke
1980St10	ZPAAD	295,	259	O. Straume, G. Løvhøiden, D.G. Burke
1980Ta07	PRVCA	21,	1667	E.M. Takagui, O. Dietzsch
1980Tr04	PRVCA	22,	17	R.E. Tribble, D.M. Tanner, A.F. Zeller
1980Ve01	ZPAAD	294,	144	D. Vermeulen, H.-G. Clerc, W. Lang, K.H. Schmidt, G. Münzenberg
1980Ve05	NUPAB	344,	421	R. Vennink, J. Kopecky, P.M. Endt, P.W.W. Glaudemans
1980Vi.A	PrvCom	AHW		V.D. Vitman, F.V. Moroz, Yu. Ya. Sergeev, V.K. Tarasov
1980Vy01	IANFA	44,	67	Ts. Vylov, S. Omanov, V. Csaleksandrov, N.B. Badalov, A. Budzyak, V.V. Kuznetsov, A.I. Muminov, Han Ken Mo
1980Ya07	JINCA	42,	1539	H. Yamamoto, Y. Ikeda, K. Kawade, T. Katoh, T. Nagahara



1981Ad02	NUPAB	356,	129	I. Adam, M. Honusek, Z. Hons, V.V. Kuznetsov, T.M. Muminov, R.R. Usmanov, A. Budzyak
1981Aj02	PRVCA	24,	1762	F. Ajzenberg-Selove, R.E. Brown, E.R. Flynn, J.W. Sunier
1981Ai03	PRVCA	23,	473	D.E. Alburger, D.J. Millener, D.H. Wilkinson
1981Ai20	ZPAAD	302,	241	K. Aleklett, P. Hoff, E. Lund, G. Rudstam
1981Ar13	PYLBB	104,	186	Y. Arai, M. Fujioka, E. Tanaka, J. Shinozuka, H. Miyatake, M. Yoshii, T. Ishimatsu, see also NUPAB 420(84)193
1981Ar.A	JINR-P6-81-524			K.P. Artamonova, A. Budzyak, E.P. Grigorev, A. Dzumamuratov, A.V. Zolotavin, A.I. Ivanov, V.G. Kalinnikov, V.V. Kuznetsov, V.O. Sergeev, R. Usmanov
1981Ba53	IANFA	45,	727	I.F. Barchuck, V.I. Goyshkin, E.N. Gorban, A.F. Ogorodnik
1981Be03	PRVCA	23,	555	C.E. Bemis, Jr., P.F. Dittner, R.L. Ferguson, D.C. Hensley, F. Plasil, F. Pleasonton
1981Be40	PRVCA	24,	756	M. Bernas, J.C. Peng, H. Doubre, M. Langevin, M.J. Le Vine, F. Pougheon, P. Roussel
1981Bj01	NUPAB	359,	1	T. Bjornstad, H.A. Gustafsson, P.G. Hansen, B. Jonson, V. Lindfors, S. Mattsson, A.M. Poskanzer, H.L. Ravn, ISOLDE
1981Bo30	ZPAAD	302,	121	J. Bonn, P. Hartmann, D. Weskott
1981Bo.B	AnRpt Julich		76	M. Bogdanovic, T.D. MacMahon, H. Seyfarth
1981Bu.A	P-Samarkand		621	M. Budzinski, K. Ya. Gromov, V.V. Kuznetsov, T.M. Muminov, P.R. Usmanov, T. Chazratov
1981Ci01	PRVCA	23,	1453	J.A. Cizewski, E.R. Flynn, R.E. Brown, D.L. Hanson, S.D. Orbesen, J.W. Sunier
1981Co17	PRVCA	24,	911	T. Cousins, T.J. Kennett, W.V. Prestwich
1981De22	ZPAAD	300,	251	S. Della Negra, C. Deprun, D. Jacquet, Y. Le Beyec
1981De25	ZPAAD	301,	165	R. Decker, K.D. Wunsch, H. Wollnik, G. Jung, J. Münzel, G. Siegert, E. Koglin
1981De38	ZPAAD	303,	151	J. Deslauriers, S.C. Gujrathi, S.K. Mark
1981Dr07	ZPAAD	302,	361	S. Drissi, S. Andre, J. Genevey, V. Barci, A. Gizon, J. Gizon, J.A. Pinston, J. Jastrzebski, R. Kossakowski, Z. Preibisz
1981Eb01	ZPAAD	299,	209	I.D.U. Ebong, R.R. Roy
1981El03	PRVCA	23,	480	Y.A. Ellis-Akovali, K.S. Toth, C.R. Bingham, H.K. Carter, D.C. Sousa
1981En07	NUPAB	372,	125	G. Engler, R.E. Chrien, H.I. Liou
1981Ew01	NUPAB	352,	13	G.T. Ewan, E. Hagberg, P.G. Hansen, B. Jonson, S. Mattsson, H.L. Ravn, P. Tidemand-Petersson
1981Fi02	PRVCA	24,	902	E.R. Flynn, F. Ajzenberg-Selove, R.E. Brown, J.A. Cizewski, J.W. Sunier, and erratum PRVCA 25(1982)2851
1981Ga36	IANFA	45,	1861	N. Ganbaatar, J. Kormicki, K.A. Mezilev, Y.N. Novikov, Y.P. Prokofiev, A. Potempa, F. Tarkani
1981Gi01	PYLBB	98,	29	F. Girshik, K. Krien, R.A. Naumann, G.L. Struble, R.G. Lanier, L.G. Mann, J.A. Cizewski, E.R. Flynn, T. Nail, R.K. Sheline
1981Ha08	NUPAB	357,	356	J.C. Hardy, G.C. Ball, W.G. Davies, J.S. Forster, H. Schmeing, E.T.H. Clifford
1981Ha44	NUPAB	371,	349	J.C. Hardy, T. Faestermann, H. Schmeing, J.A. Macdonald, H.R. Andrews, J.S. Geiger, R.L. Graham, K.P. Jackson
1981Ho10	ZPAAD	299,	281	S. Hofmann, G. Münzenberg, F. Heßberger, W. Reisdorf, P. Armbruster, B. Thuma
1981Ho17	ZPAAD	300,	289	P. Hoff, K. Aleklett, E. Lund, G. Rudstam
1981Ho18	NUIMA	186,	257	P. Hornshøj, H.L. Nielsen, N. Rud, H.L. Ravn
1981Ho.A	P-Helsingor		190	S. Hofmann, G. Münzenberg, W. Faust, F. Heßberger, W. Reisdorf, J.R.H. Schneider, P. Armbruster, K. Güttner, B. Thuma
1981Ho.B	PrvCom AHW		Oct	C. Hofmeyr, D. Warner, H.G. Börner, G. Barreau, R.F. Casten, M. Steltz, J.S. Dionisio
1981Hs02	PRVCA	23,	1217	H.-C. Hseuh, E.-M. Franz, P.E. Haustein, S. Katcoff, L.K. Peker
1981Hu03	NUPAB	352,	247	M. Huysse, K. Cornelis, G. Lhersonneau, J. Verplancke, W.B. Wolters, K. Heyde, P. Van Isacker, M. Warnquier, G. Wenes, H. Vincx
1981Jo.A	P-Helsingor		265	B. Jonson, H. Å. Gustafsson, P.G. Hansen, P. Hoff, P.O. Larsson, S. Mattsson, G. Nyman, H.L. Ravn, D. Schardt

1981Jo.B	P-Helsingor		640	B. Jonson, O.B. Nielsen, L. Westgaard, J. Žylicz
1981Ke02	CJPHA	59,	93	T.J. Kennett, M.A. Islam, W.V. Prestwich
1981Ke03	ZPAAD	299,	323	T.J. Kennett, W.V. Prestwich, M.A. Islam
1981Ke11	CJPHA	59,	1212	T.J. Kennett, W.V. Prestwich, M.A. Islam
1981Ko.A	PrvCom	NDG	Oct	B.K. Koene, R.E. Chrien, M.L. Stets, L.K. Peker
1981La11	NUPAB	366,	449	M. Langevin, C. Détraz, D. Guillemaud, F. Naulin, M. Epherre, R. Klapisch, S.K.T. Mark, M. de Saint Simon, C. Thibault, F. Touchard
1981Le23	PRVCA	24,	2370	M.E. Leino, S. Yashita, A. Ghiorso
1981Li12	PRVCA	24,	260	C.J. Lister, P.E. Hausteijn, D.E. Alburger, J.W. Olness
1981Lo.A	P-Grenoble		383	M.A. Lone
1981Ma30	NUPAB	370,	1	S. Matsuki, N. Sakamoto, K. Ogino, Y. Kadota, T. Tanabe, Y. Okuma
1981Me17	RAACA	29,	93	D.H. Meikrantz, R.J. Gehrke, L.D. McIsaac, J.D. Baker, R.C. Greenwood
1981Mi12	ZPAAD	301,	199	P. Misaelides, P. Tidemand-Petersson, U.J. Schrewe, I.S. Grant, R. Kirchner, O. Klepper, I.C. Malcolm, P.J. Nolan, E. Roeckl, W.-D. Schmidt-Ott, J.L. Wood
1981Mu06	ZPAAD	300,	107	G. Müntenberg, S. Hofmann, F.P. Heßberger, W. Reisdorf, K.H. Schmidt, J.R.H. Schneider, P. Armbruster, C.C. Sahn, B. Thuma
1981Mu12	ZPAAD	302,	7	G. Müntenberg, S. Hofmann, W. Faust, F.P. Heßberger, W. Reisdorf, K.-H. Schmidt, T. Kitahara, P. Armbruster, K. Güttner, B. Thuma, D. Vermeulen
1981Na.A	P-Helsingor		376	F. Naulin, C. Détraz, M. Roy-Stephan, M. Bernas, J. de Boer, D. Guillemaud, M. Langevin, F. Pougheon, P. Roussel
1981Ni08	RAACA	29,	113	K. Nishiizumi, R. Gensho, M. Honda
1981Ox01	ZPAAD	303,	63	K. Oxorn, S.K. Mark
1981Pa17	ZPAAD	302,	117	A.D. Panagiotou, P.K. Kananis, E.N. Gazis, M. Bernas, C. Détraz, M. Langevin, D. Guillemaud, E. Plagnol
1981Ri04	PRVCA	23,	2342	B.G. Ritchie, K.S. Toth, H.K. Carter, R.L. Mlekodaj, E.H. Speje
1981Ro02	PRVCA	23,	973	R.G.H. Robertson, J.A. Nolen, Jr., T. Chapuran, R. Vodhanel
1981Sa09	PRVCA	23,	1713	T. Saito, T. Toriyama, M. Kanbe, K. Hisatake
1981Sc17	NUPAB	368,	153	D. Schardt, T. Batsch, R. Kirchner, O. Klepper, W. Kurcewicz, E. Roeckl, P. Tidemand-Petersson
1981Se11	PYLBB	103,	409	U. Sennhauser, L. Felawka, T. Kozłowski, H.K. Walter, F.W. Schlepuetz, R. Engfer, E.A. Hermes, P. Heusi, H.P. Isaak, H.S. Pruys, A. Zgliniski, W.H.A. Hesselning
1981Se.A	P-Helsingor		655	K.T. Seth
1981Sm02	PYLBB	102,	114	L.G. Smith, E. Koets, A.H. Wapstra
1981So06	PRVCA	24,	1615	K. Sofia, B.N. Subba Rao, J.E. Cramfort
1981St18	PRVCA	24,	1785	P. Stephans, E. Mordechai, H.T. Fortune
1981Su.A	Leninst-YF-644			L.A. Sushkov, V.L. Alekseev, L.D. Kabina, I.A. Kondurov, D.D. Uorner
1981Th04	PRVCA	23,	2720	C. Thibault, F. Touchard, S. Buttgenbach, R. Klapisch, M. de Saint Simon, H.T. Duong, P. Jacquinet, P. Juncar, S. Liberman, P. Pillet, J. Pinard, J.L. Vialle, A. Pesnelle, G. Huber
1981To02	NUPAB	356,	26	K.S. Toth, Y.A. Ellis-Akovali, D.M. Moltz, C.R. Bingham, H.K. Carter, D.C. Sousa
1981Va27	IANFA	45,	1861	V.M. Vakhel, N.A. Golovkov, R.B. Ivanov, M.I. Mikhailova, A.F. Novgorodov, Y.V. Norseev, V.G. Chumin, Y.V. Yushkevich
1981Vo03	NUPAB	365,	26	T. von Egidy, G. Barreau, H.G. Börner, W.F. Davidson, J. Larysz, D.D. Warner, P.H.M. Van Assche, K. Nybo, T.F. Thorsteinsen, G. Lovhoiden, E.R. Flynn, J.A. Cizewski, R.K. Sheline, D. Decman, D.G. Burke, G. Sletten, N. Kaffrell, W. Kurcewicz, T. Bjornstad, G. Nyman
1981Wa11	NUPAB	362,	1	C. Wagemans, E. Allaert, A. De Clerq, P. D'Hondt, A. De Ruytter, G. Barreau, A. Emsallem
1981We12	NUPAB	368,	117	H. Weigmann, C. Wagemans, A. Emsallem, M. Ashgar
1981Wh03	PYLBB	105,	116	R.E. White, H. Naylor, P.H. Barker, D.M.J. Lovelock, R.M. Smythe
1981Ya06	JINCA	43,	855	H. Yamamoto, Y. Ikeda, K. Kawade, T. Katoh, T. Nagahara
			1982	
1982Ah01	NUPAB	373,	434	I. Ahmad, E.P. Horwitz

1982A107	ZPAAD	305,	185	G.D. Alkhozov, K.A. Mezilev, Yu. N. Novikov, V.N. Panteleyev, A.G. Polyakov, V.P. Afanasyev, N. Ganbaatar, K. Ya. Gromov, V.G. Kalinikov, J. Kormicki, A. Latuszynski, A. Potempa, J. Sieniawski, F. Tarkanyi, Yu. V. Yushkevich
1982A119	NUIMA	197,	383	P.F. AAlkemade, C. Alderliesten, P. De Wit, C. Van der Leun
1982A129	PRVCA	26,	1157	K. Aleklett, P. Hoff, E. Lund, G. Rudstam
1982An12	JPHGB	8,	1659	M.S. Antony
1982Au01	NUPAB	378,	443	G. Audi, M. Epherre, C. Thibault, A.H. Wapstra, K. Bos
1982Ba15	IANFA	46,	63	I.F. Barchuk, V.I. Golyshkin, E.N. Gorban
1982Ba28	NUPAB	380,	189	A. Backlin, G. Hedin, B. Fogelberg, M. Saraceno, R.C. Greenwood, C.W. Reich, H.R. Koch, H.A. Baader, H.D. Breitig, O.W.B. Schult, K. Schreckenbach, T. von Egidy, W. Mampe
1982Ba69	IANFA	46,	2077	I.F. Barchuk, V.I. Golyshkin, E.N. Gorbinj
1982Be20	NCIAA	33,	273	E. Bellotti, E. Fiorini, C. Liguori, A. Pullia, A. Sarracino, L. Zanotti
1982Be21	PRVCA	25,	2848	G. Berrier-Ronsin, M. Vergnes, G. Rotbard, J. Verlotte, S. Fortier, J.M. Maison, R. Tamisier
1982Be.A	P-Kiev		127	R.B. Begdzanov, K. Sh. Azimov
1982Bo04	PRVCA	25,	941	J.D. Bowman, R.E. Eppley, E.K. Hyde
1982Br23	PRVCA	26,	2166	D.S. Brenner, M.K. Martel, A. Aprahamian, R.E. Chrien, R.L. Gill, H.I. Liou, M. Shmid, M.L. Stelts, A. Wolf, F.K. Wahn, D.M. Rehfield, H. Dejbakhsh, C. Chung
1982Cr01	PYLBB	109,	8	G.M. Crawley, W. Benenson, G. Bertsch, S. Gales, D. Weber, B. Zwieglinsky
1982De03	PRVCA	25,	146	P. De Gelder, D. De Frenne, E. Jacobs, K. Heyde, S. Fortier, J.M. Maison, M.N. Rao, C.P. Massolo
1982De06	PRVCA	25,	504	J. Deslauriers, S.C. Gujrathi, S.K. Mark
1982De11	ANPHA	7,	149	S. Della Negra, C. Deprun, D. Jacquet, Y. Le Beyec
1982De36	ZPAAD	307,	305	S. Della Negra, H. Gauvin, D. Jacquet, Y. Le Beyec
1982De43	ZPAAD	308,	243	S. Della Negra, D. Jacquet, Y. Le Beyec
1982Di05	NUPAB	378,	273	W.R. Dixon, R.S. Storey, A.F. Bielajew
1982En03	PRVCA	25,	1830	H.A. Enge, M. Salomaa, A. Sperduto, J. Ball, W. Schier, A. Graue, A. Graue
1982Ew01	NUPAB	380,	423	G.T. Ewan, E. Hagberg, B. Jonson, S. Mattsson, P. Tidemand-Petersson
1982Fi10	NUPAB	385,	505	L.K. Fifield, J.L. Durell, M.A.C. Hotchkis, J.R. Leigh, T.R. Ophel, D.C. Weissner
1982Fi09	PRVCA	25,	2851	E.R. Flynn, F. Ajzenberg-Selove, R.E. Brown, J.A. Cizewski, J.W. Sunier
1982Gi.A	Th.-Mainz			H. Gietz
1982Gr.A	P-Amsterdam			K.Y. Gromov, et al
1982Hi14	ZPAAD	309,	27	R. Hingmann, H.-G. Clerc, C.C. Sahn, D. Vermeulen, K.H. Schmidt, J.G. Keller
1982Ho07	PRVCA	25,	2232	R.W. Hoff, W.F. Davidson, D.D. Warner, H.G. Börner, T. von Egidy
1982Is05	PRVCA	25,	3184	M.A. Islam, T.J. Kennett, W.V. Prestwich
1982Jo03	JPHGB	8,	1405	M.G. Johnson, I.S. Grant, P. Misealides, P.J. Nolan, P. Peuser, R. Kirchner, O. Klepper, E. Roeckl, P. Tidemand-Petersson
1982Ka.A	PrvCom	AHW	Jul	W. Kane, et al
1982Ko06	PRVCA	25,	1076	R.T. Kouzes, M.M. Lowry, C.L. Bennett, and PrvCom AHW May 1988
1982Kr05	ZPAAD	304,	307	H. Kräwinkel, H.W. Becker, L. Buchmann, J. Görres, K.U. Kettner, W.E. Kieser, R. Santo, P. Schmalbrock, H.P. Trautvetter, A. Vliks, C. Rolf, J.W. Hammer, R.E. Azuma, W.S. Rodney
1982Kr12	NUPAB	386,	245	B. Krusche, K.P. Lieb, H. Daniel, T. von Egidy, G. Barreau, H.G. Börner, R. Brissot, C. Hofmeyr, R. Rascher
1982Ku15	ZPAAD	308,	21	W. Kurcewicz, E.F. Zganjar, R. Kirchner, O. Klepper, E. Roeckl, P. Komninos, E. Nolte, D. Schardt, P. Tidemand-Petersson
1982La22	NUIMA	196,	559	R.G. Lanier, L.G. Mann, G.L. Stuble
1982Mi14	NATUA	300,	414	J.-F. Minster, J.-L. Birck, C.J. Allègre
1982Mo04	PRVCA	25,	1276	S. Mordechai, S. Lafrance, H.T. Fortune
1982Mo10	PYLBB	113,	16	D.M. Moltz, K.S. Toth, F.T. Avignone III, H. Noma, B.G. Ritchie, B.D. Kern
1982Mo12	PRVCA	25,	3218	C.L. Morris, H.T. Fortune, L.C. Bland, R. Gilman, S.J. Greene, W.B. Cottingham, D.B. Holtkamp, G.R. Burleson, C.F. Moore

1982Mo23	PRVCA	26,	1914	D.M. Moltz, K.S. Toth, R.E. Tribble, R.E. Neese, J.P. Sullivan
1982No06	ZPAAD	305,	289	E. Nolte, H. Hick
1982No08	ZPAAD	306,	223	E. Nolte, S.Z. Gui, G. Colombo, G. Korschinek, K. Eskola
1982Oh04	JUPSA	51,	43	M. Ohshima, Z. Matumoto, T. Tamura
1982OI01	NUPAB	373,	13	J.W. Olness, E.K. Warburton, D.E. Alburger, C.J. Lister, D.J. Millener
1982Pa24	ZPAAD	308,	345	B. Pahlmann, U. Keyser, F. Münnich, B. Pfeiffer, see also 87Gr. A
1982Pi05	NUPAB	388,	93	A. Plochocki, J. Żylicz, R. Kirchner, O. Klepper, E. Roeckl, P. Tidemand-Petersson, I.S. Grant, P. Misealides
1982Ra13	ZPAAD	305,	359	M.S. Rapaport, G. Engler, A. Gayer, I. Yoresh
1982Ra.A	PrvCom	AHW	Nov	A. Raemy, J.C. Dousse, J. Kern, W. Schwitz
1982Sc03	NUPAB	376,	144	K. Schreckenbach, A.I. Namenson, W.F. Davidson, T. von Egidy, H.G. Börner, J.A. Pinston, R.K. Smither, D.D. Warner, R.F. Casten, M.L. White, W. Stoff
1982Sc14	PRVCA	25,	2888	H.H. Schmidt, P. Hungerford, H. Daniel, T. von Egidy, S.A. Kerr, R. Bristot, G. Barreau, H.G. Börner, C. Hofmeyr, K.P. Lieb
1982Sc15	PRVCA	25,	3091	U.J. Schrewe, E. Hagberg, H. Schmeing, J.C. Hardy, V.T. Koslowsky, K.S. Sharma, E.T.H. Clifford
1982Sc25	ZPAAD	308,	183	H.J. Scheerer, D. Pereira, A. Chalupka, R. Gyufko
1982Sg01	CJPHA	60,	361	A.P. Sguigna, A.J. Larabee, J.C. Waddington
1982So.A	P-Kiev		51	L.M. Solin, V.A. Yakovlev, V.N. Kushmin, Yu. A. Nemilov
1982So.B	AnRpt	Julich	54	F. Soramel-Stanco, R. Julin, B. Rubio, A. Ercan, P. Kleinheinz, J. Tain, G.P.A. Berg, W. Huerliman, I. Katayama, S.A. Martin, J. Messburger, J.G.M. Roemer, B. Styczen, H.J. Scheerer
1982Th01	PRVCA	25,	331	C.E. Thorn, W.F. Piel, Jr., M.J. LeVine, P.D. Bond, A. Gallmann
1982Ti02	NUPAB	376,	421	T.A.A. Tielens, J. Kopecky, F. Stecher-Rasmussen, W. Ratinsky, K. Abrahams, P.M. Endt
1982To02	PYLBB	108,	169	F. Touchard, P. Guimbal, S. Buttgenbach, R. Klapisch, M. de Saint Simon, J.M. Serre, C. Thibault, H.T. Duong, P. Juncar, S. Liberman, J. Pinard, J.L. Vialle
1982To14	PYLBB	117,	11	K.S. Toth, Y.A. Ellis-Akovali, D.M. Moltz, R.L. Mlekodaj
1982Va13	NUPAB	380,	261	C. Van der Leun, C. Alderliesten
1982Vy02	IANFA	46,	16	Ts. Vylov, V.M. Gorodzhankin, K. Ya. Gromov, V.G. Kalinnikov, T. Kretsu, V.V. Kuznetsov
1982Vy03	IANFA	46,	834	Ts. Vylov, V.M. Gorodzhankin, K. Ya. Gromov, V.V. Kuznetsov
1982Vy06	IANFA	46,	2066	Ts. Vylov, V.G. Kalinnikov, V.V. Kuznetsov, Z.N. Li, A.A. Solnyshkin, Y.U. Yuskevich
1982Vy07	IANFA	46,	2239	Ts. Vylov, V.M. Gorodzhankin, K.Y. Gromov, V.V. Kuznetsov, T. Kretsu, N.A. Lebedev, Yu. V. Yushkevich
1982Vy10	YAFIA	36,	812	Ts. Vylov, V.M. Gorodzhankin, K. Ya. Gromov, A.I. Ivanov, I.F. Uchevatkin, V.G. Chumin
1982Zu02	PRVCA	26,	965	J.D. Zumbro, C.P. Browne, J.F. Mateja, H.T. Fortune, R. Middleton
1982Zu04	PRVCA	26,	2668	J.D. Zumbro, A.A. Rollefson, R.W. Tarara, C.P. Browne
1983				
1983Ad05	CZYPA	33,	465	J. Adam, V. Hnatowicz, A. Kugler
1983Al06	ZPAAD	310,	247	G.D. Alkhazov, K.A. Mezilev, Yu. N. Novikov, N. Ganbaatar, K. Ya. Gromov, V.G. Kalinnikov, A. Potempa, E. Sieniawski, F. Tarkanyi
1983Al.A	PrvCom	AHW	Jan	G.D. Alkhazov
1983Al.B	P-Moscow		87	G.D. Alkhazov, A.A. Akhmonen, L. Kh. Batist, Yu. S. Blinnikov, N. Ganbataar, K. Ya. Gromov, Yu. V. Elkin, V.G. Kalinnikov, K.A. Mezilev, F.V. Moroz, Yu. N. Novikov, A.M. Nurmukhamedov, V.N. Panteleev, A.G. Polyakov, A. Potempa, E. Senyavski, V.K. Tarasov, F. Tarkani
1983An15	JPHGB	9,	L245	M.S. Antony, J. Britz, J.B. Buep, A. Papp
1983Ay01	NUPAB	404,	1	J. Äystö, J. Honkanen, W. Trzaska, K. Eskola, K. Vierinen, S. Messelt
1983Be18	NUPAB	399,	131	H. Behrens, P. Christmas
1983Be.C	PrvCom	GAu	Sep	M. Bernas, et al
1983Bl16	ZPAAD	314,	199	J. Blomqvist, A. Kerek, B. Fogelberg
1983Bo29	PYLBB	130,	167	P.D. Bond, R.F. Casten, D.D. Warner, D. Horn

1983Bu03	CJPHA	61,	460	D.G. Burke, I. Nowikov, Y.K. Peng, J.C. Yanch
1983Ca04	PRVCA	27,	1310	R.F. Casten, D.D. Warner, G.M. Gowdy, N. Rofail, K.P. Lieb
1983Ch08	ZPAAD	310,	135	A. Chalupka, H. Vonach, E. Hueges, H.J. Scheerer
1983Ch39	PRVCA	28,	2099	C. Chung, W.B. Walters, D.S. Brenner, A. Aprahamian, R.L. Gill, M. Schmid, R.E. Chrien, L.-J. Yuan, A. Wolf, Z. Berant
1983Ch47	NIMAE	215,	397	P. Christmas, S.M. Judge, T.B. Ryves, D. Smith, G. Winkler
1983Ci01	PRVCA	27,	1040	J.A. Cizewski, D.G. Burke, E.R. Flynn, R.E. Brown, J.W. Sunier
1983De03	PRVCA	27,	892	R.A. Dewberry, R.T. Kouzes, R.A. Neumann
1983De04	NUPAB	394,	378	C. Détraz, M. Langevin, M.C. Goffri-Kouassi, D. Guillemaud, M. Epherre, G. Audi, C. Thibault, F. Touchard
1983De17	ZPAAD	312,	209	D.J. Decman, R.K. Sheline, Y. Tanaka, E.T. Jurney
1983De20	NUPAB	401,	397	P. De Gelder, D. De Frenne, K. Heyde, N. Kaffrell, A.M. VanDenBerg, N. Blasi, M.N. Harakah, W. Sterrenburg
1983De28	NUPAB	404,	225	M.G. Delfini, J. Kopecky, J.B.M. de Haas, H.I. Liou, R.E. Chrien, P.M. Endt
1983De29	NUPAB	404,	250	M.G. Delfini, J. Kopecky, R.E. Chrien, H.I. Liou, P.M. Endt
1983Do11	ZPAAD	313,	207	Zs. Dombrádi, A. Krasznahorkay, J. Gulyás
1983En03	NSENA	85,	139	T.R. England, W.B. Wilson, R.E. Schenter, F.M. Mann
1983Fe06	ZPAAD	314,	159	P. Fettweiss, J.C. Dehaes
1983Fl06	PRVCA	28,	575	E.R. Flynn, R.E. Brown, F. Ajzenberg-Selove, J.A. Cizewski
1983Fo.B	PrvCom	AHW	Jun	I. Förster
1983Ga.A	P-Moscow		90	N. Ganbaatar, Ya. Kormitski, K.A. Mezilev, Yu. N. Novikov, A.M. Nur-mukhamedov, A. Potempa, E. Senyavski, F. Tarkani
1983Ge08	NIMAE	211,	89	W. Gelletly
1983Gn01	NUPAB	406,	29	B.E. Gnade, R.E. Fink, J.L. Wood
1983Gr01	PYLBB	120,	63	H. Grawe, H. Haas
1983Ha06	NUPAB	395,	152	E. Hagberg, J.C. Hardy, H. Schmeing, E.T.H. Clifford, V.T. Koslowsky
1983Ha35	IJAR	34,	1241	H.H. Hansen
1983Hi08	NUPAB	404,	51	R. Hingmann, H.-G. Clerc, C.-C. Sahn, D. Vermeulen, K.-H. Schmidt, J.G. Kekeller
1983Ho08	NUPAB	398,	130	M.A.C. Hotchkis, L.K. Fifield, J.R. Leigh, T.R. Ophel, G.D. Putt, D.C. Weiser
1983Hu11	ZPAAD	313,	325	P. Hungerford, T. von Egidy, H.H. Schmidt, S.A. Kerr, H.G. Börner, E. Monnard
1983Hu12	ZPAAD	313,	337	P. Hungerford, T. von Egidy, H.H. Schmidt, S.A. Kerr, H.G. Börner, E. Monnard
1983Hu13	ZPAAD	313,	349	P. Hungerford, T. von Egidy, H.H. Schmidt, S.A. Kerr, H.G. Börner, E. Monnard
1983Ia02	CJCHA	61,	694	R. Iafigliola, M. Chatterjee, H. Dautet, J.K.P. Lee
1983Jo04	NUPAB	396,	479c	B. Jonson, J.U. Andersen, G.J. Beyer, G. Charpak, A. De Rújula, B. Elbek, H.A. Gustavson, P.G. Hansen, P. Knudsen, E. Laegsgaard, J. Pedersen, H.L. Ravn
1983Ke.A	P-Florence		B118	S.A. Kerr, F. Hoyler, K. Schreckenbach, H.G. Börner, G.G. Colvin, see also P-Knoxville(1984)416
1983La23	PYLBB	130,	251	M. Langevin, C. Détraz, D. Guillemaud-Mueller, A.C. Mueller, C. Thibault, F. Touchard, G. Klotz, C. Miché, G. Walter, M. Epherre, C. Richard-Serre
1983Le.A	Th.-Helsinki			M. Leino (Report HU-P-D37)
1983Li11	PRVCA	28,	2127	C.J. Lister, B.J. Varley, D.E. Alburger, P.E. Haustein, S.K. Saha, J.W. Olness, H.G. Price, A.D. Irving
1983Mo09	PRVCA	28,	623	S. Mordechai, S. LaFrance, H.T. Fortune
1983Ni05	ZPAAD	312,	265	J.M. Nitschke, M.D. Cable, W.-D. Zeitz
1983Og.A	JINR-D7-83-644			Yu. Ts. Oganessian
1983Pa.A	Th.-Berkeley			R.F. Parry DABBB 44,2472(1984)
1983Po10	NUPAB	411,	65	M.G. Porquet, C. Bourgeois, P. Kilcher, J. Sauvage-Letessier, ISOCELE
1983Pu01	NUPAB	399,	190	G.P. Putt, L.K. Field, M.A.C. Hotchkis, T.R. Ophel, D.C. Weisser
1983Ra04	PRVCA	27,	1188	S. Raman, E.T. Jurney, D.A. Outlaw, I.S. Towner
1983Ra.A	P-Florence		I-1	K.V. Ramaniah, S.B. Reddy, V.V. Rama Murti, K.L. Narasimham
1983Re05	PRVCA	27,	3002	P.L. Reeder, R.A. Warner, R.L. Gill

1983Ro08	NUPAB	401,	41	M. Rotbard, M. Vergnes, J. Vernotte, G. Berrier-Ronsin, J. Kalifa, R. Tamisier
1983Ru06	NUPAB	399,	163	E. Runte, W.-D. Schmidt-Ott, P. Tidemand-Petersson, R. Kirchner, O. Klepper, W. Kurcewicz, E. Roeckl, N. Kaffrell, P. Peuser, K. Rykaczewski, M. Bernas, P. Dessagne, M. Langevin
1983Ru08	NUPAB	407,	60	J.F.G.A. Ruyll, P.M. Endt
1983Sa44	RRALA	58,	263	J. Sato, Y. Ohoka, T. Hirose
1983Sc18	ZPAAD	310,	295	U.J. Schrewe, E. Hagberg, H. Schmeing, J.C. Hardy, V.T. Koslowsky, K.S. Sharma
1983Sc24	ZPAAD	312,	21	J.R.H. Schneider, S. Hofmann, F.P. Heßberger, G. Münzenberg, W. Reisdorf, P. Armbruster
1983Se17	IANFA	47,	885	V.A. Sergienko, A.V. Borontsovskii, M.A. Nain
1983Sh06	ZPAAD	311,	71	K. Shizuma, H. Lawin, K. Sistemich
1983Sh31	PRVCA	28,	1712	B. Sherrill, K. Beard, W. Benenson, B.A. Brown, E. Kashy, W.E. Ormand, H. Nann, J.J. Kehayias, A.D. Bacher, T.E. Ward
1983Ta.A	BAPSA	28,	658	R.W. Tarara, C.P. Browne, see BAPSA 28,968
1983Ti02	NUPAB	403,	13	T.A.A. Tielens, J. Kopecky, K. Abrahams, P.M. Endt
1983To01	PRVCA	27,	889	K.S. Toth
1983To20	NUPAB	411,	209	Y. Tokunaga, H. Seyfarth, O.W.B. Schult, H.G. Börner, Ch. Hofmeyr, G. Barreau, R. Brissot, Ch. Monkemeyer, U. Kaup
1983Ts01	PRVCA	27,	2397	J.S. Tsai, T.J. Kennett, W.V. Prestwich
1983Ve06	IANFA	47,	834	G.V. Veselov, N. Ganbaatar, Ya. Kormitski, Yu. N. Novikov, A. Potempa, E. Senyavski, V.A. Sergienko, F. Tarkani
1983Ve.A	P-Moscow		99	G.V. Veselov, N. Ganbaatar, K.A. Mezilev, Yu. N. Novikov, A. Potempa, V.A. Sergienko, F. Tarkanyi, A.G. Teterin
1983Vi.A	P-Moscow		575	V.D. Vitman, F.V. Moroz, S. Yu. Orlov, V.K. Tarasov
1983Vo10	ZPAAD	313,	167	E. Voth, W.D. Schmidt-Ott, H. Behrens
1983Vo.A	PrvCom	AHW	Jul	H. Vonach
1983Wa27	NUPAB	411,	81	F.B. Waanders, J.P.L. Reinecke, H.N. Jacobs, J.J.A. Smit, M.A. Meyer, P.M. Endt
1983We07	ZPAAD	313,	173	B. Weiss, C.F. Liang, P. Paris, A. Peghaire, A. Gizon, and PrvCom GAU Oct 1983
1983Wi14	NUPAB	411,	151	C.A. Wiedner, R. Haupt, W. Saathoff, J. Haas, R. Gyufko, K.R. Cordell, S.T. Thornton, R.A. Cecil, R.L. Parks
1983Wi.B	PrvCom	AHW	Jun	C.-A. Wiedner, et al
1983Wo01	PRVCA	27,	27	C.J. Woodward, R.E. Tribble, D.M. Tanner
1983Wo04	PRVCA	27,	1745	J.M. Wouters, H.M. Thierens, J. Äystö, M.D. Cable, P.E. Haustein, R.F. Parry, J. Cerny
1983Wo10	PRLTA	51,	873	F.K. Wohn, J.C. Hill, R.F. Petry, H. Dejbakhsh, Z. Berant, R.L. Gill
1983Zu01	NUPAB	393,	15	J.D. Zumbro, R.W. Tarara
			1984	
1984Ah02	NUPAB	413,	423	I. Ahmad, J.L. Lerner
1984Ai08	YAFIA	39,	513	D.V. Aleksandrov, E.A. Ganza, Yu. A. Glukhov, B.G. Novatskiï, A.A. Ogloblin, D.N. Stepanov
1984Ai36	IANFA	48,	834	G.D. Alkhazov, N. Ganbaatar, K. Ya. Gromov, V.K. Kalinnikov, K.A. Mezilev, Yu. N. Novikov, A.M. Nurmhukhamedov, A. Potempa, F. Tarkani
1984An03	NCIAA	79,	100	M.S. Antony, J. Britz, J.B. Bueb, A. Pape
1984An17	NCIAA	81,	414	M.S. Antony, J. Britz, J. Bueb, A. Pape
1984Ay01	PYLBB	138,	369	J. Äystö, J. Arje, V. Koponen, P. Taskinen, H. Hyvonen, A. Hautajarvi, K. Vierinen
1984Be10	NUPAB	413,	363	M. Bernas, Ph. Dessagne, M. Langevin, J. Payet, F. Pougheon, P. Roussel, W.-D. Schmidt-Ott, P. Tidemand-Petersson, M. Girod
1984Bh02	NCIAA	79,	471	P. Bhattacharya
1984Bl.A	P-Darmstadt		134	F. Blönnigen, G. Bewersdorf, C. Geisse, W. Lippert, B. Pfeiffer, U. Stöhlker, H. Wollnik
1984Br.A	AnRpt	IPN	13	F. Bragança Gil, C. Bourgeois, P. Kilcher, M.G. Porquet, B. Roussière, J. Sauvage, ISOCELE

1984Bu14	PRVCA	29,	2339	D.G. Burke
1984Ca32	PRVCA	30,	1671	F. Calaprice, G.T. Ewan, R.-D. von Dincklage, B. Jonson, O.C. Jonsson, H.L. Ravn
1984Co19	ZPAAD	319,	107	M.D. Cohler, D.L. Watson, R. Wadsworth, S.M. Lane, M.J. Smithson, R.E. Brown, J.-C. Peng, N. Stein, J.W. Sunier, D.M. Drake
1984Da.A	P-Darmstadt		257	H. Dautet, N. Campeau, J.K.P. Lee, C. Bourgeois, B. Roussière, A. Houdayer
1984De15	NUPAB	419,	101	J.B.M. De Hass, K. Abrahams, T.A.A. Tielens, H. Postma, W.J. Huiskamp
1984De16	NUPAB	419,	165	D.J. Decman, H. Grawe, H. Kluge, K.H. Maier, A. Maj, M. Menningen, N. Roy, W. Wiegner
1984De33	NUPAB	426,	399	Ph. Dessagne, M. Bernas, M. Langevin, G.C. Morrison, J. Payet, F. Pougheon, P. Roussel
1984El05	PYLBB	141,	306	R.J. Ellis, K.S. Sharma, R.C. Barber, S.R. Loewen, H.E. Duckworth
1984Fa04	PYLBB	137,	23	T. Faestermann, A. Gillitzer, K. Hartel, P. Kienle, E. Nolte, and AMCO-7, p.177,184
1984Fi02	NUPAB	417,	534	L.K. Fifield, M.A.C. Hotchkis, P.V. Drumm, T.R. Ophel, G.D. Putt, D.C. Weisser
1984Fi05	PRVCA	29,	2118	B.W. Filippone, C.N. Davids, R.C. Pardo, J. Äystö
1984Fo19	NUPAB	429,	205	B. Fogelberg, J. Blomqvist
1984Fo.A	P-Knoxville		427	I. Förster, H.G. Börner, P. von Brentano, G.G. Colvin, A.M.I. Haque, S.A. Kerr, R. Rascher, R. Richter, K. Schreckenbach
1984Gi09	PRVCA	30,	958	R. Gilman, H.T. Fortune, L.C. Bland, R.R. Kiziah, C.F. Moore, P.A. Seidl, C.L. Morris, W.B. Cottingame
1984Gu19	NUPAB	426,	37	D. Guillemaud-Mueller, C. Détraz, M. Langevin, F. Naulin, M. de Saint Simon, C. Thibault, F. Touchard, M. Epherre
1984Ha20	PYLBB	138,	260	B.J. Hall, R.J. Ellis, G.R. Dyck, C.A. Lander, R. Beach, K.S. Sharma, R.C. Barber, H.E. Duckworth
1984Ha27	NUPAB	420,	351	R. Hanninen
1984Ha31	ZPAAD	317,	193	R. Haupt, C.-A. Wiedner, G.J. Wagner, K. Wannebo, T.S. Bhatia, H. Hafner, R. Maschuw, W. Saathoff, S.T. Thornton
1984Ha.A	P-Darmstadt		89	W. Hampel, R. Schlotz
1984He.A	Th.-Montreal			D.W. Hetherington
1984Ho02	PRVCA	29,	618	R.W. Hoff, T. von Egidy, R.W. Lougheed, D.H. White, H.G. Börner, K. Schreckenbach, G. Barreau, D.D. Warner
1984Ho.A	P-Darmstadt		184	S. Hofmann, Y.K. Agarwal, P. Armbruster, F.P. Heßberger, P.O. Larson, G. Münzenberg, K. Poppensieker, W. Reisdorf, J.R.H. Schneider, H.J. Schött
1984Ho.B	Th.-Canberra			M.A.C. Hotchkis
1984Ia.A	P-Darmstadt		141	R. Iafigliola, H. Dautet, S.W. Xu, J.K.P. Lee, R. Chrien, R. Gill, M. Schmid
1984Is09	KURAA	17,	132	T. Ishii, H. Yamamoto, M. Yoshida, K. Kawade, H. Miyade, Y. Iwata, T. Katoh, J.-Z. Ruan, Y. Fumakoshi, Y. Kawase, K. Okano
1984Ka.A	P-Alma Ata		128	V.G. Kalinnikov, V.V. Kuznetsov, V.I. Stegailov, see also P-Yurmala(1987)p119
1984Ke11	CJPHA	62,	861	T.J. Kennett, W.V. Prestwich, J.S. Tai
1984Ke15	PRVCA	30,	1840	T.J. Kennett, M.A. Islam, W.V. Prestwich
1984Ko10	PRVCA	29,	2343	R.T. Kouzes, M.M. Lowry, C.L. Bennett, and PrvCom AHW May 1988
1984Ko29	NUPAB	427,	413	J. Kopecky, M.G. Delfini, R.E. Chrien
1984Kr05	NUPAB	417,	231	B. Krusche, K.P. Lieb, L. Ziegler, H. Daniel, T. von Egidy, R. Rascher, H.G. Börner, G. Barreau, D.D. Warner
1984Kr.B	P-Darmstadt		127	K.-L. Kratz, A. Schröder, H. Ohm, H. Gabelmann, W. Ziegert, B. Steinmüller, B. Pfeiffer
1984La03	NUPAB	414,	151	M. Langevin, C. Détraz, D. Guillemaud-Mueller, A.C. Mueller, C. Thibault, F. Touchard, M. Epherre
1984La06	NUPAB	413,	236	R.G. Lanier, R.K. Sheline, G.L. Struble, L.G. Mann, J.A. Cizewski, and erratum NUPAB 427,650
1984La27	PYLBB	146,	176	M. Langevin, C. Détraz, M. Epherre, D. Guillemaud-Mueller, B. Jonson, C. Thibault, ISOLDE
1984Li05	NUPAB	417,	365	Y.-F. Liu, K.J. Moody, D. Lee, Y. Morita, G.T. Seaborg, H.R. von Gunten
1984Li.A	AnRpt Berkeley			W.X. Li, K.E. Gregorich, R.B. Welch, W. Kot, D. Lee, G.T. Seaborg

1984Lu02	ZPAAD	315,	295	E. Lund, B. Fogelberg
1984Ma49	ZPAAD	319,	287	W.A. Mayer, W. Henning, R. Holzwarth, H.J. Körner, G. Korschinek, W.U. Mayer, G. Rosner, H.J. Scheerer
1984Mu07	ZPAAD	315,	145	G. Münzenberg, W. Reisdorf, S. Hofmann, Y.K. Agarwal, F.P. Heßberger, K. Poppensieker, J.R.H. Schneider, W.F.W. Schneider, K.-H. Schmidt, H.J. Schött, P. Armbruster, C.-C. Sahn, D. Vermeulen
1984Ni03	ZPAAD	316,	249	J.M. Nitschke, P.A. Wilmarth, P.K. Lemmert, W.-D. Zeitz, J.A. Honkanen
1984Ni16	PZETA	39,	441	E.N. Nikolaev, Yu. I. Neronov, M.V. Gorshkov, V.L. Talroze
1984No05	NUPAB	423,	197	G.J.L. Nooren, C. van der Leun
1984Og02	ZPAAD	319,	215	Yu. Ts. Oganessian, A.G. Demin, M. Hussonnois, S.P. Tretyakova, Yu. P. Kharitonov, V.K. Utyonkov, I.V. Shirokovsky, O. Constantinescu, H. Bruchertseifer, Yu. S. Korotkin
1984Og03	RAACA	37,	113	Yu. Ts. Oganessian, M. Hussonnois, A.G. Demin, Yu. P. Kharitonov, H. Bruchertseifer, O. Constantinescu, Yu. S. Korotkin, S.P. Tretyakova, V.K. Utyonkov, I.V. Shirokovsky, J. Estevez
1984Ox01	ZPAAD	316,	97	K. Oxorn, S.K. Mark
1984Pi03	NUPAB	414,	219	Š. Piskoř, P. Franc, J. Kremenek, W. Schäferlingová
1984Po09	RRALA	35,	23	P. Polak, L. Lindner
1984Ra09	PRVCA	30,	26	S. Raman, W. Ratynski, E.T. Jurney, M.E. Bunker, J.W. Starner
1984Ro.A	BAPSA	29,	1041	G. Rotbard, M. Vergnes, J. Vernotte, G. Berrier Ronsin, S. Gales, G.M. Crawley
1984Ru06	NUPAB	419,	439	J.F.A.G. Ruyl, J.B.M. de Haas, P.M. Endt, L. Zybert
1984Ru.A	P-Darmstadt		196	B. Rubio, R. Julin, A. Ercan, K. Zuber, P. Kleinheinz, J.L. Tain, G.P.A. Berg, G. Hlawatsch, I. Katayama, J. Meissburger, D. Paul, J.G. Roemer, J. Blomqvist
1984Ry02	NIMAE	223,	325	A. Rytz, R.A.P. Wiltshire
1984Sc06	ZPAAD	315,	49	U.J. Schrewe, E. Hagberg, H. Schmeing, J.C. Hardy, V.T. Koslowsky, K.S. Sharma
1984Sc13	ZPAAD	316,	19	K.-H. Schmidt, C.-C. Sahn, K. Pielenz, H.-G. Clerc
1984Sc18	ZPAAD	317,	305	U.J. Schrewe, E. Voth, U. Bosch, W.-D. Schmidt-Ott, H. Behrens
1984Sc.A	GS1-84-3			J. Schneider Thesis
1984Sc.B	P-Darmstadt		203	U.J. Schrewe, P. Tidemand-Petersson, H. Behrens, H. Dornhöfer, R. Michaelsen, E. Runte, W.-D. Schmidt-Ott, E. Voth
1984Sc.C	P-Darmstadt		229	D. Schardt, P.O. Larsson, R. Kirchner, O. Klepper, V.T. Koslowsky, E. Roeckl, K. Rykaczewski, P. Kleinheinz, K. Zuber
1984Sh31	AENGA	56,	245	V.M. Shatinsky
1984So03	PRVCA	29,	1556	P.C. Sood
1984Th08	PRVCA	30,	1442	C.E. Thorn, J.W. Olness, E.K. Warburton, S. Raman
1984To07	PRVCA	30,	712	K.S. Toth, D.M. Moltz, E.C. Schloemer, M.D. Cable, F.T. Avignone III, Y.A. Ellis-Akovali
1984To09	PRLTA	53,	1623	K.S. Toth, Y.A. Ellis-Akovali, C.R. Bingham, D.M. Moltz, D.C. Sousa, H.K. Carter, R.L. Mlekodaj, E.H. Spejewski
1984To11	NUPAB	430,	269	Y. Tokunaga, H. Seyfarth, O.W.B. Schult, S. Brant, V. Paar, D. Vretnar, H.G. Börner, G. Barreau, H. Faust, Ch. Hofmeyr, K. Schreckenbach, R.A. Meyer
1984Vo01	JPHGB	10,	221	T. von Egidy, H. Daniel, P. Hungerford, H.H. Schmidt, K.P. Lieb, B. Krusche, S.A. Kerr, G. Barreau, H.G. Börner, R. Brissot, C. Hofmeyr, R. Rascher
1984Vo07	PRVCA	29,	1243	T. von Egidy, R.W. Hoff, R.W. Lougheed, D.H. White, H.G. Börner, K. Schreckenbach, D.D. Warner, G. Barreau, E. Hungerford
1984Ya.A	Th.-Berkeley			S. Yashita LBL-15562 ; Diss. Abstr. 45B(1984)872
				1985
1985Ad.A	P-Leningrad		93	Dz. Adam, T. Dzelev, D. Zakoutski, B. Kratsik, I. Penev
1985Af.A	P-Leningrad		1083	V.P. Afanasiev, Yu. S. Blinnikov, N. Ganbaatar, V. Dzeleznyakov, V.G. Kalinikov, Ya. Kormitski, K.A. Mezilev, Yu. N. Novikov, A.M. Nurmudzamedov, V.N. Panteleev, A.G. Polyakov, A. Potempa, F. Tarkani
1985Ah.1	P-Bombay			S.A. Ahmad, et al, and 89Ot.1



1985Al08	NUPAB	438,	482	G.D. Alkhozov, A.A. Bykov, V.D. Wittmann, V.E. Starodubsky, S.Y. Orlov, V.N. Panteleyev, A.G. Polyakov, V.K. Tarasov
1985Al11	PRLTA	55,	799	T. Altizoglou, F. Calaprice, M. Dewey, M. Lowry, L. Piilonen, J. Brorson, S. Hagen, F. Loeser
1985Al13	PYLBB	157,	350	G.D. Alkhozov, A.A. Bykov, V.D. Wittmann, S. Yu. Orlov, V.K. Tarasov
1985Al17	PRVCA	32,	1358	D.E. Alburger, J.B. Cumming
1985An17	NCIAA	88,	265	M.S. Antony, J. Britz, J.B. Bueb, V.B. Ndocko-Ndongué
1985Ap01	PZETA	42,	233	A.M. Apalikov, S.D. Boris, A.I. Golutvin, L.P. Laptin, V.A. Lyubimov, N.F. Myasoedov, V.V. Nagovitsyn, E.G. Novikov, V.Z. Nozik, V.A. Soloshchenko, I.N. Tikhomirov, E.F. Tretyakov
1985Au07	ZPAAD	321,	533	G. Audi, R.L. Graham, J.S. Geiger
1985Ay02	PRVCA	32,	1700	J. Äystö, X.J. Xu, D.M. Moltz, J.E. Reiff, J. Cerny, B.H. Wildenthal
1985Ba57	ZPAAD	322,	457	A. Baas-May, J.V. Kratz, N. Trautmann
1985Be17	ZPAAD	320,	693	F.J. Bergmeister, K.P. Lieb, K. Pampus, M. Uhrmacher
1985Be50	PYLBB	162,	87	W. Benenson, K. Beard, C. Bloch, B. Sherrill, B.A. Brown, A.D. Panagiotou, J. van der Plicht, J.S. Winsfield, C.E. Thorn
1985Bo34	PYLBB	159,	217	S. Boris, A. Golutvin, L. Laptin, V. Lubimov, V. Nagovizin, E. Novikov, V. Nozik, V. Soloshenko, I. Tikhomirov, E. Tretjakov
1985Bo46	PRLTA	55,	2269	J.A. Bounds, C.R. Bingham, P. Juncar, H.K. Carter, G.A. Leander, R.L. Mlekodaj, E.H. Spejewski, W.M. Fairbank, Jr.
1985Bo49	PYLBB	164,	22	U. Bosch, W.-D. Schmidt-Ott, P. Tidemand-Petersson, E. Runte, W. Hillebrandt, M. Lechle, F.-K. Thielemann, R. Kirchner, O. Klepper, E. Roeckl, K. Rykaczewski, D. Schardt, N. Kaffrell, M. Bernas, Ph. Dessagne, W. Kurcewicz
1985Br03	PYLBB	150,	75	M. Brauner, D. Rychel, R. Gyufko, C.A. Wiedner, S.T. Thornton
1985Co06	PRLTA	54,	1783	E. Coenen, K. Deneffe, M. Huysse, P. Van Duppen, J.L. Wood
1985Co.B	PrvCom	AHW	Dec	G.G. Colvin
1985De08	JPHGB	11,	L59	K. Deneffe, E. Coenen, M. Huysse, P. Van Duppen, J. Vanhorenbeeck, P. del Marmol, P. Fettweis
1985De14	NUPAB	436,	311	D.J. Decman, H. Grawe, H. Kluge, K.H. Maier, A. Maj, N. Roy, Y.K. Agarwal, K.P. Blume, M. Guttormsen, H. Hubel, J. Recht
1985De40	CJPHA	63,	966	V.P. Derenchuk, R.J. Ellis, K.S. Sharma, R.C. Barber, H.E. Duckworth
1985Dr06	NUPAB	441,	95	P.V. Drumm, L.K. Fifield, R.A. Bark, M.A.C. Hotchkis, C.L. Woods, P. Maier-Komor
1985Dy04	PYLBB	157,	139	G.R. Dyck, R.J. Ellis, K.S. Sharma, C.A. Lander, M.H. Sidky, R.C. Barber, H.E. Duckworth
1985E101	NUPAB	435,	34	R.J. Ellis, R.C. Barber, G.R. Dyck, B.J. Hall, K.S. Sharma, C.A. Lander, H.E. Duckworth, and PrvCom AHW October 1991
1985Fi03	NUPAB	440,	531	L.K. Fifield, C.L. Woods, R.A. Bark, P.V. Drumm, M.A.C. Hotchkis
1985Fi08	NUPAB	437,	141	L.K. Fifield, P.V. Drumm, M.A.C. Hotchkis, T.R. Ophel, C.L. Woods
1985Fr01	NUPAB	433,	351	R. Franke, H. Kockskamper, B. Steinheuer, K. Wingender, W. von Witsch
1985Ge02	JPHGB	11,	1055	W. Gelletly, J.R. Larysz, H.G. Börner, R.F. Casten, W.F. Davidson, W. Mampe, K. Schreckenbach, D.D. Warner
1985Ha12	PRVCA	31,	1594	F.X. Hartmann, R.A. Naumann
1985He06	ZPAAD	321,	317	F.P. Heßberger, G. Münzenberg, S. Hofmann, W. Reisdorf, K.-H. Schmidt, H.J. Schmidt, P. Armbruster, R. Hingmann, B. Thuma, D. Vermeulen
1985He22	ZPAAD	322,	557	F.P. Heßberger, G. Münzenberg, S. Hofmann, Y.K. Agarwal, K. Poppen sieker, W. Reisdorf, K.-H. Schmidt, J.R.H. Schneider, W.F.W. Schneider, H.J. Schött, P. Armbruster, B. Thuma, C.-C. Sahn, D. Vermeulen
1985He.A	GSI-85-11			F.P. Heßberger
1985Hi.A	AnRpt GSI		88	R. Hingmann, W. Kuehn, V. Metag, R. Novotny, A. Ruckelshausen, H. Strocher, F.P. Heßberger, S. Hofmann, G. Münzenberg, W. Reisdorf
1985Ho21	PYLBB	160,	375	E. Hourani, M. Hussonnois, L. Stab, L. Brillard, S. Gales, J.P. Schapira
1985Ho.A	PrvCom	NDG	876	C. Hofmeyr, C. Franklyn, G. Barreau, H.G. Börner, R. Brissot, H. Faust, K. Schreckenbach
1985Hu03	PRVCA	31,	2226	A. Huck, G. Klotz, A. Knipper, C. Miehé, C. Richard-Serre, G. Walter, A. Poves, H.L. Ravn, G. Marguier
1985Ke08	ZPAAD	322,	121	T.J. Kennett, W.V. Prestwich, J.S. Tsai
1985Ke11	PRVCA	32,	2148	T.J. Kennett, W.V. Prestwich, J.S. Tsai

1985Kh04	PYLBB	156,	155	S. Khan, Th. Kihm, K.T. Knöpfle, G. Mairle, V. Bechtold, L. Friedrich
1985Ko47	NIMBE	12,	325	P.J.J. Kok, K. Abrahams, H. Postma, W.J. Huiskamp
1985Kr06	NUPAB	439,	219	B. Krusche, Ch. Winter, K.P. Lieb, P. Hungerford, H.H. Schmidt, T. von Egidy, H.J. Scheerer, S.A. Kerr, H.G. Börner
1985La17	IJARA	36,	443	R.M. Lambrecht, S. Mirzadeh
1985Le10	PRVCA	32,	277	R.S. Lee, J.H. Hamilton, A.V. Ramayya, A.P. de Lima, D.L. Sastry, K.S.R. Sastry, E.H. Spejewski, R.L. Mlekodaj, H.K. Carter, W.-D. Schmidt-Ott, J. Lin, C.R. Bingham, L.L. Riedinger, E.F. Zganjar, J.L. Weil, B.D. Kern, A.C. Xenoulis, R.W. Fink, Sun Xi-jun, Guo Junsheng, Cho Chi-cheng, Pan Zong-you, Guo Ying-xian
1985Li02	PRLTA	54,	285	E. Lippmaa, R. Pikver, E. Suurmaa, J. Past, J. Puskar, I. Koppel, A. Tammik
1985Ma54	JPHGB	11,	1231	T.D. MacMahon, G.R. Massoumi, T. Mitsunari, M. Thein, O. Chalhoub, D. Breitig, H.A. Baader, U. Heim, H.R. Koch, L. Wimmwer, H. Seyfarth, K. Schreckenbach, G.B. Orr, G.J. Smith, W.R. Kane, I.A. Kondurov, P.A. Sushkov, Yu. E. Loginov, D. Rabenstein, M. Bogdanovic
1985Ma59	PRVCA	32,	2215	J. Markey, F. Boehm
1985Mu11	ZPAAD	322,	227	G. Münzenberg, S. Hofmann, H. Folger, F.P. Heßberger, J. Keller, K. Poppenzieker, B. Quint, W. Reisdorf, K.-H. Schmidt, H.J. Schött, P. Armbruster, M.E. Leino, R. Hingmann
1985No03	PRVCA	31,	1937	E.B. Norman
1985Oh06	PYLBB	160,	322	T. Ohi, M. Nakajima, H. Tamura, T. Matsuzaki, T. Yamazaki, O. Hashimoto, R.S. Hayano
1985Pf.A	P-Birmingham		75	B. Pfeiffer, K.-L. Kratz, H. Gabelmann, W. Ziegert, V. Harms, B. Leist, and 93Ru01
1985Pi03	PRVCA	31,	1032	A.A. Pilt, J.A. Cameron, R.B. Schubank, E.E. Habib
1985Re01	PRVCA	31,	1029	P.L. Reeder, R.A. Warner, R.M. Liebsch, R.L. Gill, A. Piotrowski
1985Re02	NUPAB	435,	333	J.P.L. Reinecke, F.B. Waanders, P. Oberholzer, P.J.C. Janse van Rensburg, J.A. Cilliers, J.J.A. Smit, M.A. Meyer, P.M. Endt
1985Re.A	P-Chicago		171	P.L. Reeder, et al, and 93Ru01
1985Ry02	ZPAAD	322,	263	K. Rykaczewski, I.S. Grant, R. Kirchner, O. Klepper, V.T. Koslowsky, P.O. Larsson, E. Nolte, G. Nyman, E. Roeckl, D. Schardt, L. Spanier, P. Tidemand-Petersson, E.F. Zganjar, J. Żylicz
1985Sa15	ZPAAD	321,	255	M. Samri, J.G. Costa, G. Klotz, D. Magnac, R. Selz, J.P. Zirnfeld
1985Sc09	ZPAAD	320,	595	U.J. Schrewe, H. Dornhoefer, E. Runte, W.D. Schmidt-Ott, T. Tidemand-Petersson
1985Sc16	NIMAE	236,	225	H. Schölermann, B.R.L. Siebert
1985Si25	JPSLB	46,	L1095	C. Signarbieux, G. Simon, J. Trochon, F. Brisard and PrvCom GAU Jan 1988
1985So03	PRVCA	31,	1801	L.P. Somerville, M.J. Nurmia, J.M. Nitschke, A. Ghiorso, E.K. Hulet, R.W. Lougheed
1985St02	PRVCA	32,	582	R.E. Stone, C.E. Bingham, L.L. Riedinger, R.W. Lide, H.K. Carter, R.L. Mlekodaj, E.H. Spejewski
1985Ta.A	P-Swansea		343	V.L. Talrose, E.N. Nikolaev
1985Ti01	ZPAAD	320,	405	P. Tidemand-Petersson, E. Runte, W.-D. Schmidt-Ott, U.J. Schrewe
1985Ti02	NUPAB	437,	342	P. Tidemand-Petersson, R. Kirchner, O. Klepper, E. Roeckl, D. Schardt, A. Plochocki, J. Żylicz
1985To10	NUPAB	439,	427	Y. Tokunaga, H. Seyfarth, R.A. Meyer, O.W.B. Schult, H.G. Börner, G. Barreau, H.R. Faust, K. Schreckenbach, S. Brant, V. Paar, M. Vouk, D. Vretenar
1985Ts01	ZPAAD	322,	295	J.S. Tsai, T.J. Kennett, W.V. Prestwich
1985Ts02	ZPAAD	322,	597	J.S. Tsai, W.V. Prestwich, T.J. Kennett
1985Uh01	NIMBE	9,	234	M. Uhrmacher, K. Pampus, F.J. Bergmeister, D. Purschke, K.P. Lieb
1985Va03	PYLBB	154,	354	P. Van Duppen, E. Coenen, K. Deneffe, M. Huyse, J.L. Wood
1985Va.A	JINR-R6-85-22			E.V. Vasileva, et al
1985Vo03	PRVCA	31,	1510	R.-D. von Dincklage, J. Gerl, H.L. Ravn, G.J. Beyer
1985Vo13	NUPAB	445,	113	R.-D. von Dincklage, H.J. Hay, H.L. Ravn
1985Vo15	ZPAAD	322,	669	T. von Egidy, H.G. Börner, F. Hoyler
1985Wh03	MTRGA	21,	193	R.E. White, P.H. Barker, D.M.J. Lovelock
1985Wi07	ZPAAD	321,	179	P.A. Wilmarth, J.M. Nitschke, P.K. Lemmertz, R.B. Firestone

1985Wo01	PYLBB	150,	79	P.J. Woods, R. Chapman, J.L. Durell, J.N. Mo, N.E. Sanderson, R.A. Cunningham, B.R. Fulton
1985Wo04	NUPAB	437,	454	C.L. Woods, L.K. Fifield, R.A. Bark, P.V. Drumm, M.A.C. Hotchkis
1986				
1986Ad07	IANFA	50,	855	J. Adam, V. Vagner, M. Gonusek, B. Kratick
1986Ag.A	P-Charkov		98	V.A. Ageev, V.S. Belyavenko, V.A. Dzeltonodzkii, A.A. Klyushnikov
1986Au02	NUPAB	449,	491	G. Audi, A. Coc, M. Epherre, G. Le Scornet, C. Thibault, F. Touchard, ISOLDE
1986Ba26	PRVCA	34,	362	S.W. Barwick, P.B. Price, H.L. Ravn, E. Hourani, M. Hussonnois
1986Ba72	IANFA	50,	1898	K.A. Baskova, G.I. Borisov, A.B. Vovk, T.M. Gerus, L.I. Go
1986Be35	NUPAB	460,	352	A.V. Belozyorov, C. Borcea, Z. Dlouhy, A.M. Kalinin, R. Kalpakchieva, Nguyen Hoai Chau, Yu. Ts. Oganessian, Yu. E. Penionzhkevich
1986Be53	UFZHA	31,	1773	V.S. Belyavenko, G.P. Boroznets, I.N. Vishnevsky, V.A. Zheltonozhsky
1986Bj01	NUPAB	453,	463	T. Björnstad, M.J.G. Borge, J. Blomqvist, R.D. von Dincklage, G.T. Ewan, P. Hoff, B. Jonson, K. Kawade, A. Kerek, O. Klepper, G. Løvholden, S. Mattsson, G. Nyman, H.L. Ravn, G. Rudstam, K. Sistemich, O. Tengblad, ISOLDE
1986Bo28	ZPAAD	325,	149	V.R. Bom, P.C. Coops, R.W. Hollander, E. Coenen, K. Deneffe, P. Van Duppen, M. Huysse
1986Bo41	NUPAB	460,	373	M.J.G. Borge, M. Epherre-Rey-Campagnolle, D. Guillemaud-Mueller, B. Jonson, M. Langevin, G. Nyman, C. Thibault, ISOLDE
1986Bo46	PHSTB	34,	591	M.J.G. Borge, A. De Rújula, P.G. Hansen, B. Jonson, G. Nyman, H.L. Ravn, K. Riisager, ISOLDE
1986Bu18	PRVCA	34,	2316	B.L. Burks, R.L. Varner, E.J. Ludwig
1986Co12	ZPAAD	324,	485	E. Coenen, K. Deneffe, M. Huysse, P. Van Duppen, J.L. Wood
1986Cu01	PRLTA	56,	34	M.S. Curtin, L.H. Harwood, J.A. Nolen, B. Sherrill, Z.Q. Xie, B.A. Brown
1986Da.A	AnRpt McGill		29	H. Dautet, R. Turcotte, S.K. Mark
1986De13	NUPAB	454,	1	H.P.L. De Esch, C. van der Leun
1986De14	NUPAB	454,	48	H.P.L. De Esch, J.B.J.M. Lanen, C. van der Leun
1986Ek01	PHSTB	34,	614	B. Ekström, B. Fogelberg, P. Hoff, E. Lund, A. Sangiyavanish
1986Fi06	NUPAB	453,	497	L.K. Fifield, C.L. Woods, W.N. Catford, R.A. Bark, P.V. Drumm, K.T. Keoghan
1986Ga19	PRVCA	34,	1663	C.A. Gagliardi, D.R. Semon, R.E. Tribble, L.A. Van Ausdeln
1986Gi07	PRLTA	56,	1874	R.L. Gill, R.F. Casten, D.D. Warner, A. Piotrowski, H. Mach, J.C. Hill, K.K. Worn, J.A. Winger, R. Moreh
1986Gr01	PRLTA	56,	819	G.L. Greene, E.G. Kessler, Jr., R.D. Deslattes, H. Börner
1986Ha22	NUPAB	455,	231	A.M.I. Hague, R.F. Casten, I. Förster, A. Gelberg, R. Rascher, R. Richter, P. von Brentano, G. Barreau, H.G. Börner, S.A. Kerr, K. Schreckenbach, D.D. Warner
1986Hu01	PRLTA	56,	313	E.K. Hulet, J.F. Wild, R.J. Dougan, R.W. Loughheed, J.H. Landrum, A.D. Dougan, M. Schädel, R.L. Hahn, P.A. Baisden, C.M. Henderson, R.J. Dupzyk, K. Summerer, G.R. Bethune
1986Hu05	PRVCA	34,	1394	E.K. Hulet, R.W. Loughheed, J.F. Wild, R.J. Dougan, K.J. Moody, R.L. Hahn, C.M. Henderson, R.J. Dupzyk, G.R. Bethune
1986Ka43	NUPAB	460,	437	N. Kaffrell, P. Hill, J. Rogowski, H. Tetzlaff, N. Trautmann, E. Jacobs, P. De Gelder, D. De Frenne, K. Heyde, G. Skarnemark, J. Alstad, N. Blasi, M.N. Harakeh, W.A. Sterrenburg, K. Wolfsberg
1986Ke03	NUPAB	452,	173	J.G. Keller, K.-H. Schmidt, F.P. Heßberger, G. Münzenberg, W. Reisdorf, H.-G. Clerc, C.-C. Sahm, and PrvCom K.-H. Schmidt to AHW November 1992
1986Ke14	NIMAE	249,	366	T.J. Kennett, W.V. Prestwich, J.S. Tsai
1986Ko19	ZPAAD	324,	271	P.J.J. Kok, J.B.M. de Haas, K. Abrahams, H. Postma, W.J. Huiskamp
1986Li11	NATUA	320,	246	M. Lindner, D.A. Leich, R.J. Borg, G.P. Russ, J.M. Bazan, D.S. Simons, A.R. Date
1986Lo16	JCOMA	122,	461	R.W. Loughheed, E.K. Hulet, R.J. Dougan, J.F. Wild, R.J. Dupzyk, C.M. Henderson, K.J. Moody, R.L. Hahn, K. Summerer, G. Bethune
1986Ma40	PRVCA	34,	729	L.G. Mann, R.G. Lanier, G.L. Struble, R.A. Naumann, R.T. Kouzes

1986Ma42	PRVCA	34,	1117	H. Mach, R.L. Gill, D.D. Warner, A. Piotrowski, R. Moreh
1986Mi08	PRVCA	33,	1736	C. Miehé, Ph. Dessagne, P. Baumann, A. Huck, G. Klotz, A. Knipper, G. Walter, C. Richard-Serre
1986Mi14	PRVCA	33,	2204	D. Miljanic, S. Blagus, M. Zadro
1986Pr03	NUPAB	455,	1	P.T. Prokofjev, V.A. Bondarenko, T.V. Guseva, N.D. Kramer, L.I. Simonova, J.J. Tambergs, K. Schreckenbach, W.F. Davidson, J.A. Pinston, D.D. Warner, P.H.M. van Assche, A.M.J. Spits
1986Pr05	ZPAAD	325,	321	W.V. Prestwich, T.J. Kennett, J.S. Tsai
1986Ru04	ZPAAD	324,	27	B. Rubio, A. Ercan, G. de Angelis, P. Kleinheinz, J.L. Tain, B. Brinkmoeller, D. Paul, J. Meissburger, L.G. Mann, D.J. Decman, T.N. Massey, G.L. Struble, H.J. Scheerer, J. Blomqvist
1986Ru05	ZPAAD	324,	119	E. Runte, T. Hild, W.-D. Schmidt-Ott, U.J. Schrewe, P. Tidemand-Petersson, R. Michaelsen
1986Ry04	NIMAE	253,	47	A. Rytz, R.A.P. Wiltshire, M. King
1986Sc16	NUPAB	454,	267	H.H. Schmidt, T. von Egidy, H.J. Scheerer, P. Hungerford, H.G. Börner, S.A. Kerr, K. Schreckenbach, R.F. Casten, W.R. Kane, D.D. Warner, A. Chalupka, M.K. Balodis, T.V. Guseva, P.T. Prokofjev, J.J. Tambergs
1986Sc25	JPHGB	12,	411	H.H. Schmidt, W. Stöfl, T. von Egidy, P. Hungerford, H.J. Scheerer, K. Schreckenbach, H.G. Börner, D.D. Warner, R.E. Chrien, R.C. Greenwood, C.W. Reich
1986Se04	PYLBB	173,	397	K.K. Seth, S. Iversen, M. Kaletka, D. Barlow, A. Saha, R. Soundranayagam
1986Sm05	ZPAAD	324,	283	R.J. Smith, P.J. Woods, R. Chapman, J.L. Durell, J.N. Mo, B.R. Fulton, R.A. Cunningham
1986To12	PYLBB	178,	150	K.S. Toth, Y.A. Ellis-Akovali, J.M. Nitschke, P.A. Wilmarth, P.K. Lemmert, D.M. Moltz, F.T. Avignone III
1986Ts04	CJPHA	64,	1569	J.S. Tsai, W.V. Prestwich, T.J. Kennett
1986U102	ZPAAD	325,	247	G. Ulm, S.K. Bhattacharjee, P. Dabkiewicz, G. Huber, H.-J. Kluge, T. Kuhl, H. Lochmann, E.-W. Otten, K. Wendt, S.A. Ahmad, W. Klempt, R. Neugart, ISOLDE
1986Va08	PRVCA	33,	1141	G. Vandenput, P.H.M. van Assche, L. Jacobs, J.M. van den Cruyce, R.K. Smither, K. Schreckenbach, T. von Egidy, D. Breitig, H.A. Baader, H.R. Koch
1986Ve.A	P-Charkov		107	G.V. Veselov, K.A. Mezilev, Yu. N. Novikov, A.V. Lopov, V.A. Sergienko
1986Ve.B	P-Charkov		138	G.V. Veselov, K.A. Mezilev, Yu. N. Novikov, A.V. Lopov, Yu. Ya. Sergeev, V.A. Sergienko, V.I. Tichonov
1986Vi09	PRLTA	57,	3253	D.J. Vieira, J.M. Wouters, K. Vaziri, R.H. Krauss, Jr., H. Wollnik, G.W. Butler, F.K. Wohn, A.H. Wapstra
1986Wa17	RAEFB	94,	27	R.A. Warner, P.L. Reeder
1986Wi15	ZPAAD	325,	485	P.A. Wilmarth, J.M. Nitschke, R.B. Firestone, J. Gilat
1986Wi16	NUPAB	460,	501	Ch. Winter, B. Krusche, K.P. Lieb, H.H. Schmidt, T. von Egidy, P. Hungerford, F. Hoyler, H.G. Börner
1986Wo07	PYLBB	182,	297	P.J. Woods, R. Chapman, J.L. Durell, J.N. Mo, R.J. Smith, B.R. Fulton, R.A. Cunningham, P.V. Drumm, L.K. Fifield
1986Ya17	PYLBB	181,	169	S. Yasumi, M. Ando, H. Maezawa, H. Kitamura, T. Ohta, F. Ochiai, A. Mikuni, M. Maruyama, M. Fujioka, K. Ishii, T. Shinozuka, K. Sera, T. Omori, G. Izawa, M. Yagi, K. Masumoto, K. Shima, T. Mukoyama, Y. Inagaki, I. Sugai, A. Masuda, O. Kawakami
1987				
1987Aj.A	PrvCom	AHW	Jul	F. Ajzenberg-Selove
1987Ba52	NUPAB	472,	445	M.K. Balodis, P.T. Prokofjev, N.D. Kramer, L.I. Simonova, K. Schreckenbach, W.F. Davidson, J.A. Pinston, P. Hungerford, H.H. Schmidt, H.J. Scheerer, T. von Egidy, P.H.M. van Assche, A.M.J. Spits, R.F. Casten, W.R. Kane, D.D. Warner, J. Kern
1987Bo07	PRLTA	58,	2019	S. Boris, A. Golutvin, L. Laptin, V. Lubimov, V. Nagovizin, V. Nozik, E. Novikov, V. Soloshenko, I. Tihomirov, E. Tretjakov, N. Myasoedov

1987Bo24	NUPAB	470,	13	M. Bogdanović, R. Brissot, G. Barreau, K. Schreckenbach, S. Kerr, H.G. Börner, I.A. Kondurov, Yu. E. Loginov, V.V. Martynov, P.A. Sushkov, H. Seyfarth, T. von Egidy, P. Hungerford, H.H. Schmidt, H.J. Scheerer, A. Chalupka, W. Kane, G. Alaga
1987Bo29	HYIND	34,	25	W. Borchers, R. Neugart, E.W. Otten, H.T. Duong, G. Ulm, K. Wendt, ISOLDE, and 89Ot.1
1987Br05	NUPAB	465,	221	A. Bruce, D. Hicks, D.D. Wagner
1987Br.B	AnRpt Julich		9	B. Brinkmoeller, H.P. Morsch, R. Siebert, P. Decowski, M. Rogge, P. Turek
1987Co08	NUPAB	465,	240	G.G. Colvin, H.G. Börner, P. Geltenbort, F. Hoyler, S.A. Kerr, K. Schreckenbach, J.A. Cizewski, and PrvCom AHW December 1988
1987De04	ZPAAD	326,	155	J. Deslauriers, S.C. Gujrathi, S.K. Mark
1987De33	JPHGB	13,	1283	C.T.A.M. De Laat, P. Polak, A. Taal, J. Konijn, W. Lourens, A.H. Wapstra
1987De.A	AnRpt Leuven		47	P. Dendooven, M. Huysse, G. Reusen, J. Wouters, P. Van Duppen, I. Ahmad, R. Holzmann, R.V.F. Janssens
1987Eb02	NUPAB	464,	9	J. Eberz, U. Dinger, G. Huber, H. Lochmann, R. Menges, R. Neugart, R. Kirchner, O. Klepper, T. Kuhl, D. Marx, G. Ulm, K. Wendt, ISOLDE
1987El02	JPHGB	13,	93	A.M.Y. El-Lawindy, J.D. Burrows, P.A. Butler, J.R. Cresswell, V. Holliday, G.D. Jones, R. Tanner, R. Wadsworth, D.L. Watson, K.A. Connell, J. Simpson, C. Lauterbach, J.R. Mines
1987El09	PRVCA	36,	1529	Y.A. Ellis-Akovi, K.S. Toth, H.K. Carter, C.R. Bingham, I.C. Girit, M.O. Kortelahti
1987Fa.A	P-Rosseau		675	T. Faestermann, A. Gillitzer, K. Hartel, W. Henning, P. Kienle
1987Fo20	NUPAB	475,	301	B. Fogelberg, A.M. Bruce, D.D. Warner
1987Ga.B	P-Yurmala		86	N. Ganbaatar, G.V. Veselov, K.A. Mezilev, V.G. Kalinnikov
1987Ge01	JPHGB	13,	69	W. Gelletly, J.R. Larysz, H.G. Börner, R.F. Casten, W.F. Davidson, W. Mampe, K. Schreckenbach, D.D. Warner
1987Gi02	ZPAAD	326,	107	A. Gillitzer, T. Faestermann, K. Hartel, P. Kienle, E. Nolte
1987Gi05	PYLBB	192,	39	A. Gillibert, W. Mittag, L. Bianchi, A. Cunsolo, B. Fernandez, A. Foti, J. Gastebois, C. Gregoire, Y. Schutz, C. Stephan
1987Go25	PZETA	45,	205	M.G. Gornov, Y.B. Gurov, V.P. Koptev, P.V. Morokhov, K.O. Oganessian, B.P. Osipenko, V.A. Pechkurov, V.I. Savel'ev, F.M. Sergeev, A.A. Khomutov, B.A. Chernyshev, R.R. Shafigullin, A.V. Shishkov
1987Gr18	ZPAAD	327,	383	M. Graefenstedt, U. Keyser, F. Münnich, F. Schreiber, H.R. Faust, H. Weikard
1987Gr.A	P-Rosseau		30	M. Graefenstedt, U. Keyser, F. Münnich, F. Schreiber
1987Ha.A	AnRpt Tohoku		43	H. Hama, et al
1987He10	EULEE	3,	895	F.P. Heßberger, S. Hofmann, G. Münzenberg, A.B. Quint, K. Stümmerer, P. Armbruster
1987He21	NUPAB	474,	484	K. Heiguchi, S. Mitarai, B.J. Min, T. Kuroyanagi
1987He28	NUPAB	474,	77	R.G. Helmer, M.A. Lee, C.W. Reich, I. Ahmad
1987Ho01	PRVCA	35,	315	M.A.C. Hotchkis, J.E. Reiff, D.J. Vieira, F. Blönnigen, T.F. Lang, D.M. Moltz, X. Xu, J. Cerny
1987Ho06	ARISE	38,	195	D.D. Hoppes, B.M. Coursey, F.J. Schima, D. Yang
1987Ju02	ARISE	38,	193	S.M. Judge, A.M. Privitera, M.J. Woods
1987Ju04	ARISE	38,	839	S.M. Judge, P. Christmas, P. Cross, D. Smith, W.D. Hamilton, and PrvCom AHW February 1989
1987Ka29	NUPAB	470,	141	N. Kaffrell, P. Hill, J. Rogowski, H. Tetzlaff, N. Trautmann, E. Jacobs, P. De Gelder, D. De Frenne, K. Heyde, S. Borjesson, G. Skarnemark, J. Alstad, N. Blasi, M.N. Harakeh, W.A. Sterrenburg, K. Wolfsberg
1987Ke09	CJPHA	65,	1111	T.J. Kennett, W.V. Prestwich, J.S. Tsai
1987Ki.A	P-Rosseau		517	P. Kilcher, J. Sauvage, C. Bourgeois, F. Le Blanc, J. Oms, B. Roussière, J. Munsch, J. Obert, A. Caruette, A. Ferro, G. Boissier, J. Fournet-Fayas, M. Ducourtieux, G. Landois, R. Sellem, D. Sznadrdjerman, ISOCELE, A. Wojtasiewicz, M.C. Abreu, A. Ben Braham, K. Fransson, M.G. Porquet
1987Ko34	NUPAB	472,	419	V.T. Koslowsky, J.C. Hardy, E. Hagberg, R.E. Azuma, G.C. Ball, E.T.H. Clifford, W.G. Davies, H. Schmeing, U.J. Schrewe, K.S. Sharma
1987Li09	PYLBB	191,	245	C.F. Liang, P. Paris, P. Kleinheinz, B. Rubio, M. Piiparinen, D. Schardt, A. Plochocki, R. Barden
1987Li.A	P-Rosseau		521	C.F. Liang, P. Paris, Ch. Briançon

1987Me08	ZPAAD	327,	171	F. Meissner, E. Runte, V. Freystein, T. Hild, W.-D. Schmidt-ott, H. Salewski, R. Michaelsen
1987Mo06	PRVCA	35,	1275	D.M. Moltz, A.C. Betker, J.P. Sullivan, R.H. Burch, C.A. Gagliardi, R.E. Tribble, K.S. Toth, F.T. Avignone III
1987Mu15	ZPAAD	328,	49	G. Münzenberg, P. Armbruster, G. Berthes, H. Folger, F.P. Heßberger, S. Hofmann, J. Keller, K. Poppensieker, A.B. Quint, W. Reisdorf, K.-H. Schmidt, H.-J. Schött, K. Sümmerer, I. Zychor, M.E. Leino, R. Hingmann, U. Gollerthan, E. Hanelt
1987Ne.A	P-Rosseau		126	R. Neugart, E. Arnold, W. Borchers, W. Neu, G. Ulm, K. Wendt
1987Pe06	PRVCA	35,	1617	K.I. Pearce, N.M. Clarke, R.J. Griffiths, P.J. Simmonds, A.C. Dodd, D. Barker, J.B.A. England, M.C. Mannion, C.A. Ogilvie
1987Po04	ZPAAD	327,	17	F. Pougheon, J.C. Jacmart, E. Quiniou, R. Anne, D. Bazin, V. Borrel, J. Galin, D. Guerreau, D. Guillemaud-Mueller, A.C. Mueller, E. Roeckl, M.G. Saint-Laurent, C. Détraz
1987Ra06	PRVCA	36,	303	M.S. Rapaport, C.F. Liang, P. Paris, and PrvCom GAU July 1988
1987Ra12	NIMBE	26,	72	H.L. Ravn
1987Ru05	ZPAAD	328,	373	E. Runte, F. Meissner, V. Freystein, T. Hild, H. Salewski, W.-D. Schmidt-Ott, R. Michaelsen
1987Sc.A	P-Rosseau		477	D. Schardt, R. Barden, R. Kirchner, O. Klepper, A. Plochocki, E. Roeckl, P. Kleinheinz, M. Piiparinen, B. Rubio, K. Zuber, C.F. Liang, P. Paris, A. Huck, G. Walter, G. Marguier, H. Gabelmann, J. Blomqvist
1987Se04	NUPAB	464,	381	P.B. Semmes, R.A. Braga, R.W. Fink, J.L. Wood, J.D. Cole
1987Se05	PRLTA	58,	1930	K.K. Seth, M. Artuso, D. Barlow, S. Iversen, M. Kaletka, H. Nann, B. Parker, R. Soundranayagam
1987Se07	NUPAB	467,	93	T. Sekine, J. Cerny, R. Kirchner, O. Klepper, V.T. Koslowsky, A. Plochocki, E. Roeckl, D. Schardt, B. Sherrill, B.A. Brown
1987Se.A	P-Rosseau		324	K.K. Seth
1987Sp02	PRVAA	35,	679	P.T. Springer, C.L. Bennett, P.A. Baisden
1987Sp09	NUPAB	474,	359	L. Spanier, K. Aleklett, B. Ekström, B. Fogelberg
1987Sp.A	P-Leuven		S559	A.M.J. Spits, S.J. Robinson
1987St04	ZPAAD	326,	139	E. Stiliaris, H.G. Bohlen, X.S. Chen, B. Gebauer, A. Miczaika, W. von Oertzen, W. Weller, T. Wilpert
1987St11	PRVCA	35,	2033	G.S.F. Stephans, H.T. Fortune, L.C. Bland, M. Carchidi, R. Gilman, G.P. Gilfoyle, J.W. Sweet
1987St.A	P-Rosseau		489	J. Styczen, P. Kleinheinz, W. Starzecki, B. Rubio, G. de Angelis, H.J. Hahn, C.F. Liang, P. Paris, R. Reinhardt, P. von Brentano, J. Blomqvist
1987To02	PRVCA	35,	310	K.S. Toth, D.C. Sousa, J.M. Nitschke, P.A. Wilmarth
1987To05	PRVCA	35,	620	K.S. Toth, D.C. Sousa, J.M. Nitschke, P.A. Wilmarth
1987To09	PRVCA	35,	2330	K.S. Toth, D.M. Moltz, F. Blönnigen, F.T. Avignone, III
1987Va09	PRVCA	35,	1861	P. Van Duppen, E. Coenen, K. Deneffe, M. Huyse, J.L. Wood
1987Ve.A	P-Yurmala		146	G.V. Veselov, K.A. Mezilev, Yu. N. Novikov, A.V. Lopov, V.A. Sergienko
1987Vi01	NUPAB	463,	605	K. Vierinen
1987Wh01	PRVCA	35,	81	D.H. White, H.G. Börner, R.W. Hoff, K. Schreckenbach, W.F. Davidson, T. von Egidy, D.D. Warner, P. Jeuch, G. Barreau, W.R. Kane, M.L. Stelts, R.E. Chrien, R.F. Casten, R.G. Lanier, R.W. Loughheed, R.T. Kouzes, R.A. Naumann, R. Dewberry
1987Wi15	NUPAB	473,	129	Ch. Winter, B. Krusche, K.P. Lieb, T. Weber, G. Hlawatsch, T. von Egidy, F. Hoyler
1987Zi02	NUPAB	466,	280	F. Zijderhand, R.C. Makkus, C. van der Leun
			1988	
1988Ah02	NUPAB	483,	244	S.A. Ahmad, W. Klempt, R. Neugart, E.W. Otten, P.-G. Reinhard, G. Ulm, K. Wendt, ISOLDE
1988Aj01	NUPAB	490,	1	F. Ajzenberg-Selove
1988Ax01	PYLBB	210,	249	H. Axelsson, M. Cronqvist, A. De Rújula, P.G. Hansen, L. Johannsen, B. Jonson, R.A. Naumann, G. Nyman, J.W. Petersen, H.L. Ravn, K. Riisager, J.A. Scircle, ISOLDE
1988Ay01	PYLBB	201,	211	J. Äystö, P. Taskinen, M. Yoshii, J. Honkanen, P. Jauho, H. Penttilä, C.N. Davids

1988Ay02	NUPAB	480,	104	J. Äystö, C.N. Davids, J. Hattula, J. Honkanen, P. Jauho, R. Julin, S. Juutinen, J. Kumpalainen, T. Loenroth, A. Pakkanen, A. Passoja, H. Penttälä, P. Taskinen, E. Verho, A. Virtanen, M. Yoshi
1988Ba10	ZPAAD	329,	319	R. Barden, R. Kirchner, O. Klepper, A. Plochocki, G.-E. Rathke, E. Roeckl, K. Rykaczewski, D. Schardt, J. Żylicz
1988Ba42	ZPAAD	330,	341	D. Barnéoud, J. Blachot, J. Genevey, A. Gizon, R. Béraud, R. Duffait, A. Emsallem, M. Meyer, N. Redon, D. Rolando-Eugio
1988Be.A	P-StMalo		A1	R. Béraud, R. Duffait, A. Emsallem, M. Meyer, N. Redon, D. Rolando-Eugio, D. Barnéoud, J. Blachot, J. Genevey, A. Gizon
1988Bo06	NUPAB	477,	89	U. Bosch, W.-D. Schmidt-Ott, E. Runte, P. Tidemand-Petersson, P. Koschel, F. Meissner, R. Kirchner, O. Klepper, E. Roeckl, K. Rykaczewski, D. Schardt
1988Bo28	ZPAAD	331,	21	V.R. Bom, R.W. Hollander, E. Coenen, K. Deneffe, P. Van Duppen, M. Huysse
1988Bo39	NUPAB	490,	287	M.J.G. Borge, H. Cronberg, M. Cronqvist, H. Gabelmann, P.G. Hansen, L. Johannsen, B. Jonson, S. Mattsson, G. Nyman, A. Richter, K. Riisager, O. Tengblad, M. Tomaselli
1988Bu08	NUPAB	483,	221	D.G. Burke, G. Løvhøiden, T.F. Thorsteinsen
1988Ca21	NUPAB	489,	347	W.N. Catford, L.K. Fifield, T.R. Ophel, N.A. Orr, D.C. Weisser, C.L. Woods
1988CI04	JPHGB	14,	1399	N.M. Clarke, P.R. Hayes, M.B. Becha, K.I. Pearce, R.J. Griffiths, J.B.A. England, L. Zybert, C.N. Pinder, G.M. Field, R.S. Mackintosh
1988Co18	JPHGB	14,	1411	G.G. Colvin, S.J. Robinson, F. Hoyle
1988CoTa	CODBA	63,	1	E.R. Cohen, B.N. Taylor
1988De03	NUPAB	476,	316	H.P.L. De Esch, C. van der Leun
1988Du09	PYLBB	206,	195	J.P. Dufour, R. Del Moral, F. Hubert, D. Jean, M.S. Pravikoff, A. Fleury, A.C. Mueller, K.-H. Schmidt, K. Sümmerer, E. Hanelt, J. Frehaut, M. Beau, G. Giraudet
1988Fi04	NUPAB	484,	117	L.K. Fifield, R. Chapman, J.L. Durell, J.N. Mo, R.J. Smith, P.J. Woods, B.R. Fulton, R.A. Cunningham, P.V. Drumm
1988Fo05	PYLBB	209,	173	B. Fogelberg, Ye Zongyuan, L. Spanier
1988Gi04	PRVCA	37,	2600	M. Girod, Ph. Dessagne, M. Bernas, M. Langevin, F. Pougheon, P. Roussel
1988Gr30	RAACA	43,	223	K.E. Gregorich, R.A. Henderson, D.M. Lee, M.J. Nurmia, R.M. Chasteler, H.L. Hall, D.A. Bennett, C.M. Gannett, R.B. Chadwick, J.D. Leyba, D.C. Hoffman, G. Herrmann
1988Ho.A	AnRpt Daresb		49	M.A.C. Hotchkis, R. Chapman, J.H. McNeill, R.A. Cunningham, R.D. Page, P.J. Woods, G.D. Jones
1988Ka14	ZPAAD	330,	55	T. Karlewski, N. Hildebrand, M. Brügger, N. Kaffrell, N. Trautmann, G. Herrmann
1988Ka32	JUPSA	57,	2873	H. Kawakami, S. Kato, F. Naito, K. Nisimura, T. Ohshima, S. Shibata, T. Suzuki, K. Ukai, N. Morikawa, N. Nogawa, T. Nagafuchi, H. Taketani, M. Iwahashi, K. Hisatake, Y. Fukushima, T. Matsuda, T. Taniguchi
1988Ke09	CJPHA	66,	947	T.J. Kennett, W.V. Prestwich, J.S. Tsai
1988Ku14	NUPAB	484,	264	T. Kuroyanagi, S. Mitarai, B.J. Min, H. Tomura, Y. Haruta, K. Heiguchi, S. Suematsu, Y. Onizuka
1988Li11	NUPAB	481,	477	W.J. Lin, O.K. Manuel, G.L. Cumming, D. Krstic, R.I. Thorpe
1988Ma.A	P-BadHonnef		391	H. Mach, E.K. Warburton, R.L. Gill, R.F. Casten, A. Wolf, Z. Berant, J.A. Winger, K. Sistemich, G. Molnár, S.M. Yates
1988Me.A	Th.-Mainz			R. Menges, et al. and 89Ot.1
1988Mi13	PRVCA	38,	895	L.W. Mitchell, P.H. Fisher
1988Mo18	PRVCA	38,	737	M.F. Mohar, E. Adamides, W. Benenson, C. Bloch, B.A. Brown, J. Clayton, E. Kashy, M. Lowe, J.A. Nolen, Jr., W.E. Ormand, J. van der Plicht, B. Sherrill, J. Stevenson, J.S. Winfield
1988Mu08	ZPAAD	330,	63	A.C. Mueller, D. Bazin, W.D. Schmidt-Ott, R. Anne, D. Guerreau, D. Guillemaud-Mueller, M.G. Saint-Laurent, V. Borrel, J.C. Jacmart, F. Pougheon, A. Richard
1988Ni02	PRVCA	37,	2694	J.M. Nitschke, P.A. Wilmarth, J. Gilat, K.S. Toth, F.T. Avignone III
1988No02	PRVCA	37,	860	E.B. Norman, K.T. Lesko, A.E. Champagne
1988Or.A	Th.-Canberra			N.A. Orr

1988Pe13	PRVCA	38,	931	H. Penttilä, P. Taskinen, P. Jauho, V. Koponen, C.N. Davids, J. Äystö
1988Qu.A	AnRpt GSI		16	A.B. Quint, W. Morawek, K.-H. Schmidt, P. Armbruster, F.P. Heßberger, S. Hofmann, G. Münzenberg, W. Reisdorf, H. Stelzer, H.-G. Clerc, C.-C. Sahn
1988Sa06	ZPAAD	329,	169	H. Salewski, W.-D. Schmidt-Ott
1988Sa18	PRVCA	37,	2371	J.-L. Salicio, S. Drissi, M. Gasser, J. Kern, H.G. Börner, G.G. Colvin, K. Schreckenbach, R.W. Hoff, R.W. Loughheed
1988Vi02	PRVCA	38,	1509	K.S. Vierinen, A.A. Shihab-Eldin, J.M. Nitschke, P.A. Wilmarth, R.M. Chasteler, R.B. Firestone, K.S. Toth
1988Wi05	ZPAAD	329,	503	P.A. Wilmarth, J.M. Nitschke, K. Vierinen, K.S. Toth, M. Kortelahti
1988Wo02	NUPAB	476,	392	C.L. Woods, W.N. Catford, L.K. Fifield, N.A. Orr, R.J. Sadleir
1988Wo07	NUPAB	484,	145	C.L. Woods, W.N. Catford, L.K. Fifield, N.A. Orr
1988Wo09	ZPAAD	331,	229	J.M. Wouters, R.H. Kraus, Jr., D.J. Vieira, G.W. Butler, K.E.G. Lobner
1989				
1989A133	IANFA	53,	2089	G.D. Alkhozov, B.N. Belyayev, V.D. Domkin, Yu. G. Korobulin, V.V. Lukashovich, V.S. Mukhin
1989An02	NUPAB	491,	290	E. Andersen, M.J.G. Borge, D.G. Burke, H. Gietz, P. Hill, N. Kaffrell, W. Kurcewicz, G. Løvholden, S. Mattsson, R.A. Naumann, K. Nybø, G. Nyman, T.F. Thorsteinsen, ISOLDE
1989An13	YAFIA	50,	619	A.N. Andreyev, D.D. Bogdanov, A.V. Yerimin, A.P. Kabachenko, O.A. Orlova, G.M. Ter-Akopian, V.I. Chepigin
1989An.A	P-Dubna		508	A.N. Andreyev, D.D. Bogdanov, V.I. Chepigin, A.P. Kabachenko, O.A. Orlova, S. Sharo, G.M. Ter-Akopian, A.V. Yeremin, and 89An13
1989Ba22	PYLBB	223,	273	A.S. Barabash, V.V. Kuzminov, V.M. Lobashev, V.M. Novikov, B.M. Ovchinnikov, A.A. Pomansky
1989Ba28	PRVCA	40,	940	S.C. Baker, M.J. Brown, P.H. Barker
1989Ba42	NUPAB	500,	1	E.L. Bakkum, C. van der Leun
1989Ba50	PYLBB	228,	458	P. Baumann, A. Huck, G. Klotz, A. Knipper, G. Walter, G. Marguier, H.L. Ravn, C. Richard-Serre, A. Poves, J. Retamosa
1989Ba.B	AnRpt CRN		76	P. Baumann, A. Huck, G. Klotz, A. Knipper, G. Marguier, H. Ravn, C. Richard-Serre, G. Walter
1989Bo.A	PrvCom	GAu	Dec	H.G. Bohlen
1989Bu09	ZPAAD	333,	131	D.G. Burke, H. Folger, H. Gabelmann, E. Hagebø, P. Hill, P. Hoff, O. Jonsson, N. Kaffrell, W. Kurcewicz, G. Løvholden, K. Nybø, G. Nyman, H. Ravn, K. Riisager, J. Rogowski, K. Steffensen, T.F. Thorsteinsen, ISOLDE
1989Ca25	NUPAB	503,	263	W.N. Catford, L.K. Fifield, N.A. Orr, C.L. Woods
1989Ch01	PRVCA	39,	248	A.E. Champagne, R.T. Kouzes, A.B. McDonald, M.M. Lowry, D.R. Benton, K.P. Coulter, Z.Q. Mao
1989Ci02	NUPAB	493,	293	E.T.H. Clifford, E. Hagberg, J.C. Hardy, H. Schmeing, R.E. Azuma, H.C. Evans, V.T. Koslowsky, U.J. Schrewe, K.S. Sharma, I.S. Towner
1989Dr03	NUPAB	496,	530	P.V. Drumm, L.K. Fifield, R.A. Bark, M.A.C. Hotchkis, C.L. Woods
1989Fi01	PRVCA	39,	219	R.B. Firestone, J.M. Nitschke, P.A. Wilmarth, K. Vierinen, J. Gilat, K.S. Toth, Y.A. Akovali
1989Gr03	NUPAB	491,	373	M. Graefenstedt, U. Keyser, F. Münnich, F. Schreiber, ISOLDE
1989Gr23	ZPAAD	334,	239	M. Graefenstedt, P. Jürgens, U. Keyser, F. Münnich, F. Schreiber, K. Balog, T. Winkelmann, H.R. Faust
1989Gu03	ZPAAD	332,	189	D. Guillemaud-Mueller, Y.E. Penionzhkevich, R. Anne, A.G. Artukh, D. Bazin, V. Borrel, C. Détraz, D. Guerreau, B.A. Gvozdev, J.C. Jacmart, D.X. Jiang, A.M. Kalinin, V.V. Kamanin, V.B. Kutner, M. Lewitowicz, S.M. Lukyanov, A.C. Mueller, N. Hoai Chau, F. Pougheon, A. Richard, M.G. Saint-Laurent, W.D. Schmidt-Ott (see also 93Po.A)
1989Ha27	NUPAB	500,	90	Y. Hatsukawa, T. Ohtsuki, K. Sueki, H. Nakahara, I. Kohno, M. Magara, N. Shinohara, H.L. Hall, R.A. Henderson, C.M. Gannett, J.A. Leyba, R.B. Chadwick, K.E. Gregorich, D. Lee, M.J. Nurmia, D.C. Hoffman
1989Ha.A	PENUC	III,	99	J.C. Hardy, E. Hagberg
1989Ha.B	PENUC	III,	157	P.G. Hansen, B. Jonson



1989He03	NIMAE	274,	522	F.P. Heßberger, S. Hofmann, G. Münzenberg, K.-H. Schmidt, P. Armbruster, R. Hingmann
1989He13	ZPAAD	333,	111	F.P. Heßberger, H. Gäggeler, P. Armbruster, W. Brüchle, H. Folger, S. Hofmann, D. Jost, J.V. Kratz, M.E. Leino, G. Münzenberg, V. Ninov, M. Schädel, U. Scherer, K. Sümmerer, A. Türler, D. Ackermann
1989Hi04	NUPAB	492,	237	T. Hild, W.-D. Schmidt-Ott, V. Freystein, F. Meissner, E. Runte, H. Salewski, R. Michaelsen
1989Ho08	ZPAAD	332,	407	P. Hoff, B. Ekström, B. Fogelberg PrvCom of L. Spanier et al to ref.
1989Ho12	ZPAAD	333,	107	S. Hofmann, P. Armbruster, G. Berthes, T. Faestermann, A. Gillitzer, F.P. Heßberger, W. Kurcewicz, G. Münzenberg, K. Poppensieker, H.J. Schött, I. Zychor
1989Ho13	NUPAB	496,	462	J. Honkanen, V. Koponen, P. Taskinen, J. Aysto, K. Eskola, S. Messelt, K. Ogawa
1989Ho15	NUPAB	500,	111	C. Hofmeyr
1989Hu03	PRVCA	39,	997	H. Huck, A. Jech, G. Marti, M.L. Perez, J.J. Rossi, H.M. Sofia
1989Je07	NUPAB	503,	77	C. Jeanperrin, L.H. Rosier, B. Ramstein, E.I. Obiajunwa
1989Ka04	PRVCA	39,	818	S. Kato, S. Kubono, M.H. Tanaka, M. Yasue, T. Nomura, Y. Fuchi, S. Ohkawa, T. Miyachi, K. Iwata, T. Suehiro, Y. Yoshida
1989Ki11	NUPAB	496,	429	S.W. Kikstra, C. van der Leun, S. Raman, E.T. Jurney, I.S. Towner
1989Ko02	PRVCA	39,	636	M.O. Kortelahti, K.S. Toth, K.S. Vierinen, J.M. Nitschke, P.A. Wilmarth, R.B. Firestone, R.M. Chasteler, A.A. Shihab-Eldin
1989Ko07	ZPAAD	332,	229	M.O. Kortelahti, H.K. Carter, R.A. Braga, R.W. Fink, B.D. Kern
1989Ko22	ZPAAD	333,	339	V. Koponen, J. Äystö, J. Honkanen, P. Jauho, H. Penttilä, J. Suhonen, P. Taskinen, K. Rykaczewski, J. Żylicz, C.N. Davids
1989Kr12	NUPAB	503,	113	A. Krasznahorkay, Zs. Dombrádi, J. Timár, Z. Gácsi, T. Kibédi, A. Passoja, R. Julin, J. Kumpulainen, S. Brant, V. Paar
1989Le16	NUPAB	496,	477	M. Lewitowicz, Yu. E. Penionzhkevich, A.G. Artukh, A.M. Kalinin, V.V. Kamanin, S.M. Lukyanov, Nguyen Hoai Chau, A.C. Mueller, D. Guillemaud-Mueller, R. Anne, D. Bazin, C. Détraz, D. Guerreau, M.G. Saint-Laurent, V. Borrel, J.C. Jacmart, F. Pougheon, A. Richard, W.D. Schmidt-Ott
1989Li30	GCACA	53,	1597	M. Lindner, D.A. Leich, G.P. Russ, J.M. Bazan, R.J. Borg
1989Lo07	NUPAB	494,	157	G. Løvholden, T.F. Thorsteinsen, E. Andersen, M.F. Kiziltan, D.G. Burke
1989Ma05	JPGPE	15,	173	A.M. Mandal, S.K. Saha, S.M. Sahakundu, A.P. Patro
1989Me02	ZPAAD	332,	153	F. Meissner, W.-D. Schmidt-Ott, V. Freystein, T. Hild, E. Runte, H. Salewski, R. Michaelsen
1989Mi03	PRVCA	39,	992	Ch. Miehé, Ph. Dessagne, P. Baumann, A. Huck, G. Klotz, A. Knipper, G. Walter, G. Marguier
1989Mi16	NUPAB	501,	437	S. Michaelsen, Ch. Winter, K.P. Lieb, B. Krusche, S. Robinson, T. von Egidy
1989Mi17	NUPAB	501,	557	H. Miyatake, T. Nomura, S. Kubono, J. Tanaka, M. Oyaizu, H. Okawa, N. Ikeda, K. Sueki, H. Kudo, K. Morita, T. Shinozuka
1989Mi.A	P-Dubna		66	V.L. Mikheev, et al
1989Mu09	ZPAAD	333,	163	G. Münzenberg, P. Armbruster, S. Hofmann, F.P. Heßberger, H. Folger, J.G. Keller, V. Ninov, K. Poppensieker, A.B. Quint, W. Reisdorf, K.-H. Schmidt, J.R.H. Schneider, H.J. Schött, K. Sümmerer, I. Zychor, M.E. Leino, D. Ackermann, U. Gollerthan, E. Hanelt, W. Morawek, D. Vermeulen, Y. Fujita, T. Schwab
1989Mu16	NUPAB	502,	571	G. Münzenberg
1989Or03	NUPAB	491,	443	N.A. Orr, W.N. Catford, L.K. Fifield, M.A.C. Hotchkis, T.R. Ophel, D.C. Weisser, C.L. Woods
1989Or04	NUPAB	491,	457	N.A. Orr, L.K. Fifield, W.N. Catford, C.L. Woods
1989Ot.A	THISc	8,	517	E.W. Otten
1989Po09	NUPAB	499,	495	M.G. Porquet, C. Bourgeois, P. Kilcher, B. Roussière, J. Sauvage, H. Dautet, J.K.P. Lee, ISOCELE
1989Po10	NUPAB	500,	287	F. Pougheon, V. Borrel, J.C. Jacmart, R. Anne, C. Détraz, D. Guillemaud-Mueller, A.C. Mueller, D. Bazin, R. Del Moral, J.P. Dufour, F. Hubert, M.S. Pravikoff, G. Audi, E. Roeckl, B.A. Brown
1989Pr.A	PENUC	II,	205	P.B. Price, S.W. Barwick

1989Re.A	P-Miami			P.L. Reeder, et al
1989Ri03	NUPAB	499,	221	R. Richter, I. Förster, A. Gelberg, A.M.I. Haque, P. von Brentano, R.F. Casten, H.G. Börner, G.G. Colvin, K. Schreckenbach, G. Barreau, S.A. Kerr, H.H. Schmidt, P. Hungerford, H.J. Scheerer, T. von Egidy, R. Rascher
1989Ry02	ZPAAD	332,	275	K. Rykaczewski, A. Plochocki, I.S. Grant, H. Gabelmann, R. Barden, D. Schardt, J. Żylicz, G. Nyman, ISOLDE
1989Sa01	JPGPE	15,	73	S.K. Saha, S.M. Sahakundu
1989Sa11	NUPAB	494,	36	S.L. Sakharov, I.A. Kondurov, Yu. E. Loginov, V.V. Martynov, A.A. Radionov, P.A. Sushkov, Yu. L. Khazov, A.I. Egorov, V.K. Isupov, H.G. Börner, F. Hoyler, S. Kerr, K. Schreckenbach, G. Hlawatsch, T. von Egidy, H. Lindner
1989Sc24	NUPAB	501,	86	H. Schölermann, R. Böttger
1989Sc31	NUPAB	504,	1	H.H. Schmidt, P. Hungerford, T. von Egidy, H.J. Scheerer, H.G. Börner, S.A. Kerr, K. Schreckenbach, F. Hoyler, G.G. Colvin, A.M. Bruce, R.F. Casten, D.D. Warner, I.L. Kugava, V.A. Bondarenko, N.D. Kramer, P.T. Prokofjef, A. Chalupka
1989Sc.A	NDSAA	57,	515	M.R. Schmorak
1989Sh10	NIMAE	275,	123	K.S. Sharma, H. Schmeing, H.C. Evans, E. Hagberg, J.C. Hardy, V.T. Koslowsky
1989Si04	PRVDA	39,	1825	J.J. Simpson, A. Hime
1989Sm06	SAPHD	12,	74	J.J.A. Smit, Z.H.J. Pretorius, F.B. Waanders, J.P.L. Reinecke, J. Keilonen
1989Si05	PRVCA	39,	1503	S.T. Staggs, R.G.H. Robertson, D.L. Wark, P.P. Nguyen, J.F. Wilkerson, T.J. Bowles
1989St06	PRVCA	39,	1963	C.A. Stone, S.H. Faller, W.B. Walters
1989Su.A	BAPSA	34,	1819	B. Sur, E.B. Norman, K.T. Lesko, E. Browne, R.M. Larimer, H.L. Hall, J.D. Leyba, D.C. Hoffman
1989Ta11	ZPAAD	333,	29	J.L. Tain, B. Rubio, P. Kleinheinz, D. Schardt, R. Barden, J. Blomqvist
1989To01	PRVCA	39,	1150	K.S. Toth, D.M. Moltz, J.D. Robertson
1989Vi04	NUPAB	499,	1	K.S. Vierinen, J.M. Nitschke, P.A. Wilmarth, R.B. Firestone, J. Gilat
1989Wa10	PRVCA	39,	1647	S. Wang, D. Snowden-Ifft, P.B. Price, K.J. Moody, E.K. Hulet
1989Wi05	NUPAB	491,	395	Ch. Winter, B. Krusche, K.P. Lieb, S. Michaelsen, G. Hlawatsch, H. Linder, T. von Egidy, F. Hoyler, R.F. Casten
1989Yu01	PRVCA	39,	256	S. Yuan, T. Zhang, S. Xu, W. Li, L. Zhang, M. Liu, X. Ou, W. Li
1989Zh04	PRVCA	39,	1985	Z. Zhao, M. Gai, B.J. Lund, S.L. Rugari, D. Mikolas, B.A. Brown, J.A. Nolen, Jr., M. Samuel
1989Zl.A	PrvCom	GAu	May	I. Žlimer
				1990
1990Aj01	NUPAB	506,	1	F. Ajzenberg-Selove, and PrvCom AHW
1990Ak04	PRVCA	42,	1130	Y.A. Akovali, K.S. Toth, C.R. Bingham, M.B. Kassim, M. Zhang, H.K. Carter, W.D. Hamilton, J. Kormicki
1990Am04	PZETA	51,	607	A.I. Amelin, M.G. Gornov, Yu. B. Gurov, A.I. Ilin, V.P. Koplev, P.V. Morokhov, K.O. Oganessian, V.A. Pechkurov, V.I. Saveliev, E.M. Sergeev, B.A. Chern'yshev, R.R. Shafigulin, A.V. Shishkov
1990Am05	YAFIA	52,	1231	A.I. Amelin, M.G. Gornov, Y.B. Gurov, A.L. Il'in, P.V. Morokhov, V.A. Pechkurov, V.I. Savelev, F.M. Sergeev, S.A. Smirnov, B.A. Chernyshev, R.R. Shafigullin, A.V. Shishkov
1990An19	ZPAAD	337,	229	A.N. Andreyev, D.D. Bogdanov, V.I. Chepigina, A.P. Kabachenko, S. Sharov, G.M. Ter-Akopian, A.V. Yeremin
1990An22	ZPAAD	337,	231	A.N. Andreyev, D.D. Bogdanov, V.I. Chepigina, A.P. Kabachenko, S. Sharov, G.M. Ter-Akopian, A.V. Yeremin, O.N. Malyshev
1990Au.A	PrvCom	GAu	Feb	G. Audi, and PrvCom to 99Sa. A
1990Ba02	PRVCA	41,	246	P.H. Barker, G.D. Leonard
1990Be.A	PrvCom	AHW	Jun	C.E. Bemis
1990Be.B	P-Leningrad		132	E.A. Belomytseva, G.V. Veselov, K.A. Mezilev, Yu. N. Novikov, A.G. Polyakov, A.V. Popov, Yu. Ya. Sergeev, V.A. Sergienko, V.I. Tichonov
1990Bo16	PYLBB	241,	179	R. Bonetti, E. Fioretto, C. Migliorino, A. Pasinetti, F. Barranco, E. Vigezzi, R.A. Broglia

1990Bo39	YAFIA	52,	358	D.D. Bogdanov, V.P. Bugrov, S.G. Kadmenskiĭ
1990Bo52	IANFA	54,	1787	S.T. Boneva, E.V. Vasileva, V.D. Kulik, L.K. Khem, Yu. P. Popov, A.M. Sukhovoi, V.A. Khitrov, Yu. V. Kholnov
1990Bu17	PRVCA	42,	499	D.G. Burke, P.E. Garrett, Tao Qu, R.A. Naumann
1990Bu28	YAFIA	52,	305	E. Bukhner, I.N. Vishnevsky, F.A. Danevich, Yu. G. Zdesenko, H.V. Klapdor, B.N. Kropivnyansky, V.N. Kuts, A. Piepke, V.I. Tretyak, G. Heusser, J. Schneider, H. Strecker
1990Ch34	PRVCA	42,	1171	R.M. Chasteler, J.M. Nitschke, R.B. Firestone, K.S. Vierinen, P.A. Wilmarth
1990Ch37	PRVCA	42,	1796	R.M. Chasteler, J.M. Nitschke, R.B. Firestone, K.S. Vierinen, P.A. Wilmarth
1990De43	NUPAB	519,	529	C. Détraz, R. Anne, P. Bricault, D. Guillemaud-Mueller, M. Lewitowicz, A.C. Mueller, Yu Hu Zhang, V. Borrel, J.C. Jacmart, F. Pougheon, A. Richard, D. Bazin, J.P. Dufour, A. Fleury, F. Hubert, M.S. Pravikoff
1990Dy04	PYLBB	245,	343	G.R. Dyck, M.H. Sidky, J.G. Hykawy, C.A. Lander, K.S. Sharma, R.C. Barber, H.E. Duckworth
1990En02	NUPAB	510,	209	P.M. Endt, C. Alderliesten, F. Zijderhand, A.A. Wolters, A.G.M. van Hees
1990Endt	NUPAB	521,	1	P.M. Endt
1990Fo07	ZPAAD	337,	251	B. Fogelberg, Y. Zongyuan, B. Ekström, E. Lund, K. Aleklett, L. Sihver
1990Ge05	PRVCA	41,	2878	R.J. Gehrke, C. Casey, R.K. Murray
1990Ge12	ZDACE	17,	119	Ch. Gerz, D. Wilsdorf, G. Werth
1990Gr10	ZPAAD	336,	247	M. Graefenstedt, P. Jürgens, U. Keyser, F. Münnich, F. Schreiber, K. Balog, T. Winkelmann, H.R. Faust, B. Pfeiffer
1990Ha02	PRVCA	41,	618	H.L. Hall, K.E. Gregorich, R.A. Henderson, C.M. Gannett, R.B. Chadwick, J.D. Leyba, K.R. Czerwinski, B. Kadkhodayan, S.A. Kreek, D.M. Lee, M.J. Nurmi, D.C. Hoffman, C.E.A. Palmer, P.A. Baisden
1990He11	PRVCA	41,	2325	M. Hellström, B. Fogelberg, L. Spanier, H. Mach
1990Ho02	PRVCA	41,	484	R.W. Hoff, S. Drissi, J. Kern, W. Strassmann, H.G. Börner, K. Schreckenbach, G. Barreau, W.D. Ruhter, L.G. Mann, D.H. White, J.H. Landrum, R.J. Dupzyk, R.F. Casten, W.R. Kane, D.D. Warner
1990Ho03	PRVCA	41,	631	D.C. Hoffman, D.M. Lee, K.E. Gregorich, M.J. Nurmi, R.B. Chadwick, K.B. Chen, K.R. Czerwinski, C.M. Gannett, H.L. Hall, R.A. Henderson, B. Kadkhodayan, S.A. Kreek, J.D. Leyba
1990Ho10	NUPAB	512,	189	F. Hoyler, J. Jolie, G.G. Colvin, H.G. Börner, K. Schreckenbach, P. Van Isacker, P. Fettweis, H. Göktürk, J.C. Dehaes, R.F. Casten, D.D. Warner, A.M. Bruce
1990Is02	PRVCA	41,	1272	M.A. Islam, T.J. Kennett, W.V. Prestwich
1990Is03	ZPAAD	335,	173	M.A. Islam, T.J. Kennett, W.V. Prestwich
1990Is07	PRVCA	42,	207	M.A. Islam, T.J. Kennett, W.V. Prestwich
1990Is09	CJPHA	68,	1237	M.A. Islam, T.J. Kennett, W.V. Prestwich
1990Ka01	PRVCA	41,	1276	S. Kato, S. Kubono, M.H. Tanaka, M. Yasue, T. Nomura, Y. Fuchi, Y. Funatsu, S. Ohkawa, T. Miyachi, K. Iwata, T. Suehiro, Y. Yoshida, O. Nitoh
1990Ka10	PRVCA	41,	2004	S. Kato, S. Kubono, T. Nomura, Y. Fuchi, Y. Funatsu, S. Ohkawa, T. Miyachi, T. Suehiro, Y. Yoshida
1990Ka19	PRVCA	42,	563	S. Kato, S. Kubono, M.H. Tanaka, T. Nomura, Y. Fuchi, Y. Funatsu, S. Ohkawa, T. Miyachi, T. Suehiro, Y. Yoshida
1990Ka21	NUPAB	514,	173	A. Kaerts, P.H.M. van Assche, S.A. Kerr, F. Hoyler, H.G. Börner, R.F. Casten, D.D. Warner
1990Ka27	PRVCA	42,	1918	S. Kato, S. Kubono, M.H. Tanaka, M. Yasue, Y. Fuchi, Y. Funatsu, S. Ohkawa, T. Miyachi, T. Suehiro, Y. Yoshida
1990Ki07	NUPAB	512,	425	S.W. Kikstra, C. van der Leun, P.M. Endt, J.G.L. Booten, A.G.M. van Hees, A.A. Wolters
1990Ko25	PRVCA	42,	1267	M.O. Kortelahti, B.D. Kern, R.A. Braga, R.W. Fink, I.C. Girit, R.L. Mlekdaj
1990Le03	ZPAAD	335,	117	M. Lewitowicz, R. Anne, A.G. Artukh, D. Bazin, A.V. Belozyorov, P. Bricault, C. Détraz, D. Guillemaud-Mueller, J.C. Jacmart, E. Kashy, A. Latimier, S.M. Lukyanov, A.C. Mueller, Yu. E. Penionzhkevich, F. Pougheon, A. Richard, W.D. Schmidt-Ott, Y. Zhang
1990Li40	NIMAE	297,	217	H. Lindner, H. Trieb, T. von Egidy, H. Hiller, J. Klora, U. Mayerhofer, A. Walter, A.H. Wapstra

1990Ma03	PRVCA	41,	226	H. Mach, E.K. Warburton, R.L. Gill, R.F. Casten, J.A. Becker, B.A. Brown, J.A. Winger
1990Me08	PRVCA	41,	2921	J.T. Meek, W.G. Millen, G.W. Stockton, R.T. Kouzes
1990Me13	ZPAAD	337,	109	K.A. Mezilev, Yu. N. Novikov, A.V. Popov, Yu. Ya. Sergeev, V.I. Tikhonov
1990Mi23	PRLTA	25,	3092	H.S. Miley, F.T. Avignone III, R.L. Brodzinski, J.I. Collar, J.H. Reeves
1990Mu06	NUPAB	513,	1	A.C. Mueller, D. Guillemaud-Mueller, J.C. Jacmart, E. Kashy, F. Pougheon, A. Richard, A. Staudt, H.V. Klapdor-Kleingrothaus, M. Lewitowicz, R. Anne, P. Bricault, C. Détraz, Yu. E. Penionzhkevich, A.G. Artukh, A.V. Belozorov, S.M. Lukyanov, D. Bazin, W.D. Schmidt-Ott
1990Ne.A	PrvCom		Gizon	R. Neugart
1990Ne.B	P-Monterey			Zs. Netmeth, Karlsruhe
1990Ni05	ZPAAD	336,	473	V. Ninov, F.P. Heßberger, P. Armbruster, S. Hofmann, G. Münzenberg, M. Leino, Y. Fujita, D. Ackermann, W. Morawek, A. Lüttgen
1990Og01	PYLBB	235,	35	A.A. Ogloblin, N.I. Venikov, S.K. Lisin, S.V. Pirozhkov, V.A. Pchelin, Yu. F. Rodionov, V.M. Semochkin, V.A. Shabrov, I.K. Shvetsov, V.M. Shubko, S.P. Tretyakova, V.L. Mikheev
1990Pi05	NUPAB	510,	301	Š. Piskoř, W. Schäferlingová
1990Po13	IANFA	54,	852	A.V. Potempa, V.P. Afanasjev, Ya. Vavryshchuk, K. Ya. Gromov, V.G. Kalinnikov, N. Yu. Kovotskii, V.V. Kuznetsov, M. Lewandowski, Ya. A. Saidimov, M. Yakhim, Zh. Sereter, V.I. Fominykh, V. Charnadski, Yu. V. Yushkevich, M. Yanistki, A. Yasinski
1990Pr02	CJPHA	68,	261	W.V. Prestwich, T.J. Kennett, and erratum CJPHA 68,1352
1990Ri01	PYLBB	235,	30	K. Riisager, M.J.G. Borge, H. Gabelmann, P.G. Hansen, L. Johannsen, B. Jonson, W. Kurcewicz, G. Nyman, A. Richter, O. Tengblad, K. Wilhelmssen, ISOLDE
1990Ru02	JPGPE	16,	255	E. Ruchowska, J. Żylicz, C.F. Liang, P. Paris, Ch. Briançon
1990Sa16	PRVCA	41,	2418	K.E. Sale, T.-F. Wang, R.N. Boyd, G.J. Mathews, D.W. Heikkinen, M.L. Roberts, M.S. Islam, P.B. Corn
1990Sa32	ZPAAD	337,	161	H. Salewski, K. Becker, W.-D. Schmidt-Ott, T. Hild, F. Meissner, E. Runte, R. Michaelsen
1990Sa.A	Th.-Göttingen			H. Salewski
1990Se17	FZKAA	22,	183	H. Seyfarth, H.H. Guven, B. Kardon, G. Lhersonneau, K. Sistemich, S. Brant, N. Kaffrell, P. Maier-Komor, H.K. Vonach, V. Paar, D. Vorkapic, R.A. Meyer
1990Sh15	IMPAE	5,	2821	R.K. Sheline, C.F. Liang, P. Paris
1990Sh.A	AnRpt LBL		114	A.A. Shihab-Eldin, et al
1990So08	PRAMC	35,	329	P.C. Sood, R.K. Sheline
1990St13	ZPAAD	336,	369	U. Stöhlker, A. Blönnigen, W. Lippert, H. Wollnik
1990Ta07	ZPAAD	335,	477	I. Tago, Y. Kawase, K. Okano
1990Tu01	ZPAAD	337,	361	X.L. Tu, X.G. Zhou, D.J. Vieira, J.M. Wouters, Z.Y. Zhou, H.L. Seifert, V.G. Lind
1990Tu.A	Wallet Cards			J.K. Tuli
1990Va18	MPLAE	5,	1299	A.A. Vasenko, I.V. Kirpichnikov, V.A. Kuznetsov, A.S. Starostin, A.G. Djanyan, V.S. Pogosov, S.P. Shachysisyan, A.G. Tamanyan
1990Wa22	NIMAE	292,	671	A.H. Wapstra
1990We01	PRVCA	41,	778	D. Weselka, P. Hille, A. Chalupka
1990Wi12	PRVCA	42,	954	J.A. Winger, J.C. Hill, F.K. Wahn, E.K. Warburton, R.L. Gill, A. Piotrowski, R.B. Schuhmann, D.S. Brenner
1991				
1991Aj01	NUPAB	523,	1	F. Ajzenberg-Selove
1991An10	ZPAAD	338,	363	A.N. Andreyev, D.D. Bogdanov, V.I. Chepigin, A.P. Kabachenko, O.N. Malyshev, G.M. Ter-Akopian, A.V. Yeremin
1991Ay.A	P-Foros			J. Äystö, et al
1991Ba06	NUPAB	523,	261	M.K. Balodis, N.D. Kramer, P.T. Prokofjev, A.V. Afanasjev, T.V. Guseva, J.J. Tambergs, K. Schreckenbach, W.F. Davidson, D.D. Warner, J.A. Pinston, P.H.M. van Assche, A.M.J. Spits
1991Be25	NUPAB	533,	113	A. Ben Braham, C. Bourgeois, P. Kilcher, F. Le Blanc, B. Roussière, J. Sauvage, A.J. Kreiner, M.G. Porquet, ISOCELE

1991Be33	PRLTA	67,	3661	M. Bernas, P. Armbruster, S. Czajkowski, H. Faust, J.P. Bocquet, R. Brissot
1991Bi04	PRVCA	44,	1208	C.R. Bingham, M.B. Kassim, M. Zhang, Y.A. Akovali, K.S. Toth, W.D. Hamilton, H.K. Carter, J. Kormicki, J. von Schwarzenberg, M.M. Jarrio
1991Bi05	PRVCA	44,	325	S. Blagus, D. Miljanic, M. Zadro, G. Calvi, M. Lattuada, F. Riggi, C. Spitaleri, C. Blyth, O. Karban
1991Bo20	PRVCA	44,	888	R. Bonetti, C. Chiesa, A. Guglielmetti, C. Migliorino, A. Cesana, M. Ter-rani, P.B. Price
1991Bo22	ZPAAD	339,	311	A. Bouldjedri, A. Astier, R. Béraud, R. Duffait, A. Emsallem, H. Haas, ISOLDE
1991Bo35	NUPAB	534,	255	H.G. Börner, R.F. Casten, I. Förster, D. Lieberz, P. von Brentano, S.J. Robinson, T. von Egidy, G. Hlawatsch, H. Lindner, P. Geltenbort, F. Hoyler, H. Faust, G. Colvin, W.R. Kane, M. MacPhail
1991Ej02	PYLBB	258,	17	H. Ejiri, K. Fushimi, T. Kamada, H. Kinoshita, M. Kobiki, H. Ohsumi, K. Okada, H. Sano, T. Shibata, T. Shima, N. Tanabe, J. Tanaka, T. Taniguchi, T. Watanabe, N. Yamamoto
1991El04	JPGPE	17,	S145	S.R. Elliott, M.K. Moe, M.A. Nelson, M.A. Vient
1991Fi03	PRVCA	43,	1066	R.B. Firestone, J. Gilat, J.M. Nitschke, P.A. Wilmarth, K.S. Vierinen
1991Go19	NUPAB	531,	613	M.G. Gornov, Yu. B. Gurov, P.V. Morokhov, V.A. Pechkurov, V.I. Save-lyev, F.M. Sergeev, B.A. Chernyshev, R.R. Shafigullin, A.V. Shishkov, V.P. Koptev, K.O. Oganessian, B.P. Osipenco
1991Gr12	NUPAB	530,	401	J.C. Griffin, R.A. Braga, R.W. Fink, J.L. Wood, H.K. Carter, R.L. Mlekodaj, C.R. Bingham, E. Coenen, M. Huyse, P. Van Duppen
1991Gr13	PRVCA	44,	1728	V. Grafen, B. Ackermann, H. Baltzer, T. Bihn, C. Günther, J. de Boer, N. Gollwitzer, G. Graw, R. Hertenberg, H. Kader, A. Levon, A. Lösch
1991He04	ZPAAD	338,	7	K. Heiguchi, T. Hosoda, T. Komatsubara, T. Nomura, K. Furuno, R. Nakatani, S. Mitarai, T. Kuroyanagi
1991He21	ZPAAD	340,	225	F. Heine, T. Faestermann, A. Gillitzer, J. Homolka, M. Köpf, W. Wagner, see also 92He. A
1991Hi02	PRVCA	43,	2591	J.C. Hill, D.D. Schwellenbach, F.K. Wahn, J.A. Winger, R.L. Gill, H. Ohm, K. Sistemich
1991Hi.A	AnRpt LBL		69	M.M. Hindi, K.L. Wedding, E.B. Norman, K.T. Lesko, B. Sur, R.-M. Larimer, M.T.F. da Cruz, K.R. Czerwinski
1991Ho05	JPGPE	17,	145	T.H. Hoare, P.A. Butler, G.D. Jones, M. Loiselet, O. Naviliat-Cuncic, J. Vervier, M. Dahlinger, A.M.Y. El-Lawindy, R. Wadsworth, D.L. Watson
1991Ho08	CZYPA	41,	525	J. Honzatko, K. Konecny, Z. Kosina
1991Hy01	PRLTA	67,	1708	J.G. Hykawy, J.N. Nxumalo, P.P. Unger, C.A. Lander, R.C. Barber, K.S. Sharma, R.D. Peters, H.E. Duckworth
1991Is01	PRVCA	43,	1086	M.A. Islam, T.J. Kennett, W.V. Prestwich
1991Is02	CJPHA	69,	658	M.A. Islam, T.J. Kennett, W.V. Prestwich
1991Jo11	ZPAAD	340,	21	A. Jokinen, J. Äystö, P. Dendooven, K. Eskola, Z. Janas, P.P. Jauho, M.E. Leino, J.M. Parmonen, H. Penttilä, K. Rykaczewski, P. Taskinen
1991Ju05	ZPAAD	340,	125	A. Jungclaus, K.P. Lieb, C.J. Gross, J. Heese, D. Rudolph, D.J. Blumenthal, P. Chowdhury, P.J. Ennis, C.J. Lister, C. Winter, J. Eberth, S. Skoda, M.A. Bentley, W. Gelletly, B.J. Varley
1991Ka41	PYLBB	256,	105	H. Kawakami, S. Kato, T. Ohshima, S. Shibata, K. Ukai, N. Morikawa, N. Nogawa, K. Haga, T. Nagafuchi, M. Shigeta, Y. Fukushima, T. Taniguchi
1991Ke06	NIMAE	300,	67	H. Keller, R. Kirchner, O. Klepper, E. Roeckl, D. Schardt, R.S. Simon, P. Kleinheinz, C.F. Liang, P. Paris
1991Ke08	ZPAAD	339,	355	H. Keller, R. Barden, R. Kirchner, O. Klepper, E. Roeckl, D. Schardt, I.S. Grant, A. Plochocki, K. Rykaczewski, J. Szerypo, J. Żylicz, ISOLDE
1991Ke10	NUPAB	534,	77	J. Kern, A. Raemy, W. Beer, J.-Cl. Dousse, W. Schwitz, M.K. Balodis, P.T. Prokofjev, N.D. Kramer, L.I. Simonova, R.W. Hoff, D.G. Gardner, M.A. Gardner, R.F. Casten, R.L. Gill, R. Eder, T. von Egidy, E. Hagn, P. Hungerford, H.J. Scheerer, H.H. Schmidt, E. Zech, A. Chalupka, A.V. Murzin, V.A. Libman, I.V. Kononenko, C. Coceva, P. Giacobbe, I.A. Kondurov, Yu. E. Loginov, P.A. Sushkov, S. Brant, V. Paar

1991Ke11	ZPAAD	340,	363	H. Keller, R. Kirchner, O. Klepper, E. Roeckl, D. Schardt, R.S. Simon, P. Kleinheinz, R. Menegazzo, C.F. Liang, P. Paris, K. Rykaczewski, J. Żylicz, and Thesis H. Keller THD report GSI-91-6 February 1991
1991Ki04	NUPAB	529,	39	S.W. Kikstra, Z. Guo, C. van der Leun, P.M. Endt, S. Raman, T.A. Walkiewicz, J.W. Starner, E.T. Jurney, I.S. Towner
1991KI02	PRVCA	44,	2801	N. Klay, F. Kaeppler, H. Beer, G. Schatz, H. Börner, F. Hoyler, S.J. Robinson, K. Schreckenbach, B. Krusche, U. Mayerhofer, G. Hlawatsch, H. Lindner, T. von Egidy, W. Andrejtscheff, P. Petkov
1991Ko.A	P-Minsk		117	I.A. Kondurov, Yu. E. Loginov, P.A. Sushkov
1991Ko.B	P-Niigata		187	T. Kobayashi
1991Kr15	ZPAAD	340,	419	K.-L. Kratz, H. Gabelmann, P. Möller, B. Pfeiffer, H.L. Ravn, A. Wöhr, ISOLDE
1991Kr.A	AnRpt LBL		57	S.A. Kreek, et al
1991Le15	ZPAAD	340,	107	M. Lewandowski, A.W. Potempa, V.I. Fominikh, K.Y. Gromov, M. Janicki, J.V. Juschkevich, V.G. Kalinnikov, N.J. Kotovskij, V.V. Kuznetsov, N. Raschkova, J.A. Sajdimov, J. Wawryszczuk
1991Ly01	PRVCA	44,	764	J.E. Lynn, E.T. Jurney, S. Raman
1991Mc.A	ORNL-6660		63	J.H. McNeill, Y.A. Akovali, C.R. Bingham, J. Breitenbach, H.K. Carter, J.D. Garrett, J. Kormicki, P.F. Mantica
1991Me05	ZPAAD	339,	315	F. Meissner, W.-D. Schmidt-Ott, K. Becker, U. Bosch-Wicke, U. Ellmers, H. Salewski, R. Michaelsen
1991Mi08	ZPAAD	338,	371	S. Michaelsen, K.P. Lieb, S.J. Robinson
1991Mi15	NUPAB	530,	211	B.J. Min, S. Suematsu, S. Mitarai, T. Kuroyanagi, K. Heiguchi, M. Matsuzaki
1991No07	JPGPE	17,	S291	E.B. Norman, B. Sur, K.T. Lesko, M.M. Hindi, R.-M. Larimer, T.R. Ho, J.T. Witort, P.N. Luke, W.L. Hansen, E.E. Haller
1991Or01	PYLBB	258,	29	N.A. Orr, W. Mittig, L.K. Fifield, M. Lewitowicz, E. Plagnol, Y. Schutz, W.L. Zhan, L. Bianchi, A. Gillibert, A.V. Belozyorov, S.M. Lukyanov, Yu. E. Penionzhkevich, A.C.C. Villari, A. Cunsolo, A. Foti, G. Audi, C. Stephan, L. Tassan-Got, and PrvCom GAu December 1990, and erratum PYLBB 271(1991)468
1991Pr02	PRVCA	43,	1781	P.B. Price, K.J. Moody, E.K. Hulet, R. Bonetti, C. Migliorino
1991Ra01	PRVCA	43,	521	S. Raman, T.A. Walkiewicz, S. Kahane, E.T. Jurney, J. Sa, Z. Gacsi, J.L. Weil, K. Allaart, G. Bonsignori, J.F. Shriner, Jr.
1991Re.A	PrvCom	GAu	Sep	G. Reusen, M. Huyse
1991Ro07	PRLTA	67,	957	R.G.H. Robertson, T.J. Bowles, G.J. Stephenson, Jr., D.L. Wark, J.F. Wilkerson, D.A. Knapp
1991Ro.A	P-PacGrove		440	S.J. Robinson, H.G. Börner, S. Judge, J. Jolie, P. Schillebeeckx
1991Ry01	ADNDA	47,	205	A. Rytz
1991Se01	ZPAAD	338,	245	P.J. Sellin, P.J. Woods, R.D. Page, S.J. Bennett, R.A. Cunningham, M. Freer, B.R. Fulton, M.A.C. Hotchkis, A.N. James
1991Sh19	PRVCA	44,	2439	K.S. Sharma, E. Hagberg, G.R. Dyck, J.C. Hardy, V.T. Koslowsky, H. Schmeing, R.C. Barber, S. Yuan, W. Perry, M. Watson
1991Su09	PRLTA	66,	2444	B. Sur, E.B. Norman, K.T. Lesko, M.M. Hindi, R.-M. Larimer, P.N. Luke, W.L. Hansen, E.E. Haller
1991To08	PRVCA	44,	1868	K.S. Toth, K.S. Vierinen, M.O. Kortelahti, D.C. Sousa, J.M. Nitschke, P.A. Wilmarth
1991To09	ZPAAD	340,	343	K.S. Toth, K.S. Vierinen, J.M. Nitschke, P.A. Wilmarth, R.M. Chasteler
1991Tu02	PRLTA	67,	3211	A.L. Turkevich, T.E. Economou, G.A. Cowan
1991Va04	NUPAB	529,	268	P. Van Duppen, P. Decroock, P. Dendooven, M. Huyse, G. Reusen, J. Wauters
1991Wa.A	PrvCom	AHW		A.H. Wapstra
1991Zh24	PYLBB	260,	285	X.G. Zhou, X.L. Tu, J.M. Wouters, D.J. Vieira, K.E.G. Lobner, H.L. Seifert, Z.Y. Zhou, G.W. Butler
1991ZI01	PRLTA	67,	560	I. Žlimen, A. Ljubičić, S. Kaučić, B.A. Logan
				1992
1992Al.A	B-Bernkastel		PC2	D.V. Aleksandrov, Yu. A. Glukhov, E. Yu. Nikolskii, B.G. Novatskii, A.A. Ogloblin, D.N. Stepanov

1992An04	ZPAAD	342,	123	A.N. Andreyev, D.D. Bogdanov, V.I. Chepigin, A.P. Kabachenko, O.N. Malyshev, R.N. Sagajdak, G.M. Ter-Akopian, A.V. Yeremin
1992An.A	P-Bernkastel		759	A.N. Andreyev, D.D. Bogdanov, V.I. Chepigin, M. Florek, A.P. Kabachenko, O.N. Malyshev, S. Saro, G.M. Ter-Akopian, M. Veselsky, A.V. Yeremin
1992Ay02	PRLTA	69,	1167	J. Äystö, A. Astier, T. Enqvist, K. Eskola, Z. Janas, A. Jokinen, K.-L. Kratz, M. Leino, H. Penttilä, B. Pfeiffer, J. Żylicz
1992Ba01	PRVCA	45,	69	D. Bazin, R. Del Moral, J.P. Dufour, A. Fleury, F. Hubert, M.S. Pravikoff, R. Anne, P. Bricault, C. Détraz, M. Lewitowicz, Y. Zheng, D. Guillemaud-Mueller, J.C. Jacmart, A.C. Mueller, F. Pougheon, A. Richard
1992Ba28	ZPAAD	342,	125	K. Balog, M. Graefenstedt, M. Groß, P. Jürgens, U. Keyser, F. Münnich, T. Otto, F. Schreiber, T. Winkelmann, J. Wulff, ISOLDE
1992Ba.A	P-Bernkastel		777	P.H. Barker, S.A. Brindhaban
1992Be17	ZPAAD	341,	155	M.R. Beitins, S.T. Boneva, V.A. Khitrov, L.A. Malov, Y.P. Popov, P.T. Prokofjev, G.L. Rezvaya, L.I. Simonova, A.M. Sukhovoij, E.V. Vasilieva
1992Be30	PRLTA	69,	2341	T. Bernatowicz, J. Brannon, R. Brazzle, R. Cowsik, C. Hohenberg, F. Podosek
1992Be.A	IPNO-DRE-25			M. Bernas, et al
1992Bo02	NUPAB	536,	260	R. Böttger, H. Schölermann
1992Bo05	NUPAB	539,	249	M.J.G. Borge, D.G. Burke, H. Gietz, P. Hill, N. Kaffrell, W. Kurcewicz, G. Løvholden, S. Mattsson, R.A. Naumann, K. Nybø, G. Nyman, T.F. Thorsteinsen, ISOLDE
1992Bo28	JMOPE	39,	257	G. Bollen, H.-J. Kluge, Th. Otto, G. Savard, L. Schweikhard, H. Stolzenberg, G. Audi, R.B. Moore, G. Rouleau, ISOLDE, and PrvCom GAU November 1991
1992Bo37	ZPAAD	344,	135	V. Borrel, R. Anne, D. Bazin, C. Borcea, G.G. Chubarian, R. Del Moral, C. Détraz, S. Dogny, J.P. Dufour, L. Faux, A. Fleury, L.K. Fifield, D. Guillemaud-Mueller, F. Hubert, E. Kashy, M. Lewitowicz, C. Marchand, A.C. Mueller, F. Pougheon, M.S. Pravikoff, M.G. Saint-Laurent, O. Sorlin
1992Bo.B	PrvCom	AHW	Apr	R. Böttger
1992Bo.D	P-Bernkastel		743	V.A. Bolshakov, A.G. Dernjatin, K.A. Mezilev, Yu. N. Novikov, A.V. Popov, Yu. Ya. Sergeev, V.I. Tikhonov, V.A. Sergienko, G.V. Veselov
1992Br17	NUPAB	542,	1	A.M. Bruce, W. Gelletly, G.G. Colvin, P. Van Isacker, D.D. Warner
1992Bu10	ZPAAD	342,	403	D. Bucurescu, M.S. Rapaport, C.F. Liang, P. Paris, G. Cata-Danil
1992Bu12	NUPAB	550,	179	D.G. Burke, P.E. Garrett
1992Ch27	PRLTA	69,	3151	M. Chen, D.A. Imel, T.J. Radcliffe, H. Henrikson, F. Boehm
1992Co23	PYLBB	295,	143	E. Cosulich, G. Gallinaro, F. Gatti, S. Vitale
1992Cz.A	LBL-32		233	K.R. Czerwinski (thesis)
1992Da03	ARISE	43,	69	J. Dalmaso, G. Barci-Funel, G.J. Ardisson
1992Do10	PRVCA	46,	2127	J. Döring, G. Winter, L. Funke, B. Cederwall, F. Lidén, A. Johnson, A. Atac, J. Nyberg, G. Sletten, M. Sugawara
1992Ei07	PRVCA	46,	1535	S.R. Elliott, A.A. Hahn, M.K. Moe, M.A. Nelson, M.A. Vient
1992Ga15	NUPAB	550,	1	P.E. Garret, D.G. Burke
1992Go10	PRVCA	46,	833	J. Görres, M. Wiescher, K. Scheller, D.J. Morrissey, B.M. Sherrill, D. Bazin, J.A. Winger
1992Gr02	PRVCA	45,	1058	K.E. Gregorich, H.L. Hall, R.A. Henderson, J.D. Leyba, K.R. Czerwinski, S.A. Kreek, B.A. Khadkodayan, M.J. Nurmia, D.M. Lee, D.C. Hoffman
1992Gr06	NIMAE	311,	512	M. Groß, P. Jürgens, U. Keyser, S. Kluge, M. Mehrrens, S. Müller, F. Münnich, J. Wulff
1992Gr09	ZPAAD	341,	247	H. Grawe, P. Hoff, J.P. Omtvedt, K. Steffensen, R. Eder, H. Haas, H. Ravn, ISOLDE
1992Gr.A	P-Bernkastel		77	M. Groß, P. Jürgens, S. Kluge, M. Mehrrens, S. Müller, F. Münnich, J. Wulff, see also 87Gr18
1992Gu03	NUPAB	540,	117	Z. Guo, C. Alderliesten, C. van der Leun, P.M. Endt
1992Ha10	PRVCA	45,	1609	E. Hagberg, X.J. Sun, V.T. Koslowsky, H. Schmeing, J.C. Hardy
1992Ha15	NIMAE	313,	237	F.X. Hartmann, R.A. Naumann
1992Ha21	ZPAAD	343,	7	A. Harder, S. Michaelsen, A. Jungclaus, K.P. Lieb, A.P. Williams, H.G. Börner, M. Trautmannsheimer

1992Ha22	PRVCA	46,	1873	T.M. Hamilton, K.E. Gregorich, D.M. Lee, K.R. Czerwinski, N.J. Hannink, C.D. Kacher, B. Kadkhodayan, S.A. Kreek, M.J. Nurmia, M.R. Lane, M.P. Neu, A. Türler, D.C. Hoffman
1992Ha.B	P-Bernkastel		783	E. Hagberg, V.T. Koslowsky, I.S. Towner, J.C. Hardy, J.G. Hykawy, G. Savard, T. Shinozuka, P.P. Unger, H. Schmeing
1992He.A	P-Bernkastel		331	F. Heine, T. Faestermann, A. Gillitzer, H.J. Körner
1992Ho09	PYLBB	287,	381	E. Holzschuh, M. Fritschi, W. Kündig
1992Hu04	PRVCA	46,	1209	M. Huyse, P. Decrock, P. Dendooven, G. Reusen, P. Van Duppen, J. Wauters
1992Id01	ZPAAD	341,	427	N. Idrissi, A. Gizon, J. Genevey, P. Paris, V. Barci, D. Barnéoud, J. Blachot, D. Bucurescu, R. Duffait, J. Gizon, C.F. Liang, B. Weiss
1992Jo05	NUPAB	549,	420	A. Jokinen, J. Äystö, P.P. Jauho, M. Leino, J.M. Parmonen, H. Penttilä, K. Eskola, Z. Janas
1992Ju01	PRLTA	69,	2164	M. Jung, F. Bosch, K. Beckert, H. Eickhoff, H. Folger, B. Franzke, A. Gruber, P. Kienle, O. Klepper, W. Koenig, C. Kozhuharov, R. Mann, R. Moshhammer, F. Nolden, U. Schaaf, G. Soff, P. Spädtke, M. Steck, T. Stöhlker, K. Stümmerer
1992Ke06	PHSTB	46,	575	J. Kern, T. Engel, D. Hagen, G. Werth
1992Kr01	PRVCA	45,	1064	J.V. Kratz, M.K. Guber, H.P. Zimmermann, M. Schädel, W. Brütchle, E. Schimpf, K.E. Gregorich, A. Türler, N.J. Hannink, K.R. Czerwinski, B. Kadkhodayan, D.M. Lee, M.J. Nurmia, D.C. Hoffman, H. Gäggeler, D. Jost, J. Kovacs, U.W. Scherer, A. Weber
1992Kr.A	AnRpt LBL		58	S.A. Kreek, et al
1992Li09	ZPAAD	341,	401	C.F. Liang, P. Paris, A. Gizon, V. Barci, D. Barneou, R. Béraud, J. Blachot, Ch. Briançon, J. Genevey, R.K. Sheline, and PrvCom GAu September 1992
1992Lo.B	UCRL-JC-109951			R.W. Loughheed, et al
1992Me10	ZPAAD	343,	283	F. Meissner, H. Salewski, W.-D. Schmidt-Ott, U. Bosch-Wicke, R. Michaelsen
1992Mo03	PRVCA	45,	1392	K.J. Moody, E.K. Hulet, P.B. Price
1992Mo15	ZPAAD	342,	273	D.M. Moltz, J.C. Batchelder, T.F. Lang, T.J. Ognibene, J. Cerny, P.E. Haustein, P.L. Reeder
1992Mo25	PRVCA	46,	2624	K.J. Moody, R.W. Loughheed, E.K. Hulet
1992Mu12	ZPAAD	342,	393	J. Mukai, A. Odahara, R. Nakatani, Y. Haruta, H. Tomura, B.J. Min, K. Heiguchi, S. Suematsu, S. Mitarai, T. Kuroyanagi
1992Os04	ZPAAD	343,	489	A.N. Ostrowski, H.G. Bohlen, A.S. Demyanova, B. Gebauer, R. Kalpakchieva, Ch. Langner, H. Lenske, M. von Lucke-Petsch, W. von Oertzen, A.A. Ogloblin, Y.E. Penionzhkevich, M. Wilpert, Th. Wilpert
1992Pa05	PRLTA	68,	1287	R.D. Page, P.J. Woods, R.A. Cunningham, T. Davinson, N.J. Davis, S. Hofmann, A.N. James, K. Livingston, P.J. Sellin, A.C. Shotton
1992Po14	BRSPE	56,	666	A.V. Potempa, K. Ya. Gromov, J. Wawryszczuk, V.G. Kalinikov, V.V. Kuznetsov, M. Levandovsky, J. Saraatar, Ya. Saidimov, V.I. Fominykh, Yu. V. Yushkevich, M.B. Yuldashev
1992Pr03	ZPAAD	342,	23	M. Przewloka, A. Przewloka, P. Wächter, H. Wollnik
1992Pr04	ZPAAD	342,	27	M. Przewloka, A. Przewloka, P. Wächter, H. Wollnik
1992Ra18	PRVCA	46,	2241	S. Raman, J.L. Campbell, A. Prindle, R. Gunnink, J.C. Palathingal
1992Ra19	PRVCA	46,	972	S. Raman, E.T. Jurney, J.W. Starnier, J.E. Lynn
1992Ro21	HYIND	75,	457	I. Romanski, I. Berkes, D.E. Brown, M. De Jesus, R. Eder, I.S. Grant, E. Hagn, P. Harding, P. Herzog, B. Hinfurtner, B. Kastelein, H. Postma, J. Prinz, P. Richards, K. Schlosser, N.J. Stone, L. Vanneste, E. Zech, NICOLE, ISOLDE
1992Sa03	NUPAB	540,	83	J. Sauvage, C. Bourgeois, P. Kilcher, F. Le Blanc, B. Roussiére, M.I. Macias-Marques, F. Bragança Gil, M.G. Porquet, H. Dautet, ISOCELE
1992Sc16	NUPAB	545,	646	W.-D. Schmidt-Ott, H. Salewski, F. Meissner, U. Bosch-Wicke, P. Koschel, V. Kunze, R. Michaelsen
1992Sc.A	P-Bernkastel		627	W.-D. Schmidt-Ott, K. Becker, U. Bosch-Wicke, T. Hild, F. Meissner, R. Kirchner, E. Roeckl, K. Rykaczewski



1992Sh.A	P-Bernkastel	31		K.S. Sharma, P. Unger, G.R. Dyck, R.C. Barber, E. Hagberg, J.G. Hykawy, V.T. Koslowsky, J.C. Hardy, H. Schmeing, G. Savard, W. Perry, M. Watson, and PrvCom AHW October 1992
1992Te03	ZPAAD	342,	303	O. Tengblad, M.J.G. Borge, L. Johannsen, B. Jonson, M. Lindroos, T. Nilsson, G. Nyman, A. Poves, H.L. Ravn, J. Retamosa, K. Riisager, P. Sona, K. Wilhelmssen, ISOLDE
1992Th06	NUPAB	548,	71	K. Theine, A.P. Byrne, H. Hubel, M. Murzel, R. Chapman, D. Clarke, F. Khazaie, J.C. Lisle, J.N. Mo, J.D. Garrett, H. Ryde, R. Wyss
1992To02	PRVCA	45,	856	K.S. Toth, H.J. Kim, J.W. McConnell, C.R. Bingham, D.C. Sousa
1992Ul.A	PrvCom	AHW	Mar	S. Ulbig
1992Wa06	PRVCA	45,	1597	T.A. Walkiewicz, S. Raman, E.T. Jurney, J.W. Starnier, J.E. Lynn
1992Wo03	ARISE	43,	551	D.H. Woods, S.A. Woods, M.J. Woods, J.L. Makepeace, C.W.A. Downey, D. Smith, A.S. Munster, S.E.M. Lucas, H. Sharma
1992Wu09	ZPAAD	344,	205	S. Wüstenbecker, H.W. Becker, H. Ebbing, W.H. Schulte, M. Berheide, M. Buschmann, C. Rolfs, G.E. Mitchell, J.S. Schweitzer
1992Xu04	PRVCA	46,	510	S.-W. Xu, J.-S. Guo, S.-G. Yuan, M.-Q. Liu, E. Hagberg, V.T. Koslowsky, J.C. Hardy, G. Dyck, H. Schmeing, and erratum PRVCA 46(1992)2644
				1993
1993Ab11	PYLBB	316,	26	H. Abele, G. Helm, U. Kania, C. Schmidt, J. Last, D. Dubbers
1993Al03	ZPAAD	344,	425	G.D. Alkhazov, L.H. Batist, A.A. Bykov, F.V. Moroz, S. Yu. Orlov, V.K. Tarasov, V.D. Wittmann
1993An07	ZPAAD	345,	247	A.N. Andreyev, D.D. Bogdanov, V.I. Chepigin, A.P. Kabachenko, O.N. Malyshev, R.N. Sagaidak, G.M. Ter-Akopian, M. Veselsky, A.V. Yeremin
1993An19	NIMAE	330,	125	A.N. Andreyev, D.D. Bogdanov, V.I. Chepigin, V.A. Gorshkov, K.V. Mikhailov, A.P. Kabachenko, G.S. Popeko, S. Daro, G.M. Ter-Akopian, A.V. Yeremin
1993As02	PRVCA	47,	2954	K. Ashktorab, J.W. Jänecke, F.D. Becchetti, D.A. Roberts
1993Ba12	PRVCA	47,	2038	J.C. Batchelder, D.M. Moltz, T.J. Ognibene, M.W. Rowe, J. Cerny
1993Be21	PRVCA	48,	R1	G.E. Berman, M.L. Pitt, F.P. Calaprice, M.M. Lowry
1993Be46	ZPAAD	346,	325	P. Bednarczyk, G. de Angelis, P. Spolaore, D. Ackermann, J. Rico, D. Bazzacco, S. Lunardi, L. Müller, C. Rossi Alvarez, F. Scarlassara, G.F. Segato, F. Soramel
1993Bl.A	AnRpt GSI		53	B. Blank, S. Andriamonte, R. Del Moral, J.P. Dufour, A. Fleury, T. Josso, M.S. Pravikoff, S. Czajkowski, Z. Janas, A. Piechaczek, E. Roeckl, K.-H. Schmidt, K. Stümmerer, W. Trinder, M. Weber, T. Brohm, A. Grewe, E. Hanelt, A. Heinz, A. Junghans, C. Rohl, S. Steinhauser, B. Voss, M. Pfützner
1993Bo01	NUPAB	551,	54	V.A. Bondarenko, I.L. Kuvaga, P.T. Prokofjev, V.A. Khitrov, Yu. V. Kholnov, Le Hong Khiem, Yu. P. Popov, A.M. Sukhovojev, S. Brant, V. Paar, V. Lopac
1993Bo03	ZPAAD	344,	381	H.G. Bohlen, B. Gebauer, M. von Lucke-Petsch, W. von Oertzen, A.N. Ostrowski, M. Wilpert, Th. Wilpert, H. Lenske, D.V. Alexandrov, A.S. Demyanova, E. Nikolskii, A.A. Korshennikov, A.A. Ogloblin, R. Kalpakchieva, Y.E. Penionzhkevich, Š. Piskof
1993Bo26	NUPAB	562,	32	R. Bonetti, C. Chiesa, A. Guglielmetti, R. Matheoud, C. Migliorino, A.L. Pasinetti, H.L. Ravn
1993Bo.A	AnRpt GSI		65	F. Bosch, M. Jung
1993Br22	NUPBB	31,	76	R.L. Brodzinski, F.T. Avignone, J.I. Collar, H. Courant, E. Garcia, C.K. Guerard, W.K. Hensley, I.V. Kirpichnikov, H.S. Miley, A. Morales, J. Morales, R. Nunez-Lagos, S.B. Osetrov, V.S. Pogosov, A.A. Pomansky, J. Puimdon, J.H. Reeves, K. Ruddick, C. Saenz, A. Salinas, M.L. Sarsa, A.A. Smolnikov, A.S. Starostin, A.G. Tamanyan, S.I. Vasilev, J.A. Villar
1993Bu02	PRVCA	47,	131	D.G. Burke, P.C. Sood, P.E. Garrett, Tao Qu, R.K. Sheline, R.W. Hoff
1993Ch21	PRVCA	48,	109	R.E. Chrien, B.K.S. Koene, M.L. Stelts, R.A. Meyer, S. Brant, V. Paar, V. Lopac
1993Di03	PRVCA	47,	2916	D.E. DiGregorio, S. Gil, H. Huck, E.R. Batista, A.M.J. Ferrero, A.O. Gattone

1993Dm02	ARISE	44,	1097	S.N. Dmitriev, Yu. Ts. Oganessian, G.V. Buklabov, Yu. P. Kharitonov, A.F. Novgorodov, L.I. Salamatin, G. Ya. Starodub, S.V. Shishkin, Yu. V. Yushkevich, D. Newton
1993Do05	PRVCA	47,	2560	J. Döring, J.W. Holcomb, T.D. Johnson, M.A. Riley, S.L. Tabor, P.C. Womble, G. Winter
1993Dr.A	P-Fribourg		305	S. Drissi, M. Deleze, P.E. Garrett, J. Jolie, J. Kern, S.J. Mannanal, P.A. Tercier, J.P. Vorlet, N. Warr, G. Mouze, C. Ythier, H.G. Borner, F. Hoyler, S. Judge, K. Schreckenbach, A. Williams
1993Go37	PRVAA	47,	3433	M.V. Gorshkov, G.M. Alber, L. Schweikhard, A.G. Marshall
1993Go38	IJMPD	128,	47	M.V. Gorshkov, S. Guan, A.G. Marshall
1993Gr17	NIMAE	337,	106	R.C. Greenwood, M.H. Putnam
1993Gr.C	AnRpt Berkeley		76	K.E. Gregorich, C.D. Kacher, M.F. Mohar, D.M. Lee, M.R. Lane, E.R. Sylwester, D.C. Hoffman, M. Schädel, W. Brüchele, J.V. Kratz, R. Günther and AnRpt GSI p.14
1993Ha05	ZPAAD	345,	143	A. Harder, S. Michaelsen, K.P. Lieb, A.P. Williams
1993Ho.A	AnRpt GSI		64	S. Hofmann, V. Ninov, F.P. Heßberger, H. Folger, G. Münzenberg, H.J. Schött, P. Armbruster, A.N. Andreyev, A.G. Popeko, A.V. Yeremin, M.E. Leino, R. Janik, S. Saro, M. Veselsky, and PrvCom AHW September 1995
1993Ja03	NUPAB	552,	340	Z. Janas, J. Äystö, K. Eskola, P.P. Jauho, A. Jokinen, J. Kownacki, M. Leino, J.M. Parmonen, H. Penttilä, J. Szerypo, J. Żylicz
1993Je06	PHSTB	48,	399	R. Jertz, D. Beck, G. Bollen, J. Emmes, H.-J. Kluge, E. Schark, S. Schwarz, T. Schwarz, L. Schweikhard, P. Senne C. Carlberg, I. Bergström, H. Borgenstrand, G. Rouleau, R. Schuch, F. Söderberg
1993Ka12	PRVCA	47,	2452	A. Kawashima, K. Takahashi, A. Masuda
1993Kl02	PRVCA	47,	2502	G. Klotz, P. Baumann, M. Bounajma, A. Huck, A. Knipper, G. Walter, G. Marguier, C. Richard-Serre, A. Poves, J. Retamosa
1993Li10	NUCIA	106,	163	Sr. Little Flower, B.R.S. Babu, K. Neelakandan, R.N. Mukherjee, B.B. Baliga
1993Li18	PYLBB	312,	46	K. Livingston, P.J. Woods, T. Davinson, N.J. Davis, S. Hofmann, A.N. James, R.D. Page, P.J. Sellin, A.C. Shotter
1993Li34	PRVCA	48,	2151	K. Livingston, P.J. Woods, T. Davinson, N.J. Davis, S. Hofmann, A.N. James, R.D. Page, P.J. Sellin, A.C. Shotter
1993Li40	PRVCA	48,	3113	K. Livingston, P.J. Woods, T. Davinson, N.J. Davis, A.N. James, R.D. Page, P.J. Sellin, A.C. Shotter
1993Ma50	NUPAB	565,	543	G. Mairle, M. Seeger, H. Reinhardt, T. Kihm, K.T. Knöpfle, Chen Lin Wen
1993Mi04	NUPAB	552,	232	S. Michaelsen, A. Harder, K.P. Lieb, G. Graw, R. Hertenberger, D. Hofer, P. Schiemenz, E. Zanotti, H. Lenske, A. Weigel, H.H. Wolter, S.J. Robinson, A.P. Williams
1993Mo01	PRLTA	70,	394	J.L. Mortara, I. Ahmad, K.P. Coulter, S.J. Freedman, B.K. Fujikawa, J.P. Greene, J.P. Schiffer, W.H. Trzaska, A.R. Zeuli
1993Mo18	NUPAB	563,	21	K.J. Moody, R.W. Lougheed, J.F. Wild, R.J. Dougan, E.K. Hulet, R.W. Hoff, C.M. Henderson, R.J. Dupzyk, R.L. Hahn, K. Sümmerer, G.D. O'Kelley, G.R. Bethune
1993Nx01	PYLBB	302,	13	J.N. Nxumalo, J.G. Hykawy, P. P. Unger, C.A. Lander, R.C. Barber, K.S. Sharma, H.E. Duckworth
1993Nx02	PYLBB	312,	388	J.N. Nxumalo, J.G. Hykawy, K.J. Aarts, R.C. Barber, K.S. Sharma, H.E. Duckworth
1993Oh02	PRVDA	47,	4840	T. Ohshima, H. Sakamoto, T. Sato, J. Shirai, T. Tsukamoto, Y. Sugaya, K. Takahashi, T. Suzuki, C. Rosenfeld, S. Wilson, K. Ueno, Y. Yonezawa, H. Kawakami, S. Kato, S. Shibata, K. Ukai
1993Os06	NIMAE	332,	169	A. Osa, T. Ikuta, M. Shibata, M. Miyachi, H. Yamamoto, K. Kawade, Y. Kawase, S. Ichikawa
1993Pe11	NUPAB	561,	416	H. Penttilä, T. Enqvist, P.P. Jauho, A. Jokinen, M. Leino, J.M. Parmonen, J. Äystö, K. Eskola
1993Po.A	PrvCom	GAu	Dec	F. Pougheon
1993Pr.A	P-Fribourg		441	P.T. Prokofjev, A.V. Afanasjev, M.R. Beitins, L.I. Simonova, M.K. Balodis, G.L. Rezvaja

1993Qu03	ZPAAD	346,	119	A.B. Quint, W. Reisdorf, K.-H. Schmidt, P. Armbruster, F.P. Heßberger, S. Hofmann, J. Keller, G. Münzenberg, H. Stelzer, H.-G. Clerc, W. Morawek, C.-C. Sahn
1993Ru01	ADNDA	53,	1	G. Rudstam, K. Aleklett, L. Sihver
1993Ru03	PRVCA	47,	2574	D. Rudolph, C.J. Gross, M.K. Kadiyski, K.P. Lieb, M. Weiszflog, H. Grawe, J. Heese, K.-H. Maier, J. Eberth
1993Se04	PRVCA	47,	1933	P.J. Sellin, P.J. Woods, T. Davinson, N.J. Davis, K. Livingston, R.D. Page, A.C. Shotter, S. Hofmann, A.N. James
1993Se09	ZPAAD	346,	323	P.J. Sellin, P.J. Woods, T. Davinson, N.J. Davis, A.N. James, K. Livingston, R.D. Page, A.C. Shotter
1993Sh07	JPGPE	19,	617	R.K. Sheline, J. Kvasil, C.F. Liang, P. Paris
1993Sh23	ARISE	44,	923	M. Shibata, M. Asai, T. Ikuta, H. Yamamoto, J. Ruan, K. Okano, K. Aoki, K. Kawade
1993Si05	NIMAE	330,	195	M.H. Sidky, J.G. Hyckawy, G.R. Dyck, R.C. Barber, K.S. Sharma, C.A. Lander, H.E. Duckworth
1993Sp.A	AnRpt JYFL		95	A.M. Spits, P.H.M. Van Assche, H.G. Borner, W.F. Davidson, D.D. Warner, K. Schreckenbach, G.G. Colvin, R.C. Greenwood, C.W. Reich, P.O. Lipas, J. Suhonen, P. Sinkko, A. Backlin
1993To04	PRVCA	48,	436	K.S. Toth, D.C. Sousa, J.M. Nitschke, K.S. Vierinen, P.A. Wilmarth
1993To05	PRVCA	48,	445	K.S. Toth, P.A. Wilmarth, J.M. Nitschke, D.C. Sousa
1993Va04	PRLTA	70,	2888	R.S. Van Dyck, Jr., D.L. Farnham, P.B. Schwinberg
1993Wa03	ZPAAD	345,	21	J. Wauters, P. Dendooven, M. Huyse, G. Reusen, P. Van Duppen, R. Kirchner, O. Klepper, E. Roeckl
1993Wa04	PRVCA	47,	1447	J. Wauters, P. Dendooven, M. Huyse, G. Reusen, P. Van Duppen, P. Lievens, ISOLDE
1993We03	PYLBB	300,	210	Ch. Weinheimer, M. Przyrembel, H. Backe, H. Barth, J. Bonn, B. Degen, Th. Edling, H. Fischer, L. Fleischmann, J.U. Groß, R. Haid, A. Hermanni, G. Kube, P. Leiderer, Th. Loeken, A. Moltz, R.B. Moore, A. Osipowicz, E.W. Otten, A. Picard, M. Schrader, M. Steininger
1993Wi03	PYLBB	299,	214	J.A. Winger, D. Bazin, W. Benenson, G.M. Crawley, D.J. Morrissey, N.A. Orr, R. Pfaff, B.M. Sherrill, M. Steiner, M. Thoennessen, S.J. Yennello, B.M. Young
1993Wi05	PRLTA	70,	1759	F.E. Wietfeldt, Y.D. Chan, M.T.F. da Cruz, A. García, R.-M. Larimer, K.T. Lesko, E.B. Norman, R.G. Stokstad, I. Žilimen
1993Yo07	PRLTA	71,	4124	B.M. Young, W. Benenson, M. Fauerbach, J.H. Kelley, R. Pfaff, B.M. Sherrill, M. Steiner, J.S. Winfield, T. Kubo, M. Hellström, N.A. Orr, J. Stetson, J.A. Winger, S.J. Yennello
1993Yu03	ZPAAD	346,	187	S. Yuan, T. Zhang, S. Xu, Z. Li, Q. Pan, Z. Zhao, W. Yang, X. Zhang, W. Li, X. Yin, Y. Du, Y. Wang
				1994
1994Ah03	NUPAB	576,	246	I. Ahmad, J.E. Gindler, M.P. Carpenter, D.J. Henderson, E.F. Moore, R.V.F. Janssens, I.G. Bearden, C.C. Foster
1994An01	NUPAB	568,	323	A.N. Andreyev, D.D. Bogdanov, V.I. Chepigin, A.P. Kabachenko, O.N. Malyshev, Yu. A. Muzychka, B.I. Pustynnik, G.M. Ter-Akopian, A.V. Yeremin
1994An02	ZPAAD	347,	225	A.N. Andreyev, D.D. Bogdanov, V.I. Chepigin, A.P. Kabachenko, O.N. Malyshev, A.G. Popeko, R.N. Sagaidak, G.M. Ter-Akopian, M. Veselsky, A.V. Yeremin
1994Ar23	NIMAE	339,	168	G. Ardisson, V. Barci, O. El Samad
1994Ba06	PRVCA	49,	1221	V. Banerjee, A. Banerjee, G.S.N. Murthy, R.P. Sharma, S.K. Pardha Saradhi, A. Chakrabarti
1994Ba15	PYLBB	322,	176	A. Balysh, M. Beck, S.T. Belyaev, F. Bensch, J. Bockholt, A. Demekhin, A. Gurov, G. Heusser, H.V. Klapdor-Kleingrothaus, I. Kondratenko, D. Kotelnikov, V.I. Lebedev, B. Maier, A. Muller, F. Petry, A. Piepke, A. Pronsky, H. Strecker, M. Vollinger, K. Zuber
1994Ba50	PRVCA	50,	1180	P. Baumann, M. Bounajma, A. Huck, G. Klotz, A. Knipper, G. Walter, G. Marguier, C. Richard-Serre, H. Ravn, E. Hagebø, P. Hoff, K. Steffensen

1994Be24	PYLBB	331,	19	M. Bernas, S. Czajkowski, P. Armbruster, H. Geissel, Ph. Dessagne, C. Donzaud, H.-R. Faust, E. Hanelt, A. Heinz, M. Heese, C. Kozhuharov, Ch. Miehé, G. Münzenberg, M. Pfützner, C. Röhl, K.-H. Schmidt, W. Schwab, C. Stéphan, K. Sümmerer, L. Tassan-Got, B. Voss
1994B110	PRVCA	50,	2398	B. Blank, S. Andriamonje, R. Del Moral, J.P. Dufour, A. Fleury, T. Josso, M.S. Pravikoff, S. Czajkowski, Z. Janas, A. Piechaczek, E. Roeckl, K.-H. Schmidt, K. Sümmerer, W. Trinder, M. Weber, T. Brohm, A. Grewe, E. Hanelt, A. Heinz, A. Junghans, C. Rohl, S. Steinhauser, B. Voss, M. Pfützner
1994Bo28	NUPAB	576,	21	R. Bonetti, C. Chiesa, A. Guglielmetti, C. Migliorino, P. Monti, A.L. Pasinetti, H.L. Ravn
1994Br11	PRVCA	49,	2401	S.A. Brindhaban, P.H. Barker
1994Br37	NIMAE	340,	436	S.A. Brindhaban, P.H. Barker, M.J. Keeling, W.B. Wood
1994Bu18	ZPAAD	349,	3	D. Bucurescu, D. Barnéoud, R. Béraud, G. Cata-Danil, T. von Egidy, A. Emsallem, J. Genevey, A. Gizon, J. Gizon, C.F. Liang, P. Paris, C.A. Ur, B. Weiss
1994Cz02	ZPAAD	348,	267	S. Czajkowski, M. Bernas, P. Armbruster, H. Geissel, C. Kozhuharov, G. Münzenberg, D. Vieira, Ph. Dessagne, Ch. Miehé, E. Hanelt, G. Audi, J.K.P. Lee
1994De04	NUPAB	568,	141	M.E. Debray, A.J. Kreiner, M. Davidson, J. Davidson, D. Hojman, D. Santos, V.R. Vanin, N. Schutz, M. Aiche, A. Chevallier, J. Chevallier, J.C. Sens
1994Do08	PRVCA	49,	1867	M. Dombisky, L. Buchmann, J.M. D'Auria, U. Giesen, K.P. Jackson, J.D. King, E. Korkmaz, R.G. Korteling, P. McNeely, J. Powell, G. Roy, M. Trinczek, J. Vincent
1994Gi07	PRVCA	50,	2612	R.L. Gill
1994Go.A	PrvCom	AHW	Jul	M.V. Gorshkov
1994Gr07	PRVCA	49,	2971	P. Grabmayer, A. Mondry, G.J. Wagner, P. Woldt, G.P.A. Berg, J. Lisantti, D.W. Miller, H. Nann, E.J. Stephenson
1994Gr08	PRLTA	72,	1423	K.E. Gregorich, M.R. Lane, M.F. Mohar, D.M. Lee, C.D. Kacher, E.R. Sylwester, D.C. Hoffman
1994Ha.A	Th.-Mainz			H. Hartmann
1994He08	PRVCA	49,	1845	R.G. Helmer, C.W. Reich
1994He28	PRVCA	50,	2219	M. Hencheck, R.N. Boyd, M. Hellström, D.J. Morrissey, M.J. Balbes, F.R. Chloupek, M. Fauerbach, C.A. Mitchell, R. Pfaff, C.F. Powell, G. Raimann, B.M. Sherrill, M. Steiner, J. Vandegriff, S.J. Yennello
1994Hi04	PRVCA	49,	3289	M.M. Hindi, R.L. Kozub, S.J. Robinson
1994Hi05	PRVCA	50,	728	M.M. Hindi, A.E. Champagne, M.T.F. da Cruz, R.-M. Larimer, K.T. Lesko, E.B. Norman, B. Sur
1994Hy01	PRVCA	50,	1249	J.G. Hykawy, R.C. Barber, K.S. Sharma, K.J. Aarts, J.N. Nxumalo, H.E. Duckworth
1994Ib01	ZPAAD	350,	9	F. Ibrahim, P. Kilcher, B. Roussière, J. Sauvage, J. Genevey, A. Gizon, A. Knipper, G. Marguier, D. Barnéoud, R. Béraud, G. Cata-Danil, J. Blachot, I. Deloncle, R. Duffait, A. Emsallem, D. Hojman, A.J. Kreiner, F. Le Blanc, J. Libert, J. Oms
1994It.A	P-Tokai		185	S. Itoh, M. Yasuda, H. Yamamoto, T. Iida, A. Takahashi, K. Kawade
1994Jo.A	Th.-Jyvaskyla			A. Jokinen
1994Ka39	ZPAAD	350,	183	H. Kaur, J. Goswamy, J. Singh, A. Sharma, D. Mehta, N. Singh, R.K. Bhowmik, P.N. Trehan
1994Ke.B	AnRpt LBL		85	D.A. Keeney, et al
1994Ki.A	AnRpt CSNSM			J.B. Kim, et al
1994Ko16	PYLBB	326,	31	A.A. Korshennikov, K. Yoshida, D.V. Aleksandrov, N. Aoi, Y. Doki, N. Inabe, M. Fujimaki, T. Kobayashi, H. Kumagai, C.-B. Moon, E. Yu. Nikolskii, M.M. Obuti, A.A. Ogloblin, A. Ozawa, S. Shimoura, T. Suzuki, I. Tanihata, Y. Watanabe, M. Yanokura
1994Ko.A	AnRpt AECL		3-1	V.T. Koslowsky, E. Hagberg, G. Savard, M.J. Watson, J.C. Hardy
1994Kr03	PRVCA	49,	1859	S.A. Kreek, H.L. Hall, K.E. Gregorich, R.A. Henderson, J.D. Leyba, K.R. Czerwinski, B. Kadkhodayan, M.P. Neu, C.D. Kacher, T.M. Hamilton, M.R. Lane, E.R. Sylwester, A. Türler, D.M. Lee, M.J. Nurmia, D.C. Hoffman

1994Kr13	PRVCA	50,	2288	S.A. Kreek, H.L. Hall, K.E. Gregorich, R.A. Henderson, J.D. Leyba, K.R. Czerwinski, B. Kadkhodayan, M.P. Neu, C.D. Kacher, T.M. Hamilton, M.R. Lane, E.R. Sylwester, A. Türler, D.M. Lee, M.J. Nurmia, D.C. Hoffman
1994La22	PRLTA	73,	624	Yu. A. Lazarev, Yu. V. Lobanov, Yu. Ts. Oganessian, V.K. Utyonkov, F. Sh. Abdullin, G.V. Buklanov, B.N. Gikal, S. Iliev, A.N. Mezentsev, A.N. Polyakov, I.M. Sedykh, I.V. Shirokovsky, V.G. Subbotin, A.M. Sukhov, Yu. S. Tsyganov, V.E. Zhuchko, R.W. Loughheed, K.J. Moody, J.F. Wild, E.K. Hulet, J.H. McQuaid
1994Le05	ZPAAD	348,	151	M. Leino, J. Uusitalo, T. Enqvist, K. Eskola, A. Jokinen, K. Loberg, W.H. Trzaska, J. Äystö
1994Le22	NUPAB	576,	267	A.I. Levon, J. de Boer, G. Graw, R. Hertenberger, D. Hofer, J. Kvasil, A. Lösch, E. Müller-Zanotti, M. Würkner, H. Baltzer, V. Grafen, C. Günther
1994Li12	PRVCA	49,	2230	C.F. Liang, R.K. Sheline, P. Paris, M. Hussonois, J.F. Ledu, D.B. Isabelle
1994Li20	PRVCA	49,	3098	S. Lin, S.A. Brindhaban, P.H. Barker
1994Lo04	NIMAE	339,	164	J.M. Los Arcos, L. Rodriguez, M. Roteta, E. Garcia-Torano
1994Ma14	PRVCA	49,	1755	P.V. Magnus, E.G. Adelberger, A. García
1994Mo.A	PrvCom	GAu	Oct	D.M. Moltz
1994Os04	PYLBB	338,	13	A.N. Ostrowski, H.G. Bohlen, B. Gebauer, S.M. Grimes, R. Kalpakchieva, Th. Kirchner, T.N. Massey, W. von Oertzen, Th. Stolla, M. Wilpert, Th. Wilpert
1994Ot01	NUPAB	567,	281	T. Otto, G. Bollen, G. Savard, L. Schweikhard, H. Stolzenberg, G. Audi, R.B. Moore, G. Rouleau, J. Szerypo, Z. Patyk, ISOLDE
1994Pa11	PRVCA	49,	3312	R.D. Page, P.J. Woods, R.A. Cunningham, T. Davinson, N.J. Davis, A.N. James, K. Livingston, P.J. Sellin, A.C. Shotter
1994Pa12	PRLTA	72,	1798	R.D. Page, P.J. Woods, R.A. Cunningham, T. Davinson, N.J. Davis, A.N. James, K. Livingston, P.J. Sellin, A.C. Shotter
1994Pa37	NUPAB	580,	173	G. Passler, J. Rikowska, E. Arnold, H.-J. Kluge, L. Monz, R. Neugart, H. Ravn, K. Wendt, ISOLDE
1994Po26	IANFA	58,	41	A.V. Potempa, G.V. Veselov, V.A. Sergienko, K. Ya. Gromov, S.V. Evtisov, V.G. Kalinnikov, V.V. Kuznetsov, Zh. Sereeter, V.I. Fominykh, M.B. Yuldashev
1994Ru19	PLSSA	42,	227	W. Rühm, B. Schneck, K. Knie, G. Korschinek, L. Zerle, E. Nolte, D. Wesselka, H. Vonach
1994Sa31	PRVCA	50,	1170	C. Sáenz, E. Cerezo, E. Garcia, A. Morales, J. Morales, R. Nunez-Lagos, A. Ortiz de Solorzano, J. Puimedon, A. Salinas, M.L. Sarsa, J.A. Villar, A. Klimenko, V. Kuzminov, N. Metlinsky, V. Novikov, A. Pomansky, B. Pritychenko
1994Sc35	ZPAAD	350,	99	K. Schmidt, T.W. Elze, R. Grzywacz, Z. Janas, R. Kirchner, O. Klepper, A. Plochocki, E. Roeckl, K. Rykaczewski, L.D. Skouras, J. Szerypo
1994Se01	PYLBB	321,	323	D. Seweryniak, J. Cederkall, B. Cederwall, J. Blomqvist, C. Fahlander, A. Johnson, L.-O. Norlin, J. Nyberg, A. Atac, A. Kerek, J. Kownacki, R. Wyss, E. Adamides, H. Grawe, E. Ideguchi, R. Julin, S. Juutinen, W. Karczmarczyk, S. Mitarai, M. Piiparinen, R. Schubart, G. Sletten, S. Tormanen, A. Virtanen
1994Se12	ZPAAD	349,	25	H.L. Seifert, J.M. Wouters, D.J. Vieira, H. Wollnik, X.G. Zhou, X.L. Tu, Z.Y. Zhou, G.W. Butler
1994Sh02	PRVCA	49,	725	R.K. Sheline, C.F. Liang, P. Paris, A. Gizon, V. Barci
1994Sh07	ZPAAD	348,	25	T. Shizuma, M. Kidera, E. Ideguchi, A. Odahara, H. Tomura, S. Suematsu, T. Kuroyanagi, Y. Gono, S. Mitarai, J. Mukai, T. Komatsubara, K. Furuno, K. Heiguchi
1994St31	ZPAAD	347,	287	M.-L. Stolzenwald, G. Lhersonneau, M. Liang, G. Molnar, H. Ohm, K. Sistemich
1994Ti03	PRVCA	49,	2871	R.J. Tighe, D.M. Moltz, J.C. Batchelder, T.J. Ognibene, M.W. Rowe, J. Cerny
1994To10	PRVCA	50,	518	K.S. Toth
1994Ts.A	AnRpt JAERI		16	K. Tsukada, M. Asai, S. Ichikawa, A. Osa, Y. Nagame, I. Nishinaka, N. Shinohara, Y. Hatsukawa, H. Iimura, K. Kawade, H. Yamamoto, M. Shibata, Y. Kojima

1994Wa17	PRVCA	50,	487	C. Wagemans, S. Druyts, P. Geltenbort
1994Wa23	PRVCA	50,	2768	J. Wauters, N. Bijmens, H. Folger, M. Huyse, H.Y. Hwang, R. Kirchner, J. von Schwarzenberg, P. Van Duppen
1994We02	ZPAAD	347,	185	C. Wennemann, W.-D. Schmidt-Ott, T. Hild, K. Krumbholz, V. Kunze, F. Meissner, H. Keller, R. Kirchner, E. Roeckl
1994Xu09	ZPAAD	350,	187	S. Xu, Y. Xie, Q. Pan, Y. Wang, X. Zhang, J. Zhang, Y. Ge, X. Yin, C. Wang, T. Zhang, B. Guo
1994Ya07	PYLBB	334,	229	S. Yasumi, H. Maezawa, K. Shima, Y. Inagaki, T. Mukoyama, T. Mizogawa, K. Sera, S. Kishimoto, M. Fujioka, K. Ishii, T. Omori, G. Izawa, O. Kawakami
1994Ye08	NIMAE	350,	608	A.V. Yeremin, A.N. Andreyev, D.D. Bogdanov, G.M. Ter-Akopian, V.I. Chepigin, V.A. Gorshkov, A.P. Kabachenko, O.N. Malyshev, A.G. Popeko, R.N. Sagaidak, S. Sharo, E.N. Voronkov, A.V. Taranenko, A. Yu. Lavrentjev
1994Yo01	PRVCA	49,	279	B.M. Young, W. Benenson, J.H. Kelley, N.A. Orr, R. Pfaff, B.M. Sherrill, M. Steiner, M. Thoennessen, J.S. Winfield, J.A. Winger, S.J. Yennello, A. Zeller
1994Zh02	PRVCA	49,	R592	L. Zhang, G. Jin, J. Zhao, W. Yang, Y. Yang, Z. Zhao, J. Zheng, X. Sun, J. Wang, Z. Li, Z. Qin, G. Guo, Y. Luo, J. Żylicz, J.-Y. Zhang
1995				
1995Al31	PZETA	62,	18	D.V. Aleksandrov, E. Yu. Nikolsky, B.G. Novatsky, D.N. Stepanov, V. Buryan, V. Kroga, Ya. Novak
1995Am.A	P-Arles		537	F. Ameil, P. Armbruster, M. Bernas, S. Czajkowski, P. Dessagne, C. Donzauz, H. Geissel, A. Grewe, E. Hanelt, A. Heinz, Z. Janas, M. de Jong, C. Kozhuharov, Ch. Miehe, W. Schwab, S. Steinhäuser, and GSI-Nachrichten 11-95
1995Ap.A	PrvCom	GAu	May	A. Aprahamian, D.S. Brenner, R. Gill, A. Piotrowski, R.F. Casten
1995Ba28	PRLTA	74,	3569	D. Bazin, B.A. Brown, J. Brown, M. Fauerbach, M. Hellström, S.E. Hirzebruch, J.H. Kelley, R.A. Kryger, D.J. Morrissey, R. Pfaff, C.F. Powell, B.M. Sherrill, M. Thoennessen
1995Ba75	PRVCA	52,	1807	J.C. Batchelder, K.S. Toth, D.M. Moltz, T.J. Ognibene, M.W. Rowe, C.R. Bingham, E.F. Zganjar, B.E. Zimmerman
1995Bi01	PRVCA	51,	125	C.R. Bingham, M.B. Kassim, M. Zhang, Y.A. Akovali, K.S. Toth, W.D. Hamilton, H.K. Carter, J. Kormicki, J. von Schwarzenberg, M.M. Jarrio
1995Bi17	PRLTA	75,	4571	N. Bijmens, P. Decrock, S. Franchoo, M. Gaelens, M. Huyse, H.-Y. Hwang, G. Reusen, J. Szerypo, J. von Schwarzenberg, J. Wauters, J.G. Correia, A. Jokinen, P. Van Duppen, ISOLDE
1995Bi.A	P-Arles		545	C.R. Bingham, J.D. Richards, B.E. Zimmerman, Y.A. Akovali, W.B. Walters, J. Rikowska, P. Joshi, E.F. Zganjar, M. Lindroos, O. Tengblad, P. Van Duppen, ISOLDE, and PrvCom GAU June 1995
1995B101	NUPAB	582,	296	J. Blons, D. Goutte, A. Lepretre, R. Letourneau, R. Lucas, V. Meot, D. Paya, X.H. Phan, J. Girard, G. Barreau, T.P. Doan, G. Pedemey, Ph. Dessagne, Ch. Miehe
1995B106	PRLTA	74,	4611	B. Blank, S. Andriamonje, S. Czajkowski, F. Davi, R. Del Moral, J.P. Dufour, A. Fleury, A. Musquère, M.S. Pravikoff, R. Grzywacz, Z. Janas, M. Pfützner, A. Grewe, A. Heinz, A. Junghans, M. Lewitowicz, J.-E. Sauvestre, C. Donzauz
1995B123	PYLBB	364,	8	B. Blank, S. Andriamonje, S. Czajkowski, F. Davi, R. Del Moral, C. Donzauz, J.P. Dufour, A. Fleury, A. Grewe, R. Grzywacz, A. Heinz, Z. Janas, A. Junghans, M. Lewitowicz, A. Musquère, M.S. Pravikoff, M. Pfützner, J.-E. Sauvestre
1995Bo03	NUPAB	582,	1	V.A. Bondarenko, I.L. Kuvaga, P.T. Prokofjev, A.M. Sukhovoij, V.A. Khitrov, Yu. P. Popov, S. Brant, V. Paar
1995Bo05	NUPAB	584,	279	V.A. Bondarenko, I.L. Kuvaga, P.T. Prokofjev, A.M. Sukhovoij, V.A. Khitrov, Yu. P. Popov, S. Brant, V. Paar, Lj. Šimičić

1995Bo10	NUPAB	583,	775c	H.G. Bohlen, B. Gebauer, Th. Kirchner, M. von Lucke-Petsch, W. von Oertzen, A.N. Ostrowski, Ch. Seyfert, Th. Stolla, M. Wilpert, Th. Wilpert, S.M. Grimes, T.N. Massey, R. Kalpakchieva, Y.E. Penionzhkevich, D.V. Alexandrov, I. Mukha, A.A. Ogloblin, C. Détraz
1995Bo18	PRVCA	51,	2530	R. Bonetti, C. Chiesa, A. Guglielmetti, R. Matheoud, G. Poli, V.L. Mikheev, S.P. Tretyakova
1995Bo.B	P-StPetersbg			H.G. Bohlen, B. Gebauer, M. von Lucke-Petsch, W. von Oertzen, A.N. Ostrowski, Ch. Seyfert, Th. Stolla, M. Wilpert, Th. Wilpert, R. Kalpakchieva, Yu. E. Penionzhkevich, S.M. Grimes, T.N. Massey, I. Mukha, D.V. Alexandrov, A.A. Ogloblin, H. Lenske
1995Br24	NUPAB	595,	481	J.B. Breitenbach, J.L. Wood, M. Jarrío, R.A. Braga, H.K. Carter, J. Kormicki, P.B. Semmes
1995Bu11	NUPAB	587,	475	D. Bucurescu, D. Barnéoud, Gh. Cata-Danil, T. von Egidy, J. Genevey, A. Gizon, J. Gizon, C.F. Liang, P. Paris, B. Weiss, S. Brant, V. Paar, R. Pezer
1995Ch74	BRSPE	59,	1854	V.G. Chumin, S.S. Eliseev, K. Ya. Gromov, Yu. V. Norseev, V.I. Fominykh, V.V. Tsupko-Sitnikov
1995Cz.A	P-Arles		553	S. Czajkowski, F. Ameil, P. Armbruster, M. Bernas, P. Dessagne, C. Donzau, C. Engelmann, H.-R. Faust, H. Geissel, E. Hanelt, A. Heinz, M. Hesse, C. Kozuharov, C. Miehe, G. Münzenberg, M. Pfützner, C. Röhl, K.-H. Schmidt, W. Schwab, C. Stéphan, K. Sümmerer, L. Tassan-Got, B. Voss
1995Da14	ZPAAD	351,	225	M. Daszewski, Z. Janas, W. Kurcewicz, B. Szweryn
1995Da37	PRVDA	51,	2090	D. Dassié, R. Eschbach, F. Hubert, Ph. Hubert, M.C. Isaac, C. Izac, F. Leccia, P. Mennrath, A. Varelle, C. Longuemare, F. Mauger, F. Danevich, V. Kouts, V.I. Tretyak, Yu. Vassilyev, Yu. Zdesenko, A.B. Barabash, V.N. Kornoukhov, Yu. B. Lepikhin, V.I. Umatov, I.A. Vanushin, C. Augier, D. Blum, J.E. Campagne, S. Jullian, D. Lalanne, F. Laplanche, F. Natchez, G. Pichenot, G. Szklarz, R. Arnold, J.L. Guyonnet, T. Lamhamdi, I. Linck, F. Piquemal, F. Scheibling, V. Brudanin, V. Egorov, O. Kochetov, A. Nozdryn, Ts. Vylov, Sh. Zaporov, H.W. Nicholson, C.S. Sutton, NEMO
1995Di08	PHSTB	T59,	144	F. DiFilippo, V. Natarajan, M. Bradley, F. Palmer, D.E. Pritchard
1995Fa.A	AnRpt GSI		21	T. Faestermann, J. Friese, H. Geissel, R. Gernhäuser, H. Gilg, F. Heine, J. Homolka, P. Kienle, H.-J. Kerner, G. Munzenberg, J. Reinhold, R. Schneider, K. Summerer, K. Zeitelhack
1995Fe12	ZPAAD	353,	9	V.N. Fedoseyev, Y. Jading, O.C. Jonsson, R. Kirchner, K.-L. Kratz, M. Krieg, E. Kugler, J. Lettry, T. Mehren, V.I. Mishin, H.L. Ravn, T. Rauscher, H.L. Ravn, F. Scheerer, O. Tengblad, P. Van Duppen, A. Wöhr, ISOLDE
1995Ga04	NUPAB	581,	267	P.E. Garrett, D.G. Burke
1995Ga.A	P-Arles		595	A. Gadea, B. Rubio, J.L. Tain, J. Bea, L. Garcia-Raffi, J. Rico, L. Batist, V. Wittmann, A. Bykov, F. Moroz, H. Keller, R. Kirchner, E. Roeckl
1995Ge06	NUPAB	592,	307	R. Georgii, T. von Egidy, J. Klora, H. Lindner, U. Mayerhofer, J. Ott, W. Schauer, P. von Neumann-Cosel, A. Richter, C. Schlegel, R. Schulz, V.A. Khitrov, A.M. Sukhovich, A.V. Vojnov, J. Berzins, V. Bondarenko, P. Prokofjevs, L.J. Simonova, M. Grinberg, Ch. Stojanov
1995Ge14	YAFIA	58,	1170	A. Sh. Georgadze, F.A. Danevich, Yu. G. Zdesenko, V.V. Kobychiev, B.N. Kropivnyansky, V.N. Kuts, A.S. Nikolaiko, V.I. Tretyak and 02Tr04
1995Gh04	NUPAB	583,	861c	A. Ghiorso, D. Lee, L.P. Somerville, W. Loveland, J.M. Nitschke, W. Ghiorso, G.T. Seaborg, P. Wilmarth, R. Leres, A. Wydler, M. Nurmia, K. Gregorich, R. Gaylord, T. Hamilton, N.J. Hannink, D.C. Hoffman, C. Jarzynski, C. Kacher, B. Kadkhodayan, S. Kreek, M. Lane, A. Lyon, M.A. McMahan, M. Neu, T. Sikkeland, W.J. Swiatecki, A. Türler, J.T. Walton, S. Yashita
1995Gu01	NUPAB	583,	867c	A. Guglielmetti, B. Blank, R. Bonetti, Z. Janas, H. Keller, R. Kirchner, O. Klepper, A. Piechaczek, A. Plochocki, G. Poli, P.B. Price, E. Roeckl, K. Schmidt, J. Szerypo, A.J. Westphal
1995Gu10	PRVCA	52,	740	A. Guglielmetti, R. Bonetti, G. Poli, P.B. Price, A.J. Westphal, Z. Janas, H. Keller, R. Kirchner, O. Klepper, A. Piechaczek, E. Roeckl, K. Schmidt, A. Plochocki, J. Szerypo, B. Blank

1995Ha.B	P-Arles		487	J.H. Hamilton, Q.H. Lu, S.J. Zhu, K. Butler-Moore, A.V. Ramayya, B.R.S. Babu, L.K. Peker, W.C. Ma, T.N. Ginter, J. Kormicki, D. Shi, J.K. Deng, J.O. Rasmussen, M.A. Stoyer, S.Y. Chu, K.E. Gregorich, M.F. Mohar, S. Prussin, J.D. Cole, R. Aryaeinejad, N.R. Johnson, I.Y. Lee, F.K. McGowan, G.M. Ter-Akopian, Yu. Ts. Oganessian
1995Hi02	PRVCA	51,	1736	T. Hild, W.-D. Schmidt-Ott, V. Kunze, F. Meissner, C. Wennemann, H. Grawe
1995Hi12	PRVCA	52,	2236	T. Hild, W.-D. Schmidt-Ott, V. Kunze, F. Meissner, H. Salewski, K.S. Toth, R. Michaelsen
1995Hi14	JPGPE	21,	639	K.-H. Hiddemann, H. Daniel, O. Schwentker
1995Ho03	ZPAAD	350,	277	S. Hofmann, V. Ninov, F.P. Heßberger, P. Armbruster, H. Folger, G. Münzenberg, H.J. Schött, A.G. Popeko, A.V. Yeremin, A.N. Andreyev, S. Saro, R. Janik, M. Leino
1995Ho04	ZPAAD	350,	281	S. Hofmann, V. Ninov, F.P. Heßberger, P. Armbruster, H. Folger, G. Münzenberg, H.J. Schött, A.G. Popeko, A.V. Yeremin, A.N. Andreyev, S. Saro, R. Janik, M. Leino
1995Ho.A	GSI-Nachr.		Feb	S. Hofmann, V. Ninov, F.P. Heßberger, P. Armbruster, H. Folger, G. Münzenberg, H.J. Schött, A.G. Popeko, A.V. Yeremin, A.N. Andreyev, S. Saro, R. Janik, M. Leino
1995Ho.B	PrvCom	GAU	Mar	S. Hofmann, V. Ninov, F.P. Heßberger, and GSI Annual report 1995
1995Ho.C	P-Arles		571	S. Hofmann, F.P. Heßberger, H. Folger, V. Ninov, A.N. Andreyev, D.D. Bogdanov, V.I. Chepigin, A.P. Kabachenko, O.N. Malyshev, A.G. Popeko, G.M. Ter-Akopian, A.V. Yeremin, S. Saro
1995Ik03	JUPSA	64,	3244	T. Ikuta, A. Taniguchi, H. Yamamoto, K. Kawade, Y. Kawase
1995Ir01	PRLTA	75,	4182	H. Irnich, H. Geissel, F. Nolden, K. Beckert, F. Bosch, H. Eickhoff, B. Franzke, Y. Fujita, M. Hausmann, H.C. Jung, O. Klepper, C. Kozhuharov, G. Kraus, A. Magel, G. Münzenberg, F. Nickel, T. Radon, H. Reich, B. Schlitt, W. Schwab, M. Steck, K. Sümmerer, T. Suzuki, H. Wollnik
1995Jo02	NUPAB	584,	489	A. Jokinen, T. Enqvist, P.P. Jauho, M. Leino, J.M. Parmonen, H. Penttilä, J. Äystö, K. Eskola
1995Jo.A	P-Arles		499	A. Jokinen, et al
1995Ka.A	B-Arles		PD22	V.G. Kalinnikov, B.P. Osipenko, F. Pražak, A.A. Solnyshkin, V.I. Stegailov, P. Čaloun, S.E. Zaparov
1995Ke04	NUPAB	586,	219	M. Keim, E. Arnold, W. Borchers, U. Georg, A. Klein, R. Neugart, L. Vermeeren, R.E. Silverans, P. Lievens
1995Ke05	ZPAAD	352,	1	H. Keller, R. Kirchner, B. Rubio, J.L. Tain, Th. Dörfler, W.-D. Schmidt-Ott, E. Roeckl
1995Kr03	PRLTA	74,	860	R.A. Kryger, A. Azhari, M. Hellström, J.H. Kelley, T. Kubo, R. Pfaff, E. Ramakrishnan, B.M. Sherrill, M. Thoennessen, S. Yokoyama, R.J. Charity, J. Dempsey, A. Kirov, N. Robertson, D.G. Sarantites, L.G. Sobotka, J.A. Winger
1995Kr04	ZPAAD	351,	11	K. Krumbholz, W.-D. Schmidt-Ott, T. Hild, V. Kunze, F. Meissner, C. Wennemann, H. Keller, R. Kirchner, O. Klepper, E. Roeckl, D. Schardt, K. Rykaczewski
1995Kr.A	ISOLDE-News		01	K.-L. Kratz
1995La08	NUPAB	586,	316	G.J. Lane, G.D. Dracoulis, A.P. Byrne, P.M. Walker, A.M. Baxter, J.A. Sheikh, W. Nazarewicz
1995La09	NUPAB	588,	501	Yu. A. Lazarev, I.V. Shirokovsky, V.K. Utyonkov, S.P. Tretyakova, V.B. Kutner
1995La20	PRLTA	75,	1903	Yu. A. Lazarev, Yu. V. Lobanov, Yu. Ts. Oganessian, Yu. S. Tsyganov, V.K. Utyonkov, F. Sh. Abdullin, S. Iliev, A.N. Polyakov, J. Rigol, I.V. Shirokovsky, V.G. Subbotin, A.M. Sukhov, G.V. Buklanov, B.N. Gikal, V.B. Kutner, A.N. Mezentsev, I.M. Sedykh, D.V. Vakarov, R.W. Loughheed, J.F. Wild, K.J. Moody, E.K. Hulet
1995Le04	PRVCA	51,	1047	M.J. Leddy, S.J. Freeman, J.L. Durell, A.G. Smith, S.J. Warburton, D.J. Blumenthal, C.N. Davids, C.J. Lister, H.T. Penttilä
1995Le15	APOBB	26,	309	M. Leino, J. Äystö, T. Enqvist, A. Jokinen, M. Nurmi, A. Ostrowski, W.H. Trzaska, J. Uusitalo, K. Eskola, P. Armbruster, V. Ninov



1995Le19	PRVCA	51,	2770	Y.S. Lee, M. Kobayashi, T. Hukotome, T. Horiguchi, H. Inoue
1995Le.A	P-Arles		505	M. Leino, T. Enqvist, W.H. Trzaska, J. Uusitalo, K. Eskola, P. Armbruster, V. Ninov, and PrvCom GAU June 1995
1995Le.C	P-Arles		427	M. Lewitowicz
1995Me03	PRVCA	51,	1558	F. Meissner, T. Hild, V. Kunze, W.-D. Schmidt-Ott, C. Wennemann, P.C. Sood, R. Kirchner, E. Roeckl, K. Rykaczewski
1995Me16	PHSTB	T56,	272	K.A. Mezilev, Yu. N. Novikov, A.V. Popov, B. Fogelberg, L. Spanier
1995Mo14	ZPAAD	352,	7	K. Morita, Y.H. Pu, J. Feng, M.G. Hies, K.O. Lee, A. Yoshida, S.C. Jeong, S. Kubono, T. Nomura, Y. Tagaya, M. Wada, M. Kurokawa, T. Moto-bayashi, H. Ogawa, T. Uchibori, K. Sueki, T. Ishizuka, K. Uchiyama, Y. Fujita, H. Miyatake, T. Shimoda, T. Shinozuka, H. Kudo, Y. Nagai, S.A. Shin
1995Mo26	NUPAB	588,	203c	D.J. Morrissey, and the A1200 Group
1995Ni05	ZPAAD	351,	125	V. Ninov, F.P. Heßberger, S. Hofmann, H. Folger, A.V. Yeremin, A.G. Popeko, A.N. Andreyev, S. Saro
1995Ni.A	P-Arles		571	V. Ninov, F.P. Heßberger, H. Folger, S. Hofmann, A.G. Popeko, A.V. Yeremin, A.N. Andreyev, S. Šaro, and Abstracts PD19
1995Ok02	ZPAAD	351,	243	K. Okano, A. Taniguchi, S. Yamada, T. Sharshar, M. Shibata, K. Yamauchi
1995Os03	NUPAB	588,	185	A. Osa, M. Asai, M. Koizumi, T. Sekine, S. Ichikawa, Y. Kojima, H. Yamamoto, K. Kawade
1995Oz02	NUPAB	592,	244	A. Ozawa, G. Raimann, R.N. Boyd, F.R. Chloupek, M. Fujimaki, K. Kimura, H. Kitagawa, T. Kobayashi, J.J. Kolata, S. Kubono, I. Tanihata, Y. Watanabe, K. Yoshida
1995Pa.A	P-Arles		583	R.D. Page, P.J. Woods, R.A. Cunningham, T. Davinson, N.J. Davis, A.N. James, K. Livingston, P.J. Sellin, A.C. Shotter
1995Pf01	NUPAB	581,	205	M. Pfützner, A. Plochocki, K. Rykaczewski, J. Szerypo, J. Żylicz, H. Keller, R. Kirchner, O. Klepper, E. Roeckl, D. Schardt, M. Huyse, G. Reusen, P. Van Duppen, B.A. Brown
1995Pf04	ZPAAD	353,	1	B. Pfeiffer, G. Lhersonneau, H. Gabelmann, K.-L. Kratz, ISOLDE
1995Pi03	NUPAB	584,	509	A. Piechaczek, M.F. Mohar, R. Anne, V. Borrel, B.A. Brown, J.M. Corre, D. Guillemaud-Mueller, R. Hue, H. Keller, S. Kubono, V. Kunze, M. Lewitowicz, P. Magnus, A.C. Mueller, T. Nakamura, M. Pfützner, E. Roeckl, K. Rykaczewski, M.G. Saint-Laurent, W.-D. Schmidt-Ott, O. Sorlin
1995Po01	PRVCA	51,	519	K.R. Pohl, D.F. Winchell, J.W. Arrison, D.P. Balamuth
1995Re.A	P-Arles		587	P.L. Reeder, Y. Kim, W.K. Hensley, H.S. Miley, R.A. Warner, Z.Y. Zhou, D.J. Vieira, J.M. Wouters, H.L. Seifert, and PrvCom GAU June 1995
1995Ro09	ZPAAD	351,	127	B. Roussi�re, F. Ibrahim, P. Kilcher, F. Le Blanc, J. Oms, J. Sauvage, A. Wojtasiewicz, ISOCELE
1995Ry03	PRVCA	52,	2310	K. Rykaczewski, R. Anne, G. Auger, D. Bazin, C. Borcea, V. Borrel, J.M. Corre, T. D�rfler, A. Fomichov, R. Grzywacz, D. Guillemaud-Mueller, R. Hue, M. Huyse, Z. Janas, H. Keller, M. Lewitowicz, S. Lukyanov, A.C. Mueller, Yu. Penionzhkevich, M. Pfützner, F. Pougheon, M.G. Saint-Laurent, K. Schmidt, W.D. Schmidt-Ott, O. Sorlin, J. Szerypo, O. Tarasov, J. Wauters, J. Żylicz
1995Sa42	NUPAB	592,	221	J. Sauvage, D. Hojman, F. Ibrahim, B. Roussi�re, P. Kilcher, F. Le Blanc, J. Oms, J. Libert, ISOCELE
1995Sc03	NUPAB	582,	109	K. Scheller, J. G�rres, S. Vouzoukas, M. Wiescher, B. Pfeiffer, K.-L. Kratz, D.J. Morrissey, B.M. Sherrill, M. Steiner, M. Hellstr�m, J.A. Winger
1995Sc28	NUPAB	588,	191c	R. Schneider, T. Faestermann, J. Friese, R. Gernhauser, H. Geissel, H. Gilg, F. Heine, J. Homolka, P. Kienle, H.-J. Korner, G. M�nzenberg, J. Reinhold, K. S�mmerer, K. Zeitelhack
1995Sc33	PHSTB	56,	67	R. Schneider, T. Faestermann, J. Friese, R. Gernhauser, H. Gilg, F. Heine, J. Homolka, P. Kienle, H.-J. Korner, J. Reinhold, K. Zeitelhack, H. Geissel, G. M�nzenberg, K. S�mmerer
1995So03	NUPAB	583,	763c	O. Sorlin, D. Guillemaud-Mueller, R. Anne, L. Axelsson, D. Bazin, W. B�hmer, V. Borrel, Y. Jading, H. Keller, K.-L. Kratz, M. Lewitowicz, S.M. Lukyanov, T. Mehren, A.C. Mueller, Yu. E. Penionzhkevich, F. Pougheon, M.G. Saint-Laurent, V.S. Salamatina, S. Shoedder, A. W�hr
1995So11	PRVCA	52,	88	P.C. Sood, A. Gizon, D.G. Burke, B. Singh, C.F. Liang, R.K. Sheline, M.J. Martin, R.W. Hoff

1995So.A	P-Arles		603	O. Sorlin, Th. Dorfler, R. Anne, W. Bohmer, V. Borrel, D. Guillemaud-Mueller, S. Grevy, K.-L. Kratz, M. Lewitowicz, T. Mehren, A.C. Mueller, A. Ostrowsky, F. Pougheon, I. Rabout, Th. Rauscher, M. Robinson, M.G. Saint-Laurent, W.D. Schmidt-Ott
1995St26	PRLTA	75,	3237	W. Stoeffl, D.J. Decman
1995Sy01	PRVCA	51,	2765	I. Sykora, K. Janko, P.P. Povinec
1995Sz01	NUPAB	584,	221	J. Szerypo, M. Huyse, G. Reusen, P. Van Duppen, Z. Janas, H. Keller, R. Kirchner, O. Klepper, A. Piechaczek, E. Roeckl, D. Schardt, K. Schmidt, R. Grzywacz, M. Pfützner, A. Plochocki, K. Rykaczewski, J. Żylicz, G.D. Alkhozov, L. Batist, A. Bykov, V. Wittmann, B.A. Brown
1995Ti08	PRVCA	52,	2298	R.J. Tighe, J.C. Batchelder, D.M. Moltz, T.J. Ognibene, M.W. Rowe, J. Cerny, B.A. Brown
1995Tr02	PYLBB	348,	331	W. Trinder, E.G. Adelberger, B.A. Brown, Z. Janas, H. Keller, K. Krumbholz, V. Kunze, P. Magnus, F. Meissner, A. Piechaczek, M. Pfützner, E. Roeckl, K. Rykaczewski, W.-D. Schmidt-Ott, M. Weber
1995Tr03	PYLBB	349,	267	W. Trinder, E.G. Adelberger, Z. Janas, H. Keller, K. Krumbholz, V. Kunze, P. Magnus, F. Meissner, A. Piechaczek, M. Pfützner, E. Roeckl, K. Rykaczewski, W.-D. Schmidt-Ott, M. Weber
1995Tr07	ADNDA	61,	43	V.I. Tretyak, Yu. G. Zdesenko
1995Uu01	PRVCA	52,	113	J. Uusitalo, T. Enqvist, M. Leino, W.H. Trzaska, K. Eskola, P. Armbruster, V. Ninov
1995Va38	PHSTB	T59,	134	R.S. Van Dyck, Jr., D.L. Farnham, P.B. Schwinberg
1995Ve08	BRSPE	59,	1851	G.V. Veselov, V.A. Sergienko, A.V. Potempa, K. Ya. Gromov, V.G. Kalinikov, N. Yu. Kotovsky, V.I. Fominykh, M.B. Yuldashev
1995Wa.A	P-Arles		725	G. Walter
1995Wi20	PRVCA	52,	1028	F.E. Wietfeldt, E.B. Norman, Y.D. Chan, M.T.F. da Cruz, A. García, E.E. Haller, W.L. Hansen, M.M. Hindi, R.-M. Larimer, K.T. Lesko, P.N. Luke, R.G. Stockstad, B. Sur, I. Žilimen
1995Zh10	NUPAB	586,	483	K. Zhao, J.S. Lilley, P.V. Drumm, D.D. Warner, R.A. Cunningham, J.N. Mo
1995Zi03	PRLTA	75,	1719	M. Zinser, F. Humbert, T. Nilsson, W. Schwab, T. Blaich, M.J.G. Borge, L.V. Chulkov, H. Eickhoff, T.W. Elze, H. Emling, B. Franzke, H. Freiesleben, H. Geissel, K. Grimm, D. Guillemaud-Mueller, P.G. Hansen, R. Holzmann, H. Irnich, B. Jonson, J.G. Keller, O. Klepper, H. Klingler, J.V. Kratz, R. Kulesa, D. Lambrecht, Y. Leifels, A. Magel, M. Mohar, A.C. Mueller, G. Münzenberg, F. Nickel, G. Nyman, A. Richter, K. Riisager, C. Scheidenberger, G. Schrieder, B.M. Sherrill, H. Simon, K. Stelzer, J. Stroth, O. Tengblad, W. Trautmann, E. Wajda, E. Zude, preprint GSI-95-03
1996				
1996A130	PRLTA	77,	3319	A. Alessandrello, C. Brofferio, D.V. Camin, P. Caspani, P. Colling, O. Cremonesi, E. Fiorini, A. Giuliani, A. Nucciotti, M. Pavan, G. Pessina, E. Previtali, L. Zanotti, C. Bucci
1996An21	BRSPE	60,	119	A.N. Andreyev, A.G. Popeko, A.V. Eremin, S. Hofmann, F. Heßberger, H. Folger, V. Ninov, S. Saro
1996Ax01	PRVCA	54,	1511	L. Axelsson, M.J.G. Borge, S. Fayans, V.Z. Goldberg, S. Grévy, D. Guillemaud-Mueller, B. Jonson, K.-M. Källman, T. Lönnroth, M. Lewitowicz, P. Manngård, K. Markenroth, I. Martel, A.C. Mueller, I. Mukha, T. Nilsson, G. Nyman, N.A. Orr, K. Riisager, G.V. Rogatchev, M.-G. Saint-Laurent, I.N. Serikov, O. Sorlin, O. Tengblad, F. Wenander, J.S. Winfield, R. Wolski
1996Ba24	YAFIA	59,	197	A.S. Barabash, R.R. Saakyan and 02Tr04
1996Ba35	PRVCA	54,	949	J.C. Batchelder, K.S. Toth, E.F. Zganjar, D.M. Moltz, C.R. Bingham, T.J. Ognibene, J. Powell, M.W. Rowe
1996Ba37	JPGPE	22,	487	A.S. Barabash, R. Gurriaran, F. Hubert, Ph. Hubert, J.L. Reyss, J. Suhonen, V.I. Umatov
1996Ba80	PRLTA	77,	5186	A. Balysh, A. De Silva, V.I. Lebedev, K. Lou, M.K. Moe, M.A. Nelson, A. Piepke, A. Pronsky, M.A. Vient, P. Vogel

1996Bi07	PRVCA	54,	R20	C.R. Bingham, K.S. Toth, J.C. Batchelder, D.J. Blumenthal, L.T. Brown, B.C. Busse, L.F. Conticchio, C.N. Davids, T. Davinson, D.J. Henderson, R.J. Irvine, D. Seweryniak, W.B. Walters, P.J. Woods, B.E. Zimmerman
1996Bi17	ZPAAD	356,	3	N. Bijnens, I. Ahmad, A.N. Andreyev, J.C. Batchelder, C.R. Bingham, D. Blumenthal, B.C. Busse, X.S. Chen, L.F. Conticchio, C.N. Davids, M. Huyse, R.V.F. Janssens, P. Mantica, H. Penttilä, W. Reviol, D. Seweryniak, P. Van Duppen, W.B. Walters, J. Wauters, B.E. Zimmerman
1996B111	PRVCA	54,	572	B. Blank, S. Andriamonje, F. Boué, S. Czajkowski, R. Del Moral, J.P. Dufour, A. Fleury, P. Pourre, M.S. Pravikoff, K.-H. Schmidt, E. Hanelt, N.A. Orr
1996B121	PRLTA	77,	2893	B. Blank, S. Czajkowski, F. Davi, R. Del Moral, J.P. Dufour, A. Fleury, C. Marchand, M.S. Pravikoff, J. Benlliure, F. Boue, R. Collatz, A. Heinz, M. Hellström, Z. Hu, E. Roeckl, M. Shibata, K. Sümmerer, Z. Janas, M. Karny, M. Pfützner, M. Lewitowicz
1996Ca02	NUPAB	598,	61	P. Campbell, J.A. Behr, J. Billowes, G. Gwinner, G.D. Sprouse, F. Xu
1996Ch32	PRLTA	77,	2400	M. Chartier, G. Auger, W. Mittig, A. Lepine-Szilly, L.K. Fifield, J.M. Casandjian, M. Chabert, J. Ferme, A. Gillibert, M. Lewitowicz, M. Mac Cormick, M.H. Moscatello, O.H. Odland, N.A. Orr, G. Politi, C. Spitaels, A.C.C. Villari
1996Da06	PRLTA	76,	592	C.N. Davids, P.J. Woods, H.T. Penttilä, J.C. Batchelder, C.R. Bingham, D.J. Blumenthal, L.T. Brown, B.C. Busse, L.F. Conticchio, T. Davinson, D.J. Henderson, R.J. Irvine, D. Seweryniak, K.S. Toth, W.B. Walters, B.E. Zimmerman
1996De60	YAFIA	59,	2117	A.V. Derbin, A.I. Egorov, V.N. Muratova, S.V. Baklanov and 02Tr04
1996Do23	PRVCA	54,	2894	T. Dörfler, W.-D. Schmidt-Ott, T. Hild, T. Mehren, W. Böhmer, P. Möller, B. Pfeiffer, T. Rauscher, K.-L. Kratz, O. Sorlin, V. Borrel, S. Grévy, D. Guillemaud-Mueller, A.C. Mueller, F. Pougheon, R. Anne, M. Lewitowicz, A. Ostrowsky, M. Robinson, M.G. Saint-Laurent
1996Dr02	PRVCA	53,	1205	G.D. Dracoulis, F.G. Kondev, A.P. Byrne, T. Kibedi, S. Bayer, P.M. Davidson, P.G.D. Dracoulis, F.G. Kondev, A.P. Byrne, T. Kibedi, S. Bayer, P.M. Davidson, P.M. Walker, C. Purry, C.J. Pearson
1996Dr07	NUPAB	601,	234	S. Drissi, S. Andre, D. Barnéoud, C. Foin, J. Genevey, J. Kern
1996Dr.A	PrvCom	JBl	Sep	S. Drissi
1996En01	ZPAAD	354,	1	T. Enqvist, K. Eskola, A. Jokinen, M. Leino, W.H. Trzaska, J. Uusitalo, V. Ninov, P. Armbruster
1996En02	ZPAAD	354,	9	T. Enqvist, P. Armbruster, K. Eskola, M. Leino, V. Ninov, W.H. Trzaska, J. Uusitalo
1996Fa01	PRVCA	53,	647	M. Fauerbach, D.J. Morrissey, W. Benenson, B.A. Brown, M. Hellström, J.H. Kelley, R.A. Kryger, R. Pfaff, C.F. Powell, B.M. Sherrill
1996Fa09	NUPAB	602,	167	L. Faux, S. Andriamonje, B. Blank, S. Czajkowski, R. Del Moral, J.P. Dufour, A. Fleury, T. Josso, M.S. Pravikoff, A. Piechaczek, E. Roeckl, K.-H. Schmidt, K. Sümmerer, W. Trinder, M. Weber, T. Brohm, A. Grewe, E. Hanelt, A. Heinz, A. Junghans, C. Rohl, S. Steinhauser, B. Voss, Z. Janas, M. Pfützner
1996Ga17	PRVCA	54,	1057	A. Galindo-Uribarri, D. Ward, H.R. Andrews, G.C. Ball, D.C. Radford, V.P. Janzen, S.M. Mullins, J.C. Waddington, A.V. Afanasjev, I. Ragnarsson
1996Ga24	ZPAAD	355,	253	A. Gadea, B. Rubio, J.L. Tain, J. Rico, J. Bea, L.M. Garcia-Raffi, P. Kleinheinz, D. Schardt, E. Roeckl, R. Kirchner, J. Blomqvist
1996Ga30	NUPAB	611,	68	P.E. Garrett, N. Warr, H. Baltzer, S. Boehmsdorff, D.G. Burke, M. Deleze, S. Drissi, J. Groger, C. Gunther, J. Kern, S.J. Mannanal, J. Manns, U. Müller, J.-P. Vorlet, T. Weber
1996Ge07	ZPAAD	356,	7	J. Genevey, A. Gizon, D. Barnéoud, Gh. Cata-Danil, R. Béraud, A. Em-sallem, C. Foin, C.F. Liang, P. Paris, S. Viteritti
1996Ge12	NUPAB	611,	247	J. Genevey, A. Gizon, C. Foin, D. Bucurescu, Gh. Cata-Danil, B. Weiss, D. Barnéoud, T. von Egidy, J. Gizon, C.F. Liang, P. Paris
1996Gi08	NUPAB	605,	301	A. Gizon, J. Genevey, D. Bucurescu, Gh. Cata-Danil, J. Gizon, J. Inchaouh, D. Barnéoud, T. von Egidy, C.F. Liang, B.M. Nyako, P. Paris, I. Penev, A. Plochocki, E. Ruchowska, C.A. Ur, B. Weiss, L. Zolnai

1996Go06	JPGPE	22,	377	V.M. Gorozhankin, V.G. Kalinnikov, A. Kovalik, A.A. Solnyshkin, A.F. Novgorodov, N.A. Lebedev, N. Yu. Kotovskij, E.A. Yakushev, M.A. Mahmoud, M. Rysavy
1996He25	ZPAAD	356,	229	M. Hellström, Z. Hu, A. Weber, M. Hencheck, M.J. Balbes, R.N. Boyd, D. Cano-Ott, R. Collatz, A. Guglielmetti, Z. Janas, M. Karny, R. Kirchner, J. Morford, D.J. Morrissey, G. Raimann, E. Roeckl, K. Schmidt, J. Szerypo
1996Ho12	PRVCA	54,	78	R.W. Hoff, H.G. Borner, K. Schreckenbach, G.G. Colvin, F. Hoyler, W. Schauer, T. von Egidy, R. Georgii, J. Ott, S. Schrunder, R.F. Casten, R.L. Gill, M. Balodis, P. Prokofjevs, L. Simonova, J. Kern, V.A. Khitrov, A.M. Sukhovoij, O. Bersillon, S. Joly, G. Graw, D. Hofer, B. Valnion
1996Ho13	ZPAAD	354,	229	S. Hofmann, V. Ninov, F.P. Heßberger, P. Armbruster, H. Folger, G. Münzenberg, H.J. Schött, A.G. Popeko, A.V. Yeremin, S. Saro, R. Janik, M. Leino
1996Ho16	PRLTA	77,	1020	P. Hoff, P. Baumann, A. Huck, A. Knipper, G. Walter, G. Marguier, B. Fogelberg, A. Lindroth, H. Mach, M. Sanchez-Vega, R.B.E. Taylor, P. Van Duppen, A. Jokinen, M. Lindroos, M. Ramdane, W. Kurcewicz, B. Jonson, G. Nyman, Y. Jading, K.-L. Kratz, A. Woehr, G. Løvhøiden, T.F. Thorsteinsen, J. Blomqvist, ISOLDE
1996Ik01	PRVCA	54,	2043	H. Ikezoe, T. Ikuta, S. Hamada, Y. Nagame, I. Nishinaka, K. Tsukada, Y. Oura, T. Ohtsuki
1996Jo06	PRVCA	53,	3150	I.P. Johnstone, L.D. Skouras
1996Ko13	PRVCA	54,	R459	F.G. Kondev, G.D. Dracoulis, A.P. Byrne, T. Kibedi, S. Bayer, G.J. Lane
1996La11	PRVCA	53,	2893	M.R. Lane, K.E. Gregorich, D.M. Lee, M.F. Mohar, M. Hsu, C.D. Kacher, B. Kadkhodayan, M.P. Neu, N.J. Stoyer, E.R. Sylwester, J.C. Yang, D.C. Hoffman
1996La12	PRVCA	54,	620	Yu. A. Lazarev, Yu. V. Lobanov, Yu. Ts. Oganessian, V.K. Utyonkov, F. Sh. Abdullin, A.N. Polyakov, J. Rigol, I.V. Shirokovsky, Yu. S. Tsyganov, S. Iliiev, V.G. Subbotin, A.M. Sukhov, G.V. Buklanov, B.N. Gikal, V.B. Kutner, A.N. Mezentsev, K. Subotic, J.F. Wild, R.W. Lougheed, K.J. Moody
1996Le09	ZPAAD	355,	157	M. Leino, J. Uusitalo, R.G. Allatt, P. Armbruster, T. Enqvist, K. Eskola, S. Hofmann, S. Hurskanen, A. Jokinen, V. Ninov, R.D. Page, W.H. Trzaska
1996Lh04	PRVCA	54,	1592	G. Lhersonneau, P. Dendooven, A. Honkanen, M. Huhta, M. Oinonen, H. Penttilä, J. Äystö, J. Kurpeta, J.R. Persson, A. Popov
1996Li05	ZPAAD	354,	153	C.F. Liang, P. Paris, A. Plochocki, E. Ruchowska, A. Gizon, D. Barnéoud, J. Genevey, G. Cata, R.K. Sheline
1996Li37	PRVCA	54,	2304	C.F. Liang, P. Paris, R.K. Sheline, P. Alexa, A. Gizon
1996Li50	ZPAAD	356,	239	M. Lipoglavšek, M. Górska, J. Nyberg, A. Atac, A. Axelsson, R.A. Bark, J. Blomqvist, J. Cederkäll, B. Cederwall, G. de Angelis, C. Fahlander, H. Grawe, A. Johnson, S. Leoni, A. Likar, M. Matiuzzi, S. Mitarai, L.-O. Norlin, M. Palacz, J. Persson, H.A. Roth, R. Schubart, D. Seweryniak, T. Shizuma, Ö. Skeppstedt, D. Sohler, G. Sletten, W.B. Walters, M. Weiszflog
1996Ma72	RAACA	72,	39	M. Magara, N. Shinohara, Y. Hatsukawa, K. Tsukada, H. Imura, S. Utsuda, S.-I. Ichikawa, T. Suzuki, Y. Nagame, Y. Kobayashi, M. Oshima, T. Horichuchi
1996Me09	PRLTA	77,	458	T. Mehren, B. Pfeiffer, S. Schoedder, K.-L. Kratz, M. Huhta, P. Dendooven, A. Honkanen, G. Lhersonneau, M. Oinonen, J.-M. Parmonen, H. Penttilä, A. Popov, V. Rubchenya, J. Äystö
1996Mu19	PYLBB	367,	65	I. Mukha, M.J.G. Borge, D. Guillemaud-Mueller, P. Hornshøj, F. Humbert, B. Jonson, T.E. Leth, G. Martinez Pinedo, T. Nilsson, G. Nyman, K. Riisager, G. Schrieder, M.H. Smedberg, O. Tengblad, K. Wilhelmson Rolander, ISOLDE
1996Ni09	ZPAAD	356,	11	V. Ninov, F.P. Heßberger, S. Hofmann, H. Folger, G. Münzenberg, P. Armbruster, A.V. Yeremin, A.G. Popeko, M. Leino, S. Saro
1996Od01	ZPAAD	354,	231	A. Odahara, Y. Gono, S. Mitarai, T. Shizuma, E. Ideguchi, J. Mukai, H. Tomura, B.J. Min, S. Suematsu, T. Kuroyanagi, K. Heiguchi, T. Komatsubara, K. Furuno
1996Os04	JUPSA	65,	928	A. Osa, T. Ikuta, K. Kawade, H. Yamamoto, S. Ichikawa

1996Pa01	PRVCA	53,	660	R.D. Page, P.J. Woods, R.A. Cunningham, T. Davinson, N.J. Davis, A.N. James, K. Livingston, P.J. Sellin, A.C. Shotter, and PrvCom AHW August 1996
1996Pf01	PRVCA	53,	1753	R. Pfaff, D.J. Morrissey, W. Benenson, M. Fauerbach, M. Hellström, C.F. Powell, B.M. Sherrill, M. Steiner, J.A. Winger
1996Ra04	PRVCA	53,	616	S. Raman, E.K. Warburton, J.W. Starner, E.T. Jurney, J.E. Lynn, P. Tikkanen, J. Keinonen
1996Ra16	PRVCA	53,	2732	S. Raman, J.B. McGrory E.T. Jurney, J.W. Starner
1996Ri12	PRVCA	54,	2041	J.D. Richards, C.R. Bingham, Y.A. Akovali, J.A. Becker, E.A. Henry, P. Joshi, J. Kormicki, P.F. Mantica, K.S. Toth, J. Wauters, E.F. Zganjar
1996Ro02	PRVCA	53,	1465	M. Robinson, P. Halse, W. Trinder, R. Anne, C. Borcea, M. Lewitowicz, S. Lukyanov, M. Mirea, Yu. Oganessian, N.A. Orr, Yu. Penionzhkevich, M.G. Saint-Laurent, O. Tarasov
1996Ry.B	AnRpt JYFL		33	K. Rykaczewski
1996Sa34	PRVCA	54,	2802	H. Sakurai, N. Aoi, A. Goto, M. Hirai, N. Inabe, M. Ishihara, H. Kobinata, T. Kubo, H. Kumagai, T. Nakagawa, T. Nakamura, M. Notani, Y. Watanabe, Y. Watanabe, A. Yoshida
1996Sh27	JUPSA	65,	3172	M. Shibata, A. Odahara, S. Mitarai, Y. Gono, M. Kidera, K. Miyazaki, T. Kuroyanagi
1996Ta04	PRVCA	53,	1557	N. Takaoka, Y. Motomura, K. Nagao
1996Ta18	PRVCA	54,	2926	R.B.E. Taylor, S.J. Freeman, J.L. Durell, M.J. Leddy, A.G. Smith, D.J. Blumenthal, M.P. Carpenter, C.N. Davids, C.J. Lister, R.V.F. Janssens, D. Seweryniak
1996To01	PRVCA	53,	2513	K.S. Toth, J.C. Batchelder, C.R. Bingham, L.F. Conticchio, W.B. Walters, C.N. Davids, D.J. Henderson, R. Herman, H. Penttilä, J.D. Richards, A.H. Wuosmaa, B.E. Zimmerman
1996To08	ZPAAD	355,	225	K.S. Toth, J.C. Batchelder, D.M. Moltz, J.D. Robertson
1996Ur02	PRVCA	54,	945	W. Urban, W.R. Phillips, J.L. Durell, M.A. Jones, M. Leddy, C.J. Pearson, A.G. Smith, B.J. Varley, I. Ahmad, L.R. Morss, M. Bentaleb, E. Lubkiewicz, N. Schulz
1996Wa33	PRVCA	54,	2916	P.M. Wallace, E.G. Bilpuch, C.R. Bybee, G.E. Mitchell, E.F. Moore, J.D. Shriner, J.F. Shriner, Jr., G.A. Vavrina, C.R. Westerfeldt
1996Wi.A	AnRpt LBL		69	P.A. Wilk, et al
1996Wo.A	P-Amsterdam		D14	A. Wöhr, V. Fedoseyev, Y. Jading, A. Jokinen, T. Kautzsch, I. Klöckl, K.-L. Kratz, V.I. Mishin, H.-L. Ravn, P. Van Duppen, W.B. Walters, ISOLDE
1996Zh03	ZPAAD	353,	353	X. Zhang, S. Yuan, W. Yang, Z. Li, W. Mou, X. Yu, J. Zhong
				1997
1997Al02	PRVCA	55,	474	M. Alston-Garnjost, B.L. Dougherty, R.W. Kenney, R.D. Tripp, J.M. Krivichich, H.W. Nicholson, C.S. Sutton, B.D. Dieterle, S.D. Foltz, C.P. Leavitt, R.A. Reeder, J.D. Baker, A.J. Caffrey
1997An09	ZPAAD	358,	63	A.N. Andreyev, N. Bijmens, T. Enqvist, M. Huysse, P. Kuusiniemi, M. Leino, W.H. Trzaska, J. Uusitalo, P. Van Duppen
1997As05	PRVCA	56,	3045	M. Asai, T. Sekine, A. Osa, M. Koizumi, Y. Kojima, M. Shibata, H. Yamamoto, K. Kawade
1997Ba21	ZPAAD	357,	121	J.C. Batchelder, K.S. Toth, C.R. Bingham, L.T. Brown, L.F. Conticchio, C.N. Davids, T. Davinson, D.J. Henderson, R.J. Irvine, D. Seweryniak, W.B. Walters, P.J. Woods, J. Wauters, E.F. Zganjar
1997Ba25	PRVCA	55,	2142	J.C. Batchelder, K.S. Toth, C.R. Bingham, L.T. Brown, L.F. Conticchio, C.N. Davids, D. Seweryniak, J. Wauters, J.L. Wood, E.F. Zganjar
1997Ba35	ZPAAD	357,	351	A.S. Barabash, R. Gurriaran, F. Hubert, Ph. Hubert, V.I. Umatov
1997Be70	PYLBB	415,	111	M. Bernas, C. Engelmann, P. Armbruster, S. Czajkowski, F. Ameil, C. Bockstiegel, Ph. Dessagne, C. Donzaud, H. Geissel, A. Heinz, Z. Janas, C. Kozhuharov, Ch. Miché, G. Münzenberg, M. Pfützner, W. Schwab, C. Stephan, K. Sümmerer, L. Tassan-Got, B. Voss
1997Bl03	NUPAB	615,	52	B. Blank, F. Boué, S. Andriamonje, S. Czajkowski, R. Del Moral, J.P. Dufour, A. Fleury, P. Pourre, M.S. Pravikoff, N.A. Orr, K.-H. Schmidt, E. Hanelt

1997Bi04	ZPAAD	357,	247	B. Blank, F. Boué, S. Andriamonje, S. Czajkowski, R. Del Moral, J.P. Dufour, A. Fleury, P. Pourre, M.S. Pravikoff, E. Hanelt, N.A. Orr, K.-H. Schmidt
1997Bo10	NUPAB	616,	254c	H.G. Bohlen, W. von Oertzen, Th. Stolla, R. Kalpakchieva, B. Gebauer, M. Wilpert, Th. Wilpert, A.N. Ostrowski, S.M. Grimes, T.N. Massey
1997Bu03	NUPAB	612,	91	D.G. Burke, W. Kurcewicz, G. Løvholden, M.J.G. Borge, M. Cronqvist, H. Gabelmann, H. Gietz, P. Hill, N. Kaffrell, S. Mattsson, R.A. Naumann, K. Nybø, G. Nyman, J. Rogowski, G.L. Struble, T.F. Thorsteinsen, ISOLDE
1997Ch53	BRSPE	61,	1606	V.G. Chumin, J.K. Jabber, K.V. Kalyapkin, S.A. Kudrya, V.V. Tsupko-Sitnikov, K. Ya. Gromov, V.I. Fominykh, T.A. Furyaev
1997Da07	PRVCA	55,	2255	C.N. Davids, P.J. Woods, J.C. Batchelder, C.R. Bingham, D.J. Blumenthal, L.T. Brown, B.C. Busse, L.F. Conticchio, T. Davinson, S.J. Freeman, D.J. Henderson, R.J. Irvine, R.D. Page, H.T. Penttilä, D. Seweryniak, K.S. Toth, W.B. Walters, B.E. Zimmerman
1997De40	PRVCA	56,	2451	A. De Silva, M.K. Moe, M.A. Nelson, M.A. Vient
1997Fo01	PRVCA	55,	762	B. Fornal, R. Broda, W. Królas, T. Pawlat, J. Wrzesiński, D. Bazzacco, D. Fabris, S. Lunardi, C. Rossi Alvarez, G. Viesti, G. de Angelis, M. Cinausero, D.R. Napoli, Z.W. Grabowski
1997Ge11	NIMBE	126,	351	H. Geissel, G. Bollen, B. Franzke, G. Münzenberg, Z. Patyk
1997Ge15	BRSPE	61,	1719	A. Sh. Georgadze, F.A. Danevich, Yu. G. Zdesenko, V.V. Kobychchev, B.N. Kropivivansky, V.N. Kuts, V.V. Muzalevsky, A.S. Nikolaiko, O.A. Ponkratenko, V.I. Tretiak
1997Gi07	ZPAAD	358,	369	A. Gizon, J. Genevey, Gh. Cata-Danil, D. Barnéoud, R. Béraud, A. Emsallem, C. Foin, J. Gizon, C.F. Liang, P. Paris, I. Penev, A. Plochocki, B. Weiss
1997Go18	PRLTA	79,	2415	M. Górska, M. Lipoglavšek, H. Grawe, J. Nyberg, A. Atac, A. Axelson, R. Bark, J. Blomqvist, J. Cederkäll, B. Cederwall, G. de Angelis, C. Fahlander, A. Johnson, S. Leoni, A. Likar, M. Matiuzzi, S. Mitarai, L.-O. Norlin, M. Palacz, J. Persson, H.A. Roth, R. Schubart, D. Seweryniak, T. Shizuma, Ö. Skeppstedt, G. Sletten, W.B. Walters, M. Weiszflog
1997Gr02	PRVCA	55,	1126	R. Grzywacz, R. Anne, G. Auger, C. Borcea, J.M. Corre, T. Dorfler, A. Fomichov, S. Grevy, H. Grawe, D. Guillemaud-Mueller, M. Huysse, Z. Janas, H. Keller, M. Lewitowicz, S. Lukyanov, A.C. Mueller, N. Orr, A. Ostrowski, Yu. Penionzhkevich, A. Piechaczek, F. Pougheon, K. Rykaczewski, M.G. Saint-Laurent, W.D. Schmidt-Ott, O. Sorlin, J. Szerypo, O. Tarasov, J. Wauters, J. Żylicz
1997Gu13	PRVDA	55,	54	M. Günther, J. Hellmig, G. Heusser, M. Hirsch, H.V. Klapdor-Kleingrothaus, B. Maier, H. Päs, F. Petry, Y. Ramachers, H. Strecker, M. Völlinger, A. Balysh, S.T. Belyaev, A. Demehin, A. Gurov, I. Kondratenko, D. Kotelnikov, V.I. Lebedev, A. Müller
1997Gu32	YTHLD	19,	180	J. Guo, K. Zhao, X. Lu, Y. Cheng, T. Li, C. Fu, S. Li
1997Ha04	NUPAB	613,	183	E. Hagberg, I.S. Towner, J.C. Hardy, V.T. Koslowsky, G. Savard, S. Sterbenz
1997He29	ZPAAD	359,	415	F.P. Heßberger, S. Hofmann, V. Ninov, P. Armbruster, H. Folger, G. Münzenberg, H.J. Schött, A.G. Popeko, A.V. Yeremin, A.N. Andreyev, S. Saro
1997Ho14	ZPAAD	358,	377	S. Hofmann, F.P. Heßberger, V. Ninov, P. Armbruster, G. Münzenberg, C. Stodel, A.G. Popeko, A.V. Yeremin, S. Saro, M. Leino
1997Hu07	PRVCA	56,	1152	W.X. Huang, R.C. Ma, X.J. Xu, S.W. Xu, Y.X. Xie, Z.K. Li, Y.X. Ge, Y.Y. Wang, C.F. Wang, T.M. Zhang, X.F. Sun, G.M. Jin, Y.X. Luo
1997Hu15	ZPAAD	359,	349	W.X. Huang, R.C. Ma, X.J. Xu, S.W. Xu, Y.X. Xie, Z.K. Li, Y.X. Ge, Y.Y. Wang, C.F. Wang, T.M. Zhang, X.F. Sun, G.M. Jin, Y.X. Luo
1997Ir01	PRVCA	55,	1621	R.J. Irvine, C.N. Davids, P.J. Woods, D.J. Blumenthal, L.T. Brown, L.F. Conticchio, T. Davinson, D.J. Henderson, J.A. Mackenzie, H.T. Penttilä, D. Seweryniak, W.B. Walters
1997Ir02	PRLTA	79,	990	G.M. Irwin, K.H. Kim
1997Ja12	NUPAB	627,	119	Z. Janas, A. Plochocki, J. Szerypo, R. Collatz, Z. Hu, H. Keller, R. Kirchner, O. Klepper, E. Roeckl, K. Schmidt, R. Bonetti, A. Guglielmetti, G. Poli, A. Piechaczek

1997Ju02	PRVCA	56,	118	E.T. Jurney, J.W. Starnes, J.E. Lynn, S. Raman
1997Ka07	ZPAAD	356,	363	D. Kast, A. Jungclauss, A. Harder, K.P. Lieb, D. Rudolph, R. Schubart, H. Grawe, D. Foltescu, H.A. Roth, O. Skeppstedt, I. Bearden, T. Shizuma
1997Ku20	NUPAB	621,	827	W. Kurcewicz, I.S. Grant, K. Gulda, A.J. Aas, J. Billowes, M.J.G. Borge, D.G. Burke, P.A. Butler, J.F.C. Cocks, B. Fogelberg, S.J. Freeman, G.D. Jones, E. Hagebø, P. Hoff, J. Hønsi, A. Lindroth, G. Løvhøiden, H. Mach, T. Martinez, R.A. Naumann, K. Nybø, G. Nyman, H. Ravn, B. Rubio, J. Simpson, A.G. Smith, J.F. Smith, K. Steffensen, J.L. Tain, O. Tengblad, T.F. Thorsteinsen, ISOLDE
1997La13	PRVCA	55,	2127	G.J. Lane, D.B. Fossan, I. Thorslund, P. Vaska, R.G. Allatt, E.S. Paul, L. Kaubler, H. Schnare, I.M. Hibbert, N. O'Brien, R. Wadsworth, W. Andrejtscheff, J. deGraaf, J. Simpson, I.Y. Lee, A.O. Macchiavelli, D.J. Blumenthal, C.N. Davids, C.J. Lister, D. Seweryniak, A.V. Afanasjev, I. Ragnarsson
1997Li23	PRVCA	55,	2768	C.F. Liang, P. Paris, R.K. Sheline
1997Lo.A	PrvCom	GAu	May	R.W. Loughheed
1997Mi03	PRVCA	55,	1555	S. Mitsuoka, H. Ikezoe, T. Ikuta, Y. Nagame, K. Tsukada, I. Nishinaka, Y. Oura, Y.L. Zhao
1997Mo35	NUPAB	627,	222	D.J. Morrissey, K.N. McDonald, D. Bazin, B.A. Brown, R. Harkewicz, N.A. Orr, B.M. Sherrill, G.A. Souliotis, M. Steiner, J.A. Winger, S.J. Yenello, B.M. Young, S. Lukyanov, G. Chubarian, Yu. Ts. Oganessian
1997Mu08	PRVCA	55,	2267	U. Müller, P. Sevenich, K. Freitag, C. Günther, P. Herzog, G.D. Jones, C. Kliem, J. Manns, T. Weber, B. Will, ISOLDE
1997Oi01	PRVCA	56,	745	M. Oinonen, A. Jokinen, J. Äystö, P. Baumann, F. Didierjean, A. Honkanen, A. Huck, M. Huyse, A. Knipper, G. Marguier, Yu. Novikov, A. Popov, M. Ramdhane, D.M. Seliverstov, P. Van Duppen, G. Walter, ISOLDE
1997Pu01	ZPAAD	357,	3	Y.H. Pu, K. Morita, M.G. Hies, K.O. Lee, A. Yoshida, T. Nomura, Y. Tagaya, T. Motobayashi, M. Kurokawa, H. Minemura, T. Uchibori, T. Ariga, K. Sueki, S.A. Shin
1997Ro26	IEIMA	46,	560	S. Röttger, A. Paul, U. Keyser
1997Sa14	NUPAB	616,	311c	H. Sakurai, N. Aoi, D. Beaumel, N. Fukuda, M. Hirai, E. Ideguchi, M. Ishihara, H. Iwasaki, T. Kishida, T. Kubo, H. Kumagai, S.M. Lukyanov, T. Nakamura, M. Notani, Yu. Ts. Oganessian, Yu. E. Penionzhkevich, T. Teranishi, Y. Watanabe, Y. Watanabe, K. Yoneda, A. Yoshida
1997Sc30	NUPAB	624,	185	K. Schmidt, P.C. Divari, Th. W. Elze, R. Grzywacz, Z. Janas, I.P. Johnstone, M. Karny, H. Keller, R. Kirchner, O. Klepper, A. Plochocki, E. Roeckl, K. Rykaczewski, L.D. Skouras, J. Szerypo, J. Żylicz
1997Sh09	PRVCA	55,	1162	R.K. Sheline, C.F. Liang, P. Paris, A. Gizon
1997Sh37	ZPAAD	359,	229	T. Shizuma, G. Sletten, R.A. Bark, N.L. Gjorup, H.J. Jensen, S. Mitarai, M. Piiparinen, J. Wrzesinski
1997So07	PRVCA	55,	2146	G.A. Souliotis, W. Loveland, K.E. Zyromski, G.J. Wozniak, D.J. Morrissey, J.O. Liljenzin, K. Aleklett
1997Su06	NUPAB	616,	341c	K. Sümmerer, R. Schneider, T. Faestermann, J. Friese, H. Geissel, R. Gernhauser, H. Gilg, F. Heine, J. Homolka, P. Kienle, H.-J. Korner, G. Münzenberg, J. Reinhold, K. Zeitelhack
1997Sz04	ZPAAD	359,	117	J. Szerypo, R. Grzywacz, Z. Janas, M. Karny, M. Pfützner, A. Plochocki, K. Rykaczewski, J. Żylicz, M. Huyse, G. Reusen, J. Schwarzenberg, P. Van Duppen, A. Woehr, H. Keller, R. Kirchner, O. Klepper, A. Piechaczek, E. Roeckl, K. Schmidt, L. Batist, A. Bykov, V. Wittman, B.A. Brown
1997Ta22	PYLBB	409,	64	O. Tarasov, R. Allatt, J.C. Angélique, R. Anne, C. Borcea, Z. Dlouhy, C. Donzaud, S. Grevy, D. Guillemaud-Mueller, M. Lewitowicz, S. Lukyanov, A.C. Mueller, F. Nowacki, Yu. Oganessian, N.A. Orr, A.N. Ostrowski, R.D. Page, Yu. Penionzhkevich, F. Pougheon, A. Reed, M.G. Saint-Laurent, W. Schwab, E. Sokol, O. Sorlin, W. Trinder, J.S. Winfield
1997Uu01	ZPAAD	358,	375	J. Uusitalo, M. Leino, R.G. Allatt, T. Enqvist, K. Eskola, P.T. Greenlees, S. Hurskanen, A. Keenan, H. Kettunen, P. Kuusiniemi, R.D. Page, W.H. Trzaska

1997Wa04	ZPAAD	357,	39	J. Wawryszczuk, M.B. Yuldashev, K. Ya. Gromov, V.I. Fominykh, Zh. Sereeter, V.G. Kalinnikov, N. Yu. Kotovsky, K.V. Kalyapkin, A.W. Potempa, I.N. Izosimov, M. Yu. Myakushin, A.A. Rimsky-Korsakov, T.M. Muminov
1997Wa05	PRVCA	55,	1192	J. Wauters, J.C. Batchelder, C.R. Bingham, D.J. Blumenthal, L.T. Brown, L.F. Conticchio, C.N. Davids, T. Davinson, R.J. Irvine, D. Seweryniak, K.S. Toth, W.B. Walters, P.J. Woods, E.F. Zganjar
1997Wo06	NUPAB	621,	289c	A. Wöhr, A. Andreev, N. Bijnens, J. Breitenbach, S. Franchoo, M. Huysse, Y.A. Kudryavtsev, A. Piechaczek, R.R. Raabe, G. Reusen, L. Vermeeren, P. Van Duppen
1997Ya03	ZPAAD	357,	353	W.F. Yang, Z.Z. Zhao, Z.W. Li, W.T. Mou
1997Za07	PRLTA	79,	4306	K. Zaerpoor, Y.D. Chan, D.E. DiGregorio, M.R. Dragowsky, M.M. Hindi, M.C.P. Isaac, K.S. Krane, R.M. Larimer, A.O. Macchiavelli, R.W. Macleod, P. Mincinovic, E.B. Norman
1997Zi04	NUPAB	619,	151	M. Zinser, F. Humbert, T. Nilsson, W. Schwab, H. Simon, T. Aumann, M.J.G. Borge, L.V. Chulkov, J. Cub, Th. W. Elze, H. Emling, H. Geissel, D. Guillemaud-Mueller, P.G. Hansen, R. Holzmann, H. Irnich, B. Jonson, J.V. Kratz, R. Kulesa, Y. Leifels, H. Lenske, A. Magel, A.C. Mueller, G. Münzenberg, F. Nickel, G. Nyman, A. Richter, K. Riisager, C. Scheidenberger, G. Schrieder, K. Stelzer, J. Stroth, A. Surowiec, O. Tengblad, E. Wajda, E. Zude
1997Zi06	JPGPE	23,	1707	B.E. Zimmerman, M.P. Unterweger, J.T. Cessna
				1998
1998A127	PYLBB	437,	29	R.G. Allatt, R.D. Page, M. Leino, T. Enqvist, K. Eskola, P.T. Greenlees, P. Jones, R. Julin, P. Kuusiniemi, W.H. Trzaska, J. Uusitalo
1998Am04	EPJAA	1,	275	F. Ameil, M. Bernas, P. Armbruster, S. Czajkowski, P. Dessagne, H. Geissel, E. Hanelt, C. Kozuharov, C. Miehé, C. Donzaud, A. Grewe, A. Heinz, Z. Janas, M. de Jong, W. Schwab, S. Steinhäuser
1998Ar10	NUPAB	636,	209	R. Arnold, C. Augier, J. Baker, A. Barabash, D. Blum, V. Brudanin, A.J. Caffrey, J.E. Campagne, E. Caurier, D. Dassié, V. Egorov, R. Eschbach, T. Filipova, R. Gurriaran, J.L. Guyonnet, F. Hubert, Ph. Hubert, S. Jullian, I. Kisel, O. Kochetov, V.N. Kornoukhov, V. Kovalenko, D. Lalanne, F. Laplanche, F. Leccia, I. Linck, C. Longuemare, Ch. Marquet, F. Mauger, P. Mennrath, H.W. Nicholson, I. Pilugin, F. Piquemal, O. Purtov, J.-L. Reyss, X. Sarazin, F. Scheibling, J. Suhonen, C.S. Sutton, G. Szklarz, V. Timkin, R. Torres, V.I. Tretyak, V. Umatov, I. Vanyushin, A. Varelle, Yu. Vasilyev, Ts. Vylov, V. Zerkin,
1998Ax02	NUPAB	634,	475	L. Axelsson, J. Äystö, M.J.G. Borge, L.M. Fraile, H.O.U. Fynbo, A. Honkanen, P. Hornshøj, A. Jokinen, B. Jonson, P.O. Lipas, I. Martel, I. Mukha, T. Nilsson, G. Nyman, B. Petersen, K. Riisager, M.H. Smedberg, O. Tengblad, ISOLDE, and PrvCom GAU December 1997, and erratum NUPAB 641,529
1998Az01	PRVCA	57,	628	A. Azhari, T. Baumann, J.A. Brown, M. Hellström, J.H. Kelley, R.A. Kryger, D.J. Millener, H. Madani, E. Ramakrishnan, D.E. Russ, T. Suomijarvi, M. Thoennessen, S. Yokoyama
1998Ba13	PRVCA	57,	1042	J.C. Batchelder, C.R. Bingham, K. Rykaczewski, K.S. Toth, T. Davinson, J.A. McKenzie, P.J. Woods, T.N. Ginter, C.J. Gross, J.W. McConnell, E.F. Zganjar, J.H. Hamilton, W.B. Walters, C. Baktash, J. Greene, J.F. Mas, W.T. Milner, S.D. Paul, D. Shapira, X.J. Xu, C.H. Yu
1998Ba83	PRVCA	58,	2571	P.H. Barker, P.A. Amundsen
1998Ba85	NUPAB	641,	133	M. Balodis, P. Prokofjevs, N. Krāmere, L. Simonova, J. Bērziņš, T. Krasta, J. Kern, A. Raemy, J.C. Dousse, W. Schwitz, J.A. Cizewski, G.G. Colvin, H.G. Börner, P. Geltenbort, F. Hoyler, S.A. Kerr, K. Schreckenbach, R. Georgii, T. von Egidy, J. Klora, H. Lindner, U. Mayerhofer, A. Walter, A.V. Murzin, V.A. Libman, I.A. Kondurov, Yu. E. Loginov, P.A. Sushkov, S. Brant, V. Paar, V. Lopac
1998Ba.A	P-Bellaire		90	Y. Bai, D.J. Vieira, H.L. Seifert, J.M. Wouters, and PrvCom AHW June 1998



1998Be19	PRVCA	57,	2740	T. Belgia, B. Fazekas, Zs. Kasztovszky, Zs. Revay, G. Molnar, M. Yeh, P.E. Garrett, S.W. Yates
1998Be28	NUPAB	636,	419	A.V. Belozyorov, R. Kalpakchieva, Yu. E. Penionzhkevich, Z. Dlouhy, S. Piskor, J. Vincour, H.G. Bohlen, M. von Lucke-Petsch, A.N. Ostrowski, D.V. Alexandrov, E. Yu. Nikolsky, B.G. Novatsky, D.N. Stepanov
1998Bh04	PRVCA	58,	1247	M. Bhattacharya, A. García, M.M. Hindi, E.B. Norman, C.E. Ortiz, N.I. Kaloskamis, C.N. Davids, O. Civitarese, J. Suhonen
1998Bh12	PRVCA	58,	3677	M. Bhattacharya, A. García, N.I. Kaloskamis, E.G. Adelberger, H.E. Swanson, R. Anne, M. Lewitowicz, M.G. Saint-Laurent, W. Trindler, C. Donzaud, D. Guillemaud-Mueller, S. Leenhardt, A.C. Mueller, F. Pougheon, O. Sorlin
1998Bi.A	P-Bellaire		474	C.R. Bingham, J.C. Batchelder, J.A. Cizewski, C.N. Davids, R.J. Irvine, W. Reviol, D. Sewerniak, K.S. Toth, W.B. Walters, J. Wauters, J.L. Wood, X.J. Xu, J. Uusitalo, E.F. Zganjar
1998Bo30	NUPAB	642,	419	R. Böttger, H. Schölermann
1998By01	PYLBB	80,	2077	A.P. Byrne, S. Bayer, G.D. Dracoulis, T. Kibédi
1998Ch20	NUPAB	637,	3	M. Chartier, W. Mittig, N.A. Orr, J.-C. Angélique, G. Audi, J.-M. Casandjian, A. Cunsolo, C. Donzaud, A. Foti, A. Lépine-Szily, M. Lewitowicz, S. Lukyanov, M. Mac Cormick, D.J. Morrissey, A.N. Ostrowski, B.M. Sherril, C. Stéphan, T. Suomijärvi, L. Tassan-Got, D.J. Vieira, A.C.C. Villari, J.M. Wouters
1998Co27	EPJAA	3,	17	J.F.C. Cocks, M. Muikku, W. Korten, R. Wadsworth, S. Chmel, J. Domscheit, P.T. Greenlees, K. Helariutta, I. Hibbert, M. Houry, D. Jenkins, P. Jones, R. Julin, S. Juutinen, H. Kankaanpää, H. Kettunen, P. Kuusiniemi, M. Leino, Y. Le Coz, R. Lucas, E. Mergel, R.D. Page, A. Savelius, W. Trzaska
1998Cz01	NUPAB	628,	537	C. Czajkowski, S. Andriamonje, B. Blank, F. Boué, R. Del Moral, J.P. Dufour, A. Fleury, P. Pourre, M.S. Pravikoff, E. Hanelt, K.-H. Schmidt, N.A. Orr
1998Da03	PRLTA	80,	1849	C.N. Davids, P.J. Woods, D. Seweryniak, A.A. Sonzogni, J.C. Batchelder, C.R. Bingham, T. Davinson, D.J. Henderson, R.J. Irvine, G.L. Poli, J. Uusitalo, W.B. Walters
1998Do04	PRVCA	57,	1159	J. Döring, H. Schatz, A. Aprahamian, R.C. de Haan, J. Görres, M. Wiescher, W.B. Walters, J. Rikowska, L.T. Brown, C.N. Davids, C.J. Lister, D. Seweryniak, B. Foy
1998En.A	PrvCom	AHW	008	T. Enqvist, et al (PrvCom of H. Geissel)
1998Es02	PRVCA	57,	417	K. Eskola, P. Kuusiniemi, M. Leino, J.F.C. Cocks, T. Enqvist, S. Hurskanen, H. Kettunen, W.H. Trzaska, J. Uusitalo, R.G. Allat, P.T. Greenlees, R.D. Page
1998Fo04	EPJAA	1,	355	B. Fornal, R. Broda, W. Krolas, T. Pawlat, J. Wrzesinski, P.J. Daly, P. Bhattacharyya, Z.W. Grabowski, C.T. Zhang, D. Bazzacco, S. Lunardi, C. Rossi Alvarez, G. de Angelis, D.R. Napoli
1998Fo06	PRVCA	58,	749	B.D. Foy, D.S. Brenner, C.N. Davids, D. Seweryniak, D. Blumenthal, R.L. Gill, N.V. Zamfir, D.D. Warner, C.J. Barton
1998Fr15	PRLTA	81,	3100	S. Franchoo, M. Huyse, K. Kruglov, Y. Kudryavtsev, W.F. Mueller, R. Raabe, I. Reusen, P. Van Duppen, J. Van Roosbroeck, L. Vermeeren, A. Wöhr, K.-L. Kratz, B. Pfeiffer, W.B. Walters
1998Ge13	EPJAA	3,	225	U. Georg, W. Borchers, M. Keim, A. Klein, P. Lievens, R. Neugart, M. Neu-roth, P.M. Rao, Ch. Schulz, ISOLDE
1998Gr12	PYLBB	429,	247	R. Grzywacz, S. Andriamonje, B. Blank, F. Boué, S. Czajkowski, F. Davi, R. Del Moral, C. Donzaud, J.P. Dufour, A. Fleury, H. Grawe, A. Grewe, A. Heinz, Z. Janas, A.R. Junghans, M. Karny, M. Lewitowicz, A. Musquère, M. Pfützner, M.-G. Porquet, M.S. Pravikoff, J.-E. Sauvestre, K. Sümmerer
1998Gr14	PRLTA	81,	766	R. Grzywacz, R. Béraud, C. Borcea, A. Emsallem, M. Glogowski, H. Grawe, D. Guillemaud-Mueller, M. Hjorth-Jensen, M. Houry, M. Lewitowicz, A.C. Mueller, A. Nowak, A. Plochocki, M. Pfützner, K. Rykaczewski, M.G. Saint-Laurent, J.-E. Sauvestre, M. Schaefer, O. Sorlin, J. Szerypo, W. Trinder, S. Viteritti, J. Winfield

1998Gr.B	P-Bellaire		430	R. Grzywacz
1998Gu10	PRVCA	58,	116	V. Guimaraes, S. Kubono, N. Ikeda, I. Katayama, T. Nomura, M.H. Tanaka, Y. Fuchi, H. Kawashima, S. Kato, H. Toyokawa, C.C. Yun, T. Niizeki, T. Kubo, M. Ohura, M. Hosaka
1998Ha36	PRVCA	58,	821	P.D. Harty, N.S. Bowden, P.H. Barker, P.A. Amundsen
1998Ho13	RPPHA	61,	639	S. Hofmann
1998Ho15	PRVCA	58,	1318	I. Hossain, T. Ishii, A. Makishima, M. Asai, S. Ichikawa, M. Itoh, M. Ishii, P. Kleinheinz, M. Ogawa
1998Ik01	PRVCA	57,	2804	T. Ikuta, H. Ikezoe, S. Mitsuoka, I. Nishinaka, K. Tsukuda, Y. Nagame, J. Lu, T. Kuzumaki
1998Ik02	EPJAA	2,	379	H. Ikezoe, T. Ikuta, S. Mitsuoka, Y. Nagame, I. Nishinaka, K. Tsukada, T. Ohtsuki, T. Kuzumaki, J. Lu
1998Is06	EPJAA	2,	173	S. Issmer, M. Fruneau, J.A. Pinston, M. Asghar, D. Barnéoud, J. Genevey, Th. Kerscher, K.E.G. Löbner
1998Is11	PRLTA	81,	4100	T. Ishii, M. Asai, I. Hossain, P. Kleinheinz, M. Ogawa, A. Makishima, S. Ichikawa, M. Itoh, M. Ishii, J. Blomqvist
1998Jo18	EPJAA	3,	271	A. Jokinen, M. Oinonen, J. Äystö, P. Baumann, P. Dendooven, F. Didierjean, V. Fedoseyev, A. Huck, Y. Jading, A. Knipper, M. Koizumi, U. Köster, J. Lettry, P.O. Lipas, W. Liu, V. Mishin, M. Ramdhane, H. Ravn, E. Roeckl, V. Sebastian, G. Walter, ISOLDE
1998Ka42	NUPAB	640,	3	M. Karny, L. Batist, B.A. Brown, D. Cano-Ott, R. Collatz, A. Gadea, R. Grzywacz, A. Guglielmetti, M. Hellström, Z. Hu, Z. Janas, R. Kirchner, F. Moroz, A. Piechaczek, A. Plochocki, E. Roeckl, B. Rubio, K. Rykaczewski, M. Shibata, J. Szerypo, J.L. Tain, V. Wittmann, A. Wöhr
1998Ka.A	AnRpt GSI		22	M. Karny, L. Batist, D. Cano, R. Collatz, A. Gadea, M. Gierlik, R. Grzywacz, A. Guglielmetti, M. Hellström, Z. Hu, Z. Janas, R. Kirchner, F. Moroz, A. Piechaczek, A. Plochocki, E. Roeckl, B. Rubio, K. Rykaczewski, M. Shibata, J. Szerypo, J.L. Tain, V. Wittmann, A. Wöhr
1998Ki20	PYLBB	443,	82	S.L. King, J. Simpson, R.D. Page, N. Amzal, T. Bäck, B. Cederwall, J.F.C. Cocks, D.M. Cullen, P.T. Greenlees, M.K. Harder, K. Helariutta, P. Jones, R. Julin, S. Juutinen, H. Kankaanpää, A. Keenan, H. Kettunen, P. Kuusiniemi, M. Leino, R. Lemmon, M. Muikku, A. Savelius, J. Uusitalo, P. Van Isacker
1998Ko66	JUPSA	67,	3405	Y. Kojima, M. Asai, A. Osa, M. Koizumi, T. Sekine, M. Shibata, H. Yamamoto, K. Kawade, T. Tachibana
1998Ku17	EPJAA	2,	241	J. Kurpeta, G. Lhersonneau, J.C. Wang, P. Dendooven, A. Honkanen, M. Huhta, M. Oinonen, H. Penttilä, K. Peräjärvi, J.R. Persson, A. Plochocki, J. Äystö
1998Le15	EPJAA	2,	9	A.I. Levon, J. de Boer, M. Loewe, M. Würkner, T. Czosnyka, J. Iwanicki, P.J. Napiorkowski
1998Le.A	P-Bellaire		422	M. Leino, et al (and oral presentation)
1998Lh02	EPJAA	1,	285	G. Lhersonneau, B. Pfeiffer, J. Alstad, P. Dendooven, K. Eberhardt, S. Han-konen, I. Klöckl, K.-L. Kratz, A. Nähler, R. Malmbeck, J.P. Omtvedt, H. Penttilä, S. Schoedder, G. Skarnemark, N. Trautmann, J. Äystö
1998Li46	PRVCA	58,	2677	W. Liu, M. Hellström, R. Collatz, J. Benlliure, L. Chulkov, D. Cortina Gil, F. Farget, H. Grawe, Z. Hu, N. Iwasa, M. Pfützner, A. Piechaczek, R. Raabe, I. Reusen, E. Roeckl, G. Vancraeynest, A. Wöhr
1998Li50	PYLBB	440,	246	M. Lipoglavšek, D. Seweryniak, C.N. Davids, C. Fahlander, M. Górska, R.V.F. Janssens, J. Nyberg, J. Uusitalo, W.B. Walters, I. Ahmad, J. Blomqvist, M.P. Carpenter, J.A. Cizewski, S.M. Fischer, H. Grawe, G. Hackman, M. Huhta, C.J. Lister, D. Nisius, G. Poli, P. Reiter, J. Ressler, J. Schwartz, A. Sonzogni
1998Lu08	EPJAA	2,	149	X. Lu, J. Guo, K. Zhao, Y. Cheng, Y. Ma, Z. Li, S. Li, M. Ruan
1998Mo30	EPJAA	3,	99	T. Morek, K. Starosta, Ch. Droste, D. Fossan, G. Lane, J. Sears, J. Smith, P. Vaska
1998Ni07	ARISE	49,	1653	Y. Nir-El, N. Lavi
1998No.A	P-Bellaire		359	M. Notani, N. Aoi, N. Fukuda, H. Iwasaki, K. Yoneda, H. Ogawa, T. Teranishi, S.M. Lukyanov, Yu. E. Penionzhkevich, T. Nakamura, H. Sakurai, E. Ideguchi, A. Yoshida, Y. Watanabe, T. Kubo, M. Ishihara

1998Oi.A	JYFL-7 1998			M. Oinonen et al.
1998Pf02	PYLBB	444,	32	M. Pfützner, P. Armbruster, T. Baumann, J. Benlliure, M. Bernas, W.N. Catford, D. Cortina-Gil, J.M. Daugas, H. Geissel, M. Górská, H. Grawe, R. Grzywacz, M. Hellström, N. Iwasa, Z. Janas, A.R. Junghans, M. Karny, S. Leenhardt, M. Lewitowicz, A.C. Mueller, F. de Oliveira, P.H. Regan, M. Rejmund, K. Rykaczewski, K. Sümmerner
1998Po.A	PrvCom	GAu	Mar	F. Pougheon
1998Ri03	PRLTA	80,	3206	D.S. Richardson, D.M. Benton, D.E. Evans, J.A.R. Griffith, G. Tungate
1998Ro45	PACHA	70,	217	K.J.R. Rosman, P.D.P. Taylor
1998Sh21	ARISE	49,	1481	M. Shibata, Y. Satoh, S. Itoh, H. Yamamoto, K. Kawade, Y. Kasugai, Y. Ikeda
1998So03	NUPAB	632,	205	O. Sorlin, V. Borrel, S. Grevy, D. Guillemaud-Mueller, A.C. Mueller, F. Pougheon, W. Bohmer, K.-L. Kratz, T. Mehren, P. Moller, B. Pfeiffer, T. Rauscher, M.G. Saint-Laurent, R. Anne, M. Lewitowicz, A. Ostrowski, T. Dorfler, W.-D. Schmidt-Ott
1998St28	NUPAB	642,	361	A.E. Stuchbery, G.J. Lampard, H.H. Bolotin
1998Su16	EPJAA	2,	237	M. Sugawara, H. Kusakari, T. Murakami, T. Kohno
1998Ti06	NUPAB	636,	249	D.R. Tilley, C.M. Cheves, J.H. Kelley, S. Raman, H.R. Weller
1998To14	PRVCA	58,	1310	K.S. Toth, X.-J. Xu, C.R. Bingham, J.C. Batchelder, L.F. Conticchio, W.B. Walters, L.T. Brown, C.N. Davids, R.J. Irvine, D. Seweryniak, J. Wauters, E.F. Zganjar
1998Tu01	PRVCA	57,	1648	A. Türler, R. Dressler, B. Eichler, H.W. Gäggeler, D.T. Jost, M. Schädel, W. Bröchle, K.E. Gregorich, N. Trautmann, S. Taut
1998Uu01	PRVCA	57,	2259	J. Uusitalo, D. Seweryniak, P.F. Mantica, J. Rikowska, D.S. Brenner, M. Huhta, J. Greene, J.J. Ressler, B. Tomlin, C.N. Davids, C.J. Lister, W.B. Walters
1998Uu.A	P-Bellaire		375	J. Uusitalo, C.N. Davids, P.J. Woods, D. Seweryniak, A.A. Sonzogni, J.C. Batchelder, C.R. Bingham, T. Davinson, J. de Boer, D.J. Henderson, H.J. Maier, J. Ressler, R. Slinger, W.B. Walter
1998Vi06	PYLBB	437,	264	S.M. Vincent, P.H. Regan, D.D. Warner, R.A. Bark, D. Blumenthal, M.P. Carpenter, C.N. Davids, W. Gelletly, R.V.F. Janssens, C.D. O'Leary, C.J. Lister, J. Simpson, D. Seweryniak, T. Saitoh, J. Schwartz, S. Törmänen, O. Juillet, F. Nowacki, P. Van Isacker
1998Wa.A	PrvCom	AHW	Feb	A.H. Wapstra
1998Wh01	PRVCA	57,	1112	D.H. White, R.W. Hoff, H.G. Börner, K. Schreckenbach, F. Hoyler, G. Colvin, I. Ahmad, A.M. Friedman, J.R. Erskine
1998Wh02	PYLBB	425,	239	C. Wheldon, R. D'Alarcao, P. Chowdhury, P.M. Walker, E. Seabury, I. Ahmad, M.P. Carpenter, D.M. Cullen, G. Hackman, R.V.F. Janssens, T.L. Khoo, D. Nisius, C.J. Pearson, P. Reiter
1998Wi.A	P-Bellaire		606	J.A. Winger, H.H. Yousif, W.C. Ma, V. Ravikumar, W. Lui, S.K. Phillips, R.B. Piercey, P.F. Mantica, B. Pritychenko, R.M. Ronningen, M. Steiner
1998Wu01	PRLTA	80,	2085	A.H. Wuosmaa, I. Ahmad, S.M. Fischer, J.P. Greene, G. Hackman, V. Nanal, G. Savard, J.P. Schiffer, P. Wilt, S.M. Austin, B.A. Brown, S.J. Freedman, J.J. Connell
1998Yo06	JPGPE	24,	1395	K. Yoneda, N. Aoi, H. Iwasaki, H. Sakurai, H. Ogawa, T. Nakamura, W.-D. Schmidt-Ott, M. Schaefer, M. Notani, N. Fukuda, E. Ideguchi, T. Kishida, S.S. Yamamoto, M. Ishihara
1998Yo.A	AnRpt RIKEN		78	K. Yoneda, H. Sakurai, N. Aoi, N. Fukuda, T. Gomi, E. Ideguchi, N. Imai, H. Iwasaki, T. Kubo, Z. Liu, S.M. Lukyanov, T. Nakamura, M. Notani, H. Ogawa, Y.E. Penionzhkevich, W.-D. Schmidt-Ott, S. Shimoura, E. Sokol, Y.X. Watanabe, A. Yoshida, X. Zhou, M. Ishihara
1998Zh03	EPJAA	1,	1	Y.H. Zhang, Q.Z. Zhao, S.F. Zhu, H.S. Xu, X.H. Zhou, Y.X. Guo, X.G. Lei, J. Lu, Q.B. Gou, H.J. Jin, Z. Liu, Y.X. Luo, X.F. Sun, Y.T. Zhu
1998Zh22	PRVCA	58,	156	L. Zhang, J. Zhao, J. Zheng, J. Wang, Z. Qin, Y. Yang, C. Zhang, G. Jin, G. Guo, Y. Du, T. Guo, T. Wang, B. Guo, J. Tian, Y. Lou

1999A120	PYLBB	457,	253	A. Alessandrello, J.W. Beeman, C. Brofferio, O. Cremonesi, E. Fiorini, A. Giuliani, E.E. Haller, B. Margesin, A. Monfardini, A. Nucciotti, M. Pavan, G. Pessina, G. Pignatelli, E. Previtali, L. Zanotti, M. Zen
1999Am05	NUPAB	651,	3	F. Ames, G. Audi, D. Beck, G. Bollen, M. de Saint Simon, R. Jertz, H.-J. Kluge, A. Kohl, M. König, D. Lunney, I. Martel, R.B. Moore, T. Otto, Z. Patyk, H. Raimbault-Hartmann, G. Rouleau, G. Savard, E. Scharf, S. Schwarz, L. Schweikhard, H. Stolzenberg, J. Szerypo, ISOLDE
1999An10	PRLTA	82,	1819	A.N. Andreyev, M. Huyse, P. Van Duppen, J.F.C. Cocks, K. Helariutta, H. Kettunen, P. Kuusiniemi, M. Leino, W.H. Trzaska, K. Eskola, R. Wyss
1999An36	APOBB	30,	1255	A.N. Andreyev, N. Bijmens, J.F. Cocks, K. Eskola, K. Helariutta, M. Huyse, H. Kettunen, P. Kuusiniemi, M. Leino, W.H. Trzaska, P. Van Duppen, R. Wyss
1999An52	EPJAA	6,	381	A.N. Andreyev, D. Ackermann, P. Cagarda, J. Gerl, F. Heßberger, S. Hofmann, M. Huyse, A. Keenan, H. Kettunen, A. Kleinbohl, A. Lavrentiev, M. Leino, B. Lommel, M. Matos, G. Münzenberg, C. Moore, C.D. O'Leary, R.D. Page, S. Reshitko, S. Saro, C. Schlegel, H. Schaffner, M. Taylor, P. Van Duppen, L. Weissman, R. Wyss
1999Ar25	NUPAB	658,	299	R. Arnold, C. Augier, J. Baker, A. Barabash, D. Blum, V. Brudanin, A.J. Caffrey, J.E. Campagne, E. Caurier, D. Dassié, V. Egorov, T. Filipova, R. Gurriaran, J.L. Guyonnet, F. Hubert, Ph. Hubert, S. Jullian, I. Kisel, O. Kochetov, V.N. Kornoukhov, V. Kovalenko, D. Lalanne, F. Laplanche, F. Leccia, I. Linck, C. Longuemare, Ch. Marquet, F. Mauger, H.W. Nicholson, I. Pilugin, F. Piquemal, J.-L. Reyss, X. Sarazin, F. Scheibling, J. Suhonen, C.S. Sutton, G. Szklarz, V. Timkin, R. Torres, V.I. Tretyak, V. Umatov, I. Vanyushin, A. Varelle, Yu. Vasilyev, Ts. Vylov
1999As03	PRVCA	59,	3060	M. Asai, S. Ichikawa, K. Tsukada, M. Sakama, M. Shibata, Y. Kojima, A. Osa, I. Nishinaka, Y. Nagame, K. Kawade, T. Tachibana
1999Ba45	EPJAA	5,	49	J.C. Batchelder, K.S. Toth, C.R. Bingham, L.T. Brown, L.F. Conticchio, C.N. Davids, R.J. Irvine, D. Sewerniak, W.B. Walters, J. Wauters, E.F. Zganjar, J.L. Wood, C. De Coster, B. Decroix, K. Heyde
1999Ba84	NUPAB	657,	113	R.A. Bark, S. Törmänen, T. Bäck, B. Cederwall, S.W. Ødegård, J.F.C. Cocks, K. Helariutta, P. Jones, R. Julin, S. Juutinen, H. Kankaanpää, H. Kettunen, P. Kuusiniemi, M. Leino, M. Muikku, P. Rähkila, A. Savelius, M. Bergström, F. Ingebretsen, A. Maj, M. Mattiuzzi, W. Mueller, L.L. Riedinger, T. Saitoh, P.O. Tjøm
1999Be53	NUPAB	658,	129	U.C. Bergmann, L. Axelsson, M.J.G. Borge, V.N. Fedoseyev, C. Forssén, H.O.U. Fynbo, S. Grévy, P. Hornshøj, Y. Jading, B. Jonson, U. Köster, K. Markenroth, F.M. Marqués, V.I. Mishin, T. Nilsson, G. Nyman, A. Oberstedt, H.L. Ravn, K. Riisager, G. Schrieder, V. Sebastian, H. Simon, O. Tengblad, F. Wenander, K. Wilhelmsen Rolander, ISOLDE
1999Be63	NUPAB	660,	87	J. Benlliure, K.-H. Schmidt, D. Cortina-Gil, T. Enqvist, F. Farget, A. Heinz, A.R. Junghans, J. Pereira, J. Taieb
1999Be64	NUPBB	563,	97	P. Belli, R. Bernabei, C.J. Dai, F. Grianti, H.L. He, G. Ignesti, A. Incicchitti, H.H. Kuang, J.M. Ma, F. Montecchia, O.A. Ponkratenko, D. Prosperi, V.I. Tretyak, Yu. G. Zdesenko
1999Bi14	PRVCA	59,	2984	C.R. Bingham, J. Batchelder, K. Rykaczewski, K.S. Toth, C.-H. Yu, T.N. Ginter, C.J. Gross, R. Grzywacz, M. Karny, S.H. Kim, B.D. MacDonalld, J.F. Mas, J.W. McConnell, P.B. Semmes, J. Szerypo, W. Weintraub, E.F. Zganjar
1999Bo26	PPNPD	42,	17	H.G. Bohlen, A. Blazevic, B. Gebauer, W. von Oertzen, S. Thummerer, R. Kalpakchieva, S.M. Grimes, T.N. Massey
1999Br47	PRLTA	83,	4510	M.P. Bradley, J.V. Porto, S. Rainville, J.K. Thompson, D.E. Pritchard, and PrvCom GAU Nov 1999
1999Ca21	EPJAA	5,	1	G. Canchell, R. Béraud, E. Chabanat, E. Emsallem, N. Redon, P. Dendooven, J. Huikari, A. Jokinen, V. Kolhinen, G. Lhersonneau, M. Oinonen, A. Nieminen, H. Penttilä, K. Peräjärvi, J.C. Wang
1999Ca46	PRLTA	83,	4506	C. Carlberg, T. Fritioff, I. Bergström

1999DI01	JPHGB	25,	859	Z. Dlouhý, Yu. Penionzhkevich, R. Anne, D. Baiborodin, C. Borcea, A. Fomichev, D. Guillemaud-Mueller, R. Kalpakchieva, M. Lewitowicz, S. Lukyanov, A.C. Mueller, Yu. Oganessian, R.D. Page, A. Reed, M.G. Saint-Laurent, E. Sokol, N. Skobelev, O. Sorlin, O. Tarasov, V. Toneev, W. Trinder
1999Dr09	PRVCA	59,	3433	R. Dressler, B. Eichler, D.T. Jost, D. Piguet, A. Tuerler, Ch. Duehlmann, R. Eichler, H.W. Gaeggeler, M. Gaertner, M. Schaedel, S. Taut, A.B. Yakushev
1999Dr13	JPGPE	25,	1839	O. Dragoun, A. Spalek, M. Rysavy, A. Kovalik, E.A. Yakushev, V. Brabec, A.F. Novgorodov, N. Dragounova, J. Rizek
1999Fe10	EPJAA	6,	235	X.C. Feng, Y.X. Guo, X.H. Zhou, X.F. Sun, X.G. Lei, W.X. Huang, J.J. He, Z. Liu, Y.H. Zhang, S.F. Zhu, Y.X. Luo, S.X. Wen, G.J. Yuan, X.G. Wu
1999Fo01	PRLTA	82,	1823	B. Fogelberg, K.A. Mezilev, H. Mach, V.I. Isakov, J. Slivova
1999Fo.A	PrvCom	GAu	Oct	K. Foehl
1999Ga41	EPJAA	6,	59	Z.G. Gan, Z. Qin, J.S. Guo, L.J. Shi, H.Y. Liu, T.R. Guo, X.G. Lei, R.C. Ma, W.X. Huang, S.G. Yuan, X.Q. Zhang, G.M. Jin
1999Ga.A	B-Seeheim		O34	H.W. Gäggeler, R. Dressler, A. Türler, D.T. Jost, B. Eichler, H.R. von Gunten
1999Gi14	NUPAB	658,	97	J. Gizon, A. Gizon, J. Timár, Gh. Cata-Danil, B.M. Nyakó, L. Zolnai, A.J. Boston, D.T. Joss, E.S. Paul, A.T. Semple, N.J. O'Brien, C.M. Parry, D. Bucurescu, S. Brant, V. Paar
1999Gr28	EPJAA	6,	269	P.T. Greenlees, P. Kuusiniemi, N. Amzal, A. Andreyev, P.A. Butler, K.J. Cann, J.F.C. Cocks, O. Dorvaux, T. Enqvist, P. Fallon, B. Gall, M. Guttormsen, D. Hawcroft, K. Helariutta, F.P. Heßberger, F. Hoellinger, G.D. Jones, P. Jones, R. Julin, S. Juutinen, H. Kankaanpää, H. Kettunen, M. Leino, S. Messelt, M. Muikku, S. Ødegård, R.D. Page, A. Savelius, A. Schiller, S. Siem, W.H. Trzaska, T. Tveter, J. Uusitalo
1999Ha05	PRLTA	82,	1391	M. Hannawald, T. Kautsch, A. Wöhr, W.B. Walters, K.-L. Kratz, V.N. Fedoseyev, V.L. Mishin, W. Böhmer, B. Pfeiffer, V. Sebastian, Y. Jading, U. Köster, J. Lettry, H.L. Ravn, ISOLDE
1999He11	JPHGB	25,	877	F.P. Heßberger
1999He25	APOBB	30,	1267	K. Helariutta, M. Muikku, J.F.C. Cocks, P. Jones, R. Julin, S. Juutinen, H. Kankaanpää, H. Kettunen, P. Kuusiniemi, M. Leino, P. Rahkila, A. Savelius, W.H. Trzaska, J. Uusitalo, P.T. Greenlees, R.D. Page
1999He32	EPJAA	6,	289	K. Helariutta, J.F.C. Cocks, T. Enqvist, P.T. Greenlees, P. Jones, R. Julin, S. Juutinen, P. Jämsen, H. Kankaanpää, H. Kettunen, P. Kuusiniemi, M. Leino, M. Muikku, M. Piiparinen, P. Rahkila, A. Savelius, W.H. Trzaska, S. Törmänen, J. Uusitalo, R.G. Allatt, P.A. Butler, R.D. Page, M. Kapusta
1999Ho01	NUPAB	645,	331	J. Honzátko, I. Tomandl, V. Bondarenko, D. Bucurescu, T. von Egidy, J. Ott, W. Schauer, H.-F. Wirth, C. Doll, A. Gollwitzer, G. Graw, R. Hertzenberger, B.D. Valnion see also 98Ho16
1999Ho09	PYLBB	451,	247	E. Holzschuh, W. Kündig, L. Palermo, H. Stüssi, P. Wenk
1999Ho28	PRVCA	60,	57301	F. Hoellinger, B.J.P. Gall, N. Schulz, N. Amzahl, P.A. Butler, P.T. Greenlees, D. Hawcroft, J.F.C. Cocks, K. Helariutta, P.M. Jones, R. Julin, S. Juutinen, H. Kankaanpää, H. Kettunen, P. Kuusiniemi, M. Leino, M. Muikku, D. Savelius
1999Hu05	PRVCA	59,	2402	W.X. Huang, R.C. Ma, S.W. Xu, X.J. Xu, J.S. Guo, X.F. Sun, Y.X. Xie, Z.K. Li, Y.X. Ge, Y.Y. Wang, C.F. Wang, T.M. Zhang, G.M. Jin, Y.X. Luo
1999Hu10	PRVCA	60,	24315	Z. Hu, L. Batist, J. Agramunt, A. Algora, B.A. Brown, D. Cano-Ott, R. Collatz, A. Gadea, M. Gierlik, M. Górska, H. Grawe, M. Hellström, Z. Janas, M. Karny, R. Kirchner, F. Moroz, A. Plochocki, M. Rejmund, E. Roeckl, B. Rubio, M. Shibata, T. Szerypo, J.L. Tain, V. Wittmann
1999Ja02	PRLTA	82,	295	Z. Janas, C. Chandler, B. Blank, P.H. Regan, A.M. Bruce, W.N. Catford, N. Curtis, S. Czajkowski, Ph. Dessagne, A. Fleury, W. Gelletly, J. Giovannazzo, R. Grzywacz, M. Lewitowicz, C. Longour, C. Marchand, C. Miehé, N.A. Orr, R.D. Page, C.J. Pearson, M.S. Pravikoff, A.T. Reed, M.G. Saint-Laurent, J.A. Sheikh, S.M. Vincent, R. Wadsworth, D.D. Warner, J.S. Winfield

1999Ke05	PYLAA	255,	221	E.G. Kessler, Jr., M.S. Dewey, R.D. Deslattes, A. Henins, H.G. Börner, M. Jentschel, C. Doll, H. Lehmann
1999La14	PRVCA	59,	3086	C.A. Laue, K.E. Gregorich, R. Sudowe, M.B. Hendricks, J.L. Adams, M.R. Lane, D.M. Lee, C.A. McGrath, D.A. Shaughnessy, D.A. Strellis, E.R. Sylwester, P.A. Wilk, D.C. Hoffman
1999Lh01	PRVCA	60,	14315	G. Lhersonneau, J.C. Wang, S. Hankonen, P. Dendooven, P. Jones, R. Julin, J. Äystö
1999Li33	EPJAA	5,	351	Z. Li, S. Xu, Y. Xie, Y. Yu, C. Wang, J. Xing, Q. Pan, Q. Hu, S. Li, H. Chen, T. Zhang
1999Li46	PRVCA	60,	67304	Z. Li, S. Xu, Y. Xie, R. Ma, Y. Ge, C. Wang, W. Huang, T. Zhang
1999Mi17	EPJAA	5,	143	Ch. Miehe, Ph. Dessagne, Ch. Pujol, G. Walter, B. Jonson, M. Lindroos, ISOLDE
1999Mo30	NUPAB	657,	251	C.-B. Moon, S.J. Chae, T. Komatsubara, T. Shizuma, Y. Sasaki, H. Ishiyama, T. Jumatsu, K. Furuno
1999Mo39	JPCRB	28,	1713	P.J. Mohr, B.N. Taylor
1999Mu17	PRLTA	83,	3613	W.F. Mueller, B. Bruyneel, S. Franchoo, H. Grawe, M. Huyse, U. Köster, K.-L. Kratz, K. Kruglov, Y. Kudryavtsev, B. Pfeiffer, R. Raabe, I. Reusen, P. Thirolf, P. Van Duppen, J. Van Roosbroeck, L. Vermeeren, W.B. Walters, L. Weissman
1999Na27	PRLTA	83,	1112	T. Nakamura, N. Fukuda, T. Kobayashi, N. Aoi, H. Iwasaki, T. Kubo, A. Mengoni, M. Notani, H. Otsu, H. Sakurai, S. Shimoura, T. Teranishi, Y.X. Watanabe, K. Yoneda, M. Ishihara
1999Ni03	PRLTA	83,	1104	V. Ninov, K.E. Gregorich, W. Loveland, A. Ghiorso, D.C. Hoffman, D.M. Lee, H. Nitsche, W.J. Swiatecki, U.W. Kirbach, C.A. Laue, J.L. Adams, J.B. Patin, D.A. Shaughnessy, D.A. Strellis, P.A. Wilk
1999Og03	PYLB	451,	11	H. Ogawa, K. Asahi, K. Sakai, A. Yoshimi, M. Tsuda, Y. Uchiyama, T. Suzuki, K. Suzuki, N. Kurokawa, M. Adachi, H. Izumi, H. Ueno, T. Shimoda, S. Tanimoto, N. Takahashi, W.-D. Schmidt-Ott, M. Schäfer, S. Fukuda, A. Yoshida, M. Notani, T. Kubo, H. Okuno, H. Sato, N. Aoi, K. Yoneda, H. Iwasaki, N. Fukuda, N. Fukunishi, M. Ishihara, H. Miyatake
1999Og05	EPJAA	5,	63	Yu. Ts. Oganessian, A.V. Yeremin, G.G. Gulbekian, S.L. Bogomolov, V.I. Chepigin, B.N. Gikal, V.A. Gorshkov, M.G. Itkis, A.P. Kabachenko, V.B. Kutner, A. Yu. Lavrentev, O.N. Malyshev, A.G. Popeko, J. Roháč, R.N. Sagaidak, S. Hofmann, G. Münzenberg, M. Veselsky, S. Saro, N. Iwasa, K. Morita
1999Og07	NATUA	400,	242	Yu. Ts. Oganessian, A.V. Yeremin, A.G. Popeko, S. L. Bogomolov, G.V. Buklanov, M.L. Chelnokov, V.I. Chepigin, B.N. Gikal, V.A. Gorshkov, G.G. Gulbekian, M.G. Itkis, A.P. Kabachenko, A. Yu. Lavrentev, O.N. Malyshev, J. Rohac, R.N. Sagaidak, S. Hofmann, S. Saro, G. Giardina, K. Morita
1999Og10	PRLTA	83,	3154	Yu. Ts. Oganessian, V.K. Utyonkov, Yu. V. Lobanov, F. Sh. Abdullin, A.N. Polyakov, I.V. Shirokovsky, Yu. S. Tsyganov, G.G. Gulbekian, S.L. Bogomolov, B.N. Gikal, A.N. Mezentsev, S. Iliev, V.G. Subbotin, A.M. Sukhov, G.V. Buklanov, K. Subotic, M.G. Itkis, K.J. Moody, J.F. Wild, N.J. Stoyer, M.A. Stoyer, R.W. Loughheed
1999Og.A	B-Seeheim		O4	Yu. Ts. Oganessian, A.V. Yeremin (and oral presentation)
1999Og.B	B-Seeheim		O5	Yu. Ts. Oganessian, V.K. Utyonkov, Yu. V. Lobanov, F. Sh. Abdullin, A.N. Polyakov, I.V. Shirokovsky, Yu. S. Tsyganov, G.G. Gulbekian, S.L. Bogomolov, B.N. Gikal, A.N. Mezentsev, S. Iliev, V.G. Subbotin, A.M. Sukhov, G.V. Buklanov, K. Subotic, M.G. Itkis, K.J. Moody, J.F. Wild, N.J. Stoyer, R.W. Loughheed, and email
1999Pi08	NPBSE	77,	352	F. Piquemal, NEMO
1999Po09	PRVCA	59,	2979	G.L. Poli, C.N. Davids, P.J. Woods, D. Seweryniak, J.C. Batchelder, L.T. Brown, C.R. Bingham, M.P. Carpenter, L.F. Conticchio, T. Davinson, J. de Boer, S. Hamada, D.J. Henderson, R.J. Irvine, R.V.F. Janssens, H.J. Maier, L. Müller, F. Soramel, K.S. Toth, W.B. Walters, J. Wauters
1999Pr10	PRVCA	60,	54307	J.I. Prisciandaro, P.F. Mantica, A.M. Oros-Peusquens, D.W. Anthony, M. Huhta, P.A. Lofy, R.M. Ronningen

1999Re06	PRVCA	59,	2416	I. Reusen, I. Reusen, A. Andreyev, J. Andrzejewski, N. Bijnens, S. Franchoo, M. Huyse, Yu. Kudryavtsev, K. Kruglov, W.F. Mueller, A. Piechaczek, R. Raabe, K. Rykaczewski, J. Szerypo, P. Van Duppen, L. Vermeeren, J. Wauters, A. Wöhr
1999Re16	PRVCA	60,	24311	A.T. Reed, O. Tarasov, R.D. Page, D. Guillemaud-Mueller, Yu. E. Penionzhkevich, R.G. Allatt, J.C. Angélique, R. Anne, C. Borcea, V. Burjan, W.N. Catford, Z. Dlouhý, C. Donzaud, S. Grévy, M. Lewitowicz, S.M. Lukyanov, F.M. Marqués, G. Martinez, A.C. Mueller, P.J. Nolan, J. Novák, N.A. Orr, F. Pougheon, P.H. Regan, M.G. Saint-Laurent, T. Siiskonen, E. Sokol, O. Sorlin, J. Suhonen, W. Trinder, S.M. Vincent
1999Ry04	PRVCA	60,	11301	K. Rykaczewski, J.C. Batchelder, C.R. Bingham, T. Davinson, T.N. Ginter, C.J. Gross, R. Grzywacz, M. Karny, B.D. MacDonald, J.F. Mas, J.W. McConnell, A. Piechaczek, R.C. Slinger, K.S. Toth, W.B. Walters, P.J. Woods, E.F. Zganjar, B. Barmore, L. Gr. Ixaru, A.T. Kruppa, W. Nazarewicz, M. Rizea, T. Vertse
1999Sa06	PYLBB	448,	180	H. Sakurai, S.M. Lukyanov, M. Notani, N. Aoi, D. Beaumel, N. Fukuda, M. Hirai, E. Ideguchi, N. Imai, M. Ishihara, H. Iwasaki, T. Kubo, K. Kusaka, H. Kumagai, T. Nakamura, H. Ogawa, Yu. E. Penionzhkevich, T. Teranishi, Y.X. Watanabe, K. Yoneda, A. Yoshida
1999Sa.A	P-Bormio			F. Sarazin, et al, and PrvCom to D. Lunney March 1999
1999Sa.D	B-Seeheim		PW4	M. Sakama, K. Tsukuda, M. Asai, S. Ichikawa, Y. Oura, A. Osa, M. Shibata, I. Nishinaka, Y. Nagame, M. Ebihara, K. Kawade, H. Nakahara and poster
1999Sc12	ARISE	51,	169	U. Schotzig, E. Schonfeld, E. Gunther, R. Klein, H. Schrader
1999Se14	PRVCA	60,	31304	D. Seweryniak, J. Uusitalo, M.P. Carpenter, D. Nisius, C.N. Davids, C.R. Bingham, L.T. Brown, I. Conticchio, D.J. Henderson, R.V.F. Janssens, W.B. Walters, J. Wauters, P.J. Woods
1999Sh03	PRVCA	59,	101	R.K. Sheline, P. Alexa, C.F. Liang, P. Paris
1999Sh12	PRLTA	82,	1109	R.W. Shaw, J.P. Young, S.P. Cooper, O.F. Web
1999Sm07	EPJAA	5,	43	M.B. Smith, R. Chapman, J.F.C. Cocks, O. Dorvaux, K. Helariutta, P.M. Jones, R. Julin, S. Juutinen, H. Kankaanpaa, H. Kettunen, P. Kusiniemi, Y. Le Coz, M. Leino, D.J. Middleton, M. Muikku, P. Nieminen, P. Rakhila, A. Savelius, K.-M. Spohr
1999So17	PRLTA	83,	1116	A.A. Sonzogni, C.N. Davids, P.J. Woods, D. Seweryniak, M.P. Carpenter, J.J. Ressler, J. Schwartz, J. Uusitalo, W.B. Walters
1999So20	NUPAB	660,	3	O. Sorlin, C. Donzaud, L. Axelsson, M. Belleguic, R. Béraud, C. Borcea, G. Chancel, E. Chabanat, J.M. Daugas, A. Emsallem, D. Guillemaud-Mueller, K.-L. Kratz, S. Leenhardt, M. Lewitowicz, C. Longour, M.J. Lopez, F. de Oliveira Santos, L. Petizon, B. Pfeiffer, F. Pougheon, M.G. Saint-Laurent, J.E. Sauvestre, and erratum Nucl. Phys. A669 (2000) 351
1999Ta20	EPJAA	5,	123	Y. Tagaya, S. Hashimoto, K. Morita, Y.H. Pu, T. Ariga, K. Ohta, T. Mine-mura, I. Hisinaga, T. Motobayashi, T. Nomura
1999Ta29	EPJAA	6,	119	M. Tanigaki, K. Sekiguchi, M. Fujita, T. Hoshino, T. Baba, N. Kawamura, T. Shinozuka, M. Fujioka
1999Th09	PYLBB	467,	194	J. Thaysen, L. Axelsson, J. Äystö, M.J.G. Borge, L.M. Fraile, H.O.U. Fynbo, A. Honkanen, P. Hornshøj, Y. Jading, A. Jokinen, B. Jonson, I. Martel, I. Mukha, T. Nilsson, G. Nyman, M. Oinonen, K. Riisager, T. Siiskonen, M.H. Smedberg, O. Tengblad, F. Wenander, ISOLDE
1999To04	EPJAA	4,	233	Y. Toh, S. Yamada, A. Taniguchi, Y. Kawase
1999To11	PRVCA	60,	11302	K.S. Toth, C.R. Bingham, J.C. Batchelder, L.T. Brown, L.F. Contecchio, C.N. Davids, R.J. Irvine, D. Sewerniak, D.M. Moltz, W.B. Walters, J. Wauters, E.F. Zganjar
1999Ut01	PRLTA	82,	505	S.B. Utter, P. Beierdorfer, A. Barnes, R.W. Lougheed, J.R. Crespo Lopez-urrutia, J.A. Becker, M.S. Weiss
1999Wa09	PYLBB	454,	1	J.C. Wang, P. Dendooven, M. Hannawald, A. Honkanen, M. Huhta, A. Jokinen, K.-L. Kratz, G. Lhersonneau, M. Oinonen, H. Penttilä, K. Peräjärvi, B. Pfeiffer, J. Äystö

1999We07	PRVCA	59,	2004	L. Weissmann, A. Andreyev, B. Bruyneel, S. Franchoo, M. Huyse, K. Kruglov, Y. Kudryavtsev, W.F. Mueller, R. Raabe, I. Reusen, P. Van Duppen, J. Van Roosbroeck, L. Vermeeren, U. Köster, K.L. Kratz, B. Pfeiffer, P. Thirolf, W.B. Walters
1999Wh03	EPJAA	5,	353	C. Wheldon, P.M. Walker, R. D'Alarcao, P. Chowdhury, C.J. Pearson, E.H. Seabury, I. Ahmad, M.P. Carpenter, D.M. Cullen, G. Hackman, R.V.F. Janssens, T.L. Khoo, D. Nisius, P. Reiter
1999Xi03	EPJAA	5,	341	Y. Xie, S. Xu, Z. Li, Y. Yu, Q. Pan, C. Wang, T. Zhang, G. Long, Y. Li
1999Xi04	EPJAA	6,	239	Y. Xie, S. Xu, Z. Li, Y. Yu, Q. Pan, C. Wang, T. Zhang
1999Xu05	PRVCA	60,	61302	S.-W. Xu, Z.-K. Li, Y.-X. Xie, Q.-Y. Pan, Y. Yu, J. Adam, C.-F. Wang, J.-P. Xing, Q.-Y. Hu, S.-H. Li, H.-Y. Chen, T.-M. Zhang, G.-M. Jin, Y.-X. Luo, Yu. Penionzhkevich, Yu. Gangrsky
1999Ya.A	P-Dubna		118	E.A. Yakushev, V.M. Gorozhankin, O. Dragoun, A. Kovalik, A.F. Novgorodov, M. Rysavy, A. Shpalek
2000				
2000Ah02	PRVCA	61,	44301	I. Ahmad, R.R. Chasman, P.R. Fields
2000An14	NATUA	405,	430	A.N. Andreyev, M. Huyse, P. Van Duppen, L. Weissman, D. Ackermann, J. Gerl, F.P. Heßberger, S. Hofmann, A. Kleinböhl, G. Münzenberg, S. Reshitko, C. Schlegel, H. Schaffner, P. Cagarda, M. Matos, S. Saro, A. Keenan, C. Moore, C.D. O'Leary, R.D. Page, M. Taylor, H. Kettunen, M. Leino, A. Lavrentiev, R. Wyss, K. Heyde
2000As.A	AnRpt JAERI		13	M. Asai, K. Tsukada, S. Ichikawa, H. Haba, A. Osa, Y. Nagame, S. Goto, M. Sakama, Y. Kojima, M. Shibata, K. Akiyama, A. Toyoshima
2000Be42	EPJAA	8,	307	D. Beck, F. Ames, G. Audi, G. Bollen, F. Herfurth, H.-J. Kluge, A. Kohl, M. König, D. Lunney, I. Martel, R.B. Moore, H. Raimbault-Hartmann, E. Scharf, S. Schwarz, M. de Saint Simon, J. Szerypo, ISOLDE
2000B101	PRLTA	84,	1116	B. Blank, M. Chartier, S. Czajkowski, J. Giovinazzo, M.S. Pravikoff, J.-C. Thomas, G. de France, F. de Oliveira Santos, M. Lewitowicz, C. Borcea, R. Grzywacz, Z. Janas, M. Pfützner
2000Br63	PYLBB	495,	63	V.B. Brudanin, N.I. Rukhadze, Ch. Briancon, V.G. Egorov, V.E. Kovalenko, A. Kovalik, A.V. Salamatina, I. Štekl, V.V. Tsupko-Sitnikov, Ts. Vylov, P. Čermák
2000Ca.A	Th.-Valencia			Cano-Ott
2000Ch07	PRVCA	61,	44309	C. Chandler, P.H. Regan, B. Blank, C.J. Pearson, A.M. Bruce, W.N. Catford, N. Curtis, S. Czajkowski, Ph. Dessagne, A. Fleury, W. Gelletly, J. Giovinazzo, R. Grzywacz, Z. Janas, M. Lewitowicz, C. Marchand, Ch. Mielke, N.A. Orr, R.D. Page, M.S. Pravikoff, A.T. Reed, M.G. Saint-Laurent, S.M. Vincent, R. Wadsworth, D.D. Warner, J.S. Winfield, F. Xu
2000Da07	PYLBB	476,	213	J.M. Daugas, R. Grzywacz, M. Lewitowicz, L. Achouri, J.C. Angélique, D. Baiborodin, K. Bennaceur, R. Bentida, R. Béraud, C. Borcea, C. Bingham, W.N. Catford, A. Emsallem, G. de France, H. Grawe, K.L. Jones, R.C. Lemmon, M.J. Lopez Jimenez, F. Nowacki, F. de Oliveira Santos, M. Pfützner, P.H. Regan, K. Rykaczewski, J.E. Sauvestre, M. Sawicka, G. Sletten, M. Stanoiu
2000Da27	PRVCA	62,	45501	F.A. Danevich, A. Sh. Georgadze, V.V. Kobayev, B.N. Kropivyan-sky, A.S. Nikolaiko, O.A. Ponkratenko, V.I. Tretyak, S. Yu. Zdesenko, Yu. G. Zdesenko, P.G. Bizzeti, T.F. Fazzini, P.R. Maurenzi
2000Di18	PRVCA	62,	34316	K.Y. Ding, J.A. Cizewski, D. Seweryniak, H. Amro, M.P. Carpenter, C.N. Davids, N. Fotiades, R.V.F. Janssens, T. Lauritsen, C.J. Lister, D. Nisius, P. Reiter, J. Uusitalo, I. Wiedenhöver, A.O. Macchiavelli
2000Fy01	NUPAB	677,	38	H.O.U. Fynbo, M.J.G. Borge, L. Axelsson, J. Äystö, U.C. Bergmann, L.M. Fraile, A. Honkanen, P. Hornshøj, Y. Jading, A. Jokinen, B. Jonsson, I. Martel, I. Mukha, T. Nilsson, G. Nyman, M. Oinonen, I. Piqueras, K. Riisager, T. Siiskonen, M.H. Smedberg, O. Tengblad, J. Thaysen, F. Wenzel, ISOLDE
2000Ge01	NUPAB	662,	3	L. Genilloud, H.G. Börner, F. Corminboeuf, Ch. Doll, S. Drissi, M. Jentschel, J. Jolie, J. Kern, H. Lehmann, N. Warr, and erratum NUPAB 669(2000)407



2000Gi01	PRVCA	61,	14308	T.N. Ginter, J.C. Batchelder, C.R. Bingham, C.J. Gross, R. Grzywacz, J.H. Hamilton, Z. Janas, M. Karny, S.H. Kim, J.F. Mas, J.W. McConnell, A. Piechaczek, A.V. Ramayya, K. Rykaczewski, P.B. Semmes, J. Szerypo, K.S. Toth, R. Wadsworth, C.-H. Yu, E.F. Zganjar
2000Ha55	PRVCA	62,	54301	M. Hannawald, K.-L. Kratz, B. Pfeiffer, W.B. Walters, V.N. Fedoseyev, V.I. Mishin, W.F. Mueller, H. Schatz, J. Van Roosbroeck, U. Köster, V. Sebastian, H.L. Ravn, ISOLDE
2000He17	EPJAA	8,	521	F.P. Heßberger, S. Hofmann, D. Ackermann, V. Ninov, M. Leino, S. Saro, A. Andreyev, A. Lavrentev, A.G. Popeko, A.V. Yeremin, and erratum EPJAA 9(2000)433
2000Hu17	PRVCA	62,	64315	Z. Hu, L. Batist, J. Agramunt, A. Algora, B.A. Brown, D. Cano-Ott, R. Collatz, A. Gadea, M. Gierlik, M. Górska, H. Grawe, M. Hellström, Z. Janas, M. Karny, R. Kirchner, F. Moroz, A. Plochocki, M. Rejmund, E. Roeckl, B. Rubio, M. Shibata, J. Szerypo, J.L. Tain, V. Wittmann
2000Je09	PRVCA	62,	21302	D.G. Jenkins, M. Muikku, P.T. Greenlees, K. Hauschild, K. Helariutta, P.M. Jones, R. Julin, S. Juutinen, H. Kankaanpaa, N.S. Kelsall, H. Ketunen, P. Kuusiniemi, M. Leino, C.J. Moore, P. Nieminen, C.D. O'Leary, R.D. Page, P. Rakhila, W. Reviol, M.J. Taylor, J. Uusitalo, R. Wadsworth
2000Jo18	EPJAA	9,	9	A. Jokinen, J.C. Wang, J. Äystö, P. Dendooven, S. Nummela, J. Huikari, V. Kolhinen, A. Nieminen, K. Peräjärvi, S. Rinta-Antila
2000Kr.A	PrvCom	GAu	Jun	K.-L. Kratz, B. Pfeiffer
2000La25	PRVCA	61,	67603	C.A. Laue, K.E. Gregorich, R. Sudowe, J.L. Adams, M.R. Lane, D.M. Lee, C.A. McGrath, D.A. Shaughnessy, D.A. Strellis, E.R. Sylwester, P.A. Wilk, D.C. Hoffman
2000La34	PRVCA	62,	64307	Yu. A. Lazarev, Yu. V. Lobanov, Yu. Ts. Oganessian, V.K. Utyonkov, F.Sh. Abdullin, A.N. Polyakov, J. Rigol, I.V. Shirokovsky, Yu. S. Tsyganov, S. Iliev, V.G. Subbotin, A.M. Sukhov, G.V. Buklanov, A.N. Mezentsev, K. Subotic, K.J. Moody, N.J. Stoyer, J.F. Wild, R.W. Lougheed
2000Li37	PRVCA	62,	47303	C.F. Liang, P. Paris, R.K. Sheline
2000Ma62	PRVCA	62,	34308	K. Markenroth, L. Axelsson, S. Baxter, M.J.G. Borge, C. Donzaud, S. Fayans, H.O.U. Fynbo, V.Z. Goldberg, S. Grévy, D. Guillemaud-Mueller, B. Jonson, K.-M. Källman, S. Leenhardt, M. Lewitowicz, T. Lönnroth, P. Manngård, I. Martel, A.C. Mueller, I. Mukha, T. Nilsson, G. Nyman, N.A. Orr, K. Riisager, G.V. Rogachev, M.-G. Saint-Laurent, I.N. Serikov, N.B. Shul'gina, O. Sorlin, M. Steiner, O. Tengblad, M. Thoennessen, E. Tryggestad, W.H. Trzaska, F. Wenander, J.S. Winfield, R. Wolski
2000Ma65	EPJAA	8,	295	O.N. Malyshev, A.V. Belozarov, M.L. Chelnokov, V.I. Chepigina, V.A. Gorskov, A.P. Kabachenko, A.G. Popeko, J. Rohach, R.N. Sagaidak, A.V. Yeremin, S.I. Mulgin, S.V. Zhdanov
2000Ma95	PRVCA	62,	57303	H. Mahmud, C.N. Davids, P.J. Woods, T. Davinson, D.J. Henderson, R.J. Irvine, D. Seweryniak, W.B. Walters
2000Me.A	PrvCom	AHW	Sep	K.A. Mezilev, B. Fogelberg, V.I. Isakov, H. Mach
2000Mu10	PRVCA	61,	54308	W.F. Mueller, B. Bruyneel, S. Franchoo, M. Huyse, J. Kurpeta, K. Kruglov, Y. Kudryavtsev, N.V.S.V. Prasad, R. Raabe, I. Reusen, P. Van Duppen, J. Van Roosbroeck, L. Vermeeren, L. Weissman, Z. Janas, M. Karny, T. Kszczot, A. Plochocki, K.-L. Kratz, B. Pfeiffer, H. Grawe, U. Köster, P. Thirolf, W.B. Walters
2000Ni02	PRVCA	61,	34309	K. Nishio, H. Ikezoe, S. Mitsuoka, J. Lu
2000Oi02	PRVCA	61,	35801	M. Oinonen, J. Äystö, A. Jokinen, P. Baumann, F. Didierjean, A. Huck, A. Knipper, M. Ramdhane, G. Walter, M. Huyse, P. Van Duppen, G. Marguier, Yu. Novikov, A. Popov, D.M. Seliverstov, H. Schatz, ISOLDE
2000Oi01	PRLTA	84,	4056	J.M. Oliveira, Jr., A. Lépine-Szily, H.G. Bohlen, A.N. Ostrowski, R. Lichtenthäler, A. Di Pietro, A.M. Laird, G.F. Lima, L. Maunoury, F. de Oliveira Santos, P. Roussel-Chomaz, H. Savajols, W. Trinder, A.C.C. Villari, A. de Vismes
2000Pi15	PRVCA	62,	54317	A. Piechaczek, E.F. Zganjar, J.C. Batchelder, B.D. MacDonald, W.D. Kulp, S.D. Paul, R. Terry, J.L. Wood

2000Ra23	NUPAB	677,	75	T. Radon, H. Geissel, G. Münzenberg, B. Franzke, Th. Kerscher, F. Nolden, Yu. N. Novikov, Z. Patyk, C. Scheidenberger, F. Attallah, K. Beckert, T. Beha, F. Bosch, H. Eickhoff, M. Falch, Y. Fujita, M. Hausmann, F. Herfurth, H. Irnich, H.C. Jung, O. Klepper, C. Kozhuharov, Yu. A. Litvinov, K.E.G. Löbner, F. Nickel, H. Reich, W. Schwab, B. Schlitt, M. Steck, K. Sümmerner, T. Winkler, H. Wollnik
2000Re03	PRLTA	84,	2104	J.J. Ressler, A. Piechaczek, W.B. Walters, A. Aprahamian, M. Wiescher, J.C. Batchelder, C.R. Bingham, D.S. Brenner, T.N. Ginter, C.J. Gross, R. Grzywacz, D. Kulp, B. MacDonald, W. Reviol, J. Rikovska, K. Rykaczewski, J.A. Winger, E.F. Zganjar
2000Ri14	PRLTA	85,	1392	J. Rikovska, T. Giles, N.J. Stone, K. van Esbroeck, G. White, A. Wöhr, M. Veskovic, I.S. Towner, P.F. Mantica, J.I. Prisciandaro, D.J. Morrissey, V.N. Fedoseyev, V.I. Mishin, U. Köster, W.B. Walters, NICOLE, ISOLDE
2000Sa21	PRLTA	84,	5062	F. Sarazin, H. Savajols, W. Mittig, F. Nowacki, N.A. Orr, Z. Ren, P. Roussel-Chomaz, G. Auger, D. Baiborodin, A.V. Belozyorov, C. Borcea, E. Caurier, Z. Dlouhý, A. Gillibert, A.S. Lalleman, M. Lewitowicz, S.M. Lukyanov, F. de Oliveira, Y.E. Penionzhkevich, D. Ridikas, H. Sakurai, O. Tarasov, A. de Vismes
2000Sa52	EPJAA	9,	303	M. Sakama, K. Tsukada, M. Asai, S. Ichikawa, H. Haba, S. Goto, Y. Oura, I. Nishinaka, Y. Nagame, M. Shibata, Y. Kojima, K. Kawade, M. Ebihara, H. Nakahara
2000Sc31	EPJAA	8,	303	K. Schmidt, C. Mazzocchi, R. Borcea, J. Döring, S. Galanopoulos, M. Górská, H. Grawe, S. Harissopoulos, M. Hellström, Z. Janas, R. Kirchner, G. Kriembardis, M. La Commara, A.N. Ostrowski, G. Rainovski, E. Roeckl
2000Sm06	JPGPE	26,	787	M.B. Smith, R. Chapman, J.F.C. Cocks, K.-M. Spohr, O. Dorvaux, K. Helariutta, P.M. Jones, R. Julin, S. Juutinen, H. Kankaanpää, H. Kettunen, P. Kuusiniemi, Y. Le Coz, M. Leino, D.J. Middleton, M. Muikku, P. Nieminen, P. Rakhila, A. Savelius
2000So11	PHSTB	T88,	153	G.A. Souliotis
2000We.A	AnRpt GSI		10	E. Wefers, T. Faestermann, R. Schneider, A. Stolz, K. Sümmerner, J. Friese, H. Geissel, M. Hellström, P. Kienle, H.-J. Körner, M. Münch, G. Münzenberg, P. Thirolf, H. Weick
2000Wi15	PRLTA	85,	2697	P.A. Wilk, K.E. Gregorich, A. Türler, C.A. Laue, R. Eichler, V. Ninov, J.L. Adams, U.W. Kirbach, M.R. Lane, D.M. Lee, J.B. Patin, D.A. Shaughnessy, D.A. Strellis, H. Nitsche, D.C. Hoffman
2000Xu02	PRVCA	61,	67308	Y. Xu, S. Yuan, W. Yang, J. He, Z. Li, T. Ma, B. Xiong
2000Xu08	EPJAA	8,	435	S. Xu, Y. Xie, Y. Yu, Z. Li, Q. Pan, C. Wang, J. Xing, T. Zhang
				2001
2001An11	EPJAA	10,	129	A.N. Andreyev, D. Ackermann, P. Cagarda, J. Gerl, F.P. Heßberger, S. Hofmann, M. Huyse, A. Keenan, H. Kettunen, A. Kleinböhl, A. Lavrentiev, M. Leino, B. Lommel, M. Matos, G. Münzenberg, C.J. Moore, C.D. O'Leary, R.D. Page, S. Reshitko, S. Saro, C. Schlegel, H. Schaffner, M.J. Taylor, P. Van Duppen, L. Weissman, R. Wyss
2001Ba12	PRLTA	86,	1454	G.C. Ball, S. Bishop, J.A. Behr, G.C. Boisvert, P. Bricault, J. Cerny, J.M. D'Auria, M. Dombisky, J.C. Hardy, V. Jacob, J.R. Leslie, T. Lindner, J.A. Macdonald, H.-B. Mak, D.M. Moltz, J. Powell, G. Savard, I.S. Towner
2001Be53	EPJAA	11,	279	U.C. Bergmann, M.J.G. Borge, J. Cederkäll, C. Forssén, E. Fumero, H.O.U. Fynbo, H. Gausemel, H. Jeppesen, B. Jonson, K. Markenroth, T. Nilsson, G. Nyman, K. Riisager, H. Simon, O. Tengblad, L. Weissman, F. Wenander, K. Wilhelmsen Rolander, ISOLDE
2001Bo11	NUPAB	686,	64	R. Bonetti, C. Carbonini, A. Guglielmetti, M. Hussonnois, D. Trubert, C. Le Naour

2001Bo54	NUPAB	695,	69	R. Borcea, J. Äystö, E. Caurier, P. Dendooven, J. Döring, M. Gierlik, M. Górska, H. Grawe, M. Hellström, Z. Janas, A. Jokinen, M. Karny, R. Kirchner, M. La Commara, K. Langanke, G. Martínez-Pinedo, P. Mayet, A. Nieminen, F. Nowacki, H. Penttilä, A. Plochocki, M. Rejmund, E. Roeckl, C. Schlegel, K. Schmidt, R. Schwengner, M. Sawicka, and erratum NUPAB 703(2002)889
2001Bo59	HYIND	132,	215	G. Bollen, F. Ames, G. Audi, D. Beck, J. Dilling, O. Engels, S. Henry, F. Herfurth, A. Kellerbauer, H.-J. Kluge, A. Kohl, E. Lamour, D. Lunney, R.B. Moore, M. Oinonen, C. Scheidenberger, S. Schwarz, G. Sikler, J. Szerypo, C. Weber, ISOLDE
2001Br27	EPJDD	15,	181	S. Brunner, T. Engel, A. Schmitt, G. Werth
2001Ca37	PRVCA	64,	25802	J.A. Caggiano, D. Bazin, W. Benenson, B. Davids, R. Ibbotson, H. Scheit, B.M. Sherrill, M. Steiner, J. Yurkon, A.F. Zeller, B. Blank, M. Chartier, J. Greene, J.A. Nolen, Jr., A.H. Wuosmaa, M. Bhattacharya, A. García, M. Wiescher
2001Ca.B	AnRpt GSI		15	P. Cagarda, S. Antalic, D. Ackermann, F.P. Heßberger, S. Hofmann, B. Kindler, J. Kojouharova, B. Lommel, R. Mann, A.G. Popeko, Š. Šáro, J. Uusitalo, A.V. Yeremin
2001Ch31	PYLBB	505,	21	L. Chen, B. Blank, B.A. Brown, M. Chartier, A. Galonsky, P.G. Hansen, M. Thoennessen
2001Da22	NUPAB	694,	375	F.A. Danevich, V.V. Kobychyev, O.A. Ponkratenko, V.I. Tretyak, Yu. G. Zdesenko
2001Do08	PRLTA	86,	4259	G. Douysset, T. Fritioff, C. Carlberg, I. Bergström, M. Björkhage
2001Fr18	EPJDD	15,	141	T. Fritioff, C. Carlberg, G. Douysset, R. Schuch, I. Bergström
2001Ga01	PRVCA	63,	14302	M. Galeazzi, F. Fontanelli, F. Gatti, S. Vitale
2001Ga20	EPJAA	10,	21	Z.G. Gan, Z. Qin, H.M. Fan, X.G. Lei, Y.B. Xu, J.J. He, H.Y. Liu, X.L. Wu, J.S. Guo, X.H. Zhou, S.G. Yuan, G.M. Jin
2001Ga24	PRVCA	63,	44307	J. Garcés Narro, C. Longour, P.H. Regan, B. Blank, C.J. Pearson, M. Lewitowicz, C. Miehé, W. Gelletly, D. Appelbe, L. Axelsson, A.M. Bruce, W.N. Catford, C. Chandler, R.M. Clark, D.M. Cullen, S. Czajkowski, J.M. Daugas, P. Dessagne, A. Fleury, L. Frankland, J. Giovinazzo, B. Greenhalgh, R. Grzywacz, M. Harder, K.L. Jones, N. Kelsall, T. Kszczot, R.D. Page, A.T. Reed, O. Sorlin, R. Wadsworth
2001Ga59	EPJAA	11,	413	M. Gaelens, J. Andrzejewski, J. Camps, P. Decrock, M. Huyse, K. Kruglov, W.F. Mueller, A. Piechaczek, N. Severijns, J. Szerypo, G. Vancraeynest, P. Van Duppen, J. Wauters
2001Gi01	EPJAA	10,	73	J. Giovinazzo, B. Blank, C. Borcea, M. Chartier, S. Czajkowski, G. de France, R. Grzywacz, Z. Janas, M. Lewitowicz, F. de Oliveira Santos, M. Pfützner, M.S. Pravikoff, J.C. Thomas
2001Gi10	EPJAA	11,	247	J. Giovinazzo, B. Blank, C. Borcea, M. Chartier, S. Czajkowski, G. de France, R. Grzywacz, Z. Janas, M. Lewitowicz, F. de Oliveira Santos, M. Pfützner, M.S. Pravikoff, J.C. Thomas
2001Gi17	EPJAA	12,	309	A. Gizon, J. Genevey, C.F. Liang, P. Paris, D. Barnéoud, J. Inchaouh, I. Penev, A. Plochocki
2001Gr07	NUPAB	682,	41c	R. Grzywacz, C.H. Yu, Z. Janas, S.D. Paul, J.C. Batchelder, C.R. Bingham, T.N. Ginter, C.J. Gross, J. McConnell, M. Lipoglavsek, A. Piechaczek, D.C. Radford, J.J. Ressler, K. Rykaczewski, J. Shergur, W.B. Walters, E.F. Zganjar, C. Baktash, M.P. Carpenter, R.V.F. Janssens, C.E. Svensson, J.C. Waddington, D. Ward, E. Dragulescu
2001Ha21	NUPAB	686,	591	T. Hashimoto, K. Nakai, Y. Wakasaya, I. Tanihata, Z. Fulop, H. Kumagai, A. Ozawa, K. Yoshida, R. Goswarmi
2001Ha39	NUPAB	688,	578c	M. Hannawald, V.N. Fedoseyev, U. Koster, K.-L. Kratz, V.I. Mishin, W.F. Mueller, H.L. Ravn, J. Van Roosbroeck, H. Schatz, V. Sebastian, W.B. Walters, ISOLDE
2001Ha46	PRLTA	87,	72501	K. Hauschild, M. Rejmund, H. Grawe, E. Caurier, F. Nowacki, F. Becker, Y. Le Coz, W. Kortem, J. Döring, M. Górska, K. Schmidt, O. Dorvaux, K. Helariutta, P. Jones, R. Julin, S. Juutinen, H. Kettunen, M. Leino, M. Muikku, P. Nieminen, P. Rakhila, J. Uusitalo, F. Azaiez, M. Belleguic

2001Ha66	HYIND	132,	291	M. Hausmann, J. Stadlmann, F. Attallah, K. Beckert, P. Beller, F. Bosch, H. Eickhoff, M. Falch, B. Franczak, B. Franzke, H. Geissel, Th. Kerscher, O. Klepper, H.-J. Kluge, C. Kozhuharov, Yu. A. Litvinov, K.E.G. Lobner, G. Munzenberg, N. Nankov, F. Nolden, Yu. N. Novikov, T. Ohtsubo, T. Radon, H. Schatz, C. Scheidenberger, M. Steck, Z. Sun, H. Weick, H. Wollnik
2001He29	PRLTA	87,	142501	F. Herfurth, J. Dilling, A. Kellerbauer, G. Audi, D. Beck, G. Bollen, H.-J. Kluge, D. Lunney, R.B. Moore, C. Scheidenberger, S. Schwarz, G. Sikler, J. Szerypo, ISOLDE
2001He35	EPJAA	12,	57	F.P. Heßberger, S. Hofmann, D. Ackermann, V. Ninov, M. Leino, G. Münzenberg, S. Saro, A. Lavrentev, A.G. Popeko, A.V. Yeremin, Ch. Stodel and PrvCom
2001He36	PRVAA	64,	62504	T.P. Heavner, S.R. Jefferts, G.H. Dunn
2001He.A	AnRpt GSI		3	F.P. Heßberger, S. Hofmann, D. Ackermann
2001Hi06	PRVCA	63,	65502	M.M. Hindi, B.O. Faircloth, R.L. Kozub, K.R. Czerwinski, R.-M. Larimer, E.B. Norman, B. Sur, I. Žilim
2001Ho06	EPJAA	10,	5	S. Hofmann, F.P. Heßberger, D. Ackermann, S. Antalic, P. Caggarda, S. Cwiok, B. Kindler, J. Kojouharova, B. Lommel, R. Mann, G. Münzenberg, A.G. Popeko, S. Saro, H.J. Schött, A.V. Yeremin
2001Ib02	EPJAA	10,	139	F. Ibrahim, J. Genevey, E. Cottureau, A. Gizon, A. Knipper, F. Le Blanc, G. Marguier, J. Obert, J. Oms, J.C. Putaux, B. Roussi�re, J. Sauvage, A. Wojtasiewicz, ISOLDE
2001Ke05	APOBB	32,	989	H. Kettunen, P.T. Greenlees, K. Helariutta, P. Jones, R. Julin, S. Juutinen, P. Kuusiniemi, M. Leino, M. Muikku, P. Nieminen, J. Uusitalo
2001Ke06	PRVCA	63,	44315	H. Kettunen, J. Uusitalo, M. Leino, P. Jones, K. Eskola, P.T. Greenlees, K. Helariutta, R. Julin, S. Juutinen, H. Kankaanpaa, P. Kuusiniemi, M. Muikku, P. Nieminen, P. Rakkila
2001Ki13	PPNPD	46,	73	P. Kienle, T. Faestermann, J. Friese, H.-J. K�rner, M. M�nch, R. Schneider, A. Stolz, E. Wefers, H. Geissel, G. M�nzenberg, C. Schlegel, K. S�mmerer, H. Weick, M. Hellstr�m, P. Thirolf
2001KI11	EPJAA	12,	147	H.V. Klapdor-Kleingrothaus, A. Dietz, L. Baudis, G. Heusser, I.V. Krivosheina, B. Majorovits, H. Paes, H. Strecker, V. Alexeev, A. Balysh, A. Bakalyarov, S.T. Belyaev, V.I. Lebedev, S. Zhukov
2001KI13	MPLAE	16,	2409	H.V. Klapdor-Kleingrothaus, A. Dietz, H.L. Harney, I.V. Krivosheina
2001Ko44	PYLBB	512,	268	F.G. Kondev, M.P. Carpenter, R.V.F. Janssens, K. Abu Saleem, I. Ahmad, H. Amro, J.A. Cizewski, M. Danchev, C.N. Davids, D.J. Hartley, A. Heinz, T.L. Khoo, T. Lauritsen, C.J. Lister, W.C. Ma, G.L. Poli, J. Ressler, W. Reviol, L.L. Riedinger, D. Seweryniak, M.B. Smith, I. Wiedenh�ver and PrvCom AHW August 2001
2001Ko52	PRLTA	87,	92501	A.A. Korshennikov, M.S. Golovkov, I. Tanihata, A.M. Rodin, A.S. Fomichev, S.I. Sidorchuk, S.V. Stepantsov, M.L. Chelnokov, V.A. Gorshkov, D.D. Bogdanov, R. Wolski, G.M. Ter-Akopian, Yu. Ts. Oganessian, W. Mittig, P. Roussel-Chomaz, H. Savajols, E.A. Kuzmin, E. Yu. Nikolsky, A.A. Ogloblin
2001Ko.B	PrvCom	AHW	Aug	F.G. Kondev
2001La31	HYIND	132,	315	A.S. Lalleman, G. Auger, W. Mittig, M. Chabert, M. Chartier, J. Ferme, A. Gillibert, A. Lepine-Szily, M. Lewitowicz, M.H. Moscatello, N.A. Orr, G. Politi, F. Sarazin, H. Savajols, P. Van Isacker, A.C.C. Villari
2001Li17	PRVCA	63,	47307	K. Lindenberg, F. Neumann, D. Galaviz, T. Hartmann, P. Mohr, K. Vogt, S. Volz, A. Zilges
2001Li44	PRVCA	64,	34310	C.F. Liang, P. Paris, R.K. Sheline
2001Lu17	PRVCA	64,	54311	D. Lunney, G. Audi, H. Doubre, S. Henry, C. Monsanglant, M. de Saint Simon, C. Thibault, C. Toader, C. Borcea, G. Bollen, ISOLDE
2001Lu20	HYIND	132,	299	D. Lunney, C. Monsanglant, G. Audi, G. Bollen, C. Borcea, H. Doubre, C. Gaulard, S. Henry, M. de Saint Simon, C. Thibault, C. Toader, N. Vieira, ISOLDE
2001Ma08	PRVCA	63,	24613	V. Maddalena, T. Aumann, D. Bazin, B.A. Brown, J.A. Caggiano, B. Davids, T. Glasmacher, P.G. Hansen, R.W. Ibbotson, A. Navin, B.V. Pritychenko, H. Scheit, B.M. Sherrill, M. Steiner, J.A. Tostevin, J. Yurkon

2001Ma69	PRVCA	64,	31303	H. Mahmud, C.N. Davids, P.J. Woods, T. Davinson, A. Heinz, G.L. Poli, J.J. Ressler, K. Schmidt, D. Seweryniak, M.B. Smith, A.A. Sonzogni, J. Uusitalo, W.B. Walters
2001Ma96	EPJAA	12,	269	C. Mazzocchi, Z. Janas, J. Döring, M. Axiotis, L. Batist, R. Borcea, D. Cano-Ott, E. Caurier, G. de Angelis, E. Farnea, A. Faßbender, A. Gadea, H. Grawe, A. Jungclaus, M. Kapica, R. Kirchner, J. Kurcewicz, S.M. Lenzi, T. Martínez, I. Mukha, E. Náchér, D.R. Napoli, E. Roeckl, B. Rubio, R. Schwengner, J.L. Tain, C.A. Ur
2001Ma.A	AnRpt GSI		4	C. Mazzocchi, et al
2001Mi22	EPJAA	11,	9	M.N. Mineva, M. Hellström, M. Bernas, J. Gerl, H. Grawe, M. Pfützner, P.H. Regan, M. Rejmund, D. Rudolph, F. Becker, C.R. Bingham, T. Enqvist, B. Fogelberg, H. Gausemel, H. Geissel, J. Genevey, M. Górska, R. Grzywacz, K. Hauschild, Z. Janas, I. Kojouharov, Y. Kopatch, A. Korqul, W. Korten, J. Kurcewicz, M. Lewitowicz, R. Lucas, H. Mach, S. Mandal, P. Mayet, C. Mazzocchi, J.A. Pinston, Zs. Podolyák, H. Schaffner, Ch. Schlegel, K. Schmidt, K. Sümmerer, H.J. Wollersheim
2001Mo05	PRVCA	63,	34302	T. Morek, J. Srebrny, Ch. Droste, M. Kowalczyk, T. Rzaca-Urban, K. Starosta, W. Urban, R. Kaczarowski, E. Ruchowska, M. Kisielinski, A. Kordyasz, J. Kownacki, M. Palacz, E. Wesolowski, W. Gast, R.M. Lieder, P. Bednarczyk, W. Meczynski, J. Styczen
2001Mu26	PRVCA	64,	44308	M. Muikku, P.T. Greenlees, K. Hauschild, K. Helariutta, D.G. Jenkins, P. Jones, R. Julin, S. Juutinen, H. Kankaanpää, N.S. Kelsall, H. Ketunen, P. Kuusiniemi, M. Leino, C.J. Moore, P. Nieminen, C.D. O’Leary, R.D. Page, P. Rahkila, W. Reviol, M.J. Taylor, J. Uusitalo, R. Wadsworth
2001No07	EPJAA	11,	257	Yu. N. Novikov, H. Schatz, P. Dendooven, R. Béraud, Ch. Miehé, A.V. Popov, D.M. Seliverstov, G.K. Vorobjev, P. Baumann, M.J.G. Borge, G. Cachel, Ph. Dessagne, A. Emsallem, W. Huang, J. Huikari, A. Jokinen, A. Knipper, V. Kolhinen, A. Nieminen, M. Oinonen, H. Penttilä, K. Peräjärvi, I. Piqueras, S. Rinta-Antila, J. Szerypo, Y. Wang, J. Äystö
2001Nu01	PRVCA	63,	44316	S. Nummela, P. Baumann, E. Caurier, P. Dessagne, A. Jokinen, A. Knipper, G. Le Scornet, C. Miehé, F. Nowacki, M. Oinonen, Z. Radivojevic, M. Ramdhane, G. Walter, J. Äystö, ISOLDE
2001Og01	PRVCA	63,	11301	Yu. Ts. Oganessian, V.K. Utyonkov, Yu. V. Lobanov, F. Sh. Abdullin, A.N. Polyakov, I.V. Shirokovsky, Yu. S. Tsyganov, G.G. Gulbekian, S.L. Bogomolov, B.N. Gikal, A.N. Mezentsev, S. Iliev, V.G. Subbotin, A.M. Sukhov, O.V. Ivanov, G.V. Buklanov, K. Subotic, M.G. Itkis, K.J. Moody, J.F. Wild, N.J. Stoyer, M.A. Stoyer, R.W. Loughheed, C.A. Laue, Ye. A. Karelin, A.N. Tatarinov
2001Og08	PRVCA	64,	54606	Yu. Ts. Oganessian, V.K. Utyonkov, Yu. V. Lobanov, F. Sh. Abdullin, A.N. Polyakov, I.V. Shirokovsky, Yu. S. Tsyganov, A.N. Mezentsev, S. Iliev, V.G. Subbotin, A.M. Sukhov, K. Subotic, O.V. Ivanov, A.N. Voinov, V.I. Zagrebaev, K.J. Moody, J.F. Wild, N.J. Stoyer, M.A. Stoyer, R.W. Loughheed
2001Po05	PRVCA	63,	44304	G.L. Poli, C.N. Davids, P.J. Woods, D. Seweryniak, M.P. Carpenter, J.A. Cizewski, T. Davinson, A. Heinz, R.V.F. Janssens, C.J. Lister, J.J. Ressler, A.A. Sonzogni, J. Uusitalo, W.B. Walters
2001Ro35	HYIND	132,	153	E. Roeckl
2001Ro.B	B-Aulanko		PH23	M.W. Rowe, J.C. Batchelder, T.N. Ginter, K.E. Gregorich, F.Q. Guo, F.P. Heßberger, V. Ninov, J. Powell, K.S. Toth, X.J. Xu, J. Cerny
2001Ry01	NUPAB	682,	270c	K.P. Rykaczewski, R.K. Grzywacz, M. Karny, J.W. McConnell, M. Momayezi, J. Wahl, Z. Janas, J.C. Batchelder, C.R. Bingham, D. Hartley, M.N. Tantawy, C.J. Gross, T.N. Ginter, J.H. Hamilton, W.D. Kulp, M. Lipoglavsek, A. Piechaczek, E.F. Zganjar, W.B. Walters, J.A. Winger
2001Sc41	NUPAB	693,	533	S. Schwarz, F. Ames, G. Audi, D. Beck, G. Bollen, C. De Coster, J. Dilling, O. Engels, R. Fossion, J.-E. Garcia Ramos, S. Henry, F. Herfurth, K. Heyde, A. Kellerbauer, H.-J. Kluge, A. Kohl, E. Lamour, D. Lunney, I. Martel, R.B. Moore, M. Oinonen, H. Raimbault-Hartmann, C. Scheidenberger, G. Sikler, J. Szerypo, C. Weber, ISOLDE

2001Se03	PRLTA	86,	1458	D. Seweryniak, P.J. Woods, J.J. Ressler, C.N. Davids, A. Heinz, A.A. Sonzogni, J. Uusitalo, W.B. Walters, J.A. Caggiano, M.P. Carpenter, J.A. Cizewski, T. Davinson, K.Y. Ding, N. Fotiadis, U. Garg, R.V.F. Janssens, T.L. Khoo, F.G. Kondev, T. Lauritsen, C.J. Lister, P. Reiter, J. Shergur, I. Wiedenhöver
2001Sh36	PRVCA	64,	54307	I. Shestakova, G. Mukherjee, P. Chowdhury, R. D'Alarcao, C.J. Pearson, Zs. Podolyak, P.M. Walker, C. Wheldon, D.M. Cullen, I. Ahmad, M.P. Carpenter, M.P. Carpenter, R.V.F. Janssens, T.L. Khoo, F.G. Kondev, C.J. Lister, D. Seweryniak, I. Wiedenhoever
2001Si.A	PrvCom	GAu	Aug	G. Sikler
2001So02	PRVCA	63,	31304	F. Soramel, A. Guglielmetti, L. Stroe, L. Müller, R. Bonetti, G.L. Poli, F. Malerba, E. Bianchi, A. Andrighetto, J.Y. Guo, Z.C. Li, E. Maglione, F. Scarlassara, C. Signorini, Z.H. Liu, M. Ruan, M. Ivascu, C. Broude, P. Bednarczyk, L.S. Ferreira
2001St.A	AnRpt GSI		7	A. Stolz, T. Faestermann, R. Schneider, K. Suemmerer, E. Wefers, J. Friese, H. Geissel, J. Gerl, M. Hellstroem, P. Kienle, H.-J. Koerner, M.N. Mineva, M. Muench, G. Muenzenberg, C. Schlegel, R.S. Simon, P. Thirolf, H. Weick, K. Zeitelhack
2001Th01	PRVCA	63,	14308	M. Thoennessen, S. Yokoyama, P.G. Hansen
2001To06	PRVCA	63,	34314	B.E. Tomlin, C.J. Barton, N.V. Zamfir, M.A. Caprio, R.L. Gill, R. Krücken, J.R. Novak, J.R. Cooper, K.E. Zyromski, G. Cata-Danil, C.W. Beausang, A. Wolf, N.A. Pietralla, H. Newman, J. Cederkall, B. Liu, Z. Wang, R.F. Casten, D.S. Brenner
2001Tu.B	AnRpt PSI		121	A. Türler et al
2001Va33	HYIND	132,	163	R.S. Van Dyck, Jr., S.L. Zafonte, P.B. Schwinberg
2001Va.A	PrvCom	AHW	Oct	R.S. Van Dyck, Jr.
2001Va.B	AnRpt GSI		14	K. Van de Vel, A.N. Andreyev, D. Ackermann, S. Antalic, H.J. Boardman, P. Cagarda, J. Gerl, F.P. Heßberger, S. Hofmann, M. Huyse, D. Karlgren, B. Kindler, I. Kozhoukharov, M. Leino, B. Lommel, G. Muenzenberg, C. Moore, R.D. Page, C. Schlegel, P. Van Duppen
2001Wa50	HYIND	132,	323	C. Wagemans, J. Wagemans, G. Goeminne
2001Xu04	EPJAA	11,	277	S.-W. Xu, Y.-X. Xie, X.-D. Wang, Z.-K. Li, B. Guo, C.-G. Leng, C.-F. Wang, Y. Yu, and erratum EPJAA 12(2001)375
2001Xu05	EPJAA	11,	375	S.-W. Xu, Z.-K. Li, Y.-X. Xie, X.-D. Wang, B. Guo, C.-G. Leng, Y. Yu
2001Xu06	EPJAA	12,	1	S.-W. Xu, Z.-K. Li, Y.-X. Xie, X.-D. Wang, B. Guo, C.-G. Leng, Y. Yu
2001Yu03	EPJAA	10,	1	S. Yuan, W. Yang, Y. Xu, Q. Pan, B. Xiong, J. He, D. Wang, Y. Li, T. Ma, Z. Yang
2001Ze.A	Th.-Orsay			T. Zerguerras
				2002
2002Aa.1	MPLAE to be pd			C.E. Aalseth, F.T. Avignone III, A. Barabash, et al arXiv:hep-ex/0202018 v1 7 Feb 2002
2002An15	EPJAA	14,	63	A.N. Andreyev, K. Van de Vel, A. Barzakh, A. De Smet, H. De Witte, D.V. Fedorov, V.N. Fedoseyev, S. Franchoo, M. Górska, M. Huyse, Z. Janas, U. Köster, W. Kurcewicz, J. Kurpeta, V.I. Mishin, K. Partes, A. Plochocki, P. Van Duppen, L. Weissman
2002An19	PRVCA	66,	14313	A.N. Andreyev, M. Huyse, K. Van de Vel, P. Van Duppen, O. Dorvaux, P. Greenlees, K. Helariutta, P. Jones, R. Julin, S. Juutinen, H. Kettunen, P. Kuusiniemi, M. Leino, M. Muikku, P. Nieminen, P. Rakhila, J. Uusitalo, R. Wyss, K. Hauschild, Y. Le Coz
2002An.A	AnRpt GSI		9	A.N. Andreyev, D. Ackermann, F.P. Heßberger, S. Hofmann, M. Huyse, B. Kindler, I. Kojouharov, B. Lommel, G. Muenzenberg, R.D. Page, K. Van de Vel, P. Van Duppen
2002Be64	PHSTB	66,	201	I. Bergström, T. Fritioff, R. Schuch, J. Schönfelder
2002Be74	PYLBB	546,	23	R. Bernabei, P. Belli, F. Cappella, R. Cerulli, F. Montecchia, A. Incicchitti, D. Prosperi, C.J. Dai
2002Bf02	NIMAE	487,	618	I. Bergström, C. Carlberg, T. Fritioff, G. Douysset, J. Schönfelder, R. Schuch

2002Bo41	NUPAB	709,	3	V. Bondarenko, J. Berzins, P. Prokofjevs, L. Simonova, T. von Egidy, J. Honzátko, I. Tomandl, P. Alexa, H.-F. Wirth, U. Köster, Y. Eisermann, A. Metz, G. Graw, R. Hertenberger, L. Rubacek
2002Ca37	PRLTA	89,	82501	P. Campbell, H.L. Thayer, J. Billowes, P. Dendooven, K.T. Flanagan, D.H. Forest, J.A.R. Griffith, J. Huikari, A. Jokinen, R. Moore, A. Nieminen, G. Tungate, S. Zemlyanoi, J. Äystö
2002Cl.A	P-Aulanko		39	J.A. Clark, R.C. Barber, C. Boudreau, F. Buchinger, J.A. Caggiano, J.E. Crawford, H. Fukutani, S. Gulick, J.C. Hardy, A. Heinz, J.K.P. Lee, M. Maier, R.B. Moore, G. Savard, J. Schwarz, D. Sewerniak, K.S. Sharma, G. Sprouse, J. Vaz, J.C. Wang
2002Di.A	Th.-Mainz			I. Dillmann
2002Fr.B	ISOLDE-News		Sep	S. Franchoo Isolde Newsletters at <a href="http://www.cern.ch/ISOLDE/">http://www.cern.ch/ISOLDE/</a>
2002Ga12	NUPAB	700,	117	E. Garrido, D.V. Fedorov, A.S. Jensen
2002Gi09	PRLTA	89,	102501	J. Giovinazzo, B. Blank, M. Chartier, S. Czajkowski, A. Fleury, M.J. Lopez Jimenez, M.S. Pravikoff, J. >C. Thomas, F. de Oliveira Santos, M. Lewitowicz, V. Maslov, M. Stanoiu, R. Grzywacz, M. Pfütznner, C. Borcea, B.A. Brown
2002He23	EPJAA	15,	17	F. Herfurth, A. Kellerbauer, F. Ames, G. Audi, D. Beck, K. Blaum, G. Bollen, O. Engels, H.-J. Kluge, D. Lunney, R.B. Moore, M. Oinonen, E. Sauvan, C. Scheidenberger, S. Schwarz, G. Sikler, C. Weber, ISOLDE
2002He29	EPJAA	15,	335	F.P. Heßberger, S. Hofmann, I. Kojouharov, D. Ackermann, S. Antalic, P. Cagarda, B. Kindler, B. Lommel, R. Mann, A.G. Popeko, S. Saro, J. Uusitalo, A.V. Yeremin
2002He.A	P-Aulanko		337	F.P. Heßberger, S. Hofmann, D. Ackermann
2002Ho11	EPJAA	14,	147	S. Hofmann, F.P. Heßberger, D. Ackermann, G. Münzenberg, S. Antalic, P. Cagarda, B. Kindler, J. Kojouharova, M. Leino, B. Lommel, R. Mann, A.G. Popeko, S. Reshitko, S. Saro, J. Uusitalo, A.V. Yeremin
2002Hu14	EPJAA	15,	329	A. Hürstel, M. Rejmund, E. Bouchez, P.T. Greenlees, K. Hauschild, S. Juutinen, H. Kettunen, W. Kortén, Y. Le Coz, P. Nieminen, Ch. Theisen, A.N. Andreyev, F. Becker, T. Enqvist, P.M. Jones, R. Julin, H. Kankaanpää, A. Keenan, P. Kuusiniemi, M. Leino, A.-P. Leppänen, M. Muikku, J. Pakarinen, P. Rähkila, J. Uusitalo
2002Iz01	FECLA	111,	36	I.N. Izosimov, A.A. Kazimov, A.A. Solnyshkin
2002Ja16	PYLBB	546,	55	R.V.F. Janssens, B. Fornal, P.F. Mantica, B.A. Brown, R. Broda, P. Bhat-tacharyya, M.P. Carpenter, M. Cinausero, P.J. Daly, A.D. Davies, T. Glas-macher, Z.W. Grabowski, D.E. Groh, M. Honma, F.G. Kondev, W. Królas, T. Lauritsen, S.N. Liddick, S. Lunardi, N. Marginean, T. Mizusaki, D.J. Morrissey, A.C. Morton, W.F. Mueller, T. Otsuka, T. Pawlat, D. Sew-eryniak, H. Schatz, A. Stolz, S.L. Tabor, C.A. Ur, G. Viesti, I. Wiedenhöver, J. Wrzesiński
2002Je07	PRVCA	64,	64307	D.G. Jenkins, N.S. Kelsall, C.J. Lister, D.P. Balamuth, M.P. Carpenter, T.A. Sienko, S.M. Fischer, R.M. Clark, P. Fallon, A. Görger, A.O. Macchiavelli, C.E. Svensson, R. Wadsworth, W. Reviol, D.G. Sarantites, G.C. Ball, J. Rikowska Stone, O. Juillet, P. Van Isacker, A.V. Afanasjev, S. Frauendorf
2002Je09	PRVCA	66,	11301	D.G. Jenkins, A.N. Andreyev, R.D. Page, M.P. Carpenter, R.V.F. Janssens, C.J. Lister, F.G. Kondev, T. Enqvist, P.T. Greenlees, P.M. Jones, R. Julin, S. Juutinen, H. Kettunen, P. Kuusiniemi, M. Leino, A.-P. Leppänen, P. Nieminen, J. Pakarinen, P. Rähkila, J. Uusitalo, C.D. O'Leary, P. Raddon, A. Simons, R. Wadsworth, D.T. Joss
2002Je11	NUPAB	709,	119	H. Jeppesen, U.C. Bergmann, M.J.G. Borge, J. Cederkäll, V.N. Fedoseyev, H.O.U. Fynbo, V.Y. Hansper, B. Jonson, K. Markenroth, V.I. Mishin, T. Nilsson, G. Nyman, K. Riisager, O. Tengblad, K. Wilhelmson Rolander, ISOLDE
2002Ke.A	Th.-Heidelberg			A. Kellerbauer
2002Ke.C	PrvCom	NDG	May	H. Kettunen
2002La18	NUPAB	708,	167	M. La Commara, K. Schmidt, H. Grawe, J. Döring, R. Borcea, S. Galanopoulos, M. Górska, S. Harissopoulos, M. Hellström, Z. Janas, R. Kirchner, C. Mazzocchi, A.N. Ostrowski, C. Plettner, G. Rainovski, E. Roeckl

2002Le16	PRVCA	65,	54318	A. Lépine-Szily, J.M. Oliviera,Jr, V.R. Vanin, A.N. Ostrowski, R. Lichtenthaler, A. Di Pietro, V. Guimaraes, A.M. Laird, I. Mannoury, G.F. Lima, F. de Oliviera Santos, P. Roussel-Chomaz, H. Savajois, W. Trindler, A.C.C. Villari, A. de Vismes
2002Le.A	PrvCom	GAu	Jun	Lettre électronique de l'In2p3
2002Li24	PRVCA	65,	44618	G.F. Lima, A. Lépine-Szily, G. Audi, W. Mittig, M. Chartier, N.A. Orr, R. Lichtenthaler, J.-C. Angélique, J.-M. Casandjian, A. Cunsolo, C. Donzaud, A. Foti, A. Gillibert, M. Lewitowicz, S. Lukyanov, M. Mac Cormick, D.J. Morrissey, A.N. Ostrowski, B.M. Sherrill, C. Stéphan, T. Suomijärvi, L. Tassan-Got, D.J. Vieira, A.C.C. Villari, J.M. Wouters
2002Lo13	PRVCA	66,	25803	M.J. López Jiménez, B. Blank, M. Chartier, S. Czajkowski, P. Dessagne, G. de France, J. Giovinazzo, D. Karamanis, M. Lewitowicz, V. Maslov, C. Miehé, P.H. Regan, M. Stanoiu, M. Wiescher
2002Ma19	PYLBB	532,	29	C. Mazzocchi, Z. Janas, L. Batist, V. Belleguic, J. Döring, M. Gierlik, M. Kapica, R. Kirchner, G.A. Lalazissis, H. Mahmud, E. Roeckl, P. Ring, K. Schmidt, P.J. Woods, J. Żylicz
2002Ma61	EPJAA	15,	85	H. Mahmud, C.N. Davids, P.J. Woods, T. Davinson, A. Heinz, J.J. Ressler, K. Schmidt, D. Seweryniak, J. Shergur, A.A. Sonzogni, W.B. Walters
2002Me07	PRLTA	88,	102501	M. Meister, K. Markenroth, D. Aleksandrov, T. Aumann, L. Axelsson, T. Baumann, M.J.G. Borge, L.V. Chulkov, W. Dostal, B. Eberlein, Th. W. Elze, H. Emling, C. Forssén, H. Geissel, M. Hellström, R. Holzmann, B. Jonson, J.V. Kratz, R. Kulesa, Y. Leifels, A. Leistenschneider, I. Mukha, G. Münzenberg, F. Nickel, T. Nilsson, G. Nyman, A. Richter, K. Riisager, C. Scheidenberger, G. Schrieder, H. Simon, O. Tengblad, M.V. Zhukov
2002Mo29	PYLBB	544,	274	A.C. Morton, P.F. Mantica, B.A. Brown, A.D. Davies, D.E. Groh, P.T. Hosmer, S.N. Liddick, J.I. Prisciandaro, H. Schatz, M. Steiner, A. Stolz
2002Mo31	PYLBB	547,	200	R. Moore, A.M. Bruce, P. Dendooven, J. Billowes, P. Campbell, A. Ezwam, K.T. Flanagan, D.H. Forest, J. Huikari, A. Jokinen, A. Nieminen, H.L. Thayer, G. Tungate, S. Zemlyanoi, J. Äystö
2002Ni10	PRLTA	89,	39901	V. Ninov, K.E. Gregorich, W. Loveland, A. Ghiorso, D.C. Hoffman, D.M. Lee, H. Nitsche, W.J. Swiatecki, U.W. Kirbach, C.A. Laue, J.L. Adams, J.B. Patin, D.A. Shaughnessy, D.A. Strellis, P.A. Wilk
2002No11	PYLBB	542,	49	M. Notani, H. Sakurai, N. Aoi, Y. Yanagisawa, A. Saito, N. Imai, T. Gomi, M. Miura, S. Michimasa, H. Iwasaki, N. Fukuda, M. Ishihara, T. Kubo, S. Kubono, H. Kumagai, S.M. Lukyanov, T. Motobayashi, T.K. Onishi, Yu. E. Penionzhkevich, S. Shimoura, T. Teranishi, K. Ue, V. Ugryumov, A. Yoshida
2002PaDG	PRVDA	66,	10001	Particle Data Group
2002Pe15	EPJAA	14,	439	C.M. Petrache, G. Lo Bianco, P.G. Bizzeti, A.M. Bizzeti-Sona, D. Bazzacco, S. Lunardi, M. Nespola, G. de Angelis, P. Spolaore, N. Blasi, S. Brant, V. Krstić, D. Vretenar
2002Pfo2	EPJAA	14,	279	M. Pfützner, E. Badura, C. Bingham, B. Blank, M. Chartier, H. Geissel, J. Giovinazzo, L.V. Grigorenko, R. Grzywacz, M. Hellström, Z. Janas, J. Kurcewicz, A.S. Lalleman, C. Mazzocchi, I. Mukha, G. Münzenberg, C. Plettner, E. Roeckl, K.P. Rykaczewski, K. Schmidt, R.S. Simon, M. Stanoiu, J.-C. Thomas
2002Pi.A	PrvCom	GAu	Nov	J.A. Pinston
2002Pi03	PRVCA	66,	44319	Plettner, C. , L. Batisit, J. Doering, A. Blazhev, H. Grawe, V. Belleguic, C.R. Bingham. R. Borcea, M. Gierlik, M. Goerska, N. Harringyon, Z. Janas, M. Karny, R. Kirchner, C. Mazzocchi, P. Munro, E. Roeckl, K. Schmidt, R. Schwengner
2002Ra16	NIMAE	481,	464	Z. Radivojevic, P. Baumann, E. Caurier, J. Cederkäll, S. Courtin, Ph. Dessagne, A. Jokinen, A. Knipper, G. Le Scornet, V. Lyapin, Ch. Miehé, F. Nowacki, S. Nummela, M. Oinonen, E. Poirier, M. Ramdhané, W.H. Trzaska, G. Walter, J. Äystö, ISOLDE
2002Ra23	NUPAB	706,	3	H. Raimbault-Hartmann, G. Audi, D. Beck, G. Bollen, M. de Saint Simon, H.-J. Kluge, M. König, R.B. Moore, S. Schwarz, G. Savard, J. Szerypo, ISOLDE



2002Ra.A	PrvCom	GAu	Apr	S. Raman
2002Re18	PRVCA	65,	57302	G.A. Rech, E. Browne, I.D. Goldman, F.J. Schima, E.B. Norman
2002Ro17	PRVCA	65,	54310	M.W. Rowe, J.C. Batchelder, T.N. Ginter, K.E. Gregorich, F.Q. Guo, F.P. Heßberger, V. Ninov, J. Powell, K.S. Toth, X.J. Xu, J. Cerny
2002Ro.A	Th.-Valencia			D. Rodríguez
2002Sc.A	PrvCom	AHW	Aug	Ch. Scheidenberger, Y. Litvinov
2002Sh08	PRVCA	65,	34313	J. Shergur, B.A. Brown, V. Fedoseyev, U. Köster, K.-L. Kratz, D. Seweryniak, W.B. Walters, A. Wöhr, D. Fedorov, M. Hannawald, M. Hjorth-Jensen, V. Mishin, B. Pfeiffer, J.J. Ressler, H.O.U. Fynbo, P. Hoff, H. Mach, T. Nilsson, K. Wilhelmson-Rolander, H. Simon, A. Bickley, ISOLDE
2002Sh16	JUPSA	71,	1401	M. Shibata, T. Shindou, A. Taniguchi, Y. Kojima, K. Kawade, S.-I. Ichikawa, Y. Kawase
2002Sh.A	AnRpt JAERI		26	M. Shibata, T. Shindou, Y. Kojima, M. Asai, K. Tsukada, S. Ichikawa, H. Haba, Y. Nagame, K. Kawade
2002Sh.B	P-Aulanko		479	M. Shibata, T. Shindou, K. Kawade, V. Kojima, A. Taniguchi, Y. Kawase, S. Ichikawa
2002So.A	PrvCom	GAu	Oct	O. Sorlin
2002St.A	PrvCom	AHW	Jul	J. Stadlmann, C. Scheidenberger
2002Tr04	ADNDA	80,	83	V.I. Tretyak, Yu. G. Zdesenko
2002Tu05	EPJAA	15,	271	A. Türler "Heavy-element chemistry - Status and perspectives"
2002Un02	ARISE	56,	125	M.P. Unterweger
2002Vi.A	P-Aulanko		21	N. Vieira, G. Audi, Z. Djouadi, H. Doubre, G. Gaulard, S. Henry, D. Lunney, M. de Saint Simon, C. Thibault, G. Bollen, ISOLDE, and oral
2002We03	PRVCA	65,	24315	L. Weissman, U. Köster, R. Catherall, S. Franchoo, U. Georg, O. Jansson, V.N. Fedoseyev, V.I. Mishin, M.D. Seliverstov, J. Van Roosbroeck, S. Gheysen, M. Huysse, K. Kruglov, G. Neyens, P. Van Duppen, ISOLDE
2002We07	PRVCA	65,	44321	L. Weissman, J. Cederkall, J. Äystö, H. Fynbo, L. Fraile, V. Fedoseyev, S. Franchoo, A. Jokinen, U. Köster, G. Martinez-Pinedo, T. Nilsson, M. Oinonen, K. Peräjärvi, M.D. Seliverstov, ISOLDE
2002Xu11	PRVCA	66,	47302	S.-W. Xu, Z.-K. Li, F.-R. Xu, Y.-X. Xie, X.-D. Wang
2002Zd02	PYLBB	546,	206	Yu. G. Zdesenko, F.A. Danevich, V.I. Tretyak

## 2003

2003Al.1	PRVCA to be pd			S.D. Al-Garni, P.H. Regan, P.M. Walker, E. Roeckl, R. Kirchner, F.R. Xu, L. Batist, A. Blazhev, R. Borcea, D.M. Cullen, J. Döring, H.M. El-Masri, J. Garces Narro, H. Grawe, M. La Commara, C. Mazzocchi, I. Mukha, C.J. Pearson, C. Plettner, K. Schmidt, W.D. Schmidt-Ott, Y. Shimbara, C. Wheldon, R. Wood, S.C. Wooding
2003As01	EPJAA	16,	17	M. Asai, K. Tsukada, S. Ichikawa, M. Sakama, H. Haba, Y. Nagame, I. Nishinaka, K. Akiyama, A. Toyoshima, T. Kaneko, Y. Oura, Y. Kojima, M. Shibata
2003Ba18	PRVCA	67,	34310	C.J. Barton, D.S. Brenner, N.V. Zamfir, M.A. Caprio, A. Aprahamian, M.C. Wiescher, C.W. Beausang, Z. Berant, R.F. Casten, J.R. Cooper, R.L. Gill, R. Krücken, J.R. Novak, N. Pietralla, M. Shawcross, A. Teymurazy, A. Wolf
2003Ba20	EPJAA	16,	489	T. Bäck, B. Cederwall, K. Lagergren, R. Wyss, A. Johnson, D. Karlgren, P. Greenlees, D. Jenkins, P. Jones, D.T. Joss, R. Julin, S. Juutinen, A. Keenan, H. Kettunen, P. Kuusiniemi, M. Leino, A.-P. Leppänen, M. Muikku, P. Nieminen, J. Pakarinen, P. Rauhila, J. Uusitalo
2003Ba39	NUPAB	720,	245	L. Batist, J. Döring, I. Mukha, C. Plettner, C.R. Bingham, R. Borcea, M. Gierlik, H. Grawe, K. Hauschild, Z. Janas, I.P. Johnstone, M. Karny, M. Kavatsyuk, R. Kirchner, M. La Commara, C. Mazzocchi, F. Moroz, J. Pavan, A. Plochocki, E. Roeckl, B. Salvachúa, K. Schmidt, j, R. Schwengner, L.D. Skouras, S.L. Tabor, M. Wiedeking
2003Ba47	PRVCA	67,	61303	T. Baumann, N. Frank, B.A. Luther, D.J. Morrissey, J.P. Seitz, B.M. Sherrill, M. Steiner, J. Stetson, A. Stolz, M. Thoennessen, I. Wiedenhöver
2003Ba49	PRVCA	67,	64316	D.K. Barillari, J.V. Vaz, R.C. Barber, K.S. Sharma
2003Ba.A	PrvCom	GAu	Apr	C. Bachelet

2003Be02	EPJDD	22,	41	I. Bergström, M. Björkhage, K. Blaum, H. Bluhme, T. Fritioff, Sz. Nagy, R. Schuch
2003Be05	NUPAB	714,	21	U.C. Bergmann, C.A. Diget, K. Riisager, L. Weissman, G. Auböck, J. Ced-erkäll, L.M. Fraile, H.O.U. Fynbo, H. Gausemel, H. Jeppesen, U. Köster, K.-L. Kratz, P. Möller, T. Nilsson, B. Pfeiffer, H. Simon, K. Van de Vel, J. Äystö, ISOLDE
2003Be18	EPJAA	16,	447	A.V. Belozarov, M.L. Chelnokov, V.I. Chepigin, T.P. Drobina, V.A. Gorshkov, A.P. Kabachenko, O.N. Malyshev, I.M. Merkin, Yu. Ts. Oganessian, A.G. Popeko, R.N. Sagaidak, A.I. Svirikhin, A.V. Yeremin, G. Berek, I. Brida, Š. Šáro
2003Bi05	PRVCA	67,	65801	I. Bikit, N. Zikić-Todorović, J. Slivka, M. Vesković, M. Krmar, Lj. Čonkić, J. Puzović, I.V. Aničin
2003Bl.1	PRLTA to be pd			K. Blaum, G. Audi, D. Beck, G. Bollen, A. García, F. Herfurth, A. Kellerbauer, H.-J. Kluge, E. Sauvan, S. Schwarz, ISOLDE
2003Bl.A	PrvCom	GAu	Jan	K. Blaum
2003Ce01	PYLBB	556,	14	S. Cebrián, N. Coron, G. Dambier, P. de Marcillac, E. García, I.G. Irastorza, J. Leblanc, A. Morales, J. Morales, A. Ortiz de Solórzano, J. Puimedón, M.L. Sarsa, J.A. Villar
2003Da05	PRVCA	67,	14310	F.A. Danevich, A. Sh. Georgadze, V.V. Kobychiev, S.S. Nagorny, A.S. Nikolaiko, O.A. Ponkratenko, V.I. Tretyak, S. Yu. Zdesenko, Yu. G. Zdesenko, P.G. Bizzeti, T.F. Fazzini, P.R. Maurenzig
2003Da09	NUPAB	717,	129	F.A. Danevich, A.S. Georgadze, V.V. Kobychiev, A.S. Nikolaiko, O.A. Ponkratenko, V.I. Tretyak, S.Y. Zdesenko, Y.G. Zdesenko, P.G. Bizzeti, T.F. Fazzini, P.R. Maurenzig
2003De11	NATUA	422,	876	P. de Marcillac, N. Coron, G. Dambier, J. Leblanc, J.-P. Moalic
2003Di.1	EPJAA to be pd			J. Dilling, F. Herfurth, A. Kellerbauer, G. Audi, G. Bollen, H.-J. Kluge, R.B. Moore, S. Schwarz, G. Sikler, ISOLDE
2003Do01	PRVCA	67,	14315	J. Döring, R.A. Kaye, A. Aprahamian, M.W. Cooper, J. Daly, C.N. Davids, R.C. de Haan, J. Görres, S.R. Leshner, J.J. Ressler, D. Seweryniak, E.J. Stech, A. Susalla, S.L. Tabor, J. Uusitalo, W.B. Walters, M. Wiescher
2003Do.1	PRVCA to be pd			J. Döring, H. Grawe, K. Schmidt, R. Borcea, S. Galanopoulos, M. Górska, S. Harissopoulos, M. Hellström, Z. Janas, R. Kirchner, M. La Commara, C. Mazzocchi, E. Roeckl, R. Schwengner
2003Fi.A	IAEA-Tecdoc		5	R.B. Firestone, R.M. Lindstrom, G.L. Molnar, S.M. Mughabghab, A.V.R. Reddy, Z. Revay, V.H. Tan, C.M. Zhou, R. Paviotti-Corcuera to be published
2003Fr08	PHSTB	67,	276	T. Fritioff, G. Douysset
2003Ga.A	PrvCom	GAu	Jun	C. Gaulard
2003Ge04	PRVCA	67,	54312	J. Genevey, J.A. Pinston, H.R. Faust, R. Orlandi, A. Scherillo, G.S. Simpson, I.S. Tsekhanovich, A. Covello, A. Gargano, W. Urban
2003Gi06	NUPAB	724,	313	M. Gierlik, A. Plochocki, M. Karny, W. Urban, Z. Janas, L. Batist, F. Moroz, R. Collatz, M. Górska, H. Grawe, M. Hellström, Z. Hu, R. Kirchner, W. Liu, M. Rejmund, E. Roeckl, M. Shibata, J. Agramunt, A. Algora, A. Gadea, B. Rubio, J.L. Tain, D. Cano-Ott, S. Harissopoulos
2003Go11	PYLBB	566,	70	M.S. Golovkov, Yu. Ts. Oganessian, D.D. Bogdanov, A.S. Fomichev, A.M. Rodin, S.I. Sidorchuk, R.S. Slepnev, S.V. Stepanov, G.M. Ter-Akopian, R. Wolski, V.A. Gorshkov, M.L. Chelnokov, M.G. Itkis, E.M. Kozulin, A.A. Bogatchev, N.A. Kondratiev, I.V. Korzyukov, A.A. Yukhimchuk, V.V. Perevozchikov, Yu. I. Vinogradov, S.K. Grishechkin, A.M. Demin, S.V. Zlatoustovsky, A.V. Kuryakin, S.V. Fil'chagin, R.I. Il'kayev, F. Hanappe, T. Materna, L. Stuttgart, A.H. Ninane, A.A. Korshennikov, E. Yu. Nikolskii, I. Tanihata, P. Roussel-Chomaz, W. Mittig, N. Alamanos, V. Lapoux, E.C. Pollacco, L. Nalpas
2003Gr02	PRVCA	67,	14302	G.F. Grinyer, J.C. Waddington, C.E. Svensson, R.A.E. Austin, G.C. Ball, G. Hackman, J.M. O'Meara, C. Osborne, F. Sarazin, H.C. Scraggs, H.D.H. Stöver
2003Gr13	NUPAB	724,	14	C. Granja, S. Pospíšil, J. Kubašta, S.A. Telezhnikov

2003Gu06	PRVCA	67,	64601	V. Guimarães, S. Kubono, F.C. Barker, M. Hosaka, S.C. Jeong, I. Katayama, T. Miyachi, T. Nomura, M.H. Tanaka, Y. Fuchi, H. Kawashima, S. Kato, C.C. Yun, K. Ito, H. Orihara, T. Terakawa, T. Kishida, Y. Pu, S. Hamada, M. Hirai, H. Miyatake
2003Gu.A	PrvCom	GAu	Sep	C. Guénaut, ISOLTRAP
2003He06	EPJAA	16,	365	F.P. Heßberger, S. Hofmann, D. Ackermann
2003Hu01	EPJAA	16,	359	J. Huikari, M. Oinonen, A. Algora, J. Cederkäll, S. Courtin, P. Dessagne, L. Fraile, S. Franchoo, H. Fynbo, W.X. Huang, A. Jokinen, A. Knipper, F. Marechal, C. Miehe, E. Nacher, K. Peräjärvi, E. Poirier, L. Weissman, J. Äystö, ISOLDE
2003Hy02	PRVCA	68,	15501	B.C. Hyman, V.E. Jacob, A. Azhari, C.A. Gagliardi, J.C. Hardy, V.E. Mayes, R.G. Neilson, M. Sanchez-Vega, X. Tang, L. Trache, R.E. Tribble
2003Ka04	PRLTA	90,	12502	M. Karny, R.K. Grzywacz, J.C. Batchelder, C.R. Bingham, C.J. Gross, K. Hagino, J.H. Hamilton, Z. Janas, W.D. Kulp, J.W. McConnell, M. Momayezi, A. Piechaczek, K.P. Rykaczewski, P.A. Semmes, M.N. Tantawy, J.A. Winger, C.H. Yu, E.F. Zganjar
2003Ke04	EPJAA	16,	457	H. Kettunen, T. Enqvist, M. Leino, K. Eskola, P.T. Greenlees, K. Helariutta, P. Jones, R. Julin, S. Juutinen, H. Kankaanpää, H. Koivisto, P. Kuusiniemi, M. Muikku, P. Nieminen, P. Rakkila, J. Uusitalo
2003Ke.A	PrvCom	GAu	Sep	A. Kellerbauer
2003Ko11	PRLTA	90,	82501	A.A. Korshennikov, E. Yu. Nikolskii, E.A. Kuzmin, A. Ozawa, K. Morimoto, F. Tokanai, R. Kanungo, I. Tanihata, N.K. Timofeyuk, M.S. Golovkov, A.S. Fomichev, A.M. Rodin, M.L. Chelnokov, G.M. Ter-Akopian, W. Mittig, P. Roussel-Chomaz, H. Savajols, E. Pollacco, A.A. Ogloblin, M.V. Zhukov
2003Ko.A	Th.-Jyvaskyla			V. Kolhinen
2003Kr.1	RAACA	91,	59	J.V. Kratz, A. Nähler, U. Rieth, A. Kronenberg, B. Kuczewski, E. Strub, W. Brüche, M. Schädel, B. Schausten, A. Türler, H.W. Gäggeler, D.T. Jost, K.E. Gregorich, H. Nitsche, C. Laue, R. Sudowe, P.A. Wilk
2003Li.A	PrvCom	GAu	Jul	Y. Litvinov, Ch. Scheidenberger
2003Ma02	PRVCA	67,	14311	P.F. Mantica, A.C. Morton, B.A. Brown, A.D. Davies, T. Glasmacher, D.E. Groh, S.N. Liddick, D.J. Morrissey, W.F. Mueller, H. Schatz, A. Stolz, S.L. Tabor, M. Honma, M. Horoi, T. Otsuka
2003Me11	NUPAB	723,	13	M. Meister, L.V. Chulkov, H. Simon, T. Aumann, M.J.G. Borge, Th. W. Elze, H. Emling, H. Geissel, M. Hellström, B. Jonson, J.V. Kratz, R. Kulesa, Y. Leifels, K. Markenroth, G. Münzenberg, F. Nickel, T. Nilsson, G. Nyman, V. Pribora, A. Richter, K. Rüsager, C. Scheidenberger, G. Schrieder, O. Tengblad
2003Pf.A	PrvCom	GAu	Jul	B. Pfeiffer, O. Arndt
2003Pi03	EPJAA	16,	313	I. Piqueras, M.J.G. Borge, Ph. Dessagne, J. Giovinazzo, A. Huck, A. Jokinen, A. Knipper, C. Longour, G. Marguier, M. Ramdhane, V. Rauch, O. Tengblad, G. Walter, Ch. Miehe, ISOLDE
2003Pi08	PRVCA	67,	51305	A. Piechaczek, E.F. Zganjar, G.C. Ball, P. Bricault, J.M. D'Auria, J.C. Hardy, D.F. Hodgson, V. Jacob, P. Klages, W.D. Kulp, J.R. Leslie, M. Lipoglavsek, J.A. Macdonald, H.-B. Mak, D.M. Moltz, G. Savard, J. von Schwarzenberg, C.E. Svensson, I.S. Towner, J.L. Wood
2003Sa02	EPJAA	16,	51	M. Sawicka, J.M. Daugas, H. Grawe, S. Ćwiok, D.L. Balabanski, R. Béraud, C. Bingham, C. Borcea, M. La Commara, G. de France, G. Georgiev, M. Górska, R. Grzywacz, M. Hass, M. Hellström, Z. Janas, M. Lewitowicz, H. Mach, I. Matea, G. Neyens, C. O'Leary, F. de Oliveira Santos, R.D. Page, M. Pfützner, Zs. Podolyák, K. Rykaczewski, M. Stanoiu, J. Żylicz
2003Sh.A	PrvCom	GAu	Apr	K.S. Sharma
2003So02	EPJAA	16,	55	O. Sorlin, C. Donzaud, F. Nowacki, J.C. Angélique, F. Azaiez, C. Bourgeois, V. Chisté, Z. Dlouhy, S. Grévy, D. Guillemaud-Mueller, F. Ibrahim, K.-L. Kratz, M. Lewitowicz, S.M. Lukyanov, J. Mrazek, Yu.-E. Penionzhkevich, F. de Oliveira Santos, B. Pfeiffer, F. Pougheon, A. Poves, M.G. Saint-Laurent, M. Stanoiu

2003To03	PRVCA	67,	35503	N.R. Tolich, P.H. Barker, P.D. Harty, P.A. Amundsen
2003To08	NUPAB	717,	149	I. Tomandl, T. von Egidy, J. Honzátko, V. Bondarenko, H.-F. Wirth, D. Bucurescu, V.Y. Ponomarev, G. Graw, R. Hertenberger, Y. Eisermann, S. Raman
2003Va.1	PRLTA to be pd			R.S. Van Dyck, Jr., S.L. Zafonte, S. Van Liew, D.B. Pinegar, P.B. Schwinger
2003Va.2	PRLTA to be pd			J. Van Roosbroeck, C. Guénaut, G. Audi, D. Beck, K. Blaum, G. Bollen, J. Cederkall, P. Delahaye, H. De Witte, D. Fedorov, V.N. Fedoseyev, S. Franchoo, H. Fynbo, M. Gorska, F. Herfurth, K. Heyde, M. Huyse, A. Kellerbauer, H.-J. Kluge, U. Köster, K. Kruglov, D. Lunney, A. De Maesschalck, V.I. Mishin, W.F. Müller, S. Nagy, S. Schwarz, L. Schweikhard, N.A. Smirnova, K. Van de Vel, P. Van Duppen, A. Van Dyck, W.B. Walters, L. Weissman, C. Yazidjian, ISOLDE
2003Va.A	PrvCom	GAu	Aug	R.S. Van Dyck, Jr.
2003Vo03	NUPAB	714,	355	T. von Egidy, C. Doll, J. Jolie, N.V. Warr, J. Kern, M. Crittin, L. Genilloud
2003Wa13	PRVCA	67,	64303	Y. Wang, S. Rinta-Antila, P. Dendooven, J. Huikari, A. Jokinen, V.S. Kolhinen, G. Lhersonneau, A. Nieminen, S. Nummela, H. Penttilä, K. Peräjärvi, J. Szerypo, J.C. Wang, J. Äystö
2003We09	PRVCA	67,	54314	L. Weissman, U. Bergmann, J. Cederkall, L.M. Fraile, S. Franchoo, H. Fynbo, H. Gausemel, H. Jeppesen, U. Köster, K.-L. Kratz, T. Nilsson, B. Pfeiffer, K. Van del Vel, ISOLDE
2003We.A	Th.-Heidelberg			C. Weber
2003Wi02	NUPAB	716,	3	H.-F. Wirth, T. von Egidy, I. Tomandl, J. Honzátko, D. Bucurescu, N. Mrginean, V. Yu. Ponomarev, R. Hertenberger, Y. Eisermann, G. Graw
2003Xu04	EPJAA	16,	347	S.-W. Xu, Y.-X. Xie, Z.-K. Li, X.-D. Wang, B. Guo, C.-G. Leng, C.-F. Wang, Y. Yu
2003Yo02	PRVCA	67,	14316	K. Yoneda, N. Aoi, H. Iwasaki, H. Sakurai, H. Ogawa, T. Nakamura, W.-D. Schmidt-Ott, M. Schafer, M. Notani, N. Fukuda, E. Ideguchi, T. Kishida, S.S. Yamamoto, M. Ishihara